

Food
Amounts
Booklet

Please, keep this near your phone

Squares and Rectangles

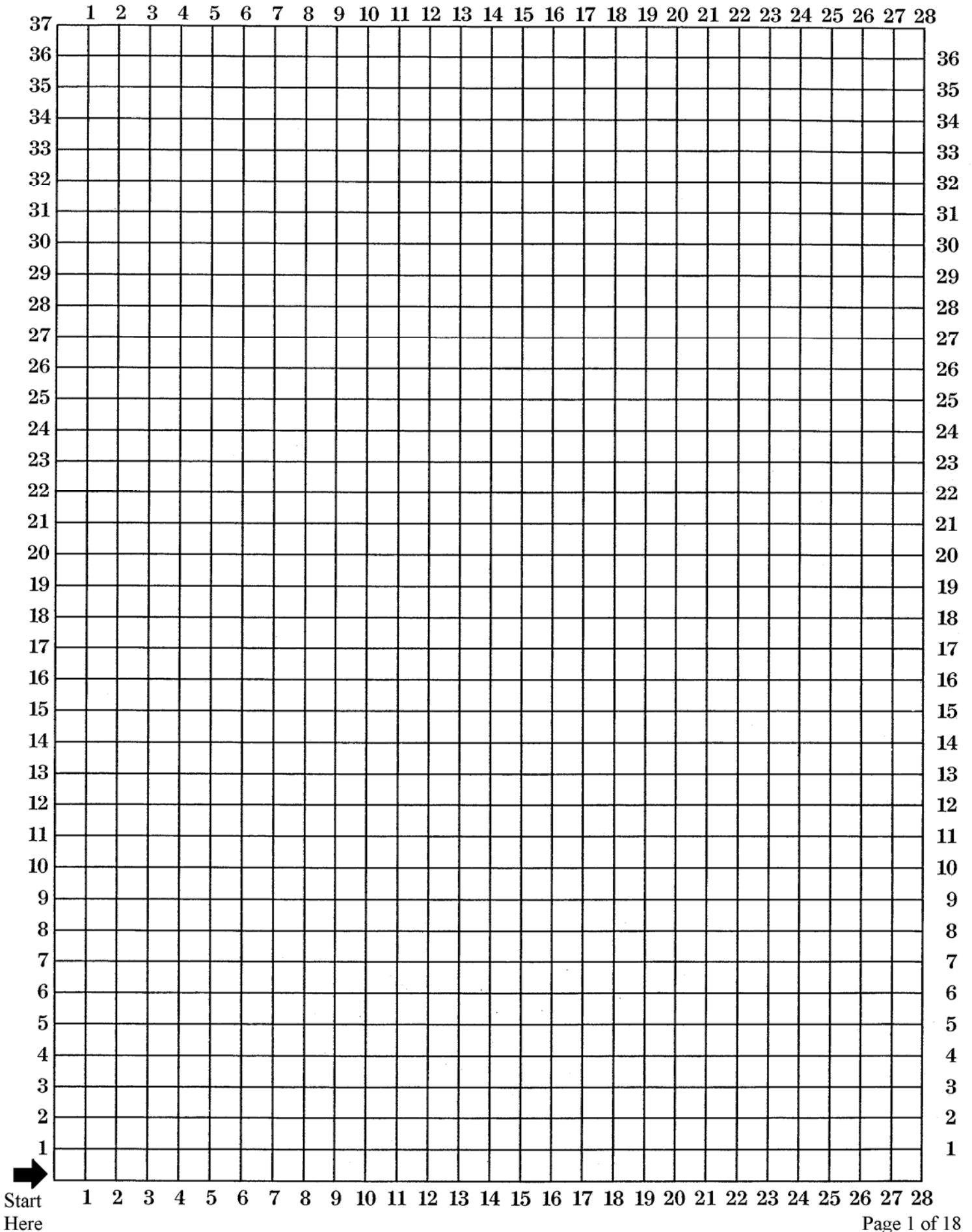

Circles

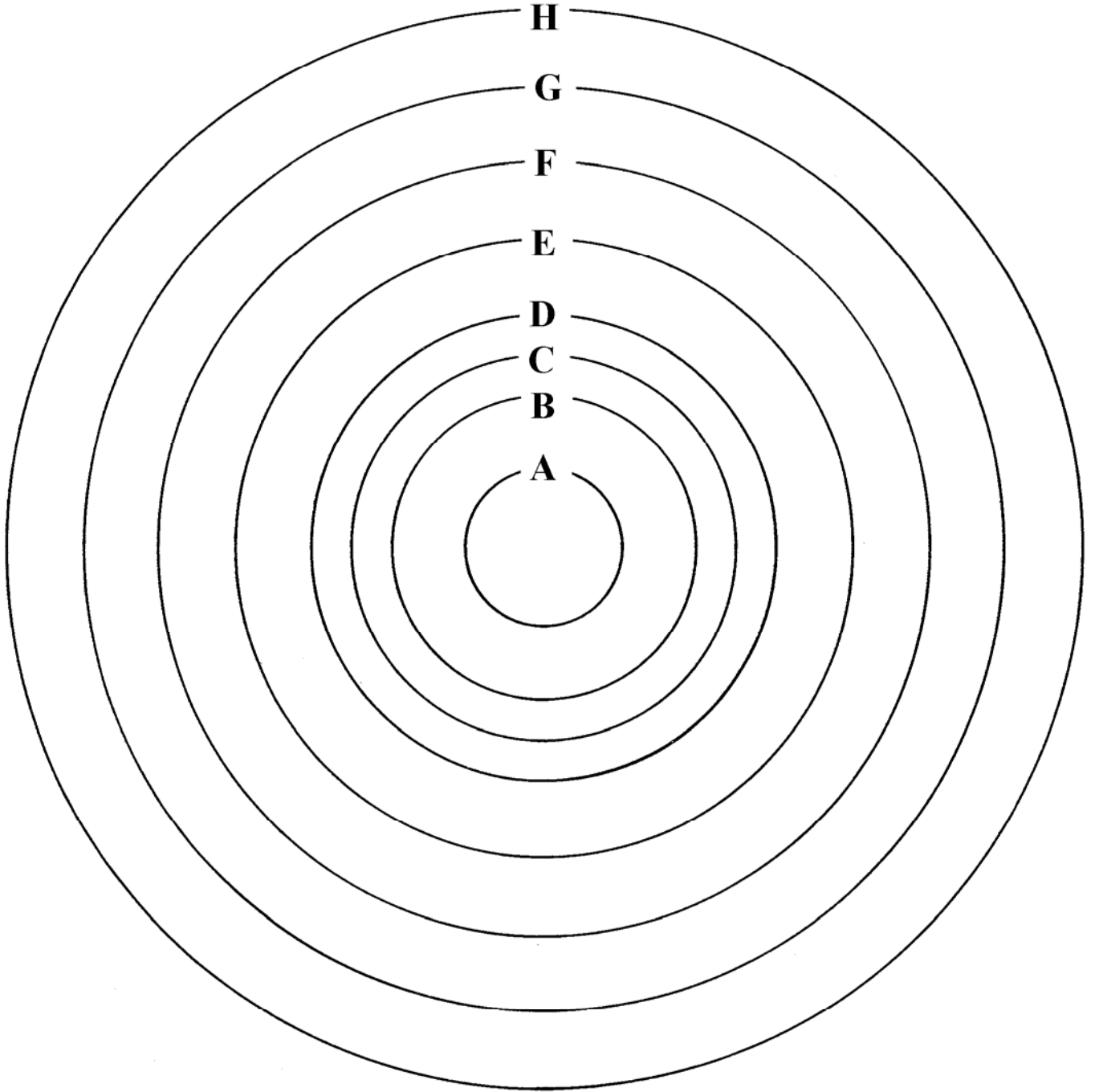

Wedges

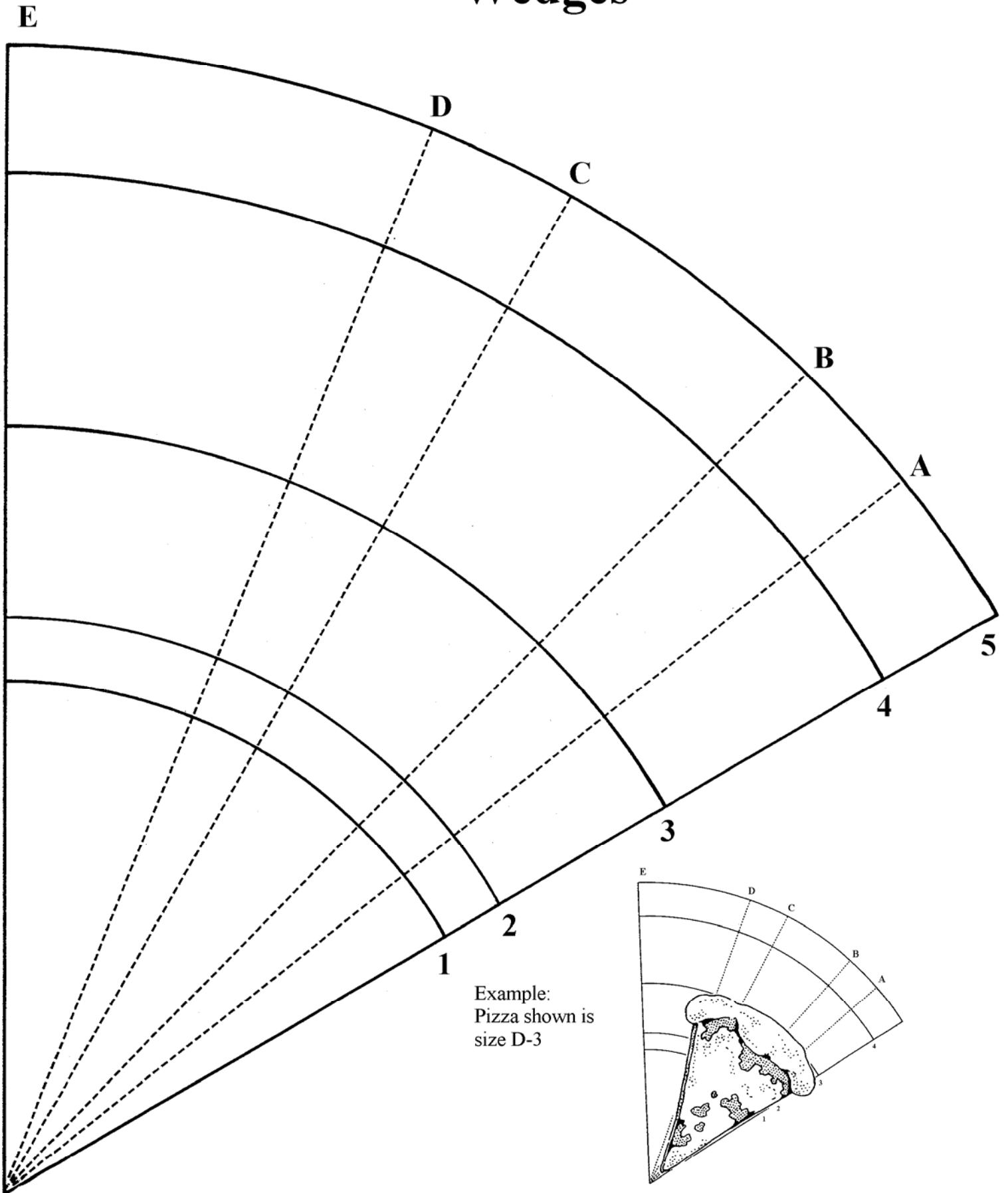

Example:
Pizza shown is
size D-3

Thickness

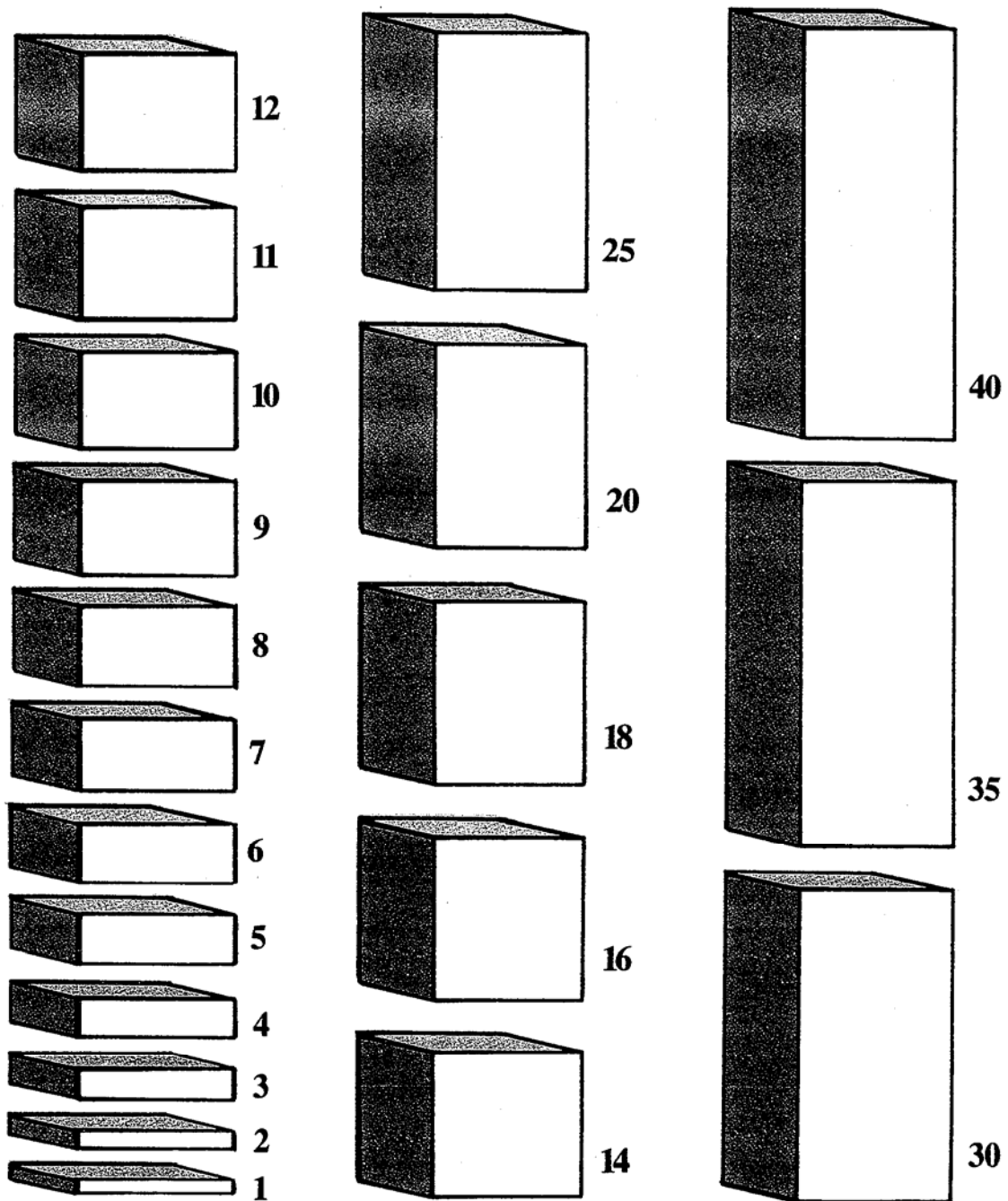

Measuring Spoons

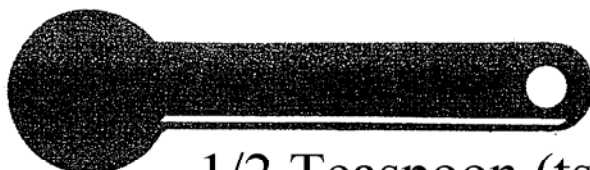

1/2 Teaspoon (tsp)

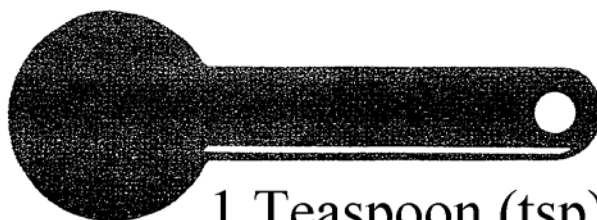

1 Teaspoon (tsp)



1/2 Tablespoon (Tbsp)



1 Tablespoon (Tbsp)

Eating and Serving Spoons

Teaspoons

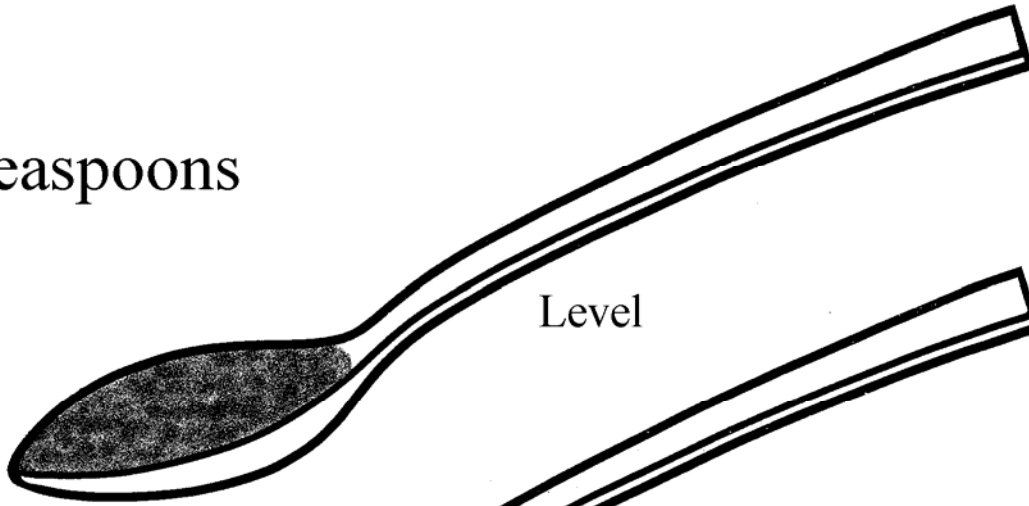

Level

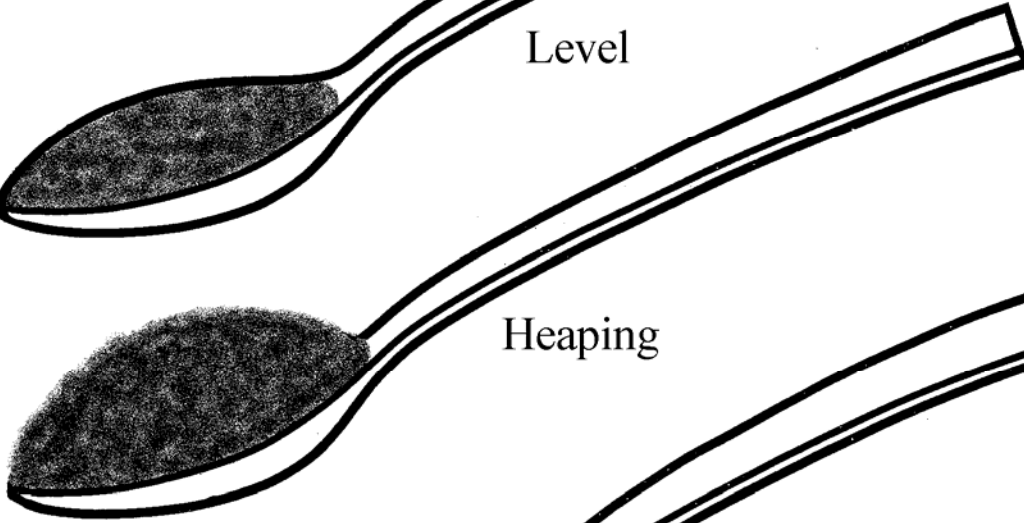

Heaping

Tablespoons

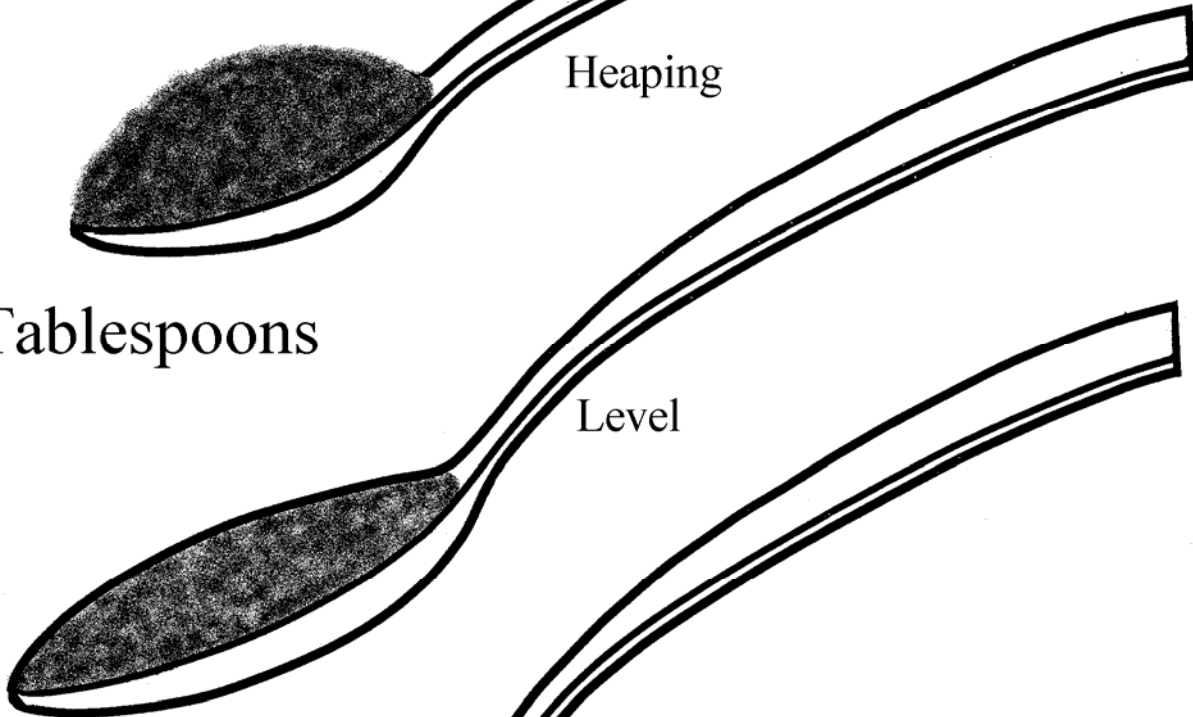

Level

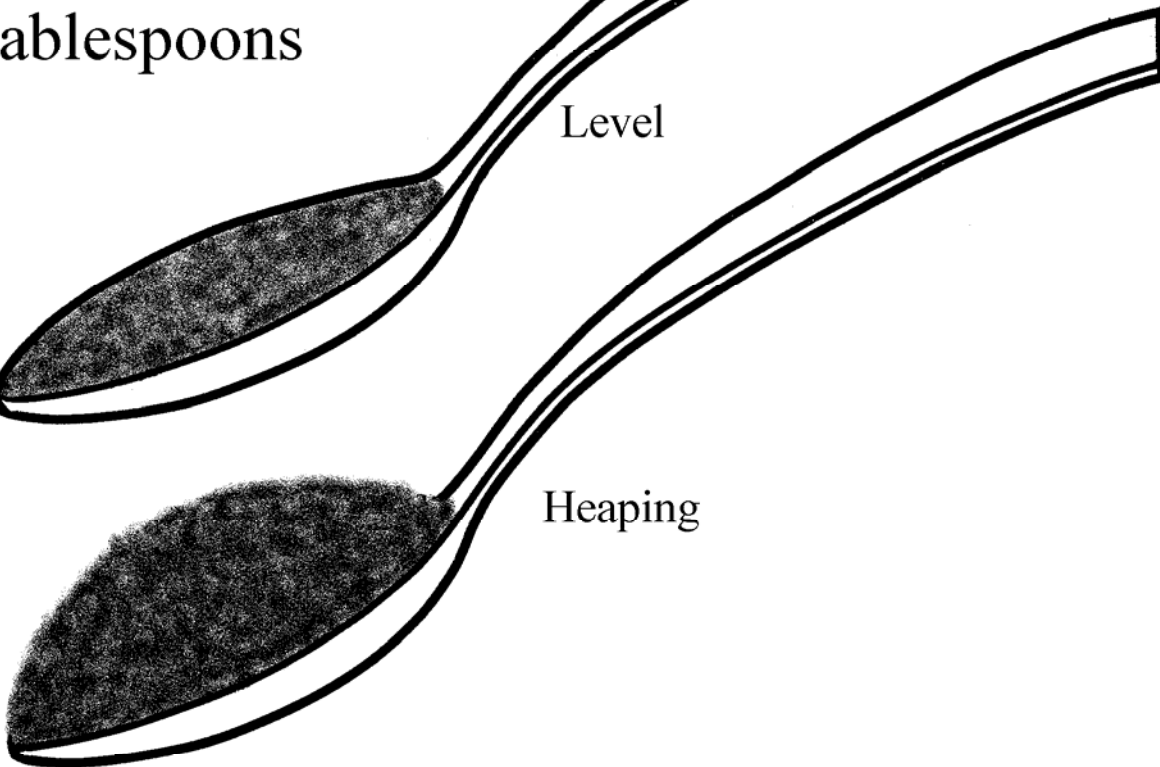

Heaping

Measuring Cups

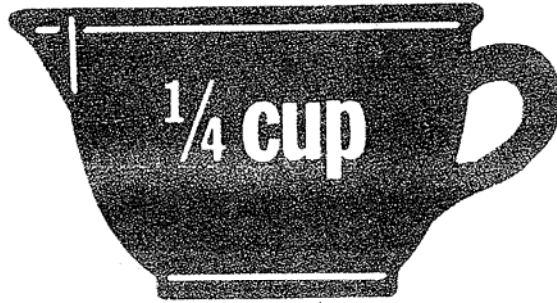

Glasses

1

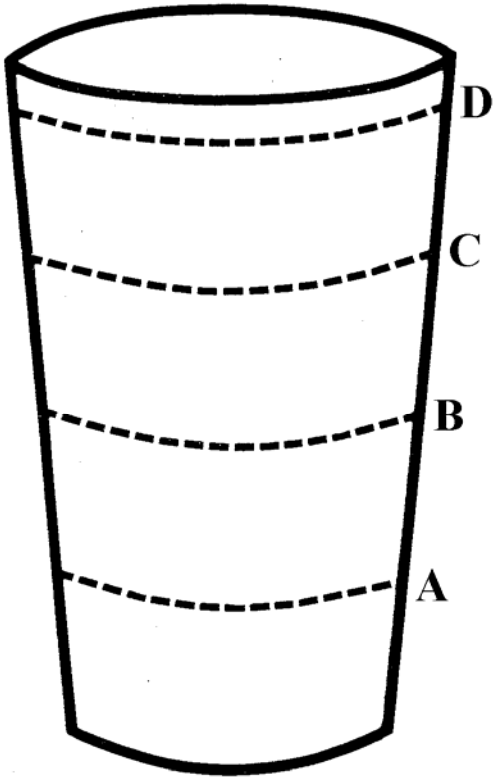

3

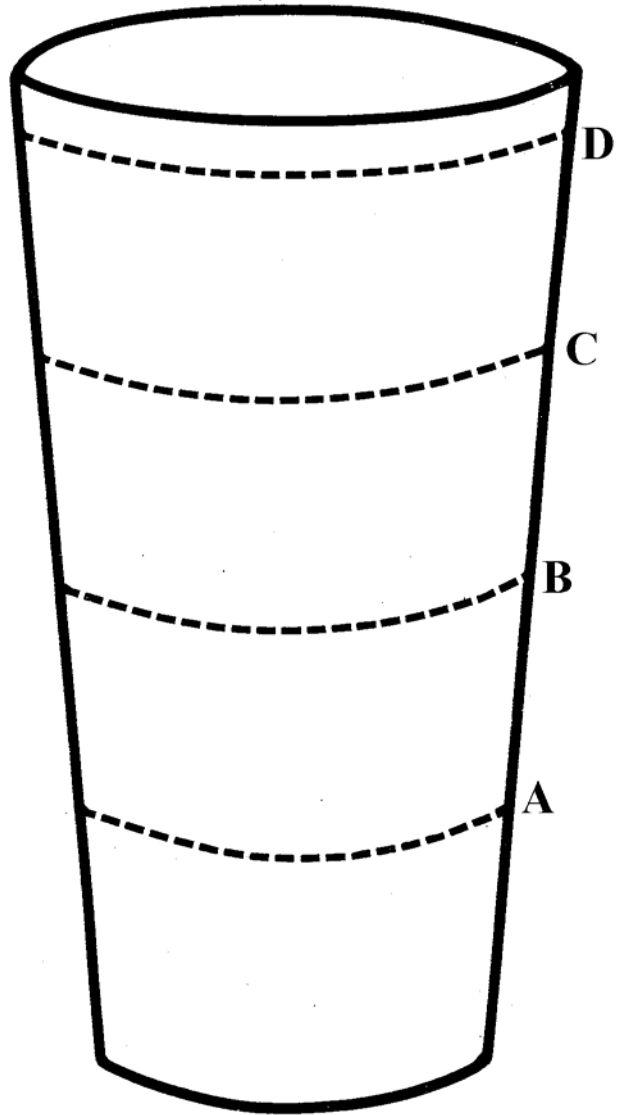

2

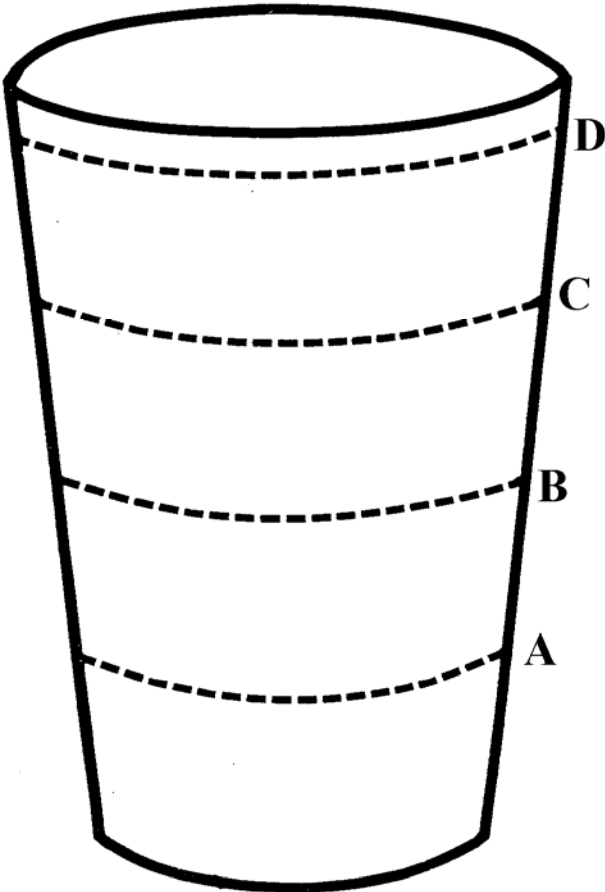

Glasses

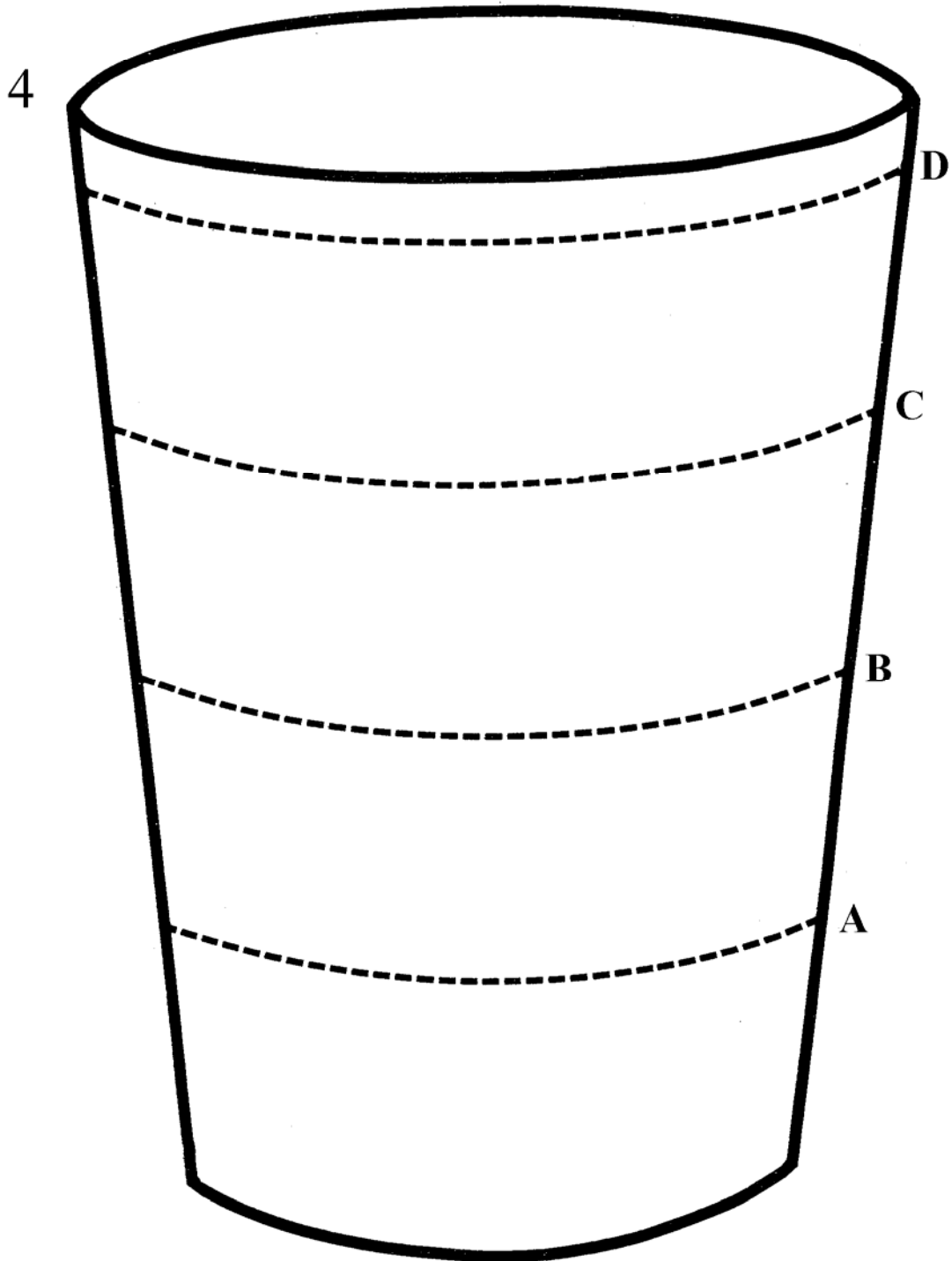

Bowls

1

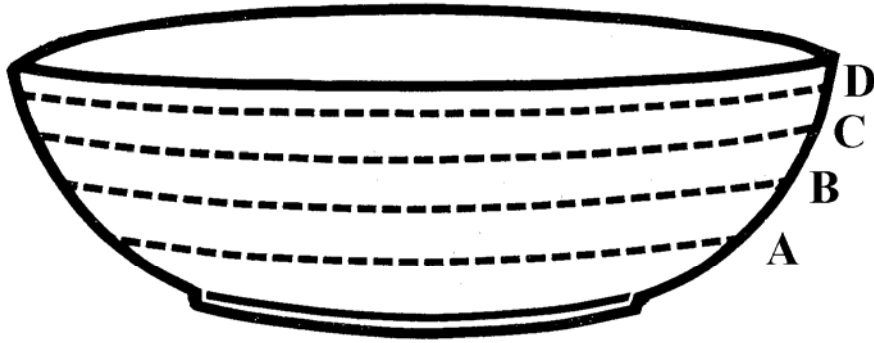

2

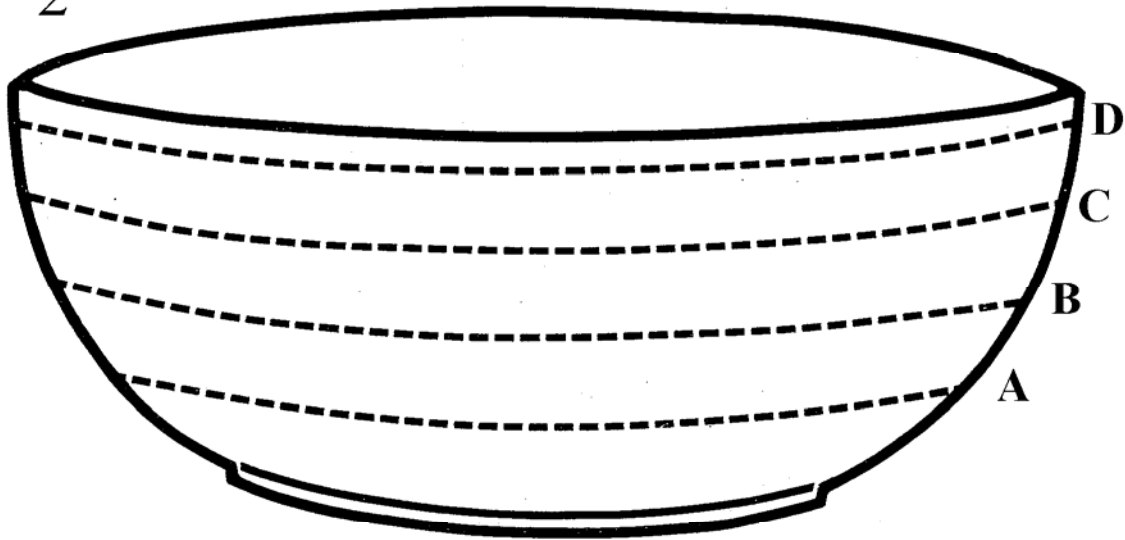

3

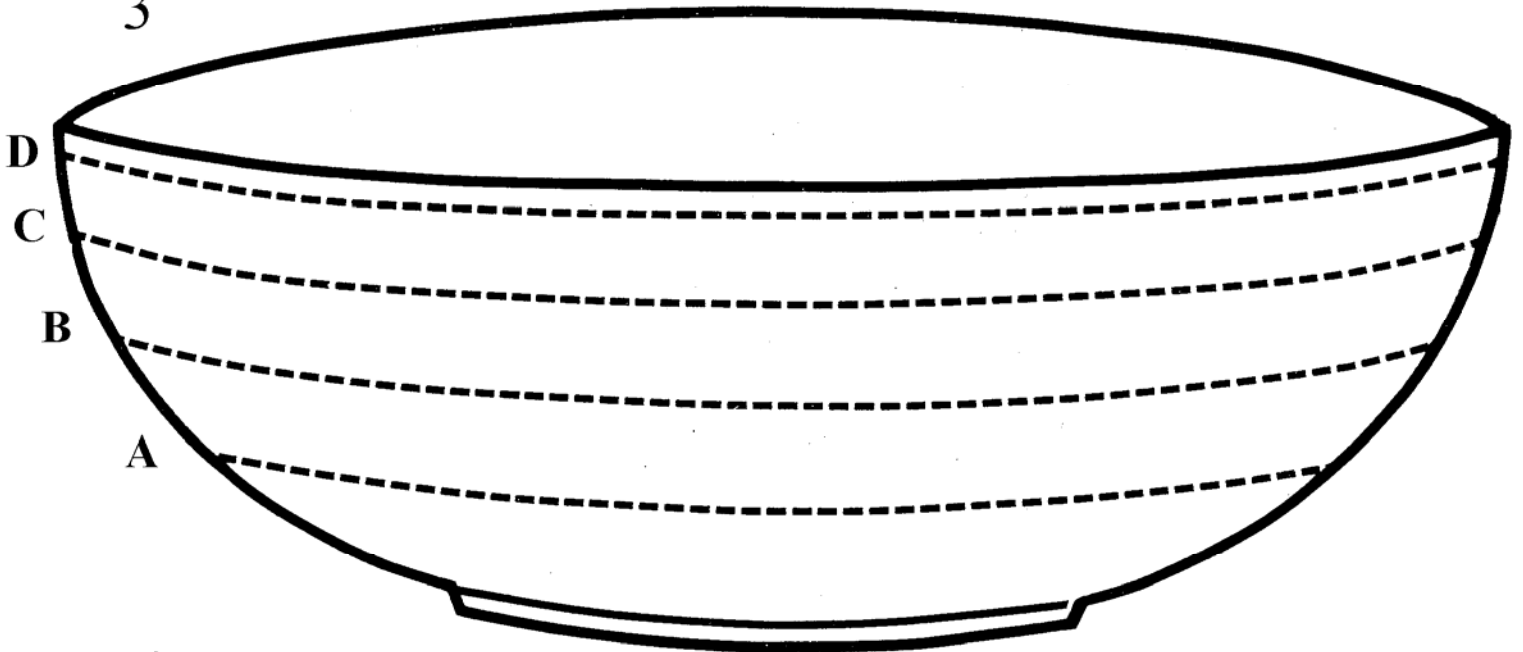

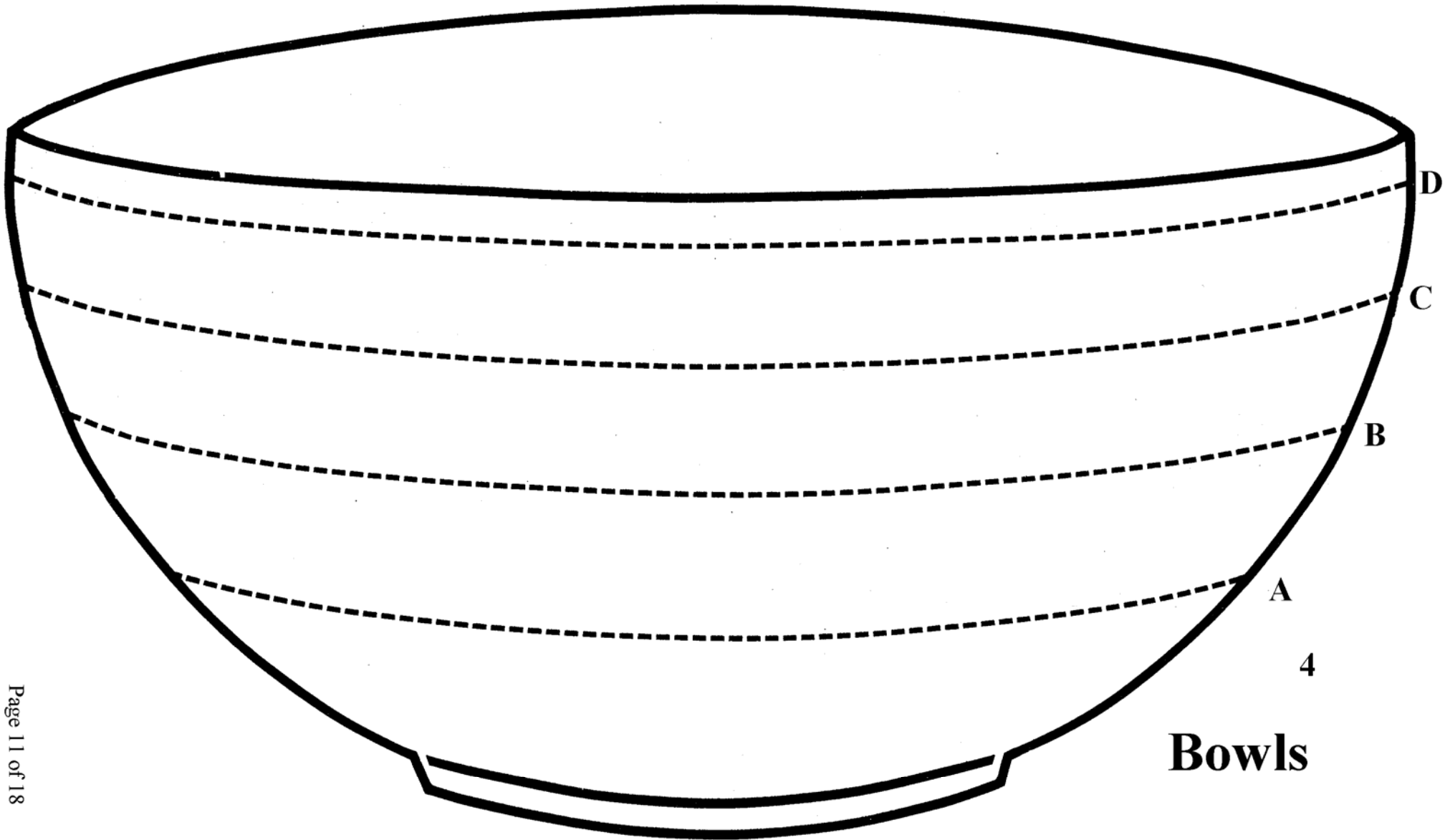

Bowls

Wine Glass

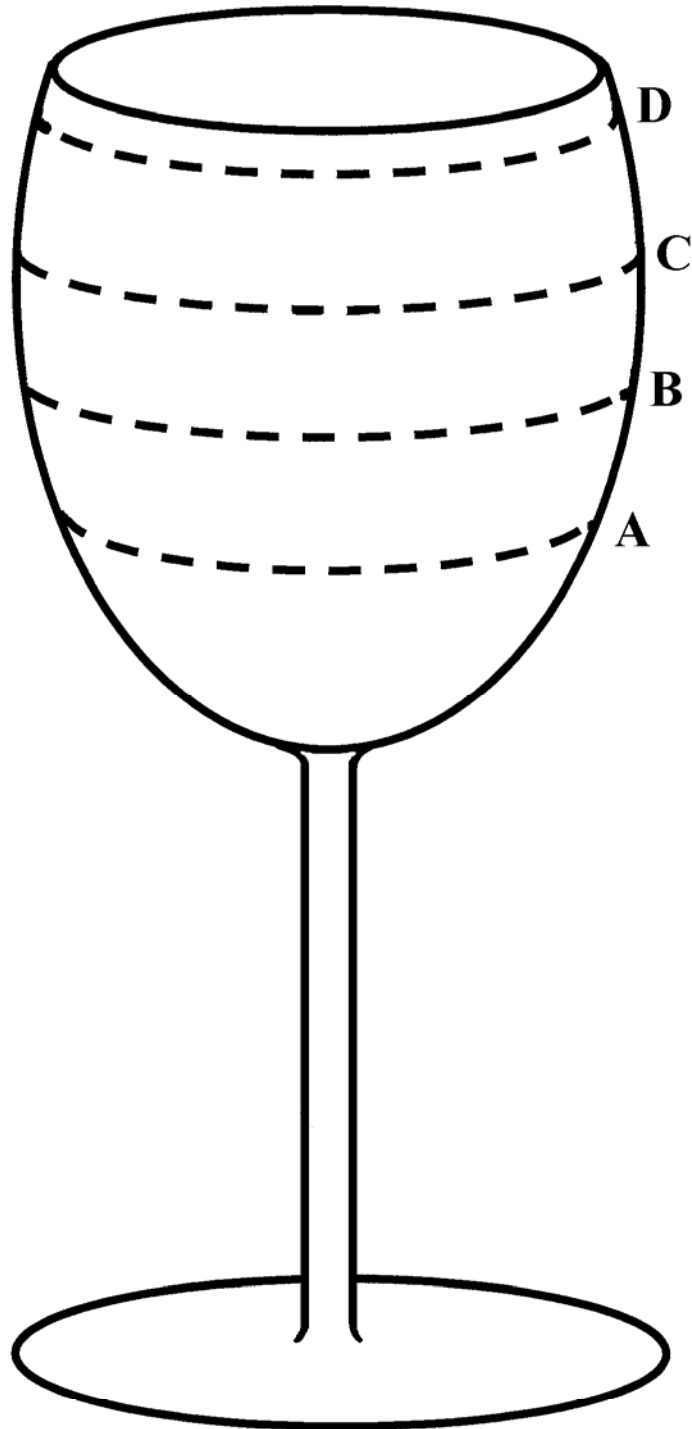

Mug

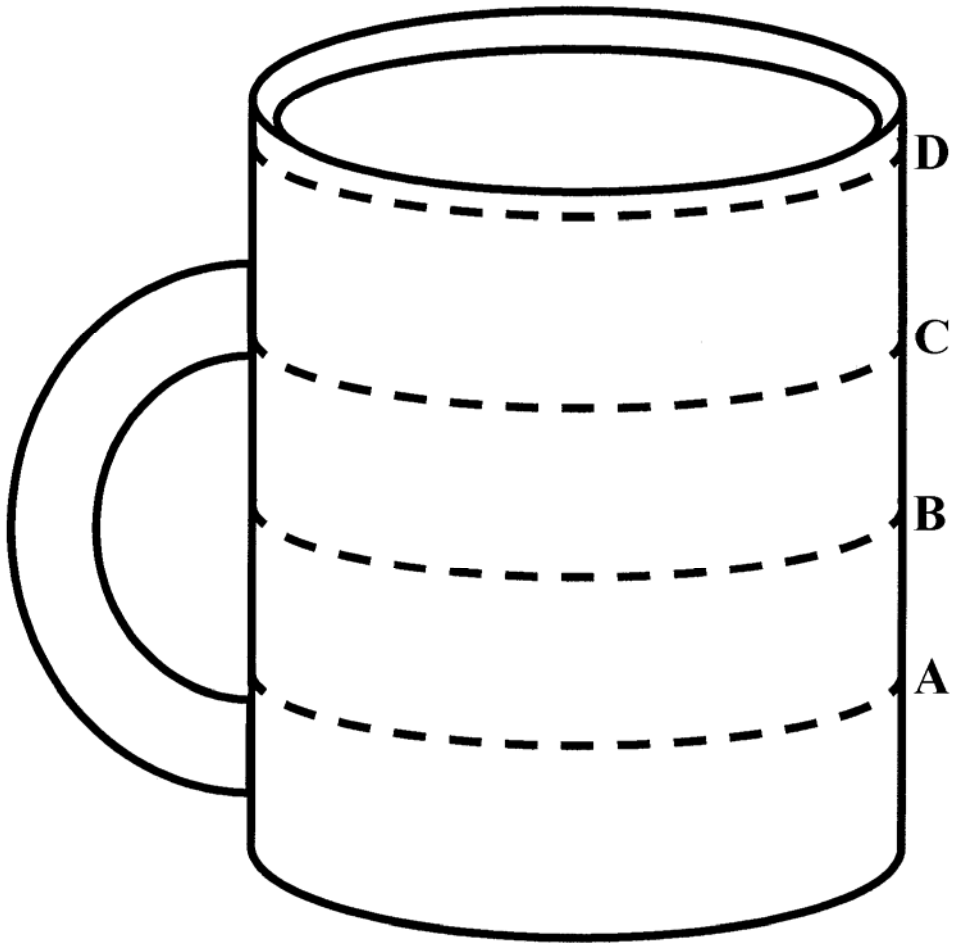

Mounds

1

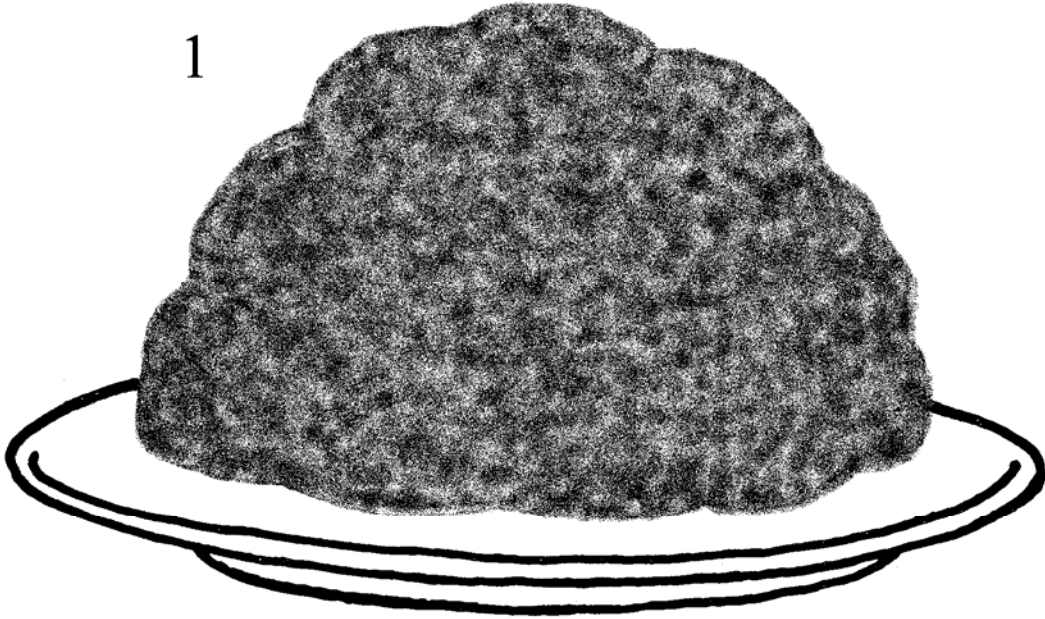

2

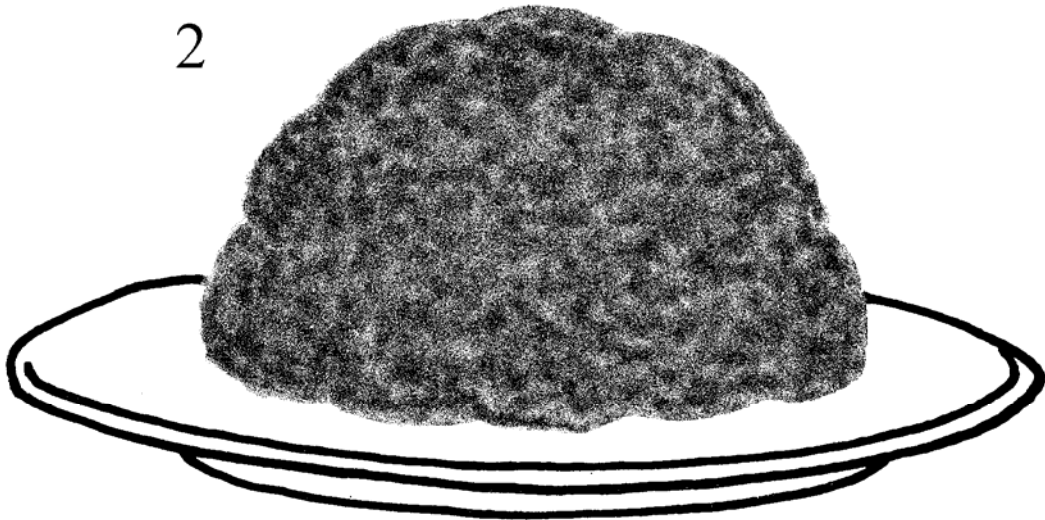

Mounds

3

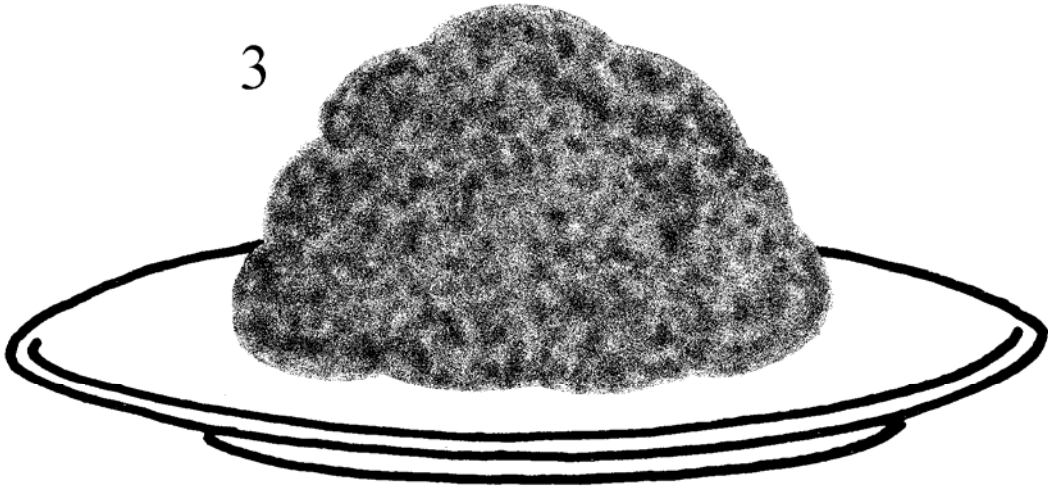

4

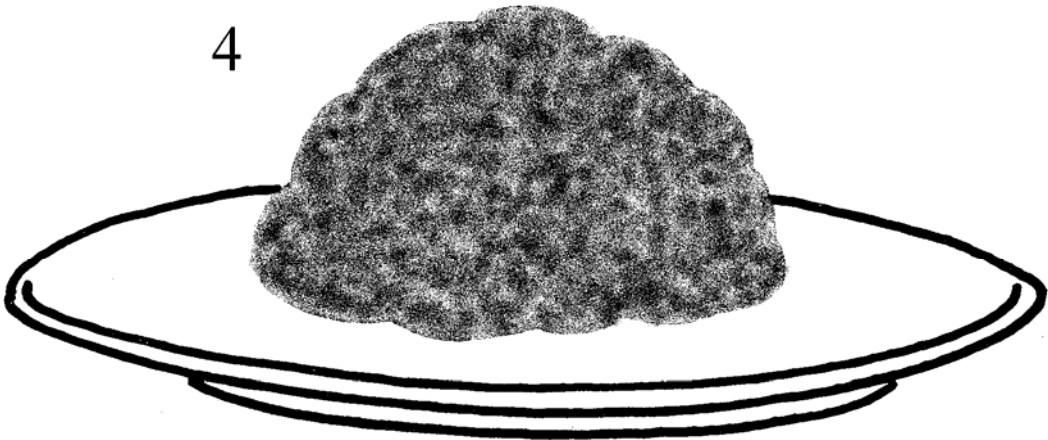

5

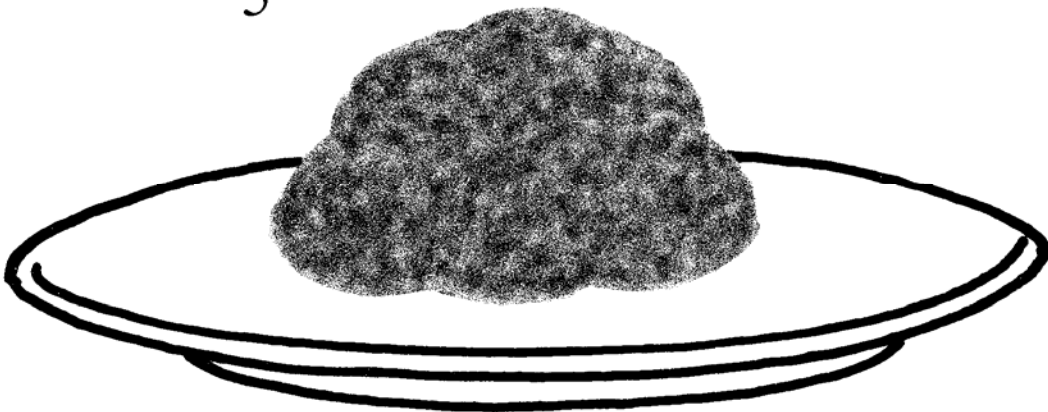

Meats

1

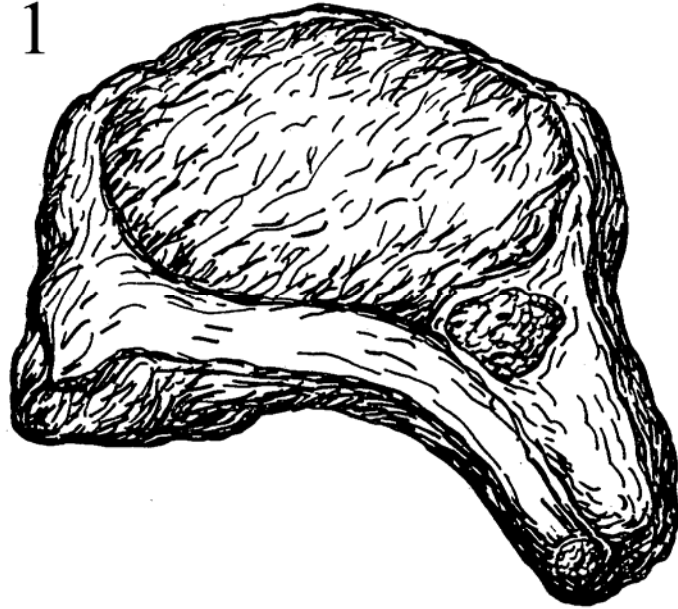

2

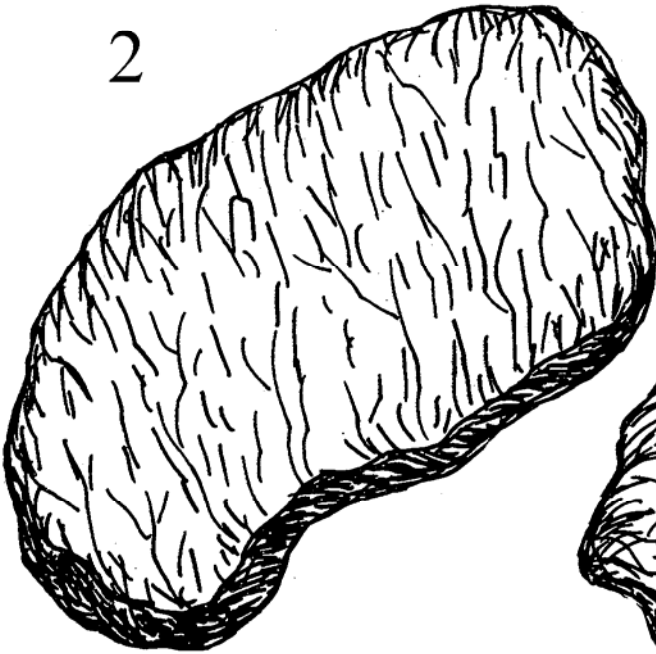

3

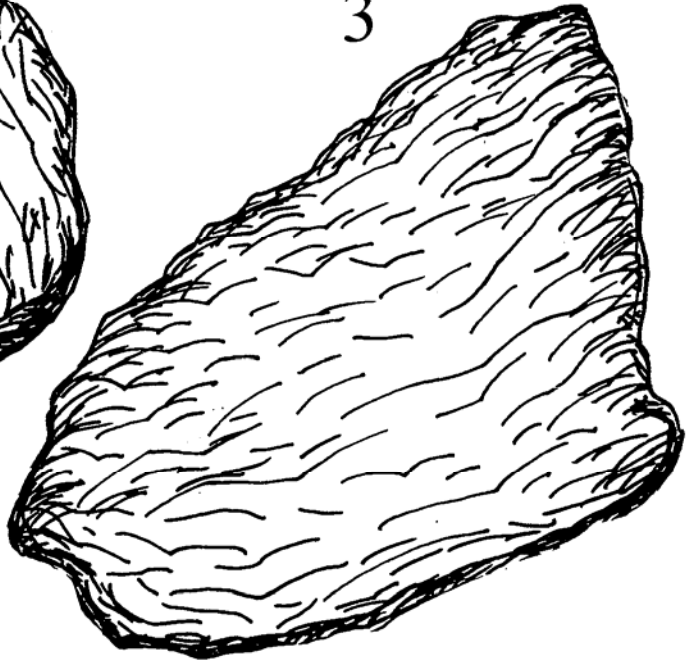

Chicken

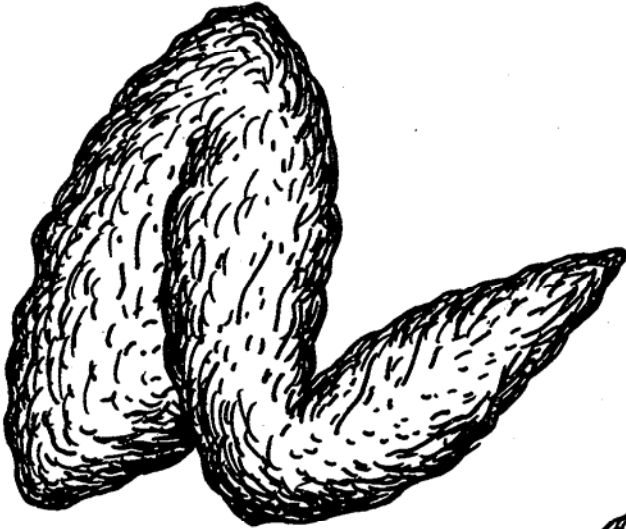

1. Wing

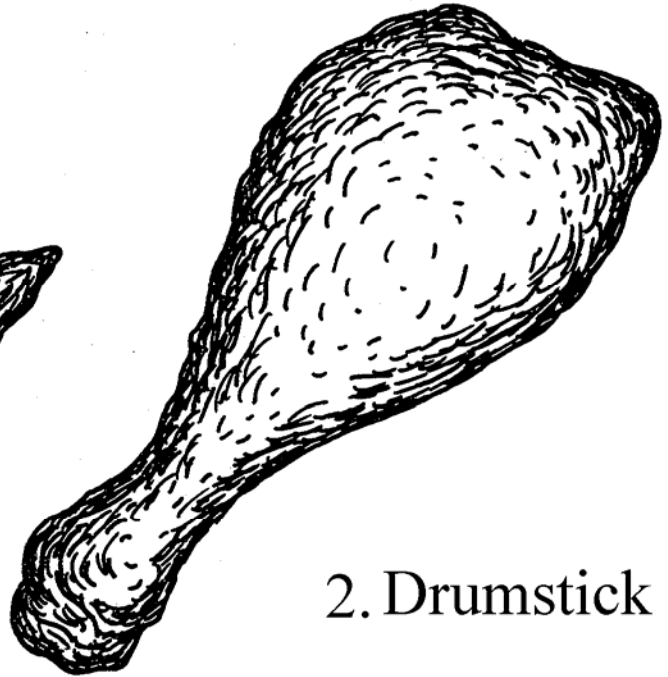

2. Drumstick

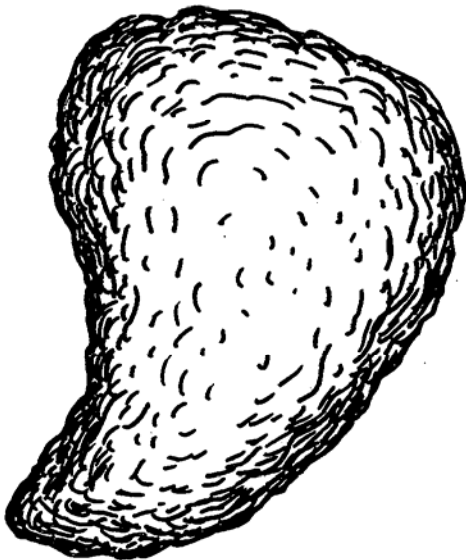

3. Thigh

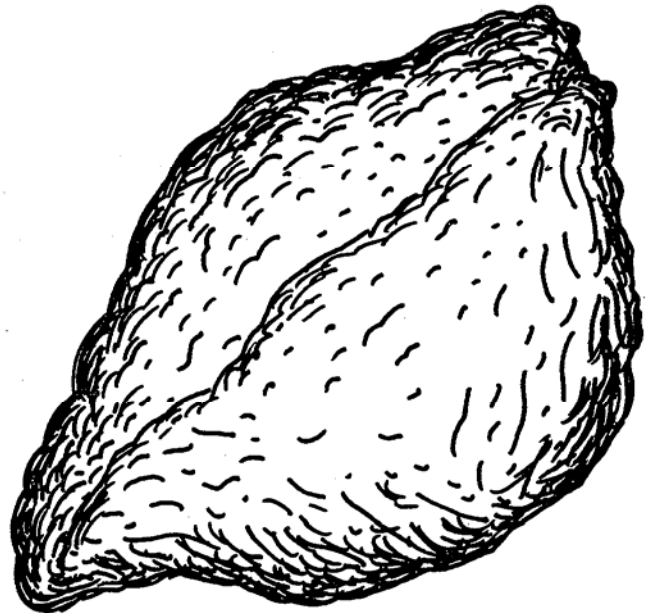

4. Breast

Fish

1

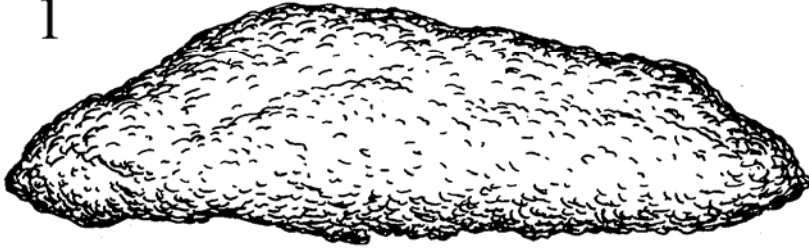

2

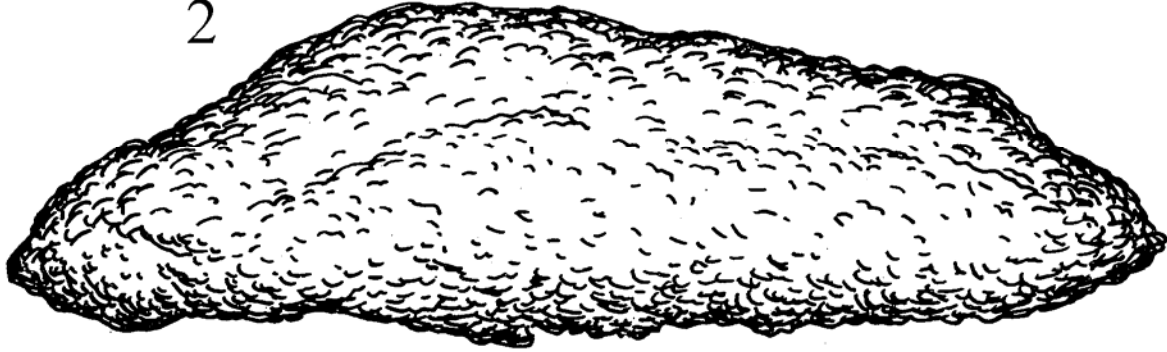

3

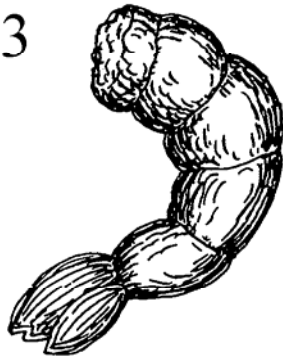

4

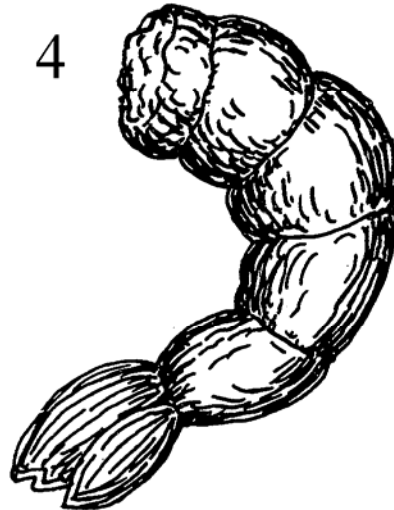

Adapted from: Van Horn LV, Stumbo P, Moag-Stahlberg A, Obarzanek E, Hartmuller VW, Farris RP, Kimm SY, Frederick M, Snetselaar L, Liu K. The Dietary Intervention Study in Children (DISC): dietary assessment methods for 8- to 10-year-olds. *J Am Diet Assoc.* 1993 Dec;93(12):1396-403.
Modified by Alejandra Valencia, Mary Stevens, Nutrition Coordinating Center, University of Minnesota for the Hispanic Community Health Study, Study of Latinos, 2007.