

Brand Name **Tohamadi Large Volume Infusion Pump**

Manufacturer **Ivy Test Systems**

Model **TOW724**

Customer Service: 1-800-555-1212

www.tohamadi.com

Last Updated: 03/25/2010

Table of Contents

Description	1
Uses	1
Contraindications	1
Risks	1
Instructions for Use	2
Warnings and Precautions	2
Cleaning the Pump	2
Compatible Accessories	2
Common Alarms	3
Troubleshooting	3

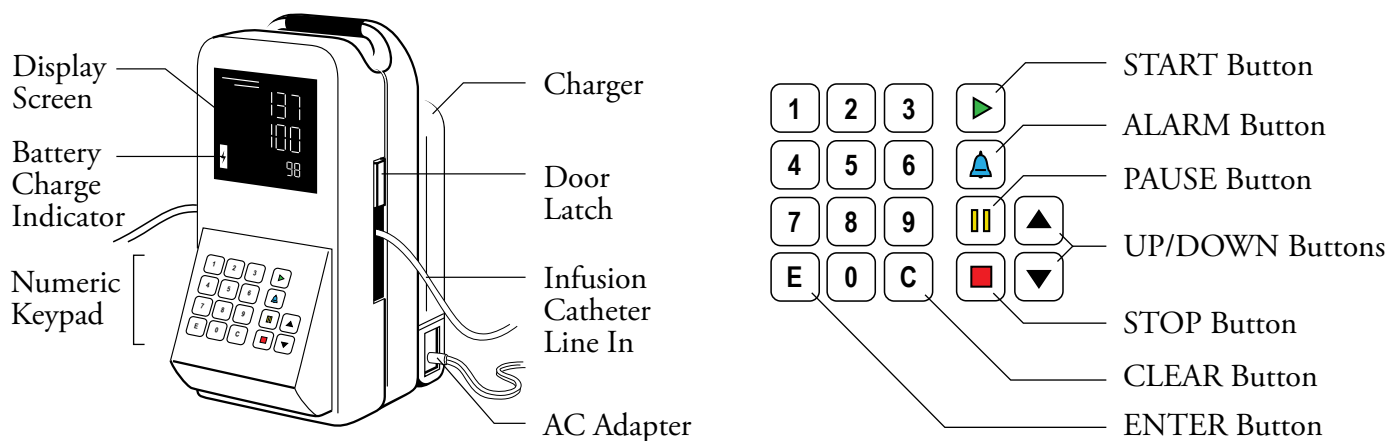

Description

Single channel large volume infusion pump. Features: flow sensor, alarms for occlusions, air in line, and low battery; no lockout mechanism; and can be mounted on pole.

Uses

Continuous or intermittent infusions of viscous liquids: general IV fluids, blood, antibiotics, lipids, TPN, and enteral feedings.

Contraindications

Not to be used for:
insulin
pain medication
antispasmodics

Not for use in children under 5 years of age.

Risks









Air embolism
Delay in therapy
Incorrect therapy
Overdose
Underdose

Instructions for Use

How to Operate the Pump

Verify you have the custom tubing and the pole clamp.
Connect the pump to the charger. Mount the charger on an IV pole.
Connect the charger to the power cord and into a standard AC outlet.
Open the door and thread infusion catheter through pump mechanism.
Close the door.
Connect the infusion set to the medication bag. Mount the bag on the IV pole.
Prime the primer line.
Connect the infusion set to the patient.
Press the START  button once. You will hear 4 beeps and the display screen will light up.
The pump is now ready to use.

Programming the Pump

Press the PAUSE  button to see the volume to be infused (VTBI).
Use UP  or DOWN  button to adjust the volume or enter the volume on the keypad.
Press ENTER  to save the VTBI.
Use UP  or DOWN  button to adjust the rate or enter the rate on the keypad.
Press ENTER  to save the rate.
Press START  to begin the infusion.

For Battery Operation and to Use the Pump in Transit

Lift the latch at the top of the pump where it is attached to the charger.
The pump will release from the charger.

To Clear All Programming

Press the CLEAR  button.

To Pause or Reprogram

Press the PAUSE  button.

To Stop the Pump

Press the STOP  button to stop the infusion.

Warnings and Precautions

This pump has not been tested for administration of infusion to pregnant women.
Use only accessories designed for this system.
Do not reuse tubing or other disposables.
Do not use in the presence of flammable anesthetics.

Cleaning the Pump





For general cleaning, clean exterior surfaces with a damp cloth.
For disinfection, use only cleaners listed in the full device labeling.

Compatible Accessories

Custom Tohamadi 9.2" intravenous tubing
AC adapter/charger
Rechargeable battery pack
Reusable pole clamps

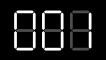
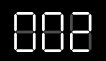
Common Alarms

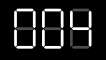

Alarm

	Air In Line
	Battery Low
	Occlusion
	Volume Low
	Door Open

Refer to full device labeling for more information on alarms.

Troubleshooting



Air in the Line

If there's air in the line, press STOP  or PAUSE  and check to see if the tubing is properly inserted. Remove the air from the line by closing the clamps, disconnecting the pump from the patient, and priming the fluid path. Press START  to restart the pump.



Low Battery

If the battery is low, plug the cord into an AC electrical source within 10 minutes of the alarm.



Occlusion

If there's an occlusion in the line, press STOP  or PAUSE  and open the clamps. Check for a bend or kink in the tubing, the occlusion pressure setting, and the IV site for any signs of infiltration. Remove the obstruction and press START  to restart the pump.

Low Volume

Press the STOP  button and change the medication bag. Restart the infusion and press START  to restart the pump.

Door Will not Close

If the door is open, press STOP  or PAUSE  and check to make sure the tubing is aligned properly in the pump. Check to make sure the latch is in the proper position. Close the door and press START .

Display Does not Light

If operating on battery power, the battery may need recharging. Connect the power cable to the pump and plug it into a regular 120V outlet. Check to make sure the power cables are firmly attached and the pump is switched to the ON position.

ATTENTION: These instructions do not include all the information needed for the safe and effective use of this pump. See the full device labeling for more complete information on the use of this device.