

ATTENTION: These instructions do not include all the information needed for the safe and effective use of this pump. See the full Device Labeling for more complete information on the use of this device.

Brand Name **Tohamadi Large Volume Infusion Pump**

Manufacturer **Ivy Test Systems**

Model **TOW724**

Customer Service: 1-800-555-1212

www.tohamadi.com

Last Updated: 01/25/2010

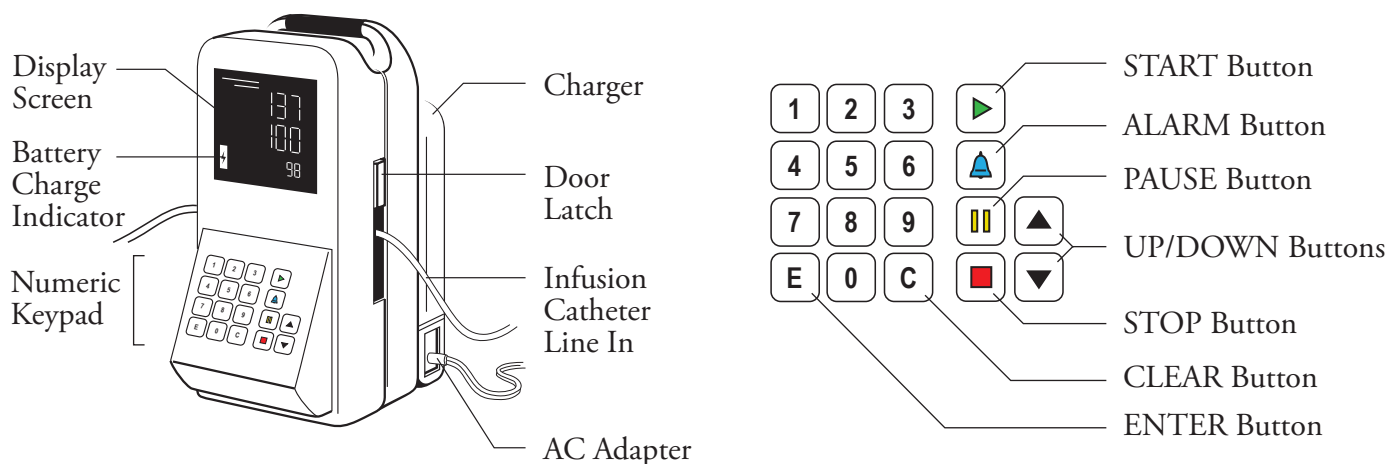

Description

- Single channel large volume infusion pump
- Features:
 - flow sensor
 - alarms for occlusions, air in line, and low battery
 - no lockout mechanism
 - can be mounted on pole

Uses

- Continuous or intermittent infusions of viscous liquids:
 - general IV fluids
 - blood
 - antibiotics
 - lipids
 - TPN
 - enteral feedings

Contraindications

- Not to be used for:
 - insulin
 - pain medication
 - antispasmodics
- Not for use in children under 5 years of age

Risks









- Air embolism
- Delay in therapy
- Incorrect therapy
- Overdose
- Underdose

Instructions for Use

How to Operate the Pump

1. Verify you have the custom tubing and the pole clamp.
2. Connect the pump to the charger. Mount the charger on an IV pole.
3. Connect the charger to the power cord and into a standard AC outlet.
4. Open the door and thread infusion catheter through pump mechanism. Close the door.
5. Connect the infusion set to the medication bag. Mount the bag on the IV pole.
6. Prime the primer line.
7. Connect the infusion set to the patient.
8. Press the START  button once. You will hear 4 beeps and the display screen will light up.
9. The pump is now ready to use.

Programming the Pump

1. Press the PAUSE  button to see the volume to be infused (Screen will read VTBI).
2. Use UP  or DOWN  button to adjust the volume or enter the volume on the keypad.
3. Press ENTER  to save the VTBI.
4. Use UP  or DOWN  button to adjust the rate or enter the rate on the keypad.
5. Press ENTER  to save the rate.
6. Press START  to begin the infusion.

For Battery Operation and to Use the Pump in Transit

Lift the latch at the top of the pump where it is attached to the charger. The pump will release from the charger.

To Clear All Programming

Press the CLEAR  button.

To Pause or Reprogram

Press the PAUSE  button.

To Stop the Pump

Press the STOP  button to stop the infusion.

Warnings and Precautions

- This pump has not been tested for administration of infusion to pregnant women.
- Use only accessories designed for this system.
- Do not reuse tubing or other disposables.
- Do not use in the presence of flammable anesthetics.











Cleaning the Pump

- For general cleaning, clean exterior surfaces with a damp cloth.
- For disinfection, use only cleaners listed in the full device labeling.

Compatible Accessories

- Custom Tohamadi 9.2” intravenous tubing
 - AC adapter/charger
 - Rechargeable battery pack
 - Reusable pole clamps
-

Common Alarms/Troubleshooting

Alarm	Troubleshooting
001 Air In Line	<ul style="list-style-type: none">• Press STOP  or PAUSE .• Check the tubing is properly inserted.• Remove air from the line by closing clamps, disconnecting the pump from the patient, and priming the fluid path.• Press START  to restart the pump.
002 Battery Low	<ul style="list-style-type: none">• Plug cord into AC electrical source within 10 minutes.
003 Occlusion	<ul style="list-style-type: none">• Press STOP  or PAUSE .• Open clamps and check for a bend or kink in the tubing.• Check the occlusion pressure setting.• Check the IV site for signs of infiltration.• Remove the obstruction and press START  to restart the pump.
004 Volume Low	<ul style="list-style-type: none">• Press the STOP  button.• Change the medication bag.• Restart the infusion.• Press START  to restart the pump.
005 Door Open	<ul style="list-style-type: none">• Press STOP  or PAUSE .• Check that the tubing is aligned properly in the pump.• Check to make sure the latch is in the proper position.• Close door.• Press START .
N/A Display Does not Light	<p>If operating on battery power, the battery may need recharging.</p> <ul style="list-style-type: none">• Connect the power cable to the pump and plug it into a regular 120V outlet.• Check to make sure the power cables are firmly attached and the pump is switched to the ON position.

Refer to full device labeling for more information on alarms.