

# CHAPTER I

## INTRODUCTION

### BACKGROUND

The Federal Highway Administration (FHWA) has the responsibility to assure that adequate highway transportation information is available to support its functions and responsibilities, including those of the Administration and the Congress. The primary purpose of the Highway Performance Monitoring System (HPMS) is to serve these data and information needs. The HPMS provides data that reflects the extent, condition, performance, use, and operating characteristics of the nation's highways.

The provision of HPMS data is a cooperative effort with state highway agencies (SHAs), local governments and metropolitan planning organizations (MPOs) working in partnership to collect, assemble, and report the necessary information. In consultation with its HPMS partners, stakeholders, and customers, FHWA has identified the data to be reported and has provided data definitions and standards. FHWA has developed and maintains PC-based data submittal software and analytical models and techniques that FHWA and a number of States use with the HPMS data to do policy sensitive system, corridor, and subarea planning and programming. Taken together, these activities support informed highway planning, policy making, and decision making at the national, state, and local levels.

### CONTENTS OF THE HPMS FIELD MANUAL

Chapter I provides general information on the background, scope, and major uses of the HPMS, provides an overview of reporting requirements and introduces the sampling concept. Chapters II through VII provide more specific information on submittal requirements and the major components of an HPMS submittal:

Chapter II	Data definitions
Chapter III	Reporting summary data
Chapter IV	Data item coding instructions
Chapter V	Linear Referencing System (LRS) reporting requirements
Chapter VI	Data update cycles
Chapter VII	Sample selection and maintenance

Additional detailed information on specific data coding, sample selection, and technical procedures and requirements are included in Appendices A through N. These appendices should be consulted by those collecting and reporting HPMS data for explanation of specific requirements, techniques, or procedures to be used in developing the HPMS data set for FHWA.

### USES OF HPMS DATA

Length, lane-mile, and travel data are used for apportionment of Federal-aid highway funds under the Transportation Equity Act for the 21<sup>st</sup> Century (TEA-21). HPMS data are also used for assessing and reporting highway system performance under FHWA's strategic planning process. HPMS data form the basis of the analyses that support the Condition and Performance Reports to Congress and are the source for a substantial portion of the information published in *Highway Statistics* and in other FHWA publications and media. Finally, the HPMS data are widely used throughout the transportation community, including other governmental interests, business and industry, institutions of higher learning, the media and general public. Table I-1 contains information on the source of selected length, lane-mile, and travel data from the HPMS data set.

**Table I-1. Sources of selected HPMS data**

HPMS Data	Rural Functional Systems					
	Interstate	Other Principal Arterials	Minor Arterial	Major Collector	Minor Collector	Local
Interstate Lane Miles Interstate VMT	Universe Universe					
Non-Interstate PAS Lane Miles Non-Interstate PAS VMT		Universe Universe				
FA Highway Lane Miles 1/ FA Highway VMT 1/	Universe Universe	Universe Universe	Universe Sample 2/	Universe Sample 2/		
NHS Lane Miles	Universe	Universe	Universe	Universe	Universe	Universe
Miles Lane Miles VMT	Universe Universe Universe	Universe Universe Universe	Universe Universe Sample 2/	Universe Universe Sample 2/	Universe Universe 3/ Summary 4/	Universe Universe 3/ Summary 4/
Total Public Road Miles	Certified Mileage -----					
HPMS Data	Urban Functional Systems					
	Interstate	Other Freeways & Expressways	Other Principal Arterial	Minor Arterial	Collector	Local
Interstate Lane Miles Interstate VMT	Universe Universe					
Non-Interstate PAS Lane Miles Non-Interstate PAS VMT		Universe Universe	Universe Universe			
FA Highway Lane Miles 1/ FA Highway VMT 1/	Universe Universe	Universe Universe	Universe Universe	Universe Sample 2/	Universe Sample 2/	
NHS Lane Miles	Universe	Universe	Universe	Universe	Universe	Universe
Miles Lane Miles VMT	Universe Universe Universe	Universe Universe Universe	Universe Universe Universe	Universe Universe Sample 2/	Universe Universe Sample 2/	Universe Universe 3/ Summary 4/
Total Public Road Miles	Certified Mileage -----					

1/ Universe data are used to estimate lane-miles & VMT for the few miles of NHS that are on the minor collector & local functional systems.

2/ Expanded sample data are used.

3/ Universe miles times 2 (lanes) are used. States are not required to report number of through lanes on these systems.

4/ Summary data are used. States are not required to report section level AADT on these systems.

**Definitions:**

Universe: Data reported for all roadway links in the system.

Sample: Data reported for a randomly selected sample of roadway links in the system.

Summary: Data reported in aggregated form by functional system.

PAS: Principal arterial system made up of interstate, other freeways & expressways, and other principal arterial systems.

VMT: Vehicle miles of travel.

FA: Federal-aid.

NHS: National highway system.

Table I-2 provides information on how HPMS data are used in the Federal-Aid Highway Program apportionment formula.

**Table I-2. HPMS Data Used for Apportionment**

<b>Fund</b>	<b>Factors</b>	<b>Weight</b>
Interstate Maintenance	Interstate System Lane Miles	33 1/3 %
	Vehicle Miles Traveled on the Interstate System	33 1/3 %
National Highway System (NHS)	Lane Miles of Principal Arterial Highways (excluding Interstate System)	25 %
	Vehicle Miles Traveled on Principal Arterial Highways (excluding Interstate System)	35 %
	Total Lane Miles of Principal Arterial Highways divided by the State's Population	10 %
Surface Transportation Program (STP)	Lane Miles of Federal-Aid Highways	25 %
	Vehicle Miles Traveled on Federal-Aid Highways	40 %
Highway Safety Programs	State Population	75 %
	Public Road Miles	25 %

## SCOPE OF THE HPMS

The HPMS is a nationwide inventory system that includes data for **all** of the Nation's public road mileage as certified by the States' Governors on an annual basis. This includes facilities both on and off State-owned highway systems. Each State is required to furnish annually all data requirements specified in the *HPMS Field Manual*. The District of Columbia and the Commonwealth of Puerto Rico are considered to be States for HPMS reporting purposes. United States Territories (Guam, the Commonwealth of the Northern Marianas, American Samoa, and the Virgin Islands) are required to annually report limited HPMS summary data only in addition to public road mileage certifications.

## OVERVIEW OF HPMS REPORTING REQUIREMENTS

The HPMS is an integrated database that was developed in 1978 as a national highway transportation system database. It includes limited data on all public roads, more detailed data for a sample of the arterial and collector functional systems, and area wide summary information for urbanized, small urban and rural areas. The HPMS also requires the reporting of supplemental air quality non-attainment area sample data and LRS data for FHWA use in a geographic information system.

- The **statewide summary data** includes information on travel, system length, and vehicle classification by functional system and area type, in addition to land area and population by area type. The area types include rural, small urban, individual urbanized and the donut area of National Ambient Air Quality Standards (NAAQS) non-attainment areas.
- The term **universe data** refers to a limited set of data items reported for the entire public road system as individual or grouped length sections.
- HPMS **sample data** consists of data items added to the universe data that are reported for a small portion of the total highway system length. The sampled sections nominally are a fixed sample panel of highway sections that are monitored from year to year and, when expanded, represent the universe of the systems that are sampled. The more detailed information collected for a sample section is used to represent similar conditions on the associated functional system after expansion.
  - A **standard sample** contains the universe data plus additional data items related to the physical characteristics, condition, performance, use, and operation of the sampled sections of a highway. These sample data provide detailed information, which is used as the basis for evaluating change

over time, and provides the basic input to the HPMS simulation models [Analytical Process (AP) and Highway Economic Requirements System (HERS)].

- **Donut area samples** are unique in that their sole purpose is to enhance the precision of travel estimates in the area lying outside of the adjusted urbanized area(s) boundary but within the NAAQS non-attainment areas designated by the Environmental Protection Agency (EPA). Consequently, donut sample data item additions are limited to identification, annual average daily traffic (AADT) and an expansion factor. Donut area sample data are required only for those non-attainment areas using HPMS developed travel estimates for meeting EPA travel monitoring requirements.
- The HPMS LRS data provide a linear referencing system for the universe and sample data on selected highway functional systems. The represented functional systems include urban and rural principal arterials, rural minor arterials, and all National Highway System (NHS) routes and connectors. This permits the analyses of HPMS data in a geographic information system (GIS) environment.

The Manual contains reporting specifications for the various types of data in HPMS, a timetable for coordinating and updating the various data items and components of the HPMS, and information on maintaining the HPMS sample; information related to the use and maintenance of the HPMS submittal software is included in the software documentation. All HPMS data are to represent conditions as of December 31 of the data year. Since travel, length, and lane miles are used to apportion funds, it is important that these data represent the entire calendar year. Each State is expected to make an annual submittal of HPMS data in accordance with the procedures, formats, and codes specified in this Manual. Each State should also assure that there is agreement between the Certified Public Road Mileage and the total length (kilometers or miles) reported to FHWA via HPMS. After the initial reporting of LRS data, only updated information is required on an annual basis.

Regulations governing the FHWA State Planning and Research (SPR) funded work programs [23 Code of Federal Regulations (CFR), Part 420] outline responsibilities for furnishing FHWA adequate information for administering the Federal-aid highway program. Maintaining a valid HPMS database is an item of national significance; items of national significance must be adequately addressed in each State's annual work program. This extends beyond the simple reporting of data each year and includes taking actions to assure that all data are complete, current, and accurate. Although there may be other participants in the collection and reporting process, the ultimate responsibility for the accuracy and timely reporting of HPMS data lies with the State highway agency.

The submission of false data is a violation of the United States Code (U.S.C.), Title 18, Section 1020.

**HPMS due date:** June 15<sup>th</sup> of the year following the data year.

**Send items that are in other than electronic format to:**

- FHWA Division Office
- Office of Highway Policy Information  
Attention: HPPI-20, Room 3306  
Federal Highway Administration  
400 Seventh Street, S.W.  
Washington, D.C. 20590

**Arrangements for delivery of items to be provided in electronic format should be made with the Office of Highway Policy Information and the Division Office on a State specific basis.**

Hhhhhh

## CHAPTER II

### DEFINITIONS

This chapter contains definitions to be used in preparing HPMS data for FHWA. Specific details addressing summary, universe, standard and donut area sample data, and LRS locational data are contained in Chapters III, IV and V, respectively. Chapter VI contains data updating requirements and Chapter VII contains information on sample selection and maintenance. Collectively, these chapters provide necessary definitions, guidelines, coding instructions, reporting formats, and update specifications necessary to facilitate the reporting of current, consistent, and uniform data on a nationwide basis.

**Certification of Public Road Mileage:** An annual document furnished by each state to FHWA certifying the total public road length (kilometers or miles) in the state as of December 31<sup>st</sup>. This document is to be signed by the Governor of the State or by his/her designee and provided to FHWA by June 1<sup>st</sup> of the year following (23 CFR 460). See the definition of "Public Road".

**Combination Truck or Vehicle:** Any multi-unit vehicle described by vehicle types 8-13 in Chapter III.

**Comment File:** A text file that accompanies the HPMS data submittal to FHWA. It explains data issues, problems, deficiencies, unusual conditions, and any significant changes from the previous HPMS submittal. It may be provided as an electronic file attached to the HPMS submittal or as a separate paper submittal.

**Confidence Level/Precision Level:** The degree of accuracy resulting from the use of a statistical sample. For example, if a sample is designed at the 90-10 confidence (precision) level, the resultant sample estimate will be within  $\pm 10$  percent of the true value, 90 percent of the time.

**Divided Highway:** A multi-lane facility with a curbed or positive barrier median or a median that is 1.2 meters (4 feet) or wider.

**Donut Area:** The area outside of the FHWA-approved adjusted Census boundary of one or more urbanized areas but within the boundary of an NAAQS nonattainment area is defined as the "donut area." In the example shown in Appendix G, the donut area includes six small urban areas and the remaining rural area.

**Donut Area Sample Data:** These data consist of a combination of existing standard sample data and supplementary sample data taken in the nonurbanized portion (donut area) of EPA designated NAAQS nonattainment areas. This is done to enhance the precision of the estimate of vehicle travel in the donut area to a 90-10 confidence level to meet EPA's travel monitoring requirements. Data are used primarily for establishing regional transportation-related emissions for transportation conformity purposes. Estimated travel based on these data is used for calibration and validation of base-year network travel models when required for nonattainment or maintenance areas. The sample panels consist of two unique sample stratifications within each donut area further stratified by volume group:

- (1) combined rural minor arterial and small urban area minor arterial, and

- (2) combined rural major collector and small urban area collector.

A discussion of the donut area sample design is included in Appendix G.

**Donut Area Sample Sections:** The combination of existing standard sample sections and randomly selected supplementary sample sections if needed for the donut area of an NAAQS nonattainment area. Used only to estimate travel in the donut area on the rural and small urban minor arterial, rural major collector, and small urban collector systems. The supplementary samples are chosen from the universe length of these systems. A discussion of the donut area sample design is included in Appendix G.

**English Units:** The term "English" refers to the United States legislative interpretation of the units as defined in a document prepared by the National Institute of Standards and Technology (NIST), U.S. Department of Commerce, Special Publication 330. Commonly used English units in HPMS are miles, feet, and inches.

**Expressway:** A divided highway facility with partial control of access and two or more lanes for the exclusive use of through traffic in each direction; includes grade separations at most major intersections.

**FHWA-Approved Adjusted Census Urban Boundary:** Designated boundaries of a Census urban place or urbanized area as adjusted by responsible State and local officials in cooperation with each other, subject to the approval by FHWA (23 U.S.C. 101). Urban and rural data in HPMS must be reported in accordance with FHWA-approved adjusted boundaries.

**Freeway:** A divided highway facility with full control of access and two or more lanes for the exclusive use of through traffic in each direction.

**Functional Systems:** Functional systems result from the grouping of highways by the character of service they provide. The functional systems designated by the States in accordance with 23 CFR 470 are used in the HPMS. Guidance criteria and procedures are provided in the FHWA publication *Highway Functional Classification: Concepts, Criteria, and Procedures*, March 1989. Functional system names and codes are included in Chapter IV.

**Geographic Information System (GIS):** A system for the management, display, and analysis of spatial information. For HPMS purposes, GIS includes the spatial data defining the highway network and the geographically referenced HPMS section and bridge data.

**Highway:** The term highway includes roads, streets, and parkways and all their appurtenances (23 U.S.C. 101).

**Linear Referencing System (LRS):** A set of procedures for determining and retaining a record of specific points along a highway. Typical methods used are kilometerpoint (milepoint), kilometerpost (milepost), reference point, and link-node.

**LRS Data:** Provides a linear referencing system for the universe and sample data on selected highway functional systems. LRS data are a required part of the annual HPMS data submittal due June 15<sup>th</sup> of each year. Specific instructions for reporting network control LRS data are contained in Chapter V. For LRS data reporting instructions, see Items 10, 11, and 12 in Chapter IV. Further guidance on updating LRS information is provided in Appendix H.

**Metric Units:** The term "metric" refers to the modernized metric system known as the International System (SI). Further information is available under NIST's Special Publication 811, titled *Guide for the*

*Use of the International System of Units: The Modernized Metric System*, and the American Society for Testing and Materials (ASTM) Standard E380-89a. Commonly used metric units in the HPMS are kilometers, meters, and millimeters. HPMS data must be reported in metric units; however, if State inventory systems are maintained in English units, the FHWA data submittal software will convert data inputs to the required metric format.

**Metropolitan Planning Organization (MPO):** The term MPO is used in HPMS as defined in 23 U.S.C. 134.

**National Ambient Air Quality Standards (NAAQS) Nonattainment Area:** An area not meeting the NAAQS is designated by EPA as a “nonattainment area” out to boundaries established under the Clean Air Act Amendments (CAAA) of 1990. HPMS data are used for travel tracking for air quality assurance purposes in nonattainment areas as required by EPA under the 1990 CAAA (Section 187) and the Transportation Conformity Rule, 40 CFR parts 51 and 93. More specifically, these data are used primarily for establishing regional transportation-related emissions for transportation conformity purposes. Estimated travel based on these data is used for calibration and validation of base-year network travel models when required for nonattainment or maintenance areas. See Appendix G for additional information.

**National Highway System (NHS):** The National Highway System is a network of nationally significant highways approved by Congress in the National Highway System Designation Act of 1995. It includes the Interstate System and nearly 114,000 miles of arterial and other roads and connectors to major intermodal terminals. All NHS routes and connectors must be identified in the HPMS.

**Public Road:** A public road is any road or street owned and maintained by a public authority and open to public travel. [23 U.S.C. 101(a)]. Under this definition, a ferryboat is not a public road.

- The term "maintenance" means the preservation of the entire highway, including surfaces, shoulders, roadsides, structures, and such traffic-control devices as are necessary for safe and efficient utilization of the highway. [23 U.S.C. 101(a)]
- To be open to public travel, a road section must be available, except during scheduled periods, extreme weather or emergency conditions, passable by four-wheel standard passenger cars, and open to the general public for use without restrictive gates, prohibitive signs, or regulation other than restrictions based on size, weight or class of registration. Toll plazas of public toll roads are not considered restrictive gates. [23 CFR 460.2(c)]
- A public authority is defined as a Federal, State, county, town or township, Indian tribe, municipal or other local government or instrumentality with authority to finance, build, operate, or maintain toll or toll-free facilities. [23 U.S.C. 101(a)]

**Roadway:** The portion of a highway intended for vehicular use.

**Rural Areas:** All areas of a State outside of the FHWA-approved adjusted Census boundaries of small urban and urbanized areas.

**Single-Unit Truck or Vehicle:** Any single-unit vehicle described by vehicle types 3-7 in Chapter III.

**Small Urban Areas:** Small urban areas are defined by Census as places of 5,000 to 49,999 urban population (except in the case of cities in Maine and New Hampshire) outside of urbanized areas. As a minimum, a small urban area includes any place containing an urban population of at least 5,000 as designated by Census. Designated boundaries of an urban place can be adjusted by responsible State

officials subject to approval by FHWA (23 U.S.C. 101). Urban and rural data in HPMS must be reported in accordance with FHWA-approved adjusted boundaries.

**Standard Sample Data:** These data consist of additional inventory, condition, use, pavement, operational, and improvement data that complement the universe data for those sections of roadway that have been selected as standard samples. When expanded through use of an appropriate expansion factor, the data represents the entire universe from which the sample was drawn, permitting evaluation of highway system performance. The sample sections form nominally "fixed" panels of road segments that are monitored on an established cyclical basis. Samples can be added or deleted from the sample panels as the need arises.

Panels of roadway sections are established using a statistically designed sampling plan based on the random selection of road segments at predetermined precision levels. The sample is stratified by area, by functional system, and by traffic volume group. Sample selection is done randomly within each stratum (a predetermined AADT volume group) for each arterial and major collector functional highway system in rural, and for each arterial and collector functional system in small urban and urbanized areas of the State. A discussion of the HPMS sample selection design is included in Chapter VII.

Unique sampling is required for each urbanized area having  $\geq 200,000$  population and smaller urbanized areas that are NAAQS nonattainment areas. Rural and small urban areas (5,000 to 49,999 population) are sampled collectively statewide.

**Standard Sample Sections:** Sections selected at random from the universe of arterial and collector systems (excluding rural minor collector) for which additional physical and operational data elements are reported along with the universe data. A discussion of the HPMS sample selection design for the arterial and collector systems is included in Chapter VII.

**State (Codes):** The term "State" refers to any one of the 50 States, the District of Columbia, or the Commonwealth of Puerto Rico. The Federal Information Processing Standard Codes for States (FIPS PUB 5-2) are included in Appendix A.

**Strategic Highway Corridor Network (STRAHNET):** The STRAHNET includes highways which are important to the United States strategic defense policy and which provide defense access, continuity, and emergency capabilities for the movement of personnel, materials, and equipment in both peacetime and war time.

**Summary Data:** These data consist of annual summary reports for certain data not included in the HPMS universe and sample data set for the minor collector and local functional systems. Summary data must be coded manually onto the several summary screens contained in the HPMS submittal software. These additional data are derived from State and local sources such as statewide highway databases, management systems, Intelligent Transportation Systems (ITS) and traffic monitoring systems, and data made available from local governments and MPOs. Summary data and data screens are discussed in more detail in Chapter III.

**Supplemental Sample Sections (in donut areas):** Additional samples needed to obtain a donut area travel estimate at the 90-10-confidence level. A discussion of the donut area sample design is contained in Appendix G.

**System Length:** The total length of public roads as of December 31<sup>st</sup> of a data year that is to be reported via HPMS (see definition of public road). System length includes all public roads owned by Federal, State, and local governments, or instrumentality thereof, within the boundaries of the reporting State.



Planned, unbuilt facilities on the NHS are also reported in the HPMS system length (see Item 20 in Chapter IV).

**Universe Data:** Data representing total system length including National Highway System length not yet built or open to traffic. These data consist of a complete inventory of length (kilometers or miles) by functional system, jurisdiction, geographic location, (rural, small urban, urbanized, and NAAQS nonattainment areas) and other selected characteristics. Universe data fully reflect all open-to-traffic public roads in the State and contain basic information for planned, unbuilt future NHS. Universe data can be reported in **either** of the following ways:

- **Section Data:** Data reported for a continuous length of roadway that is homogeneous with respect to the physical, operational, administrative, and jurisdictional characteristics being reported. Interstate System, other freeways and expressways, other principal arterial, rural minor arterial, NHS, and all standard sample and supplementary donut area sample sections must be reported in section data form; or
- **Grouped Data:** Data reported for a group of highway sections, not necessarily contiguous, with length aggregated with respect to the homogeneous administrative, physical, and jurisdictional characteristics being reported. Grouped data can only be reported for lower order, non-NHS functional systems and non-sample road sections.

**Urbanized Areas and Codes:** Areas with a population of 50,000 or more, as designated by the Census. An FHWA-approved adjusted urbanized area includes the Census urbanized area plus transportation centers, shopping centers, major places of employment, satellite communities, and other major trip generators near the edge of the urbanized area, including those expected to be in place in the near future. FHWA's three-digit urbanized area codes are included in Appendix B. For multi-State urbanized areas, each State must report HPMS information for the portion of the FHWA-approved adjusted urbanized area within its State boundary.

**U.S. Territories:** The U.S. Territories include American Samoa, Guam, the Commonwealth of the Northern Marianas, and the Virgin Islands. The Federal Information Processing Standard Codes (FIPS PUB 5-2) are included in Appendix A. A reduced HPMS data set is required for U.S. Territories. See Chapter III.

## CHAPTER III

### SUMMARY DATA REQUIREMENTS

#### INTRODUCTION

The purpose of this chapter is to explain the HPMS summary data reporting requirements. With the exception of data on the U.S. Territories, summary data are submitted to FHWA as part of the HPMS data file. Data are coded on four summary screens included in the HPMS submittal software package. In general, only data that cannot be generated from the HPMS universe or sample data files are required to

be reported via the summary screens. Summary data are primarily limited to pavement and vehicle travel information for the minor collector and local functional systems, population and land area reporting, and supplementary travel information by vehicle type. Territorial data are provided via hard copy form as shown elsewhere in this Chapter. States are not required to maintain metric data; however, data must be reported in metric units to meet FHWA’s statutory metric obligations. If State inventory systems are maintained in English units, the FHWA data submittal software will convert data inputs to the required metric format.

Four summary screens are required for complete summary data reporting. Each summary screen is discussed in the following sections. For additional information, the user is directed to the documentation and help screens in the HPMS Submittal Software.

## TRAVEL AND DEMOGRAPHIC DATA

This summary requires the reporting of limited vehicle travel and demographic information not available from the HPMS data set as shown in the following summary screen. The HPMS software will automatically fill the Urban Code, Name and Nonattainment Code, and Name cells shown on the screen. However, the user must code all daily travel, population, and land area value cells shown.

**All Travel information is in thousands.**

Travel

Rural

Minor Collector

Local

Small Urban

Local

Demographics

Rural

Population (000)

Net Land Area

Small Urban

Population (000)

Net Land Area

Urbanized Area	Urbanized Name	Local Travel
I		0

**Donut Area Data (Rural and Small Urban). Population in thousands.**

Code	Nonattainment Name	Minor Collector Travel	Local Travel	Population	Net Land Area
I		0	0	0	0

Calculate Print Save Help

Figure III-1. HPMS Software Summary Screen

Daily vehicle travel is the amount of travel (in thousands) accumulated over a 24-hour day, midnight to midnight, for all days of a calendar year. It should reflect travel occurring on public roads, by motorized vehicles, excluding construction equipment or farm tractors. Exclude vehicle travel not occurring on public roads, such as that occurring on private access roads, parking lots, etc. Report vehicle travel that occurs on public roads for the functional systems and areas shown:

Area Type	Functional Systems	
	Local	Minor Collector
Each Urbanized Area	X	
Small Urban Statewide	X	
Rural Statewide	X	X
Each NAAQS Nonattainment Donut Area:		
Small Urban	X	
Rural	X	X

States are encouraged to improve traffic estimating practices on the local and rural minor collector functional systems. Rural areas in or near fast growing communities will require the most attention to determine changes in travel. It can be reasonably assumed that a portion of the rural minor collector and local functional systems, away from the major growth areas of the State, will experience little traffic change, thereby reducing the effort required to update this information. Travel estimates on the rural minor collector and the rural, small urban, and urbanized area local functional systems should be traffic count based. Donut area data need only be reported when HPMS is used to develop travel estimates to meet EPA requirements in NAAQS nonattainment areas. Sufficient emphasis should be placed on the development of these travel estimates to assure that they are reasonable and can be consistently generated.

Land area is determined in accordance with the U.S. Bureau of the Census definitions. Land area includes dry land and land temporarily or partially covered by water, such as marshlands, swamps and river flood plains. It also includes systems, sloughs, estuaries, and canals less than 0.2 kilometers (1/8 of a statute mile) in width, and lakes, reservoirs, and ponds less than 0.16 square kilometers (1/16 square mile) in area. [For Alaska, 0.8 kilometers (1/2 mile) and 2.60 square kilometers (1 square mile) are substituted for these values.] It excludes areas of oceans, bays, sounds, etc., lying within the 4.8-kilometer (3-mile) U.S. jurisdiction as well as inland water areas larger than indicated above. Land area is reported to HPMS for rural, small urban, and urbanized areas based on FHWA-approved, adjusted urban and urbanized area boundaries.

Population is based on the annual Census estimate of State resident population as of July 1<sup>st</sup> (April 1<sup>st</sup> in decennial Census years) for the calendar year for which the HPMS data are being reported. The allocation of Census-reported State resident population to rural, urban, or urbanized areas can be accomplished by using growth factors applied to the last official decennial figures, the most recent census estimate if available from the U.S. Bureau of the Census, or from population estimates available from MPOs or other State agencies. All reported population estimates must be adjusted to match the FHWA-approved, adjusted urban and urbanized area boundaries.

## PAVEMENT DATA

This summary requires the reporting of limited pavement type information not available from the HPMS

data set as shown in the following pavement type screen. Enter the paved and unpaved length for the specified functional systems. The Control Total is the length reported in the HPMS database for each functional system. The definitions of paved roads should be consistent with those included in Item 50, Surface/Pavement Type, codes 2 - 6.

LOWER SYSTEMS	PAVED	UNPAVED	TOTAL	CONTROL TOTAL
Rural/Minor Collector	0	0	0	0
Rural/Local	0	0	0	0
Urban/Local	0	0	0	0
TOTAL	0	0	0	0

**Figure III-2. HPMS Pavement Type Screen**

## TRAVEL DATA BY VEHICLE TYPE

This summary requires the reporting of the percentage of travel made by various vehicle types over the various functional systems of highways as shown in the travel activity screen on the following page. The percentage of travel is reported for each vehicle type relative to the total vehicle travel for each functional system or functional system groups by rural and urban areas. The values for each functional system or functional system groups must sum to 1.000 (100 percent). The individual vehicle type data cell values should be entered as a decimal number to the nearest thousandth.

States using equipment that they believe cannot differentiate automobiles from other two-axle, four-tire single-unit vehicles may report these two vehicle types as an aggregate figure. If a State that uses automated equipment normally augments its data with automobile-specific information, that data should be used to complete the summary. States are encouraged to provide automobile information distinct from other two-axle, four-tire single-unit vehicles even if estimates based on limited manual counts serve as the base. When entering aggregate data of two-axle, four-tire vehicles for a functional system, the values should be entered in the passenger car column and the "other two-axle, four-tire" column should be entered as zero.

December 2000

### Travel Activity by Vehicle Type

#### Basic Data

Shaded cells are reserved for titles and computer software generated values. Enter data in the unshaded cells only. Enter data as a decimal to the nearest thousandth.

FUNCTIONAL SYSTEM	PERCENT OF TRAVEL						
	MOTOR-CYCLES [OPTIONAL]	PASSENGER CARS [2 AXLE, 4 TIRE]	LIGHT TRUCKS [OTHER 2 AXLE, 4 TIRE]	BUSES	SINGLE-UNIT TRUCKS	COMBINATION TRUCKS	TOTAL
<b>RURAL</b>							
INTERSTATE							
OTHER ARTERIAL							
OTHER RURAL							
<b>URBAN</b>							
INTERSTATE							
OTHER ARTERIAL							

OTHER URBAN							
-------------	--	--	--	--	--	--	--

Report is in English Units.

Report rural and urban vehicle activity information for interstate system and functional system groups. The Traffic Monitoring Guide (TMG) should be consulted for recommended practices regarding the development of the vehicle classification coverage count program. The procedures are flexible, allow incorporation of existing automated sites, and are sufficient to meet the area wide and standard sample section reporting needs of the HPMS. If the TMG procedures have not been fully implemented, the source and derivation of the cell values should be thoroughly documented (as discussed in Appendix F)

If the standard sample is statistically valid, estimates of percent travel for all vehicle type/functional system cells in the summary are computed as the average of all the classification sample locations within that cell. Example 1 should be used for estimates of percent travel for rural interstate and urban interstate. Example 2 should be used for estimates of percent travel for functional system groups.

Example 1: The percentage of buses on the rural interstate system is the average of the percent of buses of all vehicle classification measurements in the sample taken on the rural interstate system. If the sample consisted of 9 sections and the percent buses measured at each section were 0.9, 0.5, 1.1, 0.8, 0.4, 0.2, 1.3, 0.5, and 0.3 (total = 6.0), then the average of 0.67 would be the estimated percentage of buses and would be entered as .007 for the rural interstate cell of the summary.

Example 2: The percentage of buses on the rural other arterial group is the average of the percent of buses of all vehicle classification measurements in the sample taken on rural other principal arterials (ROPA) and rural minor arterials (RMA). If the sample consisted of 8 sections from ROPA and 7 sections from RMA, and the percent buses measured at each section were 0.8, 0.7, 0.6, 0.9, 0.7, 0.8, 0.6, 1.1 for ROPA and 1.1, 1.2, 0.5, 0.9, 0.7, 0.8, 0.6 for RMA (total = 12.0, then the average of 0.8 would be the estimate percentage of the buses and would be entered as .008 for the rural other arterial group cell of the summary.

In reporting information for the area wide Travel Activity by Vehicle Type Form, the following criteria should be followed:

- Single-Unit Trucks are described by vehicle type 5 – 7 as defined in the TMG, and exclude buses.
- Combination-Unit Trucks are described by vehicle type 8 – 13 as defined in the TMG.
- Truck-tractor units traveling without a trailer should be considered single-unit trucks.
- A truck-tractor unit pulling other such units in a "piggyback" (or "saddle-mount") configuration should be considered as one single-unit truck and be defined only by the axles on the pulling unit.
- Vehicles should be defined based on the number of axles in contact with the roadway. Therefore, "floating" axles are counted only when in the down position.
- The term "trailer" includes both semi- and full-trailers.
- Rural Other Arterial includes rural other principal and rural minor arterial functional systems.
- Other Rural includes major collector, rural minor collector, and rural local functional systems.
- Other Urban Arterial includes urban other freeways & expressways, urban other principal arterials, and urban minor arterials.
- Other Urban includes urban collector and urban local functional systems.

The States collect vehicle classification data annually at continuous permanent installations and portable sites. The site-specific classification and station description data should be sent with the truck Weigh In Motion data to the Office of Highway Policy Information (HPPI-30) using the FHWA data formats by June 15<sup>th</sup> of the year following the year for which the data are collected. Additional information about FHWA data formats is found in the TMG.

**Vehicle Type Codes and Descriptions<sup>1</sup>**

Code	Description
1	<b>Motorcycles (Optional):</b> All two- or three-wheeled motorized vehicles. Typical vehicles in this category have saddle type seats and are steered by handlebars rather than a wheel. This category includes motorcycles, motor scooters, mopeds, motor-powered bicycles, and three-wheeled motorcycles. This vehicle type may be reported at the option of the State, but should not be reported with any other vehicle type.
2	<b>Passenger Cars:</b> All sedans, coupes, and station wagons manufactured primarily for the purpose of carrying passengers and including those passenger cars pulling recreational or other light trailers. Vehicles registered as passenger cars that are pickups, panels, vans, etc. (described as vehicle type "3") should be reported as vehicle type "3".
3	<b>Other Two-Axle, Four-Tire, Single-Unit Vehicles:</b> All two-axle, four-tire vehicles, other than passenger cars. Included in this classification are pickups, panels, vans, and other vehicles such as campers, motor homes, ambulances, hearses, and carryalls. Other two-axle, four-tire single-unit vehicles pulling recreational or other light trailers are included in this classification.
4	<b>Buses:</b> All vehicles manufactured as traditional passenger-carrying buses with two-axes, six-tires and three or more axles. This category includes only traditional buses (including school buses) functioning as passenger-carrying vehicles. All two-axle, four-tire minibuses should be classified as other two-axle, four-tire, single-unit vehicles (type "3"). Modified buses should be considered as trucks and be appropriately classified.
5	<b>Two-Axle, Six-Tire, Single-Unit Trucks:</b> All vehicles on a single frame including trucks, camping and recreational vehicles, motor homes, etc., having two axles and dual rear wheels.
6	<b>Three-Axle, Single-Unit Trucks:</b> All vehicles on a single frame including trucks, camping and recreational vehicles, motor homes, etc., having three axles.
7	<b>Four-or-More Axle, Single-Unit Trucks:</b> All vehicles on a single frame with four or more axles.
8	<b>Four-or-Less Axle, Single-Trailer Trucks:</b> All vehicles with four or less axles consisting of two units, one of which is a tractor or straight truck power-unit.
9	<b>Five-Axle, Single-Trailer Trucks:</b> All five-axle vehicles consisting of two units, one of which is a tractor or straight truck power-unit.
10	<b>Six-or-More Axle, Single-Trailer Trucks:</b> All vehicles with six or more axles consisting of two units, one of which is a tractor or straight truck power-unit.
11	<b>Five-or-Less Axle, Multi-Trailer Trucks:</b> All vehicles with five or less axles consisting of three or more units, one of which is a tractor or straight truck power-unit.

<sup>1</sup> ? Additional information about the means of identifying the vehicle types may be found in the *Traffic Monitoring Guide*, FHWA, February 1995.



Code	Description
12	<b>Six-Axle, Multi-Trailer Trucks:</b> All six-axle vehicles consisting of three or more units, one of which is a tractor or straight truck power-unit.
13	<b>Seven-or-More Axle, Multi-Trailer Trucks:</b> All vehicles with seven or more axles consisting of three or more units, one of which is a tractor or straight truck power-unit.

Additional information about the means of identifying the vehicle types may be found in the *Traffic Monitoring Guide*, FHWA, February 1995.

## U.S. TERRITORY INFORMATION

A paper summary report is required annually from the U.S. Territories of Guam, Northern Marianas Islands, American Samoa, and Virgin Islands as shown in the following form. This summary report contains the totals for population, land area, system length and vehicle travel data.

Population and land area data should be reviewed and updated annually and related to changes in decennial Census estimates. The U.S. Territories should annually submit revised estimates when changes have occurred in either population or land area for rural or small urban areas. Annual updates between decennial Censuses should be based on local trends or Census or territorial estimates.

System length should include all arterial and collector system public roads on the Territorial Highway System and other public roads that are maintained by a public authority. Under 23 U.S.C. 215, each territory must establish, with FHWA approval, a system of arterial and collector highways designated as the Federal-aid Territorial Highway System. Breakdowns by paved and unpaved surface types should be consistent with Item 50, Surface/Pavement Type. The total reported length must be consistent with the public roads mileage certified annually to the FHWA.

Daily vehicle travel should accurately indicate the usage of the public roads by motorized highway vehicles. The U.S. Territories are encouraged to use traffic count-based practices to develop travel estimates by arterial, collector, and local functional systems in rural and small urban areas. Since vehicle use in the U.S. Territories is limited to motorized vehicles maintained on the islands, other procedures, such as annual odometer surveys, could also be used to verify total travel. Procedures used to develop estimates of travel should be thoroughly documented and meet the requirements of Appendix F.

### U.S. Territory Information

Territory: \_\_\_\_\_

Territory FIPS Code: \_\_\_\_\_

Units: [ ] English 1/ [ ] Metric 2/

Data Year: \_\_\_\_\_ Date: \_\_\_\_\_

Category	Rural	Urban	Total
Population (1,000)			

Land Area			
Federal-Aid Territorial Highway System - Arterial:			
Paved Length			
Unpaved Length			
Subtotal			
Daily Travel (1,000)			
Federal-Aid Territorial Highway System - Collector:			
Paved Length			
Unpaved Length			
Subtotal			
Daily Travel (1,000)			
Other Public Roads:			
Paved Length			
Unpaved Length			
Subtotal			
Daily Travel (1,000)			
All Public Roads:			
Total Length			
Total Daily Travel (1,000)			
<p>1/ English units for length and travel are miles and daily vehicle-miles (in thousands), respectively.                  2/ Metric units for length and travel are kilometers and daily vehicle-kilometers (in thousands), respectively.</p>			

## CHAPTER IV

## UNIVERSE AND SAMPLE DATA REQUIREMENTS

### UNIVERSE DATA

Certain basic inventory information is required to be reported for all open-to-traffic, public road systems in the universe portion of the HPMS data set (Items 1-46). The total length reported for all open-to-traffic records should agree with the Certified Public Road Mileage. Limited universe data for facilities on planned National Highway System (NHS) roadways that are not yet built or open to traffic also are to be reported. Universe data must be reported on a section-by-section basis for all rural arterials, urban principal arterials, the NHS and all standard sample and donut area supplemental sample sections; universe data may be reported for the remaining functional systems on a grouped length basis.

### STANDARD SAMPLE DATA

Additional detailed information is required for a statistically chosen sample of roadways on major functional systems. The sampled functional systems include all but the rural minor collector, rural local, and urban local systems. The additional detailed data are reported for the standard sample portion of the HPMS data set (Items 47-98). The standard sample is intended to represent all applicable systems both on and off the State highway system. The standard sample is used for a variety of purposes including performance measurement, investment requirements modeling in support of Condition and Performance Reports to Congress, policy, other analyses, and in various publication media.

### DONUT AREA SAMPLE DATA

An additional sample is required for the donut area portions of NAAQS nonattainment areas that use the HPMS as the basis of VMT estimates for air quality travel tracking and conformity purposes. The donut area supplementary sample consists of sections in the rural and small urban minor arterial, rural major collector, and small urban collector functional systems that are located outside of urbanized area(s), but within the nonattainment area boundary. The donut area supplementary sample is used to enhance the existing standard sample to achieve higher confidence levels for travel estimates. The purpose of the donut area supplementary sample is limited to the development of travel estimates. The combination of existing standard samples in the donut area plus the donut area supplementary samples makes up the donut area sample.

In addition to the universe data items, donut area supplementary sample sections need only have sample data Items 47 and 48 coded.

### CODING NONUNIFORM ROADWAYS

The HPMS is an inventory system that requires reported data to represent both directions of roadway condition and operation. As a result, conflicts in data item coding may arise for specific data items under certain reporting conditions. The following provides some guidance in addressing conflicts.

Data items that involve widths, types, condition, etc., may differ in shape or dimension on each side of a roadway. To resolve this, choose one side of the facility for inventory purposes and code only the applicable data items for the chosen side of the highway. This should be done for all roadways, whether divided or undivided with common or independent alignments. The “inventory direction” should be chosen on a statewide basis (i.e., always South to North, East to West, or vice versa) and once selected never changed.

Some data items such as AADT, number of through lanes, median width, etc., reflect the complete two-way facility. Exercise extra care when reporting through lane counts and AADT because these data are used for apportionment purposes.

Appendix E requires IRI to be reported for the same direction and lane all of the time. The “inventory direction” of a facility should be used as the side where IRI is measured and reported. IRI should not be reported or averaged for both sides of a roadway.

Averages can be used for some dimensioned items that change back and forth over a section length (i.e., median width, shoulder width). In situations where a condition changes back and forth between two or more possible types over the section length, the predominant condition can be reported (i.e., shoulder type, surface type). In both cases, the lesser or worse measurement or condition for the roadway section can be reported instead.

If one part of an existing section becomes very different from the other due to a change, for instance, in the number of lanes, urban/rural break, new construction, etc., the predominant condition cannot be reported and the existing section may need to be split. A full discussion of this topic and a list of the changes that require sample splitting can be found in Chapter VII.

## **STRUCTURE TREATMENT**

The total length of all public roads, including structures, must be represented in the HPMS; note that a ferryboat is not a public road and should not be reported in HPMS. Where structures are a part of a universe or standard sample section, the reported data items should reflect the off-structure roadway conditions. However, since the HPMS standard sample is intended to represent the off-structure roadway and its conditions, standard sample sections that exist entirely on structures should be avoided if at all possible. Structures should be used as standard samples only when a volume group sample size requirement cannot be satisfied without inclusion of a structure-only section and the section cannot be combined with a roadway section.

Existing standard sample sections totally on structures should be eliminated in favor of standard sample sections on off-structure roadways where possible. Alternately, on-structure standard samples can be combined with adjacent roadway sections and the roadway characteristics reported in HPMS. When choosing new standard samples, delete any sections that are totally on structures from the list of candidates.

When a section is entirely on a structure, only the following data items need be reported, as applicable:

Universe data items: 1-34; 37-46

Sample data items: 47-49; 54; 56; 57; 80-84; 97; 98

Code all other data items “0” or “0.0” as appropriate. Supplementary donut area sample sections that are totally on structures are permitted.

## **PLANNED UNBUILT FACILITY**

Limited data for unbuilt facilities are included in HPMS for NHS routes only. Unbuilt facilities should only be included if there are plans for the route to be built. For unbuilt sections, only universe data items 1-19 and 30 are required.

## GENERAL REPORTING REQUIREMENTS

The HPMS data are used for a variety of purposes ranging from apportionment of highway funds to public information; therefore, the use of a data item governs the HPMS required coding. Although reporting agencies may have a need for highway inventory data coded differently from the HPMS, the State's highway inventory data system must nevertheless be capable of providing the HPMS data according to the coding requirements contained in this Manual. If there is not a one-for-one relationship between the State data inventory system and the HPMS coding requirements, the State may need to obtain additional data, revise its inventory data coding to match the HPMS, or provide means to aggregate, disaggregate, or convert State inventory data into data that meets HPMS coding requirements. Where the State has a need for a data item or some physical attribute that is not needed for HPMS, the data can be retained in the State's inventory system.

## DATA ITEM SUMMARY TABLE

In the following data item summary tables (Tables IV-1 and IV-2), an "A" indicates that the item is required for **all** universe, standard sample, and supplementary donut area sample sections; an "S" indicates that the item is required only if the section is a standard sample; and a "D" indicates that the item is required only if the section is a supplementary donut area sample. A blank indicates that the data item is not coded for the functional system. The following abbreviations are used in the column headings.

PAS/ NHS	Principal arterial system (PAS) includes rural and urban Interstate, urban other freeways and expressways, and rural and urban other principal arterial functional systems; National Highway System (NHS) is made up primarily of these same systems, plus a minor amount of roadways on other functional systems.
Int	Interstate
OFE	Other Freeways and Expressways
OPA	Other Principal Arterial
MA	Minor Arterial
MaC	Major Collector
MiC	Minor Collector
Col	Collector
Loc	Local

Do not rely solely on the data item summary table for data coding requirements. A number of data items require additional discussion regarding the type of section to which the data coding applies. For example, although the summary table indicates that Percent Passing Sight Distance (Item 78) is required for the rural standard sample sections, it is required only for rural paved, two-lane facilities.

**Table IV-1. Universe Data Summary**

Item No.	Required Universe Items								Data Item	Data Type
	Rural				Urban					
	PAS/NHS	MA	MaC	MiC & Loc	PAS/NHS	MA	Col	Loc		
<b>IDENTIFICATION</b>										
1	A	A	A	A	A	A	A	A	Year of Data	Numeric; Integer
2	A	A	A	A	A	A	A	A	State Code	Numeric; Codes
3	A	A	A	A	A	A	A	A	Reporting Units- Metric or English	Numeric; Codes
4	A	A	A	A	A	A	A	A	County Code	Numeric; Codes
5	A	A	A	A	A	A	A	A	Section Identification	Character Field
6									Is Standard Sample	Numeric; Codes
7									Is Donut Sample	Numeric; Codes
8									State Control Field	Character Field
9	A	A	A	A	A	A	A	A	Is Section Grouped?	Numeric; Codes
10	A	A			A				LRS Identification*	Character Field
11	A	A			A				LRS Beginning Point*	Numeric; Decimal
12	A	A			A				LRS Ending Point*	Numeric; Decimal
13	A	A	A	A	A	A	A	A	Rural/Urban Designation	Numeric; Codes
14	A	A	A	A	A	A	A	A	Urbanized Area Sampling Technique	Numeric; Integer
15	A	A	A	A	A	A	A	A	Urbanized Area Code	Numeric; Codes
16	A	A	A	A	A	A	A	A	NAAQS Nonattainment Area Code	Numeric; Codes
<b>SYSTEM</b>										
17	A	A	A	A	A	A	A	A	Functional System Code	Numeric; Codes
18	A	A	A	A	A	A	A	A	Generated Functional System Code	Software Calculated
19	A	A	A	A	A	A	A	A	National Highway System (NHS)	Numeric; Codes
20	A				A				Planned Unbuilt Facility	Numeric; Codes
21	A				A				Official Interstate Route Number	Character Field
22	A	A			A				Route Signing*	Numeric; Codes
23	A	A			A				Route Signing Qualifier*	Numeric; Codes
24	A	A			A				Signed Route Number*	Character Field
<b>JURISDICTION</b>										
25	A	A	A	A	A	A	A	A	Governmental Ownership	Numeric; Codes
26	A	A	A	A	A	A	A	A	Special Systems	Numeric; Codes
<b>OPERATION</b>										
27	A	A	A	A	A	A	A	A	Type of Facility	Numeric; Codes
28	A	A	A	A	A	A	A	A	Designated Truck Route	Numeric; Codes
29	A	A	A	A	A	A	A	A	Toll	Numeric; Codes
<b>OTHER</b>										
30	A	A	A	A	A	A	A	A	Section Length	Numeric; Decimal
31		A	A			A	A		Donut Area Sample AADT Volume Group Identifier <sup>2</sup>	Numeric; Integer
32	A	A	A		A	A	A		Standard Sample AADT Volume Group Identifier	Numeric; Integer
33	A	S&D	S&D		A	S&D	S&D		AADT*	Numeric; Integer
34	A	A	A		A	A	A		Number of Through Lanes	Numeric; Integer
35	A	S			A				Measured Pavement Roughness (IRI)*	Numeric; Decimal
36			S			S	S		Present Serviceability Rating (PSR)	Numeric; Decimal
37	A	A	A	A	A	A	A	A	High Occupancy Vehicle (HOV) Operations	Numeric; Codes

2 <sup>?</sup> The "A" in the summary table cells for the Donut Area Volume Group (Item 31) is meant to indicate that all data records (universe only and sample) for the noted functional systems in a donut area are to include these data.

Item No.	Required Universe Items								Data Item	Data Type
	Rural				Urban					
	PAS/NHS	MA	MaC	MiC & Loc	PAS/NHS	MA	Col	Loc		
38	A	A	A	A	A	A	A	A	Electronic Surveillance	Numeric; Codes
39	A	A	A	A	A	A	A	A	Metered Ramps	Numeric; Codes
40	A	A	A	A	A	A	A	A	Variable Message Signs	Numeric; Codes
41	A	A	A	A	A	A	A	A	Highway Advisory Radio	Numeric; Codes
42	A	A	A	A	A	A	A	A	Surveillance Cameras	Numeric; Codes
43	A	A	A	A	A	A	A	A	Incident Detection	Numeric; Codes
44	A	A	A	A	A	A	A	A	Free Cell Phone	Numeric; Codes
45	A	A	A	A	A	A	A	A	On-Call Service Patrol	Numeric; Codes
46	A	A	A	A	A	A	A	A	In-Vehicle Signing	Numeric; Codes
End of universe data items.										

Key: A = Code for "All" universe, standard sample, and supplementary donut area sample sections.  
 S = Code for all "Standard" sample sections.  
 D = Code for all "Donut" area supplementary sample sections.  
 \* = See individual data item for exceptions.

**Table IV-2 Sample Data Summary**

Item No.	Required Sample Items										Data Item	Data Type
	Rural					Urban						
	Int	OPA	MA	MAC	Int	OFE	OPA	MA	Col			
<b>IDENTIFICATION</b>												
47	S	S	S&D	S&D	S	S	S	S&D	S&D	Sample Identifier	Character Field	
<b>COMPUTATIONAL</b>												
48			D	D				D	D	Donut Area Sample Expansion Factor	Software Calculated	
49	S	S	S	S	S	S	S	S	S	Standard Sample Expansion Factor	Software Calculated	
<b>PAVEMENT</b>												
50	S	S	S	S	S	S	S	S	S	Surface/Pavement Type	Numeric; Codes	
51	S	S	S	S	S	S	S	S	S	SN or D	Numeric; Decimal	
52	S	S	S	S	S	S	S	S	S	General Climate Zone	Software Set	
53	S	S	S	S	S	S	S	S	S	Year of Surface Improvement	Numeric; Integer	
<b>GEOMETRICS</b>												
54	S	S	S	S	S	S	S	S	S	Lane Width	Numeric; Decimal	
55	S	S	S	S	S	S	S	S	S	Access Control	Numeric; Codes	
56	S	S	S	S	S	S	S	S	S	Median Type	Numeric; Codes	
57	S	S	S	S	S	S	S	S	S	Median Width	Numeric; Decimal	
58	S	S	S	S	S	S	S	S	S	Shoulder Type	Numeric; Codes	
59	S	S	S	S	S	S	S	S	S	Shoulder Width -Right	Numeric; Decimal	
60	S	S	S	S	S	S	S	S	S	Shoulder Width - Left	Numeric; Decimal	
61					S	S	S	S	S	Peak Parking	Numeric; Codes	
62	S	S	S	S	S	S	S	S	S	Widening Feasibility	Numeric; Codes	
63	S	S	S		S	S	S			Length Class A Curves	Numeric; Decimal	
64	S	S	S		S	S	S			Length Class B Curves	Numeric; Decimal	
65	S	S	S		S	S	S			Length Class C Curves	Numeric; Decimal	
66	S	S	S		S	S	S			Length Class D Curves	Numeric; Decimal	
67	S	S	S		S	S	S			Length Class E Curves	Numeric; Decimal	
68	S	S	S		S	S	S			Length Class F Curves	Numeric; Decimal	
69				S						Horizontal Alignment Adequacy*	Software Calculated	

Item No.	Required Sample Items										Data Item	Data Type
	Rural					Urban						
	Int	OPA	MA	MAC	Int	OFE	OPA	MA	Col			
70	S	S	S	S							Type of Terrain	Numeric; Codes
71				S							Vertical Alignment Adequacy*	Software Calculated
72	S	S	S		S	S	S				Length Class A Grades	Numeric; Decimal
73	S	S	S		S	S	S				Length Class B Grades	Numeric; Decimal
74	S	S	S		S	S	S				Length Class C Grades	Numeric; Decimal
75	S	S	S		S	S	S				Length Class D Grades	Numeric; Decimal
76	S	S	S		S	S	S				Length Class E Grades	Numeric; Decimal
77	S	S	S		S	S	S				Length Class F Grades	Numeric; Decimal
78	S	S	S	S							Percent Passing Sight Distance*	Numeric; Integer
<b>TRAFFIC/CAPACITY</b>												
79											Weighted Design Speed	Software Calculated
80	S	S	S	S	S	S	S	S	S	S	Speed Limit	Numeric; Integer
81	S	S	S	S	S	S	S	S	S	S	Percent Single Unit Trucks - Peak	Numeric; Integer
82	S	S	S	S	S	S	S	S	S	S	Percent Single Unit Trucks - Average Daily	Numeric; Integer
83	S	S	S	S	S	S	S	S	S	S	Percent Combination Trucks - Peak	Numeric; Integer
84	S	S	S	S	S	S	S	S	S	S	Percent Combination Trucks - Average Daily	Numeric; Integer
85	S	S	S	S	S	S	S	S	S	S	K-Factor	Numeric; Integer
86	S	S	S	S	S	S	S	S	S	S	Directional Factor	Numeric; Integer
87	S	S	S	S	S	S	S	S	S	S	Number of Peak Lanes	Numeric; Integer
88					S	S	S	S	S	S	Left Turning Lanes	Numeric; Codes
89					S	S	S	S	S	S	Right Turning Lanes	Numeric; Codes
90					S	S	S	S	S	S	Prevailing Type of Signalization	Numeric; Codes
91					S	S	S	S	S	S	Typical Peak Percent Green Time*	Numeric; Integer
92	S	S	S	S	S	S	S	S	S	S	Number At-Grade Intersections - Signals	Numeric; Integer
93	S	S	S	S	S	S	S	S	S	S	Number At-Grade Intersections - Stop Sign	Numeric; Integer
94	S	S	S	S	S	S	S	S	S	S	Number At-Grade Intersections - Other/No Control	Numeric; Integer
95	S	S	S	S	S	S	S	S	S	S	Peak Capacity	Software Calculated
96	S	S	S	S	S	S	S	S	S	S	Volume/Service Flow Ratio (V/SF)	Software Calculated
97	S	S	S	S	S	S	S	S	S	S	Future AADT	Numeric; Integer
98	S	S	S	S	S	S	S	S	S	S	Year of Future AADT	Numeric; Integer
End of sample data items.												

Key: A = Code for "All" universe, standard sample, and supplementary donut area sample sections.  
 S = Code for all "Standard" sample sections.  
 D = Code for all "Donut" area supplementary sample sections.  
 \* = See individual data item for exceptions.

## GENERAL CODING INSTRUCTIONS

Data items in the summary table are denoted in the Data Type column as having either "numeric" or "character" reporting specifications.

For numeric data items:

- leading zero must be coded in decimal value when the value is less than an integer (length = 0.21); otherwise, leading zeros are not required
- decimal points are required for all data items labeled "Numeric; Decimal," i.e., those reported in tenths, hundredths, or thousandths (PSR = 2.2; length = 10.252, etc.)
- one digit must be coded after a decimal point for all data items labeled "Numeric; Decimal"



- (PSR = 3 must be coded 3.0); additional trailing zeros are not required for the decimal portion
- when data is not available, code “0” or “0.0” as appropriate

For character data items:

- any alphanumeric character (A through Z; 0 through 9; space) may be coded
- do NOT use double quotes (“”) within the character string

For data items with assigned values (codes):

- select the appropriate value from the table
- the value must be coded precisely as listed in the table

## DATA CODING INSTRUCTIONS

### Item 1 — Year of Data (Numeric; Integer)

Enter the four digits of the calendar year for which the data apply. The HPMS software is “year 2000” compliant.

If adding a section while working in the HPMS software, the year will automatically be set based on the year in which the user is working. The year is displayed on top of the screen.

### Item 2 — State Code (Numeric; Codes)

The State FIPS code is used in the HPMS database to identify the reporting State. Enter the State FIPS code as listed in Appendix A.

If adding a section while working in the HPMS software, the State code will automatically be coded based on the State selected. The State name is displayed on top of the screen.

### Item 3 — Reporting Units - Metric or English (Numeric; Codes)

Code for all sections to indicate the units used to report measured and other measurement related data items. All data submitted to FHWA must be in metric units; the HPMS software will automatically convert all data to metric during the FHWA submit process. The same reporting unit must be used for all applicable data items for the entire data set. There can be no mixing of units within the data set.

Code	Description
0	Section data is coded using the English system of unit measurement (miles, feet, inches, etc.).
1	Section data is coded using the modernized metric system of unit measurement known as the SI (kilometers, meters, millimeters, etc.).

Most used **soft conversions:**

1 mile = 1.609344 kilometers	1 foot = 0.3048 meters = 304.8 millimeters
1 square mile = 2.59 square kilometers	1 inch = 0.0254 meters = 25.4 millimeters

Most used **hard conversions:**

11 foot lane = 3.3 meters	10 foot lane or shoulder = 3.0 meters
12 foot lane = 3.6 meters	55 mph = 90 km/h
8 foot shoulder = 2.4 meters	65 mph = 105 km/h

Reference: American Association of State Highway Transportation Officials (AASHTO) *Guide To Metric Conversion*, 1993

Hard conversion of data Items 54 (Lane Width); 59 and 60 (Shoulder Width); 79 (Weighted Design Speed); and 80 (Speed Limit) is preferred. A soft conversion for data Item 35, Measured Pavement Roughness, is provided in Appendix E as 63.36 inches/mile = 1.0 meter/kilometer.

HPMS conversion software is discussed in Appendix L; the software will perform the appropriate conversions of all of the applicable data items from English to Metric.

**Item 4 — County Code** (Numeric; Codes)

The FIPS county code permits analysis and mapping of information at a sub-State level. Enter the three-digit FIPS county code from FIPS Publication 6-4, *Counties and Equivalent Entities of the United States, Its Possessions, and Associated Areas*. Use county equivalents in HPMS for the following:

State	County Equivalent
Alaska	Highway Districts
Louisiana	Parishes
Puerto Rico	Municipio Districts

In the HPMS software, the County Names table must be kept current. To add a county, modify a county name, or delete a county code, select “Tools/County Names.” When adding a section, the county code must be in the County Names table or the system will not allow the section to be added.

**Item 5 — Section Identification** (Character Field)

This item permits locating specific roadway section data within the HPMS database. This item must contain a 12-character countywide unique identifier. It provides flexibility to identify sections in accordance with a State's needs independent of the unique identifier that must be maintained for sample sections. This item may be defined to suit the needs of the State and may contain any right-justified alphanumeric character.

- For all individually reported sections (code “0” in item 9), supply a countywide unique section identifier. This may be a location specific identifier such as route kilometerpoint (milepoint), A-node/B-node, or a unique number.
- For highways reported as grouped sections (code “1” in Item 9), provide a countywide, unique group identifier. REMINDER: Only nonsample urban minor arterial, collector and local, and nonsample rural major and minor collector and local data can be grouped; NHS routes cannot be grouped regardless of functional system.

Examples:

1. **Section Identifier** (Item 9 = 0)

Use any countywide unique identifier with no more than 12 “right justified” characters. An example using a location specific identifier:

Interstate Inventory Route 56, Kilometerpoint 4.321												
Code	0	0	0	I	5	6	0	0	4	3	2	1

2. **Grouped Length** (Item 9 = 1)

Use any countywide unique identifier - no limit on number of digits. An example using a unique number:

Grouped Length Record 98365												
Code	0	0	0	0	0	0	0	9	8	3	6	5

**Item 6 — Is Standard Sample** (Numeric; Codes)

This data item is used by the software to indicate if a section is a standard sample.

Code	Description
0	Section <b>is not</b> a standard sample.
1	Section <b>is</b> a standard sample.

**Item 7 — Is Donut Sample** (Numeric; Codes)

This data item is used by the software to indicate if the section is a donut sample.

Code	Description
0	Section <b>is not</b> a donut sample.
1	Section <b>is</b> a donut sample.

If a section is:

- a universe section only, code “0” for both Items 6 and 7;
- both a standard sample and a donut sample, code “1” for both Items 6 and 7;
- a donut sample, code “0” for Item 6 and code “1” for Item 7;
- a standard sample, code “1” for Item 6 and code “0” for Item 7.

**Item 8 — State Control Field** (Character Field)

This is a data item of up to 100 alphanumeric characters for State use for identification or any other purpose. It may contain any keyboard characters; however, do not use binary zeros or double quotes. FHWA does not use this data item.

**Item 9 — Is Section Grouped?** (Numeric; Codes)

This item is used by the software to indicate whether the data reported are for a single section or for a group of sections.

Code	Description
0	Individual Section Data

1	Grouped Section Data
---	----------------------

Use code “0” for all sections, including universe, standard sample, and supplementary donut area sample sections that are being reported on an individual section basis. Code “0” must be used for all principal arterial system (PAS), rural Minor Arterial, and NHS sections - grouping within these systems is not permitted.

Use the grouped length code “1” only when grouping homogeneous sections for reporting purposes; contiguous sections should not be reported as grouped sections. Only nonsample rural major collector, rural minor collector, rural local, nonsample urban minor arterial, nonsample urban collector, and urban local system sections not on the NHS can be grouped. Grouping may only be done when the data for Items 4; 13-17; 25-29; and 31-32 are homogeneous across all sections being grouped.

**Item 10 — LRS Identification** (Character Field)

This item, along with Items 11 and 12, permits users to reference HPMS information to the map location of road sections. Code for all PAS, NHS, and rural minor arterial system sections, in conjunction with LRS beginning and ending points (Items 11 and 12). More information concerning the LRS may be found in Chapter V, Linear Referencing System Requirements.

**Inventory Route and Subroute Numbers for LRS Use:**

The inventory route and subroute numbers reported in this item must be consistent with the inventory route and subroute numbers identified on the Inventory Route and Node Maps and in the Inventory Route Link Data File discussed in Chapter V, Linear Referencing System Requirements.

The inventory route number is a 10-character, right justified value. The LRS inventory route number can be alphanumeric, but must not contain blanks; leading zeros must be coded. The inventory route number is not necessarily the same as that posted along the roadway, but is a number used to uniquely identify a route within at least a county or, alternately, throughout the State. The inventory route number is followed by a 2-character numeric subroute number that uniquely identifies the AHEAD and BACK portions of an inventory route section where duplicate kilometerpoints (KMPTs) [milepoints (MPTs)] occur.

Example: Inventory Route 63951, Subroute Number 2

Code	0	0	0	0	0	6	3	9	5	1	0	2
------	---	---	---	---	---	---	---	---	---	---	---	---

**Item 11 — LRS Beginning Point** (Numeric; Decimal)

This item, along with Items 10 and 12, permits users to reference HPMS information to the map location of road sections. Code this item for all PAS, NHS, and rural minor arterial system section records for the purpose of establishing an LRS. This numeric item must be coded with the beginning KMPT (MPT) for the section on the inventory route and for the subroute number coded in the LRS Identification (Item 10).

The KMPT (MPT) for the section must be consistent with the LRS information found on the Inventory Route and Node Maps and in the Inventory Route Link Data File for a particular route and subroute. In order to be consistent, section breaks must adhere to the conditions listed in Chapter V, particularly under the section titled “Effects of LRS on HPMS Sections.” See Chapter V for a full discussion on coding of the Linear Referencing System.

Code “0.0” for this item if LRS information is not provided. Code the beginning KMPT (MPT) to three decimal points. The KMPT (MPT) represents the distance in kilometers (miles) from a set reference point to the beginning of the highway segment and is the lowest KMPT (MPT) of the section.

The KMPT (MPT) numbering format should be such that the combination of county, inventory route number, subroute number, and KMPT (MPT) information will define a unique location.

Example: Beginning kilometerpoint 98.252 for the inventory route and subroute number coded in Item 10:

Code	9	8	.	2	5	2
------	---	---	---	---	---	---

**Item 12 — LRS Ending Point** (Numeric; Decimal)

This item, along with Items 10 and 11, permits users to reference HPMS information to the map location of road sections. Code this item for all PAS, NHS, and rural minor arterial system section records for the purpose of establishing an LRS. This numeric item must be coded with the ending KMPT (MPT) for the section on the inventory route and for the subroute number coded in the LRS Identification (Item 10).

The KMPT (MPT) for the section must be consistent with the LRS information found on the Inventory Route and Node Maps and in the Inventory Route Link Data File for a particular route and subroute. In order to be consistent, section breaks must adhere to the conditions listed in Chapter V, particularly under the section titled “Effects of LRS on HPMS Sections.” See Chapter V for a full discussion on coding of the Linear Referencing System.

Code “0.0” for this item if LRS information is not provided. Code the ending KMPT (MPT) to three decimal points. The KMPT (MPT) represents the distance in kilometers (miles) from a set reference point to the end of the highway segment and is the highest KMPT (MPT) of the section.

The KMPT (MPT) numbering format should be such that the combination of county, inventory route number, subroute number, and KMPT (MPT) information will define a unique location.

Example: Ending kilometerpoint 101.206 for the inventory route and subroute number coded in Item 10:

Code	1	0	1	.	2	0	6
------	---	---	---	---	---	---	---

**Item 13 — Rural/Urban Designation** (Numeric; Codes)

This item permits analysis and mapping of information at a sub-State level. Code the value best describing the area.

Code	Description
1	Rural Area
2	Small Urban Area (Population 5,000 to 49,999)
3	Small Urbanized Area (Population 50,000 to 199,999)
4	Large Urbanized Area (Population 200,000 or More)

The FHWA-approved adjusted census urban boundary, including portions that cross State boundaries, is used to establish population criteria for coding this data item. July 1<sup>st</sup> estimates of population should be used as a base when determining the urbanized area size (code “3” or “4”). County level estimates are available by the end of each calendar year on the Internet at [www.census.gov](http://www.census.gov).

**Item 14 — Urbanized Area Sampling Technique** (Numeric; Integer)

This item is used by the software to calculate expansion factors. All urbanized areas that contain a population of 200,000 persons or more, or smaller urbanized areas that are within an NAAQS nonattainment area boundary, or smaller urbanized areas that are NAAQS nonattainment areas on their own must be individually sampled. This includes any portion of a nonattainment urbanized area that crosses a State boundary, and individual State portions of an urbanized area that, in the aggregate (all States), contain more than 200,000 persons, even if the State's portion does not reach that population by itself. The State may retain existing grouped urbanized areas; however, in the future all urbanized areas must be individually sampled.

Code “0” for rural universe and standard sample sections and urban universe and standard sample sections that are located in urbanized areas, which are being individually sampled. For grouped urbanized areas, code universe and standard sample roadway sections as follows:

If two or more areas are being grouped, one number, starting with “1,” should be used to identify the sections in each group. For example, if a State has consolidated all qualifying urbanized areas (<200,000 population and not an NAAQS nonattainment area) into one group, “1” should be coded for all sections in the group. If qualifying areas have been consolidated into two groups, sections in the first group of qualifying areas should be coded “1”, and those in the second group coded “2.” Sections in remaining individually sampled urbanized areas should be coded “0.”

**Item 15 — Urbanized Area Code** (Numeric; Codes)

This item permits analysis and mapping of information at the urbanized area level. Enter the numeric urbanized area code for sections within an urbanized area boundary when the Rural/Urban Designation (Item 13) is coded “3” or “4”. Otherwise, code “0.” Codes are included in Appendix B. Code for universe and standard sample sections only. Leading zeros are not required.

In the HPMS software, the Urbanized Area Names table must be kept current.

**Item 16 — NAAQS Nonattainment Area Code** (Numeric; Codes)

This item permits analysis and mapping of information for EPA designated nonattainment areas. Enter the numeric urbanized area code for the EPA-named NAAQS nonattainment area for all rural, small urban, and urbanized area universe, standard sample, and supplemental sample sections within the NAAQS nonattainment area boundary. When more than one urbanized area is within the nonattainment area boundary, enter the code for the most populous urbanized area. Leading zeros are not required.

Code “0” for sections that are not within a nonattainment area boundary, or if an NAAQS nonattainment area contains partial or split urbanized areas. Because the HPMS sample can represent only whole urbanized areas, expanded results are not legitimate for partial urbanized areas and HPMS cannot be used for travel tracking or other air quality purposes in these areas.

Urbanized area codes are included in Appendix B; assignment of NAAQS nonattainment area codes is discussed in Appendix G. The Houston nonattainment area coding example in Appendix G provides more explanation for coding this data item.

**Item 17 — Functional System Code** (Numeric; Codes)

This item permits analysis and mapping of information by highway functional system. Code the value that represents the functional system upon which the section is located.

Code	Description	Code	Description
<b>RURAL</b>		<b>URBAN</b>	
1	Principal Arterial -	11	Principal Arterial - Interstate

Code	Description	Code	Description
2	Principal Arterial - Other	12	Principal Arterial-Other Freeways &
6	Minor Arterial	14	Principal Arterial - Other
7	Major Collector	16	Minor Arterial
8	Minor Collector	17	Collector
9	Local	19	Local

Definitions of the highway functional systems can be found in *Highway Functional Classification, Concepts, Criteria and Procedures*, FHWA, March 1989.

**Item 18 — Generated Functional System Code** (Software Calculated)

This item is encoded by the HPMS software based on the Functional System (Item 17), and is used as a software aid. If Item 17 is changed, the standard calculations in the HPMS software package must be run to obtain the proper code in this field. The codes are as follows:

Code	Description	
	RURAL	URBAN
1	Interstate	Interstate
2	Other Principal Arterial	Other Freeways and Expressways
3	Minor Arterial	Other Principal Arterial
4	Major Collector	Minor Arterial
5	Minor Collector	Collector
6	Local	Local

**Item 19 — National Highway System (NHS)** (Numeric; Codes)

This item, along with item 20, is used to track changes to the approved NHS, including intermodal connectors. Code this item for all sections to indicate whether the section is on the NHS or is an NHS connector to an intermodal facility. See the definition of NHS in Chapter II. Enter one of the following codes:

Code	Description
0	This section <b>is not</b> on the NHS
1	This section <b>is</b> on the NHS but <b>is not</b> an NHS intermodal connector
2 - 9	This section <b>is</b> an NHS intermodal connector. Type of connector: 2 Major Airport 3 Major Port Facility 4 Major Amtrak Station 5 Major Rail/Truck Terminal 6 Major Intercity Bus Terminal 7 Major Public Transit or Multi-Modal Passenger Terminal 8 Major Pipeline Terminal 9 Major Ferry Terminal If more than one connector type is involved, use the predominant type.

**Item 20 — Planned Unbuilt Facility** (Numeric; Codes)

This item, along with item 19, is used to track changes to the approved NHS, including

intermodal connectors. Code the status of the section being reported.

Code	Description
0	This roadway section <b>is not</b> on the NHS.
1	This roadway section <b>is on</b> the NHS and is open to public travel.
2	This roadway section <b>is on</b> the NHS but is not yet built.

For sections coded “0” or “1”, code all applicable data items. For sections coded “2”, report at least items 1-19 and 30, as applicable.

**Item 21 — Official Interstate Route Number** (Character Field)

This item, along with Items 22, 23, and 24, is used to track HPMS information by specific route. Code for all Interstate System sections using the officially approved AASHTO/FHWA Interstate route number. Enter a 5-character, right justified, alphanumeric value for the Interstate System route number. If two or more Interstate routes occupy the same roadway, code the lowest official route number. If the route is not an official Interstate route, leave blank or zero-fill, regardless of signing.

Alaska, Hawaii, and Puerto Rico may use alpha characters in the Interstate route number field as part of the official AASHTO/FHWA route number. Other exceptions include coding for Interstate routes with parallel or diverging branches having cardinal direction letters in the official route number; for example, Interstate Route 35 in Minnesota splits with 35E going through St. Paul and 35W through Minneapolis.

**Item 22 — Route Signing** (Numeric; Codes)

This item, along with Items 21, 23, and 24, is used to track HPMS information by specific route. Code for all PAS, NHS, and rural minor arterial system sections. Reporting for other systems is optional. Code the value which best represents the manner in which the highway segment is signed with route markers. If the roadway is unsigned, use code “0.”

Code	Description	Code	Description
0	Not Signed or Not Applicable	5	County
1	Interstate	6	Township
2	U.S.	7	Municipal
3	State	8	Parkway Marker or Forest Route Marker
4	Off-Interstate Business Marker	9	None of the Above

When a section is signed with two or more identifiers (i.e., Interstate 83 and U.S. 32), code the highest class of route (Interstate in this example). Follow the hierarchy as ordered above.

**Item 23 — Route Signing Qualifier** (Numeric; Codes)

This item, along with Items 21, 22, and 24, is used to track HPMS information by specific route. Code for all PAS, NHS, and rural minor arterial system sections. Reporting for other systems is optional. Code the value which best represents the manner in which the highway segment is signed on the route marker described in Item 22. Where more than one code is applicable, use the lower code. If the roadway is unsigned, use code “0.”

Code	Description	Code	Description
------	-------------	------	-------------



0	No Qualifier or Not Signed or Not Applicable	5	Loop
1	Alternate	6	Proposed
2	Business Route	7	Temporary
3	Bypass	8	Truck Route
4	Spur	9	None of the Above

**Item 24 — Signed Route Number** (Character Field)

This item, along with Items 21, 22, and 23, is used to track HPMS information by specific route. Code for all PAS, NHS, and rural minor arterial system sections. Reporting for other systems is optional. Enter an 8-character, right-justified, alphanumeric value for the signed route number shown on the marker described in Items 22 and 23. If two or more routes of the same class in the hierarchy are signed along a roadway section (i.e., Interstate 64 and Interstate 81), code the lowest route number (Interstate 64 in this example). If Items 22 or 23 are coded “9,” code other descriptive alphabetic character prefixes or suffixes abbreviated to 8 characters if available. If Item 22 is coded “0,” leave blank or zero-fill.

**Item 25 — Governmental Ownership** (Numeric; Codes)

This item identifies the road owner and is used in cost allocation studies, to track historic data, and in the national highway database. Code the level of government that best represents the highway owner irrespective of whether agreements exist for maintenance or other purposes. The purpose of this item is to identify the owner of public roads; do not include privately owned roads in HPMS. If more than one code applies, code the lowest numerical value.

Code	Description	Code	Description
1	State Highway Agency	5	Other State Agency
2	County Highway Agency	6	Other Local Agency
3	Town or Township Highway Agency	7	Federal Agency
4	Municipal Highway Agency	8	Other

For purposes of this data item:

“**State**” means owned by one of the 50 States, the District of Columbia, or the Commonwealth of Puerto Rico including quasi-official State commissions or organizations;

“**County, local, municipal, town, or township**” means owned by one of the officially recognized governments established under State authority;

“**Federal**” means owned by one of the branches of the U.S. Government or independent establishments, government corporations, quasi-official agencies, organizations, or instrumentalities;

“**Other**” means owned by tribal Nations, or nongovernmental organizations with the authority to build, operate, or maintain toll or free highway facilities.

**Item 26 — Special Systems** (Numeric; Codes)

This item is used to track changes to the STRAHNET and is used by the Department of Defense (DOD) to identify strategic deployment routes. Code whether an open-to-traffic section is on the STRAHNET or a STRAHNET connector (see definition in Chapter 2). Code all open-to-traffic Interstate System sections “1.”

Code	Description
0	Section <b>is not</b> on STRAHNET or a STRAHNET connector
1	Section <b>is</b> on STRAHNET or a STRAHNET connector

**Item 27 — Type of Facility** (Numeric; Codes)

This item is used to determine whether a roadway or structure is a one- or two-way operation. It is used in investment requirements modeling to calculate capacity and estimate roadway deficiencies and improvement needs, in the cost allocation pavement model, and in the national highway database.

Code	Description
1	One-Way Roadway
2	Two-Way Roadway
3	One-Way Structure (Bridge, Tunnel, Causeway, etc.)
4	Two-Way Structure (Bridge, Tunnel, Causeway, etc.)

Use code "1" or "2" as applicable except when the section being reported is **entirely** on a structure.

**One-Way:** A roadway or structure section with traffic moving in only one direction during non-peak period hours. When part of a one-way couplet, report each roadway/structure section independently.

**Two-Way:** A roadway or structure with traffic moving in both directions during non-peak period hours.

**Item 28 — Designated Truck Route** (Numeric; Codes)

This item is used in truck size and weight studies as an administrative identifier to determine whether a section is on or off a truck route designated under Federal regulatory authority. Code this item for all sections.

Code	Description
0	Not on a designated truck route
1	Designated truck route under <b>Federal authority</b> in 23 CFR 658.

Designated truck routes (code “1”) are those routes that are available to truck tractor and 14.63-meter (48-foot), or longer if “grandfathered”, semi trailer combinations, truck tractor and 8.53-meter (28-foot) twin trailer combinations, both subject to no overall length limits, and specialized combination vehicles such as automobile and boat transporters, maxicube vehicles, and saddle mount combinations, subject to Federal minimum overall length limits [generally 19.81 to 22.86 meters (65 to 75 feet)], all of which may be up to 2.59 meters (102 inches) wide.

Designated truck routes, shown in Appendix A to 23 CFR 658, are open to vehicles subject to Federal minimum length limits specified in Section 411 of the Surface Transportation Assistance Act (STAA) of 1982 and the Federal width limit of 2.59 meters (102 inches) specified in Section 416 of STAA. Additional routes for such vehicles may have been designated under State authority.

Do not include the following as designated truck routes for the purposes of this data item (use code “0”):

- a. Routes (or portions thereof) that simply provide “access” for these large vehicles to terminals and for food, fuel, repair, or rest services.
- b. Those routes designated only under State authority that restrict some of the trucks described above because of length or width limitations or because of time of day restrictions.

**Item 29 — Toll** (Numeric; Codes)

This item is used as an administrative identifier to determine whether a section is on or off a toll road. Toll data are also used for historic trends, policy analysis, and legislation development purposes. Code this item for all sections.

Code	Description
0	Section is non-Toll
1	Section is Toll

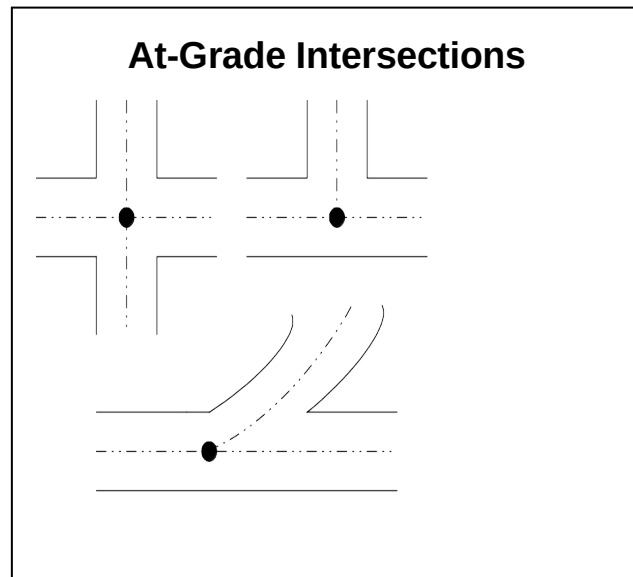
In general, code a section as toll if a fee is charged for its use. If portions of a contiguous facility can be traversed without the payment of a toll, but a toll is charged on other portions, code the entire contiguous facility as toll. This applies even if some vehicles can enter and exit from the main through route without payment of a toll. If a toll is charged in only one direction, the “free” direction is also considered to be toll. Code a facility operated by a toll authority upon which no toll is charged as non-toll.

**Item 30 — Section Length** (Numeric; Decimal)

This item provides basic inventory information on the amount of public roads. It is extensively used for apportionment, administrative, legislative, analytical, and national highway database purposes. Code this numeric data item for all sections. Report length, in kilometers (miles), as measured along the centerline of the roadway. If the state has chosen an inventory direction for data reporting on divided facilities, the length is as measured along the centerline of the inventory direction. On independently aligned, divided highways, centerline length also may be reported as the average of the lengths of the directional roadways, measured along their center lines. Report the length of the two roadways of a one-way couplet independently; do not average.

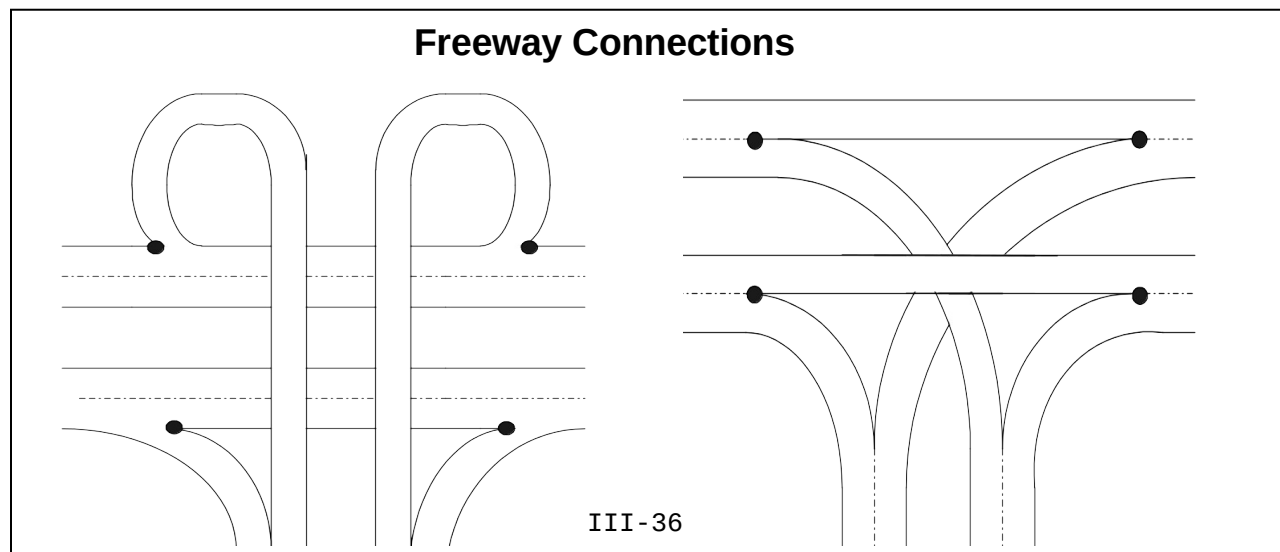
When measuring length between at-grade route intersections, use the actual center of the intersection as the point of measurement (Figure IV-1). If grade separated, measure to the theoretical center of the intersecting roadways. When a route terminates at a tee interchange, measure the length as the average of the four directional, connecting ramp lengths to the first point of intersection with the other mainline route (Figure IV-2). In all other situations, ramps are considered part of the mainline routes and their length is not reported for HPMS purposes.

When grouping homogeneous nonsample roadways (see Items 5 and 9), code the total combined length of the grouped sections. Code length to the nearest thousandth, although measurements may reflect the precision normally utilized by the State. Minimal measurement precision to at least the nearest tenth kilometer (mile) is requested. **Length cannot be zero-coded.**



**Figure IV-1. Two-Way At-Grade Intersections.**

Length is measured to the midpoint of the roadways.



**Figure IV-2. Freeway Tee Intersection.**

**Length is an average of the four connectors (Ramps) measured to the gore points.**

**Item 31 — Donut Area Sample AADT Volume Group Identifier (Numeric; Integer)**

This item is used to identify the AADT volume group for a section when an actual AADT is not reported in Item 33. Code a donut area sample volume group number (valid codes 1-5) for the section when an AADT is not coded in Item 33; when an AADT is coded, the HPMS software will assign the volume group number if the State is using the FHWA volume group ranges. The AADT or volume group must be coded for applicable universe, standard sample, and donut area supplementary sample sections for the rural minor arterial and major collector, and the small urban minor arterial and collector functional systems that are within the donut area portion of a nonattainment area. Code “0” for all other sections. The AADT ranges for each volume group number are shown in Appendix C, Table C-5.

When AADT is not known, use traffic flow maps, count data obtained from local governments, and other available data to make reasonable volume group assignments.

A discussion of NAAQS nonattainment and donut areas and a description of the donut area sampling scheme is contained in Appendix G.

**Item 32 — Standard Sample AADT Volume Group Identifier (Numeric; Integer)**

This item is used to identify the AADT volume group for a section when an actual AADT is not reported in Item 33. Code a standard sample volume group number (valid codes 1-13) for the section when an AADT is not coded in Item 33; when an AADT is coded, the HPMS software will assign the volume group number if the State is using the FHWA volume group ranges. An AADT or the volume group must be coded for applicable universe, standard sample, and donut area supplementary sample sections for all except the rural minor collector and the rural and urban local functional systems. Code “0” for all other sections. The AADT ranges for each volume group number are shown in Appendix C, Tables C-1 to C-4.

When AADT is not known, use traffic flow maps, count data obtained from local governments, and other available data to make reasonable volume group assignments.

A description of the standard sampling scheme is contained in Chapter VII.

**Item 33 — Annual Average Daily Traffic (AADT) (Numeric; Integer)**

This item provides basic existing traffic inventory information for selected sections. It is extensively used for apportionment, administrative, legislative, analytical, and national highway database purposes. Code this numeric data item for all PAS, NHS, standard sample, and donut area supplementary sample sections; leading zeros are not required. Coding is optional for remaining sections. Code “0” when AADT is not coded.

Enter the section AADT for the data year. For two-way facilities, provide the AADT for both directions; provide the directional AADT if part of a one-way couplet or for one-way streets. Since many applications, including travel estimates, are based on section AADTs, States should provide AADT values that are count-based (actual counts adjusted to represent AADT) rather than estimated values.

Update reported AADT values annually. All counts must reflect application of day of week, seasonal, and axle correction factors, as necessary. Growth factors must be applied if the AADT is not derived from current year counts. Specific guidance for the frequency and size of traffic data collection programs, factor development, age of data, and other applications is contained in Appendix F and the *Traffic Monitoring Guide*.

REMINDER: Metropolitan planning organizations and other local governmental agencies may use an average weekday traffic volume for local purposes. The HPMS requires reported AADT to be an average

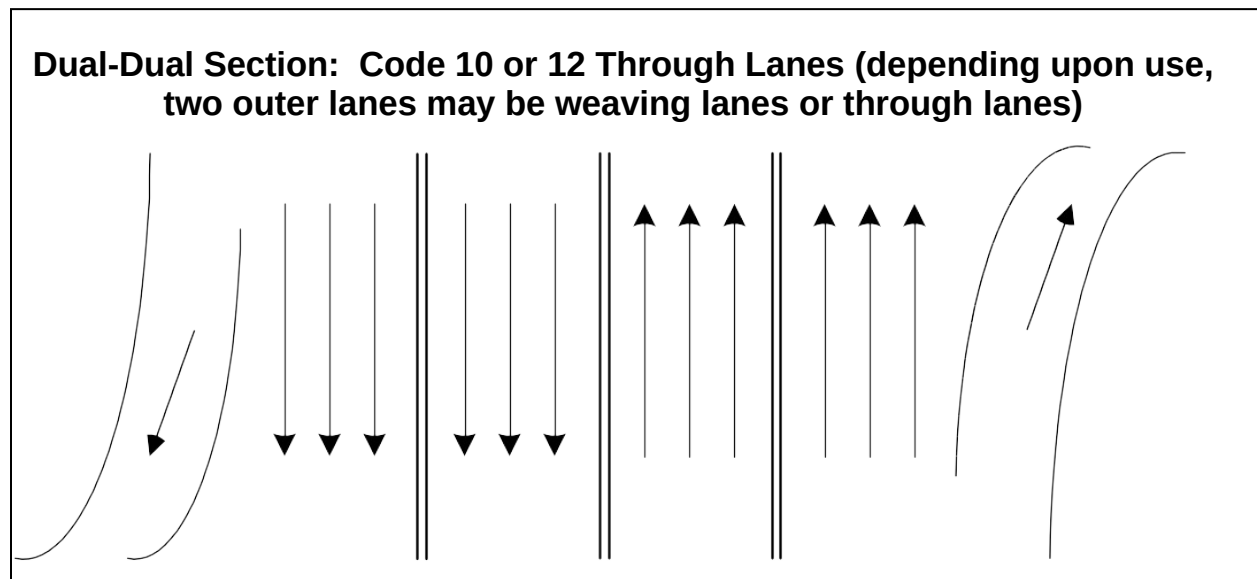
daily value that represents all days of the reporting year.

**Item 34 — Number of Through Lanes** (Numeric; Integer)

This item provides basic inventory information on the amount of public road supply. It is extensively used for apportionment, administrative, legislative, analytical, and national highway database purposes. Code this numeric data item for all HPMS sections except those on the rural minor collector and the rural and urban local functional systems; leading zeros are not required. Code “0” when data not provided.

Code the number of through lanes according to the striping, if present, on multilane facilities, or according to traffic use or State/local design guidelines if no striping or only centerline striping is present.

Enter the prevailing number of through lanes in both directions carrying through traffic in the off-peak period (Figure IV-3). Exclude what are defined as auxiliary lanes, such as collector-distributor lanes, weaving lanes, frontage road lanes, parking and turning lanes, acceleration/deceleration lanes, toll collection lanes and truck climbing lanes. See the *AASHTO Design Guide* for additional information on auxiliary lanes.



**Figure IV-3. Number of Through Lanes**

**Item 35 — Measured Pavement Roughness (IRI)** (Numeric; Decimal)

This item provides information on pavement surface roughness on selected roadway sections. It is used in investment requirements modeling to estimate pavement deterioration, section deficiencies, and needed improvements, in cost allocation studies, in pavement condition trends, and for other analysis purposes including NHS performance. Code the International Roughness Index (IRI) for paved sections in accordance with minimum reporting specifications contained in Table IV-3; IRI is required for all NHS sections regardless of functional system. IRI should be remeasured in the field on a two-year cycle; however, retain existing IRI values for sections until they are replaced by new measured values.

**Table IV-3. Roughness Reporting Requirements**

Functional System	Section Type	Roughness
<b>RURAL</b>		
Interstate	All Sections	Required
Other Principal Arterial	All Sections	Required
Minor Arterial	Standard Sample	Required
Major Collector	Standard Sample	Recommended
<b>URBAN</b>		
Interstate	All Sections	Required
Other Freeways & Expressways	All Sections	Required
Other Principal Arterial	All Sections	Required
Minor Arterial	Standard Sample	Recommended
Collector	Standard Sample	Recommended

Enter the measured IRI value to the nearest unit per length measurement, hundredths of meters/kilometer (x.xx) for the Metric system or whole inches/mile (x.0) for the English system. The entry must be in accordance with the reporting units chosen for Metric (or English) Reporting Units (Item 3). Code “0.0” for unpaved facilities and for sections for which IRI data are not provided.

Default values or values obtained by other means or conversions that are not directly obtained from measured road profiles are not to be used. However, when a pavement improvement is made on an applicable section, a temporary value for the improved section reflecting a reasonable average value for new pavement may be provided until replaced by a measured value. States are encouraged to use data from State or local pavement management systems when they are available, are current, and when they meet HPMS reporting requirements.

A PSR value is required for those standard sample sections where an IRI value is not reported. If a measured IRI value is reported for a section, a PSR value for that section is not required. **A standard sample section must have either PSR or IRI reported.**

FHWA has adopted AASHTO Provisional Standard PP37-99 as the preferred method of providing IRI data for the HPMS. Appendix E contains the AASHTO provisional standard along with recommended additional good practice guidelines and data collection procedures.

**Item 36 — Present Serviceability Rating (PSR)** (Numeric; Decimal)

This item provides information on pavement condition on selected roadway sections. It is used in investment requirements modeling to estimate pavement deterioration, section deficiencies, and needed improvements, in the cost allocation pavement model, and for national highway database purposes. Code a PSR or equivalent value, to the nearest tenth (x.x), for all paved standard sample sections where Item 35, Measured Pavement Roughness, is not reported. Code “0.0” for unpaved facilities and for sections for which PSR data are not provided. Code PSR or the Present Serviceability Index (PSI) where available. If sufficiency ratings of pavement condition are available, they may be used after a correlation between the sufficiency rating scale and the PSR scale or other rating factors is developed.

If there are no current PSR, PSI, or sufficiency ratings that can be adapted, the section can be rated using values in Table IV-4. Estimates to the nearest tenth within the applicable range should be made, e.g., 2.3. Where different lanes have different pavement condition ratings, code the worst condition.



If IRI is reported for a section, then PSR for that section is not required to be reported. **A standard sample section must have either PSR or IRI reported.**

**Table IV-4. Pavement Condition Rating (Use full range of values)**

PSR	Description
4.0 - 5.0	Only new (or nearly new) superior pavements are likely to be smooth enough and distress free (sufficiently free of cracks and patches) to qualify for this category. Most pavements constructed or resurfaced during the data year would normally be rated in this category.
3.0 - 4.0	Pavements in this category, although not quite as smooth as those described above, give a first class ride and exhibit few, if any, visible signs of surface deterioration. Flexible pavements may be beginning to show evidence of rutting and fine random cracks. Rigid pavements may be beginning to show evidence of slight surface deterioration, such as minor cracks and spalling.
2.0 - 3.0	The riding qualities of pavements in this category are noticeably inferior to those of new pavements, and may be barely tolerable for high-speed traffic. Surface defects of flexible pavements may include rutting, map cracking, and extensive patching. Rigid pavements in this group may have a few joint failures, faulting and/or cracking, and some pumping.
1.0 - 2.0	Pavements in this category have deteriorated to such an extent that they affect the speed of free-flow traffic. Flexible pavement may have large potholes and deep cracks. Distress includes raveling, cracking, rutting and occurs over 50 percent of the surface. Rigid pavement distress includes joint spalling, patching, cracking, scaling, and may include pumping and faulting.
0.0 - 1.0	Pavements in this category are in an extremely deteriorated condition. The facility is passable only at reduced speeds, and with considerable ride discomfort. Large potholes and deep cracks exist. Distress occurs over 75 percent or more of the surface.

**Item 37 — High Occupancy Vehicle (HOV) Operations** (Numeric; Codes)

This item is used to identify those roadway sections with HOV operations. Code this data item for all sections to best reflect the nature of existing HOV operations.

Code	Description
0	Section does not have HOV lanes
1	Section has exclusive HOV lanes (HOV use only; no other uses permitted)
2	Normal through lane(s) used for exclusive HOV in specified time periods
3	Shoulder/parking lane(s) used for exclusive HOV in specified time periods

**Items 38-46 — Highway Surveillance Systems** (Numeric; Codes)

These items are used to track the deployment of ITS surveillance technologies. Code these data items to best describe the nature of existing surveillance systems. Enter the appropriate code for “yes” or “no” to describe the surveillance systems. If the surveillance system affects the operation of the roadway, code this data item even if the system does not actually exist on the section (i.e., variable message signs may be mounted every few miles, but the whole roadway is affected from the first such sign to the last; all sections in between should contain the “yes”

code).

Item	No	Yes	Description
38	0	1	Section is under electronic surveillance to collect real time traffic data to monitor traffic flow.
39	0	1	Section has metered entrance ramps.
40	0	1	Section is covered by permanent variable message signs.
41	0	1	Section is covered by highway advisory radio.
42	0	1	Section is covered by surveillance cameras.
43	0	1	Section is covered by incident detection technology algorithms.
44	0	1	Section is covered by free cell phone to dedicated number other than 911, statewide DUI, etc.
45	0	1	Section is covered by publicly sponsored on-call service patrol or towing service.
46	0	1	Section has hardware needed to provide in-vehicle signing information to equipped vehicles.

**Item 47 — Sample Identifier** (Character Field)

The sample identifier is a statewide or countywide unique 12-character alphanumeric code that cannot change once it has been assigned. It is used to track standard and supplementary sample sections over time, and must never change for any reason. For existing sections, carry over the sample identifier from year to year. For a new sample section, assign a new, unique sample identifier. When an existing sample is split, assign the existing sample identifier to the section retained as the HPMS sample; see Chapter VII for a further discussion of sample splitting.

The State may change the Section Identification (Item 5) if necessary; the State Control Field (Item 8) should be used for additional State required identifiers.

**Item 48 — Donut Area Sample Expansion Factor** (Software Calculated)

Expansion factors are used to expand sampled data to represent the universe from which the sample is drawn. This value is calculated and coded to the donut area sample section by the HPMS software using the volume group information in Item 31. By definition, the expansion factor is the ratio of the total length in a volume group to the total sampled volume group length:

$$\text{Expansion Factor} = \frac{\text{Total length in the Volume Group}}{\text{Sampled length in the Volume Group}}$$

If the expansion factor for a volume group exceeds 100.000, select additional sample sections from the universe volume group until the expansion factor is reduced to a maximum of 100.000. If there are fewer than three samples in a volume group and additional universe sections are available, select additional samples from the universe volume group.

Appendix G contains a discussion of travel estimate requirements for the donut area portion of NAAQS nonattainment areas and describes the donut area sample selection and maintenance scheme.

**Item 49 — Standard Sample Expansion Factor** (Software Calculated)

Expansion factors are used to expand sampled data to represent the universe from which the sample is drawn. This value item is calculated and coded to the standard sample section by the HPMS software using the volume group information in Item 32. By definition, the expansion factor is the ratio of the total length in a volume group to the total sampled volume group length:

$$\text{Expansion Factor} = \frac{\text{Total length in the Volume Group}}{\text{Sampled length in the Volume Group}}$$

If the expansion factor for a volume group exceeds 100.000, select additional sample sections from the universe volume group until the expansion factor is reduced to a maximum of 100.000. If there are fewer than three samples in a volume group and additional universe sections are available, select additional samples from the universe volume group.

Chapter VII contains a description of the standard sample selection and maintenance scheme.

**Item 50 — Surface/Pavement Type** (Numeric; Codes)

This item details the type of pavement surface on sample roadway sections. It is used in investment requirements modeling to estimate pavement deterioration and loading history, for the cost allocation pavement model, and for the national highway database. Enter the code which best represents the type of surface on the section.

Code	Description
1	Road is unpaved.
2	<u>Low type</u> bituminous surface-treated—a bituminous surface course with or without a seal coat, the total compacted thickness of which is less than 25 millimeters (1 inch). Seal coats include those known as chip seals, drag seals, plant-mix seals, and rock asphalt seals.
3	<u>Intermediate type</u> mixed bituminous or bituminous penetration surface—a surface course 25 millimeters (1 inch) or greater and less than 178 millimeters (7 inches) in compacted thickness composed of gravel, stone, sand or similar material, and mixed with bituminous material under partial control as to grading and proportions or bound with bituminous penetration material.
4	<u>High type flexible</u> —mixed bituminous or bituminous penetration road on a flexible base with a combined surface and base thickness of 178 millimeters (7 inches) or more. Includes any bituminous concrete, sheet asphalt, or rock asphalt having a high load-bearing capacity. Includes any brick, stone, wood, or steel block pavement with or without a wearing surface of less than 25 millimeters (1 inch).
5	<u>High type rigid</u> —Portland cement concrete (PCC) pavement with or without joints; with or without mesh or similar reinforcement. Includes continuously reinforced PCC pavement, PCC pavement over a PCC pavement, either bonded, unbonded, or partially bonded, and PCC pavement over a bituminous pavement, either mixed or penetration.
6	<u>High type composite</u> —mixed bituminous or bituminous penetration road on a rigid pavement with a combined surface and base thickness of 178 millimeters (7 inches) or more. Includes any bituminous concrete, sheet asphalt or rock asphalt overlay of rigid pavement that is greater than 25 millimeters (1 inch) of compacted bituminous material; otherwise use code “5.”

**Item 51 — SN or D** (Numeric; Decimal)

This item provides specific information about the pavement section in terms of structural number [SN] for flexible pavement or thickness (depth) [D] for rigid pavement on sample roadway sections. It is used in investment requirements modeling to estimate pavement deterioration and loading history and in the cost allocation pavement model. Code this numeric item for all standard sample sections. Enter SN to the nearest tenth (xx.x) and D to the nearest whole millimeter or inch (xx.0). When known, enter the actual value; otherwise code a typical value for the functional system and pavement type based upon historic data or State practice. The SN or D value should reflect the last improvement on the section. That is, when an improvement is made, take all new or redesigned base and pavement materials into consideration when determining the appropriate value.

Code SN or D consistent with the reporting units chosen for Metric (or English) Reporting Units (Item

3). Calculate SN (a unitless number) such that the layer coefficients [value per millimeter (inch)] and the layer thicknesses [millimeters (inches)] are in the appropriate reporting unit system.

**Item 52 — General Climate Zone (Software Set)**

This item is a calculated value locating the sample section in one of nine climate zones. It is used in the cost allocation pavement model. This numeric item is coded by the HPMS software from county/climate zone equivalency tables. It should be checked and may be changed if found not to be representative of the area in question. If the county code is changed, the climate zone should be updated using the HPMS calculation software. The definitions for the nine climate zones are included in Appendix I.

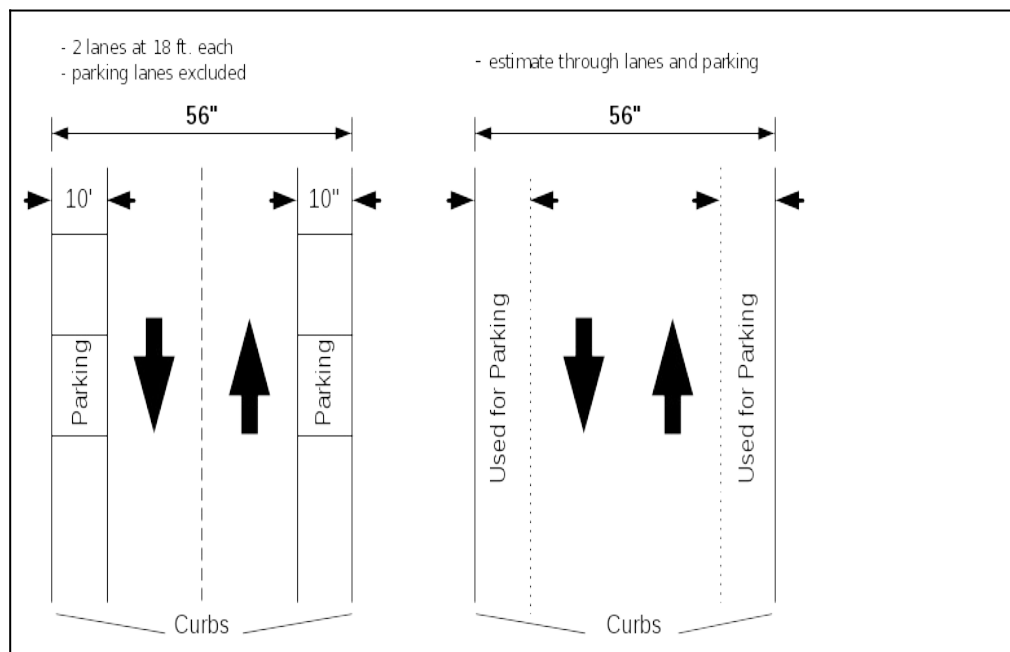
**Item 53 — Year of Surface Improvement (Numeric; Integer)**

This item is used to identify the year in which the sample section roadway surface was last improved. It is used in the cost allocation pavement model to deteriorate pavement condition. Enter the 4-digit year when the last surface improvement was completed on the section. Retain the coded improvement year in this data item until another improvement affecting the surface is completed. Code “0” if the section has not been improved since the initial reporting year (1988). Include post 1987 improvements on newly selected sample sections. Twenty-five millimeters (one inch) or more of compacted pavement material must be put in place for it to be considered a surface improvement for HPMS purposes.

**Item 54 — Lane Width (Numeric; Decimal)**

This item is a measure of existing lane width on sample roadway sections. It is used in investment requirements modeling to calculate capacity, estimate needed improvements, and compute a safety index, for cost allocation pavement models, and for other policy analysis and national highway data base purposes. Enter the prevailing through lane width to the nearest tenth of a meter (x.x) or whole foot (x.0). Code according to the reporting units chosen for Metric (or English) Reporting Units (Item 3).

Lane width should be coded according to where the pavement/shoulder surface changes, or to the pavement lane striping if the shoulder and pavement surface are the same, or according to traffic use or State/local design guidelines if no striping or only centerline striping is present. For example, the number of through lanes in Figure IV-4 would probably be 2; deducting 3



meters (10 feet) for parking on each side would leave width for two 5.5 meter (18 foot) lanes. Number of through lanes (Item 34) and lane width would be coded accordingly.

Where there is no delineation between the through traffic lane and the shoulder or parking lane, or

where there is no centerline, estimate a reasonable split between the actual width used by traffic and the

shoulder or parking lane based on State/local design guides.

**Figure IV-4. Lane Width**

**Item 55 — Access Control** (Numeric; Codes)

This item is a measure of the degree of access control on sample roadway sections. It is used in investment requirements modeling to calculate capacity and estimate type of design, in truck size and weight studies, and for national highway data base purposes. Code the type of access control for all standard sample sections.

Code	Description
1	<b>Full Access Control:</b> Preference given to through traffic movements by providing interchanges with selected public roads and by prohibiting crossing at grade and direct driveway connections.
2	<b>Partial Access Control:</b> Preference given to through traffic movement. In addition to interchanges, there may be some crossings at-grade with public roads, but direct private driveway connections have been minimized through the use of frontage roads or other local access restrictions. Control of curb cuts is not access control.
3	<b>No Access Control:</b> Include all sections that do not meet the criteria above.

**Item 56 — Median Type** (Numeric; Codes)

This item is a characterization of the type of median on sample roadway sections. It is used in investment requirements modeling to calculate capacity and estimate type of design and for national highway data base purposes. Code the type of median for all standard sample sections.

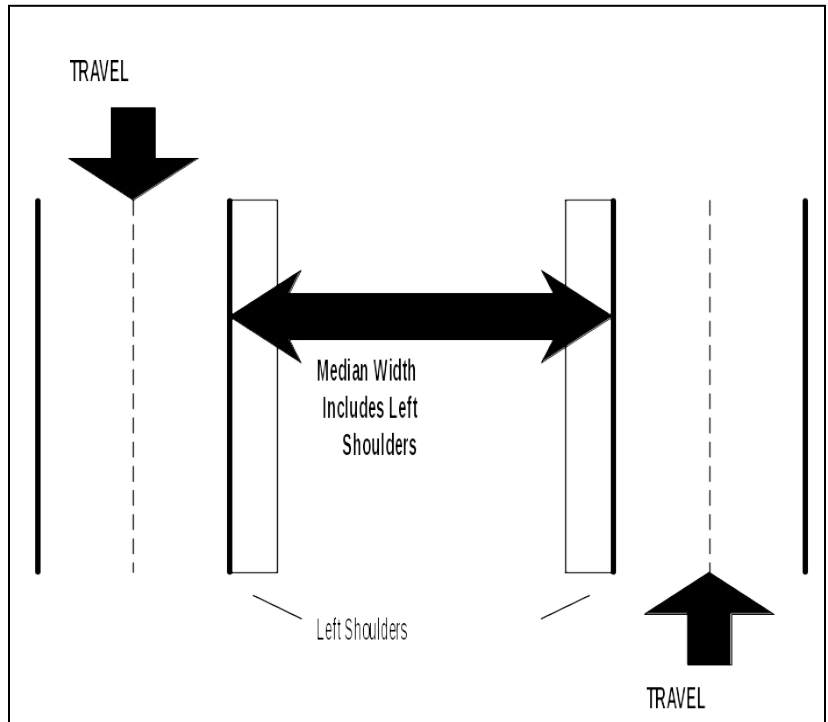
Code	Description
1	Curbed
2	Positive Barrier
3	Unprotected
4	None

A positive barrier normally consists of a guardrail or concrete barrier, but could consist of thick, impenetrable vegetation. Turning lanes or bays are not considered medians unless the turning lanes/bays are cut into an existing median at intersections, entrance drives, etc; a continuous turning lane is not a median. Use code “3” if an unprotected median is at least 1.2 meters (4 feet) wide; otherwise, use code “4,” None.

**Item 57 — Median Width** (Numeric; Decimal)

This item is a measure of existing median width on sample roadway sections. It is used in investment requirements modeling to calculate capacity and estimate type of design and for national highway data base purposes. Code the median width for all standard sample sections. Code according to the reporting units chosen for Metric (or English) Reporting Units (Item 3).

Enter the predominant median width including left shoulders, if any, measured between the inside edges of the through lanes, to a tenth of a meter (x.x) or the nearest foot (x.0). Enter “0.0” where Item 56 is coded “4.” Enter “999.9” where the median width is 30 meters or 100 feet or greater. Ignore turning bays cut into the median. See Figure IV-5.



**Figure IV-5. Median Measurement.**

**Item 58 — Shoulder Type** (Numeric; Codes)

This item provides information on the type of existing shoulders on sample roadway sections. It is used in investment requirements modeling to estimate needed improvements. Enter the code for the type of shoulder on the section. If the shoulder type changes back and forth along the length of the section, code the predominant type. If left and right shoulder types differ on a divided facility, code the right shoulder type as the predominant type. If there is a shoulder in front of a barrier curb, code the shoulder type and width, but do not code as a shoulder the area behind a barrier curb. Ignore mountable curbs for reporting purposes; if there is a shoulder either in front of or behind a mountable curb, code the shoulder type and width. If the section has parking abutting the through lane, there cannot be a shoulder; if a bike lane abuts the through lane, there cannot be a shoulder unless it is a combined shoulder/bike lane. If there is parking on one side of a divided roadway and a shoulder or a curb on the other side, code both parking and shoulder type and width accordingly. A shoulder cannot exist between a traffic lane and a parking lane. If a bike lane or parking is completely separated from the roadway, it should not be considered.

Code	Description
1	None: No shoulders or curbs exist.
2	Surfaced shoulder exists (bituminous concrete or Portland cement concrete surface).
3	Stabilized shoulder exists (stabilized gravel or other granular material with or without admixture).
4	Combination shoulder exists (shoulder width has two or more surface types; for instance, part of the shoulder width is surfaced and a part of the width is earth, etc.).
5	Earth shoulder exists.



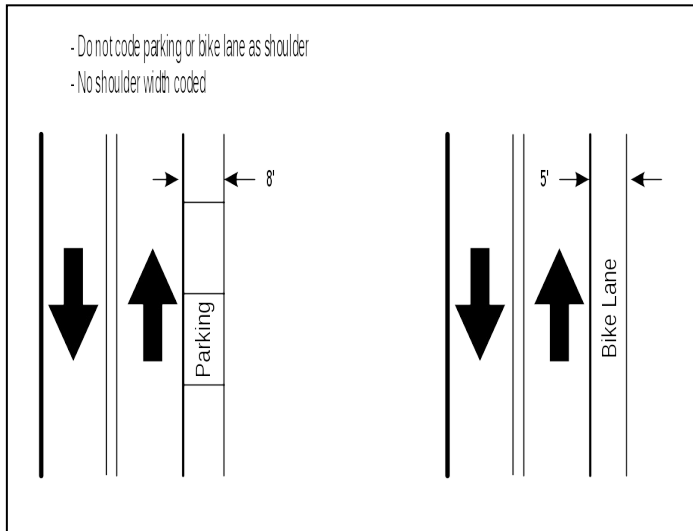
6	Barrier curb exists; no shoulders in front of curb.
---	---

**Item 59 — Right Shoulder Width** (Numeric; Decimal)

This item measures the existing shoulder width on sample roadway sections. It is used in investment requirements modeling to calculate capacity and estimate needed improvements. Enter the width of the right shoulder to the nearest tenth of a meter (x.x) or whole foot (x.0). Code “0.0” if no right shoulder exists. Refer to Item 58 and Figures IV-6A-C for additional coding details. Do not include parking or bicycle lanes in the shoulder width measurement; code the predominant width where it changes back and forth along a roadway section; ensure that the total width of combination shoulders is reported. Include rumble strips and gutter pans in shoulder width.

**Figure IV-6A. Shoulder Type/Width**

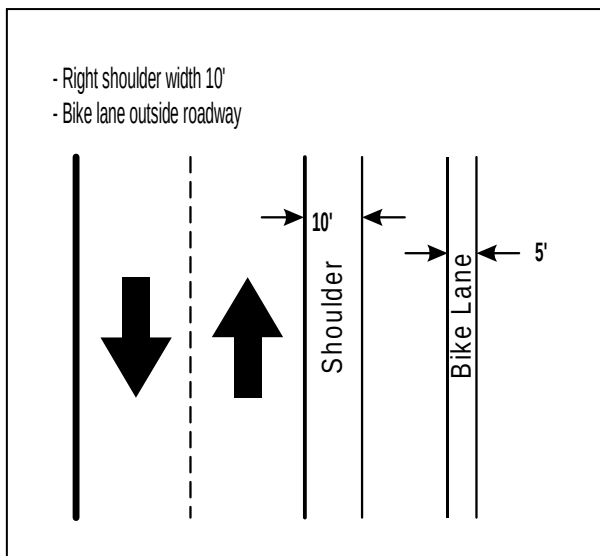




**Item 60 — Left Shoulder Width**

(Numeric; Decimal)

This item measures the existing shoulder width on sample roadway sections. It is used in investment requirements modeling to calculate capacity and estimate needed improvements. On divided highways, enter the width of the left (median) shoulder to the nearest tenth of a meter (x.x) or whole foot (x.0). Code “0.0” where no left shoulder exists or if the section is undivided. Refer to Item 58 and Figures IV-6A-C for additional coding details. Do not include parking or bicycle lanes in the shoulder width measurement; code the predominant width where it changes back and forth along a roadway section; ensure that the total width of combination shoulders is reported. Include rumble strips and gutter pans in shoulder width.

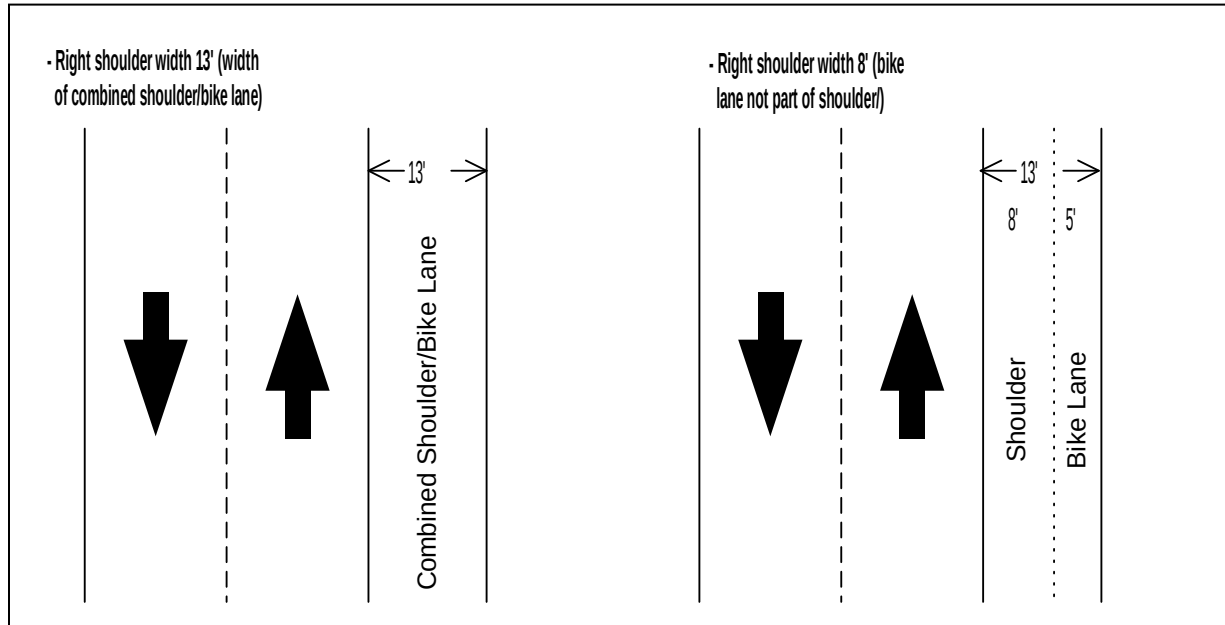


**Figure IV-6B. Shoulder Type/Width**

**Item 61 — Peak Parking** (Urban Data Item) (Numeric; Codes)

This item provides specific information about the presence of peak parking on urban sample roadway sections. It is used in investment requirements modeling to calculate capacity on sections with signals. Enter the code that best reflects the type of peak parking that exists on the section. Code to reflect permitted use; code permitted parking even if the section is not formally signed or striped for parking. If parking is actually beyond the shoulder or the pavement edge where there is no shoulder, use code “3” for no parking. If parking lanes are legally used for through traffic or turning lanes during the peak-hour, code the appropriate in-use condition.

Code	Description
0	Not Applicable; Section is Rural
1	Parking Allowed One Side
2	Parking Allowed Both Sides
3	No Parking Allowed or None Available



**Figure IV-6C. Shoulder Type/Width**

**Item 62 — Widening Feasibility** (Numeric; Codes)

This item provides a measure of whether it is feasible to widen an existing sample section. It is used in investment requirements modeling to estimate needed capacity improvements. Enter the code which best represents the extent to which it is feasible to widen the existing road. Consider mainly the physical features along the roadway section, such as large single family residences or office buildings, shopping centers and other large enterprises, severe terrain, cemeteries, wet lands, and park land, as well as where widening would be otherwise cost or environmentally prohibitive. Do not consider restrictions because of current right-of-way width, State practices concerning widening, politics, or projected traffic.

The code is to represent the lanes that could be added in both directions; e.g., if a lane could be added for each direction of the roadway, then use code “4”; if one full lane only can be added, use code “3”; if only minor widening or widening narrow lanes can occur, use code “2”. Restriping to narrower lanes, resulting in an additional lane on a multilane facility, does not constitute widening feasibility. When coding this item, also consider medians and other areas already within the right-of-way to be available for widening.

Code	Description
1	No Widening is Feasible
2	Yes, Partial Lane
3	Yes, One Lane
4	Yes, Two Lanes
5	Yes, Three Lanes or More

**Items 63-68 — Curves by Class** (Numeric; Decimal)

These items provide specific information regarding the length of horizontal curves by degree of curvature for sample sections. They are used in investment requirements modeling to calculate horizontal alignment adequacy and estimate running speed and operating costs. Code for paved rural arterials and urban principal arterials in accordance with Table IV-5. Curves by class may be coded for other functional systems if the data are available; code “0.0” when curve data are not reported. When this item is not reported for the required rural systems, code Horizontal Alignment Adequacy (Item 69).

**Table IV-5. Coding Guide for Curves and Grade by Class.**  
(Items 63-69 & 71-77)

Highway Category	Items 63-68	Item 69	Items 71	Item 72-77
	Curves by Class	Horizontal Alignment Adequacy	Vertical Alignment Adequacy	Grades by Class
<b>PAVED - RURAL</b>				
Principal Arterial	Required	Software Coded	Software Coded	Required
Minor Arterial	Required	Software Coded	Software Coded	Required
Major Collector	Not Required	Required	Required	Not Required
<b>PAVED - URBAN</b>				
Principal Arterial	Required	Not Required	Not Required	Required
Minor Arterial	Not Required	Not Required	Not Required	Not Required
Collector	Not Required	Not Required	Not Required	Not Required

Each curve and tangent segment is coded as a separate curve; segments are summed by curve class to obtain the total length in each class. Report the sum of the class lengths for each of the six curve classes in kilometers (miles); the sum of all curve lengths must equal the section length. Code according to the reporting units chosen for Metric (or English) Reporting Units (Item 3); when reporting in Metric units, curve classes are identified by the radius length in meters. They are approximately equivalent to the English unit degree of curvature classes

shown below:

Item	Curve Classes			Length of Curves in Class (to 3 decimals) xx.xxx
	Curve Class	Radius Length (Metric)	Degree of Curvature (English)	
63	A	506+	0.0- 3.4	—
64	B	321- 505	3.5-5.4	—
65	C	206- 320	5.5- 8.4	—
66	D	126- 205	8.5-13.9	—
67	E	61- 125	14.0-27.9	—
68	F	<61	28+	—

**Item 69 — Horizontal Alignment Adequacy** (Rural Data Item)(Software Calculated)

This item provides information about the adequacy of horizontal alignment when curve data are not reported. It is used in investment requirements modeling to estimate horizontal alignment deficiencies and in the truck size and weight analyses. Code for all paved sample sections unless Curves by Class (Items 63 - 68) are coded for the section. (See Table IV-5.) If curves by class are coded, horizontal alignment adequacy will be calculated for paved sections from the curve data. Use the following codes:

Code	Description
0	Curve data are reported or this item is not required for the section.
1	All curves meet appropriate design standards for the type of roadway. Reduction of curvature would be unnecessary even if reconstruction were required to meet other deficiencies (i.e., capacity, vertical alignment, etc.).
2	Although some curves are below appropriate design standards for new construction, all curves can be safely and comfortably negotiated at the prevailing speed limit on the section. The speed limit was not established by the design speed of curves.
3	Infrequent curves with design speeds less than the prevailing speed limit on the section. Infrequent curves may have reduced speed limits for safety purposes.
4	Several curves uncomfortable or unsafe when traveled at the prevailing speed limit on the section, or the speed limit on the section is severely restricted due to the design speed of curves.

**Item 70 — Type of Terrain** (Rural Data Item)(Numeric; Codes)

This item provides information on the type of terrain through which the sampled roadway passes. It is used in investment requirements modeling to calculate capacity and estimate needed capacity improvements and in the truck size and weight analysis process. For all rural sample sections, enter the code that best characterizes the terrain classification for the sampled roadway. In coding this item, consider the terrain of an extended length of the roadway upon which the sample is located rather than the grade on the specific sample section by itself. The extended roadway section may be several miles

long and contain a number of upgrades, downgrades, and level sections; for long sample sections, such as rural freeway samples extending between interchanges, the extended roadway section and the sample section may be the same. Code according to the following table:



Code	Terrain Type
0	Not Applicable; this is an Urban Section.
1	<b>Level:</b> Any combination of grades and horizontal or vertical alignment that permits heavy vehicles to maintain the same speed as passenger cars; this generally includes short grades of no more than 2 percent.
2	<b>Rolling:</b> Any combination of grades and horizontal or vertical alignment that causes heavy vehicles to reduce their speeds substantially below those of passenger cars but that does not cause heavy vehicles to operate at crawl speeds for any significant length of time.
3	<b>Mountainous:</b> Any combination of grades and horizontal or vertical alignment that causes heavy vehicles to operate at crawl speeds for significant distances or at frequent intervals.

**Item 71 — Vertical Alignment Adequacy** (Rural Data Item)(Software Calculated)

This item provides information about the adequacy of vertical alignment when grade data are not reported. It is used in investment requirements modeling to estimate vertical alignment deficiencies. Code for all paved sample sections unless Grades by Class (Items 72 - 77) are coded for the section. (See Table IV-5.) If grades by class are coded, vertical alignment adequacy will be calculated for all paved sections from the grade data. Use the following codes:

Code	Description
0	Grade data are reported or this item is not required for the section.
1	All grades (rate and length) and vertical curves meet minimum design standards appropriate for the terrain. Reduction in rate or length of grade would be unnecessary even if reconstruction were required to meet other deficiencies (i.e., capacity, horizontal alignment, etc.).
2	Although some grades (rate and/or length) and vertical curves are below appropriate design standards for new construction, all grades and vertical curves provide sufficient sight distance for safe travel and do not substantially affect the speed of trucks.
3	Infrequent grades and vertical curves that impair sight distance or affect the speed of trucks (when truck climbing lanes are not provided).
4	Frequent grades and vertical curves that impair sight distance or severely affect the speed of trucks; truck climbing lanes are not provided.

**Items 72-77 — Grades by Class** (Numeric; Decimal)

These items provide specific information regarding the length of vertical grades by percent gradient for sample sections. It is used in investment requirements modeling to calculate vertical alignment adequacy and estimate running speed and operating costs and in the truck size and weight analysis process. Code for paved rural arterials and urban principal arterials in accordance with Table IV-5. Grades by class may be coded for other functional systems if the data are available; code "0.0" when grade data are not reported. When this item is not reported for the required rural systems, code Vertical Alignment Adequacy (Item 71).

Each grade and flat segment is coded as a separate segment; segments are typically measured between vertical points of intersection (VPI) and summed by grade class to obtain the total length in each class. Report the sum of the class lengths for each of the six grade classes in kilometers (miles); the sum of all grade lengths must equal the section length. Code according

to the reporting units chosen for Metric (or English) Reporting Units (Item 3). Report the following data:

Item	Grade Class	Grade Classes by Gradient (Percent)	Length of Grades in Class (to 3 decimals) xx.xxx
72	A	0.0-0.4	—
73	B	0.5-2.4	—
74	C	2.5-4.4	—
75	D	4.5-6.4	—
76	E	6.5-8.4	—
77	F	8.5+	—

**Item 78 — Percent Passing Sight Distance** (Rural Data Item)(Numeric; Integer)

This item provides specific information on the percent of the sample section meeting the sight distance requirement for passing. It is used in investment requirements modeling to calculate capacity and estimate running speed and for truck size and weight analysis purposes. Code this numeric item for all rural, paved two-lane sample sections. Enter the percent of the section length that is striped for passing. Where there is a discernable directional difference, code for the more restrictive direction. Code “0” for nonapplicable sections as well as for very curved or very hilly sections without passing zones.

**Item 79 — Weighted Design Speed** (Software Calculated)

This item is a calculated value that provides a design speed weighted by the length of individual horizontal curves and tangents in a sample section. It is used in investment requirements modeling to calculate capacity and estimate needed capacity improvements. This item is calculated by the HPMS software from curve data; when curve data are not provided, a default value based upon functional system and facility type is used as shown in the following table.

Facility Type	Functional Class								
	1	2	6	7	11	12	14	16	17
Multilane Divided	70	70	70	65	70	70	70	60	55
Multilane Undivided	70	70	70	60	70	70	70	55	45
2/3 Lane	70	70	65	60	70	65	65	55	45

**Item 80 — Speed Limit** (Numeric; Integer)

This item provides information on the posted speed limit on sample sections. It is used in investment requirements modeling to estimate running speed and for other analysis purposes, including delay estimation. Enter the daytime speed limit for automobiles posted or legally mandated on the greater part of the section. Code according to the reporting units chosen for Metric (or English) Reporting Units (Item 3). If there is no legally mandated maximum daytime speed limit for automobiles, code “999”.

**Item 81 — Percent Peak Single Unit Trucks** (Numeric; Integer)

This item provides information on truck use on a sample section. It is used in investment requirements modeling to calculate capacity and design volumes. Code this item with the percent from Item 82 unless the State has determined that the percent of trucks in the peak period is different from the average daily percent trucks. Some routes, such as urban commuter or recreational routes, may exhibit significant

differences in truck percentages between peak period and average daily operation; these differences may have a significant impact on route capacity. In cases where the State determines that differing peak period operations have a significant bearing on route capacity, code a separate peak usage value for the section, even if it is an estimated value.

**Item 82 — Percent Average Daily Single Unit Trucks** (Numeric; Integer)

This item provides information on truck use on a sample section. It is used in investment requirements modeling to estimate pavement deterioration and operating speeds, in the cost allocation pavement model, and in the truck size and weight analysis process. Code single unit truck traffic as a percentage of section AADT to the nearest whole percent. This value should be representative of all single unit truck activity over all days of the week and seasons of the year as a percent of total annual traffic. Single unit trucks include vehicle classes 4 through 7 (buses through four-or-more axle, single-unit trucks). Further information on vehicle classes is included in Chapter III. Section specific measured values are requested. If not available, use values derived from classification station data on the same route or on a similar route with similar traffic in the same area. Avoid using a single statewide value or statewide values by functional system.

**Item 83 — Percent Peak Combination Trucks** (Numeric; Integer)

This item provides information on truck use on a sample section. It is used in investment requirements modeling to calculate capacity and design volumes. Code this item with the percent from Item 84 unless the State has determined that the percent of trucks in the peak period is different from the average daily percent trucks. Some routes, such as urban commuter or recreational routes, may exhibit significant differences in truck percentages between peak period and average daily operation; these differences may have a significant impact on route capacity. In cases where the State determines that differing peak period operations have a significant bearing on route capacity, code a separate peak usage value for the section, even if it is an estimated value.

**Item 84 — Percent Average Daily Combination Trucks** (Numeric; Integer)

This item provides information on truck use on a sample section. It is used in investment requirements modeling to estimate pavement deterioration and operating speeds, in the cost allocation pavement model, and in the truck size and weight analysis process. Code combination truck traffic as a percentage of section AADT to the nearest whole percent. This numeric value should be representative of all combination truck activity over all days of the week and seasons of the year as a percent of total annual traffic. Combination trucks include vehicle classes 8 through 13 (four-or-less axle, single-trailer trucks through seven-or-more axle, multi-trailer trucks). Further information on vehicle classes is included in Chapter III. Section specific measured values are requested. If not available, use values derived from classification station data on the same route or on a similar route with similar traffic in the same area. Avoid using a single statewide value or statewide values by functional system.

**Item 85 — K-Factor** (Numeric; Integer)

This item provides the design hour volume as a percent of AADT for a sample section. It is used in investment requirements modeling to calculate capacity and estimate needed capacity improvements, in the cost allocation pavement model, and for other analysis purposes, including delay estimation. Code the K-factor for the section to the nearest percent. The K-factor is the design hour volume (30th highest hour) as a percentage of the annual average daily traffic. Section specific values are requested. If not available, use values derived from continuous count station data on the same route or on a similar route with similar traffic in the same area. Avoid using a single statewide value or statewide values by functional system. The K-Factor normally ranges from 6 to 18 percent.

**Item 86 — Directional Factor** (Numeric; Integer)

This item provides the percent of design hour volume flowing in the peak direction on a sample section. It is used in investment requirements modeling to calculate capacity and estimate needed capacity improvements, in congestion, delay, and other analyses, and in the cost allocation pavement model. Enter the percentage of the design hour volume (30th highest hour) flowing in the peak direction. Code “100” for one-way facilities. Section specific values are requested. If not available, use values derived from continuous count station data on the same route or on a similar route with similar traffic in the same area. Avoid using a single statewide value or statewide values by functional system. The directional factor normally ranges from 50 to 70 percent.

**Item 87 — Number of Peak Lanes** (Numeric; Integer)

This data item is used to provide information on the number of lanes used in the peak hour direction of flow on a sample section. It is used in investment requirements modeling to calculate capacity, and in congestion analyses, including estimates of delay. Code the number of through lanes used in the peak period in the peak direction. Include reversible lanes, parking lanes, or shoulders that legally are used for through traffic whether for SOV or HOV operation. For rural 2- or 3-lane sections, code the number of through lanes in both directions in the peak period. The number of peak lanes is used in the HCM-based capacity calculation procedure (see Appendix N).

**Items 88-89 — Left/Right Turning Lanes** (Urban Data Items)(Numeric; Codes)

These items provide information on the presence of turning lanes at a typical intersection on a sample section. They are used in investment requirements modeling to calculate capacity and in congestion analyses, including estimates of delay. Enter the code from the following tables that best describes the peak-period turning lane operation on the inventory section. Where peak capacity for a section is governed by a particular intersection that is on the section, code the turning lane operation at that location; otherwise code for a typical intersection. Code turning lanes and the percent green time for the same intersection. Include turning lanes that are located at entrances to shopping centers, industrial parks, and other large traffic generating enterprises as well as public cross streets.

Code a continuous turning lane with painted turn bays as a continuous turning lane. Code a through lane that becomes an exclusive turning lane at an intersection as a turning lane (see Figure IV-8); however, if through and turning movements can be made from a lane at an intersection, it is not a turning lane.

**Examples:**

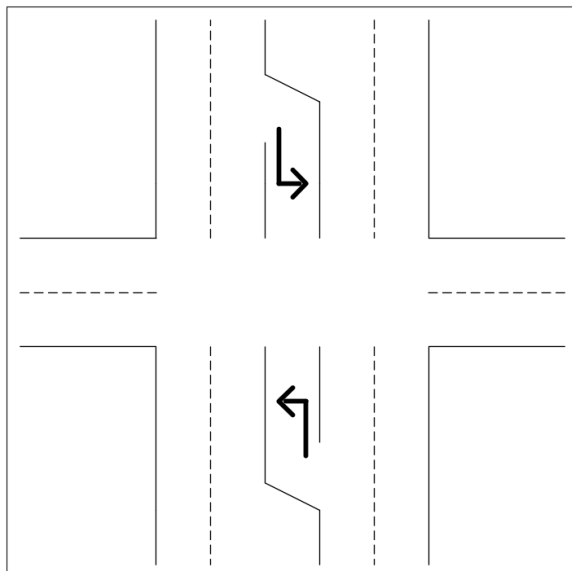
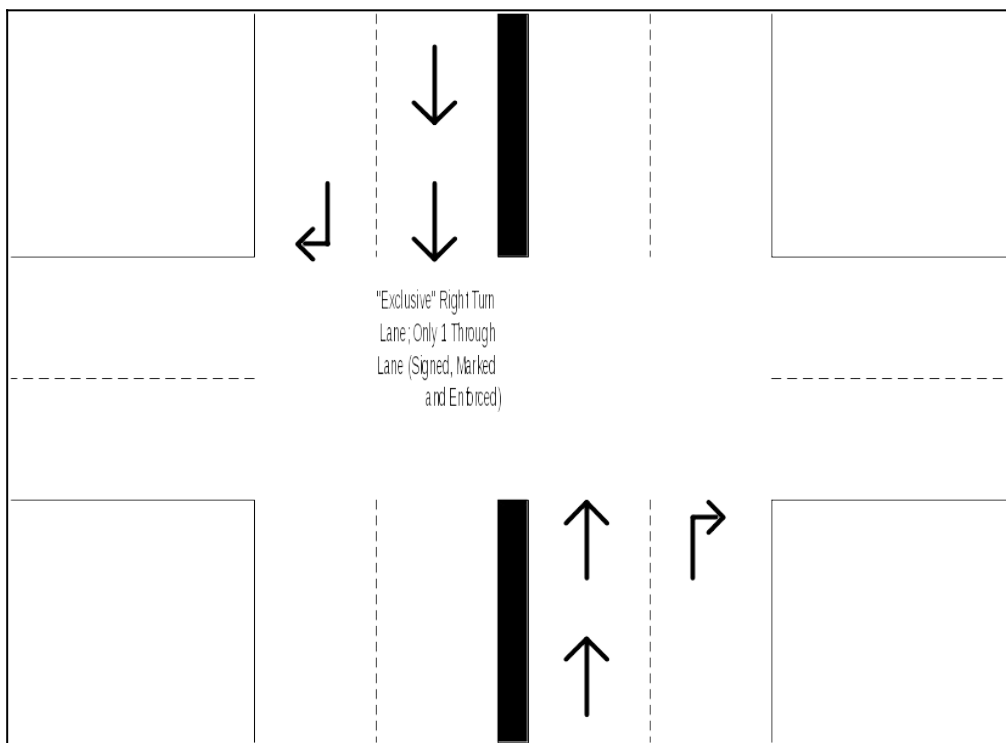


Figure IV-7 contains a section that has a single left turn lane, and nothing for the right turns; both left and right turns are permitted in the peak period. Code “3” for Item 88 (turns permitted; a single left turning lane exists) and “4” for Item 89 (turns permitted; no right turning lanes exist). There are four through lanes (Item 34) and two peak period through lanes (Item 87).

### Figure IV-8. Exclusive Right Turn Lane

Figure IV-8 contains what appears to be four through lanes, but one in each direction becomes an exclusive right turn lane at the intersection; both left and right turns are permitted in the peak period. The correct codes would be “4” for Item 88 (turns permitted; no left turning lanes exist) and “3” for Item 89 (a single right turning lane exists). The number of through lanes is 2 (Item 34) and the number of peak period through lanes is 1 (Item 87).

### Figure IV-7. Left Turn Lanes



#### Item 88 — Left Turn Lane Codes (Numeric; Codes)

Code	Description
0	Not applicable; this is a rural section or <b>no intersections exist on the section.</b>
1	Turns permitted; multiple exclusive left turning lanes exist. Through movements are prohibited in these lanes. Multiple turning lanes allow for simultaneous turns from all turning lanes.

2	Turns permitted; a continuous exclusive left turning lane exists from intersection to intersection. Through movements are prohibited in this lane.
3	Turns permitted; a single exclusive left turning lane exists.
4	Turns permitted; no exclusive left turning lanes exist.
5	No left turns are permitted during the peak period.

**Item 89 — Right Turn Lane Codes** (Numeric; Codes)

Code	Description
0	Not applicable; this is a rural section or <b>no intersections exist on the section.</b>
1	Turns permitted; multiple exclusive right turning lanes exist. Through movements are prohibited in these lanes. Multiple turning lanes allow for simultaneous turns from all turning lanes.
2	Turns permitted; a continuous exclusive right turning lane exists from intersection to intersection. Through movements are prohibited in this lane.
3	Turns permitted; a single exclusive right turning lane exists.
4	Turns permitted; no exclusive right turning lanes exist.
5	No right turns are permitted during the peak period.

**Item 90 — Prevailing Type of Signalization** (Urban Data Item)(Numeric; Codes)

This item describes the predominant type of signal system on a sample section. It is used in the investment requirements modeling process to calculate capacity and estimate delay. Enter the code that best describes the predominant type of signal system for the direction of travel on the inventory section. Signal information may be coded for rural sections on an optional basis.

Code	Description
0	Not applicable; this is a rural section.
1	Uncoordinated Fixed Time (may include pre-programmed changes for peak or other time periods).
2	Traffic Actuated.
3	Progressive (coordinated signals through several intersections).
4	No signal systems exist.

**Item 91 — Typical Peak Percent Green Time** (Urban Data Item)(Numeric; Integer)

This item provides information on the typical through lane percent green time in effect at intersections on a sample section. It is used in investment requirements modeling to calculate capacity and in congestion analyses, including estimates of delay. Enter the percent green time in effect during the peak period for through traffic at signalized intersections for the direction of travel on the inventory section; percent green time may be coded for rural sections on an optional basis. Where peak capacity for a section is governed by a particular intersection that is on the section, code the percent green time at that location; otherwise code for a typical intersection. Code the percent green time for the same intersection where Items 88 and 89 are coded. Code "0" if no signalized intersections exist or if the section is rural. Use results of a field check of several peak period light cycles to determine a "typical" green time for traffic actuated/demand responsive traffic signals. Ignore separate green-arrow time for turning movements.

**Items 92-94 — Number of At-Grade Intersections** (Numeric; Integer)

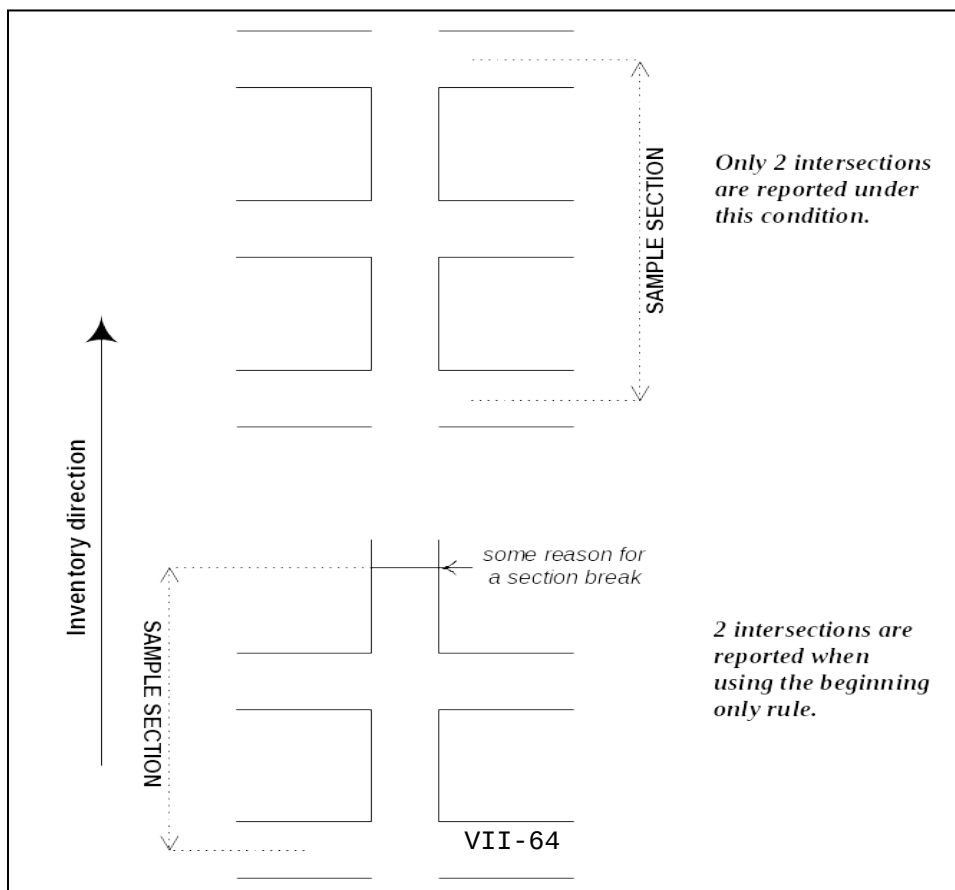
These items provide a count of the number of intersections and traffic controls on the sample section. They are used in investment requirements modeling to calculate capacity and estimate delay. Code the number of intersections on the inventory route according to the following table. Include at-grade intersections at entrances to shopping centers, industrial parks, and other large traffic generating enterprises.

Item	Description
92	<b>Signals:</b> Enter the number of at-grade intersections with a signal controlling traffic on the inventory route. A signal that cycles through red, yellow, and green for all or a portion of the day should be counted as a signalized intersection. If none, enter "0."
93	<b>Stop Signs:</b> Enter the number of at-grade intersections with a stop sign controlling traffic on the inventory route. A continuously operating, flashing red signal should be counted as a stop sign control. If none, enter "0".
94	<b>Other or No Controls:</b> Enter the number of at-grade intersections where traffic on the inventory route is not controlled by either a signal or a stop sign; or is controlled by other types of signing; or has no controls. A continuously operating, flashing yellow signal should be considered as "other or no control." If none, enter "0."

Care needs to be taken to prevent over counting. Special treatment is required when a sample section begins and/or ends with a counted data item. This is accomplished by doing the following:

- Choose a statewide direction for inventory (South to North, West to East, etc.)
- Choose a statewide rule to always count the beginning only or the ending only, but never both
- Count and report accordingly

In the upper portion of Figure IV-9, the intersection count is the same (2) using either the beginning only or ending only rule. In the lower portion of Figure IV-9, a count of two results using the bottom to top inventory direction and the beginning only rule. If the inventory direction remains bottom to top, but the ending only rule is followed, the count is only one.



**Figure IV-9. Count Items**



**Item 95 — Peak Capacity** (Software Calculated)

This item provides existing peak hour capacity for a sample section. It is used in investment requirements modeling to calculate capacity, in the cost allocation pavement model, and in congestion, delay, and other analyses.

The rural and urban peak capacity values are calculated by procedures in the HPMS software provided to the States. The procedures used in the software for determining highway capacity conform to the Highway Capacity Manual (HCM). The capacity calculations are based on service flow rates for level of service E. Capacity calculation procedures are described in Appendix N.

All urban capacity is for the peak direction as is rural capacity for freeways and other multi-lane facilities. If a rural facility has 2 or 3 lanes with one-way operation, it is considered to be a multi-lane facility for determining capacity. The capacity for rural facilities with 2 or 3 lanes and two-way operation is for both directions.

The state may override the calculated capacity if it determines that the capacity is too low or too high because of operational conditions that are not appropriately reflected in the HPMS data items used in the calculation.

**Figure IV-9, Count Items****V/SF** (Software Calculated)

This item is a computed value reflecting peak hour congestion for a sample section. It is used in investment requirements modeling to estimate needed capacity improvements, in the national highway database, and for congestion, delay, and other data analyses. This value is generated by the HPMS software from HPMS data; procedures are described in Appendix N.

**Item 97 — Future AADT** (Numeric; Integer)

This item provides forecast AADT information for a sample section. It is used in investment requirements modeling to estimate deficiencies and future improvement needs, in the cost allocation pavement model and in other analytical studies. Code the forecasted two-way AADT for the year coded in Item 98, Year of Future AADT. The intent is to include a 20-year forecast in the HPMS but the estimate may be for some other period of time within an 18 to 25 year time span. This item may be updated at any time but must be updated when the forecast falls below 18 years.

Future AADT should come from a technically supportable State procedure or data from MPOs or other local sources. HPMS forecasts for urbanized areas should be consistent with those developed by the MPO at the functional system and urbanized area level.

For example, the expanded HPMS sample value of travel for the urban OF&E functional system in an urbanized area should be consistent with the MPO travel forecast for that functional system. Total travel from the expanded HPMS sample for all functional systems in an urbanized area should also be consistent with total travel estimates produced by MPO models.

Link-by-link comparisons may not be possible to attain due to differences in the MPO network and the on-the-ground road system covered by the HPMS.

**Item 98 — Year of Future AADT** (Numeric; Integer)

This item provides the year for which the AADT has been forecast. It is used to normalize the forecast AADT to a consistent 20-year horizon. Enter the four-digit year for which Future AADT (Item 97) has been forecasted. This cannot be for less than 18 years nor more than 25 years from the data year (Item 1).

## CHAPTER V

### LINEAR REFERENCING SYSTEM REQUIREMENTS

In the past, HPMS data has been analyzed and viewed as tables, charts, and graphs. Furthermore, any analysis of HPMS data could only include data fields contained within the HPMS with little opportunity to use information outside it. With the advent of Geographic Information Systems (GIS), a new spatial dimension is now being introduced into HPMS analysis.

What is GIS? Within the context of this chapter, it is sufficient to say it is a way to view and analyze data spatially using specialized software. What this means is that previously discrete databases can now be related together and examined; a relationship that exists through the spatial coordinates these data share. While there are a variety of methods used to locate objects in the real world, the most commonly used among State Departments of Transportation (DOTs) are Linear Referencing Systems (LRS). This chapter contains the requirements for reporting the State's LRS data. The guidelines presented will allow the State to submit its LRS information in a format that will allow it to be incorporated into the FHWA's GIS.

The GIS will advance HPMS state-of-the-art and will enable FHWA, the States, and others to analyze HPMS data for rural arterials, urban principal arterials, and other NHS roadways within a spatial context. The ability to integrate data through GIS will result in enhanced analysis and presentation of the HPMS data State and Nation wide. Introducing this spatial component facilitates greater versatility of the HPMS in its application and integration with other databases, and enables the HPMS to meet the increasing demands placed on it as a transportation analytical and management tool. The HPMS GIS is an important step to increase the effectiveness of HPMS as an information system. **The LRS information submitted in accordance to Chapter V is in addition to the LRS information reported in Chapter IV.**

The LRS reported in this chapter will be integrated into the National Highway Planning Network (NHPN). The NHPN is the database that contains the geographic or spatial locations of the Nation's principal highways. The NHPN, initially developed in a separate mid-1980's effort sponsored by FHWA, is a digital database representing the National Highway System and the remaining rural arterials and urban principal arterials. The NHPN was developed based on 1:100,000 Digital Line Graphs (DLGs) from the U.S. Geological Survey and augmented by State-supplied information describing roads and streets not represented in the DLGs. In this context, the NHPN represents highway geometry, and the HPMS is its attributes. The two databases are related to each other via LRS information. The LRS, in effect, gives each data base addresses that can be identified in the real world. Through this tie, any location in the NHPN should have a corresponding HPMS record. The two data bases are being brought together through a process called dynamic segmentation, which in many ways resembles a simple database relate. To perform a relate, common fields must exist in all identified databases. In this case, the common fields used to link HPMS to the NHPN are:

- County FIPS
- Inventory Route Number
- Inventory Subroute Number
- Kilometerpoint/Milepoint (KMPT/MPT)

The combination of these data will identify a unique location on the State's highway system. Anything less than this could give ambiguous results.

The county, inventory route, and inventory subroute fields are used to identify a particular portion of a route. The beginning and ending KMPT/MPT fields are used to find a specific location along a route. The general model for an LRS is that one end of the route is identified as its point of origin. It then accumulates measured distance along its course, in KMPTs/MPTs, until it reaches the end of the route. Typically, States modify this concept to meet their own particular needs. Regardless of how the State accomplishes this, all methods of identifying roadway features can be related back to the general model described above. The instructions in this chapter were written to accommodate the State's existing LRS in order to ensure long-range State support of the LRS and a continuing tie between HPMS and State databases.

Because of the detail involved, all figures in this chapter contain English units. Metric units may be substituted.

The NHPN with LRS attached (either in its entirety or by State or portion thereof) is available to the States and others for use in their GIS activities. The NHPN serves as a national framework for information exchange and will be provided to the U.S. Geological Survey, the Bureau of Census, the Intelligent Transportation System (ITS) community, and the Bureau of Transportation Statistics (BTS) to represent the higher order highways.

## GENERAL LRS RULES

One of the biggest challenges faced by the FHWA is converting the 52 different State LRSs into one consistent national LRS. In order to accomplish this efficiently, some rules of standardization must be followed. These rules focus on fundamental components of the LRS by addressing three general areas.

- Defining inventory routes.
- The placement of nodes. Some SHAs do not use nodes in their LRS; however, the FHWA requires the use of nodes for the purpose of LRS accuracy. These nodes do not require the State to change its own internal LRS but have been defined to allow them to be easily added without affecting the former.
- Incorporating LRS discontinuities.

The LRS used is a conventional KMPT/MPT. The KMPT/MPT represents the distance in kilometers/miles along the route from a reference point. The reference point can be a State boundary, county boundary, or the beginning point of a route. This distance may be modified by physical route breaks and KMPT/MPT equations that compensate for gaps or excess KMPT/MPT brought on by realignments or recalibration. The following general rules apply:

### **Base Network:**

All NHS plus remaining rural and urban principal arterial and rural minor arterial routes must have an inventory route number. Existing State inventory routes should be used to maximize the relationship between the State's own road inventory and HPMS databases. These routes can consist of both existing and planned unbuilt facilities (see Item 20 in Chapter IV).

### **General LRS Definition:**

- An LRS will be defined for each of the inventory routes identified above.

- Only one LRS is to be reported for each inventory route. Independently aligned roadways (divided highways) are treated as one highway with one KMPT/MPT system.
- Two or more inventory routes may not be assigned to a given highway link (a stretch of roadway between any two corresponding nodes—see Node Location Criteria below). For HPMS reporting purposes, one inventory route must be chosen to represent the link and the remaining inventory route(s) must be ended and restarted where it diverges from the chosen inventory route.
- Ramps and collectors/distributors are considered to be part of the mainline system and do not have separate LRSs. Frontage roads belong to functional systems of their own and are to be treated as separate roadways.

### **Node Location Criteria:**

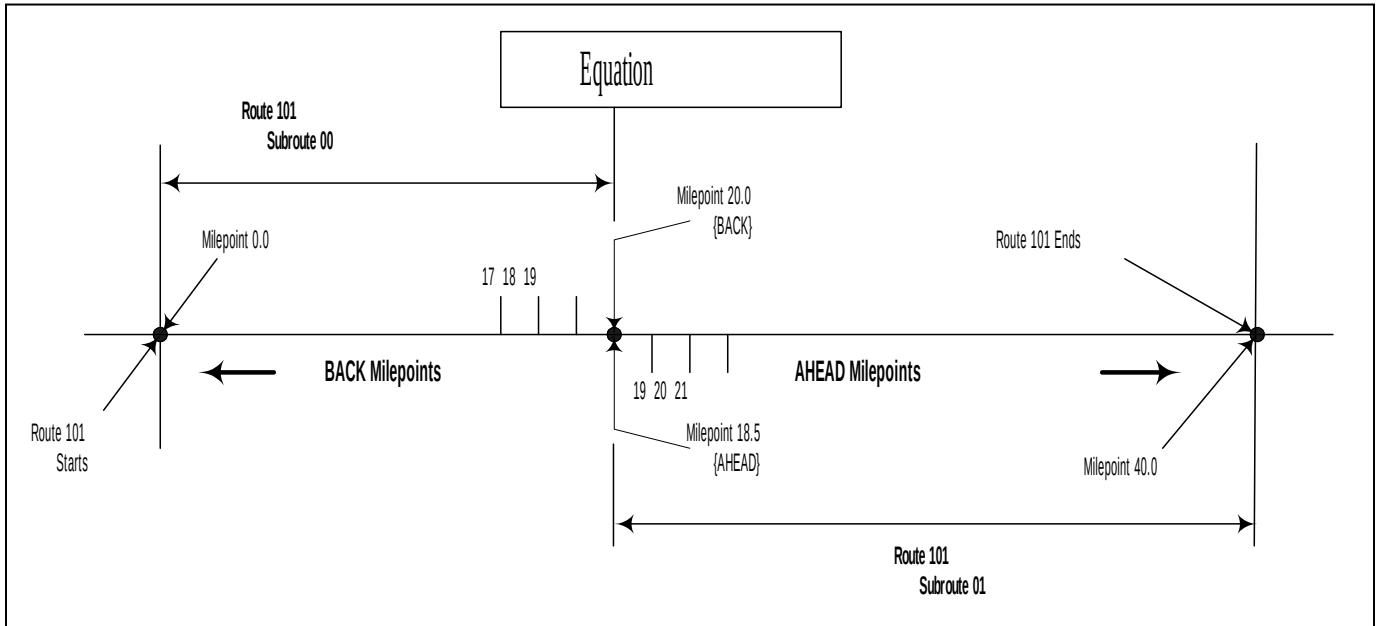
A single node must be established at the following points:

- Beginning of an inventory route
- Where the inventory route crosses another inventory route(s)
- Where the inventory route crosses a county line
- Where the inventory route encounters an equation
- Where the inventory route is temporarily suspended or incurs other types of physical breaks
- Where the inventory route ends

### **Defining Unique Locations:**

A unique location within a State for the HPMS LRS is defined by the combination of county, inventory route, inventory subroute, and KMPT/MPT.

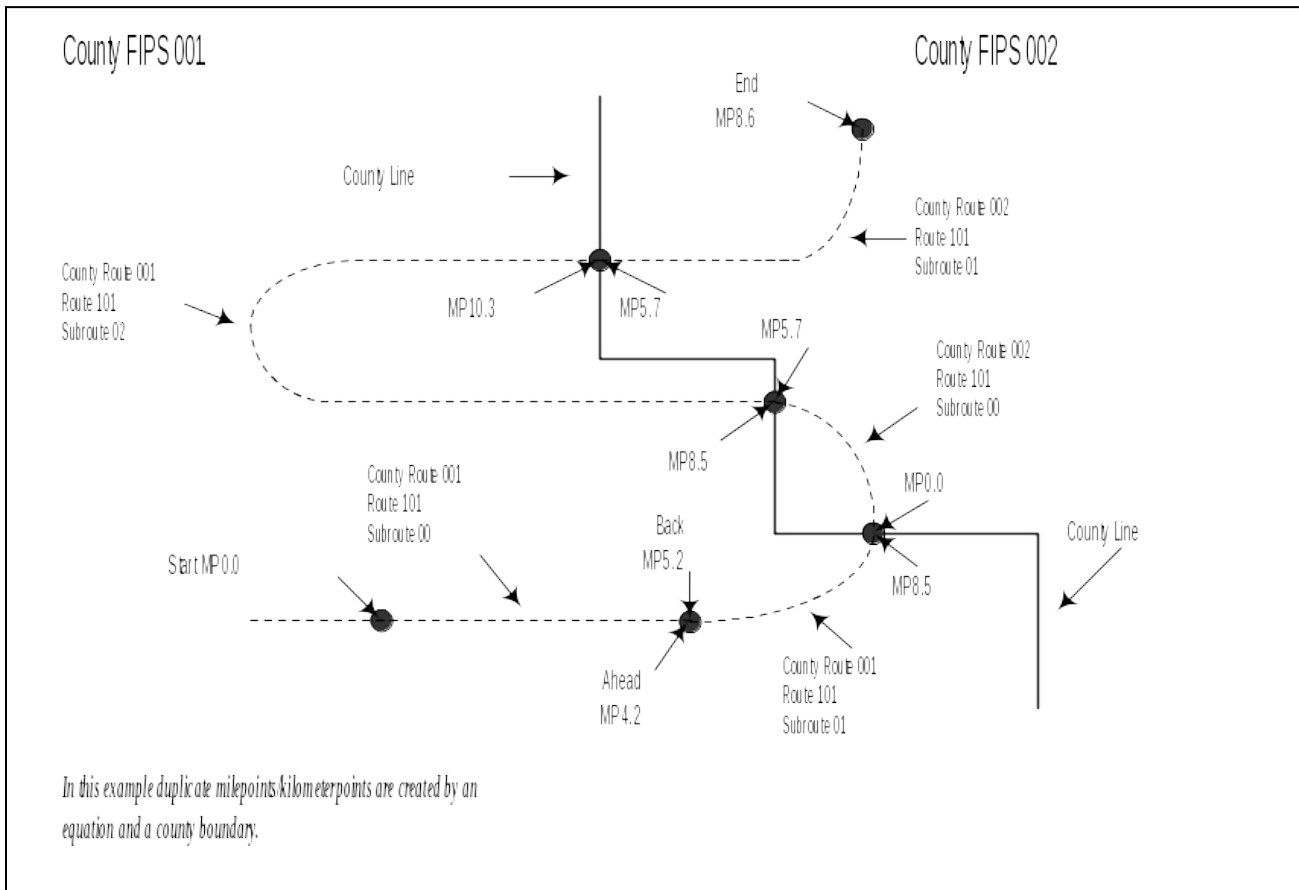
Under certain conditions, duplicate KMPTs/MPTs can occur along a route in a state's linear referencing system. These conditions can occur when the route encounters certain types of equations, route breaks, or county lines. Duplicate KMPTs/MPTs are not allowed on a given inventory route within a county. Inventory subroutes must be used to independently identify highway links with duplicate KMPTs/MPTs.



**Figure V-1. Duplicate Milepoint Equation**

**Equations:** Locations on a route where discontinuities in KMPTs/MPTs occur (usually caused by construction) are remedied in some State systems through the establishment of an equation. Some equations will create two lengths of roadway with duplicate ranges of KMPTs/MPTs; i.e., the BACK KMPT/MPT is larger than the AHEAD KMPT/MPT. In such instances, a subroute number must be used to distinguish between duplicate KMPTs/MPTs.

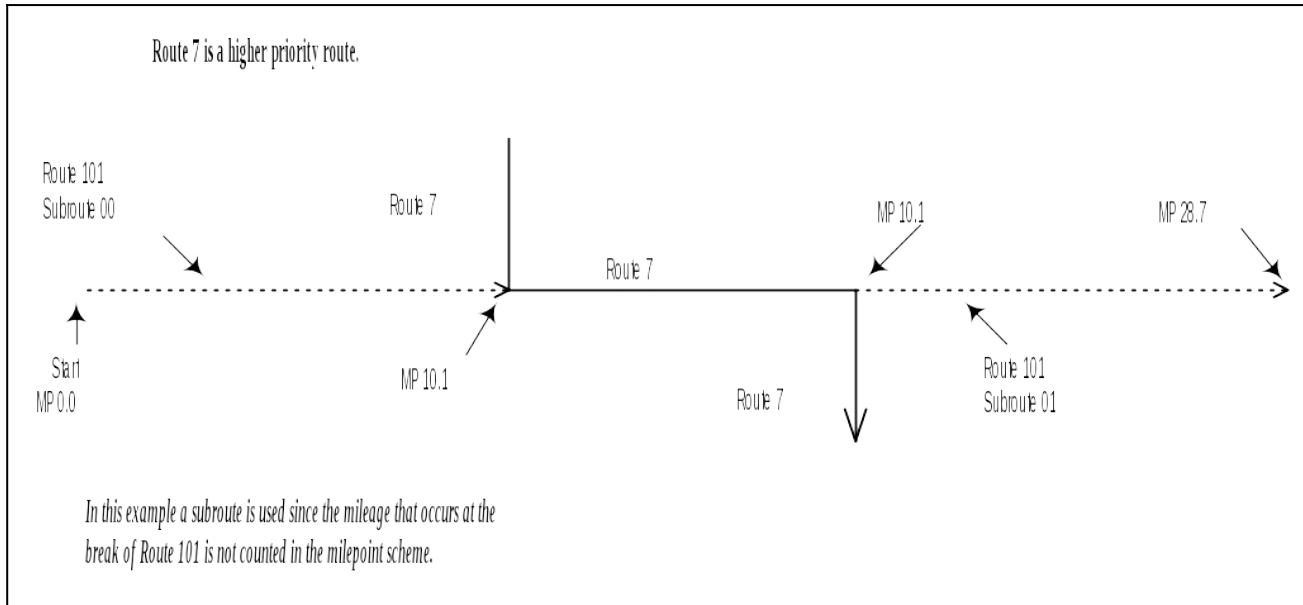
For example, on inventory Route 101, an equation of BACK 20.00 = AHEAD 18.50 creates two 1.50 mile lengths of road with the range of milepoints from 18.50 to 20.00. The route starts at 0.00 milepoint and goes to BACK 20.00 where the mileage is adjusted to AHEAD 18.50, and goes to the end at milepoint 40.00. This route needs to be divided into two subroutes to distinguish between the duplicate milepoints. Subroute number 00 starts at 0.00 milepoint and goes to BACK 20.00. Subroute number 01 starts at AHEAD 18.50 milepoint and goes forward to milepoint 40.00 as illustrated in Figure V-1. The subroute number is continued until either another occurrence of duplicate KMPTs/MPTs (another equation, a route break, or a county boundary) is encountered or the end of the route is reached. For example, if another equation (like the one mentioned above) is encountered, then the subroute number is incremented to 02, etc.



**Figure V-2. Re-Entering a County; Equation Created**

**County Reentries and Route Breaks:** When a route reenters a county or a route break occurs (and the intervening mileage is not counted) and duplicate KMPTs/MPTs occur, inventory subroutes must be used to properly identify highway links. For example, in Figure V-2, inventory Route 101 reenters counties 001 and 002 with the entry KMPTs/MPTs equal to the exit milepoints, requiring the subroute numbers to be incremented to maintain uniqueness within the counties.

In Figure V-3, the length of discontinuity in inventory Route 101 is ignored, and the inventory subroute must be incremented to recognize the duplicate KMPTs/MPTs.

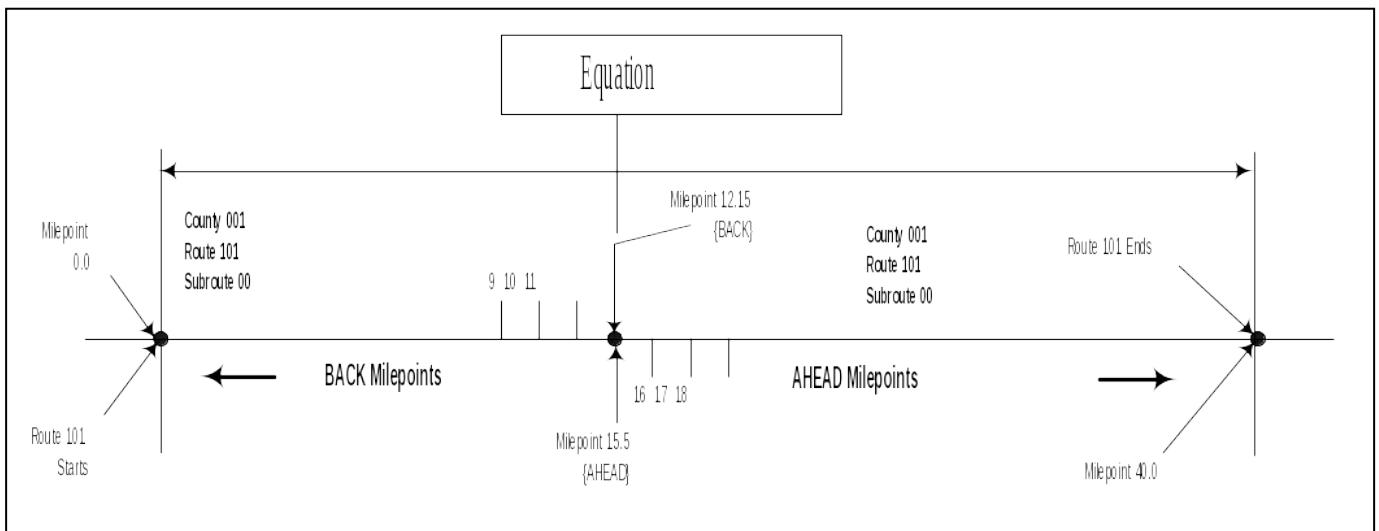


**Figure V-3. Route Stops and Restarts at a Different Location; Milepoint Stays the Same**

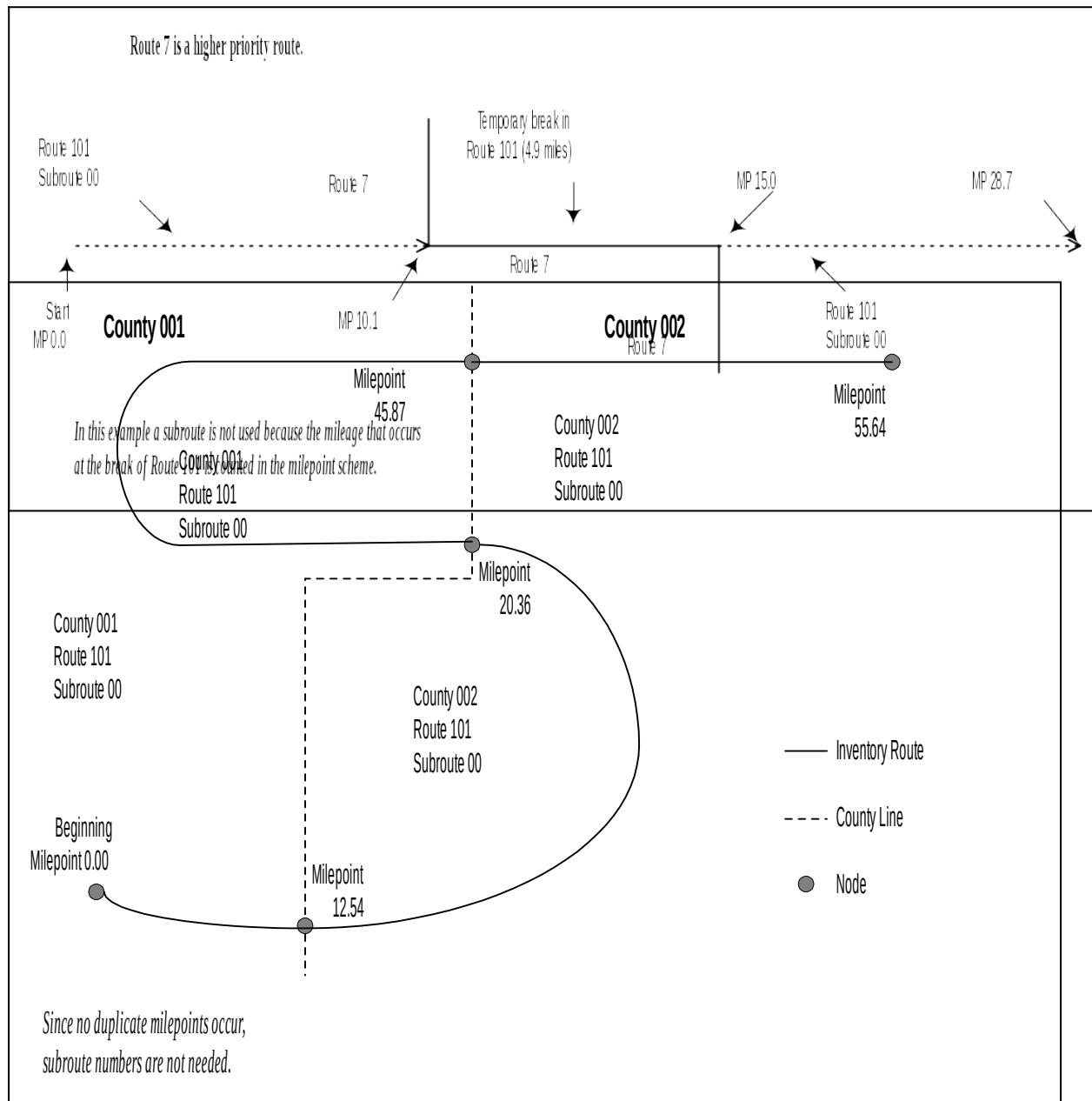
**Subroutes:**

- An inventory route's subroute numbers must not be duplicated within any one county.
- Inventory subroutes along a route do not have to be in order.
- Inventory subroutes need not be used in cases where gaps in kilometers/milepoints occur on an inventory route. In many cases, duplicate KMPTs/MPTs do not exist on inventory routes. In these instances, KMPTs/MPTs are either continuous or gaps occur where KMPTs/MPTs are skipped. These situations do not require the use of inventory subroutes to uniquely identify links (i.e., the subroute is "00" or remains at the last established value).

Equations that are used to compensate for a gap in the KMPT/MPT system are those in which the BACK KMPT/MPT is smaller than the AHEAD KMPT/MPT. For example, an equation of  $BACK\ 12.15 = AHEAD\ 15.55$  creates a 3.40-mile gap in the milepoint system (Figure V-4).



**Figure V-4. Nonduplicate Milepoint Equation**



**Figure V-5. Re-Entering a County; No Duplicate Milepoints**

Likewise, an inventory route can be stopped and restarted at another location without duplicating KMPTs /MPTs (Figures V-5 and V-6). In the above instances, duplicate KMPTs/ MPTs are not created since the intervening mileage is kept. No changes in inventory subroutes are required.

If no duplicate KMPT/ MPT condition exists within the county, the combination of county, inventory route, and KMPT/MPT will identify a unique location.

**Figure V-6. Route that Stops and Restarts at Different Locations; Milepoint Increases**



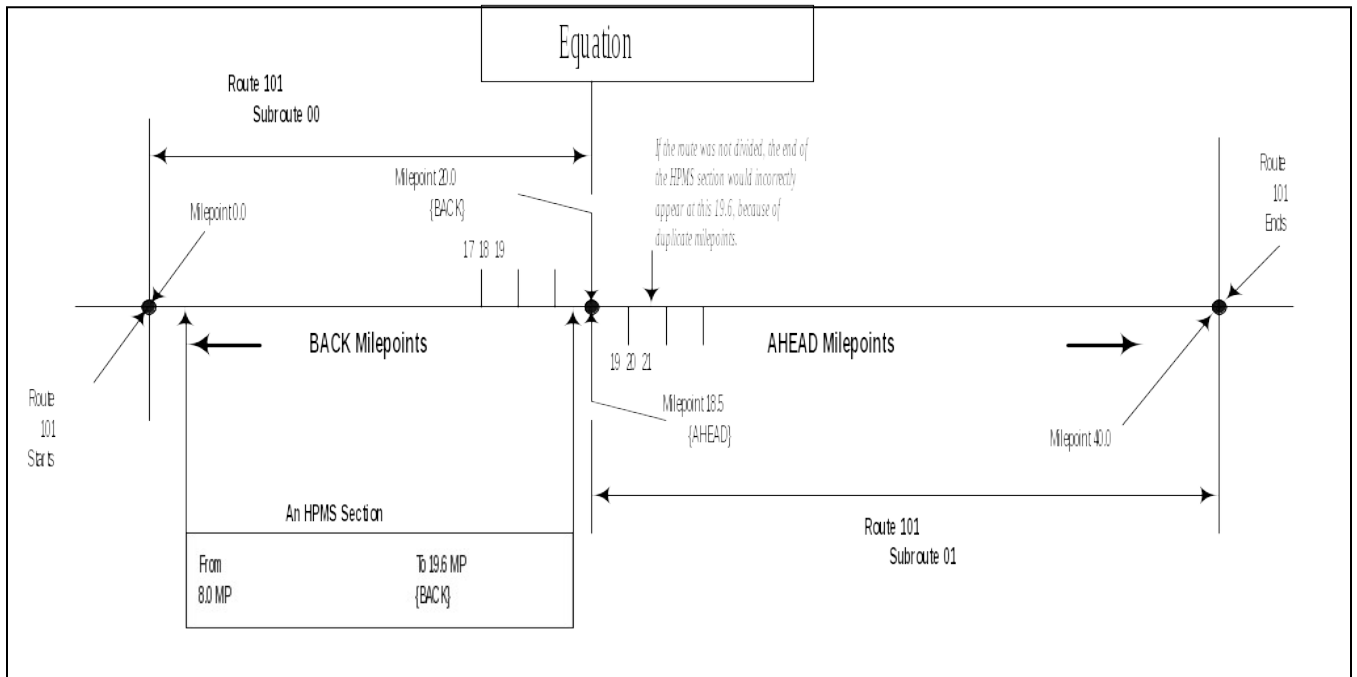
**Effects of LRS on HPMS Sections:**

HPMS sections must be adjusted (or divided) where inventory routes or subroutes change along the length of that section. The division of inventory routes into inventory subroutes, where duplicate KMPTs/MPTs occur, could have a direct impact on the physical length of HPMS universe and sample sections. The subroute field effectively creates a new route any time the subroute number changes.

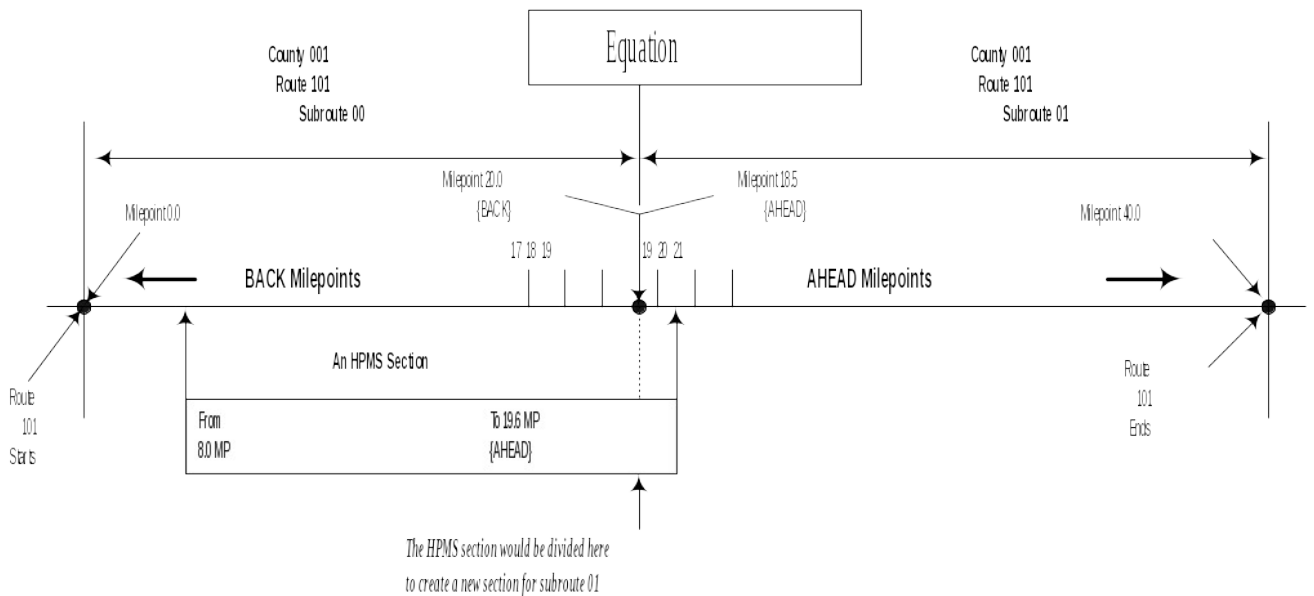
Figure V-7 shows an HPMS section starting at milepoint 8.0 and extending to milepoint BACK 19.6 - not AHEAD 19.6. In this case, no change to the HPMS section is necessary since the section occurs entirely within county 001, Route 101, Subroute 00. Figure V-8 illustrates the same route conditions with the exception that the HPMS section starts at milepoint 8.0 and extends to milepoint AHEAD 19.6 - not BACK 19.6. In this case, the HPMS section must be adjusted (or divided) at that equation point to accommodate the duplicate KMPTs/MPTs. Two sections must be created: milepoint 8.0 to the equation and then from the equation to milepoint AHEAD 19.6.

In contrast, where an HPMS section crosses a nonduplicating equation point, the section need not be adjusted (see Figure V-9).

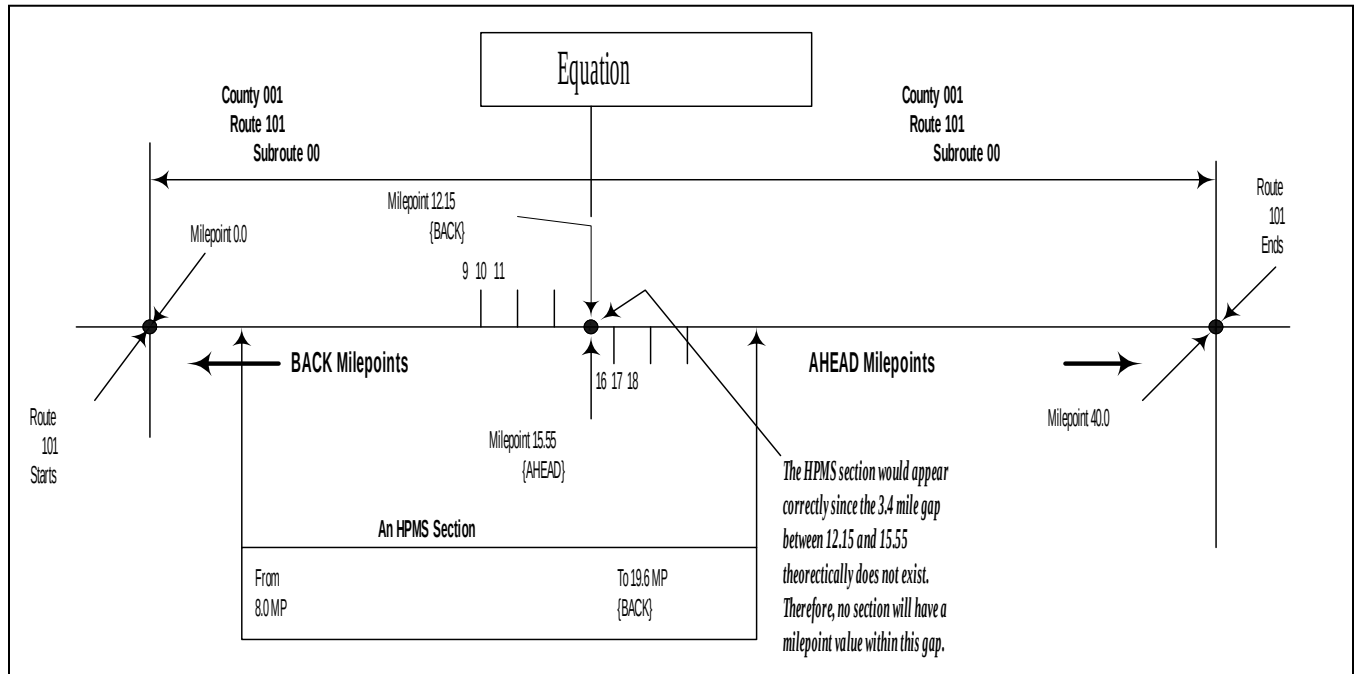
Because of inventory route design, an HPMS section may have more than one inventory route traversing it. Where this occurs, the HPMS section must be divided to reflect the beginning and ending of the inventory routes. Figure V-10 shows an HPMS section extending across two inventory routes: 101 and 7. In this case, the HPMS section must be divided into three sections at the points where the inventory route changes. Since HPMS sections should already begin/end at county lines, no modification to the sections is required where subroutes are created at county lines.



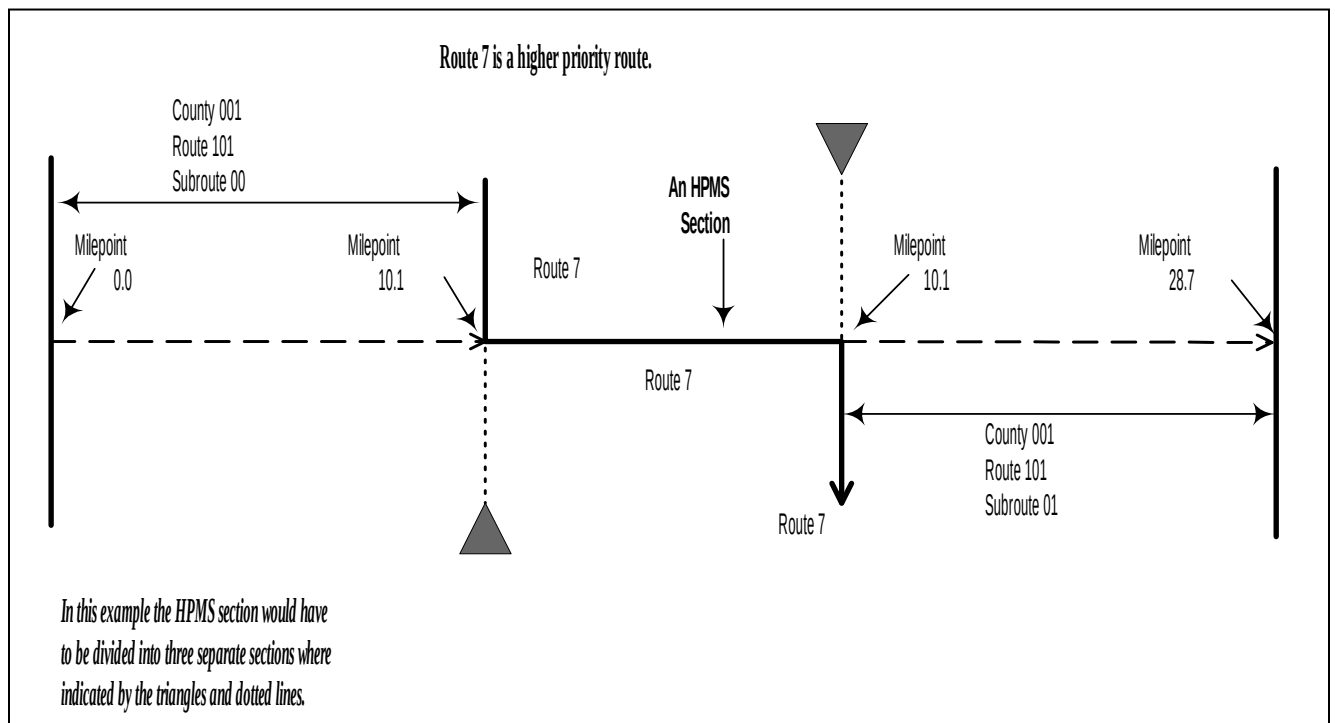
**Figure V-7. HPMS Section Near a Duplicate Milepoint Equation**



**Figure V-8. HPMS Section Crossing a Duplicate Milepoint Equation**



**Figure V-9. HPMS Section Crossing a Nonduplicate Milepoint Equation**



**Figure V-10. An HPMS Section that Runs through Overlapping Routes**

## SUMMARY OF LRS DATA REQUIREMENTS

In addition to the data provided in each HPMS record as outlined in Chapter IV (see Items 9, 10, 11, and 12), each State is to provide the following information. (NOTE: The following discussion assumes that an initial LRS submittal has been made. Appendix H discusses establishing an LRS for the first time.)

## LRS SUBMITTAL OPTION 1 - MAPS AND COMPUTER FILES

- ***Inventory Route and Node Maps*** showing the location of **new, deleted and revised** inventory routes, inventory subroutes and nodes on the base network of rural arterials, urban principal arterials and other designated NHS routes. Sufficient coverage of existing, unchanged links and nodes must be provided to enable FHWA to locate changed nodes and links.
- A ***Node Data File*** that, at a minimum, describes **new, revised and deleted** nodes in the network.
- An ***Inventory Route Link Data File*** that, at a minimum, describes **new, revised and deleted** inventory routes within the network.
- **The complete node and link files may be provided if it is more convenient to the States.**

Each product is described in more detail below. A dBase template has been provided to the States for entering and reporting the Node Data and Inventory Route Link Data files discussed above. Data can be submitted on floppy disk, CD, or as an electronic file in dBase or ASCII format.

### **Inventory Route and Node Map Labeling Instructions**

As part of the HPMS submission requirements, States will be required to prepare and submit maps showing, at least new, revised and deleted inventory routes and nodes. **To insure that the revised data is located properly, adjacent node and link information should also be provided.** These maps will be used to ensure the correct location of these inventory routes and nodes on the network in preparation for attaching a linear referencing system and linking HPMS data to the network. The amount of data on these maps should be kept to a minimum and only data necessary to check and transfer the information to the network is requested. Therefore, five basic categories of data must be displayed on the maps:

1. Appropriate portions of the base State highway network — rural arterials, urban principal arterials, and other NHS routes.
2. State/county boundaries.
3. Principal signed routes (U.S., State, etc.).
4. Inventory route and subroute numbers.
5. Nodes with node numbers.

These data should be placed on maps that are at a scale that keeps the number of map sections to a minimum, while maintaining good visual quality for data location and readability.

In order to reduce confusion regarding which number goes with what feature, qualifiers must be added as follows:

Map Feature	Map Qualifiers
Inventory Route	X
Inventory Subroute	( )
Node	N
Signed Routes	No Special Map Qualifiers (Use Existing Prefixes)

For example, inventory Route “234” with a subroute number of 05 would appear on the map as “X234(05).” The “X” and “N” prefixes and “( )” are meant to be used only on the map, so the numbers can be more easily distinguished. **These qualifiers shall not be used on the HPMS records, route/link file, or node file.** To identify the signed route, the State should place the sign route numbers on the map with a prefix (such as “US,” “SR,” etc.), unless shields exist on the maps that contain the route numbers.

#### Map Item Description

**The Base Network:** Contains Interstate, other freeways and expressways, other principal arterials, and rural minor arterials. In addition, those routes not so classified, but are part of the NHS, must also be identified. Finally, officially approved proposed routes are to be included in this base network in keeping with HPMS data Item 20, Planned Unbuilt Facility. Since these LRS data will be used with the HPMS, centerline of dual alignments must be indicated. However, in the case of one-way pairs (couplets), each directional roadway is to be separately defined, as is done in the HPMS records.

**Boundaries & County Name Labels:** The State must place the name and the county FIPS code within the boundaries.

**Principal Signed Route Number Labels:** The principal signed route or street name must be provided for each link (i.e., between any two nodes). While the Inventory Route Link Data File allows for up to three signed routes, because of the need for good map readability, only one (the principal route) is required for each link on the map.

**Inventory Route and Subroute Number Labels:** Only one inventory route and subroute number is to be assigned for each link between any two nodes. In the case of one-way pairs (couplets), each directional roadway is considered a different inventory route. For identification purposes on the map only, route numbers are to begin with an “X” and subroutes are to be enclosed in parentheses.

**Nodes and Node Number Labels:** Nodes will be established for:

1. Intersections of other inventory routes.
2. Intersections of inventory routes and State boundaries.
3. Intersections of inventory routes and county boundaries.
4. Equation locations.
5. Route termini (including route discontinuity termini).

Each node should have a unique node number clearly displayed beside the node; node numbers must be unique within the State. For identification purposes on the map only, these node numbers are to begin with “N.”

All new, revised and deleted nodes and links in the node and link data files must be shown on the map along with

adjacent nodes and links.

## NODE DATA FILE CODING INSTRUCTIONS

The Node Data File, together with the Inventory Route Link Data File and maps, are used to define the geographic location of the inventory routes and the kilometers/milepoints. These records complement the data supplied in the Inventory Route Link Data File and the Inventory Route and Node Map. In the following table, Items 6-11 identify each of the conditions that will create a node. (Items 1-5 and 12-14 provide other descriptor information about the nodes.) This information is necessary for accurate placement of the node on the network.

Item Number	Position	Length	Data Type	Data Item Description
<b>IDENTIFICATION</b>				
1	1-4	4	N	Year
2	5-6	2	N	State FIPS Code
3a	7-9	3	N	County FIPS Code No. 1
3b	10-12	3	N	County FIPS Code No. 2
4	13	1	N	Record Status
5	14-23	10	AN	Node Number
<b>NODE TYPES</b>				
6	24	1	N	Inventory Route Intersection
7	25	1	N	County Boundary
8	26	1	N	State Boundary
9	27	1	N	Equation
10	28	1	N	Spur Route Termini
11	29	1	N	Inventory Route Termini
<b>COORDINATES (Optional)</b>				
12	30-39	10	N	X Coordinate - Geographic
13	40-49	10	N	Y Coordinate - Geographic
<b>OTHER DESCRIPTORS (Optional)</b>				
14	50-149	100	AN	Description of Node
N = Numeric                      AN = Alphanumeric				

**All numeric data items must be right justified and zero-filled. The alphanumeric field of Item 5 will be right justified and can use numbers and capitalized English letters. However, this field should not be considered case sensitive. No embedded blanks are allowed. Item 14 may contain any characters, placed anywhere within the 100 positions.**

## DATA ITEM DETAILS

### Item 1 – Year (Length = 4)

See Item 1 of the HPMS Universe Data Coding Instructions in Chapter IV.

### Item 2 – State FIPS Code (Length = 2)

See Item 2 of the HPMS Universe data coding instructions in Chapter IV.

### Item 3a – County FIPS Code No. 1 (Length = 3)

A node is created when an inventory route and a county boundary intersect.

When nodes occur at boundaries between adjoining counties, Item 3a will identify one of the two counties sharing the boundary at the node and Item 3b will identify the other county (Figure V-11, Examples A and B). The counties can be identified in any sequence. If the node occurs at a boundary of three or more counties, any two of the possible three will be reported.

Figure V-11. Nodes and Political Boundaries

When nodes occur within counties or at a State boundary where the county is not joining another county within that State, only one county is identified and will appear in both Items 3a and 3b (See Figure V-11, Examples C and D).

Use the three-digit FIPS county code. (See Item 4 of the HPMS Universe Data Coding Instructions in Chapter IV.)

Adjoining counties of neighboring States, under any of the above-described conditions, are not to be coded.

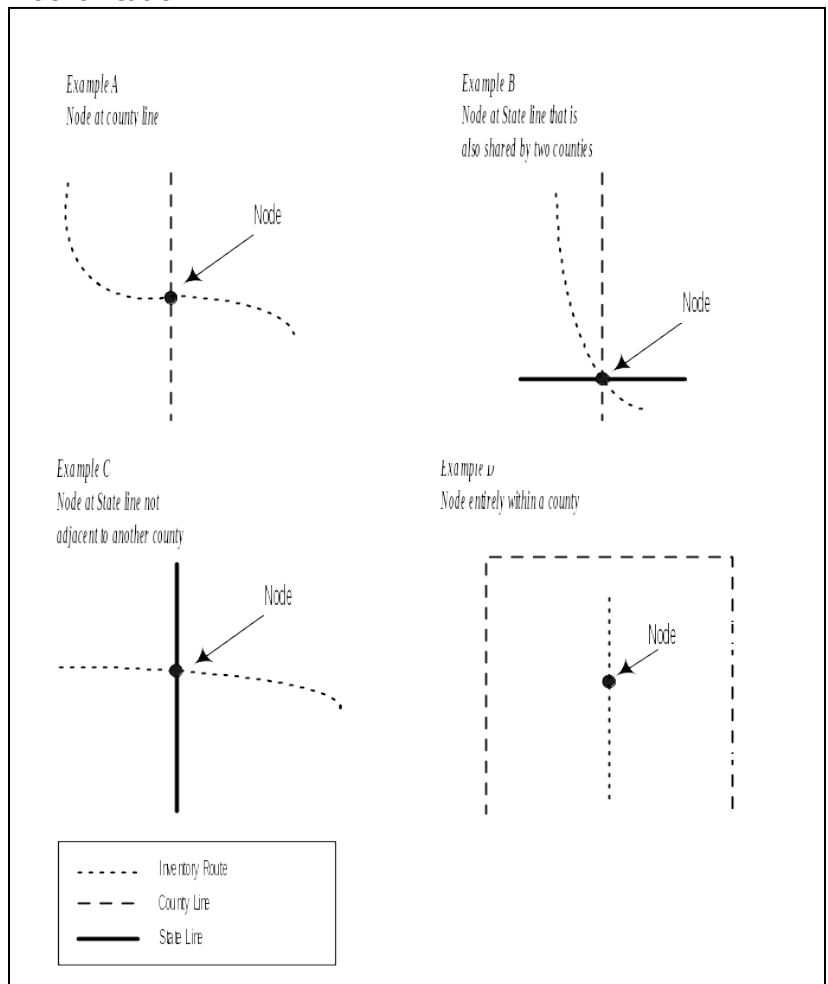
### Item 3b – County FIPS Code No. 2 (Length = 3)

This item identifies the second of the two counties sharing the boundary at the node, as discussed above.

### Item 4 – Record Status (Length = 1)

This item depicts the condition of the node relative to the data submittal of the past year; that is, a newly

## Identification





created node or an existing node which has incurred a change in one or more of the data items represented in the Node File. In the first year's submittal, all nodes should be coded "0." In subsequent years, if a node is added or one or more of the characteristics have changed, it will be coded as either "2" or "1," respectively. If no change occurs to an existing node, then it will be coded "0." When a node is reported as being deleted, it must be dropped from subsequent years' submittals. **For example, where a realignment occurs along a route and the old alignment no longer qualifies as part of the "Base Network," the old node(s) will be deleted and new node(s) will be added as needed.**

Code	Description
0	No Change
1	Changed - one or more data items on the node list have been changed or added
2	New Node
3	Deleted Node

**Item 5 – Node Number** (Length = 10)

All nodes must be identified with a number that can be comprised of both alpha characters and numbers. Each node number must be unique within the State and right justified in the field.

**Node Types:** Items 6-11 represent different characteristics of a node. Nodes should be created based on one or more of these conditions. Mark each condition that applies to each node (all conditions that describe a particular node should be coded as "1").

**Item 6 – Inventory Route Intersection** (Length = 1)

Node that occurs where two inventory routes intersect:

Code	Description
0	NO
1	YES

**Item 7 – County Boundary** (Length = 1)

Node that occurs where an inventory route is intersected by a county boundary:

Code	Description
0	NO
1	YES

**Item 8 – State Boundary** (Length = 1)

Node that occurs where an inventory route is intersected by a State boundary:

Code	Description
------	-------------

0	NO
1	YES

**Note:** Since a State line will also be a county boundary, Items 7 and 8 will both be coded as “1” at all State lines.

**Item 9 – Equation** (Length = 1)

Node that occurs where an equation occurs on an inventory route:

Code	Description
0	NO
1	YES

**Item 10 – Spur Route Termini** (Length = 1)

Node that occurs where an inventory route terminates without intersecting another inventory route:

Code	Description
0	NO
1	YES

**Note:** If this item is marked “yes,” Item 11 is also to be marked “yes.”

**Item 11 – Inventory Route Termini** (Length = 1)

Node that occurs where an inventory route begins, ends, stops at a discontinuity, or starts after a discontinuity.

Code	Description
0	NO
1	YES

**Coordinates (Optional):** Specify in the letter of transmittal whether these data exist, and the coordinate system and decimal positions (if any) used for the LRS submittal.

**Item 12 – X Coordinate** (Length = 10) (Optional)

Enter the “X” coordinate for the node. This should be a nonprojection geographic coordinate, preferably decimal degrees.

**Item 13 – Y Coordinate** (Length = 10) (Optional)

Enter the “Y” coordinate for the node. This should be a nonprojection geographic coordinate, preferably decimal degrees.

**Other Descriptors (Optional)**

**Item 14 – Description of Node** (Length = 100) (Optional)

This item is provided if the State desires to provide additional descriptive information regarding node location. Any alphanumeric characters may be entered, including blanks.

## INVENTORY ROUTE LINK DATA FILE CODING INSTRUCTIONS

The Inventory Route Link Data File, together with the Node Data File and maps, are used to define the geographic location of the inventory route and the KMPTs/MPTs. This record compliments the data supplied in the Node Data File and the Inventory Route and Node Map. A link is the roadway between two nodes. The Inventory Route and Node Map illustrates the locations of the links and nodes. All data in this file must be right justified and zero filled.

Item Number	Position	Length	Data Type	Data Item Description
<b>Identification</b>				
1	1-4	4	N	Year
2	5-6	2	N	State FIPS Code
3	7-9	3	N	County FIPS Code
4	10	1	N	Record Status
5	11-20	10	AN	Inventory Route Number
6	21-22	2	N	Inventory Subroute Number
7	23-32	10	AN	Beginning Node Number
8	33-40	8	N	Beginning Milepoint/Kilometerpoint
9	41-50	10	AN	Ending Node Number
10	51-58	8	N	Ending Milepoint/Kilometerpoint
<b>Signed Route 1</b>				
11	59	1	N	Route Signing 1
12	60	1	N	Route Qualifiers 1
13	61-68	8	AN	Route Number 1
<b>Signed Route 2</b>				
14	69	1	N	Route Signing 2
15	70	1	N	Route Qualifiers 2
16	71-78	8	AN	Route Number 2
<b>Signed Route 3</b>				
17	79	1	N	Route Signing 3
18	80	1	N	Route Qualifiers 3
19	81-88	8	AN	Route Number 3
<b>Other</b>				
20	89-118	30	AN	Street Name
N = Numeric		AN = Alphanumeric		

**All data must be right justified and zero-filled. Beginning and ending node numbers must be right justified.**

**DATA ITEM DETAILS****Identification****Item 1 – Year** (Length = 4)

See Item 1 of the HPMS Universe Data Coding Instructions in Chapter IV.

**Item 2 – State FIPS Code** (Length = 2)

See Item 2 of the HPMS Universe Data Coding Instructions in Chapter IV.

**Item 3 – County FIPS Code** (Length = 3)

See Item 4 of the HPMS Universe Data Coding Instructions in Chapter IV.

**Item 4 – Record Status** (Length = 1)

This item depicts the status of the route link, relative to the previous year's submittal; that is, a newly created link or an existing link which has incurred a change or addition to one or more of the data items represented in the link file. In the first year's submittal, all links must be coded "0." In subsequent years, if a link is added or one or more of its characteristics have changed, it will be coded as either "2" or "1," respectively. However, if no change occurs to an existing link, then it will be coded "0." When a link is reported as being deleted, it must be dropped from subsequent years' submittals. **For example, where a realignment occurs along a route and the old alignment no longer qualifies as part of the "Base Network," the old link(s) will be deleted and new links(s) will be added as needed.**

Code	Description
0	No Change
1	Changed - one or more data items on the Route Link record has changed
2	New Route Link
3	Deleted Route Link

**Item 5 – Inventory Route Number** (Length = 10)

The inventory route number, which is not necessarily the same as that posted along the roadway, is a number used to uniquely identify a route for inventory purposes. The inventory route number must be unique within a county, but it is recommended that it be unique within the State. This number can be alphanumeric, but must not contain blanks; it must be right justified in the field. Provide leading zeroes.

**Item 6 – Inventory Subroute Number** (Length = 2)

This number is used to uniquely identify portions of an inventory route within a county where certain conditions (KMPT/MPT equations, inventory route breaks, or KMPTs/MPTs that are adjusted at county boundaries) create a length of roadway with a [duplicate](#) KMPT/MPT or range of KMPTs/MPTs. A new subroute number must be assigned each time a duplicate KMPT/MPT or range of KMPTs/MPTs is encountered. These subroute numbers must only be unique within each county. In the absence of duplicate KMPTs/MPTs and previous to the first duplicate KMPT/MPT condition encountered, code zero.

**Item 7 – Beginning Node Number** (Length = 10)

This is the number of the first of two nodes of the link. This node is at the end of the link with the lowest KMPT/MPT.

**Item 8 – Beginning Milepoint/Kilometerpoint** (xxxx.xxx — code the decimal)(Length = 8)  
This is the lowest KMPT/MPT of the link.

**Item 9 – Ending Node Number** (Length = 10)  
This is the number of the last of two nodes of the link. This node is at the end of the link with the highest KMPT/MPT of the link.

**Item 10 – Ending Milepoint/Kilometerpoint** (xxxx.xxx — code the decimal)(Length = 8)  
This is the highest KMPT/MPT of the link.

**Signed Routes 1, 2, and 3:** These three groups of three items define up to three signed route numbers assigned to a link. The priority of the signed routes shall be based on Item 11 below, where those with a non-zero lower code have the higher priority.

**Items 11, 14, and 17 – Route Signing 1, 2, and 3** (Length = 1)  
These codes specify the manner in which the highway segment is signed.

Code	Description
0	Not Signed or No More Signed Routes
1	Interstate
2	U.S.
3	State
4	Off-Interstate Business Markers
5	County
6	Township
7	Municipal
8	Parkway
9	None of the Above

**Items 12, 15, and 18 – Route Qualifiers 1, 2 and 3** (Length = 1)  
These codes specify the manner in which the highway segment is signed. Where more than one code is applicable, use the lower code excluding zero.

Code	Description
0	No Qualifier
1	Alternate
2	Business Route
3	Bypass
4	Spur
5	Loop
6	Proposed
7	Temporary
8	Truck Route
9	None of the Above

**Items 13, 16, and 19 – Route Number 1, 2 and 3** (Length = 8)

Enter the signed route number (on the marker), right justified. Any alphabetic character prefixes or suffixes that cannot be identified with the Route Signing or Qualifier list of codes should be reported and abbreviated to fit into the field length, if necessary. Zero-fill if the route is unsigned or there are no more signed routes.

**Item 20 – Street Name** (Length = 30)

Enter a street, road, or highway name. This field need only be used when a signed route number is not available for use in describing the route. Otherwise, leave the field blank. If used, ensure that the name includes the proper suffix (street, place, court, etc.) to eliminate duplicate name possibilities.

For example: U.S. 5 Business Route and State 2 Truck Route are on the same link:

Item 11 = “2”	(U.S.)
Item 12 = “2”	(Business Route)
Item 13 = “00000005”	(Route Number)
Item 14 = “3”	(State)
Item 15 = “8”	(Truck Route)
Item 16 = “00000002”	(Route Number)

## **LRS SUBMITTAL OPTION 2 - LRSEDIT FILES PLUS MAPS FOR NEW LINKS AND NODES**

An LRSEDIT file for the complete base highway network with a copy of the LRSEDIT printed reports must be submitted along with maps depicting new links and nodes that did not exist on the NHPN. Maps must be labeled in accordance with instructions for coding inventory route and node maps under Option 1 above. Beginning and ending kilometerpoints/milepoints for the links must also be included.

## **LRS SUBMITTAL OPTION 3 - GIS FILES**

A complete GIS file encompassing the base highway network shall be submitted. This file shall contain all data required by Chapter V in a format agreed upon by the State and FHWA.

### **LRS Updates**

After the initial reporting of LRS data, only updated information is required on an annual basis. LRS reporting status should be noted in the comment file, annually.

### **Technical Assistance**

For technical assistance or further information regarding this chapter or about LRS, please contact Roger Petzold of the Federal Highway Administration; Phone: 202-366-4074, E-mail: roger.petzold@fhwa.dot.gov.

# **CHAPTER V**

## LINEAR REFERENCING SYSTEM REQUIREMENTS

In the past, HPMS data has been analyzed and viewed as tables, charts, and graphs. Furthermore, any analysis of HPMS data could only include data fields contained within the HPMS with little opportunity to use information outside it. With the advent of Geographic Information Systems (GIS), a new spatial dimension is now being introduced into HPMS analysis.

What is GIS? Within the context of this chapter, it is sufficient to say it is a way to view and analyze data spatially using specialized software. What this means is that previously discrete databases can now be related together and examined; a relationship that exists through the spatial coordinates these data share. While there are a variety of methods used to locate objects in the real world, the most commonly used among State Departments of Transportation (DOTs) are Linear Referencing Systems (LRS). This chapter contains the requirements for reporting the State's LRS data. The guidelines presented will allow the State to submit its LRS information in a format that will allow it to be incorporated into the FHWA's GIS.

The GIS will advance HPMS state-of-the-art and will enable FHWA, the States, and others to analyze HPMS data for rural arterials, urban principal arterials, and other NHS roadways within a spatial context. The ability to integrate data through GIS will result in enhanced analysis and presentation of the HPMS data State and Nation wide. Introducing this spatial component facilitates greater versatility of the HPMS in its application and integration with other databases, and enables the HPMS to meet the increasing demands placed on it as a transportation analytical and management tool. The HPMS GIS is an important step to increase the effectiveness of HPMS as an information system. **The LRS information submitted in accordance to Chapter V is in addition to the LRS information reported in Chapter IV.**

The LRS reported in this chapter will be integrated into the National Highway Planning Network (NHPN). The NHPN is the database that contains the geographic or spatial locations of the Nation's principal highways. The NHPN, initially developed in a separate mid-1980's effort sponsored by FHWA, is a digital database representing the National Highway System and the remaining rural arterials and urban principal arterials. The NHPN was developed based on 1:100,000 Digital Line Graphs (DLGs) from the U.S. Geological Survey and augmented by State-supplied information describing roads and streets not represented in the DLGs. In this context, the NHPN represents highway geometry, and the HPMS is its attributes. The two databases are related to each other via LRS information. The LRS, in effect, gives each data base addresses that can be identified in the real world. Through this tie, any location in the NHPN should have a corresponding HPMS record. The two data bases are being brought together through a process called dynamic segmentation, which in many ways resembles a simple database relate. To perform a relate, common fields must exist in all identified databases. In this case, the common fields used to link HPMS to the NHPN are:

- County FIPS
- Inventory Route Number
- Inventory Subroute Number
- Kilometerpoint/Milepoint (KMPT/MPT)

The combination of these data will identify a unique location on the State's highway system. Anything less than this could give ambiguous results.

The county, inventory route, and inventory subroute fields are used to identify a particular portion of a route. The beginning and ending KMPT/MPT fields are used to find a specific location along a route. The general model for an LRS is that one end of the route is identified as its point of origin. It then



accumulates measured distance along its course, in KMPTs/MPTs, until it reaches the end of the route. Typically, States modify this concept to meet their own particular needs. Regardless of how the State accomplishes this, all methods of identifying roadway features can be related back to the general model described above. The instructions in this chapter were written to accommodate the State's existing LRS in order to ensure long-range State support of the LRS and a continuing tie between HPMS and State databases.

Because of the detail involved, all figures in this chapter contain English units. Metric units may be substituted.

The NHPN with LRS attached (either in its entirety or by State or portion thereof) is available to the States and others for use in their GIS activities. The NHPN serves as a national framework for information exchange and will be provided to the U.S. Geological Survey, the Bureau of Census, the Intelligent Transportation System (ITS) community, and the Bureau of Transportation Statistics (BTS) to represent the higher order highways.

## GENERAL LRS RULES

One of the biggest challenges faced by the FHWA is converting the 52 different State LRSs into one consistent national LRS. In order to accomplish this efficiently, some rules of standardization must be followed. These rules focus on fundamental components of the LRS by addressing three general areas.

- Defining inventory routes.
- The placement of nodes. Some SHAs do not use nodes in their LRS; however, the FHWA requires the use of nodes for the purpose of LRS accuracy. These nodes do not require the State to change its own internal LRS but have been defined to allow them to be easily added without affecting the former.
- Incorporating LRS discontinuities.

The LRS used is a conventional KMPT/MPT. The KMPT/MPT represents the distance in kilometers/miles along the route from a reference point. The reference point can be a State boundary, county boundary, or the beginning point of a route. This distance may be modified by physical route breaks and KMPT/MPT equations that compensate for gaps or excess KMPT/MPT brought on by realignments or recalibration. The following general rules apply:

### **Base Network:**

All NHS plus remaining rural and urban principal arterial and rural minor arterial routes must have an inventory route number. Existing State inventory routes should be used to maximize the relationship between the State's own road inventory and HPMS databases. These routes can consist of both existing and planned unbuilt facilities (see Item 20 in Chapter IV).

### **General LRS Definition:**

- An LRS will be defined for each of the inventory routes identified above.
- Only one LRS is to be reported for each inventory route. Independently aligned roadways (divided highways) are treated as one highway with one KMPT/MPT system.
- Two or more inventory routes may not be assigned to a given highway link (a stretch of roadway between any two corresponding nodes—see Node Location Criteria below). For HPMS reporting purposes, one inventory route must be chosen to represent the link and the

remaining inventory route(s) must be ended and restarted where it diverges from the chosen inventory route.

- Ramps and collectors/distributors are considered to be part of the mainline system and do not have separate LRSs. Frontage roads belong to functional systems of their own and are to be treated as separate roadways.

**Node Location Criteria:**

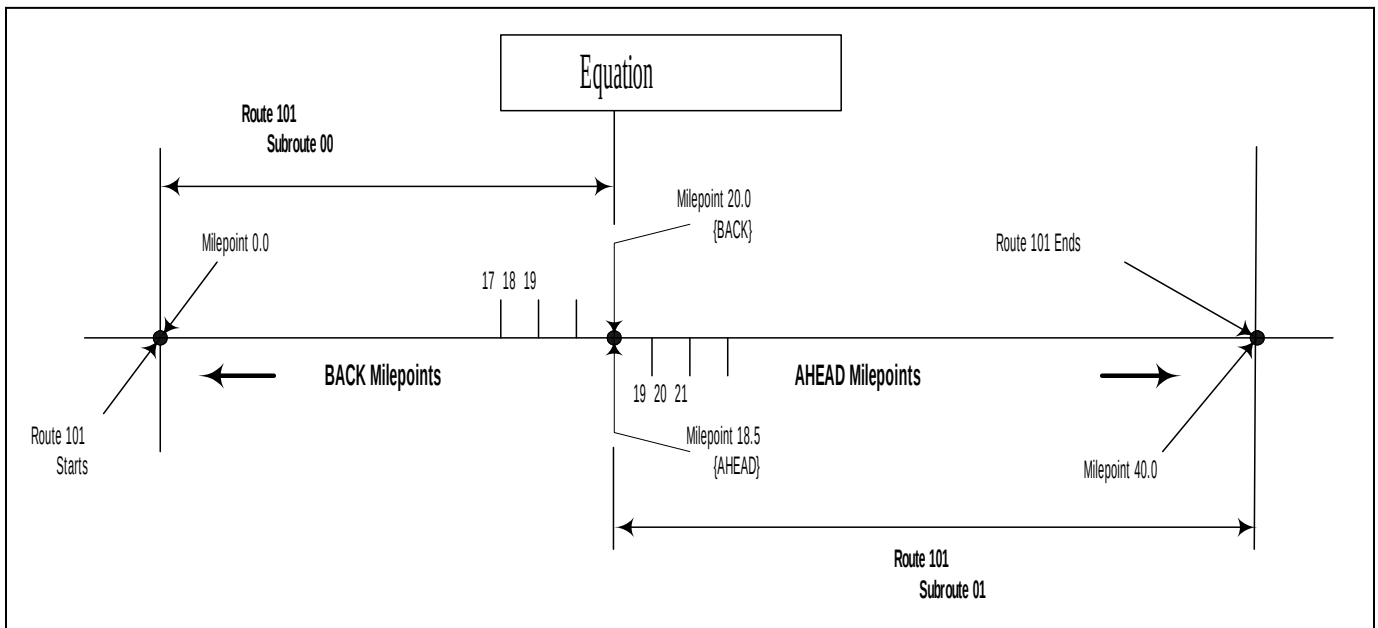
A single node must be established at the following points:

- Beginning of an inventory route
- Where the inventory route crosses another inventory route(s)
- Where the inventory route crosses a county line
- Where the inventory route encounters an equation
- Where the inventory route is temporarily suspended or incurs other types of physical breaks
- Where the inventory route ends

**Defining Unique Locations:**

A unique location within a State for the HPMS LRS is defined by the combination of county, inventory route, inventory subroute, and KMPT/MPT.

Under certain conditions, duplicate KMPTs/MPTs can occur along a route in a state's linear referencing system. These conditions can occur when the route encounters certain types of equations, route breaks, or county lines. Duplicate KMPTs/MPTs are not allowed on a given inventory route within a county. Inventory subroutes must be used to independently identify highway links with duplicate KMPTs/MPTs.

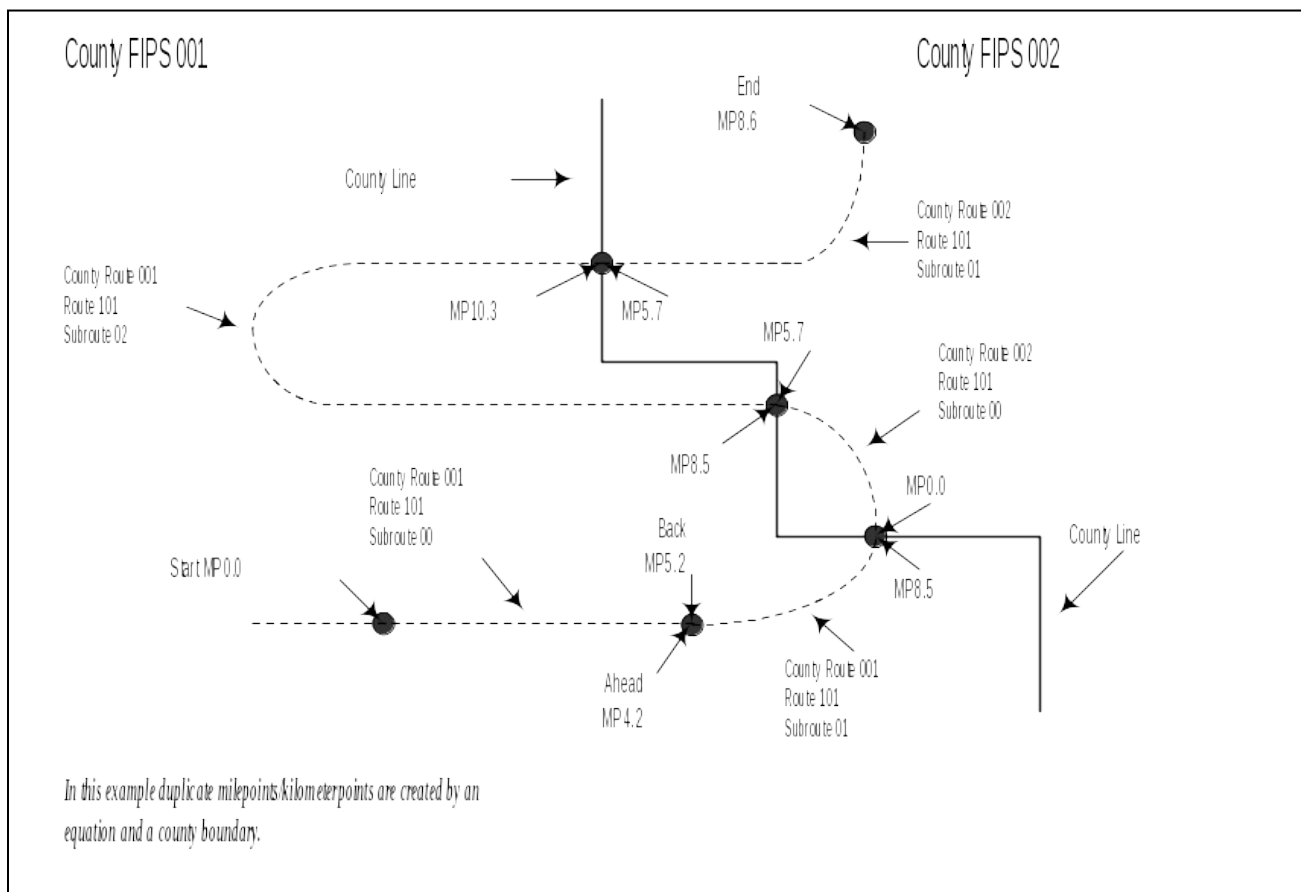


**Figure V-1. Duplicate Milepoint Equation**

**Equations:** Locations on a route where discontinuities in KMPTs/MPTs occur (usually caused by construction) are remedied in some State systems through the establishment of an equation. Some equations will create two lengths of roadway with duplicate ranges of KMPTs/MPTs; i.e., the BACK

KMPT/MPT is larger than the AHEAD KMPT/MPT. In such instances, a [subroute](#) number must be used to distinguish between duplicate KMPTs/MPTs.

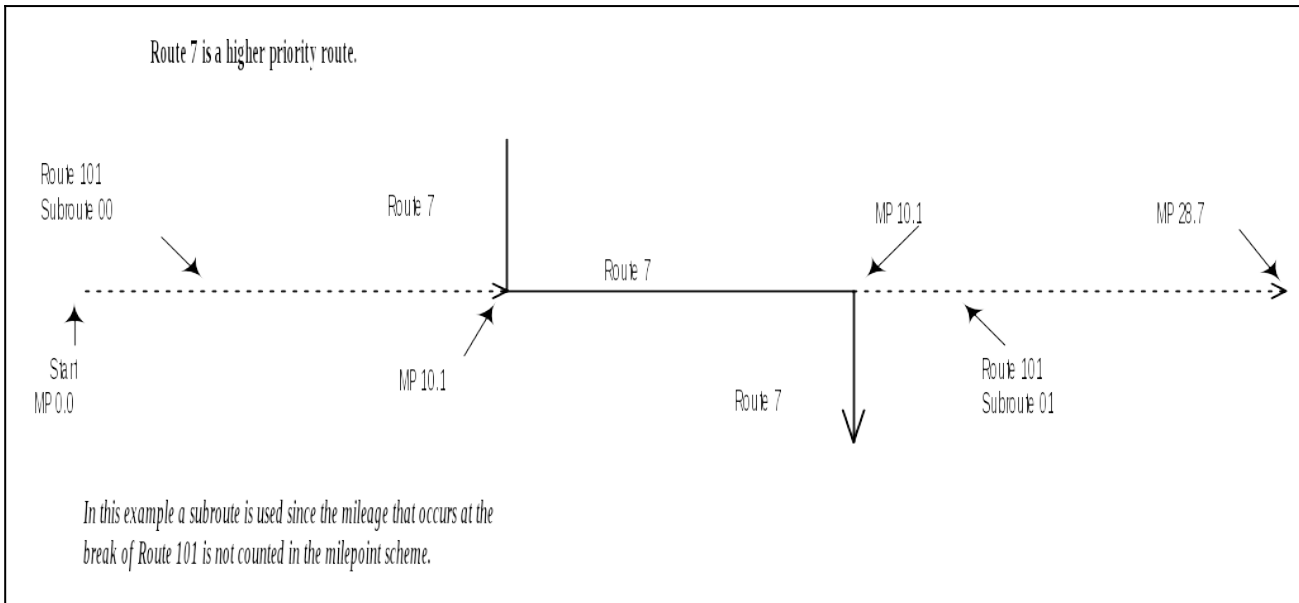
For example, on inventory Route 101, an equation of BACK 20.00 = AHEAD 18.50 creates two 1.50 mile lengths of road with the range of milepoints from 18.50 to 20.00. The route starts at 0.00 milepoint and goes to BACK 20.00 where the mileage is adjusted to AHEAD 18.50, and goes to the end at milepoint 40.00. This route needs to be divided into two subroutes to distinguish between the duplicate milepoints. Subroute number 00 starts at 0.00 milepoint and goes to BACK 20.00. Subroute number 01 starts at AHEAD 18.50 milepoint and goes forward to milepoint 40.00 as illustrated in Figure V-1. The subroute number is continued until either another occurrence of duplicate KMPTs/MPTs (another equation, a route break, or a county boundary) is encountered or the end of the route is reached. For example, if another equation (like the one mentioned above) is encountered, then the subroute number is incremented to 02, etc.



**Figure V-2. Re-Entering a County; Equation Created**

**County Reentries and Route Breaks:** When a route reenters a county or a route break occurs (and the intervening mileage is not counted) and duplicate KMPTs/MPTs occur, inventory subroutes must be used to properly identify highway links. For example, in Figure V-2, inventory Route 101 reenters counties 001 and 002 with the entry KMPTs/MPTs equal to the exit milepoints, requiring the subroute numbers to be incremented to maintain uniqueness within the counties.

In Figure V-3, the length of discontinuity in inventory Route 101 is ignored, and the inventory subroute must be incremented to recognize the duplicate KMPTs/MPTs.

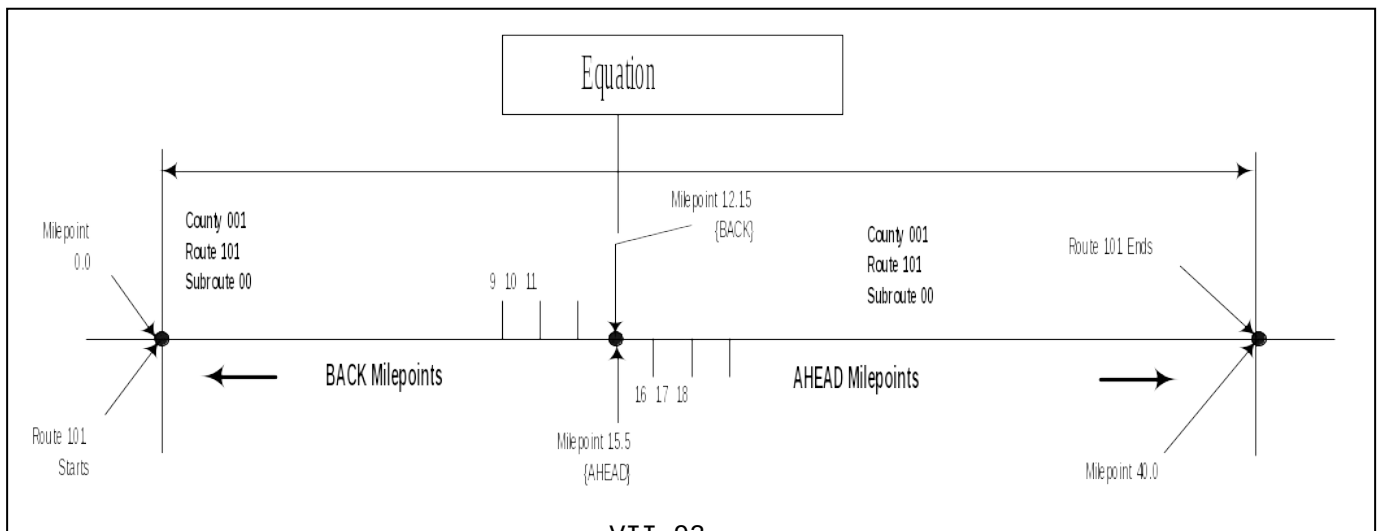


**Figure V-3. Route Stops and Restarts at a Different Location; Milepoint Stays the Same**

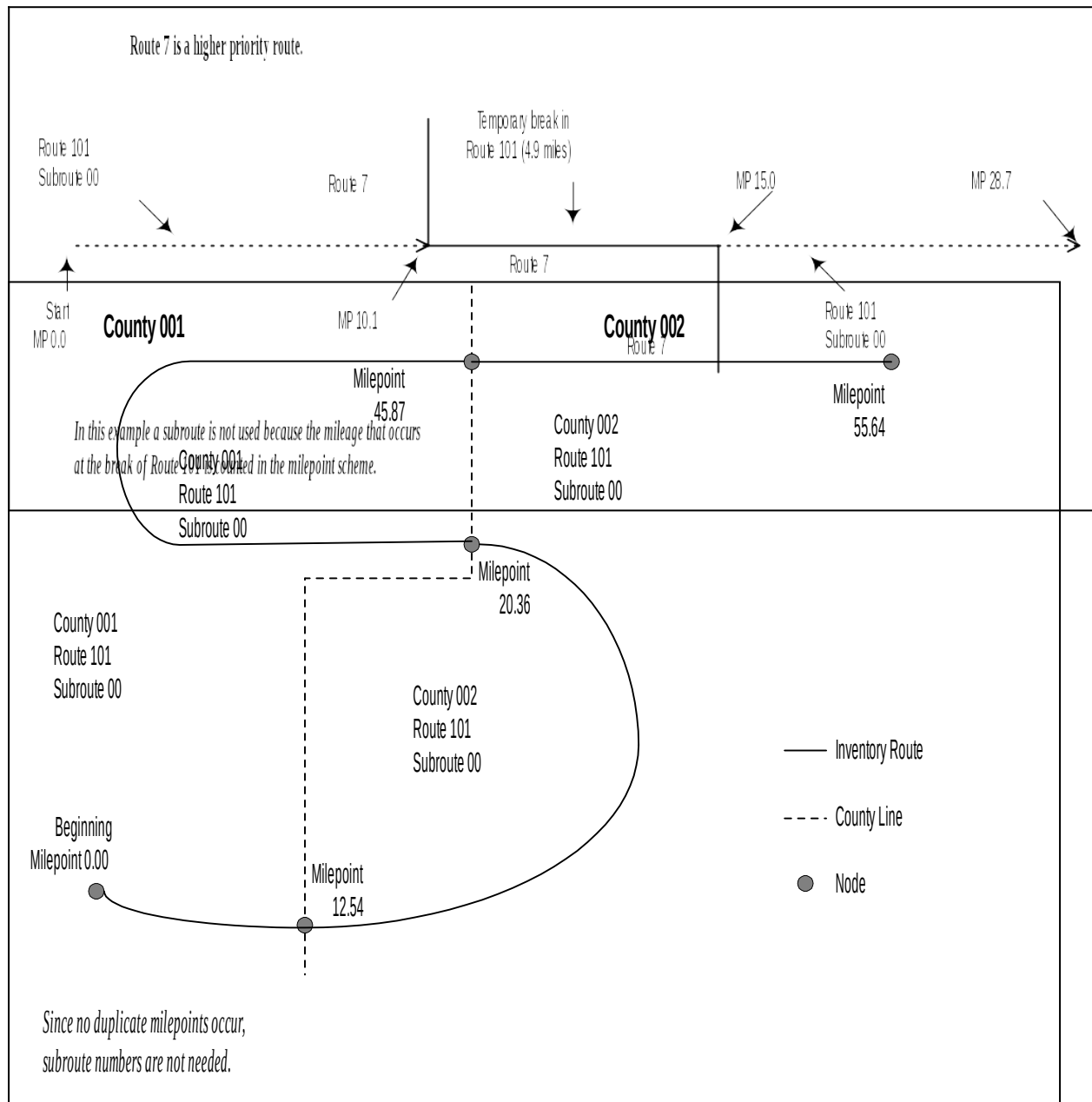
**Subroutes:**

- An inventory route's subroute numbers must not be duplicated within any one county.
- Inventory subroutes along a route do not have to be in order.
- Inventory subroutes need not be used in cases where gaps in kilometers/milepoints occur on an inventory route. In many cases, duplicate KMPTs/MPTs do not exist on inventory routes. In these instances, KMPTs/MPTs are either continuous or gaps occur where KMPTs/MPTs are skipped. These situations do not require the use of inventory subroutes to uniquely identify links (i.e., the subroute is "00" or remains at the last established value).

Equations that are used to compensate for a gap in the KMPT/MPT system are those in which the BACK KMPT/MPT is smaller than the AHEAD KMPT/MPT. For example, an equation of BACK 12.15 = AHEAD 15.55 creates a 3.40-mile gap in the milepoint system (Figure V-4).



**Figure V-4. Nonduplicate Milepoint Equation**



**Figure V-5. Re-Entering a County; No Duplicate Milepoints**

Likewise, an inventory route can be stopped and restarted at another location without duplicating KMPTs /MPTs (Figures V-5 and V-6). In the above instances, duplicate KMPTs/ MPTs are not created since the intervening mileage is kept. No changes in inventory subroutes are required.

If no duplicate KMPT/ MPT condition exists within the county, the combination of county, inventory route, and KMPT/MPT will identify a unique location.

**Figure V-6. Route that Stops and Restarts at Different Locations; Milepoint Increases**

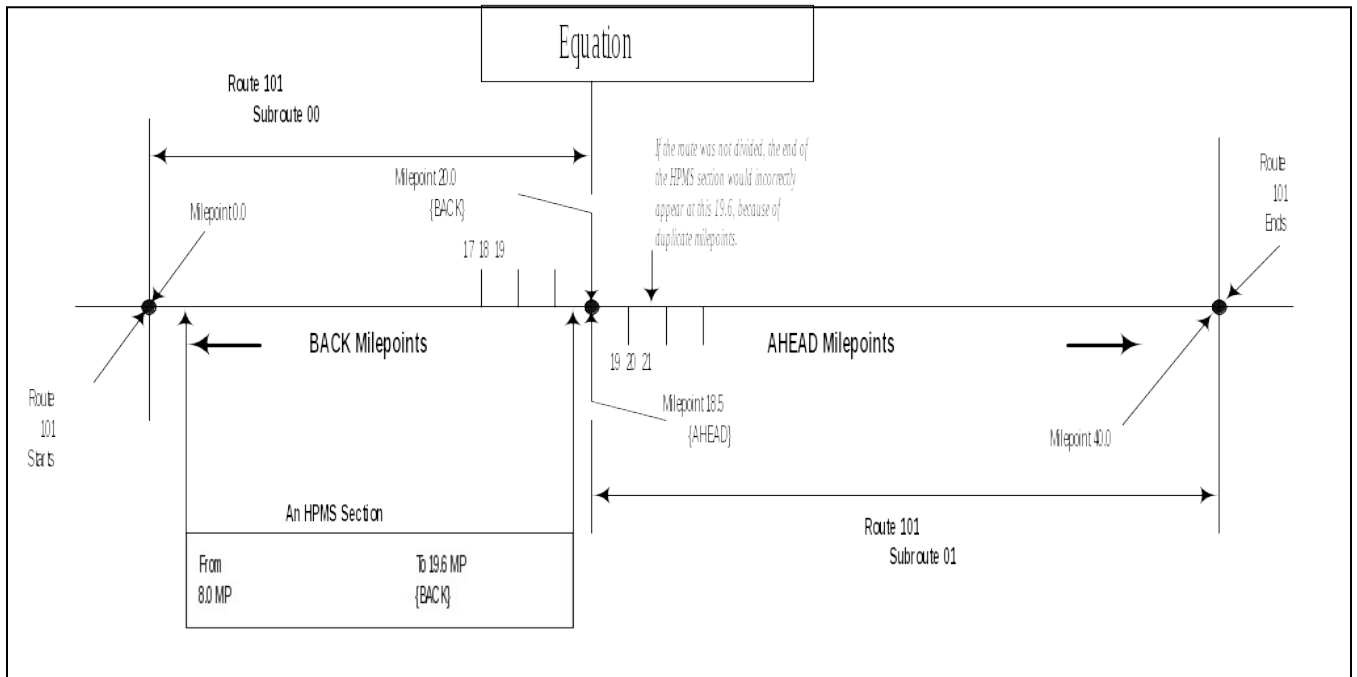
**Effects of LRS on HPMS Sections:**

HPMS sections must be adjusted (or divided) where inventory routes or subroutes change along the length of that section. The division of inventory routes into inventory subroutes, where duplicate KMPTs/MPTs occur, could have a direct impact on the physical length of HPMS universe and sample sections. The subroute field effectively creates a new route any time the subroute number changes.

Figure V-7 shows an HPMS section starting at milepoint 8.0 and extending to milepoint BACK 19.6 - not AHEAD 19.6. In this case, no change to the HPMS section is necessary since the section occurs entirely within county 001, Route 101, Subroute 00. Figure V-8 illustrates the same route conditions with the exception that the HPMS section starts at milepoint 8.0 and extends to milepoint AHEAD 19.6 - not BACK 19.6. In this case, the HPMS section must be adjusted (or divided) at that equation point to accommodate the duplicate KMPTs/MPTs. Two sections must be created: milepoint 8.0 to the equation and then from the equation to milepoint AHEAD 19.6.

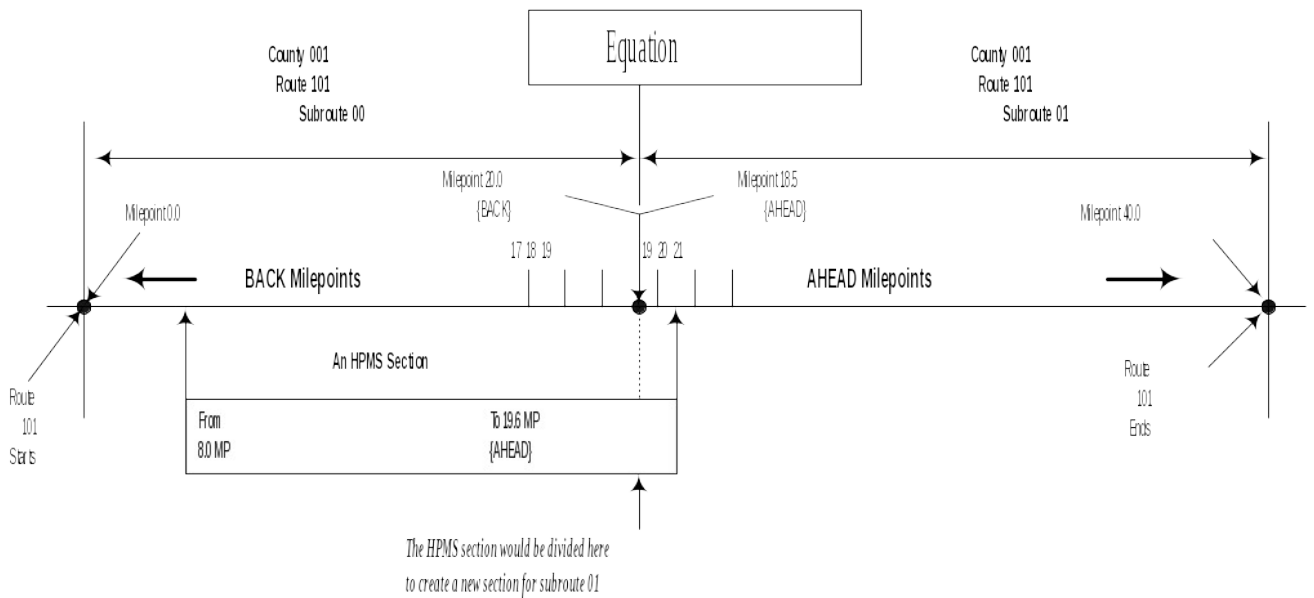
In contrast, where an HPMS section crosses a nonduplicating equation point, the section need not be adjusted (see Figure V-9).

Because of inventory route design, an HPMS section may have more than one inventory route traversing it. Where this occurs, the HPMS section must be divided to reflect the beginning and ending of the inventory routes. Figure V-10 shows an HPMS section extending across two inventory routes: 101 and 7. In this case, the HPMS section must be divided into three sections at the points where the inventory route changes. Since HPMS sections should already begin/end at county lines, no modification to the sections is required where subroutes are created at county lines.

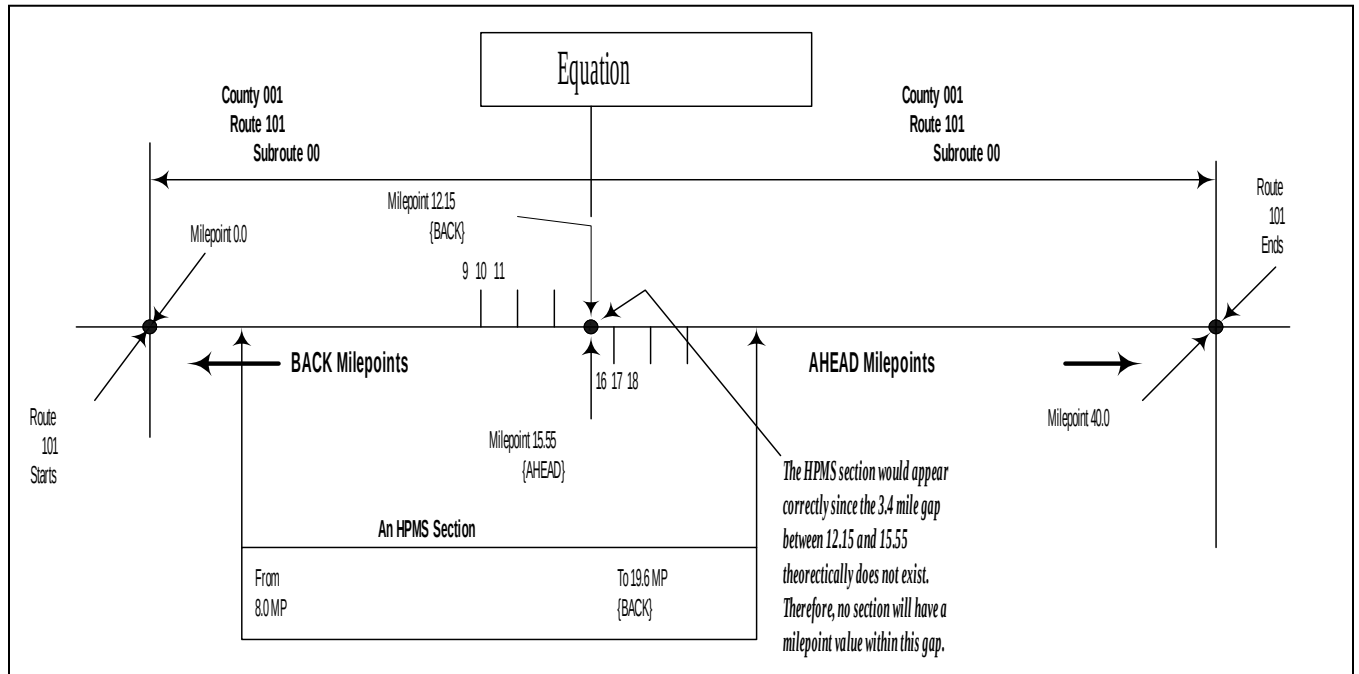


**Figure V-7. HPMS Section Near a Duplicate Milepost Equation**

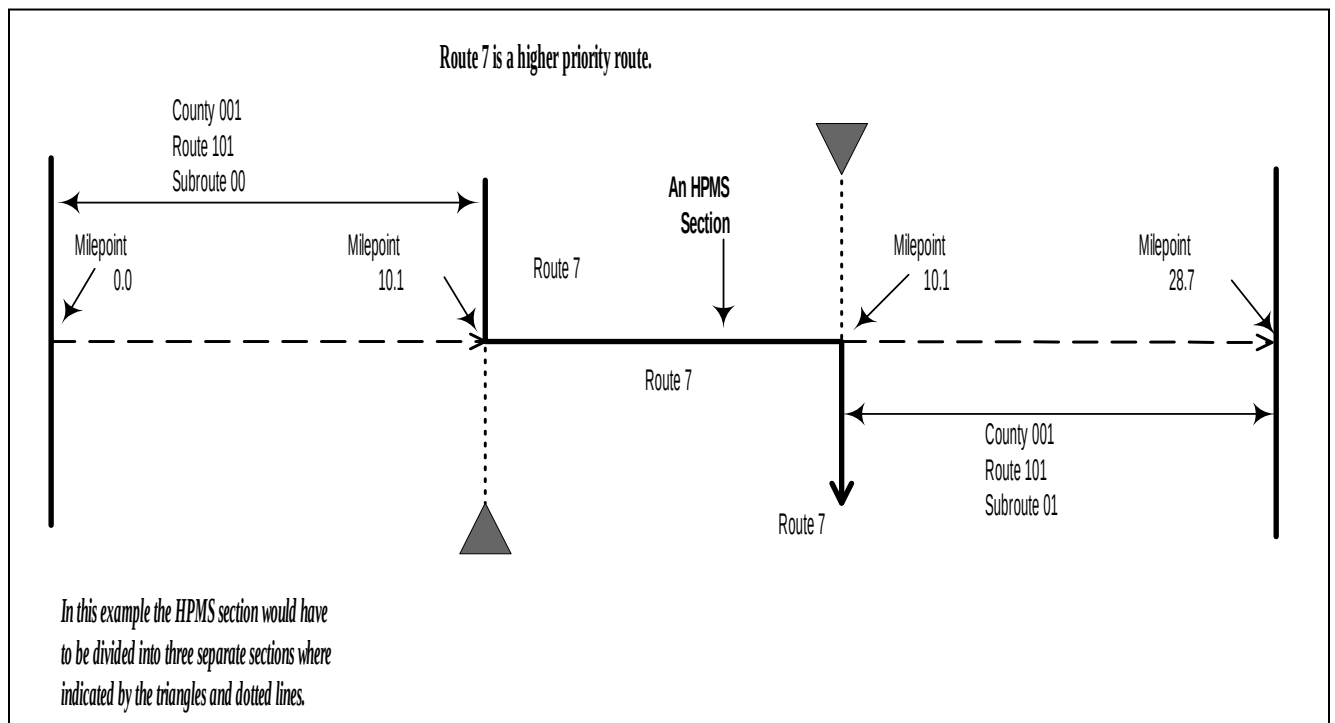
**Figure V-8. HPMS Section Crossing a Duplicate Milepoint Equation**







**Figure V-9. HPMS Section Crossing a Nonduplicate Milepoint Equation**



**Figure V-10. An HPMS Section that Runs through Overlapping Routes**

## SUMMARY OF LRS DATA REQUIREMENTS

In addition to the data provided in each HPMS record as outlined in Chapter IV (see Items 9, 10, 11, and 12), each State is to provide the following information. (NOTE: The following discussion assumes that an initial LRS submittal has been made. Appendix H discusses establishing an LRS for the first time.)

## LRS SUBMITTAL OPTION 1 - MAPS AND COMPUTER FILES

- **Inventory Route and Node Maps** showing the location of **new, deleted and revised** inventory routes, inventory subroutes and nodes on the base network of rural arterials, urban principal arterials and other designated NHS routes. Sufficient coverage of existing, unchanged links and nodes must be provided to enable FHWA to locate changed nodes and links.
- A **Node Data File** that, at a minimum, describes **new, revised and deleted** nodes in the network.
- An **Inventory Route Link Data File** that, at a minimum, describes **new, revised and deleted** inventory routes within the network.
- **The complete node and link files may be provided if it is more convenient to the States.**

Each product is described in more detail below. A dBase template has been provided to the States for entering and reporting the Node Data and Inventory Route Link Data files discussed above. Data can be submitted on floppy disk, CD, or as an electronic file in dBase or ASCII format.

### Inventory Route and Node Map Labeling Instructions

As part of the HPMS submission requirements, States will be required to prepare and submit maps showing, at least new, revised and deleted inventory routes and nodes. **To insure that the revised data is located properly, adjacent node and link information should also be provided.** These maps will be used to ensure the correct location of these inventory routes and nodes on the network in preparation for attaching a linear referencing system and linking HPMS data to the network. The amount of data on these maps should be kept to a minimum and only data necessary to check and transfer the information to the network is requested. Therefore, five basic categories of data must be displayed on the maps:

6. Appropriate portions of the base State highway network — rural arterials, urban principal arterials, and other NHS routes.
7. State/county boundaries.
8. Principal signed routes (U.S., State, etc.).
9. Inventory route and subroute numbers.
10. Nodes with node numbers.

These data should be placed on maps that are at a scale that keeps the number of map sections to a minimum, while maintaining good visual quality for data location and readability.

In order to reduce confusion regarding which number goes with what feature, qualifiers must be added as follows:

Map Feature	Map Qualifiers
Inventory Route	X
Inventory Subroute	( )
Node	N
Signed Routes	No Special Map Qualifiers (Use Existing Prefixes)

For example, inventory Route “234” with a subroute number of 05 would appear on the map as “X234(05).” The “X” and “N” prefixes and “( )” are meant to be used only on the map, so the numbers can be more easily distinguished. **These qualifiers shall not be used on the HPMS records, route/link file, or node file.** To identify the signed route, the State should place the sign route numbers on the map with a prefix (such as “US,” “SR,” etc.), unless shields exist on the maps that contain the route numbers.

#### Map Item Description

**The Base Network:** Contains Interstate, other freeways and expressways, other principal arterials, and rural minor arterials. In addition, those routes not so classified, but are part of the NHS, must also be identified. Finally, officially approved proposed routes are to be included in this base network in keeping with HPMS data Item 20, Planned Unbuilt Facility. Since these LRS data will be used with the HPMS, centerline of dual alignments must be indicated. However, in the case of one-way pairs (couplets), each directional roadway is to be separately defined, as is done in the HPMS records.

**Boundaries & County Name Labels:** The State must place the name and the county FIPS code within the boundaries.

**Principal Signed Route Number Labels:** The principal signed route or street name must be provided for each link (i.e., between any two nodes). While the Inventory Route Link Data File allows for up to three signed routes, because of the need for good map readability, only one (the principal route) is required for each link on the map.

**Inventory Route and Subroute Number Labels:** Only one inventory route and subroute number is to be assigned for each link between any two nodes. In the case of one-way pairs (couplets), each directional roadway is considered a different inventory route. For identification purposes on the map only, route numbers are to begin with an “X” and subroutes are to be enclosed in parentheses.

**Nodes and Node Number Labels:** Nodes will be established for:

1. Intersections of other inventory routes.
2. Intersections of inventory routes and State boundaries.
3. Intersections of inventory routes and county boundaries.
4. Equation locations.
5. Route termini (including route discontinuity termini).

Each node should have a unique node number clearly displayed beside the node; node numbers must be unique within the State. For identification purposes on the map only, these node numbers are to begin with “N.”

All new, revised and deleted nodes and links in the node and link data files must be shown on the map along with

adjacent nodes and links.

## NODE DATA FILE CODING INSTRUCTIONS

The Node Data File, together with the Inventory Route Link Data File and maps, are used to define the geographic location of the inventory routes and the kilometers/milepoints. These records complement the data supplied in the Inventory Route Link Data File and the Inventory Route and Node Map. In the following table, Items 6-11 identify each of the conditions that will create a node. (Items 1-5 and 12-14 provide other descriptor information about the nodes.) This information is necessary for accurate placement of the node on the network.

Item Number	Position	Length	Data Type	Data Item Description
<b>IDENTIFICATION</b>				
1	1-4	4	N	Year
2	5-6	2	N	State FIPS Code
3a	7-9	3	N	County FIPS Code No. 1
3b	10-12	3	N	County FIPS Code No. 2
4	13	1	N	Record Status
5	14-23	10	AN	Node Number
<b>NODE TYPES</b>				
6	24	1	N	Inventory Route Intersection
7	25	1	N	County Boundary
8	26	1	N	State Boundary
9	27	1	N	Equation
10	28	1	N	Spur Route Termini
11	29	1	N	Inventory Route Termini
<b>COORDINATES (Optional)</b>				
12	30-39	10	N	X Coordinate - Geographic
13	40-49	10	N	Y Coordinate - Geographic
<b>OTHER DESCRIPTORS (Optional)</b>				
14	50-149	100	AN	Description of Node
N = Numeric                      AN = Alphanumeric				

**All numeric data items must be right justified and zero-filled. The alphanumeric field of Item 5 will be right justified and can use numbers and capitalized English letters. However, this field should not be considered case sensitive. No embedded blanks are allowed. Item 14 may contain any characters, placed anywhere within the 100 positions.**

## DATA ITEM DETAILS

### Item 1 – Year (Length = 4)

See Item 1 of the HPMS Universe Data Coding Instructions in Chapter IV.

### Item 2 – State FIPS Code (Length = 2)

See Item 2 of the HPMS Universe data coding instructions in Chapter IV.

### Item 3a – County FIPS Code No. 1 (Length = 3)

A node is created when an inventory route and a county boundary intersect.

When nodes occur at boundaries between adjoining counties, Item 3a will identify one of the two counties sharing the boundary at the node and Item 3b will identify the other county (Figure V-11, Examples A and B). The counties can be identified in any sequence. If the node occurs at a boundary of three or more counties, any two of the possible three will be reported.

Figure V-11. Nodes and Political Boundaries

When nodes occur within counties or at a State boundary where the county is not joining another county within that State, only one county is identified and will appear in both Items 3a and 3b (See Figure V-11, Examples C and D).

Use the three-digit FIPS county code. (See Item 4 of the HPMS Universe Data Coding Instructions in Chapter IV.)

Adjoining counties of neighboring States, under any of the above-described conditions, are not to be coded.

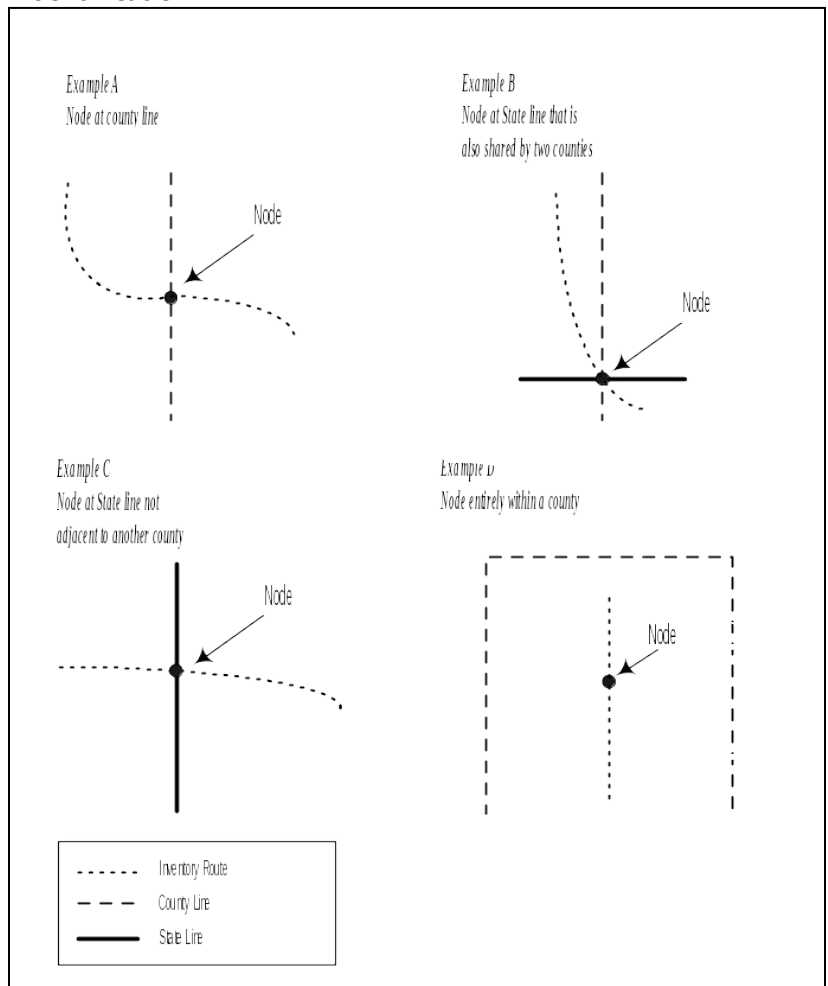
### Item 3b – County FIPS Code No. 2 (Length = 3)

This item identifies the second of the two counties sharing the boundary at the node, as discussed above.

### Item 4 – Record Status (Length = 1)

This item depicts the condition of the node relative to the data submittal of the past year; that is, a newly

## Identification



created node or an existing node which has incurred a change in one or more of the data items represented in the Node File. In the first year's submittal, all nodes should be coded "0." In subsequent years, if a node is added or one or more of the characteristics have changed, it will be coded as either "2" or "1," respectively. If no change occurs to an existing node, then it will be coded "0." When a node is reported as being deleted, it must be dropped from subsequent years' submittals. **For example, where a realignment occurs along a route and the old alignment no longer qualifies as part of the "Base Network," the old node(s) will be deleted and new node(s) will be added as needed.**

Code	Description
0	No Change
1	Changed - one or more data items on the node list have been changed or added
2	New Node
3	Deleted Node

**Item 5 – Node Number** (Length = 10)

All nodes must be identified with a number that can be comprised of both alpha characters and numbers. Each node number must be unique within the State and right justified in the field.

**Node Types:** Items 6-11 represent different characteristics of a node. Nodes should be created based on one or more of these conditions. Mark each condition that applies to each node (all conditions that describe a particular node should be coded as "1").

**Item 6 – Inventory Route Intersection** (Length = 1)

Node that occurs where two inventory routes intersect:

Code	Description
0	NO
1	YES

**Item 7 – County Boundary** (Length = 1)

Node that occurs where an inventory route is intersected by a county boundary:

Code	Description
0	NO
1	YES

**Item 8 – State Boundary** (Length = 1)

Node that occurs where an inventory route is intersected by a State boundary:

Code	Description
------	-------------

0	NO
1	YES

**Note:** Since a State line will also be a county boundary, Items 7 and 8 will both be coded as “1” at all State lines.

**Item 9 – Equation** (Length = 1)

Node that occurs where an equation occurs on an inventory route:

Code	Description
0	NO
1	YES

**Item 10 – Spur Route Termini** (Length = 1)

Node that occurs where an inventory route terminates without intersecting another inventory route:

Code	Description
0	NO
1	YES

**Note:** If this item is marked “yes,” Item 11 is also to be marked “yes.”

**Item 11 – Inventory Route Termini** (Length = 1)

Node that occurs where an inventory route begins, ends, stops at a discontinuity, or starts after a discontinuity.

Code	Description
0	NO
1	YES

**Coordinates (Optional):** Specify in the letter of transmittal whether these data exist, and the coordinate system and decimal positions (if any) used for the LRS submittal.

**Item 12 – X Coordinate** (Length = 10) (Optional)

Enter the “X” coordinate for the node. This should be a nonprojection geographic coordinate, preferably decimal degrees.

**Item 13 – Y Coordinate** (Length = 10) (Optional)

Enter the “Y” coordinate for the node. This should be a nonprojection geographic coordinate, preferably decimal degrees.



**Other Descriptors (Optional)**

**Item 14 – Description of Node** (Length = 100) (Optional)

This item is provided if the State desires to provide additional descriptive information regarding node location. Any alphanumeric characters may be entered, including blanks.

## INVENTORY ROUTE LINK DATA FILE CODING INSTRUCTIONS

The Inventory Route Link Data File, together with the Node Data File and maps, are used to define the geographic location of the inventory route and the KMPTs/MPTs. This record compliments the data supplied in the Node Data File and the Inventory Route and Node Map. A link is the roadway between two nodes. The Inventory Route and Node Map illustrates the locations of the links and nodes. All data in this file must be right justified and zero filled.

Item Number	Position	Length	Data Type	Data Item Description
<b>Identification</b>				
1	1-4	4	N	Year
2	5-6	2	N	State FIPS Code
3	7-9	3	N	County FIPS Code
4	10	1	N	Record Status
5	11-20	10	AN	Inventory Route Number
6	21-22	2	N	Inventory Subroute Number
7	23-32	10	AN	Beginning Node Number
8	33-40	8	N	Beginning Milepoint/Kilometerpoint
9	41-50	10	AN	Ending Node Number
10	51-58	8	N	Ending Milepoint/Kilometerpoint
<b>Signed Route 1</b>				
11	59	1	N	Route Signing 1
12	60	1	N	Route Qualifiers 1
13	61-68	8	AN	Route Number 1
<b>Signed Route 2</b>				
14	69	1	N	Route Signing 2
15	70	1	N	Route Qualifiers 2
16	71-78	8	AN	Route Number 2
<b>Signed Route 3</b>				
17	79	1	N	Route Signing 3
18	80	1	N	Route Qualifiers 3
19	81-88	8	AN	Route Number 3
<b>Other</b>				
20	89-118	30	AN	Street Name
N = Numeric		AN = Alphanumeric		

**All data must be right justified and zero-filled. Beginning and ending node numbers must be right justified.**

**DATA ITEM DETAILS****Identification****Item 1 – Year** (Length = 4)

See Item 1 of the HPMS Universe Data Coding Instructions in Chapter IV.

**Item 2 – State FIPS Code** (Length = 2)

See Item 2 of the HPMS Universe Data Coding Instructions in Chapter IV.

**Item 3 – County FIPS Code** (Length = 3)

See Item 4 of the HPMS Universe Data Coding Instructions in Chapter IV.

**Item 4 – Record Status** (Length = 1)

This item depicts the status of the route link, relative to the previous year's submittal; that is, a newly created link or an existing link which has incurred a change or addition to one or more of the data items represented in the link file. In the first year's submittal, all links must be coded "0." In subsequent years, if a link is added or one or more of its characteristics have changed, it will be coded as either "2" or "1," respectively. However, if no change occurs to an existing link, then it will be coded "0." When a link is reported as being deleted, it must be dropped from subsequent years' submittals. **For example, where a realignment occurs along a route and the old alignment no longer qualifies as part of the "Base Network," the old link(s) will be deleted and new links(s) will be added as needed.**

Code	Description
0	No Change
1	Changed - one or more data items on the Route Link record has changed
2	New Route Link
3	Deleted Route Link

**Item 5 – Inventory Route Number** (Length = 10)

The inventory route number, which is not necessarily the same as that posted along the roadway, is a number used to uniquely identify a route for inventory purposes. The inventory route number must be unique within a county, but it is recommended that it be unique within the State. This number can be alphanumeric, but must not contain blanks; it must be right justified in the field. Provide leading zeroes.

**Item 6 – Inventory Subroute Number** (Length = 2)

This number is used to uniquely identify portions of an inventory route within a county where certain conditions (KMPT/MPT equations, inventory route breaks, or KMPTs/MPTs that are adjusted at county boundaries) create a length of roadway with a [duplicate](#) KMPT/MPT or range of KMPTs/MPTs. A new subroute number must be assigned each time a duplicate KMPT/MPT or range of KMPTs/MPTs is encountered. These subroute numbers must only be unique within each county. In the absence of duplicate KMPTs/MPTs and previous to the first duplicate KMPT/MPT condition encountered, code zero.

**Item 7 – Beginning Node Number** (Length = 10)

This is the number of the first of two nodes of the link. This node is at the end of the link with the lowest KMPT/MPT.

**Item 8 – Beginning Milepoint/Kilometerpoint** (xxxx.xxx — code the decimal)(Length = 8)  
This is the lowest KMPT/MPT of the link.

**Item 9 – Ending Node Number** (Length = 10)  
This is the number of the last of two nodes of the link. This node is at the end of the link with the highest KMPT/MPT of the link.

**Item 10 – Ending Milepoint/Kilometerpoint** (xxxx.xxx — code the decimal)(Length = 8)  
This is the highest KMPT/MPT of the link.

**Signed Routes 1, 2, and 3:** These three groups of three items define up to three signed route numbers assigned to a link. The priority of the signed routes shall be based on Item 11 below, where those with a non-zero lower code have the higher priority.

**Items 11, 14, and 17 – Route Signing 1, 2, and 3** (Length = 1)  
These codes specify the manner in which the highway segment is signed.

Code	Description
0	Not Signed or No More Signed Routes
1	Interstate
2	U.S.
3	State
4	Off-Interstate Business Markers
5	County
6	Township
7	Municipal
8	Parkway
9	None of the Above

**Items 12, 15, and 18 – Route Qualifiers 1, 2 and 3** (Length = 1)  
These codes specify the manner in which the highway segment is signed. Where more than one code is applicable, use the lower code excluding zero.

Code	Description
0	No Qualifier
1	Alternate
2	Business Route
3	Bypass
4	Spur
5	Loop
6	Proposed
7	Temporary
8	Truck Route
9	None of the Above

**Items 13, 16, and 19 – Route Number 1, 2 and 3** (Length = 8)

Enter the signed route number (on the marker), right justified. Any alphabetic character prefixes or suffixes that cannot be identified with the Route Signing or Qualifier list of codes should be reported and abbreviated to fit into the field length, if necessary. Zero-fill if the route is unsigned or there are no more signed routes.

**Item 20 – Street Name** (Length = 30)

Enter a street, road, or highway name. This field need only be used when a signed route number is not available for use in describing the route. Otherwise, leave the field blank. If used, ensure that the name includes the proper suffix (street, place, court, etc.) to eliminate duplicate name possibilities.

For example: U.S. 5 Business Route and State 2 Truck Route are on the same link:

Item 11 = “2”	(U.S.)
Item 12 = “2”	(Business Route)
Item 13 = “00000005”	(Route Number)
Item 14 = “3”	(State)
Item 15 = “8”	(Truck Route)
Item 16 = “00000002”	(Route Number)

## **LRS SUBMITTAL OPTION 2 - LRSEDIT FILES PLUS MAPS FOR NEW LINKS AND NODES**

An LRSEDIT file for the complete base highway network with a copy of the LRSEDIT printed reports must be submitted along with maps depicting new links and nodes that did not exist on the NHPN. Maps must be labeled in accordance with instructions for coding inventory route and node maps under Option 1 above. Beginning and ending kilometerpoints/milepoints for the links must also be included.

## **LRS SUBMITTAL OPTION 3 - GIS FILES**

A complete GIS file encompassing the base highway network shall be submitted. This file shall contain all data required by Chapter V in a format agreed upon by the State and FHWA.

### **LRS Updates**

After the initial reporting of LRS data, only updated information is required on an annual basis. LRS reporting status should be noted in the comment file, annually.

### **Technical Assistance**

For technical assistance or further information regarding this chapter or about LRS, please contact Roger Petzold of the Federal Highway Administration; Phone: 202-366-4074, E-mail: roger.petzold@fhwa.dot.gov.

# **CHAPTER VII**

## **SAMPLE SELECTION AND MAINTENANCE**

## INTRODUCTION

The purpose of this Chapter is to address a number of subjects related to the selection and maintenance of the HPMS sample and sample panels. The data reported for sampled roadway sections are the source of the condition, use, and operational information provided by the HPMS. Expanded sample data are used for apportionment of funds, for monitoring trends and impacts in performance data over time, and for analyses in support of national budgeting for highway improvements through the *Condition and Performance* reports to Congress. Selection and maintenance of an adequate, up-to-date HPMS sample should be a high priority, continuing activity.

Although developed for the HPMS standard sample, most of the following discussion applies equally for donut area supplementary sample panels; Appendix G contains additional discussion of the donut area sample panel.

## SAMPLE PANEL CONSIDERATIONS

The HPMS sample includes the arterial and collector functional systems, excluding the rural minor collector system. While it is assumed that there is a “technically best” way to collect sample data, a sample design also must be simple and cost efficient to meet manpower and cost considerations; this involves tradeoffs. The required number of samples for HPMS are derived by formula from the normal dispersion characteristics of AADT values within a framework of preselected AADT groups (strata). The sample size requirements relate to the critical data element, AADT, whose values can be conveniently stratified. Information obtained from the existing sample or universe data in each State is used to optimize and maintain the sample panel.

Procedures for determining necessary sample size based on the analysis of existing data are described in this chapter. In order to obtain cost-effective, valid comparisons of system performance over time and to reduce technical effort, the sample was designed as a fixed sample panel. With a fixed sample panel, the same sections that are inventoried are then updated in future years on a cyclical basis. This means of obtaining data is efficient because:

1. The need for the periodic drawing of a complete new sample is eliminated.
2. The need to update or reinventory all data elements for every cycle is eliminated.
3. Only those data elements that change over time need be updated on a cyclical basis.

The length of the cycle is determined by the known statistical characteristics of individual elements, the intended use and accuracy needed, and the time and cost required to collect and report the data.

However, the use of fixed panel sections is not without disadvantages. These include:

- the possible loss of the sample's representativeness as the highway networks and traffic patterns change, and
- the inability to assess the correctness of the estimates by comparing them with those of a different sample.

sampling procedures are both simple and efficient and, if applied properly, the selected sample will achieve the predetermined levels of desired precision and yield an adequate sample for performance monitoring.

## **SAMPLE STRATIFICATION AND PRECISION LEVELS**

Data needs vary for rural, small urban, and urbanized areas; this variation is reflected in the sample design. The design is capable of producing valid estimates of highway condition and operating and performance characteristics on a State-by-State basis. Rural and small urban functional systems are sampled on a statewide basis; although States with urbanized areas with less than 200,000 population that are not in an NAAQS nonattainment area may retain existing collective urbanized area samples at the State's option, all urbanized areas must be sampled individually in the future. A shift to individual urbanized area samples is encouraged for all States.

The sampling plan consists of the random selection of a panel of road sections within predetermined AADT volume groups (strata) for each functional system in the rural, small urban, and urbanized areas of the State. The stratification of sections (sampling units) into relatively homogeneous AADT volume groups produces estimates of greater accuracy with respect to VMT for a smaller number of samples at the functional system (summation) levels. Although stratification for sample selection is based on the critical data element AADT, tests have shown that AADT stratification is compatible with the sampling of nonvolume related data elements.

The required sample size is a function of the variability of AADT within a volume group, the functional system volume group precision level, and the number of sections available for sampling in the volume group (the universe). The term "precision level" is defined as the degree of confidence that the sampling error of a produced estimate will fall within a desired fixed range. For a precision level of 80-percent confidence with 10-percent allowable error (80-10), there is the probability that 80 times out of 100 the error of a data element estimate will be no greater than  $\pm 10$  percent of its true value. The precision levels specified in Appendix C represent minimum FHWA requirements for rural, small urban, and urbanized area functional system volume groups. The precision levels determined for the sample design apply specifically to the individual volume strata. The sample size estimating procedures shown in Appendix D are used to determine the required number of samples to meet the target precision levels at the volume group level. The sample adequacy software described in Appendix K produces a table that contains a standard sample size estimation based on Appendix D criteria.

Sample size requirements by functional system will vary by State according to the total number of road sections, the number of predetermined volume groups, the validity of the State's AADT data, and the design precision level. The HPMS sample size requirements are more stringent for the arterial systems, where a higher level of precision is needed because of higher Federal interest. In rural, small urban, and collective urbanized areas, the sample sizes are based on a 90-5 precision level for the volume groups of the principal arterial system, 90-10 for the minor arterial system, and 80-10 for the collector (excluding minor collector) systems. The sample for individually sampled urbanized areas is broken into two major categories of precision levels:

1. For individual urbanized areas with a population of 200,000 or more and those that are in an NAAQS nonattainment area, the design precision levels are 90-10 for the arterial systems and 80-10 for the collector system.
2. For urbanized areas that are less than 200,000 population and are individually sampled, the design precision levels for individual volume strata are 80-10 or 70-15, depending upon the number of urbanized areas the State designates as individual sampling areas:

- Those States with less than three should use a precision level of 80-10 for all functional systems.
- Those with three or more may use the lower precision level of 70-15 for the minor arterial and collector systems and 80-10 for the principal arterial systems thereby requiring a smaller number of samples.

The statewide summation of individual urbanized functional system data element estimates will result in an overall precision level of at least 80-10.

The higher precision levels at the State level are necessary to obtain comparable urban and rural precision levels and to obtain precision levels that can adequately accommodate desired levels of accuracy for estimates of proportionate values as well as average and aggregate values. That is, although the HPMS sample is designed to measure AADT, the same samples are used to estimate the proportionate values of data such as pavement condition. Since the level of accuracy for estimated proportions is closely related to sample size, precision levels have been set sufficiently high to produce reasonable proportionate estimates at the functional system level.

## **PREPARATION FOR SAMPLE SELECTION**

Before a sample can be drawn, the universe from which it is selected must be defined. This is very important since expansion factors, and the reliability of the expanded sample data, relate directly to the universe definition. Initial steps include:

- First, delimit the boundaries between rural, small urban, and urbanized areas using FHWA-approved, adjusted urban boundaries.
- Next, identify the functional system of all arterial and collector routes within each of these areas.
- Then, break the arterial and collector routes into logical roadway sections.
- Finally, assign all road sections in these functional systems to the predetermined AADT groups shown in Appendix C.

An AADT volume group assignment is required for all roadway sections on functional systems subject to sampling (all but rural minor collector and rural and urban local). Assigning sections to proper volume groups and maintaining proper volume group assignments is an important step. Because of economic growth and development, AADT growth may require periodic adjustments to volume group assignments over time. The HPMS software will assign a volume group for each section where an AADT is provided. Maintaining accurate volume groups requires States and other data providers to maintain comprehensive, high quality, traffic count programs (see Appendix F).

If volume groups other than the predetermined volume groups shown in Appendix C are selected, the AADT limits of these volume groups must be reported to FHWA, and the State will need to assign each section to the appropriate volume group.

Each HPMS section should be relatively homogeneous as to geometrics, traffic volume, cross section, and condition, and should be long enough to constitute a logical section for various analyses such as determining highway investment requirements. In general:

- Rural section lengths should range from 0.5 to 16.1 kilometers (0.3 to 10.0 miles)



- Urban access controlled facility section lengths should usually not exceed 8.0 kilometers (5.0 miles)
- All other urban section lengths should range from 0.2 to 4.8 kilometers (0.1 to 3.0 miles).

These suggested lengths are intended to keep the sample normalized on a national basis. Shorter lengths may be warranted where there are nonhomogeneous roadway elements; longer sections reduce the number of universe sections and result in a somewhat smaller number of initial samples. However, longer sections may have to be split in later years in order to maintain sample homogeneity; this will increase the number of universe sections and may result in an increase in the required number of samples.

Finally, it is important to precisely document the exact location of each sampled section to assure that yearly and cyclical updates, field reviews, traffic counts, etc., are performed on the appropriate roadway sections.

## **CALCULATION OF EXPANSION FACTORS**

The purpose of the HPMS sample panel is to provide an expandable base for rural, small urban and urbanized area data in each State, stratified by functional system and traffic volume group. An expansion factor is calculated for each volume stratum within each functional system. This is accomplished by dividing the total kilometers (miles) in the stratum by the kilometers (miles) included in that stratum's sample. As noted above, the total universe length in each stratum is a known value based on the AADT volume group identifier. Expansion factors are calculated by the HPMS software for each sample section. The expansion factor allows sample data to be expanded to represent entire functional systems for rural, small urban, and urbanized areas.

## **SAMPLING RURAL AND SMALL URBAN AREAS**

Both rural and small urban area data are sampled on a statewide basis, stratified only by functional system and volume group. The volume group for each road section in the sampling universe must be identified using the tables in Appendix C before sample selection can begin. The number of sections to be included in the sample is determined using the calculation procedure in Appendix D. A minimum of three unique sample sections is required for each volume group; if less than three universe sections exist in a volume group, they must all be sampled and the expansion factor will be 1.000. Sections should be selected from the universe of each functional system and volume group using a random number table or random number generation computer software, until the required number of samples is reached.

## **SAMPLING INDIVIDUAL URBANIZED AREAS**

Urbanized area data are sampled on an individual area basis stratified by functional system and volume group. Each State must individually sample new urbanized areas regardless of population size. However, the State has the option to determine which of the existing urbanized areas it will retain in existing collective samples. For each individually sampled urbanized area, the volume group for each road section in the sampling universe must be identified using the tables in Appendix C before sample selection can begin. Where AADTs higher than those contained in this table are encountered, the State may add higher volume groups that contain a range similar to that for the highest volume group shown in the table for the appropriate functional system. However, States electing this option will have to assign all sections to appropriate volume groups. As an alternate, the State may leave the sections in the highest

volume group.

The number of sections to be included in the sample is determined using the calculation procedure in Appendix D. As with rural and small urban areas, sections should be selected from the universe of each functional system and volume group using a random number table or random number generation computer software, until the required number of samples is reached; a minimum of three sections per stratum is required.

Unless part of an existing collective sample, each State must sample its part of a multi-State urbanized area individually. All portions of multi-State urbanized areas must be sampled. When sampled as individual areas, the sample in each State should not be less than its pro rata share for the entire urbanized area by functional system and volume group nor in any case less than one section per applicable volume group. If length does not exist in a particular volume group in one (or more) portion(s) of a multi-State urbanized area, all of the sampling should take place in the State(s) where the length does exist. In such areas, expansion factors must be calculated separately for each State's portion. To ensure a consistent sampling approach, States having multi-State urbanized areas are urged to coordinate with the appropriate neighboring State(s) so that all portions of an urbanized area are sampled in the same manner.

An individual sampling approach must be applied to all parts of multi-State urbanized areas if expanded estimates are desired for the complete urbanized area. If even one State includes its portion of a multi-State area in the collective category, then no sample based estimates for the complete urbanized area are possible.

## **SAMPLING COLLECTIVE URBANIZED AREAS**

In the future, all urbanized areas must be sampled individually, and state are encouraged to eliminate all existing urbanized area collective samples as soon as possible.

As with individually sampled urbanized areas, the volume group for each road section in the grouped sample universe must be identified using the tables in Appendix C before sample selection can begin. The number of sections to be included in the sample is determined using the calculation procedure in Appendix D. Sections should be selected from the universe of each functional system and volume group using a random number table or random number generation computer software, until the required number of samples is reached; a minimum of three sections per stratum is required.

## **SAMPLE MAINTENANCE**

An HPMS sample adequacy review should be performed on a periodic basis as part of a State's sample maintenance activities; a 3-year sample review cycle is strongly recommended. The review should be completed shortly after the annual submittal of the HPMS data set; this permits the data provider to assess the adequacy of the sample in time to make changes for the next reporting cycle. A number of elements should be considered when making a review of HPMS sample adequacy. These should include not only the assessment of number of samples by volume group, but also checks for potential sample biases.

When conducting a sample adequacy review, the State also should check for biases that may have been inadvertently introduced into the sample. Although the HPMS sample was designed as a fixed panel sample, additions, deletions, and other changes may have been made to the sample to account for system

and other changes that occurred over time. And, although changes to the HPMS sample are to be made on a random basis, this may or may not have been a closely observed practice.

As a result, sample bias may have been introduced in areas such as samples on State versus non-State owned roads, subarea biases by highway district or county, or nonrandom selection of adjacent roadway sections as new samples. Some of these biases may be disclosed by comparing the number of miles sampled; for instance, the percent of State owned miles sampled compared with the percent of non-State owned miles sampled. Others may require a more detailed examination of the sample and its distribution; are samples clustered in groups on the same facility, for instance. A periodic review of sample adequacy provides an opportunity to identify if any of these problems exist; as further changes are made to the HPMS sample, any biased sample selection procedures should be eliminated to improve sample randomness.

### **Need for Sample Panel Adjustments**

There are any number of occurrences that may result in a need to reconsider the suitability of the existing sample panel. Some of the more common reasons for considering sample panel adjustments include:

- The decennial census of population is likely to require changes in HPMS sample panels. The sampling basis may need to change because the numbers of small urban areas and individual urbanized areas may change, and/or the FHWA approved, adjusted Census urban boundaries of existing urban areas may be altered.
- The addition of new areas and the expansion of current urban boundaries are likely to require the functional reclassification of roadways within the new boundaries. This will in turn likely require transferring universe and sample sections from one area's panel to another and randomly drawing additional samples to satisfy urban area requirements. Also, the loss of samples caused by movement from rural to small urban or from rural or small urban to urbanized areas may cause a deficiency in the rural or small urban area panels.
- Changes in the existing functional system length and HPMS sample panels are likely to result from functional reclassification, non-Census related changes in urban boundaries, or new road construction.
- Migration of sections among and between volume groups may also result in a need to change HPMS sample panels. Each volume group contained in a functional system is a separate sampling universe; normally, over the short term (less than 3 years), there should be only minor changes in sample section and universe length assignments to specific volume groups as a result of traffic increases or decreases. Universe volume group information for each roadway section must be kept up to date so that correct volume group reassignments can be made (see Appendix C).

A thorough sample adequacy review, conducted on a 3-year cycle basis, provides an opportunity to update the HPMS sample panels when necessary to meet the changed conditions reflected above.

### **Making Sample Panel Adjustments**

Sample panel adjustments should be made as necessary upon completion of a sample adequacy review; use of a 3-year cycle will minimize the burden of completing this task. The following general procedures should be considered when adjusting sample panels:

- Functionally reclassify roadway sections that have moved from rural areas into new or expanded urban/urbanized areas or out of contracting urban areas into rural areas; use appropriate classification criteria and good engineering judgment to determine the extent of change warranted.

- Stratify the reclassified roadway sections within these same areas into traffic volume groups consistent with the groups established for the latest HPMS sample.
- Transfer rural, urban, or urbanized sample sections that have moved from one area type to another into the appropriate functional systems and volume groups in the new panel.
- Calculate the required number of standard samples required for the revised rural, small urban, and urbanized area panels in accordance with Appendix D procedures and select additional samples where necessary.

In using these general procedures, the user should keep in mind that:

- When small urban or urbanized areas contract in size, changes to small urban or rural sample panels will occur; universe and sample sections affected by such changes should be assigned to the correct functional system and volume group in the new panel.
- Make adjustments to standard and donut area sample panels independently. It is better to update the standard sample panels prior to updating the donut area sample panels, since existing standard samples in the donut areas become donut area samples; in general, the same procedures apply (see Appendix G).
- If a new urbanized nonattainment area is designated by EPA, a new donut area sample must be drawn for that nonattainment area in accordance with the procedures in Appendix G.

### **Selecting Additional Samples**

The selection of additional sample sections for a given volume group is straightforward for most sample panel updates. Basically, the number of existing sample sections is compared to the required number as determined from the Appendix D procedures, and additional sample sections are randomly drawn from the nonsampled universe sections in the same volume group to cover any shortfalls. Again, maintaining accurate volume groups requires States and other data providers to maintain comprehensive, high quality, traffic count programs (see Appendix F). This procedure is to be used for the standard sample panels in rural, small urban and individually sampled urbanized areas, and for the donut areas of nonattainment areas; it also is to be used when newly designated urbanized areas are sampled as individual areas.

### **Sample Permanence**

Once a roadway section has been selected for a sample panel, it must be maintained as a sample regardless of changes in volume group assignment, functional system, or geographic area. Sample sections transferred to other geographic areas become part of the sample base for those areas. Samples may be dropped in cases where a roadway is truly abandoned and not relocated, where sample sections are reclassified to the rural or urban local or rural minor collector functional systems, or where sample sections are dropped from use as a result of a sample reduction plan. When samples are deleted, the State must submit a list of the sample numbers, the reasons for the deletions, and where the deletions will occur.

### **Deleting Samples**

Since the standard sample panel has been in existence for some time, the addition of samples and the movement of universe and sample sections from one volume group to another are likely to have caused over sampling in some volume groups. Significant oversampling is not encouraged because of cost and efficiency impacts; sample reductions should be considered a normal part of sample maintenance. Before

proceeding with a sample reduction exercise, the State should prepare a sample reduction plan and provide it to the FHWA for evaluation. A sample reduction plan should take account of the following:

1. All sampling criteria must be met; sample size requirements in Appendix D must be maintained for each standard sample functional system.
2. Sample AADT and universe section volume group data must be up to date and accurate.
3. Individual volume group reductions of less than three sample sections in any volume group should not be considered.
4. Random deletion of the samples within each over sampled volume group is required.
5. The three samples per volume group minimum must be maintained.
6. Trends of sample/universe section migration among volume groups should be examined; volume groups that continually gain samples may warrant keeping a few excess samples.
7. An expansion factor maximum of 100.000 should be observed.
8. A State using the HPMS analytical package or the HPMS data base for other purposes may want to keep an oversampled sample panel intact or consider using higher precision levels.
9. The sample reduction process may require more effort than the apparent resulting benefit of maintaining fewer samples; however, a periodic review and adjustment of the sample is needed to maintain the overall viability of the HPMS sample program.
10. A sample reduction should be considered as part of the 3-year sample adequacy review.

### **Updating Expansion Factors**

When updating sample panels, any change in sample length and/or the length of the sampling frame (the universe) requires updating the expansion factors related to affected volume groups. Expansion factors are recalculated before every HPMS submittal to ensure that all changes to volume groups (both universe and sample), whatever the cause, have been properly accommodated. Expansion factor recalculation is one of the final data preparation steps when the HPMS submittal software is used.

### **A Tabular Summary**

The following table provides an overview of conditions which generally require making changes to HPMS sample panels, both standard and donut area. It is divided into those changes triggered either directly or indirectly by Bureau of Census actions, or by changes unrelated to Census actions. The table outlines the “causes” for potential sample panel change and the “Recommendations” to deal with the change.

CAUSE	RECOMMENDATION
<b>CENSUS RELATED</b>	
New Small Urban Areas (Rural to Small Urban)	Adjust all rural sample section records within the new area to urban requirements. Verify statewide rural and small urban area sample and universe bases and select additional samples as necessary.
New Urbanized Areas (Small Urban and/or Rural to Urbanized)	Adjust all rural and small urban area sample section records within the new area to urbanized area requirements. Procedures for drawing new standard samples for individual panels are discussed above. Procedures for drawing donut area samples are discussed in Appendix G. Verify all sample and universe bases and select additional samples as necessary.
Expansion of the Adjusted Boundaries of Small Urban or Urbanized Areas (Rural to Small Urban and Rural and/or Small Urban to Individual Urbanized)	Adjust all affected rural sample section records to urban requirements. Verify all affected sample and universe bases and select additional samples as necessary.
Functional System Reclassification--Any Area	Reassign reclassified sections (universe and sample) to appropriate areas and volume groups. Sample new sections as necessary to maintain required volume group precision levels.
Losses in Urban Population	No action until Census area designation changes.
Major Revision of Boundaries Based on New Census	Redraw sample panel and include old samples, if possible.
Changes or Additions to Nonattainment Area(s).	Updates to the donut area samples are made based on the procedures in Appendix G.
<b>NON-CENSUS RELATED</b>	
New Length by Functional System	Verify sample and universe base; sample new sections, if necessary.
Functional System Reclassification in Any Area	In addition to the movement of sections because of reclassification, there may be a need for possible volume group changes for universe and/or sample sections, precision level changes, and additional samples.
Volume Group Reassignment of Sections	Reassign sample sections but no further action is needed if changes are minor; if changes are major, verify volume group sample and universe bases for all affected volume groups and add samples, if necessary.
Expansion Factor	Adjust expansion factor values for sample section records in the affected group.

### Splitting Samples

county code, functional system, urban/rural/urbanized status, and number of lanes. Many times these changes are the product of adjacent land development, which may result in the improvement of a portion of an existing sample, an increase in traffic on the improved portion, and/or the inclusion of the improved portion in an urbanized area boundary. In general, a change in any of the following key HPMS data items on an existing sample section should result in splitting an HPMS sample:

Item Number	Data Item
4	County Code
13	Rural/Urban Designation
15	Urbanized Area Code
16	NAAQS Nonattainment Area Code
17	Functional System
19	National Highway System
25	Governmental Ownership
26	Special Systems
27	Type of Facility
33	AADT
34	Number of Through Lanes

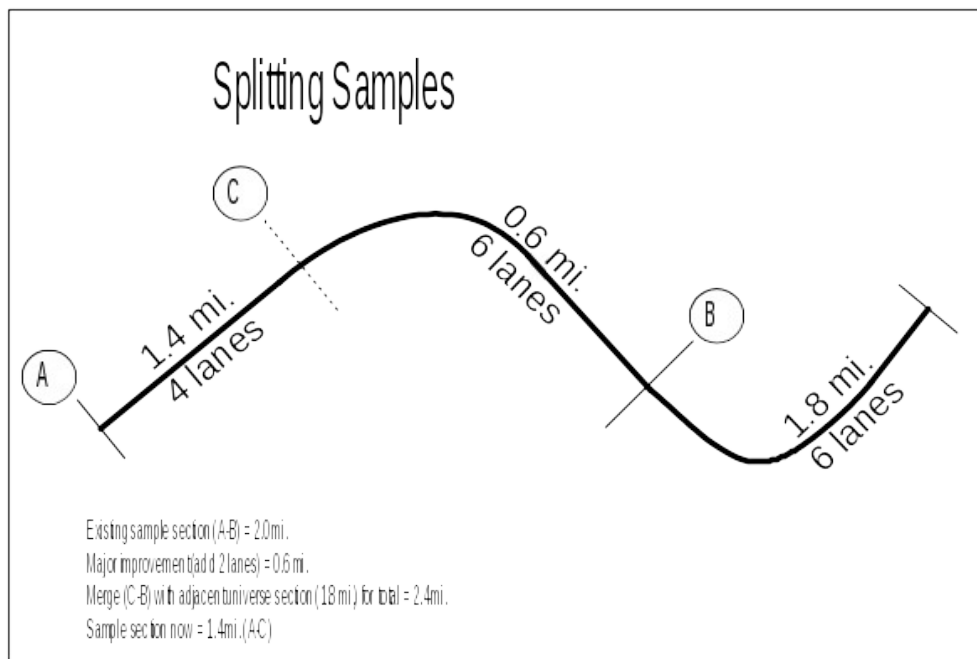
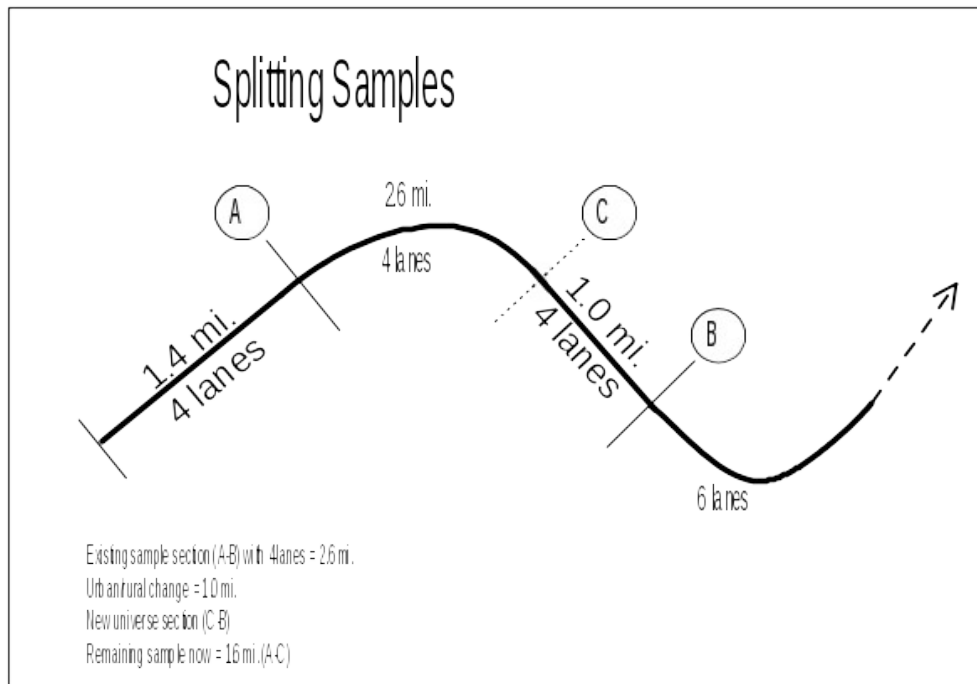
It may be necessary to split HPMS samples when there are changes in other HPMS data items; however, the State needs to make a reasoned judgment of the particular case beyond these minimum specifications. In most cases, for changes in other HPMS data items on existing sample sections, it is more than adequate to code the predominant or typical condition on the existing sample section and retain the entire sample. If a shoulder type, for instance, is changed on a portion of an existing sample section, it is acceptable to code the resulting predominant type of shoulder on the entire section in lieu of splitting the sample. If part of a sample is improved and the remaining portion is to be improved in the next construction season, it is likewise acceptable to code the predominant condition and retain the entire sample. Samples should not be split for changes in non-HPMS related State inventory items, such as guardrail changes or highway district boundary, etc.

When splitting an existing sample section, the State should select the portion to remain as the sample based either on length - keep the longest portion - or by random pick; the selected portion becomes the sample and retains the existing sample identifier. Although FHWA suggests that the longest section be retained as the sample, either is acceptable. The remaining portion should be converted to a universe section or merged with an adjoining universe section. It is important that all count information is adjusted to reflect actual conditions on the retained sample section. Two examples follow.









## ELIMINATING SHORT SAMPLE SECTIONS

As part of sample maintenance activities, existing samples should be reviewed to see if they can be deleted or recombined with adjacent sample sections. In the past, excessive splitting of HPMS sample sections has resulted in the accumulation of many short adjacent sample sections. Adjacent short

samples not meeting minimum length requirements should be recombined into longer sample sections if they have similar roadway characteristics and the key data items listed under the “Splitting Samples” discussion are the same. Excessive short samples resulting from previous sample splits can also be considered for deletion if HPMS-critical roadway characteristics are the same for a number of adjacent samples. In this case, the State may wish to retain the longest sample and recombine the remaining samples with an adjacent universe section or merge them into a new universe section. The sample section to be retained can also be selected randomly. Either way, a reduction in an excessive number of short samples may save the State financial and personnel resources and will improve sample representation.