

QUINQUENNIAL REPORT TO THE FEDERAL RESERVE BANK OF NEW YORK

**REPORT OF U.S. OWNERSHIP OF  
FOREIGN SECURITIES, INCLUDING  
SELECTED MONEY MARKET  
INSTRUMENTS (SHC)**

**Mandatory Report  
Response Required By Law  
(22 U.S.C. 3101 et seq.)**



**Department of the Treasury  
Federal Reserve Bank of New York  
Board of Governors of the Federal Reserve System  
September 30, 2011**

# TABLE OF CONTENTS

	Page
<b>I. INTRODUCTION</b>	
A. Purpose	1
B. Authority	1
C. Confidentiality of Data Reported	1
D. Penalties for Failure to Report	2
E. Paperwork Reduction Act Notice	2
<b>II. GENERAL INSTRUCTIONS</b>	
A. Who Must Report	3
B. Which Schedules to Report	4
C. Exemptions	4
D. Reporting Dates	5
E. Submission Instructions and Contact Information	5
<b>III. WHAT SECURITIES MUST BE REPORTED</b>	7
A. Reportable Foreign Securities	7
B. Do Not Report	9
C. Funds and Related Equity Holdings	9
D. Securities Involved in Repurchase and Securities Lending Arrangements	12
E. Depositary Receipts/Shares	13
F. Stripped Securities	13
G. Direct Investment	13
H. Securities Held by Central Securities Depositories	13
I. Country Attribution	14
J. Limited Partnerships	14
K. Accounting Rules, Valuation of Securities, and Calculation of U.S. Dollar Values	14
L. Data Retention Period	15
M. Review of Data and Requests for Revised Data	15
<b>IV. INSTRUCTIONS FOR COMPLETING REPORTING SCHEDULES</b>	
A. Schedule 1 - Reporter Contact Identification and Summary of Financial Information	16
B. Schedule 2 - Details of Securities	19
C. Schedule 3 - Custodians Used	23
<b>APPENDICES</b>	
A. Sample Reporting Schedules	25
Reporter Contact Identification and Summary Financial Information	Schedule 1, Page 1 of 3
Details of Securities	Schedule 2, Page 1 of 2
Custodians Used	Schedule 3, Page 1 of 1
B. Reporting Requirement Flowcharts	32
C. List of Security Identification Systems	38
D. List of Country Codes	39
E. List of International and Regional Organizations	40
F. List of Currency Codes	41
G. List of Custodian Codes	43
H. Glossary	46
I. Technical Information for Electronic Submission	53



## **I. INTRODUCTION**

### **A. PURPOSE**

The Department of the Treasury, with the assistance of the Board of Governors of the Federal Reserve System and the Federal Reserve Bank of New York (FRBNY), is conducting a mandatory quinquennial survey of the ownership of foreign securities, including selected money market instruments, by U.S. residents as of December 31, 2011. The data will be collected by the FRBNY, acting as fiscal agent for the Department of the Treasury. The data collected will be used by the U.S. Government in the computation of the U.S. balance of payments accounts and the U.S. international investment position, and in the formulation of international economic and financial policies. This report also is part of the Coordinated Portfolio Investment Survey (CPIS), an internationally coordinated effort under the auspices of the IMF, to improve the statistics on the holdings of foreign securities by major investing countries.

In order to reduce reporting burden and costs to the government, there will be a substantial reduction in the number of reporters in four out of every five years. A benchmark survey (Form SHC) of all significant U.S.-resident custodians and end-investors will continue to be held approximately every five years. In non-benchmark years, the annual survey (Form SHCA) will require reports from only the very largest U.S.-resident custodians and end-investors. The data reported under these annual surveys (Form SHCA) will be used in conjunction with the results of the previous benchmark survey to compute economy-wide estimates for the non-benchmark years.

The determination of who must report on the annual reports (Form SHCA) will be based upon the data submitted during the previous benchmark survey. Certain U.S.-resident custodians and end-investors (including fund managers) will be designated to file detailed foreign security data on Schedule 2 and data on foreign securities entrusted to U.S.-resident custodians on Schedule 3, i.e., they will be required to file in the same manner as they did on the December 31, 2011 benchmark survey.

### **B. AUTHORITY**

This survey is conducted under the authority of the *International Investment and Trade in Services Survey Act* (22 U.S.C. 3101 et seq., [the Act]) and Executive Order 11961 of January 19, 1977. The Act specifies that the President has the authority to conduct a regular data collection program, including such studies and reports as may be necessary and feasible, to secure current information on international investment, including (but not limited to) such information as may be necessary for computing and analyzing the balance of payments and the international investment position of the United States (22 U.S.C. 3103). In Executive Order 11961 §2, the President designated the Secretary of the Treasury to be responsible for collecting data on portfolio investment required by the Act.

### **C. CONFIDENTIALITY OF DATA REPORTED**

The information collected by this survey may be used only for analytical and statistical purposes and to enforce the Act. Access to the information is available only to officials and employees (including consultants and contractors and their employees) designated to perform functions under the Act. Persons having access to individual company information submitted pursuant to the Act are subject to penalties for unauthorized disclosure (22 U.S.C. §3104 and 18 U.S.C. §1905). The results of this survey will be made available to the general public at an aggregated level so that neither the U.S. persons or organizations providing information nor individual or organizational ownership of foreign securities can be identified.

#### **D. PENALTIES FOR FAILURE TO REPORT**

Reporting as directed in this package is mandatory for any U.S. person or organization subject to the reporting requirements set forth in the report instructions. Failure by an organization to provide timely and accurate data can result in a civil penalty of not less than \$2,500 and not more than \$25,000, or injunctive relief ordering such person to comply, or both (22 U.S.C. §3105(a)).

Willfully failing to submit any required information under the Act can result in a fine of not more than \$10,000; and, if an individual, may result in imprisonment for not more than a year, or both. Any officer, director, employee or agent who knowingly participates in such violation, upon conviction, may be punished by a like fine, imprisonment, or both (22 U.S.C. §3105(c)).

#### **E. PAPERWORK REDUCTION ACT NOTICE**

This report has been reviewed and approved by the Office of Management and Budget in accordance with the *Paperwork Reduction Act of 1995* and assigned OMB Control Number 1505-0146. The purpose is to collect accurate and complete data that will enable the Treasury Department to fulfill its responsibility under the Act. The estimated annual average preparation time per respondent (over five years) is about 84 hours, but this will vary widely from respondent to respondent. (a) In the year of a benchmark survey (using Form SHC), it is estimated that exempt SHC reporters will require an average of 16 hours; custodians of securities providing security-by-security information will require an average of 360 hours, but this figure will vary widely for individual custodians; end-investors providing security-by-security information will require an average of 120 hours; and end-investors and custodians employing U.S. custodians will require an average of 40 hours. (b) In a non-benchmark year (using Form SHCA), custodians of securities providing security-by-security information will require an average of 700 hours (because only the largest U.S.-resident custodians will report), end-investors providing security-by-security information will require an average of 145 hours; and SHCA reporters entrusting their foreign securities to U.S. custodians will require an average of 48 hours. Comments concerning the accuracy of this burden estimate and suggestions for reducing the burden should be directed to:

Administrator, International Portfolio Investment Data Systems  
U.S. Department of the Treasury  
1500 Pennsylvania Avenue NW, Room 4410-1440NYA  
Washington, DC 20220, or

The Office of Management and Budget  
Paperwork Reduction Project (1505-0146)  
Washington, DC 20503

No person is required to respond to any U.S. Government collection of information unless it displays a currently valid OMB control number.

## II. GENERAL INSTRUCTIONS

### A. WHO MUST REPORT

All U.S. resident custodians and end-investors with holdings of foreign portfolio securities above the reporting thresholds must report. (See Section II.C, Exemptions.) In addition, all U.S.-resident custodians and end-investors that are notified by the Federal Reserve Bank of New York that they are required to file must report.

1) **Custodians** are all organizations that hold securities in safekeeping for other organizations. Most U.S.-resident custodians also invest in foreign securities for their own account, i.e., are also U.S.-resident end-investors for purposes of this report. U.S.-resident custodians should report both the foreign portfolio securities held in safekeeping for other U.S. residents and their own foreign portfolio securities.

2) **End-Investors** are U.S.-resident organizations that invest in foreign securities for their own portfolios or invest on behalf of others, such as investment managers/fund sponsors. This includes securities that are held-for-trading, available-for-sale, or held-to-maturity. Collectively, such investors are referred to as “end-investors” throughout these instructions. U.S.-resident end-investors include, but are not limited to:

- Financial and non-financial organizations
- Managers of private and public pension funds
- Managers/sponsors of mutual funds (including money market mutual funds), country funds, unit-investment funds, exchange-traded funds, collective-investment trusts, hedge funds or any other similarly pooled, commingled funds. Also managers/sponsors of private equity companies, venture capital companies, hedge funds and other private investment vehicles
- Insurance companies
- Foundations
- Institutions of higher learning (e.g., university endowments)
- Trusts and estates
- Funds and similar entities that own shares or units of, or other portfolio equity interests in, a foreign related or non-related entity.

Reports should include all reportable securities held or managed by all U.S.-resident parts of the organization, including all U.S.-resident branches, offices, and subsidiaries. U.S. residents include organizations organized under the laws of the Commonwealth of Puerto Rico or of U.S. territories and possessions. Please see Appendix H – Glossary for the complete definition of United States. It is the responsibility of the top U.S.-resident parent entity in each organization to ensure that its report covers all applicable entities within the organization.

If any of the following conditions apply, please contact the FRBNY staff:

- Your organization is not the top U.S.-resident parent entity in your organization and has been notified of its obligation to report by, the Federal Reserve Bank of New York.
- Your organization cannot submit a single report for the entire organization.

Additional copies of the reporting forms and instructions may be printed from the Internet at:

<http://www.treasury.gov/resource-center/data-chart-center/tic/Pages/forms.aspx>

## B. WHICH SCHEDULES TO REPORT

- **Schedule 1**

Schedule 1 must be filed by all entities that are notified by the Federal Reserve Bank of New York that they are required to file the SHC report and by all U.S.-resident custodians or end-investors with holdings of foreign securities that meet the reporting thresholds. (See Section II.C, Exemptions.)

Schedule 1 requests information that identifies the reporter. It also provides contact information, indicates the reporting status, and summarizes the data, if any, reported on Schedule 2 and/or Schedule 3.

- **Schedule 2:**

Schedule 2 is used to report detailed information on foreign securities owned by U.S.-resident investors (1) that the reporter safe-keeps for itself or for its U.S.-resident clients or (2) for which the reporter directly employs foreign-resident sub-custodians or U.S.-resident or foreign-resident central securities depositories (CSDs) to manage the safekeeping of those securities (Foreign securities in safekeeping with U.S.-resident CSDs are reportable on Schedule 2.) (See Section III.H.) or (3) that are instruments of the type that there is no U.S. custodian to manage the safekeeping of those securities.

- **Schedule 3:**

Schedule 3 is used to report summary amounts for all foreign securities entrusted to the safekeeping of a U.S.-resident custodian, excluding those entrusted to a U.S.-resident CSD. (See Section III.H.)

## C. EXEMPTIONS

- **Schedule 1**

If you have been notified of a reporting responsibility by the Federal Reserve Bank of New York, there is NO exemption level for Schedule 1. You must complete the reporter identification, the contact and certifying information parts of Schedule 1. However, items requesting aggregate data on foreign securities on Schedule 1 should be left blank if you are not required to report data on Schedule 2 or Schedule 3.

- **Schedule 2**

SHC reporters are exempt from reporting on Schedule 2 if the total fair value of foreign securities whose safekeeping they manage for themselves and for other U.S. residents or whose safekeeping the reporter has entrusted directly to foreign-resident custodians or U.S. or foreign-resident central securities depositories **is less than US\$ 100 million** (aggregated over all accounts) as of December 31.

- **Schedule 3**

SHC reporters are exempt from reporting on a Schedule 3 holdings that are entrusted to an unaffiliated U.S.-resident custodian that is not a U.S.-resident CSD, if the total fair value of the foreign securities entrusted to that U.S.-resident custodian by the U.S. parts of the reporter's organization and its U.S.-resident clients whom the reporter represents as end-investor – aggregated over all accounts - **is less than US\$ 100 million** as of December 31.

## D. REPORTING DATES

Report data as of December 31, 2011. Data should be submitted to the Federal Reserve Bank of New York (FRBNY) no later than the first Friday of March 2012 (March 2).

## E. SUBMISSION INSTRUCTIONS AND CONTACT INFORMATION

**Schedule 1** must be submitted on paper, unless you are submitting Schedule 2 data electronically via the IESUB application (see below). If you are submitting Schedule 2 data via the IESUB application, you must submit Schedule 1 via IESUB.

**Schedule 2** reports consisting of **200 or more** records must be submitted electronically on diskette(s) or compact disk(s) (CDs) or via IESUB using the format specified in Appendix I.

**Schedule 2** reports consisting of **less than 200** records may be submitted electronically on diskette(s) or compact disk(s) (CDs) **or** via IESUB using the format specified in Appendix I **or** on paper, using the form contained in Appendix A.

**Schedule 3** reports may be submitted on paper using the form in Appendix A or via IESUB. If you are submitting Schedule 3 data via the IESUB application, you must submit Schedule 1 via IESUB.

Reports can be mailed or sent by courier to:

**Federal Reserve Bank of New York  
Statistics Function, 4<sup>th</sup> Floor  
33 Liberty Street  
New York, NY 10045-0001**

## IESUB

The Federal Reserve System's Internet **E**lectronic **S**ubmission (IESUB) System is fast, easy to use and secure. IESUB provides a confirmation of the receipt of the data at the Federal Reserve Bank of New York and performs a number of validity checks of your file format.

For more information on how to submit data using the IESUB system, contact the SHC staff at 212-720-6300 or 646-720-6300 or at [SHC.Help@ny.frb.org](mailto:SHC.Help@ny.frb.org). Alternatively, additional information and an application to register for IESUB can be obtained at:

<http://www.frbervices.org/centralbank/reportingcentral/iesub.html>

Completed applications should be sent to:

Federal Reserve Bank of New York  
Statistics Function, 4<sup>th</sup> Floor  
33 Liberty Street  
New York, New York 10045-0001

or faxed to 1-212-720-8028 or 8216.



**If your business or technical contact information changes after submission of your Schedule 1 or if you have any questions pertaining to the report, please contact the FRBNY staff:**

Phone: (212) 720-6300 or (646) 720-6300

Email: [SHC.Help@ny.frb.org](mailto:SHC.Help@ny.frb.org)

### III. WHAT SECURITIES MUST BE REPORTED

This report collects information on U.S. resident holdings of foreign **portfolio** securities, including foreign equities, short-term debt securities (including selected money market instruments), and long-term debt securities. Asset-backed securities are to be reported separately from other debt securities. Foreign securities are all securities issued by entities that are established under the laws of a foreign country (i.e., any entity that is legally incorporated, otherwise legally organized or licensed (such as branches) , in a foreign country) and all securities issued by international or regional organizations, such as the International Bank for Reconstruction and Development (IBRD or World Bank), and the Inter-American Development Bank (IADB), even if these organizations are physically located in the United States.

**Reportable securities may be traded or issued in the United States and in foreign countries, and may be denominated in any currency, including euros and U.S. dollars. Neither the country in which the securities are traded or issued, nor the currency in which the securities are denominated, is relevant in determining whether the securities are reportable.**

As an exception, foreign securities held by a U.S. depository to back depository receipts/shares should not be reported. Instead, the U.S.-resident holders of the depository receipts/shares should report the receipts/shares. This exception is necessary to identify the portion of depository receipts/shares actually held by U.S. residents, because many depository receipts/shares are held by foreign residents.

#### A. REPORTABLE FOREIGN SECURITIES

**Reportable securities include:**

- Securities issued by international and regional organizations, such as the International Bank for Reconstruction and Development (IBRD or World Bank) or the Inter-American Development Bank (IDB), whether physically located in the United States or abroad.
- Securities issued in the United States by foreign-resident organizations (e.g., Canadian or Mexican firms), even if they are denominated in U.S. dollars and trade on U.S. securities exchanges.
- Securities issued by foreign-resident subsidiaries of U.S.-resident organizations (e.g., GMAC Canada) and foreign-resident offices of U.S. banks or U.S. broker/dealers, even if they are guaranteed by the U.S. parent company, or issued in the United States.
- Depository receipts/shares, including American Depositary Receipts (ADRs), American Depositary Shares (ADS), Global Depositary Receipts (GDRs), and International Depositary Receipts (IDRs), if the underlying securities are issued by foreign residents - (See Section III.E.).
- Securities issued by foreign-resident entities under Section 144A of the SEC Act.
- Money market instruments, including negotiable certificates of deposit (CDs) issued by foreign-resident entities.

**Equity Interests** represent an ownership interest in foreign-resident organizations.

*Include as equities:*

- Common stock (ordinary shares);
- Preferred stock (participating and nonparticipating preference shares);
- Restricted stock;
- Depository receipts/shares (e.g., ADRs, ADSs, GDRs, IDRs) **provided** the underlying securities used to collateralize the receipts/shares are foreign securities (See Section III.E.);
- Shares/units/other equity interests in foreign-resident funds (including mutual funds and money market funds), index-linked funds, exchange-traded funds, private equity companies, venture capital companies,

investment trusts, common trust funds, commingled investment accounts, hedge funds and other investment vehicles – (See Section III.C.);

- U.S.-resident limited partner interests in foreign-resident limited partnerships and equity interests in other companies that do not issue shares (General partner ownership interests are excluded.) (See Section III. J.); and
- Other equity securities, including privately placed equity interests.

**Short-Term Debt Securities** include bills, commercial paper, and other money market instruments specified below with an **original maturity of one year or less** that give the holder the unconditional right to financial assets. Asset-backed short-term debt securities should be reported as asset-backed securities. (See below.)

*Include as short-term debt securities:*

- Short-term foreign government securities;
- Short-term bankers' acceptances and trade acceptances;
- Short-term commercial and financial paper, including asset-backed commercial paper;
- Short-term **negotiable** certificates of deposit, bank notes, and deposit notes;
- Short-term notes issued under note issuance facilities and revolving underwriting facilities, even though the underlying facility may be for more than one year;
- Short-term medium-term notes;
- Short-term promissory notes;
- Stripped securities with an original maturity of one year or less; and
- Other short-term debt securities.

**Long-Term Debt Securities** (excluding asset-backed securities) include bonds and notes, with an **original maturity of over one year**, that usually give the holder the unconditional right to financial assets.

*Include as long-term debt securities:*

- Bonds such as foreign treasury, zero coupon, stripped, deep-discounted, currency-linked (e.g., dual-currency), floating rate, equity-related (e.g., convertible bonds) bonds and Eurobonds;
- Long-term index-linked debt securities;
- Long-term floating rate notes (FRN), such as perpetual notes (PRN), variable rate notes (VRN), structured FRN, reverse FRN, collared FRN, step up recovery FR (SURF), and range/corridor/accrual notes;
- Long-term medium-term notes;
- Bonds with multiple call options, the last of which is more than one year after issue;
- Long-term debentures;
- Long-term negotiable certificates of deposit, bank notes, and deposit notes;
- Long-term bearer depositary receipts denoting ownership of debt securities issued by nonresidents;
- Brady bonds;
- Covered bonds (e.g., Pfandbriefe);
- Long-term securities backed by a sinking fund; and
- Other long-term debt securities.

**Asset-Backed Securities** are securitized interests in a pool of assets, which give the purchaser a claim against the cash flows generated by the underlying assets. In many cases, the security's outstanding principal is reduced over time as principal repayments are received and passed on to the holders of the security. Securities backed by revolving credits, such as pools of credit card receivables, do not meet this criterion, but are still classified as ABS if the return to the holder is based upon these credits (i.e., the credits do not merely serve as collateral). The ABS is reported if the **issuer securitizing the assets** is a foreign resident. The underlying asset should not be used to determine if the securities are reportable. **Asset-backed commercial paper should be reported as**

## **commercial paper with other short-term debt.**

*Include as asset-backed securities all collateralized mortgage obligations (CMOs), collateralized bond obligations (CBOs), collateralized loan obligations (CLOs), collateralized debt obligations (CDOs), and other securities which give the purchaser a claim against the cash flows generated by pools of:*

- Mortgages;
- Credit card receivables;
- Automobile loans;
- Consumer and personal loans;
- Commercial and industrial loans and other whole loans; and
- Other assets.

## **B. DO NOT REPORT**

Do not report any:

- Derivative contracts (including futures, forwards, swaps, options, and warrants) meeting the definition of a derivative under ACS 815 (formerly FAS 133). If the embedded derivative has not been bifurcated from the host contract under FAS 133, then the security should be reported without separating the embedded derivative from the host contract. However, if the embedded derivative is bifurcated from the host contract, then the derivative should be excluded from the report and the host security should be included on the report.
- Loans and loan participation certificates;
- Letters of credit;
- Non-negotiable certificates of deposit ;
- Bank deposits, including time deposits (except for negotiable CDs) and demand deposits;
- Foreign securities temporarily acquired under reverse repurchase, borrowing, or lending arrangements (See Section III.D.);
- The underlying security of a depositary receipt, even if a foreign security (See Section III.E.);
- Direct investments (See Section III.G.), including investments in real estate and general partner ownership interests (However, limited partner ownership interests are reportable investments.);and
- All U.S. securities, including:
  1. Securities issued by U.S.-resident organizations, even if they are denominated in foreign currencies or traded on foreign securities exchanges;
  2. Securities issued by U.S.-resident subsidiaries of foreign-resident organizations and U.S.-resident offices of foreign banks or foreign broker/dealers, even if they are guaranteed by the foreign parent company, or issued outside of the United States;
  3. Securities issued by U.S.-resident entities under Section 144A of the SEC Act;
  4. Ownership of shares of U.S.-resident funds, even if the fund invests in foreign securities (See Section III.C.); and
  5. Stripped securities issued by a U.S.-resident financial institution, even if the underlying security is a foreign security (See Section III.F.).

## **C. FUNDS AND RELATED EQUITY HOLDINGS**

1. Report U.S. residents' ownership of shares/units of, or other equity interests in, funds legally established

outside of the United States (foreign-resident funds) as equity securities. All U.S. residents' holdings of foreign-resident funds should be assigned security type 3 (fund shares), and not categorized as a debt security, regardless of the types of securities held by the fund.

For purposes of this report, funds include all investment vehicles that pool the money of one or more investors and that invest the pooled money in one or more of a variety of assets. Funds include, but are not limited to:

- Mutual funds (including both closed-end and open-end mutual funds);
- Money market funds;
- Investment trusts;
- Index-linked funds;
- Exchange traded funds (ETFs);
- Investment vehicles that use the money of a single investor to buy securities that the investment vehicle owns (single investor funds);
- Commingled accounts;
- Investment trusts;
- Common trust funds;
- Hedge funds;
- Private equity funds.

The determination of whether ownership interests in a fund are foreign securities is based on the country in which the fund is legally established, not on the type of securities the fund purchases. For example, an interest in a fund organized in Bermuda that purchases U.S. Treasury securities is a reportable foreign equity security. Likewise, an interest in a fund established in the United States is a U.S. security and should be excluded from the report, even if the U.S.-resident fund invests in foreign securities.

Many funds established outside the United States have names that are similar to U.S.-resident fund names. This often occurs when the fund is managed by a group that manages many U.S.-resident funds and therefore may be thought of as managing only U.S.-resident funds. If there is doubt as to whether the investment should be classified as a fund or whether a fund is U.S. or foreign, please contact FRBNY report staff at (212) 720-6300 or (646) 720-6300.

## 2. Report U.S.-resident funds' ownership of foreign securities.

Although ownership of equity interests in U.S.-resident funds is excluded from this report, the foreign securities owned by U.S.-resident funds are reportable. These are distinct holdings and, therefore, are not duplicate reporting. Foreign securities owned by U.S.-resident funds should be classified as equity, debt, or asset-backed securities, as indicated in Section III. A.

## 3. How to report hedge funds and other alternative investment vehicles

- a) Investment advisors, managers or similar types of legal entities and fund sponsors that create master-feeder fund structures both outside and inside the U.S. should report any portfolio investments between the U.S. and foreign-resident affiliate funds that the investment manager sets up.

### **Example 1**

A **U.S.-resident** investment manager/fund sponsor (IM/FS) creates a Cayman master fund, a Cayman feeder fund and a U.S. feeder fund. The investments by the U.S. IM/FS in the Cayman funds are direct investments since the IM/FS controls the affiliated firms and should be reported to the Department of Commerce, Bureau of Economic Analysis as direct investments. However, the investment that the U.S. feeder fund has in the Cayman Master Fund is portfolio investment and should be reported on the SHC by the IM/FS as the representative of the U.S. feeder fund as the owner (end-investor). However, if a U.S. custodian holds the equity interests of the U.S feeder fund in the foreign master fund, then the U.S. custodian would have the responsibility of reporting those interests on the SHC.

### **Example 2**

A **foreign-resident** IM/FS sets up a Cayman master fund, a Cayman feeder fund, and a U.S. feeder fund. The investments between the foreign IM/FS and the U.S. feeder fund are direct investment since the foreign IM/FS controls the feeder fund. However, the equity investment that the U.S. feeder fund has in the foreign master fund is portfolio investment and should be reported by the U.S. feeder fund as ownership of foreign equity on the SHC. If a U.S. custodian holds the equity interest of the U.S. feeder in the foreign master fund, then the U.S. custodian would have the responsibility of reporting on the SHC.

- b) Exclude any investment between the investment manager or other entity that formed the funds (as a general partner) and all the entities it creates. These are direct investments and should be reported to the Bureau of Economic Analysis.

Note: The descriptions of the various examples are based on common master/feeder fund structures. It is possible for there to be different types of structures when creating these funds and they may be called different names by some entities. Ultimately, if the investment is not direct investment, then it will fall into the category of portfolio investment and needs to be reported as part of the TIC system.

- 4. Fund ownership by Pension and Retirement Plans (including those of State and Local governments, including municipalities)

A state pension plan holds foreign investments through (a) onshore funds (including funds of hedge funds) and (b) offshore funds (including funds of hedge funds). For the purposes of TIC, the requirement to report is based on the country in which the fund is legally established.

(a) The investments in onshore U.S. funds (including funds of hedge funds) are investments in U.S.-resident entities and are therefore not reportable on the SHC.

(b) The investments in offshore funds (including funds of hedge funds) are investments in foreign-resident entities, and are therefore reportable on the SHC. Only the shares of the funds themselves are reportable (not their underlying investments), and only if the pension investments are portfolio investment.

If those investments are direct investments, such as general partnership interests, then the investments are reportable to the Bureau of Economic Analysis of the Department of Commerce. If a U.S. custodian holds the foreign portfolio interests in the offshore funds on behalf of the pension plans, the U.S. custodian would have the reporting responsibility to report on the SHC and the TIC Form SLT report.

#### **D. SECURITIES INVOLVED IN REPURCHASE AND SECURITIES LENDING ARRANGEMENTS**

A repurchase agreement (repo) is an arrangement involving the sale of securities at a specified price for cash with a commitment to repurchase the same or similar securities at a specified price on a future date. A reverse repo is an agreement whereby a security is purchased at a specified price with a commitment to resell the same or similar securities at a specified price on a specified future date. Securities lending/borrowing arrangements are agreements whereby the ownership of a security is transferred in return for collateral, usually another security or cash, under condition that the security or similar security will revert to its original owner at a future date. All of these arrangements, as well as buy/sell agreements, should be treated as follows:

- Securities sold under repurchase agreements or lent under securities lending arrangements, or collateral provided, should be reported by the original owner of the securities (or their U.S.-resident custodian) as if the securities were continuously held; that is, as if the repurchase or security lending agreement did not exist. Thus, if a U.S. resident transferred a foreign security under a repurchase or securities lending arrangement, the U.S. resident (or their U.S.-resident custodian) transferring the security should include it in its Schedule 2 or Schedule 3 records. The country reported should be the country of the issuer of the security and not the country of the counterparty to the repo or other agreement.
- Securities, including collateral, temporarily acquired by U.S. residents under reverse repurchase or borrowing or lending arrangements should not be reported.
- However, if cash was temporarily received as collateral and was used to purchase securities, those securities should be reported.

## E. DEPOSITORY RECEIPTS/SHARES

Depository receipts/shares, including American depository receipts (ADRs) or bearer depository receipts, should be attributed to the country of residence of the issuer of the security underlying the depository receipt/share. Issuers of depository receipts/shares should **not** report their holdings of the actual foreign securities. Only U.S. residents' holdings of depository receipts/shares should be reported.

In addition, the security type reported should be determined based on the security underlying the depository receipt/share. For example, if the underlying security is foreign common stock then the security type reported in Item 7 of the Schedule 2 should be 1 (common stock).

## F. STRIPPED SECURITIES

Stripped securities are securities that have been transformed from a principal amount with periodic interest coupons into a series of zero coupon securities, with the range of maturities matching the coupon payment dates and the redemption date of the principal amount.

The country of residence of a stripped security is the country of residence of the entity that issued the stripped security, not the country of residence of the entity that issued the underlying security. Stripped securities issued by foreign residents, (the interest-only (IO) component, the principal-only (PO) component and tranches of stripped asset-backed securities), and held by U.S. residents are reportable. If a U.S.-resident financial institution issued the stripped securities, the issuer of the stripped securities should report its ownership of the underlying foreign securities. Exclude U.S. residents' holdings of stripped securities issued by a U.S.-resident financial institution.

## G. DIRECT INVESTMENT

All holdings known to be direct investment should be excluded from the survey.

A direct investment relationship exists when a U.S. resident owns, directly or indirectly, 10% or more of the voting equity securities of an incorporated foreign business (or an equivalent interest in an unincorporated foreign business or branch. (See Section III.K.) If a direct investment relationship exists, then, in general, all securities held by the parent entity that were issued by the affiliate of the parent are considered to be direct investment.

**However, if one of the entities is a depository institution, a securities firm, a bank holding company or financial holding company, then inter-company holdings are not considered to be direct investment and are reportable on the SHC.** See the Glossary for a complete definition of direct investment.

## H. SECURITIES HELD BY CENTRAL SECURITIES DEPOSITORIES

Foreign securities entrusted to U.S.-resident custodians that are in turn held at a U.S.-resident central securities depository (such as the Depository Trust Company or the Federal Reserve Bank of New York), or a foreign-resident central securities depository (such as Euroclear or Clearstream), must be reported by the U.S.-resident custodian, not by the U.S. or foreign-resident central securities depository. Likewise, foreign securities held by a U.S.-resident end-investor directly with a U.S.-resident or foreign-resident central securities depository must be reported by the U.S.-resident end-investor, not by the central securities depository.

Foreign securities provided to the Federal Reserve Bank of New York (FRBNY) for discount window loan collateral must be reported by the "lender" of the securities, not by the FRBNY.



## I. COUNTRY ATTRIBUTION

Except for securities issued by international and regional organizations and depositary receipts, securities should be reported based upon **the country of residence of the issuer of the securities**. The country of residence of any entity is where it is legally incorporated or otherwise legally organized, with the exception of bank branches, whose country of residence is the country where they are licensed. In cases where a foreign subsidiary of a U.S.-resident organization issues a reportable security, report these securities in the country where the foreign subsidiary is resident if the security is the direct legal obligation of the foreign subsidiary.

**Depositary receipts** should be attributed to the country of residence of the issuer of the security underlying the depositary receipt.

**Securities issued by international and regional organizations are not allocated to the country in which the international or regional organization is located.** The country attribution for **most** international and regional organizations is group code 79995. **Refer to Appendix E for a list of international and regional organizations.**

**A few** international and regional organizations have their own geographic classification (country) codes in the Appendix and those codes should be used in reporting on the SHC.

**Attribution of country of residence of the issuer should not be affected by the currency of issue or by the country of a guarantor.**

## J. LIMITED PARTNERSHIPS

U.S.-resident limited partner interests in foreign-resident limited partnerships should be reported as Other Equity (Schedule 2, Item 7 = 4). Limited partners' ownership does not carry voting rights; therefore, such ownership, even if greater than 10%, is reportable. The Number of Shares Held field on the Schedule 2 (Item 16) should be defaulted to the value reported in the US\$ Fair Value field (Item 14a) because limited partnerships do not issue shares.

U.S.-resident general partner interests in foreign-resident limited partnerships are always considered to be direct investment and are excluded from this report.

## K. ACCOUNTING RULES, VALUATION OF SECURITIES, AND CALCULATION OF U.S. DOLLAR VALUES

### Accounting Rules

All securities should be reported using settlement date accounting. Gross long positions should be reported. Do not net any short positions from long positions. Do not enter decimals or negative values in any cells.

### Valuation of Securities

Report the fair value of securities as December 31, 2011. The fair value follows the definition of ASC 820 (formerly FAS 157). Fair value is the amount at which an asset could be bought or sold in a current transaction between willing parties, other than in a forced or liquidation sale. If a quoted market price is available for an instrument, the fair value is the product of the number of trading units times that market price. For securities that do not regularly trade, the estimate of fair value should be based on the best information available in the circumstances. The estimate of fair value should consider prices for similar assets and the results of valuation techniques to the extent available in the circumstances. Examples of valuation techniques include discounted

cash flow, matrix pricing, option-adjusted spread models and fundamental analysis.

For asset-backed securities, the fair value of the unpaid principal amount outstanding on December 31 should be reported; if principal has been repaid, this fair value will **not** be the same as the original face value revalued at end-period market prices.

U.S.-resident custodians should, at a minimum, report the fair value to the extent that it is available as part of their normal services provided to customers, even if the price available is prior to December 31. If there is doubt as to whether to report the available fair value or to report a fair value of zero, please contact FRBNY report staff at (212) 720-6300 or (646) 720-6300.

### **Foreign Currency Denominated Securities – Calculation of U.S. Dollar Values**

If the security is not denominated in U.S. dollars (US\$) and a US\$ fair value is not available in your system, convert the foreign currency denominated fair value into US\$ using the spot exchange rate as of December 31. If you need assistance locating an exchange rate, please contact FRBNY staff at (212) 720-6300 or (646) 720-6300.

If the exchange rate is normally quoted in units of foreign currency per US\$, such as ¥105.75/US\$, divide foreign currency values by the foreign exchange rate to obtain the US\$ values. For example, if the value of a security issued in Japan is ¥ 200,000, divide ¥ 200,000 by 105.75 to obtain US\$ 1,891.

If the exchange rate is normally quoted in US\$ per units of the foreign currency, such as US\$1.75/UK£, then multiply foreign currency values by the US\$ exchange rate value of the foreign currency to obtain US\$ values. For example, if the value of a security issued in the United Kingdom is UK £1,000, multiply UK £1,000 by 1.75 to obtain US\$ 1,750.

### **L. DATA RETENTION PERIOD**

The reporter must retain all data used to create this report for a period of 36 months from the date of the report's submission.

### **M. REVIEW OF DATA AND REQUESTS FOR REVISED DATA**

Data submitted on the reporting schedules are reviewed by FRBNY staff. As a result of this review, the reporter may be asked by FRBNY staff to provide supplemental information, including reasons for significant data changes between reporting periods, or corrected data. In addition, FRBNY staff may request: (1) information to ensure that all reportable foreign securities have been reported; (2) information to ensure that all reported foreign securities are held by U.S. residents; or (3) other information that helps to explain or corroborate the submitted data.

Entities filing data on electronic media that are not formatted per the specifications in Appendix I will be required to re-submit the data in the proper format.

## IV. INSTRUCTIONS FOR COMPLETING REPORTING SCHEDULES

### A. SCHEDULE 1 - REPORTER CONTACT IDENTIFICATION AND SUMMARY OF FINANCIAL INFORMATION

Schedule 1 must be completed by all organizations that meet the survey reporting requirements as specified in Section II.A. This schedule is used to provide basic identifying information and provide summaries of data reported on Schedule 2 and Schedule 3 records. Please type or print all information.

**1. Reporter Identification Number** - Enter your organization's ten-digit Reporter Identification Number. If you do not know the Reporter Identification Number for your organization, please contact FRBNY staff at (212) 720-6300 or (646) 720-6300.

**(Please enter your ten-digit Reporter Identification number at the top of each page of Schedule 1.)**

**2. Organization Name and Address** - Include the full legal name and mailing address of the reporting entity.

**3. Reporting Status**

Select **1** if your organization is Exempt from reporting on both Schedules 2 and 3 as defined in Section II.C  
**OR** if your organization's reportable foreign securities are included in the report of its U.S.-resident parent.  
Select **2** if your organization is filing only Schedule 2 records.  
Select **3** if your organization is filing only Schedule 3 records.  
Select **4** if your organization is filing both Schedule 2 and Schedule 3.

**4. Industrial Classification Code** - Enter one of the following that best describes your organization.

1 = Bank	4 = Insurance Company	7 = Foundation, Trust, or Estate
2 = Mutual Fund or Investment Trust	5 = Other Financial Organization	8 = Institution of Higher Learning (e.g., university)
3 = Pension Fund	6 = Non-Financial Organization	9 = Other (not listed above)

A Bank is any depository institution (i.e., an institution that takes deposits), a bank holding company, or a financial holding company organized under Regulation Y of the Federal Reserve Act.

An Other Financial Organization is any other organization that acts as a financial intermediary, such as a finance company or a broker/dealer or an investment manager/asset manager, which is operated separately from an organization in one of the other categories listed above.

A Non-Financial Organization is an organization that conducts commercial, industrial or trade activities.

**5. Name of Contact** - Enter the name of the person who will be the primary contact for this report and can answer questions about the data reported.

**6. Title** - Enter the job title of the contact identified in item 5.

**7. Telephone Number** - Enter the telephone number of the contact identified in item 5.

**8. Fax Number** - Enter the fax number of the contact identified in item 5.

**9. Email Address** - Enter the email address of the contact identified in item 5.

- 10. Name of Service Provider or Vendor Used** - If a service provider or vendor was used to prepare the data reported, enter the name of the service provider.
- 11. Name of Technical Contact** - Enter the name of a person who will serve as a contact should any technical issues, such as incorrect file formats, arise. If a service provider was used to prepare the data reported, the technical contact may be a vendor employee.
- 12. Title** - Enter the job title of the technical contact identified in item 11.
- 13. Telephone Number** - Enter the telephone number of the technical contact identified in item 11.
- 14. Email Address** - Enter the email address of the technical contact identified in item 11.
- 15. Valuation Technique** - For each reporting unit, describe the valuation technique(s) used to calculate the reported fair values. If securities are automatically valued at zero after a specified time period of inactivity, please specify the time period and whether this applies to the fair value of the security or to the client's holdings (quantity) of the security. Also, please specify how securities not actively traded on the report date and those with internally generated security identification numbers are valued. If your organization has more than four reporting units, please attach additional copies of Schedule 1, page 2, with item 15 completed.

#### **SUMMARY OF SCHEDULE 2 INFORMATION**

This section contains summary data for the information reported on **Schedule 2** records. If your organization submits Schedule 2 data on multiple media, the summary Schedule 2 data should represent aggregate data across all media submitted for the same reporter identification number.

- 16. Total Number of Schedule 2s Submitted** - Enter the total number of Schedule 2 records submitted.
- 17. Total US\$ Fair Value of All Equity Securities** - Enter the sum of the US\$ fair value of all equity security records (records with Schedule 2, Item 7 = 1, 2, 3, or 4), rounded to the nearest U.S. dollar.
- 18. Total US\$ Fair Value of All Short-Term Debt Securities** (excluding asset-backed securities) - Enter the sum of the US\$ fair value of all short-term debt security (including asset-backed commercial paper) records (records with Schedule 2, Item 7 = 5, 6, 7, 8, or 9 and Item 10 = 1), rounded to the nearest U.S. dollar.
- 19. Total US\$ Fair Value of All Long-Term Debt Securities** (excluding asset-backed securities) - Enter the sum of the US\$ fair value of all long-term debt security (excluding asset-backed securities) records (records with Schedule 2, Item 7 = 6, 7, 8, or 9 and Item 10 = 2), rounded to the nearest U.S. dollar.
- 20. Total US\$ Fair Value of All Asset-Backed Securities** - Enter the sum of the US\$ fair value of all asset-backed security records (records with Schedule 2, Item 7 = 10), rounded to the nearest U.S. dollar.

#### **SUMMARY OF SCHEDULE 3 INFORMATION**

This section contains summary data for the information reported on **Schedule 3** records.

- 21. Total Number of Schedule 3s Submitted** - Enter the total number of Schedule 3 records submitted.
- 22. Total US\$ Fair Value of All Equity Securities** - Enter the sum of all Schedule 3 records, item 4.

**23. Total US\$ Fair Value of All Short-Term Debt Securities** (excluding asset-backed securities) - Enter the sum of all Schedule 3 records, item 5.

**24. Total US\$ Fair Value of All Long-Term Debt Securities** (excluding asset-backed securities) - Enter the sum of all Schedule 3 records, item 6.

**25. Total US\$ Fair Value of All Asset-Backed Securities** - Enter the sum of all Schedule 3 records, item 7.

#### **CERTIFYING INFORMATION**

**All reporters must complete this section.**

By signing and dating the certification, the Certifier acknowledges that:

- He/she has read and understood the reporting requirements of this report;
- He/she is aware that both civil and criminal penalties may be imposed for filing a false report; and
- He/she is sufficiently knowledgeable about the activities and functions of this organization that he/she can knowingly and with reasonable confidence certify that the information provided in this report is both accurate and complete.

**26 - 30** - Enter the name, job title, telephone number, and email address of the duly authorized officer of your organization who certifies that the information provided is complete and accurate, as well as the date and signature.

## B. SCHEDULE 2 - DETAILS OF SECURITIES

(Please enter your ten-digit Reporter Identification Number at the top of each page of Schedule 2.)

**1. Reporter Identification Number** - Enter your organization's ten-digit Reporter Identification Number. If you do not know the Reporter Identification Number for your organization, please contact FRBNY staff at (212) 720-6300 or (646) 720-6300.

**2. Sequence Number** - Enter the sequence number of this detail record, right justified. The first detail record should be assigned sequence number 1, and each succeeding Schedule 2 should be assigned a sequence number one higher than the previous record.

**3a. Reporting Unit Code** - If data being submitted are collected from multiple databases or reporting systems, please report the internal code used in your organization to identify the database or system from which the information on this Schedule 2 came. This information may greatly reduce the costs of identifying and fixing reporting errors that occur.

**3b. Name of Reporting Unit** - Enter a description or name of the reporting unit or area that corresponds to the code reported in item 3a.

**4. Security ID** - Enter the security ID code used to identify the security reported on this Schedule 2. ISIN codes are strongly preferred. If the ISIN code is not available, please use a code listed as "Primary" in Appendix C. If no "primary" code is available, please use a "secondary" code listed in Appendix C other than "internally generated." **Do not use internally generated codes unless this security has not been assigned a code by any recognized numbering agency (e.g., limited partnerships).** All records for securities for which a portion is restricted and a portion is not restricted should be reported with the numbering agency code assigned to the unrestricted portion. If excessive internal codes are used, we may have to contact you to resubmit your report with external ids or to help identify characteristics of individual securities. **Please include the security id's check digit and exclude any internal coding characters added to the ISIN, CUSIP, or other numbering agency code.**

**5. Security Description** - Briefly describe the security, providing any relevant descriptive information available. Ideally, this would include, but is not restricted to: (a) for preferred stock, the annual dividend; (b) for debt securities, the interest rate, if any, whether it is stripped interest only (IO) or principal only (PO), convertibility, and currency of denomination; (c) for floating rate notes, how the interest is calculated (e.g., Libor plus 1.5); and (d) for depositary receipts, a description of the underlying security.

**6. Security ID System** - Select the appropriate number from the list provided in Appendix C. For example, if the Security ID Number entered in Item 4 was an ISIN number, enter "01"; if it was a CINS, enter "33." If the security ID system used is not listed, enter a code of 99 (other) and provide the name of the organization generating the code in item 6a. If the code is internally generated, enter a code of 98 and explain how your internal coding system assigns numbers in item 6a.

**6a. Comment Line** - If you entered a code of 99 (other) in item 6 you must provide the name of the organization generating the security ID code. If you entered a code of 98 (internally generated) in item 6 please explain how your internal coding system assigns numbers.

**7. Security Type** - Enter the appropriate Security Type code from the listed options below:

<b>Equity</b>	<b>Debt (excluding asset-backed securities)</b>		<b>Asset-backed Securities</b>
1 = Common stock	5 = Commercial paper	9 = Unstripped note or bond	10 = Asset-backed security
2 = Preferred stock	6 = Negotiable CD	& all other non-asset-	
3 = Fund shares	7 = Convertible debt security	backed debt	
4 = All other equity	8 = Zero coupon & stripped security		

Common stock includes securities representing equity ownership in a foreign corporation. All foreign common stock, including restricted common stock and depositary receipts where the underlying security is common stock should be reported as security type 1.

Preferred stock includes securities representing equity ownership in a foreign corporation where the holder's claim is given priority over common shares. Preference shares, non-participating preference shares, convertible preferred stock, restricted preferred stock, and depositary receipts where the underlying security is preferred stock should be reported as security type 2.

Funds include all investment vehicles that pool investors' money and invest the pooled money in one or more of a variety of assets. Also, funds include investments vehicles owned by a single investor when the vehicle, not the investor in the fund, is the owner of the securities. All ownership interests in funds should be reported as security type 3, regardless of the types of securities held by the fund. (See Section III.C.)

All other equity includes U.S.-resident limited partner ownership of foreign-resident limited partnerships and any other form of equity not specified in Security Types 1, 2, and 3 and should be reported as security type 4.

Commercial paper, security type 5, includes **all** commercial paper, including asset-backed commercial paper.

Negotiable certificates of deposit, security type 6, include negotiable bank notes and negotiable deposit notes.

Convertible debt securities, security type 7, include all convertible debt such as convertible bonds and zero-coupon convertible debt. Note that non-convertible debt securities with embedded warrants or options should be reported as either security type 8, if a zero coupon bond or note, or as security type 9, if **straight debt**.

Zero coupon & stripped securities, security type 8, includes bonds and notes that do not provide explicit interest payments, such as discount notes and stripped, non-asset-backed securities (both the interest-only (IO) and principal-only (PO) components) **except** zero-coupon convertible debt, which should be reported as security type 7, and stripped asset-backed securities, (including their tranches, and all IO and PO components) which should be reported as security type 10.

Unstripped notes, bonds, and all other non-asset-backed debt, security type 9, includes non-asset-backed debt that is not covered in security types 5 through 8. These are bonds or notes that : (1) cannot be converted to equity securities; (2) provide explicit interest payments; (3) have not been stripped; and (4) do not give the owner a claim on cash flows generated by the underlying assets (i.e., are not asset-backed). These bonds and notes are commonly referred to as "straight debt."

Asset-backed securities, security type 10, includes securities that represent securitized interests in a pool of assets and that give the investor a claim against the cash flows generated by the underlying assets, **except** for asset-backed commercial paper, which should be reported as security type 5. All tranches of stripped asset-backed securities, as well as unstripped asset-backed securities, should be reported as security type 10. Debt which is collateralized by assets (real or financial), but only give the investor a claim against the underlying interest if the issuer defaults, should reported as security types 5 through 9, as appropriate.

**8. Depository Receipt/Share** - Enter **1** if the security is a depository receipt/share. Enter **2** otherwise.

**9. Name of Issuer** - Enter the full legal name of the organization that issued the security. For branches of banks, please provide the location of the branch.

**10. Term Indicator** (based on original maturity) – Enter **1** (short-term) if the period from the issue date to the maturity date is one year or less, regardless if a leap year; enter **2** (long-term), if the period from the issue date to the maturity date is greater than one year. Term indicator only applies to debt, including asset-backed debt. If there are multiple issue dates or redemption dates, term should be determined by the length of the period between the initial/first issue date and the latest redemption date. Perpetual debt should be classified as long-term debt.

**11. Country of Issuer** - Enter the country code from Appendix D that corresponds to the country of residence of the entity that issued the security. (Refer to Section III.I, Country Attribution.)

**12. Currency of Denomination** - Enter the ISO code from Appendix F that corresponds to the currency in which the security being reported is denominated.

**13. Ownership Code** - Enter the appropriate code from the list below:

- 1 = if your organization is reporting as the owner of this security
- 2 = if your organization is reporting as the custodian for a U.S.-resident mutual fund for this security
- 3 = if your organization is reporting as the custodian for a U.S.-resident pension fund for this security
- 4 = if your organization is reporting as the custodian for a U.S.-resident insurance company for this security
- 5 = if your organization is reporting as the custodian for any other U.S. residents for this security
- 6 = if your organization is the custodian for a U.S.-resident beneficial owner whose type is unknown

Ownership code 1 should be used if your organization is the owner of this security and either holds the security or uses a foreign-resident custodian or a U.S.-resident or foreign-resident central securities depository.

Ownership code 2 should be used if your organization is the custodian and the beneficial owner is identified as a U.S.-resident that is a mutual fund.

Ownership code 3 should be used if your organization is the custodian and the beneficial owner is identified as a U.S.-resident that is a pension fund.

Ownership code 4 should be used if your organization is the custodian and the beneficial owner is identified as a U.S.-resident that is an insurance company.

Ownership code 5 should be used if your organization is the custodian and the beneficial owner is identified as a U.S.-resident that is not a mutual fund, pension fund, or insurance company (which are reported as ownership codes 2 through 4). When your organization is the custodian and cannot identify the entity type of the beneficial owner, the ownership code should be reported as ownership code 6.

Ownership code 6 should be used if your organization is the custodian and the entity type of the owner is unknown.



**14a. US\$ Fair Value of Security Held** - Enter the US\$ fair value of the security being reported, rounded to the nearest U.S. dollar. (See Section III.K, Accounting Rules, Valuation of Securities, and Calculation of U.S. Dollar Values, for more information on how to calculate the US\$ fair value.)

**14b. Fair Value of Security Held Denominated in Currency of Issue** - Enter the fair value of the security being reported, rounded to the nearest currency of issue unit. If the currency of issue is US\$, report the same value as in item 14a. (See Section III.K, Accounting Rules, Valuation of Securities, and Calculation of U.S. Dollar Values, for more information on how to calculate the fair value.)

**15. Intentionally left blank.** Leave this field null or enter a blank space for each record.

#### **FOR EQUITY SECURITIES ONLY**

**16. Number of Shares Held** - Enter the number of shares held, rounded to the nearest share. Securities for which the amount of shares held is zero should not be reported.

#### **FOR SHORT-TERM AND LONG-TERM DEBT SECURITIES EXCLUDING ASSET-BACKED SECURITIES ONLY**

**17. Face Value in Currency of Denomination** - For both short-term and long-term securities, enter the face value held in the currency of denomination, rounded to the nearest whole currency unit. If a security is traded in units, then calculate the face value as: (face value of each unit) \* (the number of units held) and report the result in this field. Securities for which the amount held is zero should not be reported.

**18. Issue Date** - Enter the issue date of this security in MMDDYYYY format. For example, if the security was issued on October 4, 1985, enter 10041985. If there are multiple issue dates, enter the first such issue date.

**19. Maturity Date** - Enter the final maturity date (when all remaining principal and interest is due) of this security in MMDDYYYY format. For example, if the security's final maturity date is January 5, 2010, enter 01052010.

#### **FOR SHORT-TERM AND LONG-TERM ASSET-BACKED SECURITIES ONLY**

**20. Original Face Value in Currency of Denomination** - Enter the original face value in the currency of denomination, rounded to the nearest whole currency unit. This is the value that is (would have been) outstanding if no principal has been (had been) repaid. If a security is traded in units, then calculate the original face value as: (original face value of each unit) \* (the number of units held) and report the result in this field.

**21. Remaining Principal Outstanding in Currency of Denomination** - Enter the remaining principal outstanding as of December 31, in the currency of denomination, rounded to the nearest whole currency unit. This will equal the original face value if no principal has been repaid. If a security is traded in units, then calculate the remaining face value as: (remaining face value of each unit) \* (the number of units held) and report the result in this field. Securities for which the amount held is zero should not be reported.

**22. Issue Date** - Enter the issue date of this security in MMDDYYYY format. For example, if the security was issued on October 4, 1985, enter 10041985. If there are multiple issue dates, enter the first such issue date.

**23. Maturity Date** - Enter the final maturity date of this security in MMDDYYYY format. For example, if the security's final maturity date is January 5, 2010, enter 01052010.

## C. SCHEDULE 3 - CUSTODIANS USED

**(Please enter your ten-digit Reporter Identification Number at the top of each page of Schedule 3.)**

- 1. Reporter Identification Number** - Enter your organization's ten-digit Reporter Identification Number. If you do not know the Reporter Identification Number for your organization, please contact FRBNY staff at (212) 720-6300 or (646) 720-6300.
- 2. Sequence Number** - Enter the sequence number of this detail record, right justified. The first detail record should be assigned sequence number 1, and each succeeding Schedule 3 should be assigned a sequence number one higher than the previous record.
- 3. Custodian Code** - Please refer to Appendix G for a list of the major U.S.-resident custodians. If you do not see your U.S.-resident custodian listed in Appendix G, please enter 99 and complete items 9 through 14. (Items 4 through 8 should be completed on all Schedule 3s)
- 4. Total US\$ Fair Value of Equities Entrusted** - Enter the aggregate US\$ fair value for all foreign equities that you entrusted to the organization(s) reported in the custodian code field, rounded to the nearest U.S. dollar.
- 5. Total US\$ Fair Value of Short-Term Debt (excluding asset-backed securities) Entrusted** - Enter the aggregate US\$ fair value for all foreign short-term debt securities (excluding asset-backed securities) that you entrusted to the organization(s) reported in the custodian code field, rounded to the nearest U.S. dollar.
- 6. Total US\$ Fair Value of Long-Term Debt (excluding asset-backed securities) Entrusted** - Enter the aggregate US\$ fair value for all foreign long-term debt securities (excluding asset-backed securities) that you entrusted to the organization(s) reported in the custodian code field, rounded to the nearest U.S. dollar.
- 7. Total US\$ Fair Value of Asset-Backed Securities Entrusted** - Enter the aggregate US\$ fair value for all foreign asset-backed securities that you entrusted to the organization(s) reported in the custodian code field, rounded to the nearest U.S. dollar.
- 8. Reporting As** - Enter 1 if you are the U.S.-resident end-investor or fund manager or 2 if you are the U.S.-resident custodian that is entrusting foreign securities to the organization reported in the custodian code field. (See Appendix H for the definitions of end-investor and custodian.) **Please note that, if you are the custodian, but do not fully disclose the identities of your clients to the sub-custodian, your organization should report those securities on Schedule 2, not on Schedule 3.**

### **COMPLETE ITEMS 9 THROUGH 14 ONLY IF THE CUSTODIAN CODE (ITEM 3) IS 99**

- 9. Name of U.S.-Resident Custodian** - Enter the full legal name of the U.S.-resident custodian to which you entrusted the securities.
- 10. Street Address of U.S.-Resident Custodian** - Enter the mailing address of the U.S.-resident custodian identified in item 9.
- 11. City** - Enter the city in which the U.S.-resident custodian identified in item 9 is located.
- 12. State** - Enter the state in which the U.S.-resident custodian identified in item 9 is located.

**13. Zip Code** - Enter the zip code for the address of the U.S.-resident custodian identified in item 9.

**14. Telephone Number of U.S.-Resident Custodian** - Enter the telephone number of the U.S.-resident custodian identified in item 9.

## **APPENDIX A: SAMPLE REPORTING SCHEDULES**



Please enter your 10-digit Reporter Identification Number.....

--	--	--	--	--	--	--	--	--	--

15. Valuation Technique(s) Used to Determine Market Values

For each reporting unit, please describe the valuation technique(s) used to determine reported market values. If securities are automatically valued at zero after a specified time period of inactivity, please specify the time period and whether this applies to the security or to the client's holdings of the security. Also, please specify how securities not actively traded on the report date and those with internally generated security identification numbers are valued.

Reporting Unit                      Valuation Description

--	--	--

---

---

---

---

---

--	--	--

---

---

---

---

---

--	--	--

---

---

---

---

---

--	--	--

---

---

---

---

---

Please enter your 10-digit Reporter Identification Number.....

**SUMMARY OF SCHEDULE 2 INFORMATION**

16. Total Number of Schedule 2s Submitted.....

17. Total US\$ Fair Value of All Equity Securities ..... ,

18. Total US\$ Fair Value of All Short-Term Debt Securities... ,  
(excluding asset-backed securities) Reported on Schedule 2(s)

19. Total US\$ Fair Value of All Long-Term Debt Securities.... ,  
(excluding asset-backed securities) Reported on Schedule 2(s)

20. Total US\$ Fair Value of All Asset-Backed..... ,  
Securities Reported on Schedule 2(s)

**SUMMARY OF SCHEDULE 3 INFORMATION**

21. Total Number of Schedule 3s Submitted.....  ,

22. Total US\$ Fair Value of All Equity Securities ..... ,

23. Total US\$ Fair Value of All Short-Term Debt Securities... ,  
(excluding asset-backed securities) Reported on Schedule 3(s)

24. Total US\$ Fair Value of All Long-Term Debt Securities.... ,  
(excluding asset-backed securities) Reported on Schedule 3(s)

25. Total US\$ Fair Value of All Asset-Backed..... ,  
Securities Reported on Schedule 3(s)

**CERTIFYING INFORMATION**

By signing the certification below you acknowledge that:

- You have read and understood the reporting requirements of this survey.
- You are aware that both civil and criminal penalties may be imposed for filing a false report; and
- You are sufficiently knowledgeable about the activities and functions of your organization that you can knowingly and with reasonable confidence certify that the information provided in this report is both accurate and complete.

Certifier's Signature: \_\_\_\_\_

26. Certifier's Name: \_\_\_\_\_

27. Certifier's Title: \_\_\_\_\_

28. Certifier's Telephone Number: \_\_\_\_\_ 29. Date Signed: \_\_\_\_\_

30. Certifier's Email Address: \_\_\_\_\_

**SCHEDULE 2: DETAILS OF SECURITIES**

1. Reporter Identification Number: Enter your 10-digit identification number.....
2. Sequence Number: From 1 to the number of Schedule 2 records submitted.....  ,    ,
- 3a. Reporting Unit.....
- 3b. Name of Reporting Unit: \_\_\_\_\_
4. Security ID.....
5. Security Description: \_\_\_\_\_
6. Security ID System: Please select the appropriate code from the list in Appendix C.....
- 6a. For code of Other (99) enter the name of the organization or system that assigned the Security ID:  
\_\_\_\_\_
7. Security Type: Please enter one of the following.....  

<u>Equity</u>	<u>Debt (excluding asset-backed securities)</u>	<u>Asset-Backed Securities</u>
1 = Common stock	5 = Commercial paper	9 = Unstripped bond or note &
2 = Preferred stock	6 = Negotiable CD	all other non-asset backed debt
3 = Fund shares	7 = Convertible debt security	
4 = All other equity	8 = Zero-coupon & stripped security	10 = Asset-backed security
8. Depository Receipt/Share: Please enter one of the following.....
  - 1 = Yes, the security is a Depository Receipt/Share
  - 2 = No, the security is NOT a Depository Receipt/Share
9. Name of Issuer: \_\_\_\_\_
10. Term Indicator (debt, including ABS, only; based on original maturity)..... 
  - 1 = Short Term
  - 2 = Long Term
11. Country of Issuer:.....      

Enter the code from Appendix D for the country of residence of the entity issuing the security.
12. Currency of Denomination:.....   

Enter the code from Appendix F for the currency in which the security was issued.
13. Ownership Code: Please enter one of the following ..... 
  - 1 = If your organization is the owner of this security
  - 2 = If your organization is the custodian for a U.S.-resident mutual fund for this security
  - 3 = If your organization is the custodian for a U.S.-resident pension fund for this security
  - 4 = If your organization is the custodian for a U.S.-resident insurance company for this security
  - 5 = If your organization is the custodian for any other U.S. residents for this security
  - 6 = If your organization is the custodian and the entity-type of the owner is unknown



Reporter Identification Number: Enter your 10-digit identification number.....

14a. US\$ Fair Value of Security Held.....

14b. Fair Value of Security Held Denominated in the  
Currency of Issue (If US\$ is the currency of issue, then enter the  
same value as item 14a.).....

15. Intentionally Left Blank.

**FOR EQUITY SECURITIES ONLY**

(Security Types 1, 2, 3 or 4)

16. Number of Shares Held: Enter the number of shares held  
rounded to the nearest share.....

**FOR SHORT-TERM AND LONG-TERM DEBT SECURITIES EXCLUDING  
ASSET-BACKED SECURITIES**

(Security Types 5, 6, 7, 8, or 9)

17. Face Value in Currency of Denomination: Enter the face value in the  
currency of denomination.....

18. Issue Date: MMDDYYYY format.....

19. Maturity Date: MMDDYYYY format.....

**FOR SHORT-TERM AND LONG-TERM ASSET-BACKED SECURITIES**

(Security Type 10)

20. Original Face Value in Currency of Denomination: Enter the face value.....          
the currency of denomination that would have been outstanding if no  
principal had been repaid.

21. Remaining Principal Outstanding in Currency of Denomination: Enter .....          
the remaining principal outstanding as of December 31 in the  
currency of denomination.

22. Issue Date: MMDDYYYY format.....

23. Maturity Date: MMDDYYYY format.....

**SCHEDULE 3: CUSTODIANS USED**

- 1. Reporter Identification Number: Enter your 10-digit identification number.....
- 2. Sequence Number: From 1 to the number of Schedule 3 records submitted: .....   ,
- 3. Custodian Code: Please see Appendix G for a list of custodians. If the U.S.-resident custodian used is not .....    
on the Appendix, please enter 99 and complete items 9 through 14.
- 4. Total US\$ Fair Value of Foreign Equity Securities Entrusted to this Custodian as of December 31.....       ,       ,       ,       ,
- 5. Total US\$ Fair Value of Foreign Short-Term Debt Securities (excluding asset-backed securities) Entrusted to this Custodian as of December 31 .....       ,       ,       ,
- 6. Total US\$ Fair Value of Foreign Long-Term Debt Securities (excluding asset-backed securities) Entrusted to this Custodian as of December 31 .....       ,       ,       ,
- 7. Total US\$ Fair Value of Foreign Asset-Backed Securities Entrusted to this Custodian as of December 31 .....       ,       ,       ,
- 8. Reporting As: Please enter one of the following..... 
  - 1 = U.S.-resident end-investor (as defined in Appendix H - Glossary)
  - 2 = U.S.-resident custodian (as defined in Appendix H - Glossary), who is in turn entrusting these securities to another U.S.-resident custodian that knows the identities of its customers

**Complete only if the U.S.-Resident Custodian Code in Item 3 is 99:**

- 9. Name of U.S.-Resident Custodian:  
\_\_\_\_\_
- 10. Street Address of U.S.-Resident Custodian:  
\_\_\_\_\_
- 11. City: \_\_\_\_\_ 12. State: \_\_\_\_\_ 13. Zip Code: \_\_\_\_\_
- 14. Telephone Number of U.S.-Resident Custodian:  
\_\_\_\_\_

## **APPENDIX B: REPORTING REQUIREMENT FLOWCHARTS**

### **1. Reporting Requirements for Reporters that are U.S.-Resident Custodians (See Section II.A.)**

- Flowchart 1a - Foreign securities held in custody for your own organization or for your U.S.-resident clients that are not in turn entrusted to any other organization
- Flowchart 1b - Foreign securities entrusted to the safekeeping of a U.S.-resident central securities depository
- Flowchart 1c - Foreign securities held abroad, either by employing a foreign-resident custodian or by directly entrusting to a foreign-resident central securities depository
- Flowchart 1d - Foreign securities entrusted to the safekeeping of another U.S.-resident custodian (excluding U.S.-resident central securities depositories)

### **2. Reporting Requirements for Reporters that are U.S.-Resident End-Investors (See Section II.A.)**

- Flowchart 2a - Foreign securities held for your own organization or for your U.S.-resident clients that are not in turn entrusted to any other organization (held in self-custody)
- Flowchart 2b - Foreign securities entrusted to the safekeeping of a U.S.-resident central securities depository
- Flowchart 2c - Foreign securities held abroad, either by employing a foreign-resident custodian or by directly entrusting to a foreign-resident central securities depository
- Flowchart 2d - Foreign securities entrusted to the safekeeping of a U.S.-resident custodian (excluding U.S.-resident central securities depositories)

### **3. Determining Reportable Securities**

**Please note that flowcharts designed for the TIC SLT, a complementary/companion report, are also available for guidance at**

**<http://www.treasury.gov/resource-center/data-chart-center/tic/Pages/forms-slt.aspx>**

## Reporting Requirements for Reporters that are U.S.-Resident Custodians (See Section II.A.)

**Flowchart 1a - Foreign securities held in custody for your own organization or for your U.S.-resident clients that are not in turn entrusted to any other organization**

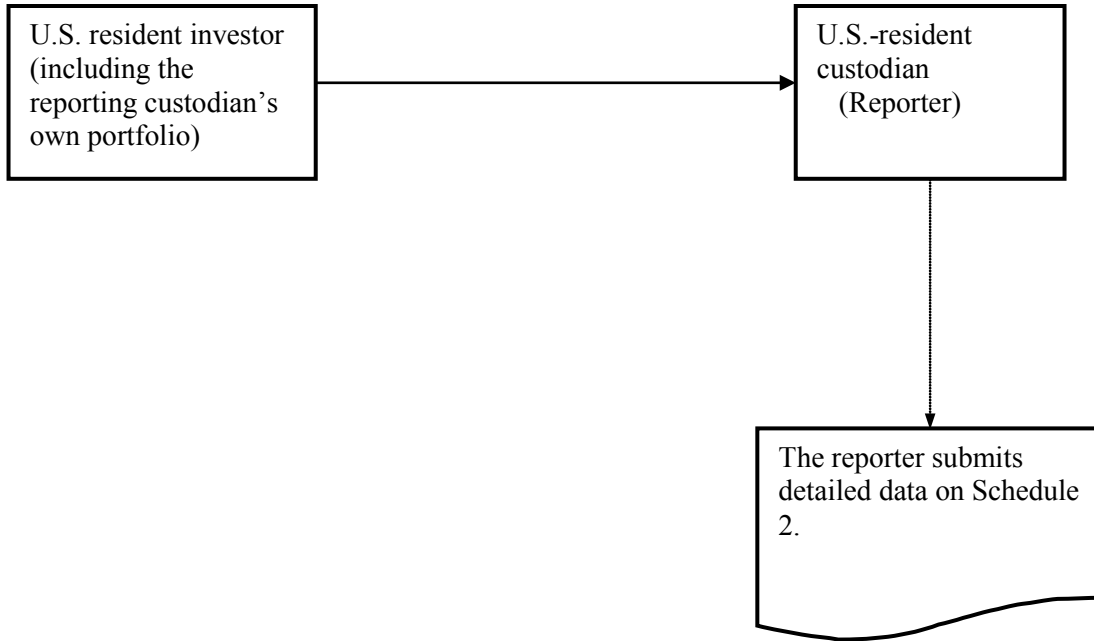

**Flowchart 1b - Foreign securities entrusted to the safekeeping of a U.S.-resident central securities depository**

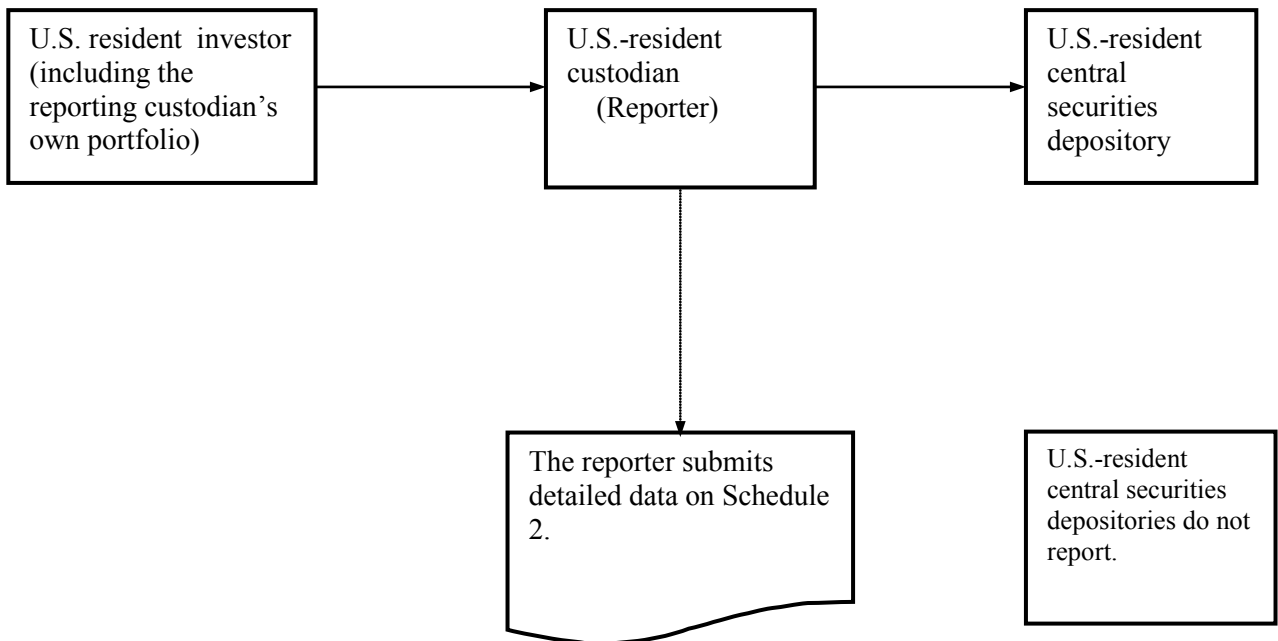

**Reporting Requirements for Reporters that are  
U.S.-Resident Custodians (See Section II.A.)**

**Flowchart 1c - Foreign securities held abroad, either by employing a foreign-resident custodian or by directly entrusting to a foreign-resident central securities depository**

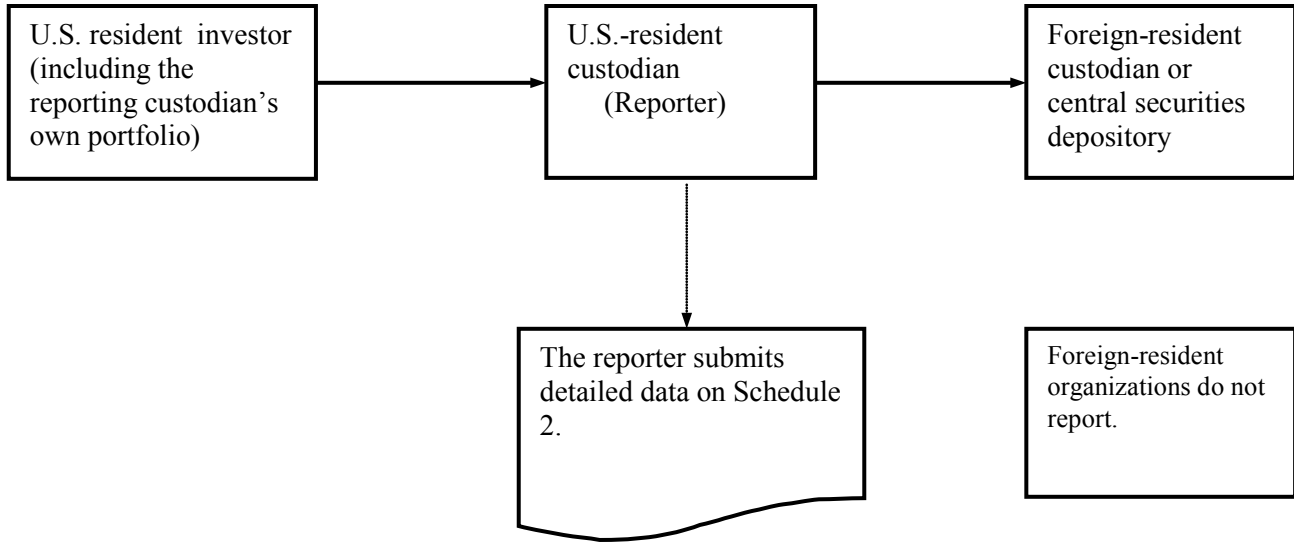

**Flowchart 1d - Foreign securities entrusted to the safekeeping of another U.S.-resident custodian (excluding U.S.-resident central securities depositories)**

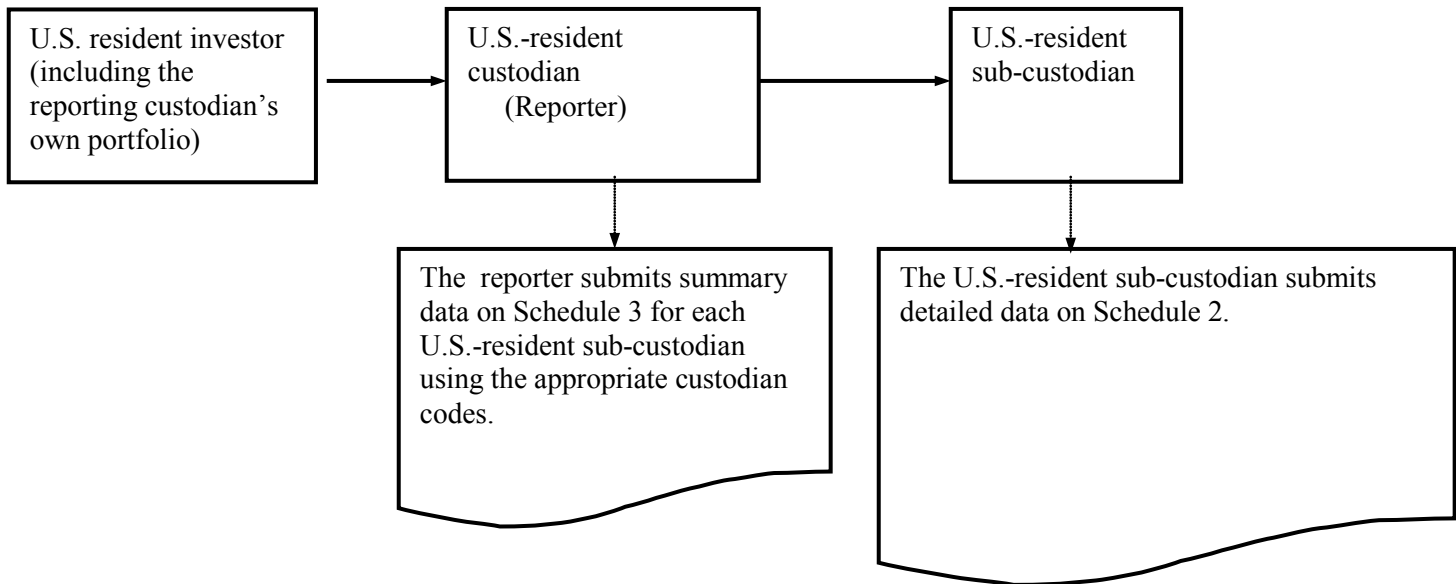

**Reporting Requirements for Reporters that are U.S.-Resident End-Investors, including Investment Managers (See Section II.A.)**

**Flowchart 2a - Foreign securities held for your own organization or for your U.S.-resident clients that are not in turn entrusted to any organization**

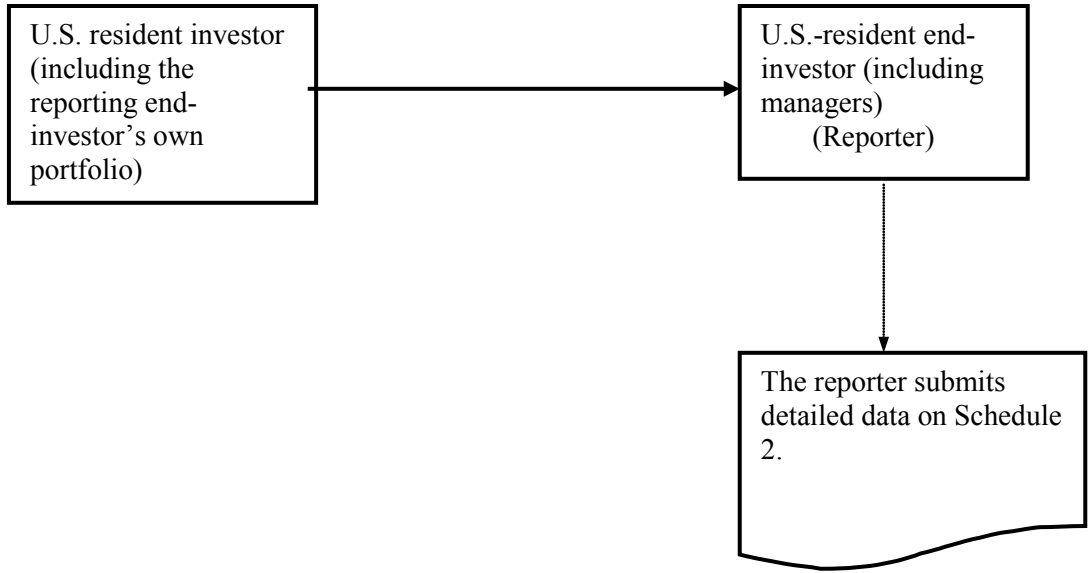

**Flowchart 2b - Foreign securities entrusted to the safekeeping of a U.S.-resident central securities depository**

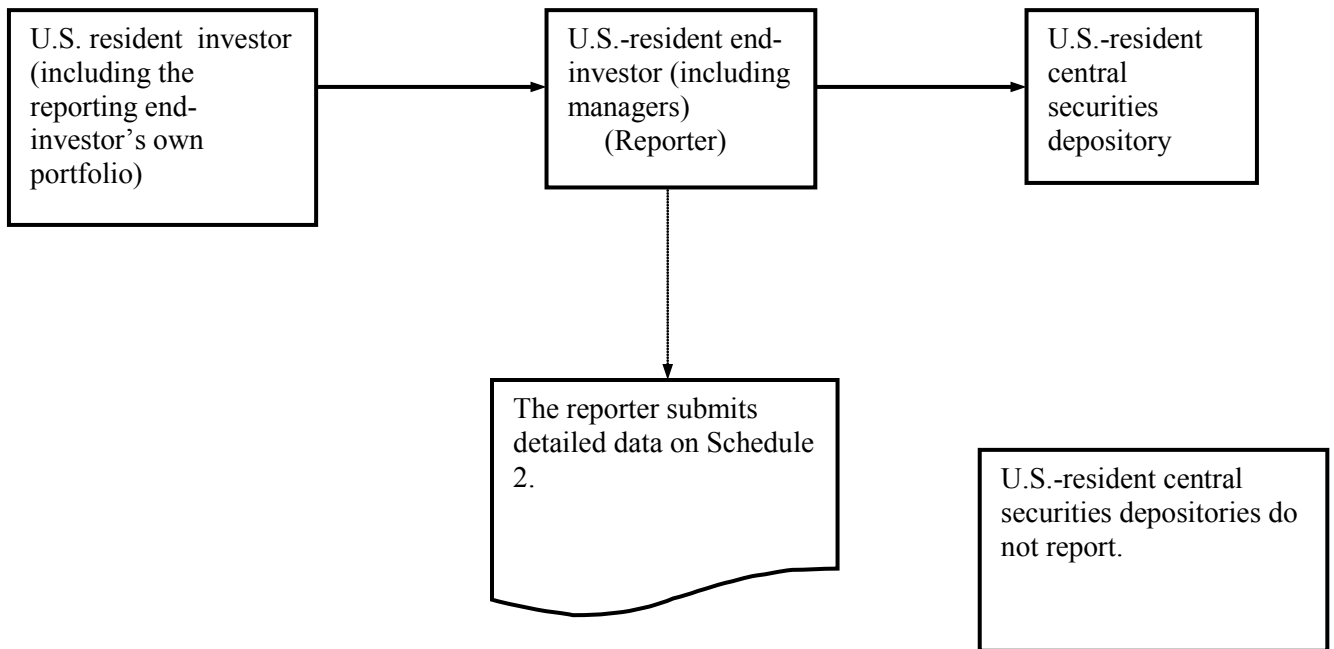

**Reporting Requirements for Reporters that are  
U.S.-Resident End-Investors (See Section II.A.) (cont'd)**

**Flowchart 2c - Foreign securities held abroad, either by employing a foreign-resident custodian or by directly entrusting to a foreign-resident central securities depository**

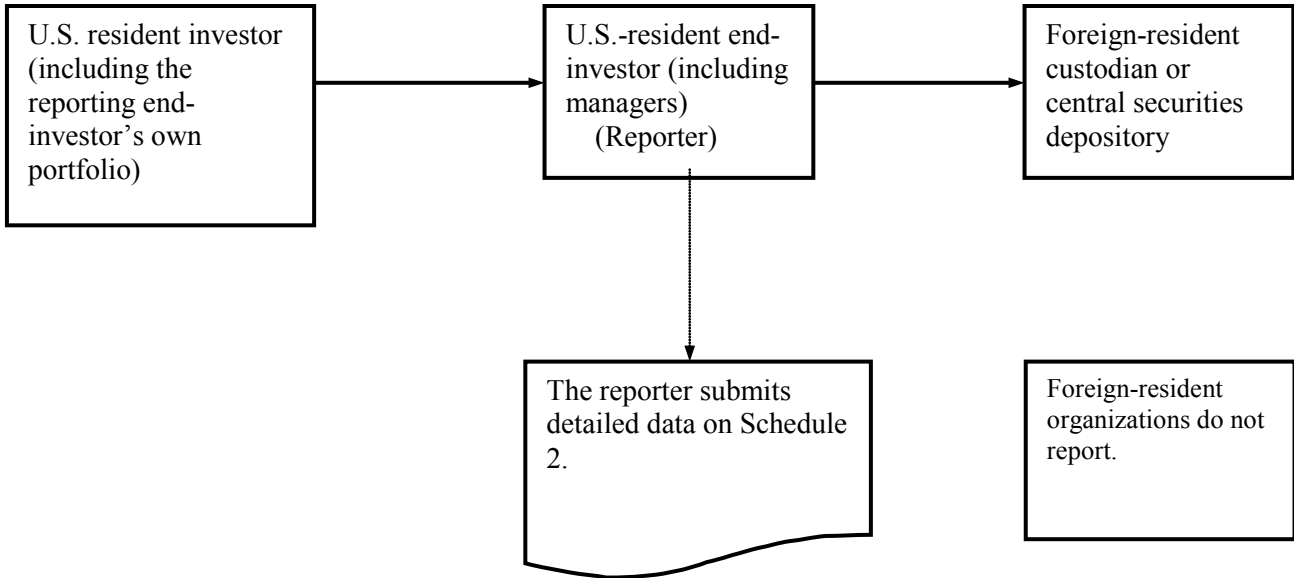

**Flowchart 2d - Foreign securities entrusted to the safekeeping of a U.S.-resident custodian (excluding U.S.-resident central securities depositories)**

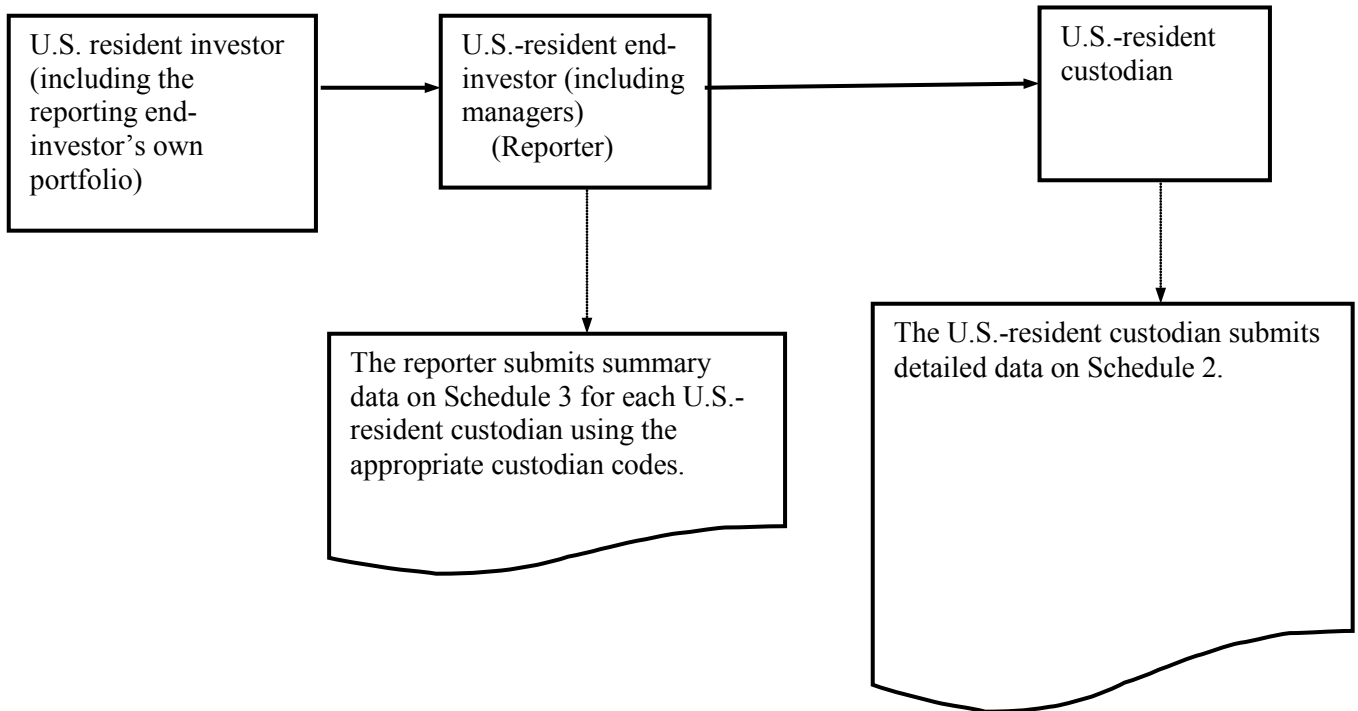

### Flowchart 3 Determining Reportable Securities

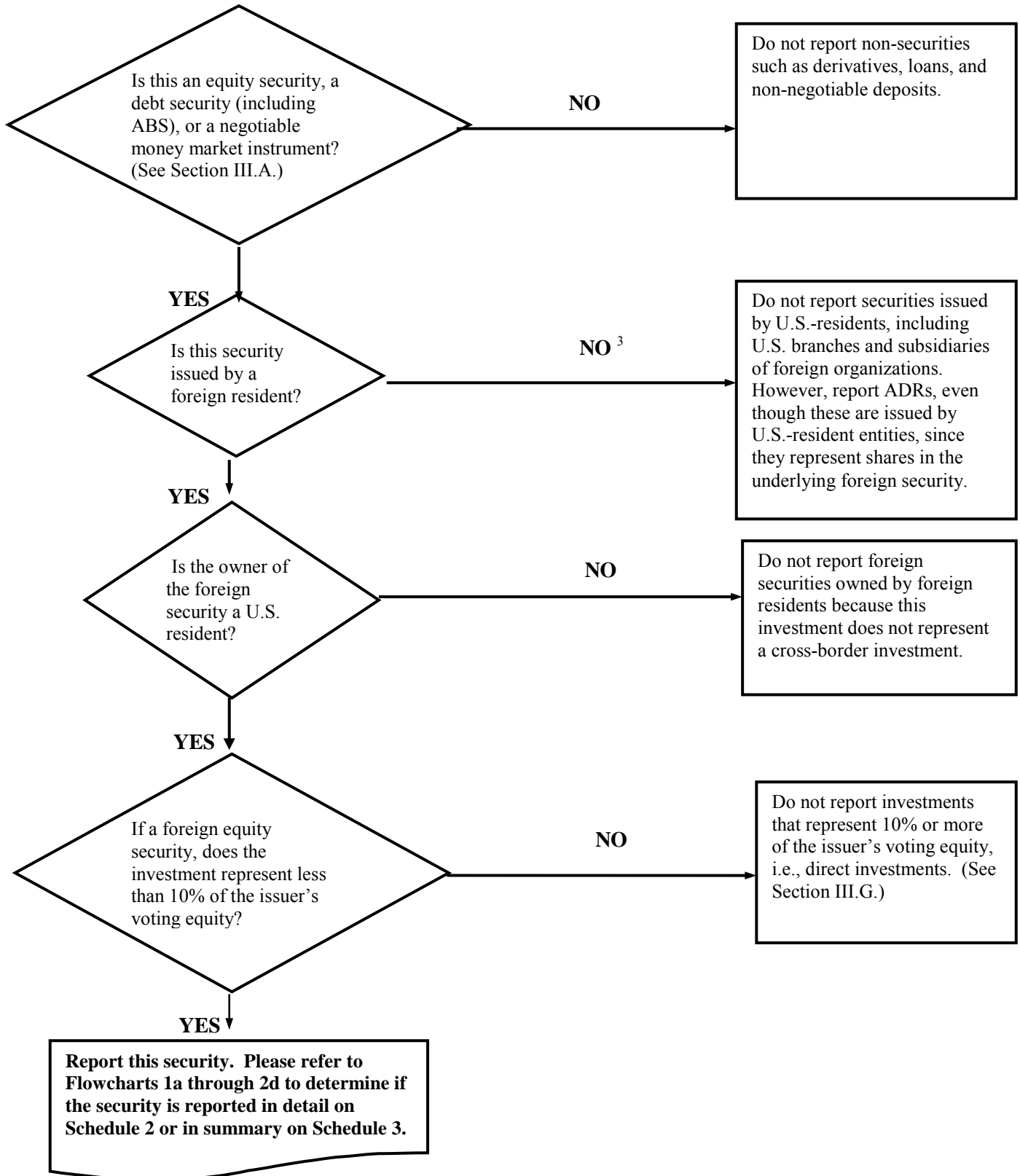



## APPENDIX C: LIST OF SECURITY IDENTIFICATION SYSTEMS

Code	Issuing Country/Agency	Security Identification Coding System
------	---------------------------	---------------------------------------

**Primary Codes - If they are not applicable, use the secondary codes listed below.**

01	International Organization for Standardization (ISO)	ISIN (International Securities Identification Number)
02	Common Code	"European" Common Code (Clearstream/CedeUEuroclear)
31	United Kingdom	SEDOL (Stock Exchange Daily Official List)
33	United States	CINS (CUSIP International Numbering System for Non-North American Securities)

**Secondary Codes — Only use these codes if none of the primary codes listed above are available.**

03	Euroclear	Euroclear Code (old)
04	Cedel	Cedel Code (old)
05	Australia	ASX Security Code (Australian Stock Exchange)
06	Austria	WPK Nummer (Wertpapier Kenn-Nummer)
07	Belgium	SVM Code (Secretariat des Valeurs Mobilieres)
08	Brazil	National Stock Exchange Association Code (Comissao Nacional de Bolsas de Valores)
09	Brazil	Rio de Janeiro Stock Exchange Code
10	Brazil	Sao Paulo Stock Exchange Code
11	Denmark	Fondskode
12	France	SICOVAM (Societe Interprofessionnelle pour la Compensation des Valeurs Mobilieres)
13	Germany	WKN Nummer (Wertpapier Kenn-Nummer)
14	Hong Kong	Stock Exchange of Hong Kong Code
15	Italy	UIC Code (Ufficio Italiano dei Cambi)
16	Italy	ABI Code (Codice Associazione Bancaria Italiana)
17	Japan	SICC Code (Security Identification Code Conference)
18	Japan	TSE Code (Tokyo Stock Exchange Code) (Toushou Code)
19	Korea	Clearing Code (Korean Stock Exchange Code)
20	Mexico	Mexican Stock Exchange Code (Clave de pizarra de la Bolsa Mexicana de Valores)
21	Netherlands	Clearing Code (Amsterdam Stock Exchange Code)
22	New Zealand	New Zealand Stock Exchange Code
23	Norway	Modified ISIN (Verdipapirsentralen) (VPS)
24	Portugal	Lisbon Stock Exchange Code
25	Portugal	Oporto Stock Exchange Code
26	South Africa	Clearing House Code (Johannesburg Stock Exchange Code)
27	Spain	CNMV Code (Comision Nacional del Mercado de Valores)
28	Sweden	VPC Number (Vardepapperscentralen)
29	Switzerland	VALOR (Valoren-Nummer)
30	Thailand	Stock Exchange of Thailand Code
32	United States	CUSIP Number (for North American Securities)
40	BB	Bloomberg security identification code issued by Bloomberg
50	RIC	Reuters Identification Code issued by Reuters
98	Your Company	Internally-Generated Code
99	Other	Other Coding System Not Specified Above

## **APPENDIX D: COUNTRY/AREA CODES**

**DEPARTMENT OF THE TREASURY**

### **CODES FOR COUNTRIES & AREAS TO BE USED FOR PURPOSES OF REPORTING ON TREASURY INTERNATIONAL CAPITAL FORMS**

The most recent version of this appendix is now a separate document.

A copy is on the TIC website at:

<http://www.treasury.gov/resource-center/data-chart-center/tic/Documents/fctry-june2006.pdf>

## **APPENDIX E: INTERNATIONAL & REGIONAL ORGANIZATIONS**

### **DEPARTMENT OF THE TREASURY**

#### **CODES FOR INTERNATIONAL & REGIONAL ORGANIZATIONS TO BE USED FOR PURPOSES OF REPORTING ON TREASURY INTERNATIONAL CAPITAL FORMS**

The most recent version of this appendix is now a separate document.

A copy is on the TIC website at:

<http://www.treasury.gov/resource-center/data-chart-center/tic/Pages/foihome.aspx>

## APPENDIX F: LIST OF CURRENCY CODES

Code	Currency	Code	Currency
AFN	Afghanistan Afghani	CYP	Cyprus Pound
ALL	Albanian Lek	CZK	Czech Koruna
DZD	Algerian Dinar	DKK	Danish Krone
ADP	Andorran Peseta	DJF	Djibouti Franc
AOR	Angolan Kwanza Reajustado	DOP	Dominican Peso
ARS	Argentine Peso	XCD	East Caribbean Dollar
AMD	Armenian Dram	EGP	Egyptian Pound
AWG	Aruban Guilder	SVC	El Salvador Colon
AUD	Australian Dollar	ERN	Eritrea Nakfa
I AZM	Azerbaijani New Manat	EEK	Estonia Kroon
BSD	Bahamian Dollar	ETB	Ethiopian Birr
BHD	Bahraini Dinar	EUR	European Union Euro
BDT	Bangladeshi Taka	FKP	Falkland Islands Pound
BBD	Barbados Dollar	FJD	Fiji Dollar
BYR	Belarussian Ruble	GMD	Gambia Dalasi
BZD	Belize Dollar	GEL	Georgia Lari
BMD	Bermudian Dollar	GHC	Ghana Cedi
BTN	Bhutan Ngultrum	GIP	Gibraltar Pound
BOB	Bolivian Boliviano	GTQ	Guatemala Quetzal
BWP	Botswana Pula	GWP	Guinea-Bissau Peso
I BAM	Bosnia & Herzegovina Convertible Marks	GNF	Guinea Franc
BRL	Brazilian Real	GYD	Guyana Dollar
BND	Brunei Dollar	HTG	Haitian Gourde
BGN	Bulgarian Lev	HNL	Honduras Lempira
BIF	Burundi Franc	HKD	Hong Kong Dollar
KHR	Cambodian Riel	HUF	Hungarian Forint
CAD	Canadian Dollar	ISK	Iceland Krona
CVE	Cape Verde Escudo	INR	Indian Rupee
KYD	Cayman Islands Dollar	IDR	Indonesian Rupiah
XOF	CFA Franc BCEAO	IRR	Iranian Rial
XAF	CFA Franc BEAC	IQD	Iraqi Dinar
XPF	CFP Franc	JMD	Jamaican Dollar
CLP	Chilean Peso	JPY	Japanese Yen
CNY	Chinese Yuan Renminbi	JOD	Jordanian Dinar
COP	Colombian Peso	KZT	Kazakhstan Tenge
KMF	Comoro Franc	KES	Kenyan Shilling
CDF	Congolais Franc	KWD	Kuwaiti Dinar
CRC	Costa Rican Colon	KGS	Kyrgyzstan Som
HRK	Croatian Kuna	LAK	Laos Kip
CUP	Cuban Peso	LVL	Latvian Lats

<u>Code</u>	<u>Currency</u>	<u>Code</u>	<u>Currency</u>
LBP	Lebanese Pound	STD	Sao Tome & Principe Dora
LSL	Lesotho Lote	SAR	Saudi Arabian Riyal
LRD	Liberian Dollar	SCR	Seychelles Rupee
LYD	Libyan Dinar	SLL	Sierra Leone Leone
LTL	Lithuanian Litas	SGD	Singapore Dollar
MOP	Macau SAR Pataca	SKK	Slovak Koruna
MKD	Macedonian Denar	SIT	Slovenia Tolar
MGF	Malagasy Franc	SBD	Solomon Islands Dollar
MWK	Malawi Kwacha	SOS	Somali Shilling
MYR	Malaysian Ringgit	ZAR	South African Rand
MVR	Maldives Rufiyaa	KRW	South Korean Won
MTL	Maltese Lira	LKR	Sri Lanka Rupee
MRO	Mauritania Ouguiya	SDD	Sudanese Dinar
MUR	Mauritius Rupee	SRG	Suriname Guilder
MXN	Mexican Peso	SZL	Swziland Lilangeni
MDL	Moldovan Leu	SEK	Swedish Krona
MNT	Mongolian Tugrik	CHF	Swiss Franc
MAD	Moroccan Dirham	SYP	Syrian Pound
I MZM	Mozambique New Metical	TWD	Taiwan New Dollar
MMK	Myanmar Kyat	TJS	Tajikistan Somoni
NAD	Namibia Dollar	TZS	Tanzanian Shilling
NPR	Nepalese Rupee	THB	Thailand Baht
ANG	Netherlands Antillean Guilder	TOP	Tongan Pa'anga
ILS	New Israeli Shekel	TTD	Trinidad and Tobago Dollar
TWD	New Taiwan Dollar	TND	Tunisian Dinar
NZD	New Zealand Dollar	TRY	Turkish Yani
NIO	Nicaraguan Cordoba Oro	TMM	Turkmenistan Manat
NGN	Nigerian Naira	UGX	Uganda New Shilling
KPW	North Korean Won	UAH	Ukrainian Hryvnia
NOK	Norwegian Krone	AED	United Arab Emirates
OMR	Omani Rial	USD	United States Dollar
PKR	Pakistani Rupee	UYU	Uruguayo Peso
PAB	Panamanian Balboa	UZS	Uzbekistan Sum
PGK	Papua New Guinea Kina	VUV	Vanuatu Vatu
PYG	Paraguay Guarani	VEB	Venezuelan Bolivar
PEN	Peruvian New Sol	VND	Vietnamese Dong
PHP	Philippine Peso	YER	Yemeni Rial
PLN	Polish Zloty	YUM	Yugoslavian Dinar
GBP	Pound Sterling	ZMK	Zambian Kwacha
QAR	Qatari Rial		
ROL	Romanian Leu		
RUB	Russian Ruble		
RWF	Rwanda Franc		
SHP	Saint Helena Pound		
WST	Samoan Tala		

## APPENDIX G: LIST OF CUSTODIAN CODES

If your securities are held by any U.S. subsidiary of one of the custodians below, please use the custodian code of the listed firm.

<u>Name of U.S.-Resident Custodian</u>	<u>Custodian Code</u>
Bank of America Corporation (including but not limited to LaSalle Bank, U.S. Trust Co., Merrill Lynch)	41
Bank of New York Mellon Corporation (including but not limited to former affiliates of Bank of New York, The and Mellon Financial Corporation, PFPC Trust Co and other former affiliates of PNC Global Investment Services; <b>excluding</b> Pershing LLC below)	4
Barclays Bank PLC (U.S.-resident branches)	63
Barclays Group Inc./Barclays Capital Inc. ( <b>excluding</b> branches of Barclays Bank PLC)	64
BMO Financial Corporation (including but not limited to BMO Harris Bank, Marshall & Ilsley (M&I) companies)	62
BNP Paribas (U.S.-resident branches only)	7
Brown Brothers Harriman & Co.	8
Charles Schwab Corporation, The (including but not limited to Charles Schwab & Co., Inc. and Charles Schwab Bank)	58
Citigroup Inc./Citibank, N.A. (including but not limited to Salomon Smith Barney)	9
Comerica Incorporated (including but not limited to Comerica Bank and Comerica Securities, Inc.)	61
Deutsche Bank Aktiengesellschaft (U.S.-resident branches only) ( <b>excludes</b> Deutsche Bank Trust Company Americas and Taunus Corporation below)	12
Deutsche Bank Trust Company Americas (part of Taunus Corporation below)	6
Fidelity Management and Research Corp. (FMR Corp.) (including but not limited to Fidelity Investments, Fidelity Management Trust Company, and National Financial Services Corporation)	26

Fifth Third Bancorp/Fifth Third Bank	25
Goldman Sachs Group L.P.	27
Harris Bank/BMO Harris Bank (part of BMO Financial Corporation above)	62
HSBC North America Inc./HSBC Bank USA, N.A.	14
JPMorgan Chase & Co./JPMorgan Chase Bank	16
Marshall & Ilsley Investment Corporation/Marshall & Ilsley Trust Co. (part of BMO Financial Corp. above)	62
Merrill Lynch & Company, Inc. (part of Bank of America above)	41
Morgan Stanley, Dean Witter & Co.	29
Northern Trust Company, The	18
Pershing LLC (including but not limited to Lockwood Advisors, Inc.; <b>excluded</b> from Bank of New York Mellon above)	40
PNC Financial Services Group, Inc., The (including but not limited to PNC Bank, N.A.; <b>excluding</b> PFPC Trust Company and other affiliates of PNC Global Investment Services, Inc. that are now part of Bank of New York Mellon above)	30
State Street Bank and Trust Company (including but not limited to International Fund Services, Investors Financial Services Corporation, Investors Bank and Trust, and Investors Trust Company)	20
Taunus Corporation/Deutsche Bank Trust Company Americas (including but not limited to Deutsche Bank Securities Inc.)	6
UBS AG (U.S.-resident branches only)	21
UBS Financial Services Inc.	59
UBS Securities LLC	60
Union Bancorp/Union Bank of California, N.A.	22
UMB Financial Corporation/UMB Bank N.A.	33
U.S. Bancorp/U.S. Bank N.A.	32
Wachovia Corporation /Wachovia Bank N.A. (acquired by Wells Fargo & Co. below)	35

Wells Fargo & Co./Wells Fargo Bank, N.A. (including but not limited to Wachovia Corporation, Wachovia Bank, A.G. Edwards& Sons, Inc.)	35
U.S.-Resident custodian that is not listed above	99



## APPENDIX H: GLOSSARY

**AMERICAN DEPOSITARY RECEIPT (ADR)** – Negotiable certificates, typically issued by a U.S.-resident company, for shares of stock issued by a foreign corporation. The securities are held in a custodial account, either at the issuing bank or by an agent. The ADR should be reported, not the foreign securities held by the depository. Report the ADR as common stock (security type=1) if the underlying foreign security is common stock or as preferred stock (security type =2) if the underlying foreign security is preferred stock. (See Section III.E for more information on the correct reporting of these securities.)

**AMERICAN DEPOSITARY SHARE (ADS)** – Negotiable securities certificate issued in the United States by transfer agents acting on behalf of foreign issuers, where the foreign issuers absorb part or all of the handling costs involved. The ADS should be reported, not the foreign securities held in custody. Report the ADS as common stock (security type =1) if the underlying foreign security is common stock or as preferred stock (security type =-2) if the underlying foreign security is preferred stock. (See Section III.E for more information on the correct reporting of these securities.)

**ASSET-BACKED SECURITIES** – Securitized interests in a pool of assets, which give the purchaser a claim against the cash flows generated by the underlying assets. These pools may be derived from mortgage loans, auto loans, credit card receivables, vehicle and equipment leases, consumer loans, commercial loans or other assets. Include as asset-backed securities (ABS): CMOs, CLOs, CBOs and CDOs. ABS give the holder an undivided interest in the securitized assets and payments made from the cash flows received by the issuer from the payments of principal and interest from the borrowers. (ABS do not include securities, such as covered bonds or pfandbriefes, where the security is collateralized, but the holder of the security does not have a claim of the cash flows generated by the collateral.) ABS, including stripped ABS, are reported as security type 10 (asset-backed security), **except** for asset-backed commercial paper, which is reported as security type 5 (commercial paper).

**BEARER BOND** – Securities that are not registered in the name of their owner. The owner collects interest and dividends upon presentation of detachable coupons to a bank or fiduciary agent. These securities are reported as security type 9 (unstripped bond or note and all other long-term debt).

**BRADY BONDS** – Collateralized dollar-denominated bonds issued by a foreign government or central bank in exchange for loans under the Brady Plan. These securities are reported as all other long-term debt (security type = 9).

**COMMERCIAL PAPER** – A promissory note, either unsecured or backed by assets such as loans or mortgages. They are usually sold at a discount and customarily have a fixed maturity of 270 days or less. All commercial paper should be reported as security type = 5 (commercial paper).

**COMMINGLED ACCOUNT** – An account in which the investment funds of individual clients are pooled, with each client owning portions of the pooled account. Foreign securities held in U.S.-resident commingled accounts should be reported. U.S. residents' ownership of foreign-resident commingled should also be reported.

**CONVERTIBLE BOND** – A bond that can be exchanged at a set price for equity securities by the holder under certain conditions. These securities are reported as convertible debt (security type = 7).

**COVERED BOND** – Also known as Mortgage Bond or Pfandbriefe. A bond that is backed by loans, typically mortgages, but does not give the purchaser a claim against the cash flows generated by the

underlying assets. These securities are reported as security type 9 (unstripped bond or note and all other long-term debt).

**CUSTODIAN** – A bank or other organization that manages or administers the custody or safekeeping of stock certificates, debt securities, or other assets for institutional and private investors.

**DEPOSITARY RECEIPTS** – See American Depositary Receipts (ADR). Related types of depositary receipts, such as Global Depositary Receipts, are reported in the same manner as ADRs.

**DEPOSITARY** – An entity that holds securities, either in certificated or uncertificated (dematerialized) form, to enable the transfer of ownership of securities. Depositories are not necessarily custodians, since they may be responsible only for registering and settling security transactions.

**DERIVATIVE CONTRACT** – Financial instrument or other contract with all three of the following characteristics:

1. (a) One or more underlyings; (b) one or more notional amounts; and (c) payment provisions. These terms determine the amount of the settlement or settlements, and, in some cases, whether or not a settlement is required.
2. Requires no initial investment, or an initial net investment that is much smaller than would be required for other types of contracts that would be expected to have a similar response to changes in market factors.
3. The terms require or permit net settlement, it can readily be settled net by a means outside the contract, or it provides for delivery of an asset that puts the recipient in a position not substantially different from net settlement.

Derivative contracts are excluded from the report. Embedded derivatives that are not bifurcated under ASC 815 (formerly FAS 133) should be reported without separating the embedded derivative from the host contract. However, if the embedded derivative is bifurcated from the host contract, then the derivative should be excluded from the report and the host security should be included on the report.

**DEVELOPMENT BANKS** – Entities owned by national governments and established to promote economic development of sectors of the economy, such as trade, housing, agriculture, finance and industry. Securities issued by foreign development banks should be reported.

**DIRECT INVESTMENT** – Investment in which a resident of one country obtains a degree of influence over the management of a business enterprise in another country. The criterion used to define direct investment is ownership of at least 10 percent of the voting securities of an incorporated business enterprise or the equivalent interest in an unincorporated business enterprise. U.S. direct investment abroad represents the ownership or control, directly or indirectly, by one U.S. resident (U.S. parent) of at least 10 percent of a foreign business enterprise, which is called a foreign affiliate. Foreign direct investment in the United States represents the ownership or control, directly or indirectly, by one foreign resident (foreign parent) of at least 10 percent of a U.S. business enterprise, which is called a U.S. affiliate. For guidance on how to apply the direct investment criterion in the case of a limited partnership, see “Limited partnerships and direct investment” below.

Direct investment transactions and positions include the equity that gives rise to control or influence and intercompany lending, i.e., debt between affiliated enterprises. However, debt between selected affiliated financial intermediaries is not classified as direct investment because it is not considered to be so strongly connected to the

direct investment relationship. The financial intermediaries covered by this case are: (a) deposit-taking corporations; (b) securities brokers and dealers; and (c) financial and bank holding companies. Insurance companies, investment funds and other financial intermediaries are not covered by this case.

All direct investment transactions and positions are excluded from the TIC system. These transactions and positions should instead be reported to the Bureau of Economic Analysis (BEA). U.S. residents in direct investment relationships are required to file reports with BEA unless exempt. (See forms and reporting requirements at: <http://www.bea.gov/international/index.htm#surveys>.) For U.S. direct investment abroad, call 202-606-5566; for foreign direct investment into the United States, call 202-606-5577.

**Limited partnerships and direct investment** - The determination of whether a partner and a limited partnership are in a direct investment relationship is based on who controls the partnership; it is NOT based on the percentage of ownership in the partnership's equity.

In most cases, the general partner is presumed to control a limited partnership and therefore, to be in a direct investment relationship with the limited partnership. If there is more than one general partner, the partnership is presumed to be controlled equally by each of the general partners, unless a clause to the contrary is contained in the partnership agreement.

Limited partners do not normally exercise any control over a limited partnership. Therefore unless a clause to the contrary is contained in the partnership agreement, limited partners are presumed not to be in a direct investment relationship with the limited partnership.

Some partnership agreements grant voting rights to limited partners. In such a case, the limited partner could be in a direct investment relationship with the limited partnership if it met the 10 percent voting rights criterion for direct investment.

**END-INVESTOR** – An entity that invests in foreign securities for its own account (for trading, investment, or any other purpose) or invests on behalf of others, including asset pools, such as managers of mutual funds, managers of insurance company policyholder assets, and pension fund managers. (See Section II.A for examples of end-investors.)

**FOREIGN RESIDENT (FOREIGN, FOREIGNER)** - Any individual, corporation, or other entity legally established outside of the United States, regardless of the actual center of economic activity of the entity. Thus, a corporation incorporated outside the United States is a foreign resident even if it has no physical presence outside the United States. Foreigners/foreign residents include:

1. Individuals, including citizens of the United States, residing outside the United States. (This includes individuals that have filed an IRS Form W-8, indicating that the individual is a non-resident alien. However, if an IRS form is not available, the mailing address can be used to determine residency.)
2. Entities that have filed an IRS Form W-8, indicating that the individual or entity is a nonresident alien or foreign entity not subject to certain United States information return reporting or to backup withholding rules.
3. Any corporation or other organization legally established outside of the United States, including branches, subsidiaries and other affiliates of U. S. entities located abroad.
4. Foreign governments and any subdivision, agency or instrumentality thereof, including all foreign official nonbanking institutions, even if located in the United States (e.g., an embassy, consulate, or other diplomatic establishment of a foreign country). (However, all U.S.-resident subsidiaries of foreign

corporations, including government-owned foreign corporations, are U.S. residents.)

5. International or regional organizations or subordinate or affiliated agencies thereof, created by treaty or convention between sovereign states, even if located in the United States, including the International Bank for Reconstruction and Development (IBRD or World Bank), the International Monetary Fund (IMF), and the United Nations (UN). (See Appendix E for a list of international and regional organizations.)

**FOREIGN-RESIDENT CUSTODIAN** – A custodian organized under the laws of a country other than the United States, including a foreign affiliate of a U.S. custodian. Reporters should determine the residence of a custodian according to the country in which the custodian is incorporated, or otherwise legally established, not according to the country of the custodian's parent firm, and not according to the location of the custodian's operations center.

**FOREIGN SUBCUSTODIAN** – A foreign institution that holds in safekeeping foreign securities for a U.S.-resident custodian.

**FUNDS** – Pooled, separate and general investment accounts of one or more of the following institutional and private investors: private and public pension funds; mutual funds, country funds, exchange traded funds, unit investment trusts, collective-investment trusts, and any other similarly pooled, commingled investment funds; insurance companies; foundations; institutions of higher learning; government-sponsored enterprises and other independently acting government agencies; financial and nonfinancial corporations; investment advisors; trusts and estates; and private individuals. U.S. ownership of shares of foreign-resident funds are reported as funds (security type= 3), regardless of the types of securities held by the fund. Foreign securities held in U.S.-resident funds should also be reported. (See Section III.0 for the correct reporting of funds.)

**INVESTMENT TRUST SHARE** – A share of a company bound by a trust deed issued in registered form, formed to invest in specific types of securities. Shares in an investment trust can usually be bought and sold only through the stock exchange. Sometimes referred to as a 'closed-end' fund. Investment trust shares are reported as fund shares (security type =3), regardless of the types of securities held by the trust. U.S. ownership of shares of foreign-resident investment trust are reported as funds (security type= 3), regardless of the types of securities held by the trust. Foreign securities held in U.S.-resident investment trusts or their foreign equivalents should also be reported. (See Section III.0 for the correct reporting of funds.)

**LONG-TERM** – No contractual maturity or an original maturity of more than one year.

**LONG-TERM DEBT SECURITY** – Debt security with no contractual maturity or with an original maturity of more than one year.

**NATIONALIZED BANK** – Institution owned by a foreign central government that is classified as a bank in its own country. A nationalized bank is considered to be an official organization only if it also performs the functions of a central bank.

**NEGOTIABLE CERTIFICATES OF DEPOSIT** – A negotiable (transferable) instrument or deposit in book entry form evidenced by a receipt or similar acknowledgement issued by a bank, which provides on its face that the amount of such deposit is payable to bearer or any specified person (e.g., deposit notes, bank notes). These negotiable money market instruments should be reported as security type 6.

**SECURITY** – Any bill, note, bond, debenture, instrument representing ownership of equity in a company, negotiable money market instrument, or similar instrument that is commonly referred to as a security,

whether or not is tradeable. Do not include loans, even if tradeable. See Section III.A for a list of reportable foreign securities.

**SETTLEMENT DATE** – The date a security is delivered to the purchaser.

**SETTLEMENT DATE ACCOUNTING** – Under settlement date accounting, the purchase and sale of assets are not recorded until the settlement date. Settlement date accounting should be used for purposes of this report.

**SHORT-TERM** – Original maturity of one year or less.

**SHORT-TERM DEBT SECURITY** – Debt security, including negotiable money market instruments, with an original maturity of one year or less.

**STRUCTURED NOTE OR BOND** – An over-the-counter financial instrument created specifically to meet the needs of one or a small number of investors. Some of the more common structures include: step-up bonds, index amortizing notes, dual index notes, deleveraged bonds, range bonds, and inverse floaters. These securities are reportable debt securities.

**SUBORDINATED DEBT** – A security evidencing debt that the holder agrees to rank after senior creditors, but before shareholders, in a bankruptcy.

**SUBSIDIARY** – A company in which another company (parent) owns 50 percent or more of the voting securities, or an equivalent interest.

**TREASURY BILL** – a common form of sovereign debt issued by many governments. Foreign treasury bills should be reported as security type 9 (unstripped bond or note and all other non-asset-backed debt).

**UNITED STATES** – The fifty (50) States of the United States, the District of Columbia, the Commonwealth of Puerto Rico, the Commonwealth of the Northern Mariana Islands, and the following: American Samoa, Baker Island, Guam, Howland Island, Jarvis Island, Johnston Atoll, Kingman Reef, Midway Islands, Navassa Island, Palmyra Atoll, the U.S. Virgin Islands, and Wake Island.

**UNIT INVESTMENT TRUST** – A fixed portfolio of securities that are assembled by an underwriter sponsor and upon completion of the underwriting, are deposited with an independent trustee. Unit investment trusts have a definite termination date, usually between 6 months and 10 years. U.S. ownership of shares of foreign-resident unit investment trusts are reported as fund shares (security type = 3), regardless of the types of securities in held by the trust. Foreign securities held in U.S.-resident unit investment trusts should also be reported. (See Section III.0 for the correct reporting of unit investment trusts.)

**U.S. RESIDENT** – Any individual, corporation, or other entity incorporated or legally established in the United States, including branches, subsidiaries and affiliates of foreign entities located in the United States. Corporations incorporated in the United States are considered to be U.S. residents even if they have no "physical presence" in the United States.

**U.S.-RESIDENT CUSTODIAN** – A custodian that is resident in the United States, including a U.S.-resident affiliate of a foreign custodian.

**U.S.-RESIDENT END-INVESTOR** – An entity that is resident in the United States, including a U.S. affiliate of a foreign end-investor, that either invests for its own account (for trading, investment and other purposes) or on behalf of others, including managed accounts and asset pools. U.S.-resident end-investors include managers of a mutual fund, managers of assets held for insurance company policyholders, and managers of pension and endowment funds.

**ZERO-COUPON BOND** – Bonds that do not provide interest payments. Zero coupon bonds usually have an issue price well below 100% of the face value with repayment on maturity at face value or par. The investors' return is the difference between the issue price and redemption value. These securities are reported as security type **8** (zero coupon & stripped security).

## **APPENDIX I: TECHNICAL INFORMATION FOR ELECTRONIC SUBMISSION**

Included in this appendix are instructions for how to properly prepare data in a file for submission. Your entity must retain a copy of the data for a period of 36 months from the date of the report's submission.

### **I. Requirements for submitting data via IESUB**

- ✓ Each file should contain data for only one Reporter Identification Number. If your entity will be reporting using multiple Reporter Identification Numbers, the data pertaining to each Reporter Identification Number must be reported in a separate file.
- ✓ Your entity must agree to the Terms and Use for Internet Reporting. This information can be found at: <http://www.treas.gov/tic/forms-sh.html>
- ✓ Your entity must have a connection to the Internet that supports the World Wide Web (WWW). Your connection must not block or disable JavaScript.
- ✓ Your entity must have a web browser program (e.g., Microsoft Internet Explorer 5.5 or higher) that supports 128-bit Secure Sockets Layer (SSL) encryption. 128-bit encryption is used for all communication between you and the Federal Reserve System.
- ✓ All Schedule 1 information must be data entered before Schedule 2 data can be submitted.
- ✓ All files must be text files and have file names ending with .TXT (e.g., Schedule\_2\_Company\_Name.TXT)

### **II. Requirements for submitting data via Diskette/CD**

- ✓ Each diskette/CD (media) should contain data for only one Reporter Identification Number. If your entity will be reporting using multiple Reporter Identification Numbers, the data pertaining to each Reporter Identification Number must be reported on separate media.
- ✓ Each media for a particular Reporter Identification Number must be accompanied by a paper format Schedule 1.

- ✓ A dump or print out that includes at least the first ten detail records should accompany each media.
- ✓ Include a printout of the command string used to create the file if the file was created directly from the mainframe.
- ✓ Include any special instructions on how to unload the file.
- ✓ All Schedule 2 data must be provided in a standard DOS, ASCII flat file on one of the following media:
  - High density, IBM PC-compatible diskette(s)
  - Standard 700 MB CD(s)

Data must be submitted to:

Federal Reserve Bank of New York  
Statistics Function, 4<sup>th</sup> Floor  
33 Liberty Street  
New York, NY 10045-0001

Should you have any questions concerning the instructions in this appendix, please contact the FRBNY automation staff at 212-720-1989 or 646-720-1989.



### III. Electronic File Formats for both IESUB and Diskette/CD Submissions for Schedule 2(s).

Reporters must use either a semicolon-delimited format or positional format. The layouts and examples of each follows.

#### Semicolon Delimited Format

<b>Data Field and Instructions</b>	<b>Field Format</b>	<b>Schedule 2 Item Number</b>
<b>Reporter Identification Number</b>	<b>N10</b>	<b>1</b>
Delimiter	Semi-colon	
<b>Sequence Number (value from 1 - maximum number of records)</b>	<b>N7</b>	<b>2</b>
Delimiter	Semi-colon	
<b>Reporting Unit</b>	<b>N3</b>	<b>3a</b>
Delimiter	Semi-colon	
<b>Name of Reporting Unit</b>	<b>A80</b>	<b>3b</b>
Delimiter	Semi-colon	
<b>Security ID</b>	<b>A12</b>	<b>4</b>
Delimiter	Semi-colon	
<b>Security Description</b>	<b>A80</b>	<b>5</b>
Delimiter	Semi-colon	
<b>Security ID System (Refer to Appendix C)</b>	<b>N2</b>	<b>6</b>
Delimiter	Semi-colon	
<b>Security ID System Description</b>	<b>A80</b>	<b>6a</b>
Delimiter	Semi-colon	
<b>Security Type (Refer to Schedule 2, Page1)</b>	<b>N2</b>	<b>7</b>
Delimiter	Semi-colon	
<b>Depository Receipt/Share (Refer to Schedule 2, Page1)</b>	<b>N1</b>	<b>8</b>
Delimiter	Semi-colon	
<b>Name of Issuer</b>	<b>A80</b>	<b>9</b>
Delimiter	Semi-colon	
<b>Term Indicator (Refer to Schedule 2, Page1)</b>	<b>N1</b>	<b>10</b>
Delimiter	Semi-colon	
<b>Country of Issuer (Refer to Appendix D)</b>	<b>N5</b>	<b>11</b>
Delimiter	Semi-colon	
<b>Currency of Denomination (Refer to Appendix F)</b>	<b>A3</b>	<b>12</b>
Delimiter	Semi-colon	
<b>Ownership Code (Refer to Schedule 2, Page1)</b>	<b>N1</b>	<b>13</b>
Delimiter	Semi-colon	
<b>US\$ Fair (Market) Value of Security Held</b>	<b>N12</b>	<b>14a</b>
Delimiter	Semi-colon	
<b>Fair (Market) Value of Security Held Denominated in the Currency of Issue</b>	<b>N12</b>	<b>14b</b>
Delimiter	Semi-colon	

<b>Intentionally Left Blank</b>	<b>N1</b>	<b>15</b>
Delimiter	Semi-colon	
<b>Number of Shares Held</b>	<b>N11</b>	<b>16</b>
Delimiter	Semi-colon	
<b>Face Value in Currency of Denomination (non-ABS debt only)</b>	<b>N12</b>	<b>17</b>
Delimiter	Semi-colon	
<b>Issue Date (MMDDYYYY) (non-ABS debt only)</b>	<b>N8</b>	<b>18</b>
Delimiter	Semi-colon	
<b>Maturity Date (MMDDYYYY) (non-ABS debt only)</b>	<b>N8</b>	<b>19</b>
Delimiter	Semi-colon	
<b>Original Face Value in Currency of Denomination (ABS only)</b>	<b>N12</b>	<b>20</b>
Delimiter	Semi-colon	
<b>Remaining Principal Outstanding in Currency of Denomination (ABS only)</b>	<b>N12</b>	<b>21</b>
Delimiter	Semi-colon	
<b>Issue Date (MMDDYYYY) (ABS only)</b>	<b>N8</b>	<b>22</b>
Delimiter	Semi-colon	
<b>Maturity Date (MMDDYYYY) (ABS only)</b>	<b>N8</b>	<b>23</b>

### Data Specifications

In addition to the instructions in the above table, follow these instructions:

- Semi-colons must be used as space-delimiters between fields.
- No special characters should be present in numeric fields (e.g. currency signs, commas, negative signs, slashes, etc.).
- All numeric fields should be unpacked, unsigned and with leading zeros.
- A format specification of N12 is numeric, with length of up to 12.
- A format specification of A80 is alphanumeric, with length of up to 80.
- Issue Date and Maturity Date fields should be in the format of MMDDYYYY with leading zero for months January-September and for the 1<sup>st</sup> to the 9<sup>th</sup> day of the month (e.g. 01092004 = January 9, 2004).

**External Label for Diskette/CD submissions** (affix to media, not to cover)

Company Name

Reporter Identification Number as assigned by the FRBNY

Data Processing Contact Name and Telephone Number

Diskette/CD Identification Number (as identified in your records)

Total Number of Diskette/CD: 1 of \_\_\_

Creation Date

Contents: Report of U.S. Ownership of Foreign Securities, Including Selected Money Market Instruments  
(SHC(A))

## Sample Equity Record

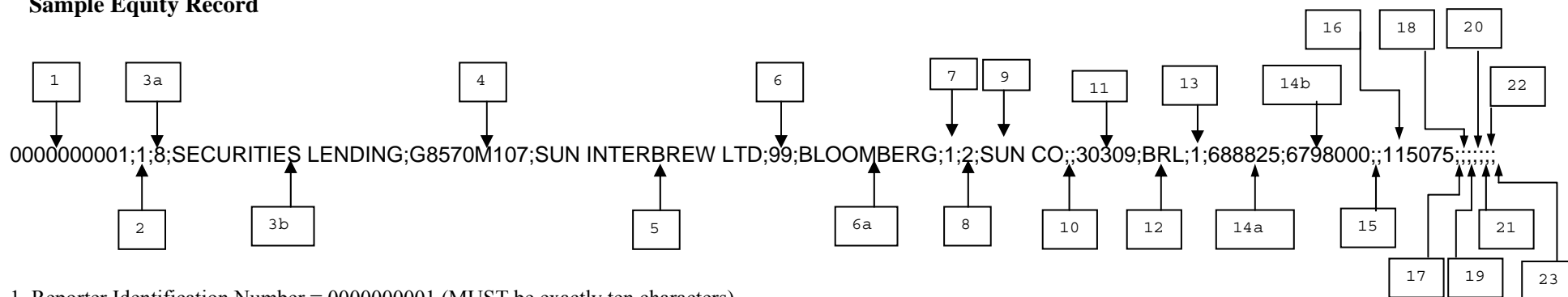

1. Reporter Identification Number = 0000000001 (MUST be exactly ten characters)
2. Sequence Number (can also be of format: 0000001)
- 3a. Reporting Unit (internal code to identify the area within your organization that the data came from)
- 3b. Name of Reporting Unit (can be up to 80 characters in length)
4. Security ID (can be up to 12 characters in length)
5. Security Description (can be up to 80 characters in length)
6. Security ID System (use security ID system codes from Appendix C)
- 6a. Security ID System "Other" (name of the organization or system that assigned the security ID)
7. Security Type (use security types listed on Schedule 2, Page 1)
8. Depository Receipt/Share (refer to Schedule 2, Page 1 for codes)
9. Name of Issuer (can be up to 80 characters in length)
10. Term Indicator – must be null for an equity record
11. Country of Issuer (use country codes listed in Appendix D)
12. Currency of Denomination (use currency codes listed in Appendix F)
13. Ownership Code (refer to Schedule 2, Page 1 for codes)
- 14a. US\$ Fair (Market) Value of Security Held (can be up to 12 characters in length)
- 14b. Fair (Market) Value of Security Held Denominated in the Currency of Issue (can be up to 12 characters in length)
15. Intentionally Left Blank
16. Number of shares held – (can be up to 11 characters in length) **Must have a value greater than zero for an equity record.**
17. Face Value in Currency of Denomination – must be null for an equity record
18. Issue Date – must be null for an equity record
19. Maturity Date – must be null for an equity record
20. Original Face Value in Currency of Denomination – must be null for an equity record
21. Remaining Principal Outstanding in Currency of Denomination – must be null for an equity record
22. Issue Date – must be null for an equity record
23. Maturity Date – must be null for an equity record

Null

Note: Null fields are to be included. They are represented by the inclusion of a delimiter as if a value were present. E.g. - ;desc;;

### Sample Short-term/Long-term Debt Record (excluding Asset-Backed securities)

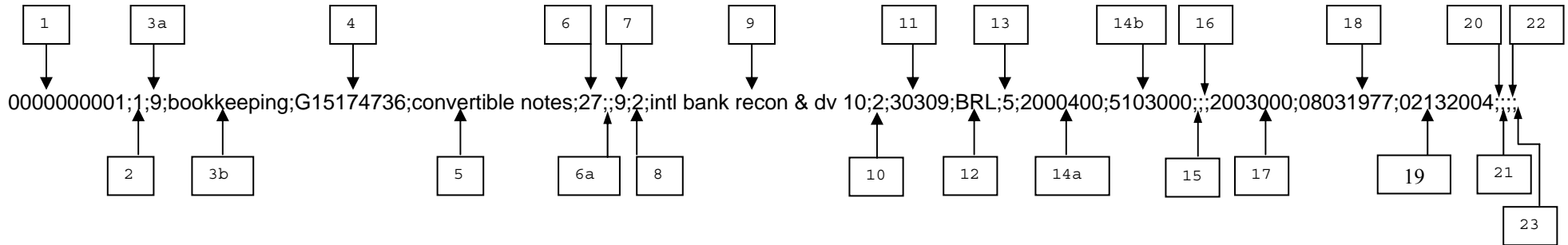

1. Reporter Identification Number = 0000000001 (MUST be exactly ten characters)
2. Sequence Number (can also be of format: 0000001)
- 3a. Reporting Unit (internal code to identify the area within your organization that the data came from)
- 3b. Name of Reporting Unit (can be up to 80 characters in length)
4. Security ID (can be up to 12 characters in length)
5. Security Description (can be up to 80 characters in length)
6. Security ID System (use security ID system codes from Appendix C)
- 6a. Security ID System "Other" (name of the organization or system that assigned the security ID)
7. Security Type (use security types listed on Schedule 2, Page 1)
8. Depository Receipt/Share (refer to Schedule 2, Page 1 for codes)
9. Name of Issuer (can be up to 80 characters in length)
10. Term Indicator (refer to Schedule 2, Page 1 for codes)
11. Country of Issuer (use country codes listed in Appendix D)
12. Currency of Denomination (use currency codes listed in Appendix F)
13. Ownership Code (refer to Schedule 2, Page 1 for codes)
- 14a. US\$ Fair (Market) Value of Security Held (can be up to 12 characters in length)
- 14b. Fair (Market) Value of Security Held Denominated in the Currency of Issue (can be up to 12 characters in length)
15. Intentionally Left Blank
16. Number of shares held – must be null for short-term/long-term debt record (excluding asset-backed securities)
17. Face Value in Currency of Denomination - (can be up to 12 characters in length). **Must have a value greater than zero for a short-term/long-term debt record (excluding asset-backed securities).**
18. Issue Date – MMDDYYYY format (08031977 = August 3, 1977)
19. Maturity Date – MMDDYYYY format (02132004 = February 13, 2004)
20. Original Face Value in Currency of Denomination – must be null for short-term/long-term debt record (excluding asset-backed securities)
21. Remaining Principal Outstanding in Currency of Denomination – must be null for short-term/long-term debt record (excluding asset-backed securities)
22. Issue Date – must be null for short-term/long-term debt record (excluding asset-backed securities)
23. Maturity Date – must be null for short-term/long-term debt record (excluding asset-backed securities)

## Sample Asset-Backed Long-term Debt Record

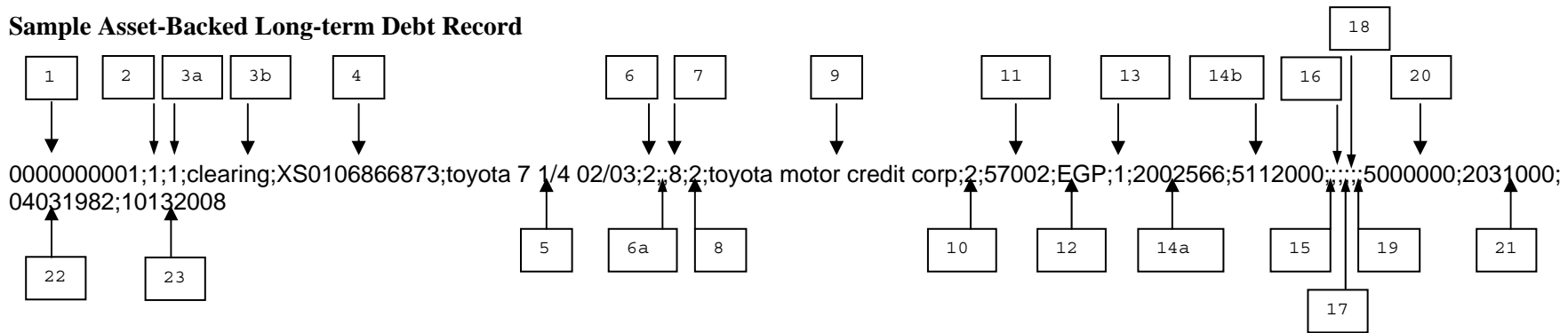

1. Reporter Identification Number = 0000000001 (MUST be exactly ten characters)
2. Sequence Number (can also be of format: 0000001)
- 3a. Reporting Unit (internal code to identify the area within your organization that the data came from)
- 3b. Name of Reporting Unit (can be up to 80 characters in length)
4. Security ID (can be up to 12 characters in length)
5. Security Description (can be up to 80 characters in length)
6. Security ID System (use security ID system codes from Appendix C)
- 6a. Security ID System "Other" (name of the organization or system that assigned the security ID)
7. Security Type (use security types listed on Schedule 2, Page 1)
- 8 Depository Receipt/Share (refer to Schedule 2, Page 1 for codes)
9. Name of Issuer (can be up to 80 characters in length)
10. Term Indicator (refer to Schedule 2, Page 1 for codes)
11. Country of Issuer (use country codes listed in Appendix D)
12. Currency of Denomination (use currency codes listed in Appendix F)
13. Ownership Code (refer to Schedule 2, Page 1 for codes)
- 14a. US\$ Fair (Market) Value of Security Held (can be up to 12 characters in length)
- 14b. Fair (Market) Value of Security Held Denominated in the Currency of Issue (can be up to 12 characters in length)
15. Intentionally Left Blank
16. Number of shares held – must be null for an asset-backed long-term debt record
17. Face Value in Currency of Denomination - must be null for an asset-backed long-term debt record
18. Issue Date – must be null for an asset-backed long-term debt record
19. Maturity Date – must be null for an asset-backed long-term debt record
20. Original Face Value in Currency of Denomination – for ABS debt only (can be up to 12 characters in length). **Must have a value greater than zero for an asset-backed long-term debt record.**
21. Remaining Principal Outstanding in Currency of Denomination – for ABS debt only (can be up to 12 characters in length). **Must have a value greater than zero for an asset-backed long-term debt record.**
22. Issue Date – MMDDYYYY format (04031982 = April 3, 1982)
23. Maturity Date – MMDDYYYY format (10132008 = October 13, 2008)

**Positional Format (Record length = 496 characters)**

<b>Position</b>	<b>Data Field and Instructions</b>	<b>Field Format</b>	<b>Schedule 2 Item Number</b>
1-10	<b>Reporter Identification Number</b>	<b>N10</b>	<b>1</b>
11	Filler (space)	Space	
12-18	<b>Sequence Number (value from 1 - maximum number of records)</b>	<b>N7</b>	<b>2</b>
19	Filler (space)	Space	
20-22	<b>Reporting Unit</b>	<b>N3</b>	<b>3a</b>
23	Filler (space)	Space	
24-103	<b>Name of Reporting Unit</b>	<b>A80</b>	<b>3b</b>
104	Filler (space)	Space	
105-116	<b>Security ID</b>	<b>A12</b>	<b>4</b>
117	Filler (space)	Space	
118-197	<b>Security Description</b>	<b>A80</b>	<b>5</b>
198	Filler (space)	Space	
199-200	<b>Security ID System (Refer to Appendix C)</b>	<b>N2</b>	<b>6</b>
201	Filler (space)	Space	
202-281	<b>Security ID System Description</b>	<b>A80</b>	<b>6a</b>
282	Filler (space)	Space	
283-284	<b>Security Type (Refer to Schedule 2, Page1)</b>	<b>N2</b>	<b>7</b>
285	Filler (space)	Space	
286	<b>Depository Receipt/Share (Refer to Schedule 2, Page1)</b>	<b>N1</b>	<b>8</b>
287	Filler (space)	Space	
288-367	<b>Name of Issuer</b>	<b>A80</b>	<b>9</b>
368	Filler (space)	Space	
369	<b>Term Indicator (Refer to Schedule 2, Page1)</b>	<b>N1</b>	<b>10</b>
370	Filler (space)	Space	
371-375	<b>Country of Issuer (Refer to Appendix D)</b>	<b>N5</b>	<b>11</b>
376	Filler (space)	Space	
377-379	<b>Currency of Denomination (Refer to Appendix F)</b>	<b>A3</b>	<b>12</b>
380	Filler (space)	Space	
381	<b>Ownership Code (Refer to Schedule 2, Page1)</b>	<b>N1</b>	<b>13</b>
382	Filler (space)	Space	
383-394	<b>US\$ Fair (Market) Value of Security Held</b>	<b>N12</b>	<b>14a</b>
395	Filler (space)	Space	
396-407	<b>Fair (Market) Value of Security Held Denominated in the Currency of Issue</b>	<b>N12</b>	<b>14b</b>
408	Filler (space)	Space	
409	<b>Intentionally Left Blank</b>	<b>N1</b>	<b>15</b>
410	Filler (space)	Space	
411-421	<b>Number of Shares Held</b>	<b>N11</b>	<b>16</b>
422	Filler (space)	Space	
423-434	<b>Face Value in Currency of Denomination (non-ABS debt only)</b>	<b>N12</b>	<b>17</b>
435	Filler (space)	Space	

436-443	<b>Issue Date (MMDDYYYY) (non-ABS debt only)</b>	<b>N8</b>	<b>18</b>
444	Filler (space)	Space	
445-452	<b>Maturity Date (MMDDYYYY) (non-ABS debt only)</b>	<b>N8</b>	<b>19</b>
453	Filler (space)	Space	
454-465	<b>Original Face Value in Currency of Denomination (ABS only)</b>	<b>N12</b>	<b>20</b>
466	Filler (space)	Space	
467-478	<b>Remaining Principal Outstanding in Currency of Denomination(ABS only)</b>	<b>N12</b>	<b>21</b>
479	Filler (space)	Space	
480-487	<b>Issue Date (MMDDYYYY) (ABS only)</b>	<b>N8</b>	<b>22</b>
488	Filler (space)	Space	
489-496	<b>Maturity Date (MMDDYYYY) (ABS only)</b>	<b>N8</b>	<b>23</b>

496 character logical records blocked at 60 logical records or a block size of 29,760 bytes.

### Data Specifications

In addition to the instructions in the above table, follow these instructions:

- No special characters should be present in numeric fields (e.g. currency signs, commas, negative signs, slashes, etc.).
- All numeric fields should be unpacked, unsigned, **right** justified with leading zeros, e.g., COBOL PIC 9(12). A format specification of N12 is numeric, with length of up to 12.
- Alphanumeric data should be **left** justified and blank filled, e.g., COBOL PIC X(50). A format specification of A80 is alphanumeric, with length of up to 80.
- Issue Date and Maturity Date fields should be in the format of MMDDYYYY with leading zero for months January-September and for the 1<sup>st</sup> to the 9<sup>th</sup> day of the month (e.g., 01092004 = January 9, 2004)
- The filler should be a space, e.g., in COBOL PIC X value spaces.
- Columns corresponding to null or not applicable items should be space filled



**External Label for Diskette/CD submissions** (affix to media, not to cover)

Company Name

Reporter Identification Number as assigned by the FRBNY

Data Processing Contact Name and Telephone Number

Diskette/CD Identification Number (as identified in your records)

Total Number of Diskette/CD: 1 of \_\_

Creation Date

Contents: Report of U.S. Ownership of Foreign Securities, Including Selected Money Market Instruments  
(SHC(A))

Below are sample equity, short-term/long-term debt (excluding asset-backed securities), and asset-backed debt records for the positional file layout. For purposes of *illustration only*, a darkened circle (●) represents the filler referred to on pages [\[enter pages\]](#) between fields and an open square ( ) represents a field position where information can be entered.

**Equity:**

0000000001•0000001•008•SECURITIES  
 LENDING  
 ●G8570M107 ●SUN INTERBREW LIMITED COMMON ●99•BLOOMBERG ●01  
 STOCK  
 ●2•SUN  
 COMPANYINCORPORATED  
 ●30309•BRL•1•000000688825•000006798000• ●00000115075•  
 ● ● ● ● ● ● ● ●

**Short-term/Long-term Debt Record (excluding Asset-Backed securities):**

0000000001•0000002•009•BOOKKEEPING ●G15174736 ●CONVERTIBLE  
 NOTES  
 ●27●  
 ●09•2•INTERNATIONAL BANK FOR RECONSTRUCTION  
 ANDDEVELOPMENT ●2•30309•BRL•5•000002000400•000005103000●  
 ● ●000002003000•08031977•02132004● ● ● ● ● ● ● ●

**Asset-Backed Long-term Debt Record:**

0000000001•0000003•010•CLEARING•XS0106866873 ●TOYOTA7  
 1/402/03  
 ●02●  
 ●08•2•TOYOTA MOTOR ●2•838  
 CREDITCORPORATION ●000  
 44•EGP•1•000002002566•000005112000● ● ● ● ● ● ● ●  
 005000000•000002031000•04031982•10132008

436-443	<b>Issue Date (MMDDYYYY) (non-ABS debt only)</b>	<b>N8</b>	<b>18</b>
444	Filler (space)	Space	
445-452	<b>Maturity Date (MMDDYYYY) (non-ABS debt only)</b>	<b>N8</b>	<b>19</b>
453	Filler (space)	Space	
454-465	<b>Original Face Value in Currency of Denomination (ABS only)</b>	<b>N12</b>	<b>20</b>
466	Filler (space)	Space	
467-478	<b>Remaining Principal Outstanding in Currency of Denomination(ABS only)</b>	<b>N12</b>	<b>21</b>
479	Filler (space)	Space	
480-487	<b>Issue Date (MMDDYYYY) (ABS only)</b>	<b>N8</b>	<b>22</b>
488	Filler (space)	Space	
489-496	<b>Maturity Date (MMDDYYYY) (ABS only)</b>	<b>N8</b>	<b>23</b>

496 character logical records blocked at 60 logical records or a block size of 29,760 bytes.

### Data Specifications

In addition to the instructions in the above table, follow these instructions:

- No special characters should be present in numeric fields (e.g. currency signs, commas, negative signs, slashes, etc.).
- All numeric fields should be unpacked, unsigned, **right** justified with leading zeros, e.g., COBOL PIC 9(12). A format specification of N12 is numeric, with length of up to 12.
- Alphanumeric data should be **left** justified and blank filled, e.g., COBOL PIC X(50). A format specification of A80 is alphanumeric, with length of up to 80.
- Issue Date and Maturity Date fields should be in the format of MMDDYYYY with leading zero for months January-September and for the 1<sup>st</sup> to the 9<sup>th</sup> day of the month (e.g., 01092004 = January 9, 2004)
- The filler should be a space, e.g., in COBOL PIC X value spaces.
- Columns corresponding to null or not applicable items should be space filled

**External Label for Diskette/CD submissions** (affix to media, not to cover)

Company Name

Reporter Identification Number as assigned by the FRBNY

Data Processing Contact Name and Telephone Number

Diskette/CD Identification Number (as identified in your records)

Total Number of Diskette/CD: 1 of \_\_

Creation Date

Contents: Report of U.S. Ownership of Foreign Securities, Including Selected Money Market Instruments  
(SHC(A))

Below are sample equity, short-term/long-term debt (excluding asset-backed securities), and asset-backed debt records for the positional file layout. For purposes of *illustration only*, a darkened circle (●) represents the filler referred to on pages [\[enter pages\]](#) between fields and an open square ( ) represents a field position where information can be entered.

**Equity:**

0000000001•0000001•008•SECURITIES  
 LENDING  
 ●G8570M107 ●SUN INTERBREW LIMITED COMMON ●99•BLOOMBERG ●01  
 STOCK  
 ●2•SUN  
 COMPANYINCORPORATED  
 ●30309•BRL•1•000000688825•000006798000• ●00000115075•  
 ● ● ● ● ● ● ● ●

**Short-term/Long-term Debt Record (excluding Asset-Backed securities):**

0000000001•0000002•009•BOOKKEEPING ●G15174736 ●CONVERTIBLE  
 NOTES  
 ●27●  
 ●09•2•INTERNATIONAL BANK FOR RECONSTRUCTION  
 ANDDEVELOPMENT ●2•30309•BRL•5•000002000400•000005103000●  
 ● ●000002003000•08031977•02132004● ● ● ● ● ● ● ●

**Asset-Backed Long-term Debt Record:**

0000000001•0000003•010•CLEARING•XS0106866873 ●TOYOTA7  
 1/402/03  
 ●02●  
 ●08•2•TOYOTA MOTOR ●2•838  
 CREDITCORPORATION ●000 ● ● ● ● ● ● ● ●  
 44•EGP•1•000002002566•000005112000● ● ● ● ● ● ● ●  
 005000000•000002031000•04031982•10132008 ●000