

# Division of Laboratory Sciences Laboratory Protocol

**Analytes:** Antimony, Arsenic, Barium, Beryllium, Cadmium, Cesium, Cobalt, Lead, Manganese, Molybdenum, Platinum, Strontium, Thallium, Tin, Tungsten, and Uranium

**Matrix:** Urine

**Method:** Urine Multi-Element ICP-DRC-MS

**Method Code:** 3018 (15 element panel) and 3018A (total arsenic)

**Branch:** Inorganic and Radiation Analytical Toxicology Branch

Prepared By: Jeffery M Jarrett, MS \_\_\_\_\_  
author's name signature date

Supervisor: Kathleen L. Caldwell, PhD \_\_\_\_\_  
supervisor's name signature date

Branch Chief: Robert L Jones PhD \_\_\_\_\_  
Branch Chief signature and date

Adopted: 01 October 1994  
date

Updated: June 2011  
date

Director's Signature Block:

Reviewed:

\_\_\_\_\_  
signature date

\_\_\_\_\_  
signature date

\_\_\_\_\_  
signature date

\_\_\_\_\_  
signature date



## Laboratory Procedure Manual

*Analytes:* **Antimony, Arsenic, Barium, Beryllium, Cadmium, Cesium, Cobalt, Lead, Manganese, Molybdenum, Platinum, Strontium, Thallium, Tin, Tungsten, and Uranium**

*Matrix:* **Urine**

*Method:* **Urine Multi-Element ICP-DRC-MS**  
Renamed from "Inductively Coupled Plasma-Mass Spectrometry (ICP-DRC-MS)"

*Method No:* **3018 (15 element panel) and 3018A (total arsenic)**

*Revised:* **June 13, 2011**

*As performed by:* Inorganic Radionuclides and Toxicology  
Division of Laboratory Sciences  
National Center for Environmental Health

*Contact:* Dr. Kathleen L. Caldwell  
Phone: 770-488-7990  
Fax: 770-488-4097  
Email: [KCaldwell@cdc.gov](mailto:KCaldwell@cdc.gov)

James L. Pirkle, M.D., Ph.D.  
Director, Division of Laboratory Sciences

### **Important Information for Users**

The Centers for Disease Control and Prevention (CDC) periodically refines these laboratory methods. It is the responsibility of the user to contact the person listed on the title page of each write-up before using the analytical method to find out whether any changes have been made and what revisions, if any, have been incorporated.

## Table of Contents

<b>Cross reference to DLS CLIA and Policy and Procedures</b> . . . . .	4
<b>Index of tables and figures</b> . . . . .	5
<b>1) Clinical Relevance &amp; Summary of Test Principle</b>	
a. Clinical Relevance . . . . .	7
b. Test Principle . . . . .	7
<b>2) Limitations of Method; Interfering Substances and Conditions</b>	
a. Interferences Addressed by This Method	
i. Argon Chloride ( $^{40}\text{Ar}^{35}\text{Cl}$ ) on Arsenic ( $^{75}\text{As}$ ) . . . . .	8
ii. Tin ( $^{114}\text{Sn}$ ) and Molybdenum Oxide ( $^{98}\text{Mo}^{16}\text{O}$ ) on Cadmium ( $^{114}\text{Cd}$ ) . .	8
iii. Matrix Enhancement of Arsenic Signal . . . . .	8
b. Limitations of Method (Interferences Remaining in Method)	
i. Calcium Chloride ( $^{40}\text{Ca}^{35}\text{Cl}$ ) on Arsenic ( $^{75}\text{As}$ ) . . . . .	9
<b>3) Procedures for Collecting, Storing, and Handling Specimens; Criteria for Specimen Rejection</b>	
a. Procedures for Collecting, Storing, and Handling Specimens . . . . .	9
b. Criteria for Specimen Rejection . . . . .	9
c. Transfer or Referral of Specimens; Procedures for Specimen Accountability and Tracking . . . . .	10
<b>4) Safety Precautions</b>	
a. General Safety . . . . .	10
b. Radiation Safety . . . . .	11
c. Waste Disposal . . . . .	11
<b>5) Instrument &amp; Material Sources</b>	
a. Sources for ICP-MS Instrumentation . . . . .	12
b. Sources for ICP-MS Parts & Consumables . . . . .	12
c. Sources for ICP-MS Maintenance Equipment & Supplies . . . . .	19
d. Sources for General Laboratory Equipment & Consumables . . . . .	19
e. Sources for Chemicals, Gases, & Regulators . . . . .	21
<b>6) Preparation of Reagents and Materials</b>	
a. Internal Standard Intermediate Mixture . . . . .	24

- b. Diluent and Carrier ..... 24
- c. Base Urine ..... 26
- d. ICP-DRC-MS Rinse Solution ..... 26
- e. Standards and Calibrators
  - i. Multi-element Intermediate Stock Calibration Standard ..... 28
  - ii. Multi-element Intermediate Working Calibration Standards. .... 29
  - iii. Working Multi-element Calibrators ..... 29
  - iv. Multi-element Intermediate Stock Calibration Verification Standard ..... 30
  - v. Multi-element Intermediate Working Calibration Verification Standards .. 31
  - vi. Internal Quality Control Materials (“Bench” QC) ..... 32

**7) Analytical Instrumentation & Parameters**

- a. Instrumentation & Equipment Setup
  - i. ICP-DRC-MS ..... 34
    - 1. Modifications made to ICP-DRC-MS ..... 34
    - 2. Configuration of tubing for liquid handling ..... 35
    - 3. Cones used ..... 36
    - 4. Gases & Regulators setup ..... 36
    - 5. Chiller / Heat Exchanger. .... 37
  - ii. Computer. .... 37
  - iii. Autosampler ..... 37
- b. Parameters for Instrument and Method (see Table 1) ..... 37

**8) Method Procedures**

- a. Quality Control
  - i. Types of Quality Control ..... 37
  - ii. Calibration Verification ..... 38
- b. Daily Analysis of Samples
  - i. Preparation of the Analytical Equipment ..... 40
  - ii. Preparation of Samples for Analysis ..... 42
  - iii. Specimen Storage and Handling During Testing ..... 43
  - iv. Starting the Analysis ..... 43
  - v. Monitoring the Analysis ..... 43

vi. Records of Results . . . . .	45
vii. Transfer of Results to the Laboratory Database . . . . .	45
viii. Analyst Evaluation of Run Results . . . . .	47
ix. Submitting Final Work for Review . . . . .	49
x. Overnight operation (or Any Use of Auto Stop) . . . . .	49
c. Equipment Maintenance	
i. ICP-MS Maintenance . . . . .	50
ii. Data Backup . . . . .	50
<b>9) Interpretation of the Results</b>	
a. Reportable Range . . . . .	50
b. Reference Ranges (Normal Values) . . . . .	51
c. Action Levels . . . . .	51
<b>10) Method Calculations</b>	
a. Method Limit of Detection (LOD) . . . . .	51
b. Method Limit of Quantitation (LOQ) . . . . .	51
c. QC Limits . . . . .	51
<b>11) Alternate Methods for Performing Test and Storing Specimens If Test System Fails . . . . .</b>	<b>51</b>
<b>Appendix A (Ruggedness Test Results) . . . . .</b>	<b>52</b>
<b>Appendix B (Tables) . . . . .</b>	<b>67</b>
<b>References . . . . .</b>	<b>102</b>

**Cross reference to DLS CLIA and Policy and Procedures policy**

1. Summary of Test Principle and Clinical Relevance  
**1.a, 1.b**
2. Safety Precautions  
**4**
3. Computerization; Data System Management  
**7.a.ii, 8.b.vi, 8.b.vii, 8.b.vix, 8.c.ii**
4. Specimen Collection, Storage, and Handling Procedures; Criteria for Specimen Rejection  
**3**
5. Procedures for Microscopic Examinations; Criteria for Rejection of Inadequately Prepared Slides  
**- As no microscope used in this process there are no procedures for microscopic examinations; and as no slides are prepared for this analysis there is no criteria for rejection of inadequately prepared slides**
6. Preparation of Reagents, Calibrators (Standards), Controls, and All Other Materials; Equipment and Instrumentation  
**5, 6, 7, 8**
7. Calibration and Calibration Verification Procedures  
**8.a.ii**
8. Procedure Operating Instructions; Calculations; Interpretation of Results  
**8, 9**
9. Reportable Range of Results  
**9.a**
10. Quality Control (QC) Procedures  
**8.a.i, 8.b.viii, 10.c**
11. Remedial Action If Calibration or QC Systems Fail to Meet Acceptable Criteria  
**8.b.viii**
12. Limitations of Method; Interfering Substances and Conditions  
**2**
13. Reference Ranges (Normal Values)  
**9.b**
14. Critical Call Results ("Panic Values")  
**9.c**
15. Specimen Storage and Handling During Testing  
**8.b.iii**
16. Alternate Methods for Performing Test or Storing Specimens If Test System Fails  
**11**
17. Test Result Reporting System; Protocol for Reporting Critical Calls (If Applicable)  
**8.b.vi, 8.b.vii, 8.b.ix, 9.c.**
18. Transfer or Referral of Specimens; Procedures for Specimen Accountability and Tracking  
**3.c**
19. References

**List of Tables**

**Table 1.** Instrument and Method Parameters . . . . . 67

**Table 2.** Suggested maximum analyte concentrations for base urine . . . . . 73

**Table 3.** Concentrations of Analytes in the Multi-Element Intermediate Stock  
Standard from High Purity Standards . . . . . 74

**Table 4.** Preparation of Multi-element Intermediate Working Standards . . . . . 75

**Table 5.** Acceptable ways to perform two consecutive analytical runs, bracketing  
with bench quality control samples . . . . . 76

**Table 6.** A typical SAMPLE/BATCH window . . . . . 77

**Table 7.** Preparation of Multi-element Intermediate Working Standards . . . . . 78

**Table 8.** Range of Reporting and Calibration Verification Requirements . . . . . 79

**Table 9.** Boundary Concentrations for Urine Concentrations ( $\mu\text{L}$ ) . . . . . 80

**Table 10.** Reference Ranges for Urine Concentrations (from the Third National  
Report on Exposure to Environmental Chemicals). All results in  $\mu\text{g/L}$  . . . 81

**Table 11.** References to Total Urine Arsenic Concentrations . . . . . 82

### List of Figures

<b>Figure 1.</b>	Configuration of tubing and devices for liquid handling	
a.	ESI SC4 Autosampler . . . . .	84
<b>Figure 2.</b>	ELAN ICP-DRC-MS Method Screen Shots (12 element panel)	
a.	Timing Page . . . . .	85
b.	Processing Page. . . . .	86
c.	Equations Page. . . . .	87
d.	Calibration Page. . . . .	88
e.	Sampling Page. . . . .	89
f.	Report Page. . . . .	90
<b>Figure 3.</b>	ELAN ICP-DRC-MS Method Screen Shots (12 element panel)	
a.	Timing Page . . . . .	91
b.	Processing Page. . . . .	92
c.	Equations Page. . . . .	93
d.	Calibration Page. . . . .	94
e.	Sampling Page. . . . .	95
f.	Report Page. . . . .	96
<b>Figure 4.</b>	Appendix B (cont)	
a.	ESI SC4 Autosampler Screen Shots used (Main page) . . . . .	97
b.	ESI SC4 Autosampler Screen Shots used (“Configure” page) . . . . .	98
c.	ESI SC4 Autosampler Screen Shots used (“Communication” page)	98
d.	ESI SC4 Autosampler Screen Shots (“FAST” page) *As only* . . . . .	99
e.	ESI SC4 Autosampler Screen Shots (5x12 Rack Setup window) . . . . .	100
f.	ESI SC4 Autosampler Screen Shots (50mL Tube Rack Setup) . . . . .	100
g.	ESI SC4 Autosampler Screen Shots (Rinse Station Rack Setup) . . . . .	101



## 1) Clinical Relevance & Summary of Test Principle

### a. Clinical Relevance:

This method is used to achieve rapid and accurate quantification of fifteen elements of toxicological and nutritional interest including Antimony (Sb), Arsenic (As), Barium (Ba), Beryllium (Be), Cadmium (Cd), Cesium (Cs), Cobalt (Co), Lead (Pb), Manganese (Mn), Molybdenum (Mo), Platinum (Pt), Strontium (Sr), Thallium (Tl), Tin (Sn), Tungsten (W), and Uranium (U). The method may be used to screen urine when people are suspected to be acutely exposed to these elements or to evaluate chronic environmental or other non-occupational exposure. [1-4].

### b. Test Principle:

Inductively coupled plasma dynamic reaction cell mass spectrometry (ICP-DRC-MS) is a multi-element analytical technique capable of trace level elemental analysis [1-4]. This ICP-DRC-MS method is used to measure either arsenic, a 15 element panel (Antimony, Barium, Beryllium, Cadmium, Cesium, Cobalt, Lead, Manganese, Molybdenum, Platinum, Strontium, Thallium, Tin, Tungsten, and Uranium), or any subgroup of the 15 element panel.

Liquid samples are introduced into the ICP through a nebulizer and spray chamber carried by a flowing argon stream. By coupling radio-frequency power into flowing argon, plasma is created in which the predominant species are positive argon ions and electrons and has a temperature of 6000-8000 K. The sample passes through a region of the plasma and the thermal energy atomizes the sample and then ionizes the atoms. The ions, along with the argon, enter the mass spectrometer through an interface that separates the ICP (at atmospheric pressure, ~760 torr) from the mass spectrometer (operating at a pressure of  $10^{-5}$  torr). The ions pass through a focusing region, the dynamic reaction cell, the quadrupole mass filter, and finally are counted in rapid sequence at the detector allowing individual isotopes of an element to be determined. The dynamic reaction cell operates in one of two modes. In 'standard' mode the cell is not pressurized and ions pass through the cell to the quadrupole mass filter unaffected. In 'DRC' mode the cell is pressurized with a gas which will collide or react with the incoming ions to either eliminate an interfering ion or change the ion of interest to a new mass which is free from interference. In this method the instrument is operated in DRC mode when analyzing for cadmium, manganese and arsenic, but in standard mode when analyzing for all of the other analytes. For arsenic, the reaction cell is pressurized with a mixture of hydrogen (10%) and argon (90%) which causes the breakup of the  $^{40}\text{Ar}^{35}\text{Cl}^+$  ion which would otherwise interfere with detection of  $^{75}\text{As}$  at  $m/z$  75. When analyzing for cadmium, the reaction cell is pressurized with oxygen. The  $^{98}\text{Mo}^{16}\text{O}^+$  ions which would normally interfere with detection of  $^{114}\text{Cd}$  at  $m/z$  114 react with the oxygen in the cell creating  $^{98}\text{Mo}^{16}\text{O}_2^+$  and  $^{98}\text{Mo}^{16}\text{O}_3^+$  at masses which no longer represent an interference to  $^{114}\text{Cd}$  analysis. The DRC is also pressurized with

oxygen gas when analyzing for  $^{55}\text{Mn}$ . The  $^{39}\text{K}^{16}\text{O}^+$  ions which would normally interfere with the detection of  $^{55}\text{Mn}$  at  $m/z$  55 react with the oxygen in the cell and no longer represent interference to  $^{55}\text{Mn}$  analysis. Electrical signals resulting from the detection of ions are processed into digital information that is used to indicate first the intensity of the ions and then the concentration of the element. This method was originally based on the method by Mulligan et al. [5]. The DRC portions of the method are based on work published by Tanner et al. [2, 3]. Urine samples are diluted 1+ 9 with 2% (v/v) concentrated nitric acid (and 1.5% ethanol in the case of arsenic). The diluent for the 15 element panel contains iridium (Ir), rhodium (Rh) for multi-internal standardization. The diluent for arsenic contains gallium (Ga) for internal standardization. Nitric acid is used for the purpose of solubilizing and stabilizing metals in solution. Internal standards are a constant concentration in all blanks, calibrators and samples. Monitoring the instrument signal ratio of a metal to its internal standard allows correction for instrument noise and drift, and sample-to-sample matrix differences. Ethanol is used in the case of arsenic for the purpose of providing a constant amount of signal enhancement (carbon effect) across all blanks, calibrators, and samples.

## 2) Limitations of Method; Interfering Substances and Conditions

### a. Interferences Addressed by This Method

i. Breakup of Argon Chloride ( $^{40}\text{Ar}^{35}\text{Cl}$ ) Interference on Arsenic ( $^{75}\text{As}$ ) Using DRC: The dynamic reaction cell of the ELAN ICP-DRC-MS is used in this method to break apart the argon chloride ( $^{40}\text{Ar}^{35}\text{Cl}$ ) interference on arsenic at  $m/z$  75 [6] which is common to urine analysis by ICP-MS (see Section 1.b for an explanation of this process).

ii. Correction & Elimination of Interferences ( $^{114}\text{Sn}$ ,  $^{98}\text{Mo}^{16}\text{O}$ ) on Cadmium ( $^{114}\text{Cd}$ ).

1. Mathematical Correction for Tin ( $^{114}\text{Sn}$ ) Interference:

The correction equation ( $-0.026826 * \text{Sn}118$ ) is used in the "Equations" tab of the method to correct the counts observed as  $m/z$  114 to exclude counts due to  $^{114}\text{Sn}$ .

2. Elimination of Molybdenum Oxide ( $^{98}\text{Mo}^{16}\text{O}$ ) Interference Using DRC:

The dynamic reaction cell of the ELAN ICP-DRC-MS is used in this method to eliminate interference from molybdenum oxide ( $^{98}\text{Mo}^{16}\text{O}$ ) onto cadmium at  $m/z$  114 [7]. See Section 1.b for an explanation of this process.

iii. Elimination of interference ( $^{39}\text{K}^{16}\text{O}$ ) on manganese  $^{55}\text{Mn}$  using DRC:

The dynamic reaction cell of the ELAN ICP-DRC-MS is used in this method to reduce the potassium oxide ( $^{39}\text{K}^{16}\text{O}$ ) interference on manganese at  $m/z$  55. See section 1.b for an explanation of this process.

iv. Matrix Enhancement of Arsenic Signal:

Matrix induced signal enhancement in ICP-MS analysis from carbon on arsenic has been previously reported in the literature [8, 9]. When arsenic is being determined by this method, ethanol (1.5% v/v) is added in the diluent and rinse solutions to “normalize” the arsenic signal enhancement in all blanks, calibrators, and samples.

b. Limitations of Method (Interferences Remaining in Method)

i. Calcium Chloride ( $^{40}\text{Ca}^{35}\text{Cl}$ ) Interference on Arsenic ( $^{75}\text{As}$ ):

It has been determined that a small interference remains at m/z 75 when the urine matrix contains **both** high chloride **and** high calcium levels [6]. Even at extreme calcium and chloride levels, this interference is has not been found to be significant (approximately 0.4  $\mu\text{g/L}$ ).

ii. Gallium Oxide ( $^{71}\text{Ga}^{17}\text{O}$ ) Interference on Strontium ( $^{88}\text{Sr}$ ):

Arsenic only analysis requires Ga to be used as the internal standard and is added to the diluent at a concentration of 10  $\mu\text{g/L}$  (see section 6.c for the preparation of diluent). Gallium should not be added to the diluent (for the purpose of being used as an internal standard for As) when strontium is measured (15 element panel) due to the formation of  $^{71}\text{Ga}^{17}\text{O}^+$ , which occurs at the same m/z as  $^{88}\text{Sr}^+$ . A 5  $\mu\text{g/L}$  solution of Ga in 2%  $\text{HNO}_3$  resulted in a background equivalent concentration (BEC) of 50  $\text{ng/L}$  for  $^{88}\text{Sr}$ . Based on these results, the expected increase in  $^{88}\text{Sr}$  concentration in a diluted urine sample is 1  $\mu\text{g/L}$ .

**3) Procedures for Collecting, Storing, and Handling Specimens; Criteria for Specimen Rejection; Specimen Accountability and Tracking**

- a. Procedures for Collecting, Storing, and Handling Specimens: Specimen handling conditions, special requirements, and procedures for collection and transport are discussed in the division (DLS) Policies and Procedures Manual [10]. Copies are available in branch, laboratory, and special activities specimen-handling offices. An electronic copy is available at:

[http://intranet.nceh.cdc.gov/dls/pdf/policiesprocedures/Policy\\_and\\_Procedures\\_Manual.DLS.2002mod.pdf](http://intranet.nceh.cdc.gov/dls/pdf/policiesprocedures/Policy_and_Procedures_Manual.DLS.2002mod.pdf). In general,

- i. No fasting or special diets are required before collection of urine.
- ii. Use sterile, lot screened collectors for specimen acquisition.
- iii. Urine specimens should be transported frozen (packed in dry ice during shipment is preferred when possible).
- iv. Once received, store long term at  $\leq -20^\circ\text{C}$  until time for analysis. Short-term storage at  $2\text{-}4^\circ\text{C}$  is acceptable. Refreeze at  $\leq -20^\circ\text{C}$  portions of the sample

that remain after analytical aliquots are withdrawn. Thawing and refreezing samples has not been found to compromise sample results.

- v. Acceptable containers for analytical aliquots include lot screened polypropylene (PP) cryovials or tubes (i.e. 5 mL cryogenic vial or 15mL centrifuge tube).
- b. Criteria for Specimen Rejection: Specimen characteristics that may compromise test results are indicated above. Reasons for rejection of a sample for analysis include
  - i. Low volume: Optimal amount of urine is 1.8+ mL. The volume of urine used for one analysis is 0.5 mL.
  - ii. Contamination: Improper collection procedures or collection devices can contaminate the urine by contact with dust, dirt, etc.

In all cases, request a second urine specimen.

- c. Transfer or Referral of Specimens; Procedures for Specimen Accountability and Tracking: Location, status, and final disposition of the specimens will be tracked at least by paper document in the "Study Folder" (created before analysts receive the samples). Apart from this specimen tracking form, this folder will also contain the paper print outs of results from analysis of the specimens. Maintain records for a minimum of 3 years. Use only numerical identifiers for samples within the laboratory (e.g., case ID numbers) in order to safeguard confidentiality. Only the medical supervisor (MS) or project coordinator (PC) i.e. non CDC personnel should have access to the personal identifiers.

#### 4) Safety Precautions

- a. General Safety
  - i. Observe all safety regulations as detailed in the Division (DLS) Safety Manual. Additional information can be found in your lab's chemical hygiene plan.
  - ii. Observe Universal Precautions when working with urine.
  - iii. Wear appropriate gloves, lab coat, and safety glasses while handling all solutions. Consult the laboratory chemical hygiene plan.
  - iv. Exercise special care when handling and dispensing concentrated nitric acid. Add acid to water. Nitric acid is a caustic chemical that is capable of causing severe eye and skin damage. ***If nitric acid comes in contact with any part of the body, quickly wash the affected area with copious quantities of water for at least 15 minutes.***

- v. Use secondary containment for containers of biological or corrosive liquids.
  - vi. The use of the foot pedal on the Micromedic Digiflex™ is recommended because it reduces analyst contact with work surfaces that have been in contact urine and also keeps the analyst's hands free to hold the specimen cups and autosampler tubes and to wipe off the tip of Micromedic Digiflex™.
  - vii. Training will be given before operating the ICP-DRC-MS, as there are many possible hazards including ultraviolet radiation, high voltages, radio-frequency radiation, and high temperatures. This information is also detailed in the PerkinElmer ELAN® ICP-DRC-MS System Safety Manual.
  - viii. Use flash arrestors on oxygen and argon / hydrogen gas cylinders and properly secure gas cylinders with safety harnesses.
  - ix. Wipe down all work surfaces at the end of the day with bleach-rite spray or freshly prepared 10% (v/v) sodium-hypochlorite solution.
- b. Radiation Safety: All personnel performing this method must successfully meet requirements of a CDC-OHS radiation worker (RW) due to the use of natural uranium in this method and observe all necessary radiation safety considerations indicated in the CDC Radiation Safety Manual [11].
- c. Waste Disposal: Operators of this method should take the CDC-OHS Hazardous Chemical Waste Management Course (initial and yearly refreshers).
- i. Waste to be Placed Into Biohazard Autoclave Bags & Pans:
    1. All biological samples and diluted specimens (after analysis run).
    2. All disposable plastic and paper which contact urine (autosampler tubes, gloves, etc.).
    3. Used non-glass/quartz ICP-MS consumables (i.e. probes, tubing, cones, ion lenses).
  - ii. Waste to be Placed Into Sharps Containers: Pipette Tips, broken glass or quartz instrument consumables (broken spray chambers, torches, nebulizers, etc. . .). Large broken glass which will not fit in the sharps container should be placed in a separate autoclave pan from other waste and labeled as "broken glass" (see the "Autoclaving" section of the CDC safety policies and practices manual located in the laboratory).
  - iii. Liquid Waste

1. Waste discarded down sink: Only liquid waste from the ICP-DRC-MS instrument can be discarded at the sink. Flush the sink with copious amounts of water.
2. Waste to be Picked up by the Radiation Safety Office: Contact the laboratory radiation inventory person and the CDC Radiation Safety Office for disposal of any single element uranium standard, intermediate stock standard, or intermediate working standard solutions.
3. Waste to be Picked up by Hazardous Waste Program: Submit request for hazardous waste removal of all other liquid waste.

## 5) Instrument & Material Sources

### a. Sources for ICP-MS Instrumentation

- i. ICP-MS: Inductively Coupled Plasma Dynamic Reaction Cell Mass Spectrometer (ELAN<sup>®</sup> 6100 DRC<sup>Plus</sup> or ELAN<sup>®</sup> DRC II) (PerkinElmer Norwalk, CT, [www.perkinelmer.com](http://www.perkinelmer.com)).
1. DXi-FAST upgrade: Standard peristaltic pump replaced by DXi\_FAST micro-peristaltic pump / FAST actuator and valve combination unit. For ELAN DRCII, part # DXI-54-P4-F6.
- ii. Recirculating chiller / heat exchanger for ICP-MS: Refrigerated chiller (PolyScience 6105PE for ELAN<sup>®</sup> 6100 DRC<sup>Plus</sup> instruments) or heat exchanger (PolyScience 3370 for ELAN<sup>®</sup> DRC II instruments) (PerkinElmer Norwalk, CT, [www.perkinelmer.com](http://www.perkinelmer.com)).
- iii. Autosampler: ESI SC-4 autosampler (Elemental Scientific Inc., Omaha, NE) or equivalent.
- iv. FAST Sample Introduction System (Elemental Scientific Inc., Omaha, NE).
  1. FAST controller
  2. FAST actuator: CTFE high-flow valve head like part number SC-0599-1210 (part number includes lines and probes).

### b. Sources for ICP-MS Parts & Consumables

NOTE: The minimum number of spares recommended before reordering (if owning one instrument) are listed as “# Spares =” in the descriptions below.

- i. Adapter, PEEK: Securely connects 1.6mm O.D. PFA tubing to 0.03” I.D. peristaltic tubing. Composed of three PEEK parts.

1. Female nut for 1.6mm O.D. (1/16") tubing. Like part P-420 (Upchurch Scientific, Oak Harbor, WA, [www.upchurch.com](http://www.upchurch.com)).
  2. PEEK ferrule. Like part P-260x (10pk SuperFlangeless ferrule, Upchurch Scientific, Oak Harbor, WA, [www.upchurch.com](http://www.upchurch.com)).
  3. Conical Adapter Body. Like part P-692 (Upchurch Scientific, Oak Harbor, WA, [www.upchurch.com](http://www.upchurch.com)).
- ii. Bottles (for rinse solution): Four liter screw-cap polypropylene container with 2 luer connections (like catalog# SC-0305-1, Elemental Scientific Inc., Omaha, NE., [www.elementalscientific.com](http://www.elementalscientific.com)).
  - iii. Carboy and cap assembly for waste collection: 10-15 L, polypropylene widemouth carboy (100 mm neck size) with handles and no spigot (Like part #7BE-25126, Lab Safety Supply, Janesville, WI, [www.lss.com](http://www.lss.com)) with cap assembly like part # N0690271 (PerkinElmer, Norwalk, CT, [www.perkinelmer.com](http://www.perkinelmer.com)).
  - iv. Coolant, for Polyscience chiller or heat exchanger: Only PerkinElmer part # WE01-6558 (PerkinElmer Norwalk, CT, [www.perkinelmer.com](http://www.perkinelmer.com)) is approved for use by PerkinElmer. # Spares = 6.
  - v. Cone, sampler (nickel/platinum): PerkinElmer part # WE021140/WE027802 (PerkinElmer Norwalk, CT, [www.perkinelmer.com](http://www.perkinelmer.com)). Part # SC2011-Ni (Testing has also found Spectron, Ventura, CA, [www.spectronus.com](http://www.spectronus.com) cones to be comparable). # Spares = 4.
  - vi. Cone, skimmer (nickel/platinum): PerkinElmer part # WE021137/WE027803 (PerkinElmer Norwalk, CT, [www.perkinelmer.com](http://www.perkinelmer.com)). Part # SC2012-Ni (Testing has also found Spectron, Ventura, CA, [www.spectronus.com](http://www.spectronus.com) cones to be comparable) # Spares = 4.
  - vii. Connector (for tubing): Use to connect 1/8" I.D. PVC tubing to 0.125" I.D peristaltic pump tubing. Use part # 3140715 (PerkinElmer Norwalk, CT, [www.perkinelmer.com](http://www.perkinelmer.com)) or equivalent. # Spares = 4.
  - viii. Detector, electron multiplier: Like part # N8125001 (PerkinElmer Norwalk, CT, [www.perkinelmer.com](http://www.perkinelmer.com)). Available direct from manufacturer (part # 14210, SGE Incorporated, Austin, Texas, <http://www.etpsci.com>) or various distributors. # Spares = 1.
  - ix. FAST accessories
    1. Valve: CTFE High-flow valve head for SC-FAST (uses ¼-28 fittings). Like part # SC-0599-1010 (Elemental Scientific Inc., Omaha, NE., [www.elementalscientific.com](http://www.elementalscientific.com)).
    2. Stator: CTFE Stator for 6 port SC-FAST high flow valve (¼-28 fittings). Like part # SC-0599-1010-01 (Elemental Scientific Inc., Omaha, NE., [www.elementalscientific.com](http://www.elementalscientific.com)).
    3. Rotor: Composite rotor for 6 port SC-FAST high flow valve (¼-28 fittings). Like part # SC-0599-1010-05 (Elemental Scientific Inc., Omaha, NE., [www.elementalscientific.com](http://www.elementalscientific.com)).

4. Sample Loop:
  - a. Multielement analysis: 3 mL Teflon, white connector-nuts for high flow valve head. Like part # SC-0315-30 (Elemental Scientific Inc., Omaha, NE., [www.elementalscientific.com](http://www.elementalscientific.com)).
  - b. Arsenic only analysis: Default volume is 1.5mL Teflon sample loop with white nut connectors for high flow valve head of FAST sample introduction system. This volume loop can be created by cutting 25% off the length of a 2mL Teflon sample loop was cut to the 1.5mL length. Like part # SC-0315-20 (Elemental Scientific Inc., Omaha, NE., [www.elementalscientific.com](http://www.elementalscientific.com)). Volumes larger than 1.5mL can be used, but will require longer loop fill (ESI software) and sample flush (ELAN software) times, and proportionally larger volumes used in sample preparation (Table 7 in the Appendix).
5. Probe, Autosampler: Teflon, carbon fiber support, 0.8mm i.d., blue marker, 1/4-28 fittings. Like part number SC-5037-3751 (Elemental Scientific Inc., Omaha, NE., [www.elementalscientific.com](http://www.elementalscientific.com)). # Spares = 2.
6. Probe, Carrier Solution: Teflon, carbon fiber support, 0.5mm i.d., orange marker, 1/4-28 fittings. Like part number SC-5037-3501 (Elemental Scientific Inc., Omaha, NE., [www.elementalscientific.com](http://www.elementalscientific.com)). # Spares = 2.
7. Tubing, FAST vacuum: Vacuum line for SC-FAST high flow valve, connects to port #6, black nut for connection to valve head, natural brown color nut on other end for connection to SC autosampler vacuum port. Like part # SC-0321 (Elemental Scientific Inc., Omaha, NE., [www.elementalscientific.com](http://www.elementalscientific.com)).
8. Tubing, connects nebulizer to valve: See “Nebulizer, PolyPro-ST micro flow”
- x. Hose, for connection to chiller: Push on hose. I.D. = 1/2”, O.D. = 3/4”. Use part # PB-8 (per inch, Georgia Valve and Fitting, Atlanta, GA, [www.swagelok.com](http://www.swagelok.com)) or equivalent. Do not normally need spare hose (unless moving instrument into a new location).
- xi. Hose, for exhaust of ELAN: Available as part of ELAN installation kit from Perkin Elmer (PerkinElmer Norwalk, CT, [www.perkinelmer.com](http://www.perkinelmer.com)). Available direct from manufacturer as part # S-LP-10 air connector (Thermafex, Abbeville, SC, [www.thermafex.net](http://www.thermafex.net)). Equivalent part may be substituted. # Spares = 10 feet of 4” diameter and 10 feet of 6” diameter hose.
- xii. Injector, quartz with ball joint: I.D. = 2.0 mm. PerkinElmer part # WE023948 (PerkinElmer Norwalk, CT, [www.perkinelmer.com](http://www.perkinelmer.com)). Available direct from manufacturer as part # 400-30 (Precision Glass Blowing, Centennial, CO, [www.precisionglassblowing.com](http://www.precisionglassblowing.com)) or from various distributors. # Spares = 2.
- xiii. Injector support (for pass-through injector): PerkinElmer part # WE023951 (PerkinElmer Norwalk, CT, [www.perkinelmer.com](http://www.perkinelmer.com)). Available direct from manufacturer as part # 400-37 (Precision Glass Blowing, Centennial, CO, [www.precisionglassblowing.com](http://www.precisionglassblowing.com)) or from various distributors. # Spares = 2.



- xiv. Ion Lens: PerkinElmer part # WE018034 (PerkinElmer Norwalk, CT, [www.perkinelmer.com](http://www.perkinelmer.com)). # Spares = 3.
- xv. Nebulizer: PolyPro-ST micro flow polypropylene nebulizer with external 1/4-28 threaded connector for liquid delivery, low pressure version or equivalent. Like part # ES-4040-7010 (Elemental Scientific Inc., Omaha, NE., [www.elementalscientific.com](http://www.elementalscientific.com)). # Spares = 1. Different nebulizers may be used, however, the nebulizer gas flow rate, sample flush time, read delay time, loop fill time, loop size, urine sample dilution preparation volume, and sample-to-sample carry-over must be evaluated and optimized.
1. Gas connection:
    - a. Teflon tubing: 4mm o.d., 2.4mm i.d. Teflon tubing (like part # ES-2502, Elemental Scientific Inc., Omaha, NE., [www.elementalscientific.com](http://www.elementalscientific.com)). # Spares = 1.
    - b. Adapter kit: Plastic adapters to connect Teflon tubing (2.4mm i.d) to 1/4" male Swagelok (compression) port on ICP-DRC-MS. Parts can be obtained as components in a "gas fittings kit for microflow nebulizer", kit part # ES-2501-1000, Elemental Scientific Inc., Omaha, NE., [www.elementalscientific.com](http://www.elementalscientific.com)). # Spares = 1.
  2. Liquid connection: Connects nebulizer to port #3 of high flow FAST valve head with green, 1/4- 28 fitting. Like part # SC-0317-0250 (Elemental Scientific Inc., Omaha, NE., [www.elementalscientific.com](http://www.elementalscientific.com)). # Spares = 2.
- xvi. Nut: (for flanged connections of 1.59mm (1/16") o.d. PFA tubing) Flanged, for 1/16" o.d. tubing, 1/4-28 threads. Use part # P-406x (pkg. of 10, Upchurch Scientific, Oak Harbor, WA, [www.upchurch.com](http://www.upchurch.com)) or equivalent. Use a Teflon-coated Viton o-ring with this nut instead of the stainless steel washer that comes with part # P-406x). # Spares = 10.
- xvii. Nut and Ferrule set, 1/8" Swagelok: Such as part # SS-200-NFSET (stainless steel) or part # B-200-NFSET (brass) (Georgia Valve and Fitting, Atlanta, GA, [www.swagelok.com](http://www.swagelok.com)) or equivalent. For part numbers listed here a quantity of 1 means 1 nut, 1 front ferrule, and 1 back ferrule. Spares = 20.
- xviii. Nut and Ferrule set, 1/4" Swagelok: Such as part # SS-400-NFSET (stainless steel) or part # B-400-NFSET (brass) (Georgia Valve and Fitting, Atlanta, GA, [www.swagelok.com](http://www.swagelok.com)) or equivalent. For part numbers listed here a quantity of 1 means 1 nut, 1 front ferrule, and 1 back ferrule. Spares = 20.
- xix. Oil, Welch Directorr Gold: For roughing pumps. Available direct from manufacturer as part # 8995G-15 (1 gallon, Welch Rietschle Thomas, Skokie, IL, [www.welchvacuum.com](http://www.welchvacuum.com)) or from various distributors. Equivalent oil may be substituted. # Spares = 4.
- xx. O-ring: (for sampler cone) PerkinElmer part # N8120511 (pkg. of 5, PerkinElmer, Shelton, CT, [www.perkinelmer.com](http://www.perkinelmer.com)) or equivalent. # Spares = 20 o-rings.

- xxi. O-ring: (for skimmer cone) PerkinElmer part # N8120512 (pkg. of 5, PerkinElmer, Shelton, CT, [www.perkinelmer.com](http://www.perkinelmer.com)) or equivalent. # Spares = 20 o-rings.
- xxii. O-ring: (for flanged connections of 1.59mm (1/16") o.d. PFA tubing) Teflon-coated Viton o-ring, i.d. = 1/16", thickness = 1/16", o.d. = 3/16". Such as part # V75-003 (O-rings West, Seattle, WA, [www.oringswest.com](http://www.oringswest.com)) or equivalent. # Spares = 20.
- xxiii. O-ring: (for injector support).
1. Internal o-rings: ID = 1/4", OD = 3/8", thickness = 1/16". Need 2 o-rings per injector support setup. PerkinElmer part # N8122008 (PerkinElmer, Shelton, CT, [www.perkinelmer.com](http://www.perkinelmer.com)) or equivalent (such as part # V75-010, O-rings West, Seattle, WA, [www.oringswest.com](http://www.oringswest.com)). # Spares = 20.
  2. External o-rings: ID = 3/8", OD = 1/2", thickness = 1/16". Need 2 o-rings for each injector support setup. PerkinElmer part # N8122009 (PerkinElmer, Shelton, CT, [www.perkinelmer.com](http://www.perkinelmer.com)) or equivalent (such as part # V75-012, O-rings West, Seattle, WA, [www.oringswest.com](http://www.oringswest.com)). # Spares = 20.
- xxiv. O-ring: (for inside spray chamber at nebulizer port) Such as part # 120-56 (Precision Glass Blowing, Centennial, CO, [www.precisionglassblowing.com](http://www.precisionglassblowing.com)). Additional o-rings can sometimes be obtained free of charge or at reduced price when acquired while purchasing spray chambers. # Spares = 20.
- xxv. O-ring: (for inside of torch mount): Part # WE017284 (PerkinElmer, Shelton, CT, [www.perkinelmer.com](http://www.perkinelmer.com)). Do not substitute. The PerkinElmer o-ring is specially metal impregnated to minimize RF leakage through the torch mount. # Spares = 2.
- xxvi. Photon Stop: PerkinElmer part # WE018278 (PerkinElmer, Shelton, CT, [www.perkinelmer.com](http://www.perkinelmer.com)). # Spares = 1.
- xxvii. Plugs, Quick Change for Roughing Pump Oil: These plugs will only work on the Varian roughing pumps which come standard on ELAN DRC II ICPMS instruments. These plugs will not fit the Leybold pumps which come standard on the ELAN DRC Plus instruments. Part # W1011013 (PerkinElmer, Shelton, CT, [www.perkinelmer.com](http://www.perkinelmer.com)). No spares typically needed.
- xxviii. Probes
1. for ESI autosampler: Teflon, carbon fiber support, 0.8mm i.d., blue marker, 1/4-28 fittings. Like part number SC-5037-3751 (Elemental Scientific Inc., Omaha, NE., [www.elementalscientific.com](http://www.elementalscientific.com)). # Spares = 2.
  2. for carrier solution of FAST sample introduction system: Teflon, carbon fiber support, 0.5mm i.d., orange marker, 1/4-28 fittings. Like part number SC-5037-3501 (Elemental Scientific Inc., Omaha, NE., [www.elementalscientific.com](http://www.elementalscientific.com)). # Spares = 2.
- xxix. RF coil. PerkinElmer part # WE02-1816 (PerkinElmer, Shelton, CT, [www.perkinelmer.com](http://www.perkinelmer.com)) or equivalent. # Spares = 2.

- xxx. Screw, for Torch Mount: PerkinElmer part # WE011870. (PerkinElmer, Shelton, CT, [www.perkinelmer.com](http://www.perkinelmer.com)) or equivalent. # Spares = 3.
- xxxii. Spray chamber, quartz concentric: PerkinElmer part # WE025221 (PerkinElmer, Shelton, CT, [www.perkinelmer.com](http://www.perkinelmer.com)) or equivalent. Available direct from manufacturer as part # 400-20 (Precision Glass Blowing, Centennial, CO, [www.precisionglassblowing.com](http://www.precisionglassblowing.com)) or from various distributors. # Spares = 2.
- xxxiii. Torch, quartz: PerkinElmer part # N812-2006 (PerkinElmer, Shelton, CT, [www.perkinelmer.com](http://www.perkinelmer.com)) or equivalent. Available direct from manufacturer as part # 400-10 (Precision Glass Blowing, Centennial, CO, [www.precisionglassblowing.com](http://www.precisionglassblowing.com)) or various distributors. Damaged torches can often be repaired for substantially lower cost than purchasing a new one by companies such as Wilmad LabGlass (Buena, NJ, [www.wilmad-labglass.com](http://www.wilmad-labglass.com)) or Precision Glass Blowing (Centennial, CO, [www.precisionglassblowing.com](http://www.precisionglassblowing.com)). # New Spares = 2.
- xxxiv. Tubing and adapter, for SC autosampler rinse station drain: Tygon tubing and adapter to attach to back of SC autosampler for draining rinse station waste (like part # SC-0303-002, Elemental Scientific Inc., Omaha, NE., [www.elementalscientific.com](http://www.elementalscientific.com)).
- xxxv. Tubing and adapters, for SC autosampler rinse station filling: Teflon tubing and adapters (to attach to back of SC autosampler for filling rinse stations and to attach to rinse containers). Like part # SC-0302-0500, Elemental Scientific Inc., Omaha, NE., [www.elementalscientific.com](http://www.elementalscientific.com)).
- xxxvi. Tubing and nut, for FAST carrier solution: 0.5mm i.d. Teflon tubing (orange marker) with red ¼-28 male nut. Connects to high flow FAST valve head, port #2. Like part # SC-0316-0500 (Elemental Scientific Inc., Omaha, NE., [www.elementalscientific.com](http://www.elementalscientific.com)).
- xxxvii. Tubing, FAST vacuum: Vacuum line for SC-FAST high flow valve, connects to port #6, black nut for connection to valve head, natural brown color nut on other end for connection to SC autosampler vacuum port. Like part # SC-0321 (Elemental Scientific Inc., Omaha, NE., [www.elementalscientific.com](http://www.elementalscientific.com)).
- xxxviii. Tubing, main argon delivery to instrument: I.D. = 1/8", O.D. = ¼". Such as part # C-06500-02 (pkg. of 100ft, polypropylene, Fisher Scientific International, Hampton, NH, [www.fishersci.com](http://www.fishersci.com)) or equivalent. # Spares = 50ft.
- xxxix. Tubing, PFA: I.D. = 0.5mm, O.D. = 1.59mm (1/16"). Used to transfer liquid between rinse solution jug and peristaltic pump tubing  
The Perfluoroalkoxy (PFA) copolymer is a form of Teflon<sup>®</sup>. Such as part # 1548 (20ft length, Upchurch Scientific, Oak Harbor, WA, [www.upchurch.com](http://www.upchurch.com)) or equivalent. # Spares = 20ft.
- xl. Tubing, peristaltic, 0.045" i.d. (rinse station feed): Standard PVC, 2-stop (red / red) peristaltic pump tubing, i.d. = 0.045". PerkinElmer part # N0680375, (PerkinElmer, Shelton, CT, [www.perkinelmer.com](http://www.perkinelmer.com)) or equivalent. # Spares = 6 packs of 12 tubes.

- xl. Tubing, peristaltic, 0.03" i.d. (carrier solution for ESI autosampler): use either
1. Standard PVC, 2-stop (black / black) peristaltic pump tubing, i.d. = 0.03". PerkinElmer part # 09908587 (PerkinElmer, Shelton, CT, [www.perkinelmer.com](http://www.perkinelmer.com)) or equivalent. # Spares = 6 packs of 12 tubes.
  2. Standard PVC, 3-stop (black/ black/black) peristaltic pump tubing, i.d. 0.76 mm. Spectron part # SC0056 (Spectron, Ventura, CA, [www.spectronus.com](http://www.spectronus.com)) or equivalent. #Spares = 6 packs of 12 tubes. Use this type of tubing with ESI DXi micro-peristaltic pump.
- xli. Tubing, peristaltic, 0.125" i.d. (spray chamber drain): use either
1. Standard PVC, 2-stop (black / white) peristaltic pump tubing, i.d. = 0.125" or equivalent. PerkinElmer part # N812-2012 (PerkinElmer, Shelton, CT, [www.perkinelmer.com](http://www.perkinelmer.com)) or equivalent. # Spares = 6 packs of 12 tubes.
  2. Standard Santoprene, 3-stop (grey/ grey/ grey) peristaltic pump tubing, i.d. 1.30 mm. Spectron part # SC0311 (Spectron, Ventura, CA, [www.spectronus.com](http://www.spectronus.com)) or equivalent. #Spares = 6 packs of 12 tubes. Use this type of tubing with ESI DXi micro-peristaltic pump.
- xlii. Tubing, PVC, i.d. = 1/8", o.d. = 3/16". May be used to transfer liquid
1. between spray chamber waste port and peristaltic pump
  2. between peristaltic pump and liquid waste jug
- Like part # 14-169-7A (pkg. of 50ft, Fisher Scientific International, Hampton, NH, [www.fishersci.com](http://www.fishersci.com)) or equivalent. # Spares = 20ft.
- xliii. Tubing, Stainless Steel, o.d. = 1/8", wall thickness = 0.028": Used to connect DRC gas cylinders to ELAN DRC gas ports. Also used to replace plastic tubing in the DRC gas path within the ELAN. Like part # SS-T2-S-028-20 (20ft, Georgia Valve and Fitting, Atlanta, GA, [www.swagelok.com](http://www.swagelok.com)) or equivalent. Spares = 20ft.
- xliv. Tubing, Teflon, corrugated, 1/4" o.d.: Connects to the auxiliary and plasma gas side-arms of the torch. Part # WE015903 (PerkinElmer, Shelton, CT, [www.perkinelmer.com](http://www.perkinelmer.com)). # Spares = 2.
- xlv. Tubing, vinyl (argon delivery to nebulizer): Vinyl Tubing, 1/8" ID x 1/4" OD. Like part # EW-06405-02 (Cole Parmer, Vernon Hills, Illinois, [www.coleparmer.com](http://www.coleparmer.com)) or equivalent. Equivalent tubing material may be substituted. # Spares = 10ft.
- xlvi. Union Elbow, PTFE 1/4" Swagelok: Connects argon tubing to torch auxiliary gas sidearm on bayonet mount ELAN ICPMS instruments. Like part # T-400-9 (Georgia Valve and Fitting, Atlanta, GA, [www.swagelok.com](http://www.swagelok.com)) or equivalent. Spares = 2.
- xlvii. Union Tee, PTFE, 1/4" Swagelok: Connects argon tubing to torch plasma gas sidearm and holds igniter inside torch sidearm on bayonet mount ELAN ICPMS instruments. Like part # T-400-3 (Georgia Valve and Fitting, Atlanta, GA, [www.swagelok.com](http://www.swagelok.com)) or equivalent. Spares = 2.

c. Sources for ICP-MS Maintenance Equipment & Supplies

- i. Anemometer: Like digital wind-vane anemometer (Model 840032, SPER Scientific LTD., Scottsdale, AZ, [www.sperscientific.com](http://www.sperscientific.com)) or equivalent. Use to verify adequate exhaust ventilation for ICP-MS (check with hoses fully disconnected).
- ii. Pan, for changing roughing pump oil: Like part # 53216 (United States Plastics Corporation, Lima, OH, [www.usplastic.com](http://www.usplastic.com)) or equivalent. # On hand = 1.
- iii. Container, to hold acid baths for glassware: Polypropylene or polyethylene containers with lids (must be large enough for torch, injector, or spray chamber submersion). May be purchased from laboratory or home kitchen supply companies. # On hand = 4.
- iv. Cotton swabs: Any vendor. For cleaning of cones and glassware.
- v. Cutter (for 1/8" o.d. metal tubing): Terry tool with 3 replacement wheels. Like part # TT-1008 (Chrom Tech, Inc., Saint Paul, MN, [www.chromtech.com](http://www.chromtech.com)) or equivalent.
- vi. Getter Regeneration Kit: Part # WE023257 (PerkinElmer, Shelton, CT, [www.perkinelmer.com](http://www.perkinelmer.com)). Use this as needed (at least annually) to clean the getter in the pathway of channel A DRC gas.
- vii. Magnifying glass: Any 10x + pocket loupe for inspection of cones and other ICP-MS parts. Plastic body is preferred for non-corrosion characteristics. Like part # 5BC-42813 (Lab Safety Supply, Janesville, WI, [www.labsafety.com](http://www.labsafety.com)).
- viii. Screw Driver, for Ion Lens Removal: Screw driver with long, flexible shaft, and 2mm ball-Allen end for removal of ion lens screws (if lens is not in quick-release mount), part # W1010620. Extra 2mm bits, part # W1010598 (PerkinElmer, Shelton, CT, [www.perkinelmer.com](http://www.perkinelmer.com)).
- ix. Toothbrush: Any vendor. For cleaning ion lens and glassware.
- x. Ultrasonic bath: Like ULTRASONIK™ Benchtop Cleaners (NEYTECH, Bloomfield, CT, [www.neytech.com](http://www.neytech.com)) or equivalent.

d. Sources for General Laboratory Consumable Supplies

- i. Bar Code Scanner: Like Code Reader 2.0 (Code Corporation, Draper, UT, [www.codecorp.com](http://www.codecorp.com)) or equivalent. For scanning sample IDs during analysis setup. Any bar code scanner capable of reading Code 128 encoding at a 3 mil label density can be substituted.
- ii. Carboy (for preparation of urine quality control pool and waste jug for ICPMS sample introduction system): Polypropylene 10-L carboy (like catalog # 02-960-20C, Fisher Scientific, Pittsburgh, PA, [www.fishersci.com](http://www.fishersci.com)) or equivalent. Carboys with spouts are not advised due to potential for leaking.
- iii. Containers for diluent and Rinse Solution: Two liter Teflon™ containers (like catalog# 02-923-30E, Fisher Scientific, Pittsburgh, PA., [www.fishersci.com](http://www.fishersci.com)) and 4L polypropylene jugs (like catalog# 02-960-10A, Fisher Scientific,

- Pittsburgh, PA, [www.fishersci.com](http://www.fishersci.com)) have both been used. Acid rinse before use. Equivalent containers may be substituted.
- iv. Cups for urine collection: Like polypropylene 4.5 oz cup, catalog # 354013 (Becton Dickinson Labware, Franklin Lakes, NJ, [www.bd.com](http://www.bd.com)) or equivalent. Each lot of cups used must be lot screened (tested to be free of trace metal contamination). Clear plastics tend to have lowest trace metal contamination.
  - v. Gloves: Powder-free, low particulate nitrile (like Best CleaN-DEX™ 100% nitrile gloves, any vendor). Equivalent nitrile or latex gloves may be substituted.
  - vi. Paper towels: For general lab use, any low-lint paper wipes such as KIMWIPES®EX-L Delicate Task Wipers or KAYDRY®EX-L Delicate Task Wipers (Kimberly-Clark Professional, Atlanta, GA, [www.kcprofessional.com](http://www.kcprofessional.com)). For sensitive applications in cleanrooms, a wipe designed for cleanroom use may be desired such as the Econowipe or Wetwipe (Liberty, East Berlin, CT, [www.liberty-ind.com](http://www.liberty-ind.com)).
  - vii. Pipette (for preparation of urine dilutions to be analyzed): Micromedic Digiflex-CX Automatic™ pipette equipped with 10.0-mL dispensing syringe, 2 mL sampling syringe, 0.75-mm tip, and foot pedal (Titertek, Huntsville, AL, <http://www.titertek.com/>).
  - viii. Pipettes (for preparation of intermediate stock working standards & other reagents): Like Brinkmann Research Pro Electronic pipettes (Brinkmann Instruments, Inc., Westbury, NY, <http://www.brinkmann.com/home/>). 5-100 µL (catalog #4860 000.070), 20-300 µL (catalog #4860 000.089), 50-1000 µL (catalog #4860 000.097), 100-5000 µL (catalog #4860 000.100). Note: pipette catalog numbers are without individual chargers. Can purchase individual chargers (pipette catalog numbers will differ) or a charging stand that will hold four pipettes (catalog #4860 000.860). When purchasing pipette tips (epTips), purchase one or more boxes, then “reloads” for those boxes after that: 5-100 µL (box catalog # 22 49 133-4, reload catalog # 22 49 153-9), 20-300 µL (box catalog # 22 49 134-2, reload catalog # 22 49 154-7), 50-1000 µL (box catalog # 22 49 135-1, reload catalog # 22 49 155-5), 100-5000 µL (box catalog # 22 49 138-5, reload catalog # 22 49 198-9, bulk bag catalog # 22 49 208-0). Equivalent pipettes and tips can be substituted.
  - ix. Tubes for sample analysis (for autosampler): Like polypropylene 15-mL conical tubes, BD Falcon model #352097 (Becton Dickinson Labware, Franklin Lakes, NJ, [www.bd.com](http://www.bd.com)). Equivalent tubes may be substituted which are shown by lot screening to be free of trace metal contamination. Clear plastics tend to have lowest trace metal contamination. Blue colored caps have also been used successfully for this method.
  - x. Tubes for storage of intermediate working stock standards: Like polypropylene 50-mL conical tubes, BD Falcon model #352098 (Becton Dickinson Labware, Franklin Lakes, NJ, [www.bd.com](http://www.bd.com)). For use in storage of intermediate working stock standards. Equivalent tubes may be substituted which are shown by lot screening to be free of trace metal contamination. Clear plastics tend to have

lowest trace metal contamination. Blue colored caps have also been used successfully for this method.

- xi. Vortexer: Like MV-1 Mini Vortexer (VWR, West Chester, PA, [www.vwr.com](http://www.vwr.com)). Used for vortexing urine specimens before removing an aliquot for analysis. Equivalent item can be substituted.
- xii. Water purification system: Like NANOpure Diamond Ultrapure Water System (Barnstead International, Dubuque, Iowa, [www.barnstead.com](http://www.barnstead.com)). For ultra-pure water used in reagent and dilution preparations. An equivalent water purification unit capable of producing  $\geq 18$  Mega-ohm-cm water may be substituted.

e. Sources of Chemicals, Gases, and Regulators

- i. Acid, Hydrochloric acid: Veritas™ double-distilled grade, 30-35% (GFS Chemicals Inc. Columbus, OH, [www.gfschemicals.com](http://www.gfschemicals.com)). This is referred to as “concentrated” hydrochloric acid in this method write-up. For use in preparation of intermediate working stock standards. An equivalent hydrochloric acid product may be substituted, but it must meet or exceed the purity specifications of this product for trace metals content.
- ii. Acid, Nitric acid: Veritas™ double-distilled grade, 68-70% (GFS Chemicals Inc. Columbus, OH, [www.gfschemicals.com](http://www.gfschemicals.com)). For use in diluent, rinse solution, intermediate working stock standards, and QC pool preparations. This is referred to as “concentrated” nitric acid in this method write-up. An equivalent nitric acid product may be substituted, but it must meet or exceed the purity specifications of this product for trace metals content.
- iii. Ethanol (EtOH): USP dehydrated 200 proof (Pharmco Products, Inc.) or equivalent.
- iv. Argon Gas (for plasma & nebulizer) and Regulator: High purity argon (>99.999% purity, Specialty Gases Southeast, Atlanta, GA, [www.sgsgas.com](http://www.sgsgas.com)) for torch and nebulizer. Minimum tank source is a dewar of liquid argon (180-250L). Bulk tank (1500<sup>+</sup>L is preferred).
  - 1. Regulator for argon (at dewar): Stainless steel, single stage, specially cleaned regulator with 3000 psig max inlet, 0-100 outlet pressure range, CGA 580 cylinder connector, and needle valve shutoff on delivery side terminating in a ¼” Swagelok connector. Part number KPRAFPP415A2AG10 (Georgia Valve and Fitting, Atlanta, GA, [www.swagelok.com](http://www.swagelok.com)). An equivalent regulator from an alternate vendor may be substituted. # Spares = 1.
  - 2. Regulator for argon (between bulk tank and PerkinElmer filter regulator): Single Stage 316SS Regulator, with 0-300 psi Inlet Gauge, 0-200 psi Outlet Gauge, Outlet Spring Range, 0-250 psi, ¼” Swagelok Inlet Connection, ¼ turn Shut off Valve on Outlet with ¼” Swagelok Connection and Teflon Seals. Part number KPR1GRF412A20000-AR1 (Georgia Valve

- and Fitting, Atlanta, GA, [www.swagelok.com](http://www.swagelok.com)). An equivalent regulator from an alternate vendor may be substituted. # Spares = 1.
3. Regulator for argon (PerkinElmer filter regulator on back of ELAN): Argon regulator filter kit. Catalog number N812-0508 (PerkinElmer, Shelton, CT, [www.perkinelmer.com](http://www.perkinelmer.com)).
- v. Argon / hydrogen: Argon (90%) / hydrogen (10%) for DRC channel A. Initial purity of argon = 99.9997+% (“Research grade 5.7”). Initial purity of hydrogen = 99.9999+% (“Research Grade 6.0”). Mixture is typically purchased in cylinder size 35 (6”x24”) (Airgas South, Atlanta, GA, [www.airgas.com](http://www.airgas.com)).
1. Regulator for argon / hydrogen: Stainless steel, two stage, specially cleaned regulator with 3000 psig max inlet, 0-25 outlet pressure range, CGA 350 cylinder connector, and needle valve shutoff on delivery side terminating in a ¼” Swagelok connector. Like part number KCYADPF412A2AD10 (Georgia Valve and Fitting, Atlanta, GA, [www.swagelok.com](http://www.swagelok.com)). An equivalent regulator from an alternate vendor may be substituted. # Spares = 1.
  2. Flash Arrestor (Stainless steel): Like part # 6104 (Matheson Tri Gas, Montgomeryville, PA, [www.mathesontrigas.com](http://www.mathesontrigas.com)) or equivalent.
- vi. Disinfectant, for work surfaces: Bleach-rite spray (any distributor). On-site dilutions of bleach (1part bleach + 9 parts water) may be substituted, but must be re-made daily.
- vii. Oxygen: Oxygen (“Research Grade Research Grade 5.0”, 99.9999% purity) for DRC channel B. Typically purchased in cylinder size 300 (9.5” x 54”) (Airgas South, Atlanta, GA, [www.airgas.com](http://www.airgas.com)).
1. Regulator for oxygen: High purity brass body with monel trim, two stage regulator. Stainless steel is not used for this application due to safety concerns of working with oxygen at high pressure [12]. For one regulator, order the following parts, and ask that they be tested and assembled (Engineered Specialty Products, Kennesaw, GA, [www.espgauges.com](http://www.espgauges.com)).
    - a. Tescom part # 44-3410S24-555  
*Regulator body*: Brass bar stock, two stage, Monel trim, TFE seats, Elgiloy diaphragms, Cv=0.05, 3000 psig max inlet, 1-25 psig outlet range, 1/4 FNPT inlet / outlet / gauge ports, O<sub>2</sub> cleaned to ASTM G93 and CGA4.1.
    - b. Tescom part # 60500-3000N  
*Inlet pressure gauge*: 2” diameter, 0-3000 psig range , O<sub>2</sub> cleaned, ¼” MNPT bottom, brass.
    - c. Tescom part # 60500-0015N  
*Delivery pressure gauge*: 2” diameter, 0-15 psig range , O<sub>2</sub> cleaned, ¼” MNPT bottom, brass.
    - d. Tescom part # 63842-540-B



*NPT to CGA Adaptor:* ¼" NPT to CGA 540 adaptor, brass.

e. Swagelok part # B-200-1-4:

*Adaptor:* Brass male connector, ¼" MNPT to 1/8" Swagelok (Georgia Valve and Fitting, Atlanta, GA, [www.swagelok.com](http://www.swagelok.com)).

An equivalent regulator from an alternate vendor may be substituted.

# Spares = 1.

2. Flash Arrestor (brass): Like part # 6103 (Matheson Tri Gas, Montgomeryville, PA, [www.mathesontrigas.com](http://www.mathesontrigas.com)) or equivalent.
- viii. Standard, Gallium: Like 1,000 mg/L, item # PLGA2-2Y. (SPEX Industries, Inc., Edison, NJ, [www.spexcsp.com](http://www.spexcsp.com)). Used as an internal standard in diluent. Any vendor whose standards are traceable to the National Institute for Standards and Technology may be substituted. The standard must have low trace metal contamination. Gallium is only used in the diluent for the measurement of arsenic (As).
- ix. Standard, Iridium: Like 1,000 mg/L iridium, item # PLIR3-2Y (SPEX Industries, Inc., Edison, NJ, [www.spexcsp.com](http://www.spexcsp.com)). Used as an internal standard in diluent. Any vendor whose standards are traceable to the National Institute for Standards and Technology may be substituted. The standard must have low trace metal contamination.
- x. Standard, Multi-element intermediate stock standard: Item number SM-2107-003 (High Purity Standards, Charleston, SC, <http://www.hps.net/>). This is a custom mix solution (see Table 3 in Appendix B for concentrations). This solution is diluted to prepare the intermediate stock working standards, which are in turn diluted to prepare the working calibrators. This solution can be prepared in-house from NIST traceable single element stock solutions if necessary.
- xi. Standard, Rhodium: Like 1,000 mg/L, item # PLRH3-2Y. (SPEX Industries, Inc., Edison, NJ, [www.spexcsp.com](http://www.spexcsp.com)). Used as an internal standard in diluent. Any vendor whose standards are traceable to the National Institute for Standards and Technology may be substituted. The standard must have low trace metal contamination.
- xii. Standard, single element stock standards for preparation of urine quality control pools: National Institute of Standards and Technology (NIST) Standard Reference Materials (SRMs) 3103a (As), 3105a (Be), 3113 (Co), 3134 (Mo), 3108 (Cd), 3102a (Sb), 3111a (Cs), 3104a (Ba), 3163 (W), 3128 (Pb), 3140 (Pt), 3158 (Tl), and 3164 (U) (National Institute of Standards and Technology (NIST), Office of Standard Reference Materials, Gaithersburg, MD, [www.nist.gov](http://www.nist.gov)). Other sources of standards can be used if they are NIST traceable.
- xiii. Triton X-100™ surfactant: Like "Baker Analyzed" TritonX-100™ (J.T. Baker Chemical Co., [www.jtbaker.com](http://www.jtbaker.com)). Another source may be substituted, but it must be free of trace-metal contamination.

## 6) Preparation of Reagent and Materials.

### a. Internal Standard Intermediate Mixture

i. For Urine 15 Element (Ir and Rh): Preparation of single intermediate solution containing all internal standards will simplify the addition of the internal standards into the final diluent solution. This solution can be purchased rather than prepared. To prepare 200 mL of the Intermediate internal standard solution:

1. Partially fill a 200 mL acid-washed volumetric flask (PP, PMP, or Teflon™) with  $\geq 18$  Mega-ohm-cm water (approximately 100-150 mL).
2. Carefully add 4 mL of double-distilled, concentrated nitric acid. Mix into solution.
3. Add 0.8 mL of 10,000 ug/mL Rh standard. If initial Rh standard concentration is different, adjust volume proportionally.
4. Add 0.8 mL of 10,000 ug/mL Ir standard. If initial Ir standard concentration is different, adjust volume proportionally.
5. Fill to mark (200mL) and mix thoroughly.
6. Label should include "Internal Standard Intermediate Mixture. 40 ug/mL Rh, Ir, and. 2% (v/v) HNO<sub>3</sub>", "Store at room temperature", preparation date, expiration date 1 year from preparation date, and preparer's initials.

ii. For Arsenic (Ga): Dilution of a Ga standard to be used as an internal standard in the final diluents solution. This solution can be purchased rather than prepared. To prepare 200 mL of the Intermediate internal standard solution:

1. Partially fill a 200 mL acid-washed volumetric flask (PP, PMP, or Teflon™) with  $\geq 18$  Mega-ohm-cm water (approximately 100-150 mL).
2. Carefully add 4 mL of double-distilled, concentrated nitric acid. Mix into solution.
3. Add 0.8 mL of 10,000 ug/mL Ga standard. If initial Ga standard concentration is different, adjust volume proportionally.
4. Fill to mark (200mL) and mix thoroughly.
5. Label should include "Internal Standard Intermediate Mixture. 40 ug/mL Ga, 2% (v/v) HNO<sub>3</sub>", "Store at room temperature", preparation date, expiration date 1 year from preparation date, and preparer's initials.

### b. Diluent and Carrier

i. Purpose: All samples (blanks, calibrators, QC, or patient samples) are combined with the diluent during the sample preparation step before analysis. This is where the internal standards are added which during the analysis will compensate for instrumental variations on the analyte signal. If using the FAST sample introduction system, the diluent is also used as the carrier solution.

ii. Preparation:

1. Diluent Preparation for 15 element method (*not including arsenic*) – NO ETHANOL

- a. Contents: An aqueous solution of 10 microgram/L Rh, Ir, and in 2% (v/v) double-distilled nitric acid.
- b. Preparation (4L) & storage: This solution does not have to be made up in a volumetric flask. The important thing about the concentration of the internal standards is that they be consistent within all samples in one run. To prepare different volumes of diluent, add proportionally larger or smaller volumes of the solution constituents.
  - i. Acid-rinse a 4 L container (material may be polypropylene (PP), polymethylpentene (PMP), or Teflon™).
  - ii. Partially fill the 4 L container with  $\geq 18$  megaohm-cm water.
  - iii. Carefully add 80 mL double-distilled, concentrated nitric acid and mix.
  - iv. Add 1 mL of the 40 ug/mL Rh, Ir, internal standard solution. If other concentrations are used, the volume added should be adjusted proportionally.
  - v. Make up to volume (4 L) with  $\geq 18$  megaohm-cm water.
  - vi. Store at room temperature and prepare as needed.
  - vii. Label should include “10  $\mu\text{g/L}$  Rh, and Ir,” “2% (v/v)  $\text{HNO}_3$ ”, “Store at room temperature”, preparation date, expiration date (1 year from prep), and preparer’s initials.

2. Diluent Preparation *for urine arsenic* method – CONTAINS ETHANOL

- a. Contents: An aqueous solution of 10 microgram/L Ga in 2% (v/v) double-distilled nitric acid and 1.5% (v/v) ethanol.
- b. Preparation (4L) & storage: This solution does not have to be made up in a volumetric flask. The important thing about the concentration of the internal standards is that they be consistent within all samples in one run. To prepare different volumes of diluent, add proportionally larger or smaller volumes of the solution constituents.
  - i. Acid-rinse a 4 L container (material may be polypropylene (PP), polymethylpentene (PMP), or Teflon™).
  - ii. Partially fill the 4 L container with  $\geq 18$  megaohm-cm water.
  - iii. Carefully add 80 mL double-distilled, concentrated nitric acid and mix.
  - iv. Carefully add 60 mL dehydrated 200 proof ethanol and mix.

- v. Add 1 mL of the 40 ug/mL Ga internal standard solution. If other concentrations are used, the volume added should be adjusted proportionally.
- vi. Make up to volume (4 L) with  $\geq 18$  megaohm-cm water.
- vii. Store at room temperature and prepare as needed.
- viii. Label should include "10  $\mu\text{g/L}$  Ga", "2% (v/v)  $\text{HNO}_3$ ", "1.5% (v/v) Ethanol", "Store at room temperature", preparation date, expiration date (1 year from prep), and preparer's initials.

c. Base Urine

- i. Purpose: This urine pool material will be mixed with the intermediate working calibrators just prior to analysis to matrix-match the calibration curve to the urine matrix of the unknown samples.
- ii. Contents: A mixture of multiple urine sources collected from anonymous donors are used to approximate an average urine matrix.
- iii. Preparation & Storage:
  1. Collect urine anonymously by placing screened containers and collection cups in the restrooms with a sign stating the reason the specimens are being collected, the name of the investigator to contact for additional information, and requesting that people provide a urine specimen (complete details can be found in CDC protocol #3994, ProTrack # DLSITN0313).
  2. Once the urine is collected from donors, it should be analyzed to ensure that concentrations of the analytes in this method are relatively low, so as to not interfere with the proper measurement of calibrators (see Table 2 in Appendix B for suggested maximum base urine concentrations).
  3. Once screened, mix the urine collections together in a larger container (i.e. acid washed polypropylene (PP), polymethylpentene (PMP), or Teflon™) and stir for 30+ minutes on a large stir plate (acid wash large Teflon™ stir bar before use).
  4. For short term storage, store at 2-4°C. For long-term storage, dispense into smaller-volume tubes (i.e., 50-mL acid-washed or lot screened polypropylene tubes) and store at  $\leq -20^\circ\text{C}$ .
  5. Labels on 50mL tubes should include "Base Urine for Multi-element Method", "Store Long Term at  $20^\circ\text{C}$ ", "Store Short Term at 2 -4° C", preparation date, expiration date 3 years from prep date, and preparer's initials.

d. ICP-DRC-MS Rinse Solution

- i. Purpose: Pump this solution into the sample introduction system between samples to prevent carry-over of the analytes of interest from one sample measurement to the next.
- ii. Preparation:

1. Intermediate Triton X-100 Solution: To avoid the process of dissolving pure Triton X-100 on a daily basis, prepare an intermediate 2% Triton X-100™ / 5% (v/v) double-distilled, nitric-acid solution for daily use.
  - a. To prepare 2L of Intermediate Triton X-100 Solution:
    - i. Partially fill a 2 L acid-washed bottle (PP, PMP, or Teflon™) with  $\geq 18$  Mega-ohm-cm water (approximately 1-1.5 L). Use of volumetric flask is not required.
    - ii. Add 20 mL of Triton X-100™ and stir until completely dissolved. Use a Teflon™ stir bar and stir plate if necessary (acid wash stir bar before use).
    - iii. Carefully add 100 mL of double-distilled, concentrated nitric acid.
    - iv. Fill to 2 L and stir thoroughly.
    - v. Label should include “2% Triton X-100™ / 5% (v/v) HNO<sub>3</sub>”, “Store at room temperature”, preparation date, expiration date 1 year from preparation date, and preparer’s initials.
2. Rinse Solution Preparation for 15 element method (*not including arsenic*) – NO ETHANOL
  - a. Contents: A 0.002% Triton X-100™, 5% (v/v) double-distilled nitric acid solution.
  - b. Preparation & Storage: To Prepare 4 L of the Final Rinse Solution,
    - i. Partially fill a 4 L acid-washed bottle (PP, PMP, or Teflon™ ) with  $\geq 18$  Mega-ohm-cm water (approximately 2-3 L). Use of volumetric flask is not required.
    - ii. Add 4 mL of the 2% Triton X-100™ / 5% (v/v) double-distilled, nitric-acid intermediate stock solution and mix well.
    - iii. Carefully add 200 mL of double distilled concentrated nitric acid and mix well.
    - iv. Fill to 4 L using  $\geq 18$  Megaohm-cm water.
    - v. Store at room temperature and prepare as needed. To prepare volumes other than specified here, add proportionally larger or smaller volumes of the solution constituents.
    - vi. Label should include “0.002% Triton X-100™ / 5% (v/v) HNO<sub>3</sub>”, “Store at room temperature”, preparation date, expiration date one year from preparation date, and preparer’s initials.
3. Rinse Solution Preparation for arsenic method – INCLUDES ETHANOL
  - a. Contents: A 0.002% Triton X-100™, 5% (v/v) double-distilled nitric acid solution and 1.5% (v/v) ethanol.
  - b. Preparation & Storage: To Prepare 4 L of the Final Rinse Solution,

- i. Partially fill a 4 L acid-washed bottle (PP, PMP, or Teflon™ ) with  $\geq 18$  Mega-ohm-cm water (approximately 2-3 L). Use of volumetric flask is not required.
- ii. Add 4 mL of the 2% Triton X-100™ / 5% (v/v) double-distilled, nitric-acid intermediate stock solution and mix well.
- iii. Carefully add 200 mL of double distilled concentrated nitric acid and mix well.
- iv. Carefully add 60 mL dehydrated 200 proof ethanol and mix well.
- v. Fill to 4 L using  $\geq 18$  Megaohm-cm water.
- vi. Store at room temperature and prepare as needed. To prepare volumes other than specified here, add proportionally larger or smaller volumes of the solution constituents.
- vii. Label should include "0.002% Triton X-100™ / 5% (v/v) HNO<sub>3</sub>, 1.5% (v/v) ethanol", "Store at room temperature", preparation date, expiration date one year from preparation date, and preparer's initials.

e. Standards and Calibrators

i. Multi-element Intermediate Stock Calibration Standard

1. Purpose: This master solution will be diluted to prepare five intermediate working calibrators.
2. Contents: An aqueous solution containing all 16 elements of interest (15 element panel analytes, arsenic, and elements for future R&D (see certificate of analysis), but does not include the internal standards). Concentrations are listed in Table 3 of the Appendix. Matrix is 2% (v/v) HNO<sub>3</sub> and 1% (v/v) HCl with traces of HF in  $\geq 18$  Mega-ohm-cm water.
3. Preparation (Purchase) & Storage:
  - a. Purchasing from vendors: Either purchased as a NIST-traceable custom mixture, or prepared in-house.

Current vendor & preparation process: Currently purchased from High Purity Standards (Charleston, SC, part number SM-2107-003).
  - b. In-house Preparation: Standard may be made in the lab from NIST-traceable single element standards.
  - c. Storage: Store at room temperature. Label with additional information such as "store at room temperature", date received, date opened, and initials of person to first open.

ii. Multi-element Intermediate Working Calibration Standards

1. Purpose: Use each day of analysis to prepare the final five working calibrators that will be placed on the autosampler.
2. Content: Five aqueous dilutions of the multi-element intermediate stock calibration standard solution in 2% (v/v) double-distilled nitric acid and 1% (v/v) hydrochloric acid. Final concentrations are listed in Table 4 of the Appendix.
3. Preparation & Storage: Different volumes may be prepared by adding proportionally larger or smaller volumes of solution constituents.
  - a. Cleaning flasks: Acid-rinse three 100-mL, one 200-mL, one 500-mL PP, and one 2 L PP (or PMP) volumetric flasks. Check their cleanliness by comparing the counts observed on the ICP-DRC-MS for 1% (v/v) HNO<sub>3</sub> before and after contact with the flasks. Mark each flask according to intended use. Dedicate to purpose.
  - b. HNO<sub>3</sub> & HCl Diluent Preparation: In the cleaned 2L flask, add 1-1.5L  $\geq 18$  Megaohm-cm water, 40 mL high purity concentrated HNO<sub>3</sub>, and 20 mL high purity concentrated HCl. Fill to the mark and mix thoroughly. Use this diluent to fill the remaining flasks during preparation of the intermediate working calibration standards.
  - c. Dilutions & Storage:
    - i. Partially fill the 100 mL, 200 mL, and 500 mL flasks with the HNO<sub>3</sub> & HCl diluent (50-75% full).
    - ii. Using the volumes listed (Table 4 of the Appendix) pipette the appropriate volume of the multi-element intermediate stock calibration standard solution into each of the five volumetric flasks. Dilute each to the volumetric mark with the HNO<sub>3</sub> & HCl diluent using a pipette for the final drops. Mix each solution thoroughly. Final concentrations are listed in Table 4 of the Appendix.
    - iii. Once mixed, transfer to acid-cleaned, labeled, 50-mL containers (PP, PMP, or Teflon™) for storage. Labels should include information such as "Multi-element Urine Working Calibrators", "2% (v/v) HNO<sub>3</sub>, 1% (v/v) HCl", date of preparation, expiration date (1 year from date of preparation), "store at room temperature", initials of preparer, and concentrations for each element.

iii. Working Multi-element Calibrators

1. Purpose: The working multi-element calibrators will be analyzed in each run to provide a signal-to-concentration response curve for each analyte in the method. The concentration of an analyte in a patient urine sample dilution is determined by comparing the observed signal from the dilution of the patient urine sample to the response curve from the working multi-element calibrators.

2. Content: Dilutions (1:100) of the corresponding five intermediate working calibration standards. The dilutions are described in Table 7 of the Appendix.
3. Preparation & Use: Made immediately prior to analysis when the intermediate working calibration standards are mixed with base urine (Section 7.b) and diluent (Section 7.a) using a Digiflex automatic pipetter. See Table 7 of the Appendix and section 8.b.2 for details of sample preparation.

iv. Multi-element Intermediate Stock Calibration Verification Standard

1. Purpose: This is the master solution from which all working calibration verification standards will be prepared. It will be diluted to prepare intermediate working calibration verification standards which are in turn diluted and used to verify the accuracy of instrument response to analyte concentrations greater than the calibration range. This stock solution contains all elements needed for both the arsenic and the 12 element panel.
2. Contents: The concentrations of the elements in the intermediate stock calibration standards are listed in Table 3 of the Appendix. For long shelf life, these four aqueous solutions have different matrices which are optimized to the elements in each (this was recommended for the calibration verification stock standard solutions because the elemental concentrations were very high compared to the concentrations in the calibration stock standard solution.
  - a. Solution A: HNO<sub>3</sub> (10%), HF (0.5%)
  - b. Solution B: HCl (10%), trace HNO<sub>3</sub>
  - c. Solution C: HCl (1%)
  - d. Solution D: HCl (2%)
3. Preparation (Purchase) & Storage:
  - a. Purchasing from vendors: The intermediate stock calibration verification standard solutions may be purchased as custom mixtures from any vendor which prepares multi-element solutions that are traceable to the National Institute for Standards and Technology (NIST) for their accuracy.

Current vendor & preparation process: Currently it is purchased from High Purity Standards (Charleston, SC, part number SM-2107-012, solutions A, B, C, and D).
  - b. In-house Preparation: If outside laboratories were not available to prepare the intermediate stock calibration standard solution, it is also possible to make it in the laboratory from single element standards which are NIST traceable.
  - c. Storage: Due to the uranium content, and in keeping with the guidance of the CDC radiation safety manual [11], the intermediate



stock standards must be kept in a lockbox. Store the solutions at room temperature. Label these bottles from HPS with additional information such as “store at room temperature”, date received, date opened, and initials of person to first open.

v. Multi-element Intermediate Working Calibration Verification Standards

1. Purpose: Verification of accuracy of instrument response to analyte concentrations greater than the calibration range
2. Content: The intermediate working calibration verification standard solutions used in this method are aqueous dilutions of the multi-element intermediate stock calibration verification standard solution in 2% (v/v) double-distilled nitric acid and 1% (v/v) hydrochloric acid containing all 13 elements of interest (does not include the internal standards). The concentrations of the 13 elements in the intermediate stock calibration verification standard are listed in Table 8 in Appendix B.
  - a. Preparation & Storage: Prepare the Intermediate Calibration Verification Standards for analysis just as a Intermediate Working calibrators are prepared, but using volumes and concentrations from Table 8 in Appendix B.

vi. Internal Quality Control Materials (“Bench” QC)

1. Purpose: Internal (or “bench”) quality control (QC) materials are used to evaluate the accuracy and precision of the analysis process, and to determine if the analytical system is “in control” (is producing results that are acceptably accurate and precise). They are included in the beginning and at the end of each analytical run.
2. Content: The internal (or “bench”) quality control (QC) materials used in this method are pooled human urine, acidified to 1-2% (v/v) HNO<sub>3</sub>, and may have been spiked to reach a desired concentration. The analyte concentrations in the “low QC” are in the low-normal concentration range. The analyte concentrations in the “high QC” are in the high-normal concentration range.
3. Preparation & Storage: Quality control materials can be either prepared by and purchased from an external laboratory or prepared within the CDC laboratories. Quality control must always be traceable to the National Institute for Standards and Technology (NIST). The CDC laboratory currently prepares its own bench QC materials using the following procedures:
  - a. Collection of urine: Collect urine anonymously by placing screened containers and / or collection cups in the restrooms with a sign stating the reason the specimens are being collected, the name of the investigator to contact for additional information, and requesting that people provide a urine specimen (complete details can be found in CDC protocol #3994, ProTrack # DLSITN0313). Volume of urine to

- collect is dependent on the desired pool size. This write-up will assume a 10-L pool size for both the low and high bench QC.
- b. Screening Urine: Screen collected samples for metal content before mixing together to make 2 separate base urine pools (for preparing the low and high bench QC materials). Samples can be screened individually or after combining several together (reduces number of analyses).
    - i. Keep urine refrigerated whenever possible to minimize microbial growth.
    - ii. Because this is only a quick screen of the metal content, the number of replicates in the urine method can be reduced to one in order to reduce analysis time.
    - iii. Analyte concentrations in the the final urine pool to be spiked for the low bench QC pool should be in the low-normal population range. Analyte concentrations in the final urine pool to be spiked for the high bench QC pool should be less than some pre-selected target concentration values in the high normal population range. See the Second National Report on Human Exposure to Environmental Chemicals for estimations of the normal population ranges for metals (<http://www.cdc.gov/exposurereport/>).
  - c. Combining Collected Urine: Be attentive not to combine only diluted matrix urine samples into the low pool and only concentrated matrix urine samples into the high pool. The goal is for combining samples is to approach an 'average' matrix for each pool.
    - i. Graduate four acid-washed 10-L carboys (PP or PMP) in 0.5 L increments (two will be used for decanting into).
    - ii. Combine collected urine samples into two separate acid-washed 10-L carboys (PP or PMP), according to their concentrations, for the low bench and high bench QC pools.
    - iii. Mix each urine pool using large acid washed, Teflon™ coated stir bars and large stir plates. Keep urine refrigerated whenever possible.
    - iv. Acidify each urine pool to 1% (v/v) HNO<sub>3</sub> by adding the appropriate volume of double distilled HNO<sub>3</sub>. Stir for 30+ min on large stir plates.
  - d. Settling out of solids:
    - i. Refrigerate the urine (no stirring) for 1-3 days to allow for settling out of solids.
    - ii. For each urine pool, decant the urine into another of the acid-washed 10-L carboys to remove the urine from the solids settled out on the bottom of the carboy.

- iii. Repeat steps (i) and (ii) until minimal solids are left at the bottom of the carboy after sitting overnight.
- e. Spiking of urine
- i. Analyze a sample of each urine pool. Record these results for future recovery calculations.
  - ii. Use these results to determine target analyte concentrations possible for the pools
  - iii. Calculate the volume of single element standards needed to spike each pool to the desired concentrations.
  - iv. While stirring the pools on large stir plates, spike each pool with calculated volumes of single element standards (all spiking standards used must be traceable to NIST).
  - v. Continue to stir pools for 30+ minutes after spiking, then reanalyze.
  - vi. Repeat steps 4 and 5 until all analytes reach target concentrations keeping track of the total volume of spiking solution added to each urine pool.
- f. Dispensing and Storage of urine
- i. Container Types: Dispense urine into lot screened containers (i.e. – 5 or 15 mL polypropylene tubes). If possible, prepare tubes of QC which have only enough volume for one typical run + 1 repeat analysis. This allows for one vial of QC to be used per day of analysis, reducing chances of contamination of QC materials due to multi-day use.
  - ii. Labels: Place labels on vials after dispensing and capping if the vials are originally bagged separately from the caps. This minimizes the chance for contamination during the process. Include at least the name of QC pool (text and bar code), date of preparation, and a vial number on the labels.
  - iii. Dispensing: Dispensing can be accomplished most easily using a Digiflex automatic pipetter in continuous cycling dispense mode. This process should be done in a clean environment (i.e. a class 100 cleanroom area or hood).
    - 1. Allow urine pool to reach room temperature before dispensing (to prevent temperature gradients possibly causing concentration gradients across the large number of vials being dispensed and to prevent condensation problems during labeling of vials). This may require leaving the carboy of urine at room temperature overnight before dispensing.
    - 2. Replace the tubing attached to the dispensing syringe (left when looking at front of Digiflex) with a length of clean Teflon™ tubing long enough to reach into the bottom of the 10L carboy while it is sitting on the stir plate.

3. Check cleanliness of Digiflex before use by analyzing 1-2% (v/v) HNO<sub>3</sub> which has been flushed through the Digiflex with a portion of the same solution which has not been through the Digiflex.
  4. Approximately one hour before dispensing begins,
    - a. With the large stir plate close to the left side of the Digiflex, begin stirring the urine pool to be dispensed.
    - b. Also during this time, flush the Digiflex with urine from the pool to be dispensed. Place the ends of the tubing attached to both the sample and dispensing syringes into the carboy of urine so that urine won't be used up during this process. Be sure to secure both ends of tubing in the carboy with Parafilm so they will not come out during the flushing process.
  5. After dispensing the urine into the vials, cap the vials and label them. Placing labels on vials after capping minimizes the chance for contamination during the process.
- iv. Homogeneity Testing: After dispensing, check homogeneity of analyte concentrations in pool aliquots by analysis of every Nth sample dispensed (where N ~ 20 - 50 depending on the pool size). Sample more heavily from the beginning and the ending portions of the tubes dispensed (these are the regions where most homogeneity problems occur). Keep samples pulled for homogeneity analysis in the sequence that they were dispensed for the purpose of looking for trends in concentrations. Once dispensed and homogeneity has been shown to be good throughout the tubes of a pool, store tubes at  $\leq -20^{\circ}\text{C}$  and pull tubes out as needed for analysis.
  - v. Storage: Urine pools should be stored long term at  $\leq -20^{\circ}\text{C}$ . Short term storage (several days) at refrigerator temperature ( $\sim 2-4^{\circ}\text{C}$ ).

## 7) Analytical Instrumentation & Parameters

(see Section 6 for details on hardware used, including sources)

### a. Instrumentation & Equipment Setup:

- i. ICP-DRC-MS: Inductively Coupled Plasma Dynamic Reaction Cell Mass Spectrometer ELAN<sup>®</sup> 6100 DRC<sup>Plus</sup> or ELAN<sup>®</sup> DRC II.

#### 1. Modifications made to ICP-DRC-MS

- a. Plastic tubing for between mass flow controllers and dynamic reaction cell have been replaced with stainless steel. Stainless steel tubing is

preferred between the reaction gas cylinder / regulator and the back of the ICP-DRC-MS instrument.

- b. A second mass flow controller has been added (channel B) for use with oxygen.
- c. Standard built-in peristaltic pump replaced by DXi-FAST micro-peristaltic pump / FAST actuator unit.

## 2. Configuration of tubing for liquid handling:

### a. Sample introduction system:

- i. SC-FAST valve setup: Valve connections must match this description for urine total arsenic analysis. See Appendix B, Figure 1a.

1. Port 1: 1.5mL sample loop (white nut). See "Loop, for FAST valve" in section 5.b. for details.
2. Port 2: 0.5 mm ID probe (red nut) for carrier solution. See "Probes" in section 5.b. for details.
3. Port 3: nebulizer line (green nut) for transfer of liquid to nebulizer. See "Nebulizers" in section 5.b. for details.
4. Port 4: sample loop (white nut). See "Loop, for FAST valve" in section 5.b. for details.
5. Port 5: 0.8 mm ID probe (blue nut) for diluted samples. See "Probes, for ESI autosampler" in section 5.b. for details.
6. Port 6: vacuum line (black nut). See "Tubing, FAST vacuum" in section 5.b. for details.

- ii. SC autosampler setup for non-FAST applications:  
See Appendix B, Figure 1b.

- b. Tubing connection between autosampler rinse station and rinse solution reservoir: Tubing of different inner diameters can be obtained from Elemental Scientific, their distributors, or custom built in the lab to optimize the rinse station fill rate between samples. Rinse station should not go empty at any point.
- c. Tubing for autosampler rinse station waste removal: Use minimum drain tubing to make this connection. If this tube is too long, the rinse station will not drain properly.
- d. Rinse solution jug: Leave one of the caps on the top of the rinse jug loose to allow air venting into the jug as liquid is removed. Otherwise the jug will collapse on itself as the liquid is removed and a vacuum is created inside. Use secondary containment tray and label appropriately (see solution preparation instructions).

- e. Waste solution jug: Use secondary containment tray and label appropriately (see solution preparation instructions).
- f. Configuration of tubing and probe for carrier solution: Use a 'peristaltic to Teflon tubing adapter' (see consumables descriptions in section 5.b) for connections.

3. Cones used

Nickel and platinum cones have been used.

4. Gases & Regulators setup:

- a. Argon: Argon stored as liquid in a dewar (180-250L) or bulk tank. Gaseous argon used for plasma and nebulizer.
  - i. Regulator for argon source (if a dewar): Keep the inlet pressure (headspace pressure of liquid argon dewar) above 100 psi. Set delivery pressure to 60-100psi to allow for pressure drop across tubing that stretches to the instrument. See Section 6.f. for part numbers and details.
  - ii. Step down regulator (if source of argon is a bulk tank): Place this single stage regulator in the lab so that incoming argon pressure can be monitored and adjusted. Set delivery pressure to 60-100 psig. See Section 6.f. for part numbers and details.
  - iii. Regulator at ICP-DRC-MS: Single stage "argon regulator filter kit" supplied with the ICP-DRC-MS. Set the delivery pressure depending on the specifications for that model of ELAN ICP-DRC-MS instrument (see the PE Hardware Manual). This will be  $52 \pm 1$  psi for instruments having a 0-60psi gauge and  $60 \pm 1$  for instruments having a 0-100psi gauge. See Section 6.f. for regulator part numbers.
- b. Argon (90%) / hydrogen (10%) mixture for DRC channel A. NOTE: Only for arsenic analysis.
  - i. Regulator for Ar / H<sub>2</sub> gas mixture: Set delivery pressure to 5-7 psig. See Section 6.f. for part numbers and details.
  - ii. Flash arrestor: Stainless steel flash arrestor is used on outlet side of regulator. See Section 6.f. for part numbers and details.
- c. Oxygen (99.999<sup>±</sup>%) gas for DRC channel B. NOTE: Only for cadmium and manganese analysis
  - i. Regulator for O<sub>2</sub> gas: Set the delivery pressure = 5-7 psig. See Section 6.f. for part numbers and details.

- ii. Flash arrestor: Brass flash arrestor is used on outlet side of regulator. See Section 6.f. for part numbers and details.
- 5. Chiller / Heat Exchanger: Refrigerated chiller (for ELAN<sup>®</sup> 6100 DRC<sup>Plus</sup> instruments) or heat exchanger (for ELAN<sup>®</sup> DRC II instruments). For refrigerated chiller, set temperature control to 18°C.
- ii. Computer: Dell Optiplex GX150, GX270, or GX280 have all been used. Processors used have included Pentium III (1 GHz) through Pentium IV (2.8 GHz). Recommend 512Mb - 1Gb RAM. External hard disk drive for nightly backups of data connects via USB port. Software used includes Windows XP Professional, service pack 2 and ELAN v3.3.
- iii. Autosampler: ESI SC4 autosampler with (arsenic) or without (multi-element) FAST sample introduction. Rack calibration, tubing ID for rinse supply, additional rinse time, probe movement speeds, and probe depth is optimized per autosampler (see Table 1 in Appendix B for default settings).
- b. Parameters for Instrument and Method: See Table 1 in Appendix B for a complete listing of the instrument and method parameters. Also, see Figures 2a-2g and 3a-3g in Appendix B for images of the ELAN method screens (15 element panel and arsenic respectively).

## 8) Method Procedures

- a. Quality Control: Quality control procedures implemented in this method are defined by the Division Procedures and Practices Guidelines and include two types of QC systems which are both subjected to the complete analytical process. The data from these materials are then used to estimate methodological imprecision and to assess the magnitude of any time-associated trends. The concentrations of these materials should cover the expected concentration range of the analytes for the method. Before QC materials can be used to judge patient analytical runs, acceptable QC concentration limits must be calculated from the concentration results observed in at least 20 characterization runs. During the 20 characterization runs, previously characterized QCs or pools with target values assigned by outside laboratories should be included to evaluate the analysis. The process of limits calculation is performed using the laboratory database and the SAS division QC characterization program.
- i. Types of Quality Control:
  - 1. “Bench QC”: The bench QC pools used in this method comprise two levels of concentration spanning the “low-normal” and “high-normal” ranges of the analyte of interest. The intent of bench QC is for the analyst to evaluate the performance of the analytical system on the day of analysis. The analyst inserts both the “low” and the “high” bench QC specimens two times in each analytical run (a set of consecutive assays performed without interruption) so that judgments may be made on the day of analysis. The

first analysis of the two bench QC pools is done after the calibration standards are analyzed but before any patient samples are analyzed (so that judgments on the calibration curves may be made before analysis of patient samples). The second analysis of the two bench QC pools is done at the end of the run (approximately 20 patient samples total). If more patient samples are analyzed on the same calibration curve after the second run of the bench QC, both the low-normal and high-normal bench QC must be reanalyzed before and after the additional samples. For example, the schemes shown in Table 5 in Appendix B are both acceptable ways to analyze multiple consecutive “runs”.

2. **“Blind QC”**: When possible, “blind” QC samples are QC materials placed in vials, labeled, and processed so that they are indistinguishable from the subject samples handled by the analyst. Ideally, the supervisor decodes and reviews the results of the blind specimens without the analyst knowing of their presence in the runs. When it is not possible to have blind QC materials processed so that they are indistinguishable by the analyst from the patient samples, it is acceptable for the analyst to randomly insert into the run a QC material which only the QC reviewer knows the acceptable concentration limits for. At least one low-normal concentration and one high-normal concentration QC material should be kept in the laboratory for this purpose.
  3. **External Reference Materials**: Materials produced by laboratories outside of the CDC which have assigned target concentrations can be helpful in verifying method performance. Some examples include Standard Reference Materials (SRM) from the National Institute of Standards and Technology (NIST) (i.e. SRM 2670a low & 2607a high) and samples from previous challenges of proficiency testing programs (i.e. Centre de Toxicologie du Quebec (CTQ)). However, only the results for the bench and blind QC materials are used to determine if the run results can be used.
- ii. **Calibration Verification**:
- a. **Bi-annual tests as defined in the DLS Policy and Procedures manual**: CLIA requires the verification of accuracy of instrument response to analyte concentration be completed at least every 6 months. NIST traceable calibrators are analyzed in each run to define this response up to the concentration of the highest calibrator in the run. To verify accuracy of instrument response at concentrations higher than the highest calibrator in each run, analyze a NIST traceable standard with very high concentrations (see Table 8 in Appendix B for concentrations) at least every 6 months. Prepare the Calibration Verification Standard for analysis just as a working calibrator is prepared. Use the “Urine Blank” as the blank when it is analyzed. If the observed concentrations for the Calibration Verification Standard are not within 10% of the target value (see Table 8 in Appendix B) the lab supervisor should be notified and the issue should be investigated. Do not substitute



external reference materials (i.e. biological samples from a PT program) for the Calibration Verification Standard when performing this. Solutions needed for the Calibration Verification checks can be purchased from standards vendors (i.e. SPEX, High Purity Standards, etc . . .) or prepared in-house from NIST traceable single element standards. Always verify that normal background levels have been re-achieved through adequate rinse time following analysis of elevated standards for calibration verification.

- b. As-needed confirmations (per supervisor discretion): When a sample result is greater than the highest calibrator in the run, the supervisor may request that the result be confirmed in an analysis run which includes a standard or external reference material with equivalent (within 10%) or greater concentration than the sample. In order to avoid needless contamination of the instrument with high concentrations of analytes, the analyst should use the lowest appropriate calibration verification solution concentrations to meet the need.

For *infrequent* verification needs, the calibration verification stock solutions can be used to prepare verification standards to appropriate concentrations. This will, however, introduce elevated concentrations of all elements in the method to the sample introduction system. Frequent measurement of these very high concentrations can result in high background levels in the instrument which are difficult to rinse out and which may limit the ability to measure low concentrations.

For frequent verification needs (i.e. when certain studies have many elevated results on particular elements) or when a concentration higher than those shown in Table 8 in Appendix B needs to be verified, use NIST-traceable single element stock standards to prepare single element verification standards. This will limit the exposure of the instrument to elevated concentrations of only the elements needing verification.

An external reference material (i.e. historical proficiency testing sample) can be substituted in place of the Calibration Verification Standard sample in these situations IF

- i. The target value has been assigned by an external source (i.e. NIST, or the proficiency testing program).
- ii. The concentration of the external reference material is within 10% or is higher than the concentration of the material you need it to *confirm*.
- iii. There is confidence that there is no contamination of previously used external reference material.
- iv. A note to file is made that this was done.
- v. If the observed concentrations are not within 10% of the target value the lab supervisor should be notified and the issue should be investigated.

Always verify that normal background levels have been re-achieved through adequate rinse time following analysis of calibration verification standard 3 or higher (including samples with those concentrations).

b. Daily Analysis of Samples

i. Preparation of the Analytical Equipment

*For further details on any part of this description, see the ITN Daily Startup SOP for ELAN ICPMS instruments.*

1. Power on the computer, printer, and autosampler, and log into the operating system.
2. Peristaltic pump: Set up the peristaltic pump tubing with proper tension for the sample rinse station.
3. Software: Starting the ESI software before starting the ELAN software may improve stability of software.
4. Daily Pre-Ignition Maintenance Checks: Perform daily maintenance checks as described in the IRAT Daily Startup SOP for ELAN instruments (i.e., Ar supply pressure, interface components cleanliness and positioning, interface pump oil condition, vacuum pressure, etc.). Make appropriate notes in the Daily Maintenance Checklist and Instrument Log Book.
5. Start the Plasma: In the INSTRUMENT window of the software (or on the front of the ELAN), press the “Start” button to ignite the plasma.
6. Aspirate rinse (multi-element method) or carrier (arsenic method) solution: Send Probe to Rinse Station (multi-element method) or manually place carrier probe into carrier solution (arsenic method).
7. Start the peristaltic pump: Start the peristaltic pump by pressing the appropriate arrow in the DEVICES window (make sure that the rotational direction is correct for the way the tubing is set up in the peristaltic pump). Set the pump speed to a slow speed in the DEVICES window during warm-up.
8. Warm-up time: Allow approximately 30 to 45 minutes warm-up time for the ICP-DRC-MS after igniting the plasma. This warm-up time is for the RF generator. There will be another “Stability time” for the DRC later in this procedure.
9. Optimizations and Daily Performance Check: After this warm-up time, perform a daily performance check and any optimizations necessary (as described in the ITN Daily Startup SOP for ELANs). Include Be (m/z 9) in the daily performance check. Fill in the Daily Maintenance Checklist according to the optimization procedures performed.
  - a. Magnesium (<sup>24</sup>Mg) may have high RSDs due to the use of Triton-X100 in the rinse solution. Avoid this problem by either temporarily using non-Triton-containing rinse solution during the daily check, or repeating the daily check multiple times in succession with no rinse time between.

- i. Saving the Files: Save new tuning (mass calibration) parameters to the file “default.tun.” Save new optimization parameters (i.e., detector voltages, autolens values, nebulizer gas flow rate) to the file “default.dac.”

#### 10. Software setup for Analysis:

- a. Workspace (files & folders): Click on “Open Workspace” from the “File” menu. Select the workspace file “CDC\_urine multi-element.wrk” (or one customized for user preferences). Select “Review Files” from the “File” menu. Verify & set up the correct files and data directories for your analysis (See Table 1 in Appendix B).
- b. Samples / Batch Window: Update the window to reflect the current sample set. The only fields which need to be filled in include the autosampler location, sample identification (id), measurement action, method, sample flush time, sample flush speed, read delay time, read delay & analysis speed, wash time, wash speed. Use a bar code scanner to input data whenever possible. See Table 1 in Appendix B for times and speeds. Save the Sample window file and re-use it on other days by simply replacing the sample IDs for the patient samples.

1. DRC Stability Time: Best analyte-to-internal standard ratio stability is obtained after 1-1.5 hrs of analysis of urine samples using the DRC method. Analyze enough “dummy” urine sample dilutions prior to any DRC analysis run to fill 1-1.5 hours of analysis time (not necessary if analyzing only a subgroup of the method containing no DRC analytes). If analyzing the full set of method analytes, 10 samples will be sufficient. See Table 5 in Appendix B for example of setup in the Samples / Batch window.

#### 2. Urine vs. Aqueous Method Files:

- a. The difference: There are two method files for this one method (see Table 1 in Appendix B). It is necessary to use both to accomplish each run because the current PerkinElmer software will not allow for more than one blank per method file. The ONLY DIFFERENCE between these two files is on the Sampling tab where one lists the autosampler positions of the urine blank and urine calibrators (the “urblk” method file) and the other lists the autosampler position of the aqueous blank (the “aqblk” method file).
- b. Use: The ONLY TIME when it matters which of these files is used is when the measurement action *includes* “Run blank” or “Run standards”. When the measurement action is only ‘run sample’, it does not matter whether the “urblk” or “aqblk” method file is used. Analysts typically follow the

pattern below, however, for the sake of consistency and as a reminder of which blank must be used for which type of sample. See Table 6 in Appendix B.

- i. The “urblk” method file: Use to analyze the initial urine blank (blank for the calibration curve), the urine calibrators, and the urine blank checks (urblkchk1 & urblkchk2) at the very beginning of the run. The urine blank method defines the autosampler location of the urine blank and the urine calibration standards.
- ii. The “aqblk” method file must be used to analyze all QC materials and patient samples. The aqueous blank method defines the aqueous blank in autosampler location.

3. Notation of Dilutions: To designate an extra dilution of a sample, edit the sample ID to reflect the level of dilution being performed (i.e., A 1:2 dilution of sample 1 would be reflected in the sample ID “sample 1 (2x dilution)”. This sample ID will be edited during the data-import process to the database so that it is recognized as the appropriate sample. Do not use the ELAN® software to automatically correct for sample dilutions. Extra dilution is performed on urine samples whose concentration is greater than the concentrations listed in Table 8 in Appendix B (linearity of the method has been documented up to these concentrations).

ii. Preparation of Samples for Analysis (See Table 7 in Appendix B)

1. Thaw the frozen urine specimens; allow them to reach ambient temperature.
2. DRC stability “dummy urine matrix”. Prepare 50+mL of standard 2 or standard 3 to be analyzed for 1-1.5 hr before the beginning of the run. This can be prepared using 50mL polypropylene tubes or a wide-mouth bottle (which can be put on the autosampler in place of one of the tube trays).
3. Set up a series of 15-mL polypropylene tubes corresponding to the number of blanks, standards, QCs, and patient samples to be analyzed.
4. Prepare the following solutions in the 15-mL falcon tubes using the Micromedic Digiflex™ (see Table 3 in Appendix B for a summary).
  - a. *Aqueous Blank:* Prepare two aqueous blanks consisting of 1,000  $\mu\text{L}$  of  $\geq 18$  Mega-ohm-cm water and 9,000  $\mu\text{L}$  of diluent. One will be the actual aqueous blank and the other will be a backup (“Aqueous Blank Check”) in case the original aqueous blank gets contaminated.
  - b. *Urine Blank:* Prepare two urine blank dilutions consisting of 900  $\mu\text{L}$  of base urine (same material used to prepare the urine calibration standards), 100  $\mu\text{L}$  of  $\geq 18$  Mega-ohm-cm water, and 9,000  $\mu\text{L}$  of

- diluent. One of these urine blanks will be the blank for the calibration standards; the other will be analyzed twice after standard 5 as UrBlkChk1 and UrBlkChk2, respectively. Results from the UrBlkChks will be used to determine the method limit of detection.
- c. *Calibrators*: Prepare the working calibration standards as 100  $\mu\text{L}$  of the appropriate aqueous intermediate working calibration standard, 900  $\mu\text{L}$  of base urine, and 9,000  $\mu\text{L}$  of diluent.
  - d. *Patient & QC Samples*: Before taking an aliquot for analysis, mix the sample so that no particulates remain on the bottom of the tube. Prepare urine sample dilutions as 4,500  $\mu\text{L}$  of diluent and 500  $\mu\text{L}$  of the urine sample.
  - e. Cap all of the blanks, standards, and samples and mix them well. Uncap them and place them in the autosampler of the ELAN<sup>®</sup> ICPMS in the order that was entered in the Samples / Batch window of the ELAN software.
- iii. Specimen Storage and Handling During Testing: Specimens may be left at room temperature during analysis in case confirmation analyses must be made. Take stringent precautions to avoid external contamination by the metals to be determined. Specimens may be stored short term at refrigerated temperatures, but should be stored long term (>4 weeks) at  $\leq -20$  °C.
  - iv. Starting the Analysis: To begin analysis, highlight (click and drag with the mouse) the table rows of the samples that should be included in the run, and then click on “Analyze Batch.”
  - v. Monitoring the Analysis: Initiate work in a timely manner so that the run may be monitored. Make every effort to complete analysis within the work day so that the entire run can be monitored. If it is not possible to complete the analysis by the end of the work day, the run may be left to complete itself unattended as long as appropriate planning is made for either overnight operation or Auto Stop (see below).

Monitor the analysis for the following:

1. *DRC stability (analyte / internal standard ratio stability)*

After the analysis of the DRC stability “dummy” samples, these results can be reviewed to determine if sufficient stability of the analyte-to-internal standard ratio was reached before beginning analysis. Importing data into an MS Excel template file is useful to visualizing magnitude of drift.

2. *Proper operation of the instrument.*

3. *Contaminated blanks.*

4. *Linear calibration curves.*

- a. Typical correlation coefficients will be 0.999 to 1.000.
- b. The ELAN software generates a “simple linear” calibration curve (using a least squares calculation) for each of the 13 elements in this method.

The curves are generated using the results from analysis of the urine blank and the 5 external urine calibrators whose concentrations are defined in the Calibration tab of the Method file. Specifically, the software plots the “net intensity” (y-axis) versus the analyte concentration (x-axis). The “net intensity” is the blank subtracted **ratio** of the measured intensity for the analyte to the measured intensity of the associated internal standard and is calculated as follows:

$$\text{net intensity} = \frac{\text{Analyte Meas Intensity}_{\text{sample}}}{\text{Internal Std Meas. Intensity}_{\text{sample}}} - \frac{\text{Analyte Meas Intensity}_{\text{Blank}}}{\text{Internal Std Meas Intensity}_{\text{Blank}}}$$

5. *Bench QC results within the acceptable limits.*

If an analyte result for the beginning QC material(s) falls outside of the 99% limits, then the following steps are recommended:

- a. If a particular calibration standard is obviously in error, remake a new dilution at the Digiflex of that working calibrator, reanalyze it, and reprocess the sample analyses using this new result as part of the calibration curve.
- b. Prepare a fresh dilution of the failing QC material and reanalyze it.
- c. Prepare fresh dilutions at the Digiflex of all of the calibration standards (working urine multi-element standards) and reanalyze the entire calibration curve using the freshly prepared standards.

If these three steps do not result in correction of the out-of-control values for QC materials, consult the supervisor for other appropriate corrective actions. Do not report analytical results for runs that are not in statistical control.

6. *Good precision among replicates.*

7. *Consistent measured intensities of the internal standards.*

Some sample-to-sample variations are to be expected. However the intensities should be within a few percent of one another, and should fluctuate around an average value (not drift continuously in one direction).

8. *Elevated patient results.* After any sample having a concentration greater than the third calibration verification standard (see CV3 in Table 8 of Appendix B), verify the instrument background levels have returned to normal before proceeding in analysis to the next sample, adding additional rinsing time if necessary. If this cannot be done in real-time, the sample analyzed immediately after the elevated sample should be repeated for confirmation (within 10% of the original result) prior to reporting. Report the first analytically verified result.

- vi. Records of Results: Run results will be documented daily in both electronic and paper form.
1. Electronic Records:
    - a. Transfer of Results to the Laboratory Information System / Database: Transfer data electronically between computers or software to reduce errors. When keyboard entry must be used, proofread transcribed data after entry.
    - b. Long-Term Storage of ELAN software files: Files used and produced by the ELAN software in analyzing samples will be backed up long term on compact disk and kept a minimum of three years.
  2. Paper Records: The paper copy of the results from the run should be put into the study folder(s) and should include
    - a. A summary of the calibration curve statistics.
    - b. A printout of analysis of each measurement made during the run.
    - c. Optional, but helpful, is a printout of the DRC stability check measurements in graphical form.
    - d. On the front sheet of the printed records, write the following
      - i. Analyst initials
      - ii. Instrument ID
      - iii. Date of Analysis
      - iv. Run # for the day on this instrument
      - v. Study ID and Group Number
      - vi. Database batch ID (Not known until the run is imported into the database)
- vii. Transfer of Results to the Laboratory Database: Every analytical run performed for the analysis of patient samples should be entered into the laboratory results database unless the run is not useable for obvious reasons (i.e. the run is stopped for some reason before ending QC is analyzed, no internal standard spiked into the diluent, etc. . . ).
1. Data Export Process (from ELAN® software to .TXT file): If the data file was not created during the initial analysis, reprocess the data of interest either with “original conditions” option, or by loading the files and folders used during the analysis. In the ELAN® ICP-DRC-MS software, select “Review Files” from the “File” menu. From this window, you must open the files and directories that were used when collecting the data of the run that you wish to export. (If the analysis has just ended, all of these files and directories will still be open.) NOTE: A second copy of the ELAN® software can be run as an Edit/Reprocess copy without affecting an ongoing analysis by the first copy of the software running in Windows. After you open the relevant files, go to the “Report” page in the METHOD

window. Deselect the box that prints a paper copy of data and select the box that sends data to a file. Select the "Report Options Template" named "CDC\_Database Output.rop" and type in a report filename using a format such as "2005-0714a\_group55.txt" to designate data from analysis of group 55 from July 14, 2005, run #1. Under "Report Format", choose the "Use Separator" option, and under the "File Write" section choose "Append." Finally, reprocess the data of interest. (See PerkinElmer ELAN® ICPMS Software Manual.) Make sure you apply the aqueous blank to all sample and quality control material analyses.

2. Data Import Process (from .TXT file to Microsoft Access™ database):

- a. Move the .TXT file to the appropriate subdirectory on the network drive where exported data are stored. Directories for data storage are named according to instrument \ year \ month\, such as I:\Instruments\ELANDRC2A\2005\07\.
- b. Using the ITN Database Frontends, import the instrument file into the database. On the GoTo window, click on "Add Sample Results to Database", then "Import Instrument Data File".
- c. Enter the appropriate information to identify the instrument, assay, analysis date & time, run number, analyst, calibrator lot number and prep date used (use the "IS Lot Number" field) and study. If other than default values for Method LOD, High Calibrator, Rep Delta Limit, and units were used in the run, document what was used by clicking on the "View/Set Batch Parameters" button, changing the appropriate values, and then clicking "Back".
- d. Press the "Import" button, then browse to the correct network folder to select the file which contains the results from the run. Select the file and click "OK".
- e. In the "Import Instrument Results" table, pressing the "Find X's" button will show only those samples whose sample ID is not recognized as a valid QC pool ID or sample ID for this study. (Sample IDs are set up when the study is logged into the database.) Corrections to sample IDs and dilution factors can be made in this table (e.g., correction of transcription errors and adjustment for level of dilution). If samples were diluted for analysis, both the sample ID and the dilution factor need to be edited in this table before the values are transferred to the database (the Replace command under the Edit window is helpful in this case). When corrections to sample IDs are made, press the "Check IDs" button to re-evaluate the sample IDs. Any sample or analyte row marked "Not Recognized" will not be transferred to the database when the "Transfer" button is pressed. Once transferred into the database, the data should be evaluated for QC pass / fail, then set with the with the appropriate settings for QC accept / reject, final value status, and comment(s). See the database programmers for more detail on working in the database.



viii. Analyst Evaluation of Run Results:

1. Bench Quality Control: After completing a run, and importing the results into the database, export the QC results to the SAS program where the run will be judged to be in or out of control. The QC limits are based on the average and standard deviation of the beginning and ending analyses of each of the bench QC pools, so it will not be possible to know if the run is *officially* accepted or rejected until it is completed.

a. Quality Control Rules: The SAS program applies the division QC rules to the data as follows:

i. If both QC run means (low & high bench QC) are within  $2S_m$  limits and individual results are within  $2S_i$  limits, then accept the run.

ii. If 1 of the 2 QC run means is outside a  $2S_m$  limit - reject run if:

1. Extreme Outlier – Run mean is beyond the characterization mean  $\pm 4S_m$

2. 1 3S Rule - Run mean is outside a  $3S_m$  limit

3. 2 2S Rule - Both run means are outside the same  $2S_m$  limit

4. 10 X-bar Rule – Current and previous 9 run means are on same side of the characterization mean

iii. If one of the 4 QC individual results is outside a  $2S_i$  limit - reject run if:

1. R 4S Rule – Within-run ranges for all pools in the same run exceed  $4S_w$  (i.e., 95% range limit)

Note: Since runs have multiple results per pool for 2 pools, the R 4S rule is applied within runs only.

Abbreviations:

$S_i$  = Standard deviation of individual results (the limits are not shown on the chart unless run results are actually single measurements).

$S_m$  = Standard deviation of the run means (the limits are shown on the chart).

$S_w$  = Within-run standard deviation (the limits are not shown on the chart).

b. Implications of QC Failures: If the division SAS program declares the run out of control” for any analyte, use the following to determine the implications on usability of the data from the run.

i. For 1 or 2 analytes: ONLY the analytes which were “out of control” are invalid for reporting from the run. Set all run results for those 1 or 2 analytes as “QC Rejected” in the database.

- ii. For 3 or more analytes: All results, regardless of analyte, are invalid for reporting from the run. Set all run results for all analytes as “QC Rejected” in the database. Note in the batch comment field why all results were marked QC rejected.

2. Patient Results:

a. Elevated Results:

i. Boundaries Requiring Confirmatory Measurement:

1. Results Greater than the First Upper Boundary (1UB): Concentrations observed greater than the “first upper boundary” (defined in the laboratory database as the “1UB”) should be confirmed by repeat analysis of a new sample preparation. The concentration assigned to the 1UB for an element is determined by study protocol but default concentrations are in Table 9 in Appendix B. Report the original result, as long as the confirmation is within 10% of the original. Continue repeat analysis until a concentration can be confirmed.
  2. Results Greater Than Highest Calibrator: When a sample result is greater than the highest calibrator in the run, the supervisor may request that the result be confirmed in an analysis run which includes a standard or external reference material with equivalent (within 10%) or greater concentration than the sample.
  3. Results Greater Than Calibration Verification Tested: Perform an extra dilution on any urine sample whose concentration is greater than those listed in Table 8 in Appendix B (the linearity of the method has been documented up to these concentrations). See Table 7 in Appendix B for description of sample preparation with extra dilution.
  4. Uranium Isotope Ratio Measurement for Elevated Uranium Concentrations: A uranium 235/238 isotope ratio analysis is performed for all urine uranium samples where the urine total uranium concentration is greater than the 2UB boundary (see Table 9 in Appendix B).
- ii. Inadequate Precision in Confirmation of a Measurement: If a sample is reanalyzed to obtain a confirmation of an initially elevated result, the confirmation should be within 10% of the original result.
  - iii. Analyst Reporting of Elevated Results: Concentrations observed greater than the “second upper boundary” (defined in the laboratory database as the “2UB”) should be reported to the QC reviewer as an “elevated result”. The concentration assigned to

the 2UB for an element is determined by study protocol but default concentrations are in Table 9 in Appendix B. The analyst should report any patient results confirmed to be greater than the second upper boundary to the QC reviewer as an “elevated result”. There is no routine notification for elevated levels for the metals determined in this method. The protocol for supervisors reporting elevated results to medical personnel is defined according to the study protocol.

- b. Inadequate Precision Within One Measurement: If the range of the three replicate readings (maximum replicate concentration value - minimum replicate concentration value) for a single sample analysis is greater than the criteria listed in Table 9 in Appendix B (“>Lim Rep Delta” in the database) **and** the range of the three replicate readings is greater than 10% of the observed concentration, do not use the measurement for reporting. Repeat the analysis of the sample.
- ix. Submitting Final Work for Review: Once results have been imported, reviewed, and set as final in the database by the analyst,
  1. Submit an email to the QC reviewer informing them of the readiness of the data for final review. The email should include
    - a. Instrument ID, run Date, run number, study ID, group ID.
    - b. Any bench QC failures (include reasons if known).
    - c. Any patient sample result greater than the 2UB boundaries (see Table 9 in Appendix B).
    - d. Anything out of the ordinary about this analytical work which could have a bearing on the availability (i.e. insufficient sample to analyze), accuracy, or precision of the results.
  2. Include all items called for by the study folder cover sheet in the study folder (i.e. printouts from the ICP-MS, bench QC evaluation) together in the study folder before submitting the folder for review when analysis is complete.
- x. Overnight Operation or Using Auto Stop: Make every effort to complete analysis within the work day so that the entire run can be monitored. If it is not possible to complete the analysis by the end of the work day, the run may be left to complete itself unattended as long as appropriate planning is made for either overnight operation or Auto Stop.
  1. *24 hrs / day operation in DRC mode*:
    - a. To reduce startup time in the mornings, the analyst is encouraged to operate the ELAN in DRC mode 24hrs/day during the work week. This eliminates the need for daily 45 minute RF generator warm-up, and possibly the need for DRC stability time (if the DRC gas is not off for extended periods of time before analysis). To maintain the instrument in DRC mode when not analyzing patient samples, setup multiple sample rows in the Samples / Batch window with autosampler position

- n zero (rinse station of autosampler) and wash time of 1800s (30 minutes). Repeat this sample row enough times to keep the instrument in analysis mode overnight (1 sample with 15 minute wash will take ~ 25 minutes).
2. *AutoStop*: If 24 hrs / day ELAN operation is not desired, the instrument can shut the plasma off unattended after analysis. Setup this as follows:
    - a. On the “Auto Start / Stop” tab of the Instrument window, enable the Auto Stop feature.
    - b. Press the “Change” button within the Auto Stop box and set the Delayed shutdown time to 5 minutes. This will rinse the sample introduction system of urine matrix before turning off the plasma.
    - c. It will be necessary to replace the sample peristaltic pump tubing the next day since it will have been clamped shut overnight.
  - c. Equipment Maintenance: Analysts are expected to follow a 4-day analysis / 1-day maintenance schedule in the laboratory.
    - i. ICPMS Maintenance: On the maintenance day, perform all maintenance per the Inorganic Toxicology and Nutrition Branch ELAN ICP-MS Weekly Maintenance SOP. All equipment maintenance should be documented in the instrument logbook.
    - ii. Data Backup: Data on the ELAN computer will be backed up via two backup routines.
      1. Daily Backups to External Hard Drive: Automatic backups of the “elandata” directory and all subdirectories should be programmed to occur each night onto an external hard disk.
      2. Weekly Backup to CD: Backup all files in the active “elandata” directory and all subdirectories onto one recordable compact disc during the weekly maintenance SOP. When the active “elandata” directory on the ICP-DRC-MS computer hard drive becomes too large to fit onto a single recordable compact disc, the oldest data can be removed from the computer to make it easier to backup the entire directory weekly. This can usually be done annually.
        - a. Backup the oldest data on the hard drive to two duplicate compact disks and verify that the files on the CD are readable
        - b. Label them with the name of the instrument, the date range of the data, the current date, your name, and “Copy 1 of 2” or “Copy 2 of 2”
        - c. After verifying that the CDs are readable, the oldest, backed up data can be deleted from the ICP-MS computer hard drive.
        - d. It is best to not store duplicate copies in the same location.

## 9) Interpretation of the Results

- a. Reportable Range: Urine multi-element values are reportable in the range between the method LOD (see Appendix, Table 8 in Appendix B) and the highest

concentration verified accurate by bi-annual calibration verification tests (see Appendix, Table 8 in Appendix B). For example, if a urine cadmium value is less than the method LOD of 0.042, report it as  $< 0.042 \mu\text{g/L}$ . Above the highest concentration verified, extra dilutions are made of the urine sample to bring the concentration within the verified range.

- b. Reference Ranges (Normal Values): In this method the 95% reference ranges (see Appendix, Table 10 in Appendix B) for these elements in urine fall within the range of the calibrators.
- c. Action Levels: Due to the uncertainty of the health implications of elevated concentrations of many of the elements determined with this method, there is no routine notification for elevated levels of every analyte determined with this method. The present NRC standard for workplace removal is  $15 \mu\text{g/L}$  of U in urine [13]. Other action levels for reporting to supervising physicians are determined on a study-by-study basis.

## 10) Method Calculations

- a. Method Limit of Detection (LODs): The method detection limits for elements in blood specimens are defined as 3 times  $s_0$ , where  $s_0$  is the estimate of the standard deviation at zero analyte concentration.  $S_0$  is taken as the y-intercept of a linear or 2<sup>nd</sup> order polynomial regression of standard deviation versus concentration (4 concentration levels of the analytes in blood each measured 60 times across at least a 2-month timeframe). Method LODs are re-evaluated periodically.
- b. Method Limit of Quantitation (LOQ): The Division of Laboratory Sciences does not currently utilize limits of quantitation in regards to reporting limits [10].
- c. QC Limits: Quality control limits are calculated based on concentration results obtained in at least 20 separate runs. It is preferable to perform separate analyses on separate days and using multiple calibrator lot numbers, instruments, and analysts to best mimic real-life variability. The statistical calculations are performed using the SAS program developed for the Division of Laboratory Sciences (DLS\_QC\_compute\_char\_stats.sas).

## 11) Alternate Methods for Performing Test and Storing Specimens If Test System Fails:

If the analytical system fails, the analysis may be setup on other ELAN DRC instruments in the laboratory. If no other instrument is available, store the specimens at  $\sim 4^\circ\text{C}$  until the analytical system can be restored to functionality. If interruption longer than 4 weeks is anticipated, then store urine specimens at  $\leq -20^\circ\text{C}$ .

**Appendix A. Ruggedness Testing Results**

Parameter Test #1 (15 Element Panel): Evaluate the impact on analysis results if the RF Power is increased to 1600W (instrument maximum) or decreased to 1150W (by 20%) for the analytical run.

Test Details:

1. Three different RF power settings were tested in separately prepared, consecutive runs on the instrument without turning off the plasma. At least 15 minutes stabilization time was allowed between each run after the RF power was changed. “Junk urine” samples (20) were analyzed between the beginning and ending QC of each run. All other method parameters were kept per method.
2. Run #1 (method default, 1450W).
3. Run #2 (Decreased RF power by 20% to 1150W).
4. Run #3 (Increased RF power to instrument maximum, 1600W).

<b>Parameter Test 1 Results (Table 1 of 3 for 15 Element Panel).</b> All concentrations in ug/L. Test performed 3/24/2010 by Denise Tevis using ELAN DRC-2N.					
Sample ID	RF Power Tested	Ba	Be	Cd	Co
LU-04310_UMP3_e	<i>Characterized Mean</i> (±2SD Range)	0.76 (0.65 - 0.86)	0.69 (0.59 - 0.79)	0.32 (0.28 - 0.36)	0.42 (0.38 - 0.47)
	1150W (reduced)	0.67	0.62	0.28	0.39
	1450W (per method)	0.70	0.66	0.31	0.32*
	1600W (increased)	0.75	0.75	0.33	0.42
HU-04311_UMP3_e	<i>Characterized Mean</i> (±2SD Range)	5.01 (4.54 - 5.24)	5.28 (4.48 - 6.07)	1.62 (1.47 - 1.78)	1.88 (1.66 - 2.09)
	1150W (reduced)	4.93	5.75	1.6	1.96
	1450W (per method)	5.55	5.28	1.75	1.67
	1600W (increased)	4.85	5.82	1.58	1.90
*Data are not statistically different according to the expected precision of the method (QC 3SD = 0.072)					

Appendix A. Ruggedness Testing Results. (continued)

Parameter Test 1 Results (Table 2 of 3 for 15 Element Panel). All concentrations in ug/L. Test performed 3/23/2011 by Denise Tevis using ELAN DRC-2N.					
Sample ID	RF Power Tested	Cs	Mo	Pb	Pt
LU-04310_UMP_e	Characterized Mean (±2SD Range)	2.38 (2.25 - 2.51)	19.3 (18.6 - 20.0)	0.42 (0.37 - 0.48)	0.10 (0.07 - 0.13)
	1150W (reduced)	2.13 <sup>‡</sup>	17.2 <sup>*</sup>	0.42	0.09
	1450W (per method)	2.32	18.9	0.41	0.09
	1600W (increased)	2.42	18.8	0.43	0.10
HU-04311_UMP_e	Characterized Mean (±2SD Range)	9.82 (9.03 - 10.6)	136 (131 - 142)	2.95 (2.82 - 3.08)	0.85 (0.71 - 1.00)
	1150W (reduced)	9.62	136	3.03	0.93
	1450W (per method)	10.56	133	2.89	1.02 <sup>#</sup>
	1600W (increased)	9.55	135	3.05	1.08 <sup>#</sup>
Sample ID	RF Power Tested	Sb	Tl	W	U
LU-04310_UMP_e	Characterized Mean (±2SD Range)	0.19 (0.17 - 0.21)	0.18 (0.17 - 0.19)	0.22 (0.19 - 0.24)	0.014 (0.011 - 0.016)
	1150W (reduced)	0.21	0.16	0.19	0.017 <sup>α</sup>
	1450W (per method)	0.16	0.19	0.22	0.014
	1600W (increased)	0.20	0.18	0.22	0.017 <sup>α</sup>
HU-04311_UMP_e	Characterized Mean (±2SD Range)	0.66 (0.60 - 0.71)	0.58 (0.55 - 0.61)	0.94 (0.90 - 0.99)	0.128 (0.115 - 0.141)
	1150W (reduced)	0.69	0.59	0.90	0.153 <sup>α</sup>
	1450W (per method)	0.61	0.57	0.93	0.126
	1600W (increased)	0.66	0.60	0.91	0.150 <sup>α</sup>

‡Data are not statistically different; expected precision of the method (QC 3SD = 0.2)

\*Data are not statistically different; expected precision of the method (QC 3SD = 1.08)

#Data are not statistically different; expected precision of the method (QC 3SD = 0.22)

α Data are not statistically different; expected precision of the method (QC 3SD = 0.02)

Appendix A. Ruggedness Testing Results. (continued)

Parameter Test 1 Results (Table 3 of 3 for 15 Element Panel). All concentrations in ug/L. Test performed 3/23/2011 by Denise Tevis using ELAN DRC-2N.				
Sample ID	RF Power Tested	Mn	Sn	Sr
NYDOH UE09-05‡	<i>Characterized Mean (±2SD Range)</i>	1.37 (1.55 -1.19)	2.2 (2.0-2.8)	
	1150W (reduced)	1.22	2.9	
	1450W (per method)	0.98	2.8	
	1600W (increased)	1.30	3.0	
NYDOH UE09-06‡	<i>Characterized Mean (±2SD Range)</i>	31.1 (26.3 -35.9)	61 (55.0 - 67.0)	
	1150W (reduced)	29.4	67.4	
	1450W (per method)	23.8	68.5	
	1600W (increased)	30.0	66.7	
Seronorm Trace Elements Urine§	<i>Characterized Mean (±2SD Range)</i>	12.3 (10.9 - 13.7)	54.6 (51.9 - 57.3)	110 (104 -116)
	1150W (reduced)	10.4	62.3	113
	1450W (per method)	8.46	62.3	111
	1600W (increased)	10.5	61.4	111

§Purchased from Sero AS, Billingstad, Norway.

‡ Purchased from Wadsworth Center, New York State Department of Health



**Appendix A. Ruggedness Testing Results. (continued)**

Parameter Test #1 (Arsenic): Evaluate the impact on analysis results if the set RF Power is increased to 1600W (instrument maximum) or decreased to 1150W (by 20%) for the analytical run.

Test Details:

1. Three different RF power settings were tested in separately prepared, consecutive runs on the instrument without turning off the plasma. At least 15 minutes stabilization time was allowed between each run after the RF power was changed. "Junk urine" samples (40) were analyzed between the beginning and ending QC of each run. All other method parameters were kept per method.
2. Run #1 (method default, 1450W).
3. Run #2 (Decreased RF power by 20% to 1150W).
4. Run #3 (Increased RF power to instrument maximum, 1600W).

<b>Parameter Test 1 Results (Arsenic).</b> All concentrations in ug/L. Test performed 3/26/10 by Graylin Mitchell using ELAN DRC-2G.		
<b>QC Pool ID</b>	<b>RF Power Tested</b>	<b>As</b>
LU-04310_UMP_e	Characterized Mean	3.74
	Characterized 2SD Range	3.21 – 4.27
	Characterized 3SD Range	2.95 – 4.53
	1150W (Reduced)	3.72
	1450W (Per Method)	4.10
	1600W (Increased)	3.66
HU-04311_UMP_e	Characterized Mean	55.8
	Characterized 2SD Range	53.3 – 58.3
	Characterized 2SD Range	52.1 – 59.6
	1150W (Reduced)	55.6
	1450W (Per Method)	58.8
	1600W (Increased)	52.2

**Appendix A. Ruggedness Testing Results. (continued)**

Parameter Test #2 (cadmium and manganese): Evaluate the impact on analysis results if the cell gas flow rate is increased or decreased by 20% for the analytical run.

Test Details:

1. Three different cell gas flow rates were tested in separately prepared, consecutive runs on the instrument without turning off the plasma. Samples were prepared with diluent containing 400 ppm K and 60 ppb Mo in addition to the internal standards. At least 15 minutes stabilization time was allowed between each run after the cell gas flow rate was changed. "Junk urine" samples (20) were analyzed between the beginning and ending QC of each run
2. Run #1 (method default = 2.3 mL/min)
3. Run #2 (decreased cell gas flow rate by 20% to 1.8 mL/min).
4. Run #3 (increased cell gas flow rate by 20% to 2.75 mL/min).

<b>Parameter Test 2 Results (Table 1 of 2 for 15 element).</b> All concentrations in ug/L. Test performed 4/4/11 by Denise Tevis using ELAN DRC-2N.			
<b>Sample ID</b>	<b>Cell gas Flow Rate Tested</b>	<b>Cd</b>	<b>Mn</b>
LU-04310_UMP3_e	<i>Characterized Mean (±2SD Range)</i>	0.32 (0.28 - 0.36)	
	1.8 mL/min (reduced)	0.29	
	2.3 mL/min (per method)	0.29	
	2.75 mL/min (increased)	0.28	
HU-04311_UMP3_e	<i>Characterized Mean (±2SD Range)</i>	1.62 (1.47 - 1.78)	
	1.8 mL/min (reduced)	1.65	
	2.3 mL/min (per method)	1.62	
	2.75 mL/min (increased)	1.57	
Seronorm Trace Elements Urine§	<i>Characterized Mean (±2SD Range)</i>		12.3 (8.70 - 15.9)
	1.8 mL/min (reduced)		11.0
	2.3 mL/min (per method)		10.1
	2.75 mL/min (increased)		10.7

§Purchased from Sero AS, Billingstad, Norway.

Appendix A. Ruggedness Testing Results. (continued)

Parameter Test 2 Results (Table 2 of 2 for 15 element). All concentrations in ug/L. Test performed 4/4/11 by Denise Tevis using ELAN DRC-2N.			
Sample ID	Cell gas Flow Rate Tested	Cd	Mn
NYDOH UE 10-04‡	Characterized Mean (±2SD Range)		24.5 (19.7 - 29.3)
	1.8 mL/min (reduced)		27.0
	2.3 mL/min (per method)		24.4
	2.75 mL/min (increased)		26.2
NYDOH UE 10-10‡	Characterized Mean (±2SD Range)		2.1 (1.1 - 3.1)
	1.8 mL/min (reduced)		1.82
	2.3 mL/min (per method)		1.60
	2.75 mL/min (increased)		1.78

‡ Purchased from Wadsworth Center, New York State Department of Health

**Appendix A. Ruggedness Testing Results. (continued)**

Parameter Test #2 (Arsenic): Evaluate the impact on analysis results if the cell gas flow rate is increased or decreased by 20% for the analytical run.

Test Details:

1. Three different cell gas flow rates were tested in separately prepared, consecutive runs on the instrument without turning off the plasma. At least 15 minutes stabilization time was allowed between each run after the cell gas flow rate was changed. “Junk urine” samples (40) were analyzed between the beginning and ending QC of each run (diluent was prepared to a 1% HCl matrix so ArCl+ interference removal would be challenged).
2. Run #1 (method default = 0.95 mL/min).
3. Run #2 (decreased cell gas flow rate by 20% to 0.76 mL/min).
4. Run #3 (increased cell gas flow rate by 20% to 1.14 mL/min).

<b>Parameter Test 2 Results (Arsenic).</b>		
Test performed 5/13/10 by Graylin Mitchell using ELAN DRC2-G.		
<b>QC Pool ID</b>	<b>Cell Gas Flow Rate Tested</b>	<b>As (ug/L)</b>
LU-04310_UMP_e	<i>Characterized Mean</i>	3.74
	<i>Characterized 2SD Range</i>	3.21 – 4.27
	<i>Characterized 3SD Range</i>	2.95 – 4.53
	0.76 mL/min (Reduced)	4.35
	0.95 mL/min (Method Default)	4.02
	1.14 mL/min (Increased)	4.03
HU-04311_UIMP_e	<i>Characterized Mean</i>	55.8
	<i>Characterized 2SD Range</i>	53.3 – 58.3
	<i>Characterized 2SD Range</i>	52.1 – 59.6
	0.76 mL/min (Reduced)	57.6
	0.95 mL/min (Method Default)	54.2
	1.14 mL/min (Increased)	59.2

**Appendix A. Ruggedness Testing Results. (continued)**

Parameter Test #3 (DRC elements: cadmium and manganese): Evaluate the impact on analysis results if the RPq is increased or decreased by 20% for the analytical run.

Test Details:

1. Three RPq settings were tested for cadmium and manganese in separately prepared, consecutive runs on the instrument without turning off the plasma. Samples were prepared with diluent containing 400 ppm K and 60 ppb Mo in addition to the internal standards. At least 15 minutes stabilization time was allowed between each run after DRC RPq was changed. "Junk urine" samples (20) were analyzed between the beginning and ending QC of each run.
2. Run #1 (instrument default DRC RPq: 0.45).
3. Run #2 (~20% decrease; DRC RPq: 0.35).
4. Run #3 (~20% increase; DRC RPq: 0.55 ).

<b>Parameter Test 4 Results.</b> All concentrations in ug/L. Test performed 3/30/11 by Denise Tevis using ELAN DRC-2N.			
<b>Sample ID</b>	<b>RPQ Tested</b>	<b>Cd</b>	<b>Mn</b>
LU- LU- 04310_UMP3_e	<i>Characterized Mean</i> (±2SD Range)	0.32 (0.28 - 0.36)	
	0.35 (reduced)	0.32	
	0.45 (typical)	0.31	
	0.55 (increased)	0.29	
HU- HU- 04311_UMP3_e	<i>Characterized Mean</i> (±2SD Range)	1.62 (1.47 - 1.78)	
	0.35 (reduced)	1.58	
	0.45 (typical)	1.48	
	0.55 (increased)	1.46	
Seronorm Trace Elements Urine§	<i>Characterized Mean</i> (±2SD Range)		12.3 (8.70 - 15.9)
	0.35 (reduced)		10.7
	0.45 (typical)		11.8
	0.55 (increased)		11.0
NYDOH UE 09-06‡	<i>Characterized Mean</i> (±2SD Range)		31.1 (26.3 - 35.9)
	0.35 (reduced)		29.3
	0.45 (typical)		32.1
	0.55 (increased)		30.9
NYDOH UE 09-05‡	<i>Characterized Mean</i> (±2SD Range)		1.8 (1.0 - 2.6)
	0.35 (reduced)		1.28
	0.45 (typical)		1.41
	0.55 (increased)		1.29

§Purchased from Sero AS, Billingstad, Norway.

‡ Purchased from Wadsworth Center, New York State Department of Health

**Appendix A. Ruggedness Testing Results. (continued)**

**Parameter Test #3 (Arsenic):** Evaluate the impact on analysis results if the RPq is increased or decreased by 20% for the analytical run.

Test Details:

1. Three different RPQ settings were tested for Cadmium in separately prepared, consecutive runs on the instrument without turning off the plasma. At least 15 minutes stabilization time was allowed between each run after DRC RPQ was changed. “Junk urine” samples (40) were analyzed between the beginning and ending QC of each run. The diluent included 1% HCl.
2. Run #1 (previous method default DRC RPQ: 0.75).
3. Run #2 (decreased DRC RPQ 20%: 0.62).
4. Run #3 (increased DRC RPQ 20%: 0.88 ).
5. Additional test Run #4 (increased DRC RPQ: 0. 25).
6. Additional test Run #5 (increased DRC RPQ: 0. 45).

<b>Parameter Test 3 Results (Arsenic).</b>		
Test performed 3/18/10 by Gulchekhra Shakirova.		
<b>QC Pool ID</b>	<b>RPQ Tested</b>	<b>As (ug/L)</b>
LU-04310_UMP_e	<i>Characterized Mean</i>	3.74
	<i>Characterized 2SD Range</i>	3.21 – 4.27
	<i>Characterized 3SD Range</i>	2.95 – 4.53
	DRC RPQ: 0.38	3.92
	DRC RPQ: 0.48	3.93
HU-04310_UMP_e	DRC RPQ: 0.60	3.71
	DRC RPQ: 0.72	3.70
	<i>Characterized Mean</i>	55.8
	<i>Characterized 2SD Range</i>	53.3 – 58.3
	<i>Characterized 2SD Range</i>	52.1 – 59.6
HU-04310_UMP_e	DRC RPQ: 0.38	54.9
	DRC RPQ: 0.48	54.9
	DRC RPQ: 0.60	55.2
	DRC RPQ: 0.72	54.2

**Appendix A. Ruggedness Testing Results. (continued)**

Parameter Test #4 (cadmium and manganese): Evaluate the impact on analysis results if the axial field voltage (AFV) is increased or decreased by 20% for the analytical run.

Test Details:

1. Three different DRC AFV were tested in separately prepared, consecutive runs on the instrument without turning off the plasma. Samples were prepared with diluent containing 400 ppm K and 60 ppb Mo in addition to the internal standards. At least 15 minutes stabilization time was allowed between each run after the axial field voltage was changed. "Junk urine" samples (20) were analyzed between the beginning and ending QC of each run. The diluent including 60 ug/L Molybdenum.
2. Run #1 (instrument default DRC AFV = 375)
3. Run #2 (decreased DRC AFV by 20% to 300).
4. Run #3 (increased DRC AFV by 17% to 450).

<b>Parameter Test 4 Results.</b> All concentrations in ug/L. Test performed 4/5/11 by Denise Tevis using ELAN DRC-2N.			
Sample ID	AFV Tested	Cd	Mn
LU- 04310_UMP3_e	<i>Characterized Mean</i>	0.32	
	<i>(±2SD Range)</i>	(0.28 - 0.36)	
	300 (reduced)	0.32	
	375 (typical)	0.34	
HU- 04311_UMP3_e	<i>Characterized Mean</i>	1.62	
	<i>(±2SD Range)</i>	(1.47 - 1.78)	
	300 (reduced)	1.62	
	375 (typical)	1.64	
Seronom Trace Elements Urine§	<i>Characterized Mean</i>		12.3
	<i>(±2SD Range)</i>		(8.70 - 15.90)
	300 (reduced)		10.8
	375 (typical)		10.7
NYDOH UE 09-06‡	<i>Characterized Mean</i>		31.1
	<i>(±2SD Range)</i>		(26.3 - 35.9)
	300 (reduced)		32.0
	375 (typical)		32.0
NYDOH UE 10-06‡	<i>Characterized Mean</i>		1.4
	<i>(±2SD Range)</i>		(0.2 - 2.6)
	300 (reduced)		0.81
	375 (typical)		0.98
	450 (increased)		1.02

§Purchased from Sero AS, Billingstad, Norway.

‡ Purchased from Wadsworth Center, New York State Department of Health

**Appendix A. Ruggedness Testing Results. (continued)**

Parameter Test #4 (Arsenic): Evaluate the impact on analysis results if the axial field voltage (AFV) is increased or decreased for the analytical run.

Test Details:

1. Four different DRC AFV were tested in separately prepared, consecutive runs on the instrument without turning off the plasma. At least 15 minutes stabilization time was allowed between each run after the axial field voltage was changed. "Junk urine" samples (40) were analyzed between the beginning and ending QC of each run.
2. Run #1 (method default DRC AFV = 250)
3. Run #2 (increased DRC AFV to 300).
4. Run #3 (decreased DRC AFV to 200).

<b>Parameter Test 4 Results (Arsenic).</b>		
Test performed 6/2/10 by Graylin Mitchell using ELAN DRC2-G.		
<b>QC Pool ID</b>	<b>Axial Field Voltage Tested</b>	<b>As (ug/L)</b>
LU-04310_UMP_e	<i>Characterized Mean</i>	3.74
	<i>Characterized 2SD Range</i>	3.21 – 4.27
	<i>Characterized 3SD Range</i>	2.95 – 4.53
	200 (Reduced)	4.51
HU-04311_UMP_e	250 (Typical)	4.37
	300 (Increased)	4.08
	<i>Characterized Mean</i>	55.8
	<i>Characterized 2SD Range</i>	53.3 – 58.3
HU-04311_UMP_e	200 (Reduced)	54.2
	250 (Typical)	55.9
	300 (Increased)	54.0



**Appendix A. Ruggedness Testing Results. (continued)**

Parameter Test #5 (15 Element Panel): Method descriptions and SOP assume preparation and analysis on same day. Evaluate the impact on analysis results if the analytical run is prepared to analyze but circumstances do not allow for analysis to occur until 24 or 48 hours later.

Test Details:

1. Three separate run sets (A, B, and C) were prepared at one sitting from the same starting materials. Set 'A' was analyzed immediately per the assumption of the method. Set's 'B' and 'C' were stored at room temperature for 24 and 48 hours, respectively before analysis. "Junk urine samples (20) were analyzed between the beginning and ending QC of each run, making each a normal length run. All other method parameters were kept per method.
2. On day two, a fresh run set ("D") was prepared and analyzed immediately for comparison to results from set "B" (Run 2 of the day. Results not shown).
3. On day three, another fresh run set ("E") was prepared and analyzed immediately for comparison to results from set "C" (Run 2 of the day. Results not shown).

**Parameter Test 5 Results (Table 1 of 2 for 15 Element Panel).** All concentrations in ug/L. Test begun 3/23/11 by Denise Tevis using ELAN DRC-2N.

Sample ID	Time from Preparation to Analysis	Ba	Be	Cd	Co
LU-04310_UMP 3_e	<i>Characterized Mean (±2SD Range)</i>	0.76 (0.65 - 0.86)	0.69 (0.59 - 0.79)	0.32 (0.28 - 0.36)	0.42 (0.38 - 0.47)
	freshly prepared	0.70	0.66	0.32	0.32
	24 hours	0.70	0.69	0.31	0.42
	48 hours	0.86	0.67	0.31	0.43
HU-04311_UMP 3_e	<i>Characterized Mean (±2SD Range)</i>	5.01 (4.54 - 5.24)	5.28 (4.48 - 6.07)	1.62 (1.47 - 1.78)	1.88 (1.66 - 2.09)
	freshly prepared	5.55	3.48	1.75	1.67
	24 hours	4.66	5.76	1.57	1.94
	48 hours	5.12	5.49	1.67	1.84

‡Data are not statistically different according to the expected precision of the method (QC 3SD = 0.072)

Appendix A. Ruggedness Test #5 Results (continued)

Parameter Test 5 Results (Table 2 of 3 for 15 Element Panel). All concentrations in ug/L. Test begun 3/23/11 by Denise Tevis using ELAN DRC-2N.					
Sample ID	Time from Preparation to Analysis	Cs	Mo	Pb	Pt
LU-04310_UMP_e	Characterized Mean	2.38	19.3	0.42	0.10
	(±2SD Range)	(2.25 - 2.51)	(18.6 - 20.0)	(0.37 - 0.48)	(0.07 - 0.13)
	freshly prepared	2.32	18.9	0.41	0.09
	24 hours	2.35	19.2	0.44	0.11
	48 hours	2.30	19.0	0.46	0.10
HU-04311_UMP_e	Characterized Mean	9.82	136	2.95	0.85
	(±2SD Range)	(9.03 - 10.6)	(131 - 142)	(2.82 - 3.08)	(0.71 - 1.00)
	freshly prepared	10.6	133	2.89	1.02
	24 hours	9.36	134	3.08	1.03
	48 hours	10.0	132	3.04	1.12
Sample ID	Time from Preparation to Analysis	Sb	Tl	W	U
LU-04310_UMP_e	Characterized Mean	0.19	0.18	0.22	0.014
	(±2SD Range)	(0.17 - 0.21)	(0.17 - 0.19)	(0.19 - 0.24)	(0.011 - 0.016)
	freshly prepared	0.16	0.19	0.22	0.014
	24 hours	0.19	0.18	0.21	0.013
	48 hours	0.19	0.19	0.22	0.014
HU-04311_UMP_e	Characterized Mean	0.61	0.58	0.94	0.128
	(±2SD Range)	(0.60 - 0.71)	(0.55 - 0.61)	(0.90 - 0.99)	(0.115 - 0.141)
	freshly prepared	0.61	0.57	0.93	0.126
	24 hours	0.65	0.60	0.90	0.128
	48 hours	0.69	0.59	0.90	0.126

\* Data are not statistically different according to the expected precision of the method (QC 3SD = 0.02)

‡Data are not statistically different according to the expected precision of the method (QC 3SD = 0.2)

\*Data are not statistically different according to the expected precision of the method (QC 3SD = 1.08)

#Data are not statistically different according to the expected precision of the method (QC 3SD = 0.22)

Appendix A. Ruggedness Testing Results. (continued)

Parameter Test 5 Results (Table 3 of 3 for 15 Element Panel). All concentrations in ug/L. Test begun 3/23/11 by Denise Tevis using ELAN DRC-2N.				
Sample ID	Time from Preparation to Analysis	Mn	Sn	Sr
NYDOH UE09-05‡	<i>Characterized Mean</i> <i>(±2SD Range)</i>	1.37 (1.55 -1.19)	2.2 (2.0-2.8)	
	freshly prepared	0.98	2.8	
	24 hours	1.26	2.6	
	48 hours	1.47	2.6	
NYDOH UE09-06‡	<i>Characterized Mean</i> <i>(±2SD Range)</i>	31.1 (26.3 -35.9)	61 (55.0 - 67.0)	
	freshly prepared	23.8	68.5	
	24 hours	30.6	62.8	
	48 hours	31.9	61.4	
Seronorm Trace Elements Urine§	<i>Characterized Mean</i> <i>(±2SD Range)</i>	12.3 (10.9 - 13.7)	54.6 (51.9 - 57.3)	110 (104 -116)
	freshly prepared	8.47	62.3	111
	24 hours	10.9	57.5	112
	48 hours	10.4	58.3	114

§Purchased from Sero AS, Billingstad, Norway.

‡ Purchased from Wadsworth Center, New York State Department of Health

**Appendix A. Ruggedness Test #5 Results (continued)**

Parameter Test #5 (Arsenic): Method descriptions and SOP assume preparation and analysis on same day. Evaluate the impact on analysis results if the analytical run is prepared to analyze but circumstances do not allow for analysis to occur until 24 or 48 hours later.

Test Details:

1. Three separate run sets (A, B, and C) were prepared at one sitting from the same starting materials. Set 'A' was analyzed immediately per the assumption of the method. Set's 'B' and 'C' were stored at room temperature for 24 and 48 hours, respectively before analysis. "Junk urine samples (20) were analyzed between the beginning and ending QC of each run, making each a normal length run. All other method parameters were kept per method.
2. On day two, a fresh run set ("D") was prepared and analyzed immediately for comparison to results from set "B" (Run 2 of the day. Results not shown).
3. On day three, another fresh run set ("E") was prepared and analyzed immediately for comparison to results from set "C" (Run 2 of the day. Results not shown).

<b>Parameter Test 4 Results (Arsenic).</b>		
Test performed 5/26-28/10 by Graylin Mitchell using ELAN DRC2-G.		
<b>QC Pool ID</b>	<b>Axial Field Voltage Tested</b>	<b>As (ug/L)</b>
LU-04310_UMP_e	<i>Characterized Mean</i>	3.74
	<i>Characterized 2SD Range</i>	3.21 – 4.27
	<i>Characterized 3SD Range</i>	2.95 – 4.53
	Fresh Preparation	3.40
	After 24 Hours	3.37
	After 48 Hours	3.41
HU-04311_UMP_e	<i>Characterized Mean</i>	55.8
	<i>Characterized 2SD Range</i>	53.3 – 58.3
	Fresh Preparation	54.7
	After 24 Hours	53.8
	After 48 Hours	53.5

Appendix B

<b>Table 1. Instrument and Method Parameters. Parameters are the same for arsenic and the 15 element panel unless otherwise noted.</b>	
<b>Instrument:</b> PerkinElmer ELAN DRC <sup>Plus</sup> or DRC II ICP-MS	
<b>Autosampler:</b> ESI SC4 Autosampler with FAST sample introduction system	
<b>Optimization Window Parameters</b>	
RF power	1.45 KW
Plasma Gas Flow (Ar)	15 L/min
Auxiliary Gas Flow (Ar)	1.2 L/min
Nebulizer Gas Flow (Ar)	~0.90 – 1.0 L/min (optimized as needed for sensitivity)
Ion Lens Voltage(s)	AutoLens (optimized as needed for sensitivity)
QRO, CRO, CPV, Discriminator Threshold	Optimized per instrument by service engineer, or advanced user.
Parameters of x-y alignment, nebulizer gas flow, AutoLens voltages, mass calibration, and detector voltages are optimized regularly. Optimization file name = default.dac.	
<b>Configurations Window Parameters</b>	
Cell Gas Changes Pause Times	Pressurize Delay (From Standard to DRC) = 30 Exhaust Delay (From DRC to Standard mode) = 30 Flow Delay (Gas changes while in DRC mode) = 30 Channel Delay (channel change in DRC mode) = 30
<b>File Names &amp; Directories</b>	
Method file names	
Dataset	Create a new dataset subfolder each day. Name as "2011-0718" for all work done on July 18, 2011
Sample File	Create for each day's work
Report file name	<i>For sample results printouts</i> cdc_quant comprehensive_multielement.rop  <i>For calibration curve information</i> CDC_Quant Comprehensive (calib curve info).rop
Tuning	Default.tun
Optimization	Default.dac
Calibration	N/A
Polyatomic	elan.ply
Report Options Template (transferring results to the database)	CDC_Database Output.rop <i>Report Format Options: select only "Use Separator"</i> <i>File Write Option: Append</i> <i>Report File name: include date, instrument, and group being analyzed in file name (i.e. 2005-0311b_DRC2A_HM-0364.txt)</i>
<b>Method Parameters</b>	
<b>Method Parameters: Timing Page (see Figures 2a and 3a in the Appendix)</b>	
Sweeps/reading	70
Readings/replicate	1
Replicates	3
Enable QC Checking	Off

Table 1. Instrument and Method Parameters. Parameters are the same for arsenic and the 15 element panel unless otherwise noted.	
Isotopes Monitored and Internal Standard Associations (Exact Mass)	<p><b>For Arsenic</b>            (use <math>^{71}\text{Ga}</math> as an internal standard)  <math>^{71}\text{Ga}</math> (70.9249), <math>^{75}\text{As}</math> (74.9216)</p> <p><b>For 15 Element Panel</b></p> <p><b>Group 1</b> (use <math>^{103}\text{Rh}</math> as an internal standard)  <math>^9\text{Be}</math> (9.0122), <math>^{59}\text{Co}</math> (58.9332), <math>^{88}\text{Sr}</math> (87.9056), <math>^{98}\text{Mo}</math> (97.9055), <math>^{103}\text{Rh}</math> (102.905), <math>^{118}\text{Sn}</math> (117.902), <math>^{121}\text{Sb}</math> (120.904), <math>^{133}\text{Cs}</math> (132.905), <math>^{138}\text{Ba}</math> (137.905)</p> <p><b>Group 2</b> (use <math>^{193}\text{Ir}</math> as an internal standard)  <math>^{184}\text{W}</math> (183.951), <math>^{193}\text{Ir}</math> (192.963), <math>^{195}\text{Pt}</math> (194.965), <math>^{205}\text{Tl}</math> (204.975), <math>^{208}\text{Pb}</math> (207.977), <math>^{238}\text{U}</math> (238.05)</p> <p><b>Group 3</b> (use <math>^{103}\text{Rh}</math> as an internal standard)  <math>^{103}\text{Rh}</math> (102.905), <math>^{114}\text{Cd}</math> (113.904), <math>^{55}\text{Mn}</math> (54.9381),</p>
Dwell Times	<p><b>30 ms</b> for <math>^{59}\text{Co}</math>, <math>^{88}\text{Sr}</math>, <math>^{98}\text{Mo}</math>, <math>^{118}\text{Sn}</math>, <math>^{103}\text{Rh}</math> in Standard mode, <math>^{121}\text{Sb}</math>, <math>^{133}\text{Cs}</math>, <math>^{138}\text{Ba}</math>, <math>^{184}\text{W}</math>, <math>^{193}\text{Ir}</math>, <math>^{205}\text{Tl}</math>, and <math>^{208}\text{Pb}</math></p> <p><b>50 ms</b> for <math>^{71}\text{Ga}</math>, <math>^{75}\text{As}</math> and <math>^{55}\text{Mn}</math> in DRC mode</p> <p><b>100 ms</b> for <math>^9\text{Be}</math>, <math>^{195}\text{Pt}</math>, <math>^{238}\text{U}</math>, <math>^{103}\text{Rh}</math> in DRC mode, and <math>^{114}\text{Cd}</math></p>
Scan Mode	Peak Hopping for all isotopes (1 MCA channel)
DRC channel A Gas Flow Rate	<p><b>For Arsenic</b>            10% hydrogen / 90% argon            (5-7 psig delivery pressure)</p> <p>Typically 0.7 to 1.3 mL/min *            *(optimized per instrument, and periodically verified)</p> <p><b>For 15 Element Panel</b>            Not used.</p>
DRC channel B Gas Flow Rate	<p><b>For Arsenic</b>            Not used.</p> <p><b>For 15 Element Panel</b>            Oxygen (5-7 psig delivery pressure)            Typically 2.0 – 2.5 mL/min *            * (optimized instrument, and periodically verified)</p>
RPa	0 for all isotopes

**Table 1. Instrument and Method Parameters. Parameters are the same for arsenic and the 15 element panel unless otherwise noted.**

RPq	<p><b>For Arsenic</b>  <i>DRC Mode (As group):</i> Typically* 0.65 - 0.75 for <sup>71</sup>Ga (70.9249), <sup>75</sup>As (74.9216). Use the same RPQ for each.</p> <p><b>For 15 Element Panel</b>  <i>Standard Mode:</i> 0.25 for all standard mode isotopes  <i>DRC Mode (Cd and Mn group):</i> default 0.45 *, typical range 0.35 - 0.55 for <sup>114</sup>Cd (113.904) and <sup>55</sup>Mn (54.9381), and <sup>103</sup>Rh (102.905) in DRC mode. Use the same RPQ for each.          (* Optimize per instrument, and periodically verified)</p>
<b>Method Parameters: Processing Page (see Figures 2b and 3b in the Appendix)</b>	
Detector mode	Pulse
Process Spectral Peak	N/A
AutoLens	On
Isotope Ratio Mode	Off
Enable Short Settling Time	Off
Blank subtraction	After internal standard
Measurement units	Cps
Process Signal Profile	N/A
<b>Method Parameters: Equations Page (see Figures 2c and 3c in the Appendix)</b>	
Equations	<p>On <sup>208</sup>Pb, use "+ Pb 206 + Pb 207"</p> <p>On <sup>238</sup>U, use "+ U 235"</p> <p>On 114Cd, use "- 0.027250 * Sn 118"</p>
<b>Method Parameters: Calibration Page (see Figures 2d and 3d in the Appendix)</b>	
Calibration Type	External Std.
Curve type	Simple Linear
Sample units	"µg/L" or "ppb"
Calibration Standard Concentrations (µg/L)	<p>Be: 0.1, 0.3, 1, 3, 10</p> <p>Co: 0.075, 0.225, 0.75, 2.25, 7.5</p> <p>Sr: 3, 9, 30, 90, 300</p> <p>Mo: 3, 9, 30, 90, 300</p> <p>Sn: 0.3, 0.9, 3, 9, 30</p> <p>Sb: 0.08, 0.24, 0.8, 2.4, 8</p> <p>Cs: 0.2, 0.6, 2, 6, 20</p> <p>Ba: 0.2, 0.6, 2, 6, 20</p> <p>W: 0.06, 0.18, 0.6, 1.8, 6</p> <p>Pt: 0.025, 0.075, 0.25, 0.75, 2.5</p> <p>Tl: 0.04, 0.12, 0.4, 1.2, 4</p> <p>Pb: 0.1, 0.3, 1, 3, 10</p> <p>U: 0.005, 0.015, 0.05, 0.15, 0.5</p> <p>Cd: 0.08, 0.24, 0.8, 2.4, 8</p> <p>Mn: 0.1, 0.3, 1, 3, 10</p> <p>As: 2, 6, 20, 60, 200</p>
<b>Method Parameters: Sampling Page (see Figures 2e and 3e in the Appendix)</b>	

<b>Table 1. Instrument and Method Parameters. Parameters are the same for arsenic and the 15 element panel unless otherwise noted.</b>	
“Peristaltic Pump Under Computer Control”	On
Autosampler Tray Port Sampling Device	<p><b><i>If using ESI autosampler</i></b>            Autosampler Type: AS-93plus            Tray Name: esi.try            (either use shortcut in C:\Elandata\Autosampler\AS-93 or link to file in C:\program files\esi\esi sc\esi.try)            Port: GPIB1            Sampling Device: None</p> <p><b><i>If using other autosampler</i></b>            Refer to autosampler user guide.</p>
Sample Flush	<p><b><i>FAST Defaults For Arsenic</i></b>            6s at 6 rpm (standard ELAN peristaltic pump)            6s at 3rpm (ESI micro-peristaltic pump)</p> <p><b><i>FAST Defaults For 15 Element Panel</i></b>            6s at 6 rpm (standard ELAN peristaltic pump)            6s at 3rpm (ESI micro-peristaltic pump)</p> <p>Can be optimized as needed to adequately fill the FAST loop. As a matter of lab practice, set this time to equal the loop fill time in the ESI FAST program. As long as the combined time of sample flush + read delay is equal to the time required for signal to reach stability, analytical measurement will be good.</p>
Read Delay	<p><b><i>Default For Arsenic</i></b>            24s at 6 rpm (standard ELAN peristaltic pump)            24s at 3rpm (ESI micro-peristaltic pump)</p> <p><b><i>Default For 15 Element Panel</i></b>            30s at 6 rpm (standard ELAN peristaltic pump)            30s at 3rpm (ESI micro-peristaltic pump)</p> <p>Can be optimized as needed to reach signal stability before beginning analysis. As a matter of lab practice, set this time equal to the total time required for the signal to reach stability minus the loop fill time. As long as the combined time of sample flush + read delay is equal to the time required for signal to reach stability, analytical measurement will be good.</p>



<b>Table 1. Instrument and Method Parameters. Parameters are the same for arsenic and the 15 element panel unless otherwise noted.</b>	
Wash	<p><b>Default For Arsenic</b>            20s at 6 rpm (standard ELAN peristaltic pump)            20s at 3rpm (ESI micro-peristaltic pump)</p> <p>Can be optimized to allow for changes in FAST loop rinsing (must be greater than total time of steps in FAST program after the initial “on rinse” command).</p> <p><b>Default For 15 Element Panel</b>            50s at 6 rpm (standard ELAN peristaltic pump)            50s at 3 rpm (default for entire panel)</p>
Autosampler Locations of Blanks and Standards	<p><b>For Arsenic</b>  <i>For calibration curve (points to urine blank)</i>            CDC_UMP3_DLS3018A_Urine Arsenic_urblk.mth            Urine Blank and Calibration Stds 1 – 5 in autosampler positions 102 – 107 by default, but can be customized.</p> <p><i>For QC &amp; patient sample analysis (points to aqueous blank)</i>            CDC_UMP3_DLS3018A_Urine Arsenic_aqblk.mth            Aqueous Blank in autosampler position 119, but can be customized.</p> <p><b>For 15 Element Panel</b>  <i>For calibration curve (points to urine blank)</i>            CDC_UMP3_DLS3018_15 elem_urblk.mth            Urine Blank and Calibration Stds 1 – 5 in autosampler positions 101 – 106, but can be customized.</p> <p><i>For QC &amp; patient sample analysis (points to aqueous blank)</i>            CDC_UMP3_DLS3018_15 elem_aqblk.mth            Aqueous Blank in autosampler position 119, but can be customized.</p>
<p><b>FAST Parameters: See Figures 4a through 4g in Appendix B for details</b></p>	
Configuration File	default.sc (saved at C:\Program Files\ESI\ESI-SC)
FAST program	<p><b>For Arsenic</b>            CDC_UMP3_DLS3018A_Urine Arsenic_SCFAST.txt</p> <p><b>For 15 Element Panel</b>            Urine 15 element_mthUMP3_DLS3018_SCFAST.txt</p>

**Table 1. Instrument and Method Parameters. Parameters are the same for arsenic and the 15 element panel unless otherwise noted.**

<b>Potential Emergency Response Modifications:</b>	
<u>Cadmium:</u>	Analyze cadmium in standard mode with rhodium as the internal standard. Set dwell time to 50ms, DRC gas flow to 0, and RPq to 0.25.
<u>Arsenic:</u>	<ul style="list-style-type: none"> <li>• Use pure argon in place of 10% hydrogen 90% argon for the DRC gas. A tee can be setup on the main argon delivery line for the ICP-MS to provide this argon for the DRC. No modifications of the DRC gas flow rate necessary.</li> <li>• Analyze arsenic along with the 15-element method to create a 16-element panel. Diluent and reagents should not include ethanol. Use revised QC limits for arsenic (will have “_CT” at the end of the QC pool name).</li> </ul>
<u>Non-FAST sample introduction system:</u>	<p>If the FAST sample introduction system is not available on any instruments, the method can still be implemented, but these changes will need to be made in the ELAN (and ESI software if present).</p> <ul style="list-style-type: none"> <li>• <u>Sample Flush:</u> Default is ~90s at 10 rpm. Set so that solution reaches nebulizer.</li> <li>• <u>Read Delay:</u> Default is 20s at 10rpm. Set for best reproducibility of replicate measured intensities.</li> <li>• <u>Wash:</u> Default is 120s at 24rpm. Set to prevent significant carry-over from one sample to the next.</li> <li>• If using ESI autosampler without FAST, disable FAST in the ESI software before running analysis.</li> </ul>

Appendix B (continued)

Table 2. Suggested maximum analyte concentrations for base urine.	
Analyte	Concentration ( $\mu\text{g/L}$ )
Be	0.5
Co	0.25
Mo	30
Sb	0.2
Cs	3
Ba	2
W	0.2
Pt	0.25
Tl	0.2
Pb	0.75
U	0.03
Cd	0.25
Mn	0.1
Sr	80
Sn	3
As	5

**Table 3. Concentrations of Analytes in the Multi-Element Stock Standard from High Purity Standards.**

Analyte	Stock Calibration Standard Conc. (mg/L) High Purity Standards Item # SM-2107-029	Stock Calibration Verification Standard Conc. (mg/L) High Purity Standards Item # SM-2107-035
Be	10	200 <sup>A</sup>
Co	7.5	300 <sup>A</sup>
Mo	300	1800 <sup>B</sup>
Sb	8	200 <sup>A</sup>
Cs	20	1000 <sup>C</sup>
Ba	20	300 <sup>B</sup>
W	6	200 <sup>A</sup>
Pt	2.5	700 <sup>D</sup>
Tl	4	50 <sup>A</sup>
Pb	10	500 <sup>A</sup>
U	0.5	40 <sup>B</sup>
As	200	6000 <sup>A</sup>
Cd	8	200 <sup>A</sup>
Sr	300	8000 <sup>D</sup>
Sn	30	600 <sup>A</sup>
Mn	10	200 <sup>A</sup>
<sup>A</sup> Solution A: HNO <sub>3</sub> (10%), HF (0.5%) <sup>B</sup> Solution B: HCl (10%), trace HNO <sub>3</sub> <sup>C</sup> Solution C: HCl (1%) <sup>D</sup> Solution D: HCl (5%)		

Appendix B (continued)

Table 4. Preparation of Multi-element Intermediate Working Standards					
Standard #	1	2	3	4	5
Volume of Flask (mL)	500	200	100	100	100
Volume Spike of Int. Stock Std. (mL)	0.050	0.060	0.100	0.300	1.00
	<b>Concentrations (ug/L)<sup>‡</sup></b>				
Be*	1 (0.1) <sup>‡</sup>	3 (0.3) <sup>‡</sup>	10 (1.0) <sup>‡</sup>	30 (3.0) <sup>‡</sup>	100 (10.0) <sup>‡</sup>
Co*	0.75 (0.075) <sup>‡</sup>	2.25 (0.225) <sup>‡</sup>	7.5 (0.75) <sup>‡</sup>	22.5 (2.25) <sup>‡</sup>	75 (7.5) <sup>‡</sup>
Mo*	30 (3.0) <sup>‡</sup>	90 (9.0) <sup>‡</sup>	300 (30) <sup>‡</sup>	900 (90) <sup>‡</sup>	3000 (300) <sup>‡</sup>
Sb*	0.8 (0.08) <sup>‡</sup>	2.4 (0.24) <sup>‡</sup>	8 (0.8) <sup>‡</sup>	24 (2.4) <sup>‡</sup>	80 (8.0) <sup>‡</sup>
Cs*	2 (0.2) <sup>‡</sup>	6 (0.6) <sup>‡</sup>	20 (2.0) <sup>‡</sup>	60 (6.0) <sup>‡</sup>	200 (20) <sup>‡</sup>
Ba*	2 (0.2) <sup>‡</sup>	6 (0.6) <sup>‡</sup>	20 (2.0) <sup>‡</sup>	60 (6.0) <sup>‡</sup>	200 (20) <sup>‡</sup>
W <sup>†</sup>	0.6 (0.06) <sup>‡</sup>	1.8 (0.18) <sup>‡</sup>	6 (6.0) <sup>‡</sup>	18 (1.8) <sup>‡</sup>	60 (6.0) <sup>‡</sup>
Pt <sup>†</sup>	0.25 (0.025) <sup>‡</sup>	0.75 (0.075) <sup>‡</sup>	2.5 (0.25) <sup>‡</sup>	7.5 (0.75) <sup>‡</sup>	25 (2.5) <sup>‡</sup>
Tl <sup>†</sup>	0.4 (0.04) <sup>‡</sup>	1.2 (0.12) <sup>‡</sup>	4 (0.4) <sup>‡</sup>	12 (1.2) <sup>‡</sup>	40 (4.0) <sup>‡</sup>
Pb <sup>†</sup>	1 (0.1) <sup>‡</sup>	3 (0.3) <sup>‡</sup>	10 (1.0) <sup>‡</sup>	30 (3.0) <sup>‡</sup>	100 (10) <sup>‡</sup>
U <sup>†</sup>	0.05 (0.005) <sup>‡</sup>	0.15 (0.015) <sup>‡</sup>	0.5 (0.05) <sup>‡</sup>	1.5 (0.15) <sup>‡</sup>	5 (0.5) <sup>‡</sup>
Cd*	0.8 (0.08) <sup>‡</sup>	2.4 (0.24) <sup>‡</sup>	8 (0.8) <sup>‡</sup>	24 (2.4) <sup>‡</sup>	80 (8.0) <sup>‡</sup>
Sr	30 (3.0) <sup>‡</sup>	90 (9.0) <sup>‡</sup>	300 (30) <sup>‡</sup>	900 (90) <sup>‡</sup>	3000 (300) <sup>‡</sup>
Sn	3 (0.3) <sup>‡</sup>	9 (0.9) <sup>‡</sup>	30 (3.0) <sup>‡</sup>	90 (9.0) <sup>‡</sup>	300 (30) <sup>‡</sup>
Mn*	1 (0.1) <sup>‡</sup>	3 (0.3) <sup>‡</sup>	10 (1.0) <sup>‡</sup>	30 (3.0) <sup>‡</sup>	100 (10) <sup>‡</sup>
As <sup>¥</sup>	20 (2.0) <sup>‡</sup>	60 (6.0) <sup>‡</sup>	200 (20) <sup>‡</sup>	600 (60) <sup>‡</sup>	2000 (200) <sup>‡</sup>
<p>* Rh-103 used as internal standard            † Ir-193 used as internal standard            ¥ Ga-71 used as internal standard            ‡ A further 1:10 dilution occurs when added to base urine. Enter concentrations in parentheses into the ELAN software (method window, calibration page).</p>					

Appendix B (continued)

<b>Table 5. Acceptable ways to perform two consecutive analytical runs, bracketing with bench quality control samples.</b>	
<b>Setup 1</b>	<b>Setup 2 (typical)</b>
<p><i>Run #1</i>            Calibration Standards            Low Bench QC            High Bench QC                patient samples            Low Bench QC            High Bench QC</p> <p><i>Run #2</i>            Low Bench QC            High Bench QC                patient samples            Low Bench QC            High Bench QC</p>	<p><i>Run #1</i>            Calibration Standards            Low Bench QC            High Bench QC                patient samples            Low Bench QC            High Bench QC</p> <p><i>Run #2</i>            Calibration Standards            Low Bench QC            High Bench QC                patient samples            Low Bench QC            High Bench QC</p>

Appendix B (continued)

<b>Table 6. A typical SAMPLE/BATCH window.</b>			
<u>AS Location*</u>	<u>Sample ID</u>	<u>Measurements Action</u>	<u>Method</u>
236	DRCstability1	Run sample	...15elem_urblk.mth
236	DRCstability2	Run sample	...15elem_urblk.mth
236	DRCstability3	Run sample	...15elem_urblk.mth
236	DRCstability4	Run sample	...15elem_urblk.mth
Continue DRC stability samples . . .			
236	DRCstability9	Run sample	...15elem_urblk.mth
236	DRCstability10 <sup>£</sup>	Run sample	...15elem_urblk.mth
101	UrBlkChk1	Run blank, standards, and sample **	...15elem_urblk.mth
113	UrBlkChk2	Run sample	...15elem_urblk.mth
120	Aq Blk Check	Run blank and sample ‡	...15elem_aqblk.mth
130	L Bench QC	Run sample	...15elem_aqblk.mth
160	H Bench QC	Run sample	...15elem_aqblk.mth
301	Sample 1	Run sample	...15elem_aqblk.mth
302	Sample 2	Run sample	...15elem_aqblk.mth
303	Sample 3	Run sample	...15elem_aqblk.mth
129	L Bench QC	Run sample	...15elem_aqblk.mth
159	H Bench QC	Run sample	...15elem_aqblk.mth

\* The exact autosampler positions of QCs and patient samples do not have to be those shown above, but the order in which these are run should be as shown above.

\*\* When executing this row, the ELAN will first analyze the urine blank at AS position 114, then standards 1-5 at autosampler positions 102-106, then the "UrBlkChk1" sample at A/S position 100. The sampling information about AS positions 102-106 are stored in the "urblk" method file and can be customized.

‡ When executing this row, the ELAN will first analyze the aqueous blank at AS position 119, then the "Aq Blk Check" at AS position 120. The sampling information about AS positions 119 is stored in the "urblk" method file and can be customized.

£ A larger number of DRC stability samples will need to be analyzed to make this stability period 1-1.5 hrs when measuring only arsenic (~55 measurements = 1hour).

Appendix B (continued)

<b>Table 7. Preparation of samples, working standards, and QC materials for analysis</b>					
Total volume of prepared sample may be changed, from what is presented here. However, volumes for each component should be adjusted proportionally.					
<b>Dilution ID</b>	<b>Water (µL)</b>	<b>Base Urine (µL)</b>	<b>AQ Intermediate Working Standard (µL)</b>	<b>Patient or QC urine sample (µL)</b>	<b>Diluent (µL)</b>
AQ Blank	1000	-	-	-	9000 *
Urine Blank and UrBlkChk	100	900	-	-	9000 *
Working Calibration Standards	-	900	100	-	9000 *
Patient Urine or Urine-Based QC	-	-	-	500	4500
Patient Urine <i>2x Dilution</i> <sup>H</sup>	500	-	-	500	9000 *
Patient Urine <i>10x Dilution</i> <sup>H</sup>	900	-	-	100	9000*
* 9000 µL diluent is best dispensed from the Digiflex™ as 2 4500-µL portions (i.e.- When preparing a Working Calibration Standard dilution, dispense 4500 µL diluent + 100 µL water in one cycle of Digiflex™, then 4500 µL diluent + 900 µL base urine in the next cycle of the Digiflex™ to prepare a 10 mL total volume dilution.)					
<sup>H</sup> Extra dilution is performed on urine samples whose concentration is greater than the concentrations listed in Table 8 in the Appendix (linearity of the method has been documented up to these concentrations). Any extra level of dilution can be prepared as long as the 9:10 ratio of diluent to total dilution volume is maintained. Use of the lowest possible dilution level is preferred because matrix differences may lead to different observed concentration results as the sample dilution becomes greater (i.e. 2x dilution is preferred over 10x if 2x is sufficient to dilute analyte into the documented linearity range).					



Appendix B (continued)

<b>Table 8. Range of Reporting and Calibration Verification Concentrations</b>				
<b>Standard #</b>	<b>CV-1</b>		<b>CV-2</b>	<b>CV-3</b>
<b>Volume of Flask (mL)</b>	100		100	100
<b>Volume Spike of Int. Stock Std. (mL)</b>	Sol A	0.150	0.250	0.500
	Sol B	0.100	0.500	1.000
	Sol C	0.025	0.125	0.250
	Sol D	0.050	0.100	0.200
<b>Analyte</b>	<b>Concentration (ug/L)</b>			
Be*	300 (30) ‡	500 (50) ‡	1,000 (100) ‡	
Co*	450 (45) ‡	750 (75) ‡	1,500 (150) ‡	
Mo*	1,800 (180) ‡	9,000 (900) ‡	18,000 (1,800) ‡	
Sb*	300 (30) ‡	500 (50) ‡	1,000 (100) ‡	
Cs*	250 (25) ‡	1,250 (125) ‡	2,500 (250) ‡	
Ba*	300 (30) ‡	1,500 (150) ‡	3,000 (300) ‡	
W†	300 (30) ‡	500 (50) ‡	1,000 (100) ‡	
Pt†	350 (35) ‡	700 (70) ‡	1,400 (140) ‡	
Tl†	75 (7.5) ‡	125 (12.5) ‡	250 (25) ‡	
Pb†	750 (75) ‡	1,250 (125) ‡	2,500 (250) ‡	
U†	40 (4) ‡	200 (20) ‡	400 (40) ‡	
Cd*	300 (30) ‡	500 (50) ‡	1,000 (100) ‡	
Mn	300 (30) ‡	500 (50) ‡	1,000 (100) ‡	
Sr	4,000(400) ‡	8,000 (800) ‡	16,000 (1600) ‡	
Sn	900 (90) ‡	1,500 (150) ‡	3000 (300) ‡	
As‡	9,000 (900) ‡	15,000 (1,500) ‡	30,000 (3,000) ‡	
* Rh-103 used as internal standard † Ir-193 used as internal standard ‡ Ga-71 used as internal standard ‡ A further 1:10 dilution occurs when added to base urine.				

**\* If observed results are not within 10% of target, investigate the problem with the involvement of the lab supervisor.**

Appendix B (continued)

<b>Table 9. Boundary Concentrations for Urine Concentrations (µ/L).</b>			
<b>Analyte</b>	<b>1<sup>st</sup> Upper Boundary ("1UB") *</b>	<b>2<sup>nd</sup> Upper Boundary ("2UB") **</b>	<b>Range Maximum ("Lim Rep Delta") †</b>
Be	0.2	0.4	0.3
Co	2.83	5.66	0.3
Mo	293.5	587	4.0
Sb	0.8	1.6	0.2
Cs	16.5	33	0.5
Ba	17.1	34.2	0.4
W	1.38	2.76	0.2
Pt	0.2	0.4	0.2
Tl	0.62	1.24	0.2
Pb	7.8	15.6	0.3
U	0.277	0.554	0.03
Cd	2.54	5.08	0.3
Mn	4	8	0.2
Sr	400	800	3
Sn	25	50	0.5
As	100	200	10

\* Typically, the 1<sup>st</sup> upper boundary (1UB) is the 99<sup>th</sup> percentile of non-weighted, non-creatinine corrected concentration results from the NHANES 1999-2000 subset groups. Concentrations observed greater than the "first upper boundary" (defined in the laboratory database as the "1UB") should be confirmed by repeat analysis of a new sample preparation. The concentration assigned to the 1UB for an element is determined by study protocol but default concentrations are listed in this table. Report the original result, as long as the confirmation is within 10% of the original. Continue repeat analysis until a concentration can be confirmed.

\*\* Typically the 2<sup>nd</sup> upper boundary (2UB) is set to 2x the 1UB. At the discretion of the supervisor, the 1UB may vary per study according to the concerns of the study. Regardless of the study, report patient results confirmed to be greater than the 2UB to the QC reviewer as an "elevated result".

† Range maximum is the range of the three replicate readings for a single sample analysis. This value is also called the "Lim RepDelta" in the database which handles data for the Inorganic and Radiation Analytical Toxicology Branch. If the range of replicate readings is greater than the range maximum, and represents greater than a 10% relative standard deviation for the measurement, do not use the measurement for reporting.

Appendix B (continued)

**Table 10. Reference Ranges for Urine Concentrations (from the Third National Report on Exposure to Environmental Chemicals [14] ). All results in µg/L.**

Analyte	Survey Years	Geometric Mean	50 <sup>th</sup>	75 <sup>th</sup>	90 <sup>th</sup>	95 <sup>th</sup>	N
Be	99-00	≤ 0.13 *	≤ 0.13	≤ 0.13	≤ 0.13	≤ 0.13	2465
	01-02	≤ 0.13	≤ 0.13	≤ 0.13	≤ 0.13	≤ 0.13	2690
Co	99-00	0.375	0.400	0.630	0.940	1.32	2465
	01-02	0.379	0.410	0.610	0.930	1.27	2690
Mo	99-00	45.9	50.7	84.9	134	178	2257
	01-02	45.0	52.4	83.3	124	165	2690
Sb	99-00	0.132	0.130	0.210	0.330	0.420	2276
	01-02	0.134	0.130	0.180	0.260	0.340	2690
Cs	99-00	4.35	4.80	7.10	9.60	11.4	2464
	01-02	4.81	5.49	7.91	10.4	12.6	2690
Ba	99-00	1.50	1.50	3.00	5.40	6.80	2180
	01-02	1.52	1.63	3.12	5.22	7.48	2690
W	99-00	0.093	0.090	0.180	0.320	0.500	2338
	01-02	0.082	0.060	0.150	0.300	0.450	2652
Pt	99-00	≤ 0.04 **	≤ 0.04	≤ 0.04	≤ 0.04	≤ 0.04	2465
	01-02	≤ 0.04	≤ 0.04	≤ 0.04	≤ 0.04	≤ 0.04	2690
Tl	99-00	0.176	0.200	0.280	0.400	0.450	2413
	01-02	0.165	0.180	0.270	0.360	0.440	2653
Pb	99-00	0.766	0.800	1.30	2.10	2.90	2465
	01-02	0.677	0.600	1.20	2.00	2.60	2690
U	99-00	0.008	0.007	0.013	0.026	0.046	2464
	01-02	0.009	0.008	0.014	0.029	0.046	2690
Cd	99-00	0.193	0.232	0.475	0.858	1.20	2257
	01-02	0.210	0.229	0.458	0.839	1.20	2690
As †	See Table 11 in Appendix B for urine arsenic reference values.						
<p>* Results were lower than the method detection limit of 0.13 µg/L.          ** Results were lower than the method detection limit of 0.04 µg/L.          † Urine As was not included in the Third National Report on Exposure to Environmental Chemicals.</p>							

Appendix B (continued)

<b>Table 11. References to Total Urine Arsenic Concentrations</b>		
<u>Reference</u>	<u>Concentration (µg/L)</u>	<u>Group Type Sampled</u>
<b>Normal</b>		
Stokinger, 1981 [15]	<100	
Fowler, 1977 [16]	15	
Iffland, 1994 [17]	1 – 80 (Generally < 10)	
<b>Elevated</b>		
Iffland, 1994 [17]	300	After seafood consumption
	200	Copper smelter workers
	5 - 952 vs. 5 - 365	Wood treatment workers vs. comparison group (11)
	25.9 – 667	Seafood-preferring population
	74.1 378.1	Low-Inhalation exposure High-Inhalation exposure (12)
Gerhardsson et al., 1996 [18]	50 – 100	High intake of seafood or increased exposure of inorganic arsenic from food or air

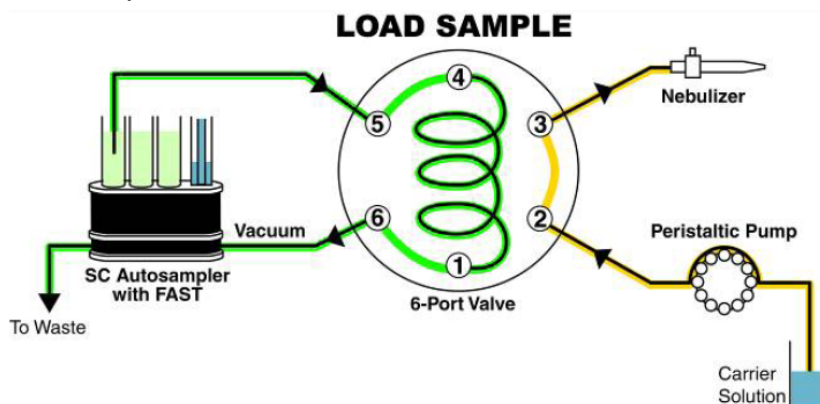
Appendix B (continued)

<b>Table 12.</b> Reference to urine Mn, Sn, or Sr concentrations			
Analyte	Reference	Concentration (ug/L)	Group Type Sampled
<b>Normal (i.e. non-exposed)</b>			
Mn	Health Canada, 2010[19]	0.15	General population
Mn	Heitland et al., 2006[20]	0.1	German children
Mn	Heitland et al., 2006[20]	0.087	German adults
Mn	Paschal et al., 1998[21]	1.19	NHANES III
Mn	ASTDR[22]	1 to 8	General population
Sr	Heitland et al., 2006[20]	154	German children
Sr	Heitland et al., 2006[20]	166	German adults
Sr	Usuda et al., 2006	143.9 <sup>‡</sup>	Japanese adults
Sn	Heitland et al., 2006[20]	1.2	German children
Sn	Heitland et al., 2006[20]	8.6	German adults
Sn	Paschal et al., 1998[21]	6.29	NHANES III
<b>Elevated (exposed)</b>			
Mn	Moreno et al., 2010[23]	5.2	Children living in a mine tailings zone in Mexico
Mn	Gil et al., 2011[24]	0.43 +/- 4,00	Iron and steel industry workers in Spain
Mn	Wang et al., 2011[25]	3.15 +/- 3.45	e-waste dismantling workers in China
Sr	Moreno et al., 2010[23]	49.2	Children living in a mine tailings zone in Mexico
Sn	Juliao et al., 2007[26]	0.45 +/- 0.93	Workers in a niobium mine in Brazil
<sup>‡</sup> concentration is a geometric mean and measurements were made via ICP-AES			

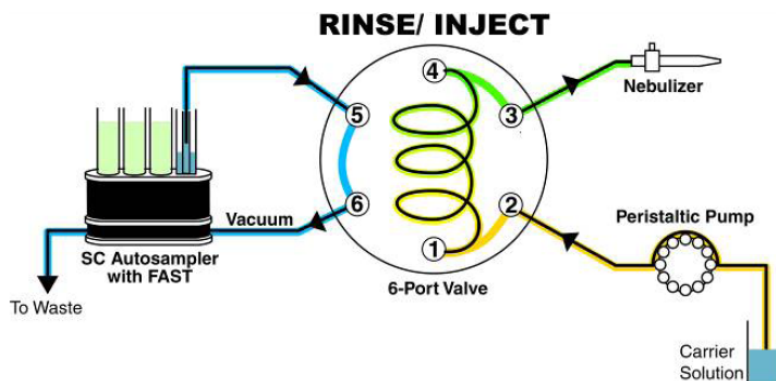
Appendix B (continued): Figures

Figure 1a. Configuration of tubing and devices for liquid handling using FAST sample introduction.

Below shows the correct connections to the 6-port FAST valve. The two diagrams show the differences in liquid flow directions when the valve changes from “Load” to “Inject”. This change is internal to the valve. The shift of the valve cannot be seen, but it can be heard, and felt (with hand on the valve). The light indicators on the actuator body also indicate the valve position.



Teflon vacuum pump loads sample into loop while carrier solution is nebulized



Carrier solution pushes sample into nebulizer at the same time sample line is rinsed

The connections to the valve are color-coded (see section 7.a.2).

Enable the FAST program in the ESI software before running the method, but optimizations can be done in either FAST or non-FAST mode.

Appendix B (continued).

Figure 2a. ELAN ICP-DC-MS Method Screen Shots (timing page, 15 element panel).

The screenshot displays the ELAN software interface for a quantitative analysis method. The window title is "ELAN Edit/Reprocess Session - [Quantitative Analysis Method - C:\Elandata\Method\DCDC\_UMP3\_DLS3004\_15\_element\_urblk.mth]". The interface includes a menu bar, a toolbar with icons for various functions like "Timing", "Processing", "Equation", "Calibration", "Sampling", "Devices", "SmartTune", "Optimize", "RptOption", "RptView", "Interactive", "Calibview", "Method", "Dataset", "Sample", and "Analysis".

Key parameters are set as follows:

- Sweeps / Reading: 70
- Est. Reading Time: 0:01:21.900
- Readings / Replicate: 1
- Est. Replicate Time: 0:01:21.900
- Replicates: 3
- Est. Sample Time: 0:04:35.700
- Enable  C Checking
- Get Cell Parameters

The main data table lists 18 elements with the following columns: Int Std, Analyte (\*), Mass (amu), Scan Mode (\*), MCA Channels, Dwell Time per AMU (ms), Integration Time (ms), Corrections, Cell Gas A, Cell Gas B, RP a, RP q, and Mode. A callout box labeled "Optimize Per Instrument (DRC mode only)" points to the "RP a" and "RP q" columns. The last three rows (16, 17, 18) are highlighted in yellow.

Int Std	Analyte (*)	Mass (amu)	Scan Mode (*)	MCA Channels	Dwell Time per AMU (ms)	Integration Time (ms)	Corrections	Cell Gas A	Cell Gas B	RP a	RP q	Mode
1	Be	9.0122	Peak Hopping	1	100	7000		0	0	0	0.25	Standard
2	Co	58.9332	Peak Hopping	1	30	2100		0	0	0	0.25	Standard
3	Sr	87.9056	Peak Hopping	1	30	2100		0	0	0	0.25	Standard
4	Mo	97.9055	Peak Hopping	1	30	2100		0	0	0	0.25	Standard
5	Rh	102.905	Peak Hopping	1	30	2100		0	0	0	0.25	Standard
6	Sn	117.902	Peak Hopping	1	30	2100		0	0	0	0.25	Standard
7	Sb	120.904	Peak Hopping	1	30	2100		0	0	0	0.25	Standard
8	Cs	132.905	Peak Hopping	1	30	2100		0	0	0	0.25	Standard
9	Ba	137.905	Peak Hopping	1	30	2100		0	0	0	0.25	Standard
10	W	183.951	Peak Hopping	1	30	2100		0	0	0	0.25	Standard
11	Ir	192.963	Peak Hopping	1	30	2100		0	0	0	0.25	Standard
12	Pt	194.965	Peak Hopping	1	100	7000		0	0	0	0.25	Standard
13	Tl	204.975	Peak Hopping	1	30	2100		0	0	0	0.25	Standard
14	Pb	207.977	Peak Hopping	1	30	2100	Pb, Pb	0	0	0	0.25	Standard
15	U	238.05	Peak Hopping	1	100	7000	U	0	0	0	0.25	Standard
16	Rh-1	102.905	Peak Hopping	1	30	2100		2.3	0	0	0.45	DRC
17	Cd	113.904	Peak Hopping	1	100	7000	Sn	2.3	0	0	0.45	DRC
18	Mn	54.9381	Peak Hopping	1	50	3500		2.3	0	0	0.45	DRC

The bottom status bar shows "For help, Press F1", "Mode: Standard", "2 elan", "EST SC Autosa...", "SptbManager", "Microsoft Powe...", and "LOG 1:16 PM".

Appendix B (continued).

Figure 2b. ELAN ICP-DC-MS Method Screen Shots (processing page, 15 element panel).





Appendix B (continued).

Figure 2c. ELAN ICP-DC-MS Method Screen Shots (equation page, 15 element panel).

The screenshot shows the 'Interferences' window in the ELAN software. The window title is 'Interferences' and it displays the following data:

Int Std	Analyte (*)	Mass (amu)	Corrections	Potential Interferences
1	Be	9.0122		
2	Co	58.9332		CaO
3	Sr	87.9056		Yb++, LuH++
4	Mo	97.9055		Ru, BrO
5	Rh	102.905		SrO
6	Sn	117.902		MnO, U++
7	Sb	120.904		
8	Cs	132.905		
9	Ba	137.905		La, Ce
10	W	183.951		Os, ErO, YbO
11	Ir	192.963		HfO, LuO
12	Pt	194.965		HfO
13	Tl	204.975		
14	Pb	207.977	+ Pb 206 + Pb 207	
15	U	238.05	+ U 235	
16	Rh-1	102.905		
17	Cd	113.904	- 0.027250 * Sn 118	Sn, MoO
18	Mn	54.9381		ArN, HClO, ClO
19				
20				

The software interface also shows the 'Isotope Information' section with the following details:

- Isotope: Be 9
- Mass: 9.0122
- Abundance: 100.000000

The top of the window shows 'Report' and 'Notes' tabs. The bottom of the window displays the Windows taskbar with the Start button and system tray icons.



Appendix B (continued).

Figure 2e. ELAN ICP-DC-MS Method Screen Shots (sampling page, 15 element panel).

The screenshot displays the ELAN software interface for the sampling page. The top menu bar includes 'Report' and 'Notes'. The main control panel contains several input fields and buttons:

- Autosampler:** AS-93plus
- Tray:** c:\program files\esi\sc\esi.try
- Sampling Device:** (None)
- Dil. Factor:** 10
- Dil. To Vol. (mL):** 10
- 1st. Dil. Pos:** 1
- Probe Purge Pos.:** 10
- Equation:**  Peristaltic Pump Under Computer Control

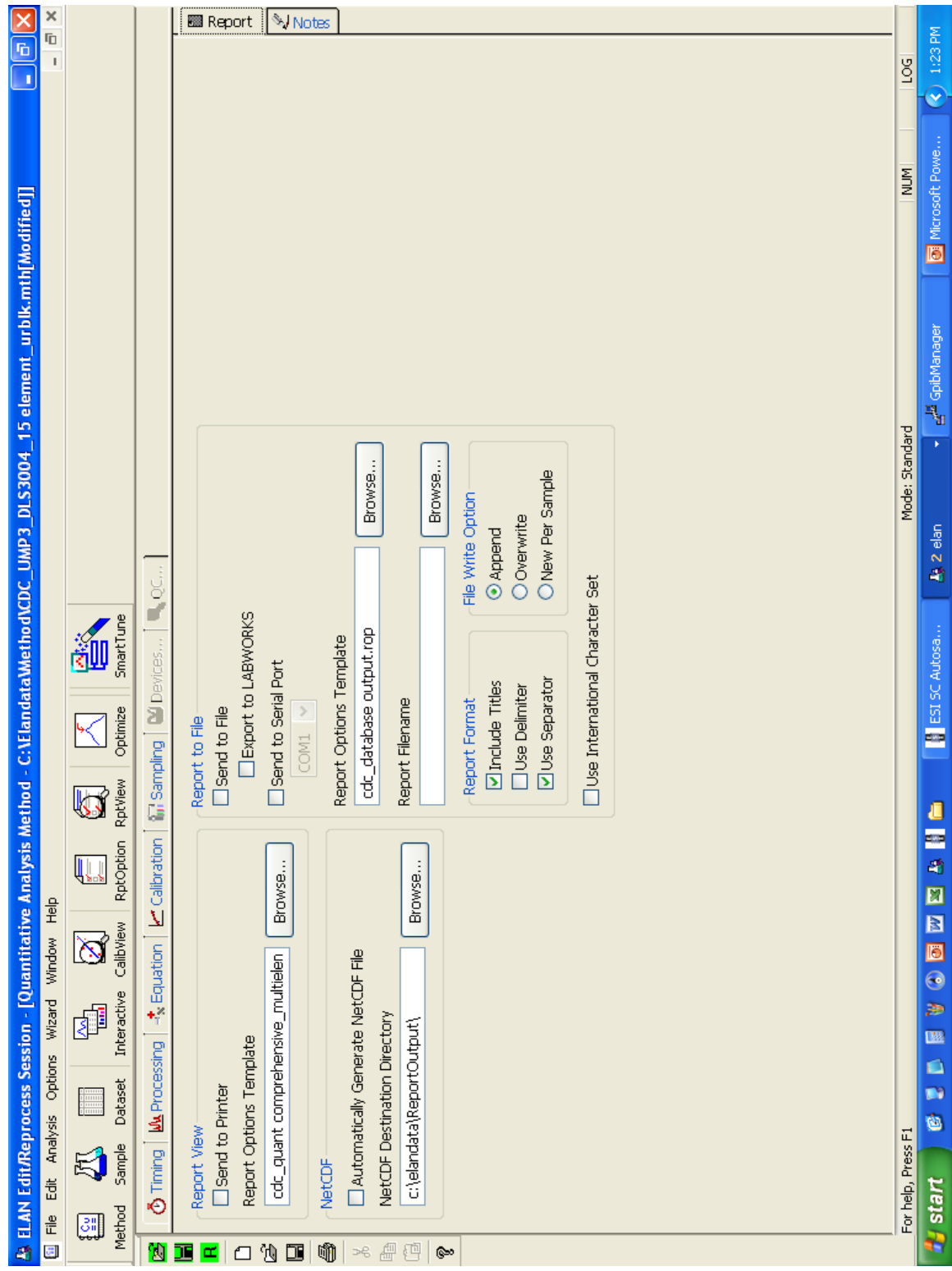
The main data table lists 18 rows of sampling parameters:

Standard	Solution ID	A/S Loc.	Sample Flush (sec)	Sample Flush Speed (+/- rpm)	Read Delay (sec)	Delay & Analysis Speed (+/- rpm)	Wash (sec)	Wash Speed (+/- rpm)
1	Blank	101	10	-3	30	-3	50	-3
2	Standard 1	102	10	-3	30	-3	50	-3
3	Standard 2	103	10	-3	30	-3	50	-3
4	Standard 3	104	10	-3	30	-3	50	-3
5	Standard 4	105	10	-3	30	-3	50	-3
6	Standard 5	106	10	-3	30	-3	50	-3
7	Standard 6		10	-3	30	-3	50	-3
8	Standard 7		10	-3	30	-3	50	-3
9	Standard 8		10	-3	30	-3	50	-3
10	Standard 9		10	-3	30	-3	50	-3
11	Standard 10		10	-3	30	-3	50	-3
12	Standard 11		10	-3	30	-3	50	-3
13	Standard 12		10	-3	30	-3	50	-3
14	Standard 13		10	-3	30	-3	50	-3
15	Standard 14		10	-3	30	-3	50	-3
16	Standard 15		10	-3	30	-3	50	-3
17	Standard 16		10	-3	30	-3	50	-3
18	Standard 17		10	-3	30	-3	50	-3

The bottom status bar shows 'For help, Press F1', 'start' logo, and system tray icons including '2 elan', 'GpibManager', and 'Microsoft Power...'. The system clock shows '1:20 PM'.

Appendix B (continued).

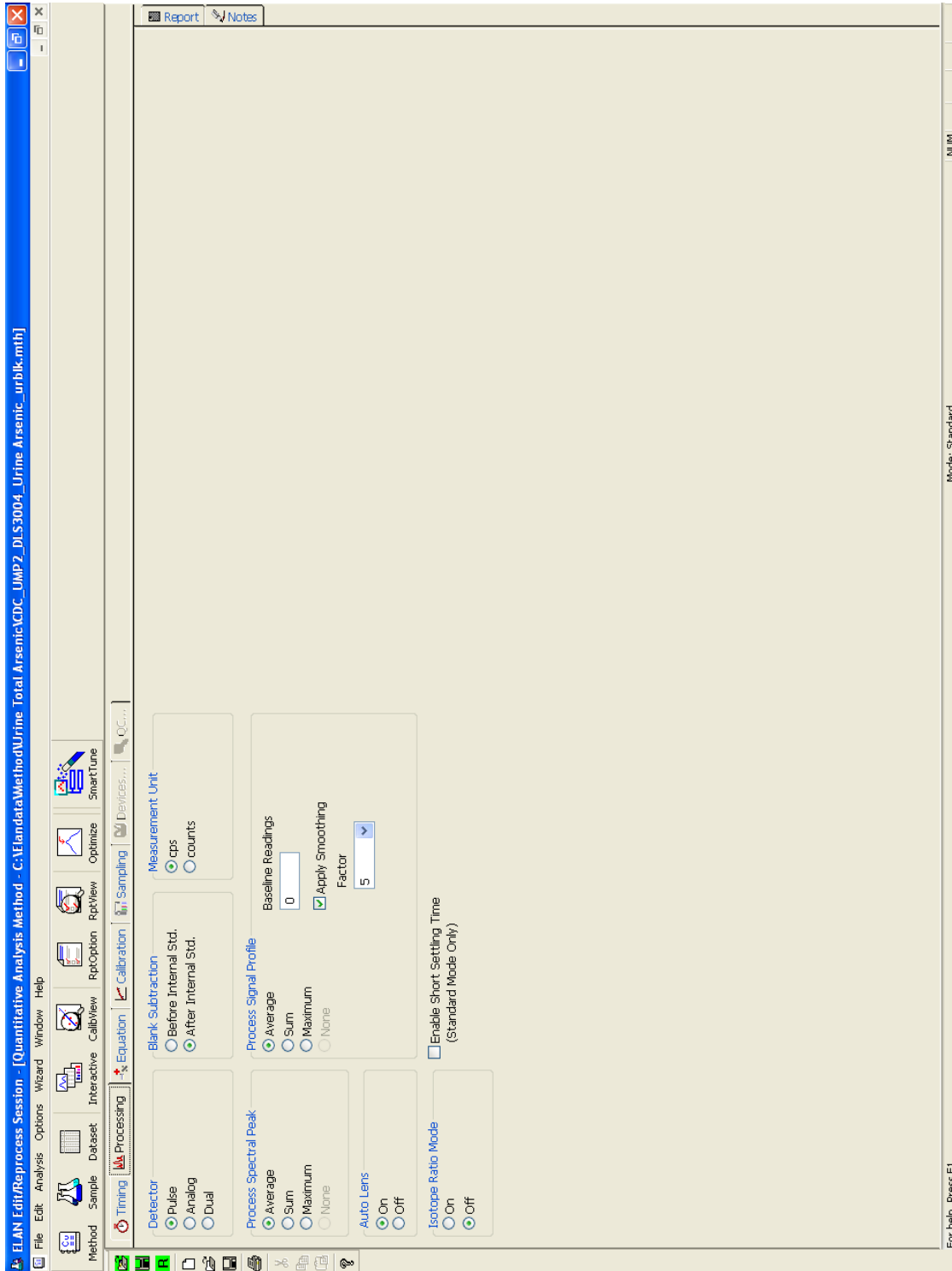
Figure 2f. ELAN ICP-DC-MS Method Screen Shots (report page, 15 element panel).





Appendix B(continued).

Figure 3b. ELAN ICP-DC-MS Method Screen Shots (processing page, arsenic).



Appendix B (continued).  
 Figure 3c. ELAN ICP-DC-MS Method Screen Shots (equation page, arsenic).

The screenshot displays the ELAN software interface for the equation page of the Arsenic method. The main window shows a table with the following data:

Int Std	Analyte (*)	Mass (amu)	Corrections	Potential Interferences
1	Ga	70.9249		ArCl, CO2, ArP, Ce++, NH++, NH++
2	As	74.9216		ArCl, Sm++, Nd++, Eu++
3				
4				
5				
6				
7				
8				
9				
10				
11				
12				
13				
14				
15				
16				
17				
18				
19				
20				
21				
22				
23				
24				
25				
26				
27				
28				
29				
30				
31				
32				

Additional information visible in the interface includes:

- Isotope Information:**
  - Mass: 68.9257, 70.9249
  - Abundance: 60.108000, 39.892000
- Interferences:** ArP, ClO2, V0, Iat+, Ce++, Ba++, La++
- Corrections:** ArCl, ClO2, ArP, Ce++, NH++, NH++
- Potential Interferences:** ArCl, CO2, ArP, Ce++, NH++, NH++

Appendix B (continued).

Figure 3d. ELAN ICP-DC-MS Method Screen Shots (calibration page, arsenic).

ELAN Edit/Reprocess Session - [Quantitative Analysis Method - C:\ELAN\data/Method/Urine Total Arsenic\DCDC\_UMP2\_DLS3004\_Urine Arse...]

File Edit Analysis Options Wizard Window Help

Method Sample Dataset Interactive CalibView RptOption RptView Optimize SmartTune

Timing Processing Equation Calibration Sampling Devices... QC...

External Std.  
 Std. Addition

	Int Std	Analyte (*)	Mass (amu)	Curve Type (*)	Sample Units (*)	Standard Units (*)	Std 1	Std 2	Std 3	Std 4	Std 5	Std 6
1		Ga	70.9249	Simple Linear	ppb	ppb						
2		As	74.9216	Simple Linear	ppb	ppb	2	6	20	60	200	
3												
4												
5												
6												
7												
8												
9												
10												
11												
12												
13												
14												
15												
16												
17												
18												
19												
20												
21												

Mode: Standard  
 For help, Press F1



Appendix B (continued).

Figure 3e. ELAN ICP-DC-MS Method Screen Shots (sampling page, arsenic).

ELAN Edit/Reprocess Session - [Quantitative Analysis Method - C:\elandata\Method\Urine Total Arsenic\CDC\_UMP2\_DL\_S3004\_Urine Arsenic\_urbllc.mth]

File Edit Analysis Options Wizard Window Help

Method Sample Dataset Interactive CalView RptOption RptView Optimize SmartTune

Timing Processing Equation Calibration Sampling Devices...

Autosampler AS-93plus Dil. Factor 10 Dil. To Vol. (mL) 10  
 Tray c:\program files\esi\sc\esltry 1st. Dil. Pos 1 Probe Purge Pos. 10  
 Sampling Device (None)  Peristaltic Pump Under Computer Control

Pump speed shown is for ESI micro-peristaltic pump.  
 ELAN standard pump speed is 6 rpm.

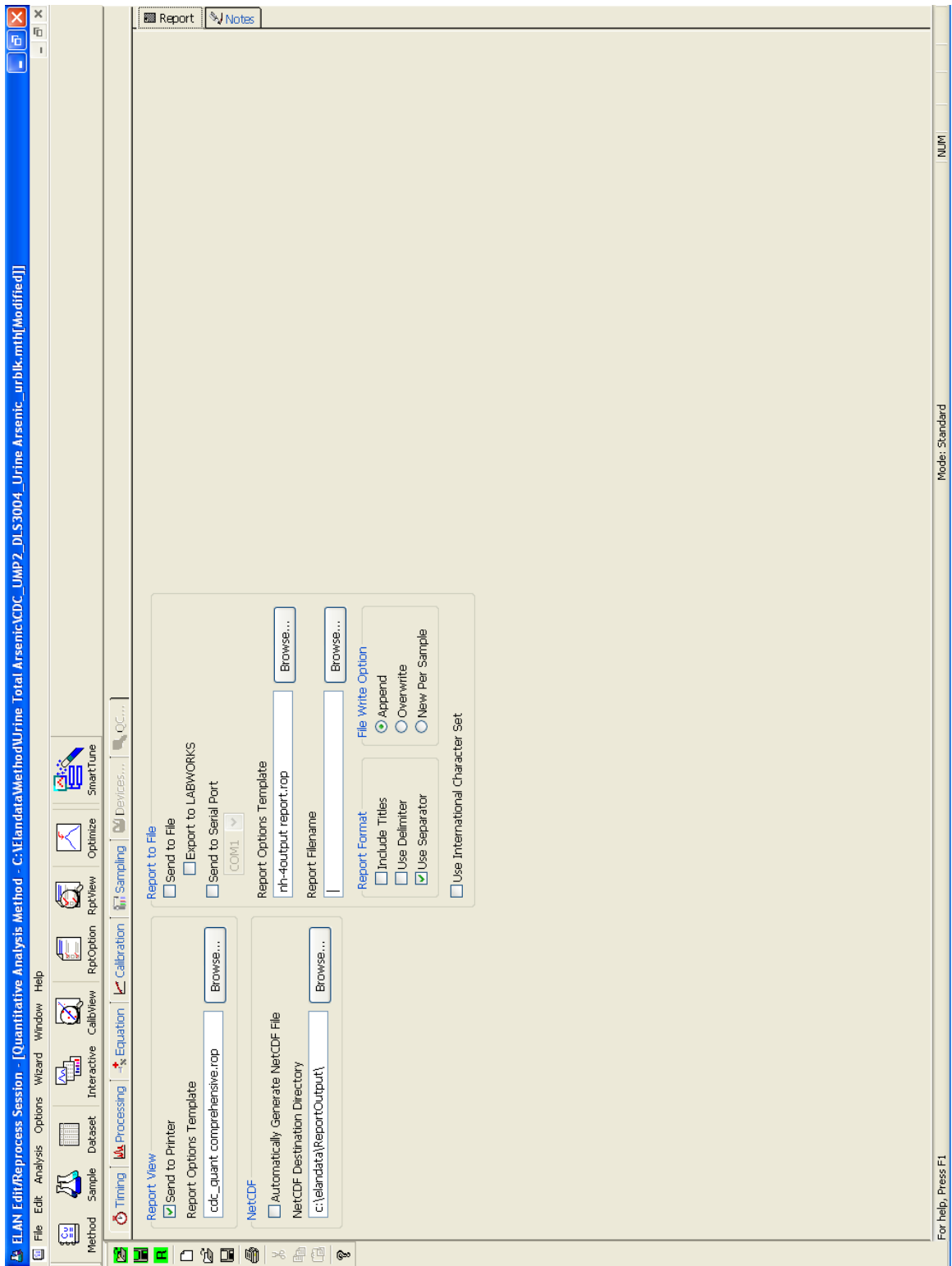
	Standard	Solution ID	A/S Loc.	Sample Flush (sec)	Sample Flush Speed (+/- rpm)	Read Delay (sec)	Delay & Analysis Speed (+/- rpm)	Wash (sec)	Wash Speed (+/- rpm)
1	Blank		102	6	-3	24	-3	20	-3
2	Standard 1		103	6	-3	24	-3	20	-3
3	Standard 2		104	6	-3	24	-3	20	-3
4	Standard 3		105	6	-3	24	-3	20	-3
5	Standard 4		106	6	-3	24	-3	20	-3
6	Standard 5		107	6	-3	24	-3	20	-3
7	Standard 6			6	-3	24	-3	20	-3
8	Standard 7			6	-3	24	-3	20	-3
9	Standard 8			6	-3	24	-3	20	-3
10	Standard 9			6	-3	24	-3	20	-3
11	Standard 10			6	-3	24	-3	20	-3
12	Standard 11			6	-3	24	-3	20	-3
13	Standard 12			6	-3	24	-3	20	-3
14	Standard 13			6	-3	24	-3	20	-3
15	Standard 14			6	-3	24	-3	20	-3
16	Standard 15			6	-3	24	-3	20	-3
17	Standard 16			6	-3	24	-3	20	-3
18	Standard 17			6	-3	24	-3	20	-3
19	Standard 18			6	-3	24	-3	20	-3
20	Standard 19			6	-3	24	-3	20	-3
21	Standard 20			6	-3	24	-3	20	-3
22	Standard 21			6	-3	24	-3	20	-3
23	Standard 22			6	-3	24	-3	20	-3
24	Standard 23			6	-3	24	-3	20	-3
25	Standard 24			6	-3	24	-3	20	-3
26	Standard 25			6	-3	24	-3	20	-3
27	Standard 26			6	-3	24	-3	20	-3
28	Standard 27			6	-3	24	-3	20	-3
29	Standard 28			6	-3	24	-3	20	-3
30	Standard 29			6	-3	24	-3	20	-3

Mode: Standard NUM

For help, Press F1

Appendix B (continued).

Figure 3f. ELAN ICP-DC-MS Method Screen Shots (report page, arsenic).

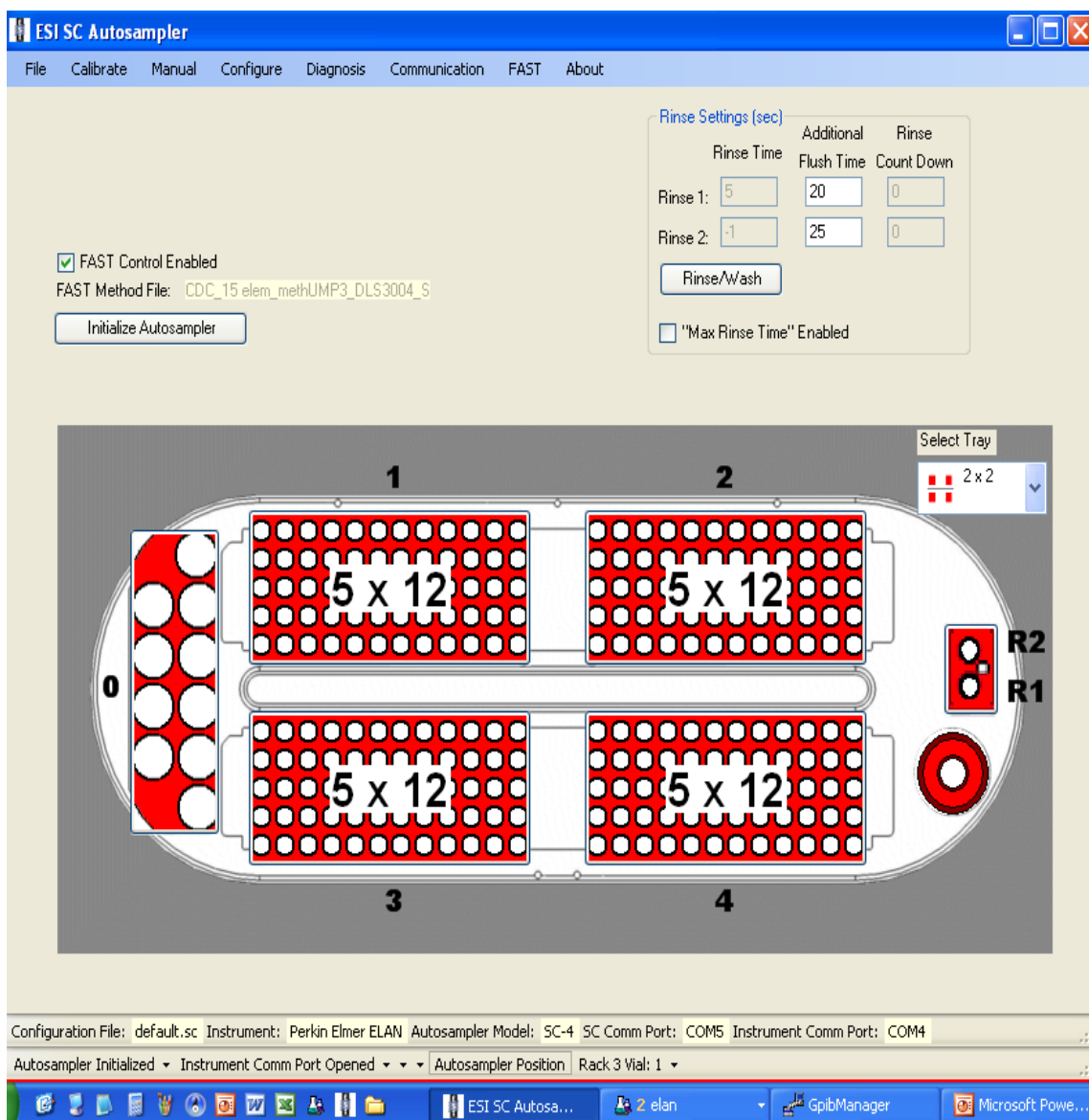


**Appendix B (continued).**

**Figure 4a. ESI SC4 Autosampler Screen Shots used (Main page).** Additional flush times and “Max Rinse Time” are default, but can be optimized for best reduction of elemental carry-over between samples. Tray types can be changed to allow for different volumes of diluted sample digests. ‘FAST control’ must be enabled before start of method, but does not need to be used in instrument optimization (pre-analysis) steps. Rinse and additional flush times for eliminating carry-over from one sample to the next while using the minimum amount of rinse solution.

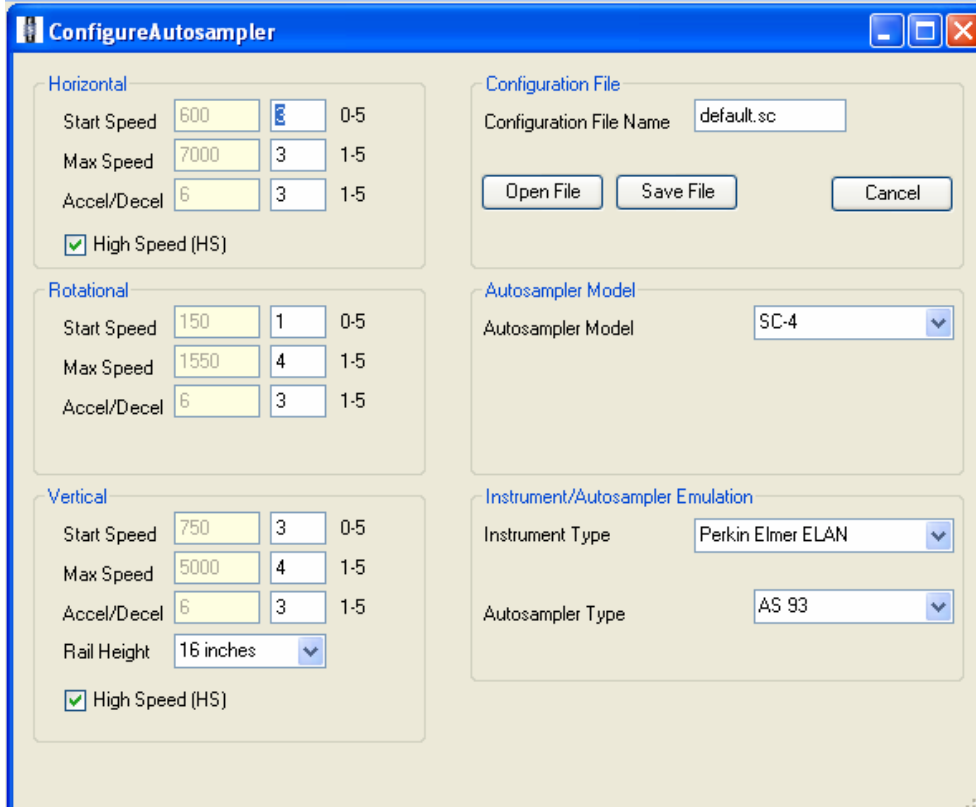
A rinse time of -1 causes the rinse station to be skipped.

A rinse time of 0 causes the probe to only dip into the station, but spends no time there. Additional flush times can be optimized to keep the rinse station full while not using too much rinse solution. The inner diameter size of the tubing providing the rinse solution to the rinse station determines how quickly the station will fill. Various sizes are available for purchase or can be made in the laboratory.

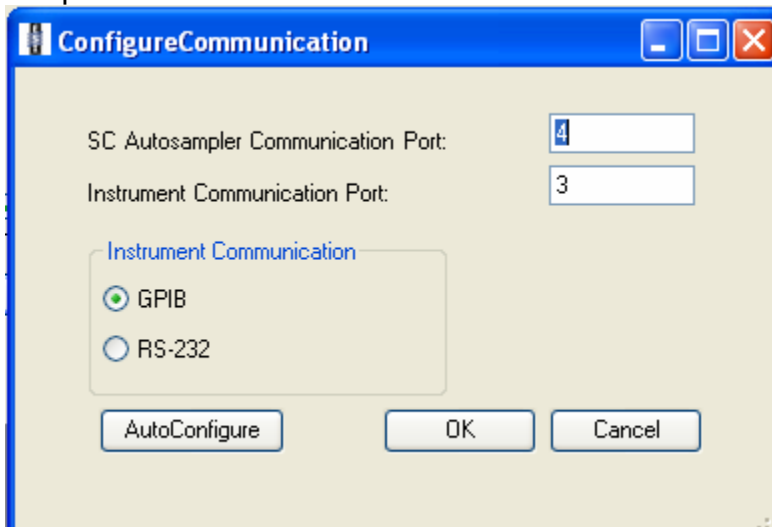


**Appendix B (continued).**

**Figure 4b. ESI SC4 Autosampler Screen Shots used (“Configure” page).** “High Speed” option is to only be used for ‘High Speed’ models of the SC4 (look for “HS” in serial number). Speeds and accel / decel values can be optimized per analyst preference and to minimize droplet splatter off of probe.



**Figure 4c . ESI SC4 Autosampler Screen Shots used (“Communication” page).** Communication ports will differ depending on available ports on instrument control computer.



Appendix B (continued).

Figure 4d. ESI SC4 Autosampler Screen Shots (“FAST” page) \*used for Arsenic only\*. Timer A can be optimized to achieve proper filling of loop with diluted sample digestate. Timers B, C, D, E, and F control rinsing the loop after analysis and can be optimized for eliminating carry-over from one sample to the next while using the minimum amount of rinse solution. File should be saved with the name “Urine Arsenic\_methITU001B\_HPS2107-003\_SCFast.txt”. It can be found in the directory C:\Program Files\ESI\ESI-SC\.

Manually clicking the “Load” button prior to starting analysis will ensure the position of the actuator is always the same at the beginning of the analysis.

Manually clicking the “Vacuum On” button prior to starting the analysis will help initial sample uptake to be consistent (the vacuum pump may be slow to start for the first sample if this is not done, possibly resulting in loop filling inconsistencies).

The screenshot shows the 'FAST Method Control' software interface. The main window contains a table with columns for Event, Action, Parameters, Parameter Units, and Event Parameters. The 'Events' list on the right includes actions like 'Probe In Sample', 'Rinse Completed', 'Move Into Next Co', etc. The 'FAST Control' panel includes a checkbox for 'Enable FAST Control', a 'Method File Name' field, and 'RinseTime [s]' settings for Rinse1 (5), Rinse2 (-1), and Max Vacuum Time (500). The 'Syringe Control' panel has buttons for 'Dispense S1', 'Fill S1', 'Prime S1', 'Stop S1', and 'Continuous S1'. The 'Output Actions' panel lists events like 'A1 On', 'A2 On', 'A3 On', etc. The Windows taskbar at the bottom shows the start button, taskbar icons, and system tray with the time 1:29 PM.

Event	Action	Parameters	Parameter Units	Event Parameters
On Probe Down	Vacuum On			
On Probe Down	Load			
Probe In Sample	Timer A	6.5	seconds	
Timer A Expires	Inject			
Timer A Expires	Move Rinse			
Rinse Completed	Probe Up			
On Rinse	Vacuum On			
On Rinse	Probe Down			
On Rinse	Load			
On Rinse	Timer B	4	seconds	
Timer B Expires	Probe Up			
Timer B Expires	Timer C	4	seconds	
Timer B Expires	A1 On			
Timer C Expires	Probe Down			
Timer C Expires	Timer D	4	seconds	
Timer D Expires	Probe Up			
Timer D Expires	Timer E	4	seconds	
Timer D Expires	A1 Off			
Timer E Expires	Probe Down			
Timer E Expires	Timer F	4	seconds	
Timer F Expires	Probe Up			
Timer F Expires	Timer G	4	seconds	
Timer G Expires	Probe Down			
Timer G Expires	Timer H	4	seconds	
Timer H Expires	Probe Up			
Timer H Expires	Timer I	5	seconds	
Timer I Expires	Move Next			

Appendix B (continued).

Figure 4e. ESI SC4 Autosampler Screen Shots (5x12 Rack Setup window).

Settings are approximate. To be sure the loop is filled, the probe should go down close to the bottom of the cup, but not touch. Optimize retraction speed for least droplet splatter.

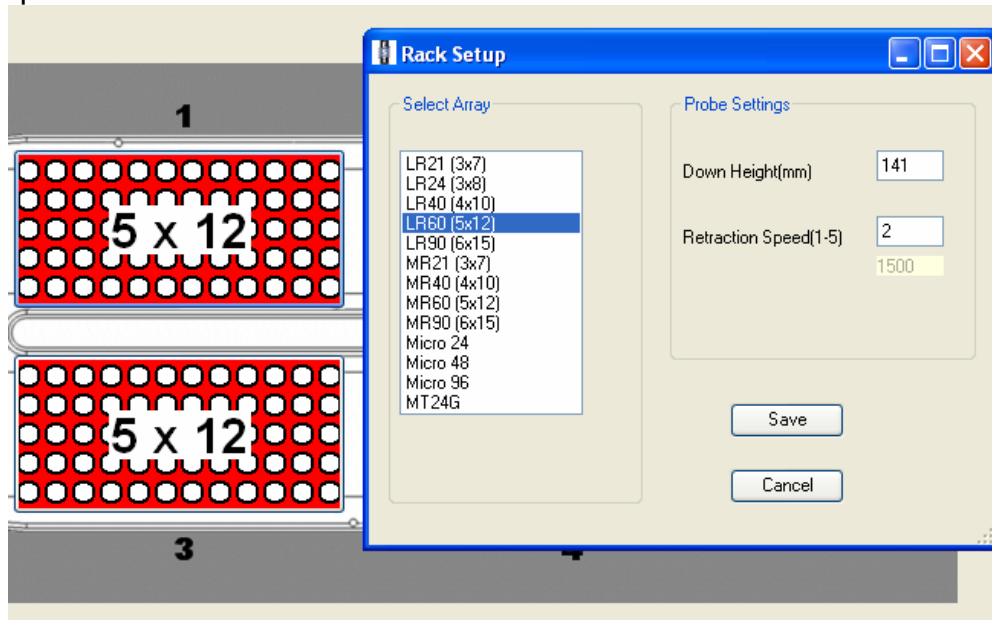
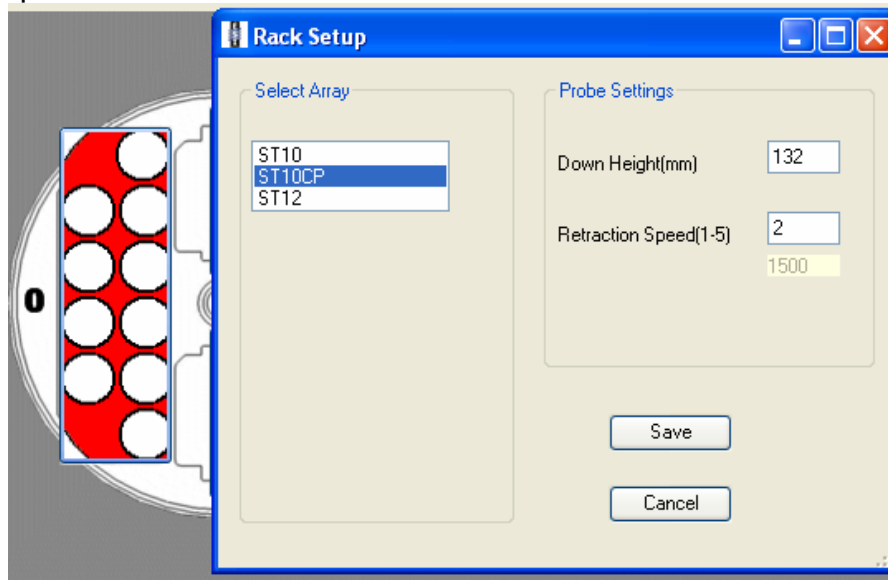


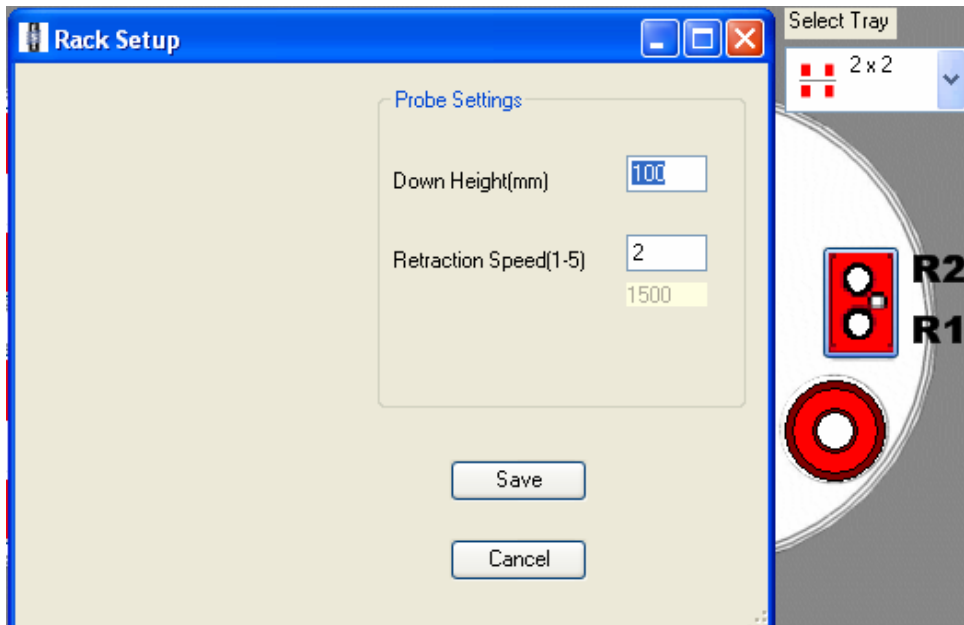
Figure 4f. ESI SC4 Autosampler Screen Shots (50mL Tube Rack Setup window).

Settings are approximate. To be sure the loop is filled, the probe should go down close to the bottom of the cup, but not touch. Optimize retraction speed for least droplet splatter.



Appendix B (continued).

**Figure 4g. ESI SC4 Autosampler Screen Shots (Rinse Station Rack Setup Window).** Settings are approximate. Optimize down height for best probe cleaning, and retraction speed for least droplet splatter.



## References

1. Thomas, R., *Practical Guide to ICP-MS (Practical Spectroscopy)*. 2003, New York, NY: Marcel Dekker 336.
2. Tanner, S.D., Baranov, Vladimir I, *Theory, Design, and Operation of a Dynamic Reaction Cell for ICP-MS*. Atomic Spectroscopy, 1999. **20**(2): p. 45-52.
3. Tanner, S.D., V.I. Baranov, and D.R. Bandura, *Reaction cells and collision cells for ICP-MS: a tutorial review*. Spectrochimica Acta Part B-Atomic Spectroscopy, 2002. **57**(9): p. 1361-1452.
4. PerkinElmer SCIEX Instruments, *ELAN DRC II Hardware Guide*. 2001, Canada.
5. Mulligan, K.J., T.M. Davidson, and J.A. Caruso, *Feasibility Of The Direct Analysis Of Urine By Inductively Coupled Argon Plasma Mass-Spectrometry For Biological Monitoring Of Exposure To Metals*. Journal Of Analytical Atomic Spectrometry, 1990. **5**(4): p. 301-306.
6. Jarrett, J.M., *Total Urine Arsenic Biomonitoring Using Inductively Coupled Plasma Mass Spectrometry with a Dynamic Reaction Cell*. 2005, Centers for Disease Control and Prevention.
7. Jarrett, J.M., *Elimination of Molybdenum Oxide Interference In Urine Cadmium Analysis Using Inductively Coupled Plasma Reaction Cell Mass Spectrometry*. 2004, Centers for Disease Control and Prevention.
8. Larsen, E.H. and S. Sturup, *Carbon-enhanced Inductively Coupled Plasma Mass Spectrometric Detection of Arsenic and Selenium and Its Application to Arsenic Speciation*. Journal Of Analytical Atomic Spectrometry, 1994. **9**: p. 1101-1105.
9. Amarasiriwardena, C.J., et al., *Determination of the total arsenic concentration in human urine by inductively coupled plasma mass spectrometry: a comparison of the accuracy of three analytical methods*. Analyst, 1998. **123**(3): p. 441-445.
10. Office of Health and Safety in the Division of Laboratory Sciences, *Policies and Procedures Manual*. 2002, Division of Laboratory Sciences (DLS), National Center for Environmental Health, Centers for Disease Control and Prevention, Public Health Service, Department of Health and Human ServicesCenters for Disease Control and Prevention, .
11. Centers for Disease Control and Prevention (CDC) Radiation Safety Committee, *CDC/ATSDR Occupational Health and Safety Manual (Radiation Safety chapter)*. Centers for Disease Control and Prevention, Public Health Service, Department of Health and Human ServicesCenters for Disease Control and Prevention.
12. Heitland, P. and H.D. Koster, *Biomonitoring of 37 trace elements in blood samples from inhabitants of northern Germany by ICP-MS*. Journal of Trace Elements in Medicine and Biology, 2006. **20**(4): p. 253-262.
13. U.S. Nuclear Regulatory Commission, *Regulatory guide 8.22 (revision 1). Bioassay at uranium mills*. 1988: Atlanta, GA.
14. Centers for Disease Control and Prevention, *Third National Report on Human Exposure to Environmental Chemicals*, <http://www.cdc.gov/exposurereport>. 2005.
15. Stokinger, H.E., *The metals*, in *Patty's industrial hygiene and toxicology* G. Clayton and F. Clayton, Editors. 1981, John Wiley and Sons: New York. p. 1493-2060.
16. Fowler, B.A., in *Toxicology of trace elements* R. Goyer and M. Mehlman, Editors. 1977, John Wiley and Sons: New York. p. p. 79.



17. Iffland, R., *Arsenic*, in *Handbook on metals in clinical and analytical chemistry*, H. Seiler, A. Sigel, and H. Sigel, Editors. 1994, Marcel Dekker, Inc.: New York. p. 238-250.
18. Gerhardsson, L. and S. Skerfving, *Concepts on biological markers and biomonitoring for metal toxicity*, in *Toxicology of metals*, L. Chang, Editor. 1996, CRC Press: Boca Raton, Florida. p. 98.
19. *Report on Human Biomonitoring of Environmental Chemicals in Canada*. 2010, Health Canada: Ottawa.
20. Heitland, P. and H.D. Koster, *Biomonitoring of 30 trace elements in urine of children and adults by ICP-MS*. *Clinica Chimica Acta*, 2006. **365**(1-2): p. 310-318.
21. Paschal, D.C., et al., *Trace metals in urine of United States residents: Reference range concentrations*. *Environmental Research*, 1998. **76**(1): p. 53-59.
22. Agency for Toxic Substances and Disease Registry (ATSDR). 2000. Toxicological profile for Manganese. Atlanta, G.U.S.D.o.H.a.H.S., Public Health Service. , *Toxicological Profile for Manganese*, ATSDR, Editor. 2000. p. 15.
23. Moreno, M.E., et al., *Biomonitoring of metal in children living in a mine tailings zone in Southern Mexico: A pilot study*. *International Journal of Hygiene and Environmental Health*, 2010. **213**(4): p. 252-258.
24. Gil, F., et al., *Biomonitorization of cadmium, chromium, manganese, nickel and lead in whole blood, urine, axillary hair and saliva in an occupationally exposed population*. *Science of the Total Environment*, 2011. **409**(6): p. 1172-1180.
25. Wang, H.M., et al., *Urinary heavy metal levels and relevant factors among people exposed to e-waste dismantling*. *Environment International*, 2011. **37**(1): p. 80-85.
26. Juliao, L., et al., *Exposure of workers in a mineral processing industry in Brazil*. *Radiation Protection Dosimetry*, 2007. **125**(1-4): p. 513-515.

# Division of Laboratory Sciences Laboratory Protocol

<b>Analytes:</b>	<b>Cadmium, Lead, Manganese, Mercury, and Selenium</b>
<b>Matrix:</b>	<b>Whole Blood</b>
<b>Method:</b>	<b>Blood Metals Panel 2 (BMP2) by ICP-DRC-MS</b>
<b>Method Code:</b>	<b>DLS 3016</b>
<b>Branch:</b>	<b>Inorganic Radionuclides and Analytical Toxicology</b>

Prepared By: Deanna M. Jones, PhD \_\_\_\_\_  
author's name signature date

Supervisor: Jeffery M. Jarrett, MS \_\_\_\_\_  
supervisor's name signature date

Branch Chief: Robert L Jones PhD \_\_\_\_\_  
Branch Chief signature and date

Adopted: \_\_\_\_\_  
date

Updated: \_\_\_\_\_  
date

Director's Signature Block:

Reviewed:

_____	_____
signature	date
_____	_____
signature	date
_____	_____
signature	date
_____	_____
signature	date

**Modifications/Changes:** see Procedure Change Log

## Procedure Change Log

Procedure: Blood Metals Panel 2 by (BMP2) ICP-DRC-MS

DLS Method Code: 3016

Date	Changes Made	By	Rev'd By (Initials)	Date Rev'd
4/1/2011	1UB and 2UB for Mn changed from 15 to 25 ug/L and from 30 to 50 ug/L, respectively.	JJ	JJ	
4/1/2011	Limit Rep Delta for Mn changed from 1.0 to 2.0.	JJ	JJ	
7/28/2011	Revised matrix of internal standard intermediate to 1% v/v HNO <sub>3</sub> .	JJ	JJ	
8/9/2011	Changed BMN 1UB (25 ug/L to 20 ug/L) and 2UB (50ug/L to 35 ug/L). Supporting references added.	JJ	JJ	
10/7/2011	Added comment to CV standard tables regarding use of gravimetric preparation.	JJ	JJ	



## Laboratory Procedure Manual

*Analytes:* **Cadmium, Lead, Manganese,  
Mercury, and Selenium**

*Matrix:* **Whole Blood**

*Method:* **Blood Metals Panel 2 (BMP2) ICP-DRC-MS**

*Method No:* DLS 3016

*Revised:*

*As performed by:* Inorganic Radionuclides and Toxicology  
Division of Laboratory Sciences  
National Center for Environmental Health

*Contact:* Jeffery M. Jarrett, MS  
Phone: 770-488-7906  
Fax: 770-488-4097  
Email: [JJarrett@cdc.gov](mailto:JJarrett@cdc.gov)

Dr. Jim Pirkle, MD, PhD, Director  
Division of Laboratory Sciences

### **Important Information for Users**

The Centers for Disease Control and Prevention (CDC) periodically refines these laboratory methods. It is the responsibility of the user to contact the person listed on the title page of each write-up before using the analytical method to find out whether any changes have been made and what revisions, if any, have been incorporated.

## Table of Contents

<b>Cross reference to DLS CLIA and Policy and Procedures</b> .....	4
<b>Index of tables</b> .....	5
<b>List of Figures</b> .....	6
<b>1) Clinical Relevance &amp; Summary of Test Principle</b>	
a. Clinical Relevance .....	7
b. Test Principle .....	10
<b>2) Limitations of Method; Interfering Substances and Conditions</b>	
a. Interferences Addressed by This Method .....	12
i. Argon dimer ( $^{40}\text{Ar}_2^+$ ) on $^{80}\text{Se}^+$	
ii. Argon Nitride ( $^{40}\text{Ar}^{15}\text{N}^+$ ), Argon Hydroxide ( $^{38}\text{Ar}^{16}\text{O}^1\text{H}^+$ )	
iii. Chlorine Oxide ( $^{37}\text{Cl}^{18}\text{O}^+$ ), Iron Hydride ( $^{54}\text{Fe}^1\text{H}^+$ )	
<b>3) Procedures for Collecting, Storing, and Handling Specimens; Criteria for Specimen Rejection</b>	
a. Procedures for Collecting, Storing, and Handling Specimens .....	13
b. Criteria for Specimen Rejection .....	14
c. Transfer or Referral of Specimens; Procedures for Specimen Accountability and Tracking .....	14
<b>4) Safety Precautions</b>	
a. General Safety .....	14
b. Waste Disposal .....	15
<b>5) Instrument &amp; Material Sources</b>	
a. Sources for ICP-MS Instrumentation .....	16
b. Sources for ICP-MS Parts & Consumables .....	16
c. Sources for ICP-MS Maintenance Equipment & Supplies .....	21
d. Sources for General Laboratory Equipment & Consumables .....	22
e. Sources for Chemicals, Gases, & Regulators .....	23
<b>6) Preparation of Reagents and Materials</b>	
a. Internal Standard Intermediate Mixture .....	26
b. 20% Triton X-100 <sup>®</sup> intermediate solution .....	26
c. Diluent .....	27

- d. DRC Stability Test Solution ..... 27
- e. Base Blood ..... 28
- f. ICP-DRC-MS Rinse Solution ..... 28
- g. Single-element Stock Standards for preparation of intermediate stock calibration standard ..... 29
- h. 3 % (v/v) HCl ..... 29
- i. Intermediate Stock Calibration Standard ..... 29
- j. Intermediate Working Calibration Standard ..... 31
- k. Working Calibration Standards ..... 31
- l. Single-Element Stock Standards For Preparation of Intermediate Stock Calibration Verification Standard ..... 32
- m. Intermediate Stock Calibration Verification Standard ..... 32
- n. Intermediate Working Calibration Verification Standard ..... 33
- o. Internal Quality Control Materials (“Bench” QC) ..... 33

**7) Analytical Instrumentation & Parameters**

- a. Instrumentation & Equipment Setup
  - i. ICP-DRC-MS ..... 36
  - ii. Sample introduction system setup ..... 37
  - iii. Cones ..... 38
  - iv. Gases & Regulators setup ..... 38
  - v. Chiller / Heat Exchanger. .... 38
  - vi. Computer. .... 38
  - vii. Autosampler ..... 39
- b. Parameters for Instrument and Method (see Table 1) ..... 39

**8) Method Procedures**

- a. Quality Control
  - i. Types of Quality Control ..... 39
  - ii. Calibration Verification ..... 40
- b. Daily Analysis of Samples
  - i. Preparation of the Analytical Equipment ..... 41
  - ii. Preparation of Samples for Analysis ..... 44

- iii. Specimen Storage and Handling During Testing . . . . . 45
- iv. Starting the Analysis . . . . . 45
- v. Monitoring the Analysis . . . . . 45
- vi. Records of Results . . . . . 46
- vii. Transfer of Results to the Laboratory Database . . . . . 47
- viii. Analyst Evaluation of Run Results . . . . . 48
- ix. Submitting Final Work for Review . . . . . 50
- x. Overnight operation (or Any Use of Autostop) . . . . . 50
- c. Equipment Maintenance
  - i. ICP-MS Maintenance . . . . . 51
  - ii. Data Backup . . . . . 51
- 9) Interpretation of the Results**
  - a. Reportable Range . . . . . 51
  - b. Reference Ranges (Normal Values) . . . . . 52
  - c. Action Levels . . . . . 52
- 10) Method Calculations**
  - a. Method Limit of Detection (LOD) . . . . . 52
  - b. Method Limit of Quantitation (LOQ) . . . . . 52
  - c. QC Limits . . . . . 52
- 11) Alternate Methods for Performing Test and Storing Specimens If Test System Fails . . . . . 52**
- Appendix A (Critical Parameter Test Results)**
  - Critical Parameter Test #1 . . . . . 53
  - Critical Parameter Test #2 . . . . . 54
  - Critical Parameter Test #3 . . . . . 55
  - Critical Parameter Test #4 . . . . . 57
  - Critical Parameter Test #5 . . . . . 59
- Appendix B (Tables referenced in the method) . . . . . 60**
- References . . . . . 85**

**Cross reference to DLS CLIA and Policy and Procedures policy**

1. Summary of Test Principle and Clinical Relevance  
**1) a. b.**
2. Safety Precautions  
**4) a.b.c.**
3. Computerization; Data System Management  
**8) b.vi vii ix**
4. Specimen Collection, Storage, and Handling Procedures; Criteria for Specimen Rejection  
**3) a.b.**
5. Procedures for Microscopic Examinations; Criteria for Rejection of Inadequately Prepared Slides  
**- As no microscope is used in this process there are no procedures for microscopic examinations and therefore no slide rejection criteria.**
6. Preparation of Reagents, Calibrators (Standards), Controls, and All Other Materials; Equipment and Instrumentation  
**5) a. i ii iii b. 6) a. b. c. d. e. 7) a. b. c. d. 8) c. i ii**
7. Calibration and Calibration Verification Procedures  
**8) ii**
8. Procedure Operating Instructions; Calculations; Interpretation of Results  
**8) b. i ii iv v x**
9. Reportable Range of Results  
**9) a.**
10. Quality Control (QC) Procedures  
**8) a. i**
11. Remedial Action If Calibration or QC Systems Fail to Meet Acceptable Criteria  
**8) ii 1, ii 2, e.**
12. Limitations of Method; Interfering Substances and Conditions  
**2) a. b**
13. Reference Ranges (Normal Values)  
**9) b.**
14. Critical Call Results ("Panic Values")  
**9) c.**
15. Specimen Storage and Handling During Testing  
**8) b. iii**
16. Alternate Methods for Performing Test or Storing Specimens If Test System Fails  
**11)**
17. Test Result Reporting System; Protocol for Reporting Critical Calls (If Applicable)  
**9) c.**
18. Transfer or Referral of Specimens; Procedures for Specimen Accountability and Tracking  
**3) c.**
19. References



**List of Tables**

**Table 1.** Instrument and Method Parameters . . . . . 60 - 62

**Table 2.** Suggested maximum analyte concentrations for base blood and Quality control material. . . . .62

**Table 3.** Preparation of Intermediate Stock Calibration Solution from NIST primary standards. . . . .62

**Table 4.** Preparation of Intermediate Stock Calibration Solution from single element stock calibrator solutions without Pb.....63

**Table 5.** Preparation of Intermediate Working Standards.....63

**Table 6.** Preparation of samples, working standards, and QC materials for analysis..64

**Table 7.** Preparation and Final Concentrations of Intermediate Stock Calibration Verification Standards. . . . .65

**Table 8.** Preparation and Final Concentrations of Intermediate Working Calibrator Verification Standards. . . . .65

**Table 9.** Acceptable ways to perform two consecutive analytical runs, bracketing with bench quality control samples.....67

**Table 10.** A typical SAMPLE/BATCH window. . . . .68

**Table 11.** Boundary Concentrations for Whole Blood Concentrations ( $\mu\text{g/L}$ ).....68

**Table 12.** Reference Ranges for Blood Concentrations.....69

**List of Figures**

**Figure 1. ELAN ICP-DRC-MS Method Screen Shots**

a. Timing Page . . . . .	71
b. Processing Page. . . . .	72
c. Equations Page. . . . .	73
d. Calibration Page. . . . .	74
e. Sampling Page (Aq blank) . . . . .	75
f. Sampling Page (BldBlank). . . . .	76
g. Report Page. . . . .	77

**Figure 2. ESI SC4 Autosampler Screen Shots**

a. Main Page. . . . .	78
b. Configure Page. . . . .	79
c. Communication Page. . . . .	80
d. FAST Page. . . . .	81
e. 5x12 Rack Setup window. . . . .	82
f. 50 mL Tube Rack Setup window. . . . .	83
g. Rinse Station Rack Setup Window. . . . .	84

## 1) Clinical Relevance & Summary of Test Principle

### a. Clinical Relevance:

Metals ions affect human health in various ways. Some metals (i.e. lead, cadmium, and mercury) show only deleterious effects on human health. Some (i.e. selenium and manganese) play an essential role in the human biological system if within certain concentration ranges, while negative health implications are observed when concentrations in biological systems are in deficit or excess. Determination of a person's level of environmental exposure to chemicals through direct measurement of the substances or their metabolites in human specimens such as blood is called biomonitoring. Biomonitoring reduces the uncertainty of determining levels of exposure over making these determinations through calculations of estimated dose based on analysis of environmental samples and assumptions about exposure pathways[1]. Biomonitoring measurements are the most health-relevant assessments of exposure because they indicate the amount of the chemical that actually gets into people from all environmental sources (e.g., air, soil, water, dust, or food) combined, rather than the amount that may get into them. The laboratory method described here is a multi-element technique for monitoring the concentrations of cadmium (Cd), lead (Pb), manganese (Mn), mercury (Hg), and selenium (Se) in whole human blood for the purpose of biomonitoring.

There is no known biological role of mercury in the human body. The main sources of mercury intake in humans are fish, dental amalgams, and occupational exposures[2]. The main organs affected by mercury are the brain and the kidneys. Exposure of childbearing-aged women is of particular concern because of the potential adverse neurologic effects of Hg in fetuses. The health effects of mercury are diverse and depend on the form of mercury encountered and the severity and length of exposure. The general population may be exposed to three forms of mercury: elemental, inorganic, and organic (predominantly methyl). However, this method tests only for the total amount of mercury in the blood without regard to chemical form. In the general population, total blood mercury is due mostly to the dietary intake of organic forms which are formed through microbial action from inorganic mercury that has deposited in aquatic environments and bioaccumulated through the food chain (especially into large predatory fish)[3]. Exposure to inorganic or elemental mercury (e.g. dental amalgams or occupational exposures) is particularly reflected in urine excretion rather than blood. Psychic and emotional disturbances are the initial signs of chronic intoxication by elemental mercury vapors or salts. Parasthesia, neuralgias, renal disease, digestive disturbances, and ocular lesions may develop[4]. Massive exposure over a longer period of time results in violent muscular spasms, hallucinations, delirium, and death[5]. Except for methylmercury exposures, blood is considered useful if samples are taken within a few days of exposure. This is because most forms of mercury in the blood decrease by one-half every three days if exposure has been stopped. Thus,

mercury levels in the blood provide more useful information after recent exposures than after long-term exposures. Several months after an exposure, mercury levels in the blood and urine are much lower. Table 12 in Appendix B lists reference concentrations which have been reported in the literature.

There is no known biological role of lead in the human body. Lead, a naturally occurring metal, has had many different commercial uses from which a person can be exposed either in the occupational / manufacturing process or by the manufactured products such as paint (paint chips, or dust and soil contaminated from deteriorating paint), solder or pipes (only now in older homes), gasoline (now outlawed for all but specialized applications), glazes on pottery, hobby uses (e.g. stained glass), commercial products (e.g. batteries, lead-containing jewelry), home remedy medicines containing lead compounds and non-Western cosmetics. Soil may contain lead naturally, or from man-made uses of lead such as paint (near older homes), gasoline (near roadways), mining, manufacturing, and disposal. The main target for lead toxicity is the nervous system, both in adults and children. The developing biological systems of children are most sensitive to the effects of Pb, where effects are being recognized even at blood lead levels  $<10 \mu\text{g/dL}$ [6]. In its initial phase, acute lead poisoning is associated with anorexia, dyspepsia, and constipation followed by diffuse paroxysmal abdominal pain. Lead exposure may cause encephalopathy, particularly in children[7]. The alkyl lead species are highly toxic to the central nervous system[8]. The primary screening method for lead exposure is blood lead, which primarily reflects recent exposures (excretory half-life in blood is approximately 30 days)[9]. Lead in blood is primarily (99%) in the red blood cells. Table 12 in Appendix B lists reference concentrations which have been reported in the literature.

There is no known biological role of cadmium in the human body. The predominant commercial use of cadmium is in battery manufacturing. Other uses include pigment production, coatings and plating, plastic stabilizers, and nonferrous alloys. Since 2001, U.S. cadmium use has declined in response to environmental concerns. In the United States, for nonsmokers the primary source of cadmium exposure is from the food supply. People who regularly consume shellfish and organ meats will have higher exposures. In general, leafy vegetables such as lettuce and spinach, potatoes and grains, peanuts, soybeans, and sunflower seeds contain high levels of cadmium due to bioaccumulation from the soil. Tobacco leaves accumulate high levels of cadmium from the soil, and smoking is the primary non-occupational source of cadmium exposure for smokers. Generally, the critical organ for Cd is the kidney. Kidney dysfunction is one of the most characteristic signs of exposure to Cd. Workers in an environment with high exposure levels have developed proteinuria, renal glucosuria, aminoaciduria, hypercalciuria, phosphaturia, and polyuria. Chronic obstructive lung disease of varying degrees of severities is frequently seen in Cd workers. Concentration of cadmium in blood of healthy unexposed adults are in the range  $0.1 - 4 \mu\text{g/L}$ [10]. Newborn babies are

practically free of Cd[11]. Exposure to high concentration of fumes appearing from heated cadmium metal or compounds has led to acute poisoning and in some cases to the death of workers[7]. Principal symptoms reported were respiratory distress due to chemical pneumonitis and edema. It has been estimated that 8 hrs exposure to 5 gm Cd/m<sup>3</sup> will be lethal[7]. Ingestion of high amounts of Cd may lead to a rapid onset with severe nausea, vomiting, and abdominal pain. Cadmium levels in blood, urine, feces, liver, kidney, hair, and other tissues have been used as biological indicators of exposure to cadmium. Blood cadmium levels are principally indicative of recent exposure(s) to cadmium rather than whole-body burdens[12-15]. Urine cadmium levels primarily reflect total body burden of cadmium, although urine levels do respond somewhat to recent exposure[16]. Table 12 in Appendix B lists reference concentrations which have been reported in the literature.

Manganese (Mn) is a trace element essential to humans and is associated with the formation of connective and bony tissue, growth and reproductive functions and with carbohydrate and lipid metabolism [17]. Manganese is also a known neurotoxin but little information exists about levels of manganese that cause toxicity. Symptoms of manganese toxicity are similar to Parkinson's Disease and can also include disorientation, memory impairment, anxiety and compulsive behavior [18]. There is much concern for the levels of manganese in humans whom are occupationally exposed to it [19-25]. Recently, there are growing concerns over exposure due to contamination of drinking water with manganese [26-28] and as a result of methylcyclopentadienyl manganese tricarbonyl (MMT) used as an anti-knocking additive in gasoline[29-35]. Populations suffering from iron deficiencies may be particularly susceptible to manganese toxicity because iron deficiency may lead to an accumulation of manganese in the central nervous system [32]. To fully understand the essentiality and toxicity of manganese, further investigations are needed regarding the levels of manganese in biological matrices. Group average levels in blood appear to be related to manganese body burden, while average urinary excretion levels appear to be most indicative of recent exposures[36]. On an individual basis the correlation between the level of workplace exposure and the levels in blood or urine has always been found to be a reliable predictor of exposure[20, 36-38]. Manganese in blood or urine may be useful in detecting groups with above-average current exposure, but measurements of manganese in these body fluids in individuals may only be related to exposure dose after the exposure has ceased. In addition to individual variability, another factor that limits the usefulness of measuring manganese in blood, urine, or feces as a measure of excess manganese exposure is the relatively rapid rate of manganese clearance from the body. Excess manganese in blood is rapidly removed by the liver and excreted into the bile, with very little excretion in urine[39, 40]. Thus, levels of manganese in blood or urine are not expected to be the most sensitive indicators of exposure[41]. Table 12 in Appendix B lists reference concentrations which have been reported in the literature.

Selenium is an essential element that is required to maintain good health but both selenium deficiency and excessive levels of selenium are associated with several disorders[42, 43]. Selenium is a naturally occurring mineral element that is distributed widely in nature in most rocks and soils. Most processed selenium is used in the electronics industry, but it is also used: as a nutritional supplement; in the glass industry; as a component of pigments in plastics, paints, enamels, inks, and rubber; in the preparation of pharmaceuticals; as a nutritional feed additive for poultry and livestock; in pesticide formulations; in rubber production; as an ingredient in antidandruff shampoos; and as a constituent of fungicides. Radioactive selenium is used in diagnostic medicine. In the body, selenium is incorporated into proteins to make selenoproteins, which are important antioxidant enzymes. The antioxidant properties of selenoproteins help prevent cellular damage from free radicals. Free radicals are natural by-products of oxygen metabolism that may contribute to the development of chronic diseases such as cancer and heart disease[43, 44]. Other selenoproteins help regulate thyroid function and play a role in the immune system[45-48]. Human selenium deficiency is rare in the U.S. but is seen in other countries where soil concentration of selenium is low[49]. There is evidence that selenium deficiency may contribute to development of a form of heart disease, hypothyroidism, and a weakened immune system[50, 51]. There is also evidence that selenium deficiency does not usually cause illness by itself. Rather, it can make the body more susceptible to illnesses caused by other nutritional, biochemical or infectious stresses[52]. Symptoms of very high exposure to selenium, a condition called selenosis, include gastrointestinal upsets, hair loss, white blotchy nails, garlic breath odor, fatigue, irritability, and mild nerve damage[42]. Selenium can be detected in the blood, feces, urine, hair, and nails of exposed individuals, however, field studies have used primarily blood or urine levels to indicate the degree of selenium exposure[53]. Table 12 in Appendix B lists reference concentrations which have been reported in the literature.

The laboratory method presented here can be used to achieve rapid and accurate quantification of five elements of toxicological and nutritional interest including cadmium (Cd), lead (Pb), mercury, manganese (Mn) and selenium (Se) in whole human blood. The method may be used to screen blood when people are suspected to be acutely exposed to these elements or to evaluate chronic environmental or other non-occupational exposure.

b. Test Principle:

This method directly measures the Cd, Mn, Hg, Pb, and Se content of whole blood specimens using mass spectrometry after a simple dilution sample preparation step.

During the sample dilution step, a small volume of whole blood is extracted from a larger whole blood patient specimen after the entire specimen is mixed (vortexed) to create a uniform distribution of cellular components. This mixing step is important because some metals (e.g. Pb) are known to be associated

mostly with the red blood cells in the specimen and a uniform distribution of this cellular material must be produced before a small volume extracted from the larger specimen will accurately reflect the average metal concentration of all fractions of the larger specimen. Coagulation is the process in which blood forms solid clots from its cellular components. If steps are not taken to prevent this process from occurring, i.e. addition of anti-coagulant reagents such as EDTA in the blood collection tube prior to blood collection, blood will immediately begin to form clots once leaving the body and entering the tube. These clots prevent the uniform distribution of cellular material in the blood specimen even after rigorous mixing, making a representative sub-sample of the larger specimen unattainable. It is important that prior to or during sample preparation the analyst identify any sample having clots or micro-clots (small clots). Consequently, blood samples containing clots should not be analyzed by this method due to the inhomogeneity issues and expected results from the sample should be documented as not reportable.

Dilution of the blood in the sample preparation step prior to analysis is a simple dilution of 1 part sample + 1 part water + 48 parts diluent. The effects of the chemicals in the diluent are to release metals bound to red blood cells making them available for ionization, reduce ionization suppression by the biological matrix, prevent clogging of the sample introduction system pathways by undissolved biological solids, and allow introduction of internal standards to be utilized in the analysis step. Tetramethylammonium hydroxide (TMAH, 0.25% v/v) and Triton X-100® (0.05%) in the sample diluent solubilizes blood components. Triton X-100® also helps prevent biological deposits on internal surfaces of the instrument's sample introduction system and reduce collection of air bubbles in sample transport tubing. Ammonium pyrrolidine dithiocarbamate (APDC) in the sample diluent (0.25%) aids in solubilizing metals released from the biological matrix. Ethyl alcohol in the sample diluent (1%) aids solubility of blood components and aids in aerosol generation by reduction of the surface tension of the solution. The internal standards, rhodium, iridium and tellurium, are at a constant concentration in all blanks, calibrators, QC, and samples. Monitoring the instrument signal ratio of a metal to its internal standard allows correction for instrument noise and drift, and sample-to-sample matrix differences.

Liquid samples are introduced into the mass spectrometer through the inductively coupled plasma (ICP) ionization source. The liquid diluted blood sample is forced through a nebulizer which converts the bulk liquid into small droplets in an argon aerosol. The smaller droplets from the aerosol are selectively passed through the spray chamber by a flowing argon stream into the ICP. By coupling radio-frequency power into flowing argon, plasma is created in which the predominant species are positive argon ions and electrons and has a temperature of 6000-8000 K. The small aerosol droplets pass through a region of the plasma and the thermal energy vaporizes the liquid droplets, atomizes the molecules of the sample and then ionizes the atoms. The ions, along with the

argon, enter the mass spectrometer through an interface that separates the ICP (at atmospheric pressure, ~760 torr) from the mass spectrometer (operating at a pressure of  $10^{-5}$  torr). The ions first pass through a focusing region, then the dynamic reaction cell (DRC), the quadrupole mass filter, and finally are selectively counted in rapid sequence at the detector allowing individual isotopes of an element to be determined.

Generally, the DRC operates in one of two modes. In 'vented' (or 'standard') mode the cell is not pressurized and ions pass through the cell to the quadrupole mass filter unaffected. In 'DRC' mode, the cell is pressurized with a gas for the purpose of causing collisions and/or reactions between the fill gas and the incoming ions. In general, collisions or reactions with the incoming ions selectively occur to either eliminate an interfering ion, change the ion of interest to a new mass, which is free from interference, or collisions between ions in the beam and the DRC gas can focus the ion beam to the middle of the cell and increase the ion signal. In this method, the instrument is operated in DRC mode when analyzing for manganese, mercury and selenium. For selenium, the DRC is pressurized with methane gas ( $\text{CH}_4$ , 99.999%) which reduces the signal from  $^{40}\text{Ar}_2^+$  while allowing the  $^{80}\text{Se}^+$  ions to pass relatively unaffected through the DRC on toward the analytical quadrupole and detector. Manganese and mercury are both measured when the DRC is pressurized with oxygen gas ( $\text{O}_2$ , 99.999%). They are analyzed at the same flow rate of oxygen to the DRC cell to avoid lengthening analysis time due to pause delays that would be necessary if different gas flows were used for the two analytes. The oxygen reduces the ion signal from several interfering ions ( $^{37}\text{Cl}^{18}\text{O}^+$ ,  $^{40}\text{Ar}^{15}\text{N}^+$ ,  $^{38}\text{Ar}^{16}\text{O}^1\text{H}^+$ ,  $^{54}\text{Fe}^1\text{H}^+$ ) while allowing the  $\text{Mn}^+$  ion stream to pass relatively unaffected through the DRC on toward the analytical quadrupole and detector. In the case of mercury, collisional focusing of the mercury ions occurs, increasing the observed mercury signal at the detector by approximately a factor of two (2x).

Once ions pass through the DRC cell and electrically selected for passage through the analytical quadrupole, electrical signals resulting from the ions striking the discrete dynode detector are processed into digital information that is used to indicate the intensity of the ions. The intensity of ions detected while aspirating an unknown sample is correlated to an elemental concentration through comparison of the analyte:internal standard signal ratio with that obtained when aspirating calibration standards. This method was originally based on the method by Lutz et al.[54] The DRC portions of the method are based on work published by Tanner et al. [55, 56].

## 2) Limitations of Method; Interfering Substances and Conditions

### a. Interferences Addressed by This Method

- i. Reduction of argon dimer ( $^{40}\text{Ar}^{2+}$ ) interference on selenium ( $^{80}\text{Se}^+$ ) using ICP-DRC-MS:  $^{40}\text{Ar}^{2+}$  is a polyatomic ion formed in the plasma as a result of a



reaction between the plasma gas (Ar) and itself. The dynamic reaction cell of the ELAN ICP-DRC-MS is used to reduce ion signals from polyatomic ions via ion-molecule reaction chemistry [56, 57]. In the reaction cell, methane (CH<sub>4</sub>) molecules react with <sup>40</sup>Ar<sup>2+</sup> ions through a charge transfer reaction. The products of the reaction are <sup>40</sup>Ar<sup>+</sup> (ion at a different mass) and <sup>40</sup>Ar (neutral). The background ion signal at m/z 80 is reduced by six orders of magnitude because of this reaction.

- ii. Reduction of argon nitride (<sup>40</sup>Ar<sup>15</sup>N<sup>+</sup>), argon hydroxide (<sup>38</sup>Ar<sup>16</sup>O<sup>1</sup>H<sup>+</sup>) interference on manganese (<sup>55</sup>Mn) using ICP-DRC-MS: <sup>40</sup>Ar<sup>15</sup>N<sup>+</sup> and <sup>38</sup>Ar<sup>16</sup>O<sup>1</sup>H<sup>+</sup> are polyatomic ions formed in the plasma as a result of reactions between the plasma gas (Ar) and atmospheric gases (N<sub>2</sub>, O<sub>2</sub>) or the solvent (H<sub>2</sub>O). The dynamic reaction cell of the ELAN ICP-DRC-MS is used to reduce ion signals from polyatomic ions via ion-molecule reaction chemistry[56, 57]. In the reaction cell, oxygen molecules react with <sup>40</sup>Ar<sup>15</sup>N<sup>+</sup> and <sup>38</sup>Ar<sup>16</sup>O<sup>1</sup>H<sup>+</sup> ions through either charge transfer reactions or oxygen transfer reactions. The products of the reactions are either neutral molecules and are not detected (charge transfer), or a new ion with higher mass (oxygen transfer). In either case, attenuation of the background ion signal at m/z 55 occurs.
- iii. Reduction of <sup>37</sup>Cl<sup>18</sup>O<sup>+</sup>, <sup>39</sup>K<sup>16</sup>O<sup>+</sup>, <sup>54</sup>Fe<sup>1</sup>H<sup>+</sup> interferences on manganese (<sup>55</sup>Mn) using ICP-DRC-MS: <sup>37</sup>Cl<sup>18</sup>O<sup>+</sup>, <sup>39</sup>K<sup>16</sup>O<sup>+</sup>, <sup>54</sup>Fe<sup>1</sup>H<sup>+</sup> are polyatomic ions created in the plasma as a result of reactions between elements present in the blood matrix (Cl, K, and Fe) and the solvent (H<sub>2</sub>O). Due to the high concentrations of Cl, K, and Fe in the blood matrix the resulting ion signals of <sup>37</sup>Cl<sup>18</sup>O<sup>+</sup>, <sup>39</sup>K<sup>16</sup>O<sup>+</sup>, and <sup>54</sup>Fe<sup>1</sup>H<sup>+</sup> interfere with the measurement of <sup>55</sup>Mn<sup>+</sup> at m/z 55. The dynamic reaction cell of the ELAN ICP-DRC-MS is used to reduce ion signals from polyatomic ions via ion-molecule reaction chemistry[56, 57]. In the reaction cell, oxygen molecules react with <sup>37</sup>Cl<sup>18</sup>O<sup>+</sup>, <sup>39</sup>K<sup>16</sup>O<sup>+</sup>, <sup>54</sup>Fe<sup>1</sup>H<sup>+</sup> ions through either charge transfer reactions or oxygen transfer reactions. The products of the reactions are either neutral molecules and are not detected (charge transfer), or a new ions with higher mass (oxygen transfer). In either case, attenuation of the background ion signal at m/z 55 occurs.

### 3) Procedures for Collecting, Storing, and Handling Specimens; Criteria for Specimen Rejection; Specimen Accountability and Tracking

- a. Procedures for Collecting, Storing, and Handling Specimens: Specimen handling conditions, special requirements, and procedures for collection and transport are discussed in the division (DLS) Policies and Procedures Manual [58]. Copies are available in branch, laboratory, and special activities specimen-handling offices. An electronic copy is available at:  
[http://intranet.nceh.cdc.gov/dls/pdf/policiesprocedures/Policy\\_and\\_Procedures\\_Manual.DLS.2002mod.pdf](http://intranet.nceh.cdc.gov/dls/pdf/policiesprocedures/Policy_and_Procedures_Manual.DLS.2002mod.pdf). In general,
  - i. No fasting or special diets are required before collection of blood

- ii. Specimen type – whole blood
  - iii. Optimal amount of specimen is 1-2 ml. Request a minimum volume of 0.4 ml. Volume for one analytical measurement is 0.1 ml.
  - iv. Sample collection devices and containers should be verified to be free of significant contamination (“pre-screened”) before use.
  - v. Draw the blood through a stainless steel needle into a pre-screened vacutainer.
  - vi. Blood specimens should be transported and stored at  $\leq 4^{\circ}\text{C}$ . Once received, they can be frozen at  $\leq -20^{\circ}\text{C}$  until time for analysis. Specimen stability has been demonstrated for several months at  $\leq -20^{\circ}\text{C}$ .
- b. Criteria for Specimen Rejection: The criteria for an unacceptable specimen include:
- i. Contamination: Improper collection procedures, collection devices, or sample handling can contaminate the blood through contact with dust, dirt, etc. Manganese is present in the general environment, found often in combination with iron, and is present in many alloys (especially stainless steel).
  - ii. Low Volume: Request a minimum volume of 0.4 ml. Volume for one analytical measurement is 0.1 ml.
- In all cases, a second blood specimen should be requested.
- c. Transfer or Referral of Specimens; Procedures for Specimen Accountability and Tracking: Location, status, and final disposition of the specimens will be tracked at least by paper document in the “Study Folder” (created before analysts receive the samples). Apart from this specimen tracking form, this folder will also contain the paper print outs of results from analysis of the specimens. Maintain records for a minimum of 3 years. Use only numerical identifiers for samples within the laboratory (e.g., case ID numbers) in order to safeguard confidentiality. Only the medical supervisor (MS) or project coordinator (PC) i.e. non CDC personnel should have access to the personal identifiers.

#### **4) Safety Precautions**

- a. General Safety
  - i. Observe all safety regulations as detailed in the Division (DLS) Safety Manual. Additional information can be found in your lab’s chemical hygiene plan.

- Participate in training regarding blood-borne pathogens prior to performing this method.
- ii. Observe Universal Precautions when working with blood.
  - iii. Wear appropriate gloves, lab coat, and safety glasses while handling all solutions.
  - iv. Special care should be taken when handling and dispensing bases and concentrated acids. Wear powder free gloves, a lab coat, safety glasses, and face / neck protection. **If TMAH or concentrated hydrochloric acid comes in contact with any part of the body, quickly wash with copious quantities of water for at least 15 minutes.**
  - v. Use secondary containment for containers holding biological or corrosive liquids.
  - vi. Dispose of all biological samples and diluted specimens in a biohazard autoclave bag at the end of the analysis according to CDC/DLS guidelines for disposal of hazardous waste.
  - vii. The use of the foot pedal on the Digiflex™ is recommended because it reduces analyst contact with work surfaces that have been in contact with blood and also keeps the analyst's hands free to hold the specimen cups and autosampler tubes and to wipe off the tip of Digiflex™.
  - viii. Training will be given before operating the ICP-DRC-MS, as there are many possible hazards including ultraviolet radiation, high voltages, radio-frequency radiation, and high temperatures. This information is also detailed in the PerkinElmer ELAN® ICP-DRC-MS System Safety Manual.
  - ix. Transport and store compressed gas cylinders with proper securing harnesses. For compressed oxygen gas, use regulators which are oil-free and are equipped with a flash arrestor.
  - x. Wipe down all work surfaces at the end of the day with bleach-rite spray or freshly prepared 10% (v/v) sodium-hypochlorite solution.
- b. Waste Disposal: Operators of this method should take the CDC-OHS Hazardous Chemical Waste Management Course (initial and yearly refreshers).
- i. Waste to be Placed Into Biohazard Autoclave Bags & Pans:
    1. All biological samples and diluted specimens (after analysis run).

2. All disposable plastic and paper which contact blood (autosampler tubes, gloves, etc.).
  3. Used non-glass/quartz ICP-MS consumables (i.e. probes, tubing, cones, ion lenses).
- ii. Waste to be Placed Into Sharps Containers: Pipette Tips, broken glass or quartz instrument consumables (broken spray chambers, torches, nebulizers, etc. . .). Large broken glass which will not fit in the sharps container should be placed in a separate autoclave pan from other waste and labeled as “broken glass” (see the “Autoclaving” section of the CDC safety policies and practices manual located in the laboratory).

## 5) Instrument & Material Sources

### a. Sources for ICP-MS Instrumentation

i. ICP-MS: Inductively Coupled Plasma Dynamic Reaction Cell Mass Spectrometer (ELAN<sup>®</sup> DRC II) (PerkinElmer Norwalk, CT, [www.perkinelmer.com](http://www.perkinelmer.com)).

1. DXi-FAST upgrade: Standard peristaltic pump replaced by DXi-FAST micro-peristaltic pump / FAST actuator and valve combination unit. For ELAN DRC2, part # DXI-54-P4-F6.

ii. Recirculating chiller / heat exchanger for ICP-MS: Refrigerated chiller (PolyScience 6105PE for ELAN<sup>®</sup> 6100 DRC<sup>Plus</sup> instruments) if unit is to be placed remotely from ICP-MS or heat exchanger (PolyScience 3370 for ELAN<sup>®</sup> DRC II instruments) if unit is to be placed alongside ICP-MS (PerkinElmer Norwalk, CT, [www.perkinelmer.com](http://www.perkinelmer.com)).

### iii. Autosampler:

1. ESI SC4 autosampler: Dual rinse station supplied by two independent pumps built internal to the autosampler (Elemental Scientific Inc., Omaha, NE).

2. FAST: Purchase as an option onto the ESI SC4 autosampler (Elemental Scientific Inc., Omaha, NE).

### b. Sources for ICP-MS Parts & Consumables

NOTE: The minimum number of spares recommended before reordering (if owning one instrument) are listed as “# Spares =” in the descriptions below.

i. Adapter, PEEK: Securely connects 1.6mm O.D. PFA tubing to 0.03” I.D. peristaltic tubing. Composed of three PEEK parts.

1. Female nut for 1.6mm O.D. (1/16") tubing. Like part P-420 (Upchurch Scientific, Oak Harbor, WA, [www.upchurch.com](http://www.upchurch.com)).
  2. PEEK ferrule. Like part P-260x (10pk SuperFlangeless ferrule, Upchurch Scientific, Oak Harbor, WA, [www.upchurch.com](http://www.upchurch.com)).
  3. Conical Adapter Body. Like part P-692 (Upchurch Scientific, Oak Harbor, WA, [www.upchurch.com](http://www.upchurch.com)).
- ii. Bottles (for rinse solution): Four liter screw-cap polypropylene container with 2 luer connections (like catalog# SC-0305-1, Elemental Scientific Inc., Omaha, NE., [www.elementalscientific.com](http://www.elementalscientific.com)).
  - iii. Carboy and cap assembly for waste collection: 10-15L, polypropylene wide-mouth carboy (100 mm neck size) with handles and no spigot (Like part # 7BE-25126, Lab Safety Supply, Janesville, WI, [www.lss.com](http://www.lss.com)) with cap assembly like part # N0690271 (PerkinElmer Norwalk, CT, [www.perkinelmer.com](http://www.perkinelmer.com)).
  - iv. Coolant, for Polyscience chiller or heat exchanger: Only PerkinElmer part # WE01-6558 (PerkinElmer Norwalk, CT, [www.perkinelmer.com](http://www.perkinelmer.com)) is approved for use by PerkinElmer. # Spares = 6.
  - v. Cone, sampler (nickel): PerkinElmer part # WE021140 (PerkinElmer Norwalk, CT, [www.perkinelmer.com](http://www.perkinelmer.com)). Part # SC2011-Ni (Testing has also found Spectron, Ventura, CA, [www.spectronus.com](http://www.spectronus.com) cones to be comparable). # Spares = 4.
  - vi. Cone, skimmer (nickel): PerkinElmer part # WE021137 (PerkinElmer Norwalk, CT, [www.perkinelmer.com](http://www.perkinelmer.com)). Part # SC2012-Ni (Testing has also found Spectron, Ventura, CA, [www.spectronus.com](http://www.spectronus.com) cones to be comparable) # Spares = 4.
  - vii. Detector, electron multiplier: Like part # N8125001 (PerkinElmer Norwalk, CT, [www.perkinelmer.com](http://www.perkinelmer.com)). Available direct from manufacturer (part # 14210, SGE Incorporated, Austin, Texas, <http://www.etpsci.com>) or various distributors. # Spares = 1.
- viii. FAST accessories
    1. Valve: CTFE High-flow valve head for SC-FAST (uses 1/4-28 fittings). Like part # SC-0599-1010 (Elemental Scientific Inc., Omaha, NE., [www.elementalscientific.com](http://www.elementalscientific.com)).
    2. Stator: CTFE Stator for 6 port SC-FAST high flow valve (1/4-28 fittings). Like part # SC-0599-1010-01 (Elemental Scientific Inc., Omaha, NE., [www.elementalscientific.com](http://www.elementalscientific.com)).
    3. Rotor: Composite rotor for 6 port SC-FAST high flow valve (1/4-28 fittings). Like part # SC-0599-1010-05 (Elemental Scientific Inc., Omaha, NE., [www.elementalscientific.com](http://www.elementalscientific.com)).

4. Sample Loop: 1 mL Teflon, white connector-nuts for high flow valve head. Like part # SC-0315-10 (Elemental Scientific Inc., Omaha, NE., [www.elementalscientific.com](http://www.elementalscientific.com)).
5. Probe, Autosampler: Teflon, carbon fiber support, 0.8mm i.d., blue marker, 1/4-28 fittings. Like part number SC-5037-3751 (Elemental Scientific Inc., Omaha, NE., [www.elementalscientific.com](http://www.elementalscientific.com)). # Spares = 2.
6. Probe, Carrier Solution: Teflon, carbon fiber support, 0.5mm i.d., orange marker, 1/4-28 fittings. Like part number SC-5037-3501 (Elemental Scientific Inc., Omaha, NE., [www.elementalscientific.com](http://www.elementalscientific.com)). # Spares = 2.
7. Tubing, FAST vacuum: Vacuum line for SC-FAST high flow valve, connects to port #6, black nut for connection to valve head, natural brown color nut on other end for connection to SC autosampler vacuum port. Like part # SC-0321 (Elemental Scientific Inc., Omaha, NE., [www.elementalscientific.com](http://www.elementalscientific.com)).
8. Tubing, connects nebulizer to valve: See “Nebulizer, PolyPro-ST micro flow”
- ix. Hose, for connection to chiller: Push on hose. I.D. = 1/2”, O.D. = 3/4”. Use part # PB-8 (per inch, Georgia Valve and Fitting, Atlanta, GA, [www.swagelok.com](http://www.swagelok.com)) or equivalent. Do not normally need spare hose (unless moving instrument into a new location).
- x. Hose, for exhaust of ELAN: Available as part of ELAN installation kit from Perkin Elmer (PerkinElmer Norwalk, CT, [www.perkinelmer.com](http://www.perkinelmer.com)). Available direct from manufacturer as part # S-LP-10 air connector (Thermafex, Abbeville, SC, [www.thermafex.net](http://www.thermafex.net)). Equivalent part may be substituted. # Spares = 10 feet of 4” diameter and 10 feet of 6” diameter hose.
- xi. Injector, quartz: I.D. = 2.0 mm. PerkinElmer part # WE023948 (PerkinElmer Norwalk, CT, [www.perkinelmer.com](http://www.perkinelmer.com)). Available direct from manufacturer as part # 400-30 (Precision Glass Blowing, Centennial, CO, [www.precisionglassblowing.com](http://www.precisionglassblowing.com)) or equivalent from various distributors. # Spares = 2.
- xii. Injector support (for pass-through injector): PerkinElmer part # WE023951 (PerkinElmer Norwalk, CT, [www.perkinelmer.com](http://www.perkinelmer.com)). Available direct from manufacturer as part # 400-37 (Precision Glass Blowing, Centennial, CO, [www.precisionglassblowing.com](http://www.precisionglassblowing.com)) or equivalent from various distributors. # Spares = 2.
- xiii. Ion Lens: PerkinElmer part # WE018034 (PerkinElmer Norwalk, CT, [www.perkinelmer.com](http://www.perkinelmer.com)). # Spares = 3.
- xiv. Nebulizer, PolyPro-ST micro flow: Polypropylene nebulizer with external 1/4-28 threaded connector for liquid delivery, low pressure version or equivalent. Like part # ES-4040-7010 (Elemental Scientific Inc., Omaha, NE., [www.elementalscientific.com](http://www.elementalscientific.com)). # Spares = 1.
  1. Gas connection:

- a. Teflon tubing: 4mm o.d., 2.4mm i.d. Teflon tubing (like part # ES-2502, Elemental Scientific Inc., Omaha, NE., [www.elementalscientific.com](http://www.elementalscientific.com)). # Spares = 1.
  - b. Adapter kit: Plastic adapters to connect *Teflon* tubing (2.4mm i.d) to 1/4" male Swagelok (compression) port on ICP-DRC-MS. Parts can be obtained as components in a "gas fittings kit for microflow nebulizer", kit part # ES-2501-1000, Elemental Scientific Inc., Omaha, NE., [www.elementalscientific.com](http://www.elementalscientific.com)). # Spares = 1.
2. Liquid connection: Connects nebulizer to port #3 of high flow FAST valve head with green, 1/4- 28 fitting. Like part # SC-0317-0250 (Elemental Scientific Inc., Omaha, NE., [www.elementalscientific.com](http://www.elementalscientific.com)). # Spares = 2.
- xv. Nut and Ferrule set, 1/8" Swagelok: Such as part # SS-200-NFSET (stainless steel) or part # B-200-NFSET (brass) (Georgia Valve and Fitting, Atlanta, GA, [www.swagelok.com](http://www.swagelok.com)) or equivalent. For part numbers listed here a quantity of 1 means 1 nut, 1 front ferrule, and 1 back ferrule. Spares = 20.
  - xvi. Nut and Ferrule set, 1/4" Swagelok: Such as part # SS-400-NFSET (stainless steel) or part # B-400-NFSET (brass) (Georgia Valve and Fitting, Atlanta, GA, [www.swagelok.com](http://www.swagelok.com)) or equivalent. For part numbers listed here a quantity of 1 means 1 nut, 1 front ferrule, and 1 back ferrule. Spares = 20.
  - xvii. Oil, Welch DirecTorr Gold: For roughing pumps. Available direct from manufacturer as part # 8995G-15 (1 gallon, Welch Rietschle Thomas, Skokie, IL, [www.welchvacuum.com](http://www.welchvacuum.com)) or from various distributors. Equivalent oil may be substituted. # Spares = 4.
  - xviii. O-ring: (for sampler cone) PerkinElmer part # N8120511 (pkg. of 5, PerkinElmer, Shelton, CT, [www.perkinelmer.com](http://www.perkinelmer.com)) or equivalent. # Spares = 20 o-rings.
  - xix. O-ring: (for skimmer cone) PerkinElmer part # N8120512 (pkg. of 5, PerkinElmer, Shelton, CT, [www.perkinelmer.com](http://www.perkinelmer.com)) or equivalent. # Spares = 20 o-rings.
  - xx. O-ring: (for ELAN DRC II standard injector support).
    1. Internal o-rings: ID = 1/4", OD = 3/8", thickness = 1/16". Need 2 o-rings per injector support setup. PerkinElmer part # N8122008 (PerkinElmer, Shelton, CT, [www.perkinelmer.com](http://www.perkinelmer.com)) or equivalent (such as part # V75-010, O-rings West, Seattle, WA, [www.oringswest.com](http://www.oringswest.com)). # Spares = 20.
    2. External o-rings: ID = 3/8", OD = 1/2", thickness = 1/16". Need 2 o-rings for each injector support setup. PerkinElmer part # N8122009 (PerkinElmer, Shelton, CT, [www.perkinelmer.com](http://www.perkinelmer.com)) or equivalent (such as part # V75-012, O-rings West, Seattle, WA, [www.oringswest.com](http://www.oringswest.com)). # Spares = 20.
  - xxi. O-ring: (for inside of bayonet torch mount): Part # WE017284 (PerkinElmer, Shelton, CT, [www.perkinelmer.com](http://www.perkinelmer.com)). Do not substitute. The PerkinElmer o-

ring is specially metal impregnated to minimize RF leakage though the torch mount. # Spares = 2.

- xxii. Photon Stop: PerkinElmer part # WE018278 (PerkinElmer, Shelton, CT, [www.perkinelmer.com](http://www.perkinelmer.com)). # Spares = 1.
- xxiii. Plugs, Quick Change for Roughing Pump Oil: These plugs will only work on the Varian roughing pumps which come standard on ELAN DRC II ICPMS instruments. These plugs will not fit the Leybold pumps which come standard on the ELAN DRC Plus instruments. Part # W1011013 (PerkinElmer, Shelton, CT, [www.perkinelmer.com](http://www.perkinelmer.com)). No spares typically needed.
- xxiv. RF coil: PerkinElmer part # WE02-1816 (PerkinElmer, Shelton, CT, [www.perkinelmer.com](http://www.perkinelmer.com)) or equivalent. # Spares = 2.
- xxv. Spray chamber, quartz concentric: PerkinElmer part # WE025221 (PerkinElmer, Shelton, CT, [www.perkinelmer.com](http://www.perkinelmer.com)) or equivalent. Available direct from manufacturer as part # 400-20 (Precision Glass Blowing, Centennial, CO, [www.precisionglassblowing.com](http://www.precisionglassblowing.com)) or from various distributors. # Spares = 2.
- a. O-ring: (for inside spray chamber at nebulizer port) Such as part # 120-56 (Precision Glass Blowing, Centennial, CO, [www.precisionglassblowing.com](http://www.precisionglassblowing.com)). Additional o-rings can sometimes be obtained free of charge or at reduced price when acquired while purchasing spray chambers. # Spares = 20.
- xxvi. Torch, quartz: PerkinElmer part # N812-2006 (PerkinElmer, Shelton, CT, [www.perkinelmer.com](http://www.perkinelmer.com)) or equivalent. Available direct from manufacturer as part # 400-10 (Precision Glass Blowing, Centennial, CO, [www.precisionglassblowing.com](http://www.precisionglassblowing.com)) or various distributors. Damaged torches can often be repaired for substantially lower cost than purchasing a new one by companies such as Wilmad LabGlass (Buena, NJ, [www.wilmad-labglass.com](http://www.wilmad-labglass.com)) or Precision Glass Blowing (Centennial, CO, [www.precisionglassblowing.com](http://www.precisionglassblowing.com)). # New Spares = 2.
- xxvii. Tubing, main argon delivery to instrument: I.D. = 1/8", O.D. = 1/4". Such as part # C-06500-02 (pkg. of 100ft, polypropylene, Fisher Scientific International, Hampton, NH, [www.fishersci.com](http://www.fishersci.com)) or equivalent. # Spares = 50ft.
- xxviii. Tubing, drains waste liquid from spray chamber :
1. PVC 1/8" i.d., 3/16" o.d tubing used to transfer waste liquid between spray chamber waste port and peristaltic pump waste tubing and between peristaltic pump waste tubing and liquid waste carboy. Like part # 14-169-7A (pkg. of 50ft, Fisher Scientific International, Hampton, NH, [www.fishersci.com](http://www.fishersci.com)) or equivalent. # Spares = 20ft.
  2. Connector: Use to connect 1/8" I.D. PVC tubing to 0.125" I.D peristaltic pump tubing. Use part # 3140715 (PerkinElmer Norwalk, CT, [www.perkinelmer.com](http://www.perkinelmer.com)) or equivalent. # Spares = 4.
- xxix. Tubing, peristaltic, 0.03" i.d. (sampling/carrier solution):



1. Standard PVC, 2-stop (black / black) peristaltic pump tubing, i.d. = 0.03". PerkinElmer part # 09908587 (PerkinElmer, Shelton, CT, [www.perkinelmer.com](http://www.perkinelmer.com)) or equivalent. # Spares = 6 packs of 12 tubes. *Use this type tubing with standard ELAN peristaltic pump.*
  2. Standard PVC, 3-stop. (blank / black) peristaltic pump tubing, i.d. 0.76 mm. Spectron part # SC0056 (Spectron, Ventura, CA, [www.spectronus.com](http://www.spectronus.com)) or equivalent. # Spares = 6 packs of 12 tubes. *Use this type tubing with ESI DXi micro-peristaltic pump.*
- xxx. Tubing, peristaltic, 0.045" i.d. (spray chamber drain):
1. Standard PVC, 2-stop (red / red) peristaltic pump tubing, i.d. = 0.045". PerkinElmer part # N0680375, (PerkinElmer, Shelton, CT, [www.perkinelmer.com](http://www.perkinelmer.com)) or equivalent. # Spares = 6 packs of 12 tubes.
  2. Standard Santoprene, 3-stop (grey / grey / grey) peristaltic pump tubing, i.d. 1.30 mm. Spectron part # SC0311 (Spectron, Ventura CA, [www.spectronus.com](http://www.spectronus.com)) or equivalent. # Spares = 6 packs of 12 tubes. *Use this type tubing with ESI DXi micro-peristaltic pump.*
- xxxii. Tubing, Stainless Steel, o.d. = 1/8", wall thickness = 0.028": Used to connect DRC gas cylinders to ELAN DRC gas ports. Also can be used to replace plastic tubing in the DRC gas path within the ELAN to minimize gas leaks/diffusion into gas stream. Like part # SS-T2-S-028-20 (20ft, Georgia Valve and Fitting, Atlanta, GA, [www.swagelok.com](http://www.swagelok.com)) or equivalent. Spares = 20ft.
- xxxiii. Tubing, Teflon, corrugated, 1/4" o.d.: Connects to the auxiliary and plasma gas side-arms of the torch. Part # WE015903 (PerkinElmer, Shelton, CT, [www.perkinelmer.com](http://www.perkinelmer.com)). # Spares = 2.
- xxxiiii. Union Elbow, PTFE 1/4" Swagelok: Connects argon tubing to torch auxiliary gas sidearm. Like part # T-400-9 (Georgia Valve and Fitting, Atlanta, GA, [www.swagelok.com](http://www.swagelok.com)) or equivalent. Spares = 2.
- xxxv. Union Tee, PTFE, 1/4" Swagelok: Connects argon tubing to torch plasma gas sidearm and holds igniter inside torch sidearm. Like part # T-400-3 (Georgia Valve and Fitting, Atlanta, GA, [www.swagelok.com](http://www.swagelok.com)) or equivalent. Spares = 2.
- c. Sources for ICP-MS Maintenance Equipment & Supplies
- i. Anemometer: Like digital wind-vane anemometer (Model 840032, SPER Scientific LTD., Scottsdale, AZ, [www.spersscientific.com](http://www.spersscientific.com)) or equivalent. Use to verify adequate exhaust ventilation for ICP-MS (check with hoses fully disconnected).
  - ii. Pan, for changing roughing pump oil: Like part # 53216 (United States Plastics Corporation, Lima, OH, [www.usplastic.com](http://www.usplastic.com)) or equivalent. # On hand = 1.

- iii. Container, to hold acid baths for glassware: Polypropylene or polyethylene containers with lids (must be large enough for torch, injector, or spray chamber submersion). May be purchased from laboratory or home kitchen supply companies. # *On hand* = 4.
  - iv. Cotton swabs: Any vendor. For cleaning of cones and glassware.
  - v. Cutter (for 1/8" o.d. metal tubing): Terry tool with 3 replacement wheels. Like part # TT-1008 (Chrom Tech, Inc., Saint Paul, MN, [www.chromtech.com](http://www.chromtech.com)) or equivalent.
  - vi. Getter Regeneration Kit: Part # WE023257 (PerkinElmer, Shelton, CT, [www.perkinelmer.com](http://www.perkinelmer.com)). Use this as needed (at least annually) to clean the getter in the pathway of channel A DRC gas.
  - vii. Magnifying glass: Any 10x + pocket loupe for inspection of cones and other ICP-MS parts. Plastic body is preferred for non-corrosion characteristics. Like part # 5BC-42813 (Lab Safety Supply, Janesville, WI, [www.labsafety.com](http://www.labsafety.com)).
  - viii. Toothbrush: Any vendor. For cleaning ion lens and glassware.
  - ix. Ultrasonic bath: Like ULTRASONIK™ Benchtop Cleaners (NEYTECH, Bloomfield, CT, [www.neytech.com](http://www.neytech.com)) or equivalent.
- d. Sources for General Laboratory Consumable Supplies
- i. Bar Code Scanner: Like Code Reader 2.0 (Code Corporation, Draper, UT, [www.codecorp.com](http://www.codecorp.com)) or equivalent. For scanning sample IDs during analysis setup. Any bar code scanner capable of reading Code 128 encoding at a 3 mil label density can be substituted.
  - ii. Carboy (for preparation of blood quality control pool and waste jug for ICPMS sample introduction system): Polypropylene 10-L carboy (like catalog # 02-960-20C, Fisher Scientific, Pittsburgh, PA, [www.fishersci.com](http://www.fishersci.com)) or equivalent. Carboys with spouts are not advised due to potential for leaking.
  - iii. Containers for diluent and Rinse Solution: Two liter Teflon™ containers (like catalog# 02-923-30E, Fisher Scientific, Pittsburgh, PA., [www.fishersci.com](http://www.fishersci.com)) and 4L polypropylene jugs (like catalog# 02-960-10A, Fisher Scientific, Pittsburgh, PA, [www.fishersci.com](http://www.fishersci.com)) have both been used. Acid rinse before use. Equivalent containers may be substituted.
  - iv. Gloves: Powder-free, low particulate nitrile (like Best Clean-DEX™ 100% nitrile gloves, any vendor). Equivalent nitrile or latex gloves may be substituted.
  - v. Paper towels: For general lab use, any low-lint paper wipes such as KIMWIPES®EX-L Delicate Task Wipers or KAYDRY®EX-L Delicate Task Wipers (Kimberly-Clark Professional, Atlanta, GA, [www.kcprofessional.com](http://www.kcprofessional.com)). For sensitive applications in cleanrooms, a wipe designed for cleanroom use may be desired such as the Econowipe or Wetwipe (Liberty, East Berlin, CT, [www.liberty-ind.com](http://www.liberty-ind.com)).

- vi. Pipette (for preparation of blood dilutions to be analyzed): Micromedic Digiflex-CX Automatic™ pipette equipped with 10.0-mL dispensing syringe, 2  $\mu$ L sampling syringe, 0.75-mm tip, and foot pedal (Titertek, Huntsville, AL, <http://www.titertek.com/>).
  - vii. Pipettes (for preparation of intermediate stock working standards & other reagents): Like Brinkmann Research Pro Electronic pipettes (Brinkmann Instruments, Inc., Westbury, NY, <http://www.brinkmann.com/home/>). 5-100  $\mu$ L (catalog #4860 000.070), 20-300  $\mu$ L (catalog #4860 000.089), 50-1000  $\mu$ L (catalog #4860 000.097), 100-5000  $\mu$ L (catalog #4860 000.100). Note: pipette catalog numbers are without individual chargers. Can purchase individual chargers (pipette catalog numbers will differ) or a charging stand that will hold four pipettes (catalog #4860 000.860). When purchasing pipette tips (epTips), purchase one or more boxes, then “reloads” for those boxes after that: 5-100  $\mu$ L (box catalog # 22 49 133-4, reload catalog # 22 49 153-9), 20-300  $\mu$ L (box catalog # 22 49 134-2, reload catalog # 22 49 154-7), 50-1000  $\mu$ L (box catalog # 22 49 135-1, reload catalog # 22 49 155-5), 100-5000  $\mu$ L (box catalog # 22 49 138-5, reload catalog # 22 49 198-9, bulk bag catalog # 22 49 208-0). Equivalent pipettes and tips can be substituted.
  - viii. Tubes for sample analysis (for autosampler): Like polypropylene 15-mL conical tubes, BD Falcon model #352097 (Becton Dickinson Labware, Franklin Lakes, NJ, [www.bd.com](http://www.bd.com)). Equivalent tubes may be substituted which are shown by lot screening to be free of trace metal contamination. Clear plastics tend to have lowest trace metal contamination. Blue colored caps have also been used successfully for this method.
  - ix. Tubes for storage of intermediate working stock standards: Like polypropylene 50-mL conical tubes, BD Falcon model #352098 (Becton Dickinson Labware, Franklin Lakes, NJ, [www.bd.com](http://www.bd.com)). For use in storage of intermediate working stock standards. Equivalent tubes may be substituted which are shown by lot screening to be free of trace metal contamination. Clear plastics tend to have lowest trace metal contamination. Blue colored caps have also been used successfully for this method.
  - x. Vortexer: Like MV-1 Mini Vortexer (VWR, West Chester, PA, [www.vwr.com](http://www.vwr.com)). Used for vortexing blood specimens before removing an aliquot for analysis. Equivalent item can be substituted.
  - xi. Water purification system: Like NANOpure Diamond Ultrapure Water System (Barnstead International, Dubuque, Iowa, [www.barnstead.com](http://www.barnstead.com)). For ultra-pure water used in reagent and dilution preparations. An equivalent water purification unit capable of producing  $\geq 18$  Mega-ohm-cm water may be substituted.
- e. Sources of Chemicals, Gases, and Regulators
- i. Acid, Hydrochloric acid: Veritas™ double-distilled grade, 30-35% (GFS Chemicals Inc. Columbus, OH, [www.gfschemicals.com](http://www.gfschemicals.com)). This is referred to as “concentrated” hydrochloric acid in this method write-up. For use in

preparation of intermediate working stock standards. An equivalent hydrochloric acid product may be substituted, but it must meet or exceed the purity specifications of this product for trace metals content.

- ii. Acid, Nitric acid: Veritas™ double-distilled grade, 68-70% (GFS Chemicals Inc. Columbus, OH, [www.gfschemicals.com](http://www.gfschemicals.com)). For use in cleaning any bottles, vials, tubes, and flasks. This is referred to as “concentrated” nitric acid in this method write-up. An equivalent nitric acid product may be substituted, but it must meet or exceed the purity specifications of this product for trace metals content.
- iii. Alcohol, Ethyl, USP dehydrated 200 proof (Pharmco Products, Inc.) or equivalent.
- iv. Ammonium pyrrolidine dithiocarbamate, laboratory grade (Fisher Scientific, Fairlawn, NJ) or equivalent.
- v. Argon Gas (for plasma & nebulizer) and Regulator: High purity argon (>99.999% purity, Specialty Gases Southeast, Atlanta, GA, [www.sgsgas.com](http://www.sgsgas.com)) for torch and nebulizer. Minimum tank source is a dewar of liquid argon (180-250L). Bulk tank (1500<sup>+</sup>L is preferred).
  1. Regulator for argon (at dewar): Stainless steel, single stage, specially cleaned regulator with 3000 psig max inlet, 0-100 outlet pressure range, CGA 580 cylinder connector, and needle valve shutoff on delivery side terminating in a ¼” Swagelok connector. Part number KPRAFPF415A2AG10 (Georgia Valve and Fitting, Atlanta, GA, [www.swagelok.com](http://www.swagelok.com)). An equivalent regulator from an alternate vendor may be substituted. # Spares = 1.
  2. Regulator for argon (between bulk tank and PerkinElmer filter regulator): Single Stage 316SS Regulator, with 0-300 psi Inlet Gauge, 0-200 psi Outlet Gauge, Outlet Spring Range, 0-250 psi, ¼” Swagelok Inlet Connection, ¼ turn Shut off Valve on Outlet with ¼” Swagelok Connection and Teflon Seals. Part number KPR1GRF412A20000-AR1 (Georgia Valve and Fitting, Atlanta, GA, [www.swagelok.com](http://www.swagelok.com)). An equivalent regulator from an alternate vendor may be substituted. # Spares = 1.
  3. Regulator for argon (PerkinElmer filter regulator on back of ELAN): Argon regulator filter kit. Catalog number N812-0508 (PerkinElmer, Shelton, CT, [www.perkinelmer.com](http://www.perkinelmer.com)).
- vi. Disinfectant, for work surfaces: Bleach-rite spray (any distributor). On-site dilutions of bleach (1part bleach + 9 parts water) may be substituted, but must be re-made daily.
- vii. Methane: Methane (Research Grade 5.0, 99.99% purity), for DRC channel A. Typically purchased in cylinder size 200 (part # ME R200, Airgas South, Atlanta, GA, [www.airgas.com](http://www.airgas.com)).

1. Regulator for methane: A 2-stage, high purity brass regulator with max rated inlet pressures of 3,000 psi, max outlet pressures of 15-30 psi (with gauge maximum at 15-30psi). Like part number Y12-N145A350 (Airgas South, Atlanta, GA, [www.airgas.com](http://www.airgas.com)). An equivalent regulator from an alternate vendor may be substituted. # Spares = 1.
  2. Flash Arrestor: Like part # 6103 (Matheson Tri Gas, Montgomeryville, PA, [www.mathesontrigas.com](http://www.mathesontrigas.com)) or equivalent.
- viii. Oxygen: Oxygen ("Research Grade Research Grade 5.0", 99.9999% purity) for DRC channel B. Typically purchased in cylinder size 300 (9.5" x 54") (Airgas South, Atlanta, GA, [www.airgas.com](http://www.airgas.com)).
1. Regulator for oxygen: High purity brass body with monel trim, two stage regulator. Stainless steel is not used for this application due to safety concerns of working with oxygen at high pressure [59]. For one regulator, order the following parts, and ask that they be tested and assembled (Engineered Specialty Products, Kennesaw, GA, [www.espgauges.com](http://www.espgauges.com)).
    - a. Tescom part # 44-3410S24-555  
*Regulator body*: Brass bar stock, two stage, Monel trim, TFE seats, Elgiloy diaphragms, Cv=0.05, 3000 psig max inlet, 1-25 psig outlet range, 1/4 FNPT inlet / outlet / gauge ports, O<sub>2</sub> cleaned to ASTM G93 and CGA4.1.
    - b. Tescom part # 60500-3000N  
*Inlet pressure gauge*: 2" diameter, 0-3000 psig range , O<sub>2</sub> cleaned, 1/4" MNPT bottom, brass.
    - c. Tescom part # 60500-0015N  
*Delivery pressure gauge*: 2" diameter, 0-15 psig range , O<sub>2</sub> cleaned, 1/4" MNPT bottom, brass.
    - d. Tescom part # 63842-540-B  
*NPT to CGA Adaptor*: 1/4" NPT to CGA 540 adaptor, brass.
    - e. Swagelok part # B-200-1-4:  
*Adapter*: Brass male connector, 1/4" MNPT to 1/8" Swagelok (Georgia Valve and Fitting, Atlanta, GA, [www.swagelok.com](http://www.swagelok.com)).

An equivalent regulator from an alternate vendor may be substituted.  
# Spares = 1.
  2. Flash Arrestor (brass): Like part # 6103 (Matheson Tri Gas, Montgomeryville, PA, [www.mathesontrigas.com](http://www.mathesontrigas.com)) or equivalent.
- ix. Standard, Iridium: Like 1,000 mg/L, item #CGIR1-1 (Inorganic Ventures, Christiansburg, VA <http://www.inorganicventures.com>). Used as an internal standard in diluent. Any vendor whose standards are traceable to the National

Institute for Standards and Technology may be substituted. The standard must have low trace metal contamination.

- x. Standard, Rhodium: Like 1,000 mg/L, item # PLRH3-2Y. (SPEX Industries, Inc., Edison, NJ, [www.spexcsp.com](http://www.spexcsp.com)). Used as an internal standard in diluent. Any vendor whose standards are traceable to the National Institute for Standards and Technology may be substituted. The standard must have low trace metal contamination.
- xi. Standard, Tellurium: Like 1,000 mg/L, item #CGTE1-1 (Inorganic Ventures, Christiansburg, VA <http://www.inorganicventures.com>). Used as an internal standard in diluent. Any vendor whose standards are traceable to the National Institute for Standards and Technology may be substituted. The standard must have low trace metal contamination.
- xii. Standard, single element stock standards for preparation of calibrators and blood quality control pools: National Institute of Standards and Technology (NIST) Standard Reference Materials (SRMs): 3108 (Cd), 3132 (Mn), 3128 (Pb), 3133 (Hg), 3149 (Se). (Gaithersburg, MD, [www.nist.gov](http://www.nist.gov)). Other sources of standards can be used if they are NIST traceable.
- xiii. Tetramethylammonium hydroxide, 25% w/w, or equivalent (AlfaAesar, 30 Bond St., Ward Hill, MA 01835)
- xiv. Triton X-100™ surfactant: Like “Baker Analyzed” TritonX-100™ (J.T. Baker Chemical Co., [www.jtbaker.com](http://www.jtbaker.com)). Another source may be substituted, but it must be free of trace-metal contamination.

## 6) Preparation of Reagents and Materials

- a. Internal Standard Intermediate Mixture (20 µg/mL Rh, Ir and Te):
  - i. Purpose: Preparation of single intermediate solution containing all internal standards simplifies the addition of the internal standard(s) into the final diluent solution. This solution can be purchased rather than prepared.
  - ii. Preparation: To prepare 50 mL of the intermediate internal standard solution:
    1. Partially fill a 50 mL acid-washed volumetric flask (PP, PMP, or Teflon™) with 1% v/v HNO<sub>3</sub> (approximately 25-40 mL).
    2. Add 1 mL of 1,000 µg/mL Rh standard, 1 mL of 1,000 µg/mL Ir standard, and 1 mL of 1,000 µg/mL Te standard. If initial Rh, Ir, or Te standard concentration is different, adjust volume proportionally.
    3. Fill to mark (50 mL) with 1% v/v HNO<sub>3</sub> and mix thoroughly.
    4. Label appropriately (e.g. “Internal Standard Intermediate Mixture. 20 µg/mL Rh, Ir and Te, 1% v/v HNO<sub>3</sub>”, preparation date, expiration date 1 year from preparation date, and preparer’s initials).

**b. 20% Triton X-100<sup>®</sup> intermediate solution:**

i. Purpose: Addition to diluent and rinse solutions where Triton X-100<sup>®</sup> acts as a surfactant. For ease of daily preparation of the diluent and rinse solutions, first prepare a 20% Triton X-100<sup>®</sup> solution.

ii. Preparation: To prepare 1 L of 20% Triton x-100<sup>®</sup>

1. Add 200 ml of Triton X-100<sup>®</sup> to a pre-acid washed 1L Teflon<sup>®</sup> container that is partially filled with 18 M-ohm water.
2. Fill to 1 L with 18 M-ohm water and mix until the Triton X-100<sup>®</sup> has completely dissolved into solution (overnight). A magnetic stirring plate can be used to assist mixing by adding an acid-washed Teflon<sup>®</sup> coated stirring bar to the bottle.

**c. Sample Diluent**

i. Purpose: The diluent used in this method is an aqueous solution of 5 µg/L internal standard mixture (Rh, Ir, Te), in 0.25% v/v tetramethyl ammonia hydroxide (TMAH), 1% ethyl alcohol, 0.01% APDC, and 0.025% v/v Triton X-100<sup>®</sup>. This solution will be used in the preparation of all calibrators and samples during the dilution process just prior to analysis. It is important that all samples in a run should be made from the same diluent solution so that the concentration of the internal standards will be the same among all calibrators and samples in the run. When using a flow-injection component in the sample introduction system (i.e. the Elemental Scientific SC4-FAST autosampler), the 'carrier' solution should be the same as the diluent used for the method. Larger volumes of these solutions can be prepared by adjusting component volumes proportionally.

ii. Preparation:

1. Acid rinse a 2 L Teflon<sup>®</sup> container, and partially fill with 18 M-ohm water.
2. Add 0.2 g of APDC, 5 ml of 25% v/v TMAH, 20 ml of ethyl alcohol, and 5 ml of 20% Triton X-100<sup>®</sup>.
3. Dilute to volume (2L) with 18 M-ohm water
4. Spike 500 µl of 20 mg/L Rh, Ir, Te to the final diluent.
5. Invert bottle a few times to insure thorough mixing. Allow to sit for several hours or overnight before using.
6. Label appropriately (e.g. "5 µg/L Rh, Ir and Te", "0.01% APDC in 0.25% v/v tetramethyl ammonia hydroxide (TMAH), 1% ethanol, and 0.05% v/v Triton X-100", preparation date, expiration date (1 year from prep), and preparer's initials).
7. Store at room temperature and prepare as needed.

**d. DRC Stability Test Solution**

- i. Purpose: The DRC Stability Test Solution is a “dummy” blood matrix sample analyzed for 1-1.5 hr before the beginning of the analytical run.
- ii. Preparation:
  1. Fill an acid rinsed 1 L Teflon<sup>®</sup> container with 960 mL of Sample Diluent.
  2. Add 20 mL of rejected screened human or bovine blood
  3. Add 1.5 mL of Intermediate Stock Calibration Standard
  4. Store at 4°C and prepare as needed.
- e. Base Blood
  - i. Purpose: This blood pool material will be mixed with the intermediate working calibrators just prior to analysis to matrix-match the calibration curve to the blood matrix of the unknown samples.
  - ii. Contents: A mixture of multiple blood sources collected from anonymous donors are used to approximate an average blood matrix.
  - iii. Preparation & Storage:
    1. Purchase several bags of whole blood. Bovine blood or human blood can be used. Human blood should be screened for infectious diseases such as Hepatitis B and HIV.
    2. Screen each individual bag of blood for concentration of analytes of interest. See Table 2 in Appendix B for minimum acceptable values
    3. Once screened, mix the acceptable blood together in a larger container (i.e. acid washed polypropylene (PP), polymethylpentene (PMP), or Teflon<sup>™</sup>) and stir for 30+ minutes on a large stir plate (acid wash large Teflon<sup>™</sup> stir bar before use).
    4. For short term storage, store at 2-4°C. For long-term storage, dispense into smaller-volume tubes (i.e., 2 mL cryovials) and store at ≤ -20°C.
    5. Labels on 2 mL cryovials should be labeled appropriately (e.g. “Base Blood for Blood metals panel 2, Cd, Hg, Mn, Pb, Se”, dispensed date and vial number).
- f. ICP-DRC-MS Rinse Solution
  - i. Purpose: The rinse solution used in this method is an aqueous solution of 0.25 % v/v TMAH, 1% ethyl alcohol, 0.01% APDC, and 0.05 % Triton X-100<sup>®</sup>. This solution will be pumped through the autosampler rinse station, probe, and sample loop between sample analyses to prevent carry-over of analytes from one sample measurement to the next.
  - ii. Preparation: To Prepare 4 L of the Rinse Solution:
    1. Partially fill a 4 L acid-washed bottle (PP, PMP, or Teflon<sup>™</sup>) with ≥18 Mega-ohm·cm water (approximately 2-3 L). Use of volumetric flask is not required.
    2. Add 0.4 g of APDC
    3. Add 10 ml of TMAH



4. Add 40 ml of ethyl alcohol,
  5. Add 10ml of 20% Triton X-100<sup>®</sup>, (See Section 6.b for details on preparation)
  6. Fill to 4 L using  $\geq 18$  Megaohm·cm water.
  7. Store at room temperature and prepare as needed. To prepare volumes other than specified here, add proportionally larger or smaller volumes of the solution constituents.
  8. Invert bottle a few times to ensure thorough mixing. Allow to sit for several hours or overnight before using.
  9. Label appropriately (e.g. "0.25 % v/v TMAH, 1% ethyl alcohol, and 0.05 % Triton X-100<sup>®</sup>, 0.01% (w/v) APDC", preparation date, expiration date one year from preparation date, and preparer's initials).
- g. Single-Element Stock Standards For Preparation of Intermediate Stock Calibration Standard
- i. Purpose: These single-element standards will be used to prepare the intermediate stock calibration standard.
  - ii. Contents: Separate, aqueous single-element standards of Cd, Pb, Hg, Se, and Mn. Concentrations should be 1,000 mg/L or 10,000 mg/L.
  - iii. Purchase & Storage:
    1. Purchasing from vendors: If the intermediate stock calibration standard is purchased as a special-mix standard, these single-element stock standards are not required. Purchase only NIST-traceable single-element standards at the highest purity (don't contain other metal impurities).
    2. Storage: Store at room temperature.
- h. 3% (v/v) HCl Diluent:
- i. Purpose: 3% HCl is used to dilute single element stock standards into a single intermediate stock calibration solution and finally to the intermediate working calibration standards.
  - ii. Preparation:
    1. In a cleaned 2 L flask, add 1-1.5L  $\geq 18$  Megaohm·cm water.
    2. Add 60 mL high purity concentrated HCl.
    3. Fill to the mark and mix thoroughly.
    4. Label appropriately (e.g. "3 % v/v HCl", preparation date, expiration date one year from preparation date, and preparer's initials).
  - i. Intermediate Stock Calibration Standard
    - i. Purpose: This multi-element solution will be used to prepare the five working calibration standards.

- ii. Preparation & Storage: This solution may be purchased as a special-mix standard or prepared in-house from separate single-element stock standards.
1. Purchasing from vendors: The intermediate stock calibration standard may be purchased as custom mixture from any vendor which prepares multi-element solutions that are traceable to the National Institute for Standards and Technology (NIST) for their accuracy.
  2. In-house Preparation from NIST single element standards: Different volumes may be prepared by adding proportionally larger or smaller volumes of solution constituents.
    - a. Acid-rinse one 100 mL, PP (or PMP) volumetric flask. Mark the flask according to intended use. Dedicate to purpose.
    - b. Partially fill the 100 mL flask with the 3% (v/v) HCl diluent (50-75% full).
    - c. Add necessary volumes of single-element stock standards to achieve final concentrations listed in Table 3 of Appendix B.
    - d. Dilute to the volumetric mark with the 3% (v/v) HCl diluent using a pipette for the final drops. Mix the flask solution thoroughly. Final concentrations are listed in Table 3 of Appendix B.
    - e. Once mixed, transfer to an acid-cleaned, labeled, 50-mL container (PP, PMP, or Teflon™) for storage. Label appropriately (e.g. "Whole Blood Metals Panel 2 Intermediate Stock Calibration Standard", "3% (v/v) HCl", date of preparation, expiration date (1 year from date of preparation), initials of preparer, and concentrations for each element).
  3. In-house Preparation from other single element standards: Different volumes may be prepared by adding proportionally larger or smaller volumes of solution constituents.
    - a. Acid-rinse one 100 mL, PP (or PMP) volumetric flask. Mark the flask according to intended use. Dedicate to purpose.
    - b. Partially fill the 100 mL flask with the 3% (v/v) HCl diluent (50-75% full).
    - c. Add necessary volumes of single-element stock standards to achieve final concentrations listed in Table 4 of Appendix B.
    - d. Dilute to the volumetric mark with the 3% (v/v) HCl diluent using a pipette for the final drops. Mix the flask solution thoroughly. Final concentrations are listed in Table 4 of Appendix B.
    - e. Once mixed, transfer to an acid-cleaned, labeled, 50-mL container (PP, PMP, or Teflon™) for storage. Label appropriately (e.g. "Whole Blood Metals Panel 2 Intermediate Stock Calibration Standard", "3% (v/v) HCl", date of preparation, expiration date (1 year from date of preparation), initials of preparer, and concentrations for each element).

4. Storage: Store at room temperature. If purchased, label bottle with additional information such as “store at room temperature”, date received, date opened, and initials of person to first open.
- j. Intermediate Working Calibration Standards
- i. Purpose: Used each day of analysis to prepare the final five working calibrators that will be placed on the autosampler.
  - ii. Content: Five aqueous dilutions of the intermediate stock calibration standard solution with a 3% (v/v) hydrochloric acid (HCl) matrix. Final concentrations are listed in Table 5 of Appendix B.
  - iii. Preparation & Storage: Different volumes may be prepared by adding proportionally larger or smaller volumes of solution constituents.
    1. Cleaning flasks: Acid-rinse five 100 mL, PP (or PMP) volumetric flasks. Mark each flask according to intended use. Dedicate to purpose.
    2. 3% (v/v) HCl Diluent Preparation: use the same 3% (v/v) HCl prepared in Section 6.g.
    3. Partially fill each 100 mL flask with the 3% (v/v) HCl diluent (50-75% full).
    4. Add the correct volume of the Intermediate Stock Standard Calibration Standard (according to Table 5)
      - a. If a separate Pb Intermediate Stock Calibrator is used, add the appropriate volume of this solutions according to Table 5 to the same flask.
    5. Dilute to the volumetric mark with the 3% (v/v) HCl diluent using a pipette for the final drops. Mix the flask solution thoroughly. Final concentrations are listed in Table 5 of Appendix B.
    6. Once mixed, transfer to acid-cleaned, labeled, 50 mL containers (PP, PMP, or Teflon™) for storage. Label appropriately (e.g. “Whole Blood Metals Panel 2 Intermediate Working Calibrators”, “3% (v/v) HCl”, date of preparation, expiration date (1 year from date of preparation), initials of preparer, concentration of each element, and Lot # of the stock solution).
    7. Pour 10-15 mL of each solution into 15 mL tubes for daily use.
- k. Working Calibration Standards
- i. Purpose: The working calibration standards will be analyzed in each run to provide a signal-to-concentration response curve for each analyte in the method. The concentration of the analyte of interest in a patient blood sample dilution is determined by comparing the observed signal ratio (element/internal standard) from the dilution of the patient blood sample to the signal ratio response curve from the working calibrators.
  - ii. Content: Dilutions (1:50) of the corresponding five intermediate working calibration standards. The dilutions are described in Table 6 of Appendix B.

- iii. Preparation & Use: Make immediately prior to analysis when the intermediate working calibration standards are mixed with base blood (Section 6.d) and diluent (Section 6.c) using a Digiflex automatic pipette. See Table 6 of Appendix B and Section 8.b.ii for details of sample preparation.
- I. Single-Element Stock Standards For Preparation of Intermediate Stock Calibration Verification Standard
  - i. Purpose: These single-element standards will be used to prepare the intermediate stock calibration verification standard.
  - ii. Contents: Separate, aqueous single-element standards of Cd, Pb, Hg, Se, and Mn. Concentrations should be 1,000 mg/L or 10,000 mg/L.
  - iii. Purchase & Storage:
    1. Purchasing from vendors: If the intermediate stock calibration verification standard is purchased as a special-mix standard, these single-element stock standards are not required. Purchase only NIST-traceable single-element standards at the highest purity (don't contain other metal impurities).
    2. Storage: Store at room temperature.
- m. Intermediate Stock Calibration Verification Standard
  - i. Purpose: This multi-element solution will be used to prepare the three working calibration verification standards.
  - ii. Preparation & Storage: This solution may be purchased as a special-mix standard or prepared in-house from separate single-element stock standards.
    1. Purchasing from vendors: The intermediate stock calibration verification standard may be purchased as custom mixture from any vendor which prepares multi-element solutions that are traceable to the National Institute for Standards and Technology (NIST) for their accuracy.
    2. In-house Preparation: Different volumes may be prepared by adding proportionally larger or smaller volumes of solution constituents.
      - a. Acid-rinse two 50 mL, PP (or PMP) volumetric flask. Mark the flasks according to intended use. Dedicate to purpose.
      - b. Partially fill the 50 mL flasks with the 3% (v/v) HCl diluent (50-75% full).
      - c. Add necessary volumes of single-element stock standards to achieve final concentrations listed in Table 7 of Appendix B.
      - d. Dilute to the volumetric mark with the 3% (v/v) HCl diluent using a pipette for the final drops. Mix the flask solution thoroughly. Final concentrations are listed in Table 7 of Appendix B.

- e. Once mixed, transfer to an acid-cleaned, labeled, 50-mL containers (PP, PMP, or Teflon™) for storage. Label appropriately (e.g. “Whole Blood Metals Panel 2 Intermediate Stock Calibration Verification Standard (Cd, Mn, Hg)”, and “Whole Blood Metals Panel 2 Intermediate Stock Calibration Verification Standard (Pb)”, “3% (v/v) HCl”, date of preparation, expiration date (1 year from date of preparation), initials of preparer, and concentrations for each element).
3. Storage: Store at room temperature. If purchased, label bottle with additional information such as “store at room temperature”, date received, date opened, and initials of person to first open.
- n. Intermediate Working Calibration Verification Standards:
  - i. Purpose: Used as needed to on the day of analysis to prepare the necessary working calibration verification standard(s) that will be placed on the autosampler.
  - ii. Content: Three aqueous dilutions of the intermediate stock calibration verification standard with a 3% (v/v) hydrochloric acid (HCl) matrix. Final concentrations are listed in Table 8 of Appendix B.
  - iii. Preparation & Storage: Different volumes may be prepared by adding proportionally larger or smaller volumes of solution constituents.
    1. Cleaning flasks: Acid-rinse three 100 mL, PP (or PMP) volumetric flasks. Mark each flask according to intended use. Dedicate to purpose.
    2. 3% (v/v) HCl Diluent Preparation: use the same 3% (v/v) HCl prepared in Section 6.g.
    3. Partially fill each 100 mL flask with the 3% (v/v) HCl diluent (50-75% full).
    4. Add the correct volume of the Intermediate Stock Calibration Verification Standard (according to Table 8 in Appendix B).
    5. Dilute to the volumetric mark with the 3% (v/v) HCl diluent using a pipette for the final drops. Mix the flask solution thoroughly. Final concentrations are listed in Table 8 of Appendix B.
    6. Once mixed, transfer to acid-cleaned, labeled, 50 mL containers (PP, PMP, or Teflon™) for storage. Label appropriately (e.g. “Whole Blood Metals Panel 2 Intermediate Working Calibration Verification Standard #”, “3% (v/v) HCl”, date of preparation, expiration date (1 year from date of preparation), initials of preparer, concentration of each element and Lot # of the stock solution).
    7. Pour 10-15 mL of each solution into 15 mL tubes for as-needed use.
- o. Internal Quality Control Materials (“Bench” QC)
  - i. Purpose: Internal (or “bench”) quality control (QC) materials are used to evaluate the accuracy and precision of the analysis process, and to determine if the analytical system is “in control” (is producing results that are acceptably

accurate and precise). They are included in the beginning and at the end of each analytical run.

- ii. Content: Pooled animal or human blood, and may have been spiked with NIST-traceable elemental standards to reach desired low-normal and high-normal concentrations.
- iii. Preparation & Storage: Quality control materials can be either prepared by purchased from an external laboratory or prepared within the CDC laboratories. Quality control must always be traceable to the National Institute for Standards and Technology (NIST). The CDC laboratory currently prepares its own bench QC materials using the following procedures:
  1. Purchase of whole blood: Bags of human blood can be purchased from various sources such as American Red Cross of Tennessee Blood services (<http://tennesseebloodservices.com/>). Animal blood may be available from the Wisconsin State Laboratory of Hygiene (WSLH).
  2. Screening blood: Screen bags of blood for analyte of interest concentration before mixing together to make 2 separate base blood pools (for preparing the low and high bench QC materials). Samples can be screened individually
    - a. Keep blood refrigerated whenever possible to minimize microbial growth.
    - b. Because this is only a quick screen of the analyte of interest concentration, the number of replicates in the blood method can be reduced to one in order to reduce analysis time.
    - c. Analyte concentrations in the final blood pool to be spiked for the low bench QC pool should be in the low-normal population range. Analyte concentrations in the final blood pool to be spiked for the high bench QC pool should be less than some pre-selected target concentration values in the high normal population range. See Table 2 in Appendix B for recommended concentration ranges.
  3. Combining Collected blood: The goal is for combining samples is to approach an 'average' matrix for each pool.
    - a. Graduate four acid-washed 10 L carboys (PP or PMP) in 0.5 L increments (two will be used for decanting into).
    - b. Combine collected blood samples into two separate acid-washed 10 L carboys (PP or PMP), according to their concentrations, for the low bench and high bench QC pools.
    - c. Mix each blood pool using carboy stirrers and large stir plates. Keep blood refrigerated whenever possible.
  4. Spiking of blood
    - a. Analyze three samples of each blood pool. Record these results for future recovery calculations.

- b. Use these results to determine target analyte concentrations possible for the pools
  - c. Calculate the volume of single element standards needed to spike each pool to the desired concentrations. See Table 2 in Appendix B for recommended concentration ranges.
  - d. While stirring the pools on large stir plates, spike each pool with calculated volumes of single element standards (all spiking standards used must be traceable to NIST).
  - e. Continue to stir pools overnight after spiking, then reanalyze.
  - f. Repeat steps 4 and 5 until all analytes reach target concentrations keeping track of the total volume of spiking solution added to each blood pool.
5. Dispensing and Storage of blood
- a. Container Types: Dispense blood into lot screened containers (i.e. – 2 mL polypropylene tubes). If possible, prepare tubes of QC which have only enough volume for one typical run + 1 repeat analysis. This allows for one vial of QC to be used per day of analysis, reducing chances of contamination of QC materials due to multi-day use.
  - b. Labels: Place labels on vials after dispensing and capping if the vials are originally bagged separately from the caps. This minimizes the chance for contamination during the process. Include at least the name of QC pool (text and bar code), date of preparation, and a vial number on the labels.
  - c. Dispensing: Dispensing can be accomplished most easily using a Digiflex automatic pipetter in continuous cycling dispense mode. This process should be done in a clean environment (i.e. a class 100 cleanroom area or hood).
    1. Allow blood to reach room temperature before dispensing (to prevent temperature gradients possibly causing concentration gradients across the large number of vials being dispensed and to prevent condensation problems during labeling of vials). This may require leaving the carboy of blood at room temperature overnight before dispensing.
    2. Replace the tubing attached to the dispensing syringe (left when looking at front of Digiflex) with a length of clean Teflon™ tubing long enough to reach into the bottom of the 10 L carboy while it is sitting on the stir plate.
    3. Check cleanliness of Digiflex before use by analyzing 1-2% (v/v) HNO<sub>3</sub> which has been flushed through the Digiflex with a portion of the same solution which has not been through the Digiflex.

4. Approximately one hour before dispensing begins,
  - a. With the large stir plate close to the left side of the Digiflex, begin stirring the blood pool to be dispensed.
  - b. Also during this time, flush the Digiflex with blood from the pool to be dispensed. Place the ends of the tubing attached to both the sample and dispensing syringes into the carboy of blood so that blood won't be used up during this process. Be sure to secure both ends of tubing in the carboy with Parafilm so they will not come out during the flushing process.
5. After dispensing the blood into the vials, cap the vials and label them. Placing labels on vials after capping minimizes the chance for contamination during the process.
  - ii. Homogeneity Testing: After dispensing, check homogeneity of analyte concentrations in pool aliquots. Keep samples pulled for homogeneity analysis in the sequence that they were dispensed for the purpose of looking for trends in concentrations. Once dispensed and homogeneity has been shown to be good throughout the tubes of a pool, store tubes at  $\leq -20^{\circ}\text{C}$  and pull tubes out as needed for analysis.
  - iii. Storage: Blood pools should be stored long term at  $\leq -20^{\circ}\text{C}$ . Short term storage (several days) at refrigerator temperature ( $\sim 2-4^{\circ}\text{C}$ ).

## **7) Analytical Instrumentation & Parameters**

(see Section 5 for details on hardware used, including sources)

### a. Instrumentation & Equipment Setup:

- i. ICP-DRC-MS: Inductively Coupled Plasma Dynamic Reaction Cell Mass Spectrometer ELAN<sup>®</sup> DRC II.

#### 1. Modifications made to ICP-DRC-MS

- a. Stainless steel tubing is preferred between the reaction gas cylinder / regulator and the back of the ICP-DRC-MS instrument.
- b. A second mass flow controller will be needed (channel B) that does not send the DRC gas through a 'getter'.
- c. Standard built-in peristaltic pump replaced by DXi-FAST micro-peripump / FAST actuator unit.

### ii. Sample Introduction Setup Notes and Tips

1. SC-FAST valve setup: Valve connections must match this description.



- a. Port 1: 1mL sample loop (white nut). See “Loop, for FAST valve” in Section 5.b. for details.
  - b. Port 2: 0.5 mm ID probe (red nut) for carrier solution. See “Probes” in Section 5.b. for details.
  - c. Port 3: nebulizer line (green nut) for transfer of liquid to nebulizer. See “Nebulizers” in Section 5.b. for details.
  - d. Port 4: sample loop (white nut). See “Loop” in Section 5.b. for details.
  - e. Port 5: 0.8 mm ID probe (blue nut) for diluted samples. See “Probes” in Section 5.b. for details.
  - f. Port 6: 1/8” i.d. vacuum line (black nut). See “Tubing, FAST vacuum” in Section 5.b. for details.
2. Tubing connection between autosampler rinse station and rinse solution reservoir: Tubing of different inner diameters can be obtained from Elemental Scientific, their distributors, or custom built in the lab to optimize the rinse station fill rate between samples. Rinse station should not go empty at any point.
  3. Tubing for autosampler rinse station waste removal: Use minimum drain tubing to make this connection. If this tube is too long, the rinse station will not drain properly.
  4. Rinse solution jug: Leave one of the caps on the top of the rinse jug loose to allow air venting into the jug as liquid is removed. Otherwise the jug will collapse on itself as the liquid is removed and a vacuum is created inside. Use secondary containment tray and label appropriately (see solution preparation instructions).
  5. Waste solution jug: Use secondary containment tray and label appropriately (see solution preparation instructions).
  6. Configuration of tubing and probe for carrier solution: Can use a PEEK adapter to help with connecting peristaltic tubing to Teflon tubing.
  7. Nebulizer: Changing the nebulizer type will require re-optimization of the read delay time in the ELAN software. Polypropylene nebulizer type (ESI) tends to allow for shorter read delay times than quartz concentric nebulizers.
  8. Configuration of tubing for spray chamber waste removal:
    - a. Chamber-to-peristaltic pump tubing:
      - i. Spray chambers with threaded connection: Use vendor-supplied threaded connector on base of chamber, connecting tubing directly to peristaltic pump tubing through a PEEK adapter or directly.

- ii. Spray chambers without threaded connection: Use push-on connectors with Teflon tubing available from various vendors or connect 1/8" i.d. x 1/4" o.d. PVC tubing directly to the waste port on the spray chamber. Connect other end of PVC tubing to the white / black peristaltic pump tubing using a tubing connector (PerkinElmer item # B3140715).
  - b. Waste Jug-to-peristaltic pump tubing: Connect 1/8" i.d. x 1/4" o.d. PVC tubing to the white / black peristaltic pump tubing using a tubing connector (PerkinElmer item # B3140715). Place the free end of the PVC tubing through the lid of the waste jug (be sure it is secure). Waste jug should be sitting in a secondary containment tray in case of overflow.
- iii. Cones: Platinum or Nickel cones have been used and tested to be comparable in performance from either PerkinElmer or Spectron.
- iv. Gases & Regulators setup:
1. Argon: Argon stored as liquid in a dewar (180-250 L) or bulk tank. Gaseous argon used for plasma and nebulizer.
    - a. Regulator for argon source (if a dewar): Keep the inlet pressure (headspace pressure of liquid argon dewar) above 100 psi. Set delivery pressure to 90-100psi to allow for pressure drop across tubing that stretches to the instrument. See Section 5.e for part numbers and details.
    - b. Step down regulator (if source of argon is a bulk tank): Place this single stage regulator in the lab so that incoming argon pressure can be monitored and adjusted. Set delivery pressure to approximately 85 - 100 psig. See Section 5.e for part numbers and details.
    - c. Regulator at ICP-DRC-MS: Single stage "argon regulator filter kit" supplied with the ICP-DRC-MS. Set the delivery pressure to approximately 80 psi.
  2. Methane (99.99%) gas for DRC channel A
    - a. Regulator for CH<sub>4</sub> gas: Set the delivery pressure = 5-7 psig. See section 5.e for part numbers and details.
  3. Oxygen (99.999<sup>+</sup>%) gas for DRC channel B.
    - a. Regulator for O<sub>2</sub> gas: Set the delivery pressure = 5-7 psig. See Section 5.e for part numbers and details.
    - b. Flash arrestor: Brass flash arrestor is used on outlet side of regulator. See Section 5.e for part numbers and details.

- v. Chiller / Heat Exchanger: Refrigerated chiller (for ELAN<sup>®</sup> 6100 DRC<sup>Plus</sup> instruments) or heat exchanger (for ELAN<sup>®</sup> DRC II instruments). For refrigerated chiller, set temperature control to 18°C.
- vi. Computer: Dell Optiplex GX150, GX270, or GX280 have all been used. Processors used have included Pentium III (1 GHz) through Pentium IV (2.8 GHz). Recommend 512Mb - 1Gb RAM. External hard disk drive for nightly backups of data connects via USB port. Software used includes Windows XP Professional, service pack 2 and ELAN v3.3.
- vii. Autosampler: ESI SC-FAST series
- b. Parameters for Instrument and Method: See Appendix B Table 1 pp 52-54 for a complete listing of the instrument and method parameters. Also, see Figures 1a-1g in Appendix B for images of the ELAN method screens.

## **8) Method Procedures**

- a. Quality Control: Quality control procedures implemented in this method are defined by the Division Procedures and Practices Guidelines and include two types of QC systems which are both subjected to the complete analytical process. The data from these materials are then used to estimate methodological imprecision and to assess the magnitude of any time-associated trends. The concentrations of these materials should cover the expected concentration range of the analytes for the method. Before QC materials can be used to judge patient analytical runs, acceptable QC concentration limits must be calculated from the concentration results observed in at least 20 characterization runs. During the 20 characterization runs, previously characterized QCs or pools with target values assigned by outside laboratories should be included to evaluate the analysis. The process of limits calculation is performed using the laboratory database and the SAS division QC characterization program.
- i. Types of Quality Control:
  - 1. “Bench QC”: The bench QC pools used in this method comprise two levels of concentration spanning the “low-normal” and “high-normal” ranges of the analyte of interest. The intent of bench QC is for the analyst to evaluate the performance of the analytical system on the day of analysis. The analyst inserts both the “low” and the “high” bench QC specimens two times in each analytical run (a set of consecutive assays performed without interruption) so that judgments may be made on the day of analysis. The first analysis of the two bench QC pools is done after the calibration standards are analyzed but before any patient samples are analyzed (so that judgments on the calibration curves may be made before analysis of patient samples). The second analysis of the two bench QC pools is done at the end of the run (approximately 20 patient samples total). If more patient samples are analyzed on the same calibration curve after the second run of the bench QC, both the low-normal and high-normal bench

QC must be reanalyzed before and after the additional samples. For example, the schemes shown in Table 9 p.67 are both acceptable ways to analyze multiple consecutive “runs”.

2. “Blind QC”: When possible, “blind” QC samples are QC materials placed in vials, labeled, and processed so that they are indistinguishable from the subject samples handled by the analyst. Ideally, the supervisor decodes and reviews the results of the blind specimens without the analyst knowing of their presence in the runs. When it is not possible to have blind QC materials processed so that they are indistinguishable by the analyst from the patient samples, it is acceptable for the analyst to randomly insert into the run a QC material which only the QC reviewer knows the acceptable concentration limits for. At least one low-normal concentration and one high-normal concentration QC material should be kept in the laboratory for this purpose.
3. External Reference Materials: Materials produced by laboratories outside of the CDC which have assigned target concentrations can be helpful in verifying method performance. Samples from previous challenges of proficiency testing programs (i.e. Centre de Toxicologie du Quebec (CTQ)) can be used. However, only the results for the bench and blind QC materials are used to determine if the run results can be used.

ii. Calibration Verification:

1. Bi-annual tests as defined in the DLS Policy and Procedures manual: CLIA requires the verification of accuracy of instrument response to analyte concentration be completed at least every 6 months. NIST traceable calibrators are analyzed in each run to define this response up to the concentration of the highest calibrator in the run. To verify accuracy of instrument response at concentrations higher than the highest calibrator in each run, analyze a NIST traceable standard with very high concentrations (see Table 8 p.66 in the Appendix for concentrations) at least every 6 months. Prepare the Calibration Verification Standard for analysis just as a working calibrator is prepared. Use the “Blank” as the blank when it is analyzed. If the observed concentrations for the Calibration Verification Standard are not within 10% of the target value (see Table 8 p.66 in the Appendix) the lab supervisor should be notified and the issue should be investigated. Do not substitute external reference materials (i.e. biological samples from a PT program) for the Calibration Verification Standard when performing this. Solutions needed for the Calibration Verification checks can be purchased from standards vendors (i.e. SPEX, High Purity Standards, etc . . .) or prepared in-house from NIST traceable single element standards. Always verify that normal background levels have been re-achieved through adequate rinse time following analysis of elevated standards for calibration verification.
  - a. As-needed confirmations (per supervisor discretion): When a sample result is greater than the highest calibrator in the run, the supervisor

may request that the result be confirmed in an analysis run which includes a standard or external reference material with equivalent (within 10%) or greater concentration than the sample. In order to avoid needless contamination of the instrument with high concentrations of analytes, the analyst should use the lowest appropriate calibration verification solution concentrations to meet the need.

For *infrequent* verification needs, the calibration verification stock solutions can be used to prepare verification standards to appropriate concentrations. This will, however, introduce elevated concentrations of manganese to the sample introduction system. Frequent measurement of these very high concentrations can result in high background levels in the instrument which are difficult to rinse out and which may limit the ability to measure low concentrations.

For frequent verification needs (i.e. when certain studies have many elevated results) or when a concentration higher than those shown in Table 8 p.66 needs to be verified, use NIST-traceable single element stock standards to prepare single element verification standards. This will limit the exposure of the instrument to elevated concentrations of only the elements needing verification.

Always verify that normal background levels have been re-achieved through adequate rinse time following analysis of elevated standards for calibration verification. An external reference material (i.e. historical proficiency testing sample) can be substituted in place of the Calibration Verification Standard sample in these situations IF:

- i. The target value has been assigned by an external source (i.e. NIST, or the proficiency testing program).
- ii. The concentration of the external reference material is within 10% or is higher than the concentration of the material you need it to confirm.
- iii. There is confidence that there is no contamination of previously used external reference material.
- iv. A note to file is made that this was done.
- v. If the observed concentrations are not within 10% of the target value the lab supervisor should be notified and the issue should be investigated.

b. Daily Analysis of Samples

i. Preparation of the Analytical Equipment

*For further details on any part of this description, see the IRAT Daily Startup SOP for ELAN ICPMS instruments.*

1. Power on the computer, printer, peristaltic pump, and autosampler, and log into the operating system.
2. Peristaltic pump: Set up the peristaltic pump tubing with proper tension for the sample rinse station.
3. Software: Start the ESI autosampler and ELAN® ICPMS software from Windows™.
4. Daily Pre-Ignition Maintenance Checks: Perform daily maintenance checks as described in the IRAT Daily Startup SOP for ELAN instruments (i.e., Ar supply pressure, interface component cleanliness and positioning, interface pump oil condition, vacuum pressure, etc.). Make appropriate notes in the Daily Maintenance Checklist and Instrument Log Book.
5. Start the Plasma: Press the “Start” button in the software or on the hardware to ignite the plasma.
  - a. Start the peristaltic pump: *Start the peristaltic* pump in the software at 12rpm (using a standard 6 roller peristaltic pump) or 5.4rpm if using a DXi mini-peristaltic pump. Verify the rotational direction is correct.
6. Aspirate liquid: Place the carrier probe into dilute *acid or water*.
7. Warm-up time: Allow at least 45 minutes warm-up time for the ICP-DRC-MS after igniting the plasma. This warm-up time is for the RF generator. There will be another “Stability time” for the DRC later in this procedure.
8. Daily Performance Check: After this warm-up time, perform a daily performance check and any optimizations necessary (as described in the IRAT Daily Startup SOP for ELANs). Fill in the Daily Maintenance Checklist according to the optimization procedures performed. Extra detail than can be documented in the checklist should go into the instrument logbook.
  - a. Magnesium (<sup>24</sup>Mg) may have high RSDs due to the use of Triton-X100 in the rinse solution. Avoid this problem by either temporarily using non-Triton-containing rinse solution during the daily check, or repeating the daily check multiple times in succession with no rinse time between.
  - b. Saving the Files: Save updated tuning and optimization parameters to the “default.tun” and “default.dac” files, respectively.
9. Software setup for Analysis:
  - a. Workspace (files & folders): Open the default (“CDC\_WBMP2\_methITB006A\_wrk”) or your own personalized workspace in the ELAN software. Verify & set up the correct files and data directories for your analysis (See Table 1 pp 60-62 “File Names & Directories”).
  - b. Samples / Batch Window: Update software to reflect the current sample set. The only fields which need to be filled in include the

autosampler location, sample identification (id), measurement action, method, sample flush time, sample flush speed, read delay time, read delay & analysis speed, wash time, wash speed. Use a bar code scanner to input data whenever possible. See Table 1 pp 60-62 for times and speeds. Save the Sample window file and re-use it on other days by simply replacing the sample IDs for the patient samples.

1. DRC Stability Time: Best analyte-to-internal standard ratio stability is typically obtained after 1-1.5 hrs of repeated analysis of blood samples using the DRC method. Analyze enough “dummy” blood sample dilutions prior to any DRC analysis run to fill 1-1.5 hours of analysis time. See Table 10 p.68 for example of setup in the Samples / Batch window.
2. Blood vs. Aqueous Method Files:
  - a. The difference: There are two ELAN method files for this one method (see Table 1 pp 61-62). It is necessary to use both to accomplish each run because the current PerkinElmer software will not allow for more than one blank per method file. The ONLY DIFFERENCE between these two files is on the Sampling tab where one lists the autosampler positions of the blood blank and blood calibrators (the “bldblk” method file) and the other lists the autosampler position of the aqueous blank (the “aqblk” method file).
  - b. Use: The ONLY TIME when it matters which of these files is used is when the measurement action *includes* “Run blank” or “Run standards”. When the measurement action is only ‘run sample’, it does not matter whether the “bldblk” or “aqblk” method file is used. Analysts typically follow the pattern below, however, for the sake of consistency and as a reminder of which blank must be used for which type of sample. See Table 10 p.68.
    - i. The “bldblk” method file: Use to analyze the initial blood blank (blank for the calibration curve), the blood calibrators, and the blood blank checks (WB Blank & WB Blank 2) at the very beginning of the run. The blood blank method defines the blood blank in autosampler location 105 and the blood calibration standards 1-5 in autosampler locations 106-110, respectively.
    - ii. The “aqblk” method file must be used to analyze all QC materials and patient samples. The aqueous blank method (set up for a ESI SC4 autosampler) defines the aqueous blank in autosampler location 113.

3. Notation of Dilutions: To designate an extra dilution of a sample, edit the sample ID to reflect the level of dilution being performed (e.g., A 1:2 dilution of sample 1 would be reflected in the sample ID "sample 1 (2x dilution)". This sample ID will be edited during the data-import process to the database so that it is recognized as the appropriate sample. Do not use the ELAN® software to automatically correct for sample dilutions. Extra dilution is performed on blood samples whose concentration is greater than the concentrations listed in Table 8 in Appendix B (linearity of the method has been documented up to these concentrations).
  - c. Method file modifications: This method can also be used to analyze whole human blood samples for a subset of the listed samples (i.e. Pb only). To do this delete the unnecessary elements from the method windows (bldbl and aqblk) and save the file with a descriptive name such as "WBMP2\_DLS3016\_bldblk\_Pb\_only.mth" and "WBMP2\_DLS3016\_aqblk\_Pb\_only.mth".
- ii. Preparation of Samples for Analysis (See Table 6 in Appendix B)
1. Thaw the frozen blood specimens; allow them to reach ambient temperature.
  2. Prepare enough DRC stability sample to be analyzed for 1-1.5 hr before the beginning of the run. This can be prepared using 50 mL polypropylene tubes or a wide-mouth bottle (which can be put on the autosampler in place of one of the tube trays).
  3. Set up a series of 15 mL polypropylene tubes corresponding to the number of blanks, standards, QCs, and patient samples to be analyzed.
  4. Prepare the following solutions in the 15 mL falcon tubes using the Digiflex™ (see Table 6 p.65 for a summary).
    - a. *Aqueous Blank*: Prepare two aqueous blanks consisting of 200  $\mu\text{L}$  of  $\geq 18$  Mega-ohm-cm water and 4800  $\mu\text{L}$  of diluent. One will be the actual aqueous blank and the other will be a backup ("Aqueous Blank Check") in case the original aqueous blank gets contaminated.
    - b. *Blood Blank (Std 0)*: Prepare three blood blank dilutions consisting of 100  $\mu\text{L}$  of base blood (same material used to prepare the blood calibration standards), 100  $\mu\text{L}$  of  $\geq$  standard zero (3% (v/v) HCl), and 4800  $\mu\text{L}$  of diluent. One of these blood blanks will be the blank for the calibration standards; the other will be analyzed after standard 5 as BldBlkChk.
    - c. *Calibrators*: Prepare the working calibration standards as 100  $\mu\text{L}$  of the appropriate aqueous intermediate working calibration standard, 100  $\mu\text{L}$  of base blood, and 4800  $\mu\text{L}$  of diluent.



- d. *Patient & QC Samples*: Before taking an aliquot for analysis, mix the sample on the vortex for approximately 15 seconds. Prepare blood sample dilutions as 4,800  $\mu\text{L}$  of diluent and 100  $\mu\text{L}$  of the blood sample and 100  $\mu\text{L}$  of  $\geq 18$  Mega-ohm $\cdot\text{cm}$  water.
  - e. Cap all of the blanks, standards, and samples and mix them on the Vortex for approximately 10 seconds. Uncap them and place them in the autosampler of the ELAN<sup>®</sup> ICPMS in the order that was entered in the Samples / Batch window of the ELAN software.
- iii. Specimen Storage and Handling During Testing: Specimens may be left at room temperature during analysis in case confirmation analyses must be made. Take stringent precautions to avoid external contamination by the metals to be determined. Specimens may be stored short term at refrigerated temperatures, but should be stored long term (>4 weeks) at  $\leq -20$  °C.

NOTE: Samples must be analyzed within 24 hours of preparation to obtain valid results for selenium. The method has been validated to produce valid results for other Pb, Cd, Hg, and Mn even 48 hrs after sample preparation. See critical parameter test #1 in Appendix A for details.

- iv. Starting the Analysis: Begin the analysis using the ELAN software.
- v. Monitoring the Analysis: It is preferable to initiate work early enough in the day to permit the entire run to be monitored. If it is not possible to complete the analysis by the end of the work day, the run may be left to complete itself unattended as long as appropriate planning is made for either overnight operation or Auto Stop (see below).

Monitor the analysis for the following:

1. *DRC stability (analyte / internal standard ratio stability)*

After the analysis of the DRC stability “dummy” samples, the stability of the analyte / internal standard ratios across these samples indicates the instrument stability going into the run.

2. *Proper operation of the instrument.*

3. *Contaminated blanks.*

4. *Linear calibration curves.*

- a. Typical correlation coefficients will be 0.999 to 1.000.
- b. The ELAN software generates a “simple linear” calibration curve (using a least squares calculation) for manganese in this method. The curves are generated using the results from analysis of the blood blank and the 5 external blood calibrators whose concentrations are defined in the Calibration tab of the Method file. Specifically, the software plots the “net intensity” (y-axis) versus the analyte concentration (x-axis). The “net intensity” is the blank subtracted **ratio** of the measured

intensity for the analyte to the measured intensity of the associated internal standard and is calculated as follows:

$$\text{net intensity} = \frac{\text{Analyte Meas Intensity}_{\text{sample}}}{\text{Internal Std Meas. Intensity}_{\text{sample}}} - \frac{\text{Analyte Meas Intensity}_{\text{Blank}}}{\text{Internal Std Meas Intensity}_{\text{Blank}}}$$

- c. Points (1-2) may be removed from the calibration curve if necessary to provide appropriate correlation coefficients. It is preferable, however, to re-analyze problematic calibration standards rather than dropping points. Recurring problems with calibration standards should be resolved expeditiously.

5. *Bench QC results within the acceptable limits.*

If an analyte result for the beginning QC material(s) falls outside of the 99% limits, then the following steps are recommended:

- a. If a particular calibration standard is obviously in error, remake a new dilution at the Digiflex of that working calibrator, reanalyze it, and reprocess the sample analyses using this new result as part of the calibration curve.
- b. Prepare a fresh dilution of the failing QC material and reanalyze it.
- c. Prepare fresh dilutions at the Digiflex of all of the calibration standards (working blood multi-element standards) and reanalyze the entire calibration curve using the freshly prepared standards.

If these three steps do not result in correction of the out-of-control values for QC materials, consult the supervisor for other appropriate corrective actions. Do not report analytical results for runs that are not in statistical control.

6. *Good precision among replicates.*

7. *Consistent measured intensities of the internal standards.*

Some sample-to-sample variations are to be expected. However the intensities should be within a few percent of one another, and should fluctuate around an average value (not drift continuously in one direction).

- 8. *Elevated patient results:* Confirmation by repeat measurement will be required for any result greater than the “1<sup>st</sup> upper boundary” (see Section 8.b.viii.2). A calibration verification check of equal or greater concentration must be analyzed in the same run as the elevated study sample result if it is to be used for reporting (see Section 8.a.ii.2).

vi. Records of Results: Run results will be documented daily in both electronic and paper form.

1. Electronic Records:

- a. Transfer of Results to the Laboratory Information System / Database: Transfer data electronically between computers or software to reduce errors. When keyboard entry must be used, proofread transcribed data after entry.
  - b. Long-Term Storage of ELAN software files: Files used and produced by the ELAN software in analyzing samples will be backed up long term on compact disk and kept a minimum of three years.
2. Paper Records: The paper copy of the results from the run should be put into the study folder(s) and should include
- a. A summary of the calibration curve statistics.
  - b. A printout of analysis of each measurement made during the run.
  - c. On the front sheet of the printed records, write the following
    - i. Analyst initials
    - ii. Instrument ID
    - iii. Date of Analysis
    - iv. Run # for the day on this instrument
    - v. Study ID and Group Number
    - vi. Database batch ID (Not known until the run is imported into the database)
- vii. Transfer of Results to the Laboratory Database: Every analytical run performed for the analysis of patient samples should be entered into the laboratory results database unless the run is not useable for obvious reasons (e.g. the run is stopped for some reason before ending QC is analyzed, no internal standard spiked into the diluent, etc. . . ).
1. Data Export Process (from ELAN® software to .TXT file): If the data file was not created during the initial analysis, reprocess the data of interest either with “original conditions” option, or by loading the method file used during the analysis. Use report options file “CDC\_Database Output.rop” and type in a descriptive report filename using a format such as “2005-0714a\_DRC2F\_group55.txt” to designate data from analysis of group 55 from July 14, 2005, run #1 of instrument “DRC2F”. Under “Report Format”, choose the “Use Separator” option, and under the “File Write” section, choose “Append.”
  2. Data Import Process (from .TXT file to Laboratory Information System):
    - a. Move the .TXT file created in the data export process to the appropriate subdirectory on the network drive where exported data are stored. Directories for data storage are named according to instrument \ year \ month.
    - b. Import the instrument file into the LIMS.

- c. Enter the appropriate information to identify the instrument, assay, analysis date & time, run number, analyst, calibrator lot number and prep date used (use the "IS Lot Number" field) and study. If other than default values for Method LOD, High Calibrator, Rep Delta Limit, and units were used in the run, document accordingly.
- d. In the "Import Instrument Results" table, correct sample IDs and document dilution factors if dilution factor notations were added to the ID in the ELAN software prior to analysis.
- e. Once transferred into the database, the data should be evaluated for QC pass / fail, then appropriate settings entered for QC accept / reject, final value status, and comments.

viii. Analyst Evaluation of Run Results:

1. Bench Quality Control: After completing a run, and importing the results into the LIMS, export the QC results to the SAS program where the analytes in the run will be judged to be in or out of control. The QC limits are based on the average and standard deviation of the beginning and ending analyses of each of the bench QC pools, so it will not be possible to know if the run is *officially* accepted or rejected until it is completed.
  - a. Quality Control Rules: The SAS program applies the division QC rules to the data as follows:
    - i. If both QC run means (low & high bench QC) are within 2Sm limits and individual results are within 2Si limits, then accept the run.
    - ii. If 1 of the 2 QC run means is outside a 2Sm limit - reject run if:
      1. Extreme Outlier – Run mean is beyond the characterization mean +/- 4Sm
      2. 1 3S Rule - Run mean is outside a 3Sm limit
      3. 2 2S Rule - Both run means are outside the same 2Sm limit
      4. 10 X-bar Rule – Current and previous 9 run means are on same side of the characterization mean
    - iii. If one of the 4 QC individual results is outside a 2Si limit - reject run if:
      1. R 4S Rule – Within-run ranges for all pools in the same run exceed 4Sw (i.e., 95% range limit)

Note: Since runs have multiple results per pool for 2 pools, the R 4S rule is applied within runs only.

Abbreviations:

Si = Standard deviation of individual results (the limits are not shown on the chart unless run results are actually single measurements).

Sm = Standard deviation of the run means (the limits are shown on the chart).

Sw = Within-run standard deviation (the limits are not shown on the chart).

- iv. Implications of QC Failures: If the division SAS program declares the run out of control, then all results from the run are invalid for reporting from the run. Set all run results as "QC Rejected" in the database.

## 2. Patient Results:

### a. Elevated Results:

#### i. Boundaries Requiring Confirmatory Measurement:

1. Results Greater than the First Upper Boundary (1UB): Concentrations observed greater than the "first upper boundary" (defined in the laboratory database as the "1UB") should be confirmed by repeat analysis of a new sample preparation. The concentration assigned to the 1UB for an element is determined by study protocol but default concentrations are in Table 11 p.69 in the Appendix. Report the original result, as long as the confirmation is within 10% of the original. Continue repeat analysis until a concentration can be confirmed.
  2. Results Greater Than Highest Calibrator: When a sample result is greater than the highest calibrator in the run, the supervisor may request that the result be confirmed in an analysis run which includes a standard or external reference material with equivalent (within 10%) or greater concentration than the sample.
  3. Results Greater Than Calibration Verification Standard: Perform an extra dilution on any blood sample whose concentration is greater than those listed in Table 8 p.66 in the Appendix (the linearity of the method has been documented up to these concentrations). See Table 6 p.65 for description of sample preparation with extra dilution.
- ii. Inadequate Precision in Confirmation of a Measurement: If a sample is reanalyzed to obtain a confirmation of an initially elevated result, the confirmation should be within 10% of the original result.
- iii. Analyst Reporting of Elevated Results: Concentrations observed greater than the "second upper boundary" (defined in the laboratory database as the "2UB") should be reported to the QC reviewer as an "elevated result". The concentration assigned to the 2UB for an element is determined by study protocol but default

concentrations are in Table 11 of Appendix B. The analyst should report any patient results confirmed to be greater than the second upper boundary to the QC reviewer as an “elevated result”. There is no routine notification for elevated levels for the metals determined in this method. The protocol for supervisors reporting elevated results to medical personnel is defined according to the study protocol.

- b. Inadequate Precision Within One Measurement: If the range of the three replicate readings (maximum replicate concentration value - minimum replicate concentration value) for a single sample analysis is greater than the criteria listed in Table 11 of Appendix B (“>Lim Rep Delta” in the database) **and** the range of the three replicate readings is greater than 10% of the observed concentration, do not use the measurement for reporting. Repeat the analysis of the sample.
- ix. Submitting final work for Review: Once results have been imported, reviewed, and set as final in the database by the analyst,
1. Submit an email to the QC reviewer informing them of the readiness of the data for final review. The email should follow requirements specified by the QC reviewer and will include:
    - a. Instrument ID, run Date, run number, study ID, group ID.
    - b. Any bench QC failures (include reasons if known).
    - c. Any patient sample result greater than the 2UB boundaries (see Table 11 in Appendix B).
    - d. Anything out of the ordinary about this analytical work which could have a bearing on the availability (i.e. insufficient sample to analyze), accuracy, or precision of the results.
  2. Include all items called for by the study folder cover sheet in the study folder (i.e. printouts from the ICP-MS, bench QC evaluation) together in the study folder before submitting the folder for review when analysis is complete.
- x. Overnight operation or Using Auto Stop: Make every effort to complete analysis within the work day so that the entire run can be monitored. If it is not possible to complete the analysis by the end of the work day, the run may be left to complete itself unattended as long as appropriate planning is made for either overnight operation or Auto Stop.
1. *24 hrs / day operation in DRC mode*:
    - a. To reduce startup time in the mornings, the analyst is encouraged to operate the ELAN in DRC mode 24hrs/day during the work week. This eliminates the need for daily 45 minute RF generator warm-up, and possibly the need for DRC stability time (if the DRC gas is not off for extended periods of time before analysis). To maintain the instrument in DRC mode when not analyzing patient samples, setup multiple

sample rows in the Samples / Batch window with autosampler position in zero (rinse station of autosampler) and wash time of 1800s (30 minutes). Repeat this sample row enough times to keep the instrument in analysis mode overnight (1 sample with 15 minute wash will take ~ 25 minutes).

2. *AutoStop*: If 24 hrs / day ELAN operation is not desired, the instrument can shut the plasma off unattended after analysis. Setup this as follows:
  - a. On the “Auto Start / Stop” tab of the Instrument window, enable the Auto Stop feature.
  - b. Press the “Change” button within the Auto Stop box and set the Delayed shutdown time to 5 minutes. This will rinse the sample introduction system of blood matrix before turning off the plasma.
  - c. It will be necessary to replace the sample peristaltic pump tubing the next day since it will have been clamped shut overnight.
- c. Equipment Maintenance: Analysts are expected to follow a 4-day analysis / 1-day maintenance schedule in the laboratory.
  - i. ICPMS Maintenance: On the maintenance day, perform all maintenance per the IRAT ELAN ICP-MS Weekly Maintenance SOP. All equipment maintenance should be documented in the instrument checklist and logbook.
  - ii. Data Backup: Data on the ELAN computer will be backed up via two backup routines.
    1. Daily Backups to External Hard Drive: Automatic backups of the “elandata” directory and all subdirectories should be programmed to occur each night onto an external hard disk using a three-file rotating backup scheme.
    2. Weekly Backup to CD: Backup all files in the active “elandata” directory and all subdirectories onto one recordable compact disc during the weekly maintenance SOP. When the active “elandata” directory on the ICP-DRC-MS computer hard drive becomes too large to fit onto a single recordable compact disk, the oldest data can be removed from the computer to make it easier to backup the entire directory weekly. This can usually be done annually.
      - a. Backup the oldest data on the hard drive to two duplicate compact disks and verify that the files on the CD are readable
      - b. Label them with the name of the instrument, the date range of the data, the current date, your name, and “Copy 1 of 2” or “Copy 2 of 2”
      - c. After verifying that the CDs are readable, the oldest, backed up data can be deleted from the ICP-MS computer hard drive.
      - d. It is best to not store duplicate copies in the same location.

## 9) Interpretation of the Results

- a. Reportable Range: Whole blood metals values are reportable in the range between the method LOD (see Section 10.a) and the highest concentration verified accurate by bi-annual calibration verification tests (see Appendix, Table 8 in Appendix B). For example, if a blood metals concentration is less than the method LOD, report it as < LOD. Above the highest concentration verified, extra dilutions are made of the blood sample to bring the concentration within the verified range.
- b. Reference Ranges (Normal Values): See Appendix B, Table 12.
- c. Action Levels: Concentrations observed greater than the “second upper boundary” (defined in the laboratory database as the “2UB”) should be reported to the QC reviewer as an “elevated result”. The concentration assigned to the 2UB for an element is determined by study protocol but default concentrations are listed in Table 11 in Appendix B. The analyst should report any patient results confirmed to be greater than the second upper boundary to the QC reviewer as an “elevated result”. The protocol for supervisors reporting elevated results to medical personnel is defined according to the study protocol. Levels of concern for mercury in blood are >100 µg/L for children (6 yr and younger) and >200 µg/L for adults. Levels of concern for lead in blood are 25 µg/dL for children (6yr. and younger) and 40 µg/dL for adults. Levels of concern for cadmium in blood is >5 µg/L.

## 10) Method Calculations

- a. Method Limit of Detection (LODs): The method detection limits for elements in blood specimens are defined as 3 times  $s_0$ , where  $s_0$  is the estimate of the standard deviation at zero analyte concentration.  $S_0$  is taken as the y-intercept of a linear or 2<sup>nd</sup> order polynomial regression of standard deviation versus concentration (4 concentration levels of the analytes in blood each measured 60 times across at least a 2-month timeframe). Method LODs are re-evaluated periodically.
- b. Method Limit of Quantitation (LOQ): The Division of Laboratory Sciences does not currently utilize limits of quantitation in regards to reporting limits [58].
- c. QC Limits: Quality control limits are calculated based on concentration results obtained in at least 20 separate runs. It is preferable to perform separate analyses on separate days and using multiple calibrator lot numbers, instruments, and analysts to best mimic real-life variability. The statistical calculations are performed using the SAS program developed for the Division of Laboratory Sciences (DLS\_QC\_compute\_char\_stats.sas).

## 11) Alternate Methods for Performing Test and Storing Specimens If Test System Fails:

If the analytical system fails, the analysis may be setup on other ELAN DRC instruments in the laboratory. If no other instrument is available, store the specimens at 4°C until the analytical system can be restored to functionality. If



interruption longer than 4 weeks is anticipated, then store blood specimens at  $\leq -20^{\circ}\text{C}$ .

**Appendix A: Critical Parameter Test Results**

Critical Parameter Test #1: This test documents that accurate results are attainable if something prevents a set of prepared samples from being analyzed immediately (per method). Samples which have been diluted 1+1+48 for analysis up to one (1) day (~29 hours) previously can still be analyzed. Results are presented in Table 1.

Test Details:

Day 1: Prepare a set of dilutions (calibrators, blanks, reference material, fake samples) for analysis in triplicate (three separate sets of tubes). Analyze the first set immediately (normal practice). Cap sets #2 and #3 and leave at room temperature for later analysis.

Day 2: Prepared run set #4 and analyzed it sequentially with run set #2 using normal method practices.

Day3: Prepared run set #5 and analyzed it sequentially with run set #3 using normal method practices.

**Table 1.** Ruggedness Testing Results: Evaluating the significance of time from preparation to analysis on sample stability. Test performed on December 6 – 8, 2010 by Deanna Jones. Results below are the average of the beginning and ending QC results for each analytical run.

ID	Time, prep to analysis	Hg (µg/L)	Pb (µg /dL)	Cd (µg /L)	Mn (µg /L)	Se (µg /L)
LB08707 _WB2 _I	<i>Target Mean and 2SD Range</i>	0.585 0.407 – 0.763	2.12 2.03 – 2.21	0.488 0.398 – 0.578	7.98 6.91 – 9.05	
	0 hr	0.418	2.03	0.399	6.09	
	24 hr	0.504	1.99	0.419	7.06	
	48 hr	0.396	2.04	0.509	7.82	
HB08708 _WB2 _I	<i>Target Mean and 2SD Range</i>	6.19 5.89 – 6.48	10.1 9.84 – 10.3	3.14 2.94 – 3.34	14.9 13.5 – 16.4	
	0 hr	5.86	10.0	3.03	12.5	
	24 hr	5.46	9.5	2.85	13.6	
	48 hr	2.64	9.2	2.79	13.5	
QMEQAS 07B-03*	<i>Target Mean and 2SD Range</i>					228 213 - 243
	0 hr					192
	24 hr					202
	48 hr					56
QMEQAS 10B-06*	<i>Target Mean and 2SD Range</i>					239 223 - 255
	0 hr					212
	24 hr					221
	48 hr					62

\*samples purchase from Le centre de toxicology du Quebec (Quebec, Canada)

**Appendix A: Critical Parameter Test Results (Continued)**

Critical Parameter Test #2: This test evaluated the significance of the RF Power setting of the ICP when analyzing blood samples for whole blood metals. The RF Power setting per method is 1450W. The reduced and elevated settings tested are 1150W and 1600W, respectively. Results are presented in Table 2.

Test Details:

1. Prepare a set of dilutions (calibrators, blanks, reference material, dummy samples) for analysis in triplicate (three separate sets of tubes).
2. Analyze them in three separate runs on the same day, same instrument.
3. Change the RF Power across the runs
4. Allow 15 minutes equilibration time between runs for RF Power to stabilize

**Table 2.** Ruggedness Testing Results: Evaluating the significance of RF Power setting on sample stability. Test performed on December 6 and December 10, 2010 by Deanna Jones. Results below are the average of the beginning and ending QC results for each analytical run.

ID	RF Power (W)	Hg (µg /L)	Pb (µg /dL)	Cd (µg /L)	Mn (µg /L)	Se (µg /L)
LB08707_W B2	<i>Target Mean and 2SD Range</i>	0.585 0.407 – 0.763	2.12 2.03 – 2.21	0.488 0.398 – 0.578	7.98 6.91 – 9.05	
	1150 W	0.517	2.09	0.432	7.35	
	1450 W (per method)	0.512	2.03	0.369	6.76	
	1600 W	0.529	2.02	0.418	7.17	
HB08708_W B2	<i>Target Mean and 2SD Range</i>	6.19 5.89 – 6.48	10.1 9.84 – 10.3	3.14 2.94 – 3.34	14.9 13.5 – 16.4	
	1150 W	5.90	10.0	2.93	13.7	
	1450 W (per method)	6.23	10.2	2.90	12.8	
	1600 W	5.99	10.1	3.07	13.3	
QMEQAS08 B-02*	<i>Target Mean and 2SD Range</i>					293 273 - 313
	1150 W					269
	1450 W (per method)					288
	1600 W					314
QMEQAS08 B-08*	<i>Target Mean and 2SD Range</i>					165 154 - 176
	1150 W					179
	1450 W (per method)					147
	1600 W					146

\*samples purchase from Le centre de toxicology du Quebec (Quebec, Canada)

**Appendix A: Critical Parameter Test Results (Continued)**

Critical Parameter Test #3: This test evaluated the significance of the dynamic reaction cell gas flow rate of the reaction gas (oxygen and methane) while analyzing blood samples for elements analyzed in DRC mode (Hg, Mn, and Se). The cell gas flow rate for Mn and Hg is methane (CH<sub>4</sub>) and the per method setting is 1.2 mL/min. The cell gas flow rate for Se is oxygen (O<sub>2</sub>) and the per method setting is 0.84 mL/min. The reduced and elevated settings for O<sub>2</sub> are 0.96 mL/min and 1.44 mL/min, respectively. The reduced and elevated settings for CH<sub>4</sub> are 0.7 mL/min and 1.0 mL/min, respectively. The Results are presented in Tables 3 and 4.

Test Details:

1. Prepare a set of dilutions (calibrators, blanks, reference material, dummy samples) for analysis in triplicate (three separate sets of tubes).
2. Analyze them in three separate runs on the same day using the same instrument.
3. Change the cell gas flow rate.

**Table 3.** Ruggedness Testing Results: Evaluating the significance of dynamic reaction cell gas flow rate on sample stability. Test performed on December 6, 2010 and January 4, 2010 by Deanna Jones. Results below are the average of the beginning and ending QC results for each analytical run.

ID	Cell Gas Flow Rate	Hg (µg /L)	Pb (µg /dL)	Cd (µg /L)	Mn (µg /L)	Se (µg /L)
LB08707_WB2	<i>Target Mean and 2SD Range</i>	0.585 0.407 – 0.763	2.12 2.03 – 2.21	0.488 0.398 – 0.578	7.98 6.91 – 9.05	See Table 4
	0.96 mL/min O <sub>2</sub> ; 0.7 mL/min CH <sub>4</sub>	0.457	2.10	0.471	8.49	
	1.2 mL/min O <sub>2</sub> ; 0.84 mL/min CH <sub>4</sub>	0.479	2.10	0.438	8.15	
	1.44 mL/min O <sub>2</sub> ; 1.0 mL/min CH <sub>4</sub>	0.555	2.11	0.457	8.12	
HB08708_WB2	<i>Target Mean and 2SD Range</i>	6.19 5.89 – 6.48	10.1 9.84 – 10.3	3.14 2.94 – 3.34	14.9 13.5 – 16.4	
	0.96 mL/min O <sub>2</sub> ; 0.7 mL/min CH <sub>4</sub>	4.71	10.0	3.19	14.4	
	1.2 mL/min O <sub>2</sub> ; 0.84 mL/min CH <sub>4</sub>	5.45	10.1	2.92	15.2	
	1.44 mL/min O <sub>2</sub> ; 1.0 mL/min CH <sub>4</sub>	5.34	10.3	3.04	14.6	

**Appendix A: Critical Parameter Test Results (Continued)**

**Table 4.** Ruggedness Testing Results: Evaluating the significance of dynamic reaction cell gas flow rate on sample stability. Test performed on December 6, 2010 and January 4, 2010 by Deanna Jones. Results below are the average of the beginning and ending QC results for each analytical run.

ID	Cell Gas Flow Rate	Hg (µg /L)	Pb (µg /dL)	Cd (µg /L)	Mn (µg /L)	Se (µg /L)
QMEQAS07B-09*	Target Mean and 2SD Range					157 146 - 168
	0.96 mL/min O <sub>2</sub> ; 0.7 mL/min CH <sub>4</sub>					187
	1.2 mL/min O <sub>2</sub> ; 0.84 mL/min CH <sub>4</sub>					186
	1.44 mL/min O <sub>2</sub> ; 1.0 mL/min CH <sub>4</sub>					191
QMEQAS08B-02*	Target Mean and 2SD Range					293 273 - 313
	0.96 mL/min O <sub>2</sub> ; 0.7 mL/min CH <sub>4</sub>					328
	1.2 mL/min O <sub>2</sub> ; 0.84 mL/min CH <sub>4</sub>					334
	1.44 mL/min O <sub>2</sub> ; 1.0 mL/min CH <sub>4</sub>					339

See  
Table 3

\*samples purchase from Le centre de toxicology du Quebec (Quebec, Canada)

**Appendix A: Critical Parameter Test Results (Continued)**

Critical Parameter Test #4: This test evaluated the significance of the RPq value while analyzing blood samples for Se, Mn and Hg. The RPq value setting per method for Mn and Hg is 0.6, and for Se it is 0.65. The reduced and elevated RPq values for Mn and Hg are 0.48 and 0.72, respectively. The reduced and elevated RPq values for Se are 0.52 and 0.78, respectively. The results are presented in Tables 5 and 6.

Test Details:

1. Prepare a set of dilutions (calibrators, blanks, reference material, fake samples) for analysis in triplicate (three separate sets of tubes).
2. Analyze them in three separate runs on the same day, using the same instrument.
3. Change the RPq value.

**Table 5.** Ruggedness Testing Results: Evaluating the significance of RPq value on sample stability. Test performed on December 21, 2010 by Deanna Jones. Results below are the average of the beginning and ending QC results for each analytical run.

ID	RPq	Hg (µg /L)	Pb (µg /dL)	Cd (µg /L)	Mn (µg /L)	Se (µg /L)
LB08707_WB2	<i>Target Mean and 2SD Range</i>	0.585 0.407 – 0.763	2.12 2.03 – 2.21	0.488 0.398 – 0.578	7.98 6.91 – 9.05	See Table 6
	0.48 Mn and Hg; 0.52 Se	0.455	1.97	0.361	7.86	
	0.6 Mn and Hg; 0.7 Se	0.418	2.03	0.399	6.09	
	0.72 Mn and Hg; 0.78 Se	0.402	2.07	0.402	7.99	
HB08708_WB2	<i>Target Mean and 2SD Range</i>	6.19 5.89 – 6.48	10.1 9.84 – 10.3	3.14 2.94 – 3.34	14.9 13.5 – 16.4	
	0.48 Mn and Hg; 0.52 Se	5.54	9.4	2.79	14.4	
	0.6 Mn and Hg; 0.7 Se	5.86	10.0	3.03	12.5	
	0.72 Mn and Hg; 0.78 Se	5.53	9.7	2.88	14.9	

**Table 6.** Ruggedness Testing Results: Evaluating the significance of RPq value on sample stability. Test performed on December 21, 2010 by Deanna Jones. Results below are the average of the beginning and ending QC results for each analytical run.

ID	RPq	Hg (µg /L)	Pb (µg /dL)	Cd (µg /L)	Mn (µg /L)	Se (µg /L)
QMEQAS07B-09*	<i>Target Mean and 2SD Range</i>	See Table 5				293 273 – 313
	0.48 Mn and Hg; 0.52 Se					262
	0.6 Mn and Hg; 0.7 Se					250
	0.72 Mn and Hg; 0.78 Se					277
QMEQAS08B-02*	<i>Target Mean and 2SD Range</i>					361 337 - 385
	0.48 Mn and Hg; 0.52 Se					347
	0.6 Mn and Hg; 0.7 Se					349
	0.72 Mn and Hg; 0.78 Se					364

\*samples purchase from Le centre de toxicology du Quebec (Quebec, Canada)

**Appendix A: Critical Parameter Test Results (Continued)**

Critical Parameter Test #5: This test evaluated the significance of the Axial Field Voltage (AFV) while analyzing blood samples for whole blood metals. The Axial Field Voltage may vary on each instrument. The Axial Field Voltage was increased and decreased by 20%. The results are presented in Table 7.

Test Details:

1. Prepare a set of dilutions (calibrators, blanks, reference materials, fake samples) for analysis in triplicate (three separate sets of tubes).
2. Analyze them in three separate runs on the same day, same instrument.
3. Change the AFV value +/- 100 V.

**Table 7.** Ruggedness Testing Results: Evaluating the significance of Axial Field Voltage on sample stability. Test performed on December 20, 2010 by Deanna Jones. Results below are the average of the beginning and ending QC results for each analytical run.

ID	Axial Field Voltage	Hg (µg /L)	Pb (µg /dL)	Cd (µg /L)	Mn (µg /L)	Se (µg /L)
LB08707_ - WB2	Target Mean and 2SD Range	0.585 0.407 – 0.763	2.12 2.03 – 2.21	0.488 0.398 – 0.578	7.98 6.91 – 9.05	
	(decreased)	0.511	2.00	40.415	7.77	
	(per method)	0.461	2.04	0.394	6.36	
	(increased)	0.414	2.01	0.376	6.95	
HB08708_ - WB2	Target Mean and 2SD Range	6.19 5.89 – 6.48	10.1 9.84 – 10.3	3.14 2.94 – 3.34	14.9 13.5 – 16.4	
	(decreased)	5.50	9.8	2.91	14.3	
	(per method)	5.62	9.8	2.84	12.0	
	(increased)	5.75	10.1	2.99	12.8	
QMEQAS 07B-09*	Target Mean and 2SD Range					157 146 – 168
	(decreased)					139
	(per method)					147
	(increased)					138
QMEQAS0 9B-08*	Target Mean and 2SD Range					548 511 - 585
	(decreased)					501
	(per method)					556
	(increased)					532

\*samples purchase from Le centre de toxicology du Quebec (Quebec, Canada)



## Appendix B

<b>Table 1. Instrument and Method Parameters.</b>	
<b>Instrument:</b> PerkinElmer ELAN DRC II ICP-MS ESI SC4 autosampler with (optional) PC3 Peltier cooled spray chamber	
<b>Optimization Window Parameters</b>	
RF power	1.45 KW
Plasma Gas Flow (Ar)	15 L/min
Auxiliary Gas Flow (Ar)	1.2 L/min
Nebulizer Gas Flow (Ar)	~0.90 – 1.0 L/min (optimized as needed for sensitivity)
Ion Lens Voltage(s)	AutoLens (optimized as needed for sensitivity)
QRO, CRO, CPV, Discriminator Threshold	Optimized per instrument by service engineer, or advanced user.
Parameters of x-y alignment, nebulizer gas flow, AutoLens voltages, mass calibration, and detector voltages are optimized regularly. Optimization file name = default.dac.	
<b>Configurations Window Parameters</b>	
Cell Gas Changes Pause Times	Pressurize Delay (From Standard to DRC mode) = 60 Exhaust Delay (From DRC to Standard mode) = 30 Flow Delay (Gas changes while in DRC mode) = 30 Channel Delay (Gas channel change in DRC mode) = 30
<b>File Names &amp; Directories</b>	
Method file names	<i>calibration curve (programmed for blood blank)</i> WBMP2_DLS3016_bldblk.mth <i>For QC &amp; patient sample analysis (programmed for aqueous blank)</i> WBMP2_DLS3016_aqblk.mth
Dataset	Create a new dataset subfolder each day. Name as “2011-0820” for all work done on August 20, 2011
Sample File	Create for each day’s work
Report file name	<i>For sample results printouts</i> cdc_quant comprehensive.rop  <i>For calibration curve information</i> CDC_Quant Comprehensive (calib curve info).rop
Tuning	Default.tun
Optimization	Default.dac
Calibration	N/A
Polyatomic	elan.ply
Report Options Template (transferring results to the database)	CDC_Database Output.rop <i>Report Format Options: select only “Use Separator”</i> <i>File Write Option: Append</i> <i>Report File name: include date, instrument, and group being analyzed in file name (i.e. 2005-0311b_DRC2A_HM-0364.txt)</i>

<b>Table 1. Instrument and Method Parameters.</b>	
<b>Method Parameters</b>	
<b>Method Parameters: Timing Page (see Figures 1a, 2a and 2d in Appendix B)</b>	
Sweeps/reading	30
Readings/replicate	1
Replicates	3
Enable QC Checking	Off
Isotopes Monitored and Internal Standard Associations (Exact Mass)	use $^{103}\text{Rh}$ , $^{130}\text{Te}$ , $^{193}\text{Ir}$ as internal standards $^{103}\text{Rh}$ (102.905): $^{55}\text{Mn}$ (54.93805) $^{130}\text{Te}$ (129.907): $^{202}\text{Hg}$ (201.971), $^{80}\text{Se}$ (79.9165) $^{193}\text{Ir}$ (192.963): $^{208}\text{Pb}$ (207.977), $^{114}\text{Cd}$ (113.904)
Dwell Times	100 ms for $^{55}\text{Mn}$ , $^{202}\text{Hg}$ , $^{80}\text{Se}$ , $^{208}\text{Pb}$ , and $^{114}\text{Cd}$ 50 ms for $^{130}\text{Te}$ , $^{103}\text{Rh}$ , and $^{193}\text{Ir}$
Scan Mode	Peak Hopping for all isotopes (1 MCA channel)
DRC channel A Gas Flow Rate	99.999% Methane (5-7 psig delivery pressure) typically 0.84 L/min * *optimized per instrument, and periodically verified
DRC channel B Gas Flow Rate	99.99% Oxygen (5-7 psig delivery pressure) typically 1.2 L/min * *optimized per instrument, and periodically verified
RPa	0 for all isotopes
RPq	Typically* 0.6 for $^{103}\text{Rh}$ , $^{55}\text{Mn}$ , $^{130}\text{Te}$ , and $^{202}\text{Hg}$ . 0.65 for $^{130}\text{Te}$ and $^{80}\text{Se}$ . 0.25 for $^{193}\text{Ir}$ , $^{208}\text{Pb}$ , and $^{114}\text{Cd}$ Use the same RPQ for each analyte and its IS. (* Optimize per instrument, and periodically verified)
<b>Method Parameters: Processing Page (see Figures 1b in Appendix B)</b>	
Detector mode	Pulse
Process Spectral Peak	N/A
AutoLens	On
Isotope Ratio Mode	Off
Enable Short Settling Time	Off
Blank subtraction	After internal standard
Measurement units	Cps
Process Signal Profile	N/A
<b>Method Parameters: Equations Page (see Figures 1c in Appendix B)</b>	
Equations	None
<b>Method Parameters: Calibration Page (see Figures 1d in Appendix B)</b>	
Calibration Type	External Std.
Curve type	Simple Linear

<b>Table 1. Instrument and Method Parameters.</b>	
Sample units	“µg/L” or “ppb”
Calibration Standard Concentrations (µg/L)	Mn: 1.5, 4.5, 10.5, 15, 30 Cd, Hg: 0.5, 1.5, 3.5, 5, 10 Pb (µg /dL): 1, 3, 7, 10, 20 Se: 30, 90, 210, 300, 600
<b>Method Parameters: Sampling Page (see Figures 1e and 1f in Appendix B)</b>	
“Peristaltic Pump Under Computer Control”	On
Sample Flush	6s at 1.5 rpm
Read Delay	60s at 1.5 rpm
Wash	40s at 1.5 rpm
Autosampler Locations of Blanks and Standards	<i>For calibration curve (points to blood blank)</i> WBMP2_DLS3016_bldblk.mth Blood Blank and Calibration Stds 1 – 5 in autosampler positions 105 - 110.  <i>For QC &amp; patient sample analysis (points to aqueous blank)</i> WBMP2_DLS3016_aqblk.mth Aqueous Blank in autosampler position 112 and 113.

<b>Table 2. Suggested maximum analyte concentrations for base blood and Quality control material</b>			
Analyte	Maximum Base Blood Concentration (µg/L)	Low QC Spiking Range ( µg /L)	High QC Spiking Range ( µg /L)
Mn	< 8	6 – 10	15 - 20
Hg	<0.5	0.5 – 0.75	5 – 7
Se	<200	125 – 175	225 – 275
Cd	<0.5	0.4 – 0.5	2.5 – 3.5
Pb ( µg /dL)	<2	1 – 2	9 - 11

<b>Table 3. Preparation of Intermediate Stock Calibration Solution from NIST primary standards</b>					
Analyte	Cd	Pb	Hg	Mn	Se
Certified value (mg/g)	10.005*	9.987 <sup>#</sup>	9.954 <sup>^</sup>	10.00 <sup>+</sup>	10.11 <sup>%</sup>
Target mass to add (g)	0.0101	0.201	0.0101	0.03	0.594
Target final weight (g)	100.00				
Expected final concentration (µg /g)	1.0105	20.0739	1.0054	3.000	60.0534
* certified value for lot # 060531 # certified value for lot # 030721 ^ certified value for lot # 061204 + certified value for lot # 050429 % certified value for lot # 992106					

Appendix B (continued)

**Table 4. Preparation of Intermediate Stock Calibration Solution from single element stock calibrator solutions without Pb**

Analyte	Cd	Se	Hg	Mn
Stock concentration (mg/L)	1000	1000	1000	1000
Spike volume (mL)	0.100	6.00	0.100	0.300
Final Volume (mL)	100			
Final concentration ( µg /L)	1.00	60.0	1.00	3.00

**Table 5. Preparation of Intermediate Working Standards**

Standard #	1	2	3	4	5
Volume of Flask (mL)	100	100	100	100	100
Volume Spike of Int. Stock Std. (mL)	0.05	0.15	0.35	0.50	1.00
	<b>Concentrations ( µg /L)</b>				
Cd <sup>+</sup>	0.5	1.5	3.5	5	10
Hg <sup>#</sup>	0.5	1.5	3.5	5	10
Mn <sup>*</sup>	1.5	4.5	10.5	15	30
Pb ( µg /dL) <sup>+</sup>	1	3	7	10	20
Se <sup>#</sup>	30	90	210	300	600
<sup>+</sup> <sup>193</sup> Ir used as internal standard <sup>#</sup> <sup>130</sup> Te used as internal standard <sup>*</sup> Rh-103 used as internal standard					

Appendix B (continued)

**Table 6. Preparation of samples, working standards, and QC materials for analysis**

Total volume of prepared sample may be changed, from what is presented here. However, volumes for each component should be adjusted proportionally.

Dilution ID	Water (µL)	Base Blood (µL)	AQ Intermediate Working Standard	Patient or QC blood sample (µL)	Diluent (µL)
-------------	------------	-----------------	----------------------------------	---------------------------------	--------------

			( $\mu\text{L}$ )		
AQ Blank	100	-	-	-	2400 *
Blood Blank and BldBlkChk	50	50	-	-	2400 *
Working Calibration Standards	-	50	50	-	2400 *
Patient blood or Blood-Based QC	50	-	-	50	2400 *
Patient Blood <i>2x Dilution</i> <sup>H</sup>	150	-	-	50	4800

\* 2400  $\mu\text{L}$  diluent is best dispensed from the Digiflex™ as 2 1200- $\mu\text{L}$  portions (i.e.- When preparing a Working Calibration Standard dilution, dispense 1200  $\mu\text{L}$  diluent + 50  $\mu\text{L}$  standard in one cycle of Digiflex™, then 1200  $\mu\text{L}$  diluent + 50  $\mu\text{L}$  base blood in the next cycle of the Digiflex™ to prepare a 2.5 mL total volume dilution.)

<sup>H</sup> Extra dilution is performed on blood samples whose concentration is greater than the concentrations listed in Table 8 in Appendix B (linearity of the method has been documented up to these concentrations). Any extra level of dilution can be prepared as long as the 4.8:5 ratio of diluent to total dilution volume is maintained. Use of the lowest possible dilution level is preferred because matrix differences may lead to different observed concentration results as the sample dilution becomes greater (i.e. 2x dilution is preferred over 10x if 2x is sufficient to dilute analyte into the documented linearity range).

**Appendix B (continued)**

**Table 7. Preparation and Final Concentrations of Intermediate Stock Calibration Verification Standards. \***

Flask # 1				Flask #2	
Analytes	Cd	Hg	Mn	Analyte	Pb
Stock Concentration (mg/L)	1000	1000	1000	Stock Concentration (NIST 3128) (mg/g)	9.987
Spike volume (mL)	1	1	3	Target Mass (g)	10
Final volume (mL)	100	100	100	Final volume (mL)	100
Final concentration (mg/L)	10	10	30	Final concentration (mg/L)	999

\* If standards are made gravimetrically the final concentrations will not exactly match these and the QC ID used in the laboratory database will need to change to maintain proper record keeping of analysis result to target concentration.

**Table 8. Preparation and Final Concentrations of Intermediate Working Calibrator Verification Standards**

Calibration Verification Standard #	CV1	CV2	CV3
Volume of Flask	100	100	100
Volume of Cd, Hg, Mn, Intermediate Stock Calibration Verification Standard (mL)	0.25	0.5	1
Volume of Pb Intermediate Stock Calibration Verification Standard (mL)	0.1	0.2	0.4
Volume of 1000 mg/L Se Stock Calibration Solution	0.05	0.1	0.2
Final Volume (mL)	100	100	100
Final Concentrations *	CV1	CV2	CV3
Cd ( µg /L)	25	50	100
Hg ( µg /L)	25	50	100
Mn ( µg /L)	75	150	300
Pb ( µg /dL)	100	200	400
Se ( µg /L)	500	1000	2000

\* If standards are made gravimetrically the final concentrations will not exactly match these and the QC ID used in the laboratory database will need to change to maintain proper record keeping of analysis result to target concentration.

Appendix B (continued)

**Table 9. Acceptable ways to perform two consecutive analytical runs, bracketing with bench quality control samples.**

<b>Setup 1</b>	<b>Setup 2 (typical)</b>
<p><i>Run #1</i>                      Calibration Standards                      Low Bench QC                      High Bench QC                      patient samples                      Low Bench QC                      High Bench QC</p> <p><i>Run #2</i>                      Low Bench QC                      High Bench QC                      patient samples                      Low Bench QC                      High Bench QC</p>	<p><i>Run #1</i>                      Calibration Standards                      Low Bench QC                      High Bench QC                      patient samples                      Low Bench QC                      High Bench QC</p> <p><i>Run #2</i>                      Calibration Standards                      Low Bench QC                      High Bench QC                      patient samples                      Low Bench QC                      High Bench QC</p>

## Appendix B (continued)

Table 10. A typical SAMPLE/BATCH window.

<u>AS Location*</u>	<u>Sample ID</u>	<u>Measurements Action</u>	<u>Method</u>
233	DRCstability1	Run sample	...DLS3016_bldblk.mth
233	DRCstability2	Run sample	...DLS3016_bldblk.mth
233	DRCstability3	Run sample	...DLS3016_bldblk.mth
233	DRCstability4	Run sample	...DLS3016_bldblk.mth
Continue DRC stability samples . . .			
233	DRCstability9	Run sample	...DLS3016_bldblk.mth
233	DRCstability10	Run sample	...DLS3016_bldblk.mth
103	Aq blank	Run sample	...DLS3016_bldblk.mth
104	WB Blank_chk	Run sample	...DLS3016_bldblk.mth
111	WB Blank	Run blank, standards, and sample **	...DLS3016_bldblk.mth
112	WB Blank2	Run sample	...DLS3016_bldblk.mth
103	Aq blank	Run blank and sample †	...DLS3016_aqblk.mth
113	L Bench QC	Run sample	...DLS3016_aqblk.mth
114	H Bench QC	Run sample	...DLS3016_aqblk.mth
301	Sample 1	Run sample	...DLS3016_aqblk.mth
302	Sample 2	Run sample	...DLS3016_aqblk.mth
303	Sample 3	Run sample	...DLS3016_aqblk.mth
115	L Bench QC	Run sample	...DLS3016_aqblk.mth
116	H Bench QC	Run sample	...DLS3016_aqblk.mth

\* The exact autosampler positions of QCs and patient samples do not have to be those shown above, but the order in which these are run should be as shown above.

\*\* When executing this row, the ELAN will first analyze the blood blank at AS position 105, then standards 1-5 at autosampler positions 106-110, then the "WB Blank" sample at A/S position 111. The sampling information about AS positions 105-110 are stored in the "bldblk" method file.

† When executing this row, the ELAN will first analyze the aqueous blank at AS position 112, then the "Aq blank" at AS position 103. The sampling information about AS positions 112 is stored in the "aqblk" method file.



**Appendix B (continued)**

**Table 11. Boundary Concentrations for Whole Blood Concentrations (µ/L).**

<b>Analyte</b>	<b>1<sup>st</sup> Upper Boundary (“1UB”) *</b>	<b>2<sup>nd</sup> Upper Boundary (“2UB”) **</b>	<b>Range Maximum (“Lim Rep Delta”) †</b>
Mn	20	35	2.0
Pb	10.0	10.0	1.0
Cd	5.0	5.0	1.0
Hg	10.0	10.0	1.0
Se	400	400	20

\* Typically, the 1<sup>st</sup> upper boundary (1UB) is the 99<sup>th</sup> percentile of non-weighted, corrected concentration results from the NHANES 1999-2000 subset groups. Concentrations observed greater than the “first upper boundary” (defined in the laboratory database as the “1UB”) should be confirmed by repeat analysis of a new sample preparation. The concentration assigned to the 1UB for an element is determined by study protocol but default concentrations are listed in this table. Report the original result, as long as the confirmation is within 10% of the original. Continue repeat analysis until a concentration can be confirmed.

\*\* Typically the 2<sup>nd</sup> upper boundary (2UB) is set to 2x the 1UB. At the discretion of the supervisor, the 1UB may vary per study according to the concerns of the study. Regardless of the study, report patient results confirmed to be greater than the 2UB to the QC reviewer as an “elevated result”.

† Range maximum is the range of the three replicate readings for a single sample analysis. This value is also called the “Lim RepDelta” in the database which handles data for the Inorganic Radiation and Analytical Toxicology Branch. If the range of replicate readings is greater than the range maximum, and represents greater than a 10% relative standard deviation for the measurement, do not use the measurement for reporting.

Appendix B (continued)

**Table 12. Reference Ranges for Blood Concentrations.**

Analyte (units)	Survey Years	Geometric Mean	50 <sup>th</sup>	75 <sup>th</sup>	90 <sup>th</sup>	95 <sup>th</sup>	N
Cd (µg/L)*	99-00	0.412	0.300	0.600	1.00	1.30	7970
	01-02	**	0.300	0.400	0.900	1.30	8945
Hg (µg/L)* (1-5 yrs)	99-00	0.343	0.300	0.500	1.40	2.30	705
	01-02	0.318	0.300	0.700	1.20	1.90	872
Hg (µg/L)* (16-49 yrs, female)	99-00	1.02	0.900	2.00	4.90	7.10	1709
	01-02	0.833	0.700	1.70	3.00	4.60	1928
Pb (µg/dL)*	99-00	1.66	1.60	2.40	3.80	4.90	7970
	01-02	1.45	1.40	2.20	3.40	4.40	8945
Se (µg/L) †	157 – 265 µg/L [60]						
Mn ( µg /L) †	Non-exposed 4 – 14 ( µg /L) [41]						
	Exposed workers (adults) 3.2 – 101 µg /L [23]						
	Children receiving long term parenteral nutrition 33.8 – 101 µg /L [61]						
	Ohio adults (N=49) residing near a refinery (possible Mn emission): Mean (range) 9.4 (4.2-21.7) µg/L [25]						
	Mexican infants Age 1, mean (SD) = 24.3 (4.5) µg/L, median = 23.7 µg/L, N=270 Age 2, mean (SD) = 21.1 (6.2) µg/L, median = 20.3 µg/L, N=430 [62]						
	Japanese women (N = 1420) GM 13.2 µg/L overall, Range of median (max) across 8 regions 12.0-14.3 (25.0-33.4) µg/L [63]						
	South African children, ages 8-10 years old (n = 49) Mean (SD) 8.48 (2.45) µg/L, range 4.58-18.20 µg/L. [29]						
* From the Third National Report on Exposure to Environmental Chemicals [64]							
** Not calculated. Proportion of results below limit of detection (0.3) was too high to provide a valid result.							
† Blood Se and Mn were not included in the Third National Report on Exposure to Environmental Chemicals.							

Figure 1a. ELAN ICP-DC-MS Method Screen Shots (timing page).

The screenshot displays the 'ELAN Instrument Control Session' interface. The title bar indicates the method path: 'C:\EldataMethod\Blood Metals Pane...'. The menu bar includes File, Edit, Analysis, Options, Wizard, Window, and Help. The toolbar contains icons for Method, Sample, Dataset, Realtime, Interactive, CalibView, RptOption, RptView, Optimize, Tuning, Instrument, Devices, SmartTune, and Chromera. Below the toolbar, there are tabs for Timing, Processing, Equation, Calibration, Sampling, and Devices. The main window is divided into several sections:

- Timing Section:** Sweeps / Reading: 30, Est. Reading Time: 0:00:34.380, Tuning File: default.tun, Browse...  
Readings / Replicate: 1, Est. Replicate Time: 0:00:34.380, Optimization File: default.dac, Browse...  
Replicates: 3, Est. Sample Time: 0:03:13.140,  Enable QC Checking, Get Cell Parameters
- Table Section:** A table with columns: Int Std, Analyte (\*), Mass (amu), Scan Mode (\*), MCA Channels, Dwell Time per AMU (ms), Integration Time (ms), Corrections, Cell Gas A, Cell Gas B, RP a, RP q, Mode.

The table contains the following data:

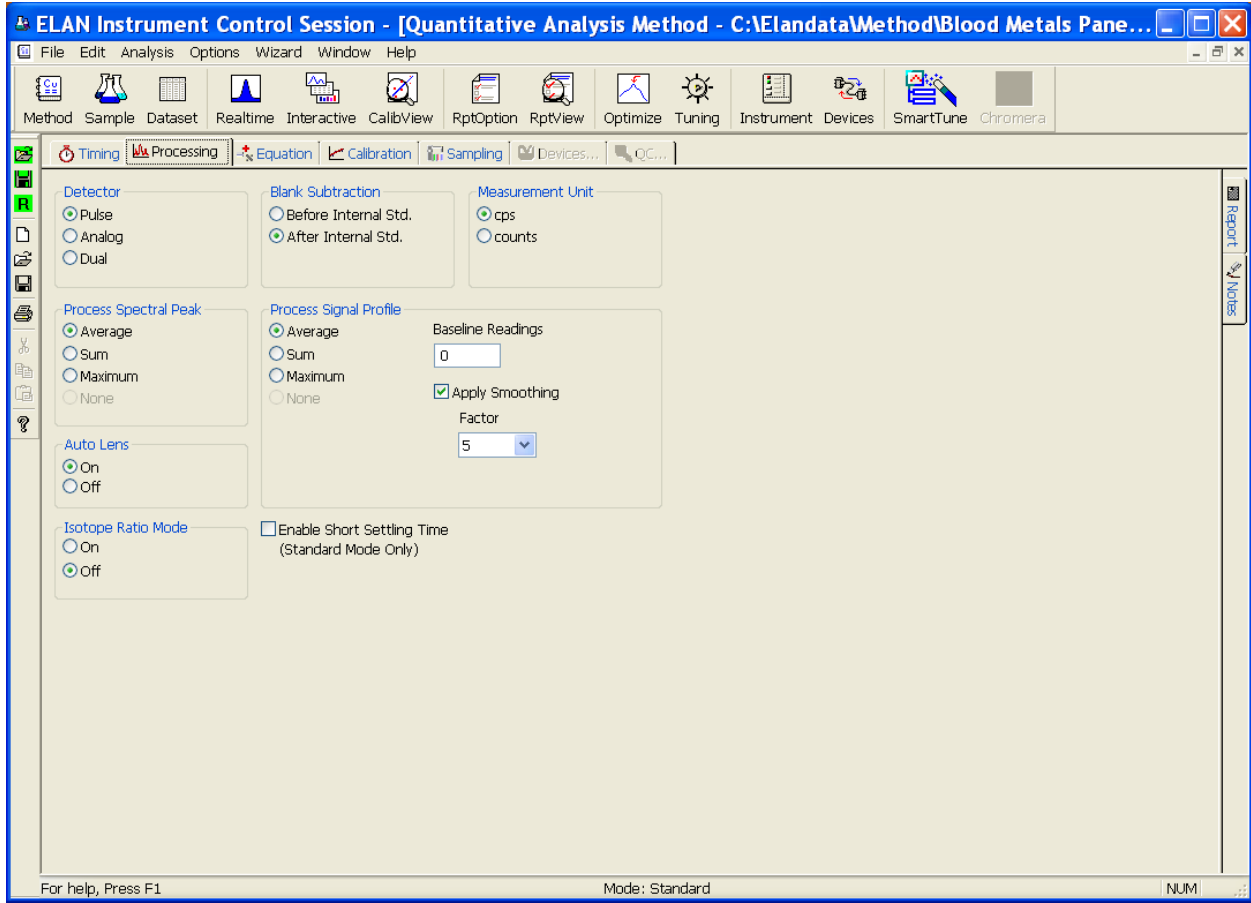
Int Std	Analyte (*)	Mass (amu)	Scan Mode (*)	MCA Channels	Dwell Time per AMU (ms)	Integration Time (ms)	Corrections	Cell Gas A	Cell Gas B	RP a	RP q	Mode
1	Mn	54.9381	Peak Hopping	1	100	3000		0	1.2	0	0.6	DRC
2	Rh	102.905	Peak Hopping	1	50	1500		0	1.2	0	0.6	DRC
3	Te	129.907	Peak Hopping	1	50	1500		0	1.2	0	0.6	DRC
4	Hg	201.971	Peak Hopping	1	100	3000	Hg	0	1.2	0	0.6	DRC
5	Se	79.9165	Peak Hopping	1	100	3000		0.84	0	0	0.65	DRC
6	Te-1	129.907	Peak Hopping	1	50	1500		0.84	0	0	0.65	DRC
7	Cd	113.904	Peak Hopping	1	100	3000	Sn	0	0	0	0.25	Standard
8	Ir	192.963	Peak Hopping	1	50	1500		0	0	0	0.25	Standard
9	Pb	207.977	Peak Hopping	1	100	3000	Pb, Pb	0	0	0	0.25	Standard
10												
11												
12												
13												
14												
15												
16												
17												
18												
19												

The 'Optimize' button in the toolbar is highlighted by a callout box labeled 'Optimize Per Instrument' with arrows pointing to it.

For help, Press F1 Mode: Standard NUI

Appendix B (continued).

Figure 1b. ELAN ICP-DC-MS Method Screen Shots (processing page).



Appendix B (continued).

Figure 1c. ELAN ICP-DC-MS Method Screen Shots (equation page).

The screenshot displays the 'Equation' page in the ELAN software. The main window title is 'ELAN Instrument Control Session - [Quantitative Analysis Method - C:\Elandata\Method\Blood Metals Pane...'. The menu bar includes File, Edit, Analysis, Options, Wizard, Window, and Help. The toolbar contains icons for Method, Sample, Dataset, Realtime, Interactive, CalibView, RptOption, RptView, Optimize, Tuning, Instrument, Devices, SmartTune, and Chromera. Below the toolbar, there are tabs for Timing, Processing, Equation (selected), Calibration, Sampling, and Devices... The 'Isotope Information' section shows Mn 55 with a mass of 54.9381, an abundance of 100.000000, and interferences ArN, HClO, ClO. The main table lists various analytes and their associated corrections and potential interferences.

Int Std	Analyte (*)	Mass (amu)	Corrections	Potential Interferences
1	Mn	54.9381		ArN, HClO, ClO
2	Rh	102.905		SrO
3	Te	129.907		Ba, Xe, MoO2
4	Hg	201.971	+ Hg 200	WO
5	Se	79.9165		Kr, Ar2, BrH, Gd++, Dy++, Dy++
6	Te-1	129.907		
7	Cd	113.904	- 0.027250 * Sn 118	Sn, MoO
8	Ir	192.963		HfO, LuO
9	Pb	207.977	+ Pb 206 + Pb 207	
10				
11				
12				
13				
14				
15				
16				
17				
18				
19				
20				
21				

At the bottom of the window, it says 'For help, Press F1', 'Mode: Standard', and 'NUM'.



Appendix B (continued).

Figure 1e. ELAN ICP-DC-MS Method Screen Shots (sampling page, AqBlank method).

The screenshot displays the 'Sampling' tab of the ELAN Instrument Control software. The interface includes a menu bar (File, Edit, Analysis, Options, Wizard, Window, Help) and a toolbar with icons for Method, Sample, Dataset, Realtime, Interactive, CalibView, RptOption, RptView, Optimize, Tuning, Instrument, Devices, SmartTune, and Chromera. Below the toolbar, there are sections for Autosampler (AS-93plus), Tray (c:\program files\esi\sc\esi.try), and Sampling Device (None). A table lists the sampling sequence with columns for Standard, Solution ID, A/S Loc., Sample Flush (sec), Sample Flush Speed (+/- rpm), Read Delay (sec), Delay & Analysis Speed (+/- rpm), Wash (sec), and Wash Speed (+/- rpm). The sequence starts with a Blank sample followed by 18 Standard samples. The status bar at the bottom indicates 'Mode: Standard' and 'NUM'.

	Standard	Solution ID	A/S Loc.	Sample Flush (sec)	Sample Flush Speed (+/- rpm)	Read Delay (sec)	Delay & Analysis Speed (+/- rpm)	Wash (sec)	Wash Speed (+/- rpm)
1	Blank		113	6	-1.5	60	-1.5	40	-1.5
2	Standard 1			6	-1.5	60	-1.5	40	-1.5
3	Standard 2			6	-1.5	60	-1.5	40	-1.5
4	Standard 3			6	-1.5	60	-1.5	40	-1.5
5	Standard 4			6	-1.5	60	-1.5	40	-1.5
6	Standard 5			6	-1.5	60	-1.5	40	-1.5
7	Standard 6			6	-1.5	60	-1.5	40	-1.5
8	Standard 7			6	-1.5	60	-1.5	40	-1.5
9	Standard 8			6	-1.5	60	-1.5	40	-1.5
10	Standard 9			6	-1.5	60	-1.5	40	-1.5
11	Standard 10			6	-1.5	60	-1.5	40	-1.5
12	Standard 11			6	-1.5	60	-1.5	40	-1.5
13	Standard 12			6	-1.5	60	-1.5	40	-1.5
14	Standard 13			6	-1.5	60	-1.5	40	-1.5
15	Standard 14			6	-1.5	60	-1.5	40	-1.5
16	Standard 15			6	-1.5	60	-1.5	40	-1.5
17	Standard 16			6	-1.5	60	-1.5	40	-1.5
18	Standard 17			6	-1.5	60	-1.5	40	-1.5
19	Standard 18			6	-1.5	60	-1.5	40	-1.5

Appendix B (continued).

Figure 1f. ELAN ICP-DC-MS Method Screen Shots (sampling page, BldBlank method).

Quantitative Analysis Method - C:\Elan\data\Method\Blood Metals Panel 2\CDC\_WBMNSEdHgPb\_BLDblnk.m

Timing Processing Equation Calibration Sampling Devices... QC...

Autosampler: AS-93plus  Dil. Factor: 10 Dil. To Vol. (mL): 10

Tray: c:\program files\esi\esi sc\esi.try  1st. Dil. Pos: 1 Probe Purge Pos.: 10

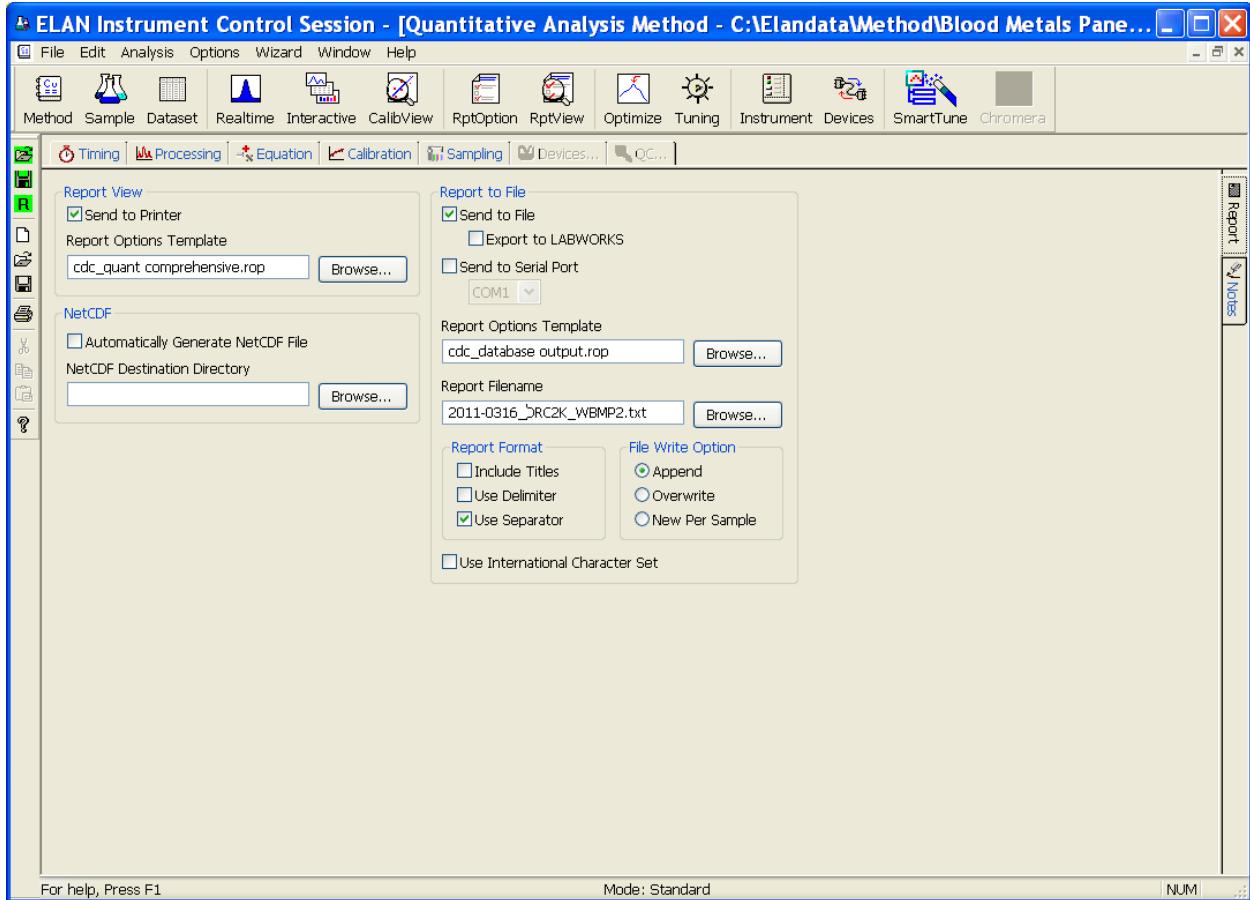
Sampling Device: (None)  Peristaltic Pump Under Computer Control

	Standard	Solution ID	A/S Loc.	Sample Flush (sec)	Sample Flush Speed (+/- rpm)	Read Delay (sec)	Delay & Analysis Speed (+/- rpm)	Wash (sec)	Wash Speed (+/- rpm)
1	Blank		105	6	-1.5	60	-1.5	40	-1.5
2	Standard 1		106	6	-1.5	60	-1.5	40	-1.5
3	Standard 2		107	6	-1.5	60	-1.5	40	-1.5
4	Standard 3		108	6	-1.5	60	-1.5	40	-1.5
5	Standard 4		109	6	-1.5	60	-1.5	40	-1.5
6	Standard 5		110	6	-1.5	60	-1.5	40	-1.5
7	Standard 6			6	-1.5	60	-1.5	40	-1.5
8	Standard 7			6	-1.5	60	-1.5	40	-1.5
9	Standard 8			6	-1.5	60	-1.5	40	-1.5
10	Standard 9			6	-1.5	60	-1.5	40	-1.5
11	Standard 10			6	-1.5	60	-1.5	40	-1.5
12	Standard 11			6	-1.5	60	-1.5	40	-1.5
13	Standard 12			6	-1.5	60	-1.5	40	-1.5
14	Standard 13			6	-1.5	60	-1.5	40	-1.5
15	Standard 14			6	-1.5	60	-1.5	40	-1.5
16	Standard 15			6	-1.5	60	-1.5	40	-1.5
17	Standard 16			6	-1.5	60	-1.5	40	-1.5
18	Standard 17			6	-1.5	60	-1.5	40	-1.5
19	Standard 18			6	-1.5	60	-1.5	40	-1.5



Appendix B (continued).

Figure 1g. ELAN ICP-DC-MS Method Screen Shots (report page).



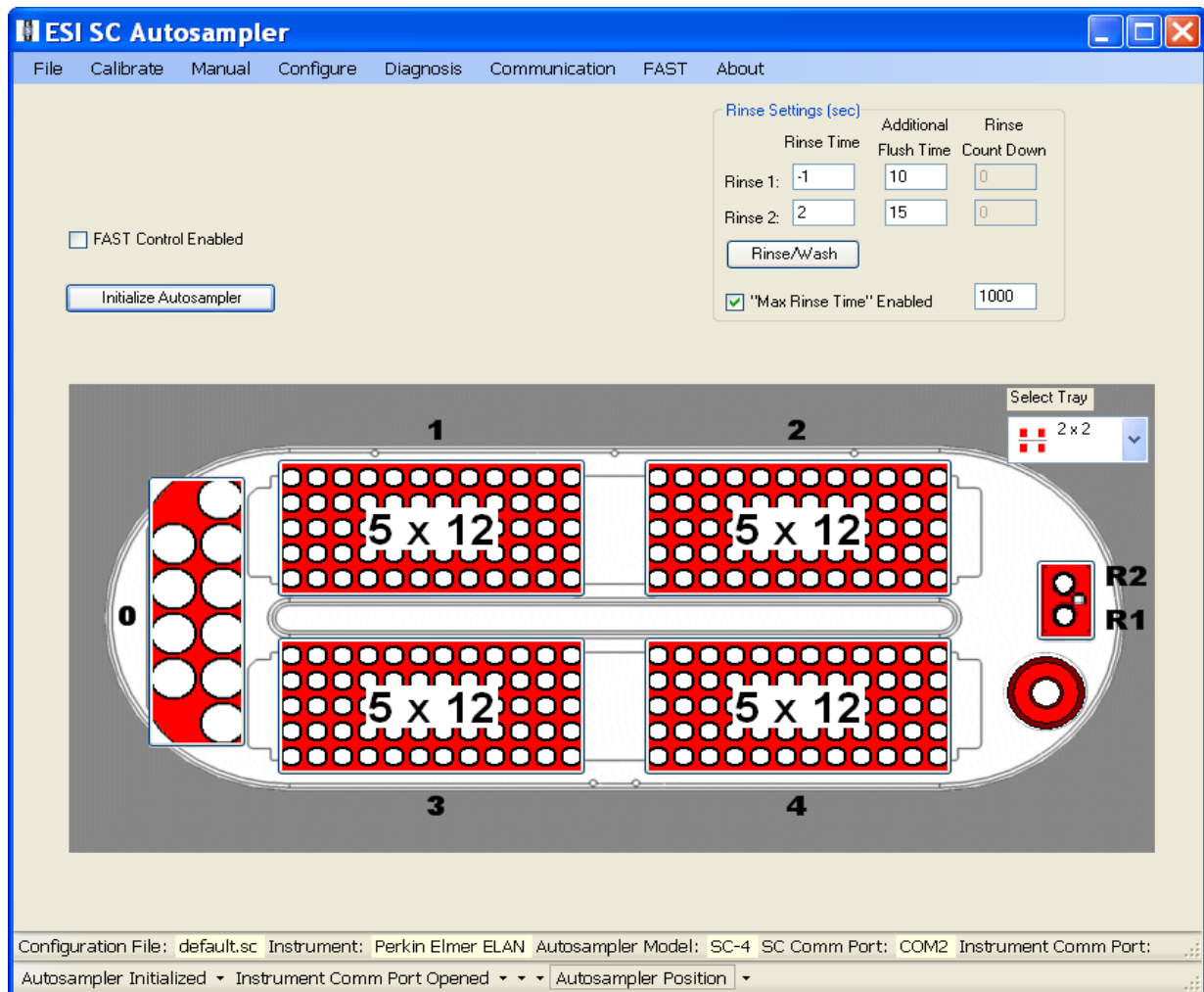
**Appendix B (continued).**

**Figure 2a. ESI SC4 Autosampler Screen Shots (Main page).** Additional flush times and “Max Rinse Time” are approximate. Optimize these for best reduction of elemental carry-over between samples. Tray types can be changed to allow for different volumes of diluted sample digests. ‘FAST control’ must be enabled before start of method, but does not need to be used in instrument optimization (pre-analysis) steps. Rinse and additional flush times for eliminating carry-over from one sample to the next while using the minimum amount of rinse solution.

A rinse time of -1 causes the rinse station to be skipped.

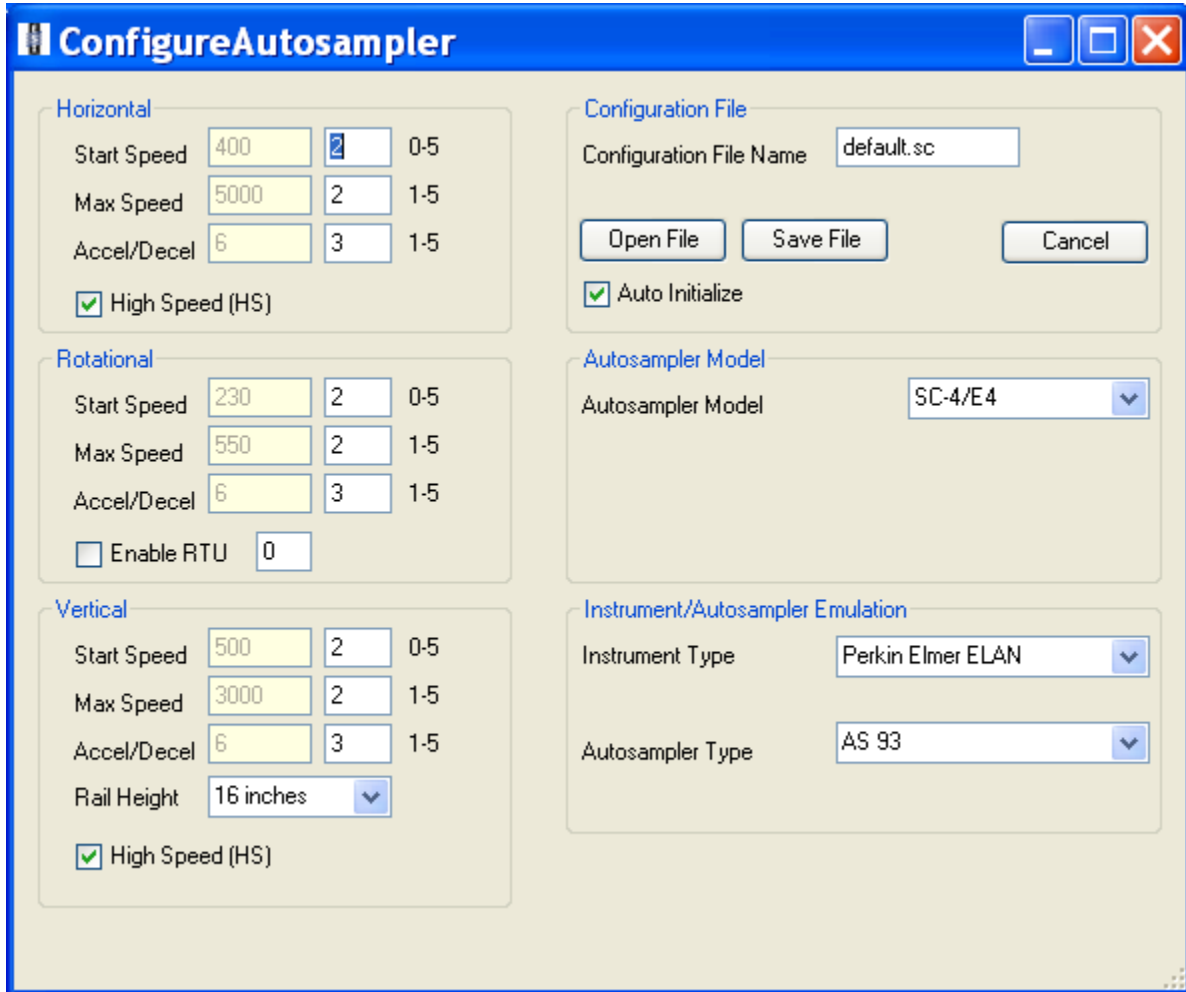
A rinse time of 0 causes the probe to only dip into the station, but spends no time there.

Additional flush times can be optimized to keep the rinse station full while not using too much rinse solution. The inner diameter size of the tubing providing the rinse solution to the rinse station determines how quickly the station will fill. Various sizes are available for purchase or can be made in the laboratory.

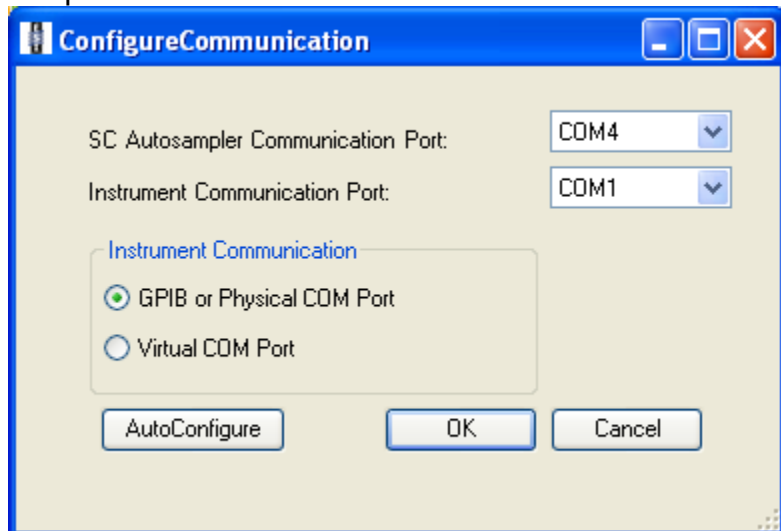


Appendix B (continued).

Figure 2b. ESI SC4 Autosampler Screen Shots (“Configure” page). “High Speed” option is to only be used for ‘High Speed’ models of the SC4 (look for “HS” in serial number). Speeds and accel / decel values can be optimized per analyst preference and to minimize droplet splatter off of probe.



**Figure 2c . ESI SC4 Autosampler Screen Shots (“Communication” page).**  
Communication ports will differ depending on available ports on instrument control computer.



Appendix B (continued).

Figure 2d . ESI SC4 Autosampler Screen Shots (“FAST” page). Timer A can be optimized to achieve proper filling of loop with diluted sample digestate. Timers B, C, D, E, and F control rinsing the loop after analysis and can be optimized for eliminating carry-over from one sample to the next while using the minimum amount of rinse solution. File should be saved with the name “Blood Clotted PbCdHgSe\_ITB004A\_2008-March-1\_SCFAST.txt”. It can be found in the directory C:\Program Files\ESI\ESI-SC\.

Manually clicking the “Load” button prior to starting analysis will ensure the position of the actuator is always the same at the beginning of the analysis.

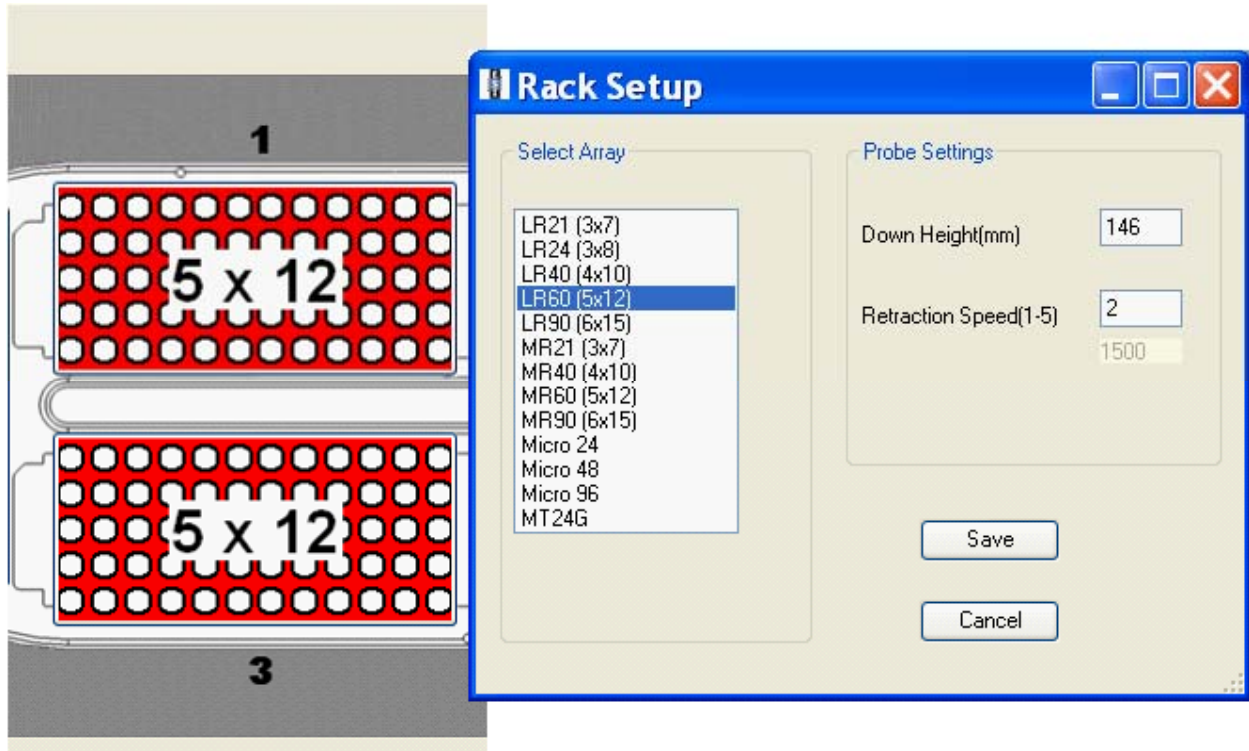
Manually clicking the “Vacuum On” button prior to starting the analysis will help initial sample uptake to be consistent (the vacuum pump may be slow to start for the first sample if this is not done, possibly resulting in loop filling inconsistencies).

Event	Action	Parameters	Parameter Units	Event Parameter
On Probe Down	Vacuum On			
On Probe Down	Load			
Probe In Sample	Timer A	6	seconds	
Timer A Expires	Inject			
Timer A Expires	Move Rinse			
Rinse Completed	Probe Up			
On Rinse	Load			
On Rinse	Probe Down			
On Rinse	Timer B	2	seconds	
Timer B Expires	Probe Up			
Timer B Expires	Timer C	2	seconds	
Timer C Expires	Probe Down			
Timer C Expires	Timer D	2	seconds	
Timer D Expires	Probe Up			
Timer D Expires	Timer E	2	seconds	
Timer E Expires	Probe Down			
Timer E Expires	Timer F	2	seconds	
Timer F Expires	Move Next			

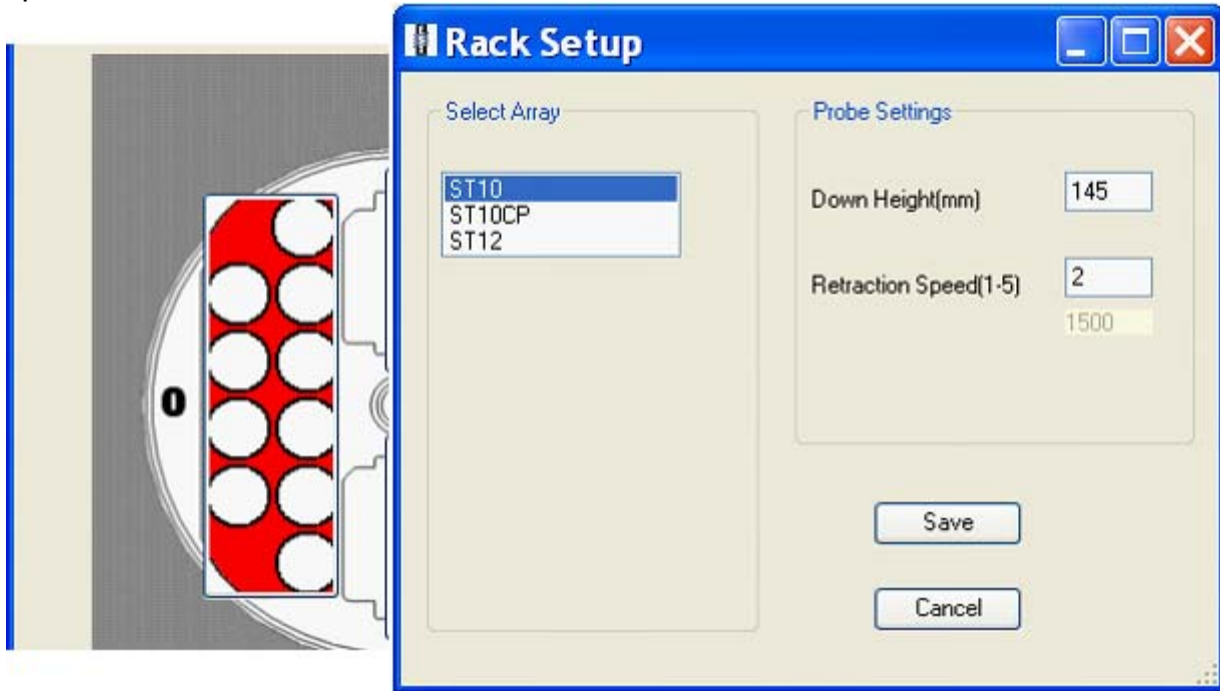
Appendix B (continued).

Figure 2e. ESI SC4 Autosampler Screen Shots (5x12 Rack Setup window).

Settings are approximate. To be sure the loop is filled, the probe should go down close to the bottom of the cup, but not touch. Optimize retraction speed for least droplet splatter.

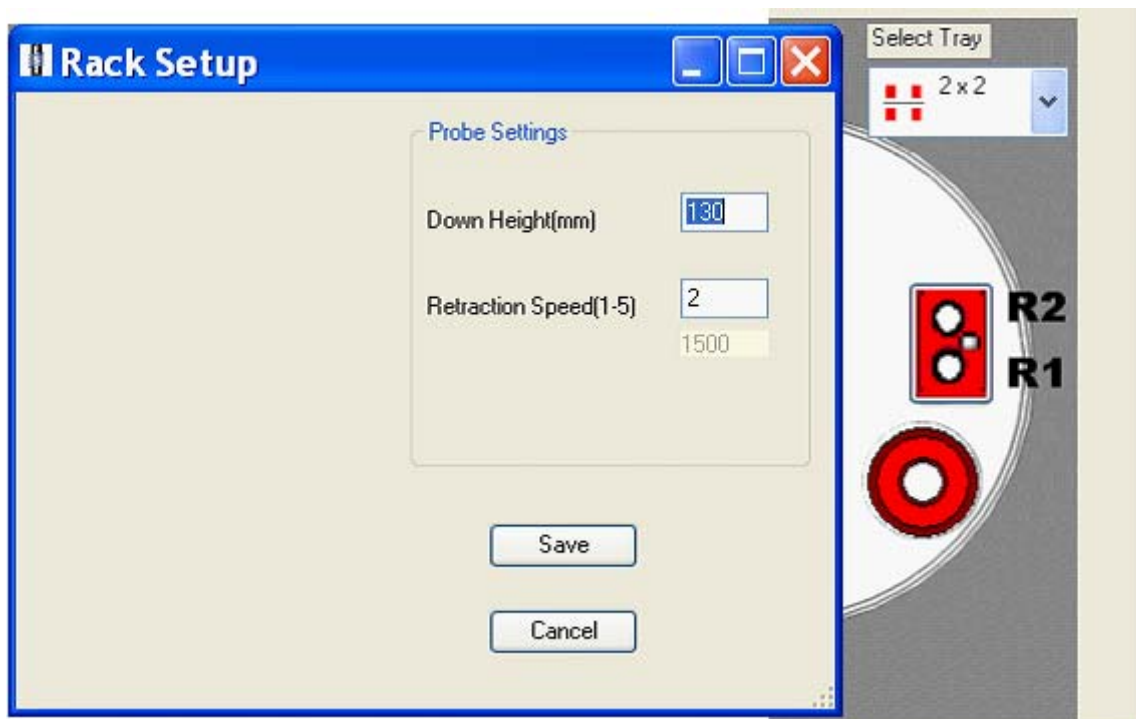


**Figure 2f. ESI SC4 Autosampler Screen Shots (50mL Tube Rack Setup window).** Settings are approximate. To be sure the loop is filled, the probe should go down close to the bottom of the cup, but not touch. Optimize retraction speed for least droplet splatter.



Appendix B (continued).

Figure 2g. ESI SC4 Autosampler Screen Shots (Rinse Station Rack Setup Window). Settings are approximate. Optimize down height for best probe cleaning, and retraction speed for least droplet splatter.





## References

1. Pirkle, J.L., et al., *National exposure measurements for decisions to protect public health from environmental exposures*. International Journal of Hygiene and Environmental Health, 2005. **208**(1-2): p. 1-5.
2. Agency for Toxic Substances and Disease Registry (ATSDR). 1999. Toxicological profile for Mercury. Atlanta, G.U.S.D.o.H.a.H.S., Public Health Service.
3. Mahaffey, K.R. *NHANES 1999 - 2002 Update on Mercury*. in *Northeast Regional Mercury Conference*. 2005.
4. Sieler, H.G., ed. *Handbook of Toxicity of Inorganic Compounds*. 1988, Marcel Dekker, INC.
5. World Health Organization, *Environmental Health Criteria 118: Inorganic Mercury*1991, Geneva.
6. Centers for Disease Control and Prevention, P.L.P.i.Y.C.A.C., *Preventing Lead Poisoning in Young Children*.
7. Sigel, H. and A. Sigel, *Handbook of Toxicity of Inorganic Compounds*, H.G. Sieler, Editor 1988, Marcel Dekker, INC.
8. Batley, G.E., *Handbook of Trace Element Speciation: Analytical Methods*1991, Boca Raton: CDC Press.
9. Agency for Toxic Substances and Disease Registry (ATSDR). 2007. Toxicological profile for Lead. Atlanta, G.U.S.D.o.H.a.H.S., Public Health Service., *Toxicological Profile for Lead*.
10. World Health Organization, *Environmental Health Criteria 134: Cadmium*1992.
11. Elinder, C.G., International Journal of Environmental Studies, 1982. **19**(3-4): p. 187-193.
12. Ghezzi, I., et al., *BEHAVIOR OF BIOLOGICAL INDICATORS OF CADMIUM IN RELATION TO OCCUPATIONAL EXPOSURE*. International archives of occupational and environmental health, 1985. **55**(2): p. 133-140.
13. Jarup, L., C. Elinder, and G. Spang, *CUMULATIVE BLOOD-CADMIUM AND TUBULAR PROTEINURIA - A DOSE-RESPONSE RELATIONSHIP*. International archives of occupational and environmental health, 1988. **60**(3): p. 223-229.
14. Lauwerys, R., et al., *CADMIUM - EXPOSURE MARKERS AS PREDICTORS OF NEPHROTOXIC EFFECTS*. Clinical Chemistry, 1994. **40**(7B): p. 1391-1394.
15. Roels, H., et al., *HEALTH SIGNIFICANCE OF CADMIUM INDUCED RENAL DYSFUNCTION - A 5 YEAR FOLLOW UP*. British journal of industrial medicine, 1989. **46**(11): p. 755-764.
16. Bernard, A. and R. Lauwerys, *Cadmium in human population*. Experientia. Supplementum, 1986. **50**: p. 114-23.
17. Milne, D.B., *Trace Elements*, in *Tietz textbook of clinical chemistry*, C.A. Burtis, Ashwood, Edward R., Editor 1999, W. B. Saunders Company: Philadelphia. p. 1029-1055.
18. Chiswell, B. and D. Johnson, *Manganese*, in *handbook on Metals in Clinical and Analytical Chemistry*, A.S. Hans G. Seiler, Helmut Sigel, Editor 1994, Marcel Dekker: New York. p. 467-478.

19. Smargiassi, A., et al., *Peripheral Markers of Catecholamine Metabolism among Workers Occupationally Exposed to Manganese (Mn)*. Toxicology Letters, 1995. **77**(1-3): p. 329-333.
20. Roels, H.A., et al., *Assessment of the Permissible Exposure Level to Manganese in Workers Exposed to Manganese-Dioxide Dust*. British Journal of Industrial Medicine, 1992. **49**(1): p. 25-34.
21. Cowan, D.M., et al., *Manganese exposure among smelting workers: blood manganese-iron ratio as a novel tool for manganese exposure assessment*. Biomarkers, 2009. **14**(1): p. 3-16.
22. Gennart, J.P., et al., *Fertility of Male Workers Exposed to Cadmium, Lead, or Manganese*. American Journal of Epidemiology, 1992. **135**(11): p. 1208-1219.
23. Bader, M., et al., *Biomonitoring of manganese in blood, urine and axillary hair following low-dose exposure during the manufacture of dry cell batteries*. International Archives of Occupational and Environmental Health, 1999. **72**(8): p. 521-527.
24. Lauwerys, R., et al., *Fertility of Male Workers Exposed to Mercury-Vapor or to Manganese Dust - a Questionnaire Study*. American Journal of Industrial Medicine, 1985. **7**(2): p. 171-176.
25. Standridge, J.S., et al., *Effect of Chronic Low Level Manganese Exposure on Postural Balance: A Pilot Study of Residents in Southern Ohio*. Journal of Occupational and Environmental Medicine, 2008. **50**(12): p. 1421-1429.
26. Woolf, A., et al., *A child with chronic manganese exposure from drinking water*. Environmental Health Perspectives, 2002. **110**(6): p. 613-616.
27. Wasserman, G.A., et al., *Water manganese exposure and children's intellectual function in Araihasar, Bangladesh*. Environmental Health Perspectives, 2006. **114**: p. 124-129.
28. Ljung, K.S., et al., *Maternal and Early Life Exposure to Manganese in Rural Bangladesh*. Environmental Science & Technology, 2009. **43**(7): p. 2595-2601.
29. Bazzi, A., J.O. Nriagu, and A.M. Linder, *Determination of toxic and essential elements in children's blood with inductively coupled plasma-mass spectrometry*. Journal of Environmental Monitoring, 2008. **10**(10): p. 1226-1232.
30. Rollin, H.B., et al., *Examining the association between blood manganese and lead levels in schoolchildren in four selected regions of South Africa (vol 103, pg 160, 2007)*. Environmental Research, 2008. **106**(3): p. 426-426.
31. Rollin, H., et al., *Blood manganese concentrations among first-grade schoolchildren in two South African cities*. Environmental Research, 2005. **97**(1): p. 93-99.
32. Aschner, M., *Manganese: Brain transport and emerging research needs*. Environmental Health Perspectives, 2000. **108**: p. 429-432.
33. Yokel, R.A., *Brain uptake, retention, and efflux of aluminum and manganese*. Environmental Health Perspectives, 2002. **110**: p. 699-704.
34. Davis, J.M., *Methylcyclopentadienyl manganese tricarbonyl: Health risk uncertainties and research directions*. Environmental Health Perspectives, 1998. **106**: p. 191-201.
35. Davis, J.M., et al., *The EPA health risk assessment of methylcyclopentadienyl manganese tricarbonyl (MMT)*. Risk Analysis, 1998. **18**(1): p. 57-70.

36. Roels, H., et al., *RELATIONSHIP BETWEEN EXTERNAL AND INTERNAL PARAMETERS OF EXPOSURE TO MANGANESE IN WORKERS FROM A MANGANESE OXIDE AND SALT PRODUCING PLANT*. American journal of industrial medicine, 1987. **11**(3): p. 297-305.
37. Jarvisalo, J., et al., *URINARY AND BLOOD MANGANESE IN OCCUPATIONALLY NONEXPOSED POPULATIONS AND IN MANUAL METAL ARC WELDERS OF MILD-STEEL*. International archives of occupational and environmental health, 1992. **63**(7): p. 495-501.
38. Smyth, L., et al., *Clinical manganism and exposure to manganese in the production and processing of ferromanganese alloy*. Journal of occupational medicine, 1973. **15**(2): p. 101-9.
39. Klaassen, C., *BILIARY-EXCRETION OF MANGANESE IN RATS, RABBITS, AND DOGS*. Toxicology and applied pharmacology, 1974. **29**(3): p. 458-468.
40. Malecki, E., et al., *Biliary manganese excretion in conscious rats is affected by acute and chronic manganese intake but not by dietary fat*. The Journal of nutrition, 1996. **126**(2): p. 489-498.
41. Agency for Toxic Substances and Disease Registry (ATSDR). 2000. Toxicological profile for Manganese. Atlanta, G.U.S.D.o.H.a.H.S., Public Health Service. , *Toxicological Profile for Manganese*, ATSDR, Editor 2000. p. 15.
42. Agency for Toxic Substances and Disease Registry (ATSDR), *Toxicological Profile for Selenium*2003: CDC. 457 p.
43. Goldhaber, S.B., *Trace element risk assessment: essentiality vs. toxicity*. Regulatory Toxicology and Pharmacology., 2003. **38**: p. 232-242.
44. Combs, G.F. and W.P. Gray, *Chemopreventive agents*. Pharmacology and Therapeutics, 1998. **79**: p. 179-192.
45. Arthur, J.R., *The role of selenium in thyroid hormone metabolism*. Can J Physiol Pharmacol, 1991. **69**: p. 1648-1652.
46. Corvilain, B., et al., *Selenium and the thyroid: How the relationship was established*. Am J Clin Nutr, 1993. **57 (2 Suppl)**: p. 244S-248S.
47. Levander, O.A., *Nutrition and newly emerging viral diseases: An overview*. J Nutr, 1997. **127**: p. 948S-950S.
48. McKenzie, R.C., T.S. Rafferty, and G.J. Beckett, *Selenium: an essential element for immune function*. Immunol Today, 1998. **19**: p. 342-345.
49. Ellis, D.R. and D.E. Salt, *Plants, selenium and human health*. Curr Opin Plant Biol, 2003. **6**: p. 273-279.
50. Combs, G.F., *Food system-based approaches to improving micronutrient nutrition: the case for selenium*. Biofactors, 2000. **12**: p. 39-43.
51. Zimmerman, M.B. and J. Kohrle, *The impact of iron and selenium deficiencies on iodine and thyroid metabolism: biochemistry and relevance to public health*. Thyroid, 2002. **12**: p. 867-878.
52. Beck, M.A., O. Levander, and J. Handy, *Selenium deficiency and viral infection*. Journal of Nutrition, 2003. **133**: p. 1463S-1467S.
53. Agency for Toxic Substances and Disease Registry (ATSDR). 2003. Toxicological profile for Selenium. Atlanta, G.U.S.D.o.H.a.H.S., Public Health Service., *Toxicological profile for Selenium*.

54. Lutz, T.M.N., P.M.V.; and Schmidt, B. , *Whole Blood Analysis by ICP-MS*, in *Applications of Plasma Source Mass Spectrometry* 1991, Royal Society of Chemistry. p. 96-100.
55. Tanner, S.D., Baranov, Vladimir I, *Theory, Design, and Operation of a Dynamic Reaction Cell for ICP-MS*. Atomic Spectroscopy, 1999. **20**(2): p. 45-52.
56. Tanner, S.D., V.I. Baranov, and D.R. Bandura, *Reaction cells and collision cells for ICP-MS: a tutorial review*. Spectrochimica Acta Part B-Atomic Spectroscopy, 2002. **57**(9): p. 1361-1452.
57. Tanner, S.D. and V.I. Baranov, *Theory, design, and operation of a dynamic reaction cell for ICP-MS*. Atomic Spectroscopy, 1999. **20**(2): p. 45-52.
58. Office of Health and Safety in the Division of Laboratory Sciences, *Policies and Procedures Manual*, 2002, Division of Laboratory Sciences (DLS), National Center for Environmental Health, Centers for Disease Control and Prevention, Public Health Service, Department of Health and Human Services Centers for Disease Control and Prevention, .
59. Heitland, P. and H.D. Koster, *Biomonitoring of 37 trace elements in blood samples from inhabitants of northern Germany by ICP-MS*. Journal of Trace Elements in Medicine and Biology, 2006. **20**(4): p. 253-262.
60. Carson, B.L., H.V.E. III, and J.L. McCann, *Selenium*, in *Toxicology and biological monitoring of metals in humans.*, B.L. Carson, H.V.E. III, and J.L. McCann, Editors. 1986, Lewis Publishers, Inc.: Chelsea, Michigan. p. 213-218.
61. Fell, J.M.E., et al., *Manganese toxicity in children receiving long-term parenteral nutrition*. Lancet, 1996. **347**(9010): p. 1218-1221.
62. Henn, B.C., et al., *Early Postnatal Blood Manganese Levels and Children's Neurodevelopment*. Epidemiology, 2010. **21**(4): p. 433-439.
63. Ikeda, M., et al., *Cadmium, chromium, lead, manganese and nickel concentrations in blood of women in non-polluted areas in Japan, as determined by inductively coupled plasma-sector field-mass spectrometry*. International Archives of Occupational and Environmental Health, 2011. **84**(2): p. 139-150.
64. Centers for Disease Control and Prevention, *Third National Report on Human Exposure to Environmental Chemicals*, <http://www.cdc.gov/exposurereport>, 2005.

# Division of Laboratory Sciences Laboratory Protocol

<b>Analyte:</b>	Inorganic Hg, methyl Hg, ethyl Hg
<b>Matrix:</b>	Blood
<b>Method:</b>	Blood mercury speciation performed by SSID-GC-ICP-DRC-MS (Species-Specific Isotope Dilution Gas Chromatography Inductively Coupled Plasma Dynamic Reaction Cell Mass Spectrometry)
<b>Method Code:</b>	DLS-3020
<b>Branch:</b>	Inorganic and Radiation Analytical Toxicology

Prepared By: \_\_\_\_\_  
Printed Name Signature Date

Supervisor: \_\_\_\_\_  
Printed Name Signature Date

Branch Chief: \_\_\_\_\_  
Printed Name Signature Date

Adopted: \_\_\_\_\_  
Date

Updated: \_\_\_\_\_  
Date

### Director's Signature Block:

Reviewed: \_\_\_\_\_  
Signature Date

Reviewed: \_\_\_\_\_  
Signature Date

Reviewed: \_\_\_\_\_  
Signature Date

Reviewed: \_\_\_\_\_  
Signature Date

This page is intentionally left blank.

Modifications/Changes:  
see Procedure Change Log STARLIMS

This page is intentionally left blank.





---

# Laboratory Procedure Manual

*Analyte:* Inorganic mercury, Methyl mercury, Ethyl mercury

*Matrix:* Blood

*Method:* Blood mercury speciation SSID-GC-ICP-DRC-MS  
(Species-Specific Isotope Dilution Gas  
Chromatography- Inductively Coupled Plasma  
Dynamic Reaction Cell Mass Spectrometry)

*Method No:* DLS-3020

*Adopted:*

*Revised:*

*As performed by:* Inorganic and Radiation Analytical Toxicology Branch  
Division of Laboratory Sciences  
National Center for Environmental Health

*Contact:* Dr. Robert L. Jones  
Phone: 770-488-7991  
Fax: 770-488-4097  
Email: [RLJones@cdc.gov](mailto:RLJones@cdc.gov)

James L. Pirkle, M.D., Ph.D.  
Director, Division of Laboratory Sciences

### ***Important Information for Users***

*CDC periodically refines these laboratory methods. It is the responsibility of the user to contact the person listed on the title page of each write-up before using the analytical method to find out whether any changes have been made and what revisions, if any, have been incorporated.*

This page is intentionally left blank.

## Table of Contents

<b>I. Clinical Relevance and Test Principle</b>	<b>7</b>
A. Clinical Relevance	7
B. Test Principle	7
<b>II. Safety Precautions</b>	<b>8</b>
<b>III. Data System Management</b>	<b>9</b>
A. Data Entry and Transfer	9
B. Routine Computer Hard Drive Maintenance	9
C. Electronic Data Backup	9
1. Schedule of Data Backups	9
2. Backup Procedures	9
D. Documentation of System Maintenance	10
1. Computer Maintenance:	10
2. Instrument Maintenance:	10
<b>IV. Collecting, Storing, and Handling Specimens; Criteria for Rejecting Specimens</b>	<b>10</b>
A. Specimen Type	10
B. Specimen Collection, Handling and Storage	10
C. Criteria for an Unacceptable Specimen	11
<b>V. Procedures for Microscopic Examinations</b>	<b>11</b>
<b>VI. Chemicals, Standards, and Quality Control Material</b>	<b>11</b>
A. Chemicals	11
B. Isotope Dilution Standards	12
C. Quality Control Material	12
<b>VII. Instrumentation, Equipment, Software and Supplies</b>	<b>12</b>
A. Instrumentation	12
1. Gas Chromatography System	12
2. ICP-DRC-MS System	12
3. Robotic Sample Processing Station	13
4. Equipment	13
5. Computer Software	14
6. Supplies	14
<b>VIII. Standard Procedure</b>	<b>15</b>
A. Preparation of Stock Solutions	15
B. Preparation of Working Spike Solution	16
1. Preparation of Working Triple-Spiked Standards Solution	16
C. Preparation of Quality Control Material	17

1.	Base pool preparation:	17
2.	Low and High pool preparation:	17
D.	Sample preparation	17
	Preparation of blood samples for digestion:	17
2.	Digestion:	17
3.	Derivatization of the digested samples:	17
E.	Requirements for Batch Analysis of Samples and QC Material	17
F.	GC Instrument Program	18
G.	CombiPal Autosampler Program	19
H.	ICP-DRC-MS Instrument Setup	21
1.	Programming the DRC Gas Flow Delay Parameter	21
2.	Programming the ELAN ".mth" file	22
3.	Creating the ELAN Sample Table ".sam" file	24
I.	ICP-DRC-MS Performance Checks	25
	The following performance checks should be recorded in an instruments log book.	25
1.	Daily Performance Check	25
2.	Weekly Performance Check	25
3.	Monthly Performance Check	27
J.	ICP-DRC-MS Warm Up	28
K.	GC-ICP-DRCII-MS System Startup	29
1.	Entering Sample Names into the ELAN Sample Table	29
L.	Starting the Run	30
M.	Instrument Shut Down	32
<b>IX.</b>	<b>Post-Run Data Analysis</b>	<b>32</b>
A.	Configuration of TotalChrom Integration Method	32
B.	Configuration of ELAN ChromLink™	36
C.	Data Processing and Analysis	37
<b>X.</b>	<b>Recording of Sample and QC Data</b>	<b>42</b>
A.	Transferring the Data to the Branch Database	42
B.	QC Data	43
<b>XI.</b>	<b>Final Data Review</b>	<b>43</b>
A.	Analysis Printouts and Analyst Run Report	43
B.	Plotting QC Results	43
C.	Supervisor Review	43
<b>XII.</b>	<b>Replacement and Periodic Maintenance of Key Components</b>	<b>43</b>
A.	ICP-MS Maintenance	43
B.	GC Maintenance	44
<b>XIII.</b>	<b>Limits of Detection</b>	<b>44</b>

<b>XIV.</b>	<b>Reportable Range of Results</b>	<b>45</b>
<b>XV.</b>	<b>Special Procedure Notes - CDC Modifications</b>	<b>45</b>
<b>XVI.</b>	<b>Quality Control Procedures</b>	<b>45</b>
A.	Establish QC limits for each QC pool.	<del>46</del> <b>45</b>
B.	Precision and Accuracy	46
C.	Remedial Action If Calibration or QC Systems Fail to Meet Acceptable Criteria	46
<b>XVII.</b>	<b>Reference Ranges</b>	<b>46</b>
<b>XVIII.</b>	<b>Action-Level Results</b>	<b>47</b>
<b>XIX.</b>	<b>Specimen Storage and Handling During Testing</b>	<b>47</b>
<b>XX.</b>	<b>Alternate Methods for Performing Test and Storing Specimens If Test System Fails</b>	<b>47</b>
<b>XXI.</b>	<b>Test-Result Reporting System; Protocol for Reporting Critical Calls (If Applicable)</b>	<b>47</b>
<b>XXII.</b>	<b>Transfer or Referral of Specimens; Procedures for Specimen Accountability and Tracking</b>	<b>48</b>
<b>XXIII.</b>	<b>References</b>	<b>48</b>
<b>XXIV.</b>	<b>Appendix</b>	<b>48</b>
A.	Appendix A. Critical Parameters Testing Results.	48
1.	Critical Parameter Test #1: Evaluate the significance of the GC injector temperature	48
2.	Critical Parameter Test #2: Evaluate the significance of the Combipal-agitator equilibration/extraction temperature	49
3.	Critical Parameter Test #3: Evaluate the significance of the length of extraction of sample from SPME fiber in GC injector	49
4.	Critical Parameter Test #4: Evaluate the significance of changing GC split ratio.	50
5.	Critical Parameter Test #5: Evaluate the significance of changing GC carrier gas flow rate.	51

## List of Tables

TABLE 8-1: Dilutions Factors for Preparing Working Triple-Spike Standards _____	<u>1716</u>
TABLE 8-2: GC Settings _____	<u>1918</u>
TABLE 8-3: CombiPAL Autosampler Settings _____	<u>2019</u>
TABLE 8-4: Chronos Settings (Baking) _____	<u>20</u>
TABLE 8-5: Chronos Settings (Conditioning) _____	<u>2120</u>
TABLE 8-6: Chronos Parameter Settings (for Run) _____	<u>2120</u>
TABLE 8-7 ELAN Timing Parameters _____	<u>2221</u>
TABLE 8-8: ELAN Analyte Parameters _____	<u>2322</u>
TABLE 8-9: ELAN Processing Parameters _____	<u>2322</u>
TABLE 8-10: ELAN Sampling Parameters _____	<u>2322</u>
TABLE 8-11: ELAN Report Parameters _____	<u>2423</u>
TABLE 8-12: Sample Template Data _____	<u>2524</u>
TABLE 8-13: ELAN Optimization Parameters _____	<u>2726</u>
TABLE 8-14: ELAN Samples Table _____	<u>2928</u>
TABLE 8-15 Chronos Samples Table _____	<u>3130</u>
TABLE 9-1: Integration _____	<u>3332</u>
TABLE 9-2: Baseline Timed Events _____	<u>3433</u>
TABLE 9-3: Replot _____	<u>3433</u>
TABLE 9-4: Global Information _____	<u>3534</u>
TABLE 9-5: Method Editor - Components Settings _____	<u>3534</u>
TABLE 9-6: Components Defaults - Identification _____	<u>3635</u>
TABLE 9-7: Components Defaults - Calibration _____	<u>3635</u>
TABLE 9-8: TotalChrom™ Navigator - Reprocess Batch _____	<u>4140</u>
TABLE 17-1: Reference ranges for Mercury Species _____	<u>4746</u>

## I. CLINICAL RELEVANCE AND TEST PRINCIPLE

### A. Clinical Relevance

Mercury (Hg) is widespread in the environment and found in its elemental form ( $\text{Hg}^0$ ), inorganic forms such as mercurous ( $\text{Hg}^+$ ), and mercuric ( $\text{Hg}^{2+}$ ) and various organic forms such as methyl mercury (MeHg), ethyl mercury (EtHg), phenyl mercury (PhHg), and others. The health effects of mercury are diverse and depend on the form of mercury encountered and the severity and length of exposure. The relative order of increasing toxicity is:  $\text{Hg}^0 < \text{Hg}^{2+} \ll \text{CH}_3\text{Hg}^+$  [1]. With large acute exposures to elemental mercury vapor, the lungs may be injured. At levels below those that can cause lung injury, low-dose or chronic inhalation may affect the nervous system. Symptoms include weakness, fatigue, loss of weight (with anorexia), gastrointestinal disturbances, salivation, tremors, and behavioral and personality changes, including depression and emotional instability [2]. Exposure to inorganic mercury usually occurs by ingestion. The most significant effect is on the kidneys, where mercury accumulates, leading to tubular necrosis. In addition, there may be an irritant or corrosive effect on the gastrointestinal tract involving stomatitis, ulceration, diarrhea, vomiting, and bleeding. Psychomotor and neuromuscular effects also may occur [3].

Methyl mercury is more toxic than inorganic mercury. The effects of methyl mercury include changes in vision, sensory disturbances in the arms and legs, cognitive disturbances, dermatitis, and muscle wasting. The critical organ for methyl mercury is the brain. Methyl mercury readily crosses the blood-brain barrier due to its lipid solubility and accumulates in the brain where it is slowly converted to inorganic mercury. Whether CNS damage is due to methyl mercury or inorganic mercury, or both, is still controversial [4]. Ethyl mercury is another organic form of mercury. Very little is actually known about ethyl mercury metabolism in humans, including whether it has the same potency as a neurotoxin, whether the blood concentration is ever significant, and even whether it crosses the blood-brain barrier. But the use of thimerosal, which metabolizes to ethyl mercury and thiosalicylate, as a vaccine preservative makes this subject very important. In the general population, total blood mercury is due mostly to the dietary intake of organic forms, particularly methyl mercury and ranges from 0.2 to  $5.8\mu\text{g/L}$  [5]. Urinary mercury mainly comprises inorganic mercury due generally to dental amalgam containing elemental mercury and occupational exposure and ranges from 0.2 to  $10\mu\text{g/L}$  [5].

The method described in this manual assesses mercury exposure, as defined by exposure to individual mercury species, by analyzing blood through the use of Solid Phase Micro Extraction (SPME) fiber for delivering sample to gas chromatography (GC) coupled to inductively coupled plasma-dynamic reaction cell-mass spectrometry (ICP-DRC-MS). Blood is chosen as a matrix because it might contain various organic mercury species as well as inorganic mercury while urine contains mostly inorganic mercury. This hyphenated method will provide accurate quantification of three mercury blood species: inorganic mercury ( $\text{Hg}^{2+}$ ), methyl mercury (MeHg), and ethyl mercury (EtHg).

Species Name	Abbreviation	Molecular Structure
Inorganic mercury	InHg	$\text{Hg}^{2+}$
Methyl mercury	MeHg	$\text{CH}_3\text{Hg}^+$
Ethyl mercury	EtHg	$\text{C}_2\text{H}_5\text{Hg}^+$

### B. Test Principle

The quantification of InHg, MeHg, and EtHg is determined by using species-specific isotope dilution (SSID) method employing gas chromatography (GC) to separate the species followed by introduction into an ICP-DRC-MS for detection. SSID is a specialized extension of the Isotope Dilution (ID) technique. SSID measures individual chemical species (inorganic, methyl and ethyl mercury species) in samples using ID principles. The blood sample is spiked with known amounts of each Hg species that have been enriched with isotopic variants of the target element of interest.

The first step of this method involves the addition ("spiking") of enriched isotopes ( $^{199}\text{Hg}^{2+}$ ,  $\text{CH}_3^{200}\text{Hg}^+$ , and  $\text{C}_2\text{H}_5^{200}\text{Hg}^+$ ) to the blood sample. Each Hg species spike is labeled with an enriched Hg isotope such that its isotopic pattern is unique to the species' chemical identity, i.e., the manner of isotope spiking is "species specific". Next, the spiked sample is digested in tetramethylammonium hydroxide (TMAH) which disassociates bound mercury species from proteins, polypeptides and other biomolecules. The digested blood sample with freed mercury species is chemically reacted ("derivatized") with a reagent\* that adds 3-carbon chains (n-propyl groups) to the mercury atom of each species molecule without compromising species identity. This type of chemical derivatization results in loss of ionic charge and reduced polarity; the net effect is to make each mercury species molecule volatile so it can escape the liquid phase and accumulate in the gas phase ("headspace") directly above the sample. Derivatization is performed inside a partially filled vial sealed with a rubber septa cap that can be penetrated by a needle.

Solid Phase Microextraction (SPME) is a sampling technique that uses a thin polymer fiber with a hydrophobic coating; the method described here uses a SPME fiber with a 100  $\mu\text{m}$  coating of polydimethylsiloxane (PDMS). The SPME assembly consists of the fiber inserted through the inside a 22 gauge stainless steel needle. A key design feature is the fiber can be mechanically withdrawn into the needle during vial septum penetration and then pushed out to expose the fiber to the headspace. During headspace exposure (the "extraction" step), the gaseous derivatized Hg species adsorb onto the PDMS coating of the SPME fiber; when other factors held are constant, the adsorbed mass increases as a function of sample concentration. After a predetermined time, the SPME fiber is retracted into the injection needle; the needle is withdrawn from sample vial; it moves to the injector port of the programmable temperature gradient gas chromatograph (GC) and, on programmatic command, performs a programmed temperature ramp injection sequence. This action transfers the propylated inorganic, methyl and ethyl Hg species to the head of a 30 m capillary GC column which, using He as the carrier gas, ramps the column temperature to 280  $^{\circ}\text{C}$ . The order of chromatographic separation of the Hg species is based on increasing molecular weight: methylpropylmercury (derivatized methyl Hg), ethylpropylmercury (derivatized ethyl Hg), last peak is dipropylmercury (derivatized inorganic Hg). Hg species exiting the GC column are seen as chromatographic peaks detected using an inductively-couple argon plasma (ICP) as the ion source and a quadrupole mass spectrometer (Q-MS) for mass specific quantification. Species identification is based on chromatographic retention time; species specific isotope ratios are calculated from integrated peak areas derived from m/z signals corresponding to  $^{199}\text{Hg}$ ,  $^{200}\text{Hg}$ ,  $^{201}\text{Hg}$  and  $^{202}\text{Hg}$  isotopes. The ICP-MS is equipped with a Dynamic Reaction Cell (DRC(tm)) for minimizing polyatomic interferences. Operating the ICP-MS in DRC mode has an added benefit of enhancing Hg signal strength through an effect known as "collisional focusing" [6,7].

## II. SAFETY PRECAUTIONS

---

### Important

**Precautionary information that is important to protecting personnel and safeguarding equipment will be presented inside a box, like this one, throughout the procedure where appropriate.**

Follow universal precautions when handling blood samples. Wear gloves, a lab coat, and safety glasses while handling human blood, plasma, serum, urine, or other bodily fluid or tissue. Place disposable plastic, glass, and paper (e.g., pipette tips, autosampler tubes, and gloves) that come in contact with human biological fluids, such as blood, in a biohazard autoclave bag. Keep these bags in appropriate containers until they are sealed and autoclaved. When work is finished, wipe down all work surfaces where human biological fluid was handled with a 10% (v/v) sodium hypochlorite solution (or equivalent). Dispose of all biological samples and diluted specimens in a biohazard autoclave bag at the end of the analysis according to CDC/DLS guidelines for disposal of hazardous waste.

PerkinElmer provides safety information that should be read before operating the instrument. This information is found in the PerkinElmer ELAN® 6100 ICP-DRC-MS System Safety Manual. Possible hazards include ultraviolet radiation, high voltages, radio-frequency radiation, and high temperatures.



**Caution!**

Exercise caution when handling and dispensing concentrated nitric and hydrochloric acid. Always remember to add acid to water. Nitric and hydrochloric acid are caustic chemicals that are capable of severe eye and skin damage. Wear powder-free gloves, a lab coat, and safety glasses. If nitric or hydrochloric acid comes in contact with any part of the body, quickly wash the exposed area with copious quantities of water for at least 15 minutes.

**III. DATA SYSTEM MANAGEMENT**

---

To maintain the integrity of specimen and analytical data generated by this method, eliminate hand entry of specimen identifiers or analytical results whenever possible, proofread all transcribed data, and regularly defragment and back up the ICP-MS computer's hard drive.

**A. Data Entry and Transfer**

Whenever possible, use bar code scanners to enter sample identifiers into the GC-ICP-DRC-MS computer software to avoid errors associated with the keyboard-entry process and to speed up sample processing. When bar code scanners cannot be used, proofread transcribed data after entry. Handle or transfer data electronically when reporting or moving data to other computerized data-handling software. In the Inorganic and Radiation Analytical Toxicology Branch sample analysis results generated by this method are stored for long periods in Microsoft Access™ or MS SQL Server (Frontends) database software. The results should include at least the analysis date, analytical run number, quality-control (QC) results for the run, results of specimen analysis by specimen identification (ID), and method identifier.

**B. Routine Computer Hard Drive Maintenance**

Defragment the computer hard drive regularly by using software such as Microsoft Windows® Disk Defragmenter (located in Start > Programs > Accessories > System Tools) or an equivalent defragmentation program to maximize computer performance and maintain data integrity for files on the hard drive. An entry will automatically be made in the Windows™ system event log when this process is done and will provide documentation of this step.

**C. Electronic Data Backup****1. Schedule of Data Backups**

- Weekly: Full data backups onto one or more recordable compact discs (CD-R) or digital video discs (DVD).
- Daily: Full data backups onto an secondary hard drive.

**2. Backup Procedures**

Whenever making a backup (daily or weekly) include the directories and subdirectories :

- C:\elandata (include all subdirectories)
- C:\gc (must include subdirectories "data" and "methods", also include other relevant directories)

Before making weekly backups, saving a copy of the Windows™ event log in the active "elandata" directory will ensure archiving of all recent software system events (including

communications between ICP-DRC-MS and ELAN software, as well as times of hard drive defragmentation, and other Windows™ system events).

**b) Secondary Hard Disk Backups**

- If available, use the computer's secondary hard disk to store backup files.
- Configure Microsoft Windows® Backup™ (Start > Programs > Accessories > System Tools) program to do a daily backup of the computer's data directories (see Backup Procedures)

**c) Compact Disc (CD) Backups**

- Use the CD writing program installed on the computer to create CD backups (e.g., "Easy CD Creator"™ by Adaptec, or equivalent software). Select the option that "closes" the CD at the end of the writing session so the CD cannot be accidentally over-written.
- Use CD-R disks only (recordable compact disks), not CD-RW disks (rewritable compact disks).

**d) Backup of Sensitive Data**

- Make a backup for sensitive data on duplicate, recordable compact disk. Store the two CD-R disks in two different buildings.

## **D. Documentation of System Maintenance**

- 1. Computer Maintenance:** Record any maintenance of computer hardware, GC or ICP-DRC-MS software in the instrument logbook. Place other electronic records relating to integrity of the data and hard drive in the Windows™ event log. Back up the event log on a regular basis by saving a copy in the active "elandata" directory. The event log will then be backed up along with the ELAN data when backup CD-R disks and tapes are made.
- 2. Instrument Maintenance:** Document system maintenance in hard copies of data records (i.e., daily maintenance checklists, PerkinElmer service records, and instrument log book) as well as in electronic records relating to instrument optimization (default.dac) and tuning (default.tun).

## **IV. COLLECTING, STORING, AND HANDLING SPECIMENS; CRITERIA FOR REJECTING SPECIMENS**

---

### **A. Specimen Type**

Specimen type is whole blood. No special instructions for fasting or special diets are required of patient or study subjects.

### **B. Specimen Collection, Handling and Storage**

- 1) The preferred volume of blood specimen is  $\geq 0.5$  mL; the minimum volume is 0.25 mL.
- 2) Acceptable containers for specimen acquisition include pre-screened polyethylene vials and pre-screened blood collection tubes.
- 3) Samples should be stored in the dark at  $-20^{\circ}\text{C}$  or lower temperature. Long term storage at  $-70^{\circ}\text{C}$  or less is preferred.
- 4) Specimen handling conditions are outlined in the Division protocol for blood collection and handling (copies available in Branch, laboratory and Special Activities specimen handling

offices). Collection, transport, and special requirements are discussed. If more than one blood collection tube is used to draw blood from a subject, the blood tube for trace metals tube should be drawn last. Draw the blood through a stainless steel needle into a pre-screened blood collection tube. Blood specimens should be transported and stored at  $\leq 4^{\circ}\text{C}$ . Once received, they can be frozen at  $\leq -20^{\circ}\text{C}$  until time for analysis. Portions of the sample that remain after analytical aliquots are withdrawn can be refrozen at  $\leq -20^{\circ}\text{C}$ . Thawing and refreezing of samples before analysis is discouraged.

### C. Criteria for an Unacceptable Specimen

The criteria for an unacceptable specimen are either a low volume ( $< 0.25\text{ mL}$ ) or suspected contamination due to improper collection procedures or collection devices. Specimen contact with dust or dirt may compromise test results. In all cases, request a second blood specimen.

## V. PROCEDURES FOR MICROSCOPIC EXAMINATIONS

---

Not applicable for this procedure.

## VI. CHEMICALS, STANDARDS, AND QUALITY CONTROL MATERIAL

---

### A. Chemicals

- 1) Deionized (DI) water,  $\geq 18\text{ M}\Omega\text{ cm}$  resistivity.
- 2) Sodium acetate anhydrous, (CAS# 127-09-3), ( $\text{C}_2\text{H}_3\text{NaO}_2$ -MW 82.04), (Sigma-Aldrich, Milwaukee, WI) or equivalent vendor.
- 3) Glacial acetic acid, (CAS# 64-19-7), ( $\text{CH}_3\text{COOH}$ -MW 60.05), reagent ACS grade (GFS Chemicals, Powell, OH) or equivalent vendor.
- 4) Double-distilled Hydrochloric Acid, (CAS# 7647-01-0), ( $\text{HCl}$ -MW 36.461-37.0%-12.1M) (GFS Chemicals Inc., Columbus, OH) or equivalent vendor.
- 5) Double-distilled Nitric Acid (CAS# 7697-37-2), ( $\text{HNO}_3$ -MW 63.013-70.0%-15.8M) (GFS Chemicals Inc., Columbus, OH) or equivalent vendor
- 6) Tetramethylammonium hydroxide, 25% w/w in methanol (CAS# 75-59-2), ( $\text{C}_4\text{H}_{13}\text{NO}$ -MW 91.15), (Alfa Aesar, Ward Hill, MA) or equivalent vendor.
- 7) Sodium tetra(n-propyl)borate, (CAS# 45067-99-0), ( $\text{NaPr}_4\text{B}$  -MW 206.16), (ABCR, Germany) or equivalent vendor.
- 8) Bleach (10% sodium hypochlorite solution) from any vendor.
- 9) [Base whole blood, donated or purchased.](#)
- 10) [Inorganic mercury, 1000 mg/L in 10% nitric acid \(SPEX, CertiPrep\) or equivalent.](#)
- 11) [Methyl mercury chloride, standard solution 1000 mg/L \(AlfaAesar\) or equivalent.](#)
- 12) [Ethyl mercury chloride, powder \(AlfaAesar\) or equivalent](#)

## B. Isotope Dilution Standards

- 1) <sup>199</sup>Hg-Isotopically-Enriched Inorganic Mercury (<sup>199</sup>HgCl<sub>2</sub>), (Applied Isotope Technologies, Inc. - Sunnyvale, CA) P/N 30530 or equivalent.
- 2) <sup>200</sup>Hg-Isotopically-Enriched Methylmercury (CH<sub>3</sub><sup>200</sup>HgCl), (Applied Isotope Technologies, Inc. - Sunnyvale, CA) P/N 30521 or equivalent.
- 3) <sup>201</sup>Hg-Isotopically-Enriched Ethylmercury (CH<sub>3</sub>CH<sub>2</sub>HgCl), (Applied Isotope Technologies, Inc. - Sunnyvale, CA) P/N 35025 or equivalent.

## C. Quality Control Material

Quality control (QC) materials are made from pools of whole blood obtained from a donor source or purchased from the vendor. See the Preparation of Quality Control Material section for details of preparation. The control "base" blood and two QC blood pools intended for the mercury speciation assay are designated as:

QC level	QC Designation ID
Base pool	BB-yy###
Low pool	LB-yy###
High pool	HB-yy###

Where substitutions are: yy = the last two digits of production year and ### = assigned pool identification number. QC material intended for bench quality control purposes needs to be "characterized" as described in the section Establish QC limits for each QC pool.

# VII. INSTRUMENTATION, EQUIPMENT, SOFTWARE AND SUPPLIES

---

## A. Instrumentation

### 1. Gas Chromatography System

- 1) Gas Chromatograph: Perkin Elmer® Clarus 500, or equivalent system.
- 2) GC capillary column: Perkin Elmer® Elite-5 30m (meter), 0.25mmID, 0.25µm df (Catalog # N9316076, Shelton, CT), or equivalent.
- 3) GC Transfer Line, noncoated capillary column: Perkin Elmer® Fused Silica Tubing 5m, 0.25mmID (Catalog # N9301356, S/N 920620, Shelton, CT), or equivalent.
- 4) GC-ICP-MS Heated Transfer Line accessory: Redshift® (P/N N0777440 for 115V or P/N N40777361 for 230V, Italy), or equivalent.
- 5) Solid Phase Micro Extraction (SPME) Fiber Assembly, specifically, Supelco Analytical 100µm Polydimethylsiloxane (PDMS) Coating (Red - Pack of 3), (Catalog # 57301, Supelco Analytical, Bellefonte, PA), or equivalent.

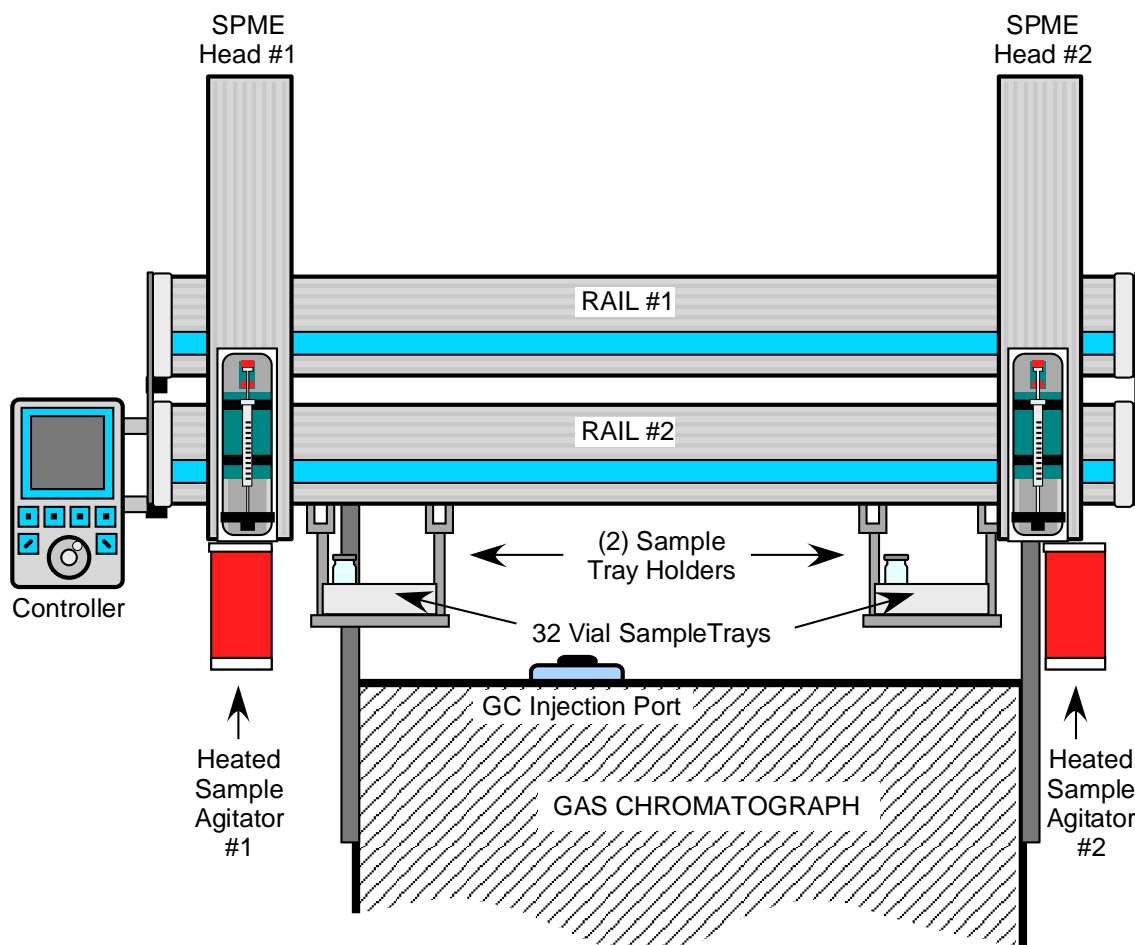
### 2. ICP-DRC-MS System

- 1) Inductively-coupled plasma mass spectrometer, specifically, the ELAN™ DRCII (PerkinElmer Instruments, Shelton CT), or equivalent.
- 2) Platinum (Pt) cones (Catalogue # SC2013-Pt and SC2014-Pt Perkin Elmer Instruments, Shelton, CT) or equivalent.

- 3) Perkin Elmer ICP-MS injector (Perkin Elmer Instruments, Shelton, CT), or equivalent.

### 3. Robotic Sample Processing Station

- 1) Robotic Liquid Sample Processing Workstation: LEAP® Technologies CombiPal® twin head system, or equivalent system (Figure 1).



**Figure 1:** Twin Head SPME Processing Workstation (LEAP Technologies, Inc.)

The Twin Head SPME CombiPAL (LEAP Technology, Inc.) sample processing workstation, mounted on top of the GC, has a unique design: features two (2) computer-controlled SPME fiber injection heads that run on a dual rail system. The two SPME Heads are independently-controlled and perform SPME fiber equilibration/injection operations in tandem. This configuration allows for increased SPME fiber equilibration time up to 20 minutes per SPME head while maintaining a sample-to-sample injection cycle time of 10 minutes. The result is improved SPME efficiency and faster duty rates (6 injections per hour).

### 4. Equipment

- 1) Water purification system for providing ultrapure water with a resistivity  $\geq 18 \text{ M}\Omega \text{ cm}$ .
- 2) High-precision analytical balance capable of accurately weighing milligram amounts of material to the tenth of a milligram or better.
- 3) A pH meter with one hundredth's of a pH unit readout or better, fitted with glass electrode (pH probe). Temperature compensation probe for pH meter.

- 4) Calibrated hand-held adjustable pipettors that cover the range of accurate liquid delivery from 5  $\mu$ L to 5000  $\mu$ L. Research Pro™ Eppendorf® electronic programmable pipettors (distributed by Brinkmann Instruments, Westbury NY) or equivalent.
- 5) Gas regulators for argon, helium and xenon (Airgas, Atlanta, GA) or equivalent.
- 6) Conventional oven (FREAS Model 605, Thermo scientific, Catalog No. 3166188), or equivalent.
- 7) Plastic tent (Captair Pyramid, Erlab, North Andover, MA) or equivalent for preparation of sodium tetra(n-propyl)borate solution.

## 5. Computer Software

- 1) The ELAN Instrument Control version 3.4 with Service Pack 2 (or later version) should be installed on the computer controlling the ELAN DRC II™.
- 2) Chromatography data handling software, specifically, TotalChrom™ Workstation, version 6.3.1 or later (PerkinElmer® Instruments, Shelton CT). Install PerkinElmer's TotalChrom Workstation package on the same computer containing the ELAN Instrument Control software\*. Contact PerkinElmer for installation and configuration of TotalChrom. Or consult the TotalChrom Workstation User's Guide. This method assumes that version 6.3.1 of TotalChrom Workstation package is installed.
- 3) Operating software for CombiPal autosampler, specifically, Chronos (2007-2010 Axel Semrau GmbH & Co KG)
- 4) ChromLink™ 2.1 software (PerkinElmer Instruments). The installation of ChromLink™ is straightforward when using the supplied installation utility.
- 5) pdFactory Pro (FinePrint Software, LLC, [www.fineprint.com](http://www.fineprint.com)) or equivalent software. This product is used for creating electronic Portable Document Files (pdf) directly from any Windows® compatible application print dialog box.
- 6) A custom Microsoft Excel® macro procedure named "Extract TC Data". See Appendix B for description and macro code.

## 6. Supplies

- 1) 200  $\mu$ L pipette tips, 960 tips per case (Eppendorf® catalogue # 2235137-1, distributed by Brinkmann Instruments, Westbury NY), or equivalent.
- 2) 300  $\mu$ L pipette tips, 960 tips per case (Eppendorf® catalogue # 2235144-3, distributed by Brinkmann Instruments, Westbury NY), or equivalent.
- 3) 1000  $\mu$ L pipette tips, 960 tips per case (Eppendorf® catalogue # 2249044-3, distributed by Brinkmann Instruments, Westbury NY), or equivalent.
- 4) 5 mL pipette tips, 500 tips per case (Eppendorf® catalogue # 2235081-1, distributed by Brinkmann Instruments, Westbury NY), or equivalent.
- 5) 50-mL acid-cleaned volumetric flasks for triple spiked solution preparation (polypropylene or Teflon flasks preferred). To acid-wash flasks, rinse with 1.2M hydrochloric acid followed by rigorous rinsing with DI water. Repeat this process several times depending on prior use of the containers.
- 6) 250-mL acid-cleaned volumetric flasks for derivitizing reagent (NaPr4B) preparation (polypropylene or Teflon flasks preferred). To acid-wash flasks, rinse with 1.2M hydrochloric acid followed by rigorous rinsing with DI water. Repeat this process several times depending on prior use of the containers.

- 7) Acid-cleaned 1L PE bottles for buffer solution preparation. To acid-wash flasks, rinse with 1.2M hydrochloric acid followed by rigorous rinsing with DI water. Repeat this process several times depending on prior use of the containers.
- 8) 50 mL polypropylene tubes pre-screened for Hg (Becton Dickinson) or equivalent.
- 9) 15 mL polypropylene tubes pre-screened for Hg (Becton Dickinson) or equivalent.
- 10) 1.5 mL polypropylene (PP) microcentrifuge tubes (Eppendorf® catalogue # 2236380-8, distributed by Brinkmann Instruments, Westbury NY), or equivalent.
- 11) Tube racks for 1.5 mL microcentrifuge tubes (Eppendorf® catalogue # 2236422-7, distributed by Brinkmann Instruments, Westbury NY), or equivalent.
- 12) Six or more PAL Tray20mL (part# 65487454, CTC Analytics, PAL system accessories)
- 13) CombiPal autosampler vials 20 mL, glass, (Microliter Analytical Supplies, Inc. product #16-2000) or equivalent.
- 14) Head space caps for 20mL glass vials (Microliter Analytical Supplies, Inc. product #16-0050M) or equivalent
- 15) Kay-Dry™ paper towels and Kim-Wipe™ tissues (Kimberly-Clark Corp., Roswell GA, or equivalent vendor).
- 16) Teflon™-coated magnetic stir bars (4). (Catalog Number 58948-974 or equivalent), VWR Scientific Products, Buffalo Grove, IL.
- 17) Teflon™-coated magnetic stir bars. (Catalog Number 58947-140 or equivalent, VWR Scientific Products, Buffalo Grove, IL).
- 18) Cotton swabs (Hardwood Products Co. ME, or equivalent vendor).
- 19) Nitrile, powder-free examination gloves (N-Dex®, Best Manufacturing Co., Menlo, GA, or equivalent vendor).
- 20) Biohazard autoclave bags (Curtin-Matheson Scientific, Inc., Florence, KY, or equivalent vendor).

## VIII. STANDARD PROCEDURE

---

### A. Preparation of Stock Solutions

#### a) NaOAc Buffer Solution (0.1 M sodium acetate anhydrous)

- 1) Dissolve 16.41g Sodium acetate anhydrous into approximately 1900 mL of DI water in a 2000 mL polypropylene vessel with a magnetic stir bar on a magnetic stir plate, and mix thoroughly.
- 2) Measure pH and adjust pH to 4.75 with glacial acetic acid. Make final volume adjustment to 2000mL with DI water.

#### b) Sodium tetra(n-propyl)borate (NaPr<sub>4</sub>B, 2% w/v)

- 1) Place one unopened vial containing 5.00 g of sodium tetra(n-propyl)borate, a squirt bottle of DI water, and a clean 50 mL conical centrifuge tube inside a glove box or tent. Fully purge glove box or tent with 100% nitrogen for 5 minutes to remove oxygen.
- 2) Open the vial containing sodium tetra(n-propyl)borate and add 10-20 mL of DI water with constant swirling.

- 3) Pour the dissolved contents into the clean 50 mL conical centrifuge tube. Wash the reagent vial with additional DI water to dissolve remaining solids and quantitatively transfer remaining reagent to the 50 mL tube. Cap the 50mL tube and remove from tent. Once dissolved, the NaPr<sub>4</sub>B solution may now be safely used in normal atmosphere.
- 4) Inside a chemical fume hood, quantitatively transfer reagent solution containing 5.00 g of NaPr<sub>4</sub>B to a 250 mL volumetric flask. Dilute to the final volume with DI water. Makes a 2% (w/v) NaPr<sub>4</sub>B solution. Store at 4 °C.

## B. Preparation of Working Spike Solution

### Caution!

Mercury compounds are toxic! Take extra care to avoid accidental dermal contact, ingestion or inhalation of these materials. Wear appropriate personal protective equipment. Above all, wear a laboratory coat and latex or nitrile gloves. Clean up any spill that might occur according to applicable hazardous material spill procedures.

*Exercise the utmost care in executing all measurements precisely to obtain the best accuracy for the final concentrations. Use only pipettes, disposable tips and volumetric flasks that have been tested for accuracy and will deliver liquid volumes with a precision of ±1% or better.*

#### 1. Preparation of Working Triple-Spiked Standards Solution

On the day samples will be digested, prepare fresh working spike solution. Take out of the 4 °C refrigerator bottles of vendor-supplied standard solutions of the following: In<sup>199</sup>Hg, Me<sup>200</sup>Hg, and Et<sup>201</sup>Hg. Allow bottles to come to room temperature. [The following intermediate and working solutions should be prepared by weighing, thus the final concentrations of "spike" material in working solution should be determined by weight.](#)

##### a) Intermediate standard solution

- 1) Pipette 50 µL of In<sup>199</sup>Hg and Me<sup>200</sup>Hg standards into separately labeled 1.5 mL centrifuge tubes. Add 1200 µL of DI water to each and mix thoroughly.
- 2) Pipette 50 µL of Et<sup>201</sup>Hg standards into a third 1.5 mL centrifuge tube. Add 150 µL of DI water to each and mix thoroughly.

##### b) Working solution (containing mixture of 3 isotope standards):

- 1) Fill the 50 mL volumetric flask approximately half full with DI water.
- 2) Pipette 100 µL of each intermediate standard solution (In<sup>199</sup>Hg, Me<sup>200</sup>Hg, and Et<sup>201</sup>Hg) into the flask. Complete the volume to the 50 mL mark with DI water.
- 3) The concentration of each isotope standard should be within a range of 0.7–1.3 µg Hg/L. Note that units of concentration are expressed in terms of elemental Hg (not molecular mass). Calculate the exact concentration of each isotope standard contained in the Working Triple-Spike Standard Solution by dividing the starting concentrations (indicated by the isotope standard's certificate of analysis) by the dilution factors shown in Table 8-1 ([dilution factors may be adjusted to produce isotope standard concentrations in the range of 0.7–1.3 µg Hg/L](#)). Make appropriate adjustments to the calculations if volumes deviate from the prescribed amounts.



**TABLE 8-1: Dilutions Factors for Preparing Working Triple-Spike Standards**

Mercury Species	Calculation (units = mL)	Dilution Factor
In <sup>199</sup> Hg	$1.2 \div 0.05 \times 50 \div 0.1 =$	12000
Me <sup>200</sup> Hg	$1.2 \div 0.05 \times 50 \div 0.1 =$	12000
Et <sup>201</sup> Hg	$0.15 \div 0.05 \times 50 \div 0.1 =$	1500

### C. Preparation of Quality Control Material

Order bovine blood from a proper vendor and characterize for total Hg (use DLS Method [ITB001A-3001](#) "Whole Blood Hg/Pb/Cd" or an equivalent method).

- 1. Base pool preparation:** Bovine blood with the lowest mercury content should be used. Distribute base blood into pre-labeled 2 ml vials by 1.5 ml aliquots.
- 2. Low and High pool preparation:** Analyze base blood for InHg, MeHg, and EtHg species. On the basis of this calculation, ~~spike add with each specie to the desired~~[appropriate volumes of InHg, MeHg, and EtHg \(not enriched\) species values](#) to obtain "low" and "high" pools. While maintaining constant stirring of each pool, aliquot 0.5 mL of blood into a sufficient number of pre-labeled 2 mL vials to provide QC material for 1000 or more runs. Store aliquoted QC material at a temperature of  $-70^{\circ}\text{C}$  or colder.

### D. Sample preparation

#### Caution!

Work with open vials containing biological samples inside of a biological safety cabinet (BSC). Recap vials before removing them from BSC. Wear appropriate personal protective equipment (lab coat, safety glasses and gloves).

#### Preparation of blood samples for digestion:

- 1) Pipette 100  $\mu\text{L}$  of blood samples into pre-labeled 1.5 mL tubes.
  - 2) Add 100  $\mu\text{L}$  of Triple Spiked Standards Solution. Recap and vortex each tube before continuing to the next tube.
  - 3) Add 500  $\mu\text{L}$  of TMAH to all tubes. Cap and vortex.
- 2. Digestion:**
    - 1) Place rack containing capped tubes in an incubator or oven set to  $80 \pm 3^{\circ}\text{C}$  for  $\geq 20$  hours.
- 3. Derivatization of the digested samples:**
    - 1) Aliquot 200  $\mu\text{L}$  of digested samples into pre-labeled 20 mL SPME vials containing a "mini" stir bar in each vial.
    - 2) Add 7.7 mL of NaOAc Buffer Solution and 250  $\mu\text{L}$  of NaPr<sub>4</sub>B Derivatization Reagent. Cap the vial immediately and mix.

### E. Requirements for Batch Analysis of Samples and QC Material

Process a predetermined set of samples and QC material for batch analysis. One "batch" run is defined as the analysis of a contiguous set of samples (typically 20, may be more) bracketed by "Bench QC" material

at the beginning and end of the set. Each Bench QC level (typically, a "high" and a "low") should be analyzed at the beginning and again at the end of the batch run. QC needs to be treated like the unknown samples, i.e., each QC sample is individually prepared and goes through all the steps as is done for unknown samples. It is not appropriate to report the QC results coming from the split analysis of a single QC sample if it has already been processed (i.e., diluted, centrifuged, filtered, digested, derivatized, etc.). Note that this limitation does not apply to the duplicate use QC material originating from the same original vial as long as they both are processed identically like unknown samples and *on the same day*. It is permissible to "piggyback" two runs in succession that are separated by at least two blanks during a single autosampler load (such as for an overnight analysis), as long as each run of samples is bracketed by their own uniquely co-prepared bench QC material.

- 1) Identify, gather, and thaw a predetermined number of sample tubes/vials containing the blood samples to be analyzed in a batch run.
- 2) For each batch of samples run, thaw one tube of low and high bench QC (often identified as "LB-yyxxx" and "HB-yyxxx"; for explanation of nomenclature, see Quality Control Material section).
- 3) Label the necessary number of 1.5 mL microcentrifuge vials with appropriate identification to ensure that they will be matched to their corresponding unknown samples and QC. Similarly, label an equal number of 20 mL SPME vials.
- 4) Use the TMAH digestion procedure for blood samples and QC material.
- 5) Use the preparation of digested samples for analysis procedure to prepare samples and QC material.
- 6) Cap all autosampler vials with the proper fitting septum caps.

The use of a barcode scanning device to electronically record sample identification from barcodes printed on vial labels should be utilized if available.

## F. GC Instrument Program

- 1) Set the GC analytical run parameters according to Table 8-2. Refer to the Clarus 500 User Guide for programming specifics.
- 2) One or more parameters specified in Table 8-2 may be changed, if determined necessary, to meet analytical performance goals.

**TABLE 8-2: GC Settings**

Parameter	Setting
GC injector Temperature	Step #1: 1 min @ 220 °C Step #2: linear ramp to 280 °C, hold
Carrier gas flow rate (Helium)	2 mL/min
Oven Temperature	Step #1: 1 min @ 75 °C Step #2: linear ramp to 250 °C (at rate = 45 °C/min)
Total flow ratio	28:1 @ 0.25 min
Transfer line Temperature (Aux - auxiliary zone)	250 °C
(Aux - auxiliary pneumatics)	OFF (all)

### G. CombiPal Autosampler Program

- 1) CombiPal is initially set up and optimized by LEAP technology service engineers. The settings can be optimized according to analyst needs (refer to PAL system user manual). The following procedures present the key steps that are taken to set up the CombiPal autosampler system for this method.
  - (a) Using PAL control terminal start at a window displaying "JOB QUEUE". Press the ESCape key to return to the previous menu. Press function key F1 - "MENU". Rotate the outer knob to scroll through items in a menu list. To select a highlighted item press the central knob (ENTER button). Then use the outer knob to scroll through available options for that item or to change a numeric value. Then press the inner knob again to ENTER the displayed option.
  - (b) In the "MENU" window select "Utilities" followed by "Tray" then select "Agitator" and enter parameters in Table 8-3. Then press "ESC" to get back to "Tray" option scroll to the right select "Tray" (this "tray" is an option for first "Tray" selection) - enter parameters
  - (c) In the "Utilities" window select "Injector" and select "GCInj1" - enter parameters. Also in the "Utilities" window select "Vial" and select "Standard" - enter parameters in Table 8-3.

**TABLE 8-3: CombiPAL Autosampler Settings**

Parameter	Setting
<b>Tray (Agitator)</b>	
Needle Penetration	20.0 mm
Tray type	SMMTray
Offset X, Y, Z	0, 0, 55.5 mm
Stand by Temp	OFF
Actual Temp	25.7 °C (changes)
Speed	750 RPM
Agitation Time ON	5s
Agitation Time OFF	2s
<b>Tray (Tray)</b>	
Needle Penetration	12.0 mm
Tray type	VT32-20
Offset X, Y, Z	-55.3, -188.1, -2.0 mm
<b>Injector (GCInj)</b>	
Needle Penetration	35.0 mm
<b>Vial (Standard)</b>	
Needle Penetration	43.0 mm

- 2) CombiPal is operated by Chronos software. Click on Chronos icon on the operating computer desktop - Chronos method files used for this method can be accessed through clicking on "Method Editor" on the Main Menu of Chronos. In the right corner click on tab "Load", which allows to upload needed method file. There are five method files used in this method: SPME bakeout LEFT.cam, SPME bakeout RIGHT.cam, SPME conditioning LEFT.cam, SPME conditioning RIGHT.cam, TWIN SPME\_cdc.cam. (The settings can be changed by the analyst for better separation and analytical response.)
- (a) To clean SPME fibers every day before starting a run - SPME bakeout LEFT.cam and SPME bakeout RIGHT.cam are used. The settings should be as shown in Table 8-4.

**TABLE 8-4: Chronos Settings (Baking)**

Parameter	Setting
Bakeout Time (s)	420
GC Runtime + Cooling Down (s)	120
Needle Penetration Vial (mm)	34
Fiber Exposure (mm)	12
Needle Penetration (mm)	35

- (b) To condition new SPME fibers use - SPME conditioning LEFT.cam and SPME conditioning RIGHT.cam. The settings should be as shown in Table 8-5.

**TABLE 8-5: Chronos Settings (Conditioning)**

Parameter	Setting
Bakeout Time (s)	1800
GC Runtime + Cooling Down (s)	120
Needle Penetration Vial (mm)	34
Fiber Exposure (mm)	12
Needle Penetration(mm)	35

- (c) To perform a run, the file "TWIN SPME\_cdc.cam" is used. The settings should be as shown in Table 8-6.

**TABLE 8-6: Chronos Parameter Settings (for Run)**

Parameter	Setting
Source Tray	Tray1,1
Time	1 s
Enrichment Time	1200 s
Desorption Time	420 s
GC Cooling Down	180 s
Needle Penetration Vial	34 mm
Fiber Exposure	12 mm
Needle Penetration Inlet	35 mm

## H. ICP-DRC-MS Instrument Setup

To improve workflow efficiency, do the programming steps described in this section before the day of analysis.

### 1. Programming the DRC Gas Flow Delay Parameter

A special ELAN DRC™ setting, called "Flow Delay", needs to be changed from its default setting to avoid the problem of the ELAN software forcing a time delay of several seconds before collecting data at the start of a chromatographic run when in DRC mode. This setting can only be changed by entering the ELAN software's Service Mode. This change only needs to be done once per software installation or upgrade, or if the setting was deliberately changed by a field service engineer. It is a good idea to inform the service engineer who intends to perform work on the instrument of the importance of returning the "Flow Delay" to the non-default value of 1.

### Important!

**While in Service Mode, DO NOT make changes to any setting except for the one change described below.**

- 1) From within the ELAN program and in the window entitled "Instrument Control Session", choose menu item "Options" > "Service Mode." You will be prompted to enter a Service Mode password. Enter the password "Elan6000" (omit the quotes and pay attention to

capitalization) and click OK. If this password is not accepted, you will have to contact a supervisor or a PerkinElmer service technician.

- 2) You will be presented with a new tab called "Service" within the Instrument window. Maximize the window. At the bottom will be a row of tabs, click on "Gas". Look for the parameter called "Flow Delay (Gas changes while in DRC Mode)". If its setting is a value other than "1", click on the "Set Pauses..." button. Change the value in the field named "Flow Change" to 1. Click the "Apply" button then click the "Close" button. Choose menu item "Options" > "Exit Service Mode."

## 2. Programming the ELAN ".mth" file

- 1) If it is not already open, launch the ELAN program and in the window entitled "Instrument Control Session", choose menu item "File" > "Review Files". Click the "Load" button for "Method", the first item on the list. Navigate to the folder "C:\elandata\Method" and click on "GC\_Hg.mth" file then click the "Open" button.
- 2) If the "GC\_Hg" file cannot be found, or it has been changed or corrupted in a manner that makes its use questionable, then cancel the open file dialog box and close the Review Files window by clicking the "Done" button. Do the following steps; otherwise, proceed to step 3:
  - (a) Make the active method file the active window (do this by clicking on the tool bar icon that looks like a notepad with a "Cu" on it). Then click "File" > "New" on the menu bar and then choose "Data Only" in the New Method window that appears. Click "OK" then maximize the window. Complete this window with the information in the Table 8-7.

**TABLE 8-7 ELAN Timing Parameters**

Parameter	Setting
Sweeps/Reading:	1
Readings/Replicate:	2725
Number of Replicates:	1
Tuning File:	C:\elandata\Tuning\default.tun
Optimization File:	C:\elandata\Optimization\gc_xe_drc.dac

- (b) On the first line of the worksheet-like table, click in the cell of row 1 of the "Analyte (\*)" column. Type "Hg" then press "Enter" key. The row will suddenly be filled-in with mercury's "Begin Mass (amu)" of 201.971 (or something close) and several default parameters. Right click on "Hg" and a periodic table will appear. Select five Hg isotopes from mass ~197.9670 to ~201.9710 and click "OK". All five isotopes should be seen in the "Analyte (\*)" column. Tab to next cells and fill in the information shown in Table 8-8.

**TABLE 8-8: ELAN Analyte Parameters**

Parameter	Setting
Analyte:	Hg
Begin Mass (amu):	197.9670* (first row, then proceed to the 4 other isotopes)
End Mass:	<leave empty>
Scan Mode:	Peak Hopping
MCA Channels:	1
Dwell Time:	25
Integration Time:	68125 (automatically determined by software)

\*Actual mass may differ by a few hundredth of amu.

(c) Click on the "Processing" tab and enter the following information:

**TABLE 8-9: ELAN Processing Parameters**

Parameter	Setting
Detector:	Dual
Measurement Unit:	Cps
Process Spectral Peak:	Average
Process Signal Profile:	Average
Apply Smoothing:	Checked
Factor:	5
Auto Lens:	Off
Isotope Ratio Mode:	Off

(d) Skip the "Equation" tab. Click on "Sampling" tab and enter the following information:

**TABLE 8-10: ELAN Sampling Parameters**

Parameter	Setting
Peristaltic Pump Under Computer Control:	Unchecked
Sampling:	External

(e) (e) Click on the "Report" tab and enter the information in Table 8-11.

**TABLE 8-11: ELAN Report Parameters**

Parameter	Setting
Report View   Send to Printer:	Unchecked
Report Options Template:	<leave empty> *
Automatically Generate NetCDF File:	Checked C:\elandata\reportoutput\
Report to File   Send to File:	Unchecked
Report Options Template:	<leave empty> *
Report File Name:	<leave empty> *
Report Format:	<leave empty> *
File Write Option	<leave empty> *

\*Content of these fields is not important since Send To Printer/File is unchecked.

(f) Choose menu item "File" > "Save As" and navigate to "C:\elandata\Methods\" folder. Enter "GC\_Hg" as the name of the method file and click the "Save" button.

3) The ELAN method "GC\_Hg" is now loaded into memory.

### 3. Creating the ELAN Sample Table ".sam" file

- 1) If it is not already open, launch the ELAN program and in the window entitled "Instrument Control Session", choose menu item "File" > "Review Files". Click the "New" button for "Dataset", the second item on the list. Navigate to the folder "C:\gc\data\" and enter the file name "Hg<yymmdd>" (where yy = last 2 digits of current year, mm = this month, and dd = date of run, for example, Hg110421 denotes Mercury Speciation run Apr.21, 2011, then click the "Open" button. The new dataset folder has been created and is now active. Click on the "DONE" button in the Review Files Window.
- 2) Clicking on the tool bar icon that looks like three Erlenmeyer flasks. Then choose "File" > "New" on the menu bar. A new window will appear entitled "Samples - [Untitled]". Click the "Batch" tab then click on the "Sample Template" button. A dialog box entitled "Sample Template Data" will appear. Enter the following information:



**TABLE 8-12: Sample Template Data**

Parameter	Setting
Sample ID:	001_ <sample name>
Measurement Action (*):	Run Sample
Method:	GC_Hg.mth
Sample type:	Sample
Wash Override (sec)	0

- 3) Parameters not mention in Table 8-12 can be left blank. Since the CombiPal autosampler can analyze 64 samples the sample ID can range from" 001\_ <sample name>" to "064\_ <sample name>" .
- 4) From the menu bar, choose "File" > "Save As" and save the file in the directory "C:\gc\data\" using the name "Hg<yymmdd>.sam" (where yy = last 2 digits of current year, mm = this month, and dd = date of run).
- 5) It is a good idea to save a copy of this file as a template, thereby avoiding the need to re-create it every time.

## I. ICP-DRC-MS Performance Checks

The following performance checks should be recorded in an instruments log book.

### 1. Daily Performance Check

- 1) Daily before samples are analyzed, Aqueous Blanks and 10X dilution of Low Bench QC should be analyzed to ensure that the instrument is functioning properly. Prepare all the following using the same technique and supplies as samples, unless stated otherwise.
  - (a) Aqueous Blank. To prepare, add 200  $\mu$ L of TMAH into a 20 mL vial. Insert a stir bar in each tube. To each tube add 7.7 mL of NaOAc Buffer solution and 250  $\mu$ L of derivatization reagent (NaPr4B). Cap the vial immediately and gently mix it. Aqueous Blanks are ready to be analyzed.
  - (b) 10X Diluted Low Bench QC. To prepare mix 0.1mL of Low Bench QC (LB) in 0.9 mL NIST 955C L1. This sample is digested and then analyzed exactly the same way as sample.
- 2) After SPME-GC-ICP-MS analysis of Aqueous Blank and 10X Diluted Low Bench QC are complete, open the Aqueous Blank and 10X Diluted Low Bench QC RAW files in TotalChrome. Examine the Aqueous Blank chromatograph for possible indicators of contamination. Then look at the 10X Diluted Low Bench QC chromatogram. This chromatogram should have visible peaks for the mass 202 isotopes of MeHg, EtHg, and InHg. Their intensities should be three times (3X) greater than the baseline RMS (root mean square) noise level, otherwise there may not be sufficient sensitivity and the instrument may need to be optimized (see weekly/monthly performance check section).

### 2. Weekly Performance Check

- 1) Visual check of Torch, injector, RF coil, and Cones:
  - (a) Slide the vacuum chamber and interface away from the torchbox, and visually check the cleanliness of these components. Notate any cleaning / replacing done

in the "Daily Maintenance / Performance Checklist". For details on cleaning procedures refer to IRAT Weekly Maintenance SOP.

- (b) Injector: There should not be deposits on the inside of the injector. If there is, remove and clean with 1-5 % v/v ultrapure nitric acid, a cotton swab. Alternatively, replace injector with spare and clean dirty one in an overnight soak in 5% v/v nitric acid (can be ultrasonicated, but is not typically necessary).
  - (c) Torch: Check for melting or cracking, and cleanliness. If necessary, replace with spare and soak overnight in 5% v/v nitric acid bath. If torch is only dirty, replacement / cleaning can be deferred to the regular weekly maintenance day.
  - (d) RF coil: Check for excessive corrosion (flaking). Replace if necessary.
  - (e) Sampler cone: Check for excessive buildup of matrix, cracking, or pitting. If necessary, replace dirty cones with clean spare cones and clean.
- 2) Replace GC injector septum.
  - 3) Visually check level and condition of oil in roughing pumps. Appropriate level for oil is  $\sim\frac{3}{4}$  full. If color indicates the need to change oil soon, do so at the next weekly maintenance. Oil is clear yellow when new. Light brown or "tea colored" is ok to use. Dark brown or "coffee colored" indicates need to replace.
  - 4) Weekly GC-ICP-MS system is optimized with Xe gas because of its similarities in ionization potential to Hg.
    - (a) Start Plasma, soon after the plasma ignites set flow rate of Xe gas mixture (0.1% Xe in Ar) at 0.01 - 0.25 mL/min on the GC main display to achieve Xe intensity > 350,000 cps (counts per second). In ELAN upload "gc\_xe\_daily\_drc.mth". After gas signal stabilizes (30-60min) in the "Sample" window press "Analyze Sample" in "manual" mode. If Xe intensity > 350,000 cps, the instrument is optimized. If not proceed with the following steps to optimize this instrumental setup. (The proffered number of counts varies with the instrument.)
    - (b) In ELAN upload "gc\_xe\_xy\_drc.mth". Also in ELAN program and in the window entitled "Instrument Control Session", choose menu item "File" > "Review Files". Click the "Load" button for "Optimization", the sixth item on the list. Navigate to the folder "C:\elandata\Optimize" and click on "gc\_xe\_drc.dac" file then click the "Open" button.
    - (c) SmartTune™ is used for DRC Mode optimization. Optimization parameters can be selected from "edit list". Appropriate method file in "method" section to be selected. The optimization for maximum Xe intensity should be performed (see IRAT Optimization SOP).
    - (d) After recommended parameters were optimized save the optimized file as "gc\_xe\_drc.dac". The current optimized values will appear automatically and will be similar to the ones in Table 8-13.
    - (e) After optimization for maximum Xe intensity navigate to the folder "C:\elandata\Method" and click on "gc\_xe\_daily\_drc.mth" file then click the "Open" button. Record this data.

**TABLE 8-13: ELAN Optimization Parameters**

Parameter	Setting	Parameter	Setting
Nebulizer Gas Flow (NEB):	1.5	Cell Path Voltage Std	- 14†
Auxiliary Gas Flow:	1.2	Rpa	0
Plasma Gas Flow:	15	Rpq	.5†
Lens Voltage:	4.75*	Cell Gas A	0.3
ICP RF Power:	1450	Cell Gas B	0
Analog Stage Voltage:	-1950*	DRC Mode NEB	1.5
Pulse Stage Voltage:	950*	DRC Mode QRO	- 16.90†
Quadrupole Rod Offset Std	0	DRC Mode CRO	- 1.90†
Cell Rode Offset Std	23	DRC Mode CPV	- 51†
Discriminator Threshold	17	Axial Field Voltage	150†

†Suggested starting values only. Optimum parameters will depend on the outcome of the optimization procedure.

### 3. Monthly Performance Check

- 1) Before starting make sure the plasma is turned off and transfer line temperature (AUX button on GC main menu) should be lowered to 25 °C (this is the lowest temperature the set-up allows for). Disconnect the transfer line from ICP-MS.
- 2) Carefully examine the end of capillary in transfer line: make sure the end is open, no melting, cracks, smooth surface, and no condensation. Replace if not in a good condition. Additionally if the chromatographic peaks are progressively broadening may consider replacing GC capillary. If this does not solve the problem, consider replacing GC column.
- 3) Connect spray chamber with the nebulizer to ICP-MS. Place the probe into the rinse solution. Clamp the sample tubing in the peristaltic pump. Start the peristaltic pump at a low to mid-range speed (i.e. 7 - 24 rpm). Allow at least 45 minutes warm-up time for the ICP-MS after igniting the plasma. This warm-up time is for the RF generator.
- 4) After this warm-up time, perform a "daily performance check". Note: for this method the standard IRAT Daily Startup SOP for ELANs is used monthly (since it requires changing instrument set up). This monthly procedures makes sure that ICP-MS part of this hyphenated method is functioning properly.

#### (a) Daily Performance Test

- Open your daily performance workspace, which should contain the following files.
- Method file: Daily Performance\_cdc.mth (the same as the Perkin Elmer file, with the addition of the analyte Be at mass 9, and with the autosampler setup under the sampling page).
- Dataset: "Daily Performance"
- Sample file: "daily\_performance\_cdc.sam"
- Report Template: "daily.rop"

- Tuning File: default.tun
  - Optimization file: default.dac
  - Calibration file: none needed
  - Polyatomic file: "elan.ply"
- (b) Place a tube of "Daily Performance Testing Solution" into the row specified in the sample window (batch tab). Select row one in the sample window (batch tab), and click "Analyze Batch".
- (c) Inspect the daily performance report as follows:
- Intensities and Oxides: Intensities should be above the Perkin Elmer specification at 3 % oxides. Intensities are in the "Meas. Intens. Mean" column. Oxides are given as a fraction under the "Net Intens. Mean" column on the "CeO" row.

Instrument	Mg	In	U	Oxides
DRC II (per 1 ppb)	>6,000cps	> 30,000cps	>20,000cps	0.03 (3%)

- Compare against historical information in the instrument log.

*Precision ("Net Intens. RSD"):*

6100 : < 2-3% for Be\*, Mg, Rh, and Pb.

DRC Plus and DRC II instruments: < 2-3% for Be\*, Mg, In, and U.

*Background counts:*

DRC II : < 2 cps for masses 8.5 and 220

*Doubly Charged species:*

Typical "Meas. Intens. Mean" for Ba<sup>++</sup> is  $\approx 0.03$ .

- (d) If the results of the daily performance test fail to meet the PerkinElmer criteria, optimization tests will need to be run (see SOP "ICP-MS Optimization")

## J. ICP-DRC-MS Warm Up

- 1) Launch the ELAN ICP-DRC-MS Software and note whether all graphical indicators of instrument readiness are green. If not, take the appropriate actions described in the instrument's software and hardware manual.
- 2) Perform necessary maintenance checks as described in Chapter 5 of the ELAN 6100 Hardware Guide (e.g., argon supply, interface components, cleanliness, positioning, and interface pump oil condition). Note the base vacuum pressure in the INSTRUMENT window of the software. (Before igniting the plasma, the vacuum is typically about  $8 \times 10^{-6}$  torr.) Keep a record any maintenance procedures along with the base vacuum pressure in the Daily Maintenance Checklist notebook.
- 3) In the INSTRUMENT window of the ELAN software, click the "Front Panel" tab and click the plasma "Start" button to ignite the plasma. In the same window, the ignition sequence bar (blue progress bar) will start to expand from the right, indicating the approximate time before plasma ignition. The plasma may at first flicker but it should establish a more or less steady intensity after 5-10 seconds.

*On a rare occasion, the plasma may ignite emitting an orange, violently flickering light, and electrical discharge noises will be heard. In this case, immediately shut off the plasma by pressing the yellow "Stop" button on the ICP-DRC-MS instrument's front*

*control panel. Wait 30 seconds then investigate the cause of the plasma misfire. A more common occurrence is that the plasma may extinguish itself a few seconds after ignition. Promptly reignite by pressing the "Start" button on the ICP-DRC-MS instrument's front control panel. Usually, the plasma will stay lit after the second try. If not, investigate the cause of this instability (refer to the ELAN DRC II Hardware Guide).*

- 4) Soon after the plasma ignites perform daily performance.
- 5) Fill in the Daily Maintenance Checklist Book according to the completed optimization procedures. If a tuning (mass-calibration) procedure was done, save it to the file "default.tun," and also in a separate file containing the analysis date "default\_MMDDYY.tun" (where MM=month, DD=day, and YY=year).

## K. GC-ICP-DRCII-MS System Startup

### 1. Entering Sample Names into the ELAN Sample Table

- 1) Click on the tool bar icon that looks like three Erlenmeyer flasks. If the current Samples window is not this run's sample file, then choose "File" > "Open" on the menu bar and navigate to and open this run's current data folder in "C:\gc\data\". Click on the file named "Hg<yymmdd>.sam" (yy = year, mm = digit month, dd = date) and open it. The Samples window will be the one created in the section Creating the ELAN Sample Table ".sam" file.
- 2) Fill in the name of each sample by double-clicking after the "\_" (underscore) in the cell "sample ID". Type in the sample name and press "Enter" on the keyboard. In this manner, enter the name of blanks, quality control, and sample that will analyzed in the run. If barcodes are used on the sample labels, use the barcode scanner attached to the ICP-DRC-MS computer to scan the sample ID from the barcode on each sample before placing it into position in CombiPal autosampler tray.
- 3) Filling out the Samples table (Table 8-14).

**TABLE 8-14: ELAN Samples Table**

A/S Loc.	Batch ID	Sample ID	Measurement Action	Method ...	Wash Speed (+/- rpm)
1		001_ Aq.Blk	Run Sample		0
1		002_ Aq.Blk	Run Sample		0
2		003_ LB 10X	Run Sample		0
2		004_ LB 10X	Run Sample		0
3		005_ LB-yyxxx	Run Sample		0
3		006_ HB-yyxxx	Run Sample		0
4		007_ Sample	Run Sample		0
4		008_ Sample	Run Sample		0
...rows for 18 samples and SRM material were omitted for brevity					
16		031_LB-yyxxx	Run Sample		0
16		032_HB-yyxxx	Run Sample		0

In the example table above, a run of 20 samples is shown so the last vial ends up being placed in A/S Location #16 (this location corresponds to autosampler location which is defined in Chronos, since there are two autosampler trays two #16 are used - "Left" and "Right". It is not necessary to put A/S loc in ELAN - only for analysts benefit).

The numbers preceding the underscore character correspond to the order of injection. These numbers will later help the analyst find individual chromatograms based on injection number instead looking for specific sample names during post-run data processing in TotalChrom.

- 4) When the sample table entries are verified to be correct choose "File" > "Save".
- 5) Print the ELAN Sample table by choosing the "File" > "Print Setup" > "Reports". In the ensuing dialog box, select the preferred printer and click "OK". Next, choose "File" > "Print" and then click the "Print" button. Refer to the printout of the ELAN Sample table for the correct vial positions when loading samples into the CombiPal autosampler tray.

## L. Starting the Run

- 1) Create daily data folder in C:\GC\Data under the name Hgyymmdd (i.e., Hg110422)
- 2) Launch ELAN Instrument Control program if it is not already up. Do not launch or start any other programs at this time.
- 3) Check that the correct ELAN method is loaded and active in the window "Instrument Control Session". If it is not correct, load the correct Method file. Check under the Sampling tab that "Peristaltic pump under computer control" is unchecked, and the pull-down menu "Sampling" indicates "External".
- 4) Check that the correct Sample file in the window "Instrument Control Session" is active. If it is not correct, load the correct Sample file.
- 5) Load created dataset file "Hgyymmdd"
- 6) Check that the GC methods are correctly programmed.
- 7) Check that CombiPal autosampler methods are correctly programmed.
- 8) This step offers the advantage that the ELAN data files will be converted in real time to TotalChrom™ ".raw" files that have names containing a date-time stamp corresponding to actual time of injection.
  - (a) Launch TotalChrom Navigator. In the resulting TotalChrom Navigator window, choose menu item "Apps" > "ChromLink" (alternatively, you may launch ChromLink™ from the operating system "Start" > "Programs" menu).
  - (b) In the ChromLink™ program window, choose the menu item "Configuration" > "Mass Details" and check the Nominal Name and Mass for mercury isotopes. If it is missing or the ELAN tune ("default.tun") file was re-optimized earlier then ChromLink™ needs to be configured (see Configuration of ELAN ChromLink™ on page 35 for details). To save time, the analyst may choose to close the TotalChrom™ Navigator and ChromLink™ windows and skip step 6 in its entirety. Data file conversion via ChromLink™ can easily be done during post-run data reprocessing.
  - (c) In the ChromLink program window, click on the "Browse" button just right of the "ELAN ChromLink file location" field. Navigate to the current working folder, double-click on it then click the "OK" button so that ChromLink knows where to save its processed files.
  - (d) Otherwise, refer to step (b) of Data Processing and Analysis on page 37 for details on proper setting of the ELAN ChromLink™ window's parameter fields. In the ELAN ChromLink window, click the button "Start Processing ELAN Data Files" to put ChromLink in watch mode so it will process each data for each injection in real time. A new dialog box will open and indicate it is ready to convert data and waiting for the first file.

- 9) Launch Chronos program, which communicates with CombiPal autosampler and ELAN software.
- In the main menu click on "Sample List" then upload analysis method for SPME fiber cleaning "baking".
  - Upload "SPME bakeout LEFT.cam" (to clean the left fiber) then select "Create Schedule". The Schedule window will appear with time intervals required for the measurement. Click "RUN" on the main menu, the run window appears and click "run" again to proceed with the fiber cleaning.
  - Repeat step (b) to clean right fiber and use "SPME bakeout RIGHT.cam"
  - After fiber cleaning and daily performance check the QC and samples are ready for analysis using SPME fibers. On the "Main Menu" select "Sample List" then click "Load List". Upload Dual SPME .csl file. This file communicates with Left and Right fibers. The table similar to the one below (Table 8-15) will appear. The table should have Analysis Method "C:\Chronos\Methods\TWIN SPME\_cdec.CAM" uploaded.

**TABLE 8-15 Chronos Samples Table**

Analysis Method	Source Vial	Incubation Time (s)	Enrichment Time (s)	Desorption Time (s)	GC cooling down (s)
C:\Chronos\Methods\TWIN SPME_cdec.CAM	1	1	1200	420	180
	1	1	1200	420	180
	2	1	1200	420	180
	2	1	1200	420	180
Rows for source vials 3 to 31 are omitted..					
	32	1	1200	420	180
	32	1	1200	420	180

- "Source Vial" column shows which autosampler position will be first analyzed. There are two racks (left and right) with vial position 1 to 32. Left rack gets analyzed by Left SPME fiber and Right rack gets analyzed by Right SPME fiber. There are two numbers "1" in the source vial column. First one always corresponds to Left rack/Left fiber.
  - Chronos communicates to autosampler through "source vial" position, the analyst has to make sure sample in ELAN correspond to location seen by Chronos. Example: if the analyst wants to analyze slots 1-5 on both racks (total of 10 samples) the rows below 10 should be deleted. To delete select the rows and click "Remove Samples".
- 10) Check that the DRC gas is indeed flowing by making the ELAN's Instrument window active and clicking on the Diagnostics tab. Inspect the Cell Gas A or B, its value should be fluctuating at the current value  $\pm 0.01$  mL/min. If it is not, see section Turning on the Reaction Cell Gas for details to turn on the DRC gas flow.
- 11) Check that all blanks, QC, and sample vials are loaded into their correct positions in the CombiPal autosampler tray as designated by the ELAN Sample window (or its printout) and in position seen by Chronos.

- 12) Before samples are analyzed, daily performance check should be analyzed to ensure that the instrument is functioning properly.
  - (a) Click on the ELAN "Instrument Control Session" window to make it active. Highlight the samples and click the "Analyze Batch" button. A Run Progress box will appear indicating that the ELAN software is now waiting for a signal from the Chronos that indicates the occurrence of an injection.
  - (b) In Chronos: to analyze sample select "Create Schedule" then press "RUN" on main menu and "RUN" again on the run window.
  - (c) View the chromatograms in TotalChrom and in the real time window of ELAN to ensure that there are no problems with the analysis. After the Aqueous Blanks and 10X LB been analyzed the run can be started.
- 13) Open the ELAN "Instrument Control Session" Real-Time window by clicking the tool bar button that looks like a Gaussian distribution (the blue chromatographic peak). After the Real-Time window opens, click on the drop-down menu and select "Signal". Real-time data will now be displayed.
- 14) CombiPal autosampler will seek the first vial and make an injection. A blue bar in the ELAN's progress box will now indicate that data is being collected. The system can now run unattended.
- 15) Check the progress of the run after 2 or 3 injections. Note the chromatograms appearing in the ELAN's Real Time window. Adjust the signal scale in the Real Time window, as necessary. Compare the positions and peak heights of each mercury species. It helps to visually compare it to a printed reference chromatogram. If abnormalities in retention time, peak height, or peak shape are readily apparent, the analyst may need to stop the autosampler and abort the run in the Chronos program and then ELAN. Correct the problem(s) and restart the run.

### Important

Remember to disable the ELAN's Auto Stop feature before re-enabling it otherwise the ELAN may perform an auto shutoff prematurely.

## M. Instrument Shut Down

- 1) The autosampler will stop after all samples have been analyzed.
- 2) Shut off ICP-DRC-MS plasma.
- 3) At the controller computer, visit the ELAN Instrument Control Session application and open the "Dataset" window. Confirm that all samples ran successfully and that the corresponding data for each sample is listed in this window.
- 4) Remove the QC and sample vials from the GC tray. Discard them according to CDC biohazard waste disposal guidelines.

## **IX. POST-RUN DATA ANALYSIS**

---

### A. Configuration of TotalChrom Integration Method

The following information is presented as a starting point to help the analyst develop robust integration method parameters that will work best for most chromatography data. Many of these parameters will work



just fine as presented below. However, the separation chemistry of GC columns can vary due to frequency of use, column replacement, or because of individual sample "oddities". Some parameters may need to be adjusted from time to time to maximize the ability of TotalChrom™ to properly integrate peaks and identify components with minimum operator intervention. Therefore, the analyst should pay particular attention to the chromatograms produced in every run and make necessary adjustments as warranted. The analyst should be familiar with the TotalChrom's frequently used integration functions, which are described in Chapter 18 of *TotalChrom Workstation User's Guide: Volume II*.

- 1) The creation of a new method file in TotalChrom is done the first time TotalChrom is setup, or it will need to be recreated if the file "Hg.mth" cannot be found or has been corrupted. In the TotalChrom Navigator window, choose the menu item "Build" > "Method." In the next dialog box, click the "Create a new method" radio button and click "OK." The default method will load into the method editor.
- 2) Click on the "Components" item in the menu bar in Method Editor. If the menu item "Delete All Components" is not grayed out, select it and click "OK" when prompted to "Delete all components, calibration levels, and calibration replicates".
- 3) Choose the menu Item "Process" > "Integration". Click on the "Integration" tab in the "Process" window. Enter the information shown in Table 9-1. These values are to be used as a starting point, but the analyst may make appropriate changes to one or more of the integration parameters as necessary.

**TABLE 9-1: Integration**

Basic Parameters		Advanced Parameters	
	Value		Value
Bunching Factor :	1	Peak Separation Criteria	
Noise Threshold :	115	Width ratio :	0.2
Area Threshold :	577	Valley to peak ratio :	0.01
		Exponential Skim Criteria	
		Peak height ratio :	5.000
		Adjusted height ratio :	4.000
		Valley height ratio :	3.000

- 4) Click on the "Baseline Timed Events" tab. Enter the information shown below in Table 9-2. The analyst may make appropriate changes to one or more of the Baseline Timed Events as may prove necessary.

TABLE 9-2: Baseline Timed Events

Defined Events				
Time	Event	Value	Code	Level
0.000	Set Area Threshold	125	AT	
0.000	Set Noise Threshold	25	NT	
0.000	Smooth Peak Ends On	5	+SM	
2.222	Set Bunching Factor	4	BF	

- 5) Click on the "Optional Reports" tab. Uncheck the box for "Keep temporary files".
- 6) Click on the "Replot" tab. Enter the information shown in Table 9-3. The analyst may make appropriate changes to one or more of the Replot parameters as may prove necessary.

TABLE 9-3: Replot

Plots		Miscellaneous	
<i>Generate a separate replot :</i>	checked	<i>Start plot at end of delay :</i>	checked
<i>Number of pages:</i>	1	<i>Gradient overlay :</i>	not checked*
<i>Retention Labels :</i>	Top of Plot*	<i>Draw baselines :</i>	checked*
<i>Component Labels :</i>	Actual time	<i>Timed Events :</i>	checked*
<i>Scaling Type :</i>	Absolute Scaling	<i>Plot Title :</i>	Chromatogram
<b>Scaling Parameters</b>		<i>X axis label :</i>	Time [min]
<i>Scale Factor :</i>	1.000000*	<i>Y axis label :</i>	Response [mV]

\*These parameters maybe altered to suit the analyst.

- 7) It is unnecessary to click on the "User Programs" tab because it is not used. Close the Process window by clicking on the "OK" button.
- 8) In the Method Editor window, choose the menu item "Components" > "Global Information." Click on the "Integration" tab in the "Process" window. Enter the information shown in Table 9-4:

**TABLE 9-4: Global Information**

Volume units :	µL	Unidentified Peak Quant.	
Quantitation units :	ng	Calibration factor :	1.000e+06
Sample Volume :	1.000	Always use calib. Factor :	selected
Void time (min) :	0.000		
Calibration		RRT Calculation	
External Standard	selected	Use first peak in run as RRT reference:	selected
Reject outliers during calibration :	not checked		
Sample Amount Options			
Correct amounts for calibration standards :	not checked		
Convert unknown samples to concentration units:	checked		

- 9) The "LIMS Results" tab is not used. Click the "OK" button to close the window. The parameters in Table 9-4 are starting points. The analyst may make appropriate changes to one or more of the Global Information parameters as may prove necessary.
- 10) In the Method Editor window, choose the menu item "Components" > "New Component." The white list box in the left portion of the window will be empty. Click in the empty field labeled "Name" and type "Hg<sup>0</sup>". Press the tab key and enter "1.614" in the field labeled "Retention time". Select the radio button labeled "Peak" if it is not already selected. Leave the other fields and check boxes unaltered. Click the "New Component" button. Enter each of the component names and parameters listed in TABLE 9-5.

**TABLE 9-5: Method Editor - Components Settings**

Name	Retention Time	Absolute window	Relative window	Find tallest peak in window
Hg <sup>0</sup>	1.614	2	3	No
InHg	3.470	0	3	No
MeHg	2.640	0	3	Yes
Ethg	3.176	0	3	Yes

- 11) Click the "New Component" button before starting a new component. After entering the last component, click the "OK" button. The values for Retention Time, Absolute Window and Relative Window serve as starting points. The analyst may alter these values as actual chromatographic results may dictate.

- 12) In the Method Editor window, choose the menu item "Components" > "Defaults." Click on the "Identification" tab". Enter the information shown in Table 9-6.

**TABLE 9-6: Components Defaults – Identification**

Parameter	Setting	Parameter	Setting
Component Type :	Peak	Reference :	blank
Absolute window :	0	Internal Standard :	blank
Relative window :	3	Find tallest peak :	Not checked

- 13) Click on the "Calibration" tab in Components Defaults Window. Enter the information shown in Table 9-7.

**TABLE 9-7: Components Defaults – Calibration**

Parameter	Setting	Amount
Calibration Type :	Use Calibration Factor	1.0000E-6
Scaling :	None	
Weighing :	None	
Response :	Area	

- 14) The "User Values/LIMS" tab is not used. Close the "Components Defaults" window by clicking the "OK" button.
- 15) In the Method Editor window, Choose "File" > "Save As." A window appears inviting you to enter any information pertinent to this method which will be saved with the method. Enter your name and the date this method was created. Click "OK" and a "TotalChrom File-Save-As" dialog box opens. Navigate the directory tree to get to the folder C:\GC\Methods ). Double-click on this folder. In the "File name:" field, enter "Hg-Template.mth". If there is already a file in that folder with the same name, highlight that file and right-click the mouse. Choose "Rename" and give the file a new name (e.g. add "backup" to the name). Now, you can click the "Save" button. Close the "Method Editor" window.

## B. Configuration of ELAN ChromLink™

ELAN ChromLink™ should be configured after initial installation of the program or when the ELAN tune ("default.tun") file is re-optimized, and when there is available at least one recent ELAN NetCDF file (with the ".nc" extension) containing data for the mass of interest that was collected since last update of the "default.tun" file.

- 1) Launch TotalChrom Navigator. In the resulting TotalChrom Navigator window, choose menu item "Apps" > "ChromLink" (alternatively, you may launch ChromLink™ from the operating system Start > Programs menu).
  - (a) Inside the ELAN ChromLink window, click on menu item "Configuration" > "Default TotalChrom Method". Click on the "Browse..." button and navigate to the directory C:\gc\methods\. Select "Hg-TC.mth" and click the "Open" button. "C:\gc\methods\Hg-TC.mth" will now be the ChromLink™ default method. Click "OK" to close the "Default TotalChrom Method" window.

- (b) Inside the ELAN ChromLink window, click on the "Set" button. A window entitled "Operating Mode" will open. Inside the ELAN ChromLink window, click on the "Set" button. A window entitled "Operating Mode" will open. Click on the "Automatic - process all ELAN NetCDF files in specified location" radio button. The lower radio buttons will gray out. Click the "OK" button to close the window.
  - (c) Click on the "Browse" button by the "ELAN NetCDF file - location/file to be converted" space. Choose the path "C:\Elandata\reportOutput". The location/file to be converted will now read "C:\Elandata\reportOutput\\*.nc".
  - (d) Click on the "Browse..." button for "ELAN NetCDF Chromlink file location (sequence and raw files generated by Chromlink)" field. An open file dialog box will open; choose the file to which all the data should be place (usually the data file that was created that day).
  - (e) Click on the "Start Processing ELAN Data Files" button. A window entitled "Processing ELAN Data" will appear.
- 2) At this time, ChromLink™ may be closed by selecting "File" > "Exit." Click "OK" at the dialog box asking if you want to quit ChromLink™.
- 3) In addition to configuring ChromLink™ itself, it is necessary to alter one value in the "seed" method file that ChromLink™ uses to set a select number of parameters to certain default values. This step only needs to be done once following the installation of ChromLink™.
  - (a) In the TotalChrom Navigator window, choose the menu item "Build" > "Sequence" and a dialog box called "Startup" will appear. Click on the radio button labeled "Load sequence stored on disk" then click the "OK" button. Navigate to the folder on the C drive that contains the ChromLink™ program file (usually in C:\PenExe\ChromLink but if it is not there, check under the C:\Program Files directory). Click on the sequence file "seed.seq" to highlight it (if this file is missing, reinstall ChromLink™). Click the "Open" button. A spreadsheet style sequence table will present itself in a window called "Sequence Information - Channel A". There will be a minimized window for channel B data; ignore this window.
  - (b) Choose menu item "File" > "Save." Close the Sequence Editor window by choosing "File" > "Exit" from the menu bar.

### C. Data Processing and Analysis

Refer to Figure 1 "Post-Run Data Processing Work Flow Diagram" (page 38) for a summary representation of the important aspects of post-run data processing.

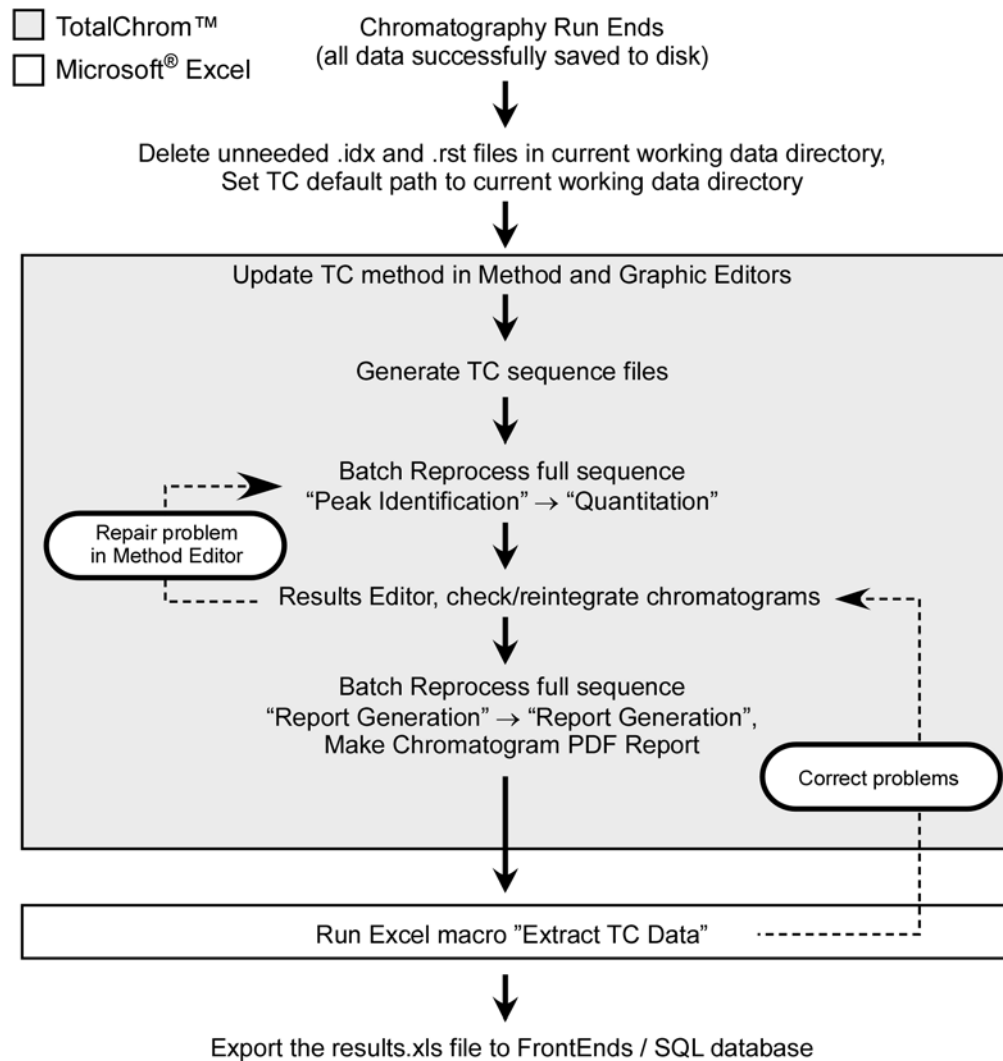
- 1) Open Microsoft Windows® File Explorer and open the current working GC data directory (e.g., C:\GC\Data\- 2) If it is not already open, launch TotalChrom.
- 3) If ChromLink was not run in real-time data collection mode during the run as described in step 6 under Starting the Run (see page 29), then do the following:
  - (a) In the TotalChrom Navigator window, choose menu item "App" > "ChromLink." Choose the menu item "Configuration" > "Mass Details" and check the Nominal Name and Mass for mercury. If it is missing or altered then ChromLink™ needs to be configured (see Configuration of ELAN ChromLink™ on page 32 for details).
  - (b) Check that the Mode field indicates "Automatic - Process all NetCDF files in specified location". If it does not, click the Set button to the right of this field and in

the resulting "Operating Mode" dialog box, click the "Automatic - process all ELAN NetCDF files in specified location" radio button, then click the OK button. Next, check that the Field labeled "ELAN NetCDF file - location/file to be converted" indicates the correct data folder. This should be "C:\elandata\Reportoutput\\*.nc". If it is not, click the Browse button to the right of it and navigate to that folder. Double-click on that folder then click the "OK" button to close the front most dialog box. Last, click the Browse button to the right of the field labeled "ELAN ChromLink file location..." In the dialog box "Select TotalChrom Data Location", navigate to the folder containing the run data and double-click on it. Click the OK button to close that dialog box. In the ELAN ChromLink window, click the button "Start Processing ELAN Data Files" to start processing of the run data. A new dialog box will open and provide current information on the status of the data conversion.

- (c) When data conversion by ChromLink is completed within a minute or two, a message in the step field will indicate "Successfully Finished". Click the Close button. At this point, you may close the ELAN ChromLink application by choosing "File" > "Exit" or clicking on the window "x" box. In the resulting "OK to quit?" confirmation dialog box, click the "OK" button.
- 4) In the TotalChrom Navigator window, choose the menu item "Build" > "Method." Click the "Load method stored on disk" radio button and click "OK." In the TotalChrom File-Open dialog box, find C:\GC\Methods folder and open the "GC\_Hg.mth" file. The template method file should now be loaded.

If, instead of loading the method file, an error message appears stating that the file is unavailable because it is in use and asks if you would like to open it in Read-Only mode, click the "No" button. Cancel the Open-File dialog box. Exit the Graphic Method Editor. In the Navigator window, choose menu item "Admin" > "CAM Administrator." A window will appear with two panes. In the left pane, click on the "+" sign in front of "TotalChrom Servers" to expand it. Click on the computer icon on the next line that just appeared to highlight it. In the right pane, under the heading "Resource/Instrument", select the first item. If there is more than one item, select every item by shift-clicking on each item. Every item should now be highlighted. Choose "Edit" > "Remove Locks" (or press the Delete key on the keyboard). Next, click on the "+" sign in front of "Users" to expand it. Click to highlight your TotalChrom user name that appeared. In the right pane, under the heading "Resource/Instrument", select every item and Choose "Edit" > "Remove Locks." This action serves to unlock files and make them available for editing. In the future, TotalChrom™ complains that files cannot be edited because they are locked, use CAM Administrator to unlock them. Choose "File" > "Exit" to quit CAM Administrator. Start again at the beginning of this step to open the Method Editor.

Figure 1: Post-Run Data Processing Work Flow Diagram



- 5) Choose "File" > "Save As." At the next window you will be invited to enter information about the method. You may enter pertinent information but this is optional. Click the "OK" button and a TotalChrom File-Save-As" dialog box opens. Navigate the directory tree to get to the folder that contains the ELAN data files for this run (typically in the folder C:\GC\Data\ ). Double-click on this folder. In the "File name:" field, enter the same name as it exactly appears for the folder that will contain it (i.e. Hg<yymmdd> convention where yy=2-digit year, mm=2-digit month, dd=2-digit date). Click the "Save" button then close the "Method Editor" window.
- 6) In the TotalChrom Navigator window, choose the menu item "Build" > "Graphic Edit." A TotalChrom File-Open" dialog box appears, but click on cancel to close it. On the Graphic Method Editor's menu bar, choose "File" > "Open" and navigate the file-open dialog box to the folder containing the method file created in the preceding step. Click on that file and click the "Open" button. Return to the Graphic Method Editor's menu bar and choose "File" > "New Data File." Navigate to C:\GC\Data\ and double-click on the folder containing the run data. Find and click on a data file (indicated by the ".raw" extension) that corresponds to the

"-LB0972". When this file appears in the File Name field, click the "Open" button. If a message box appears with the warning "Unable to open this file: default.mth", click "OK" to clear the message (you do not have to go to CAM Administration to unlock it). Do the same if another message warning box appears (i.e. click "OK" again to clear it). You should be in the "Graphic Method Editor - <path to method file>" window and see a chromatogram.

- 7) Under the menu item "Calibration" > "Show Windows" there should be a check mark beside "Show Windows." Retention window bars (looks like "H" style error bars) will be present when it is checked. Each retention time window bar should be located above the chromatographic baseline and contain an identified peak within its bounds. If there are any bars at the bottom of the chromatogram located below the baseline, choose menu item "Calibration" > "Edit Components." Click on the first mercury species peak that falls outside its retention time window to select it. In the group of data fields located on the right side of the window, click on the "Name" dropdown arrow (located on the right side of the data entry field) and choose the appropriate species by name. It is usually not necessary to alter the retention time window's "Absolute" and "Relative" window parameters, but you may do so if experience dictates that a change will be beneficial. Click the "Next" or "Prev" button. Repeat these steps for each mercury species peak that was not properly identified because it was outside its retention time window. When the editing of peak retention time windows is complete, click on the menu bar item "Return". Next, choose "File" > "Save" followed by "File > Exit".
- 8) "In the TotalChrom Navigator window, choose the menu item "Build" > "Sequence" and a dialog box called "Startup" will appear. Click on the radio button labeled "Load sequence stored on disk" then click the "OK" button. The following steps should be used to create the sequence used for reprocessing.
  - (a) Navigate to the folder containing the run data and click on the sequence file (ends with ".seq") corresponding to the run (named "Hgyymmdd.seq" where yy=2-digit year, mm=2-digit month, dd=2-digit date ). Click the "Open" button. A spreadsheet style sequence table will present itself in a window called "Sequence Information - Channel A". There will be a minimized window for channel B data, ignore this window. Look for the "Method" column and click on the first cell in row 1 in this column. Right click the mouse and a contextual menu will appear; choose "Browse". In the resulting File-Select dialog box, navigate and choose the method file (ending in ".mth") created earlier. Click on the Select button. The path and name of the new method file will replace the default information in this cell. Right click this cell again and choose Fill Down. The new file name information will fill down to every cell in the "Method" column. Look for the "Rpt Fmt File" column and follow the same process that was followed with the "Method" column. Instead of choosing the method file (ending in ".mth") choose the report file (ending in ".rpt"). If the report file is not listed, click on the "default.rpt" file. In the bar that contains the file's path, change the "default" to "Hgyymmdd." Right click this cell again and choose Fill Down. The new file name information will fill down to every cell in the "Rpt Fmt File" column.
- 9) In the TotalChrom Navigator window, choose the menu item "Reprocess" > "Batch." A new window appears entitled "Batch Reprocessing". Choose menu item "File" > "Sequence" and another window appears entitled "From Sequence". Locate the top field labeled "Sequence file" and look for a button with an open folder icon immediately to the right of the field. Click this button and navigate, if necessary, to the folder containing the run's sequence files. Click on the sequence file and click the "Open button." Upon return to the previous window, set Start Analysis to "Peak Detection" and End Analysis to "Quantitation". Set Batch Printer to "pdfFactory Pro". Change Batch Execution to "ndlb-168462" or anything other than "Interactive". Check "overwrite existing result files" and select "Update existing raw file header with new sequence". All other parameters should remain unchanged. The parameters are shown in TABLE 9-8.



- 10) Click the "OK" button. Reprocessing of the chromatographic raw data will commence. The bottom panel in the window will update with each file's name as it is processed. When processing is done, this panel will be clear of files. Close this window.

**TABLE 9-8: TotalChrom™ Navigator - Reprocess Batch**

Parameter Name	Parameter Setting
Starting Row	: 1
Ending Row	: <number of rows in sequence file>
Channel A	: Checked
Channel B	: Not Checked
Start Analysis	: Peak Detection
End Analysis	: Quantitation
Batch Execution	: "ndlab-168462" or equivalent
Batch Printer	: pdfFactoryPro
Batch Plotter	: None
Enable Optional Reports in Method	: Not Checked
Use Method is Result File	: Grayed Out
Overwrite Existing Result Files	: Checked
Raw File Treatment	: Update existing raw file header with new sequence

- 11) In the TotalChrom Navigator window, choose the menu item "Reprocess" > "Results." A new window should open called "Reprocess Results". If you get an error message telling you that you can only open this in read-only mode, then unlock the files (follow the procedure described in step 4 of this section). Select from the menu "File" > "Open." In the open file dialog box, click on the "Files of type:" dropdown menu and select "IDX files (\*.idx)". Navigate to the folder containing this run's data and click on the newest file (in the format of "Hg<yymmdd>-<today's date>-<time of reprocessing>"). Click "Open." In the Reprocess Results window will be presented a chromatogram for the first sample in the sequence. Carefully inspect the chromatogram one peak at a time for correct peak identification and accurate baseline. If you are satisfied that there are no integration problems, proceed to the next sample's chromatogram by selecting "File" > "Next File" from the menu bar or pressing "F3." Examine all chromatograms in this manner and make corrections in peak identity and integration as necessary. Make notes concerning issues encountered with individual chromatograms and changes that were made. If a chromatogram is changed or edited in any way, be sure to select "File" > "Save" to save your changes. See the chapter entitled "Developing Processing Parameters in the Method" in the PerkinElmer TotalChrom Workstation Users Guide for a detailed explanation on how to use integration events to optimize the integration of a chromatogram. After review of each and every chromatogram, select "File" > "Exit" from the Reprocess Results menu bar.
- 12) Repeat step 9 except set both Start and End Analysis to "Report Generation". Set Batch Printer to "pdfFactory Pro". A new window will open. When reprocessing has completed, click the "Save" button on the pdfFactory Pro window. In the Save As dialog box that appears, navigate to the run's data folder and create a new pdf file named "Hg<yymmdd> report". Be sure to include a space between "report" and the first word of the new file. Click the "Save" button. This pdf file is to be kept and backed up, for archival purposes, in the same folder

with all the other chromatographic data files for this run. Click the "Close" button to close pdFactory Pro window.

- [13\)](#) Open Microsoft Excel and choose "GCICPMS" > "Extract TC Data" from the menu. In the open file dialog box, navigate to the folder containing the run's data files. A box titled "Choose a Sequence File" should appear. Navigate to the folder that contains the sequence file that you are working with. Double click on the sequence file. Immediately a macro will run that will extract the data and put it into a format that is easily exported into the database. Just before the macro finishes, a "Save As" dialog box will open giving you the opportunity to save the file as an Excel workbook. Give the file a name as follows: "Hg<yymmdd> results". The multi-tabbed Excel workbook contains a worksheet suitable for data exportation to the Frontends (MS SQL Server 7™) database.
- [14\)](#) [Calculated "spike" concentrations for enriched InHg, MeHg and EtHg in Triple-spiked standard solution should be entered in the column "ppb Spike" in Microsoft Excel. Then, in Microsoft Excel toolbar choose "GCICPMS" > "Deconvolute" from the menu. sample concentration values will be calculated and appear in the column "ppb Result".](#)
- [15\)](#) The data processing portion on the instrument controller computer is now complete. At this point you may close Microsoft Excel® and TotalChrom Navigator.
- [16\)](#) [Throughout the sample analysis it is important to ensure that three mercury species peaks \(InHg, MeHg, and EtHg\) are well resolved. Thus, the following criterion is followed to accept/reject the sample analysis. The Microsoft Excel document containing concentration results displays retention times for each mercury species in the column labeled "RT". Mercury species elute from a chromatographic column in the following order MeHg, EtHg, InHg with relative retention times  \$t\_{r1}\$ ,  \$t\_{r2}\$ ,  \$t\_{r3}\$ , respectively. For the purpose of establishing relevant criterion, relative retention time for InHg \( \$t\_{r3}\$ \) is set to 1. Then the ratio  \$\(t\_{r2}/t\_{r1}\) = 0.91 \pm 0.13\$  and  \$\(t\_{r3}/t\_{r1}\) = 0.77 \pm 0.12\$  \( \$\pm\$  represents three times standard deviation\). If the relative retention time ratios fall outside the allowable error- the samples should be repeated.](#)

## **X. RECORDING OF SAMPLE AND QC DATA**

---

### **A. Transferring the Data to the Branch Database**

- 1) Transfer the "Hg<yymmdd> results".xls file via recordable media (e.g., USB flash drive) to the appropriate subdirectory on the network drive where exported data are stored. (Note that directories are named according to instrument/year/month/ and study name or ID, for example, \\cdc\project\CCEHIP\_NCEH\_DLS\_IRATB\_COMMON\Nutritional\Instruments\ELAN\_DRCM/2011/04/Hg110423 Results - Study 2006-09".)
- 2) From a computer that has access to Frontends database used for tracking data, log in using your user ID and password. After you log into the database, open the FrontEndSet folder in the GO TO window.
- 3) Click the "Add Sample Results to Database" button. New buttons will appear. Click the "Import Instrument Data File" button. For "Instrument", choose "ELAN-DRC2M" (or the appropriate instrument). For "Assay", choose "HgSpecGC". Enter the appropriate Analyst and Study for these two fields. It is not necessary to fill-in the "IS Lot Number" Field. Select the location of the data file on the network drive and press the "Open" button.

- 4) In the "Imported Results" table, pressing the "Find X's" button will show only those samples whose sample ID is not recognized as a valid QC pool ID or sample ID for this study. (Sample IDs are set up when the study is logged into the database.) If necessary, corrections to sample IDs and dilution factors can be made in this table (e.g., correction of transcription errors and adjustment for level of dilution). If samples were diluted for analysis, both the sample ID and the dilution factor need to be edited in this table before the values are transferred to the database. First, change the dilution factor to reflect the way that the sample was analyzed then edit the sample ID to remove any comments about the level of dilution at which the sample was analyzed. (The replace command is useful here.)
- 5) When corrections to sample IDs are made, press the "Recheck" button to evaluate the sample IDs. Any sample or analyte row marked "Not Recognized" will not be transferred to the database when the "Transfer" button is pressed.

## B. QC Data

Store the results of the QC samples analyzed in each run in the Frontends database when all other data for the run is imported from the ELAN software. Refer to "Recording of Data" described above for how to import data into the Frontends database. The database allows for the printing of several types of QC reports.

# XI. FINAL DATA REVIEW

---

## A. Analysis Printouts and Analyst Run Report

If the samples analyzed are part of a study that has an associated study folder place the analysis printouts in the study folder(s). Store the results of the patient samples analyzed in each run in the Frontends database when all other data for the run is imported from the ELAN software. Refer to "Recording of Data" described above for how to import data into the Frontends database. The database allows for the printing of a run summary report that indicates whether any particular patient-sample results are outside of the normal concentration reference range or whether any measurement failed precision limits.

## B. Plotting QC Results

When the Frontends database is used QC plots are updated automatically when the data are imported into the database. Monitor these plots regularly for any trends in the bench QC results. If trends are observed, contact the laboratory supervisor.

## C. Supervisor Review

The Frontends database allows the supervisor to review the QC and sample results directly in the database. The data from each analytical run is stored in pdf format on the CDC shared drive under the instrument that the analysis was performed on.

# XII. REPLACEMENT AND PERIODIC MAINTENANCE OF KEY COMPONENTS

---

## A. ICP-MS Maintenance

Part numbers listed below are PerkinElmer part numbers from their 2010-2011 Consumables Catalog.

- 1) Cross-Flow II Replacement Liquid and Gas Tip Ferrules (part #09920518 and #09920515, respectively). Keep at least two spares on hand.

- 2) Injector Support/Torch Base (part #N812-0116). Keep one spare on hand.
- 3) Torch O-Ring Kit (packages of four, part #N812-0100). Keep four spare packages on hand.
- 4) Quartz torch. At least one spare torch should be on hand (part #N812-2006).
- 5) 0.8-mm i.d. sample injector (part #N8126039). At least one spare injector should be on hand.
- 6) RF coil (part #WE02-1816). One spare should be on hand.
- 7) Platinum (Pt) Skimmer (part WE027803) and sampler cones (part WE027802). Keep at least two spares of each on hand.
- 8) Skimmer and sampler cone O-rings (part #N812-0512 and #N812-0511, respectively). Keep at least 10 spares of each on hand.
- 9) Series II replacement Ion lens (part #WE018034). Keep two spares on hand.
- 10) Pump oil for the roughing pump (part #N812-2004). Keep two bottles on hand in general lab storage.

## B. GC Maintenance

- 1) Septa (part # 20654, Supelco, Bellefonte,PA) in the GC injector should be changed weekly.
- 2) Glass inlet (part # 2631405, Supelco) in the GC injector should be checked weekly, if condensation or any particulates are found (often parts of septa) should be replaced.
- 3) GC column (Catalog # N9316076) should be replaced when the quality of chromatographs decreases.
- 4) GC Transfer Line noncoated column (Catalog # N9301356, S/N 920620,) should be changed when the quality of chromatographs worsens.
- 5) Graphite ferrules (part # 09903700, Perkin Elmer Instruments, Shelton, CT).
- 6) Vu-Union Vespel (part # 20428, Rescek).

## XIII. LIMITS OF DETECTION

---

The limit of detection (LOD) for mercury species in blood specimens are calculated using data from  $\geq 60$  separate analytical runs. To determine this method's LOD's, prepared blood samples were used containing known amounts of inorganic, methyl and ethyl mercury at four different concentrations (levels #1–4). Level #1 had concentrations of each mercury species that were close to the anticipated LOD; Level #4 had concentrations  $\sim 10X$  greater than those of Level #1. Upon final completion of this study's analytical phase, the LOD for each species was obtained from summary statistics of the pooled results. The standard deviation of pooled results at each level was plotted against its concentration and the points fitted by least squares linear regression. The Y-axis intercept (standard deviation), which is in concentration units, is multiplied by 3. It is this value that is defined as the LOD. For reporting purposes, results below the LOD are reported as "< LOD". The LOD should be reevaluated every two years.

**TABLE 13-1: Limits of Detection (LOD)**

Species Chemical Name	Abbreviated Name	Limit of Detection, µg/L
Inorganic Mercury	BHGI	0.27
Methyl Mercury	BHGM	0.12
Ethyl Mercury	BHGE	0.16

#### **XIV. REPORTABLE RANGE OF RESULTS**

---

Only analyte results having values within the analytical concentration range may be reported without requiring dilution of the sample. The analytical concentration range for this method is LOD to 10 µg/L. Samples having results greater than the upper limit of the analytical range must be diluted to bring the analyte within the analytical concentration range and reanalyzed using this method. The final result is the diluted sample result arithmetically corrected for the dilution. [Total mercury concentration values produced by DLS 3001 method will be available for the analyst to predict needed dilution factors prior the analysis of blood samples by this method \(DLS 3020\).](#)

#### **XV. SPECIAL PROCEDURE NOTES - CDC MODIFICATIONS**

---

None applicable for this operation.

#### **XVI. QUALITY CONTROL PROCEDURES**

---

The Inorganic Toxicology and Nutrition Branch uses the method described in this protocol for environmental and occupational health screening studies.

This analytical method uses two types of Quality Control (QC) systems: With one type of the QC system, the analyst inserts bench QC specimens two times in each analytical run (a set of consecutive assays performed without interruption) so that judgments may be made on the day of analysis. With the other type of QC system, "blind" QC samples are placed in vials, labeled, and processed so that they are indistinguishable from the subject samples (as many as possible). The supervisor decodes and reviews the results of the blind specimens. With both systems, taking these samples through the complete analytical process assesses all levels of the analyte concentrations. The data from these materials are then used to estimate methodological imprecision and to assess the magnitude of any time-associated trends. The bench QC pools used in this method comprise two levels of concentration spanning the "low-normal" and "high-normal" ranges for each mercury species. Both of these pools are analyzed after the calibration standards, but before any patient samples are analyzed so that judgments on the mercury species calibration curves may be made before analysis of patient samples. These bench QCs should be analyzed again at the end of the run (no more than 20 samples). If a second run of = 20 samples are analyzed using the same calibration curve as the first run, the QC results obtained from the second run's own bench QC samples need to be analyzed and treated independent of the first run.

### A. Establish QC limits for each QC pool.

Perform an analysis of the mean and standard deviation for each pool from the concentration results observed in at least 20 characterization runs. During the 20 characterization runs, analyze samples from previously characterized QCs or pools with target values assigned by outside laboratories to evaluate each run's QC. In addition to providing QC limits, the characterization runs also serve to establish homogeneity of the pools. After the homogeneity of the bench materials is established, analysis by another independent reference method (e.g., isotope dilution mass spectroscopy) is useful.

### B. Precision and Accuracy

QC Results Evaluation. After completing a run, consult the QC limits to determine whether the run is "in control." The QC rules apply to the average of the beginning and ending analyses of each of the bench QC pools. The QC rules are as follows:

- 1) If both the low-and the high-QC results are within the 2s limits, accept the run.
- 2) If one of two QC results is outside the 2s limits, apply the rules below and reject the run if any condition is met.

**1<sub>3s</sub>** - Average of both low QCs OR average of both high QCs is outside of a 3s limit.

**2<sub>2s</sub>** - Average of both low QCs AND average of both high QCs is outside of 2s limit on the same side of the mean.

**R<sub>4s</sub> sequential** - Average of both low QCs AND average of both high QCs is outside of 2s limit on opposite sides of the mean.

**10<sub>x</sub> sequential** - The previous nine average QCs results (for the previous nine runs) were on the same side of the mean for either the low OR high QC.

If the run is declared "out of control," the analysis results for all patient samples analyzed during that run are invalid for reporting.

### C. Remedial Action If Calibration or QC Systems Fail to Meet Acceptable Criteria

If an analyte result for a QC material falls outside of the limits for mean or range, the following steps should be taken, if possible:

- Check the chromatograms for each blank, QC, and sample for proper peak integration and identification. Change integration parameters or manually reintegrate peaks, if necessary, and reprocess the run in TotalChom™.
- Setup a new run for the reanalysis of the patient samples affected by the previous failed run. Be sure to use freshly prepared QC material.

If these steps do not result in correction of the out-of-control values for QC materials, consult the supervisor for other appropriate corrective actions. No analytical results should be reported for runs that are not in statistical control.

## **XVII. REFERENCE RANGES**

---

The reference range for each mercury species (see TABLE 17-1) is based on literature reports and from periodic review of accumulated data collected during the analysis of blood samples representing a normal, healthy population believed to be free of unusual exposure to mercury. Where data is absent or scant, references ranges are based on the scientific literature, if available.

**TABLE 17-1: Reference ranges for Mercury Species**

Species Chemical Name	Reference Range <sup>1</sup> , µg/L
Inorganic Hg	
Methyl Hg	< 10 µg/L (within the established linearity for the method)
Ethyl Hg <sup>2</sup>	

<sup>1</sup> Above ranges are estimates based on data from the Fourth National Report on Exposure to Environmental Chemicals.

<sup>2</sup> There are no established reference ranges for EtHg.

## **XVIII. ACTION-LEVEL RESULTS**

---

The analyst should report any patient results confirmed to be greater than the second upper boundary (defined in the laboratory database as the "2UB" and currently 5.8 µg/L) to the QC reviewer as an "elevated result". The protocol for supervisors reporting elevated results to medical personnel is defined according to the study protocol. Levels of concern for mercury in blood are >100 µg/L for children (6 years and younger) and >200 µg/L for adults. These values are based on total mercury results.

## **XIX. SPECIMEN STORAGE AND HANDLING DURING TESTING**

---

Specimens may reach and maintain ambient temperature during analysis. Take stringent precautions to avoid external contamination. After the samples are analyzed, return them to ≤ -20 °C freezer storage as soon as possible.

## **XX. ALTERNATE METHODS FOR PERFORMING TEST AND STORING SPECIMENS IF TEST SYSTEM FAILS**

---

If the analytical system fails, freezer storage (≤ -20 °C) is recommended until the analytical system is restored functionality.

## **XXI. TEST-RESULT REPORTING SYSTEM; PROTOCOL FOR REPORTING CRITICAL CALLS (IF APPLICABLE)**

---

For critical calls, the supervisor should notify the supervising physician or principal investigator as soon as possible. The most expeditious means should be used (e.g., telephone, FAX, or E-mail).

## **XXII. TRANSFER OR REFERRAL OF SPECIMENS; PROCEDURES FOR SPECIMEN ACCOUNTABILITY AND TRACKING**

---

The analyst who receives specimens or samples delivered to Inorganic and Radiation Analytical Toxicology Branch sets up a "Specimen Folder." Fill out a tracking form and place it in the folder to be given to the analyst performing the analysis. The form tracks location, status, and final disposition of the specimens.

Use standard electronic record keeping means (e.g., Microsoft Access™, optical disk, or tape backup) to track specimens. Maintain records, including related quality assurance (QA) and QC data, for 3 years or longer. Keep duplicate records (off site, if sensitive or critical) in electronic or hardcopy format. Use only numerical identifiers (e.g., case ID numbers); all personal identifiers are available only to the medical supervisor or project coordinator to safeguard confidentiality.

## **XXIII. REFERENCES**

---

1. Tietz Textbook of Clinical Chemistry, edited by Carl A. Burtis, Edward R. Ashwood, Third Edition, 1999, 992-993.
2. Agency for Toxic substances and Disease Registry (ATSDR). Toxicological profile for mercury. Atlanta, GA: Public Health service, 2000.
3. Third National Report on Human Exposure to Environmental Chemicals: Atlanta (GA): CDC, 2005.
4. Toxicological Effect of Methylmercury, National Research Council, National Academy Press, 2001, 54-59.
5. NHANES 1999-2002, Update on Hg, Mahaffey, K.R., Fish Forum-2005, US EPA, Washington, D.C., September 2005
6. Baranov VI, Tanner SD. A dynamic reaction cell for inductively coupled plasma mass spectrometry (ICP-DRC-MS). Part 1. The rf-field energy contribution in thermodynamics of ion-molecule reactions. J. Anal. At. Spectrom. 1999;14:1133-1142.
7. Tanner S, Baranov VI, Vollkopf U. A dynamic reaction cell for inductively coupled plasma mass spectroscopy (ICP-DRC-MS). Part III. Optimization and analytical performance. J. Anal. At. Spectrom. 2000;15:1261-1269.

## **XXIV. APPENDIX**

---

### **A. Appendix A. Critical Parameters Testing Results.**

1. **Critical Parameter Test #1: Evaluate the significance of the GC injector temperature**
  - a) **Test Details (to be repeated for each temperature):**
    - 1) Set up the analysis in accordance with the prescribed method.
    - 2) Set the injector temperature to 200 °C (reduced temperature).
    - 3) Digest blood QC according to the prescribed method.
    - 4) Analyze all digested samples together in one run.
    - 5) Repeat the analysis using a column oven temperature of 220 °C (the method prescribed temperature).



- 6) Repeat the analysis using a column oven temperature of 230 °C (increased temperature).

**Critical Parameter Test 1 Results.** Temperature of the GC injector. One quality control pool was tested. Tests performed 8/5/10 by Mark Fresquez. Results below are the averages of observed results at each condition along with the 95<sup>th</sup> percent confidence intervals (in parentheses).

QC Pool ID	GC injector Temperature (°C)	InHg (µg/L)	MeHg (µg/L)	EtHg (µg/L)
QC Pool LB07292	200 °C (Reduced)	<b>1.27</b> (1.17, 1.38)	<b>1.04</b> (0.99, 1.09)	<b>1.22</b> (1.14, 1.30)
	220 °C (Per Method)	<b>1.28</b> (1.00, 1.55)	<b>1.08</b> (1.00, 1.16)	<b>1.32</b> (1.27, 1.36)
	230 °C (Increased)	<b>1.39</b> (1.27, 1.51)	<b>1.09</b> (1.02, 1.17)	<b>1.20</b> (1.06, 1.35)
Expected Range ( ± 2 SD)*				

\*Expected range is a determined range calculated from the mean ± 2 SD of a 22 run characterization.

## 2. Critical Parameter Test #2: Evaluate the significance of the Combipal-agitator equilibration/extraction temperature

### a) Test Details (to be repeated for each temperature):

- 1) Set up the analysis in accordance with the prescribed method.
- 2) Set the agitator equilibration/extraction temperature to 40 °C (elevated temperature).
- 3) Digest blood QC according to the prescribed method.
- 4) Analyze all digested samples together in one run.
- 5) Repeat the analysis using an equilibration/extraction temperature at room temperatures ~ 25 °C (the method prescribed temperature).
- 6) Repeat the analysis using an equilibration/extraction temperature of 50 °C (increased temperature).

**Critical Parameter Test 2 Results.** Temperature of the Combipal – agitator equilibration/extraction. One quality control pool was tested. Tests performed 8/17/10 by Mark Fresquez. Results below are the averages of observed results at each condition along with the 95<sup>th</sup> percent confidence intervals (in parentheses).

QC Pool ID	Equilibration/Extraction Temperature (°C)	InHg (µg/L)	MeHg (µg/L)	EtHg (µg/L)
QC Pool LB07292	~ 25 °C (Per Method)	<b>1.42</b> (1.20, 1.65)	<b>1.05</b> (1.03, 1.07)	<b>1.17</b> (1.07, 1.27)
	40 °C (Increased)	<b>1.33</b> (1.27, 1.39)	<b>1.05</b> (1.01, 1.09)	<b>1.17</b> (1.11, 1.23)
	50 °C (Increased)	<b>1.25</b> (1.08, 1.42)	<b>1.07</b> (1.05, 1.10)	<b>1.19</b> (1.06, 1.32)
Expected Range ( ± 2 SD)*				

## 3. Critical Parameter Test #3: Evaluate the significance of the length of extraction of sample from SPME fiber in GC injector

### a) Test Details:

- 1) Set up the analysis in accordance with the prescribed method.
- 2) Set the extraction time to 10 minutes (reduced time).
- 3) Digest blood QC according to the prescribed method.
- 4) Analyze all digested samples together in one run.
- 5) Repeat the analysis using an extraction time of 15 minutes (reduced time).
- 6) Repeat the analysis using an extraction time of 20 minutes (the method prescribed time).

**Critical Parameter Test 3.** Length of extraction time. Test performed 8/18/10 by Mark Fresquez. Results below are the averages of observed results at each condition along with the 95<sup>th</sup> percent confidence intervals (in parentheses).

QC Pool ID	Sample extraction time (minutes)	InHg (µg/L)	MeHg (µg/L)	EtHg (µg/L)
QC Pool LB07292	10 min. (Reduced)	<b>1.69</b> (1.58, 1.80)	<b>1.02</b> (0.97, 1.08)	<b>1.16</b> (1.09, 1.22)
	15 min. (Reduced)	<b>1.34</b> (1.32, 1.38)	<b>1.04</b> (1.02, 1.05)	<b>1.20</b> (1.18, 1.22)
	20 min. (Per Method)	<b>1.33</b> (1.32, 1.37)	<b>1.05</b> (1.05, 1.09)	<b>1.17</b> (1.14, 1.18)
Expected Range ( ± 2 SD)*				

#### 4. Critical Parameter Test #4: Evaluate the significance of changing GC split ratio.

##### a) Test Details:

- 1) Set up the analysis in accordance with the prescribed method.
- 2) Set the split ratio to 20:1 (reduced ratio).
- 3) Digest blood QC according to the prescribed method.
- 4) Analyze all digested samples together in one run.
- 5) Repeat the analysis using split ratio of 28:1 (the method prescribed).
- 6) Repeat the analysis using split ratio of 35:1 (increased ratio).

**Critical Parameter Test 4.** GC split ratio. Test performed 8/24/10 by Mark Fresquez. Results below are the averages of observed results at each condition along with the 95<sup>th</sup> percent confidence intervals (in parentheses).

QC Pool ID	GC split ratio	InHg (µg/L)	MeHg (µg/L)	EtHg (µg/L)
QC Pool LB07292	20:1 (Reduced)	<b>1.31</b> (1.26, 1.36)	<b>1.06</b> (1.02, 1.10)	<b>1.17</b> (1.14, 1.19)
	28:1 (Per Method)	<b>1.34</b> (1.29, 1.39)	<b>1.04</b> (1.03, 1.05)	<b>1.15</b> (1.13, 1.19)
	35:1 (Increased)	<b>1.34</b> (1.27, 1.41)	<b>1.06</b> (1.04, 1.08)	<b>1.17</b> (1.15, 1.20)
Expected Range ( ± 2 SD)*				

5. **Critical Parameter Test #5: Evaluate the significance of changing GC carrier gas flow rate.**

a) **Test Details:**

- 1) Set up the analysis in accordance with the prescribed method.
- 2) Set the flow rate 1.5 mL/min (reduced).
- 3) Digest blood QC according to the prescribed method.
- 4) Analyze all digested samples together in one run.
- 5) Repeat the analysis using a flow rate of 2.0 mL/min (the method prescribed).
- 6) Repeat the analysis using a flow rate of 2.5 mL/min (increased).

**Critical Parameter Test 5.** GC carrier gas flow rate. Test performed 8/24/10 by Mark Fresquez. Results below are the averages of observed results at each condition along with the 95<sup>th</sup> percent confidence intervals (in parentheses).

QC Pool ID	GC carrier gas flow rate (mL/min)	InHg (µg/L)	MeHg (µg/L)	EtHg (µg/L)
QC Pool LB07292	1.5 mL/min (Reduced)	<b>1.36</b> (1.32, 1.39)	<b>1.07</b> (1.04, 1.10)	<b>1.16</b> (1.14, 1.18)
	2.0 mL/min (Per Method)	<b>1.31</b> (1.25, 1.37)	<b>1.07</b> (1.05, 1.08)	<b>1.16</b> (1.13, 1.19)
	2.5 mL/min (Increased)	<b>1.35</b> (1.31, 1.39)	<b>1.05</b> (1.03, 1.07)	<b>1.17</b> (1.12, 1.21)
Expected Range ( ± 2 SD)*				

# Division of Laboratory Sciences Laboratory Protocol

<b>Analyte:</b>	<b>arsenobetaine, arsenocholine, trimethylarsine oxide, monomethylarsonic acid, dimethylarsinic acid, arsenous (III) acid, arsenic (V) acid</b>
<b>Matrix:</b>	<b>Urine</b>
<b>Method:</b>	<b>Urine arsenic speciation HPLCICPDRCMS (Renamed from: Inductively Coupled Plasma Dynamic Reaction Cell Mass Spectrometry (HPLC-ICP-DRC-MS))</b>
<b>Method Code:</b>	<b>3000.2 (Renamed from 0161A/01-OD)</b>
<b>Branch:</b>	<b>Inorganic and Radiation Analytical Toxicology</b>

Prepared By: Carl P. Verdon, PhD \_\_\_\_\_  
author's name signature date

Supervisor: Kathleen L. Caldwell, PhD \_\_\_\_\_  
Supervisor's name signature date

Branch Chief: Robert L. Jones PhD \_\_\_\_\_  
Branch Chief's name signature date

Adopted: \_\_\_\_\_  
date

Updated: August 08, 2010  
date

Director's Signature Block:

Reviewed:

\_\_\_\_\_  
signature date

\_\_\_\_\_  
signature date

\_\_\_\_\_  
signature date

\_\_\_\_\_

**Urine arsenic species HPLCICPDRCMS** (Formerly Arsnic species in Urine)

**IRAT-DLS**

**DLS Method Code: 3000.2 (formerly 016A/01-OD)**

**This page is intentionally left blank.**

**Urine arsenic species HPLCICPDRCMS** (Formerly Arsnic species in Urine)

**IRAT-DLS**

**DLS Method Code: 3000.2 (formerly 016A/01-OD)**

**Modifications/Changes:** see Procedure Change Log STARLIMS

**Urine arsenic species HPLCICPDRCMS** (Formerly Arsnic species in Urine)

**IRAT-DLS**

**DLS Method Code: 3000.2 (formerly 016A/01-OD)**

**This page is intentionally left blank.**



---

## Laboratory Procedure Manual

*Analyte:* arsenobetaine, arsenocholine, trimethylarsine oxide, monomethylarsonic acid, dimethylarsinic acid, arsenous (III) acid, arsenic (V) acid

*Matrix:* Urine

*Method:* Urine arsenic speciation  
HPLCICPDRCMS  
(Renamed from High Performance Liquid Chromatography Inductively Coupled Plasma Dynamic Reaction Cell Mass Spectrometry (HPLC-ICP-DRC-MS))

*Method No:* 3000.2 (Formerly 0161A/01-OD)

*Revised:* **November 16, 2011**

*as performed by:*

Inorganic and Radiation Analytical Toxicology Branch  
Division of Laboratory Sciences  
National Center for Environmental Health

*contact:*

Dr. Robert L. Jones  
Phone: 770-488-7991  
Fax: 770-488-4097  
Email: [RLJones@cdc.gov](mailto:RLJones@cdc.gov)

James L. Pirkle, M.D., Ph.D.  
Director, Division of Laboratory Sciences

### *Important Information for Users*

CDC periodically refines these laboratory methods. It is the responsibility of the user to contact the person listed on the title page of each write-up before using the analytical method to find out whether any changes have been made and what revisions, if any, have been incorporated.



**Urine arsenic species HPLCICPDCMS** (Formerly Arsenic species in Urine)

**IRAT-DLS**

DLS Method Code: 3000.2 (Formerly 016A/01-OD)

**This page is intentionally left blank.**

## Table of Contents

<b>1.</b>	<b>CLINICAL RELEVANCE AND TEST PRINCIPLE .....</b>	<b>1</b>
a.	Clinical Relevance	1
b.	Test Principle	1
<b>2.</b>	<b>SAFETY PRECAUTIONS .....</b>	<b>3</b>
<b>3.</b>	<b>DATA SYSTEM MANAGEMENT.....</b>	<b>3</b>
a.	Data Entry and Transfer	3
b.	Routine Computer Hard Drive Maintenance	4
c.	Data Backup	4
(1)	Schedule of Data Backups	4
(2)	Backup Procedures	4
d.	Documentation of System Maintenance	5
<b>4.</b>	<b>COLLECTING, STORING, AND HANDLING SPECIMENS; CRITERIA FOR REJECTING SPECIMENS.....</b>	<b>5</b>
a.	Specimen Type	5
b.	Specimen Collection, Handling, and Storage	6
c.	Criteria for an Unacceptable Specimen	6
<b>5.</b>	<b>PROCEDURES FOR MICROSCOPIC EXAMINATIONS .....</b>	<b>6</b>
<b>6.</b>	<b>CHEMICALS, STANDARDS, AND QUALITY CONTROL MATERIAL.....</b>	<b>6</b>
a.	Chemicals and Standards	6
b.	Standards	7
c.	Quality Control Material	8
<b>7.</b>	<b>INSTRUMENTATION, EQUIPMENT, SOFTWARE, AND SUPPLIES.....</b>	<b>8</b>
a.	Instrumentation	8
(1)	HPLC System	8
(2)	ICP-DRC-MS System	9
b.	Equipment	9
c.	Computer Software	10
d.	Supplies	10
<b>8.</b>	<b>INSTRUMENT SETUP AND CONFIGURATION.....</b>	<b>12</b>
a.	HPLC Hardware Setup	12

b.	Software Installation	13
c.	Peristaltic Pump Setup	14
d.	Electrical Connections	14
e.	Six-Port Switching Valves	15
<b>9.</b>	<b>STANDARD PROCEDURE .....</b>	<b>18</b>
a.	Preparation of Stock Solutions	18
b.	Preparation of Matrix-Matched Material (“Base Urine”)	18
c.	Preparation of Working Solutions	19
d.	Preparation of Stock Standards (Concentrated)	20
e.	Preparation of Intermediate Standards	22
f.	Microwave Digestion for Conversion to Arsenate (AsV)	22
g.	Method of Standard Additions (MSA)	23
h.	Determining the Total Arsenic Concentration	25
i.	Assessment of Purity by HPLC-DRC-ICP-MS	26
j.	Preparation of Concentrated Stock Internal Standard	26
k.	Preparation of Working Calibrators	27
(1)	Preparation of Intermediate “Mixed Species” Calibration Solutions	27
(2)	Preparation of Working Calibrator Series	27
l.	Preparation of Quality Control Material	29
m.	Processing of Urine Samples and QC Material	29
n.	HPLC Instrument Setup	31
(1)	Programming the HPLC Pump Methods	31
(2)	Programming the HPLC Autosampler	34
o.	ICP-DRC-MS Instrument Setup	35
(1)	Programming the DRC Gas Flow Delay Parameter	35
(2)	Programming the ELAN “.mth” file	35
(3)	Programming the ELAN “.dac” file	38
(4)	Creating the ELAN Sample Table “.sam” file	38
p.	HPLC–ICP-DRC-MS System Connection and Startup	40
(1)	Interfacing the HPLC Column to the ICP-DRC-MS Nebulizer	40
(2)	Priming the HPLC Pump	41
(3)	Adjusting the External Peristaltic Pump	42
q.	ICP-DRC-MS Warm Up and Performance Check	42
r.	Turning on the Reaction Cell Gas	44
s.	Entering Sample Names into the ELAN Sample Table	45

t.	Starting the Run	47
u.	Instrument Shut Down	50
10.	POST-RUN DATA ANALYSIS.....	50
a.	Configuration of TotalChrom™ Integration Method	50
b.	Configuration of ELAN ChromLink™	55
c.	Data Processing and Analysis	57
11.	RECORDING OF SAMPLE AND QC DATA.....	65
a.	Transferring the Data to the Central Database	65
b.	QC Data	66
12.	FINAL REVIEW OF THE DATA.....	66
a.	Analysis Printouts and Analyst Run Report	66
b.	Plotting QC Results	66
c.	Supervisor Review	67
13.	REPLACEMENT AND PERIODIC MAINTENANCE OF KEY COMPONENTS.....	67
a.	ICP-MS Maintenance	67
14.	LIMIT OF DETECTION AND LINEAR RANGE TESTED .....	68
15.	REPORTABLE RANGE OF RESULTS.....	68
16.	SPECIAL PROCEDURE NOTES – CDC MODIFICATIONS .....	69
17.	QUALITY CONTROL PROCEDURES.....	69
a.	Establish QC limits for each QC pool.	69
<b><u>b.</u></b>	Precision and Accuracy	70
c.	Remedial Action If Calibration or QC Systems Fail to Meet Acceptable Criteria	70
18.	LIMITATIONS OF METHOD; INTERFERING SUBSTANCES AND CONDITIONS.....	71
19.	REFERENCE RANGES.....	71
20.	ACTION-LEVEL RESULTS .....	71
21.	SPECIMEN STORAGE AND HANDLING DURING TESTING .....	71
22.	ALTERNATE METHODS FOR PERFORMING TEST AND STORING SPECIMENS IF TEST SYSTEM FAILS .....	72
23.	TEST-RESULT REPORTING SYSTEM; PROTOCOL FOR REPORTING CRITICAL CALLS (IF APPLICABLE) .....	72

24.	TRANSFER OR REFERRAL OF SPECIMENS; PROCEDURES FOR SPECIMEN ACCOUNTABILITY AND TRACKING .....	72
25.	BI-ANNUAL EXTENDED LINEAR RANGE VERIFICATION STUDY.....	72
26.	BI-ANNUAL INSTRUMENT-TO-INSTRUMENT COMPARISON .....	72
27.	REFERENCES.....	73
28.	APPENDIX .....	76
	a. Macro Procedure “Extract TC Data”	76
	b. Sample Chromatographic Report	106

List of Tables

TABLE 1-1: Species of Arsenic.....	2
TABLE 9-1: Preparation of Stock Standards .....	21
TABLE 9-2: Formula Weights of Arsenic Species .....	22
TABLE 9-4: METHOD OF STANDARD ADDITIONS TABLE 1.....	24
TABLE 9-5: METHOD OF STANDARD ADDITIONS TABLE 2.....	25
TABLE 9-3: Gilson 402™ Settings for Making Diluted Series .....	28
TABLE 9-4: HPLC Pump Program Settings .....	32
TABLE 9-5: HPLC Pump Column Wash Program.....	33
TABLE 9-6: ELAN® Timing Parameters.....	36
TABLE 9-7: ELAN® Analyte Parameters.....	36
TABLE 9-8: ELAN® Processing Parameters.....	37
TABLE 9-9: ELAN® Sampling Parameters.....	37
TABLE 9-10: ELAN® Report Parameters.....	37
TABLE 9-11: ELAN® Optimization Parameters.....	38
TABLE 9-12: Sample Template Data.....	39
TABLE 9-13: Sample Template Data.....	39
TABLE 9-14: ELAN Samples Table .....	46
TABLE 10-1: Integration.....	51
TABLE 10-2: Baseline Timed Events.....	51
TABLE 10-3: Replot .....	52
TABLE 10-5: Method Editor – Components Settings .....	53
TABLE 10-6: Components Defaults — IDENTIFICATION .....	54
TABLE 10-7: Components Defaults — CALIBRATION .....	54
Figure 1: Post-Run Data Processing Work Flow Diagram.....	58

TABLE 10-8: TotalChrom™ Navigator – Reprocess Batch ..... 62

TABLE 14-1: Limits of Detection (LOD) and Linear Range Tested (LRT) for As Species 68

TABLE 19-1: Reference ranges for Arsenic Species..... 71

## 1. CLINICAL RELEVANCE AND TEST PRINCIPLE

---

### a. Clinical Relevance

People encounter arsenic in many chemical forms that vary in toxicity. The most toxic of the naturally-occurring arsenic compounds are inorganic forms of arsenic and their monomethylated metabolites (1). Less toxic are the organic arsenic compounds (2-5). Exposure to inorganic arsenic can result in a variety of adverse health effects, such as skin disorders, nerve impairment, cancer of the liver, bladder, kidneys, prostate, and lungs, and even death from large doses (6, 7). People may be exposed to inorganic arsenic through activities such as drinking water contaminated from geological sources (8-14) or because of occupational exposure (15-19), especially breathing air contaminated with sawdust or smoke from wood treated with chromated copper arsenic preservatives (20-25). Organic arsenic compounds are generally less toxic and may be encountered by ingesting various types of fish, shellfish, or seaweed (26-31).

The method described in this manual assesses arsenic exposure, as defined by exposure to individual arsenic species by analyzing urine through the use of high performance liquid chromatography (HPLC) coupled to inductively coupled-plasma dynamic reaction cell-mass spectrometry (ICP-DRC-MS). Urine is analyzed because urinary excretion is the major pathway for eliminating arsenic from the mammalian body (32-34). This hyphenated method will provide accurate quantification of seven urinary arsenic species: arsenite (valence III) and arsenate (valence V), organic forms of arsenic to include monomethylarsonic acid (MMA) and dimethylarsinic acid (DMA), trimethylarsine oxide (TMAO), arsenocholine (AsCo), arsenobetaine (AsB) (see TABLE 1-1).

### b. Test Principle

The concentrations of arsenate [As(V)], arsenite [As(III)], MMA, DMA, TMAO, AC, and AB are determined by using high performance liquid chromatography (HPLC) to separate the species coupled to an ICP-DRC-MS to detect the arsenic species. This analytical technique is based on separation by anion-exchange chromatography (IC) followed by detection using quadrupole ICP-MS technology and includes DRC™ technology (35), which minimizes or eliminates many argon-based polyatomic interferences (36). Column separation is largely achieved due to differences in charge-charge interactions of each negatively-charged arsenic component in the mobile phase with the positively-charged quaternary ammonium groups bound at the column's solid-liquid interface. Upon exit from the column, the chromatographic eluent goes through a nebulizer where it is converted into an aerosol upon entering the spray chamber. Carried by a stream of argon gas, a portion of the aerosol is transported through the spray chamber and then through the central channel of the plasma, where it is heated to temperatures of 6000-8000° K. This thermal energy atomizes and ionizes the sample. The ions and the argon enter the mass spectrometer through an interface that separates the ICP, which is operating at atmospheric pressure (approximately 760 torr), from the mass spectrometer, which is operating at approximately 10<sup>-5</sup> torr. The mass spectrometer permits detection of ions at each mass-to-charge ratio in rapid sequence, which allows the determination of individual isotopes of an element. Once inside the mass spectrometer, the ions pass through the ion optics, then through the DRC™, and finally through the mass-analyzing quadrupole before being detected as they strike the surface of the detector. The ion optics uses an electrical field to focus the ion beam into the DRC™. The DRC™ component is pressurized with an appropriate reaction gas and contains a quadrupole. In the



DRC™, elimination or reduction of argon-based polyatomic interferences takes place through the interaction of the reaction gas with the interfering polyatomic species in the incoming ion beam. The quadrupole in the DRC™ allows elimination of unwanted reaction by-products that would otherwise react to form new interferences.

TABLE 1-1: SPECIES OF ARSENIC

Name	Abbreviation	Structural Formula	pK <sub>a</sub>
Arsenobetaine	AB	$\begin{array}{c} \text{CH}_3 \\   \\ \text{H}_3\text{C}-\text{As}^+-\text{CH}_2\text{COOH} \\   \\ \text{CH}_3 \end{array}$	-
Arsenocholine	AC	$\begin{array}{c} \text{CH}_3 \\   \\ \text{H}_3\text{C}-\text{As}^+-\text{CH}_2\text{CH}_2\text{OH} \\   \\ \text{CH}_3 \end{array}$	-
Monomethyl arsonic acid	MMA	$\begin{array}{c} \text{OH} \\   \\ \text{H}_3\text{C}-\text{As}^{(\text{V})} \\ // \quad \backslash \\ \text{O} \quad \text{OH} \end{array}$	4.1, 8.7
Dimethylarsinic acid	DMA	$\begin{array}{c} \text{CH}_3 \\   \\ \text{H}_3\text{C}-\text{As}^{(\text{V})} \\ // \quad \backslash \\ \text{O} \quad \text{OH} \end{array}$	6.2
Trimethylarsine oxide	TMAO	$\begin{array}{c} \text{CH}_3 \\   \\ \text{H}_3\text{C}-\text{As}^{(\text{V})} \\ // \quad \backslash \\ \text{O} \quad \text{CH}_3 \end{array}$	-
Arsenic (V) acid (arsenate)	As(V)	$\begin{array}{c} \text{OH} \\   \\ \text{O}=\text{As}^{(\text{V})} \\ // \quad \backslash \\ \text{HO} \quad \text{OH} \end{array}$	2.2, 7.0, 11.5
Arsenous (III) acid (arsenite)	As(III)	$\begin{array}{c} \text{OH} \\   \\ \text{HO}-\text{As}^{(\text{III})} \\ \backslash \\ \text{OH} \end{array}$	9.2, 12.1, 13.4

## 2. SAFETY PRECAUTIONS

---

**Precautionary information that is important to protecting personnel and safeguarding equipment will be presented inside a box, such as this one, throughout the procedure where appropriate.**

Follow universal precautions. Wear gloves, a lab coat, and safety glasses while handling human blood, plasma, serum, urine or other bodily fluid or tissue. Place disposable plastic, glass, and paper (e.g., pipette tips, autosampler tubes, and gloves) that come in contact with human biological fluids, such as urine, in a biohazard autoclave bag. Keep these bags in appropriate containers until they are sealed and autoclaved. When work is finished, wipe down all work surfaces where human biological fluid was handled with a 10% (v/v) sodium hypochlorite solution. Dispose of all biological samples and diluted specimens in a biohazard autoclave bag at the end of the analysis according to CDC/DLS guidelines for disposal of hazardous waste.

PerkinElmer provides safety information that should be read before operating the instrument. This information is found in the PerkinElmer ELAN<sup>®</sup> 6100 ICP-DRC-MS System Safety Manual. Possible hazards include ultraviolet radiation, high voltages, radio-frequency radiation, and high temperatures.

### **Caution!**

**Exercise caution when handling and dispensing concentrated nitric acid. Always remember to add acid to water. Nitric acid is a caustic chemical that is capable of severe eye and skin damage. Wear powder-free gloves, a lab coat, and safety glasses. If nitric acid comes in contact with any part of the body, quickly wash the exposed area with copious quantities of water for at least 15 minutes.**

## 3. DATA SYSTEM MANAGEMENT

---

To maintain the integrity of specimen and analytical data generated by this method, eliminate hand entry of specimen identifiers or analytical results whenever possible, proofread all transcribed data, and regularly back up the ICP-MS computer's hard drive. It is recommended that a defragmentation program be run on the computer's hard drive on a periodic basis.

### a. Data Entry and Transfer

Whenever possible, use bar code scanners to enter sample identifiers into the ICP-DRC-MS computer software to avoid errors associated with the keyboard-entry process and to speed up sample processing. When bar code scanners cannot be used, proofread transcribed data after entry. Handle or transfer data electronically when reporting or moving data to other computerized data-handling software. In the Inorganic and Radiation Analytical Toxicology Branch, sample analysis results generated by this method are stored for long periods in Microsoft Access<sup>™</sup> or MS SQL Server 7<sup>™</sup> database software. The results should include at least the analysis date, analytical run number, quality-control (QC) results for the run, results of specimen analysis by specimen identification (ID), and method identifier.

b. Routine Computer Hard Drive Maintenance

Defragment the computer hard drive by using software such as Microsoft Windows® Disk Defragmenter (located in Start > Programs > Accessories > System Tools) or an equivalent program to maximize computer performance and maintain data integrity for files on the hard drive. An entry will automatically be made in the Windows™ system event log when this process is done providing documentation of this step.

c. Data Backup

**(1) Schedule of Data Backups**

**Weekly.** Full data backups onto one or more recordable compact discs (CD-R) or digital video discs (DVD).

**Daily.** Full data backups onto an external hard drive.

**(2) Backup Procedures**

Whenever making a backup (daily or weekly) include the directories and subdirectories:

- ✓ C:\elandata (include all subdirectories)
- ✓ C:\hplc (include subdirectories “data” and “methods as well as other relevant directories)
- ✓ Other relevant folders.

Before making weekly backups, saving a copy of the Windows™ event log in the active “elandata” directory will ensure archiving of all recent software system events (including communications between ICP-DRC-MS and ELAN® software, as well as times of hard drive defragmentation, and other Windows™ system events).

**(a) External Hard Disk Backups**

- Connect the ELAN data system computer to an external hard disk with sufficient storage capacity to store several copies of the backup files (≥18 gigabytes).
- Configure Microsoft Windows® Backup™ (located in Start > Programs > Accessories > System Tools) program to do a daily backup of the ELAN data system computer’s data directories (see *Backup Procedures*)

**(b) Compact Disc Backups**

- Use CD-R disks only (recordable compact disks), *not* CD-RW disks (rewritable compact disks) so that after creation the recordable compact disk cannot be over-written.
- Use Adaptec “Easy CD Creator”™ or equivalent software to backup.

**(c) Removing Data from the ICP-DRC-MS Computer Hard Drive**

When the active “elandata” and “hplc” directories on the ICP-DRC-MS computer hard drive becomes too large to fit onto a single CD-R, remove the oldest data on the hard drive so that a regular backup can be done onto a single CD-R. Usually, this procedure can be done annually.

- Back up the oldest data on the hard drive in duplicate onto two CD-R disks. Manually select each dataset folder (subdirectories under “C:\elandata\dataset” and “C:\hplc\data”) and other relevant files (i.e., optimization, tuning, and sample files) that are to be included on these backups.
- Verify that backup CD-R disks operate correctly before deleting any data from the hard drive. To verify the operation of a CD-R disk, open any file on the disk by using the appropriate computer software (ICP-DRC-MS software).
- After verifying that all backups are operational, delete the original data from the hard drive.
- Keep one copy of the CD-R disk in a building other than the laboratory (in case of fire). Keep the other near the ICP-MS laboratory.

**(d) Backup of Sensitive Data**

Make a backup for sensitive data on duplicate, recordable compact disk. Store the two CD-R disks in two different buildings.

**d. Documentation of System Maintenance**

**Computer Maintenance:** Record any maintenance of computer hardware, HPLC or ICP-DRC-MS software in the instrument logbook. Place other electronic records relating to integrity of the data and hard drive in the Windows™ event log. Back up the event log on a regular basis by saving a copy in the active “elandata” directory. The event log will then be backed up along with the ELAN data when backup CD-R disks and tapes are made.

**Instrument Maintenance:** Document system maintenance in hard copies of data records (i.e., daily maintenance checklists, PerkinElmer service records, and instrument log book) as well as in electronic records relating to instrument optimization (\*dac) and tuning (default.tun).

**4. COLLECTING, STORING, AND HANDLING SPECIMENS; CRITERIA FOR REJECTING SPECIMENS**

---

**a. Specimen Type**

Specimen type is human urine. No special instructions for fasting or special diets are required of patient or study subjects.

### b. Specimen Collection, Handling, and Storage

Optimal amount of specimen is 0.5 mL; the minimum is 0.25 mL. Use sterile specimen containers for specimen acquisition. Acceptable containers for allotment of urine for this method include 5.0-mL polypropylene cryogenic vials (e.g., Nalgene, Item # 5000-0050). Screen lots of specimen collection cups, containers, and sample tubes for total arsenic contamination before use.

Specimen handling conditions are outlined in the Division of Laboratory Science's protocol for urine collection and handling. To prevent inter-conversion of arsenic species, immediately store or transport urine specimens at  $\leq -20^{\circ}\text{C}$ . Upon receipt, they must remain frozen at  $\leq -20^{\circ}\text{C}$  until time for analysis. Refreeze at  $\leq -20^{\circ}\text{C}$  portions of the sample that remain after analytical aliquots are withdrawn. Samples thawed and refrozen several times may be compromised.

### c. Criteria for an Unacceptable Specimen

The criteria for an unacceptable specimen are low volume sample volumes ( $< 0.25$  mL), suspected contamination due to improper collection procedures or collection devices, and/or contamination during sample preparation/analysis. Specimen contact with dust or dirt may compromise test results. In all cases, request a second urine specimen, if possible.

## 5. PROCEDURES FOR MICROSCOPIC EXAMINATIONS

---

Not applicable for this procedure.

## 6. CHEMICALS, STANDARDS, AND QUALITY CONTROL MATERIAL

---

### a. Chemicals and Standards

1. Water, high purity ( $\geq 18$  M $\Omega$ ·cm resistivity).
2. Ammonium carbonate, (CAS# 506-87-6), MW 96.09, GFS Chemicals, Item #839-12471, or equivalent.
3. Tris(hydroxymethyl)aminomethane, (CAS# 77-86-1), MW 121.14, Bio-refined, GFS Chemicals, Item # 1948-75811, or equivalent.
4. Ammonium Sulfate, (CAS# 7783-20-2), MW 132.13, GFS Chemicals, Item # 1906-13341, or equivalent.
5. Ammonium Acetate, (CAS# 631-61-8), MW 77.08, GFS Chemicals, Item # 547-12401, or equivalent.
6. Acetic Acid, Glacial (CAS# 64-19-7) M.W. 60.05, GFS Chemicals Inc., Item # 624, or equivalent.
7. Ammonium Hydroxide, (CAS# 1336-21-6) M.W. 35.05, Fisher Scientific, Item # A470500, or equivalent.
8. Methanol (CAS# 67-56-1) M.W. 32.04, GFS Chemicals, Item # 2483-50441, or equivalent.
9. 10% hydrogen in argon gas mixture,  $\geq 99.999\%$  purity, Matheson Tri-Gas

- Products, San Jose, California, or equivalent.
10. Double-distilled nitric acid, GFS Chemicals, or equivalent.
  11. 1,000 mg/L Gallium, SPEX CertiPrep, Item # PLGA2-2Y, or any equivalent traceable to the National Institute for Standards and Technology.
  12. Certified pH 7 and pH 10 calibration solutions.
  13. Liquid argon.
  14. Acetonitrile, HPLC or Spectrophotometer grade, GFS Chemicals, or equivalent.
  15. Bleach (10% sodium hypochlorite solution) from any vendor.
  16. Base urine pooled from anonymous donors or purchased from a vendor.
  17. Potassium Persulfate, purified GFS Chemicals, Item #61712, or equivalent.

#### b. Standards

The following is a list of possible sources of material for the seven arsenic species. A mixture of the sources is used at any given time to provide calibration material that is from different sources. Other sources can be used, and please note that the availability of the sources listed is subject to change without notice.

1. Arsenic (III) oxide,  $\text{As}_2\text{O}_3$ , CAS 1327-53-3, MW 197.84, Sigma-Aldrich, Item # 202673, or equivalent.
2. Arsenic (III) speciation standard in 2% HCl, Spex CertiPrep, Item # SPEC-AS3, or equivalent.
3. Arsenic (V) oxide hydrate,  $\text{As}_2\text{O}_5 \cdot x\text{H}_2\text{O}$ , CAS 12044-50-7, MW 229.84, Sigma-Aldrich, Item # 363456, or equivalent source or vendor.
4. Arsenic (V) speciation standard in water, Spex CertiPrep, Item # SPEC-AS5, or equivalent.
5. Arsenobetaine,  $(\text{CH}_3)_3\text{AsCH}_2\text{COOH}$ , CAS 64436-13-1, MW 178.06, Sigma-Aldrich, Item # 11093, or equivalent.
6. Arsenobetaine,  $(\text{CH}_3)_3\text{AsCH}_2\text{COOH}$ , CAS 64436-13-1, MW 178.06, Wako USA, Item # 321-34911, or equivalent.
7. Arsenobetaine,  $(\text{CH}_3)_3\text{AsCH}_2\text{COOH}$ , CAS 64436-13-1, MW 178.06, Argus, Vernio, Italy, Item # AR60008, or equivalent.
8. Arsenocholine bromide,  $(\text{CH}_3)_3\text{AsCH}_2\text{CH}_2\text{OH} \cdot \text{Br}$ , MW 244.99, Argus, Vernio, Italy, Item # AR60010, or equivalent.
9. Arsenocholine bromide,  $(\text{CH}_3)_3\text{AsCH}_2\text{CH}_2\text{OH} \cdot \text{Br}$ , MW 244.99, Wako USA, Item # 328-34921, or equivalent.
10. Dimethylarsinic acid,  $(\text{CH}_3)_2\text{As}(\text{OH})_2$ , MW 138.01, Sigma-Aldrich, Item # PS-51, or equivalent.
11. Cacodylic Acid,  $(\text{CH}_3)_2\text{As}(\text{O})\text{OH}$ , CAS 75-60-5, MW 138.00, Sigma-Aldrich, Item # 20835-10G-F, or equivalent.
12. Disodium methyl arsenate,  $\text{CH}_3\text{AsO}_3 \cdot 6\text{H}_2\text{O}$ , CAS 144-21-8, MW 291.9, Sigma-Aldrich, Item # PS-281, or equivalent.

13. Monosodium acid methane arsonate sesquihydrate, CAS 2163-80-6, Sigma-Aldrich, Item #, PS-429, or equivalent.
14. Trimethylarsine oxide, (CH<sub>3</sub>)<sub>3</sub>AsO, CAS 4964-14-1, MW 136.03, Argus Chemicals, Vernio, Italy, Item # AR60011, or equivalent.
15. Trimethylarsine oxide, (CH<sub>3</sub>)<sub>3</sub>AsO, CAS 4964-14-1, MW 136.02, Wako USA, Item # 321-34891, or equivalent.

c. Quality Control Material

Quality control (QC) material is made from pools of human urine collected from several anonymous donors. See the “**Error! Reference source not found.**” section of this method for details of preparation. The two urine QC pools made for arsenic speciation are designated as:

QC level	QC Designation ID
low pool	LU-yy###
high pool	HU-yy###

Where yy is the last two digits of production year and ### is the assigned pool identification number.

QC material that is to be used for bench quality control purposes will need to be “characterized” as described in the section *Establish QC limits for each QC pool*.

## 7. INSTRUMENTATION, EQUIPMENT, SOFTWARE, AND SUPPLIES

---

a. Instrumentation

**(1) HPLC System**

1. HPLC Pump, specifically, PerkinElmer® Series 200™ Pump, made with biocompatible materials consisting of polyethylethylketone (PEEK) and other polymers in the fluid path (PerkinElmer LAS), or equivalent.
2. HPLC Autosampler, specifically, PerkinElmer® Series 200™ Autosampler, made with biocompatible materials consisting of PEEK and other polymers in the fluid path (PerkinElmer LAS), or equivalent.
3. Autosampler temperature cooling tray for 100 samples, specifically, PerkinElmer® Series 200™ Peltier Cooling Tray and Assembly, or equivalent.
4. Column oven, specifically, PerkinElmer® Series 200™ Column Oven, or equivalent.
5. Chromatography data handling software, specifically, TotalChrom™ Workstation, version 6.0.2 or later (PerkinElmer LAS), or equivalent.
6. Anion-exchange HPLC column, specifically, PRP-X100™, 4.6 X 150 mm dimensions, 5 µm particle size in PEEK hardware, Hamilton Company, Item # 79174, or equivalent.
7. Autosampler injection needle, stainless steel, PerkinElmer LAS, Item #

N2930023, or equivalent.

8. Autosampler injector loop, 20  $\mu$ L, IDEX Health & Science, Item # 9055-022, or equivalent.
9. Autosampler injector loop, 200  $\mu$ L, IDEX Health & Science, Item # 9055-025, or equivalent.
10. Electrically-activated 6-port switching valve, IDEX Health & Science, Item # EV750-100-S2, or equivalent. An additional switching valve may also be used as demonstrated in Section 8. *Instrument Setup and Configuration*.

## (2) ICP-DRC-MS System

1. Inductively-coupled plasma mass spectrometer, specifically, the ELAN™ DRC II with Dynamic Reaction Cell (DRC™) capability, PerkinElmer LAS, or equivalent.
2. ELAN instrument control and data handling software, version 3.0 or greater, PerkinElmer LAS.
3. Cyclonic spray chamber, PerkinElmer LAS, or equivalent.
4. Concentric glass nebulizer, Precision Glassblowing, Item # 500-70QQDAC, or equivalent.
5. External peristaltic 4-channel peristaltic pump, “Minipuls 3”, Gilson Inc., , or equivalent.

### b. Equipment

1. Water purification system for providing ultrapure water with a resistivity  $\geq 18$  M $\Omega$ -cm.
2. Eppendorf® Model 5417R refrigerated centrifuge fitted with FA45-24-11 fixed angle rotor or equivalent refrigerated centrifuge capable of  $\geq 18,000$  rcf for centrifugation of 1.5 mL capacity microcentrifuge tubes.
3. High-precision analytical balance capable of accurately weighing milligram amounts of material to the tenth of a milligram or better.
4. Analytical balance for routine weighing of material to the nearest hundredth of a gram and with a loading capacity of at least 200 g.
5. pH meter with one hundredths of a pH unit readout or better, fitted with glass electrode (pH probe).
6. Temperature compensation probe for pH meter.
7. Gilson 402™ Programmable Diluter-Dispenser (or equivalent) equipped with 10.0-mL dispensing syringe and a 2-mL sampling syringe.
8. Calibrated hand-held adjustable pipettors that cover the range of accurate liquid delivery from 50  $\mu$ L to 5000  $\mu$ L. Research Pro™ Eppendorf® electronic programmable pipettors (Fisher Scientific), or equivalent.
9. “Repeater Plus” Pipetter, Fisher Scientific, Item # 2226020-1, , or equivalent pipetting device(s) capable of accurately dispensing multiple microliter aliquots of liquid.



10. Gas regulator for 10% DRC gas, Matheson Tri-Gas Products, or equivalent.
11. Gas regulator for argon gas, Matheson Tri-Gas Products, or equivalent.
12. Ethos EZ microwave Digestion Labstation with PRO-24 High Throughput Rotor, Milestone, Inc., or equivalent.

c. Computer Software

1. pdFactory Pro 1.52 or later version, FinePrint Software, LLC, [www.fineprint.com](http://www.fineprint.com) or equivalent. This product is used for creating electronic Portable Document Files (pdf) directly from Microsoft® Windows print dialog box.
2. A custom Microsoft Excel® macro procedure named "Extract TC Data". See *Macro Procedure "Extract TC Data"* section in the *Appendix* for description and macro code.

d. Supplies

1. 2-200 µL pipette tips, 960 tips per case, Fisher Scientific, Item # 05-403-66, or equivalent.
2. 20-300 µL pipette tips, 960 tips per case, Fisher Scientific, Item # 05-403-67, or equivalent.
3. 50-1000 µL pipette tips, 960 tips per case, Fisher Scientific, Item # 05-403-68, or equivalent.
4. 5 mL pipette tips, 500 tips per case, Fisher Scientific, Item # 05-403-117, or equivalent.
5. Acid-cleaned 2 liter polyethylene (PE) bottles. To acid-wash containers, rinse with 10% (v/v) reagent-grade nitric acid, followed by rigorous rinsing with 18 MΩ-cm water. Repeat this process several times depending on prior use of the containers.
6. Acid-cleaned 1 liter PE bottles. To acid-wash containers, rinse with 10% (v/v) reagent-grade nitric acid followed by rigorous rinsing with 18 MΩ-cm water. Repeat this process several times depending on prior use of the containers.
7. Four acid-cleaned 500 mL PE bottles. To acid-wash containers, rinse with 10% (v/v) reagent-grade nitric acid followed by rigorous rinsing with 18 MΩ-cm water. Repeat this process several times depending on prior use of the containers.
8. Acid-cleaned 100 mL PE bottles. To acid-wash containers, rinse with 10% (v/v) reagent-grade nitric acid followed by rigorous rinsing with 18 MΩ-cm water. Repeat this process several times depending on prior use of the containers.
9. 1.5 mL polypropylene (PP) microcentrifuge tubes, Fisher Scientific, Catalogue # 05-402, or equivalent.
10. Tube racks for 1.5 mL microcentrifuge tubes (approximately 6), Fisher Scientific, 05-405-3, or equivalent.
11. Vial rack for HPLC autosampler vials, 50-position, Fisher Scientific, Item # 03-

- 375-9, or equivalent.
12. Five or more flangeless ferrules, “blue” for 1/16” O.D. tubing, ChromTech or IDEX Health & Science, Item # P-200X, or equivalent.
  13. Five or more “FingerTight III” HPLC “Tefzel” fittings, 10-32 threading, for 1/16” O.D. tubing, ChromTech or IDEX Health & Science Item # F-300X, or equivalent.
  14. Repeater pipetter tips, “Combitips Plus” 5 mL, Fisher Scientific, Item # 21-381-330, or equivalent.
  15. HPLC tubing, 0.007” I.D. X 1/16” O.D., polyethylethylketone (PEEK), 5 feet length.
  16. Peek sample uptake fitting, Analytical West, Item #500-QD-PEEK, or equivalent
  17. Tubing, 0.03” I.D. X 1/16” O.D., polypropylene (PP), 5 feet length.
  18. Four “end-of-tubing” prefilters (10 µm) for each HPLC reservoir bottle, (ChromTech or IDEX Health and Science, Item # A-438, or equivalent.
  19. In-line HPLC post-pump filter (2 µm), ChromTech or IDEX Health and Science, Item # A-430, or equivalent.
  20. Luer fitting plastic syringe, 10 mL or larger.
  21. Kay-Dry™ paper towels and Kim-Wipe™ tissues (Kimberly-Clark Corp., Roswell GA, or equivalent vendor).
  22. Teflon™-coated magnetic stir bars (2), VWR, Item #58948-974, or equivalent.
  23. Cotton swabs (Hardwood Products Co. ME), or equivalent.
  24. Nitrile, powder-free examination gloves (N-Dex®, Best Manufacturing Co., Menlo, GA), or equivalent.
  25. Biohazard autoclave bags (Curtin-Matheson Scientific, Inc., Florence, KY), or equivalent.
  26. 15 mL 15 ml (# 352097) and 50 ml (#352098) polypropylene centrifuge tubes or equivalent: Becton Dickinson Labware or equivalent.

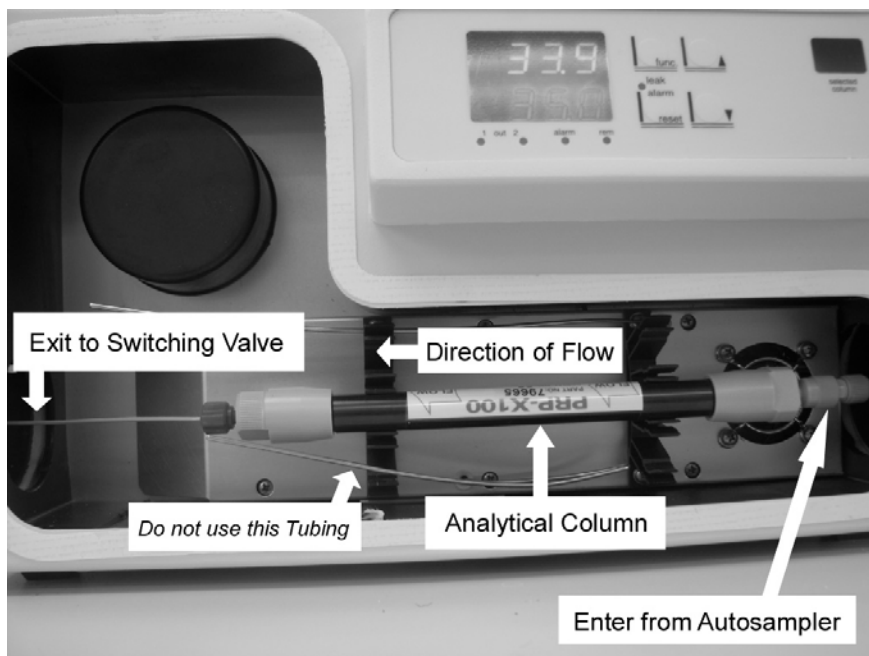
## 8. INSTRUMENT SETUP AND CONFIGURATION

---

### a. HPLC Hardware Setup

A PerkinElmer representative should perform the first installation of the Series 200™ HPLC system. If the instrument has been moved, laboratory personnel can assemble and configure the system according to the PerkinElmer supplied user manuals for the Series 200 LC Pump and the Series 200 Autosampler. The following should be considered in planning a new location:

1. Two 6-outlet A/C power strips rated for 15-amp duty will be required to plug-in all HPLC equipment and its associated components.
2. The HPLC equipment needs to be placed adjacent to the right side of the ICP-DRC-MS instrument. Allow for approximately 4 feet of bench space for the HPLC equipment and data processing computer. A bench height of 32–34 inches is optimal.
3. HPLC components need to be arranged, from left to right, in the following order:
  - (a) Six-port switching valve “#1” (EV750-100)
  - (b) Six-port switching valve “#2” (EV750-100-S2). This switching valve must have a serial port for connection to an external desktop computer.
  - (c) Column oven
  - (d) Pump with autosampler. Set the autosampler on top of the pump.
4. Replace the existing injection sample loop with a 20 µL loop.
5. Replace autosampler needle with one made of stainless steel (PerkinElmer P/N N293-0023), if it does not already have one. Titanium needles are unsuitable due to their potential to be a source of arsenic contamination. Refer to the PerkinElmer Series 200 LC Autosampler user manual for instructions on needle replacement.
6. Replace all stainless steel HPLC tubing following the HPLC pump’s purge port with “yellow” PEEK tubing, 0.007” I.D. X 1/16” O.D. Use “yellow” PEEK tubing for the remainder of the fluid path. Keep tubing lengths short but long enough to allow the connected components to be moved if necessary.
7. Install a PEEK construction in-line filter (10 µm) between the HPLC pump and the autosampler.
8. Do not use the column oven’s stainless steel tubing to preheat the mobile phase before it enters the column. The preheating is unnecessary and the extra tubing length will not help the quality of the chromatography.
9. Attach via a plastic tie clamp (or equivalent) one end of a given length of ¼” diameter Tygon™ tubing to the end of the bench holding the HPLC equipment. Position the other end of this Tygon™ tubing to empty into a large waste jug. Position this tubing close enough to the 6-port switching valves so that HPLC drain tubing from ports 5 and 6 on switching valves #1 and #2, respectively, will easily fit into the Tygon tubing. Ports 5 and 6, discussed in “e. Six-port Switching Valves”, are dedicated for effluent waste.



#### b. Software Installation

The ELAN Instrument Control version 3.0 or greater should be already installed on the computer controlling the ELAN DRC II™. If it is not, contact a PerkinElmer service representative to get the latest version of the software.

It is preferable to install PerkinElmer's TotalChrom™ Workstation package on the same computer that contains the ELAN Instrument Control software\*. It is advised that a PerkinElmer representative install and initially configure TotalChrom™. Alternatively, laboratory personnel can install and configure TotalChrom themselves by following instructions contained in *TotalChrom Workstation User's Guide*, or by getting help from PerkinElmer Technical Services. As part of installing TotalChrom™, create a folder named "hplc" on the root level of the C drive. Create the following subfolders inside the "hplc" folder: "methods", "data", "optimization", and "reports". Feel free to create additional subfolders as the need arises. This method assumes that version 6.2.0 of TotalChrom™ Workstation package is installed.

ChromLink™ 2.0 or a greater version (PerkinElmer LAS) is installed into its own program folder. The installation of ChromLink™ is quick and straightforward when using the supplied installation utility.

pdFactory Pro 1.52 or a greater version (FinePrint Software, LLC) is software used for creating electronic Portable Document Files (PDF). Documents are "printed" from the Microsoft® Windows print dialog box, but instead of printing on paper, the document appears on the screen in preview

\* Raw signal versus time data is collected by the ELAN software and stored on ELAN controller computer's hard drive as a "NetCDF" file before it is read by the TotalChrom Workstation software. For the purposes of this arsenic speciation method, TotalChrom Workstation is used only for post-run data processing and is not used to operate the HPLC or the ELAN DRC.

form. The document can then be either printed in hardcopy or saved to a hard drive or disk as a PDF file. Because of the “trial and error” nature of solving chromatographic integration challenges, frequent reprocessing (and reprinting) may be required. In these instances, generating PDF documents with the option to print a hardcopy becomes an indispensable tool.

#### c. Peristaltic Pump Setup

An external peristaltic pump offers a number of advantages over the peristaltic pump built into the ICP-DRC-MS. It can be started, stopped and its speed set independent of the ICP-DRC-MS control software. This “feature” is important when one considers that the HPLC pump “knows nothing” about the state of affairs beyond the HPLC system, and it will continue to pump mobile phase regardless of whether the spray chamber is being drained or not. Likewise, the built-in peristaltic pump is under ELAN software control only and cannot be operated in manual mode. While it is feasible to configure the ELAN software to force the built-in peristaltic pump to keep emptying the spray chamber after completing an analysis, it is nonetheless easy to make a mistake during the ELAN program setup. The built-in pump’s timing and speed is set in the ELAN’s sample file and not the method file. The sample file is created each time before a batch run posing the risk that the built-in peristaltic pump’s timing and speed could be set up incorrectly or forgotten by the analyst. If this happens, the software will stop the built-in peristaltic pump well before the HPLC pump stops, causing the spray chamber to flood and the plasma to be extinguished by mobile phase. It is quite possible for the HPLC to pump mobile phase for an extended time before it auto-stops causing extensive flooding of the torch box and the ICP-DRC-MS which can result in damage to the instrument electronics which can only be stopped manually because it is not under instrument control. Set up a 4-channel peristaltic pump (Gilson “Minipuls 3” or equivalent) on the ICP-DRC-MS spray chamber shelf behind the spray chamber.

1. Do not connect the peristaltic pump to the control computer; connect the pump to A/C power only. Run the pump in manual mode only.
2. Designate one clamp area of this pump for nebulizer waste tubing and a separate clamp area of this pump for post-column internal standard tubing.

#### d. Electrical Connections

Make the necessary electrical connections between specific I/O terminals of the HPLC autosampler, the pump, the ICP-DRC-MS, and the 6-port switching valves. The event I/O terminals are prominently labeled and are located on the right side of each instrument. For the 6-port switching valves, the terminals are located on the back of each unit.

1. Between the HPLC pump and the autosampler, use two 12 inch long common telephone wires with RJ-11 connectors to connect:
  - (a) The HPLC pump’s terminal labeled “RDY” to the HPLC autosampler’s terminal labeled “RDY IN”, and
  - (b) The HPLC pump’s terminal labeled “EXT RUN” to the HPLC autosampler’s terminal labeled “INJ 1”.
2. Use the supplied cable (PerkinElmer LAS Item # B3001203) to connect the Pump’s “RUN OUT” terminal to the ICP-DRC-MS’s “AUXILLARY I/O”.
3. Use the supplied cable (PerkinElmer LAS Item # N2600418) to connect the Pump’s “TE 1” terminal to the electrically-activated terminal block I/O on the back of 6-port switching valve #1.

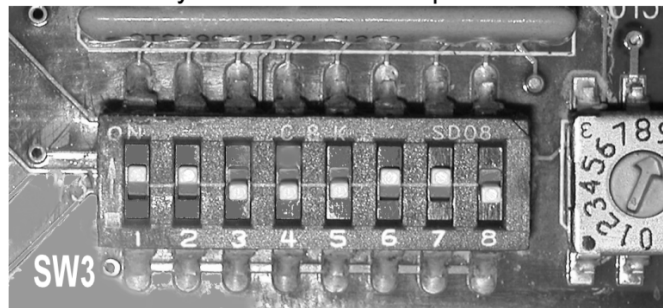
4. Use a standard serial cable to connect an external desktop computer to the back of 6-port switching valve #2.

e. Six-Port Switching Valves

Each 6-port switching valve's DIP switches need to be configured upon initial installation. If the switching valves are not put into "pulse mode", the units will not respond to the ~1 second contact closure from the PerkinElmer Series 200 HPLC autosampler. This only needs to be done once for each new unit. (Note that settings of the front panel buttons should be checked before the start of each chromatographic run.) For each 6-port switching valve:

1. Turn the switching valve unit upside down and remove the 4 screws using a Philips head screwdriver. Remove the metal cover and look for DIP switch "SW3" on the printed circuit board. Use a small flat-head screw driver or the tip of a pen to adjust the position of each switch so it matches the following illustrations. These illustrations apply to both EV750-100 and EV750-100-S2.

Detail close-up of DIP switch "SW3" on circuit board of the Rheodyne® EV750-100 6-port valve switcher.



Rheodyne® EV750-100 DIP Switch "SW3"								
DIP switch #	1	2	3	4	5	6	7	8
Position	up	up	down	down	down	up	up	down

2. Screw the cover back on the switching valve unit. For switching valve #1, connect the timed event wire leads that come from the "TE1" timed event output on the Series 200 HPLC pump to I/O junctions #4 and GND on the back of the EV750-100 (order of connection of colored wires does not matter).

Detail of Terminal Block I/O located on back of the Rheodyne® EV750-100 6-port valve.



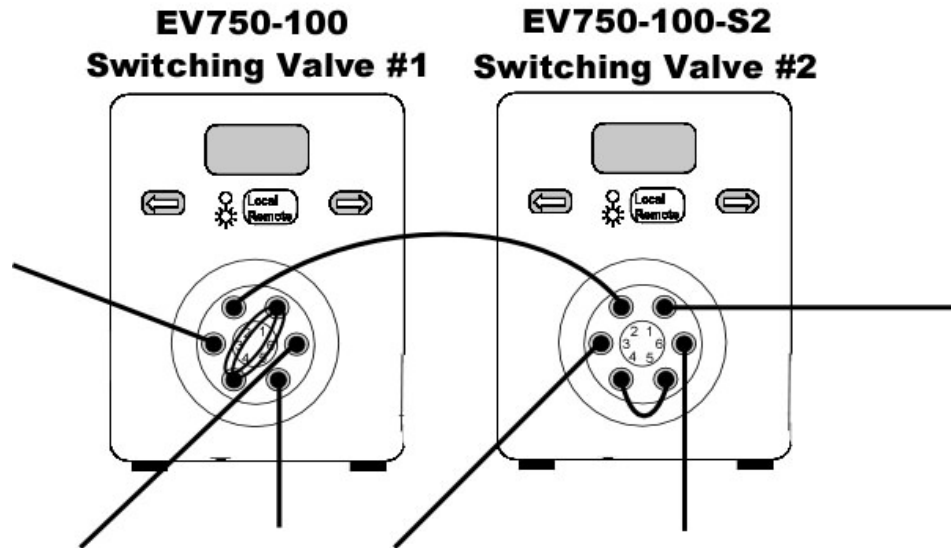
3. For switching valve #2, connect a standard serial cable from a desktop computer to the serial port on the back of the EV750-100-S2. Aside from the power cord, this is the only cable which will be attached to switching valve #2.
4. Position both 6-port switching valves close to and on the left side of the HPLC Series 200 Column Oven, adhering to the order listed in Section 8.a.3. Using supplied HPLC pressure fittings, make HPLC tubing connections to the appropriate ports as described in TABLE 8-1-A and TABLE 8-1-B.

TABLE 8-1-A: TUBING CONNECTIONS ON EV750-100

Valve Port	Flow Direction		Tubing Description
	From	To	
#1	Valve Port #1	Sample Loop	PEEK (200 µL loop)
#2	Valve Port #2 on EV750-100-S2	Valve Port #2	HPLC tubing, 0.007" i.d., 1/16" O.D., "yellow" PEEK
#3	Valve Port #3	Nebulizer	PEEK Sample Uptake Fitting
#4	Sample Loop	Valve Port #4	PEEK (200 µL loop)
#5	Valve Port #5	Waste	PP or PFA Tubing, 0.03" i.d., 1/16" o.d.,
#6	Internal Standard (via external peristaltic pump)	Valve Port #6	PP or PFA Tubing, 0.03" i.d., 1/16" o.d.,

TABLE 8-1-B: TUBING CONNECTIONS ON EV750-100-S2

Valve Port	Flow Direction		Tubing Description
	From	To	
#1	HPLC column	Valve Port #1	HPLC tubing, 0.007" i.d., 1/16" O.D., "yellow" PEEK
#2	Valve Port #2	Valve Port #2 on EV750-100	HPLC tubing, 0.007" i.d., 1/16" O.D., "yellow" PEEK
#3	Line-In for Various Solutions (via ICP-MS peristaltic pump)	Valve Port #3	PP or PFA Tubing, 0.03" i.d., 1/16" o.d.,
#4	Valve Port #4	bridge	HPLC tubing, 0.007" i.d., 1/16" O.D., "yellow" PEEK
#5	bridge	Valve Port #5	HPLC tubing, 0.007" i.d., 1/16" O.D., "yellow" PEEK
#6	Valve Port #6	Tygon™ Waste Line	PP or PFA Tubing, 0.03" i.d., 1/16" o.d.,



5. Plug-in the A/C power adapter to the back of each unit and into a regular 110V outlet. The switching valve will automatically come on and one of the diode indicators will light up. Press the "Local/Remote" button on the front of the unit so that the top yellow indicator light is on.
  - (a) For Switching Valve #1: Press the left arrow button until the LCD display indicates "1". Press the "Local/Remote" button again so that the bottom green indicator light is now on, representing "remote."
  - (b) For Switching Valve #2: Press the left arrow button until the LCD display indicates "2." Ensure that the top yellow indicator light is on, representing "local."

*Note: These LCD positions are for a typical HPLC-ICP-DRC-MS analysis run. Users may toggle between "local" and "remote" and positions "1" and "2", for instrument optimization or other tasks.*

6. The switching valves are now ready for operation.



## 9. STANDARD PROCEDURE

---

### a. Preparation of Stock Solutions

1. **0.5 M Ammonium Acetate, pH 5.** Dissolve 27.2 g of ammonium acetate and 8.0 mL of glacial acetic acid into approximately 950 mL of 18 M $\Omega$ -cm water. Adjust pH to 5.0 by adding concentrated glacial acetic acid drop-wise. Complete volume to 1000 mL with 18 M $\Omega$ -cm water. Mix thoroughly. Expires in 1 year. Prepare ahead of time or as needed.
2. **0.1 M Ammonium Acetate, pH 5.** Dissolve 5.44 g of ammonium acetate and 1.68 mL of concentrated glacial acetic acid into approximately 950 mL of 18 M $\Omega$ -cm water. Adjust pH to 5.0 using drop wise additions of either 10% ammonium hydroxide or glacial acetic acid. Complete volume to 1000 mL with 18 M $\Omega$ -cm water. Mix thoroughly. Expires in 1 year. Prepare ahead of time or as needed. *Note: This solution is not prepared as a dilution of 0.5 ammonium acetate, pH 5.*
3. **0.5 M Ammonium Carbonate.** Dissolve 48.05 g of ammonium carbonate into approximately 900 mL of 18 M $\Omega$ -cm water. Complete volume to 1000 mL with 18 M $\Omega$ -cm water. Mix thoroughly. Expires in 1 year. Prepare ahead of time or as needed.
4. **0.5 M TRIS Buffer.** Dissolve 60.57 g of tris(hydroxymethyl)aminomethane in approximately 900 mL of 18 M $\Omega$ -cm water. Complete to 1000 mL with 18 M $\Omega$ -cm water. Mix thoroughly. Expires in 1 year. Prepare ahead of time or as needed.
5. **0.5 M Ammonium Sulfate.** Dissolve 66.07 g of ammonium sulfate in approximately 900 mL of 18 M $\Omega$ -cm water. Complete to 1000 mL with 18 M $\Omega$ -cm water. Mix thoroughly. Expires in 1 year. Prepare ahead of time or as needed.
6. **5% Acetonitrile.** To make autosampler rinse solution, add 50 mL of acetonitrile (HPLC or Spectrophotometer grade) to 950 mL of 18 M $\Omega$ -cm water. Mix thoroughly. Expires in 1 year. Prepare ahead of time or as needed.

### b. Preparation of Matrix-Matched Material ("Base Urine")

Collect human urine from anonymous donors following the same collection procedure used for the preparation of QC material. Assay each donation for, if possible, speciated arsenic or, alternatively, for total arsenic. Exclude urine donations that exceed 10  $\mu$ g/L for each arsenic species or 25  $\mu$ g/L total arsenic. Pool a sufficient number of urine donations to make a volume greater than 2 liters. Divide the pool into 40 mL aliquots and save at -70°C in 50 mL centrifuge tubes labeled "Base Urine – Speciated Arsenic".

## c. Preparation of Working Solutions

1. **25% ( $V/V$ ) Base Urine Pool in 0.075 M Ammonium Acetate, pH 5.** May be prepared ahead of time before the day of analysis. Add 30 mL of 0.5 M ammonium acetate pH 5 to a clean 250 mL PP bottle. Add 50 mL of "Base Urine – Speciated Arsenic". Add 120 mL of 18 M $\Omega$ -cm water. Mix thoroughly. Prepare as needed. Store refrigerated at 4°C. Expiration date is 1 day from the date made.
2. **HPLC Buffer A Preparation.** May be prepared ahead of time before the day of analysis. To a clean 2 liter or greater capacity beaker containing a clean magnetic stir bar add approximately 1.9 L of 18 M $\Omega$ -cm water ( $\geq$  18 M $\Omega$ -cm). Add the following:
  - (a) 40.0 mL of 0.50 M ammonium carbonate
  - (b) 40.0 mL of 0.50 M TRIS buffer
  - (c) 10 mL of methanol.

Ensure that the temperature-adjust mode is enabled on the pH meter to be used. Be sure solution is being mixed on a magnetic stir plate. Using a hydrogen glass electrode (pH probe), monitor pH while slowly adding either glacial acetic acid (to lower pH) or 10% ammonium hydroxide (to increase pH) drop wise to bring the pH to  $8.60 \pm 0.05$ . In this case, an Eppendorf® Repeater Pipetter fitted with a 500  $\mu$ L syringe tip works well for adjusting pH. After complete mixing, transfer beaker's contents to a 2 L graduated cylinder. Complete volume to 2000 mL with 18 M $\Omega$ -cm water. Transfer entire contents to HPLC "Bottle A", cap, and mix thoroughly. Label bottle "10 mM Amm. Carbonate / 10 mM TRIS / 0.5% MeOH / pH 8.6" (or using other appropriate notation to indicate contents). Prepare as needed. Expiration date is 2 weeks from the date made.

3. **HPLC Buffer B Preparation.** May be prepared ahead of time before the day of analysis. To a clean 2 liter or greater capacity beaker containing a clean magnetic stir bar, add approximately 1.85 L of 18 M $\Omega$ -cm water ( $\geq$  18 M $\Omega$ -cm). Add the following:
  - (a) 40.0 mL of 0.50 M ammonium carbonate
  - (b) 40.0 mL of 0.50 M TRIS buffer
  - (c) 10 mL of methanol.
  - (d) 60.0 mL of 0.50 M ammonium sulfate

Ensure that the temperature-adjust mode is enabled on the pH meter to be used. Be sure solution is being mixed on a magnetic stir plate. Using a hydrogen glass electrode (pH probe), monitor pH while slowly adding either glacial acetic acid (to lower pH) or 10% ammonium hydroxide (to increase pH) drop wise to bring the pH to  $8.0 \pm 0.1$ . After complete mixing, transfer beaker's contents to a 2 L graduated cylinder and add 18 M $\Omega$ -cm water to complete volume to 2000 mL. Transfer entire contents to HPLC "Bottle B", cap and mix thoroughly. Label bottle "15 mM Amm. Sulfate / 10 mM Amm. Carbonate / 10 mM TRIS / 0.5% MeOH / pH 8.0" (or using other appropriate notation to indicate contents). Prepare as needed. Expiration date is 2 weeks from the date made.

4. **HPLC Buffer D Preparation.** 5% (v/v) acetonitrile (HPLC grade) in 18 M $\Omega$ -cm water. Mix thoroughly. Prepare as needed. Expiration date is 1 year from the date made.
5. **HPLC Buffer E Preparation.** 5% (v/v) acetonitrile (HPLC grade) in 18 M $\Omega$ -cm water. Mix thoroughly. Prepare as needed. Expiration date is 1 year from the date made.
6. **Internal Standard Preparation.** May be prepared ahead of time before the day of analysis. To an empty 1 liter PP bottle labeled "Internal Standard", add 5.0 mL of methanol. Next, add 50  $\mu$ L of 50 mg/L trimethylarsine oxide (TMAO Internal Standard Stock Solution). Fill with 18 M $\Omega$ -cm water to the 1000 mL mark. Mix thoroughly. Final concentration is 2.5  $\mu$ g/L TMAO. Prepare as needed. Expiration date is 1 year from the date made

d. Preparation of Stock Standards (Concentrated)

**CAUTION!**

Arsenic compounds are toxic! Take extra care to avoid accidental ingestion or inhalation of these materials. **Wear appropriate personal protective gear. At a minimum, wear a laboratory coat and latex or nitrile gloves.** Clean up any spill that might occur according to applicable hazardous material spill procedures.

*Note 1: All preparations should be performed gravimetrically (wt/wt), unless otherwise noted. All gravimetric measurements should assume the density of water equal to 1g/cm<sup>3</sup>.*

*Note 2: The steps outlined in Section 9.b – 9.h may be optionally outsourced under contract to a partner facility.*

**Definitions:**

- **Stock Standard:** Initial solution of one of seven arsenic analytes prepared by dissolving solid or liquid standard material into aqueous or acidic solution.
- **Intermediate Standard:** A 10,000ppb solution prepared from dilution of a Stock Standard.
- **Working Calibrator:** A dilution of the Intermediate Standards prepared in urine and ammonium acetate buffer. A Working Calibrator is used in urine arsenic species HPLC-ICP-DRC-MS analysis to build a calibration curve.

Use a high precision analytical balance capable of accurately weighing milligram amounts of material to the tenth of a milligram or better. It is important to use the balance in a vibration-free room that is free of air drafts and away from direct sun light, to the fullest extent possible.

1. Using a clean Teflon-coated spatula, prepare the arsenic Stock Standards described in TABLE 9-1 into 50.0 mL centrifuge tubes or other suitable storage vessels. Record the weights of the initial solid arsenic material for each species and all final weights of the corresponding arsenic solutions after dissolution.

TABLE 9-1: PREPARATION OF STOCK STANDARDS

Arsenic Species	Range to Weigh (g)	Solvent Used to Dissolve	Final Weight (g) After Dissolution
Arsenobetaine	0.02–0.03	Water (18 MΩ·cm)	10.00
Arsenocholine bromide (or other salt equivalent)	0.20–0.25	Water (18 MΩ·cm)	50.00
Disodium methyl arsenate	0.20–0.25	Water (18 MΩ·cm)	50.00
Trimethylarsine oxide	0.10–0.125	Water (18 MΩ·cm)	50.00
Dimethylarsinic acid	0.10–0.125	Water (18 MΩ·cm)	50.00
Arsenic (V) oxide hydrate	0.10–0.125	Water (18 MΩ·cm)	50.00
Arsenic (III) oxide	0.10–0.125	Dissolve in 1.5 ml of 6N HCl with mild heating. Add water (18 MΩ·cm) to complete volume	50.00

2. Tightly cap the storage vessels for future use. Expiration date is 1 year from the date weighed.
3. Calculate the concentration of each Stock Standard using the recorded weights for each species. The resulting units of concentration are milligrams per liter (mg/L). Record these values in a laboratory notebook.
4. Calculate the “Arsenic (As) atomic equivalent” concentration of each arsenic species concentrated standard using Equation 1.

Equation 1

$$\text{“As atom equivalent” conc. in mg/L} = \frac{\text{concentration of concentrated stock standard in g/L} \times \text{\# As atoms per species molecule} \times 74.92 \text{ atomic wt. As}}{\text{F.W. of As species} \times 10^{-3} \text{ g/mg}}$$

Insert into the equation the appropriate values for the formula weights (F.W.) and number of arsenic atoms per molecule for each species. A list of commonly used formula weights for each arsenic species is shown in TABLE 9-2; however, formula weights provided by the chemical manufacturers, if different, supersede the values presented in the table and should be used instead.

TABLE 9-2: FORMULA WEIGHTS OF ARSENIC SPECIES

Arsenic Species	Formula Weight	Number of Arsenic Atoms per Molecule	Formula
Arsenobetaine	178.06	1	$(\text{CH}_3)_3\text{AsCH}_2\text{COOH}$
Arsenocholine bromide	244.99	1	$(\text{CH}_3)_3\text{AsCH}_2\text{CH}_2\text{OH} \cdot \text{Br}$
Disodium methyl arsenate	291.9	1	$\text{CH}_3\text{AsO}_3 \cdot 6\text{H}_2\text{O}$
Trimethylarsine oxide	136.03	1	$(\text{CH}_3)_3\text{AsO}$
Dimethylarsinic acid	138.01	1	$(\text{CH}_3)_2\text{As}(\text{OH})_2$
Arsenic (V) oxide hydrate	229.84	2	$\text{As}_2\text{O}_5 \cdot x\text{H}_2\text{O}$
Arsenic (III) oxide	197.84	2	$\text{As}_2\text{O}_3$

*Note: All arsenic solutions from this point forward are referenced in terms of arsenic concentration.*

- Record the “arsenic (As) atomic equivalent” concentration value on each arsenic stock standard storage vessel.

#### e. Preparation of Intermediate Standards

Into separate 50 mL centrifuge tubes, gravimetrically prepare 10,000 ppb solutions of each stock standard. Use the arsenic atomic equivalent for each species to determine the appropriate dilution needed to obtain the expected concentration of approximately 10,000 ppb. Record all weights, and calculate the expected concentration of each solution marking these values in a laboratory notebook. *Note: Exact arsenic concentrations will be determined by DRC-ICP-MS in subsequent steps.*

#### f. Microwave Digestion for Conversion to Arsenate (AsV)

Even at the same arsenic concentration, different arsenic species can produce different instrument responses during analysis. Therefore, it is important to chemically convert each arsenic species to one common chemical form prior to analysis for total arsenic. Digestion of the arsenic species by microwave-assisted oxidation to arsenate (AsV) allows for analysis with an instrument calibrated using aqueous arsenate calibrators. This prevents introduction of systematic errors that otherwise might be caused by the determination of undigested arsenic species concentrations calculated from an inorganic arsenate calibration curve.

- Prepare 100 mL of 3% potassium persulfate ( $\text{K}_2\text{S}_2\text{O}_8$ ) in 18-M $\Omega$  deionized water. Expiration date is 1 day from the date made. This solution may be prepared by weight/volume.
- For each arsenic species analyte, do this step in triplicate: For each of the Intermediate Standard solutions, gravimetrically transfer 0.5 g into a

microwave Teflon vessel and record the weight to three significant digits. Add 10 mL of 3%  $K_2S_2O_8$  to each vessel. (A volumetric measure is sufficient here, as the final solution, post-microwave assisted digestion, will be gravimetrically brought to 50.0 g total weight). Additionally, triplicate blanks (0.5 g water + 10.0 mL  $K_2S_2O_8$ ) and triplicate certified AsV solution are desired for quality control if space permits in the microwave.

3. Perform microwave-assisted digestion of these solutions using the microwave program "10 ml  $K_2S_2O_8$ " or a suitable program that allows for the following parameters listed in TABLE 9-3:

Nr	t(min.)	E [W]	T <sub>1</sub> [°C]
1	00:10:00	1000 max	140°C
2	00:05:00	1000 max	200°C
3	00:15:00	1000 max	200°C
4	Ventilation 10 min.	1000 max	

4. Once the microwave-assisted digestion is complete, it is important to allow each vessel to cool to room temperature before opening to avoid possible loss of volatile arsenic. For safety purposes, open all vessels underneath a chemical fume hood (or equivalent) to avoid inhalation of toxic fumes.
5. Using the analytical balance, once digestion vessels are at room temperature, quantitatively transfer (with 18-M $\Omega$  de-ionized water) each digested solution into separate labeled 50 mL Falcon tubes. Bring the final weight to 50.0 g with 18-M $\Omega$  deionized water, and record the total mass to three significant digits. The expected arsenic concentration of each solution should be approximately 100 ppb as arsenate (AsV).
6. To determine if all arsenic species have been converted to AsV, measure an aliquot of each species by the current CLIA urine arsenic species HPLC-DRC-ICP-MS method. Since this step is performed solely to confirm that the species are no longer present in their original forms, this may be performed in a qualitative manner.

g. Method of Standard Additions (MSA)

*Note: It is imperative that the total arsenic concentration of each solution be determined by the Method of Standard Additions (MSA), and that all solutions are prepared gravimetrically (wt/wt) unless otherwise noted.*

1. Prepare 1000 mL of 2 ppb gallium in deionized water by diluting 2 mL of 1000  $\mu\text{g/L}$  stock Ga in 1000 mL of deionized water. This solution will be used to dilute post-microwave digested solutions. This solution does not need to be prepared gravimetrically.
2. Prepare a 5 ppm AsV "spiking solution" in deionized water. Weigh 0.25 g of 1,000  $\mu\text{g/L}$  certified arsenate solution and bring to a final weight of 50.0 g

using deionized water. Record all weights, and calculate the exact concentration of this solution. This concentration will be used in steps e.4.ii, iii, and iv.

3. Using the 2 ppb Ga solution prepared in Step 1, dilute each of the microwave-digested solutions 1:2 into new 50 mL centrifuge tubes by weight, with a final weight of 50.0 g. (For example, dilute 25.0 g of each microwave digested solution to 50.0 g total weight using the 2 ppb Ga solution). Record all weights. Final concentrations should be approximately 50ppb.
4. For each new 50ppb microwave-digested solution, label four new 15mL centrifuge tubes, incorporating the analyte name, replicate, and MSA spike concentration. An example (demonstrating only one replicate for one microwave-digested solution) is shown below in TABLE 9-4. Each tube will be used to prepare new solutions for MSA in subsequent steps.

*Note: A spike of 0 ppb corresponds to an unspiked sample for which a value will be determined in subsequent steps via total arsenic analysis.*

TABLE 9-4: METHOD OF STANDARD ADDITIONS TABLE 1

Tube #	Labels		
	Analyte	Replicate	Spike in ppb
1	AB	1	0
2	AB	1	25
3	AB	1	50
4	AB	1	100

5. The solutions mentioned in Step 4 and outlined in TABLE 9-4 must be prepared. For accuracy, it is important to prepare each solution in the following order:

For each 50 ppb microwave-digested solution:

- (i) Into the tube labeled 0 ppb transfer by weight 10.0 g of the approximately the approximately 50 ppb diluted microwave-digested solution prepared in Step 9.3. Record the weight.
- (ii) Into the tube labeled 25 ppb, transfer by weight approximately 0.05 g of the approximately 5 ppm spiking solution prepared in step 9.g.2. Additionally, transfer by weight 10.0 g of the approximately 50 ppb diluted microwave-digested solution prepared in Step 9.3. Record all weights.
- (iii) Into the tube labeled 50 ppb, transfer by weight approximately 0.10 g of the approximately 5 ppm spiking solution prepared in step 9.g.2. Additionally, transfer by weight 10.0 g of the approximately 50 ppb diluted microwave-digested solution prepared in Step 9.3. Record all weights.
- (iv) Into the tube labeled 100 ppb, transfer by weight approximately 0.20 g of the approximately 5 ppm spiking solution prepared in step 9.g.2. Additionally, transfer by weight 10.0 g of the approximately 50 ppb diluted microwave-digested solution prepared in Step 9.3. Record all weights. TABLE 9-5: MSA TABLE 2 shows an example of the information that needs to be recorded for each analyte and corresponding tube.

TABLE 9-5: METHOD OF STANDARD ADDITIONS TABLE 2

Tube	Target Weight, Spiking Solution	Measured Weight, Spiking Solution	Target Weight, Final Solution	Measured Weight, Final Solution
AB, Replicate 1, 0ppb	n/a	n/a	10.0g	9.8973g
AB, Replicate 1, 25ppb	0.05g	0.0517g	10.0g	9.8269g
AB, Replicate 1, 50ppb	0.10g	0.0997g	10.0g	9.8738g
AB, Replicate 1, 100ppb	0.20g	0.2051g	10.0g	9.8571g

h. Determining the Total Arsenic Concentration

1. Analyze each MSA solution for total arsenic content using a validated ICP-MS method. Ensure that the method uses Ga as an internal standard.
2. After the analysis is complete, prepare an MSA calibration curve for each solution, and calculate the concentration of the unknown sample by dividing the y-intercept by the slope.
3. Using the recorded weights for each MSA solution, calculate the exact concentrations of arsenic in each tube.
4. Once the arsenic concentration of each MSA solution has been determined, perform blank subtraction, and then use all recorded weights for each replicate to back-calculate the exact 10,000 ppb concentration of the Intermediate Standard solutions prepared in section 9.e. An example of the necessary calculation is given below:

**Intermediate Standard Concentration Determination**

calculation	$M1MSA = \frac{V2MSA * M2MSA}{V1MSA}$	$M1MW = \frac{V2MW * M2MW}{V1MW}$
-------------	---------------------------------------	-----------------------------------

Key:

- V2MSA Final Wt (g) of solution prepared in Step 9.g.3
- M2MSA Measured concentration (ppb) as determined from MSA
- V1MSA Initial Wt (g) of solution prepared in Step 9.g.3
- M1MSA Exact concentration (ppb) of microwave-digested solution (Step 9.f.2)
  
- V2MW Final wt (g) of solution prepared in Step 9.f.5
- M2MW The M1MSA concentration (ppb)
- V1MW Added amount (g) of Intermediate Standard from step 9.f.2
- M1MW Exact concentration (ppb) of Intermediate standard



5. After the concentration for each replicate of the Intermediate Standards has been determined, calculate the average concentration of all Intermediate Standard replicates per analyte.
6. Additionally, calculate the average concentration of all microwave blanks prepared in Step 9.f.2. Subtract the average blank value from all Intermediate Standard concentrations.

i. Assessment of Purity by HPLC-DRC-ICP-MS

1. From each 10,000 ppb solution, prepare a 10 ppb solution.
2. Using the CLIA "Urine arsenic species HPLC-ICP-DRC-MS" method, analyze each arsenic species for the presence of significant levels (>2%) of arsenic species impurities which are defined as the presence of any other arsenic species that are included in Table 1-1 of this method.
3. Tabulate all impurities for each solution. If significant levels of impurities are found, consider purchasing additional standard solid material from an alternative source and remake the stock standard. If the total amount of impurities is small (<2%), it is permissible to calculate a correction factor which will be used to adjust the volumes in the next dilution step (i.e., preparation of Working Calibrators) so that the final concentration reaches the intended value.
4. Correct the measured Intermediate Standard concentrations based on their purities. For example, if the Intermediate Standard solution of arsenobetaine (AB) was found to have 2% total impurities, the measured value should be multiplied by 98% to obtain the pure value of this Intermediate Standard.
5. For AB, AC, DMA, MMA, AsIII, or AsV solutions that are found to have impurities, be sure to add the concentrations of the impurities to the value of the species because once combined in the mixed calibrators, the impurities will contribute to the final value for that species. Impurities in the TMAO solution will not be used in the calculation because TMAO will not be combined with the other species.

j. Preparation of Concentrated Stock Internal Standard

Prepare ahead of time before the day of analysis. Expiration is 1 year from date of preparation.

1. Prepare concentrated Stock Internal Standard, 50 mg/L trimethylarsine oxide (TMAO). Dilute a calculated volume ( $\mu\text{L}$ ) of trimethylarsine oxide (TMAO) stock standard in 18 M $\Omega$ .cm water to make a total volume of 20 mL. Calculate the number of  $\mu\text{L}$  of stock TMAO standard to add using Equation 2:

Equation 2

$$\mu\text{L of stock TMAO standard to add} = \frac{50 \text{ ppm} \times 20 \text{ mL} \times 1000 \mu\text{L/mL}}{\text{actual ppm of stock TMAO standard}}$$

### k. Preparation of Working Calibrators

At any given time, it is necessary to have at least two sets of Working Calibrators in storage from two independent preparations of Stock Standards. The original material must be from different lots, preferably from alternate vendors. Arsenic speciation analysts should alternate between both sets of working calibrators from run to run.

#### (1) Preparation of Intermediate “Mixed Species” Calibration Solutions

Prepare the intermediate mixed species calibration solutions on the day of analysis.

1. Add 7.5 mL of 0.5 M ammonium acetate (pH 5) to a clean 50 mL volumetric flask labeled “Mixed As Species 250 µg/L” or something similar. Likewise, add 7.5 mL of ammonium acetate pH 5 to another dedicated 50 mL volumetric flask labeled “TMAO 250 µg/L” or something similar.
2. To each flask, add 12.5 mL of Base Urine.
3. Based on the pure measured value of each Intermediate Standard (which takes into consideration the addition of any impurities per analyte) prepare the 250µg/L mixed as species solution. To the flask labeled “Mixed As Species 250 µg/L”, add each of the following Intermediate Standards: AC, AB, DMA, MMA, As(III) and As(V) (six solutions in all so that each analyte’s final concentration will be 250 µg/L at a volume of 50.0 mL). Use of the dilution equation  $C_1 \cdot V_1 = C_2 \cdot V_2$  is helpful, where  $C_1$  is the pure measured value of an analyte + the sum of any impurities in the form of that analyte from the other Intermediate Standards and  $V_1$  is the weight of each Intermediate Standard for which to solve. Do not account for any impurities from TMAO in this step, as TMAO will be diluted in a separate flask and not mixed with the other arsenic species.
4. Repeat Step 3 for the TMAO Intermediate Standard. Using the flask labeled “TMAO 250 µg/L”, based on the pure measured value, weigh the appropriate amount of TMAO Intermediate Standard to obtain a 250 µg/L solution based on a final volume of 50.0 mL.
5. Bring both flasks to a final volume of 50.0 mL using 18 MΩ·cm water. Mix the contents of each flask thoroughly. Transfer each solution to an appropriately labeled 50 mL centrifuge tube or equivalent container. This solution expires in 8 hours unless it is frozen. If the solution is frozen, the expiration date is 1 year from the date made.

#### (2) Preparation of Working Calibrator Series

1. Label six clean 15 mL PP screw-top Falcon® (or equivalent) tubes with caps as follows: “Mix S0”, “Mix S1”, “Mix S2”, “Mix S3”, “Mix S4”, and “Mix S7”. Label an additional five 15 mL PP screw-top tubes as follows: “TMAO T0”, “TMAO T1”, “TMAO T2”, “TMAO T3”, and “TMAO T4”. Arrange these tubes in order and place in a test tube rack.
2. Inspect a Gilson 402™ Dilutor/Dispenser to ensure it has a clean 10 mL dispensing syringe and a clean 500 µL sample syringe. It is helpful to examine the rubber gasket for precipitate or dirt. If precipitate or dirt is found on either syringe, replace that syringe with a new one. If possible, it helps to have syringes dedicated to calibrator preparation.

3. Place the tubing that will draw diluent into the dilution syringe into a buffered solution consisting of 25% Base Urine in 0.075 M ammonium acetate (pH 5). Place a waste beaker in position to collect the effluent liquid from the tip of the sample/dispense tubing. Next, thoroughly rinse the liquid path by pressing the "Prime" button on the Gilson and allow the syringes to cycle 3 to 4 times before stopping the prime function with a press of the "Start/Stop" button.
4. To make the "S0" calibrator, set the diluent syringe volume to "10000" and the sample syringe volume to "0". Press the "Start/Stop" button once to draw 10 mL of diluent solution (25% urine in 0.075 M ammonium acetate pH 5) into the diluent syringe then press again to dispense 10 mL to the "Mix S0" tube.
5. To make the calibrator levels "S1" to "S4" and "S7", set the diluent syringe volume to the appropriate values indicated in TABLE 9-3 for the diluent and sample syringe volumes. Submerge the tip of the Gilson 402™ sample/dispense tubing into the "Mixed As Species 250 µg/L" intermediate solution and press the "Start/Stop" button on the Gilson. A volume in µL (indicated in the appropriate row in the third column of TABLE 9-3) will be aspirated. Place the appropriately labeled receiving tube ("S1", "S2"... "S4" and "S7") under the sample/dispense tubing and press the "Start/Stop" button. The indicated volume of diluent and sample will be dispensed to make a total volume of 10 mL of diluted calibrator in each tube. If necessary, repeat the dispense step into the same tube to make a total dispensed volume equal to 10 mL.

TABLE 9-3: GILSON 402™ SETTINGS FOR MAKING DILUTED SERIES

Calibrator Level	Gilson Volume Setting, µL		Target Arsenic Concentration (Nominal Conc. entered into HPLC software)	
	Diluent Syringe	Sample Syringe		
S0 / T0	10000	0	0	(0)
S1 / T1	9980	20	0.50	(2)
S2 / T2	9900	100	2.50	(10)
S3 / T3	9500	500	12.5	(50)
S4 / T4	8500	1500	37.5	(150)
S7	0	10000	250.0	(1000)

6. Repeat the preceding step for each calibrator level indicated in TABLE 9-3. Between calibrators, rinse the tip of the sample/dispense tubing with 18 MΩ·cm water from a squeeze bottle.
7. Repeat the previous two steps, this time using "TMAO 250 µg/L" to make "T0" through "T4".
8. Per CLIA requirements, twice per year, an extended-range linear verification analysis has to be completed for each CLIA method. Therefore, S5, S6, and T5, T6, and T7 calibrators are also made during this preparation step. The concentrations of each are as follows:

S5/T5 are 250 ppb, S6/T6 are 500 ppb, and S7/T7 are 1000 ppb.

9. Cap all tubes. Mix them thoroughly by vortexing and/or inverting repeatedly.
10. Divide each calibrator into twenty (or less) 0.5 mL aliquots contained in correspondingly labeled clean HPLC autosampler vials. Cap each with a “snap-cap” septum cap. Store at  $\leq -70^{\circ}\text{C}$ . Expires in 9 months.
11. At a later date, thaw one set of calibrators (S0 – S4 and T0 – T4) as needed for future calibrations. An S7 will be thawed, if necessary, for extended calibration range verification.

#### I. Preparation of Quality Control Material

Collect human urine from anonymous donors in clean, trace metals-free urine cups. Refrigerate urine donations at  $\leq 4^{\circ}\text{C}$  as soon as possible for periods of 2 days or less. For longer periods, freeze the urine donations until needed. Assay each donation for, if possible, speciated arsenic or, alternatively, for total arsenic. Assign urine donations to a “low” pool or to a “high” pool according to whether its arsenic concentration exceeds a predetermined threshold value (i.e.  $15\ \mu\text{g/L}$ ). Do not pool urine donations with an arsenic concentration that exceeds the threshold by more than a factor of 10. After pooling urine donations into their respective pools, clarify each pool by centrifugation in acid-washed 250 mL centrifuge bottles (30 minutes at 4000 rpm in a preparative table-top centrifuge). Pour off the supernatant and dispose of the pellets. To each pool, add a calculated volume of the chosen arsenic species standard solution to raise the concentration of that arsenic species to the desired value. While maintaining constant stirring of each pool, aliquot 1.0 mL (or more) of urine into a sufficient number of pre-labeled 2 mL vials to provide QC material for 1000 or more runs. Store aliquotted QC material at  $\leq 70^{\circ}\text{C}$ .

#### m. Processing of Urine Samples and QC Material

Process a chosen number of urine samples and QC material on the day of analysis. One run is defined as the analysis of a contiguous set of samples (typically 20) bracketed by bench QC material at the beginning and end of the set. Each bench QC level needs to be analyzed at the beginning and end of a run in separate tubes/vials. *Sharing of even a single QC tube or vial for more than a one QC determination is disallowed.* It is permissible to “piggyback” two runs in succession following a single calibration done during a single autosampler load (such as for an overnight analysis), as long as each run of samples is bracketed by its own uniquely co-prepared bench QC material. The number of samples per run can exceed 20 as long as the total analysis time does not exceed 24 hours.

1. Identify, gather, and thaw the necessary specimen tubes containing the urine samples for the batch (“run”) to be analyzed.
2. Likewise, for each batch run, thaw one tube each of low and high bench QC samples “LU-yyxx” and “HU-yyxx” (for explanation of nomenclature, see *Quality Control Material* above).
3. Label the required number of Eppendorf® (or equivalent) 1.5 mL microcentrifuge tubes corresponding to the samples and bench QC samples to be run. Label a pair of microcentrifuge tubes for each bench QC, since each bench QC will be injected at the beginning and end of each batch run

and need to be contained in separate tubes. Likewise label an equal number of HPLC autosampler vials and set these aside for later use. It is helpful to use preprinted barcode labels to improve efficiency and reduce the chance of labeling errors.

4. Attach a bottle of 0.1M ammonium acetate solution to a Gilson 402™ Dilutor/Dispenser diluent draw-line. In order to minimize evaporation, it is helpful to use a capped bottle with a small hole in the cap that is slightly larger than the outer diameter of the draw-line. Insert the draw-line through the hole and assure that the end of the draw line is completely submersed in ammonium acetate solution. *It is important that the end of the line remain submersed throughout sample preparation in order to prevent air bubbles.*
5. Using the "Prime" function on the Gilson 402™ Dilutor/Dispenser, flush lines with 0.1M ammonium acetate solution and empty into a small waste container.
6. If not done so at a previous date, create a sample preparation method on the Gilson 402™ Dilutor/Dispenser that will in a step-wise, sequential, and user-controlled fashion:
  - (a) Uptake 10 µL of air into sample draw-line.
  - (b) Uptake 200 µL of sample (urine) into sample draw-line.
  - (c) Uptake 1600 µL of 0.1M ammonium acetate solution into the diluent draw-line.
  - (d) Dispense 800 µL of sample + diluent mix (200 µL sample + 600 µL 0.1M ammonium acetate solution).
  - (e) Dispense 1000 µL of diluent (for flushing).
  - (f) Repeat steps (a) – (e) until the program is stopped.

The method should be set up such that no step shall execute until the user has pressed the black button on the black dispenser control device.

Name and save this method into memory.

*For detailed instructions on programming, please consult the Gilson 402™ Dilutor/Dispenser instrument manual.*

#### **CAUTION!**

Work with open vials or tubes containing biological samples in a biological safety cabinet (BSC). Wear appropriate personal protective equipment (gloves, lab coat and safety glasses).

7. Recall the sample preparation method created in step 6. Using this method, follow its steps (including the 10 µL air uptake) to mix 200 µL of sample from each specimen tube with 600 µL 0.1M ammonium acetate solution and to transfer the mix to each sample's respective 1.5 mL microcentrifuge tube. *Note that calibrators, which have been pre-made, do not undergo this type of sample preparation.*
8. After each sample/diluent mix is transferred, dispense 1000 µL of 0.1M ammonium acetate solution (pH 5) into a waste container and repeat the process for each remaining sample.

9. After capping all 1.5 mL microcentrifuge tubes containing sample/diluent mix, vortex each for 3-5 seconds. Next, centrifuge tubes for 5 minutes at 14,000 rpm in a refrigerated centrifuge pre-cooled to  $\leq 4^{\circ}\text{C}$ .
10. Following centrifugation, transfer approximately 0.6 mL of the supernatant to the appropriately pre-labeled HPLC autosampler vials. Be careful not to disturb any pellet that might be present at the bottom of the microcentrifuge tube during transfer.
11. Cap all autosampler vials with the proper fitting "snap-cap" septum caps.
12. Thaw one "set" of calibrators, including S0 – S4 and T0 – T4, at room temperature. Vortex each thawed calibrator for 3-5 seconds.
13. To autosampler vials labeled "Bk" (which stands for "Blank"), transfer 0.5 mL of 0.075M ammonium acetate (dilute from stock solution). The number of Bk vials will be dependent upon the total number of samples to be analyzed.
14. For each run, one extra sample of 200  $\mu\text{L}$  LU-xxxx + 600  $\mu\text{L}$  0.1M ammonium acetate solution is needed. This sample is used for instrument equilibration and conditioning only, so an LU-xxxx vial from a previous day's run containing leftover sample will suffice. If there are no leftover samples, one may be made according to step 7 of this section.
15. If barcode labels have been affixed to the vials, at the appropriate time, use the barcode scanner attached to the instrument computer to scan the sample ID from the barcode label on each sample and QC vial before placing it into position in the HPLC autosampler tray.

#### n. HPLC Instrument Setup

To improve work flow, instrument setup described in this section may be completed before the day of analysis.

##### (1) Programming the HPLC Pump Methods

1. On the PerkinElmer Series 200 Pump control panel, press the Quit button to bring the pump controller to the starting screen.
2. If the method number for the correct stored pump program is known, that method can be called up into active memory. Press the function key F6 (labeled as "DIR" on screen). The screen changes and presents a table with column headers "Method", "Name" and "Last Modified". Press function key F4 ("RCL") and you will be prompted to enter a 2-digit number. Press the number for the correct method (e.g., "1") followed by the "enter" key. The stored method will be loaded into memory and becomes the active pump program. The method can be inspected by pressing the function key F2 ("PUMP") and using the up or down arrow keys to scroll the program steps.
3. If the correct pump program cannot be found, then the pump program will have to be reentered. To do this, execute the following steps:
  - (a) Press the Quit button, then the function key F6 (labeled as "DIR" on screen). The screen changes and presents a table with column headers "Method", "Name" and "Last Modified". Press function key F4 ("RCL") and you will be prompted to enter a 2-digit number. Press "0" followed by the "enter" key. The "DEFAULT" method will now be loaded.

- (b) Press the function key F2 (“PUMP”). A new screen presents a table with column headers “Step”, “Time”, “Flow”, “%A”, “%B”, “%C”, “%D” and “Curve”. The default method has only one line, Step “0”, with the “>” marker just left of it. The highlighted data field is “Time” and contains “10.0”. Press “6.5” on the keypad followed by the right arrow key to replace the previous number. The highlight will advance right to “Flow”. Press 1 then the right arrow key. The next field is “%A”; enter 100 then press the right arrow key. Repeat this for fields “%B”, “%C” and “%D”, entering 0 for each. Press the right arrow key again to return to “Time”.
- (c) Press the “insert” key on the pump controller keypad. A new step, Step “1”, is added and is a replicate of the step before it. Input the data indicated in the table below. Notice that the last column “CURV” in step 1 calls for the input of a number. Likewise, create Step “2”, using the data from the table below. Note that you can move back and forth between fields, and up and down from one step to another, by using the left, right, up and down arrow keys on the keypad.

TABLE 9-4: HPLC PUMP PROGRAM SETTINGS

STEP	TIME	FLOW	%A	%B	%C	%D	CURV
0	6.5	1.00	100	0.0	0.0	0.0	
1	5.0	1.00	0.0	100	0.0	0.0	1
2	4.5	1.00	0.0	100	0.0	0.0	

- (i) Press the function key F6 (“STOR”). You will be prompted to enter a method number, press “1” then the “enter” key. If message comes up asking if you want to overwrite the existing method stored at that location, press the “1” key for “Yes”. Next you will be prompted to name the method, press the “0” key for “No”. (You may enter “Yes” and create a name for the method but this is optional).
- (ii) Press the function key F3 (“T.E.”). This is for entering timed events. Since an electrical-activated external switching valve is going to be used, the timing of brief ~1 second contact closures needs to be programmed.

EVENT	TIME	T.E.1	T.E.2
1	0.5	YES	-
2	1.0	YES	-

- (iii) Enter the parameters from the above table using the same technique as was used to create the pump method. Note that to successfully input the minutes for each event, you need to press “enter” after the inputting the number, instead of using the right arrow key. Timed Event #1 (“T.E.1”) is turned on by pressing “1” (“Yes”) on the keypad. Store a “ready” time (the number of minutes the pump waits during re-equilibration before allowing the next injection) by pressing function key F8 (“RDY”) and input “30” followed by the “enter” key. Press function key F6 (“STOR”) and respond to the prompt for a

method number by inputting the same method number (e.g., “1”) used to store the pump program. Respond to the next two prompts with a “yes” then a “no”.

4. Press the function key F4 (“PRESS”). Press function key F4 (“MAX”) then input “3000” followed by the “enter” key. Press function key F3 (“MIN”) then input “100” followed by the “enter” key. Press function key F6 (“STOR”) and respond to the prompt for a method number by inputting the same method number used to store the pump program. Respond to the next two prompts with a “yes” then a “no”.
5. Create a separate HPLC pump method (e.g. method “19”) which will serve as a column wash method after the completion of a batch run:
  - (a) Follow step 3 above to input the following in TABLE 9-5:

TABLE 9-5: HPLC PUMP COLUMN WASH PROGRAM

STEP	TIME	FLOW	%A	%B	%C	%D	CURV
0	0	1.00	100	0.0	0.0	0.0	
1	20	1.00	0.0	0.0	0.0	100	0
2	HALT	0	-	-	-	-	

- (b) No Timed Events need to be programmed.
6. Store this method using a number of your choosing (e.g. “19”).
7. To link the pump methods into a sequence, do the following:
  - (a) Press softkey F5 (“SEQ”) on the HPLC pump. Press F8 (“DELS”) to clear any preexisting sequence. The following fields will be shown: “SET”, “METHOD”, “FIRST”, “LAST” and “INJ”. The “METHOD” field will be active highlighted field.
  - (b) Input “1” then press the “enter” key. The next highlighted field will be “FIRST”; input “100” then press the “enter” key. The “LAST” field will automatically change to 100. Press the “enter” key again. The last field “INJ” will now be highlighted; input “5” then press the “enter” key.
  - (c) A second line for set 2 will automatically be created. Press the “enter” key to advance to the “FIRST” field and input “1” followed by the “enter” key. In the “LAST” field, enter the number of samples to be analyzed. If you do not yet know this number, leave the default number alone (it can be changed later). Advance to the “INJ” field by pressing the “enter” key and input “1” followed by the “enter” key.
  - (d) A third line for set 3 will automatically be created. Change the “METHOD” field to a value corresponding to the method number for the “column wash” pump method (e.g., 19), then change the “FIRST” and “LAST” fields to 99. Leave the “INJ” field set to “1”.
  - (e) Do not press the softkey F6 (“LINK”). This will be done later before the start of a batch run.
8. The HPLC pump is now programmed.



## (2) Programming the HPLC Autosampler

1. On the Series 200 Autosampler, press the “quit” key. This brings up the “READY” screen. Next, press function key F6 (“DIR”) to show the method names directory. Press function key F4 (“RCL”) and input “0” followed by the “enter” key. Answer the next prompt with “yes” and you will be returned to the starting screen.
2. Press function key F2 (“METH”). A new screen presents a table with column headers “First”, “Last”, “Volume”, “Replicates” and “Time”. The highlighted data field is “First” and contains a value of “1”. Key in “100”. Complete the entry by pressing the “enter” key. It will automatically advance the highlight to the data field “Last” which already contains a value of “100”. Since this method will make only make injections from position “100”, press “enter”. The next highlighted field is “VOLUME”. Input a value that is 2.5X the size of the autosampler’s injection loop. For instance, if the autosampler’s injection valve has a 20 µL loop installed, input 50 for “VOLUME”. Enter 5 as the number of “REPLICATES” so that five replicate injections will be made from the vial in position 100. Leave the default value for “TIME” unchanged. Press the function key F6 (“STOR”), key in “1” then “enter”. Respond to the next two prompts with a “yes” then a “no”.
3. To program the second method, it is not necessary to exit the existing one. Since the method just programmed was stored, you can edit the existing method in memory and save it to a different location. Using the arrow keys on the autosampler panel, highlight data field “FIRST” which will contain a value of “100”. Input the starting vial position from which the autosampler is to make its first injection, which is usually “1”. Press the “enter” key. Enter the number for the last vial position for this sample set, and then press the “enter” key. The highlighted field is “VOLUME” which is still the volume programmed for Method 1. Press the “enter” key to advance to “REPLICATES”. Replace the existing value by keying in 1. Press “enter”. Leave the default value for “TIME” unchanged. Press the function key F6 (“STOR”). Key in “2” then “enter”. Respond to the next two prompts with a “yes” then a “no”.
4. Program a third method that will be used in conjunction with the column wash pump program. This method will do an injection for a blank or empty vial in autosampler tray position 99. Set “First” and “Last” vial position fields to “99”. Set the “Replicate” field to “1”. While the “Volume” field can be set to any value, a value of “1” is preferred. Press the function key F6 (“STOR”), key in a number of your choosing (e.g., “19”) then press “enter”. Respond to the next two prompts with a “yes”. Input a name for this method (“i.e., “WASH”) then press “enter”.

If necessary, additional methods may be created following the steps in this section.

5. At the “READY” screen, press function key F5 (“SEQ”). Press F8 (“DELS”) to delete previous sequences, if present. Three columns will be shown: “SET”, “METHOD”, and “INJECTIONS”. The “METHOD” column will be highlighted; key in “1” followed by the “enter” key. The table will automatically create and jump to a line for set 2. Enter “2” then press “enter”. You will again be prompted to enter a method number for set 3. Enter “3” then press “enter”. You will be prompted to enter a fourth set, but that will not be necessary unless more than three methods need to be linked together. You can scroll the sets by using the up and down arrow keys. If you inadvertently created

too many sets, position the ">" symbol to point at the unwanted set and press the "delete" key. The "INJECTIONS" column, which shows the number of injections programmed for each method, cannot be edited.

6. Link the methods together by pressing the F6 function key ("LINK").
7. The HPLC autosampler is now programmed.

o. ICP-DRC-MS Instrument Setup

To improve workflow, complete the programming steps described in this section before the day of analysis.

### (1) Programming the DRC Gas Flow Delay Parameter

A special ELAN<sup>®</sup> DRC<sup>™</sup> setting, called "Flow Delay", needs to be changed from its default setting to avoid the problem of the ELAN software forcing a time delay of several seconds before collecting data at the start of a chromatographic run in DRC mode. This change only needs to be done once per software installation or upgrade, or if the setting was deliberately changed by a field service engineer. It is a good idea to inform the service engineer who intends to perform work on the instrument of the importance of returning the "Flow Delay" to the non-default value of 1.

#### Important!

While in Service Mode, **DO NOT make changes** to any setting except for the one change described below.

1. From within the ELAN program and in the window entitled "Instrument Control Session", choose menu item Options > Service Mode. You will be prompted to enter a Service Mode password. Enter the password "Elan6000" (omit the quotes and pay attention to capitalization) and click OK. If this password is not accepted, you will have to contact a supervisor or a PerkinElmer service technician.
2. You will be presented with a new tab called "Service" within the Instrument window. Maximize the window. Click on "Gas" in the row of tabs at the bottom of the window. Look for the parameter called "Flow Delay" (Gas changes while in DRC Mode). If its setting is a value other than "1", click on the "Set Pauses..." button. Change the value in the field named "Flow Change" to "1". Click the "Apply" button then click the "Close" button. Choose menu item Options > Exit Service Mode.

### (2) Programming the ELAN ".mth" file

1. If it is not already open, launch the ELAN program and in the "Instrument Control Session" window, choose menu item File > Review Files. Click the "Load" button for "Method", the first item on the list. Navigate to the folder "C:\elandata\Method" and click on "As\_HPLC-1\_drc.mth" file<sup>†</sup> then click the "Open" button.
2. Proceed to step three unless, the "As\_HPLC-1\_drc.mth" file cannot be found, or it has been changed or corrupted in a manner that makes its use

<sup>†</sup>Actual file names may differ from those presented throughout this document.

questionable. If this is the case, cancel the open file dialog box and close the Review Files window by clicking “Done”. Perform the following steps:

- (a) Make the active method file the active window. Do this by clicking on the tool bar icon that looks like a notepad with a “Cu” on it. Click File > New on the menu bar and then choose “Data Only” in the New Method window that appears. Click OK then maximize the window. Enter the information in TABLE 9-6 into this window :

TABLE 9-6: ELAN<sup>®</sup> TIMING PARAMETERS

Parameter	Setting
Sweeps/Reading:	1
Readings/Replicate:	1403
Number of Replicates:	1
Tuning File:	C:\elandata\Tuning\default.tun
Optimization File:	C:\elandata\Optimization\as_hplc_drc.dac
Enable Short Settling Time:	Unchecked

- (b) On the first line of the worksheet-like table, click in the cell of row 1 of the “Analyte (\*)” column. Type “As” then the enter key. The row will suddenly be filled-in with arsenic’s “Begin Mass (amu)” of 74.92 (or something close) and several default parameters. Tab from cell to cell to fill in the information shown in TABLE 9-7.

TABLE 9-7: ELAN<sup>®</sup> ANALYTE PARAMETERS

Parameter	Setting
Analyte:	As
Begin Mass (amu):	74.9216 (or something close will be automatically entered by software)
End Mass:	<leave empty>
Scan Mode:	Peak Hopping
MCA Channels:	1
Dwell Time:	488
Integration Time:	(automatically determined by software)

- (c) Click on the “Processing” tab and enter the following information:

**TABLE 9-8: ELAN® PROCESSING PARAMETERS**

Parameter	Setting
Detector:	Pulse
Measurement Unit:	Cps
Process Spectral Peak:	Average
Process Signal Profile:	Average
Apply Smoothing:	Checked
Factor:	5
Auto Lens:	Off
Isotope Ratio Mode:	Off

(d) Skip the “Equation” tab. Click on the “Sampling” tab and enter the following information:

**TABLE 9-9: ELAN® SAMPLING PARAMETERS**

Parameter	Setting
Peristaltic Pump Under Computer Control:	Unchecked
Sampling:	External

(e) Click on the “Report” tab and enter the following information:

**TABLE 9-10: ELAN® REPORT PARAMETERS**

Parameter	Setting
Report View   Send to Printer:	Unchecked
Report Options Template:	<leave empty> *
Automatically Generate NetCDF File:	C:\elandata\reportoutput\
Report to File   Send to File:	Unchecked
Report Options Template:	<leave empty> *
Report File Name:	<leave empty> *
Report Format:	<leave empty> *
File Write Option	<leave empty> *

\* Content of these fields is not important since Send To Printer/File is unchecked.

(f) Choose menu item File > Save As and navigate to “C:\elandata\Methods\” folder. Enter “As\_HPLC-1\_drc.mth” as the name of the method file and click the “Save” button.

3. The ELAN method “As\_HPLC-1\_drc.mth” is now loaded into memory.

**(3) Programming the ELAN “.dac” file**

1. If it is not already open, launch the ELAN program and in the “Instrument Control Session” window, choose menu item File > Review Files. Click the “Load” button for “Optimization”, the sixth item on the list. Navigate to the folder “C:\elandata\Optimize” and click on the “as\_hplc\_drc.dac” file then “Open”.
2. If the “as\_hplc\_drc.dac” file cannot be found, or it has been changed or corrupted in a manner that makes its use questionable, cancel the open file dialog box and close the Review Files window by clicking the “Done” button. Do the following steps; otherwise, proceed to step 3:
  - (a) Make the active method file the active window (do this by clicking on the tool bar icon that looks like a peak with a red arrow on crest of it). Then click File > Open on the menu bar navigate to the folder “C:\elandata\optimize\”. Click on the most current “default.dac” file then click the OK button. Complete the “Current Value” column with the information in TABLE 9-11. *Note: Values in TABLE 9-11 are suggested starting values. Instruments vary in their optimal parameter values, and analysts should use their discretion.*

TABLE 9-11: ELAN® OPTIMIZATION PARAMETERS

Parameter	Setting	Parameter	Setting
Nebulizer Gas Flow (NEB):	0.9*	Cell Path Voltage Std	- 16*
Auxiliary Gas Flow:	1.2	Rpa	0
Plasma Gas Flow:	15	Rpq	0.6
Lens Voltage:	7.5*	Cell Gas A	0.6*
ICP RF Power:	1450	Cell Gas B	0
Analog Stage Voltage:	- 1750*	DRC Mode NEB	0.9*
Pulse Stage Voltage:	1000*	DRC Mode QRO	- 10.5*
Quadrupole Rod Offset Std	0*	DRC Mode CRO	- 2*
Cell Rode Offset Std	- 8*	DRC Mode CPV	- 15*
Discriminator Threshold	70*		

\*Suggested starting values only. Optimum parameters will depend on outcome of the optimization procedure (see Error! Reference source not found.).

- (b) Choose menu item File > Save As in the “ELAN Instrument Control Session” window menu bar and navigate to “C:\elandata\Optimization\” folder. Enter “as\_hplc\_drc.dac” as the name of the optimization file and click the “Save” button.
3. The ELAN method “as\_hplc\_drc.dac” is now loaded into memory.

**(4) Creating the ELAN Sample Table “.sam” file**

1. If it is not already open, launch the ELAN program and in the “Instrument Control Session” window, choose menu item File > Review Files. Click the “New” button for “Dataset”, the second item on the list. Navigate to the folder “C:\hplc\data\” and enter the file name “As<yymmdd>” (where yy = last 2 digits of current year, mm = month, and dd = date of run, for example, As110201

denotes a Arsenic Speciation run on Feb 1, 2011) and click the “Open” button. The new dataset folder has been created and is now active. Click on the “DONE” button in >Review Files Window.

2. Click on the tool bar icon that looks like three Erlenmeyer flasks. Choose File > New on the menu bar. A new window will appear entitled “Samples – [Untitled]”. Click the “Batch” tab then click on the “Sample Template...” button. A dialog box entitled “Sample Template Data” will appear. Enter the following information:

TABLE 9-12: SAMPLE TEMPLATE DATA

Parameter	Setting
Sample ID Prefix:	1
Sample ID Number:	101
Sample ID Suffix:	_ <a single underscore character>
Increment:	1
Autosampler Position – Number:	100
Autosampler Position – Increment:	0
Range – Start Row:	1
Range – End Row:	5

Click the “Generate” button.

3. Again, click on the “Sample Template...” button. The same dialog box entitled “Sample Template Data” will appear. Enter this information:

TABLE 9-13: SAMPLE TEMPLATE DATA

Parameter	Setting
Sample ID Prefix:	<empty>
Sample ID Number:	001
Sample ID Suffix:	_ <a single underscore character>
Increment:	1
Autosampler Position – Number:	1
Autosampler Position – Increment:	1
Range – Start Row:	6
Range – End Row:	105

Click the “Generate” button.

4. Scroll the sample table to the right using the horizontal scroll bar until the columns “Sample Flush” through “Wash Speed” are showing. Highlight the cell in the first row of the “Sample Flush” column. Enter “0” then tab to the next cell to the right, enter “0” again, tab again...i.e. enter “0” for all cells in the first row of columns “Sample Flush” through “Wash Speed”. Next, click on the column header for “Sample Flush” to select the entire column and drag right to select all the columns right of and including the “Sample Flush” column. While these six columns are highlighted (i.e. darkened), go to the menu bar and

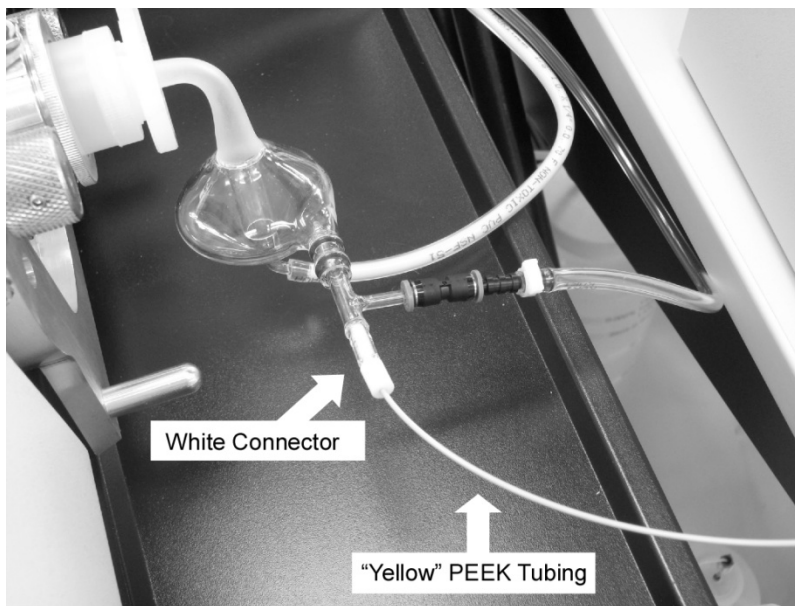
choose Edit > Fill Down. Zeros will fill down to replace every value with a zero. Scroll left to the first leftmost cell and click on it to select it.

5. From the menu bar, choose File > Save As and save the file in the directory "C:\hplc\data\" using the name "As<yyymmdd>.sam" (where yy = last 2 digits of the current year, mm = month, and dd = date of run).
6. It is a good idea to save a copy of this file as a template, thereby avoiding the need to re-create it every time.

p. HPLC-ICP-DRC-MS System Connection and Startup

**(1) Interfacing the HPLC Column to the ICP-DRC-MS Nebulizer**

1. Turn off the ICP-MS plasma if it is on.
2. Remove any non-HPLC tubing that may have been installed in the nebulizer.
3. Connect the HPLC column effluent tubing (coming from port #3 of switching valve #1) to the ICP-DRC-MS nebulizer/spray chamber assembly as shown below. Note that this tubing is the "Peek Sample Uptake Fitting (Analytical West item name "500-QD-PEEK") or equivalent".



4. The PEEK Sample Uptake Fitting is a prefabricated piece of yellow PEEK tubing attached to a white nebulizer-connector piece. When inserting the connector into the nebulizer, ensure that it is pushed in as far as it will go and is secure.

**Important!**

Inspect the tubing-nebulizer interface. It is important that there is no gap between the end of the HPLC tubing and the portion of the nebulizer where it abruptly narrows to a capillary tube. Small gaps can contribute significantly to chromatographic peak broadening and tailing.

**(2) Priming the HPLC Pump**

1. Turn on the HPLC Series 200 Vacuum Degasser (switch is on back of unit).
2. If it has not already been done, place each mobile phase reservoir tubing into the correct reservoir bottles, i.e. place end of tubing "A" into the bottle containing HPLC Buffer A, and end of tubing "B" into the bottle containing HPLC Buffer B. Reservoir tubing "D" and "E" are placed into bottles containing 5% acetonitrile in water. Press the "rinse" key on the autosampler to prime and rinse the autosampler fluid path.
3. On the HPLC pump, open the door that accesses the pump head. Attach a 30 mL or larger plastic syringe to the purge port. Open purge port by turning its knob counterclockwise  $\sim\frac{1}{4}$  to  $\frac{1}{2}$  turn.

**Important!**

**Be sure the HPLC pump's purge port is open and that a syringe is attached before completing the next step.** While there is no specific danger to the analyst, an over-pressure situation can occur that, under certain circumstances, could damage the HPLC pump, column or other components.

4. At the HPLC pump control panel, press the "Purge" button. Press F4 ("%A") followed by F3 ("FLOW"). Key in 10 then press the "enter" key. The pump will immediately start and quickly ramp up to a flow rate of 10 mL/min.
5. Allow the pump to fill the syringe with about 15 mL of buffer A. During this time, watch the reservoir tubing for air bubbles which should be flushed out. If



there are “stuck” bubbles adhering to the inside wall the tubing, strike the tubing sharply with several firm snaps from your finger to jar and free the bubble(s). The tubing should be bubble-free after ~10 mL of buffer has been pumped through.

6. Press F5 (“%B”). The pump will now switch to reservoir B. Again, watch for bubbles and make sure they are flushed out of the tubing. Allow another 15 mL of buffer to be pumped or until the syringe is almost full, then press the “stop” key to stop flow.
7. Close the purge port (turn knob clockwise), remove syringe, and close door. Dispose of syringe contents to waste or in a sink.

### (3) Adjusting the External Peristaltic Pump

1. Check the external peristaltic pump’s tubing for signs of wear which will be evident by flattening of the tubing and pinch-roller marks. Excessively worn tubing should be replaced.
2. If necessary, install new large diameter (“white-black”) peristaltic tubing on the bottom channel of the external peristaltic pump. Connect the left end of the “white-black” to the tygon “waste line” that leads to the large liquid waste carboy jug. Connect the right end of the “white-black” to the tubing that empties the ICP-DRC-MS’s spray chamber. Close the bottom channel clamp. Do a preliminary tightening of the peristaltic pump *bottom* channel’s tension clamps on the “white-black” pump tubing. Later, when you are able to observe liquid actively draining from the spray chamber, you will make further adjustments to the tension clamps so that the spray chamber will properly drain without applying excessive pressure on the tubing. Close the remaining clamps of the other channels except the top channel.
3. In the peristaltic pump’s top channel, install new small diameter “black-black” peristaltic tubing on the top channel and close its clamp. Note that the peristaltic pump will rotate counterclockwise. Into the right end of the “black-black” peristaltic tubing, insert the free end of the tubing that will draw Internal Standard solution (i.e. the one that will come from the Internal Standard bottle). Into the left end of the “black-black” peristaltic tubing, insert the tubing that will carry Internal Standard to Port #6 of switching valve #1 (see TABLE 8-1-A).

#### q. ICP-DRC-MS Warm Up and Performance Check

1. Perform a pre-ignition check of the ICP-DRC-MS according to PE recommendations specified in the manual.
2. Ensure that the digit “1” is displayed on switching valve #1. If it is not, press the “local/remote” button until a yellow light indicates local mode. Then, toggle the arrows to display a value of “1” in the digital window. Additionally, ensure that a value of “1” is in the display on switching valve #2.
3. Launch the ELAN<sup>®</sup> ICP-DRC-MS program and note whether all graphical indicators of instrument readiness are green. If not, take the appropriate actions described in the instrument’s software and hardware manual.
4. Perform necessary daily maintenance checks as described in Chapter 5 of the *ELAN<sup>®</sup> 6100 Hardware Guide* (e.g., argon supply, interface components, cleanliness, positioning, and interface pump oil condition). Note the base

vacuum pressure in the INSTRUMENT window of the software. (Before igniting the plasma, the vacuum is typically between  $8 \times 10^{-7}$  and  $1.8 \times 10^{-6}$  torr). Keep a record any maintenance procedures along with the base vacuum pressure in the *Daily Maintenance Checklist* logbook.

5. Start the peristaltic pump by pressing the appropriate arrow on the peristaltic pump control panel. Press either the up or down arrow keys to adjust the peristaltic pump speed to "6". Ensure that the direction of rotation is correct so that the spray chamber is being drained and that waste liquid will go to the waste carboy jug.
6. In the INSTRUMENT window of the ELAN software, click the "Front Panel" tab and click the plasma "Start" button to ignite the plasma. In the same window, the ignition sequence bar (blue progress bar) will start to expand to the right, indicating the approximate time before plasma ignition. Before the bar reaches its end, look at the spray chamber on the ICP-DRC-MS and watch for plasma ignition. Proper ignition will occur suddenly and with a single audible "pop". A bright white light will emanate from the injector assembly that connects to the spray chamber. The light may at first flicker, but it should establish a more or less steady intensity after 5–10 seconds.

On a rare occasion, the plasma may ignite emitting an orange, violently flickering light, and electrical discharge noises will be heard. In this case, immediately **shut off the plasma by pressing the yellow "Stop" button** on the ICP-DRC-MS instrument's front control panel. Wait 30 seconds then investigate the cause of the plasma misfire. A more common occurrence is that the plasma may extinguish itself a few seconds after ignition. Promptly reignite by pressing the "Start" button on the ICP-DRC-MS instrument's front control panel. Usually, the plasma will stay lit after the second try. If not, investigate the cause of this instability (refer to the *ELAN DRC II Hardware Guide*).

7. Soon after the plasma ignites, place the sample probe (the one connected to the peristaltic pump's "black-black" tubing, PerkinElmer P/N B300-0161, normally used for the ELAN<sup>®</sup> autosampler) into 5% nitric acid rinse solution or the daily performance check solution. Set the speed on the external peristaltic pump to "20". Watch the tubing that drains the spray chamber for a half minute or so. If the tubing is filling with liquid and you do not see bubbles being carried away from the spray chamber drain (and especially if you see liquid starting to rise within the spray chamber) immediately remove the sample probe from the rinse solution. Check that the peristaltic pump is rotating in the proper direction so that the spray chamber is draining. If not, immediately correct the direction of rotation on the peristaltic pump. Next, tighten the thumb screw on the bottom tension clamp of the peristaltic pump about  $\frac{1}{4}$  turn. Examine smoothness of flow of liquid draining from the spray chamber. If there is no liquid flow or if it continually "starts and stops", tighten the thumb screw again. Keep tightening the thumb screw until large bubbles flow through the drain line at a consistent pace. Now, slowly loosen the thumb screw until the flow stops or becomes hesitant. Make one final adjustment by tightening the thumb screw  $\frac{1}{2}$  turn. At this point, the tension on the peristaltic pump tubing should be correct. Re-insert the sample probe into the rinse solution.
8. Repeat the preceding steps for adjusting the tension clamp for the "black-black" tubing in the top channel.
9. Let the ICP-DRC-MS warm up for 30-45 minutes.

10. The following step is for the initial method setup only:
  - (a) While the instrument is warming up, in the ELAN program window entitled "Instrument Control Session", choose menu item File > Review Files. Click the "Load" button for "Optimization", the sixth item on the list. Navigate to the folder "C:\elandata\Optimize" and click on "as\_hplc\_drc.dac" file then click the "Open" button. Return to File > Review Files and click the "Load" button for "Method", the first item on the list. Navigate to the folder "C:\elandata\Method" and click on "Daily Performance.mth" file then click the "Open" button. Add a new line for arsenic "As" in the Quantitative Analysis Method window. Set the Dwell Time to 50. Do a File > Save and save the edited method as "As\_HPLC\_daily.mth". Click on the Sampling tab and uncheck "Peristaltic Pump under Computer Control". Return to the Timing tab.
11. After warm-up, complete the appropriate daily optimization procedures as described in Chapter 3 of the *ELAN<sup>®</sup> 6100 DRC Software Guide*. Include beryllium (m/z 9) in the mass calibration, and be sure to use mass calibration solution containing 1 µg/L beryllium. Do the autolens optimization and daily performance check by using a 1 µg/L multielement solution that includes 1 µg/L of arsenic. Instrument response for 1 µg/L arsenic should give counts >2000 cps (in Standard Mode). Fill in the *Daily Maintenance Checklist* in the instrument logbook according to the completed optimization procedures. If a tuning (mass-calibration) procedure was done, save it to the file "default.tun," and also in a separate file containing the analysis date "default\_MMDDYY.tun" (where MM=month, DD=day, and YY=year). Save the new optimization parameters (i.e., detector voltages, autolens values and nebulizer gas flow rate) to the file "As\_HPLC\_std.dac". Save it again to another new file named "default\_<yyymmdd.dac>" (where yy=year, mm=month, and dd=day; do not include the brackets in the file name).

If an HPLC analysis is to be run the same day, you may leave the plasma on until it is time to convert the nebulizer to interface with the HPLC. If not, press "Stop" on the ELAN control panel to turn off the plasma.

r. Turning on the Reaction Cell Gas

1. Start the flow of the reaction-cell gas (10% hydrogen, 90% argon) and allow the cell conditions to equilibrate. Make sure the regulator on the reaction-cell gas cylinder is set to approximately 7 psi.
2. Click on the "Manual Adjust" tab of the "Optimization" window and enter a value of "0" in the appropriate cell-gas field (cell-gas A or B, depending on how the instrument is set up). Then enter a value of 0.6\* in the same field. A clicking should be heard from the ICP-DRC-MS cell-gas solenoid as the flow turns on.
3. Monitor the flow on the mass-flow controller by clicking on the "Diagnostics" tab of the INSTRUMENT window of the ELAN program and look for a field labeled "Cell Gas A". The flow should reach approximately "0.6\*" within 10–15 seconds.
4. Flush the cell gas for 30 seconds by lifting the flush level at the front of the instrument. (The flush step may not be necessary if this same gas cell was used recently and no gas tubing has since been disconnected.) If possible,

allow 30 minutes for the cell to equilibrate before beginning analysis, with the cell gas flowing at 0.6\* mL/min. Note: The cell gas will automatically turn off after 45 minutes if the analysis has not begun.

\*Or the DRC gas value that is found to be optimal

5. Once the cell gas has warmed up, perform a DRC neb gas optimization and a lens voltage optimization. Update the values if needed. Perform a DRC Mode Daily Optimization Check and record the results in the *Daily Maintenance Checklist*.
6. After the analysis of the DRC mode Daily performance check is complete and deemed satisfactory, change the selections on the 6-port switching valves #1 and #2 to match the values described below:
  - (a) Switching Valve #1: Remote, "1"
  - (b) Switching Valve #2: Local, "2"
7. Place the free end of the tubing that will carry the internal standard into a bottle containing 1 liter of the Internal Standard solution.

s. Entering Sample Names into the ELAN Sample Table

1. Click on the tool bar icon that looks like three Erlenmeyer flasks. If the current Samples window is not this run's sample file, then choose File > Open on the menu bar and navigate to and open this run's current data folder in "C:\hplc\data". Click on the file named "As<yymmdd>.sam" (yy = year, mm = digit month, dd = date) and open it. The Samples window will be the one created in the *Creating the ELAN Sample Table ".sam" file* section.
2. Fill in the name of each sample by double-clicking after the "\_" (underscore) in the cell matching its "A/S Loc". Type in the sample name and press "Enter" on the keyboard. In this manner, enter the name of every blank, calibrator, quality control, and sample that will analyzed in the run. If barcodes are used on the sample labels, use the barcode scanner attached to the ICP-DRC-MS computer to scan the sample ID from the barcode on each sample before placing it into position in HPLC autosampler tray.
3. Keep the following in mind while filling out the Samples table.
  - Autosampler tray position 100 will contain the vial containing excess low or high QC sample, called "EQ", which will be injected with five replicates during the initial system equilibration period that occurs before the start of calibration. "EQ" is not used for QC but is strictly for equilibrating the HPLC and conditioning the ICP-DRC-MS.
  - Autosampler tray position 99 needs to contain a blank vial (even an empty vial will do).
  - Insert a "Bk" between the equilibrators. Also insert blank checks throughout the run as needed to show that carryover is not occurring.
  - No more than 24 hours should lapse between the time that the actual analytical run starts (the analysis of the "Bk" in autoampler location 1) and the analysis of the last vial is complete. Keep this in mind when determining how many samples will be analyzed.

TABLE 9-14: ELAN SAMPLES TABLE

A/S Loc.	Batch ID	Sample ID	Measurement Action	Method	...	Wash Speed (+/- rpm)
100		101_EQ	Run Sample			0
100		102_EQ	Run Sample			0
100		103_EQ	Run Sample			0
100		104_EQ	Run Sample			0
100		105_EQ	Run Sample			0
1		001_Bk	Run Sample			0
2		002_S0	Run Sample			0
3		003_S1	Run Sample			0
4		004_S2	Run Sample			0
5		005_S3	Run Sample			0
6		006_S4	Run Sample			0
7		007_T0	Run Sample			0
8		008_T1	Run Sample			0
9		009_T2	Run Sample			0
10		010_T3	Run Sample			0
11		011_T4	Run Sample			0
12		012_Bk check	Run Sample			0
13		013_LU-XXXX	Run Sample			0
14		014_HU-XXXX	Run Sample			0
15		015_Bk check	Run Sample			0
...	...rows for 20 samples omitted for brevity			...		...
36		036_Bk check	Run Sample			0
37		037_LU-XXXX	Run Sample			0
38		038_HU-XXXX	Run Sample			0

The sample names will resemble those typed in bold in the example table above. In the example table above, a run of 20 samples is shown so the last vial ends up being placed in A/S Location #38. Of course, the actual position of the last sample depends on the total number of vials in the autosampler tray. Note that, if more than one group of samples is to be analyzed, each group shall be bracketed by its own QC. In some instances, on the sample table this rule will result in four QC samples being run in succession (for instance, LU-xxxx, HU-xxxx, LU-xxxx, HU-xxxx). Be sure to delete all unused rows after the last vial in the ELAN Samples window, i.e. clear all rows after the last row by selecting them and press Ctrl-Delete.

The numbers preceding the underscore character (with the exception of sample numbers "101" through "105") correspond to the order of injection. These numbers will later help the analyst find individual chromatograms based on injection number rather than being forced to scroll long lists of alphabetically-sorted file names in Windows Open File dialog boxes looking for specific sample names during post-run data processing in TotalChrom™.

4. When satisfied that the Sample table entries are correct, choose File > Save.
5. Analysts may print the ELAN Sample table by choosing the File > Print Setup > Reports command. In the ensuing dialog box, select the preferred printer and click OK. Next, choose File > Print and then click the Print button. Printouts may be helpful for the correct vial positions when loading samples into the HPLC autosampler tray.

t. Starting the Run

1. Restart the ELAN controller computer by going to the Windows Start button and choosing "Restart". This serves to purge the computer of possible memory/register conflicts and will give the system and ELAN software a fresh start. It is unnecessary to shutoff the plasma as the ELAN instrument will sustain it while the computer does a restart.
2. Check the waste carboy. If more than two-thirds full, empty it.
3. Check that the tubing that draws internal standard is inserted into the bottle containing Internal Standard and that there is sufficient quantity of Internal Standard.
4. Check that there is sufficient mobile phase to last the entire run. In addition, be sure that Bottle D and the HPLC Autosampler's wash bottle contains sufficient amount of 5% (v/v) acetonitrile. It is very important that line D does not become filled with air bubbles at any point during analysis.
5. Set the HPLC Series 200 Column Oven to 35°C if it is not already at that temperature.
6. Check for stray ".nc" files by using Microsoft Windows® File Explorer to look inside the C:\elandata\ReportOutput folder. Move any existing files that end with ".nc" extension to another folder so that the C:\elandata\ReportOutput folder is empty of ".nc" files. Close Windows File Explorer.
7. Launch ELAN Instrument Control program if it is not already. Do not launch or start any other programs at this time.
8. Check that the correct Sample file in the window "Instrument Control Session" is active. If it is not correct, load the correct Sample file. In this window, note the injection number of the last vial as indicated by the numbered prefix leading the first underscore ("\_") character (e.g., 42 from "042\_samplename").
9. Check that the HPLC pump methods are correctly programmed according to *Programming the HPLC Pump Methods*. On the HPLC pump, press the softkey F5 ("SEQ"). Confirm that there are just three lines indicating sets 1, 2 and 3. Check that sets 1 and 3 are configured properly. Press softkey "SET", input 2 then press the "enter" key. Press softkey F4 ("LAST") and input the injection number of the last vial noted in the preceding step. Press the "enter" key. Press softkey F6 ("LINK") then press the "return" key. The display will return to the top level. Confirm that the top line in the pump control panel display displays "METHOD01 STORD SHTDN Q01.100.00" indicating that the pump methods are now linked. Do not press the softkey F8 ("STRT") at this time.
10. Check that the HPLC autosampler methods are correctly programmed according to *Programming the HPLC Autosampler*. On the HPLC autosampler, press the softkey F6 ("DIR"), followed by softkey F4 ("RCL").

Input 2 then press “enter” followed by “yes”. Next, press F2 (“METH”). A new screen presents a table with column headers “First”, “Last”, “Volume”, “Replicates” and “Time”. Using the arrow keys on the autosampler panel, highlight data field “LAST” and input the injection number of the last vial noted in the preceding two steps. Press the “enter” key. Next, press F6 (“STOR”), input 2 then press the “enter” key. Respond to the next two prompts with a “yes” then a “no”. Press the “return” key. If the word “LINKED” does not appear on the autosampler display, then link the methods together by pressing the F6 function key (“LINK”).

11. Check that the correct ELAN method is loaded and active in the window “Instrument Control Session”. If it is not correct, load the correct Method file. Check under the Sampling tab that “Peristaltic pump under computer control” is unchecked, and the pull-down menu “Sampling” indicates “External”.
12. Check that the DRC gas is indeed flowing by making the ELAN’s Instrument window active and clicking on the Diagnostics tab. Inspect the Cell Gas A or B, its value should be fluctuating at 0.6 (or other optimal value)  $\pm$  0.01 mL/min. If it is not, see section *Turning on the Reaction Cell Gas* for details to turn on the DRC gas flow. Make the optimization window active and Choose File > Save to save the method file.
13. Choose File > Review Files in the “Instrument Control Session” menu bar. In the next window, click the “Load” button for “Dataset” (second item) and navigate to this run’s data folder, double-click on it and click on the “OK” button. The correct Dataset path should now be indicated. Click the “Done” button.
14. Check that all blanks, calibrators, QC and sample vials are loaded into their correct positions in the HPLC autosampler tray, as designated by the ELAN Sample window (or its printout).
15. Press function key F5 (“SEQ”) on the Autosampler and check that the total number of injections (i.e., the sum of all injections for each listed method) agrees with the number of vials + 4 (accounting for the extra 4 injections of the equilibrator vial in position #100) in the autosampler tray. Press the “return” key to get back to the main screen. See section *Programming the HPLC Autosampler* for details on how to program the autosampler. Check that the HPLC autosampler’s methods are linked and that the word “LINKED” appears in the autosampler’s information screen.
16. This step is optional but offers the advantage that the ELAN data files will be converted in real time to TotalChom™ “.raw” files that have names containing a date-time stamp corresponding to actual time of injection.
  - (a) Launch TotalChom™ Navigator. In the resulting TotalChom™ Navigator window, choose menu item Apps > ChromLink (alternatively, you may launch ChromLink™ from the operating system Start > Programs menu).
  - (b) In the ChromLink™ program window, choose the menu item Configuration > Mass Details and check the Nominal Name and Mass for arsenic. If it is missing or the ELAN tune (“default.tun”) file was re-optimized earlier then ChromLink™ needs to be configured (see *Configuration of ELAN ChromLink™* on page 55 for details). To save time, the analyst may choose to close the TotalChom™ Navigator and ChromLink™ windows and skip step 16 in its entirety. Data file

conversion via ChromLink™ can easily be done during post-run data reprocessing.

- (c) In the ChromLink program window, click on the “Browse” button to the right of the “ELAN ChromLink file location” field. Navigate to the current working folder, double-click on it then click the “OK” button so that ChromLink knows where to save its processed files.
  - (d) Otherwise, refer to step (b) of *Data Processing and Analysis* for details on proper setting of the ELAN ChromLink™ window’s parameter fields. In the ELAN ChromLink window, click the button “Start Processing ELAN Data Files” to put ChromLink in watch mode so it will process each data for each injection in real time. A new dialog box will open and indicate it is ready to convert data and waiting for the first file.
17. Click on the ELAN “Instrument Control Session” window to make it active, then click the mouse in the Samples window on the corner rectangle of the sample table (where row headers intersect column names). The entire sample table will become highlighted (dark background). Click the “Analyze Batch” button. A Run Progress box will appear indicating that the ELAN software is now waiting for a signal from the HPLC that indicates the occurrence of an injection.
  18. If the HPLC pump is not already pumping, press function key F8 (“STRT”). This will start the flow of Buffer A and put the pump into a “wait for injection” mode.
  19. On the HPLC autosampler, press the “start” key. If the equilibration wait time has been reached, the autosampler will immediately begin its injection sequence. Otherwise, it will respond with the message “WAITING FOR EXTERNAL READY” and wait for the equilibration wait time to complete.
  20. In the Instrument window, click the “Auto Start/Stop” tab. It is important to note that if the “Enable” radio button is already selected and an ELAN run was cancelled by the analyst, you will need to select the “Disable” radio button to reset the Auto Stop timer. Forgetting to do this will result in premature shutoff of the plasma. Following this action, click the “Enable” radio button. Next, click on the “Change” button and set the “Delayed Shutdown Time” to 30 minutes. Click Okay.
  21. Open the ELAN “Instrument Control Session” Real-Time window by clicking the tool bar button that looks like a Gaussian distribution (or a blue chromatographic peak, if you prefer). After the Real-Time window opens, click on the drop-down menu and select “Signal”. Real-time data will now be displayed.

When the HPLC pump’s equilibration time has been reached, the autosampler will seek the first vial and make an injection. A blue bar in the ELAN’s progress box will now indicate that data is being collected. The system can now run unattended.

Check the progress of the run after 2 or 3 injections. Note the chromatograms appearing in the ELAN’s Real Time window. Adjust the signal scale in the Real Time window, as necessary. Compare the positions and peak heights of each arsenic species relative to the internal standard. It helps to visually compare it to a printed reference chromatogram. If abnormalities in retention time, peak height or shape are readily apparent, the analyst may need to stop the autosampler and pump and abort



the run in the ELAN program. The HPLC pump and autosampler are stopped by pressing the “stop” buttons on their respective control panels. Correct the problem(s) and restart the run.

### Important

Remember to disable the ELAN's Auto Stop feature before re-enabling it. Otherwise, the ELAN may perform an auto shutoff prematurely.

#### u. Instrument Shut Down

1. Shut off ICP-DRC-MS plasma if it has not already been done. Stop all peristaltic pumps and loosen tensioning bars and tubing.
2. Check that the HPLC autosampler controller readout indicates that the sequence was successfully completed. If not, note the message and investigate the reason for the message, for example, if a sample vial is missing.
3. At the controller computer, visit the ELAN Instrument Control Session application and open the “Dataset” window. Confirm that all samples were analyzed.
4. Remove the calibrator, QC and sample vials from the HPLC tray. Discard them according to CDC biohazard waste disposal guidelines.

## 10. POST-RUN DATA ANALYSIS

---

#### a. Configuration of TotalChrom™ Integration Method

The following information is presented as a starting point to help the analyst develop robust integration method parameters that will work best for most chromatography data. Many of these parameters will work just fine as presented below. However, the separation chemistry of HPLC columns can vary due to frequency of use, column replacement, or because of individual sample “oddities”. Some parameters may need to be adjusted from time to time to maximize the ability of TotalChrom™ to properly integrate peaks and identify components with minimum operator intervention. Therefore, the analyst should pay particular attention to the chromatograms produced in every run and make necessary adjustments as warranted. The analyst should be familiar with TotalChrom™ 's frequently used integration functions which are described in Chapter 18 of *TotalChrom Workstation User's Guide: Volume II*.

1. The creation of a new method file in TotalChrom™ is done the first time TotalChrom™ is setup, or it will need to be recreated if the file “Arsenic1.mth” cannot be found or has been corrupted. In the TotalChrom™ Navigator window, choose the menu item Build > Method. In the next dialog box, click the “Create a new method” radio button and click OK. The default method will load into the method editor.

2. Choose the menu item Process > Integration. Click on the “Integration” tab in the “Process” window. Enter the information shown in TABLE 10-1.

TABLE 10-1: INTEGRATION

Basic Parameters		Advanced Parameters	
Bunching Factor :	1	<i>Peak Separation Criteria</i>	
Noise Threshold :	5	Width ratio :	0.2
Area Threshold :	25	Valley to peak ratio :	0.01
		<i>Exponential Skim Criteria</i>	
		Peak height ratio :	5
		Adjusted height ratio :	4
		Valley height ratio :	2

The analyst may make appropriate changes to one or more of the Integration parameters in TABLE 10-1 if necessary.

Click on the “Baseline Timed Events” tab. As a guideline, enter the information shown in TABLE 10-2 or other parameters as determined to be appropriate.

TABLE 10-2: BASELINE TIMED EVENTS

<i>Defined Events</i>				
Time	Event	Value	Code	Level
0.000	Smooth Peak Ends On	5	+SM	
0.000	Locate Maximum On		LM	
0.000	Set Bunching Factor	3	BF	
0.000	Disable Peak Detection		- P	
0.350	Enable Peak Detection		+P	
0.500	End Peak Detection Inhibit		+I	
1.000	End Peak Detection Enable		- I	
1.000	Locate Maximum Off		-LM	
1.000	Set Bunching Factor	1	BF	
1.200	Common Baseline On		+CB	
2.200	Set Bunching Factor	2	BF	
2.250	Common Baseline Off		- CB	
6.250	Set Noise Threshold	3	NT	
6.250	Set Area Threshold	15	AT	
8.750	Peak End Detection Inhibit		+I	
10.80	Peak End Detection Enable		- I	

Be sure there is no checkmark in the box for “Correct actual times of all baseline events based on actual RT of nearest reference peak”. The parameters in TABLE 10-2 are starting points. The analyst may make appropriate changes to one or more of the Baseline Timed Events if necessary.

3. Click on the “Optional Reports” tab. Uncheck the box for “Keep temporary files”.
4. Click on the “Replot” tab. Enter the information shown in TABLE 10-3.

TABLE 10-3: REPLOT

Plots	Miscellaneous
Generate a separate replot : not checked	Start plot at end of delay : checked
Retention Labels : Peak crests*	Gradient overlay : not checked*
Component Labels : Actual time	Draw baselines : checked*
Scaling Type : Autozero offset	Timed Events : checked*
<i>Scaling Parameters</i>	X axis label : Time [min]
Full scale (mV) : 2.000*	Y axis label : Intensity [cps]

\*These parameters maybe altered to suit the analyst.

It is unnecessary to click on the “User Programs” tab because it is not used. Close the Process window by clicking on the “OK” button. The parameters in TABLE 10-3 are starting points. The analyst may make appropriate changes to one or more of the Replot parameters if necessary. In the Method Editor window, choose the menu item Components > Global Information. Click on the “Integration” tab in the “Process” window. Enter the information shown in TABLE 10-4:

TABLE 10-4: Global Information

Volume units : $\mu$ L	<i>Unidentified Peak Quant.</i>
Quantitation units : $\mu$ g/L	Calibration factor : 1.000e+99
Sample Volume : 1.000	Always use calib. Factor : selected
Void time (min) : 0.000	
<i>Calibration</i>	
Internal Standard : selected	
	<i>RRT Calculation</i>
Reject outliers during calibration : Not checked	Use first peak in run as RRT reference: selected
<i>Sample Amount Options</i>	
Correct amounts for calibration standards : Not checked	
Convert unknown samples to concentration units: Not checked	

The “LIMS Results” tab is not used. Click the “OK” button to close the window. The parameters in TABLE 10-4 are starting points. The analyst may make appropriate changes to one or more of the Global Information parameters if necessary.

- In the Method Editor window, choose the menu item Components > New Component. The white list box in the left portion of the window will be empty. Click in the empty field labeled “Name” and type “IS”. Press the tab key and enter “0.6” in the field labeled “Retention time”. Put a checkmark in the box labeled “This component is an internal standard”. Select the radio button labeled “Peak” if it is not already selected. Leave the other fields and check boxes unaltered. Click the “New Component” button. Enter each of the component names and parameters listed in TABLE 10-7.

TABLE 10-5: METHOD EDITOR – COMPONENTS SETTINGS

Name	Retention Time	Absolute window	Relative window	Find tallest peak	Is a retention reference?	Internal Standard	This Component is an Int. Std?	Use as a RRT reference?
IS	0.6	5	3	No	No		Yes	No
AC	1.70	3	3	No	No	IS	No	No
AB	2.00	0	3	No	No	IS	No	No
TMAO	2.10	3	3	No	No	IS	No	No
AsIII	2.50	5	3	No	No	IS	No	No
DMA	4.00	5	3	No	No	IS	No	No
MMA	9.70	50	3	No	No	IS	No	No
AsV	11.90	0	3	No	No	IS	No	No

Click the “New Component” button before starting a new component. After entering the last component, click the “OK” button. The values for Retention Time, Absolute Window and Relative Window serve as starting points. The analyst may alter these values as actual chromatographic results may dictate.

- In the Method Editor window, choose the menu item Components > Defaults. Click on the “Identification” tab”. Enter the information shown in TABLE 10-6.
- Click on the “Calibration” tab in Components Defaults Window. Enter the information shown in TABLE 10-7.

TABLE 10-6: COMPONENTS DEFAULTS — IDENTIFICATION

Component Type :	Peak	Reference :	blank
Absolute window :	5	Internal Standard :	IS
Relative window :	5	Find tallest peak :	Not checked

TABLE 10-7: COMPONENTS DEFAULTS — CALIBRATION

	<u>Level</u>	<u>Amount</u>	
Calibration Type :	Use Curve	S0	1.0000E-6
Curve Type :	1 <sup>st</sup> Order	S1	2
Scaling :	None	S2	10
Weighing :	None	S3	50
Purity (%) :	100	S4	150
Response :	Area		
Origin Treatment – Include :	Not checked		
Origin Treatment – Force :	Not checked		

9. The “User Values/LIMS” tab is not used. Close the “Components Defaults” window by clicking the “OK” button.
10. In the Method Editor window, click on “Components” in the menu bar. If the menu item “Delete All Components” is not grayed out, select it and click the “OK” button when prompted to “Delete all components, calibration levels, and calibration replicates”. Click the “OK” button.
11. In the Method Editor window, choose the menu item Components > New Component. The white list box in the left portion of the window will be empty. Click in the empty field labeled “Name” and type “IS”. Press the tab key and enter “0.6” in the field labeled “Retention time”. Put a checkmark in the box labeled “This component is an internal standard”. Select the radio button labeled “Peak” if it is not already selected. Leave the other fields and check boxes unaltered. Click the “New Component” button. Enter each of the component names and parameters listed in TABLE 10-7.
12. In the Method Editor window, choose the menu item Components > Edit Component then click the “Calibration” tab. Click to highlight “TMAO” in the component list box. Click on the cell containing “S0” and type “T0” (capital “T”) on the keyboard followed by the Enter key. In this manner, replace “S0” through “S4” with “T0” through “T4”, respectively. Click the “OK” button when finished.

13. In the Method Editor window, choose the menu item File > Description, and type in your name and date this method was created. Add any other pertinent information at this time. Click the OK button to close window.
14. In the Method Editor window, Choose File > Save As. A window appears inviting you to enter any information pertinent to this method, which will be saved with the method. Enter your name and the date this method was created. Click "OK" and a "TotalChrom™ File-Save-As" dialog box will open. Navigate the directory tree to get to the folder C:\HPLC\Methods. Double-click on this folder. In the "File name:" field, enter "Arsenic1.mth". If there is already a file in that folder with the same name, highlight that file and right-click the mouse. Choose "Rename" and give the file a new name (e.g. add "backup" to the name). Click "Save" and close the Method Editor window.

b. Configuration of ELAN ChromLink™

ELAN ChromLink™ should be configured after initial installation of the program or when the ELAN tune ("default.tun") file is re-optimized. At least one recent ELAN NetCDF file (with the ".nc" extension) containing data for the mass of interest that was collected since the last update of the "default.tun" file will need to be available in order to complete this step.

1. Launch TotalChrom™ Navigator. In the TotalChrom™ Navigator window that appears, choose the menu item Apps > ChromLink (alternatively, you may launch ChromLink™ from the operating system Start > Programs menu).
  - (a) Inside the ELAN ChromLink window, click on Configuration > Default TotalChrom Method. Click on the "Browse..." button and navigate to the directory C:\hplc\methods\. Select "Arsenic1.mth" and click the "Open" button. "C:\hplc\methods\arsenic1.mth" will now be the ChromLink™ default method. Click "OK" to close the "Default TotalChrom Method" window.
  - (b) Inside the ELAN ChromLink window, click on "Set". The "Operating Mode" window will open. Click on the "Manual – process single ELAN NetCDF file" radio button then click the "Review ELAN NetCDF mass file components before processing" radio button. Click "OK" to close the window. Click on the "Browse..." button for "ELAN NetCDF file – location/file to be converted" field. An open file dialog box will open, prompting you to choose a file. Navigate to the latest working HPLC Data folder and choose any file with the ".nc" extension (perhaps one of the calibrators). Click "Open". The dialog box will disappear and you will be returned to the "ELAN ChromLink" window. The path and file to be converted will now be shown in the field called "ELAN ChromLink file – location/file to be converted".
  - (c) Click on the "Start Processing ELAN Data Files" button. The "Processing ELAN Data" window will briefly open, followed by a window called "Mass Components in ELAN Data File". The file name being processed will appear in the ELAN File Contents panel along with its "Mass" and "Nominal Name". Write down the mass value. The next panel called Configured Mass Components will show the mass and nominal name of the mass components that will be identified from the configured list and

be processed as separate TotalChrom RAW files. If the fields for “Mass” and “Nominal Name” are empty, or are different compared to the corresponding fields for Configured Mass Components, then click the “Edit Configured Mass Components” button. A new window called “List of Mass Components” will open. Click on the cell in the table at the top of the window containing the mass that you wrote down earlier. Next, Click on the field named “Nominal Names” in the “Names” panel and enter “As”. Be sure the field named “ELAN Name (mass)” contains the mass value that you wrote down earlier. Leave the field “Expression” unchanged. Next, click on the “Browse...” button and navigate to “C:\hplc\methods\arsenic1.mth” then click “OK”. Put a checkmark in the box for “Process this mass component to produce its own TotalChrom RAW file”. Make sure that the box for “Process this mass component as part of an expression” is unchecked. Now, click the “Update Selected Mass Component” button. One line should now show the following information:

Nom. Name	Mass	Expression	raw?	In expr?	TotalChrom Method File
As	74.92 <sup>†</sup>		X		C:\HPLC\Methods\Arsenic1.mth

<sup>†</sup> Or some value close to the atomic weight of arsenic.

If not, repeat the above steps, except this time click the “Add as a new mass component” button. Delete unnecessary lines by clicking on the line then clicking the “Delete selected mass component” button. When satisfied that the List of Mass Components window is properly configured, click the “Close” button. Next, click the “Close” button to close the “Mass Components in ELAN Data File” window. Close the “Processing ELAN Data” window by clicking its “Close” button.

- (d) Inside the ELAN ChromLink window, click on the “Set” button. A window entitled “Operating Mode” will open. Click on the “Automatic – process all ELAN NetCDF files in specified location” radio button. The lower radio buttons will gray out. Click “OK” to close the window.
2. At this time, ChromLink™ may be closed by selecting File > Exit. Click “OK” at the dialog box asking if you want to quit ChromLink™.
3. In addition to configuring ChromLink™ itself, it is necessary to alter one value in the “seed” method file that ChromLink™ uses to set a select number of parameters to certain default values. This step only needs to be done once following the installation of ChromLink™.
  - (a) In the TotalChrom™ Navigator window, choose the menu item Build > Sequence and a dialog box called “Startup” will appear. Click on the radio button labeled “Load sequence stored on disk” then click the OK button. Navigate to the folder on the C drive that contains the ChromLink™ program file (usually in C:\PenExe\ChromLink but if it is not there, check under the C:\Program Files directory). Click on the sequence file “seed.seq” to highlight it. If this file is missing, reinstall ChromLink™. Click “Open”. A spreadsheet style sequence table will present itself in a window called “Sequence Information – Channel A”. There will be a minimized window for channel B data, ignore this window.

Scroll across to the “Int Std Amt” column and click on the first cell in row 1 of this column. Replace the existing value with the concentration of working Internal Standard which is 2.5 µg/L **Error! Reference source not found..**

- (b) Choose menu item File > Save. Close the Sequence Editor window by choosing File > Exit from the menu bar.

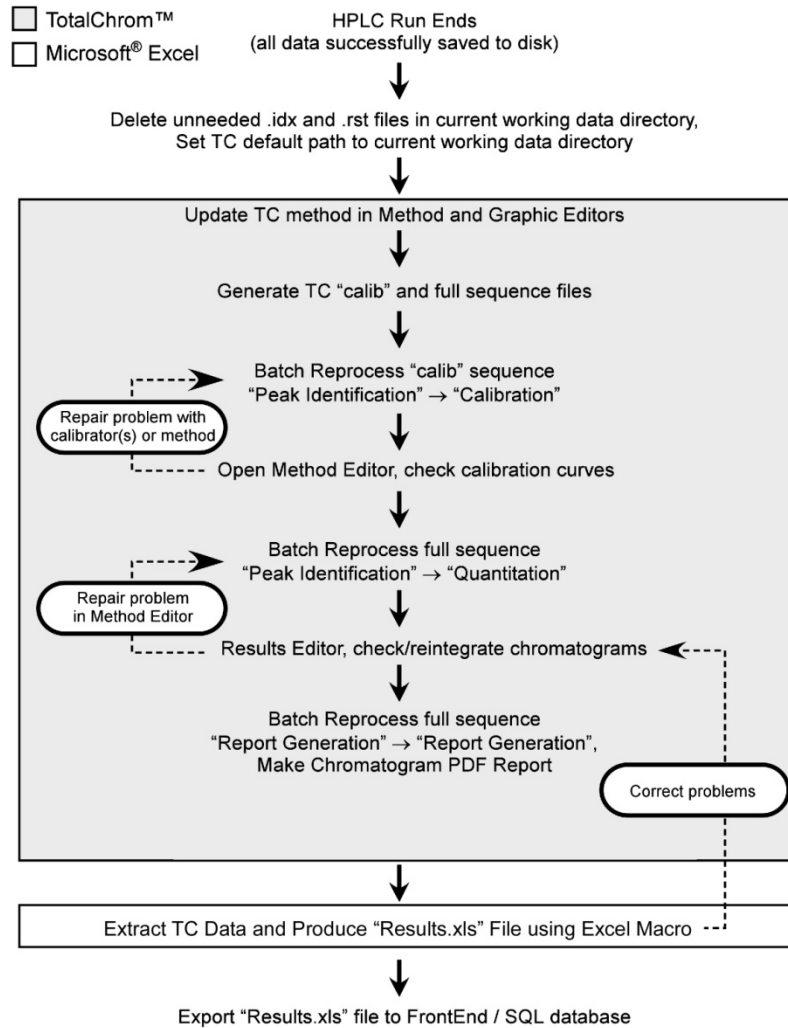
c. Data Processing and Analysis

Refer to Figure 1 “Post-Run Data Processing Work Flow Diagram” (page 58) for a summary representation of the important aspects of post-run data processing.

1. Open Microsoft Windows® File Explorer and open the current working HPLC data directory (e.g., C:\HPLC\Data\). Select all files ending with the .rst and .idx and “delete” them.
2. If it is not already open, launch TotalChrom™.
3. If ChromLink was not run in real-time data collection mode during the run as described in step 16 under *Starting the Run* (see page 48), do the following:
  - (a) In the TotalChrom™ Navigator window, choose menu item Apps > ChromLink. Choose the menu item Configuration > Mass Details and check the Nominal Name and Mass for arsenic. If it is missing or altered then ChromLink™ needs to be configured (see *Configuration of ELAN ChromLink™* on page 55 for details).
  - (b) Check that the Mode field indicates “Automatic – Process all NetCDF files in specified location”. If it does not, click the “Set” button to the right of this field and in the resulting “Operating Mode” dialog box click the “Automatic – process all ELAN NetCDF files in specified location” radio button. Click “OK”. Next, check that the Field labeled “ELAN NetCDF file – location/file to be converted” indicates the correct data folder. This should be “C:\elandata\Reportoutput\\*.nc”. If it is not, click the Browse button to the right of it, and in resulting dialog box, navigate to that folder. Double-click on that folder then click “OK” to close the front most dialog box. Click the Browse button to the right of the field labeled “ELAN ChromLink file location...”. In the dialog box “Select TotalChrom™ Data Location”. Navigate to the folder containing the run data and double-click on it. Click “OK” to close that dialog box. In the ELAN ChromLink window, click the button “Start Processing ELAN Data Files” to start processing of the run data. A new dialog box will open and provide current information on the status of the data conversion.
  - (c) When data conversion by ChromLink is completed within a minute or two, a message in the Step field will indicate “Successfully Finished”. Click “Close”. At this point, you may close the ELAN ChromLink application by choosing File > Exit or clicking on the window “x” box. In the resulting “OK to quit?” confirmation dialog box, click “OK”.
4. In the TotalChrom™ Navigator window, choose the menu item Build > Method. Click the “Load method stored on disk” radio button and click “OK”. In the TotalChrom™ File-Open” dialog box, find C:\HPLC\Methods folder and open “Arsenic1.mth” file. The template method file should now be loaded.



FIGURE 1: POST-RUN DATA PROCESSING WORK FLOW DIAGRAM



If instead of loading the method file an error message says the file is unavailable because it is in use and asks if you would like to open it in Read-Only mode, click "No". Cancel the Open-File dialog box, and exit the Graphic Method Editor. In the Navigator window, choose menu item Admin > CAM Administrator. A window will appear with two panes. In the left pane, click on the "+" sign in front of "TotalChrom Servers" to expand it. Click on the computer icon on the next line that just appeared to highlight it. In the right pane, under the heading "Resource/Instrument", select the first item. If there is more than one item, select every item by shift-clicking on each item. Every item should now be highlighted. Choose Edit > Remove Locks (or press the Delete key on the keyboard). Next, click on the "+" sign in front of "Users" to expand it. Click to highlight your TotalChrom™ user name that appeared. In the right pane, under the heading "Resource/Instrument", select every item and Choose Edit > Remove Locks. This action serves to unlock files and make them available for editing. If in the future, TotalChrom™ complains that files cannot be edited because they are locked, use CAM Administrator to unlock them. Choose File > Exit to quit CAM Administrator. Start again at the beginning of this step to open the Method Editor.

5. Choose File > Save As. At the next window you will be given the option to enter information about the method which can be done at your discretion. Click "OK" and a TotalChrom™ File-Save-As" dialog box opens. Navigate the directory tree to get to the folder that contains the ELAN data files for this run (typically in the folder C:\HPLC\Data\). Double-click on this folder. In the "File name:" field, enter the same name as it exactly appears for the folder that will contain it (i.e. As<yymmdd> convention where yy = last two digits of the year, mm = two digit month, dd = two digit date). Click "Save" then close the "Method Editor" window.
6. In the TotalChrom™ Navigator window, choose the menu item Build > Graphic Edit. Choose File > Open from the menu bar and navigate the file-open dialog box to the folder containing the method file created in the preceding step. Click on that file and then click "Open". Return to Graphic Method Editor's menu bar and choose File > New Data File. Navigate to C:\HPLC\Data\ and double-click on the folder containing the run data. Find and click on a data file (indicated by the ".raw" extension) that corresponds to the "S4" calibrator run. When this file appears in the File Name field, click the Open button. In the File-Open dialog box that appears, click "Cancel". If a message box appears with the warning "Unable to open this file: default.mth", click OK to clear the message (you do not have to go to CAM Administration to unlock it). Do the same if another message warning box appears (i.e. click OK again to clear it). You should be in the "Graphic Method Editor - <path to method file>" window and see a chromatogram.
7. Choose menu item Calibration > Show Windows and retention window bars (looks like "H" style error bars) will appear. Each retention time window bar should be located above the chromatographic baseline and contain an identified peak within its bounds. If there are any bars at the bottom of the chromatogram located below the baseline, choose menu item Calibration > Edit Components. Click on the first arsenic species peak that falls outside its retention time window to select it. In the group of data fields located on the right side of the window, click on the "Name" dropdown arrow (located on the right side of the data entry field) and choose the appropriate species by name. Next, click on the "ISTD" field's dropdown arrow and choose "IS". Be sure the

“ISTD” checkbox is unchecked unless you are editing the “IS” peak; in this case put a checkmark in the “ISTD” checkbox. It is usually not necessary to alter the retention time window’s “Absolute” and “Relative” window parameters, but you may do so if experience dictates that a change will be beneficial. Click the Next or Prev button. Repeat these steps for each arsenic species peak that was not properly identified because it was outside its retention time window. Since TMAO is not present in any of the “S” calibrators, choose File > New Data and open one of the “T” series calibrators that contain TMAO (e.g., T4) and confirm its identity and retention time window using the same process as was used for S4. When the editing of peak retention time windows is completed, click on the menu bar item “Return”. Choose File > Save followed by File > Exit.

8. Launch Microsoft<sup>®</sup> Excel and choose menu item HPLC > Create TC Sequence File (the Excel macro “Extract TC Data.xls” must be installed in Excel’s Startup folder). In the open file dialog box, navigate to the current working HPLC data folder. Click on a RAW file then click the “Open” button. Wait about 30 seconds until a “Done” message box appears. Excel will create two sequence files, one containing just the calibrators (name ending with “calib.seq”) and the other file containing all samples and calibrators (named As<yymmdd>.seq). You may leave Excel open.

Skip the following steps (a) through (c) unless, for some reason, the Excel menu item HPLC > Create TC Sequence File cannot be run:

- (a) In the TotalChrom™ Navigator window, choose the menu item Build > Sequence and a dialog box called “Startup” will appear. Click on the radio button labeled “Load sequence stored on disk” then click the OK button. Navigate to the folder containing the run data and click on the sequence file (ends with “.seq”) corresponding to the run (typically named in the As\_yymmdd.seq format). Click “Open”. A spreadsheet styled sequence table will present itself in a window called “Sequence Information – Channel A”. There will be a minimized window for channel B data. Ignore this window. Look for the “Method” column and click on the first cell in row 1 in this column. Right click the mouse and a contextual menu will appear, choose “Browse”. In the resulting File-Select dialog box, navigate and choose the method file (ending in “.mth”) created earlier. Click “Select”. The path and name of the new method file will replace the default information in this cell. Right click this cell again and choose Fill Down. The new file name information will fill down to every cell in the “Method” column. Look for the “Study Name” column and click on the first cell in row 1 in this column. Note that this cell contains redundant information that is already in the Name column. Press the delete key to clear this cell. Right click the mouse and a contextual menu will appear, choose “Fill Down”. Right click this cell again and choose Fill Down. This will clear every cell in the “Study Name” column. Choose menu item File > Save. Do not close this window yet.
- (b) Position the mouse cursor over the first row number (in the Row column on the far left side of the window) that is NOT a calibrator. The cursor should be in the form of a fat plus sign. If it looks like small vertical double-ended arrow, move the mouse slightly up or down until it changes to a fat plus sign. Press and hold down the left mouse button and drag

down across all the row numbers that are not calibrators. Check that you have not accidentally included calibrators, otherwise, deselect all the rows and try selecting again. Once you are sure that none of the calibrators are selected, choose menu item Edit > Delete. Repeat this process until only rows corresponding to calibrators are present in the sequence table. Click the cell in the first row in the "Type" column and a dropdown menu should appear. Choose "Cal:Replace". Right-click on the same cell and choose Fill Down. At this time, "Cal:Replace" should appear in every cell in the "Type" column.

- (c) Inspect the Sequence Editor window for Excel-styled workbook tabs at the bottom. Locate the tab labeled "Calibration" (if you do not see it on first look, click on the small right arrow just left of the first tab, this will cause the tabs to "scroll" left and reveal additional tabs). Click on the top cell in the "Cal Level" column. A dropdown menu will reveal "S0", "S1", "S2" through to "T4" menu choices. Moving down the column, for each calibrator you will need to assign its level by choosing correct menu item from the dropdown menu. When all calibrators are assigned their appropriate level, click on the cell in the "Calib Rpt" column corresponding to "S4" calibrator. A pop-down menu should appear; choose "Short". Likewise, change the "Calib Rpt" for "T4" from "None" to "Short". Choose menu item File > Save As. A window showing a Description field appears, just click OK and Save As dialog box will appear. Name the new sequence file the same name as the original sequence file except add the word "calib" to the end of the file name (be sure to separate the words by a space). Click the Save button. Then close the Sequence Editor window by choosing File > Exit from the menu bar.
9. In the TotalChrom™ Navigator window, choose the menu item Sequence. Open the calibrator sequence file created in the previous step (the file will be named the corresponding date Asymmdd\_calib.seq). A sequence table will open. By looking in the "name" field, ensure that this table only displays information regarding calibrators from the run. (The names for calibrators should match those in the Elan sample table created prior to the run, e.g. 002\_S0.) If blanks, quality control material, samples, or any other names are present in any row of the "name" field, delete the entire corresponding row in which they are present. Once only calibrators are present in this table, ensure that Cal:Replace is selected in the "type" field for all rows. Additionally, ensure that the "Cal Level" field is complete. Using the drop-down menu, Cal level fields for each row should match each level represented in the "name" field. Lastly, ensure that the correct method is shown in the "method" field for all rows. Save this sequence file (File > Save) and close.
10. In the TotalChrom™ Navigator window, again choose menu item Sequence. This time, open the sequence file matching the date of the run that **does not** include "calib" in the title. (It will look like Asymmdd.seq.) A sequence table containing all of the items represented in the run's Elan sample file will appear. In a manner similar to that in step 9, various field changes will have to be made. This step is important for proper database importing. In the "Type" field, use the drop-down menu to select the proper representation for each item in the entire list. In this field, Calibrators should be marked "Cal:Replace," blanks should be marked "Blank," quality control materials and other control materials should be marked "Ctrl Sample," and all other items,

including those assessed for quantitative measure and equilibrators, should be marked "Sample," unless another title in the drop-down menu is appropriate. Next, ensure that the "Cal level" field is populated for calibrator sample rows only. If this field is not populated, select calibrator levels from a drop down menu by clicking in the field. Make sure these selected calibrator levels correspond to names in the "Type" field for each row. (For instance, a name of 002\_S0 in row 2 should correspond to a Cal level of "S0" in row 2.) Next, ensure that the proper method is listed in the "Method" field of each row. (This method should be the same that was "saved as" in step 5 of this section). Lastly, at the bottom of the sequence table, click on the "calibration" tab. A new sequence table will display; ensure that each row in the field "Cal levels" is accurate. Save this sequence file (File > Save) and close.

11. In the TotalChrom™ Navigator window, choose the menu item Reprocess > Batch. A new window appears entitled "Batch Reprocessing". Choose menu item File > Sequence and the "From Sequence" window appears. Locate the top field labeled "Sequence file" and look for a button with an open folder icon immediately to the right of the field. Click this button and navigate, if necessary, to the folder containing the run's sequence files. Click on the sequence file whose name ends with "calib.seq" and click the Open button. You will be returned to the previous window. Set each parameter in this window to the values shown in TABLE 10-8.

---

TABLE 10-8: TOTALCHROM™ NAVIGATOR – REPROCESS BATCH

---

Parameter Name	Parameter Setting
Starting Row	: 1
Ending Row	: <number of rows in sequence file>
Channel A	: Checked
Channel B	: Not Checked
Start Analysis	: Peak Detection
End Analysis	: Calibration
Batch Execution	: Interactive
Batch Printer	: None
Batch Plotter	: None
Enable Optional Reports in Method	: Not Checked
Use Method as Result File	: Grayed Out
Overwrite Existing Result Files	: Checked
Raw File Treatment	: Update existing raw file header with new sequence

---

12. Click "OK".
13. Choose menu item Reprocess > Start. The middle panel will contain a list of raw file waiting to be processed. Reprocessing of the chromatographic raw data will commence. The bottom panel in the window will update with each file's name as it is processed. When processing is done, this panel will be clear of files. Close this window.

14. In the TotalChrom™ Navigator window, choose the menu item Build > Method and open the method file for this run. If you get an error message telling you that you can only open this in read-only mode, then unlock the files by doing these steps:
  - (a) Click “No” to cancel the error message. Select File > Exit to close the Method Editor.
  - (b) In TotalChrom Navigator, select Admin > CAM Administration.
  - (c) In the CAM Admin Tool window, click in the file explorer-like window on top of the “+” sign in front of “TotalChrom Servers” to expand it. Click on the server name. A list of files will reveal themselves in the right-hand window panel.
  - (d) Click on the first file, hold down the shift key and click on the last file in the list. This will highlight all the files in the list. Press the keyboard’s “delete” key. This does not delete the actual files but only unlocks them.
  - (e) Select File > Exit in the CAM Admin Tool window to close it.
  - (f) Return to Method Editor window by selecting Build > Method in the TotalChrom™ Navigator window. Begin this step again.
15. Return to the menu bar and choose Window > Component List. Position the mouse on the any of the four corners or edges of the Component List window until the mouse cursor turns to a double-headed arrow. Expand the window until it fills its parent window.
16. The Component List window is divided into three panels. The left panel lists each component by peak number, retention time and component name. Clicking on any of the components will reveal that component’s calibration data and calibration curve in the middle and right panels, respectively. Consecutively click on each component one at a time and individually inspect each component’s calibration curve. It is important to note whether the calibration curve meets requirements for linearity, slope and intercept.
  - (a) Watch for calibration points that obviously fail to display their expected Response Ratio (i.e. fall away from the regression line compared to their neighboring points). Typically, a point with a Response Ratio equal to zero indicates that a component peak was missed during peak identification phase of calibration processing. Likewise, a point that falls far from the calibration curve might be because that component’s peak was misidentified (perhaps confused for another component). Inspection of nearby eluting component’s calibration curve might reveal an oppositely misaligned point for the same calibration level. Return to Graphic Editor and alter the retention time windows as necessary, so all peaks will be correctly identified upon reprocessing.
  - (b) While the regression line does not have to intersect every point, be especially mindful of “R-squared” value at the top left of the right panel. R-squared must exceed 0.990 (“two nines”) for each component. R-squared values >0.999 is common for this procedure.

- (c) Corrective action will need to be taken in any case of failure in the above rules. Possible steps include:
- (i) Checking chromatograms to see if an autosampler injection was missed. If so, all samples will have to be re-analyzed.
  - (ii) Inspecting previous runs in database for deviating trends among calibration curves from separate runs.
  - (iii) Inspecting chromatograms from previous runs to assess chromatographic shifts in retention time, peak height, or peak broadness. These shifts could be a result of errors in buffer preparation, contaminated buffer solutions, an alteration of pH of buffer solutions, or a poor column.
  - (iv) Deleting one extreme outlier point from the calibration curve if, in doing so, adequate linearity is achieved. This step should not be common practice (for no more than 2 runs in a row should an analyst have to perform this corrective measure). Analysts must include record of this action in a run summary email to supervisor(s).
17. If the calibration curves pass inspection, close the Method Editor.
18. In the TotalChrom™ Navigator window, choose the menu item Reprocess > Batch to reopen the “Batch Reprocessing” window. Choose File > Sequence and click the button with the open folder icon located right of the field labeled “Sequence file”. Navigate, if necessary, to the folder containing the run’s sequence files and click on the other sequence file whose name does not contain “calib”. Click “Open”. Upon return to the previous window, set End Analysis to “Quantitation” and Batch Printer to “None”. All other parameters should remain unchanged.
19. Click “OK” to close the front window. Next, click the green “start arrow” button. Reprocessing of the chromatographic raw data will commence.
20. In the TotalChrom™ Navigator window, choose the menu item Reprocess > Results. A new window should open called “Reprocess Results”. If you get an error message telling you that you can only open this in read-only mode, then unlock the files (follow the procedure described in step 4 of this section). Select from the menu File > Open. In the open file dialog box, click on the “Files of type:” dropdown menu and select “IDX files (\*.idx)”. Navigate to the folder containing this run’s data and click on the newest file (in the format of “As<yymmdd>-<today’s date>-<time of reprocessing>”). Click “Open”. A chromatogram will be presented for the first sample in the sequence in the Reprocess Results window. Carefully inspect the chromatogram one peak at a time for correct peak identification and accurate baseline. If you are satisfied that there are no integration problems, proceed to the next sample’s chromatogram by selecting File > Next File from the menu bar. Examine all chromatograms in this manner and make corrections in peak identity and integration as necessary. Make notes concerning issues encountered with individual chromatograms and changes that were made. If a chromatogram is changed or edited in any way, be sure to select File > Save to save your changes. See the chapter entitled “Developing Processing Parameters in the Method” in the PerkinElmer *TotalChrom™ Workstation Users Guide* for a detailed explanation on how to use integration events to optimize the integration of a chromatogram. After review of each and every chromatogram, select File > Exit from the Reprocess Results menu bar.

21. Repeat step 18 except set both Start and End Analysis to "Report Generation". Set Batch Printer to "Find Print Factory Pro". A new window will open entitled "pdFactory Pro: <###> Jobs (## pages, ### Kb)". When reprocessing has completed, click the Save button on the pdFactory Pro window. In the Save As dialog box that appears, navigate to the run's data folder and create a new pdf file named "As<yymmdd> report". Be sure to include a space between "report" and the first word of the new file. Click the Save button. This pdf file is to be kept and backed up, for archival purposes, in the same folder with all the other chromatographic data files for this run. Click the "Close" button to close pdFactory Pro window.
22. Open Microsoft Excel and choose HPLC > Extract TC Data. In the dialog box which follows, choose the sequence file created in step 10 of this section and click Open. Immediately a macro will run that will transform the data into a format that is easily exported into the database. Just before the macro finishes, a Save As dialog box will open giving you the opportunity to save the file as an Excel workbook. Give the file a name as follows: "As<yymmdd> results". *Note: For runs containing multiple groups of samples (each group being bracketed by its own quality control material), separate filenames will be necessary for each group. The newly-created "As<yymmdd> results" Excel file should be broken into multiple smaller files, labeled as "As<yymmdd> results Run 1", "As<yymmdd> results Run 2", and so forth, where Run 1 corresponds to the first unique group in the spreadsheet, Run 2 corresponds to the second unique group in the spreadsheet.*

Each multi-tabbed Excel workbook contains a worksheet suitable for data exportation to the MS SQL Server 7™ database. Clicking on additional tabs will show worksheets for (a) summary table for easy visual review of the data, (b) quality control results, (c) calibration data with regression statistics and plotted calibration curves for each arsenic species, (d) instrument stability chart showing degree of consistency of internal standard peak areas plotted as a function of injection #, and (e) raw data (two tabs).
23. The data processing portion on the instrument controller computer is now complete. At this point you may close Microsoft Excel® and TotalChrom™ Navigator.

## 11. RECORDING OF SAMPLE AND QC DATA

---

### a. Transferring the Data to the Central Database

1. Transfer the "As<yymmdd> results".xls file (or the files representing each run) via encrypted USB drive or other data media to the appropriate subdirectory on the network drive where exported data are stored. (Note that directories are named according to instrument\year\month\ and study name or ID, for example, "Q:\Nutritional\Instruments\ELAN\ELAN\_DRC2H\2008\06\As080602".)
2. From a computer that has access to the Microsoft Access™ or MS SQL Server 7™ database used for tracking data start the program. A "GoTo2 : Form" window should automatically open. If it does not, you may have to open it manually.



3. Click the “Add Sample Results to Database” button. New buttons will appear. Click the “Import Instrument Data File” button. For “Instrument”, choose “ELAN-DRC2D” (or the appropriate instrument). For “Assay”, choose “As Speciation 2”. Choose the correct analyst from the drop-down list and the appropriate study. It is not necessary to fill-in the “IS Lot Number” Field. Click “Import”. Select the location of the data file on the network drive and press the “Open” button.
4. In the “Imported Results” table, pressing the “Find X’s” button will show only those samples whose sample ID is not recognized as a valid QC pool ID or sample ID for this study. (Sample IDs are set up when the study is logged into the database). If necessary, corrections to sample IDs and dilution factors can be made in this table (e.g., correction of transcription errors and adjustment for level of dilution). If samples were diluted for analysis, both the sample ID and the dilution factor need to be edited in this table before the values are transferred to the database. First, change the dilution factor to reflect the way that the sample was analyzed then edit the sample ID to remove any comments about the level of dilution at which the sample was analyzed. (The replace command is useful here.)
5. When corrections to sample IDs are made, press the “Recheck” button to evaluate the sample IDs. Any sample or analyte row marked “Not Recognized” will not be transferred to the database when the “Transfer” button is pressed.
6. Press the “Transfer” button to import data into the database.

#### b. QC Data

Once data is transferred to the Microsoft Access™ (or MS SQL Server 7™) database, quality control (QC) samples must be assessed for pass or failure through the generation of QC reports. The database allows for the printing of several types of QC reports. If necessary, keep a copy of the report with the analysis printouts from the run (if the data needs to be printed). The QC reports can be stored electronically.

## 12. FINAL REVIEW OF THE DATA

---

#### a. Analysis Printouts and Analyst Run Report

Per the guidelines of each study, bind the analysis printouts with a printout of the calibration curve and curve statistics and place them in the study folder(s). For some studies, this step is not necessary.

#### b. Plotting QC Results

When the Microsoft Access™ or MS SQL Server 7™ database is used, QC plots are updated automatically when the data are imported into the database. Monitor these plots regularly for any trends in the bench QC results. If trends are observed, contact the laboratory supervisor.

## c. Supervisor Review

The Microsoft Access™ or MS SQL Server 7™ database allows the supervisor to review the QC and sample results directly in the database. After the supervisor reviews the data, he or she may mark results as “Ready to Report.”

### 13. REPLACEMENT AND PERIODIC MAINTENANCE OF KEY COMPONENTS

---

## a. ICP-MS Maintenance

Part numbers listed below are PerkinElmer part numbers from their *2006/2007 Consumables Catalog*. Equivalent high quality parts from other suppliers may be used as noted.

1. Peristaltic pump tubing for sample (0.03 inch i.d., Item # 09908587), rinse station (can use either same tube type as for sample or 0.045-inch i.d., Item #N0680375) and for waste (0.125-inch i.d., Item #N8122012): Keep at least 6 packages of 12 on hand of the sample tubing, 6 for rinse station and 2 packages of 12 on hand of the waste tubing. Other suppliers may offer the same size/type of peristaltic tubing.
2. Autosampler probe assembly (Item # B3000161). Keep a spare on-hand.
3. Nebulizer capillary tubing (0.023-inch i.d., Item #09908265 or any source of polyethylene tubing, 0.6 mm i.d. x 0.97 mm o.d.). Use to connect the nebulizer and the peristaltic pump tubing. Keep one pack (10 feet) on hand.
4. Injector Support for ELAN DRC (Item # WE023951). Keep one spare on hand.
5. Ball Joint Cassette Torch Injector Support Adapter (Item # W1012406).
6. Cassette Torch Mount for ELAN DRC II (Item # W1020672).
7. Torch O-Ring Kit (packages of four, Item # N8120100). Keep four spare packages on hand.
8. Quartz torch. At least two spare torches should be on hand (Item # N8122006).
9. Quartz Sample Injector, 2.0mm Ball Joint (Item # WE023948). At least two spare injectors should be on hand.
10. RF coil (Item # WE021816). One spare should be on hand.
11. Platinum Skimmer (Item # WE027803 or equivalent) and platinum sampler cones (Item # WE027802 or equivalent). Keep at least two spares of each on hand.
12. Skimmer and sampler cone O-rings (Item # N8120512 and # N8120511, or equivalent, respectively). Keep at least 10 spares of each on hand.
13. Series II replacement Ion lens (Item # WE018034). Keep two spares on hand.
14. Pump oil for the roughing pump (Item # N8122004 or equivalent). Keep four bottles on hand. If an instrument is equipped with a Fomblin oil-based pump,

only one bottle of Fomblin oil (Ausimont or equivalent) is necessary to keep on-hand.

15. Polyscience chiller coolant (PE Sciex Coolant, Item # WE016558A): Two 1-L bottles should be kept on hand.
16. If possible, have a backup Polyscience chiller (or equivalent). See a PerkinElmer sales representative for part numbers.

#### 14. LIMIT OF DETECTION AND LINEAR RANGE TESTED

The limits of detection (LOD) for arsenic species in urine specimens are based on data taken from a minimum of 60 analytical runs. At least four levels are used in each run with one level being below the LOD. The matrix blank can be used to satisfy the criterion of having a level below the LOD. Using the data from at least 60 runs, regression can be used to validly predict the standard deviation at the LOD concentration. The LOD will be three times this calculated standard deviation, and this will represent the method detection limit. Report results below the detection limit as "< LOD" (where "LOD" is the calculated lowest detection limit). The LOD calculation is reevaluated once every two years.

TABLE 14-1: LIMITS OF DETECTION (LOD) AND LINEAR RANGE TESTED (LRT) FOR AS SPECIES

Species Chemical Name	Abbreviated Name	Limit of Detection, µg/L	Highest Concentration for Linear Range Tested, µg/L
Arsenobetaine	AB	1.19	1000
Arsenocholine	AC	0.28	1000
Trimethylarsine oxide	TMAO	0.25	1000
Monomethylarsonic acid	MMA	0.89	1000
Dimethylarsinic acid	DMA	1.8	1000
Arsenous (III) acid	As(III)	0.48	1000
Arsenic (V) acid	As(V)	0.87	1000

#### 15. REPORTABLE RANGE OF RESULTS

Urine arsenic results are reportable in the range of greater than the LOD, where LOD is the calculated limit of detection. When a sample result for any analyte is greater than the highest calibrator for the same analyte within the run, the result needs to be confirmed. If a sample's result for any analyte is greater than 110% of the Linear Range Tested ("LRT") concentration (see TABLE 14-1), then the sample must be diluted with water before a repeat analysis can be performed. Otherwise, the confirmation may be done without dilution in a run that includes an additional standard or external reference material ("Extended Range Check") having a known analyte concentration equal to or greater than that measured in the sample, up to the LRT concentration. The Extended Range Check shall not be included in the calculation of the calibration curve; instead it will be analyzed like an unknown sample. Its result will serve to check

the linearity of the regular calibration curve beyond the maximum calibration point. For the check to qualify, the measured concentration of the Extended Range Check result must be within  $\pm 10\%$  of its nominal value. If its value is within this target, the sample's original result may be reported for the analyte. If the Extended Range Check does not fall within the target specified, the sample must be diluted to bring its analyte concentration within the method's regular calibration range.

Results Greater Than Range of Linearity Tested: Perform an extra dilution on any urine sample whose concentration is greater than those listed in Table 14-1 (the highest concentration for linear range tested).

## 16. SPECIAL PROCEDURE NOTES – CDC MODIFICATIONS

---

None applicable for this method.

## 17. QUALITY CONTROL PROCEDURES

---

The Inorganic and Radiation Analytical Toxicology Branch uses the method described in this protocol for environmental and occupational health screening studies.

This analytical method uses two types of Quality Control (QC) systems: With one type of QC system, the analyst inserts bench QC specimens two times in each analytical run (a set of consecutive assays performed without interruption) so that judgments may be made on the day of analysis. With the other type of QC system, "blind" QC samples are placed in vials, labeled, and processed so that they are indistinguishable from the subject samples (as many as possible). The supervisor decodes and reviews the results of the blind specimens. With both systems, taking these samples through the complete analytical process assesses all levels of the analyte concentrations. The data from these materials are then used to estimate methodological imprecision and to assess the magnitude of any time-associated trends. The bench QC pools used in this method comprise two levels of concentration spanning the "low-normal" and "high-normal" ranges for each arsenic species. Both of these pools are analyzed after the calibration standards are analyzed but before any patient samples are analyzed. These bench QCs should be analyzed again at the end of the run. If a second run of samples are analyzed using the same calibration curve as the first run, the QC results obtained from the second run's own bench QC samples need to be analyzed and treated independent of the first run.

- a. Establish QC limits for each QC pool.

A run to assess the homogeneity of the pools is performed after the pools are aliquotted into individual vials. Vials are randomly chosen and randomly analyzed, and the first and last vials dispensed are always included in the homogeneity study. Unlike the characterization of the QC, the homogeneity study can be completed in a single run. Once analysis is complete, the data is evaluated in terms of QC recovery to determine whether or not trends exist in QC during the dispensing of the pool. If the pool does not vary from beginning to end or problem vials can be identified and eliminated, the characterization of the QC is the next step. If problems do exist, the source(s) of the problem has to be identified and the pool has to be re-made and dispensed again.

To complete the characterization that will allow you to assess limits for each pool, analyze a minimum of twenty samples of each pool (low and high) on 20 different days, preferably among all of the instruments that will be used to analyze this method. During the 20 characterization runs, previously characterized QCs or pools with target values assigned by outside laboratories are also analyzed to evaluate each run's QC. Once analysis is complete, calculate the mean and standard deviation for each pool from the concentration results. These values will be used to establish the limits for each pool.

b. Precision and Accuracy

**QC Results Evaluation.** After completing a run, consult the QC limits to determine whether the run is "in control" for each of the seven analytes. *The QC rules apply to the average of the beginning and ending analyses of each of the bench QC pools.* The QC rules are as follows:

1. If both the low-and the high-QC results are within the 2s limits, accept the run.
2. If one of two QC results is outside the 2s limits, apply the rules below and reject the run if any condition is met.
  - **1<sub>3s</sub>** – Average of both low QCs OR average of both high QCs is outside of a 3s limit.
  - **2<sub>2s</sub>** – Average of both low QCs AND average of both high QCs is outside of 2s limit *on the same side of the mean.*
  - **R<sub>4s</sub> sequential** – Average of both low QCs AND average of both high QCs is outside of 2s limit *on opposite sides of the mean.*
  - **10<sub>x</sub> sequential** – The previous nine average QCs results (for the previous nine runs) were *on the same side of the mean* for either the low OR high QC.

If the run is declared "out of control," the analysis results for all patient samples analyzed during that run are invalid for reporting for the affected analytes.

c. Remedial Action If Calibration or QC Systems Fail to Meet Acceptable Criteria

If an analyte fails to pass QC based upon the QC report, the following steps should be taken, if possible:

- Check the chromatograms for each blank, calibrator, QC, and sample for proper peak integration and identification. Check that the internal standard peak was properly integrated and identified. Change integration parameters or manually reintegrate peaks, if necessary, and reprocess the run in TotalChom™.
- Check the ICP-DRC-MS stability during the run by examining the degree of variability and drift in internal standard raw peak areas over the course of the run. Irreproducibility that exceeds 15% and drift >20% or sudden large changes in internal standard peak area likely indicates that there was a problem in plasma stability.
- Setup a new run for the reanalysis of the patient samples affected by the previous failed run. Be sure to use freshly thawed calibrators and QC material.

- If these three steps do not result in correction of the out-of-control values for QC materials, consult the supervisor for other appropriate corrective actions. No analytical results should be reported for runs that are not in statistical control.

## 18. LIMITATIONS OF METHOD; INTERFERING SUBSTANCES AND CONDITIONS

---

The argon chloride (ArCl) interferences on arsenic ( $^{75}\text{As}$ ) are eliminated by the operation of the DRC™ under the parameters noted in the sections above during the speciated arsenic analysis.

## 19. REFERENCE RANGES

---

The reference range for each arsenic species (see TABLE 19-1) is based on literature reports and from periodic review of accumulated data collected during the analysis of urine samples representing a normal, healthy population believed to be free of unusual exposure to arsenic. Where data is absent or scant, reference ranges are based on the scientific literature, if available.

TABLE 19-1: REFERENCE RANGES FOR ARSENIC SPECIES

Species Chemical Name	Reference Range <sup>1</sup> , µg/L
Arsenobetaine	<LOD – 7.9
Arsenocholine	<LOD
Trimethylarsine oxide	<LOD
Monomethylarsonic acid	<LOD – 7.1
Dimethylarsinic acid	1.8 – 12.2
Arsenous (III) acid	<LOD – 2.5
Arsenic (V) acid	<LOD – 3.2

<sup>1</sup> There are no established reference ranges for arsenic species. Above ranges are estimates based on CDC unpublished data. 5-95 percentile of randomly selected NHANES 2002 samples n=48.

## 20. ACTION-LEVEL RESULTS

---

If a patient sample has a non-dietary arsenic concentration greater than 50 µg/L, the levels will have to be reported by fax, telephone, or E-mail to the supervising physician or principal investigator. This is not done by the reviewer(s) of the data and not the analyst.

## 21. SPECIMEN STORAGE AND HANDLING DURING TESTING

---

Specimens may reach and maintain ambient temperature during analysis. Take stringent precautions to avoid external contamination. After the samples are analyzed, return them to ≤ -20°C freezer storage as soon as possible.

## 22. ALTERNATE METHODS FOR PERFORMING TEST AND STORING SPECIMENS IF TEST SYSTEM FAILS

---

If the analytical system fails, freezer storage ( $\leq -20^{\circ}\text{C}$ ) is recommended until the analytical system is restored to full functionality.

## 23. TEST-RESULT REPORTING SYSTEM; PROTOCOL FOR REPORTING CRITICAL CALLS (IF APPLICABLE)

---

Report test results as outlined in the *DLS Policies and Procedures Manual*. For critical calls, the supervisor should notify the supervising physician or principal investigator as soon as possible. The most expeditious means should be used (e.g., telephone, FAX, or E-mail).

## 24. TRANSFER OR REFERRAL OF SPECIMENS; PROCEDURES FOR SPECIMEN ACCOUNTABILITY AND TRACKING

---

For select studies, the person that receives specimens or samples delivered to Inorganic and Radiation Analytical Toxicology Branch sets up a "Specimen Folder." He or she is to fill out a tracking form and place it in the folder to be given to the analyst performing the analysis. The form tracks location, status, and final disposition of the specimens. When sample analysis is completed, update and place the tracking form in the Specimen folder.

Use standard electronic record keeping means (e.g., Microsoft Access™, encrypted USB devices, or CD-R backups) to track specimens. Maintain records, including related quality assurance (QA) and QC data, for 3 years or longer. Keep duplicate records (off site, if sensitive or critical) in electronic or hard-copy format. Use only numerical identifiers (e.g., case ID numbers); all personal identifiers are available only to the medical supervisor or project coordinator to safeguard confidentiality.

## 25. BI-ANNUAL EXTENDED LINEAR RANGE VERIFICATION STUDY

---

Per CLIA requirements, twice per year, the extended linear range of the method has to be verified. This is accomplished by analyzing the extended calibrators for each series (i.e. S5, S6, S7, T5, T6, and T7) as samples. The concentration for each species has to fall within 10% of its nominal value or remedial action has to be taken.

## 26. BI-ANNUAL INSTRUMENT-TO-INSTRUMENT COMPARISON

---

Per CLIA requirements, twice per year, if an analytical method is performed on more than one instrument, then an instrument-to-instrument comparison has to be performed. This is usually done in conjunction with the extended linear range verification study. The same samples have to be analyzed on each instrument, and the Pearson Product Moment Correlation Coefficient for the results for each species has to be greater than 0.95. If not, remedial action has to be taken.

## 27. REFERENCES

---

1. Styblo M, Drobna Z, Jaspers I, Lin S, Thomas DJ. The role of biomethylation in toxicity and carcinogenicity of arsenic: a research update. *Environmental Health Perspectives*. 2002;110:767-71.
2. Sakurai T. Biological effects of organic arsenic compounds in seafood. *Applied Organometallic Chemistry* 2002;16:401-405.
3. Francesconi KA, Edmonds JS. Arsenic and marine organisms. *Advances in Inorganic Chemistry*, Vol. 44, 1997:147-189.
4. Kojima C, Sakurai T, Ochiai M, Kumata H, Qu W, Waalkes MP, et al. Cytotoxicological aspects of the organic arsenic compound arsenobetaine in marine animals. *Applied Organometallic Chemistry* 2002;16:421-426.
5. Sakurai T, Kaise T, Saitoh T, Matsubara C. Evaluation of in vitro cytotoxicity of tetramethylarsonium hydroxide in marine animals. *Applied Organometallic Chemistry* 1999;13:101-106.
6. Agency for Toxic substances and Disease Registry (ATSDR). Toxicological profile for arsenic. Atlanta, GA: Public Health service, 2000.
7. Hall AH. Chronic arsenic poisoning. *Toxicol Lett* 2002;128:69-72.
8. Ahsan H, Perrin M, Rahman A, Parvez F, Stute M, Zheng Y, et al. Associations between drinking water and urinary arsenic levels and skin lesions in Bangladesh. *J.Occup.Environ.Med.* 2000;42:1195-1201.
9. Anawar HM, Akai J, Mostofa KM, Safiullah S, Tareq SM. Arsenic poisoning in groundwater: health risk and geochemical sources in Bangladesh. *Environ Int* 2002;27:597-604.
10. Das D, Chatterjee A, Mandal BK, Samanta G, Chakraborti D, Chanda B. Arsenic in ground water in six districts of West bengal, India: the biggest arsenic calamity in the world. Part 2. Arsenic concentration in drinking water, hair, nails, urine, skin-scale and liver tissue (biopsy) of the affected people. *Analyst* 1995;120:917-924.
11. Hsueh YM, Huang YL, Huang CC, Wu WL, Chen HM, Yang MH, et al. Urinary levels of inorganic and organic arsenic metabolites among residents in an arseniasis-hyperendemic area in Taiwan. *J.Toxicol.Environ.Health A* 1998;54:431-444.
12. Kreiss K, Zack MM, Landrigan PJ, Feldman RG, Niles CA, Chirico-Post J, et al. Neurologic evaluation of a population exposed to arsenic in Alaskan well water. *Arch.Environ.Health* 1983;38:116-121.
13. Valentine JL, Kang HK, Spivey G. Arsenic levels in human blood, urine, and hair in response to exposure via drinking water. *Environ.Res.* 1979;20:24-32.
14. Lewis DR. Dopant materials used in the microelectronics industry. *Occup Med* 1986;1:35-47.



15. Horng CJ, Tsai JL, Lin SR. Determination of urinary arsenic, mercury, and selenium in steel production workers. *Biol.Trace Elem.Res.* 1999;70:29-40.
16. Vahter M. Environmental and occupational exposure to inorganic arsenic. *Acta Pharmacol.Toxicol.(Copenh)* 1986;59 Suppl 7:31-34.
17. Hwang YH, Chen SC. Monitoring of low level arsenic exposure during maintenance of ion implanters. *Arch.Environ.Health* 2000;55:347-354.
18. Apostoli P, Alessio L, Romeo L, Buchet JP, Leone R. Metabolism of arsenic after acute occupational arsine intoxication. *J.Toxicol.Environ.Health* 1997;52:331-342.
19. Battista G, Bartoli D, Iaia TE, Dini F, Fiumalbi C, Giglioli S, et al. Art glassware and sinonasal cancer: report of three cases. *Am.J.Ind.Med.* 1996;30:31-35.
20. Aitken I. Arsenic poisoning associated with the burning of arsenic-treated timber. *P.N.G.Med.J.* 1976;19:103-104.
21. Gollop BR, Glass WI. Urinary arsenic levels in timber treatment operators. *N.Z.Med.J.* 1979;89:10-11.
22. Nygren O, Nilsson CA, Lindahl R. Occupational exposure to chromium, copper and arsenic during work with impregnated wood in joinery shops. *Ann.Occup.Hyg.* 1992;36:509-517.
23. Rosenberg MJ, Landrigan PJ, Crowley S. Low-level arsenic exposure in wood processing plants. *Am.J.Ind.Med.* 1980;1:99-107.
24. Takahashi W, Pfenninger K, Wong L. Urinary arsenic, chromium, and copper levels in workers exposed to arsenic-based wood preservatives. *Arch.Environ.Health* 1983;38:209-214.
25. Peters HA, Croft WA, Woolson EA, Darcey B, Olson M. Hematological, dermal and neuropsychological disease from burning and power sawing chromium-copper-arsenic (CCA)-treated wood. *Acta Pharmacol Toxicol (Copenh)* 1986;59 Suppl 7:39-43.
26. Brown RM, Newton D, Pickford CJ, Sherlock JC. Human metabolism of arsenobetaine ingested with fish. *Hum Exp Toxicol* 1990;9:41-6.
27. Kaise T, Horiguchi Y, Fukui S, Shiomi K, Chino M, Kikuchi T. Acute Toxicity and Metabolism of Arsenocholine in Mice. *Applied Organometallic Chemistry* 1992;6:369-373.
28. Kaise T, Ochi T, Oya-Ohta Y, Hanaoka K, Sakurai T, Saitoh T, et al. Cytotoxicological aspects of organic arsenic compounds contained in marine products using the mammalian cell culture technique. *Applied Organometallic Chemistry* 1998;12:137-143.
29. Kaise T, Watanabe S, Itoh K. The Acute Toxicity of Arsenobetaine. *Chemosphere* 1985;14:1327-1332.
30. Marafante E, Vahter M, Dencker L. Metabolism of arsenocholine in mice, rats and rabbits. *Sci.Total Environ.* 1984;34:223-240.
31. Yamauchi H, Kaise T, Yamamura Y. Metabolism and excretion of orally administered arsenobetaine in the hamster. *Bull Environ Contam Toxicol* 1986;36:350-5.

32. Tam GK, Charbonneau SM, Bryce F, Pomroy C, Sandi E. Metabolism of inorganic arsenic (74As) in humans following oral ingestion. *Toxicol Appl Pharmacol* 1979;50:319-22.
33. Pomroy C, Charbonneau SM, McCullough RS, Tam GK. Human retention studies with 74As. *Toxicol.Appl.Pharmacol.* 1980;53:550-556.
34. Buchet JP, Lauwerys R, Roels H. Urinary excretion of inorganic arsenic and its metabolites after repeated ingestion of sodium metaarsenite by volunteers. *Int.Arch.Occup.Environ.Health* 1981;48:111-118.
35. Baranov VI, Tanner SD. A dynamic reaction cell for inductively coupled plasma mass spectrometry (ICP-DRC-MS). Part 1. The rf-field energy contribution in thermodynamics of ion-molecule reactions. *J. Anal. At. Spectrom.* 1999;14:1133-1142.
36. Tanner S, Baranov VI, Vollkopf U. A dynamic reaction cell for inductively coupled plasma mass spectroscopy (ICP-DRC-MS). Part III. Optimization and analytical performance. *J. Anal. At. Spectrom.* 2000;15:1261-1269.

## 28. APPENDIX

---

### a. Macro Procedure "Extract TC Data"

The following Microsoft Excel<sup>®</sup> macro procedure was custom written to do the final reformatting of the TotalChrom<sup>™</sup> export data file so that it can be directly imported into the central Microsoft Access<sup>™</sup> database. It also creates a calibration plot for each of arsenic species calibration data including regression statistics for archival purposes. After all reprocessing steps are performed, Microsoft Excel<sup>®</sup> is opened and the macro "Extract TC Data" is ran. It will automatically perform the transformation of the reprocessed data and when it is finished, the analyst will be prompted to save the newly created Excel<sup>®</sup> workbook using a name of his or her choice. The first worksheet in the new Excel workbook file contains the run's results data that is ready to be directly imported into the database. Step by step instructions are described in "Data Processing and Analysis" in the Post-Run Data Analysis section. The entire macro can be pasted into an Excel macro module and saved.

```
Attribute VB_Name = "Module1"
Private Declare Sub TcInit Lib "TcAccess.dll" Alias "VbTcAccessInit" ()
Private Declare Function TcLoggedOn Lib "TcAccess.dll" Alias "VbTcAccessLoggedOn" () As Integer
Private Declare Function TcOpenConv Lib "TcAccess.dll" Alias "VbTcAccessOpenConversation" (ByVal
Topic As String) As Long
Private Declare Function TcCloseConv Lib "TcAccess.dll" Alias "VbTcAccessCloseConversation"
(ByVal Conv As Long) As Integer
Private Declare Function TcErrorMsg Lib "TcAccess.dll" Alias "VbTcAccessErrorMessage" () As
String
Private Declare Function TcSet Lib "TcAccess.dll" Alias "VbTcAccessSet" (ByVal Conv As Long,
ByVal ItemName As String, ByVal Value As String) As Integer
Private Declare Function TcGet Lib "TcAccess.dll" Alias "VbTcAccessGet" (ByVal Conv As Long,
ByVal ItemName As String, ByRef Value As String) As Integer

Public pathToMethodParametersFile As String
Public concIS As Variant
Public blankName As String
Public massName As String
Public zeroCalibName As String
Public injNumberPattern As String
Public myTableName As String
Public howManyBlanks As Variant
Public useAlternateFormula As Boolean
Public altFormulaCommentCode As String
Public CommandButtonDoneClicked As Boolean
Dim PromptForSaveAsDialog As Boolean
Public lastCol As Integer

Const PENenvironPath = "PEN_PATH"

Dim dataContainingRegion As String
Dim targetRangel As Integer
Dim useIntercept As Boolean
Dim arsenicspeciesInCalibMixB

Public Sub ExtractTCData()
' Version 2.0
' Created by Carl Verdon, 8/15/2006
' Updated 2/21/2008 by C. Verdon

    Dim x As Variant
    Dim y As Variant
    Dim i As Integer
```

```
Dim j As Integer
Dim compIndexCount As Integer
Dim nRows As Integer
Dim nPoints As String
Dim peakRT As String
Dim peakHt As String
Dim peakArea As String
Dim IS_peakArea As String
Dim peakRatio As Double
Dim peakRatio_zero_calib As Double
Dim peakRatio_blank As String
Dim peakName As String
Dim mthConcUnits As String
Dim mthCompName As String
Dim peakStartValue As String
Dim mthLevelConc As String
Dim mthLevelCount As String
Dim nameOfBlk As String
Dim componentResult As String
Dim finalResultFormula As String
Dim finalResultName As String
Dim componentRawResult As String
Dim peakName_index As String
Dim peakIndex As String
Dim rstSampleDilFactor As String
Dim rstPeakCount As String
Dim rstNumComponents As String
Dim seqCreationDate As String
Dim seqCreationTime As String
Dim rstCreationDate As String
Dim rstCreationTime As String
Dim seqEditDate As String
Dim seqEditTime As String
Dim seqFileAuthor As String
Dim mthMethodDescription As String
Dim peakList As String
Dim resultFile As String
Dim rawFile As String
Dim rawDataPoints As String
Dim fileSpec As Variant
Dim filespec_mth As String
Dim destWkbookname As String
Dim methodFile As String
Dim rstSampleNotes As String
Dim seqLevelName As String
Dim mthLevelName As String
Dim iSeqCycleIndex As Integer
Dim SeqNumCycles As String
Dim calibCurveCoeffients As String
Dim mthCompStr As String
Dim mthCompNum As Integer
Dim comp_level_Name As String
Dim sampleRate As String
Dim runTime As String
Dim plotAddress As String
Dim sampleNamesAddress As String
Dim iSeqNumCycles As Integer
Dim RetVal As Integer
Dim numMissingFiles As Integer
Dim iComponentIndex As Integer
Dim jComponentIndex As Integer
Dim progressIndicator As Long
Dim strComponent As String
Dim calibCurveCoeff_0 As String
Dim calibCurveCoeff_1 As String
Dim calibCurveCoeff_5 As String
Dim rsp As Variant
Dim iRet As Variant
```

```
Dim iRet2 As Variant
Dim iRet3 As Variant
Dim pkName As Variant
Dim originalStatusBar As Variant
Dim resultsSheetName As String
Dim rawSheetName As String
Dim stabilitySheetName As String
Dim chromeraSheetName As String
Dim qcResultsShtName As String
Dim seqSampleName As String
Dim seqSampleType As String
Dim rstSampleName As String
Dim rstStudyName As String
Dim rstMethodName As String
Dim workbookName As String
Dim thisFilename As String
Dim blks_seq_list As String
Dim c_SEQ As Variant           'TcAccess conversation handles
Dim c_RAW As Variant          'TcAccess conversation handles
Dim c_RST As Variant          'TcAccess conversation handles
Dim c_MTH As Variant          'TcAccess conversation handles
Dim ShowWarningMsg As Boolean
Dim thisIsTheIntStd As Boolean
Dim dirExist As Boolean
Dim itDoesExist As Boolean
Dim TcErrMsg As String
Dim useIntercept As Boolean
Dim breakHere As Boolean
Dim bIntStdWasFound As Boolean
Dim calib_S1_exists As Boolean
Dim firstLowQCSample As Boolean
Dim firstHighQCSample As Boolean
Dim internalStdWasFound As String
Dim tcNavProgramPath As String
Dim tcLCDservicePath As String
Dim strPenPath As String
Dim PEN_Service_Name As String
Dim strVersionNo As String
Dim zeroLevelName As String
Dim firstLevelName As String
Dim lowBenchQCName As String
Dim highBenchQCName As String
Dim rstIntStdConc As String
Dim currentDir As String
Dim filePathName As String
Dim nameSaveAsFile As String
Dim commandLine As String
Dim internalStdName As String
Dim equation1 As String
Dim equation2 As String
Dim macroName As String
Dim todaysDate As String
Dim currentTime As String
Dim savedNameSuffix As String
Dim columnDescription As String
Dim calibPrepDate As String
Dim stabilityShtRange As Range
Dim chromeraDataShtRange As Range
Dim btn As Object
Dim dLevel As Object
Dim dLevel2 As Object
Dim dCompName As Object
Dim dCompName_numberOfLevels As Object
Dim dCompName_i As Object
Dim dAmount As Object
Dim dSeqIndex_resultFile As Object
Dim dSeqIndex_seqSampleName As Object
Dim dSeqIndex_seqSampleType As Object
```

```

Dim dSeqIndex_rawFile As Object
Dim dSeqIndex_levelName As Object
Dim dLevelName_iSeqCycleIndex As Object
Dim dPeakNameZeroLevel_peakRatio As Object
Dim dPeakNameBlank_peakRatio As Object
Dim calibCurveCoeff_array
Dim rawPointsArray

If Len(Environ(PENenvironPath)) > 0 Then
    strPenPath = Environ(PENenvironPath)
    strPenPath = strPenPath & "\"
Else
    MsgBox "Cannot find the string " & Chr(34) & "%PEN_PATH%" & Chr(34) & " in the Operating
System's environmental variables table.", _
        vbOKOnly + vbExclamation, "Macro Aborted"
    Exit Sub
End If

strVersionNo = Mid(strPenPath, InStr(1, strPenPath, "Ver6", vbTextCompare), 8)
PEN_Service_Name = "PEN LCD Service for TcWS " & strVersionNo 'PEN LCD Service for TcWS
Ver6.2.0
tcNavProgramPath = strPenPath & "TCNav.exe"
tcLCDServicePath = strPenPath & "LCD.exe"
ShowWarningMsg = False
progressIndicator = 0
numMissingFiles = 0
firstLowQCSample = True
firstHighQCSample = True

itDoesExist = False
peakRatio_blank = 0
peakRatio_zero_calib = 0
' peakRatio_minus_bk = 0
internalStdName = "IS" 'default name for internal standard
concIS = 1 'default concentration of internal standard in ppb

massName = OGetSetting("VBA", "Sub_HPLCtransformVariables", "MassName_string", "As", True)
zeroLevelName = OGetSetting("VBA", "Sub_HPLCtransformVariables", "zeroCalibName_string",
"SO", True)
useIntercept = OGetSetting("VBA", "Sub_HPLCtransformVariables", "UseIntercept_boolean", True,
True)
lowBenchQCName = OGetSetting("VBA", "Sub_HPLCtransformVariables", "LowBenchQCName_string",
"LU-03102", True)
highBenchQCName = OGetSetting("VBA", "Sub_HPLCtransformVariables", "HighBenchQCName_string",
"HU-03104", True)
nameOfBlk = OGetSetting("VBA", "Sub_HPLCtransformVariables", "BlankName_string", "Bk", True)
columnDescription = OGetSetting("VBA", "Sub_HPLCtransformVariables",
"columnDescription_string", "not entered", True)
calibPrepDate = OGetSetting("VBA", "Sub_HPLCtransformVariables", "calibPrepDate_string", "",
True)

firstLevelName = Left(zeroLevelName, Len(zeroLevelName) - 1) & "1"

todaysDate = Date
currentTime = Time

If useIntercept Then
    savedNameSuffix = " Results"
Else
    savedNameSuffix = " Results (calib intercept not used)"
End If

fileSpec = Application.GetOpenFilename(FileFilter:="Seq Files (*.seq), *.seq", Title:="Choose
a Sequence File")
If fileSpec = False Then
    Exit Sub 'assume user clicked the Cancel button
End If

```

```
thisFilename = Right(fileSpec, Len(fileSpec) - InStrRev(fileSpec, "\", -1, vbTextCompare))
workBookName = Left(thisFilename, Len(thisFilename) - 4)

originalStatusBar = Application.DisplayStatusBar
Application.DisplayStatusBar = True

On Error Resume Next      ' Defer error handling
iRet = TcLoggedOn()
If iRet = 0 Then
    Application.StatusBar = "Starting PEN LCD Service, please wait..."
    Shell "NET START " & Chr(34) & PEN_Service_Name & Chr(34)
'C:\PenExe\TcWS\Ver6.2.0\Bin\LCD.exe
    Pause5seconds
    commandLine = tcNavProgramPath
    Application.StatusBar = "Launching TotalChrom, please wait..."
    RetVal = Shell(commandLine, vbMinimizedNoFocus)
    Pause5seconds
    If RetVal = 0 Then
        MsgBox "TotalChrom could not be launched.", vbOKOnly + vbExclamation, "Macro Aborted"
        Application.StatusBar = ""
        Application.DisplayStatusBar = originalStatusBar
        Application.ScreenUpdating = True
        Exit Sub
    End If
End If

Set dLevel = CreateObject("Scripting.Dictionary")
Set dLevel2 = CreateObject("Scripting.Dictionary")
Set dCompName = CreateObject("Scripting.Dictionary")
Set dCompName_numberOfLevels = CreateObject("Scripting.Dictionary")
Set dCompName_i = CreateObject("Scripting.Dictionary")
Set dAmount = CreateObject("Scripting.Dictionary")
Set dSeqIndex_resultFile = CreateObject("Scripting.Dictionary")
Set dSeqIndex_seqSampleName = CreateObject("Scripting.Dictionary")
Set dSeqIndex_rawFile = CreateObject("Scripting.Dictionary")
Set dSeqIndex_levelName = CreateObject("Scripting.Dictionary")
Set dSeqIndex_seqSampleType = CreateObject("Scripting.Dictionary")
Set dLevelName_iSeqCycleIndex = CreateObject("Scripting.Dictionary")
Set dPeakNameZeroLevel_peakRatio = CreateObject("Scripting.Dictionary")
Set dPeakNameBlank_peakRatio = CreateObject("Scripting.Dictionary")

Application.Workbooks.Add
Application.DisplayAlerts = False
For i = 1 To Workbooks.Count
    Sheets(i).Delete
Next i
Application.DisplayAlerts = True

If Sheets(workBookName).Name = Empty Then
    ActiveSheet.Name = Right(workBookName, 30)
Else
    ActiveSheet.Name = Right(workBookName & " copy", 30)
End If

Application.StatusBar = "Extracting TotalChrom data, please wait... "
Application.ScreenUpdating = False

resultsSheetName = ActiveSheet.Name

Sheets.Add After:=Worksheets(Worksheets.Count)
stabilitySheetName = "IS Stability"
ActiveSheet.Name = stabilitySheetName
Range("A1").Select
Set stabilityShtRange = Selection
With Selection
    .Value = "IS Area"
    .HorizontalAlignment = xlRight
    .Interior.ColorIndex = 15
```

```
.Interior.Pattern = xlSolid
End With

Sheets.Add After:=Worksheets(Worksheets.Count)
ActiveSheet.Name = Right(resultsSheetName & " Raw", 30)
rawSheetName = ActiveSheet.Name
Range("A1").Select
With Selection
    .Value = "RT (min)"
    .HorizontalAlignment = xlRight
    .Interior.ColorIndex = 15
    .Interior.Pattern = xlSolid
End With
Range("B1").Select

Sheets(resultsSheetName).Select

With ActiveSheet
    .Range("A1").FormulaR1C1 = "Run ID"
    .Range("B1").FormulaR1C1 = "Seq No."
    .Range("C1").FormulaR1C1 = "Sample ID"
    .Range("D1").FormulaR1C1 = "Type"
    .Range("E1").FormulaR1C1 = "Study ID"
    .Range("F1").FormulaR1C1 = "Result Date-Time"
    .Range("G1").FormulaR1C1 = "Result File"
    .Range("H1").FormulaR1C1 = "Method File"
    .Range("I1").FormulaR1C1 = "Dilution"
    .Range("J1").FormulaR1C1 = "Calib Name"
    .Range("K1").FormulaR1C1 = "Calib Conc"
    .Range("L1").FormulaR1C1 = "Analyte ID"
    .Range("M1").FormulaR1C1 = "Ret Time"
    .Range("N1").FormulaR1C1 = "Peak Ht"
    .Range("O1").FormulaR1C1 = "Peak Area"
    .Range("P1").FormulaR1C1 = "IS Peak Area"
    .Range("Q1").FormulaR1C1 = "Ratio"
    .Range("R1").FormulaR1C1 = "Ratio Blk"
    .Range("S1").FormulaR1C1 = "Ratio minus Blk"
    .Range("T1").FormulaR1C1 = "Ratio S0"
    .Range("U1").FormulaR1C1 = "Calib Intercept"
    .Range("V1").FormulaR1C1 = "Calib Slope"
    .Range("W1").FormulaR1C1 = "Calib Correl"
    .Range("X1").FormulaR1C1 = "Calib Number"
    .Range("Y1").FormulaR1C1 = "Raw Amount"
    .Range("Z1").FormulaR1C1 = "Adj Amount"
    .Range("AA1").FormulaR1C1 = "Column Desc"
    .Range("AB1").FormulaR1C1 = "Calib Prep Note"
    .Range("AC1").FormulaR1C1 = "Sample Note"

End With

With Range("A1:AC1")
    .Interior.ColorIndex = 15
    .Interior.Pattern = xlSolid
End With

Range("D2").Select
ActiveWindow.FreezePanes = True

' Create a second sheet for Chromera-style export
Sheets.Add After:=Worksheets(Worksheets.Count)
ChromeraSheetName = Right(resultsSheetName & " Chromera", 30)
ActiveSheet.Name = ChromeraSheetName
Range("A5:J5").Select
Set ChromeraDataShtRange = Selection

With ActiveSheet
    .Range("A5").FormulaR1C1 = "Sample ID"
    .Range("B5").FormulaR1C1 = "Replicate"
```



```

        .Range("C5").FormulaR1C1 = "Analyte"
        .Range("D5").FormulaR1C1 = "Mass"
        .Range("E5").FormulaR1C1 = "Species"
        .Range("F5").FormulaR1C1 = "Retention Time"
        .Range("G5").FormulaR1C1 = "Peak Area"
        .Range("H5").FormulaR1C1 = "Peak Height"
        .Range("I5").FormulaR1C1 = "Concentration"
        .Range("J5").FormulaR1C1 = "Units"
    End With

    With Selection
        .Interior.ColorIndex = 15
        .Interior.Pattern = xlSolid
    End With

    Range("A6").Select

' Select starting activecell on Sheet(resultsSheetName)
    Sheets(resultsSheetName).Select
    Range("A2").Select

    Call TcInit                                     'Initializes program with
TcAccess.dll

    c_SEQ = TcOpenConv("SEQ")                       'c_SEQ is the first
conversation handle. Opens conversation with the Sequence topic in TcAccess.dll
    If c_SEQ = 0 Then                               'If c_SEQ = 0 then
conversation initiation and/or opening with SEQ Topic was not successful
        MsgBox (TcErrorMsg)                       'Display error that occurred,
        End                                         'and end the program
    End If

    iRet = TcSet(c_SEQ, "FILE_NAME", fileSpec)
    iRet = TcGet(c_SEQ, "SEQ_NUM_CYCLES", SeqNumCycles)
    iRet = TcGet(c_SEQ, "FH_CDATE", seqCreationDate)
    iRet = TcGet(c_SEQ, "FH_CTIME", seqCreationTime)
    iRet = TcGet(c_SEQ, "FH_EDATE", seqEditDate)
    iRet = TcGet(c_SEQ, "FH_ETIME", seqEditTime)
    iRet = TcGet(c_SEQ, "FH_FILE_AUTHOR", seqFileAuthor)
    iRet = TcGet(c_SEQ, "FH_ETIME", seqEditTime)

    Sheets(chromeraSheetName).Select
    Range("A1").FormulaR1C1 = "Batch Name: " & workBookName
    Range("A2").FormulaR1C1 = "Description: Data Export from TotalChrom"
    Range("A3").FormulaR1C1 = "Date Analyzed: " & seqCreationDate & " " & seqCreationTime
    Range("A4").FormulaR1C1 = "Date Exported: " & todaysDate & " " & currentTime

    iSeqNumCycles = CInt(SeqNumCycles)

    For iSeqCycleIndex = 0 To iSeqNumCycles - 1
        iRet = TcSet(c_SEQ, "SEQ_CYCLE_INDEX", iSeqCycleIndex)
        iRet = TcGet(c_SEQ, "SD_RESULT_FILE", resultFile)
        dSeqIndex_resultFile.Add iSeqCycleIndex, resultFile
        iRet = TcGet(c_SEQ, "SD_SAMP_NAME", seqSampleName)
        dSeqIndex_seqSampleName.Add iSeqCycleIndex, seqSampleName
        iRet = TcGet(c_SEQ, "SD_RAW_FILE", rawFile)
        dSeqIndex_rawFile.Add iSeqCycleIndex, rawFile
        iRet = TcGet(c_SEQ, "SD_TYPE", seqSampleType)
        dSeqIndex_seqSampleType.Add iSeqCycleIndex, seqSampleType
        If Left(seqSampleType, 4) = "Cal:" Then
            iRet = TcGet(c_SEQ, "SD_EXPT_NAME", seqLevelName)
        Else
            seqLevelName = ""
        End If
        dSeqIndex_levelName.Add iSeqCycleIndex, seqLevelName
        dLevelName_iSeqCycleIndex.Add seqLevelName, iSeqCycleIndex
    Next

```

```

    calib_S1_exists = dLevelName_iSeqCycleIndex.Exists(firstLevelName)
    If Not calib_S1_exists Then
        rsp = MsgBox("Cannot find the first calibrator " & Chr(34) & firstLevelName & Chr(34) & "
in sequence file " & Chr(34) & thisFilename & Chr(34) & "." _
        & vbCrLf & "Press Okay to continue without creating the calibration sheets. " &
vbCrLf & "Press Cancel to abort this macro.", vbOKCancel + vbInformation, "MESSAGE")
        If rsp = vbCancel Then
            ActiveWorkbook.Close SaveChanges:=False
            Application.StatusBar = False
            Application.DisplayStatusBar = originalStatusBar
            Exit Sub
        End If
    End If

    iRet = TcSet(c_SEQ, "SEQ_CYCLE_INDEX", 1)
    iRet = TcGet(c_SEQ, "SD_PROCESS_FILE", filespec_mth)

    iRet = TcCloseConv(c_SEQ)

    c_MTH = TcOpenConv("MTH")

    iRet = TcSet(c_MTH, "FILE_NAME", filespec_mth)
    iRet = TcGet(c_MTH, "FH_FILE_DES", mthMethodDescription)
    iRet = TcGet(c_MTH, "SMP_NUM_COMPONENTS", mthCompStr)
    iRet = TcGet(c_MTH, "SMP_RSLT_UNITS", mthConcUnits)
    mthCompNum = CInt(mthCompStr)

    For i = 0 To mthCompNum - 1
        iRet = TcSet(c_MTH, "SMP_COMP_INDEX", i)
        iRet = TcGet(c_MTH, "CP_COMP_NAME", mthCompName)
        iRet = TcGet(c_MTH, "CP_IS_ISTD", internalStdWasFound)
        bIntStdWasFound = CBool(internalStdWasFound)
        If bIntStdWasFound Then
            internalStdName = mthCompName 'replace default name of internal std with actual name
            jComponentIndex = i
            Exit For
        End If
    Next i

    iRet = TcSet(c_MTH, "SMP_COMP_INDEX", jComponentIndex)
    iRet = TcSet(c_MTH, "SMP_LEV_INDEX", 1)
    iRet = TcGet(c_MTH, "LEV_NAME", mthLevelName)
    iRet = TcGet(c_MTH, "LEV_AMOUNT", mthLevelConc)
    concIS = mthLevelConc

    iComponentIndex = 0

    For i = 0 To mthCompNum - 1
        iRet = TcSet(c_MTH, "SMP_COMP_INDEX", i)
        iRet = TcGet(c_MTH, "CP_COMP_NAME", mthCompName)
        If mthCompName <> internalStdName Then
            iRet = TcGet(c_MTH, "CP_NUM_LEVELS", mthLevelCount)
            dCompName(iComponentIndex) = mthCompName
            dCompName_numberOfLevels(mthCompName) = mthLevelCount
            For j = 0 To mthLevelCount - 1
                iRet = TcSet(c_MTH, "SMP_LEV_INDEX", j)
                iRet = TcGet(c_MTH, "LEV_NAME", mthLevelName)
                iRet = TcGet(c_MTH, "LEV_AMOUNT", mthLevelConc)
                dLevel2(i) = mthLevelName
                dCompName_i(mthCompName & "|" & j) = mthLevelName
                dLevel(mthCompName & "|" & mthLevelName) = mthLevelConc
            Next j
            iComponentIndex = iComponentIndex + 1
        End If
    Next i

    iRet = TcCloseConv(c_MTH)

```

```

c_RAW = TcOpenConv("RAW")
If c_RAW = 0 Then
    MsgBox (TcErrMsg)
End
End If

c_RST = TcOpenConv("RST")          'c_RST is the second conversation handle.  Opens
conversation with the Result File topic in TcAccess.dll.
If c_RST = 0 Then                  'If c_RST = 0 then conversation initiation and/or opening
with SEQ Topic was not successful.
    MsgBox (TcErrorMsg)           'Display error that occurred and end the program.
End
End If

For iSeqCycleIndex = 0 To iSeqNumCycles - 1
    resultFile = dSeqIndex_resultFile.Item(iSeqCycleIndex)
    seqSampleName = dSeqIndex_seqSampleName.Item(iSeqCycleIndex)
    seqSampleType = dSeqIndex_seqSampleType.Item(iSeqCycleIndex)
    rawFile = dSeqIndex_rawFile.Item(iSeqCycleIndex)
    seqLevelName = dSeqIndex_levelName.Item(iSeqCycleIndex)

    iRet = TcSet(c_RST, "FILE_NAME", resultFile)

    If iRet = -1 Then
        ShowWarningMsg = True
        numMissingFiles = numMissingFiles + 1

        With ActiveCell
            .FormulaR1C1 = "FILE NOT FOUND"
            .Offset(0, 1).FormulaR1C1 = resultFile
            .Offset(1, 0).Select
        End With
    Else
        iRet = TcGet(c_RST, "SD_SAMP_NAME", rstSampleName)
        iRet = TcGet(c_RST, "SD_SAMPLE_FILE", rstMethodName)
        iRet = TcGet(c_RST, "AD_DATE_STARTED", rstCreationDate)
        iRet = TcGet(c_RST, "AD_TIME_STARTED", rstCreationTime)
        iRet = TcGet(c_RST, "SD_STUDY_NAME", rstStudyName)
        iRet = TcGet(c_RST, "RST_NUM_PEAKS", rstPeakCount)
        iRet = TcGet(c_RST, "SD_CYCLE_TEXT", rstSampleNotes)
        iRet = TcGet(c_RST, "SMP_NUM_COMPONENTS", rstNumComponents)
        iRet = TcGet(c_RST, "AD_NUM_POINTS", nPoints)
        iRet = TcGet(c_RST, "SD_DIL_FACTOR", rstSampleDilFactor)
        iRet = TcGet(c_RST, "SD_ACTUAL_IS_AMT", rstIntStdConc)
        iRet = TcSet(c_RST, "RST_FIND_PEAK_NAME", internalStdName)
        If iRet = 0 Then
            iRet = TcGet(c_RST, "PK_AREA", IS_peakArea)
        ElseIf Not bIntStdWasFound Then
            IS_peakArea = 1
        End If
        stabilityShtRange.Offset(iSeqCycleIndex + 1, 0).Value = IS_peakArea

        ' check for existence of QC samples, if they exist then rename macro's QC variables
        If firstLowQCSample Or firstHighQCSample Then
            If seqSampleType = "Ctrl Sample" Then
                If LCase(Left(seqSampleName, 3)) Like "[h,l][b,u][_,-]" Then
                    If UCase(Left(seqSampleName, 1)) = "L" Then
                        lowBenchQCName = seqSampleName
                        firstLowQCSample = False ' set low QC sample check to false
                    End If
                    If UCase(Left(seqSampleName, 1)) = "H" Then
                        highBenchQCName = seqSampleName
                        firstHighQCSample = False ' set high QC sample check to false
                    End If
                End If
            End If
        End If
    End If
End If

```

```

For iComponentIndex = 0 To (rstNumComponents - 1)
  strComponent = CStr(iComponentIndex)

  iRet = TcSet(c_RST, "SMP_COMP_INDEX", strComponent)
  iRet = TcGet(c_RST, "CP_COMP_NAME", peakName)
  iRet2 = TcSet(c_RST, "RST_FIND_PEAK_NAME", peakName)

  If iRet2 = 0 Then
    iRet = TcGet(c_RST, "PK_RET_TIME", peakRT)
    iRet = TcGet(c_RST, "PK_HEIGHT", peakHt)
    iRet = TcGet(c_RST, "PK_AREA", peakArea)
    iRet = TcGet(c_RST, "PK_RAW_AMOUNT", componentRawResult)
    iRet = TcGet(c_RST, "PK_RESULT", componentResult)

    peakRatio = Val(peakArea) / Val(IS_peakArea)

    If seqSampleType = nameOfBlk Then
      dPeakNameBlank_peakRatio(peakName) = peakRatio
    End If

    If dPeakNameBlank_peakRatio.Exists(peakName) Then
      peakRatio_blank = dPeakNameBlank_peakRatio.Item(peakName)
    Else
      peakRatio_blank = 0
    End If

    peakRatio_minus_bk = Val(peakRatio) - Val(peakRatio_blank)

    If seqLevelName = zeroLevelName Then
      dPeakNameZeroLevel_peakRatio(peakName) = peakRatio
    End If

    comp_level_Name = peakName & "|" & seqLevelName
    dAmount.Add comp_level_Name, peakRatio

    equation1 = "Dilution * " & peakName & "_ConcIS * (Ratio_minus_blks -
Intercept + Ratio_S0)/Slope"
    equation2 = "Dilution * " & peakName & "_ConcIS * Ratio_minus_blks/Slope"

    If useIntercept = True Then
      finalResultFormula = "=If(" & equation1 & " <0, 0, " & equation1 & ")"
    Else
      finalResultFormula = "=If(" & equation2 & " <0, 0, " & equation2 & ")"
    End If

    calibCurveCoeff_array = Split(calibCurveCoefficients, Chr(9), -1,
vbBinaryCompare)
    calibCurveCoeff_0 = Trim(calibCurveCoeff_array(0))
    calibCurveCoeff_1 = Trim(calibCurveCoeff_array(1))
    calibCurveCoeff_5 = Trim(calibCurveCoeff_array(5))
    peakRT = peakRT / 60
  Else
    peakRT = "-"
    peakHt = 0
    peakArea = 0
    peakRatio = 0
    peakRatio_blank = 0
    peakRatio_minus_bk = 0
    componentRawResult = 0
    finalResultFormula = 0
  End If

  comp_level_Name = peakName & "|" & seqLevelName
  mthLevelConc = dLevel.Item(comp_level_Name)
  If dPeakNameZeroLevel_peakRatio.Exists(peakName) Then
    peakRatio_zero_calib = dPeakNameZeroLevel_peakRatio.Item(peakName)
  Else

```

```

        peakRatio_zero_calib = 0
    End If

    Sheets(resultsSheetName).Select

    With ActiveCell
        .FormulaR1C1 = resultsSheetName
        .Offset(0, 1).FormulaR1C1 = iSeqCycleIndex + 1
        .Offset(0, 2).FormulaR1C1 = seqSampleName
        .Offset(0, 3).FormulaR1C1 = seqSampleType
        .Offset(0, 4).FormulaR1C1 = rstStudyName
        .Offset(0, 5).FormulaR1C1 = rstCreationDate & " " & rstCreationTime
        .Offset(0, 6).FormulaR1C1 = resultFile
        .Offset(0, 7).FormulaR1C1 = rstMethodName
        .Offset(0, 8).FormulaR1C1 = rstSampleDilFactor
        .Offset(0, 9).FormulaR1C1 = seqLevelName
        .Offset(0, 10).FormulaR1C1 = mthLevelConc
        .Offset(0, 11).FormulaR1C1 = peakName
        .Offset(0, 12).FormulaR1C1 = Format(peakRT, "0.00")
        .Offset(0, 13).FormulaR1C1 = Format(peakHt, "0.000")
        .Offset(0, 14).FormulaR1C1 = Format(peakArea, "0.000")
        .Offset(0, 15).FormulaR1C1 = Format(IS_peakArea, "0.000")
        .Offset(0, 16).FormulaR1C1 = peakRatio
        .Offset(0, 17).FormulaR1C1 = IIf(peakRatio_blank <> "", peakRatio_blank, 0)
        .Offset(0, 18).FormulaR1C1 = "= Ratio - Ratio_Blks"
        .Offset(0, 19).FormulaR1C1 = IIf(peakName = internalStdName, 0,
    peakRatio_zero_calib)
        If peakName <> internalStdName Then
            .Offset(0, 20).FormulaR1C1 = "=" & peakName & "_b" ' calibCurveCoeff_0
            .Offset(0, 21).FormulaR1C1 = "=" & peakName & "_m" ' calibCurveCoeff_1
            .Offset(0, 22).FormulaR1C1 = "=" & peakName & "_r2" ' calibCurveCoeff_5
        End If
        .Offset(0, 23).FormulaR1C1 = "=COUNT(INDIRECT(Analyte_ID & " & Chr(34) &
    "_conc" & Chr(34) & "))" 'Number of calibrators used
        .Offset(0, 24).FormulaR1C1 = componentRawResult
        If peakName = internalStdName Then
            finalResultFormula = 0
        End If
        .Offset(0, 25).FormulaR1C1 = finalResultFormula
        finalResultName = seqSampleName & "_" & iSeqCycleIndex & "_" & peakName
        .Offset(0, 25).Name = finalResultName
        .Offset(0, 26).FormulaR1C1 = columnDescription
        .Offset(0, 27).FormulaR1C1 = calibPrepDate
        .Offset(0, 28).FormulaR1C1 = rstSampleNotes
        .Offset(1, 0).Select
    End With

    ' now write data to chromeraDataShtName
    Sheets(chromeraSheetName).Select

    With ActiveCell
        .FormulaR1C1 = seqSampleName
        .Offset(0, 1).FormulaR1C1 = iSeqCycleIndex + 1
        .Offset(0, 2).FormulaR1C1 = massName
        .Offset(0, 3).FormulaR1C1 = ""
        .Offset(0, 4).FormulaR1C1 = peakName
        .Offset(0, 5).FormulaR1C1 = Format(peakRT, "0.00")
        .Offset(0, 6).FormulaR1C1 = Format(peakArea, "0.000")
        .Offset(0, 7).FormulaR1C1 = Format(peakHt, "0.000")
        If peakName = internalStdName Then
            finalResultFormula = 0
        End If
        .Offset(0, 8).FormulaR1C1 = "=" & finalResultName
        .Offset(0, 9).FormulaR1C1 = mthConcUnits
        .Offset(1, 0).Select
    End With

    ' finished writing data to chromeraDataShtName

```

```

        peakIndex = Empty
        peakName = Empty
        peakHt = Empty
        peakArea = Empty
        componentResult = Empty
        finalResultFormula = Empty
        peakRatio_minus_bk = Empty
        progressIndicator = 100 * iSeqCycleIndex / iSeqNumCycles
        Application.StatusBar = "Extracting TotalChrom data, please wait... " &
progressIndicator & "% done."
    Next

    Sheets(rawSheetName).Select
    ActiveCell.Value = seqSampleName
    Selection.HorizontalAlignment = xlRight
    With Selection.Interior
        .ColorIndex = 15
        .Pattern = xlSolid
    End With

    iRet = TcSet(c_RAW, "FILE_NAME", rawFile)

    If iRet = -1 Then
        ActiveCell.Offset(1, 0).Value = "MISSING RAW DATA FILE"
    Else
        iRet = TcSet(c_RAW, "RAW_POINT_INDEX", 1)
        iRet = TcSet(c_RAW, "RAW_POINT_COUNT", nPoints)
        iRet = TcGet(c_RAW, "RAW_DATA_POINTS", rawDataPoints)
        iRet = TcGet(c_RST, "IN_SAMP_RATE", sampleRate)
        iRet = TcGet(c_RST, "IN_TOTAL_RUN_TIME", runTime)
        rawPointsArray = Split(rawDataPoints, Chr(10), -1, vbBinaryCompare)
        nPoints = nPoints - 1
        For i = 1 To nPoints
            If iSeqCycleIndex = 0 Then
                ActiveCell.Offset(i, -1).Value = CSng(i / sampleRate) / 60
            End If
            ActiveCell.Offset(i, 0).Value = Val(rawPointsArray(i - 1))
        Next i
    End If

    ActiveCell.Offset(0, 1).Select

End If

Next

iRet = TcCloseConv(c_RAW)
iRet = TcCloseConv(c_RST)

' Go to Sheets(resultsSheetName) to name ranges
Sheets(resultsSheetName).Select

Range("C1").Select
Range(Selection, Selection.End(xlDown)).Select
nRows = Selection.Rows.Count
Range(ActiveCell, ActiveCell.Offset(nRows - 1, 0)).Select
Selection.Name = "Sample_Name"

Range("D1").Select
Range(ActiveCell, ActiveCell.Offset(nRows - 1, 0)).Select
Selection.Name = "Sample_Type"

Range("I1").Select
Range(ActiveCell, ActiveCell.Offset(nRows - 1, 0)).Select
Selection.Name = "Dilution"

Range("L1").Select
Range(ActiveCell, ActiveCell.Offset(nRows - 1, 0)).Select

```

```

Selection.Name = "Analyte_ID"

Range("O1").Select
Range(ActiveCell, ActiveCell.Offset(nRows - 1, 0)).Select
Selection.Name = "Peak_Area"

Range("P1").Select
Range(ActiveCell, ActiveCell.Offset(nRows - 1, 0)).Select
Selection.Name = "IS_Peak_Area"

Range("Q1").Select
Range(ActiveCell, ActiveCell.Offset(nRows - 1, 0)).Select
Selection.Name = "Ratio"

Range("R1").Select
Range(ActiveCell, ActiveCell.Offset(nRows - 1, 0)).Select
Selection.Name = "Ratio_Blks"

Range("S1").Select
Range(ActiveCell, ActiveCell.Offset(nRows - 1, 0)).Select
Selection.Name = "Ratio_minus_blks"

Range("T1").Select
Range(ActiveCell, ActiveCell.Offset(nRows - 1, 0)).Select
Selection.Name = "Ratio_S0"

Range("U1").Select
Range(ActiveCell, ActiveCell.Offset(nRows - 1, 0)).Select
Selection.Name = "Intercept"

Range("V1").Select
Range(ActiveCell, ActiveCell.Offset(nRows - 1, 0)).Select
Selection.Name = "Slope"

Range("Z1").Select
Range(ActiveCell, ActiveCell.Offset(nRows - 1, 0)).Select
Selection.Name = "Adj_Amount"

ActiveCell.CurrentRegion.Select
Selection.Name = "TC_data"
Selection.AutoFilter
Range("A:A").HorizontalAlignment = xlCenter
Range("A1").Select

' Create Calibration sheets
If calib_S1_exists Then

    mthCompNum = dCompName.Count

    For iComponentIndex = mthCompNum - 1 To 0 Step -1
        peakName = dCompName.Item(iComponentIndex)
        Sheets.Add After:=Sheets(1)
        Sheets(2).Name = peakName
        Range("A1").Formula = "CALIBRATION TABLE - Peak Area Ratios for " & peakName
        With Selection.Font
            .Name = "Arial"
            .FontStyle = "Bold"
            .Size = 10
        End With
        Range("A2").Formula = "Calib Level"
        Range("B2").Formula = "Conc"
        Range("C2").Formula = "Ratio Conc"
        Range("D2").Formula = "Ratio Peak Areas"
        Range("E2").Formula = "Deviation %"
        Range("B2:E2").HorizontalAlignment = xlRight
        Range("A3").Select

        mthLevelCount = dCompName_numberOfLevels.Item(peakName)

```

```

For i = 0 To mthLevelCount - 1
    peakName_index = peakName & "|" & i
    mthLevelName = dCompName_i.Item(peakName_index)
    comp_level_Name = peakName & "|" & mthLevelName
    mthLevelConc = dLevel.Item(comp_level_Name)
    peakRatio = dAmount.Item(comp_level_Name)
    ActiveCell.Offset(i, 0).Value = mthLevelName
    ActiveCell.Offset(i, 1).Value = mthLevelConc
    ActiveCell.Offset(i, 2).FormulaR1C1 = "= RC[-1]/" & peakName & "_ConcIS"
    ActiveCell.Offset(i, 3).FormulaR1C1 = IIf(peakRatio = Empty, 0, peakRatio)
    If i > 0 Then
        ActiveCell.Offset(i, 4).FormulaR1C1 = "= (" & peakName & "_ConcIS*(RC[-1] - "
& peakName & "_b)/" & peakName & "_m)/RC[-3] - 1"
    End If
Next i

Range("B3").Select
Range(Selection, Selection.End(xlDown)).Select
Selection.Name = peakName & "_conc"
Selection.NumberFormat = "0.00;-0.00;0.00"

Selection.Offset(0, 1).Select
Selection.Name = peakName & "_ratioConc"
Selection.NumberFormat = "0.00000;-0.00000;0.00000"

Selection.Offset(0, 1).Select
Selection.Name = peakName & "_ratioArea"
Selection.NumberFormat = "0.000000;-0.000000;0.000000"

Selection.Offset(0, 1).Select
Selection.Name = peakName & "_deviation"
Selection.NumberFormat = "0.0%"

Range("B20").Select
Range(Selection, Selection.Offset(4, 1)).Select
Selection.FormulaArray = "=LINEST(" & peakName & "!" & peakName & "_ratioArea" _
& ", " & peakName & "_ratioConc, TRUE, TRUE)"
ActiveCell.Name = peakName & "_m"
ActiveCell.Offset(0, 1).Name = peakName & "_b"
ActiveCell.Offset(2, 0).Name = peakName & "_r2"
ActiveCell.Offset(6, 1).FormulaR1C1 = "= (R[-6]C - R[-23]C[1])/R[-6]C[-1]"
ActiveCell.Offset(6, 1).NumberFormat = "0.000%"
ActiveCell.Offset(7, 0).Value = "IS Conc -->"
ActiveCell.Offset(7, 1).FormulaR1C1 = concIS
ActiveCell.Offset(7, 1).NumberFormat = "0.0000"
ActiveCell.Offset(7, 1).Name = peakName & "_ConcIS"
Range("A19").Formula = peakName & " Regression Statistics"
Range("A20").Formula = "Slope, Intercept"
Range("A21").Formula = "SE-m, SE-b"
Range("A22").Formula = "r2, SE-y"
Range("A23").Formula = "F, df"
Range("A24").Formula = "SS-reg, SS-resid"
Columns("A:A").ColumnWidth = 15
Columns("B:B").ColumnWidth = 10
Columns("C:C").ColumnWidth = 10
Columns("D:D").ColumnWidth = 15
Columns("E:E").ColumnWidth = 10
Columns("F:G").ColumnWidth = 1

AddChart peakName & "_ratioConc", peakName & "_ratioArea", peakName, True

Range("A1").Select

Next iComponentIndex
End If
' Done with creating Calibration sheets

```



```
        progressIndicator = 100
        Application.StatusBar = "Extracting TotalChrom data, please wait... " & progressIndicator &
"% done."

' Clear dictionary objects
    Set dLevel = Empty
    Set dLevel2 = Empty
    Set dCompName = Empty
    Set dCompName_numberOfLevels = Empty
    Set dCompName_i = Empty
    Set dAmount = Empty
    Set dSeqIndex_resultFile = Empty
    Set dSeqIndex_seqSampleName = Empty
    Set dSeqIndex_seqSampleType = Empty
    Set dSeqIndex_rawFile = Empty
    Set dSeqIndex_levelName = Empty
    Set dLevelName_iSeqCycleIndex = Empty
    Set dPeakNameZeroLevel_peakRatio = Empty
    Set dPeakNameBlank_peakRatio = Empty

' Create the IS Stability sheet
    If Not bIntStdWasFound Then
        Application.DisplayAlerts = False
        Sheets(stabilitySheetName).Delete
        Application.DisplayAlerts = True
    Else
        Sheets(stabilitySheetName).Select
        Range(Selection.Offset(1, 0), Selection.End(xlDown)).Select
        Selection.Name = "IS_area"

        Charts.Add
        ActiveChart.ChartType = xlLineMarkers
        ActiveChart.SetSourceData Source:=Sheets(stabilitySheetName).Range("IS_area"),
PlotBy:=xlColumns
        ActiveChart.Location Where:=xlLocationAsObject, Name:="IS Stability"
        With ActiveChart
            .HasTitle = True
            .ChartTitle.Characters.Text = "IS Peak Stability"
            .Axes(xlCategory, xlPrimary).HasTitle = True
            .Axes(xlCategory, xlPrimary).AxisTitle.Characters.Text = "Injection Number"
            .Axes(xlValue, xlPrimary).HasTitle = True
            .Axes(xlValue, xlPrimary).AxisTitle.Characters.Text = "Raw Peak Area"
        End With

        ActiveChart.Axes(xlValue).Select
        With ActiveChart.Axes(xlValue)
            .MinimumScale = 0
            .MaximumScaleIsAuto = True
            .MinorUnitIsAuto = True
            .MajorUnitIsAuto = True
            .Crosses = xlAutomatic
            .ReversePlotOrder = False
            .ScaleType = xlLinear
            .DisplayUnit = xlNone
            .TickLabels.NumberFormat = "0.0;-0.0;0"
            .TickLabels.NumberFormat = "0;-0;0"
            .TickLabels.AutoScaleFont = True
        End With

        ActiveChart.Axes(xlValue).Select
        With Selection.TickLabels.Font
            .Name = "Arial"
            .Size = 8
            .Strikethrough = False
            .Superscript = False
            .Subscript = False
            .OutlineFont = False
            .Shadow = False
```

```
.Underline = xlUnderlineStyleNone
.ColorIndex = xlAutomatic
.Background = xlAutomatic
End With
ActiveChart.Axes(xlCategory).Select
Selection.TickLabels.AutoScaleFont = True
With Selection.TickLabels.Font
.Name = "Arial"
.Size = 8
.Strikethrough = False
.Superscript = False
.Subscript = False
.OutlineFont = False
.Shadow = False
.Underline = xlUnderlineStyleNone
.ColorIndex = xlAutomatic
.Background = xlAutomatic
End With
With Selection.TickLabels
.Alignment = xlCenter
.Offset = 100
.Orientation = xlHorizontal
End With
ActiveChart.SeriesCollection(1).Select
ActiveChart.SeriesCollection(1).Name = "IS"

With ActiveSheet
.ChartObjects(1).Height = 400
.ChartObjects(1).Width = 500
.ChartObjects(1).Left = .Columns("A").Left
.ChartObjects(1).Top = .Rows("1").Top
.ChartObjects(1).Border.LineStyle = xlLineStyleNone
End With

ActiveChart.Deselect
ActiveWindow.Zoom = 100
End If
' Done with creating the IS Stability sheet

' Create the pivot table
Sheets(1).Select
ActiveWorkbook.PivotCaches.Add(SourceType:=xlDatabase,
SourceData:= "TC_data").CreatePivotTable TableDestination:= "", TableName:= "PivotTable_TCData",
DefaultVersion:=xlPivotTableVersion10
ActiveSheet.PivotTableWizard TableDestination:=ActiveSheet.Cells(3, 2)
ActiveSheet.Cells(3, 2).Select
With ActiveSheet.PivotTables("PivotTable_TCData")
.ColumnGrand = False
.HasAutoFormat = False
.DisplayErrorString = True
.ErrorString = "!error"
.RowGrand = False
End With
ActiveSheet.PivotTables("PivotTable_TCData").PivotCache.RefreshOnFileOpen = True
ActiveSheet.PivotTables("PivotTable_TCData").AddFields RowFields:=Array("Sample ID" _
, "Seq No."), ColumnFields:= "Analyte ID"
With ActiveSheet.PivotTables("PivotTable_TCData").PivotFields("Adj Amount")
.Orientation = xlDataField
.Caption = "Amount"
.Function = xlAverage
End With

ActiveSheet.PivotTables("PivotTable_TCData").PivotFields("Analyte ID").Subtotals = Array _
(False, False, False, False, False, False, False, False, False, False)
ActiveSheet.PivotTables("PivotTable_TCData").PivotFields("Seq No.").Subtotals = Array _
(False, False, False, False, False, False, False, False, False, False)
ActiveSheet.PivotTables("PivotTable_TCData").PivotFields("Sample ID").Subtotals = Array _
(False, False, False, True, False, False, False, False, False, False)
```

```
With ActiveSheet.PivotTables("PivotTable_TCDData").PivotFields("Amount")
.NumberFormat = "0.000"
End With

Range("B4").Select
With ActiveSheet.PivotTables("PivotTable_TCDData").PivotFields("Seq No.")
.Orientation = xlRowField
.Position = 2
End With

Range("A4").Select
With ActiveSheet.PivotTables("PivotTable_TCDData").PivotFields("Seq No.")
.Orientation = xlRowField
.Position = 2
End With

With ActiveSheet.PivotTables("PivotTable_TCDData").PivotFields("Sample ID")
For i = 2 To .PivotItems.Count
.PivotItems(i).Visible = False
Next i
End With

With ActiveSheet.PivotTables("PivotTable_TCDData").PivotFields("Sample ID")
If .PivotItems(lowBenchQCName).Position > 0 Then
itDoesExist = True
End If
If itDoesExist Then
.PivotItems(lowBenchQCName).Visible = True
.PivotItems(highBenchQCName).Visible = True
.PivotItems(1).Visible = False
End If
End With

With ActiveSheet.PivotTables("PivotTable_TCDData").PivotFields("Analyte ID")
.PivotItems("IS").Visible = False
End With

With ActiveSheet.PivotTables("PivotTable_TCDData")
.PivotSelect "", xlDataAndLabel, True
.Format xlTable1
.Columns.AutoFit
.PivotFields("Sample ID").LayoutBlankLine = False
End With

ActiveWorkbook.ShowPivotTableFieldList = False
Application.CommandBars("PivotTable").Visible = False

' Add a button that runs the macro for refreshing the pivot table
Set btn = ActiveSheet.Buttons.Add(3, 3, 70, 16)
macroName = ActiveWorkbook.Name & "!RefreshPivotTable"
btn.OnAction = macroName
btn.Placement = xlFreeFloating
btn.PrintObject = False
btn.Characters.Text = "Refresh Data"
With btn.Characters(Start:=1, Length:=16).Font
.Name = "Arial"
.FontStyle = "Regular"
.Size = 10
.Strikethrough = False
.Superscript = False
.Subscript = False
.OutlineFont = False
.Shadow = False
.Underline = xlUnderlineStyleNone
.ColorIndex = xlAutomatic
End With
' Done with making a button
```

```
Columns("B:Z").ColumnWidth = 12
Range("B4").Select

' Done with making the Pivot Table sheet

qcResultsShtName = "QC Results"
ActiveSheet.Name = qcResultsShtName
Sheets(qcResultsShtName).Move After:=Sheets(resultsSheetName)

' Create a new module in the workbook and insert code
ExportCode workBookName

' Make a chart showing a chromatogram
Sheets(rawSheetName).Select
sampleNamesAddress = Range(Cells(1, 1), Cells(1, iSeqNumCycles)).Address
plotAddress = Range(Cells(1, 1), Cells(nPoints + 1, 2)).Address
Charts.Add
ActiveChart.ChartType = xlXYScatterLinesNoMarkers
ActiveChart.SetSourceData Source:=Sheets(rawSheetName).Range(plotAddress), _
    PlotBy:=xlColumns
ActiveChart.Location Where:=xlLocationAsObject, Name:=rawSheetName
With ActiveChart
    .HasTitle = True
    .ChartTitle.Characters.Text = resultsSheetName
    .Axes(xlCategory, xlPrimary).HasTitle = True
    .Axes(xlCategory, xlPrimary).AxisTitle.Characters.Text = _
        "Retention Time (min)"
    .Axes(xlValue, xlPrimary).HasTitle = True
    .Axes(xlValue, xlPrimary).AxisTitle.Characters.Text = "Intensity (cps)"
End With
ActiveChart.Axes(xlValue).MajorGridlines.Select
Selection.Delete
ActiveSheet.ChartObjects(1).Select
On Error Resume Next
With ActiveSheet
    .ChartObjects(1).Left = .Columns("C").Left
    .ChartObjects(1).Top = .Rows("5").Top
    .ChartObjects(1).Height = 500
    .ChartObjects(1).Width = 700
    .ChartObjects(1).Border.LineStyle = xlLineStyleNone
End With
With ActiveChart.Axes(xlValue)
    .MinimumScale = 0
    .MaximumScaleIsAuto = True
    .MinorUnitIsAuto = True
    .MajorUnitIsAuto = True
    .Crosses = xlAutomatic
    .ReversePlotOrder = False
    .ScaleType = xlLinear
    .DisplayUnit = xlNone
End With
ActiveChart.Axes(xlValue).Select
Selection.TickLabels.AutoScaleFont = False
With Selection.TickLabels.Font
    .Name = "Arial"
    .Size = 9
    .Strikethrough = False
    .Superscript = False
    .Subscript = False
    .OutlineFont = False
    .Shadow = False
    .Underline = xlUnderlineStyleNone
    .ColorIndex = xlAutomatic
    .Background = xlAutomatic
End With
ActiveChart.Axes(xlCategory).Select
Selection.TickLabels.AutoScaleFont = True
```

```
With Selection.TickLabels.Font
    .Name = "Arial"
    .Size = 9
    .Strikethrough = False
    .Superscript = False
    .Subscript = False
    .OutlineFont = False
    .Shadow = False
    .Underline = xlUnderlineStyleNone
    .ColorIndex = xlAutomatic
    .Background = xlAutomatic
End With
ActiveChart.Axes(xlValue).AxisTitle.Select
Selection.AutoScaleFont = True
With Selection.Font
    .Name = "Arial"
    .Size = 10
    .Strikethrough = False
    .Superscript = False
    .Subscript = False
    .OutlineFont = False
    .Shadow = False
    .Underline = xlUnderlineStyleNone
    .ColorIndex = xlAutomatic
    .Background = xlAutomatic
End With
ActiveChart.Axes(xlCategory).AxisTitle.Select
Selection.AutoScaleFont = True
With Selection.Font
    .Name = "Arial"
    .Size = 10
    .Strikethrough = False
    .Superscript = False
    .Subscript = False
    .OutlineFont = False
    .Shadow = False
    .Underline = xlUnderlineStyleNone
    .ColorIndex = xlAutomatic
    .Background = xlAutomatic
End With
ActiveChart.Legend.Select
Selection.AutoScaleFont = True
With Selection.Border
    .Weight = xlHairline
    .LineStyle = xlAutomatic
End With
Selection.Shadow = False
With Selection.Interior
    .ColorIndex = 15
    .PatternColorIndex = 1
    .Pattern = xlSolid
End With
ActiveChart.Legend.Select
Selection.AutoScaleFont = True
With Selection.Font
    .Name = "Arial"
    .Size = 9
    .Strikethrough = False
    .Superscript = False
    .Subscript = False
    .OutlineFont = False
    .Shadow = False
    .Underline = xlUnderlineStyleNone
    .ColorIndex = xlAutomatic
    .Background = xlAutomatic
End With
ActiveChart.ChartTitle.Select
With Selection.Characters.Font
```

```
.Name = "Arial"
.FontStyle = "Bold"
.Size = 10
.Strikethrough = False
.Superscript = False
.Subscript = False
.OutlineFont = False
.Shadow = False
.Underline = xlUnderlineStyleNone
.ColorIndex = xlAutomatic
End With

If Not firstLowQCSample Then
  Set c = Range(sampleNamesAddress).Find(lowBenchQCName, LookIn:=xlValues)
  If Not c Is Nothing Then
    thisAddress = c.Address
  End If

  Range(thisAddress, Range(thisAddress).End(xlDown)).Select
  Selection.Copy
  ActiveSheet.ChartObjects("Chart 1").Activate
  ActiveChart.SeriesCollection.Paste Rowcol:=xlColumns, SeriesLabels:=True,
CategoryLabels:=False, Replace:=False, NewSeries:=True
  Application.CutCopyMode = False
End If

If Not firstHighQCSample Then
  Set c = Range(sampleNamesAddress).Find(highBenchQCName, LookIn:=xlValues)
  If Not c Is Nothing Then
    thisAddress = c.Address
  End If

  Range(thisAddress, Range(thisAddress).End(xlDown)).Select
  Selection.Copy
  ActiveSheet.ChartObjects("Chart 1").Activate
  ActiveChart.SeriesCollection.Paste Rowcol:=xlColumns, SeriesLabels:=True,
CategoryLabels:=False, Replace:=False, NewSeries:=True
  Application.CutCopyMode = False
End If

If (Not firstLowQCSample) Or (Not firstHighQCSample) Then
  ActiveChart.SeriesCollection(1).Delete
End If

For Each s In ActiveChart.SeriesCollection
  s.Smooth = True
Next s

ActiveChart.Deselect

' Done making a chart showing a chromatogram

' Add a button that runs the macro for adding a new series
Set btn = ActiveSheet.Buttons.Add(5, 25, 100, 25)
' ActiveSheet.Shapes(ActiveSheet.Shapes.Count).Select
macroName = ActiveWorkbook.Name & "!Chart_InsertNewSeries"
btn.OnAction = macroName
btn.Placement = xlFreeFloating
btn.PrintObject = False
btn.Characters.Text = "Add Chromatogram"
With btn.Characters(Start:=1, Length:=16).Font
  .Name = "Arial"
  .FontStyle = "Regular"
  .Size = 10
  .Strikethrough = False
  .Superscript = False
  .Subscript = False
  .OutlineFont = False
```

```
.Shadow = False
.Underline = xlUnderlineStyleNone
.ColorIndex = xlAutomatic
End With
Range("A1").Select
' Done with making a button

' Move the Chromera data sheet to the front, unless the first calibrator was
' not found then delete the Chromera data sheet
If calib_S1_exists Then
  Sheets(chromeraSheetName).Move After:=Sheets.Count
Else
  Application.DisplayAlerts = False
  Sheets(chromeraSheetName).Delete
  Sheets(qcResultsShtName).Delete
  Application.DisplayAlerts = True
  Sheets(resultsSheetName).Select
  Range("Adj_Amount").Select
  For Each c In Selection
    If IsError(c.Value) Then
      c.Value = 0
    End If
  Next c
End If

' Go to the first sheet, hide columns, turn on screen updating and return the status bar to it's
original state
Sheets(resultsSheetName).Select
Range("R:X").EntireColumn.Hidden = True
Range("A1").Select

With ActiveWorkbook.BuiltinDocumentProperties
  .Item("Title").Value = workBookName & savedNameSuffix
  .Item("Subject").Value = "Results imported from TotalChrome " & strVersionNo
  .Item("Author").Value = seqFileAuthor
  .Item("Category").Value = "summary results"
  .Item("Keywords").Value = ""
  .Item("Comments").Value = "The TotalChrom sequence file used to export data " & _
    & "to this Excel workbook was created " & seqCreationDate & " " & seqCreationTime &
  ". " & _
    & vbCrLf & mthMethodDescription
  .Item("Manager").Value = ""
  .Item("Company").Value = ""
End With

Application.StatusBar = False
Application.DisplayStatusBar = originalStatusBar
Application.ScreenUpdating = True

If ShowWarningMsg = True Then
  MsgBox "Data from " & CStr(numMissingFiles) & " TotalChrom files failed to be extracted.
Check for " & vbCrLf & _
  "missing or renamed .RST files in the sequence file " & Chr(34) & thisFilename &
Chr(34) & vbCrLf & _
  "and the source folder containing its data files.", _
  vbOKOnly + vbExclamation, "Warning"
End If

' Bring up the SaveAs dialog box, if the PromptForSaveAsDialog switch is true
If True Then
  If True Then
    currentDir = CurDir
    filePathName = "C:\HPLC\Data\" & workBookName
    dirExist = Dir(filePathName, vbDirectory) ' Retrieve the first entry.
    If dirExist <> "" Then
      ChDir filePathName
    Else
      ChDir "C:\"
    End If
  End If
End If
```

```

        nameSaveAsFile = Application.GetSaveAsFilename(InitialFileName:=workBookName & _
            savedNameSuffix, FileFilter:="Excel normal workbook (*.xls),*.xls")
    If nameSaveAsFile <> False Then
        ActiveWorkbook.SaveAs fileName:=nameSaveAsFile, _
            FileFormat:=xlWorkbookNormal, AddToMru:=True, _
            ConflictResolution:=xlUserResolution
    End If
    ChDir currentDir
End If

End Sub

'
' breakHere = IIf(componentRawResult > 0, True, False)
' breakHere = IIf(iSeqCycleIndex = 18, True, False)
' thisFilename = Right(filespec, Len(filespec) - InStrRev(filespec, "\", -1, vbTextCompare))
' workBookName = Left(thisFilename, Len(thisFilename) - 4)

Sub AddChart(x_rangeToPlot, y_rangeToPlot, chartName, useIntercept)
' Subroutine for "TransformHPLCdata"
' Macro created 12/5/2002
' Written by Carl P. Verdon, Ph.D.
'
    Charts.Add
    ActiveChart.ChartType = xlXYScatter
    ActiveChart.SetSourceData Source:=Sheets(chartName).Range(x_rangeToPlot, _
        Range(x_rangeToPlot).Offset(0, 1)), PlotBy:=xlColumns
    ActiveChart.Location Where:=xlLocationAsObject, Name:=chartName
    ActiveSheet.ChartObjects(1).Select
    On Error Resume Next
    With ActiveSheet
        .ChartObjects(1).Left = .Columns("H").Left
        .ChartObjects(1).Top = .Rows("1").Top
        .ChartObjects(1).Height = 400
        .ChartObjects(1).Width = 400
        .ChartObjects(1).Border.LineStyle = xlLineStyleNone
    End With
    With ActiveChart
        .HasTitle = True
        .ChartTitle.Characters.Text = chartName
        .HasLegend = False
        .DisplayBlanksAs = xlNotPlotted
        .PlotVisibleOnly = True
        .SizeWithWindow = False
        .Axes(xlCategory, xlPrimary).HasTitle = True
        .Axes(xlCategory, xlPrimary).AxisTitle.Characters.Text = _
            "Concentration (Ratio [Calib]/[IS])"
        .Axes(xlValue, xlPrimary).HasTitle = True
        .Axes(xlValue, xlPrimary).AxisTitle.Characters.Text = _
            "Ratio (Peak Area/IS Peak Area)"
    End With
    seriesFormulaText = "=SERIES('Calib'!RC,'Calib'!' + x_rangeToPlot + _
        ", 'Calib'!' + y_rangeToPlot + ",1)"
    ActiveChart.SeriesCollection(1).Formula = seriesFormulaText
    ActiveChart.SeriesCollection(1).Select
    With Selection.Border
        .Weight = xlHairline
        .LineStyle = xlNone
    End With
    With Selection
        .MarkerBackgroundColorIndex = 27
        .MarkerForegroundColorIndex = 1
        .MarkerStyle = xlDiamond
        .Smooth = False
        .MarkerSize = 7
        .Shadow = False
    End With
    If useIntercept Then
        ActiveChart.SeriesCollection(1).Trendlines.Add(Type:=xlLinear, Forward:=0, _

```



```
        Backward:=0, DisplayEquation:=True, DisplayRSquared:=True, _
        Name:="Regression").Select
Else
    ActiveChart.SeriesCollection(1).Trendlines.Add(Type:=xlLinear, Forward:=10, _
        Backward:=0, Intercept:=0, DisplayEquation:=True, DisplayRSquared:=True, _
        Name:="Regression").Select
End If
ActiveChart.Axes(xlValue).Select
With ActiveChart.Axes(xlValue)
    .MinimumScale = 0
    .MaximumScaleIsAuto = True
    .MinorUnitIsAuto = True
    .MajorUnitIsAuto = True
    .Crosses = xlAutomatic
    .ReversePlotOrder = False
    .ScaleType = xlLinear
    .DisplayUnit = xlNone
    .TickLabels.NumberFormat = "0.00;-0.00;0"
End With

ActiveChart.Axes(xlValue).MajorGridlines.Select
Selection.Delete

ActiveChart.SeriesCollection(1).Trendlines(1).Select
With Selection.Border
    .ColorIndex = 57
    .Weight = xlThin
    .LineStyle = xlContinuous
End With
ActiveChart.ChartTitle.Select
Selection.Characters.Text = chartName
Selection.AutoScaleFont = False
    With Selection.Characters(Start:=1, Length:=2).Font
With Selection.Characters.Font
    .Name = "Arial"
    .FontStyle = "Bold"
    .Size = 12
    .Strikethrough = False
    .Superscript = False
    .Subscript = False
    .OutlineFont = False
    .Shadow = False
    .Underline = xlUnderlineStyleNone
    .ColorIndex = xlAutomatic
End With

ActiveChart.SeriesCollection(1).Trendlines(1).DataLabel.Select
With Selection.Border
    .ColorIndex = 1
    .Weight = xlThin
    .LineStyle = xlContinuous
End With
Selection.Shadow = True
With Selection.Interior
    .ColorIndex = 2
    .PatternColorIndex = 1
    .Pattern = xlSolid
End With
Selection.AutoScaleFont = True
With Selection.Font
    .Name = "Arial"
    .FontStyle = "Bold"
    .Size = 10
    .Strikethrough = False
    .Superscript = False
    .Subscript = False
    .OutlineFont = False
    .Shadow = False
```

```

        .Underline = xlUnderlineStyleNone
        .ColorIndex = xlAutomatic
        .Background = xlAutomatic
    End With
    Selection.NumberFormat = "0.0000"
    Selection.Left = 88
    Selection.Top = 76
    ActiveChart.Deselect

```

```
End Sub
```

```

Sub addCalibSheet(speciesName, useIntercept, numberOfCalibrators)
' Subroutine for "TransformHPLCdata"
' Macro created 12/5/2002
' Written by Carl P. Verdon, Ph.D.
'
    Sheets("Calib").Copy After:=Sheets(Sheets.Count)
    Sheets(Sheets.Count).Name = speciesName
    Sheets(speciesName).Select
    Range("C2").Select
    Range(ActiveCell, Cells(ActiveCell.Row, lastCol - 1)).Select
    ncols = Selection.Columns.Count
    For i = 1 To ncols
        If ActiveCell.Formula <> speciesName Then
            ActiveCell.EntireColumn.Delete
        Else
            ActiveCell.Offset(0, 1).Select
        End If
    Next

    speciesName_calibConc = speciesName + "_calibConc"

    Range("B3").Select
    Range(ActiveCell, Selection.End(xlDown)).Select
    Selection.Name = speciesName_calibConc
    Selection.Offset(0, 1).Name = speciesName

    targetRangel = numberOfCalibrators + 10
    colNumber = 2

    Range(Cells(targetRangel, colNumber), Cells(targetRangel + 4, _
        colNumber + 1)).Select
    Selection.FormulaArray = "=LINEST(Calib!" + speciesName + _
        ", " + speciesName_calibConc + ", " + CStr(useIntercept) + ", TRUE)"
    ActiveSheet.Select
    Cells(targetRangel - 1, colNumber - 1).FormulaR1C1 = speciesName + _
        " Regression Statistics"
    Cells(targetRangel + 0, colNumber - 1).FormulaR1C1 = "Slope, Intercept"
    Cells(targetRangel + 1, colNumber - 1).FormulaR1C1 = "SE-m, SE-b"
    Cells(targetRangel + 2, colNumber - 1).FormulaR1C1 = "r2, SE-y"
    Cells(targetRangel + 3, colNumber - 1).FormulaR1C1 = "F, df"
    Cells(targetRangel + 4, colNumber - 1).FormulaR1C1 = "SS-reg, SS-resid"
    Cells(targetRangel, colNumber).Name = speciesName + "_slope"
    Cells(targetRangel, colNumber + 1).Name = speciesName + "_intercept"
    Range(Cells(targetRangel, colNumber), Cells(targetRangel + 1, _
        colNumber + 1)).Select
    Selection.NumberFormat = "0.0000"
    Cells(targetRangel - 1, colNumber - 1).Select
    With Selection.Font
        .Name = "Arial"
        .FontStyle = "Bold"
        .Size = 10
    End With

    Cells(targetRangel + 1, colNumber + 2).FormulaR1C1 = "=R[-1]C[-1]/R[-1]C[-2]"
    Cells(targetRangel + 1, colNumber + 2).NumberFormat = "0%;-0%;0%"

    Columns("A:A").ColumnWidth = 14

```

```
Range("A1").Select

AddChart speciesName_calibConc, speciesName, speciesName, useIntercept

End Sub

Sub AddMenuItems()

Dim MenuControls As Object, MenuItem As Object, menuExists As Boolean

menuExists = False
Set MenuControls = Application.CommandBars(1).Controls
For Each menuPopup In MenuControls
    If menuPopup.Caption = "&HPLC" Then
        menuExists = True
    End If
Next

If Not menuExists Then
    Set newItem = CommandBars(1).Controls.Add(Type:=msoControlPopup, Before:=9)
    With newItem
        .Caption = "&HPLC"
    End With

    With CommandBars(1).Controls("&HPLC")
        .Controls.Add(Type:=msoControlButton, Before:=1).Caption = "&Create TC Sequence File"
        .Controls("&Create TC Sequence File").OnAction = "MakeSequenceList"
        .Controls.Add(Type:=msoControlButton, Before:=2).Caption = "Create &Summary.csv File"
        .Controls("Create &Summary.csv File").OnAction = "LaunchSummaryExe"
        .Controls.Add(Type:=msoControlButton, Before:=3).Caption = "Transform &HPLC Data"
        .Controls("Transform &HPLC Data").OnAction = "TransformHPLCdata"
        .Controls.Add(Type:=msoControlButton, Before:=4).Caption = "&Extract TC Data"
        .Controls("&Extract TC Data").OnAction = "ExtractTCData"
        .Controls("&Extract TC Data").BeginGroup = True
        .Controls.Add(Type:=msoControlButton, Before:=5).Caption = "&Get Daily Performances"
        .Controls("&Get Daily Performances").OnAction = "getDailyPerformIntensities"
        .Controls.Add(Type:=msoControlButton, Before:=6).Caption = "&Import XY Data"
        .Controls("&Import XY Data").OnAction = "Import_XY_data"
        .Controls.Add(Type:=msoControlButton, Before:=7).Caption = "Set &Parameters"
        .Controls("Set &Parameters").BeginGroup = True
        .Controls("Set &Parameters").OnAction = "SetRegisters"
    End With
End If

End Sub

Sub DeleteMenuItems()

Dim MenuControls As Object, MenuItem As Object, menuExists As Boolean

menuExists = False
Set MenuControls = Application.CommandBars(1).Controls
For Each menuPopup In MenuControls
    If menuPopup.Caption = "&HPLC" Then
        menuExists = True
    End If
Next

If menuExists Then
    CommandBars(1).Controls("&HPLC").Delete
End If

End Sub

Public Sub Auto_Open()

Application.Workbooks.Add
AddMenuItems
```

```
End Sub

Public Sub Auto_Close()

    DeleteMenuItems

End Sub

Public Sub SetRegisters()
'
' concIS As Variant
' injNumberPattern As String
' howManyBlanks As Variant
' altFormulaCommentCode As String
'
    pathToMethodParametersFile = OGetSetting("VBA", "Sub_HPLCtransformVariables",
"pathToMethodParametersFile_str", "C:\HPLC\Macro\Config.txt", True)
    useIntercept = OGetSetting("VBA", "Sub_HPLCtransformVariables", "UseIntercept_boolean",
False, True)
    howManyBlanks = OGetSetting("VBA", "Sub_HPLCtransformVariables", "HowManyBlanks_integer", 3,
True)
    blankName = OGetSetting("VBA", "Sub_HPLCtransformVariables", "BlankName_string", "Bk", True)
    lowBenchQCName = OGetSetting("VBA", "Sub_HPLCtransformVariables", "LowBenchQCName_string",
"LU-03102", True)
    highBenchQCName = OGetSetting("VBA", "Sub_HPLCtransformVariables", "HighBenchQCName_string",
"HU-03104", True)
    massName = OGetSetting("VBA", "Sub_HPLCtransformVariables", "MassName_string", "As", True)
    dilFactorDelimiter = OGetSetting("VBA", "Sub_HPLCtransformVariables",
"dilFactorDelimiter_string", "^", True)
    columnDescription = OGetSetting("VBA", "Sub_HPLCtransformVariables",
"columnDescription_string", "not entered", True)
    zeroCalibName = OGetSetting("VBA", "Sub_HPLCtransformVariables", "zeroCalibName_string",
"SO", True)
    calibPrepDate = OGetSetting("VBA", "Sub_HPLCtransformVariables", "calibPrepDate_string", "",
True)
    listBoxEntries = Array(1, 2, 3, 4, 5, 6, 7)

    With SetVariablesForm1
        .TextBox1.Value = pathToMethodParametersFile
        .TextBox2.Value = blankName
        .TextBox3.Value = lowBenchQCName
        .TextBox4.Value = highBenchQCName
        .TextBox5.Value = massName
        .TextBox6.Value = columnDescription
        .TextBox7.Value = zeroCalibName
        .TextBox8.Value = calibPrepDate
        .OptionButton3.Value = useIntercept
        .OptionButton4.Value = Not useIntercept
        .ComboBox1.List() = listBoxEntries
        .ComboBox1.Text = howManyBlanks
    End With

    SetVariablesForm1.CommandButtonDone.Default = True
    CommandButtonDoneClicked = False
    SetVariablesForm1.Show
    If CommandButtonDoneClicked Then
        CommandButtonDoneClicked = True
        SetVariablesForm1.Hide
    End If
    If CommandButtonDoneCancel Then
        CommandButtonDoneClicked = False
        SetVariablesForm1.Hide
    End If

    If CommandButtonDoneClicked Then
```

```

With SetVariablesForm1

    pathToMethodParametersFile = .TextBox1.Value
    blankName = .TextBox2.Value
    lowBenchQCName = .TextBox3.Value
    highBenchQCName = .TextBox4.Value
    massName = .TextBox5.Value
    columnDescription = .TextBox6.Value
    zeroCalibName = .TextBox7.Value
    calibPrepDate = .TextBox8.Value
    howManyBlanks = CInt(.ComboBox1.Text)

    If .OptionButton3.Value = True Then
        useIntercept = True
    End If
    If .OptionButton4.Value = True Then
        useIntercept = False
    End If
End With

Else
    Exit Sub
End If

    OSaveSetting "VBA", "Sub_HPLCtransformVariables", "pathToMethodParametersFile_str",
pathToMethodParametersFile, True
    OSaveSetting "VBA", "Sub_HPLCtransformVariables", "UseIntercept_boolean", useIntercept, True
    OSaveSetting "VBA", "Sub_HPLCtransformVariables", "BlankName_string", blankName, True
    OSaveSetting "VBA", "Sub_HPLCtransformVariables", "HowManyBlanks_integer", howManyBlanks,
True
    OSaveSetting "VBA", "Sub_HPLCtransformVariables", "LowBenchQCName_string", lowBenchQCName,
True
    OSaveSetting "VBA", "Sub_HPLCtransformVariables", "HighBenchQCName_string", highBenchQCName,
True
    OSaveSetting "VBA", "Sub_HPLCtransformVariables", "MassName_string", massName, True
    OSaveSetting "VBA", "Sub_HPLCtransformVariables", "dilFactorDelimiter_string",
dilFactorDelimiter, True
    OSaveSetting "VBA", "Sub_HPLCtransformVariables", "columnDescription_string",
columnDescription, True
    OSaveSetting "VBA", "Sub_HPLCtransformVariables", "zeroCalibName_string", zeroCalibName, True
    OSaveSetting "VBA", "Sub_HPLCtransformVariables", "calibPrepDate_string", calibPrepDate, True

'    prompt = "Set the search criteria for the macro Delete Rows by Criteria. " & _
'            "Wild card values # (any single number), ? (any single character) and * (any number
of characters/numbers) are allowed."
'    criteria = Application.InputBox(prompt:=prompt, Type:=2, Default:=criteria)

End Sub

Public Function OGetSetting(ByVal AppName As String, ByVal Section As String, ByVal KeyName As
String, ByVal Default As Variant, Optional ByVal System As Boolean = False) As String
    Set wshShell = CreateObject("WScript.Shell")
    On Error GoTo errBadRead
    OGetSetting = wshShell.RegRead(IIf(System, "HKLM", "HKCU") & "\Software\Microsoft\" & AppName
& "\" & Section & "\" & KeyName)
    Set wshShell = Nothing
    Exit Function
errBadRead:
    OGetSetting = Default
    Set wshShell = Nothing
End Function

Public Function OSaveSetting(ByVal AppName As String, ByVal Section As String, ByVal KeyName As
String, ByVal Value As Variant, Optional ByVal System As Boolean = False)
    Set wshShell = CreateObject("WScript.Shell")
    On Error GoTo errBadWrite
    Call wshShell.RegWrite(IIf(System, "HKLM", "HKCU") & "\Software\Microsoft\" & AppName & "\" &
Section & "\" & KeyName, Value)

```

```

        Set wshShell = Nothing
        Exit Function
    errBadWrite:
        Set wshShell = Nothing
    End Function

Public Function ODeleteSetting(ByVal AppName As String, ByVal Section As String, ByVal KeyName As
String, Optional ByVal System As Boolean = False)
    Set wshShell = CreateObject("WScript.Shell")
    On Error GoTo errBadDelete
    Call wshShell.RegDelete(If(System, "HKLM", "HKCU") & "\Software\Microsoft\" & AppName & "\"
& Section & "\" & KeyName)
    Set wshShell = Nothing
    Exit Function
errBadDelete:
    Set wshShell = Nothing
End Function

Public Function Pause5seconds()
    Dim pauseSeconds As Long
    pauseSeconds = 5
    newHour = Hour(Now())
    newMinute = Minute(Now())
    newSecond = Second(Now()) + pauseSeconds
    waitTime = TimeSerial(newHour, newMinute, newSecond)
    Application.Wait waitTime
End Function

Public Function ExportCode(ByVal wkbkName As String)
' Macro created by Carl Verdon, 2/24/2005
' Updated by C. Verdon 8/9/2006

'   Dimension variables
    Dim strCode1 As String
    Dim strCode2 As String
    Dim strProjName As String
    Dim strChartName As String
    Dim modObj As Object
    Dim modObjItem As Object

'   Inialize variables
    strProjName = "VBAProject"
    strChartName = "Chart 1"
    strCode1 = _
"Sub Chart_InsertNewSeries()" & vbCrLf & _
"    " & vbCrLf & _
"    Dim c as Range" & vbCrLf & _
"    Dim s as Series" & vbCrLf & _
"    " & vbCrLf & _
"    Application.ScreenUpdating = False" & vbCrLf & _
"    Range(Cells(1, ActiveCell.Column), Cells(1, ActiveCell.Column + Selection.Columns.Count
- 1)).Select" & vbCrLf & _
"    Set c = Selection" & vbCrLf & _
"    If (ActiveCell.FormulaR1C1 <> Empty) And (ActiveCell.Column <> 1) Then" & vbCrLf & _
"        Range(Selection, Selection.End(xlDown)).Select" & vbCrLf & _
"        Selection.Copy" & vbCrLf & _
"        ActiveSheet.ChartObjects(" & Chr(34) & strChartName & Chr(34) & ").Activate" &
vbCrLf & _
"        ActiveChart.SeriesCollection.Paste Rowcol:=xlColumns, SeriesLabels:=True,
CategoryLabels:=False, Replace:=False, NewSeries:=True" & vbCrLf & _
"        Application.CutCopyMode = False" & vbCrLf & _
"        For each s in ActiveChart.SeriesCollection" & vbCrLf & _
"            s.Smooth = True" & vbCrLf & _
"        Next s" & vbCrLf & _
"        ActiveChart.Deselect" & vbCrLf & _
"        c.Select" & vbCrLf & _
"    Else" & vbCrLf & _
"        MsgBox" & Chr(34) & "This column does not contain signal data. Select a column

```

```

header for a column that contains signal data." & Chr(34) & vbCrLf & _
"    End If" & vbCrLf & _
"    " & vbCrLf & _
"End Sub"

strCode2 = _
"Sub RefreshPivotTable()" & vbCrLf & _
"    " & vbCrLf & _
"    Application.ScreenUpdating = False" & vbCrLf & _
"    ActiveSheet.PivotTables(" & Chr(34) & "PivotTable_TCDData" & Chr(34) &
").PivotCache.Refresh" & vbCrLf & _
"    Columns(" & Chr(34) & "B:Z" & Chr(34) & ").ColumnWidth = 12" & vbCrLf & _
"    " & vbCrLf & _
"End Sub"

' Main
Set modObj = Application.VBE.VBProjects(strProjName).Collection
Set modObjItem = modObj.Item(modObj.Count)
modObjItem.VBComponents.Add (vbext_ct_StdModule)
modObjItem.VBComponents.Item("Module1").CodeModule.AddFromString (strCode1)
modObjItem.VBComponents.Item("Module1").CodeModule.AddFromString (strCode2)

End Function

' Macro created 4/18/2006 by Carl Verdon
Public Function MakePivotTable( _
    ByVal mySourceData As Range, _
    ByVal myTableName As String, _
    ByVal myRowField As String, _
    ByVal myColField As String, _
    ByVal myDataField As String, _
    Optional ByVal startRow As Integer, _
    Optional ByVal startCol As Integer _
)

    Application.ScreenUpdating = False

    If startRow = Empty Then startRow = 3
    If startCol = Empty Then startCol = 1
    Set sourceDataArea = mySourceData

    ActiveWorkbook.PivotCaches.Add(SourceType:=xlDatabase, _
        SourceData:=sourceDataArea).CreatePivotTable _
        TableDestination:="", _
        TableName:=myTableName, _
        DefaultVersion:=xlPivotTableVersion10

    ActiveSheet.PivotTableWizard TableDestination:=ActiveSheet.Cells(startRow, startCol)
    ActiveSheet.Cells(startRow, startCol).Select

    With ActiveSheet.PivotTables(myTableName)
        .ColumnGrand = False
        .HasAutoFormat = False
        .DisplayErrorString = True
        .ErrorString = "?Data"
        .NullString = "-"
        .PreserveFormatting = False
        .RowGrand = False
    End With

    ActiveSheet.PivotTables(myTableName).AddFields RowFields:=myRowField,
ColumnFields:=myColField
    ActiveSheet.PivotTables(myTableName).HasAutoFormat = True

    With ActiveSheet.PivotTables(myTableName).PivotFields(myDataField)
        .Orientation = xlDataField
        .Caption = "Ave Data"
        .Function = xlAverage

```

```
End With

With ActiveSheet.PivotTables(myTableName).PivotFields("Ave Data")
    .NumberFormat = "0.0"
End With

With ActiveSheet.PivotTables(myTableName).PivotFields(myColField)
    .PivotItems(" (blank)").Visible = False
End With

With ActiveSheet.PivotTables(myTableName).PivotFields(myRowField)
    .PivotItems(" (blank)").Visible = False
End With

ActiveSheet.ShowPivotTableFieldList = False
Application.CommandBars("PivotTable").Visible = False

ActiveSheet.Cells(startRow, startCol).Select
ActiveSheet.Name = "Calib"

' Sub RefreshPivotTable1()
'     ActiveSheet.PivotTables("PivotTable1").PivotCache.Refresh
' End Sub

End Function

End of Program Listing
```

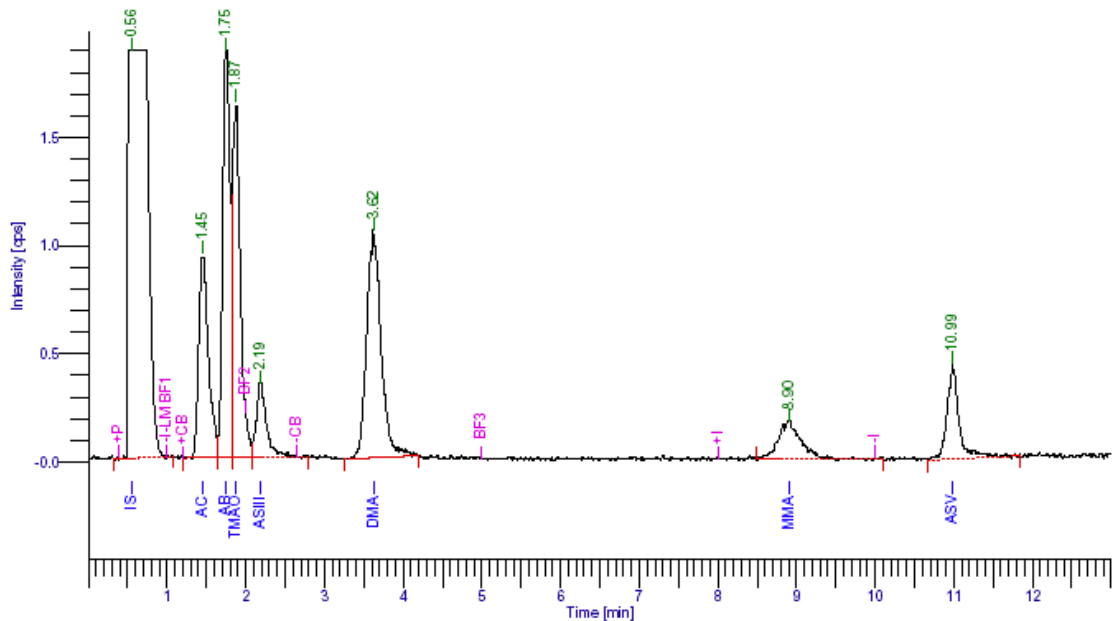


b. Sample Chromatographic Report

Example chromatogram of a bench QC sample below:

Software Version : 6.2.0.0.0:B27	Date : 10/2/2003 1:44:52 PM
Sample Name : hu-03104	Data Acquisition Time : 10/2/2003 2:46:50 AM
Instrument Name :	Channel : A
Rack/Vial : 0/1	Operator : DRC2-D
Sample Amount : 1.000000	Dilution Factor : 1.000000
Cycle : 14	

Result File : C:\HPLC\Data\As031001\014\_hu-03104-031001-230615\_As.rst  
 Sequence File : C:\HPLC\Data\As031001\As031001.seq



Peak #	Component Name	BL MODIFIED	Time [min]	Height [cps]	Area [cps*min]	Range
1	IS	*BB	0.56	3773.52	53210.59	
2	AC	*BV	1.45	952.12	8095.76	
3	AB	*VV	1.75	1930.19	12220.30	
4	TMAO	*VV	1.87	1603.77	11435.43	
5	AsIII	*VB	2.19	357.10	3106.77	
6	DMA	*BB	3.62	1002.14	13335.51	
7	MMA	*BB	8.90	175.79	3421.46	
8	AsV	*BB	10.99	419.86	4607.53	
				10214.50	109433.34	

Missing Component Report  
 Component Expected Retention (Calibration File)

All components were found

c. Sample HPLC Batch Run "Results" File in Microsoft Excel®

A screen shot of a "results" file in Microsoft Excel® after transformation by the Excel Macro "Extract TC Data".

Seq No	Sample	Type	Study ID	Result	Method	Dilution	Calib No	Calib C	Analyte	Ret Time	Peak H	Peak A	IS Peak	Ra
1	bk	Blank		#####	C:\HPLC\C:\HPLC\C	1			IS	0.57	16817.08	212214.4	212214.4	
2	bk	Blank		#####	C:\HPLC\C:\HPLC\C	1			AC	1.27	12.244	72.392	212214.4	0.
3	bk	Blank		#####	C:\HPLC\C:\HPLC\C	1			AB	-	0	0	212214.4	
4	bk	Blank		#####	C:\HPLC\C:\HPLC\C	1			TMAO	-	0	0	212214.4	
5	bk	Blank		#####	C:\HPLC\C:\HPLC\C	1			AsIII	-	0	0	212214.4	
6	bk	Blank		#####	C:\HPLC\C:\HPLC\C	1			DMA	-	0	0	212214.4	
7	bk	Blank		#####	C:\HPLC\C:\HPLC\C	1			MMA	-	0	0	212214.4	
8	bk	Blank		#####	C:\HPLC\C:\HPLC\C	1			AsV	-	0	0	212214.4	
9	s0	Cal:Replace		#####	C:\HPLC\C:\HPLC\C	1	S0		IS	0.58	16760.85	213046.2	213046.2	
10	s0	Cal:Replace		#####	C:\HPLC\C:\HPLC\C	1	S0	0.000001	AC	1.34	15.765	60.643	213046.2	0.
11	s0	Cal:Replace		#####	C:\HPLC\C:\HPLC\C	1	S0	0.000001	AB	1.63	439.183	2583.266	213046.2	0.
12	s0	Cal:Replace		#####	C:\HPLC\C:\HPLC\C	1	S0		TMAO	-	0	0	213046.2	
13	s0	Cal:Replace		#####	C:\HPLC\C:\HPLC\C	1	S0	0.000001	AsIII	-	0	0	213046.2	
14	s0	Cal:Replace		#####	C:\HPLC\C:\HPLC\C	1	S0	0.000001	DMA	3.45	470.38	5836.132	213046.2	0.
15	s0	Cal:Replace		#####	C:\HPLC\C:\HPLC\C	1	S0	0.000001	MMA	7.08	71.359	902.788	213046.2	0.
16	s0	Cal:Replace		#####	C:\HPLC\C:\HPLC\C	1	S0	0.000001	AsV	9.03	62.743	707.928	213046.2	0.
17	s1	Cal:Replace		#####	C:\HPLC\C:\HPLC\C	1	S1		IS	0.6	17359.58	221130.3	221130.3	
18	s1	Cal:Replace		#####	C:\HPLC\C:\HPLC\C	1	S1	2	AC	1.36	802.309	4719.221	221130.3	0.
19	s1	Cal:Replace		#####	C:\HPLC\C:\HPLC\C	1	S1	2	AB	1.63	1596.199	9575.303	221130.3	0.
20	s1	Cal:Replace		#####	C:\HPLC\C:\HPLC\C	1	S1		TMAO	-	0	0	221130.3	
21	s1	Cal:Replace		#####	C:\HPLC\C:\HPLC\C	1	S1	2	AsIII	2.17	463.125	5244.153	221130.3	0.
22	s1	Cal:Replace		#####	C:\HPLC\C:\HPLC\C	1	S1	2	DMA	3.45	936.899	11494.96	221130.3	0.
23	s1	Cal:Replace		#####	C:\HPLC\C:\HPLC\C	1	S1	2	MMA	7.11	326.119	6037.067	221130.3	0.
24	s1	Cal:Replace		#####	C:\HPLC\C:\HPLC\C	1	S1	2	AsV	9.03	644.512	6468.102	221130.3	0.
25	s2	Cal:Replace		#####	C:\HPLC\C:\HPLC\C	1	S2		IS	0.59	16804.69	215377	215377	
26	s2	Cal:Replace		#####	C:\HPLC\C:\HPLC\C	1	S2	10	AC	1.36	3796.202	21670.12	215377	0.
27	s2	Cal:Replace		#####	C:\HPLC\C:\HPLC\C	1	S2	10	AB	1.62	5383.807	33872.49	215377	0.
28	s2	Cal:Replace		#####	C:\HPLC\C:\HPLC\C	1	S2		TMAO	-	0	0	215377	
29	s2	Cal:Replace		#####	C:\HPLC\C:\HPLC\C	1	S2	10	AsIII	2.16	2032.735	22645.34	215377	0.
30	s2	Cal:Replace		#####	C:\HPLC\C:\HPLC\C	1	S2	10	DMA	3.43	2410.137	30626.36	215377	0.
31	s2	Cal:Replace		#####	C:\HPLC\C:\HPLC\C	1	S2	10	MMA	7.1	1311.424	22149.18	215377	0.
32	s2	Cal:Replace		#####	C:\HPLC\C:\HPLC\C	1	S2	10	AsV	9.03	2767.162	28485.58	215377	0.

# Division of Laboratory Sciences Laboratory Protocol

<b>Analyte:</b>	<b>Iodine &amp; Mercury</b>
<b>Matrix:</b>	<b>Urine</b>
<b>Method:</b>	<b>Inductively Coupled Plasma Dynamic Reaction Cell Mass Spectrometry (ICP-DRC-MS)</b>
<b>Method Code:</b>	<b>3002.1</b>
<b>Branch:</b>	<b>Inorganic Radiation Analytical Toxicology</b>

Prepared By: Ge Xiao, PhD \_\_\_\_\_  
author's name signature date

Supervisor: Kathleen L. Caldwell, PhD \_\_\_\_\_  
Supervisor's name signature date

Branch Chief: Robert L. Jones, PhD \_\_\_\_\_  
Branch Chief signature and date

Adopted: 01 September 2005  
date

Updated: 31 May 2010  
date

Director's Signature Block:

Reviewed:

_____	_____
signature	date
_____	_____
signature	date
_____	_____
signature	date
_____	_____
signature	date
_____	_____
signature	date

**Modifications/Changes:** see Procedure Change Log





---

# Laboratory Procedure Manual

*Analyte:* **Iodine & Mercury**

*Matrix:* **Urine**

*Method:* **Inductively Coupled Plasma Dynamic  
Reaction Cell Mass Spectrometry  
(ICP-DRC-MS)**

*Method No:* **3002.1**

*Revised:*

*as performed by:*

Inorganic Radionuclides and Toxicology  
Division of Laboratory Sciences  
National Center for Environmental Health

*contact:*

Dr. Robert L. Jones  
Phone: 770-488-7991  
Fax: 770-488-4097  
Email: [RLJones@cdc.gov](mailto:RLJones@cdc.gov)

James L. Pirkle, M.D., Ph.D.  
Director, Division of Laboratory Sciences

## *Important Information for Users*

CDC periodically refines these laboratory methods. It is the responsibility of the user to contact the person listed on the title page of each write-up before using the analytical method to find out whether any changes have been made and what revisions, if any, have been incorporated.

**This page is intentionally left blank.**

## TABLE OF CONTENTS

1.	CLINICAL RELEVANCE AND TEST PRINCIPLE .....	1
a.	Clinical Relevance	1
b.	Test Principle	1
2.	SAFETY PRECAUTIONS.....	2
3.	DATA SYSTEM MANAGEMENT .....	3
a.	Data Entry and Transfer	3
b.	Routine Computer Hard Drive Maintenance	3
c.	Data Backup	3
(1)	Schedule of Data Backups	3
(2)	Backup Procedures	3
d.	Documentation of System Maintenance	5
4.	COLLECTING, STORING, AND HANDLING SPECIMENS; CRITERIA FOR REJECTING SPECIMENS .....	5
a.	Specimen Type	5
b.	Specimen Collection, Handling and Storage	5
c.	Criteria for an Unacceptable Specimen	6
5.	PROCEDURES FOR MICROSCOPIC EXAMINATIONS.....	6
6.	CHEMICALS, STANDARDS, AND QUALITY CONTROL MATERIAL .....	6
a.	Chemicals	6
b.	Reagent Preparation	7
7.	STANDARDS PREPARATION .....	9
8.	INSTRUMENT & SOFTWARE FOR THE ICP-DRC- MS.....	12
a.	ICP-DRC-MS System	12
b.	Other equipment	13
c.	Supplies	13
9.	CALIBRATION AND CALIBRATION-VERIFICATION PROCEDURES .....	14
a.	Calibration Curve	14
b.	Calibration Verification	14
10.	OPERATING PROCEDURES; CALCULATIONS; INTERPRETATION OF RESULTS .	15

a. Preliminaries	15
b. Sample Preparation	15
c. Instrument Setup and Configuration	17
d. Recording of Data	21
11. FINAL REVIEW OF THE DATA .....	23
a. Abnormal Patient Results	23
b. Evaluating Bench QC of a run	24
12. REPLACEMENT AND PERIODIC MAINTENANCE OF KEY COMPONENTS .....	24
13. LIMIT OF DETECTION .....	25
14. REPORTABLE RANGE OF RESULTS.....	25
15. SPECIAL PROCEDURE NOTES – CDC MODIFICATIONS .....	26
16. QUALITY CONTROL PROCEDURES.....	26
a. Establish QC limits for each QC pool.	26
b. Evaluating the QC of a run	26
c. Remedial action if Calibration or QC systems fail acceptable criteria	27
17. REFERENCE RANGES.....	28
18. ACTION-LEVEL RESULTS.....	28
19. SPECIMEN STORAGE AND HANDLING DURING TESTING .....	28
20. ALTERNATE METHODS FOR PERFORMING TEST AND STORING SPECIMENS IF TEST SYSTEM FAILS.....	28
21. TEST - RESULT REPORTING SYSTEM; PROTOCOL FOR REPORTING CRITICAL CALLS (IF APPLICABLE).....	29
22. TRANSFER OR REFERRAL OF SPECIMENS; PROCEDURES FOR SPECIMEN ACCOUNTABILITY AND TRACKING.....	29
23. REFERENCES .....	29
24. APPENDIX A – RUGGEDNESS TESTING.....	30



**This page is intentionally left blank.**

## 1. CLINICAL RELEVANCE AND TEST PRINCIPLE

---

### a. Clinical Relevance

Iodine (I), an essential element for thyroid function, is necessary for normal growth, development, and functioning of the brain and body. Iodine-deficiency disorders (IDDs) are well-documented global health problems affecting more than a billion people worldwide. Consequences of IDD include goiter, cretinism, intellectual impairment, brain damage, mental retardation, stillbirth, spontaneous abortions, miscarriages, congenital deformities, and increased perinatal mortality. Progress toward eliminating IDDs has been substantial; an estimated 70% of the world's edible salt currently is iodized. Most excess iodine is excreted, and most people can tolerate fairly large amounts without experiencing problems. People with a tendency towards autoimmune thyroid disease are less tolerant of excess iodine. If a person has previously been iodine deficient, that person may be at risk for iodine-induced hyperthyroidism. Excessive iodine intake by a mother can pose a reproductive risk. Since urinary iodine values directly reflect dietary iodine intake, urinary iodine analysis is the recommended and most common method for biochemically assessing the iodine status of a population (1). On the other hand, Mercury (Hg) is a toxic non-essential element that can affect various organ systems within the body but especially the central nervous system. The main sources of mercury intake in humans are fish, dental amalgams, and occupational exposure. The main organs affected by mercury are the brain and the kidneys (2). Psychic and emotional disturbances are the initial signs of chronic intoxication by elemental mercury vapors or salts. Parasthesia, neuralgias, renal disease, digestive disturbances, and ocular lesions may develop (3). Massive exposure over a longer period of time results in violent muscular spasms, hallucinations, delirium, and death (4). The determination of total Hg in blood and urine are both used to assess the internal exposure. Since urine can be collected non-invasively, it is more commonly used to assess exposure to mercury, particularly in occupational health settings where biomonitoring of random spot urine samples is routinely practiced. This method is used to achieve rapid and accurate quantification of iodine (I) and / or mercury (Hg) in urine. The method can be used to analyze urine for both elements at the same time, or just one of the elements.

### b. Test Principle

Urine iodine and mercury concentrations are determined by ICP-DRC-MS (Inductively Coupled Plasma Dynamic Reaction Cell Mass Spectroscopy). This multielement analytical technique is based on quadrupole ICP-MS technology (5) and includes DRC™ technology (6, 7). Coupling radio frequency power into a flowing argon stream seeded with electrons creates the plasma, the heat source, which is ionized gas suspended in a magnetic field. Predominant species in the plasma are positive argon ions and electrons. Diluted urine samples are converted into an aerosol using a nebulizer inserted within the spray chamber. A portion of the aerosol is transported through the spray chamber and then through the central channel of the plasma, where it is exposed to temperatures of 6000-8000 K. This thermal energy atomizes and ionizes the sample. The ions and the argon enter the mass spectrometer through an interface that separates the ICP, which is operating at atmospheric pressure (approximately 760 torr), from the mass spectrometer, which is operating at

approximately  $10^{-5}$  torr. The mass spectrometer permits detection of ions at each mass-to-charge ratio in rapid sequence, which allows the determination of individual isotopes of an element. Once inside the mass spectrometer, the ions pass through the ion optics, then through DRC™, and finally through the mass-analyzing quadrupole before being detected as they strike the surface of the detector. The ion optics uses an electrical field to focus the ion beam into the DRC™. The DRC™ component is pressurized with an appropriate reaction gas and contains a quadrupole. Electrical signals resulting from the detection of the ions are processed into digital information that is used to indicate the intensity of the ions and subsequently the concentration of the element. Traditionally ICP-MS has been a trace analysis technique and the typical measurement ranges from  $< 1 \mu\text{g/L}$  to around  $100 \mu\text{g/L}$ . DRC technology can be used to provide additional control of ICP-MS sensitivity. In this method, adjustments of the reaction cell parameters dampen the sensitivity of iodine (isotope mass 127) to extend the useful concentration measurement range to higher concentrations. The reaction cell parameters in this method are also used to increase the sensitivity of mercury (isotope mass 202) by a process known as collisional focusing. Both of these processes are accomplished by filling the Dynamic Reaction Cell™ (DRC) with 100% argon. Urine samples are diluted 1+1+ 8 (sample+ water + diluent) with water and diluent containing tellurium and bismuth for internal standardization.

## 2. SAFETY PRECAUTIONS

---

**Precautionary information that is important to protecting personnel and safeguarding equipment will be presented inside a box, such as this one, throughout the procedure where appropriate.**

Follow universal precautions. Wear gloves, a lab coat, and safety glasses while handling human blood, plasma, serum, urine or other bodily fluid or tissue. Place disposable plastic, glass, and paper (e.g., pipette tips, autosampler tubes and gloves) that come in contact with human biological fluids, such as urine, in a biohazard autoclave bag. Keep these bags in appropriate containers until they are sealed and autoclaved. When work is finished, wipe down all work surfaces where human biological fluid was handled with a 10% (v/v) sodium hypochlorite solution or equivalent. The use of the foot pedal on the Micromedic Digiflex™ is recommended because it reduces analyst contact with work surfaces that have been in contact with human biological fluid and also keeps the hands free to hold specimen cups and autosampler tubes. Dispose of all biological samples and diluted specimens in a biohazard autoclave bag at the end of the analysis according to CDC/DLS guidelines for disposal of hazardous waste.

PerkinElmer provides safety information that should be read before operating the instrument. This information is found in the PerkinElmer ELAN ICP-DRC-MS System Safety Manual. Possible hazards include ultraviolet radiation, high voltages, radio-frequency radiation, and high temperatures.

**Caution!**

Exercise caution when handling and dispensing concentrated nitric acid and base Tetramethylammonium hydroxide (TMAH). Always remember to add acid to water. Nitric acid and TMAH are caustic chemicals that are capable of severe eye and skin damage. Wear powder-free gloves, a lab coat, and safety glasses. If nitric acid or TMAH comes in contact with any part of the body, quickly wash the exposed area with copious quantities of water for at least 15 minutes.

### 3. DATA SYSTEM MANAGEMENT

---

To maintain the integrity of specimen and analytical data generated by this method, eliminate hand entry of specimen identifiers or analytical results whenever possible, proofread all transcribed data, and regularly defragment and back up the ICP-MS computer's hard drive.

#### a. Data Entry and Transfer

Whenever possible, use bar code scanners to enter sample identifiers into the ICP-DRC-MS computer software to avoid errors associated with the keyboard-entry process and to speed up sample processing. When bar code scanners cannot be used, proofread transcribed data after entry. Handle or transfer data electronically when reporting or moving data to other computerized data-handling software. In the Inorganic Radiation and Analytical Toxicology Branch, sample analysis results generated by this method are stored for long periods in Microsoft Access™ or MS SQL Server database software. The results should include at least the analysis date, analytical run number, quality-control (QC) results for the run, results of specimen analysis by specimen identification (ID), and method identifier.

#### b. Routine Computer Hard Drive Maintenance

Defragment the computer hard drive regularly by using software such as Microsoft Windows® Disk Defragmenter (located in Start > Programs > Accessories > System Tools) or an equivalent backup program to maximize computer performance and maintain data integrity for files on the hard drive. An entry will automatically be made in the Windows™ system event log when this process is done and will provide documentation of this step.

#### c. Data Backup

##### (1) Schedule of Data Backups

**Weekly.** Full data backups onto one or more recordable compact discs (CD-R) or digital video discs (DVD).

**Daily.** Full data backups onto an external hard drive.

##### (2) Backup Procedures

Whenever making a backup (daily or weekly) include the directories and subdirectories: C:\elandata (include all subdirectories)

Before making weekly backups, saving a copy of the Windows™ event log in the active “elandata” directory will ensure archiving of all recent software system events (including communications between ICP-DRC-MS and ELAN® software, as well as times of hard drive defragmentation, and other Windows™ system events).

**(a) External Hard Disk Backups**

Connect the ELAN data system computer to an external hard disk with sufficient storage capacity to store several copies of the backup files ( $\geq 18$  gigabytes). Configure Microsoft Windows® Backup™ (located in Start > Programs > Accessories > System Tools) program to do a daily backup of the ELAN data system computer’s data directories (see *Backup Procedures*)

**(b) Compact Disc Backups**

Use CD-R disks only (recordable compact disks), *not* CD-RW disks (rewritable compact disks). Record the CD-R so that after creation the recordable compact disk cannot be written to again (to prevent any accidental over-writing of stored data). Use Adaptec “Easy CD Creator”™ or equivalent software to backup.

**(c) Removing Data from the ICP-DRC-MS Computer Hard Drive**

When the active “elandata” directory on the ICP-DRC-MS computer hard drive becomes too large to fit onto a single recordable compact disk, remove the oldest data on the hard drive so that a regular backup can be done onto a single CD-R. Usually, this procedure can be done annually.

- Back up the oldest data on the hard drive in duplicate onto two CD-R disks. Manually select each dataset folder (subdirectories under “C:\elandata\dataset” and other relevant files (i.e., optimization, tuning, and sample files) that are to be included on these backups.
- Verify that backup CD-R disks operate correctly before deleting any data from the hard drive. To verify the operation of a CD-R disk, open any file on the disk by using the appropriate computer software (ICP-DRC-MS software).
- After verifying that all backups are operational, delete the original data from the hard drive.
- Keep one copy of the CD-R disk in a building other than the laboratory in case of fire (currently, the storage room is room 1011 in building 103). Keep the other near the ICP-MS laboratory.

**(d) Backup of Sensitive Data**

Make a backup for sensitive data on duplicate, recordable compact disk. Store the two CD-R disks in two different buildings.

d. Documentation of System Maintenance

**(1) Computer Maintenance:**

Record any maintenance of computer hardware and ICP-DRC-MS software in the instrument logbook. Place other electronic records relating to integrity of the data and hard drive in the Windows™ event log. Back up the event log on a regular basis by saving a copy in the active “elandata” directory. The event log will then be backed up along with the ELAN data when backup CD-R disks and tapes are made.

**(2) Instrument Maintenance:**

Document system maintenance in hard copies of data records (i.e., daily maintenance checklists, PerkinElmer service records, and instrument log book) as well as in electronic records relating to instrument optimization (default.dac), tuning (default.tun).

4. COLLECTING, STORING, AND HANDLING SPECIMENS; CRITERIA FOR REJECTING SPECIMENS

---

a. Specimen Type: Specimen type is urine. No special instructions for fasting or special diets are required of patient or study subjects.

b. Specimen Collection, Handling and Storage

(1) No special instructions for fasting, special diets are required.

(2) The specimen type is urine with preservative (for mercury). The preservative is a solution of approximately 2 M sulfamic acid and. It is added for the purpose of preventing loss of mercury from the urine before analysis. Urine should be mixed with the preservative as soon as possible after initial collection in the proportion of 10 µL of preservative solution per 1 mL of urine (example: To a tube containing 50 µL of preservative, up to 5 mL of urine can be added for urine mercury analysis). Mix the urine well after addition of the preservative. See Section 6.b.2 for details on preparation of the preservative solution.

(3) Optimal amount of specimen is 1.8 mL; minimum amount in a cryo-vial is about 0.75 mL. 500 µL needed for an analysis.

(4) Acceptable containers for allotment of urine for this method include 15 mL PP centrifuge tubes (e.g., Becton, Dickinson and Company model number 352097). Use sterile collectors for specimen acquisition.

(5) Screen specimen collection cups, containers and sample tubes for iodine and mercury contamination before use.

(6) Specimen stability has been demonstrated for 1 year at  $\leq -20^{\circ}\text{C}$ .

(7) Specimen characteristics that may compromise test results are indicated above and include high storage temperature or no preservative.

- (8) Specimen handling conditions are outlined in the division protocol for urine collection and handling. Copies are available in the branch, laboratory and special activities specimen-handling offices. The protocol addresses collection, transport, and special-equipment requirements. In general, transport and store urine specimens at  $\leq -20^{\circ}\text{C}$ . Upon receipt, freeze the specimens at  $\leq -20^{\circ}\text{C}$  until time for analysis. The analyst puts the remaining samples in the freezer after analytical aliquots are done and refreezes them at  $\leq -20^{\circ}\text{C}$ . Samples that are thawed and refrozen several times will not be compromised.

c. Criteria for an Unacceptable Specimen

The criteria for an unacceptable specimen are either a low volume ( $< 0.75$  mL), suspected contamination due to improper collection procedures or collection devices, or failure to add the proper preservative to urine to prevent the loss of mercury. The volume of urine used in a single analysis is 0.5 mL, but sample volumes  $< 0.75$  mL may not allow for proper pipetting. Requested volume is  $> 1.8$  mL to allow for repeat / confirmation analysis if necessary. Specimen contact with dust or dirt may compromise test results. In all cases, request a second urine specimen.

## 5. PROCEDURES FOR MICROSCOPIC EXAMINATIONS

---

Not applicable for this procedure.

## 6. CHEMICALS, STANDARDS, AND QUALITY CONTROL MATERIAL

---

a. Chemicals

- (d) Water, high purity ( $\geq 18$  M $\Omega$ -cm resistivity using a NANOpure Diamond Ultrapure Water System or equivalent).
- (e) TritonX-100™ (Aldrich Chemical Co., Milwaukee, WI, or any source whose product is low in trace-metal contamination).
- (f) Sulfamic Acid (Columbus Chemical Industries, Columbus, WI or equivalent).
- (g) Concentrated (16M or ~70%) nitric acid (Environmental Grade from GFS Chemicals Inc., Columbus, OH or equivalent). If other stock concentrations are used, volumes must be adjusted accordingly.
- (h) Concentrated (12M or ~37%) hydrochloric acid (Superior Reagent HCl from GFS Chemicals Inc., Columbus, OH or equivalent). If other stock concentrations are used, volumes must be adjusted accordingly.
- (i) Ethyl Alcohol (Ethanol) (C<sub>2</sub>H<sub>5</sub>OH), ACS/USP Absolute, Anhydrous, 200 proof (Aaper-Pharmco Products, Inc., Shelbyville, KY or equivalent low in trace-metal contamination).
- (j) Mercury (Hg) Stock Standard 1,000 mg Hg / L in 3-10% HNO<sub>3</sub> or HCl and 10,000 mg Hg / L in 3-10% HNO<sub>3</sub> or HCl (Inorganic Ventures, Lakewood, NJ or equivalent NIST traceable vendor / product).

- (k) Iodide (I-) Stock Standard: 1,000 mg I / L in H<sub>2</sub>O+stabilizer (Inorganic Ventures, Lakewood, NJ or equivalent NIST traceable stock standard).
- (l) Tellurium (Te) Stock Standard: 1,000 mg Te / L in 2-10% HNO<sub>3</sub> (Inorganic Ventures, Lakewood, NJ or equivalent NIST traceable stock solution).
- (m) Gold (Au) Stock Standard: 1,000 mg Au / L in 2-10% HCl (Inorganic Ventures, Lakewood, NJ or equivalent NIST traceable stock standard).
- (n) Ethylenediaminetetraacetic Acid (EDTA, Sigma-Aldrich Chemicals, St.Louis, MO or equivalent source).
- (o) Tetramethylammonium hydroxide (TMAH), 25% w/w, or equivalent (AlfaAesar, 30 Bond St., Ward Hill, MA 01835).
- (p) Sodium Hypochlorite (Bleach) or equivalent for preparation of 10% bleach solution used for biological decontamination (i.e. ACTIVATE "Fresh Mix Bleach in a Bottle", an approved equivalent product that mixes the 10% bleach solution with each spray).
- (q) Liquid argon (supplied by Speciality Gases or other contract agency) equipped with approved gas regulator (Matheson Gas Products, Secaucus, NJ – or equivalent).

## b. Reagent Preparation

- (1) **Triton X-100 intermediate solution** (1% v/v Triton X-100 in water)  
For ease of the regular preparation of other solutions (diluent and urine preservative), first prepare a 1% Triton X-100™ stock solution. Add 20 mL of Triton X-100™ to a pre-acid-washed 2 L, narrow-mouth container that is partially filled with ≥18 MΩ·cm water. Fill to 2 L with ≥18 MΩ·cm water. Add an acid-washed, Teflon™ coated stirring bar, and stir on a magnetic stirrer until the Triton X-100™ has completely dissolved into solution (several hours) or mix well and allow to stand overnight for complete dissolution.
- (2) **Preservative for collected urine or intermediate standards**
  - (a) **Preservative for collected urine samples**  
(200 g/L sulfamic acid, 0.01% Triton X-100™).  
Partially fill a pre-screened or pre-acid-washed 50mL polypropylene centrifuge tube with ≥18 Mohm cm<sup>-1</sup> water. Add 10 g of sulfamic acid and 0.5mL of 1% TritonX-100 intermediate solution. Fill to the 50mL mark with ≥18 Mohm cm<sup>-1</sup> water. Dissolve the sulfamic acid by mixing well (use of a vortexer, or warm water bath is helpful in this process). Store at room temperature. Expiration is one year from preparation.
  - (b) **Preservative for intermediate standards**  
(200 g/L sulfamic acid)  
Partially fill a pre-screened or pre-acid-washed 50mL polypropylene centrifuge tube with ≥18 Mohm cm<sup>-1</sup> water. Add 10 g of sulfamic acid. Fill to the 50mL mark with ≥18 Mohm cm<sup>-1</sup> water. Dissolve the sulfamic acid by mixing well (use of a vortexer, or warm water bath is helpful in this process). Store at room temperature. Expiration is one year from preparation.
- (3) **Diluent.**
  - (a) **Internal Standard Intermediate Solution.** (100 mg/L Te in ≥18 MΩ·cm water)  
To facilitate the "as needed" preparation of the diluent, preparation of a supply of internal standard intermediate solution is recommended. Partially fill a pre-



screened or pre-acid-washed 50mL polypropylene centrifuge tube with  $\geq 18$  Mohm  $\text{cm}^{-1}$  water. Add 5mL Te stock (1000mg/L) then fill to the 50 mL mark with  $\geq 18$  Mohm  $\text{cm}^{-1}$  water. Mix well and store at room temperature. To prepare different volumes adjust the solution constituents proportionally.

- (b) Diluent** (1% (v/v) TMAH, 0.02% Triton X-100™, 25  $\mu\text{g/L}$  Te, 5% (v/v)  $\text{C}_2\text{H}_5\text{OH}$ , 500  $\mu\text{g/L}$  Au, 0.5 g/L EDTA ).

Acid-rinse a narrow-mouth 2 L container (Teflon™ preferred), and partially fill with  $\geq 18$  M $\Omega$ -cm water. Add the following, mixing in between each addition: 20 mL of 25% (v/v) TMAH, 40 mL of 1% Triton X-100™, 100 mL ethanol, 1 mL of 1,000 mg/L Au, 1g EDTA, and 0.5mL of internal standard intermediate solution (100 mg/L Te). Dilute to 2 L with  $\geq 18$  M $\Omega$ -cm water. Store at room temperature and prepare as needed. To prepare larger volumes of diluent, add proportionally larger volumes of the solution constituents. Use this diluent to prepare all standards and samples during the sample preparation / dilution process, which should occur just before analysis. It is important to make all calibrators, blanks, QC, and samples in a run from the same diluent solution so that the concentration of the internal standard is consistent. Diluent homogeneity (e.g. internal standard concentration) is enhanced by stirring the diluent on a stir plate at lowest vortex speed throughout calibrator and sample preparation.

- (4) ICP-DRC-MS Rinse Solution** ( 1% (v/v) TMAH, 0.02% Triton X-100™, 5% (v/v)  $\text{C}_2\text{H}_5\text{OH}$  and 500  $\mu\text{g/L}$  Au).

To prepare, acid-rinse a 4 L narrow-mouth Teflon™ container and partially fill with  $\geq 18$  M $\Omega$ -cm water. Add 40 mL of 25% (v/v) TMAH and 80 mL of 1% Triton X-100™ (see section 6.b.1 for preparation procedure), 200 mL  $\text{C}_2\text{H}_5\text{OH}$  and 2 mL of 1,000 mg/L Au. Dilute to 4 L with  $\geq 18$  M $\Omega$ -cm water. Store at room temperature and prepare as needed. To prepare larger volumes of rinse solution, add proportionally larger volumes of the solution constituents. Pump this solution into the sample introduction system between samples to prevent carry over of the analytes of interest from one sample measurement to the next.

- (5) Base Urine Preparation**

The base urine used in this method is a pool of urine collected from anonymous donors. Collect urine in containers screened for iodine and mercury content. After receiving donations, analyze the urine to determine iodine and mercury concentrations. The final base urine pool should be  $\leq 70$   $\mu\text{g/L}$  iodine and  $\leq 0.1$   $\mu\text{g/L}$  mercury. Donated urine specimens with acceptable concentrations of iodine and mercury, are pooled and then dispensed into smaller-volume tubes (i.e., 50 mL polypropylene tubes) for daily use. For short-term storage (a few days), store at approximately 2-4°C. For long-term storage, store at  $\leq -20^\circ\text{C}$ . A 2 L base urine pool should be enough for ~350 analysis runs (~ 14,000 samples at 40 samples per run). Combine this base urine with intermediate working standards prior to analysis each day to prepare a matrix-matched calibration curve for each run.

## 7. STANDARDS PREPARATION

---

### CAUTION!

Mercury compounds are toxic! Take extra care to avoid accidental ingestion or inhalation of these materials. **Wear appropriate personal protective gear. Above all, wear a laboratory coat and latex or nitrile gloves.** Clean up any spill that might occur according to applicable hazardous material spill procedures.

#### Materials:

**Flasks:** one 500 mL (plastic or glass) for 10% v/v HCl  
one 50mL (glass) for Hg Intermediate Stock Standard B  
four 100 mL (glass) for other Intermediate Stock Standards  
(Hg-A, IOD-A, IOD-B, Hg-C)  
five 100mL (glass) for Intermediate Working Standards 1-5.  
Three 100mL (glass) for range of linearity (calibration verification) solutions

**Pipette volumes:** 80-1000  $\mu$ L

**Glass Bottles (~0.5oz)** for final storage of standards solutions (approximately 30).

**Stock solutions:** iodine (1000 mg/L) & mercury (1000 mg/L).

**Hydrochloric acid:** Concentrated (12M or 37%) HCl

#### a. Materials preparation

- (1) Clean the flasks:
  - (a) Acid-wash flasks: Rinse each with 5% (v/v) nitric acid solution followed by rigorous rinsing with  $\geq 18$  M $\Omega$ -cm water. Repeat this process several times depending on prior use of the containers. After adequate acid washing, flasks should be clean of residual Hg and I from previous usage.
  - (b) Monitoring: This step is not usually necessary, but if performed, compare analysis results of water poured out of these flasks with results for water taken directly from the same water purification system to decide whether or not additional cleaning of the containers is needed. Analysis of the water can be done directly without dilution or calibration using the normal ICP-DRC-MS method file. Acceptable counts for clean vessels should be negligibly different from water blank counts. Typical measured intensity observed for Iodine in water is less than 100cps and Mercury <30cps (counts vary between instruments due to sensitivity differences). If background counts are too high, repeat step 7.a.1.a.
- (2) Sulfamic Acid Preservative: Prepare 200 g/L sulfamic acid preservative as per Section 6.b.2.
- (3) Prepare 10% v/v HCl: Add 25mL of concentrated HCl (12 M or 37%) to approximately 400mL water in an acid-washed 500 mL volumetric flask (see Section 7. Materials: Flasks). Dilute to the mark with  $\geq 18$  M $\Omega$ -cm water. Mix well. Store at room temperature. Expiration date is 1 year from preparation.

#### b. Intermediate Stock Standards Preparation

- (1) Mercury Intermediate Stock Standards Preparation:
  - (a) Hg Intermediate Stock Calibrator Solution A ('Hg-A', 1 mg/L mercury in 10% v/v HCl).  
Partially fill an acid-cleaned 100mL glass volumetric flask with 10% v/v HCl. Add 100  $\mu$ L of 1000mg/L Hg stock standard. Dilute to the 100 mL mark with 10% v/v HCl.

Mix well before use or storage. Store an aliquot of this solution in a properly labeled glass bottle at refrigerated temperatures (~2-4°C).

- (2) Hg Intermediate Stock Calibrator Solution B ('Hg-B', 0.1 mg/L mercury in 10% v/v HCl).  
Partially fill an acid-cleaned 50mL glass volumetric flask with 10% v/v HCl. Mix the Hg Intermediate Stock Solution A ('Hg-A') well, then pipette 5mL of it into the partially filled, 50mL flask. Dilute to the 50 mL mark with 10% v/v HCl. Mix well before use or storage. Store an aliquot of this solution in a properly labeled glass bottle at refrigerated temperatures (~2-4°C).
- (3) Hg Intermediate Stock Calibration Verification Solution ('Hg-C', 100 mg/L mercury in 10% v/v HCl).  
Partially fill an acid-cleaned 100mL glass volumetric flask with 10% v/v HCl. Add 1000 µL of 10,000 mg/L Hg stock standard. Dilute to the 100 mL mark with 10% v/v HCl. Mix well before use or storage. Store an aliquot of this solution in a properly labeled glass bottle at refrigerated temperatures (~2-4°C).

#### c. Iodine Intermediate Stock Standards Preparation:

- (1) Iodine Intermediate Stock Calibrator and Calibration Verification Solution A ('IOD-A', 100 mg/L iodine in water)  
Partially fill an acid-rinsed 100mL glass volumetric flask with  $\geq 18$  M $\Omega$ -cm water. Add 10 mL of 1000mg/L I stock standard. Dilute to the 100 mL mark with  $\geq 18$  M $\Omega$ -cm water. Mix well before use or storage. Store an aliquot of this solution in a properly labeled glass bottle at refrigerated temperatures (~2-4°C).
- (2) Iodine Intermediate Stock Calibrator Solution B ('IOD-B', 10 mg/L iodine in water)  
Partially fill an acid-rinsed 100mL glass volumetric flask with  $\geq 18$  M $\Omega$ -cm water. Mix the I Intermediate Stock Solution A ('IOD-A') well, then pipette 10mL of it into the partially filled, 100mL flask. Dilute to the 100 mL mark with  $\geq 18$  M $\Omega$ -cm water. Mix well before use or storage. Store an aliquot of this solution in a properly labeled glass bottle at refrigerated temperatures (~2-4°C).

#### d. Intermediate Working Standards Preparation

- (1) Partially fill five 100 mL glass volumetric flasks to a few centimeters below the meniscus with  $\geq 18$  M $\Omega$ -cm water. Add 1mL of the 200 g/L sulfamic acid preservative solution to each flask and mix well. Pipette the appropriate volume (see the table below) of each intermediate stock solution into the five flasks. Mix these well, then dilute each to a final volume of 100mL with  $\geq 18$  M $\Omega$ -cm water. Different volumes can be prepared by spiking with proportionally smaller or larger additions of components.

Intermediate Working Standards Preparation volumes (µL).				
Working Standard Number	Hg Intern. Stock STD B ('Hg-B') (0.1 mg/L)	Hg Intern. Stock STD A ('Hg-A') (1 mg/L)	I Intern. Stock STD B ('IOD-B') (10 mg/L)	I Intern. Stock STD A ('IOD-A') (100 mg/L)
STD 1	80		80	
STD 2	240		240	
STD 3	800		800	
STD 4		240		240
STD 5		800		800

- (2) The final concentrations of iodine and mercury in each of the intermediate working standards can be calculated by the formula below (see table below for final

concentrations). The values entered into the ICP-DRC-MS software should be the concentrations of the intermediate working standard.

$$\text{Int. Work. Std. Conc. } (\mu\text{g/L}) = \frac{\text{Int. Stock Std. Conc. } (\mu\text{g/L}) \times \text{Int. Stock Std Spike (L)}}{0.100 \text{ L}}$$

Intermediate Working Standards Concentrations (ug/L)		
	Mercury	Iodine
STD 1	0.08	8
STD 2	0.24	24
STD 3	0.8	80
STD 4	2.4	240
STD 5	8.0	800

- (3) Mix standards well and allow to equilibrate. If time allows, test one aliquot of the calibrators before aliquoting into labeled glass bottles for storage with bench QC and reference materials (as available) before using it for patient sample analysis. Store at refrigerator temperatures (~2-4°C). Expiration date is 6 month from preparation.

**e. Working Standards (Calibrators)**

The working calibrators are dilutions of the five intermediate working standards into a urine matrix (base urine) for the purpose of a matrix-matched external calibration of an analytical run (i.e. the run calibrators). Prepare the working calibration standards along with patient samples and QC using the same diluent solution. Diluent homogeneity (e.g. internal standard concentration) is enhanced by stirring the diluent on a stir plate at lowest vortex speed throughout calibrator and sample preparation. Use the same base urine for all calibrators and urine blanks to be used within the run. To prepare the working calibration standards, transfer 500 µL of the appropriate aqueous intermediate working standard, 500 µL of base urine, and 4,000 µL of diluent to a 15 mL polypropylene centrifuge tube by using the Micromedic Digiflex™. Cap the tube and mix well before analysis. Section 20 describes procedures for situations where prepared dilutions cannot be analyzed within the same workday as preparation.

**f. Range of Linearity (RLT) / Calibration Verification Intermediate Working Standards**

Partially fill three 100 mL glass volumetric flasks to a few centimeters below the meniscus with ≥18 MΩ·cm water. Add 1mL of the 200 g/L sulfamic acid preservative solution to each flask and mix well. Pipette the appropriate volume (see the table below) of each intermediate stock solution into the three flasks. Mix these well, then dilute each to a final volume of 100mL with ≥18 MΩ·cm water. Mix standards well and allow to equilibrate. If time allows, test one aliquot of the calibrators before aliquoting into labeled glass bottles for storage. Test the solutions to verify the concentrations with bench QC and reference materials (as available) before using for patient sample analysis. Store at refrigerator temperatures (~2-4°C). Expiration date is 6 month from preparation.

Range of Linearity (RLT) / Calibration Verification (CV) Intermediate Working Standards Preparation				
RLT / CV working standard number	Spike Vol. Hg Intermediate Stock Std C ('Hg-C', 100 mg/L)	Hg Conc. (ug/L)	Spike Vol. I Intermediate Stock Std A ('IOD-A', 100 mg/L)	Iodine Conc. (ug/L)
RLT / CV 1	100 µL	100 ug/L	1,200 µL	1,200 ug/L
RLT / CV 2	200 µL	200 ug/L	2,000 µL	2,000 ug/L

RLT / CV 3	250 $\mu$ L	250 ug/L	3,000 $\mu$ L	3,000 ug/L
------------	-------------	----------	---------------	------------

Different volumes can be prepared by spiking with proportionally smaller or larger additions of components. Different concentrations of RLT / CV solutions can be prepared by making dilutions of these preparations using water immediately prior to their preparation at the Digiflex (i.e. a 50 ug/L Hg solution can be prepared by initially diluting the RLT / CV intermediate stock solution 2x using water prior to preparation of the working RLT / CV standard) or by spiking proportionally different volumes of the Hg or I intermediate stock standards when making the RLT / CV intermediate working standards.

**g. Quality Control Material**

**(1) Bench QC Materials**

Analyze low and high bench QC material in each run to determine the validity of the concentration measurements being made. Quality control (QC) materials are made by spiking human urine collected from anonymous donors (see section 6.b.5) with single element iodide and mercury standards. Prepare these pools periodically, as supply dictates, by spiking base urine to desired concentrations. Prepare new pools far enough in advance so that both old and new pools can be analyzed together for a period of time (preferably at least 20 runs) before switching to the new QC materials. The two urine QC pools made for iodine and mercury assay are designated as:

QC level	QC Designation ID
low pool	LU-yy###
high pool	HU-yy###

Where substitutions are: yy = the last two digits of production year, and ### = assigned pool identification number.

QC material that is to be used for bench quality control run judge purposes will need to be "characterized" as described in the section *Establish QC limits* for each QC pool.

**(2) Reference Materials**

Analyze reference materials on a regular basis to evaluate / verify method performance. When available, use standard reference materials (NIST). Freeze dried certified reference materials (i.e. NIST SRM 2670) can be aliquoted into smaller volumes after reconstitution and stored at  $\leq -20^{\circ}\text{C}$  for use when needed.

## 8. INSTRUMENT & SOFTWARE FOR THE ICP-DRC- MS

---

**a. ICP-DRC-MS System**

- (1)** Inductively Coupled-Plasma Dynamic-Reaction Cell Mass Spectrometer ELAN<sup>®</sup> DRC Plus or DRC II (PerkinElmer Instruments, Headquarters Office, 710 Bridgeport Ave., Shelton, CT 06484-4794). Parameters of x-y alignment, mass calibration, autolens voltages, and nebulizer gas flow rates are optimized regularly. Other DRC<sup>™</sup> parameters are optimized for each specific instrument.

**ELAN<sup>®</sup> ICP-DRC-MS Method Parameters**

<u>Parameter</u>	<u>Setting</u>
RF Power	1.45 KW
Argon nebulizer gas flow is the same as the DRC mode nebulizer gas flow	Approx 0.9-1 LPM
Detector mode	Pulse
Measurement units	Cps
Autolens	On
Blank subtraction	After internal standard
Curve type	Simple Linear
Sample units	µg/L
Sweeps/reading	90
Readings/replicate	1
Replicates	3
Dwell time	30 ms for I and Te and 100 ms for Hg
Cell gas	Argon
Cell gas flow rate	~0.3 - 0.5 mL/min (optimize as needed)
RPQ	~0.75 for iodine and ~0.35 for Hg (optimize as needed)
Equations (on Te)	$1.154312 * Xe 129 - 0.009437 * Ba 137$

- (2) ELAN instrument control and data handling software, version 3.0 with service pack 2 or equivalent (PerkinElmer Instruments, Shelton CT).
- (3) Cyclonic spray chamber (PerkinElmer Instruments, Shelton CT), or equivalent.
- (4) Concentric glass nebulizer, (P/N SB-50-A2, J. E. Meinhard Associates, CA) or equivalent.

## b. Other equipment

- (1) Water purification system (NANOpure Diamond Ultrapure Water System, Barnstead International, Bedford, MA or equivalent) for providing ultrapure water with a resistivity  $\geq 18 \text{ M}\Omega\text{-cm}$ .
- (2) Analytical balance for routine weighing of material to the nearest tenth of a gram and with a loading capacity of at least 200 g.
- (3) Micromedic Digiflex<sup>™</sup> automatic pipette (or equivalent) to facilitate sample dilution / preparation equipped with 10.0 mL dispensing syringe, 2.0 mL sampling syringe, 0.75 mm tip, and foot pedal (LABREPO, Inc., 101 Witmer Rd., Suite 700, Horsham, PA 19044).

## c. Supplies

- (1) 5-100 µL pipette tips, 960 tips per case (Eppendorf<sup>®</sup> catalogue # 2235137-1, distributed by Eppendorf North America, Westbury NY), or equivalent.
- (2) 20-300 µL pipette tips, 960 tips per case (Eppendorf<sup>®</sup> catalogue # 2235144-3, distributed by Eppendorf North America, Westbury NY), or equivalent.
- (3) 1,000 µL pipette tips, 960 tips per case (Eppendorf<sup>®</sup> catalogue # 2249044-3, distributed by Eppendorf North America, Westbury NY), or equivalent.

- (4) 5 mL pipette tips, 500 tips per case (Eppendorf® catalogue # 2235081-1, distributed by Eppendorf North America, Westbury NY), or equivalent.
- (5) Acid-cleaned volumetric flasks, 100 mL (qty 12) and 50 mL (qty 1) for standards preparation (glass preferred) and 500 mL (qty 1) for 10% HCl preparation (glass or plastic acceptable). To acid-wash flasks, rinse with 5% (v/v) reagent-grade nitric acid, followed by rigorous rinsing with  $\geq 18$  M $\Omega$ -cm water. Repeat this process several times depending on prior use of the containers.
- (6) 2 Acid-cleaned 2 liter PE bottles. To acid-wash containers, rinse with 5% (v/v) reagent-grade nitric acid, followed by rigorous rinsing with  $\geq 18$  M $\Omega$ -cm water. Repeat this process several times depending on prior use of the containers.
- (7) 2 acid-cleaned 4 liter PE bottles. To acid-wash containers, rinse with 5% (v/v) reagent-grade nitric acid, followed by rigorous rinsing with  $\geq 18$  M $\Omega$ -cm water. Repeat this process several times depending on prior use of the containers.
- (8) Glass vials (10-30mL) for storage of calibration standards after preparation. (i.e. clear Qorpak vials, All-Pak, Bridgeville, PA or equivalent).
- (9) Kay-Dry™ paper towels and Kim-Wipe™ tissues (Kimberly-Clark Corp., Roswell GA, or equivalent vendor).
- (10) Teflon™-coated magnetic stir bars (2) (Catalog Number 58948-974 or equivalent), VWR Scientific Products, Buffalo Grove, IL.
- (11) Cotton swabs (Hardwood Products Co. ME, or equivalent vendor).
- (12) 15 mL (# 352097) and 50 mL (#352098) polypropylene centrifuge tubes or equivalent: (Becton Dickinson Labware, 1 Becton Drive, Franklin Lakes, New Jersey 07417 or equivalent).
- (13) Nitrile or Latex, powder-free examination gloves (N-Dex®, Best Manufacturing Co., Menlo, GA, or equivalent vendor).

## 9. CALIBRATION AND CALIBRATION-VERIFICATION PROCEDURES

---

### a. Calibration Curve

Generate a simple linear calibration curve for iodine & mercury by using a series of five external calibrators whose concentrations are defined in the calibration page of the quantitative analysis method software. The calibration curve plots the ratio of the observed intensities for iodine & mercury and the internal standards versus the concentration of the calibrators. Compare the ratio of the observed intensities for iodine & mercury and the internal standards in the patient sample to those obtained from the calibrators to determine the concentration of iodine & mercury in the sample.

### b. Calibration Verification

CLIA requires the verification of accuracy of instrument response to analyte concentration be completed at least every 6 months. Each time this method is performed, the run contains calibration curve which meets this requirement for concentrations up to that of the highest calibrator. To verify accuracy of instrument

response *at concentrations higher than the highest calibrator* take the following steps.

- (1) Bi-annual tests as defined in the DLS Policy and Procedures manual: Analyze the Range of Linearity (RLT) / Calibration Verification (CV) working standard #3 at least every 6 months. If the observed concentrations are not within 10% of the target value, the lab supervisor should be notified and the issue should be investigated. Verify that normal background measured intensities have been re-achieved on the ICP-MS following analysis of elevated standards for calibration verification prior to performing further analysis.
- (2) As-needed confirmations (per supervisor discretion): When a sample concentration is greater than 110% of the highest calibrator in the run, include an RLT / CV working standard, standard reference material, or certified reference material with equivalent (within 10%) or greater concentration than the sample. Section 7.e. describes the preparation of three concentration levels of an RLT / CV working standard. It is the analyst's discretion which concentration is prepared and used so long as it is within 10% of the concentration being verified or higher. In order to avoid needless contamination of the ICP-MS sample introduction system with high concentrations of analytes, use the lowest appropriate analyte concentration to meet the need.

Any reference material sample from a historical proficiency testing program challenge can be substituted for this verification purpose IF

- (a) The target value has been assigned by an external source (i.e. NIST, or the proficiency testing program).
- (b) The concentration of the external reference material is within 10% or is higher than the concentration of the material you need it to confirm.
- (c) There is confidence that there is no contamination of previously used external reference material.
- (d) A note to file is made that this was done.
- (e) If the observed concentrations are not within 10% of the target value the lab supervisor should be notified and the issue should be investigated.

## 10. OPERATING PROCEDURES; CALCULATIONS; INTERPRETATION OF RESULTS

---

### a. Preliminaries

- (1) For information about the reportable range of results and how to handle results outside this range, refer to the Reportable Range of Results section of this document (section 16).
- (2) Allow frozen urine specimens, QC specimens, and base urine to reach ambient temperature. Vortex the sample well so that no particulates remain on the bottom of the tube before taking an aliquot for analysis.

### b. Sample Preparation



- (1) Thaw the frozen urine specimens; allow them to reach ambient temperature (about 20°C).
- (2) Set up a series of 15 mL polypropylene centrifuge tubes corresponding to the number of blanks, standards, QCs, and patient samples to be analyzed.
- (3) Prepare the following solutions into the 15 mL polypropylene centrifuge tubes by using the Micromedic Digiflex™.

**Preparation of Samples for Analysis (All Volumes in  $\mu\text{L}$ )**

ID	Water	Intermediate Working Std.	Base Urine	Urine Sample or QC	Diluent
Urine blank	500	-	500	-	4,000
Calibration standards	-	500	500	-	4,000
Aqueous blank	1,000	-	-	-	4,000
Urine sample or QC	500	-	-	500	4,000
2x dilution of Urine sample*	750	-	-	250	4,000

**Note:** These volumes are used because the total volume each sample this method consumed for is around 3,000  $\mu\text{L}$

\* Volumes listed here are an example of how to combine the correct proportions of water, urine, and diluent in making a 2x dilution. Other volumes of the same proportions can also be used. Other dilutions can be prepared as needed by adjusting the proportion of urine to the total volume of diluted sample. Use pipettes at greater than 10% volume capacity for best accuracy.

- (a) Prepare an aqueous blank that consists of 1,000  $\mu\text{L}$  of  $\geq 18 \text{ M}\Omega\text{-cm}$  water and 4,000  $\mu\text{L}$  diluent. Use the aqueous blank for the QC pools and patient samples.
- (b) Prepare five urine blanks that consist of 500  $\mu\text{L}$  of base urine (same material used for preparation of the urine calibration standards), 500  $\mu\text{L}$  of  $\geq 18 \text{ M}\Omega\text{-cm}$  water, and 4,000  $\mu\text{L}$  of diluent. Run one of these as the blank for the calibration standards. Run two urine blanks after standard 5 (as sample IDs UrBlkChk1 and UrBlkChk2, respectively). Analyze two urine blanks before the calibration blank to condition the system.
- (c) Prepare the working calibration standards as described in section 7.d.
- (d) Prepare dilutions (10x) of the QC and patient urine samples using manual or automated pipettors: 500  $\mu\text{L}$  of  $\geq 18 \text{ M}\Omega\text{-cm}$  water, 4,000  $\mu\text{L}$  of the diluent and 500  $\mu\text{L}$  of the patient or QC urine sample.
- (e) Cap all of the blanks, standards, and samples and mix them well.
- (f) It may be necessary to operate the instrument with cell gas flowing at the method flow rate for at least 30-45 minutes before the run begins. This may be done by analyzing the rinse solution for 8-10 sample cycles prior to analysis of the first conditioning blank. This is to allow the conditions within the reaction cell to equilibrate before the run begins. Note: The cell gas will automatically turn off after 1 hour of no ICP-MS DRC mode analysis.
- (g) Uncap and place the dilution preparation of the blanks, standards, QC, and patient samples in the autosampler of the ELAN® ICP-DRC-MS immediately prior to start of the analysis run.
- (h) Section 20 describes procedures for situations where prepared dilutions cannot be analyzed within the same workday as preparation.

**c. Instrument Setup and Configuration**

- (1) Turn on the computer, printer, peristaltic pump, and autosampler. Log into the computer operating system.
- (2) Start the ELAN<sup>®</sup> ICP-DRC-MS software from Windows<sup>™</sup> and note whether all graphical indicators of instrument readiness are green. If not, take the appropriate actions described in the instrument's software and hardware manual.
- (3) Perform necessary daily maintenance checks as described in Chapter 5 of the *ELAN<sup>®</sup> ICP-DRC-MS Hardware Guide* (e.g., argon supply, interface components, cleanliness, positioning and interface pump oil condition). Note the base vacuum pressure in the INSTRUMENT window of the software (Before igniting the plasma, the vacuum is typically between  $8 \times 10^{-7}$  and  $1.8 \times 10^{-6}$  torr). Record any maintenance procedures along with the base vacuum pressure in the *Daily Maintenance Checklist* (See example of daily checklist in the [Appendix](#)).
- (4) Set up the peristaltic pump tubing for the autosampler, rinse station, and spray-chamber waste line. Position the tubing and close the pump clamps.
- (5) Start the peristaltic pump by pressing the appropriate arrow in the DEVICES window (Make sure that the rotational direction is correct for the way the tubing is set up in the peristaltic pump). Fill the rinse station reservoir quickly by pressing the "Fast" button in the DEVICES window. After the rinse station is filled with the rinse solution, type in "20" in the rpm field of the DEVICES window to set the pump speed. If the spray chamber rinse line is not draining the spray chamber correctly or the rinse solution is not flowing properly to the rinse station, adjust the tension screws on the peristaltic pump.
- (6) *Read this step through entirely before proceeding. It is important to get the tension on the autosampler tubing correct, or it will adversely affect the precision of the ICP-DRC-MS measurements.* Through the METHOD/SAMPLING window in the software, press the "Probe" button, then the "Go to Rinse" button to lower the autosampler probe into the rinse solution. Watch as the solution is taken up through the autosampler probe tubing. When the leading edge of the solution is visible, press "Stop" in the DEVICES window. The leading edge of solution in the autosampler tubing line should stop moving. If it does not stop, tighten the tension screw for this line on the back of the peristaltic pump. Loosen the peristaltic pump tubing screw for the autosampler tubing until the leading edge of solution in the autosampler tubing begins to move again, then tighten the screw just enough to make the solution edge stop. Tighten the screw another eighth to a quarter of a turn. Next, start the peristaltic pump by pressing the appropriate arrow in the DEVICES window (make sure that the rotational direction is correct for the way the tubing is set up in the peristaltic pump).
- (7) In the INSTRUMENT window of the software, press the "Start" button to ignite the plasma. After the plasma ignites, restart the peristaltic pump.
- (8) Allow approximately 30 to 45 minutes warm-up time for the ICP-DRC-MS (with plasma running). After this warm-up time, complete the appropriate daily optimization procedures as described in Chapter 3 of the *ELAN<sup>®</sup> DRCII Software Guide*. Include beryllium (m/z 9) in the mass calibration, autolens optimization, and daily performance check by using a 1-10 µg/L multielement solution. Fill in the *Daily Maintenance Checklist* according to the completed optimization procedures. Save new tuning (mass-calibration) parameters to the file "default.tun." Periodically, save these parameters also in a separate file containing the analysis date "default\_YYMMDD.tun". Save new optimization parameters (i.e., detector voltages, autolens values and nebulizer gas flow rate) to the file "default.dac". Periodically, save these parameters also in a separate file containing the analysis date "default\_YYMMDD.dac" (where YY=year, MM=month and DD=day).

- (9) To set up the run in the software, click on “Open Workspace” from the “File” menu. Select the workspace file “CDC\_Urine\_I\_Hg.wrk.”. Select “Review Files” from the “File” menu. From this window, you will be able to set up the correct files and directories for data for your analysis. Select the method, report template, tuning, and optimization files later. There is no need to select a calibration or polyatomic file (If this workspace has not been created on the instrument computer being used, follow the directions in the ELAN ICP-DRC-MS software manual to set it up using the parameters described in this write-up).
- Data set: If this is the first run of the day, create a new data set by using the date as the name (Use the format 20050801 for August 1, 2005). If a run has already been performed today, select the data set for today’s date.
  - Sample: If an analysis has been performed that is similar to the one you are going to do, select the sample file corresponding to it. Edit it later for the present analysis.
- (10) In the SAMPLES/BATCH window, update the table to reflect the current sample set (e.g., autosampler locations, sample identification (ID), analysis methods and peristaltic pump speeds). Two method files (CDC\_UIHg\_methITU007B\_urblk.mth and CDC\_UIHg\_methITU007B\_aqblk.mth) will be used. *These two methods differ only in the autosampler locations of the blank and calibration solutions.* Use the “UR” method file to run the base urine blank and the calibration standards at the very beginning of the run. Because of the autosampler positions defined in the method file (these are editable), the urine blank must go in autosampler location 11 and the urine calibration standards 1-5 must go in autosampler locations 12-16, respectively. Use the “AQ” method file to run the aqueous blank before the first sample. Because of the autosampler positions defined in the method file (these are editable), the aqueous blank must go in autosampler location 19. Except for defining the blank and calibration standards’ autosampler locations, it does not matter which of these files is used when analyzing a sample since all other analysis parameters are identical in the method files. A typical SAMPLE/BATCH window for this method will look like Table below. (Note: All other autosampler positions besides those specified above are arbitrary.)

**Typical Sample File Setup for a Urine Iodine & Mercury Analysis Run**

A/S Location	Sample ID	Measurements Action	Method File*
37	DRC Rinse Delay	Run sample	CDC_UIHg_methITU007B_urblk.mth
38	DRC Rinse Delay	Run sample	CDC_UIHg_methITU007B_urblk.mth
39	Conditioning Urine Blank	Run sample	CDC_UIHg_methITU007B_urblk.mth
40	Conditioning Urine Blank	Run sample	CDC_UIHg_methITU007B_urblk.mth
100	UrBlkChk1	<b>Run blank, standards, and sample</b>	CDC_UIHg_methITU007B_urblk.mth
101	UrBlkChk2	Run sample	CDC_UIHg_methITU007B_urblk.mth
20	AqBlkChk	<b>Run blank and sample</b>	CDC_UIHg_methITU007B_aqblk.mth
23	Low-bench QC	Run sample	CDC_UIHg_methITU007B_aqblk.mth
24	High-bench QC	Run sample	CDC_UIHg_methITU007B_aqblk.mth
35	Sample 1	Run sample	CDC_UIHg_methITU007B_aqblk.mth
36	Sample 2	Run sample	CDC_UIHg_methITU007B_aqblk.mth
37	Sample 3	Run sample	CDC_UIHg_methITU007B_aqblk.mth
Etc.	.....		
74	Sample 40	Run sample	CDC_UIHg_methITU007B_aqblk.mth
25	Low-bench QC	Run sample	CDC_UIHg_methITU007B_aqblk.mth
26	High-bench QC	Run sample	CDC_UIHg_methITU007B_aqblk.mth

Modification of the method file is allowed for situations such as

1. running only Hg or only I (and the internal standard)
2. analyzing calibrators at different autosampler locations (when you want to perform multiple runs with different sets of calibrators).

In such cases, any new file created should be renamed to have the original filenames (above) at the beginning. Examples include

CDC\_UIHg\_methITU007B\_urblk\_Hg.mth (when only analyzing for Hg) or  
 CDC\_UIHg\_methITU007B\_urblk\_calset2.mth (when performing a second run with a different set of calibrators).

The autosampler positions of QCs and patient samples do not have to be those shown above, but the order in which these are run (DRC mode delay time of approximately 1 hour with rinse solution aspirating, followed by 2 UrBlkChk conditioners, a urine blank for the calibrators, calibration standards 1-5, urine blank checks 1 and 2, low-bench QC, high-bench QC, 40-80 patient samples including 1 blind QC sample, low-bench QC, and high-bench QC) should be as shown in Table above.

The settings in Table below should be used for uptake and rinse times for all samples, QC's, and standards. (These values are already stored in the method files for the blanks and standards.)

**Sample File Timing Parameters for a Urine Iodine & Mercury Analysis Run**

	Pump Speed*	Duration
Sample flush	-20 rpm	45 s
Read delay and analysis	-20 rpm	50 s
Wash	-48 rpm	100 s

---

The QC tab/sample tab in the method should be setup so that a 200s rinse time will occur after any sample whose Hg concentration exceeds 30 µg/L or whose I concentration exceeds 2000 µg/L.

\* Note: Negative values for pump speed indicate direction of pump rotation. Make sure that pump tubing is set up appropriately to match the direction of pump rotation.

---

If using the lab database for long-term recording and handling of data (Section 10.d.(2)(d)), do not use the Elan<sup>®</sup> software to automatically correct for sample dilutions. When dilutions of any sample are run, the sample ID should be edited to reflect the level of dilution being performed (A two-fold dilution of "Sample 1" could be recorded in the sample ID as "Sample 1 (2X)". The exact wording is not critical). Edit this sample ID during the data-import process to the database so that it is recognized as the appropriate sample. (See Section 10.d.(2)(d)).

- (10) Before beginning the analysis run, start the flow of the reaction-cell gas (argon) and allow the cell conditions to equilibrate. Make sure that the reaction-cell gas pressure to the instrument is approximately 7 psi on the cell-gas cylinder regulator. In the "Manual Adjust" page of the "Optimization" window, enter a value of "0" in the appropriate cell-gas field (cell-gas A for this method). Then enter a very low, non-zero cell gas flow rate in the same field (i.e. 0.01mL/min). A clicking should be heard from the ICP-DRC-MS cell-gas solenoid as the flow turns on. Flush the cell gas for 60 seconds by lifting the flush level at the front of the instrument (The flush step may not be necessary if this same gas cell was used recently and no gas tubing has since been disconnected). After the cell gas flush, enter the method-appropriate cell gas flow rate in the same field. Monitor the flow in the ELAN software, on the Instrument window (diagnostics tab). It is usually necessary to operate the instrument with cell gas flowing at the method flow rate for 30 minutes to 1 hour before the run begins. This is to allow the conditions within the reaction cell to equilibrate before the run begins. Necessity of this equilibration time can be determined by monitoring stability of the observed iodine and mercury concentration of a standard analyzed multiple times within a run. **Note:** The cell gas will automatically turn off after 1 hour of no DRC-mode analysis.
- (11) After the parameters in the SAMPLE/BATCH window are edited for the run, place the solutions in the autosampler tray according to the setup of the SAMPLE/BATCH window and method files. Highlight (click and drag with the mouse) the table rows of the samples that are to be included in the run, then click on "Analyze Batch." If sample analysis is to finish the run unattended after normal laboratory hours, the AutoStop (Instrument window- AutoStop Tab) may be enabled to shut off the plasma when the analysis is completed. If the AutoStop is not enabled, the DRC gas will shut off approximately 1 hour after the last sample analysis in DRC mode, but the plasma will remain lit. If the plasma is to remain operating unattended, ensure that adequate rinse solution is available for the time that the instrument will be unattended.
- (12) Instrument Shut Down
- (a) Rinse the sample introduction system with water, then with no liquid (dry).
  - (b) Stop the peristaltic pump.
  - (d) Shut off ICP-DRC-MS plasma.
  - (e) Loosen tensioning bars and tubing.
  - (f) At the controller computer, visit the ELAN Instrument Control Session

application and open the "Dataset" window. Confirm that all samples ran successfully and that the corresponding data for each sample is listed in this window.

**d. Recording of Data**

**(1) QC Data**

Store the results of the QC samples analyzed in each run in the Microsoft Access™ (or MS SQL Server) database when all other data for the run is imported from the ELAN® software. See Section 10.d.(2)(d) for a description of how to import data into the Microsoft Access™ database).

**(2) Analytical Results**

**(a) Analysis Printouts and Analyst Run Report**

Bind the analysis printouts with a printout of the calibration curve and curve statistics as the top page and place them in the study folder(s). Write the following information on the cover sheet of the analysis printouts: Run date, run number, study ID, and analyst ID (the Run ID from the database is also helpful). Store the results of the patient samples analyzed in each run in the Microsoft Access™ (or MS SQL Server) database when all other data for the run is imported from the ELAN® software. See Section 10.d.(2)(b) for a description of how to import data into the laboratory database. If the database allows for the printing of a run summary report that indicates whether any particular patient-sample results are outside of the normal concentration reference range or whether any measurement failed precision limits, it may be helpful to print it out after each analysis. These reports can be helpful to keep in a notebook for future reference (See Section 10.d.(2)(b) for a description of how to import data into the database to print out a customized sample report).

**(b) Using the Microsoft Access™ Database**

After an analysis run, export the results to a .TXT file and then import into the Microsoft Access™ or MS SQL Server database that handles data for the laboratory branch.

**i. Data Export Process (from ELAN® software to .TXT or .CSV file)**

In the ELAN® ICP-DRC-MS software, select "Review Files" from the "File" menu. From this window, you must open the files and directories that were used when collecting the data of the run that you wish to export (If the analysis has just ended, all of these files and directories will still be open). NOTE: A second copy of the ELAN® software can be run as an Edit/Reprocess copy without affecting an ongoing analysis by the first copy of the software running in Windows. After you open the relevant files, go to the "Report" page in the METHOD window. Deselect the box that prints a paper copy of data and select the box that sends data to a file. Select the "Report Options Template" named "CDC\_Database\_output.rop" and type in a report filename using a format such as "20050801a\_group55.txt" (or 20050801a\_group55.csv) to designate data from analysis of group 55 from August 1, 2005, run #1. Under "Report Format", choose the "Use Separator" option, and under the "File Write" section choose "Append." Finally, reprocess the data of interest (See *PerkinElmer ELAN® II Software Manual*). Make sure you apply the correct blank to the correct samples and QCs (use the urine blank for all of the calibration standards, UrBlkChk1,

and UrBlkChk2. Use the aqueous blank for all analyses of patient samples and QC samples).

ii. **Data Import Process (from .TXT or .CSV file to Microsoft Access™ database).**

Transfer the .TXT or .CSV file to the appropriate subdirectory on the network drive where exported data are stored (Note that directories are named according to instrument/year/month/ and study name or ID, such as I:/Instruments/ELAN® DRCIIIG/2005/08/Study 2005-xx). From a computer that has access to Microsoft Access™ or MS SQL Server database used for tracking data, log in using your user ID#. After you log into the database, open the select "Import Instrument File" from the "Front End Set". Enter the appropriate information to identify the run, assay, study, instrument, and analyst and press the "Import" button. Select the location of the data file on the network drive and press the "Open" button. In the "Imported Results" table, pressing the "Find X's" button will show only those samples whose sample ID is not recognized as a valid QC pool ID or sample ID for this study (Sample IDs are set up when the study is logged into the database). Corrections to sample IDs and dilution factors can be made in this table (e.g., correction of transcription errors and adjustment for level of dilution). If samples were diluted for analysis (Section 10.c.(10)), both the sample ID and the dilution factor need to be edited in this table before the values are transferred to the database. First, change the dilution factor to reflect the way that the sample was analyzed then edit the sample ID to remove any comments about the level of dilution at which the sample was analyzed (The replace command is useful here). When corrections to sample IDs are made, press the "Recheck" button to evaluate the sample IDs. Any sample or analyte row marked "Not Recognized" will not be transferred to the database when the "Transfer" button is pressed. From this point, the data should be labeled with the appropriate settings for QC accept / reject, final value status, and comment.

## 11. FINAL REVIEW OF THE DATA

---

### a. Abnormal Patient Results:

#### a. Boundaries Requiring Confirmatory Measurement:

- (a) **Results Lower than the First Lower Boundary (1LB):** Concentrations observed less than the “first lower boundary” (defined in the laboratory database as the “1LB”) should be confirmed by repeat analysis of a new sample preparation. The concentration assigned to the 1LB for an element is determined by study protocol. The default 1LB for iodine is 10 ug/L (there is no lower confirmation boundary for mercury). Report the original result, as long as the confirmation is within 10% of the original. Continue repeat analysis until a concentration can be confirmed.
- (b) **Results Greater than the First Upper Boundary (1UB):** Concentrations observed greater than the “first upper boundary” (defined in the laboratory database as the “1UB”) should be confirmed by repeat analysis of a new sample preparation. The concentration assigned to the 1UB for an element is determined by study protocol. The default concentrations are 800 ug/L for I and 5 ug/L for Hg. Report the original result, as long as the confirmation is within 10% of the original. Continue repeat analysis until a concentration can be confirmed.
- (c) **Results Greater Than Highest Calibrator:** When a sample result is greater than the highest calibrator, the result should be confirmed in an analysis run which includes a standard or external reference material with equivalent (within 10%) or greater concentration than the sample.
- (d) **Results Greater Than Range of Linearity Tested (RLT):** Perform an extra dilution on any urine sample whose concentration is greater than the range of linearity tested / calibration verification sample analyzed along with it (Section 9.b). See table in section 10.b for details of preparing a sample with extra dilution.
- b. **Inadequate Precision in Confirmation of a Measurement:** If a sample is reanalyzed to obtain a confirmation of an initially elevated result, the confirmation should be within 10% of the original result.
- c. **Inadequate Precision Within One Measurement:** If the range of the three replicate readings (maximum replicate concentration value - minimum replicate concentration value) for a single sample analysis is greater than 30 ug/L for I or 1 ug/L for Hg (“>Lim Rep Delta” in the database) and the range of the three replicate readings is greater than 10% of the observed concentration, do not use the measurement for reporting. Repeat the analysis of the sample.



- d. **Analyst Reporting of Abnormal Patient Results:** Concentrations observed for iodine less than the second lower boundary” (defined in the laboratory database as the 2LB) or greater than the “second upper boundary” (defined in the laboratory database as the “2UB”) should be reported to the QC reviewer as an either an “abnormally low result” or an “elevated result”, respectively. The concentrations assigned to the 2LB and the 2UB for an element is determined by study protocol. The default second boundary concentrations for iodine are 10 ug/L (2LB) and 2000 ug/L (2UB). The default boundaries for mercury are 5 ug/L (1UB) and 10 ug/L (2UB). There are no lower boundaries for mercury. The analyst should report any patient results confirmed to be greater than the second upper boundary to the QC reviewer as an “elevated result”. There is no routine notification for elevated levels for the metals determined in this method. The protocol for supervisors reporting elevated results to medical personnel is defined according to the study protocol.
- b. **Evaluating Bench QC Results:** See sections 16.b-c for how to apply division QC rules and take corrective actions if necessary.
- i. Submitting Final Work for Review  
Once results have been imported, reviewed, and set as final in the database by the analyst,
- a. Submit an email to the QC reviewer informing them of the readiness of the data for final review. The email should include
1. Instrument ID, run Date, run number, study ID, group ID.
  2. Any bench QC failures (include reasons if known).
  3. Any patient sample results less than the 2LB or greater than the 2UB should be reported in the email as either an abnormally low concentration (<2LB) or an “elevated result” (>2UB).
  4. Anything out of the ordinary about this analytical work which could have a bearing on the availability (i.e. insufficient sample to analyze), accuracy, or precision of the results.
- b. Include all items called for by the study folder cover sheet in the study folder (i.e. printouts from the ICP-MS, bench QC evaluation) together in the study folder before submitting the folder for review when analysis is complete.

## 12. REPLACEMENT AND PERIODIC MAINTENANCE OF KEY COMPONENTS

---

Part numbers listed below are PerkinElmer part numbers from their *2005 Consumables Catalog*. Equivalent parts may be substituted.

- a. Autosampler probe assembly (part # B300-0161) or equivalent. Keep one spare on hand.
- b. Peristaltic pump tubing for sample (0.03 inch i.d., part #09908587), rinse station (can use either same tube type as for sample or 0.045 inch i.d., part #N0680375) and for

- waste (0.125 inch i.d., part #N8122012): Keep at least 6 packages of 12 on hand of the sample tubing, 6 for rinse station and 2 packages of 12 on hand of the waste tubing. Other suppliers may offer the same size/type of peristaltic tubing.
- c. Nebulizer capillary tubing (used to connect the nebulizer and the peristaltic pump tubing, part #09908265 or any source of polyethylene tubing, 0.6 mm i.d. x 0.97 mm o.d.). Keep one pack (10 feet) on hand.
  - d. Injector Support/Torch Base (part #N8120116). Keep one spare on hand.
  - e. Torch O-Ring Kit (packages of four, part #N8120100). Keep four spare packages on hand.
  - f. Quartz torch. At least two spare torches should be on hand (part #N8122006).
  - g. Quartz 2mm Bore Injector (part #WE023948).
  - h. RF coil Assembly, self aligning (part #WE021816). One spare should be on hand.
  - i. Nickel Skimmer (part #WE021137) and sampler cones (part #WE021140). Keep at least two spares of each on hand.
  - j. Skimmer and sampler cone O-rings (part #N8120512 and #N8120511, respectively). Keep at least 10 spares of each on hand.
  - k. Series II replacement Ion lens (part #WE018034). Keep two spares on hand.
  - l. Pump oil for the roughing pump (part #N8122004). Keep four bottles on hand.
  - m. Polyscience chiller coolant (PE Sciex Coolant, part #WE016558): Two 1 L bottles should be kept on hand. If possible, have a backup autosampler and chiller. See a PerkinElmer sales representative for part numbers.
  - n. Nebulizer, quartz concentric ~1mL/min liquid flow rate like part # 500-70QQDAC (Precision Glass Blowing, Centennial, CO, [www.precisionglassblowing.com](http://www.precisionglassblowing.com)). This nebulizer is designed to use quick disconnects part # 500-QD (liquid) and # 500-AC (argon).
  - o. Spray chamber, quartz concentric like PerkinElmer part # WE025221 (PerkinElmer, Shelton, CT, [www.perkinelmer.com](http://www.perkinelmer.com)). Available direct from manufacturer as part # 400-20 (Precision Glass Blowing, Centennial, CO, [www.precisionglassblowing.com](http://www.precisionglassblowing.com)) or from various distributors.

### 13. LIMIT OF DETECTION

---

The limits of detection (LOD) for iodine and mercury in urine specimens is based on three times the standard deviation of approximately 20 or more measurements of urine blanks or low concentration urine samples, each analyzed in a separate run. This represents the method detection limit. Report results below the detection limit as "< LOD" (where "LOD" is the calculated lowest detection limit). The LOD calculation may be reevaluated annually.

### 14. REPORTABLE RANGE OF RESULTS

---

Urine Iodine & Mercury results are reportable in the range of greater than the LOD, where LOD is the calculated lower detection limit.

## 15. SPECIAL PROCEDURE NOTES – CDC MODIFICATIONS

---

None applicable for this operation.

## 16. QUALITY CONTROL PROCEDURES

---

The Inorganic and Radiation Analytical Toxicology Branch uses the method described in this protocol for environmental and occupational health screening studies.

This analytical method uses two types of Quality Control (QC) systems: With one type of the QC system, the analyst inserts bench QC specimens two times in each analytical run (a set of consecutive assays performed without interruption) so that judgments may be made on the day of analysis. With the other type of QC system, “blind” QC samples are placed in vials, labeled, and processed so that they are indistinguishable from the subject samples (as much as possible). If it is not possible to have the blind QC inserted into the sample group before receipt into the lab, an additional low and high QC pool should be made available to the analyst so that they can manually insert the material into the run. This type of “blind QC” should match the matrix of the patient samples as much as possible and the acceptable concentration limits (characterized limits) should be unknown by the analyst(s). The supervisor decodes and reviews the results of the blind specimens. With both systems, taking these samples through the complete analytical process assesses all levels of the analyte concentrations. The data from these materials are then used to estimate methodological imprecision and to assess the magnitude of any time-associated trends. The bench QC pools used in this method comprise two levels of concentration spanning the “low-normal” and “high-normal” ranges. Both of these pools are analyzed after the calibration standards are analyzed but before any patient samples are analyzed so that judgments on the iodine and mercury calibration curves may be made before analysis of patient samples. These bench QCs should be analyzed again at the end of the run.

### a. Establish QC limits for each QC pool.

Perform an analysis of the mean and standard deviation for each pool from the concentration results observed in at least 20 characterization runs. During the 20 characterization runs, previously characterized QCs or pools with target values assigned by outside laboratories to evaluate each run’s QC. In addition to providing QC limits, the characterization runs also serve to establish homogeneity of the pools.

b. Evaluating the Quality Control of a Run. After completing a run, and importing the results into the database, export the QC results to the SAS program where the run will be judged to be in or out of control. The QC limits are based on the average and standard deviation of the beginning and ending analyses of each of the bench QC pools, so it will not be possible to know if the run is officially accepted or rejected until it is completed. The following is an explanation of the division QC rules which will be applied by the SAS program.

- (1) If both QC run means (low & high bench QC) are within  $2S_m$  limits and individual results are within  $2S_i$  limits, then accept the run.
- (2) If 1 of the 2 QC run means is outside a  $2S_m$  limit - reject run if:

- (a) Extreme Outlier – Run mean is beyond the characterization mean +/- 4Sm
- (b) 1 3S Rule - Run mean is outside a 3Sm limit
- (c) 2 2S Rule - Both run means are outside the same 2Sm limit
- (d) 10 X-bar Rule – Current and previous 9 run means are on same side of the characterization mean
- (e) If one of the 4 QC individual results is outside a 2Si limit - reject run if:
- (f) R 4S Rule – Within-run ranges for all pools in the same run exceed 4Sw (i.e., 95% range limit)

Note: Since runs have multiple results per pool for 2 pools, the R 4S rule is applied within runs only. Abbreviations:

Si = Standard deviation of individual results (the limits are not shown on the chart unless run results are actually single measurements).

Sm = Standard deviation of the run means (the limits are shown on the chart).

Sw = Within-run standard deviation (the limits are not shown on the chart).

c. Remedial Action If Calibration or QC Systems Fail to Meet Acceptable Criteria

- (1) If the division SAS program declares the run "out of control" for any analyte, ONLY the analytes which were "out of control" are invalid for reporting from the run. Set all run results for those 1 or 2 analytes as "QC Rejected" in the database. Evaluate the reason for QC failure and take corrective action. Below is a list of areas to evaluate.
- (2) Check the calibration curve(s) for linearity and for an intercept near zero. Calibration points not falling closely to the regression line may indicate a calibrator which was improperly prepared, analyzed, or needs to be made new. Be sure to use freshly prepared calibrators and QC material. Typical correlation coefficients ( $r^2$ ) are  $> 0.999$ . If possible, prepare new dilutions or preparations of calibrators which are outliers and reanalyze with the run to replace the original calibrator analysis. An individual calibration point may be removed from the curve if it is obviously an outlier. If the highest calibration point is removed, the highest calibrator used in the analysis should be specified in the laboratory database when the results are imported. If a certain calibrator is problematic repeatedly, investigate the problem and take corrective action to prevent the problem from continuing.
- (3) Check for high blanks which lead to over-subtraction from analysis results.
- (4) Check the ICP-DRC-MS stability during the run by examining the degree of variability and drift in internal standard raw peak areas over the course of the run. Irreproducibility that exceeds 15% and drift  $> 20\%$ , or sudden large changes in internal standard peak area, likely indicates that there was a problem in plasma stability.

If these steps do point to appropriate corrective action, for the out-of-control values for QC materials, consult the supervisor for other appropriate corrective actions. No analytical results should be reported for runs that are not in statistical control.

## 17. REFERENCE RANGES

---

Reference Ranges for Elements Measured (all units  $\mu\text{g/L}$ )

Element/ Isotope Monitored	Reference Ranges (10 <sup>th</sup> - 95 <sup>th</sup> Percentile, $\mu\text{g/L}$ ) (weighted, non-creatinine corrected NHANES 2001 & 2002 results)
I-127*	41- 803 <sup>(9)</sup>
Hg-202	< 4.63 <sup>(8)</sup>

\* Te-130 used as internal standard

## 18. ACTION-LEVEL RESULTS

---

Due to the uncertainty of the health implications of elevated concentrations of these elements, there is no routine notification for elevated levels of urine iodine or mercury. Action levels for reporting to supervising physicians are determined on a study-by-study basis.

## 19. SPECIMEN STORAGE AND HANDLING DURING TESTING

---

Specimens may reach and maintain ambient temperature during analysis. Take stringent precautions to avoid external contamination. After the samples are analyzed, return them to  $\leq -20^{\circ}\text{C}$  freezer storage as soon as possible.

## 20. ALTERNATE METHODS FOR PERFORMING TEST AND STORING SPECIMENS IF TEST SYSTEM FAILS

---

If prepared working calibrators, samples, and QC cannot be analyzed within the same workday of the preparation, they may be capped and stored at refrigerator temperatures ( $\sim 2-4^{\circ}\text{C}$ ) for up to 48 hours before analysis. Samples can be stored at room temperature during this time if they will only be analyzed for iodine. (see Appendix A, Parameter Test #5)

If the analytical system fails, then store urine specimen at  $\leq 4^{\circ}\text{C}$  until the analytical system is restored to functionality. If long-term interruption (longer than 4 weeks) is anticipated, then store urine specimens at  $\leq -20^{\circ}\text{C}$ . If this method is not available, a Flow Injection Mercury System method (FIMS) can be used as an alternative for urine mercury analysis and a spectrophotometric analysis method can be used as an alternative for urine iodine analysis.

## 21. TEST - RESULT REPORTING SYSTEM; PROTOCOL FOR REPORTING CRITICAL CALLS (IF APPLICABLE)

---

Report test results as outlined in the *DLS Policies and Procedures Manual*. For critical calls, the supervisor should notify the supervising physician or principal investigator as soon as possible. The most expeditious means should be used (e.g., telephone or E-mail).

## 22. TRANSFER OR REFERRAL OF SPECIMENS; PROCEDURES FOR SPECIMEN ACCOUNTABILITY AND TRACKING

---

Location, status, and final disposition of the specimens will be tracked at least by paper document in the "Study Folder" (created before analysts receive the samples). Apart from this specimen tracking form, this folder will also contain the paper print outs of results from analysis of the specimens. Maintain records for a minimum of 3 years. Use only numerical identifiers for samples within the laboratory (e.g., case ID numbers) in order to safeguard confidentiality. Only the medical supervisor (MS) or project coordinator (PC) i.e. non CDC personnel should have access to the personal identifiers.

## 23. REFERENCES

---

- (1) Hollowell JG, Staehling NW, Hannon WH, et al. 1998 iodine nutrition in the United States. Trends and public health implications: iodine excretion data from National Health and Nutrition Examination Surveys I and III (1971-1974 and 1988-1994). *J Clin Endocrinol Metab* 1998; 83:3401-8.
- (2) Carson BL, Ellis HV III, McCann JL. Toxicology and biological monitoring of metals in humans. Chelsea (MI): Lewis Publishers, Inc.; 1986: p.150-156.
- (3) Handbook of Toxicity of Inorganic Compounds, edited by Sieler, H.G., Sigel, H., Sigel, A, Marcel Dekker, INC., 1988: p. 419-436.
- (4) World Health Organization, Environmental health Criteria 118: Inorganic mercury, Geneva,1991
- (5) Thomas R, Practical Guide to ICP-MS. New York: Marcel Dekker; 2004.
- (6) Tanner SD, Baranov VI., Theory, design and operation of a DRC™ for ICP-MS. *Atomic Spectroscopy* 1999; 20(2): 45-52.
- (7) Tanner SD, Baranov VI, Bandura DR, Reaction cells and collision cells for ICP-MS: a tutorial review. *Spectrochimica Acta part B* 57, 2002: 1361-1452.
- (8) Third National Report on Human Exposure to Environmental Chemicals (CDC, July, 2005). National Health and Nutrition Examination Survey, 2001-2002.
- (9) Caldwell K, Jones R, Hollowell J. Urinary Iodine Concentration: United States NHANES 2001-2002. *Thyroid* 2005; 15(7): 687-693.

## 24. APPENDIX

**Appendix A. Ruggedness Testing Results.**

Parameter Test #1: Evaluate the impact on analysis results if the set RF Power is increased to 1600W (instrument maximum) or decreased to 1150W (by 20%) for the analytical run. (Method RF Power setting described in section 8.a.1).

Test Details:

1. Three different RF power settings were tested in separately prepared, consecutive runs on the instrument without turning off the plasma. At least 15 minutes stabilization time was allowed between each run after the RF power was changed. "Junk urine" samples (38) were analyzed between the beginning and ending QC of each run. All other method parameters were kept per method.
2. Run #1 (method default, 1450W).
3. Run #2 (Decreased RF power by 20% to 1150W).
4. Run #3 (Increased RF power to instrument maximum, 1600W).

<b>Parameter Test 1 Results.</b>			
Test performed 3/17-18/10 by Dana Henahan.			
QC Pool ID	RF Power Tested	I (ug/L)	Hg (ug/L)
LU-03250_UIHG_c	<i>Characterized Mean</i>	92.7	0.21
	<i>Characterized 2SD Range</i>	88.2 – 97.2	0.14 – 0.29
	1150W (Reduced)	93.2	0.15
	1450W (Per Method)	92.1	0.18
	1600W (Increased)	92.4	0.20
HU-03251_UIHG_c	<i>Characterized Mean</i>	308	2.30
	<i>Characterized 2SD Range</i>	293 – 322	2.05 – 2.54
	1150W (Reduced)	294	2.15
	1450W (Per Method)	307	2.23
	1600W (Increased)	315	2.19

**Appendix A. Ruggedness Testing Results. (continued)**

**Parameter Test #2:** Evaluate the impact on analysis results if the Cell Gas Flow Rate is increased or decreased by 20% for the analytical run. (Method Cell Gas Flow Rate setting described in section 8.a.1).

**Test Details:**

1. Three different Cell Gas Flow Rates were tested in separately prepared, consecutive runs on the instrument without turning off the plasma. At least 15 minutes stabilization time was allowed between each run after the cell gas flow rate was changed. "Junk urine" samples (38) were analyzed between the beginning and ending QC of each run. All other method parameters were kept per method.
2. Run #1 (method default = 0.3 mL/min)
3. Run #2 (decreased Cell Gas Flow Rate by 20% to 0.24 mL/min).
4. Run #3 (increased Cell Gas Flow Rate by 20% to 0.36 mL/min).

<b>Parameter Test 2 Results.</b>			
Test performed 3/23/10 by Dana Henahan.			
<b>QC Pool ID</b>	<b>Cell Gas Flow Rate Tested</b>	<b>I (ug/L)</b>	<b>Hg (ug/L)</b>
LU-03250_UIHG_c	<i>Characterized Mean</i>	92.7	0.21
	<i>Characterized 2SD Range</i>	88.2 – 97.2	0.14 – 0.29
	0.24 mL/min (Reduced)	92.1	0.21
	0.30 mL/min (Per Method)	93.4	0.19
	0.36 mL/min (Increased)	93.9	0.19
HU-03251_UIHG_c	<i>Characterized Mean</i>	308	2.30
	<i>Characterized 2SD Range</i>	293 – 322	2.05 – 2.54
	0.24 mL/min (Reduced)	289	2.23
	0.30 mL/min (Per Method)	293	2.34
	0.36 mL/min (Increased)	297	2.37



**Appendix A. Ruggedness Testing Results. (continued)**

**Parameter Test #3:** Evaluate the impact on analysis results if the RPQ is increased or decreased by 20% for the analytical run. (Method RPQ setting described in section 8.a.1).

**Test Details:**

1. Three different RPQ settings were tested in separately prepared, consecutive runs on the instrument without turning off the plasma. At least 15 minutes stabilization time was allowed between each run after DRC RPQ was changed. "Junk urine" samples (38) were analyzed between the beginning and ending QC of each run. All other method parameters were kept per method.
2. Run #1 (method default DRC RPQ: IOD= 0.8 Te= 0.8 Hg= 0.4).
3. Run #2 (decreased DRC RPQ 20%: IOD= 0.6 Te= 0.6 Hg= 0.3).
4. Run #3 (increased DRC RPQ 20% : IOD= 0.9 Te= 0.9 Hg= 0.5).  
(Note: 0.9 is highest RPQ instrument will allow).

<b>Parameter Test 3 Results.</b>			
Test performed 3/24/10 by Dana Henahan.			
QC Pool ID	RPQ Tested	I (ug/L)	Hg (ug/L)
LU-03250_UIHG_c	<i>Characterized Mean</i>	92.7	0.21
	<i>Characterized 2SD Range</i>	88.2 – 97.2	0.14 – 0.29
	DRC RPQ: (Reduced) IOD= 0.6 Te= 0.6 Hg= 0.3	92.6	0.16
	DRC RPQ: (Per Method) IOD= 0.8 Te= 0.8 Hg= 0.4	91.0	0.20
	DRC RPQ: (Increased) IOD= 0.9 Te= 0.9 Hg= 0.5	93.2	0.19
HU-03251_UIHG_c	<i>Characterized Mean</i>	308	2.30
	<i>Characterized 2SD Range</i>	293 – 322	2.05 – 2.54
	DRC RPQ: (Reduced) IOD= 0.6 Te= 0.6 Hg= 0.3	313	2.30
	DRC RPQ: (Per Method) IOD= 0.8 Te= 0.8 Hg= 0.4	306	2.41
	DRC RPQ: (Increased) IOD= 0.9 Te= 0.9 Hg= 0.5	311	2.39

**Appendix A. Ruggedness Testing Results. (continued)**

**Parameter Test #4:** Evaluate the impact on analysis results if the axial field voltage (AFV) is increased or decreased by 20% for the analytical run. (Method AFV setting described in section 8.a.1).

**Test Details:**

1. Three different DRC AFV were tested in separately prepared, consecutive runs on the instrument without turning off the plasma. At least 15 minutes stabilization time was allowed between each run after the axial field voltage was changed. "Junk urine" samples (38) were analyzed between the beginning and ending QC of each run. All other method parameters were kept per method.
2. Run #1 (method default DRC AFV = 275)
3. Run #2 (decreased DRC AFV by 20% to 220).
4. Run #3 (increased DRC AFV by 20% to 330).

<b>Parameter Test 4 Results.</b>			
Test performed 3/25/10 by Dana Henahan.			
<b>QC Pool ID</b>	<b>Axial Field Voltage Tested</b>	<b>I (ug/L)</b>	<b>Hg (ug/L)</b>
LU-03250_UIHG_c	<i>Characterized Mean</i>	92.7	0.21
	<i>Characterized 2SD Range</i>	88.2 – 97.2	0.14 – 0.29
	220 (Reduced)	92.1	0.19
	275 (Per Method)	91.5	0.21
	330 (Increased)	93.3	0.18
HU-03251_UIHG_c	<i>Characterized Mean</i>	308	2.30
	<i>Characterized 2SD Range</i>	293 – 322	2.05 – 2.54
	220 (Reduced)	303	2.12
	275 (Per Method)	299	2.18
	330 (Increased)	304	2.20

**Appendix A. Ruggedness Testing Results. (continued)**

Parameter Test #5: Method descriptions and SOP assume preparation and analysis on same day. Evaluate the impact on analysis results if the analytical run is prepared to analyze but circumstances do not allow for analysis to occur until 24 or 48 hours later.

Test Details:

1. Three separate run sets (A, B, and C) including blanks, calibrators, and QC were prepared at one sitting from the same starting materials. Set 'A' was analyzed immediately per the assumption of the method. Set's 'B' and 'C' were capped and stored for 24 and 48 hours, respectively, before analysis. Room temperature (~20°C) and refrigerated (~2-4°C) were both tested. All other method parameters were kept per method. Each analytical run was made normal length by including 38 dummy urine samples between QC checks.
2. On day two, a fresh run set ("D") was prepared and analyzed immediately for comparison to results from set "B" (analyzed as run 2 of the day).
3. On day two, another fresh run set ("E") was prepared and analyzed immediately for comparison to results from set "C" (analyzed as run 2 of the day).

Parameter Test 5 Results. Test performed 4/13-15/10 by Dana Henahan.					
QC Pool ID	Time From Prep To Analysis Tested	I (ug/L)		Hg (ug/L)	
LU-03250 _UIHG_c	Characterized Mean 2SD Range	92.7 88.2 – 97.2		0.21 0.14 – 0.29	
	Storage Temperature	Room Temp	2-4 °C	Room Temp	2-4 °C
	Run Set A (Freshly Prepared)	92.3	93.5	0.19	0.19
	Run Set B (After 24hr)	92.8	93.8	0.22	0.19
	Run Set C (After 48hr)	93.6	93.0	0.22	0.21
HU-03251 _UIHG_c	Characterized Mean 2SD Range	308 293 – 322		2.30 2.05 – 2.54	
	Storage Temperature	Room Temp	2-4 °C	Room Temp*	2-4 °C
	Run Set A (Freshly Prepared)	306	309	2.31	2.23
	Run Set B (After 24hr)	304	307	2.61*	2.37
	Run Set C (After 48hr)	301	304	2.58*	2.32

\* **Note:** Test results show that room temperature storage for 24-48hrs is NOT adequate for Hg analysis. Only if samples are refrigerated can a 24-48hr delay be allowed for Hg analysis.

# Division of Laboratory Sciences

## Laboratory Protocol

<b>Analytes:</b>	<b>Zinc, Copper and Selenium</b>
<b>Matrix:</b>	<b>Serum</b>
<b>Method:</b>	<b>Serum Multi-Element ICP-DRC-MS</b>
<b>Method Code:</b>	<b>ICPDRCMS-3006.1</b>
<b>Branch:</b>	<b>Inorganic Radiation Analytical Toxicology</b>

Prepared By: Ge Xiao PhD \_\_\_\_\_  
author's name signature date

Supervisor: Kathleen L. Caldwell PhD \_\_\_\_\_  
supervisor's name signature date

Branch Chief: Robert L. Jones PhD \_\_\_\_\_  
Branch Chief Signature and date

Adopted: 19 October 2006  
date

Updated: 23 October 2006  
date

Director's Signature Block:

Reviewed:

_____	_____
signature	date
_____	_____
signature	date
_____	_____
signature	date
_____	_____
signature	date
_____	_____
signature	date





## Laboratory Procedure Manual

*Analytes:* **Zinc, Copper and Selenium**

*Matrix:* **Serum**

*Method:* **Serum Multi-Element ICP-DRC-MS**

*Method No:* ICPDRCMS-3006.1

*Revised:*

*As performed by:* Inorganic Radiation Analytical Toxicology  
Division of Laboratory Sciences  
National Center for Environmental Health

*Contact:* Dr. Kathleen L. Caldwell  
Phone: 770-488-7990  
Fax: 770-488-4097  
Email: [KCaldwell@cdc.gov](mailto:KCaldwell@cdc.gov)

Dr. James L. Pirkle, M.D., PhD  
Director, Division of Laboratory Sciences

### **Important Information for Users**

**The Centers for Disease Control and Prevention (CDC) periodically refines these laboratory methods. It is the responsibility of the user to contact the person listed on the title page of each write-up before using the analytical method to find out whether any changes have been made and what revisions, if any, have been incorporated.**

**Table of Contents**

<b>Cross reference to DLS CLIA and Policy and Procedures</b> .....	5
<b>Index of tables and figures</b> .....	6
<b>1) Clinical Relevance &amp; Summary of Test Principle</b>	
a. Clinical Relevance .....	8
b. Test Principle .....	8
<b>2) Limitations of Method; Interfering Substances and Conditions</b>	
a. Interferences Addressed by This Method	
i. Correction & Elimination of Interferences ( $^{64}\text{Ni}$ , $^{36}\text{Ar}^{14}\text{N}_2$ ) on Zinc ( $^{64}\text{Zn}$ ). . .	9
1 Mathematical Correction for Nickel ( $^{64}\text{Ni}$ ) Interference:	
2 Elimination $^{36}\text{Ar}^{14}\text{N}_2$ Interference	
ii. Elimination of Interferences ( $^{40}\text{Ar}^{25}\text{Mg}$ , $^{36}\text{Ar}^{14}\text{N}_2^1\text{H}$ ) on Copper ( $^{65}\text{Cu}$ ) . . .	9
iii. Correction & Elimination of Interferences ( $^{78}\text{Kr}$ , $^{38}\text{Ar}^{40}\text{Ar}$ , $^{38}\text{Ar}^{40}\text{Ca}$ ) on Selenium ( $^{78}\text{Se}$ ). . . . .	9
b. Limitations of Method (Interferences Remaining in Method)	
i. $^{48}\text{Ca}^{16}\text{O}^1\text{H}$ Interference on Copper ( $^{65}\text{Cu}$ ). . . . .	9
ii. Time between dilution of serum materials and analysis .....	9
<b>3) Procedures for Collecting, Storing, and Handling Specimens; Criteria for Specimen Rejection</b>	
a. Procedures for Collecting, Storing, and Handling Specimens .....	10
b. Criteria for Specimen Rejection .....	10
c. Transfer or Referral of Specimens; Procedures for Specimen Accountability and Tracking .....	11
<b>4) Safety Precautions</b>	
a. General Safety .....	11
b. Waste Disposal .....	12
<b>5) Instrument &amp; Material Sources</b>	
a. Sources for ICP-MS Instrumentation .....	12
b. Sources for ICP-MS Parts & Consumables .....	13
c. Sources for ICP-MS Maintenance Equipment & Supplies .....	18

d. Sources for General Laboratory Equipment & Consumables . . . . .	19
e. Sources for Chemicals, Gases, & Regulators . . . . .	21
<b>6) Preparation of Reagents and Materials</b>	
a. Diluent . . . . .	22
b. Base Serum . . . . .	23
c. ICP-DRC-MS Rinse Solution . . . . .	24
d. Standards and Calibrators	
i. Multi-Element Intermediate Stock Standard . . . . .	25
ii. Multi-Element Intermediate Working Calibration Standards . . . . .	26
iii. Working Multi-Element Calibrators . . . . .	27
iv. Multi-Element Intermediate Working Calibration Verification Standards ...	27
v. Working Multi-Element Calibration Verification Standards.....	28
vi. Internal Quality Control Materials (“Bench” QC) . . . . .	28
<b>7) Analytical Instrumentation &amp; Parameters</b>	
a. Instrumentation & Equipment Setup	
i. ICP-DRC-MS	
1. Modifications made to ICP-DRC-MS . . . . .	31
2. Sample introduction system setup . . . . .	31
3. Configuration of tubing for liquid handling . . . . .	31
4. Cones used . . . . .	33
5. Gases & Regulators setup . . . . .	33
6. Chiller / Heat Exchanger. . . . .	34
ii. Computer. . . . .	34
iii. Autosampler . . . . .	34
b. Parameters for Instrument and Method (see Table 1, pp. 47-49) . . . . .	34
<b>8) Method Procedures</b>	
a. Quality Control . . . . .	34
i. Types of Quality Control . . . . .	34
ii. Calibration Verification . . . . .	35
b. Daily Analysis of Samples	
i. Preparation of the Analytical Equipment . . . . .	37



- ii. Preparation of Samples for Analysis . . . . . 39
- iii. Specimen Storage and Handling during Testing . . . . . 40
- iv. Starting the Analysis . . . . . 41
- v. Monitoring the Analysis . . . . . 41
- vi. Records of Results . . . . . 42
- vii. Transfer of Results to the Laboratory Database . . . . . 43
- viii. Analyst Evaluation of Run Results . . . . . 44
- ix. Submitting Final Work for Review . . . . . 46
- x. Overnight operation (or Any Use of Autostop) . . . . . 47
- c. Equipment Maintenance
  - i. ICP-MS Maintenance . . . . . 47
  - ii. Data Backup . . . . . 48
- 9) Interpretation of the Results**
  - a. Reportable Range . . . . . 48
  - b. Reference Ranges (Normal Values) . . . . . 48
  - c. Action Levels . . . . . 48
- 10) Method Calculations**
  - a. Method Limit of Detection (LOD) . . . . . 48
  - b. Method Limit of Quantitation (LOQ) . . . . . 49
  - c. QC Limits . . . . . 49
- 11) Alternate Methods for Performing Test and Storing Specimens If Test System Fails . . . . . 49**
- Appendix A (Ruggedness Test Results) . . . . . 50**
- Appendix B (Tables and Figures) . . . . . 56**
- References. . . . . 73**

This page intentionally left blank

- Cross reference to DLS CLIA and Policy and Procedures policy
1. Summary of Test Principle and Clinical Relevance  
**1) a. b.**
  2. Safety Precautions  
**4) a.b.**
  3. Computerization; Data System Management  
**8) b.vi vii ix**
  4. Specimen Collection, Storage, and Handling Procedures; Criteria for Specimen Rejection  
**3) a.b.**
  5. Procedures for Microscopic Examinations; Criteria for Rejection of Inadequately Prepared Slides  
**- As no microscope used in this process there are no procedures for microscopic examinations; and as no slides are prepared for this analysis there is no criteria for rejection of inadequately prepared slides**
  6. Preparation of Reagents, Calibrators (Standards), Controls, and All Other Materials; Equipment and Instrumentation  
**5) a. i ii iii b. 6) a. b. c. d. 7) a. b. 8) c i ii**
  7. Calibration and Calibration Verification Procedures  
**8) ii**
  8. Procedure Operating Instructions; Calculations; Interpretation of Results  
**8) b. i ii iv v x**
  9. Reportable Range of Results  
**9) a.**
  10. Quality Control (QC) Procedures  
**8) a. i**
  11. Remedial Action If Calibration or QC Systems Fail to Meet Acceptable Criteria  
**8) ii 1, ii 2, e**
  12. Limitations of Method; Interfering Substances and Conditions  
**2) a. b.**
  13. Reference Ranges (Normal Values)  
**9) b.**
  14. Critical Call Results ("Panic Values")  
**9) c.**
  15. Specimen Storage and Handling during Testing  
**8) b. iii**
  16. Alternate Methods for Performing Test or Storing Specimens If Test System Fails  
**11)**
  17. Test Result Reporting System; Protocol for Reporting Critical Calls (If Applicable)  
**9) c.**
  18. Transfer or Referral of Specimens; Procedures for Specimen Accountability and Tracking  
**3) c.**
  19. References

**List of Tables**

**Table 1.** Instrument and Method Parameters .....56

**Table 2.** Suggested Maximum Analyte Concentrations for Base Serum ..... 58

**Table 3.** Concentrations of Analytes in the Multi-Element Intermediate Stock  
Standard from High Purity Standards ..... 58

**Table 4.** Preparation of Multi-element Intermediate Working Standards ..... 59

**Table 5.** Acceptable Ways to Perform Two Consecutive Analytical Runs, Bracketing  
with Bench Quality Control Samples ..... 59

**Table 6.** A Typical SAMPLE/BATCH Window ..... 60

**Table 7.** Preparation of Multi-element Intermediate Working Standards ..... 61

**Table 8.** Range of Reporting and Calibration Verification Requirements ..... 61

**Table 9.** Boundary Concentrations and Replicate Range Maximums ..... 62

**Table 10.** Normal Ranges for Serum Concentrations ..... 62

**List of Figures**

**Figure 1.** Configuration of Tubing and Devices for Liquid Handling . . . . . 63

**Figure 2.** ELAN ICP-DRC-MS Method Screen Shots

- a. Timing Page . . . . . 64
- b. Processing Page. . . . . 65
- c. Equations Page. . . . . 66
- d. Calibration Page. . . . . 67
- e. Sampling Page. . . . . 68
- f. Report Page. . . . . 69

**Figure 3.** ESI SC4 Autosampler Screen Shots

- a. Main page . . . . . 70
- b. Configuration . . . . . 71
- c. Communication. . . . . 71
- d. 5x12 Rack Setup. . . . . 72
- e. 50mL Tube Rack Setup. . . . . 72

## 1) Clinical Relevance & Summary of Test Principle

### a. Clinical Relevance:

This method is used to achieve rapid and accurate quantification of three elements of toxicological and nutritional interest including Zinc (Zn), Copper (Cu) and Selenium (Se). The method may be used to screen serum when people are suspected to be acutely exposed to these elements or to evaluate chronic environmental or other non-occupational exposure.

### b. Test Principle:

Inductively coupled plasma dynamic reaction cell mass spectrometry (ICP-DRC-MS) is a multi-element analytical technique capable of trace level elemental analysis [1-4]. This ICP-DRC-MS method is used to measure the entire panel of 3 elements, or any subgroup of these. Liquid samples are introduced into the ICP through a nebulizer and spray chamber carried by a flowing argon stream. By coupling radio-frequency power into flowing argon, plasma is created in which the predominant species are positive argon ions and electrons and has a temperature of 6,000-8,000 K. The sample passes through a region of the plasma and the thermal energy atomizes the sample and then ionizes the atoms. The ions, along with the argon, enter the mass spectrometer through an interface that separates the ICP (at atmospheric pressure, ~760 torr) from the mass spectrometer (operating at a pressure of  $10^{-5}$  torr). The ions pass through a focusing region, the dynamic reaction cell (DRC), the quadrupole mass filter, and finally are counted in rapid sequence at the detector allowing individual isotopes of an element to be determined. In this method, the instrument is operated in 'DRC' mode where the cell is pressurized with 99.99+% ammonia gas which collides or reacts with the incoming ions to eliminate interfering ions and leave the ion of interest to be detected. After leaving the DRC cell, the ions are focused with ion optics into a quadrupole mass analyzer with a nominal mass resolution of 0.7amu. The quadrupole is sequentially scanned to specific mass to charge ratio of each analyte and intensity is detected with a pulse detector. Electrical signals resulting from the detection of ions are processed into digital information that is used to indicate first the intensity of the ions and then the concentration of the element. This method was originally based on the methods by Piraner and Walters [5-8] and the DRC portions of the method are based on work published by Tanner et al. [2, 3]. The isotopes measured by this method include zinc (m/z 64), copper (m/z 65) and selenium (m/z 78) and the internal standard gallium (m/z 71). Serum samples are diluted 1+1+28 with water and diluent containing gallium (Ga) for multi-internal standardization.

## 2) Limitations of Method; Interfering Substances and Conditions

### a. Interferences Addressed by This Method

#### i. Correction & Elimination of Interferences ( $^{64}\text{Ni}$ , $^{36}\text{Ar}^{14}\text{N}_2$ ) on Zinc ( $^{64}\text{Zn}$ ).

##### 1. Mathematical Correction for Nickel ( $^{64}\text{Ni}$ ) Interference:

The correction equation ( $-0.035297 * \text{Ni}60$ ) is used in the "Equations" tab of the method to correct the counts observed as m/z 64 to exclude counts due to  $^{64}\text{Ni}$ .

##### 2. Elimination of $^{36}\text{Ar}^{14}\text{N}_2$ Interference Using DRC: The dynamic reaction cell of the ELAN ICP-DRC-MS is used in this method to eliminate interference from $^{36}\text{Ar}^{14}\text{N}_2$ onto zinc at m/z 64. See Section 1.b for an explanation of this process.

#### ii. Elimination of Interferences ( $^{40}\text{Ar}^{25}\text{Mg}$ , $^{36}\text{Ar}^{14}\text{N}_2^1\text{H}$ ) on Copper ( $^{65}\text{Cu}$ ) Using DRC. The dynamic reaction cell of the ELAN ICP-DRC-MS is used in this method to eliminate the interference $^{40}\text{Ar}^{25}\text{Mg}$ , $^{36}\text{Ar}^{14}\text{N}_2^1\text{H}$ on copper at m/z 65. See Section 1.b for an explanation of this process.

#### iii. Correction & Elimination of Interferences ( $^{78}\text{Kr}$ , $^{38}\text{Ar}^{40}\text{Ar}$ , $^{38}\text{Ar}^{40}\text{Ca}$ ) on Selenium ( $^{78}\text{Se}$ ).

##### 1. Mathematical Correction for Krypton ( $^{78}\text{Kr}$ ) Interference:

The correction equation ( $-0.030461 * \text{Kr}83$ ) is used in the "Equations" tab of the method to correct the counts observed as m/z 78 to exclude counts due to  $^{78}\text{Kr}$ .

##### 2. Elimination of $^{38}\text{Ar}^{40}\text{Ar}$ , $^{38}\text{Ar}^{40}\text{Ca}$ Interference Using DRC: The dynamic reaction cell of the ELAN ICP-DRC-MS is used in this method to eliminate interference from $^{38}\text{Ar}^{40}\text{Ar}$ , $^{38}\text{Ar}^{40}\text{Ca}$ onto selenium at m/z 78. See Section 1.b for an explanation of this process.

### b. Limitations of Method (Interferences Remaining in Method)

#### i. $^{48}\text{Ca}^{16}\text{O}^1\text{H}$ Interference on Copper ( $^{65}\text{Cu}$ ):

It has been determined that a small interference remains at m/z 65 when the serum matrix contains very high calcium levels. Even at extreme calcium levels, this interference has not been found to be significant (< 1%).

#### ii. Time between dilution of serum materials and analysis:

Selenium is not stable in the diluted sample for more than 7 hours. Diluted serum must be analyzed within 7 hours of preparation (see Appendix A, test 5 for details).

### 3) Procedures for Collecting, Storing, and Handling Specimens; Criteria for Specimen Rejection; Specimen Accountability and Tracking

- a. Procedures for Collecting, Storing, and Handling Specimens: Specimen handling conditions, special requirements, and procedures for collection and transport are discussed in the division (DLS) Policies and Procedures Manual [9]. Copies are available in branch, laboratory, and special activities specimen-handling offices. An electronic copy is available at: [http://inside.nceh.cdc.gov/dls/pdf/policiesprocedures/Policies\\_and\\_Procedures\\_Manual.DLS.2006mod.pdf](http://inside.nceh.cdc.gov/dls/pdf/policiesprocedures/Policies_and_Procedures_Manual.DLS.2006mod.pdf) In general, if more than one vacutainer of blood is to be drawn from an individual, the trace metals tube should be drawn second or later. Draw the blood through a stainless steel needle into a pre-screened 7 mL vacutainer. Allow the blood in the stoppered vacutainer clot for 30-40 minutes, but not longer than 60 minutes. Without opening the vacutainer, centrifuge it for 10 minutes at 2400 rpm. Use a pre-screened serum separator to remove the serum from the clot. Under a laminar flow hood, pour the serum in the serum separator into pre-screened polyethylene vials. Serum specimens should be transported and stored at  $\leq 4^{\circ}\text{C}$ . Once received, they can be frozen at  $\leq -20^{\circ}\text{C}$  until time for analysis. Portions of the sample that remain after analytical aliquots are withdrawn should be refrozen at  $\leq -20^{\circ}\text{C}$ . Samples thawed and refrozen several times are not compromised.
- i. No fasting or special diets are required.
  - ii. Specimen type - serum
  - iii. Acceptable containers include pre-screened polyethylene vials and pre-screened 7 mL vacutainers should be used for specimen acquisition.
  - iv. Specimen stability has been demonstrated for several months at approximately  $-20^{\circ}\text{C}$  or at approximately  $-70^{\circ}\text{C}$  for several years.
- b. Criteria for Specimen Rejection: Specimen characteristics that may compromise test results are indicated above. Reasons for rejection of a sample for analysis include
- i. Low volume: Optimal amount of serum is 1-2 mL, minimum is about 0.8 mL. The volume of serum used for one analysis is 0.15 mL.
  - ii. Contamination: Improper collection procedures or collection devices can contaminate the serum by contact with dust, dirt, etc.

In all cases, request a second serum specimen.



- c. Transfer or Referral of Specimens; Procedures for Specimen Accountability and Tracking: Location, status, and final disposition of the specimens will be tracked at least by paper document in the “Study Folder” (created before analysts receive the samples). Apart from this specimen tracking form, this folder will also contain the paper print outs of results from analysis of the specimens. Maintain records for a minimum of 3 years. Use only numerical identifiers for samples within the laboratory (e.g., case ID numbers) in order to safeguard confidentiality. Only the medical supervisor (MS) or project coordinator (PC) i.e. non CDC personnel should have access to the personal identifiers.

#### 4) Safety Precautions

- a. General Safety
- i. Observe all safety regulations as detailed in the Division (DLS) Safety Manual. Additional information can be found in your lab’s chemical hygiene plan.
  - ii. Observe Universal Precautions when working with serum.
  - iii. Wear appropriate gloves, lab coat, and safety glasses while handling all solutions.
  - iv. Exercise special care when handling and dispensing concentrated nitric acid. Add acid to water. Nitric acid is a caustic chemical that is capable of causing severe eye and skin damage. ***If nitric acid comes in contact with any part of the body, quickly wash the affected area with copious quantities of water for at least 15 minutes.***
  - v. Use secondary containment for containers holding biological or corrosive liquids.
  - vi. The use of the foot pedal on the Micromedic Digiflex™ is recommended because it reduces analyst contact with work surfaces that have been in contact serum and also keeps the analyst’s hands free to hold the specimen cups and autosampler tubes and to wipe off the tip of Micromedic Digiflex™.
  - vii. Training will be given before operating the ICP-DRC-MS, as there are many possible hazards including ultraviolet radiation, high voltages, radio-frequency radiation, and high temperatures. This information is also detailed in the PerkinElmer ELAN® ICP-DRC-MS System Safety Manual.
  - viii. Ammonia gas cylinders (either in use or on storage) should be placed in a cabinet which is well ventilated to the house exhaust. Ammonia cylinders in use should not be placed on their side as the cylinder valve can become “frozen” in place as a result of the cooling capacity of expanding ammonia gas.

- ix. Wipe down all work surfaces at the end of the day with bleach-rite spray or freshly prepared 10% (v/v) sodium-hypochlorite solution.
- b. Waste Disposal: Operators of this method should take the CDC-OHS Hazardous Chemical Waste Management Course (initial and yearly refreshers).
  - i. Waste to be Placed in Biohazard Autoclave Bags & Pans:
    1. All biological samples and diluted specimens (after analysis run).
    2. All disposable plastic and paper which contact serum (autosampler tubes, gloves, etc.). Pipette tips can be placed in either autoclave pans or sharps containers.
    3. Used non-glass/quartz ICP-MS consumables (i.e. probes, tubing, cones, ion lenses).
  - ii. Waste to be Placed Into Sharps Containers: Broken glass or quartz instrument consumables (broken spray chambers, torches, nebulizers, etc. . .). Pipette tips can be placed in either autoclave pans or sharps containers. Large broken glass which will not fit in the sharps container should be placed in a separate autoclave pan from other waste and labeled as “broken glass” (see the “Autoclaving” section of the CDC safety policies and practices manual located in the laboratory).
  - iii. Liquid Waste
    1. Waste discarded down sink: Only liquid waste from the ICP-DRC-MS instrument can be discarded at the sink. Flush the sink with copious amounts of water.
    2. Waste to be Picked up by Hazardous Waste Program: Submit request for hazardous waste removal of all other liquid waste.

## 5) Instrument & Material Sources

- a. Sources for ICP-MS Instrumentation
  - i. ICP-MS: Inductively Coupled Plasma Dynamic Reaction Cell Mass Spectrometer (ELAN<sup>®</sup> 6100 DRC<sup>Plus</sup> or ELAN<sup>®</sup> DRC II) (PerkinElmer Norwalk, CT, [www.perkinelmer.com](http://www.perkinelmer.com)).
  - ii. Recirculating chiller / heat exchanger for ICP-MS: Refrigerated chiller (PolyScience 6105PE for ELAN<sup>®</sup> 6100 DRC<sup>Plus</sup> instruments) or heat exchanger

(PolyScience 3370 for ELAN<sup>®</sup> DRC II instruments) (PerkinElmer Norwalk, CT, [www.perkinelmer.com](http://www.perkinelmer.com)).

- iii. Autosampler: ESI SC-4 autosampler (Elemental Scientific Inc., Omaha, NE) or equivalent.

b. Sources for ICP-MS Parts & Consumables

NOTE: The minimum number of spares recommended before reordering (if owning one instrument) are listed as “# Spares =” in the descriptions below.

- i. Adapter, plastic: 1/4-28 female threads on one side, 1.8mm barb adapter on the other. Connects 1/4-28 nut at flanged tubing connection to 0.045” i.d. peristaltic pump tubing. Use part # B019-3342 (“Type A” adapter, PerkinElmer Norwalk, CT, [www.perkinelmer.com](http://www.perkinelmer.com)) or equivalent. # Spares = 4.
- ii. Adapter, PEEK: Securely connects 1.6mm O.D. PFA tubing to 0.03” I.D. peristaltic tubing. Composed of three PEEK parts.
1. Female nut for 1.6mm O.D. (1/16”) tubing. Like part P-420 (Upchurch Scientific, Oak Harbor, WA, [www.upchurch.com](http://www.upchurch.com)).
  2. PEEK ferrule. Like part P-260x (10pk SuperFlangeless ferrule, Upchurch Scientific, Oak Harbor, WA, [www.upchurch.com](http://www.upchurch.com)).
  3. Conical Adapter Body. Like part P-692 (Upchurch Scientific, Oak Harbor, WA, [www.upchurch.com](http://www.upchurch.com)).
- iii. Coolant, for Polyscience chiller or heat exchanger: Only PerkinElmer part # WE01-6558 (PerkinElmer Norwalk, CT, [www.perkinelmer.com](http://www.perkinelmer.com)) is approved for use by PerkinElmer. # Spares = 6.
- iv. Cone, sampler: Both platinum and nickel cones have been used successfully. For platinum cones, Spectron part # SC2013-Pt (Spectron, Ventura, CA, [www.spectronus.com](http://www.spectronus.com)) or equivalent. For nickel cones, PerkinElmer part # WE021140 (PerkinElmer Norwalk, CT, [www.perkinelmer.com](http://www.perkinelmer.com)) or equivalent. # Spares = 4.
- v. Cone, skimmer: Both platinum and nickel cones have been used successfully. For platinum cones, Spectron part # SC2014-Pt (Spectron, Ventura, CA, [www.spectronus.com](http://www.spectronus.com)) or equivalent. For nickel cones, PerkinElmer part # WE021137 (PerkinElmer Norwalk, CT, [www.perkinelmer.com](http://www.perkinelmer.com)) or equivalent. # Spares = 4.
- vi. Connector (for tubing): Use to connect 1/8” I.D. PVC tubing to 0.125” I.D. peristaltic pump tubing. Use part # 3140715 (PerkinElmer Norwalk, CT, [www.perkinelmer.com](http://www.perkinelmer.com)) or equivalent. # Spares = 4.
- vii. Detector, electron multiplier: Like part # N8125001 (PerkinElmer Norwalk, CT, [www.perkinelmer.com](http://www.perkinelmer.com)). Available direct from manufacturer (part # 14210,

- SGE Incorporated, Austin, Texas, <http://www.etpsci.com>) or various distributors. # Spares = 1.
- viii. Hose, for connection to chiller: Push on hose. I.D. =  $\frac{1}{2}$ ", O.D. =  $\frac{3}{4}$ ". Use part # PB-8 (per inch, Georgia Valve and Fitting, Atlanta, GA, [www.swagelok.com](http://www.swagelok.com)) or equivalent. Do not normally need spare hose (unless moving instrument into a new location).
- ix. Hose, for exhaust of ELAN: Available as part of ELAN installation kit from Perkin Elmer (PerkinElmer Norwalk, CT, [www.perkinelmer.com](http://www.perkinelmer.com)). Available direct from manufacturer as part # S-LP-10 air connector (Thermafex, Abbeville, SC, [www.thermafex.net](http://www.thermafex.net)). Equivalent part may be substituted. # Spares = 10 feet of 4" diameter and 10 feet of 6" diameter hose.
- x. Injector, quartz with ball joint: I.D. = 2.0 mm. PerkinElmer part # WE023948 (PerkinElmer Norwalk, CT, [www.perkinelmer.com](http://www.perkinelmer.com)). Available direct from manufacturer as part # 400-30 (Precision Glass Blowing, Centennial, CO, [www.precisionglassblowing.com](http://www.precisionglassblowing.com)) or from various distributors. # Spares = 2.
- xi. Injector support (for pass-through injector): PerkinElmer part # WE023951 (PerkinElmer Norwalk, CT, [www.perkinelmer.com](http://www.perkinelmer.com)). Available direct from manufacturer as part # 400-37 (Precision Glass Blowing, Centennial, CO, [www.precisionglassblowing.com](http://www.precisionglassblowing.com)) or from various distributors. # Spares = 2.
- xii. Ion Lens: PerkinElmer part # WE018034 (PerkinElmer Norwalk, CT, [www.perkinelmer.com](http://www.perkinelmer.com)). # Spares = 3.
- xiii. Nebulizer, quartz concentric: Initial work using this method has used the standard Type A, 3mL/min nebulizer. Alternatively, the Type C, 1mL/min nebulizer may be used to improve sensitivity and precision. The ELAN supplies 30psi argon to the nebulizer. Variations of these nebulizers may be substituted with or without quick connects for the gas and liquid ports. Quartz nebulizers are used to avoid potential contamination from borosilicate glass (i.e. barium, uranium). # Spares = 2.
1. Type A, Standard ELAN 3mL/min nebulizer: PerkinElmer part # WE024371 (PerkinElmer Norwalk, CT, [www.perkinelmer.com](http://www.perkinelmer.com)). Available directly from manufacturer as part # TQ-30-A3 (Meinhard Glass Products, Golden, CO, [www.meinhard.com](http://www.meinhard.com)) or from various distributors. The flangeless nut and ferrule assembly has been used for liquid sample back-end connection to this nebulizer.
  2. Type C, 1 mL/min nebulizer with quick disconnects for liquid and gas ports: One example is part # 500-70QQDAC (Precision Glass Blowing, Centennial, CO, [www.precisionglassblowing.com](http://www.precisionglassblowing.com)). This nebulizer is designed to use quick disconnects part # 500-QD (liquid) and # 500-AC (argon).
- xiv. Nebulizer Connections (gas): (for nebulizer argon side-arm).
1. If *not* using quick disconnection fitting, insert nebulizer argon side-arm into the 1/8" i.d. vinyl tubing and secure the connection with a hose clamp for

- ¼" o.d tubing (like part # EW-06832-01, Cole Palmer Instrument Company, Vernon Hills, Illinois, [www.colepalmer.com](http://www.colepalmer.com)). # Spares = 2.
2. Quick disconnection fitting: Like part # 500-AC (Precision Glass Blowing, Centennial, CO, [www.precisionglassblowing.com](http://www.precisionglassblowing.com)). # Spares = 2.
- xv. Nebulizer Connections (liquid): (for nebulizer 4mm o.d. liquid sample backend). Can use quick disconnect or flangeless nut and ferrule assembly.
1. Quick Disconnect: Like Part # 500-QD (Precision Glass Blowing, Centennial, CO, [www.precisionglassblowing.com](http://www.precisionglassblowing.com)). # Spares = 2.
2. Flangeless nut and ferrule assembly: An assembly such as part # FIT KIT 3 (Meinhard Glass Products, Golden, CO, [www.meinhard.com](http://www.meinhard.com)) or equivalent. Individual pieces of FIT KIT #3 can be purchased as follows.
- a. Nut, flangeless, 1/16", ¼-28, Delrin<sup>®</sup> (Acetal), red. Part # P202x (10pk, Upchurch Scientific, Oak Harbor, WA, [www.upchurch.com](http://www.upchurch.com)). # Spares = 10.
- b. Ferrule, flangeless, 1/16", Tefzel<sup>®</sup> (ETFE), blue. Part # P-200x (10pk, Upchurch Scientific, Oak Harbor, WA, [www.upchurch.com](http://www.upchurch.com)). # Spares = 10.
- c. Adapter, 1/4-28 internal to 5/16-24 internal, PEEK™. Part # P-135 (Upchurch Scientific, Oak Harbor, WA, [www.upchurch.com](http://www.upchurch.com)). # Spares = 2.
- d. Nut, 4mm ID PEEK. Part of fit kit 3 for concentric nebulizers. Part # S-1050 (Meinhard Glass Products, Golden, CO, [www.meinhard.com](http://www.meinhard.com)). # Spares = 2.
- e. Ferrule, 4mm ID green Delrin. Part of fit kit 3 for concentric nebulizers. Part # S-1121 (Meinhard Glass Products, Golden, CO, [www.meinhard.com](http://www.meinhard.com)). # Spares = 2.
- xvi. Nut: (for flanged connections of 1.59mm (1/16") o.d. PFA tubing) Flanged, for 1/16" o.d. tubing, 1/4-28 threads. Use part # P-406x (pkg. of 10, Upchurch Scientific, Oak Harbor, WA, [www.upchurch.com](http://www.upchurch.com)) or equivalent. Use a Teflon-coated Viton o-ring with this nut instead of the stainless steel washer that comes with part # P-406x). # Spares = 10.
- xvii. Nut: (for bottom port of autosampler rinse station) 10-32 UMC threads for 1/16" tubing. Such as part # M653x (Upchurch Scientific, Oak Harbor, WA, [www.upchurch.com](http://www.upchurch.com)) or equivalent. # Spares = 2.
- xviii. Nut and Ferrule set, 1/8" Swagelok: Such as part # SS-200-NFSET (stainless steel) or part # B-200-NFSET (brass) (Georgia Valve and Fitting, Atlanta, GA, [www.swagelok.com](http://www.swagelok.com)) or equivalent. For part numbers listed here a quantity of 1 means 1 nut, 1 front ferrule, and 1 back ferrule. Spares = 20.
- xix. Nut and Ferrule set, 1/4" Swagelok: Such as part # SS-400-NFSET (stainless steel) or part # B-400-NFSET (brass) (Georgia Valve and Fitting, Atlanta, GA,

- [www.swagelok.com](http://www.swagelok.com)) or equivalent. For part numbers listed here a quantity of 1 means 1 nut, 1 front ferrule, and 1 back ferrule. *Spares = 20.*
- xx. Oil, Welch Director Gold: For roughing pumps. Available direct from manufacturer as part # 8995G-15 (1 gallon, Welch Rietschle Thomas, Skokie, IL, [www.welchvacuum.com](http://www.welchvacuum.com)) or from various distributors. Equivalent oil may be substituted. *# Spares = 4.*
- xxi. O-ring: (for sampler cone) PerkinElmer part # N8120511 (pkg. of 5, PerkinElmer, Shelton, CT, [www.perkinelmer.com](http://www.perkinelmer.com)) or equivalent. *# Spares = 20 o-rings.*
- xxii. O-ring: (for skimmer cone) PerkinElmer part # N8120512 (pkg. of 5, PerkinElmer, Shelton, CT, [www.perkinelmer.com](http://www.perkinelmer.com)) or equivalent. *# Spares = 20 o-rings.*
- xxiii. O-ring: (for flanged connections of 1.59mm (1/16") o.d. PFA tubing) Teflon-coated Viton o-ring, i.d. = 1/16", thickness = 1/16", o.d. = 3/16". Such as part # V75-003 (O-rings West, Seattle, WA, [www.oringswest.com](http://www.oringswest.com)) or equivalent. *# Spares = 20.*
- xxiv. O-ring: (for injector support).
1. Internal o-rings: ID = 1/4", OD = 3/8", thickness = 1/16". Need 2 o-rings per injector support to setup. PerkinElmer part # N8122008 (PerkinElmer, Shelton, CT, [www.perkinelmer.com](http://www.perkinelmer.com)) or equivalent (such as part # V75-010, O-rings West, Seattle, WA, [www.oringswest.com](http://www.oringswest.com)). *# Spares = 20.*
  2. External o-rings: ID = 3/8", OD = 1/2", thickness = 1/16". Need 2 o-rings for each injector support setup. PerkinElmer part # N8122009 (PerkinElmer, Shelton, CT, [www.perkinelmer.com](http://www.perkinelmer.com)) or equivalent (such as part # V75-012, O-rings West, Seattle, WA, [www.oringswest.com](http://www.oringswest.com)). *# Spares = 20.*
- xxv. O-ring: (for inside spray chamber at nebulizer port) Such as part # 120-56 (Precision Glass Blowing, Centennial, CO, [www.precisionglassblowing.com](http://www.precisionglassblowing.com)). Additional o-rings can sometimes be obtained free of charge or at reduced price when acquired while purchasing spray chambers. *# Spares = 20.*
- xxvi. O-ring: (for inside of torch mount): Part # WE017284 (PerkinElmer, Shelton, CT, [www.perkinelmer.com](http://www.perkinelmer.com)). Do not substitute. The PerkinElmer o-ring is special metal impregnated to minimize RF leakage though the torch mount. *# Spares = 2.*
- xxvii. Photon Stop: PerkinElmer part # WE018278 (PerkinElmer, Shelton, CT, [www.perkinelmer.com](http://www.perkinelmer.com)). Alternate "snap in" lens assembly requires PerkinElmer part # W1013361 (PerkinElmer Norwalk, CT, [www.perkinelmer.com](http://www.perkinelmer.com)). *# Spares = 1.*
- xxviii. Plugs, Quick Change for Roughing Pump Oil: These plugs will only work on the Varian roughing pumps which come standard on ELAN DRC II ICPMS instruments. These plugs will not fit the Leybold pumps which come standard

- on the ELAN DRC Plus instruments. Part # W1011013 (PerkinElmer, Shelton, CT, [www.perkinelmer.com](http://www.perkinelmer.com)). No spares typically needed.
- xxix. Probes: (for ESI autosampler) Teflon, carbon fiber support, 0.8mm i.d., blue marker, 1/4-28 fittings. Like part number SC-5037-3751 (Elemental Scientific Inc., Omaha, NE., [www.elementalscientific.com](http://www.elementalscientific.com)). # Spares = 2.
- xxx. RF coil. PerkinElmer part # WE02-1816 (PerkinElmer, Shelton, CT, [www.perkinelmer.com](http://www.perkinelmer.com)) or equivalent. # Spares = 2.
- xxxi. Screw, for Torch Mount: PerkinElmer part # WE011870. (PerkinElmer, Shelton, CT, [www.perkinelmer.com](http://www.perkinelmer.com)) or equivalent. # Spares = 3.
- xxxii. Spray chamber, quartz concentric: PerkinElmer part # WE025221 (PerkinElmer, Shelton, CT, [www.perkinelmer.com](http://www.perkinelmer.com)) or equivalent. Available direct from manufacturer as part # 400-20 (Precision Glass Blowing, Centennial, CO, [www.precisionglassblowing.com](http://www.precisionglassblowing.com)) or from various distributors. # Spares = 2.
- xxxiii. Torch, quartz: PerkinElmer part # N812-2006 (PerkinElmer, Shelton, CT, [www.perkinelmer.com](http://www.perkinelmer.com)) or equivalent. Available direct from manufacturer as part # 400-10 (Precision Glass Blowing, Centennial, CO, [www.precisionglassblowing.com](http://www.precisionglassblowing.com)) or various distributors. Damaged torches can often be repaired for substantially lower cost than purchasing a new one by companies such as Wilmad LabGlass (Buena, NJ, [www.wilmad-labglass.com](http://www.wilmad-labglass.com)) or Precision Glass Blowing (Centennial, CO, [www.precisionglassblowing.com](http://www.precisionglassblowing.com)). # New Spares = 2.
- xxxiv. Tubing and adapter, for SC autosampler rinse station drain: Tygon tubing and adapter to attach to back of SC autosampler for draining rinse station waste (like part # SC-0303-002, Elemental Scientific Inc., Omaha, NE., [www.elementalscientific.com](http://www.elementalscientific.com)).
- xxxv. Tubing and adapters, for SC autosampler rinse station filling: Teflon tubing and adapters (to attach to back of SC autosampler for filling rinse stations and to attach to rinse containers). Like part # SC-0302-0500, Elemental Scientific Inc., Omaha, NE., [www.elementalscientific.com](http://www.elementalscientific.com)).
- xxxvi. Tubing, argon delivery to instrument: I.D. = 1/8", O.D. = 1/4". Such as part # C-06500-02 (pkg. of 100ft, polypropylene, Fisher Scientific International, Hampton, NH, [www.fishersci.com](http://www.fishersci.com)) or equivalent. # Spares = 50ft.
- xxxvii. Tubing, peristaltic, 0.03" i.d. (sampling): Standard PVC, 2-stop (black / black) peristaltic pump tubing, i.d. = 0.03". PerkinElmer part # 09908587 (PerkinElmer, Shelton, CT, [www.perkinelmer.com](http://www.perkinelmer.com)) or equivalent. # Spares = 6 packs of 12 tubes.
- xxxviii. Tubing, peristaltic, 0.125" i.d. (spray chamber drain): Standard PVC, 2-stop (black / white) peristaltic pump tubing, i.d. = 0.125". PerkinElmer part # N812-2012 (PerkinElmer, Shelton, CT, [www.perkinelmer.com](http://www.perkinelmer.com)) or equivalent. # Spares = 6 packs of 12 tubes.
- xxxix. Tubing, PFA: I.D. = 0.5mm, O.D. = 1.59mm (1/16"). Used to transfer liquid

1. possibly used between nebulizer and peristaltic pump tubing (if quick connection is not used for liquid sample delivery)

The Perfluoroalkoxy (PFA) copolymer is a form of Teflon<sup>®</sup>. Such as part # 1548 (20ft length, Upchurch Scientific, Oak Harbor, WA, [www.upchurch.com](http://www.upchurch.com)) or equivalent. # Spares = 20ft.
  - xl. Tubing, PVC, i.d. = 1/8", o.d. = 3/16". Used to transfer liquid
    1. between spray chamber waste port and peristaltic pumpLike part # 14-169-7A (pkg. of 50ft, Fisher Scientific International, Hampton, NH, [www.fishersci.com](http://www.fishersci.com)) or equivalent. # Spares = 20ft.
  - xli. Tubing, Stainless Steel, o.d. = 1/8", wall thickness = 0.028": Used to connect DRC gas cylinders to ELAN DRC gas ports. Also used to replace plastic tubing in the DRC gas path within the ELAN. Like part # SS-T2-S-028-20 (20ft, Georgia Valve and Fitting, Atlanta, GA, [www.swagelok.com](http://www.swagelok.com)) or equivalent. Spares = 20ft.
  - xlii. Tubing, Teflon, corrugated, 1/4" o.d.: Connects to the auxiliary and plasma gas side-arms of the torch. Part # WE015903 (PerkinElmer, Shelton, CT, [www.perkinelmer.com](http://www.perkinelmer.com)). # Spares = 2.
  - xliii. Tubing, Tygon, i.d. = 3/16", o.d. = 5/16": Used to transfer liquid between rinse station drain port and liquid waste jug. Like part # EW-06409-15 (50 ft, Cole Parmer, Vernon Hills, Illinois, [www.coleparmer.com](http://www.coleparmer.com)) or equivalent. # Spares = 20ft.
  - xliv. Tubing, vinyl (argon delivery to nebulizer): Vinyl Tubing, 1/8" ID x 1/4" OD. Like part # EW-06405-02 (Cole Parmer, Vernon Hills, Illinois, [www.coleparmer.com](http://www.coleparmer.com)) or equivalent. Equivalent tubing material may be substituted. # Spares = 10ft.
  - xlv. Union Elbow, PTFE 1/4" Swagelok: Connects argon tubing to torch auxiliary gas sidearm. Like part # T-400-9 (Georgia Valve and Fitting, Atlanta, GA, [www.swagelok.com](http://www.swagelok.com)) or equivalent. Spares = 2.
  - xlvi. Union Tee, PTFE, 1/4" Swagelok: Connects argon tubing to torch plasma gas sidearm and holds igniter inside torch sidearm. Like part # T-400-3 (Georgia Valve and Fitting, Atlanta, GA, [www.swagelok.com](http://www.swagelok.com)) or equivalent. Spares = 2.
- c. Sources for ICP-MS Maintenance Equipment & Supplies
- i. Anemometer: Like digital wind-vane anemometer (Model 840032, SPER Scientific LTD., Scottsdale, AZ, [www.sperscientific.com](http://www.sperscientific.com)) or equivalent. Use to verify adequate exhaust ventilation for ICP-MS (check with hoses fully disconnected).
  - ii. Pan, for changing roughing pump oil: Like part # 53216 (United States Plastics Corporation, Lima, OH, [www.usplastic.com](http://www.usplastic.com)) or equivalent. # On hand = 1.



- iii. Container, to hold acid baths for glassware: Polypropylene or polyethylene containers with lids (must be large enough for torch, injector, or spray chamber submersion). May be purchased from laboratory or home kitchen supply companies. # *On hand* = 4.
  - iv. Cotton swabs: Any vendor. For cleaning of cones and glassware.
  - v. Cutter (for 1/8" o.d. metal tubing): Terry tool with 3 replacement wheels. Like part # TT-1008 (Chrom Tech, Inc., Saint Paul, MN, [www.chromtech.com](http://www.chromtech.com)) or equivalent.
  - vi. Getter Regeneration Kit: Part # WE023257 (PerkinElmer, Shelton, CT, [www.perkinelmer.com](http://www.perkinelmer.com)). Use this as needed (at least annually) to clean the getter in the pathway of channel A DRC gas.
  - vii. Magnifying glass: Any 10x + pocket loupe for inspection of cones and other ICP-MS parts. Plastic body is preferred for non-corrosion characteristics. Like part # 5BC-42813 (Lab Safety Supply, Janesville, WI, [www.labsafety.com](http://www.labsafety.com)).
  - viii. Screw Driver, for Ion Lens Removal: Screw driver with long, flexible shaft, and 2mm ball-Allen end for removal of ion lens screws, part # W1010620. Extra 2mm bits, part # W1010598 (PerkinElmer, Shelton, CT, [www.perkinelmer.com](http://www.perkinelmer.com)).
  - ix. Toothbrush: Any vendor. For cleaning ion lens and glassware.
  - x. Ultrasonic bath: Like ULTRASONIK™ Benchtop Cleaners (NEYTECH, Bloomfield, CT, [www.neytech.com](http://www.neytech.com)) or equivalent.
- d. Sources for General Laboratory Consumable Supplies
- i. Bar Code Scanner: Like Code Reader 2.0 (Code Corporation, Draper, UT, [www.codecorp.com](http://www.codecorp.com)) or equivalent. For scanning sample IDs during analysis setup. Any bar code scanner capable of reading Code 128 encoding at a 3 mil label density can be substituted.
  - ii. Carboy (for preparation of serum quality control pool and waste jug for ICPMS sample introduction system): Polypropylene 10-L carboy (like catalog # 02-960-20C, Fisher Scientific, Pittsburgh, PA, [www.fishersci.com](http://www.fishersci.com)) or equivalent. Carboys with spouts are not advised due to potential for leaking.
  - iii. Containers for diluent and rinse solution: Two liter Teflon™ containers (like catalog# 02-923-30E, Fisher Scientific, Pittsburgh, PA., [www.fishersci.com](http://www.fishersci.com)) and 4L polypropylene jugs (like catalog# 02-960-10A, Fisher Scientific, Pittsburgh, PA, [www.fishersci.com](http://www.fishersci.com)) have both been used. Acid rinse before use. Equivalent containers may be substituted.
  - iv. Gloves: Powder-free, low particulate nitrile (like Best Clean-DEX™ 100% nitrile gloves, any vendor). Equivalent nitrile or latex gloves may be substituted.

- v. Paper towels: For general lab use, any low-lint paper wipes such as KIMWIPES®EX-L Delicate Task Wipers or KAYDRY®EX-L Delicate Task Wipers (Kimberly-Clark Professional, Atlanta, GA, [www.kcprofessional.com](http://www.kcprofessional.com)). For sensitive applications in cleanrooms, a wipe designed for cleanroom use may be desired such as the Econowipe or Wetwipe (Liberty, East Berlin, CT, [www.liberty-ind.com](http://www.liberty-ind.com)).
- vi. Pipette (for preparation of serum dilutions to be analyzed): Micromedic Digiflex-CX Automatic™ pipette equipped with 10.0-mL dispensing syringe, 2 mL sampling syringe, 0.75-mm tip, and foot pedal (Titertek, Huntsville, AL, <http://www.titertek.com/>).
- vii. Pipettes (for preparation of intermediate stock working standards & other reagents): Like Brinkmann Research Pro Electronic pipettes (Brinkmann Instruments, Inc., Westbury, NY, <http://www.brinkmann.com/home/>). 5-100 µL (catalog #4860 000.070), 20-300 µL (catalog #4860 000.089), 50-1,000 µL (catalog #4860 000.097), 100-5,000 µL (catalog #4860 000.100). Note: pipette catalog numbers are without individual chargers. Can purchase individual chargers (pipette catalog numbers will differ) or a charging stand that will hold four pipettes (catalog #4860 000.860). When purchasing pipette tips (epTips), purchase one or more boxes, then “reloads” for those boxes after that: 5-100 µL (box catalog # 22 49 133-4, reload catalog # 22 49 153-9), 20-300 µL (box catalog # 22 49 134-2, reload catalog # 22 49 154-7), 50-1,000 µL (box catalog # 22 49 135-1, reload catalog # 22 49 155-5), 100-5,000 µL (box catalog # 22 49 138-5, reload catalog # 22 49 198-9, bulk bag catalog # 22 49 208-0). Equivalent pipettes and tips can be substituted.
- viii. Tubes for sample analysis (for autosampler): Like polypropylene 15-mL conical tubes, BD Falcon model #352097 (Becton Dickinson Labware, Franklin Lakes, NJ, [www.bd.com](http://www.bd.com)). Equivalent tubes may be substituted which are shown by lot screening to be free of trace metal contamination. Clear plastics tend to have lowest trace metal contamination. Blue colored caps have also been used successfully for this method.
- ix. Tubes for storage of intermediate working stock standards: Like polypropylene 50-mL centrifuge tubes, Corning Incorporated #430290 (Corning, NJ, 14831. [www.scienceproduct.corning.com](http://www.scienceproduct.corning.com)). For use in storage of intermediate working stock standards. Equivalent tubes may be substituted which are shown by lot screening to be free of trace metal contamination. Clear plastics tend to have lowest trace metal contamination. Orange colored caps have also been used successfully for this method.
- x. Votexer: Like MV-1 Mini Vortexer (VWR, West Chester, PA, [www.vwr.com](http://www.vwr.com)). Used for vortexing serum specimens before removing an aliquot for analysis. Equivalent item can be substituted.
- xi. Water purification system: Like NANOpure Diamond Ultrapure Water System (Barnstead International, Dubuque, Iowa, [www.barnstead.com](http://www.barnstead.com)). For ultra-pure water used in reagent and dilution preparations. An equivalent water

purification unit capable of producing  $\geq 18$  Mega-ohm-cm water may be substituted.

e. Sources of Chemicals, Gases, and Regulators

- i. Acid, Hydrochloric acid: Veritas™ double-distilled grade, 30-35% (GFS Chemicals Inc. Columbus, OH, [www.gfschemicals.com](http://www.gfschemicals.com)). This is referred to as “concentrated” hydrochloric acid in this method write-up. It is approximately 12 molar in concentration. For use in preparation of intermediate working stock standards. An equivalent hydrochloric acid product may be substituted, but it must meet or exceed the purity specifications of this product for trace metals content.
- ii. Acid, Nitric acid: Veritas™ double-distilled grade, 68-70% (GFS Chemicals Inc. Columbus, OH, [www.gfschemicals.com](http://www.gfschemicals.com)). For use in diluent, rinse solution, intermediate working stock standards, and QC pool preparations. This is referred to as “concentrated” nitric acid in this method write-up. It is approximately 16 molar in concentration. An equivalent nitric acid product may be substituted, but it must meet or exceed the purity specifications of this product for trace metals content.
- iii. Ethyl Alcohol (C<sub>2</sub>H<sub>5</sub>OH), USP dehydrated 200 proof (Pharmco Products, Inc.) or equivalent.
- iv. TritonX-100™ (“Baker Analyzed,” J.T. Baker Chemical Co. [[www.jtbaker.com](http://www.jtbaker.com)], or any source whose product is low in trace-metal contamination).
- v. Argon Gas (for plasma & nebulizer) and Regulator: High purity argon (>99.999% purity, Specialty Gases Southeast, Atlanta, GA, [www.sgsgas.com](http://www.sgsgas.com)) for torch and nebulizer. Minimum tank source is a dewar of liquid argon (180-250L) but bulk tank for total building needs is preferred.
  1. Regulator for argon (at dewar, if used): Stainless steel, single stage, specially cleaned regulator with 3,000 psig max inlet, 0-100 outlet pressure range, CGA 580 cylinder connector, and needle valve shutoff on delivery side terminating in a ¼” Swagelok connector. Part number KPRAFPPF415A2AG10 (Georgia Valve and Fitting, Atlanta, GA, [www.swagelok.com](http://www.swagelok.com)). An equivalent regulator from an alternate vendor may be substituted. # Spares = 1.
  2. Regulator for argon (between bulk tank and PerkinElmer filter regulator): Single Stage 316SS Regulator, with 0-300 psi Inlet Gauge, 0-200 psi Outlet Gauge, Outlet Spring Range, 0-250 psi, ¼” Swagelok Inlet Connection, ¼ turn Shut off Valve on Outlet with ¼” Swagelok Connection and Teflon Seals. Part number KPR1GRF412A20000-AR1 (Georgia Valve and Fitting, Atlanta, GA, [www.swagelok.com](http://www.swagelok.com)). An equivalent regulator from an alternate vendor may be substituted. # Spares = 1.
  3. Regulator for argon (PerkinElmer filter regulator on back of ELAN): Argon regulator filter kit. Catalog number N812-0508 (PerkinElmer, Shelton, CT, [www.perkinelmer.com](http://www.perkinelmer.com)).

- vi. Ammonia: Anhydrous ammonia (>99.99%) for DRC channel A is typically purchased in cylinder size LB (2"x12") (Matheson Tri-Gas, Montgomeryville, PA, 18936. [www.mathesontrigas.com](http://www.mathesontrigas.com)).

  1. Regulator for ammonia: Stainless steel, two stage, specially cleaned regulator with 3,000 psig max inlet, 2-30 outlet pressure range, cylinder connector CGA 180 (for lecture bottle cylinder) or CGA 705 (for Airgas cylinder size 200), and needle valve shutoff on delivery side terminating in a 1/4" Swagelok connector. Like part number 3813-180 or 3813-705 (Matheson Tri-Gas, Montgomeryville, PA, [www.matheson-trigas.com](http://www.matheson-trigas.com)). An equivalent regulator from an alternate vendor may be substituted. # Spares = 1.

- vii. Disinfectant, for work surfaces: Bleach-rite spray (any distributor). On-site dilutions of bleach (1part bleach + 9 parts water) may be substituted, but must be re-made daily after dilution.
- viii. Standard, Gallium: Like 1,000 mg/L, item # PLGA2-2Y. (SPEX Industries, Inc., Edison, NJ, [www.spexcsp.com](http://www.spexcsp.com)). Used as an internal standard in diluent. Any vendor whose standards are traceable to the National Institute for Standards and Technology may be substituted. The standard must have low trace metal contamination.
- ix. Standard, multi-element intermediate stock standard: Item number SM-2107-013 (High Purity Standards, Charleston, SC, <http://www.hps.net/>). This is a custom mix solution (see Table 3 p.49 for concentrations). This solution is diluted to prepare the intermediate stock working standards, which are in turn diluted to prepare the working calibrators. This solution can be prepared in-house from NIST traceable single element stock solutions if necessary.
- x. Triton X-100™ surfactant: Like "Baker Analyzed" TritonX-100™ (J.T. Baker Chemical Co., [www.jtbaker.com](http://www.jtbaker.com)). Another source may be substituted, but it must be free of trace-metal contamination.

## 6) Preparation of Reagent and Materials.

### a. Diluent

- i. Purpose: All samples (blanks, calibrators, QC, or patient samples) are combined with the diluent during the sample preparation step before analysis. This is where the internal standards are added which during the analysis will compensate for instrumental variations on the analyte signal.
- ii. Contents: An aqueous solution of 10 µg/L Ga, 2% v/v double-distilled nitric acid, 5% Ethyl Alcohol, 0.01% Triton X-100™.
- iii. Preparation (4L) & storage: This solution does not have to be made up in a volumetric flask. The important thing about the concentration of the internal standards is that they be consistent within all samples in one run. To prepare

different volumes of diluent, add proportionally larger or smaller volumes of the solution constituents.

1. Acid-rinse a 4 L container (material may be polypropylene (PP), polymethylpentene (PMP), or Teflon™).
2. Partially fill (i.e. 70-80% full) the 4 L container with  $\geq 18$  Mega-ohm·cm water.
3. Carefully add 80 mL double-distilled, concentrated nitric acid and mix.
4. Carefully add 200 mL Ethyl Alcohol and mix.
5. Add 4 mL each of 10 mg/L Ga.
6. Add 20 mL 2% Triton X-100™ stock solution and mix.
7. Make up to volume (approximately 4 L) with  $\geq 18$  Mega-ohm·cm water.
8. Store at room temperature and prepare as needed.
9. Label should include “10  $\mu\text{g/L}$  Ga, 2% (v/v)  $\text{HNO}_3$ , 5% Ethyl alcohol, 0.01% Triton X-100™”, “Store at room temperature”, preparation date, expiration date (1 year from prep), and preparer’s initials.

b. Base Serum

- i. Purpose: This serum pool material will be mixed with the intermediate working calibrators just prior to analysis to matrix-match the calibration curve to the serum matrix of the unknown samples.
- ii. Contents: A mixture of multiple human serum sources purchased from Tennessee Blood Services, 807 Poplar Ave., Memphis, TN 38105. These serum were collected from different anonymous donors are used to approximate an average serum matrix.
- iii. Screening serum: Screen all sources of serum for metal content before mixing together to make the base serum pool. Keep serum at  $\leq -20\text{C}$  whenever possible to minimize microbial growth. Analyte concentrations in the final base serum pool should be in the low-normal population range (see Table 2, p. 49).
- iv. Preparation & Storage:
  1. Once screened, mix the serum collections together in a larger container (i.e. acid washed polypropylene (PP), polymethylpentene (PMP), or Teflon™) and stir for 30+ minutes on a large stir plate (acid wash large Teflon™ stir bar before use).
  2. For short term storage, store at  $2-4^\circ\text{C}$ . For long-term storage, dispense into smaller-volume tubes (i.e., 10 mL acid-washed or lot screened polypropylene tubes) and store at  $\leq -20^\circ\text{C}$ .
  3. Labels on 10 mL tubes should include “Base Serum for Multi-Element Method”, “Store Long Term at  $\leq 20^\circ\text{C}$ ”, “Store Short Term at  $2-4^\circ\text{C}$ ”, preparation date, expiration date 3 years from prep date, and preparer’s initials.

c. ICP-DRC-MS Rinse Solution

- i. Purpose: Pump this solution into the sample introduction system between samples to prevent carry-over of the analytes of interest from one sample measurement to the next. For this method, we also need to pump  $\geq 18$  Mega-ohm·cm water into the sample introduction system for 30 minutes after each run to prevent the clog of the probe and tubing.
- ii. Contents: An aqueous solution of 0.01% Triton X-100™ and 2% (v/v) double-distilled nitric acid solution, 5% Ethyl Alcohol, 0.5% v/v Hydrochloric acid.
- iii. Preparation & Storage:
  1. Intermediate Triton X-100 Solution: To avoid the process of dissolving pure Triton X-100 on a daily basis, prepare an intermediate 2% Triton X-100™ / 5% (v/v) double-distilled, nitric-acid solution for daily use.
    - a. To prepare 2 L of Intermediate Triton X-100 Solution:
      - i. Partially fill a 2 L acid-washed bottle (PP, PMP, or Teflon™) with  $\geq 18$  Mega-ohm·cm water (approximately 1-1.5 L). Use of volumetric flask is not required.
      - ii. Add 20 mL of Triton X-100™ and stir until completely dissolved. Use a Teflon™ stir bar and stir plate if necessary (acid wash stir bar before use).
      - iii. Carefully add 100 mL of double-distilled, concentrated nitric acid.
      - iv. Fill to 2 L and stir thoroughly.
      - v. Label should include “2% Triton X-100™ / 5% (v/v) HNO<sub>3</sub>”, “Store at room temperature”, preparation date, expiration date 1 year from preparation date, and preparer’s initials.
    2. Final Rinse Solution:
      - a. To Prepare 4 L of the Final Rinse Solution:
        - i. Partially fill a 4 L acid-washed bottle (PP, PMP, or Teflon™) with  $\geq 18$  Mega-ohm·cm water (approximately 2-3 L). Use of volumetric flask is not required.
        - ii. Carefully add 80 mL of double distilled concentrated nitric acid and mix well.
        - iii. Carefully add 200 mL ethyl alcohol and mix.
        - iv. Carefully add 20 mL double distilled concentrated hydrochloric acid.
        - v. Add 20 mL of the 2% Triton X-100™ / 5% (v/v) double-distilled, nitric-acid intermediate stock solution and mix well.
        - vi. Fill to 4 L using  $\geq 18$  Mega-ohm·cm water and mix well.

- vii. Store at room temperature and prepare as needed. To prepare volumes other than specified here, add proportionally larger or smaller volumes of the solution constituents.
- viii. Label should include “2% v/v HNO<sub>3</sub>, 5% Ethyl alcohol, 0.01% Triton X-100™, 0.5% v/v Hydrochloric acid”, “Store at room temperature”, preparation date, expiration date (1 year from prep), and preparer’s initials.

d. Standards and Calibrators

i. Multi-Element Intermediate Stock Standard (calibrators and calibration verification)

1. Purpose: This is the master solution from which all working calibrators will be prepared. It will be diluted to prepare intermediate working calibrators which are in turn diluted and included in each analytical run on the ICP-DRC-MS. This same stock standard will be diluted to prepare the intermediate working calibration verification solution which will be in turn diluted and analyzed at least every 6 months for calibration verification purposes (and as needed by supervisor request).
2. Contents: An aqueous solution containing all 3 elements of interest for this method (does not include the internal standards). The concentrations of the 3 elements in the intermediate stock standard are listed in Table 3 p.49. The matrix is 2% v/v HNO<sub>3</sub> in  $\geq 18$  Mega-ohm·cm water.
3. Preparation (Purchase) & Storage:
  - a. Purchasing from vendors: The intermediate stock standard solution may be purchased as a custom mixture from any vendor which prepares multi-element solutions that are traceable to the National Institute for Standards and Technology (NIST) for their accuracy
  - b. Current vendor & preparation process: Currently it is purchased from High Purity Standards (Charleston, SC, part number SM-2107-013). Details of the HPS preparation of the multi-element stock standard is as follows (per statement on their literature):

“Sub-boiled high purity acids were used to put the high purity metal, salts, or oxides into solution and to stabilize the standard. The solution matrix is 2% (v/v) nitric acid in  $\geq 18$  Mega-ohm·cm water. The standard was made gravimetrically by weighing the reference material to 5 significant figures. Volumetric glassware was calibrated gravimetrically to 5 significant figures.”
  - c. In-house Preparation: If outside laboratories were not available to prepare the intermediate stock standard solution, it is also possible to make it in the laboratory from single element standards which are NIST traceable.

- d. Storage: Store the solution at room temperature. Label these bottles from HPS with additional information such as “store at room temperature”, date received, date opened, and initials of person to first open.

## ii. Multi-Element Intermediate Working Calibration Standards

1. Purpose: Use the intermediate working standard solutions 1-5 each day of analysis to prepare the final working calibrators that will be placed on the autosampler of the ELAN® ICP-DRC-MS.
2. Content: The intermediate working standard solutions used in this method are aqueous dilutions of the multi-element intermediate stock standard solution in 2% (v/v) double-distilled nitric acid.
3. Preparation & Storage: To prepare different volumes, add proportionally larger or smaller volumes of the solution constituents.
  - a. Cleaning flasks: Acid-rinse five 100-mL and one 2L volumetric flasks. Check their cleanliness by comparing the counts observed on the ICP-DRC-MS for 2% (v/v) HNO<sub>3</sub> before and after contact with the flasks. Mark each of the flasks according to how they will be used. These flasks should be dedicated to this use in this method, and not used for other purposes.
  - b. HNO<sub>3</sub> Diluent Preparation: In the cleaned 2L volumetric flask, add 1-1.5L of  $\geq 18$  Mega-ohm·cm water, 40 mL high purity concentrated HNO<sub>3</sub>. Fill to the mark and mix thoroughly. Use this diluent to fill the remaining flasks during preparation of the intermediate working standards.
  - c. Dilutions & Storage:
    - i. Partially fill the 100 mL flasks with the HNO<sub>3</sub> diluent (50-75% full).
    - ii. Using the volumes listed (Table 4 p.49) pipette the appropriate volume of the multi-element intermediate stock standard solution into each of the five volumetric flasks. Dilute each solution to the mark with the HNO<sub>3</sub> diluent using a pipette for the final drops. Mix each solution thoroughly. The final concentrations of the 5 elements are listed in Table 4 p.49.
    - iii. Once mixed, transfer to acid-cleaned, labeled, 50-mL containers (PP, PMP, or Teflon™) for storage. Labels should include information such as “Multi-Element Serum Working Calibrators”, “2% (v/v) HNO<sub>3</sub>”, date of preparation, expiration date (1 year from date of preparation), “store at room temperature”, initials of preparer, and concentrations for each element.
    - iv. Store at room temperature.



### iii. Working Multi-Element Calibrators

1. Purpose: The working multi-element calibrators are dilutions of the intermediate working standards. Analysis of these calibrators provides each run with a signal to concentration response curve for each analyte in the method. The concentration of an analyte in a patient serum sample dilution is determined by comparing the observed signal from the dilution of the patient serum sample to the response curve from the working multi-element calibrators.
2. Content: The working multi-element calibrators are 1:30 dilutions of the corresponding five intermediate working standards.
3. Preparation & Use: The working multi-element calibrators are made immediately prior to analysis when the intermediate working standards are mixed with base serum (Section 6.b) and diluent (Section 6.a) using a Digiflex automatic pipetter. See Table 7 p.51 in section 8.b.ii for details of sample preparation.

### iv. Multi-Element Intermediate Working Calibration Verification Standards

1. Purpose: Use the intermediate working calibration verification standard to satisfy calibration verification requirements for the method (see section 8.a.ii).
2. Content: The intermediate working standard calibration verification solution used in this method is an aqueous dilution of the multi-element intermediate stock standard solution (same as that used to prepare the intermediate stock calibration standards) in 2% (v/v) double-distilled nitric acid.
3. Preparation & Storage: To prepare different volumes, add proportionally larger or smaller volumes of the solution constituents.
  - a. Cleaning flasks: Acid-rinse one 100-mL and one 2L volumetric flask (the same 2L flask as was used in preparing the intermediate working calibration standards can be used here). Check their cleanliness by comparing the counts observed on the ICP-DRC-MS for 2% (v/v) HNO<sub>3</sub> before and after contact with the flasks. Mark the flasks according to how they will be used. This flask should be dedicated to this use in this method, and not used for other purposes.
  - b. HNO<sub>3</sub> Diluent Preparation: In the cleaned 2L volumetric flask, add 1-1.5L of  $\geq 18$  Mega-ohm·cm water, 40 mL high purity concentrated HNO<sub>3</sub>. Fill to the mark and mix thoroughly. Use this diluent to fill the remaining flasks during preparation of the intermediate working standards.
  - c. Dilutions & Storage:
    - i. Partially fill the 100 mL flask with the 2% v/v HNO<sub>3</sub> diluent (50-75% full).

- ii. Using the volumes listed (Table 4 p.49) pipette the appropriate volume of the multi-element intermediate stock standard solution into the 100mL volumetric flask. Dilute the solution to the mark with the 2% v/v HNO<sub>3</sub> diluent using a pipette for the final drops. Mix thoroughly. The final concentrations of the 5 elements are listed in Table 4 p.49 (also Table 8).
- iii. Once mixed, transfer to acid-cleaned, labeled, 50-mL containers (PP, PMP, or Teflon™) for storage. Labels should include information such as “Multi-Element Serum Working Calibration Verification Standard”, “2% (v/v) HNO<sub>3</sub>”, date of preparation, expiration date (1 year from date of preparation), “store at room temperature”, initials of preparer, and concentrations for each element.

v. Working Multi-Element Calibration Verification Standards

1. Purpose: The working multi-element calibration verification standard is a dilution of the intermediate working calibration verification standard. Analysis of this standard meets the calibration verification requirements detailed in section 8.a.ii.
2. Content: The working multi-element calibration verification standard is a 1:30 dilution of the corresponding intermediate working calibration verification standard.
3. Preparation & Use: The working multi-element calibration verification standards are made immediately prior to analysis when the intermediate working calibration verification standards are mixed with base serum (Section 6.b) and diluent (Section 6.a) using a Digiflex automatic pipetter. See Table 7 p.51 in section 8.b.ii for details of sample preparation. Store at room temperature.

vi. Internal Quality Control Materials (“Bench” QC)

1. Purpose: Internal (or “bench”) quality control (QC) materials are used to evaluate the accuracy and precision of the analysis process, and to determine if the analytical system is “in control” (is producing results that are acceptably accurate and precise). They are included in the beginning and at the end of each analytical run. These pools will need to be prepared periodically, as supply indicates, by spiking base serum. Preparation of new pools should be made far enough in advance so that both old and new pools can be analyzed together for a period time (preferably at least 20 runs) before switching to the new quality control materials.
2. Content: The internal (or “bench”) quality control (QC) materials used in this method are pooled human serum and may have been spiked to reach a desired concentration. The analyte concentrations in the “low QC” are in the low-normal concentration range. The analyte concentrations in the “high QC” are in the high-normal concentration range.

3. Preparation & Storage: Quality control materials can be either prepared by and purchased from an external laboratory or prepared within the CDC laboratories. Quality control must always be traceable to the National Institute for Standards and Technology (NIST). The CDC laboratory currently prepares its own bench QC materials using the following procedures:
  - a. Collection of serum: Human serum can be purchased from blood services companies such as Tennessee Blood Services, 807 Poplar Ave., Memphis, TN 38105.
  - b. Screening serum: Screen different bottles for metal content before mixing together to make 2 separate base serum pools (for preparing the low and high bench QC materials).
    - i. Keep serum at  $\leq -20\text{C}$  whenever possible to minimize microbial growth.
    - ii. Analyte concentrations in the final serum pool to be spiked for the low bench QC pool should be in the low-normal population range (see Table 2, p. 49). Analyte concentrations in the final serum pool to be spiked for the high bench QC pool should be less than some pre-selected target concentration values in the high normal population range.
  - c. Spiking of serum
    - i. Analyze a sample of each serum pool. Record these results for future recovery calculations.
    - ii. Use these results to determine target analyte concentrations possible for the pools
    - iii. Calculate the volume of single element standards needed to spike each pool to the desired concentrations.
    - iv. While stirring the pools on large stir plates, spike each pool with calculated volumes of single element standards (all spiking standards used must be traceable to NIST).
    - v. Continue to stir pools for 30+ minutes after spiking, then reanalyze.
    - vi. Repeat steps 4 and 5 until all analytes reach target concentrations keeping track of the total volume of spiking solution added to each serum pool.
  - d. Dispensing and Storage of serum
    - i. Container Types: Dispense serum into lot screened containers (i.e. 2 mL polypropylene cryovials). If possible, prepare tubes of QC which have only enough volume for one typical run + 1 repeat analysis. This allows for one vial of QC to be used per day of analysis, reducing chances of contamination of QC materials due to multi-day use.

- ii. Labels: Place labels on vials after dispensing and capping if the vials are originally bagged separately from the caps. This minimizes the chance for contamination during the process. Include at least the name of QC pool (text and bar code), date of preparation, and a vial number on the labels.
- iii. Dispensing: Dispensing can be accomplished most easily using a Digiflex automatic pipette in continuous cycling dispense mode. This process should be done in a clean environment (i.e. a class 100 cleanroom area or hood).
  1. Allow serum pool to reach room temperature before dispensing (to prevent temperature gradients possibly causing concentration gradients across the large number of vials being dispensed and to prevent condensation problems during labeling of vials).
  2. Replace the tubing attached to the dispensing syringe (left when looking at front of Digiflex) with a length of clean Teflon™ tubing long enough to reach into the bottom of the carboy while it is sitting on the stir plate.
  3. Check cleanliness of Digiflex before use by analyzing 1-2% (v/v) HNO<sub>3</sub> which has been flushed through the Digiflex with a portion of the same solution which has not been through the Digiflex.
  4. Approximately one hour before dispensing begins,
    - a. With the large stir plate close to the left side of the Digiflex, begin stirring the serum pool to be dispensed.
    - b. Also during this time, flush the Digiflex with serum from the pool to be dispensed. Place the ends of the tubing attached to both the sample and dispensing syringes into the carboy of serum so that serum won't be used up during this process. Be sure to secure both ends of tubing in the carboy with Parafilm so they will not come out during the flushing process.
  5. After dispensing the serum into the vials, cap the vials and label them. Placing labels on vials after capping minimizes the chance for contamination during the process.
- iv. Homogeneity Testing: After dispensing, check homogeneity of analyte concentrations in pool aliquots by analysis of every Nth sample dispensed (where N ~ 20 - 50 depending on the pool size). Sample more heavily from the beginning and the ending portions of the tubes dispensed (these are the regions where most homogeneity problems occur). Keep samples pulled for homogeneity analysis in the sequence that they were dispensed

for the purpose of looking for trends in concentrations. Once dispensed and homogeneity has been shown to be good throughout the tubes of a pool, store tubes at  $\leq -20^{\circ}\text{C}$  and pull tubes out as needed for analysis.

- v. Storage: Serum pools should be stored long term at  $\leq -20^{\circ}\text{C}$ . Short term storage (several days) at refrigerator temperature ( $\sim 2-4^{\circ}\text{C}$ ).

## 7) Analytical Instrumentation & Parameters

(see Section 5 for details on hardware used, including sources)

### a. Instrumentation & Equipment Setup:

- i. ICP-DRC-MS: Inductively Coupled Plasma Dynamic Reaction Cell Mass Spectrometer ELAN<sup>®</sup> 6100 DRC<sup>Plus</sup> or ELAN<sup>®</sup> DRC II.

#### 1. Modifications made to ICP-DRC-MS

- a. All plastic tubing for DRC reaction gases have been replaced with 1/8" O.D. stainless steel.

#### 2. Sample introduction system setup:

*(See Figure 1 in the Appendix for diagram of generic sample introduction system. Adjustments of connections for the ESI SC4 autosampler are described below. See figures 3a through 3e in Appendix B for other default autosampler settings).*

- a. Concentric quartz nebulizer (quick connect arrangement for liquid and gas connections available from some vendors).
- b. Quartz cyclonic spray chamber.
- c. Quartz injector, 2 mm ID, ball joint end (not shown in Figure 1).

#### 3. Configuration of tubing for liquid handling:

*(See Figure 1 in the Appendix for diagram of tubing setup. This is a recommended setup, but other similar arrangements are usable. See Section 5.b. for part numbers and ordering details.)*

##### a. Tubing for liquid sample uptake:

- i. Probe-to-peristaltic pump tubing: PFA tubing from ESI SC4 autosampler probe connects either directly to sample peristaltic tubing or through a connection adaptor.
- ii. Nebulizer-to-peristaltic pump tubing:

1. 3mL/min nebulizer (TQ-30-A3): Hold square-cut end of 0.5mm x 1.59mm PFA tubing against the inside tapered nebulizer capillary using a flangeless nut and ferrule assembly. Angle-cut opposite end of tubing before inserting into end of black / black peristaltic pump tubing.
  2. 1mL/min nebulizer (500-70QQDAC): Quick connect fitting fits inside back side of nebulizer. Use a PEEK adapter to securely connect the PFA tubing to the peristaltic tubing. Higher back-pressure from the 1mL/min nebulizer is likely to cause tubing become disconnected if the PFA tubing is merely inserted into the peristaltic pump tubing.
- b. Tubing for autosampler rinse solution:
- i. SC autosampler setup for non-FAST applications:  
See Appendix B, Figure 1b for generic autosampler flow diagram. Differences to Figure 1b for the ESI SC4 autosampler include
    1. Autosampler Probe: (SC4 probe has built-in PFA tubing extending from the Teflon-coated probe, so no nut and flanged tubing connection is necessary).
    2. Rinse station filling: ESI SC4 autosampler may have a built-in vacuum pump which pumps rinse solution from the rinse jug to the rinse station ports. If so, rinse solution will not need to be routed through the peristaltic pump.
    3. Rinse station waste: ESI SC4 autosampler liquid waste may be setup to drain by gravity (see comment below).
  - ii. Tubing connection between autosampler rinse station and rinse solution reservoir: Tubing of different inner diameters can be obtained from Elemental Scientific, their distributors, or custom built in the lab to optimize the rinse station fill rate between samples. Rinse station should not go empty at any point.
  - iii. Tubing for autosampler rinse station waste removal: Use minimum drain tubing to make this connection. If this tube is too long, the rinse station will not drain properly.
  - iv. Rinse solution jug: Leave one of the caps on the top of the rinse jug loose to allow air venting into the jug as liquid is removed. Otherwise the jug will collapse on itself as the liquid is removed and a vacuum is created inside. Use secondary containment tray and label appropriately (see solution preparation instructions).
  - v. Waste solution jug: Use secondary containment tray and label appropriately (see solution preparation instructions).

c. Configuration of tubing for spray chamber waste removal:

- i. Chamber-to-peristaltic pump tubing: Connect 1/8" i.d. x 1/4 inch o.d. PVC tubing directly to the waste port on the spray chamber. Connect other end of PVC tubing to the white / black peristaltic pump tubing using a tubing connector (PerkinElmer item # B3140715).
- ii. Waste Jug-to-peristaltic pump tubing: Connect 1/8" i.d. x 1/4" o.d. PVC tubing to the white / black peristaltic pump tubing using a tubing connector (PerkinElmer item # B3140715). Place the free end of the PVC tubing through the lid of the waste jug (be sure it is secure). Waste jug should be sitting in a secondary containment tray in case of overflow.

4. Cones used

Nickel or platinum cones from either PerkinElmer or Spectron have been used successfully. Platinum cones are preferred for durability.

5. Gases & Regulators setup:

- a. Argon: Argon stored as liquid in a dewar (180-250L) or bulk tank. Gaseous argon used for plasma and nebulizer.
  - i. Regulator for argon source (if a dewar): Keep the inlet pressure (headspace pressure of liquid argon dewar) above 100 psi. Set delivery pressure to 60-100psi to allow for pressure drop across tubing that stretches to the instrument. See Section 5.e. for part numbers and details.
  - ii. Step down regulator (if source of argon is a bulk tank): Place this single stage regulator in the lab so that incoming argon pressure can be monitored and adjusted. Set delivery pressure to 70-100 psig. See Section 5.e. for part numbers and details.
  - iii. Regulator at ICP-DRC-MS: Single stage "argon regulator filter kit" supplied with the ICP-DRC-MS. If the delivery pressure gauge range is 0-60psi, set the delivery pressure to  $52 \pm 1$  psig. If the delivery pressure gauge range is 0-100psi, set the delivery pressure to  $60 \pm 1$  psig. See Section 5.e. for part numbers.
- b. Ammonia gas for DRC channel A.
  - i. Regulator for NH<sub>3</sub> gas: Set delivery pressure to 5-7 psig. See Section 5.e. for part numbers and details.

6. Chiller / Heat Exchanger: Refrigerated chiller (for ELAN<sup>®</sup> 6100 DRC<sup>Plus</sup> instruments) or heat exchanger (for ELAN<sup>®</sup> DRC II instruments). For refrigerated chiller, set temperature control to 18°C.
  - ii. Computer: Dell Optiplex GX150, GX270, or GX280 have all been used. Processors used have included Pentium III (1 GHz) through Pentium IV (2.8 GHz). Recommend 512Mb - 1Gb RAM. External hard disk drive for nightly backups of data connects via USB port. Software used includes Windows XP Professional, service pack 2 and ELAN v3.3.
  - iii. Autosampler: ESI SC4 autosampler without FAST sample introduction. Rack calibration, tubing ID for rinse supply, additional rinse time, probe movement speeds, and probe depth is optimized per autosampler (see Table 1 in Appendix B for default settings).
- b. Parameters for Instrument and Method: See Table 1 pp 46-48 for a complete listing of the instrument and method parameters. Also, see Figures 2a-2g for images of the ELAN method screens.

## 8) Method Procedures

- a. Quality Control: Quality control procedures implemented in this method are defined by the Division Procedures and Practices Guidelines and include two types of QC systems which are both subjected to the complete analytical process. The data from these materials are then used to estimate methodological imprecision and to assess the magnitude of any time-associated trends. The concentrations of these materials should cover the expected concentration range of the analytes for the method. Before QC materials can be used to judge patient analytical runs, acceptable QC concentration limits must be calculated from the concentration results observed in at least 20 characterization runs. During the 20 characterization runs, previously characterized QCs or pools with target values assigned by outside laboratories should be included to evaluate the analysis. The process of limits calculation is performed using the laboratory database and the SAS division QC characterization program.
- i. Types of Quality Control:
  1. "Bench QC": The bench QC pools used in this method comprise two levels of concentration spanning the "low-normal" and "high-normal" ranges of the analyte of interest. The intent of bench QC is for the analyst to evaluate the performance of the analytical system on the day of analysis. The analyst inserts both the "low" and the "high" bench QC specimens two times in each analytical run (a set of consecutive assays performed without interruption) so that judgments may be made on the day of analysis. The first analysis of the two bench QC pools is done after the calibration standards are analyzed but before any patient samples are analyzed (so that judgments on the calibration curves may be made before analysis of patient samples). The second analysis of the two bench QC pools is done



at the end of the run (approximately 20 patient samples total). If more patient samples are analyzed on the same calibration curve after the second run of the bench QC, both the low-normal and high-normal bench QC must be reanalyzed before and after the additional samples. For example, the schemes shown in Table 5 p.50 are both acceptable ways to analyze multiple consecutive “runs”.

2. “Blind QC”: When possible, “blind” QC samples are QC materials placed in vials, labeled, and processed so that they are indistinguishable from the subject samples handled by the analyst. Ideally, the supervisor decodes and reviews the results of the blind specimens without the analyst knowing of their presence in the runs. When it is not possible to have blind QC materials processed so that they are indistinguishable by the analyst from the patient samples, it is acceptable for the analyst to randomly insert into the run a QC material which only the QC reviewer knows the acceptable concentration limits for. At least one low-normal concentration and one high-normal concentration QC material should be kept in the laboratory for this purpose.
3. External Reference Materials: Materials produced by laboratories outside of the CDC which have assigned target concentrations can be helpful in verifying method performance. Some examples include Standard Reference Materials (SRM) from the National Institute of Standards and Technology (NIST) (i.e. SRM 1598a) and samples from previous challenges of proficiency testing programs (i.e. Centre de Toxicologie du Quebec (CTQ)). However, only the results for the bench and blind QC materials are used to determine if the run results can be used.

ii. Calibration Verification:

1. Bi-annual tests as defined in the DLS Policy and Procedures manual: CLIA requires the verification of accuracy of instrument response to analyte concentration be completed at least every 6 months. NIST traceable calibrators are analyzed in each run to define this response up to the concentration of the highest calibrator in the run. To verify accuracy of instrument response at concentrations higher than the highest calibrator in each run, analyze a NIST traceable standard with very high concentrations (see Table 8 p.52 in the Appendix for concentrations) at least every 6 months. Prepare the Calibration Verification Standard for analysis just as a working calibrator is prepared. Use the “Serum Blank” as the blank when it is analyzed. If the observed concentrations for the Calibration Verification Standard are not within 10% of the target value (see Table 8 p.52 in the Appendix) the lab supervisor should be notified and the issue should be investigated. Do not substitute external reference materials (i.e. biological samples from a PT program) for the Calibration Verification Standard when performing this. Solutions needed for the Calibration Verification checks can be purchased from standards vendors (i.e. SPEX, High Purity Standards, etc . . .) or prepared in-house from NIST traceable single

element standards. Always verify that normal background levels have been re-achieved through adequate rinse time following analysis of elevated standards for calibration verification.

2. As-needed confirmations (per supervisor discretion): When a sample result is greater than the highest calibrator in the run by more than 10%, the supervisor may request that the result be confirmed in an analysis run which includes a standard or external reference material with equivalent (within 10%) or greater concentration than the sample. In order to avoid needless contamination of the instrument with high concentrations of analytes, the analyst should use the lowest appropriate calibration verification solution concentrations to meet the need.

For *infrequent* verification needs, the calibration verification stock solutions can be used to prepare verification standards to appropriate concentrations. This will, however, introduce elevated concentrations of all elements in the method to the sample introduction system. Frequent measurement of these very high concentrations can result in high background levels in the instrument which are difficult to rinse out and which may limit the ability to measure low concentrations.

For frequent verification needs (i.e. when certain studies have many elevated results on particular elements) or when a concentration higher than those shown in Table 8 p.52 needs to be verified, use NIST-traceable single element stock standards to prepare single element verification standards. This will limit the exposure of the instrument to elevated concentrations of only the elements needing verification.

Always verify that normal background levels have been re-achieved through adequate rinse time following analysis of elevated standards for calibration verification.

An external reference material (i.e. historical proficiency testing sample) can be used to verify the linearity of calibration within a run in these situations IF

- a. The target value has been assigned by an external source (i.e. NIST, or the proficiency testing program).
- b. The concentration of the external reference material is within 10% or is higher than the concentration of the material you need it to confirm.
- c. There is confidence that there is no contamination of previously used external reference material.
- d. A note to file is made that this was done.
- e. If the observed concentrations are not within 10% of the target value the lab supervisor should be notified and the issue should be investigated.

b. Daily Analysis of Samples

i. Preparation of the Analytical Equipment

*For further details on any part of this description, see the ITN Daily Startup SOP for ELAN ICPMS instruments.*

1. Power on the computer, printer, peristaltic pump, and autosampler, and log into the operating system.
2. Peristaltic pump: Set up the peristaltic pump tubing with proper tension for the sample rinse station.
  - a. *If using an external peristaltic pump*, after lighting the plasma go to the DEVICES window of the software and press the “Connect” button to establish communication between the computer and the autosampler. Next, start the peristaltic pump by pressing the appropriate arrow in the DEVICES window (make sure that the rotational direction is correct for the way the tubing is set up in the peristaltic pump). Set the pump speed to 10 rpm in the DEVICES window.
  - b. *If using the on-board ICP-MS peristaltic pump*, start the peristaltic pump by pressing the appropriate arrow in the DEVICES window (make sure that the rotational direction is correct for the way the tubing is set up in the peristaltic pump). Set the pump speed to a slow flow rate (6 to 10 rpm) in the DEVICES window.
3. Software: Starting the ESI software before starting the ELAN software may improve stability of software.
4. Daily Pre-Ignition Maintenance Checks: Perform daily maintenance checks as described in the ITN Daily Startup SOP for ELAN instruments (i.e., Ar supply pressure, interface components cleanliness and positioning, interface pump oil condition, vacuum pressure, etc.). Make appropriate notes in the Daily Maintenance Checklist and Instrument Log Book.
5. Start the Plasma: In the INSTRUMENT window of the software (or on the front of the ELAN), press the “Start” button to ignite the plasma.
6. Send Probe to Rinse Station: Through the METHOD/SAMPLING window in the software, press the “Probe” button, then the “Go to Rinse” button to lower the autosampler probe into the rinse solution.
7. Start the peristaltic pump:
8. Warm-up time: Allow at approximately 30 to 45 minutes warm-up time for the ICP-DRC-MS after igniting the plasma. This warm-up time is for the RF generator. There will be another “Stability time” for the DRC later in this procedure.
9. Optimizations and Daily Performance Check: After this warm-up time, perform a daily performance check and any optimizations necessary (as described in the ITN Daily Startup SOP for ELANs). Include Be (m/z 9) in

the daily performance check. Fill in the Daily Maintenance Checklist according to the optimization procedures performed.

- a. Magnesium ( $^{24}\text{Mg}$ ) may have high RSDs due to the use of Triton-X100 in the rinse solution. Avoid this problem by either temporarily using non-Triton-containing rinse solution during the daily check, or repeating the daily check multiple times in succession with no rinse time between.
- i. Saving the Files: Save new tuning (mass calibration) parameters to the file "default.tun." Save new optimization parameters (i.e., detector voltages, autolens values, nebulizer gas flow rate) to the file "default.dac." monthly, or any time large changes are made in optimization parameters, save a separate copy of these optimization files under a different name (i.e. – default\_070706.dac).

#### 10. Software setup for Analysis:

- a. Workspace (files & folders): Click on "Open Workspace" from the "File" menu. Select the workspace file "CDC\_Serum multi-element.wrk" (or one customized for user preferences). Select "Review Files" from the "File" menu. Verify & set up the correct files and data directories for your analysis (See Table 1 p.47-49 "File Names & Directories").
- b. Samples / Batch Window: Update the window to reflect the current sample set. The only fields which need to be filled in include the autosampler location, sample identification (id), measurement action, method, sample flush time, sample flush speed, read delay time, read delay & analysis speed, wash time, wash speed. Use a bar code scanner to input data whenever possible. See Table 1 pp 47-49 for times and speeds. Save the Sample window file and re-use it on other days by simply replacing the sample IDs for the patient samples.
  1. DRC Stability Time: Best analyte-to-internal standard ratio stability is obtained after 1 hrs of analysis of serum samples using the DRC method. Analyze enough base serum sample dilutions prior to any DRC analysis run to fill at least one hours of analysis time. If analyzing the full set of method analytes, 10 samples will be sufficient. See Table 5 p.50 for example of setup in the Samples / Batch window.
  2. Serum vs. Aqueous Method Files:
    - a. The difference: There are two method files for this one method (see Table 1 p.47-49). It is necessary to use both to accomplish each run because the current PerkinElmer software will not allow for more than one blank per method file. The ONLY DIFFERENCE between these two files is

on the Sampling tab where one lists the autosampler positions of the serum blank and serum calibrators (the “sblk” method file) and the other lists the autosampler position of the aqueous blank (the “aqblk” method file).

b. Use: The ONLY TIME when it matters which of these files is used is when the measurement action *includes* “Run blank” or “Run standards”. When the measurement action is only ‘run sample’, it does not matter whether the “sblk” or “aqblk” method file is used. Analysts typically follow the pattern below, however, for the sake of consistency and as a reminder of which blank must be used for which type of sample. See Table 6 p.50.

i. The “sblk” method file: Use to analyze the initial serum blank (blank for the calibration curve), the serum calibrators, and the serum blank checks (sblkchk1 & sblkchk2) at the very beginning of the run. The serum blank method (set up for a ESI SC4 autosampler defines the serum blank in autosampler location 109 and the serum calibration standards 1-5 in autosampler locations 101-106, respectively.

ii. The “aqblk” method file must be used to analyze all QC materials and patient samples. The aqueous blank method (set up for a ESI SC4 autosampler) defines the aqueous blank in autosampler location 109.

3. Notation of Dilutions: To designate an extra dilution of a sample, edit the sample ID to reflect the level of dilution being performed (i.e., A 1:2 dilution of sample 1 would be reflected in the sample ID “sample 1 (2x dilution)”. This sample ID will be edited during the data-import process to the database so that it is recognized as the appropriate sample. Do not use the ELAN® software to automatically correct for sample dilutions. Extra dilution is performed on serum samples whose concentration is greater than the concentrations listed in Table 8 p.52 in the Appendix (linearity of the method has been documented up to these concentrations).

ii. Preparation of Samples for Analysis (See Table 7 p.51)

1. Thaw the frozen serum specimens; allow them to reach ambient temperature.
2. Prepare diluted serum for analysis during the DRC stability period. A 40-minute DRC stability period will consume approximately 36mL of solution. Prepare the necessary volume according to the “patient sample constituent proportions listed in Table 7, p. 51. This can be

prepared in a 50mL polypropylene tube or a wide-mouth bottle (which can be put on the autosampler in place of one of the tube trays).

**NOTE: Selenium is not stable in the diluted sample for more than 7 hours. Diluted serum must be analyzed within 7 hours of preparation (see Appendix A, test 5 for details)**

3. Set up a series of 15-mL polypropylene tubes corresponding to the number of blanks, standards, QCs, and patient samples to be analyzed.
  4. Prepare the following solutions in the 15-mL falcon tubes using the Micromedic Digiflex™ (see Table 3 p.49 for a summary).
    - a. *Aqueous Blank*: Prepare two aqueous blanks consisting of 300  $\mu\text{L}$  of  $\geq 18$  Mega-ohm $\cdot\text{cm}$  water and 4,200  $\mu\text{L}$  of diluent (2 x 2100  $\mu\text{L}$ ). One will be the actual aqueous blank and the other will be a backup ("Aqueous Blank Check") in case the original aqueous blank gets contaminated....
    - b. *Serum Blank*: Prepare three serum blank dilutions consisting of 150  $\mu\text{L}$  of base serum (same material used to prepare the serum calibration standards), 150  $\mu\text{L}$  of  $\geq 18$  Mega-ohm $\cdot\text{cm}$  water, and 4,200  $\mu\text{L}$  of diluent (2 x 2100  $\mu\text{L}$ ). One of these serum blanks will be the blank for the calibration standards; the others will be analyzed after standard 5 as sblkchk1 and sblkchk2, respectively. Results from sblkchk1 and sblkchk2 will be stored for periodic verification of the method limit of detection.
    - c. *Calibrators or Calibration Verification Standards*: Prepare the working calibration standards or the working calibration verification standards as 150  $\mu\text{L}$  of the appropriate aqueous intermediate working solution, 150  $\mu\text{L}$  of base serum, and 4,200  $\mu\text{L}$  of diluent (2 x 2100  $\mu\text{L}$ ). To avoid carryover from working calibration standards and the working calibration verification standards to other samples, rinse tip of digiflex once with concentrated nitric acid.
    - d. *Patient & QC Samples*: Before taking an aliquot for analysis, mix the sample so that no particulates remain on the bottom of the tube. Prepare serum sample dilutions as 4,200  $\mu\text{L}$  of diluent (2 x 2100  $\mu\text{L}$ ), 150  $\mu\text{L}$  of the serum sample and 150  $\mu\text{L}$  of  $\geq 18$  Mega-ohm $\cdot\text{cm}$  water.
    - e. Cap all of the blanks, standards, and samples and mix them well. Uncap them and place them in the autosampler of the ELAN® ICPMS in the order that was entered in the Samples / Batch window of the ELAN software.
- iii. Specimen Storage and Handling during Testing: Specimens may be left at room temperature during analysis in case confirmation analyses must be made. Take stringent precautions to avoid external contamination by the metals to be determined. Specimens may be stored short term at refrigerated temperatures, but should be stored long term (>4 weeks) at  $\leq -20$  °C.

- iv. Starting the Analysis: To begin analysis, highlight (click and drag with the mouse) the table rows of the samples that should be included in the run, and then click on “Analyze Batch.”
- v. Monitoring the Analysis: Initiate work in a timely manner so that the run may be monitored. Make every effort to complete analysis within the work day so that the entire run can be monitored. If it is not possible to complete the analysis by the end of the work day, the run may be left to complete itself unattended as long as appropriate planning is made for either overnight operation or Auto Stop (see below).

Monitor the analysis for the following:

1. *DRC stability (analyte / internal standard ratio stability)*

After the analysis of the DRC stability base serum samples, these results can be reviewed to determine if sufficient stability of the analyte-to-internal standard ratio has been reached before beginning analysis. Importing data into an MS Excel template file is useful to simplify this procedure.

2. *Proper operation of the instrument.*

3. *Contaminated blanks.*

4. *Linear calibration curves.*

- a. Typical correlation coefficients will be 0.999 to 1.000.

- b. The ELAN software generates a “simple linear” calibration curve (using a least squares calculation) for each of the 3 elements in this method. The curves are generated using the results from analysis of the serum blank and the 5 external serum calibrators whose concentrations are defined in the Calibration tab of the Method file. Specifically, the software plots the “net intensity” (y-axis) versus the analyte concentration (x-axis). The “net intensity” is the blank subtracted **ratio** of the measured intensity for the analyte to the measured intensity of the associated internal standard and is calculated as follows:

$$\text{net intensity} = \frac{\text{Analyte Meas Intensity}_{\text{sample}}}{\text{Internal Std Meas. Intensity}_{\text{sample}}} - \frac{\text{Analyte Meas Intensity}_{\text{Blank}}}{\text{Internal Std Meas Intensity}_{\text{Blank}}}$$

5. *Bench QC results within the acceptable limits.*

If an analyte result for the beginning QC material(s) falls outside of the 3SD (i.e. 99 percentile) limits, then the following steps are recommended:

- a. If a particular calibration standard is obviously in error, remake a new dilution at the Digiflex of that working calibrator, reanalyze it, and reprocess the sample analyses using this new result as part of the calibration curve.

- b. Prepare a fresh dilution of the failing QC material and reanalyze it.
- c. Prepare fresh dilutions at the Digiflex of all of the calibration standards (working serum multi-element standards) and reanalyze the entire calibration curve using the freshly prepared standards.

If these three steps do not result in correction of the out-of-control values for QC materials, consult the supervisor for other appropriate corrective actions. Do not report analytical results for runs that are not in statistical control.

6. *Good precision among replicates.* If "air" was sampled into the system, the precipitated serum protein might be coated within the probe, tubing and the introduction system which might cause the bad precision among replicates and/or reduced sensitivity of the instrument. Use  $\geq 18$  Mega-ohm·cm water to rinse the system for recovering the instrument performance.
7. *Consistent measured intensities of the internal standards.*  
Some sample-to-sample variations are to be expected. However the intensities should be within a few percent of one another, and should fluctuate around an average value (not drift continuously in one direction).
8. *Elevated patient results.*

vi. Records of Results: Run results will be documented daily in both electronic and paper form.

1. Electronic Records:

- a. Transfer of Results to the Laboratory Information System / Database: Transfer data electronically between computers or software to reduce errors. When keyboard entry must be used, proofread transcribed data after entry.
- b. Long-Term Storage of ELAN software files: Files used and produced by the ELAN software in analyzing samples will be backed up long term on compact disk and kept a minimum of three years.

2. Paper Records: The paper copy of the results from the run should be put into the study folder(s) and should include

- a. A summary of the calibration curve statistics.
- b. A printout of analysis of each measurement made during the run.
- c. Optional, but helpful, is a printout of the DRC stability check measurements in graphical form.
- d. On the front sheet of the printed records, write the following
  - i. Analyst initials
  - ii. Instrument ID



- iii. Date of Analysis
  - iv. Run # for the day on this instrument
  - v. Study ID and Group Number
  - vi. Database batch ID (Not known until the run is imported into the database)
- vii. Transfer of Results to the Laboratory Database: Every analytical run performed for the analysis of patient samples should be entered into the laboratory results database unless the run is not useable for obvious reasons (i.e. the run is stopped for some reason before ending QC is analyzed, no internal standard spiked into the diluent, etc. . . ).
1. Data Export Process (from ELAN® software to .TXT file): If the data file was not created during the initial analysis, reprocess the data of interest either with “original conditions” option, or by loading the files and folders used during the analysis. In the ELAN® ICP-DRC-MS software, select “Review Files” from the “File” menu. From this window, you must open the files and directories that were used when collecting the data of the run that you wish to export. (If the analysis has just ended, all of these files and directories will still be open.) NOTE: A second copy of the ELAN® software can be run as an Edit/Reprocess copy without affecting an ongoing analysis by the first copy of the software running in Windows. After you open the relevant files, go to the “Report” page in the METHOD window. Deselect the box that prints a paper copy of data and select the box that sends data to a file. Select the “Report Options Template” named “CDC\_Database Output.rop” and type in a report filename using a format such as “2006-0714a\_group55.txt” to designate data from analysis of group 55 from July 14, 2006, run #1. Under “Report Format”, choose the “Use Separator” option, and under the “File Write” section choose “Append.” Finally, reprocess the data of interest. (See PerkinElmer ELAN® ICPMS Software Manual.) Make sure you apply the aqueous blank to all sample and quality control material analyses.
  2. Data Import Process (from .TXT file to Microsoft Access™ database):
    - a. Move the .TXT file to the appropriate subdirectory on the network drive where exported data are stored. Directories for data storage are named according to instrument \ year \ month\, such as I:\Instruments\ELANDRCC\2006\07\.
    - b. Using the ITN Database Frontends, import the instrument file into the database. On the GoTo window, click on “Add Sample Results to Database”, then “Import Instrument Data File”.
    - c. Enter the appropriate information to identify the instrument, assay, analysis date & time, run number, analyst, calibrator lot number and prep date used (use the “IS Lot Number” field) and study. If other than default values for Method LOD, High Calibrator, Rep Delta Limit, and

units were used in the run, document what was used by clicking on the “View/Set Batch Parameters” button, changing the appropriate values, and then clicking “Back”.

- d. Press the “Import” button and then browse to the correct network folder to select the file which contains the results from the run. Select the file and click “OK”.
- e. In the “Import Instrument Results” table, pressing the “Find X’s” button will show only those samples whose sample ID is not recognized as a valid QC pool ID or sample ID for this study. (Sample IDs are set up when the study is logged into the database.) Corrections to sample IDs and dilution factors can be made in this table (e.g., correction of transcription errors and adjustment for level of dilution). If samples were diluted for analysis, both the sample ID and the dilution factor need to be edited in this table before the values are transferred to the database (the Replace command under the Edit window is helpful in this case). When corrections to sample IDs are made, press the “Check IDs” button to re-evaluate the sample IDs. Any sample or analyte row marked “Not Recognized” will not be transferred to the database when the “Transfer” button is pressed. Once transferred into the database, the data should be evaluated for QC pass / fail, then set with the appropriate settings for QC accept / reject, final value status, and comment(s). See the database programmers for more detail on working in the database.

viii. Analyst Evaluation of Run Results:

1. Bench Quality Control: After completing a run, and importing the results into the database, export the QC results to the SAS program where the run will be judged to be in or out of control. The QC limits are based on the average and standard deviation of the beginning and ending analyses of each of the bench QC pools, so it will not be possible to know if the run is *officially* accepted or rejected until it is completed.
  - a. Quality Control Rules: The SAS program applies the division QC rules to the data as follows:
    - i. If both QC run means (low & high bench QC) are within  $2S_m$  limits and individual results are within  $2S_i$  limits, then accept the run.
    - ii. If 1 of the 2 QC run means is outside a  $2S_m$  limit - reject run if:
      1. Extreme Outlier – Run mean is beyond the characterization mean  $\pm 4S_m$
      2. 1 3S Rule - Run mean is outside a  $3S_m$  limit
      3. 2 2S Rule - Both run means are outside the same  $2S_m$  limit
      4. 10 X-bar Rule – Current and previous 9 run means are on same side of the characterization mean

- iii. If one of the 4 QC individual results is outside a 2Si limit - reject run if:

- 1. R 4S Rule – Within-run ranges for all pools in the same run exceed 4Sw (i.e., 95% range limit)

Note: Since runs have multiple results per pool for 2 pools, the R 4S rule is applied within runs only.

Abbreviations:

Si = Standard deviation of individual results (the limits are not shown on the chart unless run results are actually single measurements).

Sm = Standard deviation of the run means (the limits are shown on the chart).

Sw = Within-run standard deviation (the limits are not shown on the chart).

- b. Implications of QC Failures: If the division SAS program declares the run out of control” for any analyte, use the following to determine the implications on usability of the data from the run.
  - i. If only one analyte of the three fails bench QC, then the other two which passed bench QC may be reported.
  - ii. If two analytes of the three fail bench QC, then none of the results from the run should be used for reporting. The cause of the QC failures should be investigated and then the entire run should be repeated.

2. Patient Results:

- a. Results Outside the Normal Range: The normal range of concentrations observed for these elements in serum is listed in Table 10.

- i. Boundaries Requiring Confirmatory Measurement:

- 1. Results Lower than the First Lower Boundary (1LB) or Higher than the First Upper Boundary (1UB): Concentrations observed less than the “first lower boundary” (defined in the laboratory database as the “1LB”) or greater than the “first upper boundary (defined as the “1UB” in the laboratory database) should be confirmed by repeat analysis of a new sample preparation. The concentration assigned to the 1LB for an element is determined by study protocol but default 1LB concentrations for elements in this method can be found in Table 9 p.52 in the Appendix. Report the original result, as long as the confirmation is within 10% of the original. Continue repeat analysis until a concentration can be confirmed.

2. Results Greater than Highest Calibrator: When a sample result is greater than the highest calibrator in the run, the supervisor may request that the result be confirmed in an analysis run which includes a standard or external reference material with equivalent (within 10%) or greater concentration than the sample.
  3. Results Greater than Range of Linearity Tested: Perform an extra dilution on any serum sample whose concentration is greater than those listed in Table 8 p.52 in the Appendix (the linearity of the method has been documented up to these concentrations). See Table 7 p.51 for description of sample preparation with extra dilution.
- ii. Analyst Reporting of Abnormally Low or Abnormally High Results: Concentrations observed lower than the “second lower boundary” (defined in the laboratory database as the “2LB”) or greater than the “second upper boundary” (defined in the laboratory database as the “2UB”) should be reported to the QC reviewer as an “abnormally low result” or an “elevated result”, respectively. The concentration assigned to the 2LB and 2UB for an element is determined by study protocol but default concentrations are in Table 9 p.52 in the Appendix. There is no routine notification for elevated levels for the metals determined in this method. The protocol for supervisors reporting elevated results to medical personnel is defined according to the study protocol.
  - b. Inadequate Precision Within One Measurement: If the range of the three replicate readings (maximum replicate concentration value - minimum replicate concentration value) for a single sample analysis is greater than the criteria listed in Table 9 p.52 in the Appendix **and** the range of the three replicate readings is greater than 10% of the observed concentration, do not use the measurement for reporting. Repeat the analysis of the sample. This type of inadequate precision is noted in the database by an ‘X’ in the “>Lim Rep Delta” field.
- ix. Submitting final work for Review: Once results have been imported, reviewed, and set as final in the database by the analyst,
    1. Submit an email to the QC reviewer informing them of the readiness of the data for final review. The email should include
      - a. Instrument ID, run Date, run number, study ID, group ID.
      - b. Any bench QC failures (include reasons if known).
      - c. Any patient sample result less than the 2LB or greater than the 2UB (see Table 9 p.52 in the Appendix).

- d. Anything out of the ordinary about this analytical work which could have a bearing on the availability (i.e. insufficient sample to analyze), accuracy, or precision of the results.
2. Include all items called for by the study folder cover sheet in the study folder (i.e. printouts from the ICP-MS, bench QC evaluation) together in the study folder before submitting the folder for review when analysis is complete.
- x. Overnight operation or Using Auto Stop: Make every effort to complete analysis within the work day so that the entire run can be monitored. If it is not possible to complete the analysis by the end of the work day, the run may be left to complete itself unattended as long as appropriate planning is made for either overnight operation or Auto Stop.
  1. *24 hrs / day operation in DRC mode*:
    - a. To reduce startup time in the mornings, the analyst is encouraged to operate the ELAN in DRC mode 24hrs/day during the work week. This eliminates the need for daily 45 minute RF generator warm-up, and possibly the need for DRC stability time (if the DRC gas is not off for extended periods of time before analysis). To maintain the instrument in DRC mode when not analyzing patient samples, setup multiple sample rows in the Samples / Batch window with autosampler position n zero (rinse station of autosampler) and wash time of 1800s (30 minutes). Repeat this sample row enough times to keep the instrument in analysis mode overnight (1 sample with 15 minute wash will take ~ 20 minutes).
    2. *AutoStop*: If 24 hrs / day ELAN operation is not desired, the instrument can shut the plasma off unattended after analysis. Setup this as follows:
      - a. On the "Auto Start / Stop" tab of the Instrument window, enable the Auto Stop feature.
      - b. Press the "Change" button within the Auto Stop box and set the Delayed shutdown time to 5 minutes. This will rinse the sample introduction system of serum matrix before turning off the plasma.
      - c. It will be necessary to replace the sample peristaltic pump tubing the next day since it will have been clamped shut overnight.
  - c. Equipment Maintenance: Analysts are expected to follow a 4-day analysis / 1-day maintenance schedule in the laboratory.
    - i. ICPMS Maintenance: On the maintenance day, perform all maintenance per the Inorganic Toxicology and Nutrition Branch ELAN ICP-MS Weekly Maintenance SOP. All equipment maintenance should be documented in the instrument logbook. For this method we can not use straight ethanol to rinse the sample introduction system, otherwise the probe and tubing will be clogged because of the precipitation of the serum protein. Use the  $\geq 18$  Mega-ohm-cm water to rinse the whole system whenever it is necessary.

- ii. Data Backup: Data on the ELAN computer will be backed up via two backup routines.
1. Daily Backups to External Hard Drive: Automatic backups of the “elandata” directory and all subdirectories should be programmed to occur each night onto an external hard disk.
  2. Weekly Backup to CD: Backup all files in the active “elandata” directory and all subdirectories onto one recordable compact disc during the weekly maintenance SOP. When the active “elandata” directory on the ICP-DRC-MS computer hard drive becomes too large to fit onto a single recordable compact disc, the oldest data can be removed from the computer to make it easier to backup the entire directory weekly. This can usually be done annually.
    - a. Backup the oldest data on the hard drive to two duplicate compact disks and verify that the files on the CD are readable
    - b. Label them with the name of the instrument, the date range of the data, the current date, your name, and “Copy 1 of 2” or “Copy 2 of 2”
    - c. After verifying that the CDs are readable, the oldest, backed up data can be deleted from the ICP-MS computer hard drive.
    - d. It is best to not store duplicate copies in the same location.

## 9) Interpretation of the Results

- a. Reportable Range: Serum multi-element values are reportable in the range between the method LOD and the highest concentration verified accurate by bi-annual calibration verification tests (see Table 8 p.52 in the Appendix). For example, if a serum Se value is less than the method LOD, report it as < “LOD” µg/L where “LOD” is the numerical LOD. Above the highest concentration verified, extra dilutions are made of the serum sample to bring the concentration within the verified range.
- b. Reference Ranges (Normal Values): In this method the normal reference ranges (see Appendix, Table 10 p.53) for these elements in serum fall within the range of the calibrators.
- c. Action Levels: There is no routine notification for levels of every analyte determined with this method. The protocol for supervisors reporting elevated results to medical personnel is defined according to the study protocol.

## 10) Method Calculations

- a. Method Limit of Detection (LODs): The detection limits for elements in serum specimens are based on 3 times the concentration standard deviation of serum blanks (named sblkchk1 or sblkchk2) analyzed in at least 20 separate runs. Method LODs are re-evaluated periodically.

- b. Method Limit of Quantitation (LOQ): The Division of Laboratory Sciences does not currently utilize limits of quantitation in regards to reporting limits [9].
- c. QC Limits: Quality control limits are calculated based on concentration results obtained in at least 20 separate runs. It is preferable to perform separate analyses on separate days and using multiple calibrator lot numbers, instruments, and analysts to best mimic real-life variability. The statistical calculations are performed using the SAS program developed for the Division of Laboratory Sciences (DLS\_QC\_compute\_char\_stats.sas).

**11) Alternate Methods for Performing Test and Storing Specimens If Test System Fails:**

If the analytical system fails, the analysis may be setup on other ELAN DRC instruments in the laboratory. If no other instrument is available, store the specimens at  $\leq 4^{\circ}\text{C}$  until the analytical system can be restored to functionality. If interruption longer than 4 weeks is anticipated, then store serum specimens at  $\leq -20^{\circ}\text{C}$ .

**Appendix A. Ruggedness Testing Results.**

Parameter Test#1: Evaluate the impact on analysis results if the set RF power is increased to 1600W (instrument maximum) or decreased to 1150W (by 20%) for the analytical run.

Test Details:

1. Three different PF power settings were tested in separately prepared, consecutive runs on the instrument without turning off the plasma. At least 15 minutes stabilization time was allowed between each run after the RF power was changed. "Junk urine" samples (20) were analyzed between the beginning and ending QC of each run. All other method parameters were kept per method.
2. Run #1 (method default, 1450W).
3. Run #2 (decreased RF power by 20% to 1150W).
4. Run #3 (increased RF power to instrument maximum, 1600W).
5. Run #4 (increased RF power to instrument maximum, 1525W).

**Parameter Test 1 Results.**

Test performed 4/2-5/17/2010; by Gulchekhira Shakirova.

QC Pool ID	RF Power Tested	Zn ( $\mu\text{g/dL}$ )	Cu ( $\mu\text{g/dL}$ )	Se ( $\mu\text{g/L}$ )
<b>LS-03601b</b>	Characterized Mean 2SD Range	50.7 41.9 - 59.5	64.9 61.9 – 67.9	75.0 66.7 – 83.3
	1150W (Reduced)	52.5	63.1	75.6
	1450W (Per Method)	49.0	62.7	70.1
	1525W (Increased)	43.3	63.4	75.7
	1600W (Increased)	54.1	63.9	75.6
<b>HS-03601b</b>	Characterized Mean 2SD Range	175 142 – 209	203 191 – 215	144 130 – 157
	1150W (Reduced)	178	197	145
	1450W (Per Method)	168	196	146
	1525W (Increased)	157	201	145
	1600W (Increased)	178	199	149



**Appendix A. Ruggedness Testing Results (continued).**

Parameter Test#2: Evaluate the impact on analysis results if the Cell Gas Flow Rate is increased or decreased by 20% for the analytical run.

Test Details:

1. Three different Cell Gas Flow Rates were tested in separately prepared, consecutive runs on the instrument without turning off the plasma. At least 15 minutes stabilization time was allowed between each run after the axial field voltage was changed. "Junk urine" samples (20) were analyzed between the beginning and ending QC of each run. All other method parameters were kept per method.
2. Run #1 (method default = 0.5mL/min).
3. Run #2 (decreased Cell Gas Flow Rate by 20% to 0.4mL/min).
4. Run #3 (increased Cell Gas Flow Rate by 20% to 0.6mL/min).

**Parameter Test 2 Results.**

Test performed 5/6/-5/17/2010 by Gulchekhira Shakirova.

QC Pool ID	Cell Gas Flow Rate Tested	Zn (µg/dL)	Cu (µg/dL)	Se (µg/L)
<b>LS-03601b</b>	Characterized Mean 2SD Range	50.7 41.9 - 59.5	64.9 61.9 – 67.9	75.0 66.7 – 83.3
	0.40 mL/min (Reduced)	49.5	65.3	80.7
	0.50 mL/min (Per Method)	49.5	67.6	73.8
	0.60 mL/min (Increased)	47.8	63.4	75.6
<b>HS-03601b</b>	Characterized Mean 2SD Range	175 142 – 209	203 191 – 215	144 130 – 157
	0.40 mL/min (Reduced)	167	204	152
	0.50 mL/min (Per Method)	169	205	146
	0.60 mL/min (Increased)	171	203	147

**Appendix A. Ruggedness Testing Results (continued).**

Parameter Test#3: Evaluate the impact on analysis results if the RPq is increased or decreased by 20% for the analytical run.

Test Details:

1. Three different RPq settings were tested in separately prepared, consecutive runs on the instrument without turning off the plasma. At least 15 minutes stabilization time was allowed between each run after the axial field voltage was changed. "Junk urine" samples (20) were analyzed between the beginning and ending QC of each run. All other method parameters were kept per method.
2. Run #1 (method default DRC RPq: 0.56).
3. Run #2 (decreased DRC RPq 20%: 0.70).
4. Run #3 (increased DRC RPq 20%: 0.84).

**Parameter Test 3 Results.**

Test performed 5/6-5/17/2010 by Gulchekhira Shakirova.

QC Pool ID	RPq Tested	Zn (µg/dL)	Cu (µg/dL)	Se (µg/L)
LS-03601b	Characterized Mean 2SD Range	50.7 41.9 - 59.5	64.9 61.9 - 67.9	75.0 66.7 - 83.3
	DRC RPq:0.56 (Reduced by 20%)	52.5	63.1	70.8
	DRC RPq:0.70 (Per Method)	49.0	62.7	70.1
	DRC RPq:0.84 (Increased by 20%)	54.1	63.9	75.9
HS-03601b	Characterized Mean 2SD Range	175 142 - 209	203 191 - 215	144 130 - 157
	DRC RPq:0.56 (Reduced by 20%)	178	197	129
	DRC RPq:0.70 (Per Method)	168	196	131
	DRC RPq:0.84 (Increased by 20%)	178	199	145

**Appendix A. Ruggedness Testing Results (continued).**

Parameter Test#4: Evaluate the impact on analysis results if the axial field voltage (AFV) is increased or decreased by 20% for the analytical run.

Test Details:

1. Three different DRC AFV were tested in separately prepared, consecutive runs on the instrument without turning off the plasma. At least 15 minutes stabilization time was allowed between each run after the axial field voltage was changed. "Junk urine" samples (20) were analyzed between the beginning and ending QC of each run. All other method parameters were kept per method.
2. Run #1 (method default DRC AFV = 450).
3. Run #2 (decreased DRC AFV to 360)
4. Run #3 (increased DRC AFV to 500)

**Parameter Test 4 Results.**

Test performed 5/6/-5/17/2010 by Gulchekhira Shakirova.

QC Pool ID	Axial Field Voltage Tested	Zn (µg/dL)	Cu (µg/dL)	Se (µg/L)
LS-03601b	Characterized Mean 2SD Range	50.7 41.9 - 59.5	64.9 61.9 – 67.9	74.9 66.7 – 83.3
	AFV-360 (Reduced)	46.9	61.5	72.8
	AFV-360 (Per Method)	47.2	64.0	75.0
	AFV-500 (Increased)	48.6	63.5	74.1
HS-03601b	Characterized Mean 2SD Range	175 142 – 209	203 191 – 215	144 130 – 157
	AFV-360 (Reduced)	163	195	142
	AFV-360 (Per Method)	170	205	147
	AFV-500 (Increased)	168	200	146

**Appendix A. Ruggedness Testing Results. (continued)**

Parameter Test #5: Method descriptions and SOP assume preparation and analysis on same day. Evaluate the impact on analysis results if the analytical run is prepared to analyze but circumstances do not allow for analysis to occur until 24 or 48 hours later.

Test Details (Part 1):

1. Three separate run sets (A, B, and C) were prepared at one sitting from the same starting materials. Set 'A' was analyzed immediately. Set's 'B' and 'C' were stored at room temperature for 24 and 48 hours, respectively before analysis. "Junk serum samples (20) were analyzed between the beginning and ending QC of each run, making each a normal length run. All other method parameters were kept per method. Results in table are average of beginning and ending QC.
2. On day two, a fresh run set ("D") was prepared and analyzed immediately for comparison to results from set "B" (Run 2 of the day. Results not shown).
3. On day three, another fresh run set ("E") was prepared and analyzed immediately for comparison to results from set "C" (Run 2 of the day. Results not shown).

<b>Parameter Test 5 Results (Part 1).</b> Test performed 3/11/2010 to 3/15/2010 by Gulchekhira Shakirova using ELAN DRC-2R.				
<b>QC ID</b>	<b>Time from Preparation</b>	<b>Zn (µg/dL)</b>	<b>Cu (µg/dL)</b>	<b>Se (µg/L)</b>
LS-03601b	<i>Characterized Mean</i>	50.7	64.9	74.9
	<i>±2SD Range</i>	41.9 – 59.5	61.9 – 67.9	66.7 – 83.3
	<i>±3SD Range</i>	37.5 – 63.9	60.4 – 69.4	52.5 – 87.4
	Fresh Preparation	47.2	65.7	74.7
	After 24 hours	51.9	67.1	<b>102</b> <b>(150, 54.5)</b>
	After 48 hours	51.0	66.2	<b>57.1</b> <b>(123, -8.8)</b>
HS-03602b	<i>Characterized Mean</i>	175	203	144
	<i>±2SD Range</i>	142 – 209	191 – 215	130 – 157
	<i>±3SD Range</i>	126 - 225	185 - 221	124 – 164
	Fresh Preparation	160	203	143
	After 24 hours	167	203	145
	After 48 hours	174	207	<b>130</b> <b>(98.2, 161)</b>

Note: The serum ICP-MS method is rugged for Zn and Cu to delays in analysis of samples after preparation for up to 48 hrs. and not rugged for Se to delay in analysis of samples after preparation for even 24 hrs. Suggested maximum amount of time from sample prep to end of the run is 450 min, which consists of 3 analytical runs.

**Appendix A. Ruggedness Testing Results. (continued)**Parameter Test #5:

Test Details (Part 2): Due to the observations in test one for selenium, a shorter time frame was examined in part two of this test.

1. Seven preparations of the low bench QC serum material were made at the beginning of the experiment. Each of these seven preparations were 4x the normal preparation volume (4 preparations into each vial).
2. Four consecutive runs of the serum method were then carried out. Each run included
  - a. blanks, calibrators, and run judge QC (beginning and ending) which were prepared immediately prior to the beginning of each run.
  - b. Seven preparations of the low bench QC which were prepared immediately prior to the beginning of each run.
  - c. Measurements of the seven preparations of the low bench QC pool which were prepared before the first run (these were alternated with the freshly prepared low bench QC sequentially throughout the run).

**Parameter Test 5 Results (Part 2).**

Test performed 5/6/2010 to 5/17/2010 by Gulchekhra Shakirova, DRC2-R.

QC Pool ID	Axial Field Voltage Tested	Zn (µg/dL)	Cu (µg/dL)	Se (µg/L)
LS-03601b	Characterized Mean	50.7	64.9	74.9
	2SD Range	41.9 – 59.5	61.9 – 67.9	66.7 – 83.3
	3SD Range	37.5 – 63.9	60.4 – 69.4	52.5 – 87.4
	Run 1 (up to 139 min elapsed)	41.8	58.3	72.5
	Run 2 (up to 303 min elapsed)	43.1	60.0	71.3
	Run 3 (up to 427 min elapsed)	51.4	65.9	71.0
	<b>Run 4 (up to 576 min elapsed)</b>	43.5	59.1	<b>54.7</b>

Note: The serum ICP-MS method is rugged for Zn and Cu to delays in analysis of samples after preparation for up to 48 hrs (see part 1). The method is only rugged to delays in analysis for selenium for up to approximately 7 hours (one 90 patient sample run, or two 40 patient sample runs).

## Appendix B. Tables and Figures.

<b>Table 1. Instrument and Method Parameters</b>	
<b>Instrument:</b> PerkinElmer ELAN DRC <sup>Plus</sup> or DRC II ICP-MS CETAC ASX 500 series autosampler (tray B)	
<b>Optimization Window Parameters</b>	
RF power	1.45 KW
Plasma Gas Flow (Ar)	15 L/min
Auxiliary Gas Flow (Ar)	1.2 L/min
Nebulizer Gas Flow (Ar)	0.90 – 1.0 L/min (optimized as needed for sensitivity)
Ion Lens Voltage(s)	AutoLens (optimized as needed for sensitivity)
QRO, CRO, CPV, Discriminator Threshold	Optimized per instrument by service engineer, or advanced user.
Parameters of x-y alignment, nebulizer gas flow, AutoLens voltages, mass calibration, and detector voltages are optimized regularly. Optimization file name = default.dac.	
<b>Configurations Window Parameters</b>	
Cell Gas Changes Pause Times	Pressurize Delay (From Standard to DRC mode) = 60 Exhaust Delay (From DRC to Standard mode) = 60 Flow Delay (Gas changes while in DRC mode) = 25 Channel Delay (Gas channel change in DRC mode) = 25
<b>File Names &amp; Directories</b>	
Method file names	Serum panel 1_methITS005A_sblk.mth  Serum panel 1_methITS005A_aqblk.mth
Dataset	Create a new dataset subfolder each day. Name as “2006-0718” for all work done on July 18, 2006
Sample File	Create for each day's work
Report file name	<i>For sample results printouts</i> cdc_quant comprehensive.rop  <i>For calibration curve information</i> CDC_Quant Comprehensive (calib curve info).rop
Tuning	Default.tun
Optimization	Default.dac
Calibration	N/A
Polyatomic	elan.ply
Report Options Template (transferring results to the database)	CDC_Database Output.rop <i>Report Format Options: select only “Use Separator”</i> <i>File Write Option: Append</i> <i>Report File name: include date, instrument, and group being analyzed in file name (i.e. 20060724a_DRCC_HM- 0364.txt)</i>

<b>Method Parameters</b>	
<b>Method Parameters: Timing Page (see Figure 1 in the Appendix)</b>	
Sweeps/reading	90
Readings/replicate	1
Replicates	3
Enable QC Checking	Off
Isotopes Monitored and Internal Standard Associations (Exact Mass)	use <sup>71</sup> Ga as an internal standard <sup>64</sup> Zn (63.9291), <sup>65</sup> Cu (64.9278), <sup>71</sup> Ga (70.9247), <sup>78</sup> Se (77.9173)
Dwell Times	30 ms for <sup>64</sup> Zn, <sup>65</sup> Cu, <sup>71</sup> Ga (70.9247), <sup>78</sup> Se (77.9173)
Scan Mode	Peak Hopping for all isotopes (1 MCA channel)
DRC channel A Gas Flow Rate	Ammonia (5-7 psig delivery pressure) 0.5 L/min * (*Optimized per instrument, every 6-12 months)
RPa	0 for all isotopes
RPq	0.7 for all isotopes
<b>Method Parameters: Processing Page (see Figure 2 in the Appendix)</b>	
Detector mode	Pulse
Process Spectral Peak	N/A
AutoLens	On
Isotope Ratio Mode	Off
Enable Short Settling Time	Off
Blank subtraction	After internal standard
Measurement units	Cps
Process Signal Profile	N/A
<b>Method Parameters: Equations Page (see Figure 3 in the Appendix)</b>	
Equations	On <sup>64</sup> Zn, use "-0.035297 * Ni60" On <sup>78</sup> Se, use "-0.030461 * Kr83"
<b>Method Parameters: Calibration Page (see Figure 4 in the Appendix)</b>	
Calibration Type	External Std.
Curve type	Simple Linear
Sample units	µg/L
Calibration Standard Concentrations (µg/L)	Zn: 30, 90, 300, 900, 3,000 Cu: 30, 90, 300, 900, 3,000 Se: 3, 9, 30, 90, 300
<b>Method Parameters: Sampling Page (see Figure 5 in the Appendix)</b>	
"Peristaltic Pump Under Computer Control"	On
Sample Flush	~35s at 24 rpm (optimize time so that solution reaches nebulizer before Read Delay begins)

Read Delay	40s at 18 rpm
Wash	60s at 24 rpm
Autosampler Locations of Blanks and Standards	<p><i>For calibration curve (points to serum blank)</i>                  Serum panel 1_methITS005A_sblk.mth                  Serum Blank and Calibration Stds 1 – 5 in autosampler positions 101 – 106.</p> <p><i>For QC &amp; patient sample analysis (points to aqueous blank)</i>                  Serum panel 1_methITS005A_aqblk.mth                  Aqueous Blank in autosampler position 109.</p> <p>See figures 3a through 3e in Appendix B for other default autosampler settings.</p>

<b>Table 2. Suggested Maximum Analyte Concentrations for Base Serum.</b>	
<b>Analyte</b>	<b>Concentration (µg/L)</b>
Zn	400 (40 ug/dL)
Cu	500 (50 ug/dL)
Se	70

<b>Table 3. Concentrations of Analytes in the Multi-Element Intermediate Stock Standard from High Purity Standards.</b>	
<b>Analyte</b>	<b><i>Intermediate Stock Standard Concentrations (mg/L)</i></b> High Purity Standards Item # SM-2107-013 (2% HNO <sub>3</sub> )
Cu	300
Zn	300
Se	30
V and Mn are also in the mix at 1 and 2 mg/L for future R&D work	



**Table 4. Preparation of Multi-Element Intermediate Working Standards (for calibrators *and* calibration verification).**

Standard #	Units	1	2	3	4	5	Calib Verification
Vol of Flask (mL)		100	100	100	100	100	100
Vol Spike of Int. Stock Std. (mL)		0.010	0.030	0.100	0.300	1.00	3.00
<b>Concentrations</b>							
Zn	ug/L	30	90	300	900	3,000	9,000
	ug/dL*	3	9	30	90	300	900
Cu	ug/L	30	90	300	900	3,000	9,000
	ug/dL*	3	9	30	90	300	900
Se	ug/L	3	9	30	90	300	900

\* Use ug/dL units for Zn and Cu in the ELAN software and for reporting.

**Table 5. Acceptable ways to perform two consecutive analytical runs, bracketing with bench quality control samples.**

Setup 1*	Setup 2 (typical)*
<p><i>Run #1</i></p> <p>Calibration Standards                      Low Bench QC                      High Bench QC                      patient samples                      Low Bench QC                      High Bench QC</p> <p><i>Run #2</i></p> <p>Low Bench QC                      High Bench QC                      patient samples                      Low Bench QC                      High Bench QC</p> <p>* Use <math>\geq 18</math> Mega-ohm-cm water to rinse the system for 30 min. between the two runs.</p>	<p><i>Run #1</i></p> <p>Calibration Standards                      Low Bench QC                      High Bench QC                      patient samples                      Low Bench QC                      High Bench QC</p> <p><i>Run #2</i></p> <p>Calibration Standards                      Low Bench QC                      High Bench QC                      patient samples                      Low Bench QC                      High Bench QC</p> <p>* Use <math>\geq 18</math> Mega-ohm-cm water to rinse the system for 30 min. between the two runs.</p>

**Table 6. A typical SAMPLE/BATCH window.**

<u>AS Location*</u>	<u>Sample ID</u>	<u>Measurements Action</u>	<u>Method</u>
5	DRCstability1	Run sample	..._sblk.mth
5	DRCstability2	Run sample	..._sblk.mth
5	DRCstability3	Run sample	..._sblk.mth
5	DRCstability4	Run sample	..._sblk.mth
Continue DRC stability samples ...			
5	DRCstability9	Run sample	..._sblk.mth
5	DRCstability10	Run sample	..._sblk.mth
100	Sblkchk1	Run blank, standards, and sample **	..._sblk.mth
101	Sblkchk2	Run sample	..._sblk.mth
127	Aq Blk Check	Run blank and sample †	..._aqblk.mth
138	L Bench QC	Run sample	..._aqblk.mth
134	H Bench QC	Run sample	..._aqblk.mth
46	Sample 1	Run sample	..._aqblk.mth
47	Sample 2	Run sample	..._aqblk.mth
48	Sample 3	Run sample	..._aqblk.mth
.	.	.	.
.	.	.	.
.	.	.	.
140	Blind QC	Run sample	..._aqblk.mth
139	L Bench QC	Run sample	..._aqblk.mth
135	H Bench QC	Run sample	..._aqblk.mth

\* The exact autosampler positions of QCs and patient samples do not have to be those shown above, but the order in which these are run should be as shown above.

\*\* When executing this row, the ELAN will first analyze the serum blank at AS position 101, then standards 1-5 at autosampler positions 102-106, then the "sblkchk1" sample at A/S position 100. The sampling information about AS positions 101-106 are stored in the "sblk" method file.

† When executing this row, the ELAN will first analyze the aqueous blank at AS position 109, then the "Aq Blk Check" at AS position 20. The sampling information about AS positions 109 is stored in the "aqblk" method file.

Dilution ID	Water (µL)	Base Serum (µL)	AQ Intermediate Working Standard (µL)	Patient or QC Serum sample (µL)	Diluent * (µL)
AQ Blank	300	-	-	-	4,200
Serum Blank and sbkchk	150	150	-	-	4,200
Working Calibrators or Working Calibration Verification Standards	-	150	150	-	4,200
Patient Serum or Serum-Based QC	150	-	-	150	4,200
Patient Serum <i>2x Dilution</i> <sup>H</sup>	225	-	-	75	4,200
Patient Serum <i>10x Dilution</i> <sup>H</sup>	570	-	-	30	8,400

<sup>H</sup> Extra dilution is performed on serum samples whose concentration is greater than the concentrations listed in Table 8 in the Appendix (linearity of the method has been documented up to these concentrations). Any extra level of dilution can be prepared as long as the 14:15 ratio of diluent to total dilution volume is maintained. Use of the lowest possible dilution level is preferred because matrix differences may lead to different observed concentration results as the sample dilution becomes greater (i.e. 2x dilution is preferred over 10x if 2x is sufficient to dilute analyte into the documented linearity range).

\* Dispense diluent using the Digiflex as 2 portions which add to the total volume required. For example, when preparing a serum blank above, do the preparation in 2 steps. Step 1: 150 µL water + 2100 µL diluent. Step 2: 150 µL base serum + 2100 µL diluent. This method of dispensing helps flush the smaller volume being added from the pipette with diluent.

Analyte	Highest Conc. (µg/L) Verified in Calibration Verification ("Range of Linearity Tested", or "RLT") *
Zn	9,000 (900 ug/dL)
Cu	9,000 (900 ug/dL)
Se	900

\* If observed results are not within 10% of target, investigate the problem with the involvement of the lab supervisor.

**Table 9. Boundary Concentrations for Serum.**

Analyte (units)	2 <sup>nd</sup> Lower Boundary ("2LB")**	1 <sup>st</sup> Lower Boundary ("1LB")*	1 <sup>st</sup> Upper Boundary ("1UB")*	2 <sup>nd</sup> Upper Boundary ("2UB")**	Range Maximum ("Lim Rep Delta") †
Zn (µg/dL)	35	35	120	240	17
Cu (µg/dL)	10	10	300	600	20
Se (µg/L)	45	45	165	330	20

\* Typically, the 1<sup>st</sup> upper boundaries (1LB and 1UB) are based on percentiles of non-weighted, non-creatinine corrected concentration results from NHANES. In the absence of that data, these boundaries can be based on normal ranges reported in the literature. The concentrations assigned to these boundaries is determined by study protocol but default concentrations are listed in this table. Report the original result, as long as the confirmation is within 10% of the original. Continue repeat analysis until a concentration can be confirmed.

\*\* These 2<sup>nd</sup> boundaries (2LB and 2UB) are set to 0.5x the 1LB and 2x the 1UB, respectively. The concentrations assigned to these boundaries is determined by study protocol but default concentrations are listed in this table. Regardless of the study, the analyst should specifically address patient results confirmed to be less than the 2LB or greater than the 2UB to the QC reviewer as unusually low or high results.

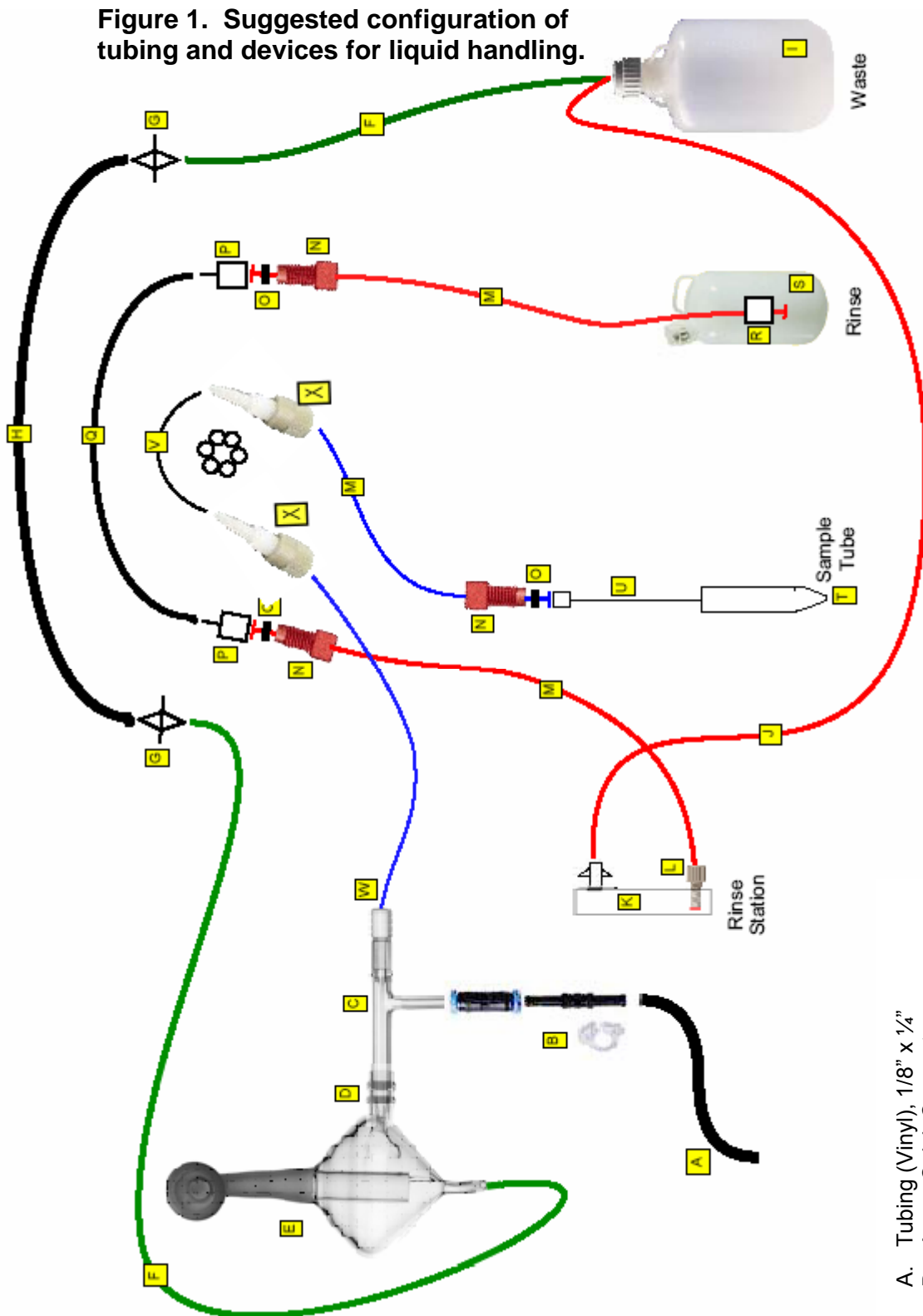
† Range maximum is the range of the three replicate readings for a single sample analysis. This value is also called the "Lim Rep Delta" in the database which handles data for the Inorganic Toxicology and Nutrition Branch. If the range of replicate readings is greater than the range maximum, and represents greater than a 10% relative standard deviation for the measurement, do not use the measurement for reporting.

**Table 10. Reference Ranges for Serum Concentrations Se in µg/L; Zn and Cu in µg/dL.**

Analyte	Reference Ranges
Zn	70-120 [10]
Cu	20-302 [10]
Se	95-165 [11], [14]

Appendix (continued): Figures

Figure 1. Suggested configuration of tubing and devices for liquid handling.



- A. Tubing (Vinyl), 1/8" x 1/4"
  - B. Argon Quick Connect
  - C. Quartz Concentric Nebulizer
  - D. Spray Chamber O-rings
  - E. Quartz Cyclonic Spray Chamber
  - F. Tubing (PVC), 1/8" x 3/16"
  - G. Tubing Connector
  - H. Tubing (Peristaltic), 0.125" ID
  - I. Carboy for Liquid Waste (10L)
  - J. Tubing (PVC), 3/16" x 5/16"
  - M. Rinse Station (Modified)
  - N. Nut, 10-32 threads, 1/16" tubing
  - O. Tubing (PFA), 0.5mm x 1.59 mm
  - P. Nut, 1/4-28 thread, 1/16" tubing
  - Q. O-ring, 1/16" ID x 3/16" OD
  - R. Adapter, 1/4-28 screw to 1.8 mm barb
  - S. Tubing (Peristaltic), 0.045" ID
- Tube (PP, lot screened), 15 mL
  - Probe, corrosion resistant
  - Tubing (Peristaltic), 0.03" ID
  - Quick Connect for liquid (can be done using Upchurch adapter)
  - PEEK adapter (1.6mm OD PFA to 0.03" ID peristaltic tubing)

Appendix B (continued)

Figure 2a. ELAN ICP-DRC-MS Method Screen Shots (timing page).

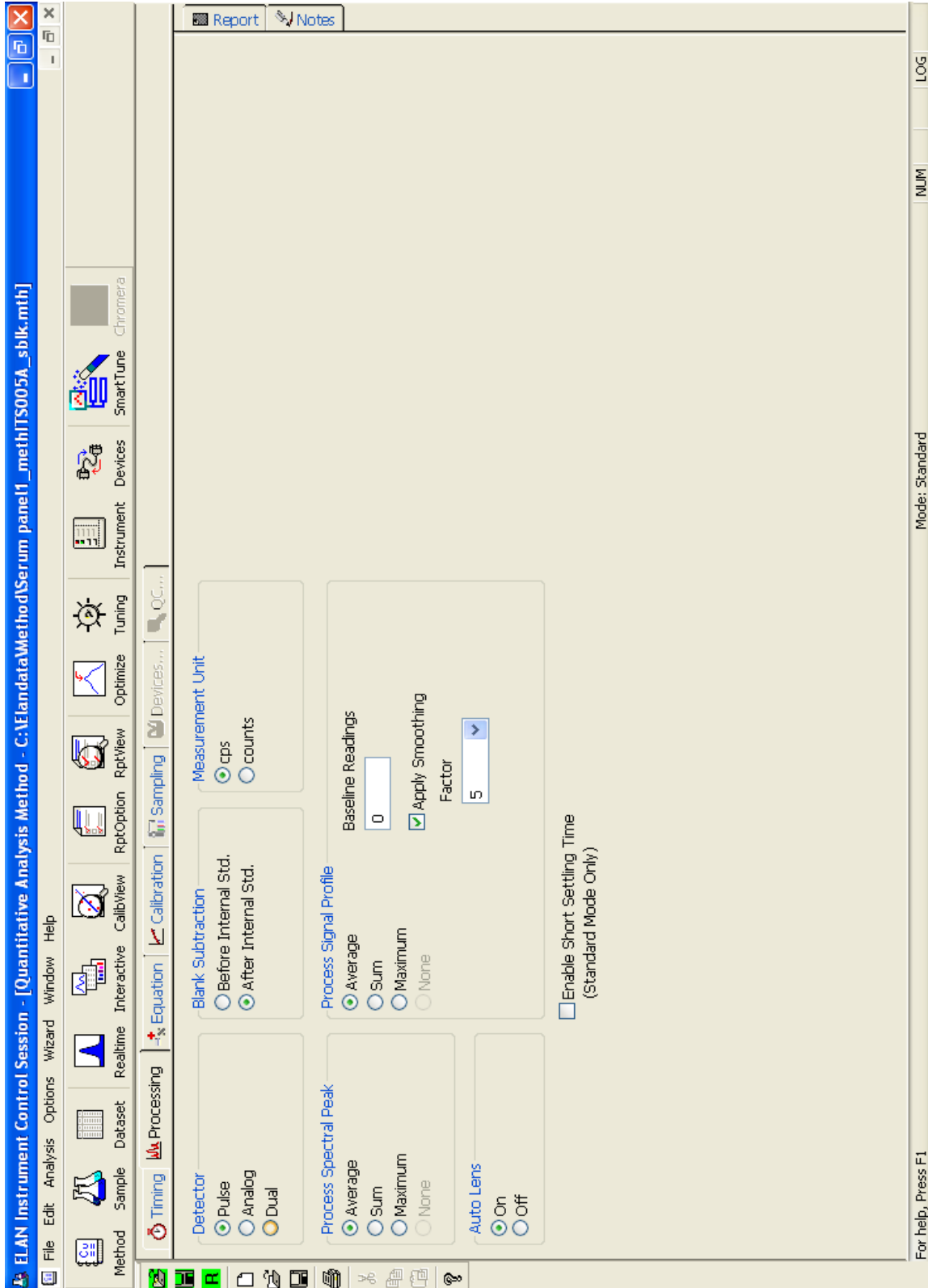
**Optimize Per Instrument**

Int Std	Analyte (*)	Mass (amu)	Scan Mode (*)	MCA Channels	Dwell Time per AMU (ms)	Integration Time (ms)	Corrections	Cell Gas A	Cell Gas B	RP a	RP q	Mode
1	V	50.944	Peak Hopping	1	100	9000		0.5	0	0	0.7	DRC
2	Mn	54.9381	Peak Hopping	1	30	2700		0.5	0	0	0.7	DRC
3	Zn	63.9291	Peak Hopping	1	30	2700	Ni	0.5	0	0	0.7	DRC
4	Cu	64.9278	Peak Hopping	1	30	2700		0.5	0	0	0.7	DRC
5	Ga	70.9249	Peak Hopping	1	30	2700		0.5	0	0	0.7	DRC
6	Se	77.9173	Peak Hopping	1	30	2700	Kr	0.5	0	0	0.7	DRC
7												
8												
9												
10												
11												
12												
13												
14												
15												
16												
17												
18												

V and Mn are only Research and Development. Not for Clinical Reporting. Remove these rows when analyzing any clinical samples (non-Proficiency Testing).

Appendix B (continued)

Figure 2b. ELAN ICP-DRC-MS Method Screen Shots (processing page).



Appendix B (continued).

Figure 2c. ELAN ICP-DRC-MS Method Screen Shots (equation page).

The screenshot shows the ELAN Instrument Control Session interface. The main window displays the following information:

**Isotope Information**

Isotope	Mass	Abundance	Interferences
V 50	49.9472	0.250000	Cr, Ti, AlC, CCl, H50, S0, AlN
V 51	50.9440	99.750000	Cl0, H50

**Table of Analyte Information:**

Int Std	Analyte (*)	Mass (amu)	Corrections	Potential Interferences
1	V	50.944		ClO, H50
2	Mn	54.9381		ArN, HClO, ClO
3	Zn	63.9291	- 0.035297 * Ni 60	Ni, SO2, TiO, CaO, PO2
4	Cu	64.9278		PO2, SO2, TiO, Ba++
5	Ga	70.9249		ArCl, ClO2, ArP, Ce++, Nd++,
6	Se	77.9173	- 0.030461 * Kr 83	Kr, Ar2, Gd++, Gd++, Dy++
7				
8				
9				
10				
11				
12				
13				
14				
15				
16				
17				
18				
19				
20				

**Warning Box:**

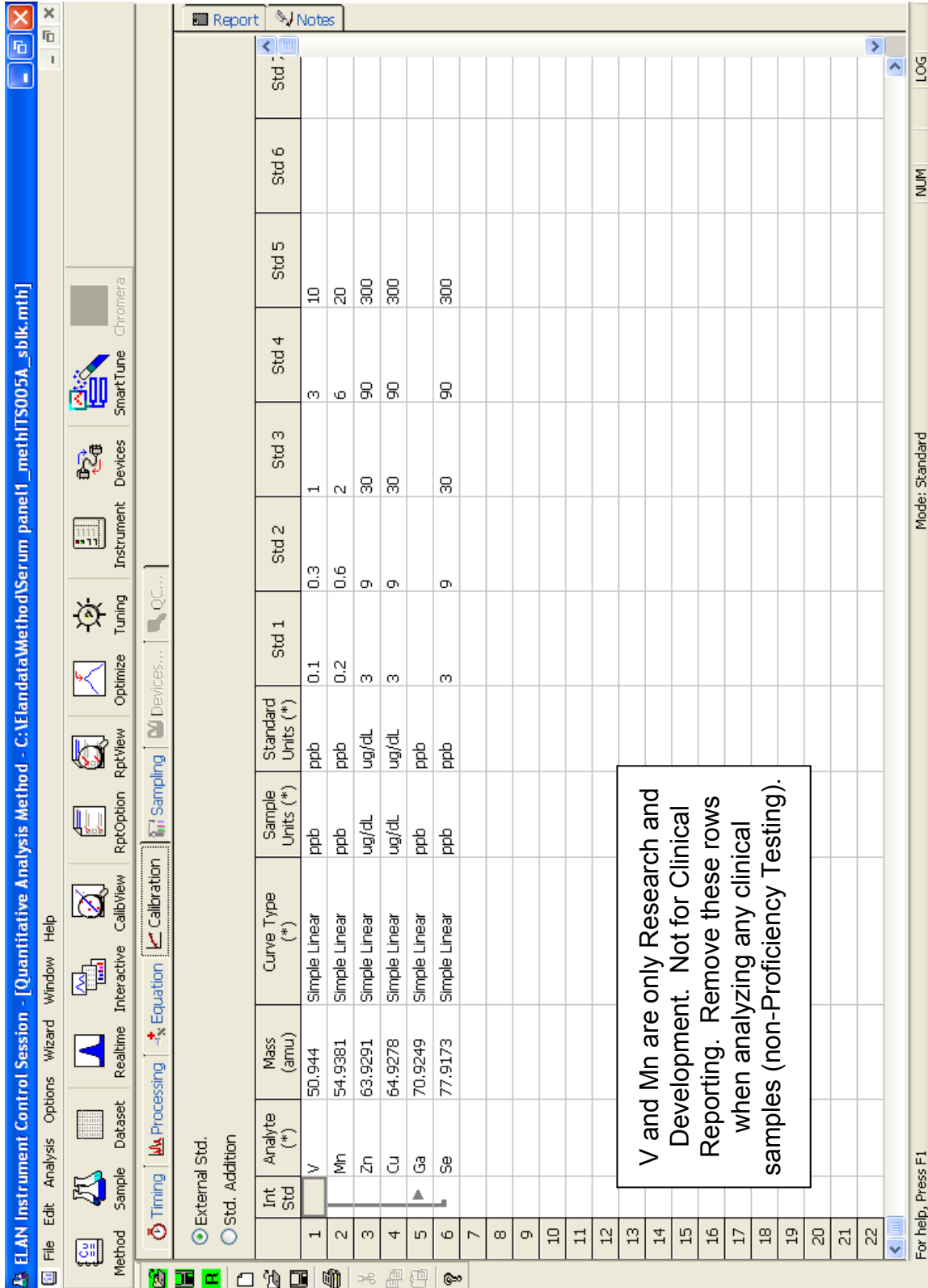
V and Mn are only Research and Development. Not for Clinical Reporting. Remove these rows when analyzing any clinical samples (non-Proficiency Testing).

The interface also shows a menu bar with options like File, Edit, Analysis, Options, Wizard, Window, Help. A toolbar contains icons for various functions such as Timing, Processing, Equation, Calibration, Sampling, RptOption, RptView, Instrument, Devices, SmartTune, and Chromera. The status bar at the bottom indicates 'Mode: Standard' and 'For help, Press F1'.



Appendix B (continued).

Figure 2d. ELAN ICP-DRC-MS Method Screen Shots (calibration page).



ELAN Instrument Control Session - [Quantitative Analysis Method - C:\Elandata\Method\Serum\panel1\_meth\TS005A\_sbik.mth]

External Std.  
Std. Addition

Int Std	Analyte (*)	Mass (amu)	Curve Type (*)	Sample Units (*)	Standard Units (*)	Std 1	Std 2	Std 3	Std 4	Std 5	Std 6	Std 7
1	V	50.944	Simple Linear	ppb	ppb	0.1	0.3	1	3	10		
2	Mn	54.9381	Simple Linear	ppb	ppb	0.2	0.6	2	6	20		
3	Zn	63.9291	Simple Linear	ug/dL	ug/dL	3	9	30	90	300		
4	Cu	64.9278	Simple Linear	ug/dL	ug/dL	3	9	30	90	300		
5	Ga	70.9249	Simple Linear	ppb	ppb							
6	Se	77.9173	Simple Linear	ppb	ppb	3	9	30	90	300		
7												
8												
9												
10												
11												
12												
13												
14												
15												
16												
17												
18												
19												
20												
21												
22												

V and Mn are only Research and Development. Not for Clinical Reporting. Remove these rows when analyzing any clinical samples (non-Proficiency Testing).

For help, Press F1

Appendix B (continued).

Figure 2e. ELAN ICP-DRC-MS Method Screen Shots (sampling page).

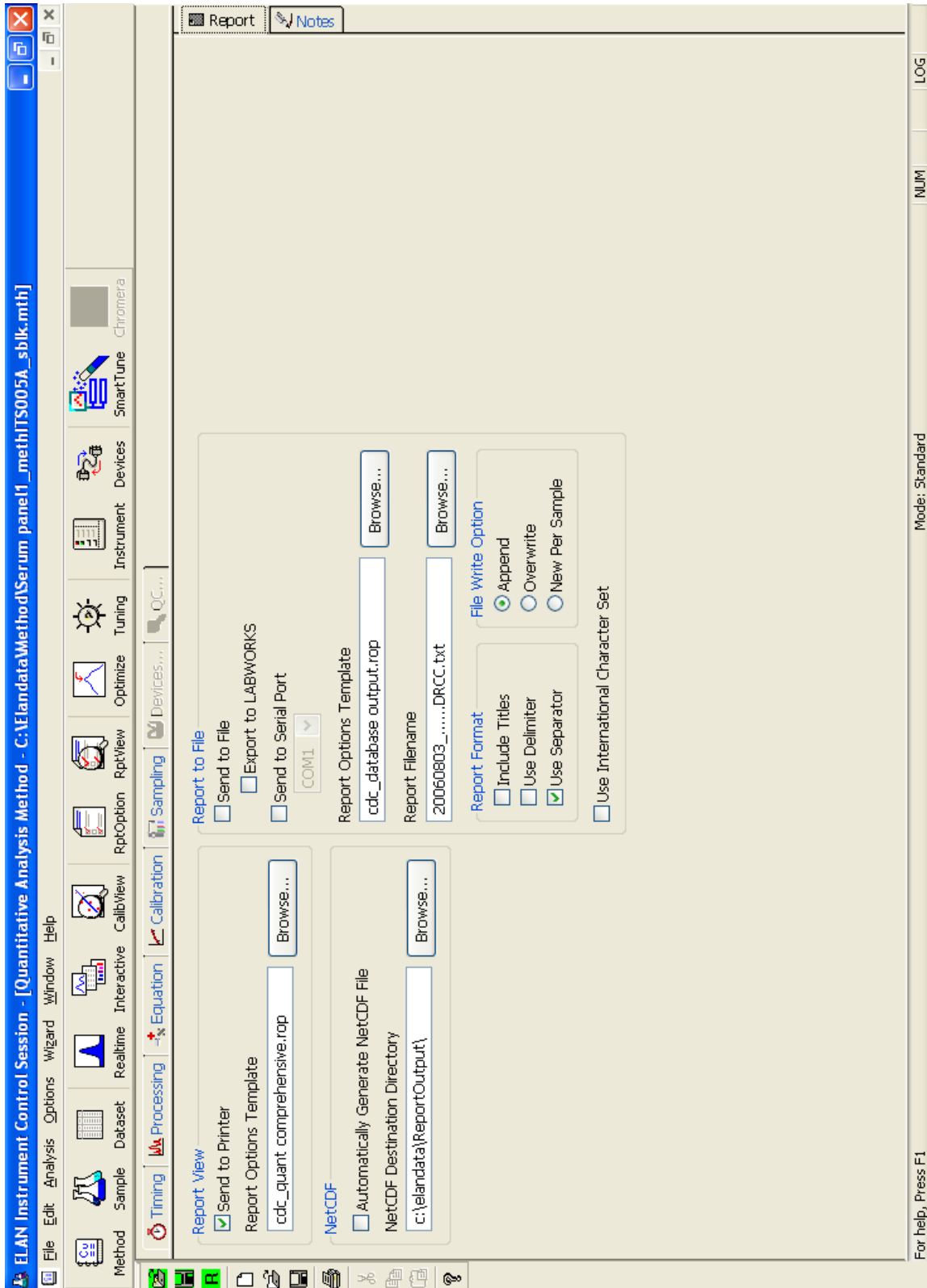
The screenshot displays the ELAN Instrument Control software interface, specifically the Sampling page. The top menu bar includes File, Edit, Analysis, Options, Wizard, Window, and Help. The toolbar contains icons for Method, Sample, Dataset, Realtime, Interactive, Calibration, RptOption, RptView, Optimize, Tuning, Instrument, Devices, SmartTune, and Chromato. The main control area features several input fields: Autosampler (AS-93plus), Dil. Factor (10), Dil. To Vol. (10), Tray (c:\program files\es\test\sc\test.try), 1st. Dil. Pos (1), and Sampling Device ((None)). A checkbox for Peristaltic Pump Under Computer Control is checked. Below the control area is a table with 26 rows and 10 columns. The table columns are: Solution ID, A/S Loc., Sample Flush (sec), Sample Flush Speed (+/- rpm), Read Delay (sec), Delay & Analysis Speed (+/- rpm), Wash (sec), and Wash Speed (+/- rpm). The rows represent different standards, from Blank to Standard 25.

	Solution ID	A/S Loc.	Sample Flush (sec)	Sample Flush Speed (+/- rpm)	Read Delay (sec)	Delay & Analysis Speed (+/- rpm)	Wash (sec)	Wash Speed (+/- rpm)
1	Blank		45	-24	45	-18	60	-24
2	Standard 1	101	45	-24	45	-18	60	-24
3	Standard 2	102	45	-24	45	-18	60	-24
4	Standard 3	103	45	-24	45	-18	60	-24
5	Standard 4	104	45	-24	45	-18	60	-24
6	Standard 5	105	45	-24	45	-18	60	-24
7	Standard 6	106	45	-24	45	-18	60	-24
8	Standard 7		45	-24	35	-18	60	-24
9	Standard 8		45	-24	35	-18	60	-24
10	Standard 9		45	-24	35	-18	60	-24
11	Standard 10		45	-24	35	-18	60	-24
12	Standard 11		45	-24	35	-18	60	-24
13	Standard 12		45	-24	35	-18	60	-24
14	Standard 13		45	-24	35	-18	60	-24
15	Standard 14		45	-24	35	-18	60	-24
16	Standard 15		45	-24	35	-18	60	-24
17	Standard 16		45	-24	35	-18	60	-24
18	Standard 17		45	-24	35	-18	60	-24
19	Standard 18		45	-24	35	-18	60	-24
20	Standard 19		45	-24	35	-18	60	-24
21	Standard 20		45	-24	35	-18	60	-24
22	Standard 21		45	-24	35	-18	60	-24
23	Standard 22		45	-24	35	-18	60	-24
24	Standard 23		45	-24	35	-18	60	-24
25	Standard 24		45	-24	35	-18	60	-24
26	Standard 25		45	-24	35	-18	60	-24

At the bottom right of the window, it says "Mode: Standard" and "For help, Press F1".

Appendix B (continued).

Figure 2f. ELAN ICP-DRC-MS Method Screen Shots (report page).



Appendix B (continued).

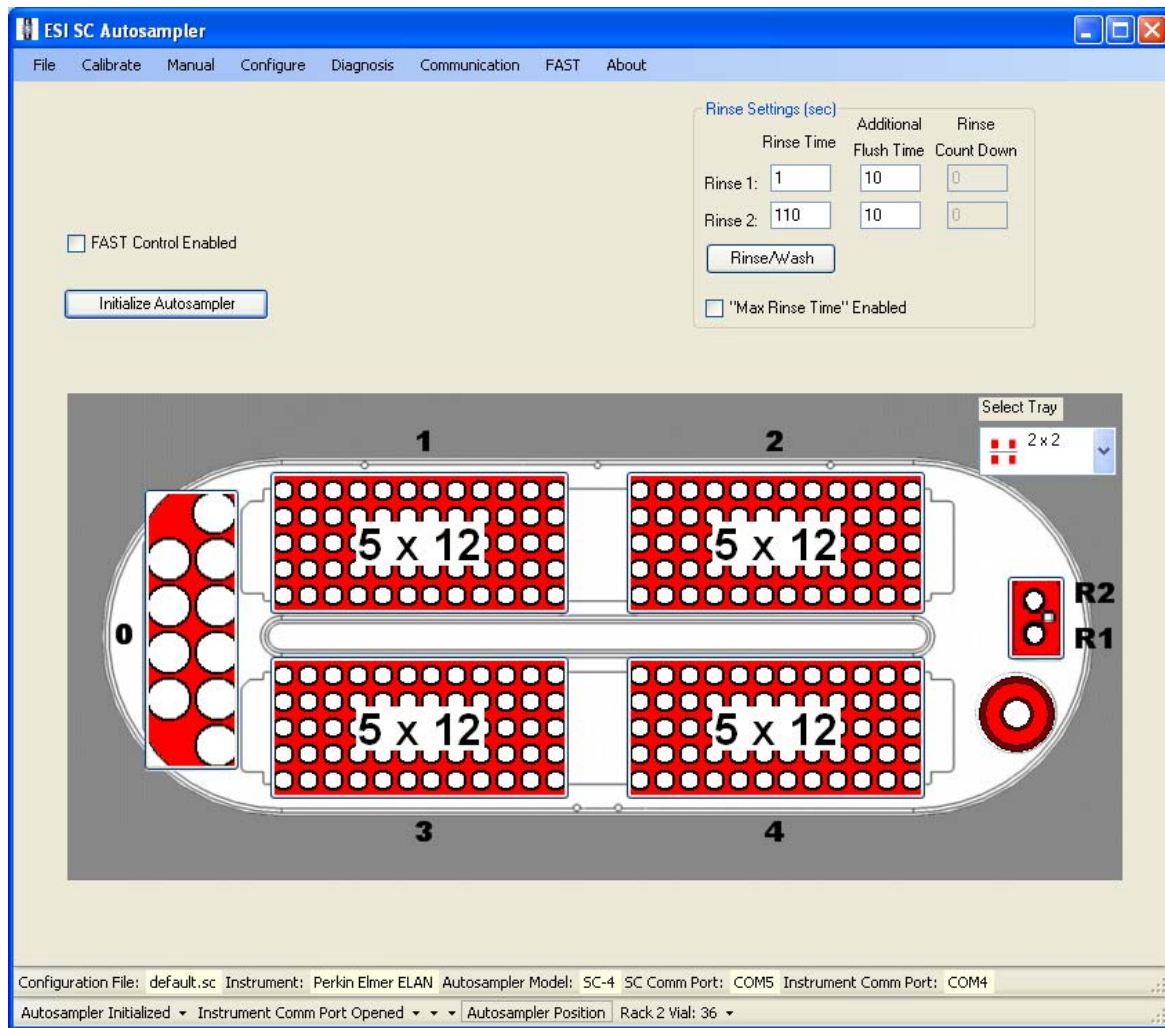
Figure 3a. ESI SC4 Autosampler Screen Shots used (Main page).

Additional flush times and “Max Rinse Time” are default, but can be optimized for best reduction of elemental carry-over between samples. Tray types can be changed to allow for different volumes of diluted sample digests. ‘FAST control’ should be unchecked. Rinse and additional flush times for eliminating carry-over from one sample to the next while using the minimum amount of rinse solution.

A rinse time of -1 causes the rinse station to be skipped.

A rinse time of 0 causes the probe to only dip into the station, but spends no time there.

Additional flush times can be optimized to keep the rinse station full while not using too much rinse solution. The inner diameter size of the tubing providing the rinse solution to the rinse station determines how quickly the station will fill. Various sizes are available for purchase or can be made in the laboratory.

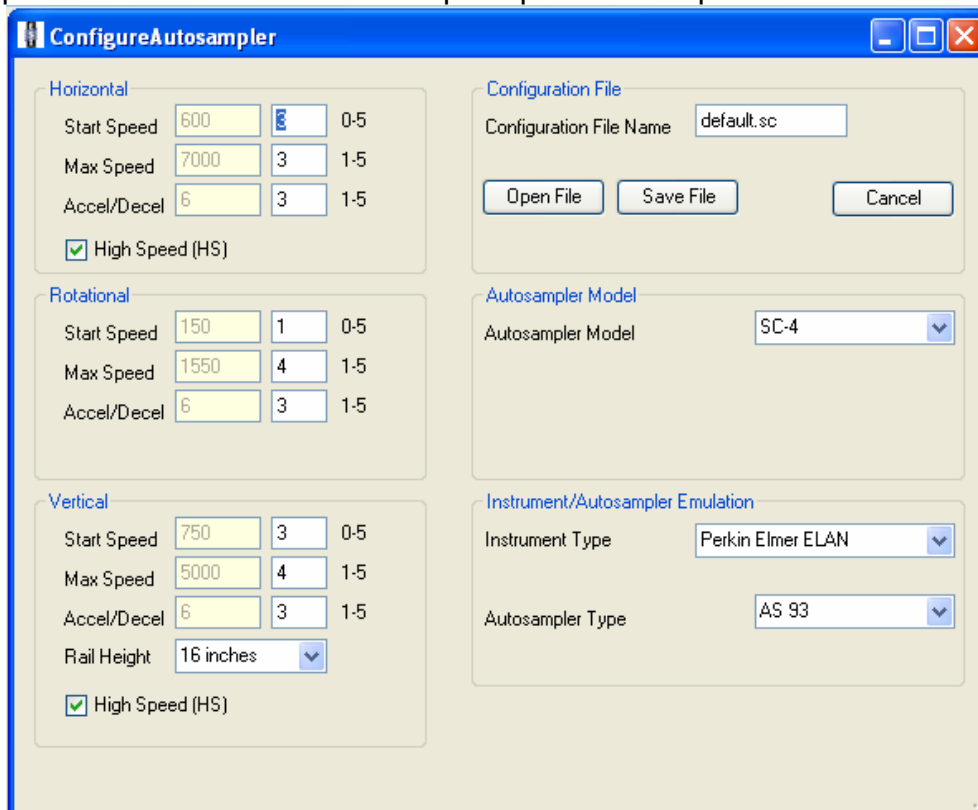


**Appendix B (continued).**

**Figure 3b. ESI SC4 Autosampler Screen Shots used (Configuration).**

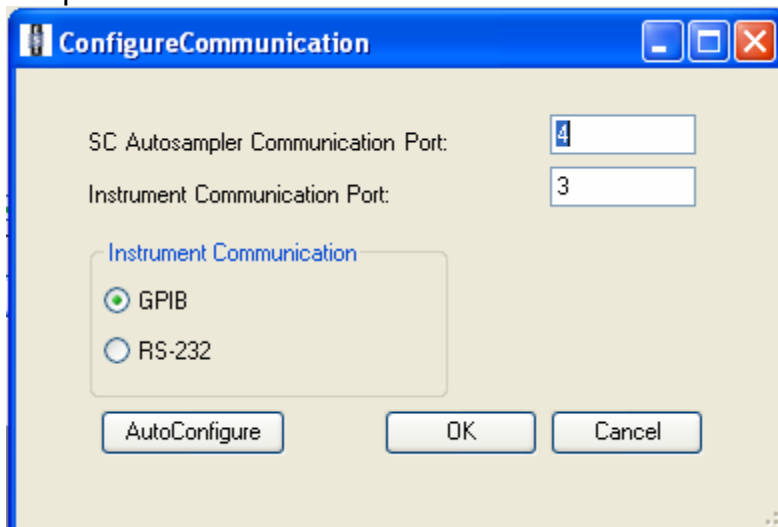
**Appendix B (continued).**

“High Speed” option is to only be used for ‘High Speed’ models of the SC4 (look for “HS” in serial number). Speeds and accel / decel values can be optimized per analyst preference and to minimize droplet splatter off of probe.



**Figure 3c . ESI SC4 Autosampler Screen Shots used (“Communication” page).**

Communication ports will differ depending on available ports on instrument control computer.



Appendix B (continued).

Figure 3d. ESI SC4 Autosampler Screen Shots (5x12 Rack Setup window).

Settings are approximate. To be sure the loop is filled, the probe should go down close to the bottom of the cup, but not touch. Optimize retraction speed for least droplet splatter.

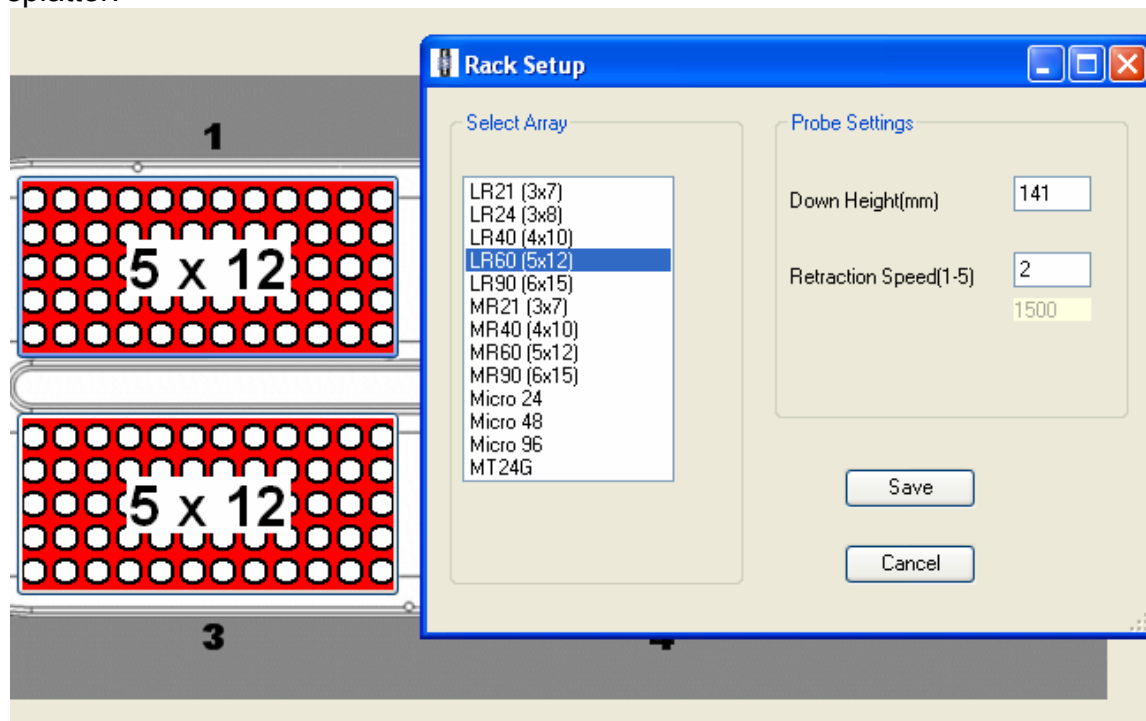
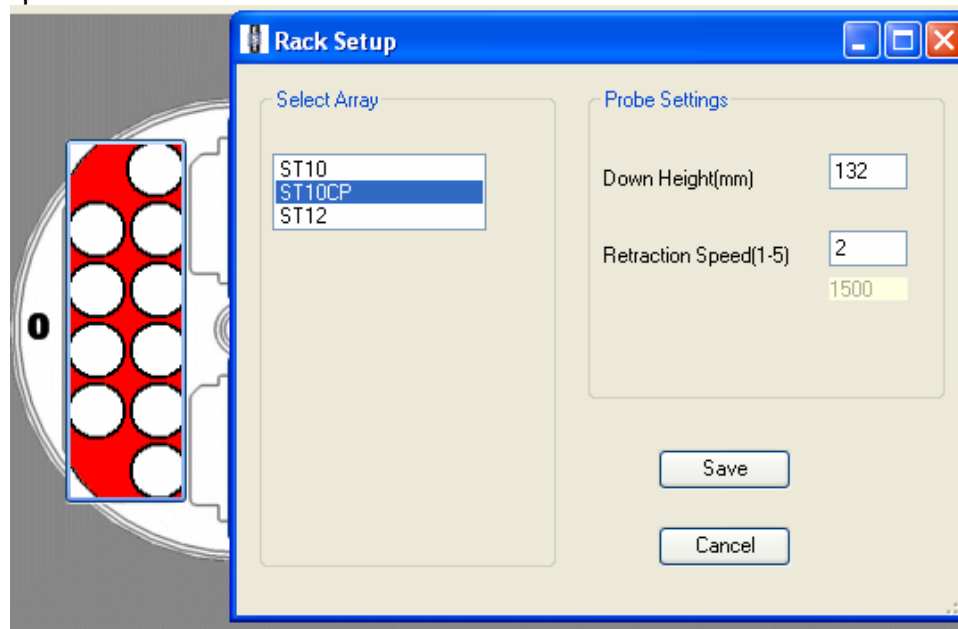


Figure 3e. ESI SC4 Autosampler Screen Shots (50mL Tube Rack Setup window).

Settings are approximate. To be sure the loop is filled, the probe should go down close to the bottom of the cup, but not touch. Optimize retraction speed for least droplet splatter.



## References

1. Thomas, R., *Practical Guide to ICP-MS (Practical Spectroscopy)*. 2003, New York, NY: Marcel Dekker. 336.
2. Tanner, S.D., Baranov, Vladimir I, *Theory, Design, and Operation of a Dynamic Reaction Cell for ICP-MS*. Atomic Spectroscopy, 1999. 20(2): p. 45-52.
3. Tanner, S.D., V.I. Baranov, and D.R. Bandura, *Reaction cells and collision cells for ICP-MS: a tutorial review*. Spectrochimica Acta Part B-Atomic Spectroscopy, 2002. 57(9): p. 1361-1452.
4. PerkinElmer SCIEX Instruments, *ELAN DRC II Hardware Guide*. 2001, Canada.
5. Piraner, O., Serum vanadium ICPDRCMS\_ITS004A. 2003, Centers for Disease Control and Prevention.
6. Piraner, O., Serum manganese ICPDRCMS\_ITS003A. 2003, Centers for Disease Control and Prevention.
7. Piraner, O., Serum selenium ICPDRCMS\_ITS002A. 2004, Centers for Disease Control and Prevention.
8. Walters, P. J., Serum Copper Zinc ICP-DRC-MS\_ITS001A. 2004, Centers for Disease Control and Prevention.
9. Office of Health and Safety in the Division of Laboratory Sciences, *Policies and Procedures Manual*. 2002, Division of Laboratory Sciences (DLS), National Center for Environmental Health, Centers for Disease Control and Prevention, Public Health Service, Department of Health and Human ServicesCenters for Disease Control and Prevention.
9. Centers for Disease Control and Prevention (CDC) Radiation Safety Committee, *CDC/ATSDR Occupational Health and Safety Manual (Radiation Safety chapter)*. Centers for Disease Control and Prevention, Public Health Service, Department of Health and Human ServicesCenters for Disease Control and Prevention.
10. Tietz Textbook of Clinical Chemistry, Third Edition, edited by Burtis C. A., Ashwood E. R., 1999
11. Agency for Toxic Substance and Disease Registry (2000). Toxicological Profile for Selenium. Atlanta, GA: U. S. Department of Health and Human Services, Public Health Service.
12. Lauwerys R.R. Chapter II: Biological monitoring of exposure to inorganic and organometallic substances, In: *Industrial Chemical Exposure: Guidelines for Biological Monitoring*, Biomedical Publications, pp. 9-50, 1983
13. *Handbook on Metals in Clinical and Analytical Chemistry*, edited by Seiler H.G., Sigel A., Sigel H., Marcel Dekker, Inc, 1994
14. Niskar AS, Paschal DC, Kieszak SM, Flegal KM, Bowman B, Gunter EW, Pirkle JL, Rubin C, Sampson EJ, McGeehin M. Serum selenium levels in the US population: Third National Health and Nutrition Examination Survey, 1988-1994. *Biol Trace Elem Res* 2003 Jan; 91(1): 1-10

## Navajo Birth Cohort Study Protocol for Cellular immunological laboratory protocol

### Flow cytometry protocol for lymphocyte phenotypization

1. For each sample, label six 12 x 75 mm or 15 ml Falcon tubes, A through F. Also label each tube with sample identification number or barcode.
2. Place 20  $\mu$ l of reagent A into tube A, 20  $\mu$ l of reagent B into tube B, 20  $\mu$ l of reagent C into tube C, 20  $\mu$ l of reagent D into tube D, 20  $\mu$ l of reagent E into tube E, and 20  $\mu$ l of reagent F into tube F.
3. For each sample, use a fresh micropipette tip and add 100  $\mu$ l of anticoagulated whole blood sample into the bottom of each of the six labeled tubes. The required WBC concentration is 3,500-9,800 cells/  $\mu$ l blood. Vortex thoroughly at low speeds for 3 seconds and incubate for 15 to 30 minutes at room temperature (20-25 °C). During this incubation protect samples from direct light. Prevent blood from running down the side of the tube, pipette directly into the staining reagents.
4. Dilute 10X Lysing Solution to 1X following the instructions for Reagent G. The 1X solution is stable at room temperature for 1 month. Add 2 mL of this 1X lysing solution to each tube. Immediately vortex them at low speed for 3 seconds and incubate for 10 to 12 minutes at room temperature in the dark. Do not exceed 12 minutes as the lysis can destroy the stained lymphocytes as well.
5. Immediately after incubation, centrifuge tubes at 300x g for 5 minutes at room temperature.
6. Aspirate the supernatant, leaving approximately 50  $\mu$ l of residual fluid in each tube to avoid disturbing the pellet.
7. Vortex thoroughly at low speed to resuspend the cell pellet in the residual fluid and then add 2 mL PBS to each tube. Vortex thoroughly at low speed for 3 seconds. Centrifuge at 200 x g for 5 minutes at room temperature.
8. Aspirate the supernatant, leaving appr. 50  $\mu$ l of residual fluid in the tube to avoid disturbing the pellet.
9. Vortex thoroughly at low speed to resuspend the cell pellet in the residual fluid and then add 0.5 mL of 1% paraformaldehyde to each tube. Vortex thoroughly for 3 seconds. Make sure that the cells are mixed well with the fixing solution.
10. The cells are ready to be analyzed on the flow cytometer. Cap or cover tubes and store them at 2- 8 °C in the dark till analysis. Analyze the fixed cells within 24 hours after staining.

### Principles of procedure

When the monoclonal antibody reagents are added to human whole blood, the fluorochrome-labeled antibodies bind specifically to antigens on the surface of leucocytes. The stained samples then treated with Lysing Solution to lyse erythrocytes and washed prior to flow cytometry analysis.

An aliquot of the stained participant sample is introduced into the flow cytometer and passed in a narrow stream through the path of a laser beam. The stained cells fluoresce when excited by the laser beam and the emitted light is collected and processed by the flow cytometer. The use of two fluorochromes permits simultaneous two-color analysis because each fluorochrome emits



light at different wavelength when excited at 488 nm by an argon-ion laser. The FITC-stained lymphocytes emit yellow-green light (maximum 515 nm) while the PE-stained lymphocytes emit red-orange light (580 nm).

For each sample, the lymphocyte acquisition gate set with LeucoGATE (tube A) and the fluorescence markers determined using the Control (tube B) are used to analyze the subsequent tubes (C through F). The software uses quadrant correction option; the lymphocyte subpopulations in tube C through F are enumerated and then expressed as percentages of lymphocytes in the acquisition gate.

### *Reagents*

**Reagent A – LeucoGATE (CD45/CD14)** LeucoGATE is used to define and evaluate the light-scatter gate that distinguishes lymphocytes from granulocytes, monocytes, unlysed or nucleated red blood cells and debris. The reagent contains FITC-labeled CD45 for identification of leucocytes, and PE-labeled CD14 for identification of monocytes.

**Reagent B – Control** This isotype IgG control is used to set the lowest quadrant markers around unstained (negative) lymphocytes. This reagent helps to establish nonantigen-specific antibody binding, in particular that caused by Fc receptors.

**Reagent C – CD3/CD19** This reagent is used to enumerate T and B lymphocytes. It contains FITC-labeled CD3 for identification of T lymphocytes and PE-labeled CD19 for identification of B cells.

**Reagent D – CD4/CD8.** This stain is used to simultaneously characterize helper/inducer and suppressor/cytotoxic lymphocytes. It contains FITC-labeled CD4 for identification of helper/inducer T lymphocytes and PE-labeled CD8 for identification of suppressor/cytotoxic T lymphocytes.

**Reagent E – CD+/Anti-HLA-DR** This reagent is used to enumerate T lymphocytes, DR+ non-T lymphocytes (mostly and primarily B cells) and activated T lymphocytes. It contains FITC-labeled CD3 for identification of T lymphocytes and PE-labeled anti-HLA-DR for identification of DR+ non-T cells and activated T lymphocytes.

**Reagent F – CD3/CD16+CD56** This stain is applied to identify T and NK lymphocytes. It contains FITC-labeled CD3 for identification of T lymphocytes. It also contains PE-labeled CD16 and PE-labeled CD56 for identification of NK cells as well T-lymphocyte subsets.

**Reagent G – 10X Lysing Solution.** This reagent contains 10X buffered Lysing Solution, with less than 50% diethylene glycol and less than 15% formaldehyde. When stored at room temperature this solution is stable until expiration date.

The reagents are under the US Patent No. 4,895,796.

Detection: fluorescence activity will be detected by flow cytometer, Becton Dickinson FACScan machine BD Catalog #34001010 or Accuri portable flow cytometer machine, Accuri, Ann Arbor, MI).

## Humoral immunological measurements

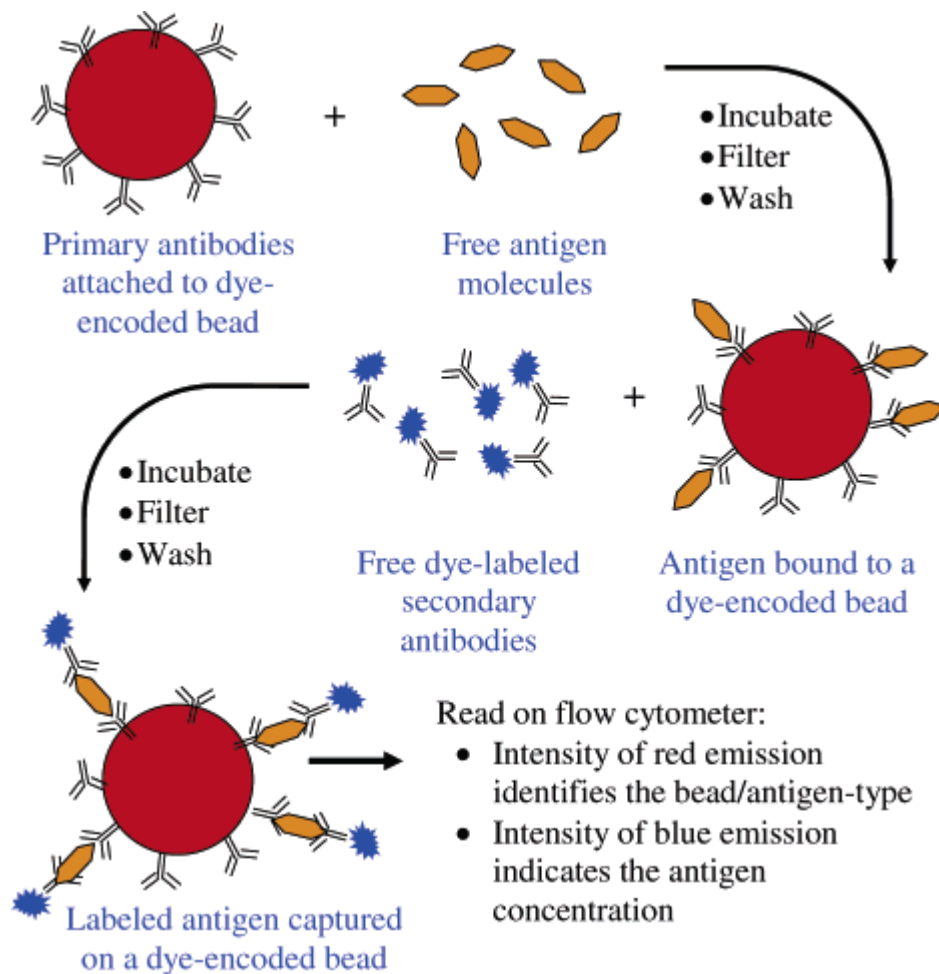
### Serum cytokine measurements

We will address inflammatory and/or hypersensitivity conditions among NBC participants applying comprehensive multiplexing technology and Luminex 100™ detection system (Luminex Co. Austin, TX) for serum cytokine production.

Cytokines play a central role in mediating both cellular and humoral immune responses against invading pathogens and tumor cells. Many of them also control the growth differentiation, effector function and survival of all cells in the body. Human 10-plex high sensitivity cytokine/chemokine panel (IL-1 $\beta$ , IL-2, IL-4, IL-5, IL-6, IL-8, IL-10, INF- $\gamma$ , TNF- $\alpha$ , and GM-CSF) will be used to detect presence or absence of inflammatory cytokines, with special attention paid to uncovering potential imbalances in Th1/Th2 immune responses.

### Assay methodology *Cytokine measurements using multiplexing technique*

Figure of the assay of determination of cytokines using flow cytometry technique



This methodology is the most advanced technology of using very small amount of patient samples. The assay requires only 50  $\mu$ l of serum samples and measures the entire panel of cytokines parallel from only 1 sample. This is not only saves a lot of samples, requires less blood donation from participants, but also the most sensitive technique. The serum cytokines detected at the pg/ml detection limits.

#### *Assay detection*

At the UNM Flow Cytometry Core Facility xMAP multiplexing technology is readily available for this project. The UNM Research Team will use Luminex 100™ detection system to quantitate immunoassays in a 96 well format.