

**Colorado Water Institute  
Annual Technical Report  
FY 2012**

# Introduction

**Colorado Water Institute Annual Report for the period:  
March 1, 2012 – February 28, 2013**

Water research is more pertinent than ever in Colorado. Whether the project explores the effects of decentralized wastewater treatment systems on water quality, optimal irrigation scheduling, household conservation patterns, the effects of wastewater reuse on turfgrass, the economics of water transfers, or historical and optimal streamflows, water is a critical issue. In a headwaters state where downstream states have a claim on every drop of water not consumed in the state, the quality and quantity of water becomes essential to every discussion of any human activity.

The Colorado Water Institute (CWI), an affiliate of Colorado State University (CSU), exists for the express purpose of focusing the water expertise of higher education on the evolving water concerns and problems being faced by Colorado citizens. We are housed on the campus of CSU but work with all public institutions of higher education in Colorado. CWI coordinates research efforts with local, state, and national agencies and organizations. State funding currently allows CWI to fund research projects at CSU, the University of Colorado, University of Northern Colorado, and Colorado School of Mines.

Our charges this year included requests from the legislature and state and federal agencies. The Colorado Legislature passed House Bill 12-1278, requiring the Colorado Water Institute to conduct a comprehensive study of groundwater utilization in the South Platte River Basin. The Colorado Department of Natural Resources requested our assistance in engaging researchers and Extension in the public discussions of water quantity issues around the state. Water Roundtables in designated water basins elicited input from stakeholders with the goal in mind of creating an environment for water sharing arrangements in the state. In addition, CWI and the Colorado Department of Agriculture are co-chairing the State's agricultural drought impact task force.

CWI serves to connect the water expertise in Colorado's institutions of higher education to the information needs of water managers and users by fostering water research, training students, publishing reports and newsletters, and providing outreach to all water organizations and interested citizens in Colorado.

## Research Program Introduction

The Colorado Water Institute funded 2 faculty research projects, 9 student research projects, and 1 internship this fiscal year. The Advisory Committee on Water Research Policy selected these projects based on the relevancy of their proposed research to current issues in Colorado.

Under Section 104(b) of the Water Resources Research Act, CWI is to plan, conduct, or otherwise arrange for competent research that fosters the entry of new scientists into water resources fields, expands understanding of water and water-related phenomena (or the preliminary exploration of new ideas that address water problems), and disseminates research results to water managers and the public. The research program is open to faculty in any institution of higher education in Colorado that has demonstrated capabilities for research, information dissemination, and graduate training to resolve State and regional water and related land problems. The general criteria used for proposal evaluation included: (1) scientific merit, (2) responsiveness to RFP, (3) qualifications of investigators, (4) originality of approach, (5) budget, and (6) extent to which Colorado water managers and users are collaborating.

Active NIWR projects and investigators are listed below:

### Faculty Research

1. *Adjoint Modeling to Quantify Stream Flow Changes Due to Aquifer Pumping*, Roseanna Neupauer, University of Colorado, \$117,847 (104g)
2. *Water Quality Impacts of the Mountain Pine Beetle Infestation in the Rocky Mountain West: Heavy Metals and Disinfection Byproducts*, John McCray, Colorado State University, \$140,162 (104g)

### Student Research (Faculty Advisor in Parenthesis)

1. *Assessing the Benefits and Drawbacks of Different Institutional Arrangements to Enhancing Forest and Water Ecosystem Services and Ecosystem Services Markets in Colorado*, Heidi Huber-Stearns (Cheng and Goldstein), Colorado State University, \$5,000 (104b)
2. *Structural and Functional Controls of Tree Transpiration in Front Range Urban Forests*, Edward Gage (Cooper), Colorado State University, \$5,000 (104b)
3. *Winter Precipitation Variability in the Colorado Rocky Mountains*, Andrew Muniz (Doesken), University of Northern Colorado, \$5,000 (104b)
4. *Reconstructing a Water Balance for the San Luis Valley: Streamflow Variability, Change, and Extremes in a Snowmelt Dominated Internal Drainage Basin*, Niah Venable (Fassnacht), Colorado State University, \$4,945 (104b)
6. *The Short and Long-Term Impacts of Drought on the Structure of Regional Economics: Investigating the Farm Supply Chain*, Ron Nelson (Goemans and Pritchett), Colorado State University, \$5,000 (104b)
7. *Quantifying Risks Producers Face when Entering Agricultural Water Lease Contracts*, Larisa Serbina (Goemans and Pritchett), Colorado State University, \$5,000 (104b)
8. *Thermal Preference of Age-0 Stonecats (Noturus Flavus): Are Thermal Water Quality Standards Protective for this Species?*, Adam Herdrich (Myrick), Colorado State University, \$4,858 (104b)
9. *Biowin Simulation to Assess Alternative Treatment Units for a Local Wastewater Treatment Plant to Meet the New Effluent Nutrient Regulations*, Keerthivasan Venkatapathi (Omur-Ozbek), Colorado State University, \$5,000 (104b)
10. *Using Water Chemistry to Characterize the Connection between Alluvial Groundwater and Streamflow Water under Argumentation at the Tamarack Ranch State Wildlife Area, Colorado*, Jason Roudebush (Stednick), Colorado State University, \$5,000 (104b)

## **Internships**

1. MOWS - Modeling of Watershed Systems, Steve Regan, USGS, \$20,000
2. CWCB Interns – Craig Godbout (Colorado State University), Andrew Baessler (University of Colorado – Denver), Matthew Baessler (University of Colorado – Denver), Jesse Hickey (Metropolitan State University of Denver)

For more information on any of these projects, contact the PI or Reagan Waskom at CWI. Special appreciation is extended to the many individuals who provided peer reviews of the project proposals.



# Adjoint Modeling to Quantify Stream Flow Changes Due to Aquifer Pumping

## Basic Information

<b>Title:</b>	Adjoint Modeling to Quantify Stream Flow Changes Due to Aquifer Pumping
<b>Project Number:</b>	2009CO195G
<b>Start Date:</b>	9/1/2009
<b>End Date:</b>	8/31/2012
<b>Funding Source:</b>	104G
<b>Congressional District:</b>	Colorado - 2
<b>Research Category:</b>	Ground-water Flow and Transport
<b>Focus Category:</b>	Groundwater, Surface Water, None
<b>Descriptors:</b>	Stream Depletion, Adjoint Model, Modeling
<b>Principal Investigators:</b>	Roseanna M Neupauer

## Publications

1. Neupauer, Roseanna M, 2011, "Adjoint Modeling to Quantify Stream Flow Changes Due to Pumping," pg. 16-17 of Colorado Water, Volume 28 issue 2.
2. Neupauer, Roseanna M, 2011, "Adjoint Modeling to Quantify Stream Flow Changes Due to Pumping," pg. 16-17 of Colorado Water, Volume 28 issue 2.
3. Neupauer, Roseanna M, 2011, "Adjoint Modeling to Quantify Stream Flow Changes Due to Pumping," pg. 16-17 of Colorado Water, Volume 28 issue 2.
4. Griebing, S.A. and R.M. Neupauer, 2012, "Adjoint Methodology to Simulate Stream Depletion due to Pumping in a Non-linear Coupled Groundwater and Surface Water System", Computational Methods in Water Resources.
5. Lackey, G., R.M. Neupauer, and J. Pitlick, 2013, "Effects of varying stream channel conductance on siting new pumping wells in an aquifer", 2013 World Environmental and Water Resources Congress, American Society of Civil Engineers.
6. Lackey, G., R.M. Neupauer, and J. Pitlick, 2013, "Effects of spatial and temporal variations of streambed hydraulic conductivity on stream depletion calculations", MODFLOW and More Conference.
7. Neupauer, R.M. and S.A. Griebing, 2013, "Comparison of forward and adjoint approaches to calculate stream depletion with application to the Upper San Pedro Basin", MODFLOW and More Conference.

## **Adjoint Modeling to Quantify Streamflow Changes Due to Aquifer Pumping**

Roseanna M. Neupauer, University of Colorado

The purpose of this project is to develop an adjoint modeling methodology to quantify stream depletion due to aquifer pumping. The methodology can be used to directly quantify stream depletion for a well at any location in the aquifer. The benefit of the adjoint approach is that with one simulation of the adjoint model, stream depletion can be calculated for a well at any location in the aquifer. If, for example, multiple locations are being considered for a new well, stream depletion can be calculated using standard modeling approaches; however, one simulation is required for each possible well location. In the adjoint approach, the same information can be obtained with a single simulation. Thus the adjoint approach is less computationally intensive.

### **Prior Work**

Prior work on this project involved the development and testing of the adjoint theory for confined and unconfined aquifers for two different cases:

1. weak coupling between the river and aquifer. In this case, the river head is assumed to be unaffected by pumping.
2. strong coupling between the river and aquifer. In this case, the river head decreases as a result of pumping.

We use MODFLOW as the groundwater flow simulator for all cases. Case 1 uses the MODFLOW River (RIV) package. In this case, the adjoint equation has the same form as the forward equation, so MODFLOW can be used directly to solve the adjoint equation, with modifications only to the interpretation of the values in some of the input and output files. Case 2 uses the MODFLOW Stream (STR) package. For this case, the adjoint equations have a slightly different form than the forward equations, so we modified the source code for the STR package, and we also modified the interpretation of values in some of the input and output files.

### **Work Completed June 2012 – May 2013**

The work completed between June 2012 and May 2013 followed three different themes. The first theme was continued testing and modification of the adjoint method for the MODFLOW STR package and preparation of journal articles on this topic. This work includes the testing of the method on the Upper San Pedro River Basin, using a USGS model developed for the site. The Upper San Pedro Basin system is more complex than the hypothetical aquifers we were using as test cases, so we had to develop the adjoint equations for this more complex system, and we had to develop the approach for solving the new adjoint equations in the MODFLOW framework. The additional complexities include evapotranspiration, tributaries, drains, and the use of the Layer Property Flow package. The theory has been developed and tested. It was published in one proceedings paper (Griebing and Neupauer 2012a) and is the subject of a journal article that is under review for publication in *Water Resources Research* (Griebing and Neupauer, 2013). The testing of the method on the Upper San Pedro River Basin is not yet complete, but is expected to be completed during the summer 2013. One presentation (Griebing and Neupauer, 2012b) and one proceedings paper (Neupauer and Griebing, 2013) document preliminary results of the San Pedro application.

The second theme of work on this project is an investigation of the effects of streambed hydraulic conductivity on stream depletion. Most modeling investigations that estimate stream depletion assume a homogeneous streambed and use an assumed value of the streambed conductivity, rather than taking measurements. The two main findings of our investigations demonstrate that

1. Within the range of typical streambed hydraulic conductivity values, the stream depletion estimates are sensitive to the selected value of streambed hydraulic conductivity for the middle of this range. At the high end and low end of the streambed hydraulic conductivity range, stream depletion may be relatively insensitive to the selected homogeneous value of streambed hydraulic conductivity.
2. Stream depletion is sensitive to the heterogeneity patterns of the streambed hydraulic conductivity. Stream depletion is higher for wells placed near high conductivity sections, and lower for wells placed near low conductivity sections.

This work has been presented at two conferences (Lackey et al., 2012, 2013c) and included in two conference proceedings papers (Lackey et al., 2013a,b).

The third theme of the current work is an extension of the adjoint theory to systems with more complicated river channel geometries. The STR package of MODFLOW assumes a wide, rectangular river channel cross section, so the adjoint theory thus far has been developed for that case. An unfunded J.D. student, Daniel McCarl, has begun working on the extension of the adjoint theory to more complicated river channel geometries. After he completes his J.D. degree, he plans to pursue a Ph.D. in civil engineering, and will continue work on this topic for that degree. Although he will not begin his Ph.D. until after this grant expires, his work builds off of the adjoint theory developed under this grant.

### **Remaining Work**

The following work remains to be completed, and is expected to be done during Summer 2013.

1. Completion of the San Pedro case study. Presently, the adjoint simulation results for the San Pedro case study match the pattern of the forward simulation results, but do not match the magnitude. Further investigation is needed to fix this inconsistency. Once it is completed, we will prepare a manuscript on the topic for submission to *Groundwater*.
2. Development of software tools to automatically create input files for MODFLOW adjoint simulations. We have written a Matlab code to take forward model MODFLOW input and output files and create from them the adjoint model MODFLOW input files. The code was written for our specific needs, and is not robust. We will write a robust Fortran code, building off of MODFLOW subroutines that read in the input files, to create the adjoint model input files. I have spoken to Mary Hill (USGS) about the possibility of including this code with the MODFLOW distribution. If we were to do that, it would require rigorous testing that would extend beyond Summer 2013. Regardless, guidance on adapting MODFLOW input files to be used for adjoint simulations will be included in the *Groundwater* article on the San Pedro study.
3. Dissemination of results of the investigation of the effects of streambed hydraulic conductivity on stream depletion. All of the work is completed on this part of the project. During Summer 2013, Gregory Lackey, the student working on this project, will complete his M.S. thesis and prepare a journal article to submit on this work.

### **Students:**

Gregory D. Lackey – M.S. student, started May 2012, expected completion is August 2013.

Daniel McCarl – J.D. student, started June 2012, unfunded.

### **Journal articles in review:**

Griebing, S.A. and R.M. Neupauer, Adjoint modeling of stream depletion in groundwater-surface water systems, *Water Resources Research*, originally submitted June 2012, revised and resubmitted April 2013.

Conference proceedings papers (published or in press):

Griebling, S.A. and R.M. Neupauer, Adjoint Methodology to Simulate Stream Depletion due to Pumping in a Non-linear Coupled Groundwater and Surface Water System, Computational Methods in Water Resources, 2012a.

Lackey, G., R.M. Neupauer, and J. Pitlick, Effects of varying stream channel conductance on siting new pumping wells in an aquifer, 2013 World Environmental and Water Resources Congress, American Society of Civil Engineers, 2013a, in press.

Lackey, G., R.M. Neupauer, and J. Pitlick, Effects of spatial and temporal variations of streambed hydraulic conductivity on stream depletion calculations, MODFLOW and More Conference, 2013b, in press.

Neupauer, R.M. and S.A. Griebling, Comparison of forward and adjoint approaches to calculate stream depletion with application to the Upper San Pedro Basin, MODFLOW and More Conference, 2013, in press.

Conference presentations:

Griebling, S.A. and R.M. Neupauer, Comparison of forward and adjoint approaches of stream depletion in the San Pedro River, Arizona, U.S.A., American Geophysical Union, Fall Meeting, 2012b.

Lackey, G.D., R.M. Neupauer, and J. Pitlick, Effects of riverbed conductance on stream depletion, American Geophysical Union, Fall Meeting, 2012.

Lackey, G.D., R.M. Neupauer, and J. Pitlick, Varying Stream Channel Conductance and its Effects on Stream Depletion Estimations, 8th Annual Hydrologic Sciences Student Symposium, University of Colorado, Boulder, Colorado, March 2013c.

# Water Quality Impacts of the Mountain Pine Beetle Infestation in the Rocky Mountain West: Heavy Metals and Disinfection Byproducts

## Basic Information

<b>Title:</b>	Water Quality Impacts of the Mountain Pine Beetle Infestation in the Rocky Mountain West: Heavy Metals and Disinfection Byproducts
<b>Project Number:</b>	2011CO245G
<b>Start Date:</b>	9/1/2011
<b>End Date:</b>	8/31/2014
<b>Funding Source:</b>	104G
<b>Congressional District:</b>	D-CO7
<b>Research Category:</b>	Water Quality
<b>Focus Category:</b>	Water Quality, Hydrogeochemistry, Treatment
<b>Descriptors:</b>	None
<b>Principal Investigators:</b>	John E. McCray, Reed Maxwell

## Publications

1. McCray, John, 2011, Water Quality Impacts of the Mountain Pine Beetle Infestation in the Rocky Mountain West: Heavy Metals and Disinfection Byproducts, Colorado Water Institute Proposal, 38 pages.
2. McCray, John, 2011, Water Quality Impacts of the Mountain Pine Beetle Infestation in the Rocky Mountain West: Heavy Metals and Disinfection Byproducts, Colorado Water Institute Proposal, 38 pages.

## **Water Quality Impacts of the Mountain Pine Beetle Infestation in the Rocky Mountain West: Heavy Metals and Disinfection Byproducts**

John E. McCray, Colorado School of Mines

The following report summarizes the work performed under Subaward Number G-2914-1; PI: Dr. John E. McCray for the reporting period ending 18 March 2013.

### *1. Research: Project Synopsis*

The goal of the research funded under this subaward, is to understand the potential for disinfection byproduct formation and metal mobilization resulting from perturbations to the water and nutrient cycles in forested watersheds currently experiencing a severe mountain pine beetle epidemic (Figure 1). The subaward provides the means to add these analyses to the existing USGS research project being conducted in Rocky Mountain National Park, under the supervision of Dr. Dave Clow.

During this reporting period, the following tasks were completed: (a) Soil sampling and sequential extractions were completed to identify differences in metal sources and mobility beneath trees experiencing different phases of attack; (b) continued coordination and field sampling with Dr. Clow (USGS) and his field team; (c) analysis of surface water samples (archived by Dr. Clow and collected by Lindsay Bearup) for stable isotopes was completed; (d) initial hydrologic flow path analysis was completed using the isotope data. The goal of the current analyses is to understand whether metal availability and mobility is altered by the MPB infestation and to investigate potential changes to stream water sources in RMNP using isotope analysis. The goal for sample collection in the next field campaign is to continue to isolate the effects of the MPB on the potential for disinfection byproduct formation and metal mobilization. Specifically, it has become apparent that hydrologic flow paths may help explain the observed discrepancy between increased metal mobility and carbon fluxes in the soils and relatively little change in stream samples. As such, the main focus of our research over the next year is intended to improve our understanding of the flow paths transporting carbon and metals to the streams, and if the MPB is impacting water sources and residence times in these high mountain systems.

### *2. Publications*

The literature review co-authored by Lindsay A. Bearup during this reporting period and funded by this subaward, directly contributed to the following review article, currently under review at *Biogeochemistry*. In addition, two conference presentations by PhD student Lindsay Bearup were published as abstracts. Finally, Professor McCray gave two invited talks (not published) in the fall related to this project. The citations for these activities are provided below.

Mikkelson KM, Bearup LA, Maxwell RM, Stednick JD, McCray JE and Sharp JO. Bark beetle infestation impacts on nutrient cycling, water quality and interdependent hydrological effects. *In review at Biogeochemistry*.

Bearup, L.A., Maxwell, R.M., Clow, D.W., McCray, J.E., Sharp, J.O. Understanding changes to interrelated hydrologic and trace metal cycles in mountain pine beetle infested watersheds. Abstract GC23C-1081. 2012 Fall Meeting, AGU, San Francisco, Calif., 3-7 Dec, 2012.

Bearup, L.A., Mikkelson, K.M., Maxwell, R.M., McCray, J.E., Sharp, J.O. Understanding changes to contaminant transport in mountain pine beetle infested watersheds. CUAHSI Colloquium, Boulder, Colorado, 16-18, July 2012.

McCray, J.E., 2012. Impact of the mountain pine beetle epidemic on water resources and quality in the Rocky Mountains, Presented at the Environmental Engineering Seminar Series, Department of Civil and Environmental Engineering, University of California Berkeley, 30 November 2012.

McCray, J.E., 2012. Impact of the mountain pine beetle epidemic on hydrology and water quality in the Rocky Mountains, Presented at the Environmental Engineering & Science Seminar Series, Department of Civil & Environmental Engineering, Stanford University, 26 October 2012

3. *Information Transfer Program*

The research group participated (as experts) at a mountain pine beetle public education forum at Denver Museum of Nature and Science on January 22, 2013. Also see journal papers and public presentations listed above.

4. *Student Support*

This subaward provided funding for one PhD student during this reporting period.

5. *Student Internship Program – N/A*

6. *Notable Achievements and Awards –*

- a. Literature review submitted and under review.
- b. 2 conference abstracts published at national conferences
- c. Professor McCray gave invited talks using material from this project in the Stanford seminar series for Environmental Engineering Science, and at Cal-Berkeley for the Civil and Environmental Engineering seminar series.
- d. 2012 Field Season completed with soil and water samples collected for analysis.
- e. Soil samples used for sequential extractions and metal mobility analysis.
- f. Water samples (archived by Dr. Clow and collected by Lindsay Bearup) analyzed for stable isotopes
- g. Initial hydrologic flow path analysis based on isotope mixing models completed.



Figure 1: MPB impacted forest above Grand Lake in Rocky Mountain National Park



Figure 2: PhD Student, Lindsay Bearup taking a stream sample for stable isotopes analysis in Rocky Mountain National Park.



# Assessing the Benefits and Drawbacks of Different Institutional Arrangements to Enhancing Forest and Water Ecosystem Services and Ecosystem Services Market in Colorado

## Basic Information

<b>Title:</b>	Assessing the Benefits and Drawbacks of Different Institutional Arrangements to Enhancing Forest and Water Ecosystem Services and Ecosystem Services Market in Colorado
<b>Project Number:</b>	2012CO257B
<b>Start Date:</b>	3/1/2012
<b>End Date:</b>	2/28/2013
<b>Funding Source:</b>	104B
<b>Congressional District:</b>	4th
<b>Research Category:</b>	Social Sciences
<b>Focus Category:</b>	Management and Planning, Water Quality, None
<b>Descriptors:</b>	None
<b>Principal Investigators:</b>	Antony Cheng

## Publications

There are no publications.

# **Assessing the Benefits and Drawbacks of Different Institutional Arrangements to Enhancing Forest and Water Ecosystem Services and Ecosystem Services Markets in Colorado**

Heidi Huber-Stearns, PhD Student, Department of Forest and Rangeland Stewardship, Colorado State University

Faculty Advisors: Antony Cheng and Joshua Goldstein

## **Introduction**

The forested watersheds of the western U.S. are critical to the supply of clean drinking water to myriad downstream users, including agriculture and urban population centers. Intensifying watershed risks, inadequate public and private funding, loss of land stewardship capacities, and limitations of existing policies are all converging on the matrix of state, federal and private lands across the region. These challenges, combined with opportunities arising from expanding cross-sector collaborations, provide a fitting context for the development of programs that incentivize the stewardship of public environmental resources across land types. Such incentive programs are geared toward linking ecosystem service providers (e.g., landowners or a federal agency improving water quality or quantity upstream) with those who depend on those services (e.g., downstream utilities, breweries). Incentive-based programs targeting watershed ecosystem services, often broadly classified as Payments for Watershed Services (PWS), have expanded rapidly in the western U.S. over the last decade. PWS is a policy tool that can be used in order to address environmental issues of concern, such as water supply and security. While relevant reports have highlighted many of these programs, until now, no comprehensive report existed that detailed characteristics for all PWS programs in the western U.S. As these programs continue to expand, a window of opportunity exists to use lessons learned from these programs to shape future design and implementation of new programs, and also to improve the effectiveness of existing programs.

## **Study Area**

Our study region included the western U.S., encompassing: Arizona, California, Colorado, Idaho, Montana, New Mexico, Nevada, Oregon, Utah, Washington, and Wyoming. The western U.S. provides an appropriate study site for this project, due both to the sheer number of PWS-type programs emerging across the region, as well as the increasing watershed and natural resource concerns, such as wildfire risk and effects, overall forest health, source water protection, and increasing water quality regulations.

## **Research Objectives**

The purpose of our investigation was to characterize PWS programs in the western U.S. region by understanding: 1) the key design elements of these programs, and 2) how experimentation on-the-ground relates to and differs from what we know of PWS literature and related theory.

## **Methods**

We began our project with a literature and document review in order to generate an informed understanding of existing documentation of PWS programs in the west, as well as to identify which program attributes we should include in documenting programs. To inform our approach, we used sources such as Ecosystem Marketplace's 2010 State of Watershed Payments report and Watershed

Connect Web-platform, as well as Carpe Diem West and EcoAgriculture reports, all of which identified a varying number and type of PWS programs in the region.

### *Survey Development and Data Analysis*

For survey design and administration, we partnered with Ecosystem Marketplace, an online source of news, data, and analytics on ecosystem services projects around the globe (see [www.ecosystemmarketplace.com/](http://www.ecosystemmarketplace.com/)). Our survey was administered online to all identified relevant programs in the study area. Survey follow-up was conducted by phone. We conducted quantitative data analysis in SPSS ("Statistical Package for the Social Sciences" from IBM) with the resulting survey data.

## **Results**

We found 41 programs in operation, 14 programs in design, and 12 programs that were either inactive or did not have data to report. In this section, findings are reported for only the 41 programs identified as currently in operation since the programs in development do not yet have complete data.

### *Overall Program Characteristics*

Geographically, the number of programs varied by state, with at least one program in each state. The highest concentration of programs was found in the Pacific Northwest (Oregon and Washington). The programs ranged in age, with the oldest programs ( $n = 9$ ) established in 1970-80s. In the past decade, the number of operating programs doubled, reaching 41 programs in 2012. The majority of programs (88 percent) include private land. By comparison, approximately 35 percent of programs include (mainly federally managed) land.

Our results demonstrate that a variety of actors are involved in these programs, including, for example, states (Water Resources, Ecology, Forestry, Fish and Wildlife departments) and water utilities as ecosystem services buyers, NGOs as program administrators (those managing program funds), and private landowners and federal agencies as sellers. The collaborative nature of these arrangements is evident from the number and differing sectors of participants. Most programs involved voluntary participation on the part of ecosystem-service sellers, but contained some regulatory driver(s) for those participating as buyers. Drivers for the programs stemmed mainly from meeting state and federal regulations, including state-specific propositions and statutes, particularly instream flow requirements. Other federal regulatory drivers include the Clean Water Act and Endangered Species Act. Seventy-six percent of programs focused on water quality ecosystem services, including a subset of programs (20 percent) that focused on phosphorous and/or nitrogen specifically. Seventy percent of the programs concentrated on flow restoration ecosystem services, which demonstrates that many programs were aimed at dual water quality and quantity goals. Programs were found to conduct different management actions in order to achieve targeted ecosystem services. Most programs (66 percent) employed water rights transactions, including acquisition of temporary leases and permanent water rights transfers. Several programs (27-34 percent) also used restoration and protection actions to achieve program goals. Other program actions included reforestation, alterations to agricultural and operational procedures, and fire suppression.

### *Mapping Project Results*

In collaboration with the Geospatial Centroid at Colorado State University, we are in the process of using the survey data and results to organize and distribute spatial data and map products. This portion of our

project contains three products: 1) a map for publication, 2) a spatial database, and 3) an initial Web map. The map for publication purposes displays the programs and their respective watersheds within the study region (Figure 1). The development of a spatial database includes detailing the spatial extent of each watershed project and attributes of each program, such as the previously described program characteristics. For the final product, the Centroid will publish the data (from the developed database) as a Web map service and will create a website where the data can be viewed. The anticipated completion date for the spatial database and web map service is April 30, 2013.

### **Conclusion/Implications**

As is evidenced by the substantial increase in programs implemented across the landscape, and the programs in design at the moment, it is clear that these types of PWS programs are continuing to grow in our region. It is important to understand how to appropriately design programs, which actors to target as potential participants, and the types of social-ecological contexts and drivers for which this type of policy tool is suitable. Another finding from our data analysis is the identification of differences between programs, dividing our dataset into subgroups. Some key differences between programs include geographic distinctions, management actions, types of sellers, and program objectives. For example, in the Pacific Northwest, many programs are focused on increasing instream flow in rivers through water rights and leases from individual private landowners. In the more arid parts of the west (e.g., Colorado, New Mexico, Arizona), programs are focused on protecting watershed health and reducing wildfire risk by employing restoration and protection actions, typically on public land (e.g., National Forest System lands managed by the U.S. Forest Service). We are currently further developing these program typologies using survey results. These distinctions can expand both practitioner and academic awareness of the differences and similarities between programs, thus generating a more mutual understanding of the types of programs, as well as where and how they operate. Understanding what and how actors, policies, and communication influence the design, implementation, and outcomes of these projects across the landscape is essential to providing lessons learned for future program design.

### **Acknowledgements**

We would like to thank the Colorado Water Institute (CWI) for sponsoring survey and mapping development for this project. This support allowed us to speed up the development and administration of our survey through funding research hours and encouraged the development of new collaborations with external partners. CWI funding also provided us the opportunity to work with the Geospatial Centroid to develop maps and related products. We thank the CSU Colorado Agricultural Experiment Station for its support of our larger research project. We also thank other project collaborators including, Genevieve Bennett and the Ecosystem Marketplace team, and AES project collaborator Ted Toombs.

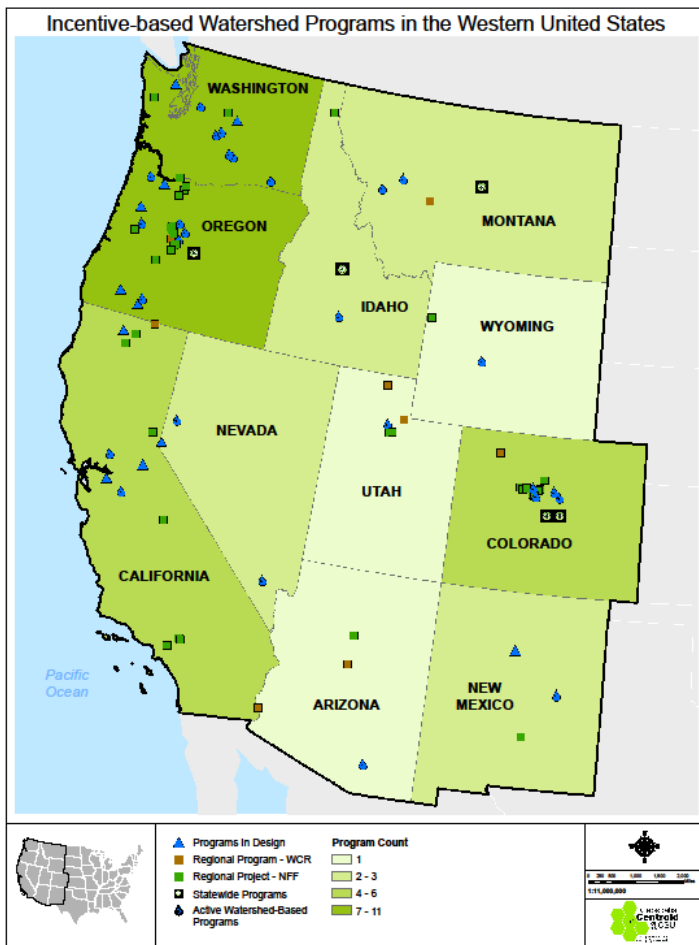

Figure 1. Incentive-based Watershed Programs in the Western United States

# Structural and Functional Controls of Tree Transpiration in Front Range Urban Forests

## Basic Information

<b>Title:</b>	Structural and Functional Controls of Tree Transpiration in Front Range Urban Forests
<b>Project Number:</b>	2012CO260B
<b>Start Date:</b>	3/1/2012
<b>End Date:</b>	2/28/2013
<b>Funding Source:</b>	104B
<b>Congressional District:</b>	4th
<b>Research Category:</b>	Climate and Hydrologic Processes
<b>Focus Category:</b>	Water Use, Climatological Processes, Economics
<b>Descriptors:</b>	None
<b>Principal Investigators:</b>	David Cooper

## Publications

There are no publications.

## **Structural and Functional Controls of Tree Transpiration in Front Range Urban Forests**

Edward Gage, PhD Candidate, Ecology, Department of Forest and Rangeland Stewardship, Colorado State University

Faculty Advisor: David J. Cooper

### **Introduction**

A few basic land cover (LC) classes dominate the urban landscape, but just as a painter can coax varied hues from a few primary colors, basic LC types such as trees, turfgrass, and pavement are arranged in complex patterns in cities. The abundance and spatial arrangement of LC classes forms a city's physical structure, which, in contrast to natural ecosystems, is largely the product of human agency. Socioeconomic, demographic, and land-use factors (e.g., zoning regulations) contribute to a city's legal and social structure. Combined, these shape a city's basic character and influence phenomena important to water managers, such as evapotranspiration (ET) and residential water demand.

Vegetation, especially trees, strongly influences urban structure and function. Front Range cities are built largely on native grasslands, and on the pre-settlement landscape, trees were generally restricted to riparian areas. An LC change commonly accompanying urbanization is the establishment of irrigation-dependent vegetation types. Water applied to support these communities often accounts for the majority of summer water demand, so an improved understanding of factors influencing plant water requirements and outdoor watering behavior is critically important to water management.

The urban forest is particularly varied, supporting trees differing in age, size, and basic functional characteristics. For example, transpiration rates and stomatal sensitivity to atmospheric drivers of ET vary among species and functional groups, due to differences in plant physiology, xylem anatomy, root distribution, and phenology. If functional differences can be generalized and inferences made to landscape-scale distribution patterns, a truer accounting of vegetation's role in urban ecohydrological processes may be possible.

### **Research Questions**

Our broad research objective is to explore landscape-scale spatial variation in vegetation characteristics potentially important as drivers of outdoor water consumption in a typical Front Range urban area. Our motivation is to develop information applicable to studies of the urban water balance and outdoor residential water demand. Specifically, we ask:

- What socioeconomic, demographic, and historical land-use history variables best predict measures of urban vegetation structure and composition?
- Does the compositional diversity of trees in the urban forest vary in relation to broader LC patterns and social structure?
- Can tree compositional diversity be reduced meaningfully by identifying functional types?

### **Methods**

#### *Land Cover Mapping and Landscape Analysis*

At the broadest scale, we used remote sensing analyses to map and characterize LC characteristics for our Aurora, Colorado study area (Figure 1). Accurate LC data of sufficiently fine grain is a

prerequisite for analyses in urban areas. Existing LC data are too coarse to be used for parcel-scale analyses, so we developed our own dataset using an object-oriented segmentation and random forest classification approach on primary and derived high spatial resolution (0.5 m GSD) multispectral imagery and lidar layers. Lidar is an active remote sensing technology similar in principle to radar that uses pulsed laser light instead of microwaves to produce point clouds characterizing the 3-D structure of what is being sensed. Six classes were mapped: trees, buildings, low vegetation, low impervious, bare soil, and water (Figure 2).

We calculated the proportional area of each LC class, as well as various image and lidar-derived structural variables (e.g., mean tree height, NDVI, etc.), for study area parcels, census blocks, and census block groups using zonal statistics tools in ArcGIS. A similar procedure was used with socio-economic, demographic, and historical land-use data from the 2010 U.S. Census, Arapahoe County Assessor's Office, and the U.S. Geological Survey. Agglomerative cluster analysis was used to define natural groupings of sampling units at a given scale and to provide a means of identifying portions of the landscape exhibiting similar structure.

Models predicting structure variables were then constructed in the R statistical program, with separate analyses constructed for parcel, block level, and block group level units. We used Random Forests, an ensemble method commonly used in data mining because of its predictive accuracy and ability to work with highly dimensional and nonlinear data. Variable importance plots were used to identify variables most useful for prediction.

#### *Analysis of Urban Tree Composition and Functional Variation*

Our LC data are precise enough to effectively discriminate among broad LC classes. However, the data sets we used contain insufficient information from which to discriminate individual tree species, so we used a tree inventory layer provided by Aurora. These data were used to evaluate spatial distribution patterns and assess the relative abundance of tree functional types defined by wood xylem anatomy (e.g., conifers, diffuse-porous and ring-porous angiosperms), a factor shown in previous studies to influence ecohydrological function.

Most studies documenting ecohydrological consequences of xylem anatomy have been conducted outside of the Front Range. To evaluate whether previous findings apply to the tree species and environmental conditions here in Colorado, we measured tree transpiration using thermal dissipation sap flow sensors at five Aurora parks. Data are still being analyzed, but will help quantify differences in tree transpiration rates among species with different physiological characteristics. Our intent isn't to directly scale-up field-based transpiration to the study area—there are too many confounding and unmeasured variables; rather, data will be used to contextualize landscape-scale tree distribution patterns and evaluate the utility of incorporating tree functional type into future sampling and modeling.

#### **Results**

Our land cover maps reveal complex spatial patterns across our study area. The relative abundance of different land cover classes varies dramatically depending on land use and zoning parameters. For example, the highest impervious cover is found in commercial settings, while vegetation cover is greatest in city owned parks, open space, and golf courses. Residential areas generally show intermediate characteristics between those found in commercial and park settings.

Total tree cover and the proportional share of vegetation cover from trees is greatest in the Northwestern portion of the assessment area, and is directly related to the age of the neighborhood (Figure 3; panels A and B). Tree height and canopy volume layers are correlated with each other and with absolute tree cover, showing similar spatial trends over the assessment area, with the greatest mean and maximum height and volume seen in older portions of the city.



Tree inventory analyses reveal additional complexity in the urban forest. Of the 48,957 trees in the assessment area, 51.8 percent were classified as diffuse-porous, 41.3 percent as ring-porous, and 6.8 percent as conifer (Figure 3). Our sap flow measurements reveal significant tree to tree variability in transpiration. Some is due to micro-site and size variation among trees, but data also suggest differences among trees with different wood anatomy.

### **Discussion**

Our research highlights the complexity of urban land cover patterns, particularly with regard to vegetation. Results suggest numerous socio-economic variables are correlated with physical structure characteristics (e.g., percent tree cover, mean tree height, etc.), a finding consistent with previous research. Our LC classification captures broad differences in LC, but fails to discriminate among tree types. Traditional tree inventories complement data from remote sensing analyses by providing species and functional type-specific information. Preliminary results from sap flow analyses support the notion documented elsewhere that tree functional types respond differently to climatic drivers of ET.

Individually, the different scales of analysis provide interesting insights on urban land cover patterns of direct importance to water managers. In future analyses, we will work to elucidate controls on these patterns, and importantly, link patterns and processes across varying scales. Results also suggest that time since development is an important conditioning factor shaping vegetation structure, but more work is needed to understand how temporal changes in structure affects urban microclimate, water and energy demand, and ecological services.

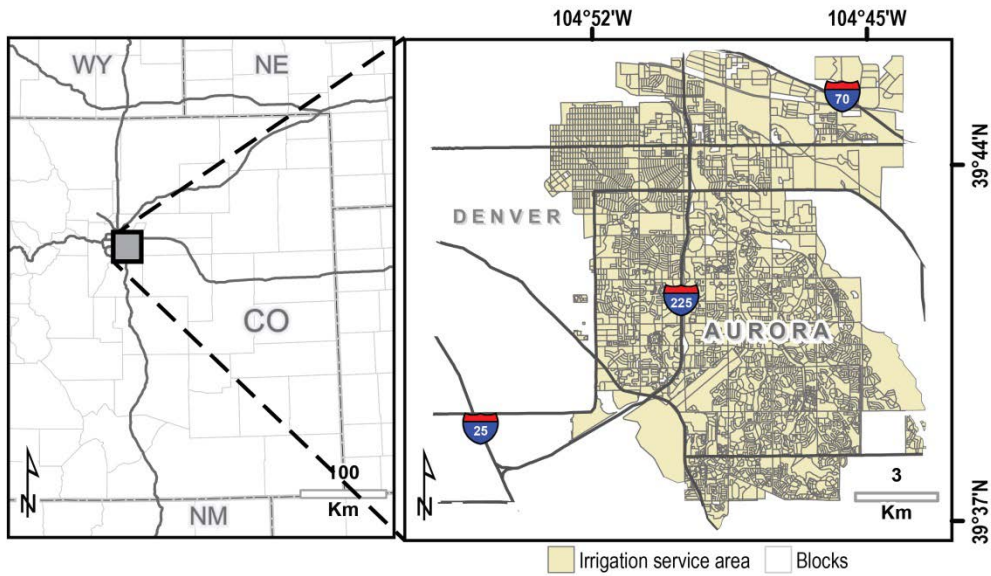

Figure 1. Map of Aurora, Colorado study area.

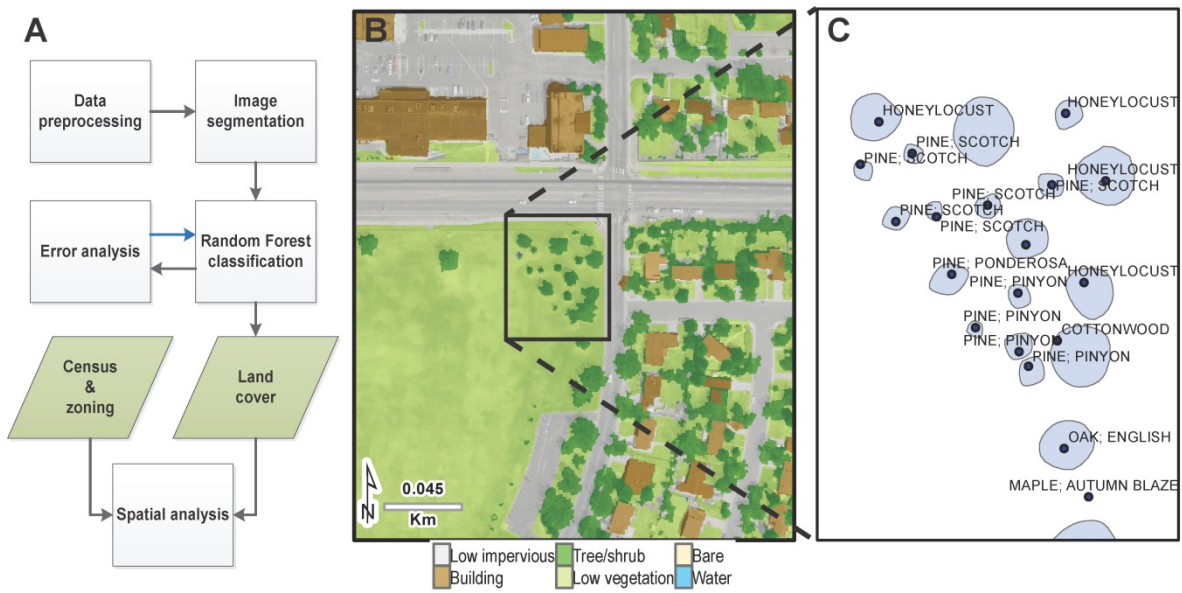

Figure 2. Flowchart illustrating main steps in development and analysis of land cover data (panel A); example of land cover product (panel B) for an Aurora Park also used in field measurements of tree sap flow (inset box, panel B; panel C).

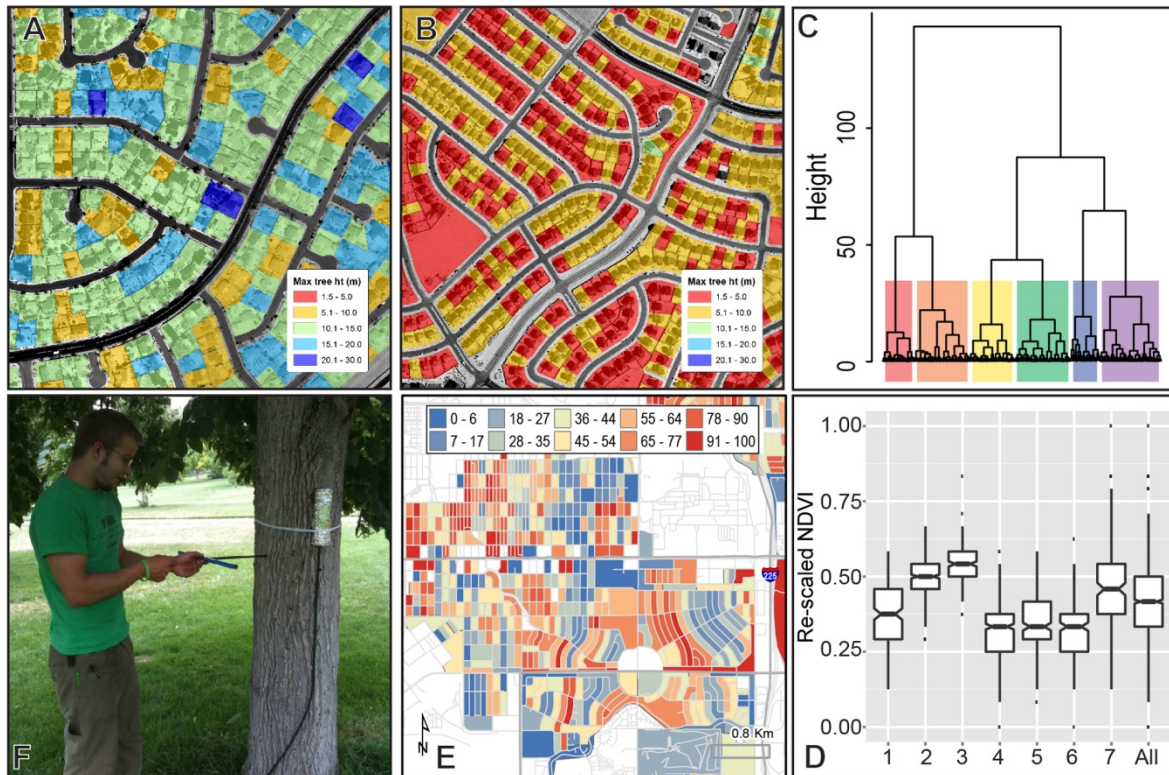

Figure 3. Clockwise from the top left: parcel level maximum tree height for an older neighborhood built in the early 1960s (panel A); maximum tree height in a newer neighborhood constructed in the early 2000's (panel B); dendrogram illustrating clustering of census blocks based on agglomerative cluster analysis of physical structure variables (panel C); box plot of mean census block Normalized Difference Vegetation Index (NDVI) clusters (panel D); intermediate-scale map illustrating the proportion of all trees in individual census blocks with ring-porous xylem anatomy (panel E); Andrew Carlson, CSU Research Associate, collecting tree core from green ash tree outfitted with sap flow sensor (panel F).

# Winter Precipitation Variability in the Colorado Rocky Mountains

## Basic Information

<b>Title:</b>	Winter Precipitation Variability in the Colorado Rocky Mountains
<b>Project Number:</b>	2012CO261B
<b>Start Date:</b>	3/1/2012
<b>End Date:</b>	2/28/2013
<b>Funding Source:</b>	104B
<b>Congressional District:</b>	4th
<b>Research Category:</b>	Climate and Hydrologic Processes
<b>Focus Category:</b>	Climatological Processes, Models, Water Quality
<b>Descriptors:</b>	None
<b>Principal Investigators:</b>	Nolan Doesken

## Publications

There are no publications.

## **Winter Precipitation Variability in the Colorado Rocky Mountains**

Andrew Muniz, Student, Earth Science: Meteorology, University of Northern Colorado

Faculty Advisor: Nolan Doesken

### **Introduction**

Skillful snowpack, streamflow, and water supply prediction with reasonable lead times is essential to water management and planning not only in Colorado, but around the U.S. With drought so widespread and severe in 2012, the interest in snowpack and streamflow prediction is at an all time high in Colorado for municipal water management, agriculture, and outdoor recreation.

The Rocky Mountains of Colorado receive a majority of their annual precipitation during the winter season, mostly as snow. The snowfall that has accumulated at elevations above 9,000 feet by mid-April each year becomes the source of most of the growing season's runoff and water supplies. This exemplifies the need and opportunity to improve forecast models to assist water management officials.

Climate teleconnections are one tool used in seasonal predictions around the world. The El Niño Southern Oscillation (ENSO) has been the most popular climate predictor here in Colorado, in terms of seasonal snowpack variability. For the purpose of this study, ENSO, North Atlantic Oscillation (NAO), and Pacific Decadal Oscillation (PDO) will be used in combination to identify correlations with snowpack and streamflow and to attempt to improve seasonal water supply forecasts.

### **Research Objectives**

Many studies have been conducted investigating seasonal patterns and year to year variations in the magnitude and timing of precipitation in the Rocky Mountain region and relating these to streamflow discharge in Colorado's major river basins. The relationship of these variations to the phase of ENSO and other modes of large scale atmospheric and oceanic circulations indicates some potential for skill in streamflow forecasting. Analyses of Colorado precipitation data, especially winter season precipitation, reveal that there are many years where precipitation anomalies (wet versus dry) appear out of phase between the northern and southern mountains of Colorado. The objective for this research is to better recognize characteristic latitudinal precipitation patterns and document their association with large scale climate indexes such as ENSO, NAO, and PDO. The end result of this project is to develop a model with more skill in forecasting snowpack and runoff to further assist water management officials.

### **Methods**

In order to document the impact each teleconnection has in Colorado, snowpack and streamflow data from diverse geographic regions of Colorado were selected. We first obtained snowpack data from 49 individual locations provided by the Natural Resources Conservation Service (NRCS), each of which has snow water equivalent, or SWE, readings dating back to 1950 or earlier. The 49 locations were separated into 11 mountainous regions throughout the state, based on geographic location and similar year to year variations in SWE. Then, one site from each of the 11 regions was selected to represent each region, which was solely based upon similar elevation. April 1 SWE data were selected since this is close to the maximum seasonal snowpack water content and is best correlated with subsequent runoff and streamflow volumes. These 11 locations, Figure 1, represent spatial differences in snowpack in Colorado from the original 49.

Seventeen streamflow gauge sites were then chosen from the United States Geological Survey (USGS) and the Colorado Division of Water Resources (CDWR). A total of nine of the overall 17 stream gauge locations are naturalized streamflow sites, meaning not influenced by human activity. We only wanted to use naturalized sites, but not enough were readily available with close proximity to each SNOTEL location. This is why eight of the total 17 gauge sites are not naturalized sites. Streamflow discharge for these 17 sites was totaled from April 1 – July 31 and measured in cubic feet per second. It was then compared against snowpack from nearby SNOTEL stations to confirm how well correlated snowpack is with runoff in various regions across the state (Table 1).

Lastly, ENSO, NAO, and PDO monthly index values were obtained from the Climate Prediction Center and National Climatic Data Center, each of which dated back to 1950. A monthly time series of each index value was obtained starting at the beginning of each water year. (October – March, Figure 2) Also, a yearly time series beginning at the point of which recording of the stream gauge began until 2012 (Figure 3).

## **Results**

Data provided for each of the preceding six monthly climate indices was correlated with seasonal (April-July) streamflow for that year using Statistical Analysis System, or SAS, and independently verified with Microsoft Excel. Streamflow versus SWE correlation show differences (Table 1) for a multitude of reasons that cannot fully be explained by climate forcings. However, most of the sites are well correlated and explain one another. The month with the highest correlation for each climate index was identified. Then the index values best correlated with streamflow were combined using multiple regression to provide a model to determine how well the three best single month correlations compared with the observed streamflow discharge values.

The results are shown in Table 1. Correlations are generally weak, even for ENSO. However, there is just enough correlation with several month lead time to possibly provide some useful predictive skill. Interestingly, for most regions the NAO showed better correlation than ENSO. The NAO was more highly correlated during the month of November (13) than all other months combined (four) and the PDO was more highly correlated during March (14) than all other months combined (three).

Based on the results in this study, it can be concluded that for the period of the years tested, ENSO is ultimately the weakest climate predictor with NAO and PDO performing better. Since many forecasters have relied more on ENSO when making their upcoming winter snowpack predictions, using a model equipped with NAO and PDO may improve forecast accuracy. To show this, (Table 2) illustrates how many times a specific climate index is the best, worst, and average predictor, based on the  $R^2$  value.

Future research for this project is to construct a full scale model, of which will include observed yearly discharge rates from April 1 – July 31 and compare it to each monthly climate index from October through March on a year to year basis. So this full model will include all six months from each climate index and total to 18 variables as compared to only three used previously. This may improve streamflow forecasts in the future and better assist water management officials in decision making. Lastly, we would like to show our forecasted values for each streamflow location based on our best three month correlation model (Table 3).

## **Acknowledgements**

We would both like to thank the Colorado Water Institute and Colorado State University for funding this research.

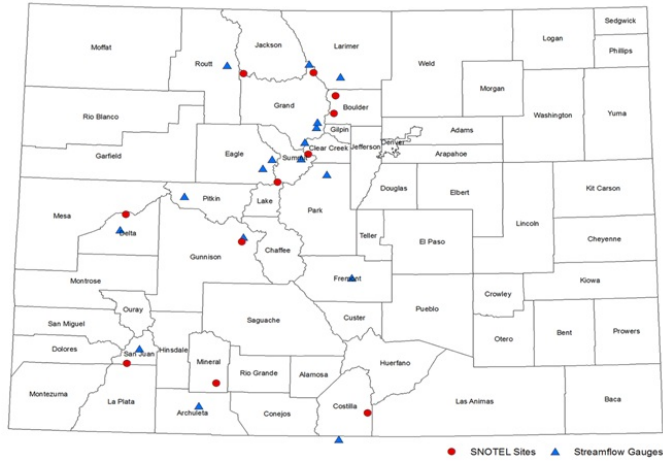

**Figure 1:** 11 SNOTEL sites denoted with a (red) circle and 17 streamflow gauge sites denoted with a (blue) triangle.

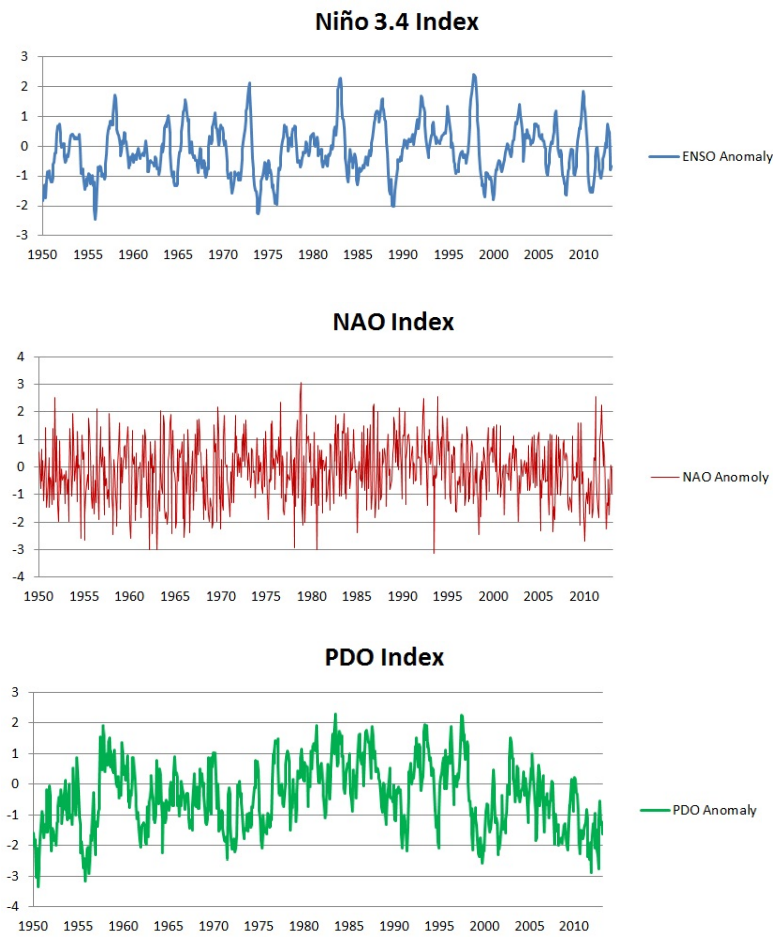

**Figure 2:** The ENSO, NAO, and PDO monthly anomaly time series from October 1950 – March 2012.



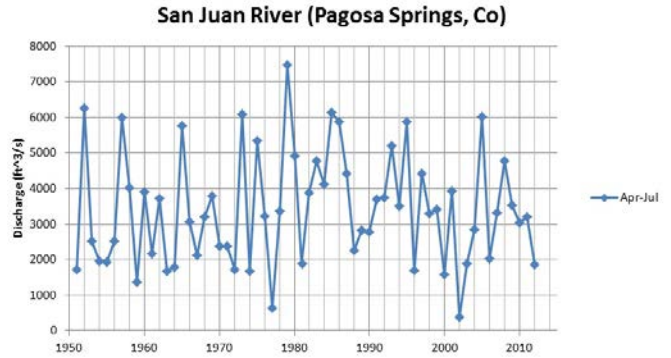
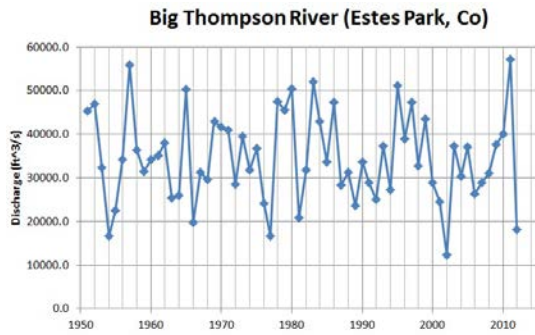

Figure 3: Streamflow time series of the San Juan River in Pagosa Springs, Co (Top) and the Big Thompson River above Lake Estes in Estes Park, Co.

<u>SNOTEL with Streamflow (Nearest City, State)</u>	<u>April - July (R Value)</u>	<u>Apr-July (R Squared Value)</u>
Cascade with Animas River (Silverton, Co)	0.5078	0.2578
Columbine with Fish Creek (Steamboat Springs, Co)	0.6908	0.4772
Copeland Lake with Big Thompson (Estes Park, Co)	0.4471	0.1999
Culebra#2 with Costilla Creek (Costilla, NM)	0.6956	0.4838
Fremont Pass with Eagle River (Red Cliff, Co)	0.7529	0.5668
Grizzly Peak with Bobtail Creek (Jones Pass, Co)	0.7368	0.5428
Lake Irene with Michigan River (Cameron Pass, Co)	0.6488	0.421
Park Cone with Taylor River (Taylor Park, Co)	0.7423	0.551
Park Reservoir with Surface Creek (Cedaredge, Co)	0.8899	0.7919
University Camp with Ranch Creek (Fraser, Co)	0.3433	0.1179
Upper San Juan with San Juan River (Pagosa Springs, Co)	0.8987	0.8077

Table 1: Correlations between April 1 SWE and April – July streamflow discharge amounts.

	ENSO	NAO	PDO
<b>Best Correlation</b>	2	9	6
<b>Middle Correlation</b>	3	7	7
<b>Worst Correlation</b>	12	1	4

Table 2: Resembles the number of times each climate index (ENSO, NAO, and PDO) contain the largest single month correlation value for each gauge site.



	<u>Forecasted Streamflow</u>
Animas River	2505
Arkansas River	2731
Big Thompson River	30944
Bobtail Creek	92.3
Costilla Creek	30.5
Crystal River	2183
Eagle River	213.6
Fish Creek	701.1
Fraser River	129
Gore Creek	134.3
Michigan River	28.5
North Fork South Platte River	14363
Ranch Creek	87.5
San Juan River	2726
Snake River	459.3
Surface Creek	166.4
Taylor River	956.6

**Table 3:** Forecasted total streamflow discharge amounts from April 1 – July 31, 2013.

# Reconstructing a Water Balance for the San Luis Valley: Streamflow Variability, Change, and Extremes in a Snowmelt Dominated Internal Drainage Basin

## Basic Information

<b>Title:</b>	Reconstructing a Water Balance for the San Luis Valley: Streamflow Variability, Change, and Extremes in a Snowmelt Dominated Internal Drainage Basin
<b>Project Number:</b>	2012CO262B
<b>Start Date:</b>	3/1/2012
<b>End Date:</b>	8/31/2013
<b>Funding Source:</b>	104B
<b>Congressional District:</b>	4th
<b>Research Category:</b>	Climate and Hydrologic Processes
<b>Focus Category:</b>	Irrigation, Surface Water, None
<b>Descriptors:</b>	
<b>Principal Investigators:</b>	Steven Fassnacht

## Publications

There are no publications.

## **Reconstructing a Water Balance for the San Luis Valley: Streamflow Variability, Change, and Extremes in a Snowmelt Dominated Internal Drainage Basin**

Niah Venable, PhD Student, Watershed Science, Colorado State University

Faculty Advisor: Steven Fassnacht

This report summarizes work to date on the CWI/NIWR State Program Project Award 2012CO262B. The project PI is Dr. Steven Fassnacht, Associate Professor of Snow Hydrology, and the student researcher is Niah Venable, a PhD student in the Watershed Science program at Colorado State University. The project originally began on March 1, 2012, with a completion date of March 1, 2013, but due to ACMS field research fellowship duties in Mongolia and fall semester GEOL 122 instructor commitments for Venable, the completion date was extended to August 1, 2013.

### *Research Project Objectives:*

- Assess the natural variability, extremes, and changes in streamflow to examine how natural systems in a closed basin function over longer periods and provide insight into the sustainability and further development of dry regions and to help define possible impacts of future change.
- Compare a modern water balance and streamflow of a catchment draining into the basin with that reconstructed from paleo-climatic data derived from tree-rings.

### *Tasks Completed:*

- Preliminary project work was initiated in Fall of 2012. Additional references and data sources were identified and the research plan for the first half of the project was finalized.
- In the Spring semester of 2013, tree-ring records from the International Tree-Ring Data Bank (ITRDB) were screened for suitability and 9 sites within about 100 km of Crestone Creek in the San Luis Valley were selected for analysis.
- The residual site chronologies were used as potential predictors of streamflow over a period 300 years longer than the observed flow record at that creek. Stepwise regression was used to develop the model. Three chronologies located to the south and east of the watershed and extending from years 1636 to 2000 provided a best fit to the streamflow record, with a final model  $R^2$  of 0.69. Other statistical tests also confirmed the robust nature of the reconstruction.
- The results of the analysis compare favorably to previous analyses performed by Woodhouse *et al.*, (2004). Her reconstructions of flow in Saguache Creek, and the Rio Grande at Del Norte, both in the San Luis Valley show similar trends in wet and dry conditions and have similar statistical results and model fits.

### *Student Support:*

This award provided support for the PhD student Venable, and will continue to provide critical support for her to complete project work over the next few months.

*Publications:*

Venable, N. B. H., Brown, P.M., Fassnacht, S. R., "Streamflow to Nowhere: Long-term Variability of Flow Into the San Luis Closed Basin, CO, USA." Poster Presentation, 33rd Annual American Geophysical Union Hydrology Days, Colorado State University, Fort Collins, CO, March 27th, 2013.

Talk prepared for the Spring Geosciences Advisory Council Student Presentations which were postponed to the Fall semester 2013 due to poor weather conditions and other departmental schedule changes.

*Remaining Work Plan (subject to revision):*

- Further examine flow regimes, extremes and long-term variability at Crestone Creek via completed flow reconstruction(s).
- Better characterize Crestone Creek area through field investigations of flow conditions, land use/land cover, etc.
- Analyze data and create modern water balance (Thornthwaite model) using PRISM inputs and observed flow (WY 1948-2012).
- Reconstruct precipitation for Crestone watershed using stepwise regression process on original pool of tree-ring chronologies. PRISM data will be used for calibration of the model.
- Examine feasibility/create a paleo-water balance using reconstructed precipitation and possibly temperatures (NOAA/ITRDB products).
- Compare results to other modeling efforts and basin analyses as appropriate.

*Project Timeline (details subject to revision):*

- Fieldwork, May 10<sup>th</sup>-13<sup>th</sup>, 2013.
- Modern water balance modeling, May 22<sup>nd</sup>-25<sup>th</sup>.
- Precipitation reconstruction, May 27<sup>th</sup>-May 31<sup>st</sup>.
- Paleo- water balance modeling, June 1<sup>st</sup>-6<sup>th</sup>.
- Reporting draft, June 9<sup>th</sup>-11<sup>th</sup>.
- Meet with Fassnacht to discuss draft and further project work, June 12<sup>th</sup>-14<sup>th</sup>.
- Final project report (draft), July 1<sup>st</sup>. Submission to CWI soon after?!
- Further incorporation of additional project work and results to conference proceedings/papers/dissertation proposal through end of 2013.

Reference: Woodhouse, C.A., et al. (2004) TreeFlow Colorado Streamflow Reconstructions. IGBP PAGES/World Data Center for Paleoclimatology Data Contribution Series # 2004-029. NOAA/NGDC Paleoclimatology Program, Boulder CO, URL <http://treeflow.info/index.html>

# The Short and Long-Term Impacts of Drought on the Structure of Regional Economics: Investigating the Farm Supply Chain

## Basic Information

<b>Title:</b>	The Short and Long-Term Impacts of Drought on the Structure of Regional Economics: Investigating the Farm Supply Chain
<b>Project Number:</b>	2012CO263B
<b>Start Date:</b>	3/1/2012
<b>End Date:</b>	2/28/2013
<b>Funding Source:</b>	104B
<b>Congressional District:</b>	4th
<b>Research Category:</b>	Social Sciences
<b>Focus Category:</b>	Drought, Economics, Methods
<b>Descriptors:</b>	None
<b>Principal Investigators:</b>	Christopher Goemans

## Publications

There are no publications.

## **The Short and Long-Term Impacts of Drought on the Structure of Regional Economics: Investigating the Farm Supply Chain**

Ron Nelson, Master's Candidate, Department of Agricultural and Resource Economics, Colorado State University

Faculty Advisors: Christopher Goemans and James Pritchett

For the last two years, agricultural producers in Colorado have been faced with severe drought conditions, resulting in significant economic losses. The drought has led to widespread crop failures, damaged rangelands, and drastically reduced crop yields and livestock productivity. The financial impacts caused by the drought will be felt by agricultural producers for years to come and may threaten the long-term economic viability of some agricultural operations. Given forward and backward linkages with other industries in the supply chain, the impact of drought typically extends well beyond those sectors and communities immediately impacted. Federal and state agencies have responded to the drought by offering millions of dollars in emergency drought relief. With a changing climate, likely leading to an increased probability of extreme and recurring droughts, it is becoming an ever more important policy concern to determine the effect that drought has on the resiliency of farmers and ranchers.

The resiliency of farmers and ranchers is the ability of the agricultural producer to return to a similar state of production after they have endured a stressor such as a drought. Understanding the factors that influence the resiliency of agricultural producers is important for multiple reasons. First, understanding existing levels of resiliency can convey how adaptable agricultural producers are to extreme and changing climatic conditions. Second, it indicates how long farmers and ranchers can endure an environmental stressor such as drought until they are ultimately forced to exit the agricultural sector. Third, by understanding the determinants of resiliency, decision makers can design policies that help agricultural producers adapt to the challenges presented by natural hazards such as drought. Fourth, because farmers and ranchers are key components of rural communities, their resiliency is directly correlated with the resiliency of rural communities. Lastly, small and mid-sized farms and ranches have been found to be less resilient than large farms, which many believe decreases the adaptability of the domestic food sector and may lead to food security concerns in the future. Therefore, by determining the characteristics that influence resiliency, we can help improve food security. By investigating resiliency, we aim to provide insight into the efficacy of the current drought relief policies and identify ways to minimize the economic impacts felt by agricultural producers and regional economies.

Past studies that have examined resiliency indicate that there are multiple producer and enterprise characteristics that influence the ability to adapt to drought and the producer's decision to exit the agricultural sector. Characteristics that have been found to influence farm exit include off-farm income, the size of the operation, experience, and age. Characteristics related to drought induced exits include decreased crop yields, number of acres fallowed, the duration of drought, access to irrigation, and decreased profit. Most recently, a theoretical model was developed that suggested proxies for a farmer's or rancher's overall wealth, such as groundwater, since it can be thought of as a savings account during drought.

Our study explores the determinants of resiliency, but mainly focuses on the roles that wealth and the duration of drought have on farmer and rancher resiliency. To investigate resiliency, we developed an online survey that was administered to agricultural producers throughout Colorado. The survey inquired about the circumstances faced during the 2012 drought and collected information on the characteristics of producers and their production enterprise(s). As a measure of wealth, we inquired about the respondent's debt-to-asset ratio before and after the 2012 drought. Debt-to-asset ratio is defined as a producer's total liabilities divided by their total assets. And as a measure of resiliency, we asked respondents what the probability was of them leaving farming/ranching if the drought continued for another year. Respondents included all major producer types, and the sample was thought to be representative of the larger agricultural enterprises in Colorado.

Using the data from the survey, we use regression analysis to estimate the determinants of resiliency (see Table 1 for complete results). Several key findings emerge from the analysis. First, the analysis suggests location is an important determinant of resiliency. Specifically, we found that the southeastern region of Colorado was more resilient than other regions of Colorado (see Figure 1). This finding is interesting partly because the Southeast region is in its second year of drought while most other regions of Colorado are in their first. The increased resiliency that the region possesses during drought may be due to the fact that the Southeast has a long history of drought and therefore has successfully adapted. This may indicate that the duration of the drought may not be as important as where the drought is occurring and if that area has been repeatedly exposed to similar droughts. A policy implication of this finding is that drought assistance in form of educational outreach and financial resources may be better utilized by regions less familiar with adapting and planning for drought.

<b>Table 1: Regression Results</b>			
<b>Dependent Variable</b>	<b>Definition</b>		
<b>Resiliency</b>	the respondent's stated probability of leaving farming in the next five years if drought continues in 2013		
<b>Independent Variables</b>	<b>Definition</b>	<b>Marginal Effect</b>	<b>P-Value</b>
<b>ln(acres)</b>	the natural log of the number of acres in an operation	-0.0009	0.955
<b>Debt-to-asset ratio</b>	the debt-to-asset ratio after the 2012 drought	0.0054**	0.036
<b>Profit</b>	profit in 2012	-0.0008	0.723
<b>(Debt-to-asset ratio)*(Profit)</b>	interaction variable	-0.0001	0.44
<b>Southeast</b>	the Southeast district of Colorado as defined by NASS	-0.1709***	0.007
<b>Irrigation</b>	the type of enterprise divided into those with water and those without	0.0525	0.436
<b>Off Farm Income</b>	the percentage of income that comes from off of the farm	-0.0008	0.426
<b>Experience</b>	the number of years the respondent has farmed and/or ranched	0.0011	0.594

Additionally, our analysis indicates that debt-to-asset ratio is a key determinant of the resiliency of a farmer or rancher. As a proxy for the wealth of the farmer or rancher, this variable reflects, in aggregate, how the farm or ranch has been financially managed over a long period of time. Debt-to-asset ratio's importance reveals that a one year drought may not be a significant factor in motivating an agricultural producer to exit the sector, since it likely will not decrease drastically in a single year. Furthermore, profit from the year 2012 was not found to influence resiliency, which furthers the claim that a one year drought may not be impacting resiliency. However, multi-year droughts will surely increase the debt-to-asset ratio of most agricultural producers, decreasing resiliency and possibly increasing agricultural sector exits. This finding has implications for policy makers, agricultural producers, and industry. First, producers and insurers need to be educated on how increasing debt can lower the resiliency of agricultural producers, and how preparing financially for drought may increase the vitality of a producer's enterprise. Second, the form of assistance currently offered, low interest emergency loans, may be decreasing farmer and rancher resiliency by increasing their debt-to-asset ratio. However, low interest emergency loans may be minimizing the negative impact felt by agricultural producers and their communities, and could be the best policy option available for the circumstances. To further determine whether or not low interest emergency loans are the best option for drought assistance, additional research could compare the exit rates of those farmers that choose to take low interest emergency loans versus those that do not.

#### AGRICULTURAL STATISTICS DISTRICTS

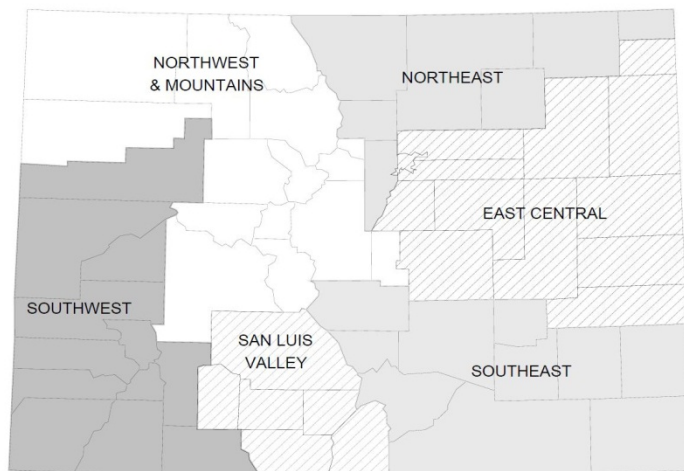

Figure 1: National Ag Statistics Service—Colorado Agricultural Statistics Districts. Source: NASS, 2012



# Quantifying Risks Producers Face when Entering Agricultural Water Lease Contracts

## Basic Information

<b>Title:</b>	Quantifying Risks Producers Face when Entering Agricultural Water Lease Contracts
<b>Project Number:</b>	2012CO264B
<b>Start Date:</b>	3/1/2012
<b>End Date:</b>	2/28/2013
<b>Funding Source:</b>	104B
<b>Congressional District:</b>	4th
<b>Research Category:</b>	Engineering
<b>Focus Category:</b>	Management and Planning, Economics, Models
<b>Descriptors:</b>	None
<b>Principal Investigators:</b>	Christopher Goemans, James Pritchett

## Publications

There are no publications.

## Quantifying Risks Producers Face when Entering Agricultural Water Lease Contracts

Larisa Serbina, Department of Agriculture and Resource Economics, Colorado State University

Faculty Advisor: Christopher Goemans

### Overview

Driven primarily by population growth along the Front Range, municipal and industrial (M&I) demand for water in Colorado is expected to nearly double by 2050. Throughout most of Colorado, water is already fully allocated—the majority of water being diverted for agricultural uses. These two factors make it likely that the gap between existing M&I supplies and future demands will be met, at least in part, by reallocating water out of agriculture. The Colorado Water Conservation Board's (CWCB) 2010 State Water Supply Initiative (SWSI) forecasts that as much as 20 percent of existing irrigated land, statewide, will be dried up due to meeting future urban demands. Growing concerns surrounding the impacts to rural communities associated with the permanent dry up of agricultural land have led many to advocate for alternatives to permanent transfers of water rights.

Water banks, interruptible water supply agreements, and multi-year leases are examples of such alternatives that when combined with rotational fallowing and/or alternative cropping patterns are thought to be less impactful on rural communities, while freeing up water to meet future needs. Regardless of the nature of the agreement, each requires the producer to make changes in their production practices to free up water. While identifying the optimal strategy is relatively easy to do *after the fact*, uncertainty in output prices and potential yields significantly complicates the decision process. Understanding the potential impacts a priori, both in terms of their impacts on expected profits and variation in profits, is critical not only for policy makers trying to understand the potential viability of such alternatives, but also for producers evaluating the potential efficacy of their choices. This research develops both a conceptual and analytic framework for evaluating alternative cropping systems that producers may choose when seeking to conserve water and compares them to baseline cases corresponding to existing irrigated cropping systems. The goal is to develop a tool for irrigators and policy makers that will allow them to evaluate the impact of various alternative cropping and rotational fallowing strategies on the distribution of future profits accounting for uncertainty in yields and output prices. While the tool can be applied anywhere, we illustrate its potential usefulness below with an example focused on Weld county of Colorado.

### Methodology

The focus of analysis is an irrigated farm manager's question: how does the underlying distribution of farm profits change when adopting a water conserving cropping system? The Excel model developed evaluates the financial tradeoffs that exist when adopting different cropping systems under uncertain price and yield conditions.

These financial tradeoffs include differences in realized profits, the potential for losses when price and/or yields are low and the opportunity cost of unrealized financial gains. Within the model, profits stemming from a "baseline" cropping pattern (e.g., 100 percent corn) are calculated and compared to those associated with user-specified, alternative systems (e.g. 50 percent corn, 50 percent fallow) that result in a given amount of conserved, consumptive water use (CU). Of key importance is the recognition that any particular comparison represents a potential outcome given

assumed prices and yields. To represent the uncertainty faced by irrigators, the comparison is repeated 500 times under different output price and yield conditions, the suite of results providing a distribution of outcomes under alternative conditions.

Figure 1 provides an illustration of the iterative process used. For each iteration, total profits are calculated under the baseline and alternative cropping systems. Total profits are equal to revenue minus the cost of production, with revenue equal to yield times prices and cost calculated based 2009 input cost data.

The iterative process begins with the selection of a random year from 1980 to 2010. The selected year (e.g., 1985) becomes the base year for that iteration. Commodity prices and the GDP deflator for the base year are used directly in the calculation, whereas the yield from that year is used to calculate an “adjusted yield.” The adjusted yield is calculated by adding a random term to the selected base yield. This is done so as to not draw from the same yield frequency. This allows the model to proxy the potential variation in yields that have been demonstrated historically, while preserving the correlation between local production conditions and national output prices. Without the random error term, the sample would be drawn from the historical distribution of yields; thus, the result would be the same distribution as that of the historical data. The addition of a random percent error term allows for variability yields outside of what has been observed historically.

The number of acres in production is multiplied by the adjusted yield to calculate total yield. The product of total yield and the commodity price equals revenue. The input costs are adjusted using the GDP ratio.

The difference between revenue and costs represents the potential profit obtained from producing a particular crop under that iteration’s conditions. For a given iteration, the difference between the profit under baseline and the alternative scenarios represents potential foregone profits for the irrigator if they were to switch to the water conserving alternative.

It is important to note that these comparisons do not include a payment for leased water associated with the conserved CU, so profits for the alternative cropping systems are expected to be less than the baseline. Model output could be used by the irrigator to determine, given their risk preferences, the amount of leasing revenue they would need to receive to offset the foregone profit associated with switching to the alternative.

### **Applying the Model to a Representative Farm in Weld County, Colorado**

To illustrate the model’s potential usefulness, results corresponding to a representative farm of 2,000 acres in Weld County, Colorado are presented below. Figure 2 illustrates the baseline and four alternative scenarios considered. The scenarios considered here were selected based on conversations with specialists at CSU and represent likely adaptations farmers would consider to reduce consumptive water use.

Table 1 presents the average, standard deviation, coefficient of variation, minimum, and maximum profit associated with the Baseline and Scenario runs generated by the model.

Table 1. Summary Statistics of Profits for a Representative Farm

Profit	Baseline	Scenario A	Scenario B	Scenario C	Scenario D
<b>Average</b>	265,240	176,836	103,044	199,517	285,354
<b>St. Dev.</b>	138,641	92,432	90,638	94,707	130,797
<b>Coef. of Var.</b>	52	52	88	47	46
<b>Min</b>	-181,317	-120,884	-134,725	-87,893	-39,825
<b>Max</b>	535,758	357,190	431,053	401,131	724,882

Both in terms of average and relative variability in profits (i.e., coefficient of variation), Scenario D is preferred over the other alternatives and the Baseline cropping pattern. The latter is true despite recently high corn prices relative to the average over the 30-year sample period. To the extent that corn prices remain high, all else equal, the model underestimates the true value of producing corn and therefore also underestimate the opportunity cost of switching to any of the alternatives.

While the figures in Table 1 provide insight into the impact of each alternative on the distribution of profits, they are difficult to compare given that the amount of water freed up, as well as the number of acres impacted, differs across each alternatives. As an alternative, we calculate the difference in profits between the Baseline and each of the scenarios and normalize them based on the amount of acres impacted (Table 2) and the consumptive water use conserved (Table 3).

Table 2: Foregone Profits per Acre Converted from Corn

	Scenario A	Scenario B	Scenario C	Scenario D
<b>Average</b>	132	238	65	-24
<b>St. Dev.</b>	72	160	70	90
<b>Coef. of Var.</b>	55	67	107	-384
<b>Min</b>	-91	-222	-126	-466
<b>Max</b>	268	643	247	256

Table 3: Foregone Profits per Acre Foot of Water Conserved (CU)

	Scenario A	Scenario B	Scenario C	Scenario D
Mean	111	569	55	-46
St.Dev.	58	363	56	199
Coef. of Var.	52	64	102	-435
Min	-76	-519	-106	-1,060
Max	224	1,504	206	583
Acre Feet Conserved	797	285	1,195	440

Again, it is important to keep in mind that profit estimates presented in Tables 2 and 3 represent deviations from Baseline production where potential revenue from water leases is not factored in.

Which alternative is preferred? Tables 2 and 3 each provide the irrigator (and policy makers) with a starting point for considering the type of returns they would need to get from leasing to offset losses in productivity. The preferred alternative will depend on the risk preferences of individual producers and the quantity of water needed. For more information about the project, and use of the model, please contact Larisa Serbina ([larisa.o.serbina@gmail.com](mailto:larisa.o.serbina@gmail.com)) or Christopher Goemans ([cgoemans@rams.colostate.edu](mailto:cgoemans@rams.colostate.edu)).

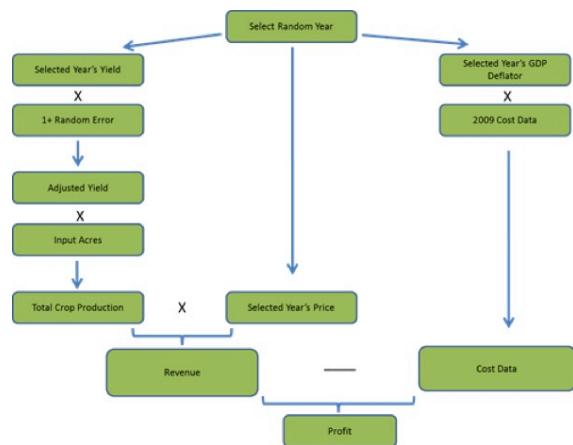

Figure 1. Model overview

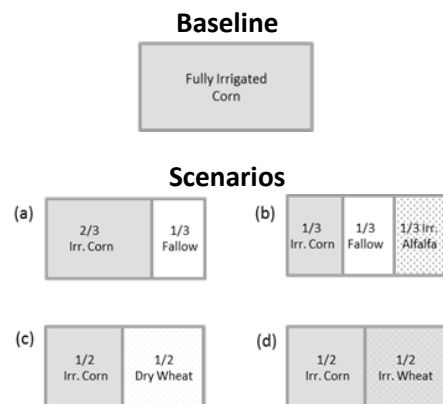

Figure 2. Baseline cropping pattern and four potential scenarios for analysis

Thermal preference of age-0 stonecats (Noturus flavus): Are thermal water quality standards protective for this species?

## Thermal preference of age-0 stonecats (Noturus flavus): Are thermal water quality standards protective for this species?

### Basic Information

<b>Title:</b>	Thermal preference of age-0 stonecats (Noturus flavus): Are thermal water quality standards protective for this species?
<b>Project Number:</b>	2012CO265B
<b>Start Date:</b>	3/1/2012
<b>End Date:</b>	2/28/2013
<b>Funding Source:</b>	104B
<b>Congressional District:</b>	4th
<b>Research Category:</b>	Biological Sciences
<b>Focus Category:</b>	Ecology, Law, Institutions, and Policy, None
<b>Descriptors:</b>	None
<b>Principal Investigators:</b>	Christopher A. Myrick

### Publications

There are no publications.

Thermal preference of age-0 stonecats (Noturus flavus): Are thermal water quality standards protective for this species?

## **Thermal Preference of Age-0 Stonecats (*Noturus flavus*): Are Thermal Water Quality Standards Protective for this Species?**

Adam Herdrich, Master's Candidate, Department of Fish, Wildlife, and Conservation Biology, Colorado State University

Faculty Advisor: Christopher A. Myrick

### **Introduction**

Transition zone streams, those coming off of the Rocky Mountains and transitioning onto the Great Plains along the Front Range of Colorado, are under increasing pressure from anthropogenic sources. Between the push for supplying drinking water for the growing population in this area, the invasion of non-native aquatic species, and the effects of urbanization, these streams have been and will continue to be impacted by human activities. The ecosystem-level effects inevitably trickle down to the fish and insect communities inhabiting these stream segments, and create conditions that are suboptimal, or even detrimental, to these assemblages.

Changes in the magnitude, timing, and duration of flows have serious impacts on these systems, but another factor, the temperature or thermal regime, is of equal or greater importance. Temperature is one of the most crucial factors in aquatic systems, largely because the vast majority of aquatic organisms are poikilotherms, or cold-blooded, and their biology is directly tied to the environmental temperature. All organisms have temperatures at which their fitness is maximized, and without the ability to internally control their body temperatures, poikilotherms, such as the fish in transition zone streams, are limited by the thermal heterogeneity offered by their environment.

The state of Colorado regulates water temperature through a tiered system that is based on the fish communities that are present at the site being regulated. Thermal tolerance data are reviewed, and regulations are set based on the most sensitive member of the fish assemblage present in the reach of interest. The most sensitive species is generally assumed to be the one that is most vulnerable to water temperature changes. Currently, Colorado develops independent standards for both acute (short-term) and chronic (long-term) exposure and differentiates between warm and cold-water species and flowing (e.g., streams, rivers) vs. impounded (e.g., ponds, reservoirs) bodies of water.

While thermal tolerance data are available for numerous fishes, the majority of studies have focused on fishes that are valued from a commercial or recreational fishing standpoint, or that are candidate species for protection under federal endangered species legislation. Until recently, relatively few studies looked at native non-game fishes such as those that dominate the transition zone assemblages.

My research focused on the thermal biology of the stonecat (*Noturus flavus*; Figure 1), a species of small catfish. The Colorado populations of stonecats are found in the St. Vrain River in the vicinity of Longmont, Colorado, and in the Republican River near Wray, Colorado; (Figure 2). Specifically, I am investigating whether the thermal regulations set by the State of Colorado Water Quality Control Division are sufficiently protective of these rare fish.

The section of the St. Vrain River where stonecats occur is presently categorized as a Tier-I Aquatic Warm-Life stream section with a Daily Maximum Temperature of 29°C. This means that the stream temperature cannot exceed 29°C more than once in three years. This regulation is driven by the presence of common shiner (*Luxilus cornutus*) and Johnny darter (*Etheostoma nigrum*) and is based on the assumption that these fishes are the most sensitive to drastic thermal changes in this stream.

My research project was designed to test this assumption, and to expand the existing knowledge of stonecat thermal biology, particularly as it relates to their thermal tolerance when acclimated to summer-type temperatures. Prior research conducted at the Center for Lake Erie Area Research (The Ohio State University) on thermal tolerance of stonecats acclimated to cold temperatures (1.6° C) showed that they selected a temperature of 29 °C.

## Methods

Adult stonecats ( $n = 20$ ; total length:  $209.75 \pm 15.64$  mm [mean  $\pm$  S.D.]; wet weight:  $105.05 \pm 23.07$  g) collected from the St. Vrain River by Colorado Parks and Wildlife (CPW) biologists were delivered to Colorado State University (CSU) where they were held in ambient (temperature & photoperiod) conditions at the CSU Foothills Fisheries Laboratory. Six weeks prior to the trials, the temperature was raised to 20°C at a rate of 2.0°C per week. This was done to simulate spring warming, culminating in water temperatures found in the St. Vrain River over the summer. We simultaneously and incrementally changed the photoperiod, culminating in a 14-hour day, also to mimic summer conditions (Figure 3) and to account for any additional stress effects, due to a decreased window of activity, on the thermal tolerance of the largely nocturnal stonecat. Stonecats were fed a mixed diet of live earthworms and commercial fish feed (Hikari Massivore Delite).

I used the Critical Thermal Maximum (CTMax) approach, as modified by Underwood et al. (2012) to measure the short-term thermal tolerance of the stonecats. The CTM methodology is a well-established and widely used technique for evaluating the acute thermal tolerance of fish and other aquatic organisms. The CDPHE thermal standards include specific guidance on how to translate the results of CTMax tests into thermal standards. Because of the limited availability of stonecats, I was not able to test fish at additional acclimation temperatures, nor was it possible to use a chronic and lethal test methodology such as the incipient upper lethal temperature (IULT) approach.

The test apparatus was based on the system assembled by Underwood et al. (2012), with the notable substitution of the 1.5-l aquaria with five larger 9-l aquaria (Figure 4) receiving 3 l/min of temperature-controlled water. The heated and ambient water were delivered to a mixing tank, then to aquariums to increase the tank temperature by 0.3°C per minute. Fish were measured (to nearest mm) weighed (to nearest g) and placed into the tanks (one fish per tank), and allowed to acclimate at ambient temperatures for one hour before a trial was started. Fish behavior was observed and the trials were ended after a sustained loss of equilibrium (LOE; greater than 10 s); with this loss of equilibrium, it can be assumed that fish will not be able to escape rapidly warming water temperatures in a natural setting. After LOE was observed, the water temperatures were recorded and the tanks were immediately flushed with ambient temperature water, and final temperatures were recorded. Fish were then returned to their holding tanks and monitored for 48 hours to check for delayed mortality. No fish were reused, and all experiments were conducted under the protocol approved by the CSU Institutional Animal Care and Use Committee (#12-3991A).

## Results

The mean  $\pm$  S. D. CTMax for the 20° C-acclimated stonecats was  $32.6 \pm 0.44$ ° C ( $n = 20$ ). A 1-way ANOVA (JMP) showed a significant effect ( $P < 0.05$ ) of total length on CTMax (Figure 5), and a non-significant trend ( $P = 0.09$ ) wherein wet weight also influenced CTMax. No delayed mortality was observed.

## Discussion

This study demonstrated that stonecats are capable of tolerating temperatures that are slightly lower than those tolerated by other transition zone and eastern plains fishes such as the Johnny darter and common shiner when acclimated to summer-type temperatures. Smith and Fausch (1997) reported that



the mean  $\pm$  SE CTMax for Johnny darter acclimated to 20°C was  $34 \pm 0.32^\circ\text{C}$ ; Beitinger et al. (2000) reported that the CTMax for common shiner acclimated to 26°C was  $35.7 \pm 0.39^\circ\text{C}$ . Based on these results, it appears that stonecats should receive serious consideration as one of the sensitive species that can influence thermal classifications, particularly when their limited distribution is considered.

Additionally, the presence of a size effect highlights the importance of follow-up studies to determine whether there are ontogenetic changes in the thermal tolerance of stonecats; if the larger adult fish are indeed more sensitive to elevated temperatures, perhaps more protective standards are required to protect them. From this study, it is clear that further research is warranted, both to better understand the effects of fish size on thermal tolerance, and to complete a thermal tolerance polygon (a figure showing the absolute thermal limits, upper and lower, for a fish species) for the stonecat.



Figure 1. The species studied was the stonecat (*Noturus flavus*), a small, rare species of catfish.

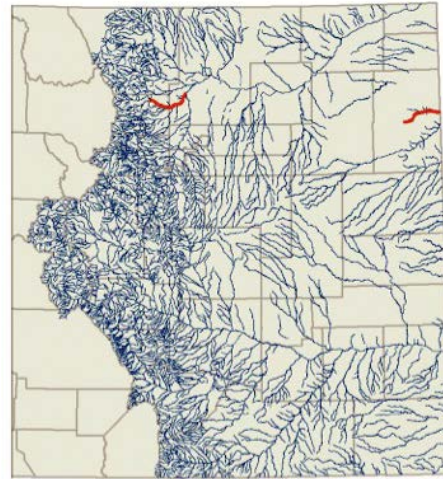

Figure 2. Current distribution of Stonecats (*Noturus flavus*) in Colorado

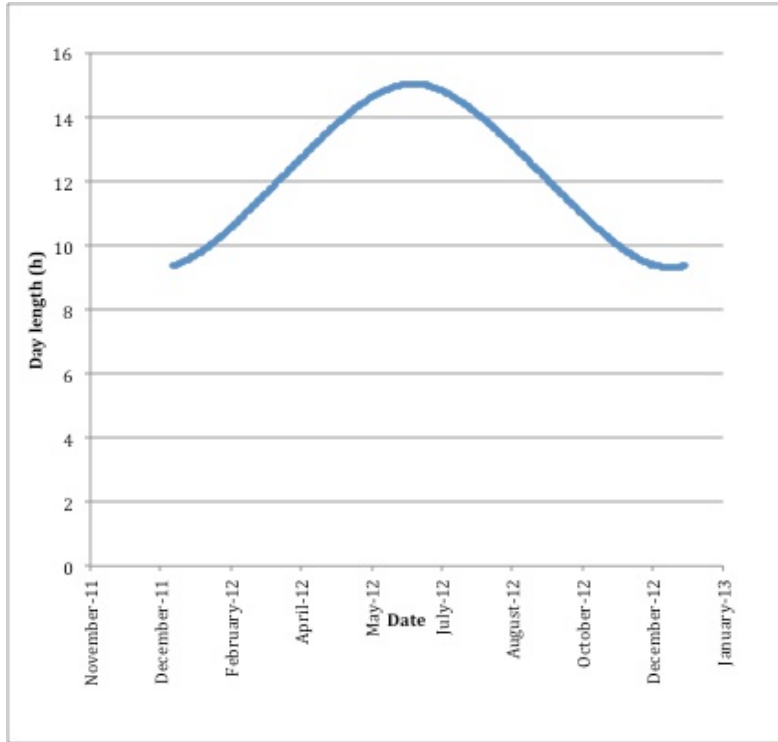

Figure 3. Photophase (length of daylight) for the Longmont, CO, area over one year

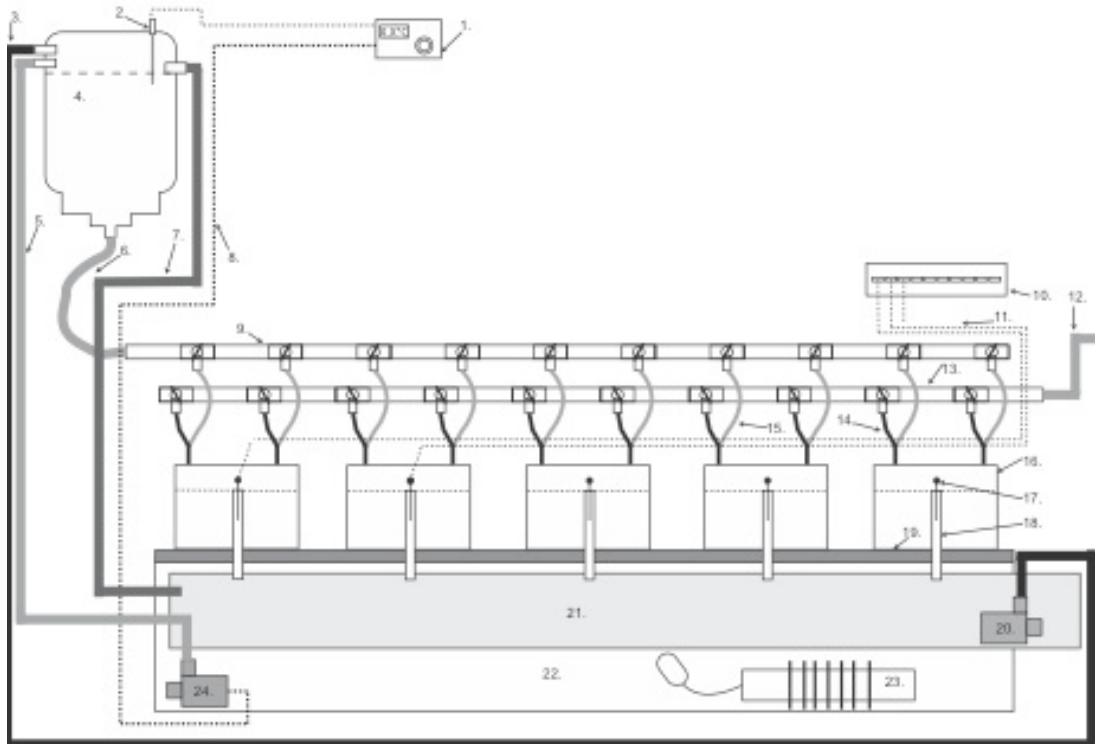

Figure 4. Schematic diagram of the thermal tolerance apparatus.  
 Key for schematic diagram of critical thermal tolerance apparatus:

1. Dynasense Mk 1 on/off relay temperature controller (model 221-017)
2. RTD temperature probe
3. Mixed water supply line (3/4" ID tubing); water is delivered from the mixed water sump (21) by the mixed water pump (20).
4. Water mixing tank; dashed line indicates nominal water level just below constant head overflow port.
5. Hot water supply line (3/4" ID tubing). Water is delivered from the hot water supply tank (22) by the hot water pump (24).
6. Mixed water delivery line; this line delivers water to the mixed water distribution manifold (9).
7. Constant-head overflow line; this line maintains a constant water level in the mixing tank (4) and delivers excess water to the mixed water sump (21).
8. Control cable from temperature controller (1) to hot water pump (24).
9. Mixed water delivery manifold; the manifold has ten individually-regulated outlets for delivery water to the tolerance chambers (16).
10. Scientific Instruments Digi-Sense 10-channel scanning thermometer; the thermometer is connected to 10 thermistor probes (11; only 3 are shown) and constantly monitors temperatures in the tolerance chambers.
11. Thermistor probes (1 per tolerance chamber) that connect to the scanning thermometer (10).
12. Ambient water delivery line (3/4" ID tubing); this line delivers water to the ambient water distribution manifold (13).
13. Ambient water distribution manifold; the manifold has ten individually-regulated outlets for delivery water to the tolerance chambers (16).
14. Ambient water delivery tubing (3/8" ID); each chamber receives water from the ambient water manifold (13) through one of these lines.
15. Mixed water delivery tubing (3/8" ID).
16. Thermal tolerance chamber.
17. Thermistor, connected to scanning thermometer (10) by wire (11). Each tolerance chamber was fitted with a single thermistor.
18. Tolerance chamber overflow drain; these drained into the mixed water sump (21).
19. Insulated tank cover that rests on the hot water supply tank (22).
20. Pondmaster MagDrive submersible pump (model 18B) used as the mixed water delivery pump.
21. Mixed water sump, which receives water from the tolerance chambers (16) and the overflow from the water mixing tank (4).
22. Hot water supply tank, fitted with an insulated cover (19).
23. Clepco Smart Heater (1.5 kW, 120V) with control unit and low-water shutoff. This heater sits in the hot water supply tank and is used to maintain the water temperature at > 40°C.
24. Pondmaster MagDrive submersible pump (model 18B) used as the hot water delivery pump.

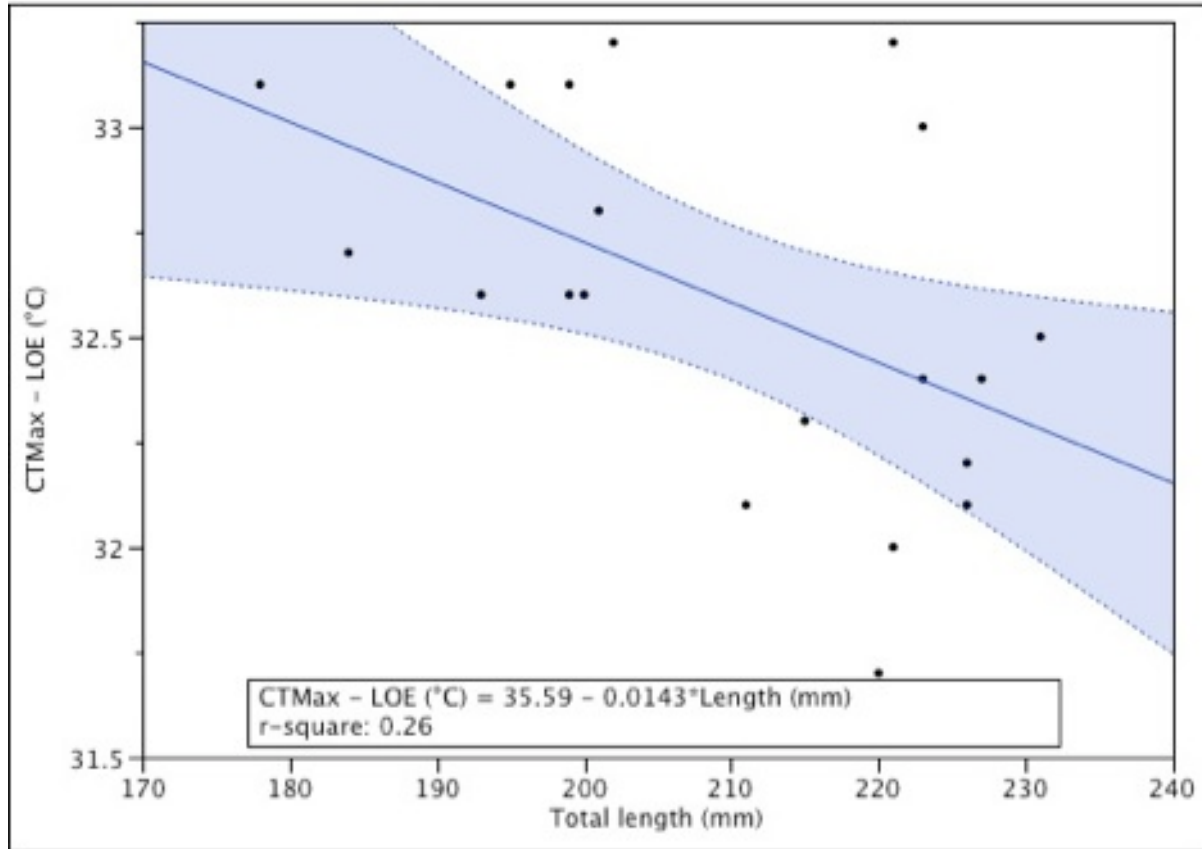

Figure 5. Effects of fish size (TL, in mm) on the critical thermal maxima - loss of equilibrium (CTMax-LOE) of adult stonecats (*Noturus flavus*) acclimated to 20°C. The shaded area shows the 95 percent confidence interval for the fitted regression line.

# Biowin Simulation to Assess Alternative Treatment Units for a Local Wastewater Treatment Plant to Meet the New Effluent Nutrient Regulations

## Basic Information

<b>Title:</b>	Biowin Simulation to Assess Alternative Treatment Units for a Local Wastewater Treatment Plant to Meet the New Effluent Nutrient Regulations
<b>Project Number:</b>	2012CO266B
<b>Start Date:</b>	3/1/2012
<b>End Date:</b>	2/28/2013
<b>Funding Source:</b>	104B
<b>Congressional District:</b>	4th
<b>Research Category:</b>	Engineering
<b>Focus Category:</b>	Wastewater, Law, Institutions, and Policy, Models
<b>Descriptors:</b>	None
<b>Principal Investigators:</b>	Pinar Omur-Ozbek

## Publications

There are no publications.

# Biowin Simulation to Assess Alternative Treatment Units for a Local Wastewater Treatment Plant to Meet the New Effluent Nutrient Regulations

Keerthivasan Venkatapathi, Civil and Environmental Engineering, Colorado State University

Faculty Advisor: Pinar Omur-Ozbek

## Introduction

Wastewater treatment plant (WWTP) effluents may contribute significant levels of nutrients (i.e., nitrogen and phosphorus) to the surface waters. Elevated levels of nutrients lead to eutrophication of the water bodies and may result in algal blooms during summer and fall. This becomes a major concern if the water body is used as a drinking water source. Algae may store and release problematic metabolites during the blooms, which include taste-and-odor compounds (e.g., geosmin and 2-methylisoborneol), toxins (e.g. microcystins), and other organic compounds that may lead to disinfection by-product formation during water treatment.

To prevent issues due to elevated levels of nutrients in surface waters, effluents from WWTPs are monitored. Colorado Department of Public Health and Environment (CDPHE) regularly updates WWTP effluent regulations to satisfy U.S. Environmental Protection Agency (EPA) guidelines. CDPHE has recently adopted a new regulation, Nutrients Management Control Regulation (Regulation 85) in June, 2012 to be effective starting in September, 2012. Two levels of discharge limits are shown in Table 1: one for the existing and another for the new WWTPs.

Table 1: CDPHE's Regulation 85 discharge limits

Parameter	Existing Discharges Annual median	Existing Discharges 95 <sup>th</sup> percentile	New Discharges Annual median	New Discharges 95 <sup>th</sup> percentile
Total Phosphorus	1.0 mg/L	2.5 mg/L	0.7 mg/L	1.75 mg/L
Total Inorganic Nitrogen	15 mg/L	20 mg/L	7 mg/L	14 mg/L

City of Loveland WWTP, selected as the model system for this research, is located 50 miles north of Denver, Colorado and employs a step feed activated sludge process with a treatment capacity of 10 million gallons per day (MGD). With new regulations, Loveland WWTP has to comply with the limits by the next permit round in 2017. The effluent data, shown in Table 2, clearly indicate that Loveland WWTP will not be able to meet the new regulation limits. To address this problem, existing Loveland WWTP should be retrofitted or upgraded. Since upgrading is an expensive and time consuming process, retrofitting the existing units was explored by this study to meet Regulation 85 by reducing the total phosphorus (TP) to below one mg/L, and the total inorganic nitrogen (TIN) to below 15 mg/L.

Table 2: Influent and effluent concentrations for City of Loveland WWTP

Parameters (Annual Average)	Influent Values-units	Effluent Values-units
Flowrate	6.29 MGD	6.19 MGD
BOD <sub>5</sub>	312 mg/L	7.6 mg/L
TSS	273 mg/L	6.9 mg/L
TKN	37.4 mg/L	2.2 mg/L
pH	7.49	6.9
NH <sub>3</sub>	24.7 mg/L	0.4 mg/L
Total Inorganic Nitrogen	N/A	<b>19.38 mg/L</b>
Total Phosphorus	6.6 mg/L	<b>4 mg/L</b>

**Methods**

Loveland WWTP was modeled and simulated using BioWin, proprietary software developed by EnviroSim Associates Ltd. Loveland WWTP has units found in a conventional WWTP; the main difference is the two identical treatment trains for the step feed activated sludge (AS) process (containing three basins each). For the AS process, primary effluent is divided among the three anoxic/aerobic basins in a predetermined ratio, with return activated sludge (RAS) (from the secondary clarifier) fed into the first basin only. The effluent from the AS trains are sent to the secondary clarifiers. Figure 1 depicts a simplified flowchart of Loveland WWTP.

Figure 1: Flowchart of City of Loveland WWTP

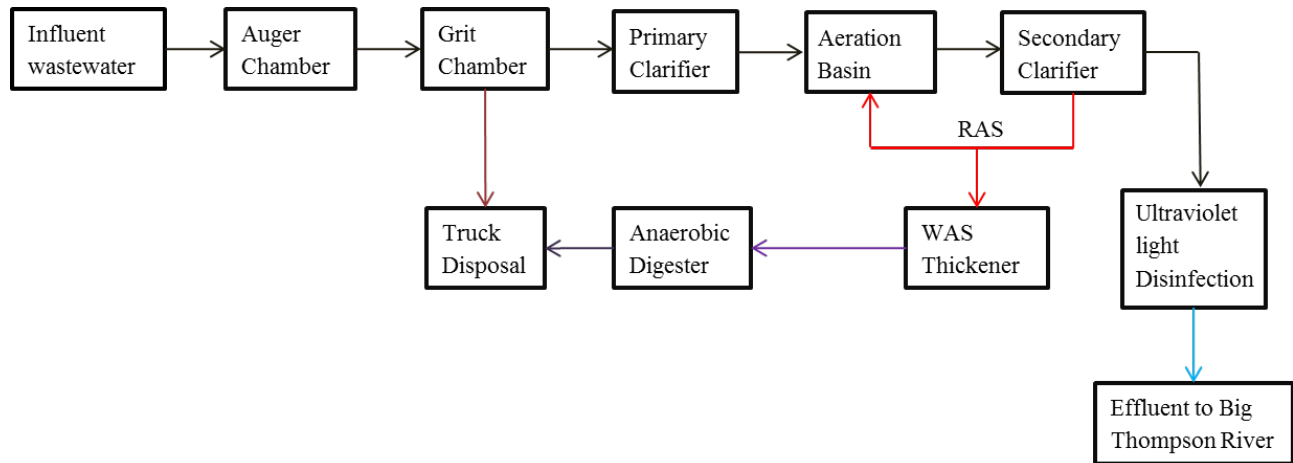

Existing step feed AS process that already contains three basins may be updated with the addition of two more basins to convert to a five-stage Bardenpho process to achieve further nutrient removal. The Bardenpho process utilizes a series of anaerobic, anoxic, aerobic (aeration), secondary anoxic and aerobic (reaeration) basins (Figure 2). The goals of the Bardenpho process are: i) to release phosphorus in the anaerobic basin and enhance its take up in the aerobic basins; and ii) to obtain nitrogen removal through nitrification and denitrification by recycling effluent from aerobic to anoxic basin.

Figure 2: Flow diagram of the 5-stage Bardenpho process

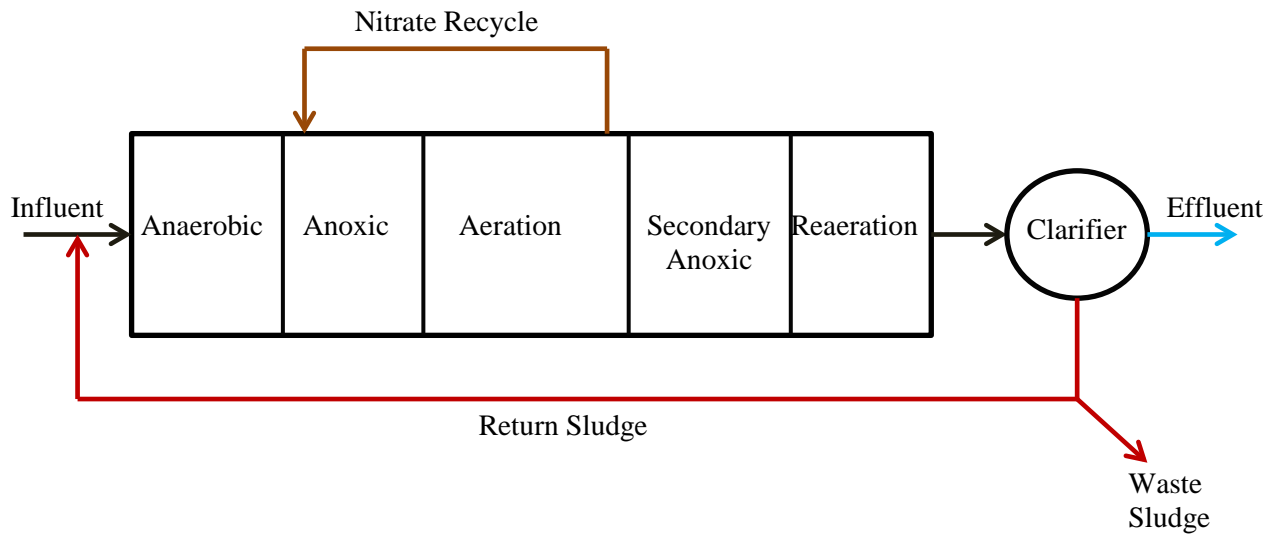

Figure 3: BioWin model of the existing City of Loveland WWTP (top) and proposed 5-stage Bardenpho process (bottom)

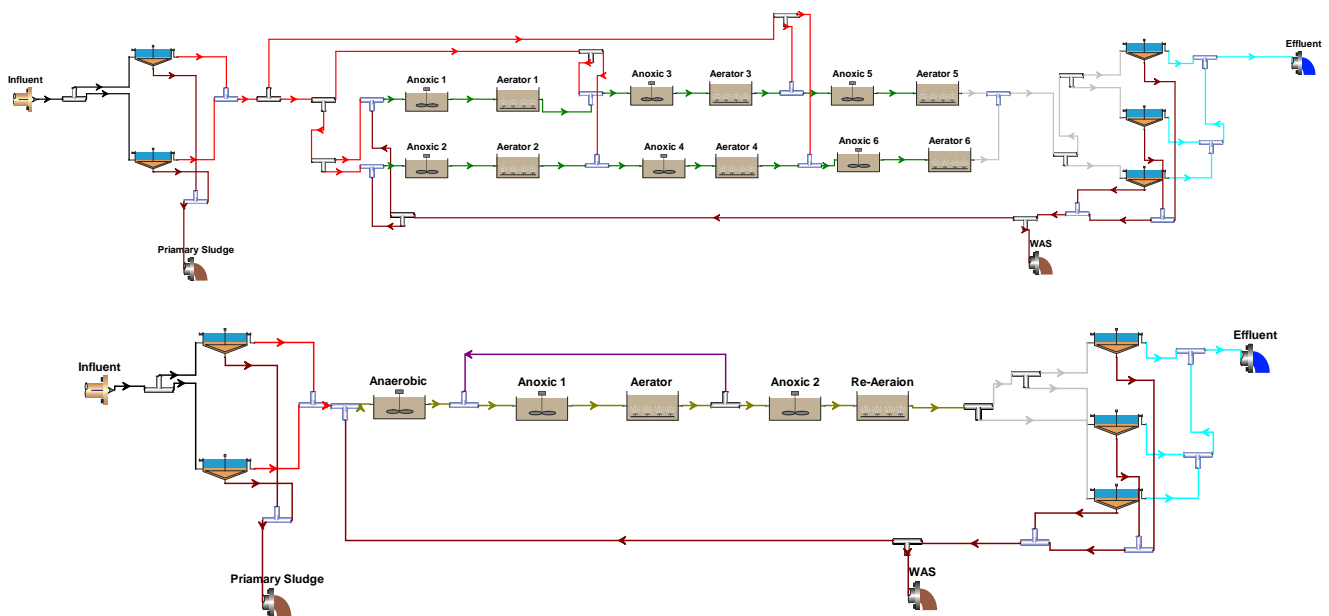



Table 3: Effluent concentrations from the plant and BioWin model

Parameters	Actual Plant Effluent (mg/L)	BioWin Model Effluent (mg/L)
BOD <sub>5</sub>	5.30	4.71
Total Suspended Solids	6.19	10.43
NH <sub>3</sub>	0.26	1.31
Total Kjeldahl Nitrogen	2.01	3.83
Total Phosphorus	3.91	3.85

For this research, the five-stage Bardenpho process was modeled with only one treatment train instead of the two trains as in the existing configuration (Figure 3). To ensure the validity of the preset parameters in the BioWin software, the existing step feed AS process was simulated, and Table 3 shows the measured and modeled effluent concentrations. The model was accepted to be reliable in predicting the effluent concentrations for the five-stage Bardenpho process.

Simulations were performed at 13.5 °C and 18.5 °C to mimic winter and summer wastewater temperatures, respectively. A higher influent wastewater flowrate of 12 MGD was modeled to accommodate for population growth and future plant expansion. Basin volumes were varied based on the ideal minimum and maximum hydraulic retention time (HRT) guidelines provided by Wastewater Treatment Plants Task Force of the Water Environment Federation and the American Society of Civil Engineers. Table 4 shows the HRTs and volumes of the basins that were selected to simulate the 5-stage Bardenpho process.

Table 4: 5-stage Bardenpho process hydraulic detention times (HRT) and basin volumes

Basin	Lower Design HRTs		Higher Design HRTs	
	HRT (d)	Volume (Mil.gal)	HRT (d)	Volume (Mil.gal)
Anaerobic	1	0.96	2	1.92
Anoxic 1	2	1.92	4	3.84
Aerobic 1	4	3.84	6	5.76
Anoxic 2	2	1.92	4	3.84
Aerobic 2	0.5	0.48	1	0.96

Internal recycle flowrate (IR) of mixed liquor suspended solids (MLSS) (i.e. microorganisms performing biological treatment and other solids) was kept at the same flowrate as the original influent wastewater flowrate (12 MGD). To determine the optimal basin volumes for a given temperature and selected HRTs, waste activated sludge (WAS) flowrate, which controls the sludge age, was varied from 0.2 MGD to 1 MGD. Methanol was added to the secondary anoxic basin as an additional carbon source for

microorganism growth, to improve denitrification. BioWin controller (similar to process control equipment available in a WWTP to have real time control over aeration rate, pump speed and chemical additions) was used to determine the optimal methanol dosage by averaging the methanol flowrate determined by the software after a dynamic simulation for 24 hours, a flowrate of 250 gal/d was selected for the simulations.

## Results and Discussion

The goal of the simulations was to determine the optimum HRTs, basin volumes and WAS flowrates to meet the Regulation 85 by reducing the TP to below 1 mg/L, and the TIN to below 15 mg/L. The results from the simulations performed for summer and winter temperatures for selected HRTs and basin volumes (Table 4) are provided in Figures 4 and 5 for varying WAS.

Figure 4: Effluent TP concentrations for various WAS flow rates

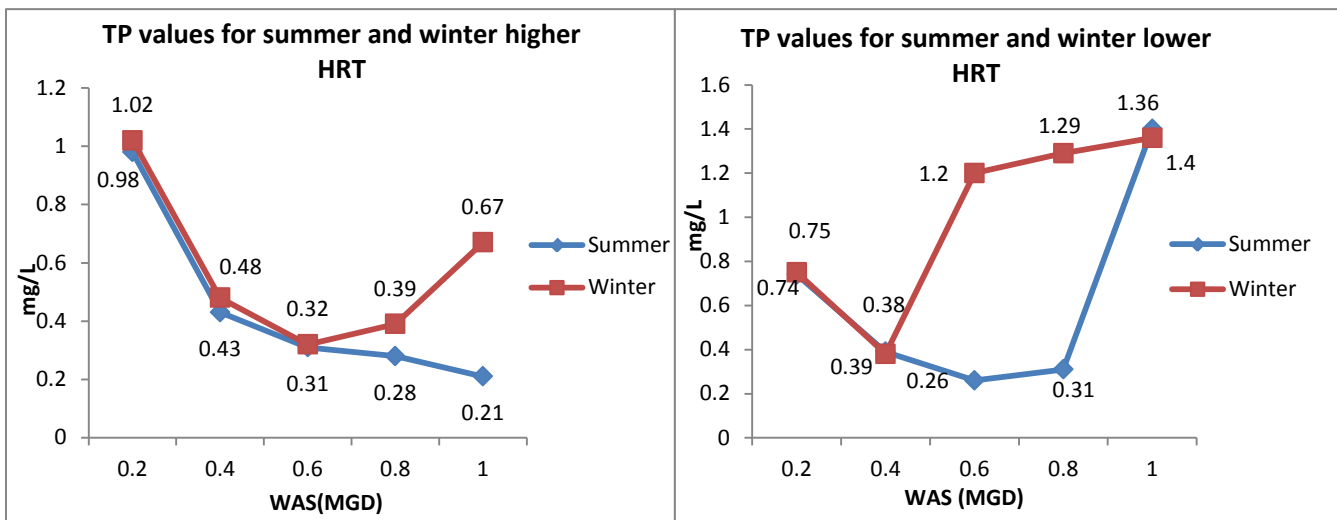
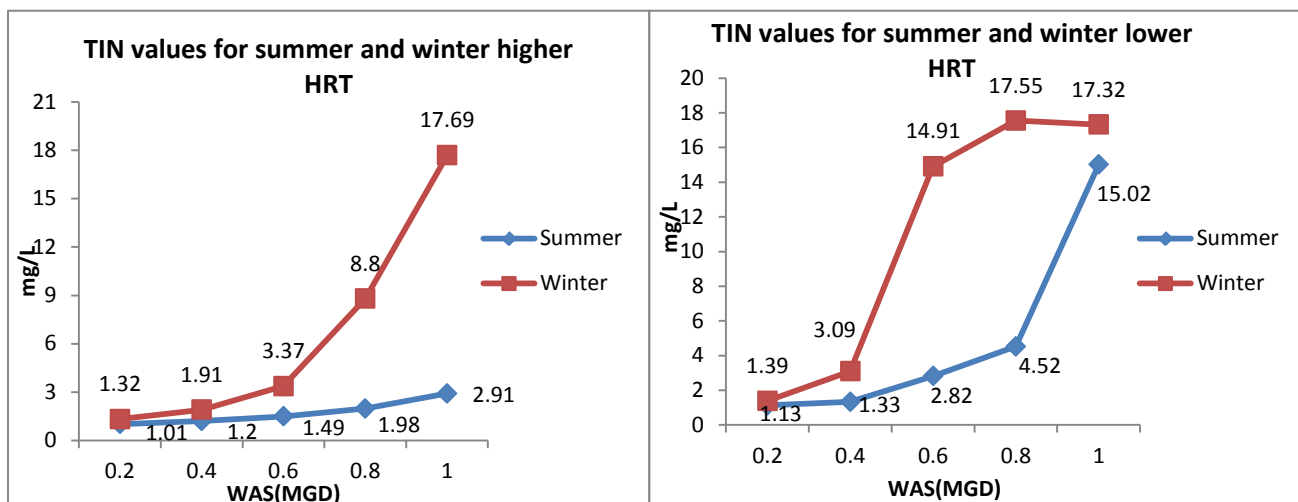

Figure 5: Effluent TIN concentrations for various WAS flowrates



Results showed that desired effluent concentrations for TP and TIN are obtained with higher design HRTs and basin volumes. Hence other effluent parameters determined using the higher design HRTs are provided in Table 5 for an influent flowrate of 12 MGD, IR of 12 MGD and methanol flowrate of 250 gal/d, for both summer and winter temperatures. As expected, the treatment efficiency is lowered during winter due to slowed metabolic reactions of the microorganisms used in the biological treatment units.

Table 5: Effluent concentrations determined by BioWin simulations for higher design HRTs

WAS (MGD)	SUMMER				WINTER			
	TIN (mg/L)	TP (mg/L)	BOD <sub>5</sub> (mg/L)	TSS (mg/L)	TIN (mg/L)	TP (mg/L)	BOD <sub>5</sub> (mg/L)	TSS (mg/L)
0.2	1.01	<b>0.98</b>	3.98	11.83	1.32	<b>1.02</b>	4.15	11.95
0.4	1.2	0.43	3.18	7	1.91	0.48	3.33	7.06
0.6	1.49	0.31	2.74	5.05	3.37	0.32	3.29	5.04
0.8	1.98	0.28	2.57	3.97	8.8	0.39	2.96	3.95
1	2.91	0.21	2.81	3.32	<b>17.69</b>	0.67	3.13	3.26

TP removal increases by increasing WAS flowrate for summer, however maximum efficiency was obtained at 0.6 MGD for winter. For TIN removal, efficiency was inversely related to WAS flowrates for both summer and winter, and hence lower WAS flowrates should be selected. It should be noted that, except for the WAS flowrate of 1 MGD for winter temperatures, all other simulated WAS flowrates meet the regulations for TIN concentrations in effluent with 0.2 MGD just making the limit for TP.

### Conclusions

BioWin simulations are helpful in guiding the WWTPs in determining how to improve and update their existing processes with minimal capital and operational costs. It should be noted, however, that the effluent results should be evaluated with a factor of safety as the preset simulation parameters for BioWin may not exactly match the conditions in the simulated WWTP. This study determined that, for Loveland WWTP, retrofitting the existing plant with two additional basins and converting the treatment process to 5-stage Bardenpho will enable them to meet the new effluent nutrient regulations.

The suggested design parameters for the new process and the obtained effluent nutrient levels are as follows: WAS flowrate of 0.6 MGD results in optimal effluent concentration of 0.31 mg/L for TP and 1.49 mg/TIN for summer (18.5 °C) and 0.32 mg/L for TP and 3.37 mg/L for TIN for winter (13.5 °C). Design HRT of 2 days for anaerobic, 4 days for anoxic, 6 days for aerobic, 4 days for secondary anoxic and 1 day for reaeration was chosen with corresponding volumes of 1.92 mil.gal, 3.84 mil.gal, 5.76 mil.gal, 3.84 mil.gal and 0.96 mil.gal, respectively. SRT was approximately 14 days for both summer and winter conditions.

# Using Water Chemistry to Characterize the Connection between Alluvial Groundwater and Streamflow Water Under Augmentation at the Tamarack Ranch State Wildlife Area, Colorado

## Basic Information

<b>Title:</b>	Using Water Chemistry to Characterize the Connection between Alluvial Groundwater and Streamflow Water Under Augmentation at the Tamarack Ranch State Wildlife Area, Colorado
<b>Project Number:</b>	2012CO267B
<b>Start Date:</b>	3/1/2012
<b>End Date:</b>	2/28/2013
<b>Funding Source:</b>	104B
<b>Congressional District:</b>	4th
<b>Research Category:</b>	Ground-water Flow and Transport
<b>Focus Category:</b>	Groundwater, Hydrology, Hydrogeochemistry
<b>Descriptors:</b>	None
<b>Principal Investigators:</b>	John Stednick

## Publications

There are no publications.

# Using Water Chemistry to Characterize the Connection between Alluvial Groundwater and Streamflow Water under Argumentation at the Tamarack Ranch State Wildlife Area, Colorado

Jason Roudebush, MS Candidate, Watershed Science, Colorado State University

Faculty Advisor: John D. Stednick

**Introduction** The presence of four threatened or endangered species—the whooping crane (*Grus americana*), interior least tern (*Sterna antillarum*), piping plover (*Charadrius melodus*), and pallid sturgeon (*Scaphirhynchus albus*)—on the Platte River in Nebraska prompted the states of Colorado, Wyoming, and Nebraska to enter into a cooperative Tri-State Agreement with the U.S. Department of the Interior to implement recovery efforts by improving riverine habitats. The Platte River Recovery Implementation Program (PRRIP) began on January 1, 2007, still allowing state water use and development to continue. Wyoming’s obligation under PRRIP is met by operating an environmental account in Pathfinder Reservoir to retime flows during periods of target flow shortages. Nebraska operates a similar environmental account in Lake McConaughy to retime flows while also providing additional land habitat in the Lexington to Chapman reach of the Platte River. Colorado’s contribution is groundwater recharge at Tamarack Ranch State Wildlife Area (TRSWA) near Crook.

Managed groundwater recharge at TRSWA is designed to meet the state of Colorado’s obligation to increase streamflow in the Platte River by an average of 10,000 acre-feet per year. This obligation is met by pumping alluvial groundwater (in priority and during times of surplus) upgradient to recharge ponds where the water seeps into the ground and returns to the river at a later time. Under designed conditions, recharge water flows through the subsurface with a timing that supplements streamflow during periods of critical low flow. The South Platte River flow regime is dominated by snowmelt in the late spring and early summer, so the target window for streamflow accretions is designed to occur between August and November.

## Modeling Approach

The three most common approaches for estimating the effects of groundwater pumping on streamflow are the Glover solution (Glover and Balmer, 1954), stream depletion factor (SDF) method (Jenkins, 1968), and numerical methods such as MODFLOW (McDonald and Harbaugh, 1988). The Glover and SDF analytical methods are both used in water rights decisions but oversimplify physical conditions (Fox *et al.*, 2002). MODFLOW, a widely used code for numerical modeling, is capable of simulating fully three-dimensional flow in systems that are horizontally and vertically heterogeneous and have complex boundary conditions (Barlow and Leake, 2012).

The original groundwater model for TRSWA was developed by Colorado Parks and Wildlife, formerly the Colorado Division of Wildlife (Halstead and Flory, 2003). This MODFLOW model was developed and calibrated based on aquifer conditions in the vicinity of the recharge wells to evaluate groundwater-surface water exchange (1996CW1063, 2012). Much of the aquifer characterization was based on earlier work utilizing drill log data (Hurr and Schneider, 1972). Additional work by Colorado State University (CSU) has better determined these physical conditions. For instance, CSU hydrology research at TRSWA inferred groundwater flow pathways from the recharge ponds to the river by contouring the water table elevation from measurements taken at a network of piezometers (Beckman, 2007). Further research confirmed this local groundwater flow direction with a fluorescein tracer study (Donnelly, 2012). Hydrogeophysical investigations into the subsurface stratigraphy of the eolian sands, alluvial sediments, and shale confining unit suggested the presence of a paleo-channel beneath the recharge ponds that

could influence the flow pathways of recharge water (Poceta, 2005). In order to better map the potential flow pathways and quantify streamflow accretion, a groundwater flow model using MODFLOW is being constructed to utilize the existing onsite hydrologic and geophysics research.

The geometry of the South Platte alluvial aquifer is more complex than previously suggested. A recent surface Electrical Resistivity Tomography (ERT) survey defines a detailed topography of the confining bedrock surface in the area located between the recharge ponds in the eolian sand hills and the river (Lonsert et al., 2013). The ERT data were used in combination with additional drill logs to create a subsurface bedrock map (Figure 1), which revealed steeper topographic relief compared to previous interpretation of the shale bedrock (Hurr and Schneider, 1972). The incorporation of the new geophysical data into the model allows a better understanding of the potential flow pathways from the recharge ponds back to the river.

The three-dimensional model of the unconfined aquifer consists of three layers. The uppermost layer represents the eolian sand hills and the bottom two layers represent the alluvium. The alluvium was divided into two layers to allow for the simulation of vertical gradients. The model domain is 17 kilometers (east to west) by 10 kilometers (north to south) by an average of 42 m deep and contains approximately 120,000 active cells. Grid spacing was refined in the area of the recharge ponds to account for the steep vertical hydraulic gradients. The lateral boundaries to the north and south are formed by the edges of the alluvial deposits digitized from USGS Geologic Maps of the area (Scott, 1978) and are considered to be no-flow boundaries. The western edge of the model is located along State Highway 55 where the Colorado Division of Water Resources (CDWR) operates a streamflow gaging station; the eastern edge is 25 kilometers downstream.

The South Platte River is simulated as a partially penetrating stream in Layer 2 using the Streamflow-Routing (SFR1) package. The SFR1 package calculates stream baseflow and groundwater-surface water exchange for each of the stream cells that are independent of the groundwater budget (Prudic et al., 2004). Advantages of using the SFR1 package include: the model computes baseflow within each cell internally, and stream stage does not need to be specified for each cell. The Gage package (GAGE) is used to designate cells in the model for monitoring so that separate output files are written for graphical post processing of the calculated data. The western model boundary is aligned with the CDWR gaging station and defines the uppermost reach of the river. This provides for an accurate representation of streamflow entering the model; subsequent contributions to base flow downstream of the gage represent streamflow accretions from recharge operations and irrigation return flow.

### **Expected Outcomes and Impacts**

Using new hydrogeophysical data, model calculations of baseflow and groundwater-surface water exchange will provide an enhanced understanding of how recharge water reaches the stream and where streamflow accretion is occurring. Achieving a more fully informed understanding of these physical processes is critical in evaluating the efficiency of recharge operations at TRSWA, and is an essential component in accomplishing the goal of accurately augmenting streamflow in the desired period. The modeling results will form the basis of an MS Thesis in Watershed Science at CSU and can subsequently be used to facilitate the design and placement of future conjunctive use sites.

## Acknowledgements

Funding for this research is provided by the Colorado Department of Parks and Wildlife and the Colorado Water Institute. Professor Michael Ronayne of CSU provided helpful suggestions on the modeling.

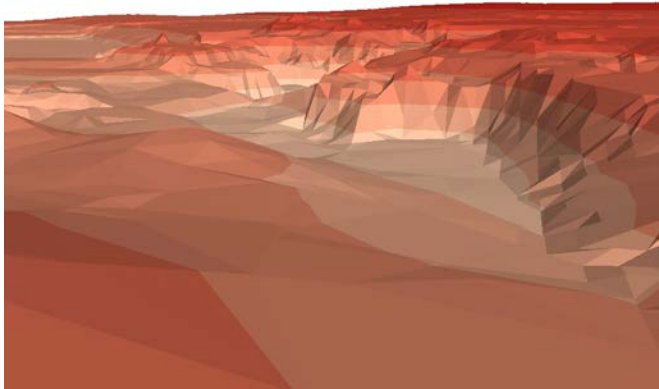

**Figure 1.** Topographic bedrock map (five times vertical exaggeration) in the vicinity of the recharge ponds based on the additional geophysical investigation

## Information Transfer Program Introduction

Requests from the Colorado legislature to facilitate and inform basin-level discussions of water resources and help develop an interbasin compact for water management purposes emphasized the role Colorado Water Institute plays in providing a nexus of information. Some major technology transfer efforts this year include:

- Providing training for Extension staff in various water basins to help facilitate discussions of water resources
- Encouraging interaction and discussion of issues between water managers, policy makers, legislators, and researchers at conferences and workshops
- Publishing the bi-monthly newsletter, which emphasizes water research and current water issues
- Posting and distributing all previously published CWI reports to the web for easier access
- Working with land grant universities and water institutes in the intermountain West to connect university research with information needs of Western Water Council, Family Farm Alliance, and other stakeholder groups
- Working closely with the Colorado Water Congress, Colorado Foundation for Water Education, USDA-CSREES funded National Water Program to provide educational programs to address identified needs



# Technology Transfer and Information Dissemination

## Basic Information

<b>Title:</b>	Technology Transfer and Information Dissemination
<b>Project Number:</b>	2012CO256B
<b>Start Date:</b>	3/1/2012
<b>End Date:</b>	2/28/2013
<b>Funding Source:</b>	104B
<b>Congressional District:</b>	4th
<b>Research Category:</b>	Not Applicable
<b>Focus Category:</b>	None, None, None
<b>Descriptors:</b>	None
<b>Principal Investigators:</b>	Reagan M. Waskom

## Publications

1. Colorado Water Newsletter, Volume 29 - Issue 2 (March/April 2012), Colorado Water Institute, Colorado State University, Fort Collins Colorado, 33 pages.
2. Colorado Water Newsletter, Volume 29 - Issue 3 (May/June 2012), Colorado Water Institute, Colorado State University, Fort Collins Colorado, 33 pages.
3. Colorado Water Newsletter, Volume 29 - Issue 4 (July/August 2012), Colorado Water Institute, Colorado State University, Fort Collins Colorado, 37 pages.
4. Colorado Water Newsletter, Volume 29 - Issue 5 (September/October 2012), Colorado Water Institute, Colorado State University, Fort Collins Colorado, 37 pages.
5. Colorado Water Newsletter, Volume 29 - Issue 6 (November/December 2012), Colorado Water Institute, Colorado State University, Fort Collins Colorado, 41 pages.
6. Colorado Water Newsletter, Volume 30 - Issue 1 (January/February 2013), Colorado Water Institute, Colorado State University, Fort Collins Colorado, 41 pages.
7. Bauder, Troy, et al. 2012. Agricultural Chemicals & Groundwater Protection in Colorado. Colorado Water Institute, Colorado State University, Fort Collins, CO. 51 pages.  
[www.cwi.colostate.edu/publications/SR/23.pdf](http://www.cwi.colostate.edu/publications/SR/23.pdf)
8. Gates, Timothy K, et al. June 2012. Irrigation Practices, Water Consumption, & Return Flows in Colorado's Lower Arkansas River Valley. Colorado State Institute, Colorado State University, Fort Collins, CO. 116 pages. [www.cwi.colostate.edu/publications/CR/221.pdf](http://www.cwi.colostate.edu/publications/CR/221.pdf)
9. Lukas, Jeffery J., Lisa Wade, and Balaji Rajagopalan. October 2012. Paleohydrology of the Lower Colorado River Basin and Implications for Water Supply Availability. Colorado Water Institute, Colorado State University, Fort Collins, CO. 34 pages.  
[www.cwi.colostate.edu/publications/CR/223.pdf](http://www.cwi.colostate.edu/publications/CR/223.pdf)



## Colorado Water Institute Activities

- The 2012 Summer Water and Energy Conference: The Balance of Power, Colorado Water Congress, August 15 – August 17, 2012
- 32<sup>rd</sup> Annual Hydrology Days, American Geophysical Union, March 21 - March 23, 2012
- Evapotranspiration Workshop, Colorado State Extension, March 21, 2012
- Celebrating 10 Years of Statewide Water Education with the CFWE, Colorado Foundation for Water Education, April 2012
- Colorado Water 2012: Celebrating a Year of Anniversaries, Education, and Bringing Awareness to Water in the West, 2012
- Water Resource Education Curriculum Crew (The WRECKing Crew), Colorado State University Extension, Colorado Water Institute and Colorado Water Conservation Board
- Colorado Water Conservation Board 2012 Drought Conference, CWCB, September 19 – September 20, 2012
- Water and Sustainability, Colorado State University Water Café, Colorado State University Water Center and School of Global Environmental Sustainability, March 22 - 23, 2013
- Addressing Global Water Resource Challenges with Local Expertise, GRAD592, Interdisciplinary Water Resources Seminar, Fall 2012
- *Colorado Water*, Colorado Water Institute, March 2012 – February 2013

# The 2012 Summer Water and Energy Conference: The Balance of Power



COLORADO WATER CONGRESS

In partnership with Colorado Coal and Power Generation

Steamboat Springs, Colorado

August 15-17, 2012



## **Workshops**

Weather, Water Supply, and Wildland Fire  
Public Trust, Public Values, and Public Interest  
Endangered Species

## **Conference Sessions**

The Regional Impact of the National Economy  
The Water and Energy Balance  
The Political Balance of Power  
State Budget and Severance Tax  
National Agenda on Balanced Fuels  
Permitting and Project Planning  
Scenario Planning  
The Power Balance in the 2012 Election

## **Public Event**

Interim Water Resources Review Committee

Please join us for the 2012 premier summer event for water.

For registration information, see our website at

[cowatercongress.org](http://cowatercongress.org)

**32nd Annual  
American Geophysical Union**

**Colorado  
State  
University**

# **HYDROLOGY DAYS**

**March 21 - March 23, 2012**

**Cherokee Park Room**

## **Colorado State University**

**Hydrology Days Award Lecturer:**

**Michael Celia**

*Professor*

*Department of Civil and Environmental Engineering  
Princeton University*

**For more information and/or to submit abstracts, go to:  
[www.hydrologydays.colostate.edu](http://www.hydrologydays.colostate.edu)**



# Evapotranspiration Workshop

USDA-Natural Resource Research Center,  
Building D, Fort Collins, CO

March 21, 8:30 a.m. - 4:30 p.m.

Topics:

Recent Trends in Evapotranspiration Calculations and Data

Case Study:

Estimating Historic Consumptive Use

Luncheon Speaker:

Marvin Jensen, "Use of Supporting Data in Estimating and  
Confirming ET Estimates"

Cost:

\$200 (all profits go to support CoAgMet weather station network)

Registration:

To register, please visit <http://col.st/zT7ZFc>

Contact Tom Trout for further information, [Thomas.Trout@ars.usda.gov](mailto:Thomas.Trout@ars.usda.gov)

# Celebrating 10 Years of Statewide Water Education with the CFWE



Caitlin Coleman, Program Associate, Colorado Foundation for Water Education

## In a Nutshell

- CFWE celebrates a successful decade, and looks ahead to expanding its reach toward the business community and elected officials

Everyone makes choices about water, whether it's at home or on a larger scale. When people understand the complexities of water issues, they make better decisions—that's the philosophy of the Colorado Foundation for Water Education (CFWE), Colorado's only statewide nonpartisan nonprofit water educator. CFWE just celebrated its 10<sup>th</sup> anniversary.

"In Colorado, water is a scarce resource and the competition for that resource is going to get more and more difficult in the future,"

says CFWE executive director, Nicole Seltzer. "Everybody needs to understand the implications of their water use on a personal and a policy level."

For the past decade, CFWE has been advancing its mission to promote better understanding of Colorado's water resources and issues by providing balanced and accurate information and education, helping Coloradans "Speak Fluent Water." Over the last 10 years, things have changed in Colorado and at the Foundation—priorities have shifted, staff and board members have transitioned in and out, and new programs have started. As CFWE's next decade begins, the landscape of water education continues to shift.

"[The CFWE] has really grown and developed; it's become a lot richer than I ever saw," says vice president of the CFWE board and Colorado Supreme Court Justice Gregory Hobbs.

Today CFWE boasts a solid backbone of basic water information and educational programming but also enhances leadership among water professionals, creates networking opportunities, helps advance the water planning dialogue in the state, and reaches out to those who aren't already involved in the world of Colorado water.

That basic, digestible water information is what CFWE was founded upon and continues to be an essential part of the organization. "The bedrock of [CFWE] is having a reliable source, the publications are a perfect example," says Greg Johnson, a representative of the Colorado Water Conservation Board and CFWE board member. "Really being able to rely on what you know is a good go-to source whether it's publications or your website or your upcoming tour—it's critical," Johnson says.

When CFWE started in 2002, it came on the heels of many failed attempts to create a water education foundation funded solely through grants. The 2002 success of launching

*Nicole Seltzer and Justice Hobbs honoring CFWE's legislative founder, Diane Hoppe during the 10<sup>th</sup> Anniversary Celebration.*

*Courtesy of CFWE*



*"We provide an important professional networking opportunity for water educators."*

*—Nicole Seltzer, CFWE Executive Director*



the nonprofit was due to legislation and strong financial support from the Colorado Water Conservation Board (CWCB). “It was a real long-term investment by the state of Colorado,” Seltzer says. Hobbs echoes the importance of that support—water professionals came together with the shared sentiment that Colorado needed an organization focused on nonbiased statewide water education. “We can point to a law that the legislature passed that is unlike anything else that I know about in the water field,” Hobbs says. “The fact that the state of Colorado has decided to support a non-advocacy, nonpolitical water foundation to communicate with people is extraordinary.”

In addition to legal support of the Foundation came the sustained financial support from the Colorado Water Conservation Board. “It was solely because of that support from the State that we’ve been able to do what we’ve done for the last ten years,” Seltzer says.

That work has also been important to the state. “CFWE is a fair and balanced third party that can convey a lot of the messages that [the CWCB] may not even have the proper position to convey, let alone the resources to do it,” Johnson says. “[CFWE] can stand outside the fray of political issues and is not the official state entity—I think there is a lot of power in that unbiased position that the Foundation holds.”

That strong support created a CFWE determined to quickly prove its worth. “There was a real pressure to deliver tangible product very quickly, right out of the gates to show the State that we were capable of producing useful educational products,” Seltzer says.

At the very beginning, Hobbs remembers working on a map illustrating the beneficial uses of water; he then volunteered to write



*The Colorado Foundation for Water Education (CFWE) celebrated its 10th anniversary in April 2012 with a reception at the Governor's Mansion in Denver.*

Courtesy of CFWE

the Citizen's Guide to Colorado Water Law— so began CFWE's Citizen's Guide Series, which now covers nine different Colorado water topics. To replicate some of the work done by a water education foundation in California, CFWE began leading river basin tours. An early executive director, Karla Brown, came up with the concept of creating Headwaters magazine. All of these programs have remained and grown as the “meat and potatoes of water education,” says CFWE board assistant secretary and director of the Colorado Water Institute at Colorado State University, Reagan Waskom.

The Foundation's work has started to extend beyond those basic products. “We provide an important professional networking opportunity for water educators,” Seltzer says. “Before CFWE was created, there was nobody that a water educator could go to for help, advice, networking, or ideas. We provide a strong network and we can get best practices out there.” That network and the Foundation's constant work with water issues brings more visibility to water in Colorado and raises awareness about water on a consistent basis, Seltzer says. “We're bringing

everybody together in service to good effective water education in Colorado.”

The Foundation has helped the CWCB convene stakeholders across the state to spread the message and interest of the Statewide Water Supply Initiative and planning for Colorado's water future. “I think that's helped a lot with the engagement that we have with the roundtable process,” Johnson says. Basin roundtables bring together local stakeholders and meet in river basins across the state to discuss the local water use priorities and use that dialogue to plan for future pressures on water supply. “The roundtables have helped change the game locally and CFWE has been a partner in that conversation,” Waskom says. “CFWE has helped take the findings and understandings of the Statewide Water Supply Initiative out to the public as well.”

Colorado Water 2012, the statewide celebration of water, was spearheaded by CFWE as another mode of bringing people together around water. “2012 happened because of a decade of good solid work,” Waskom says. For Water 2012, CFWE convened partners and volunteers across the state, profiled and shared

the work of water educators across the state, started a blog that speaks to the general public, and helped bring water festivals and other public events together under a common theme—making the small events part of something bigger, Seltzer says. “In Water 2012, working with the media, doing regular news articles, I think all of that work has greatly expanded the reach of water education in Colorado,” Seltzer says.

Launching from 2012 and into the next decade, the Foundation will continue to expand that reach. “That’s who we’re looking at as our next audience, people interested in water issues. Then we can work with them to cross the spectrum from increasing water awareness to understanding to participation,” Seltzer says.

Some board members think that role could expand beyond the borders

of Colorado. “Our impact and base could be much larger,” Waskom says. “Colorado is an amazing place to study water. I think that people around the world could learn from us.”

As water becomes increasingly scarce, competition for water will gain more national importance, Johnson says. “Having your materials, there may be room for an increased voice for the Foundation,” Johnson says. “To have that good solid background educational material available so we can inform any policy discussions at the national level too.”

The organization is celebrating the fact that it has existed for ten years, but is at a turning point. “It’s been very successful,” Johnson says. “I also think absolutely, it’s just the beginning.”

Over the last 18 months, CFWE has expanded its reach, budget, and staff capacity. “I’m really looking forward to the next ten years, continued growth and reaching more and more people with the basics of water in Colorado,” Seltzer says. In the coming years look forward to the Foundation’s role expanding as a professional development resource for water educators and branching out to reach new audiences such as the business community and elected officials.

“There’s a lot of potential moving forward,” Johnson says. “[The Foundation] is something you feel a part of, you have a sense of pride in—it’s one of those local institutions you support. It’s nice to have a group like the Foundation that includes a broad base of various water folks. It’s not just water conservation or Water Congress, it’s all of the above, it’s everything.”



# Colorado Water 2012

## Celebrating a Year of Anniversaries, Education, and Bringing Awareness to Water in the West

*Nona Shipman, Assistant Project Coordinator, Colorado Water 2012*

### In a Nutshell

- The 2012 Year of Water (“Water 2012”) celebrated water in Colorado, including the anniversaries of several fundamental water organizations in the state
- Water 2012 faced challenges, such as reaching certain parts of the state and sectors of the public
- Successes included reaching Water 2012’s goal of exposing 500,000 people to its message and creating partnerships to provide education materials to educators

“2012 is a notable year in Colorado’s history around water. 75 years ago many of the organizations and laws that govern how we use, manage, and administer Colorado’s water were born. In 2012 Coloradans will come together to honor the hard work of those who came before us, participate in solving the tough challenges that lie ahead, and celebrate our most important natural resource,” said Governor John Hickenlooper after he officially declared 2012 the Year of Water in January 2012. And he

was exactly right. 2012 served as the year for recognizing water as a necessary and vital resource in Colorado and celebrating everything that it is today, has been, and will be. To honor the organizations celebrating major anniversaries and to show equal respect to the natural resource that allows us all to live in a dry arid state, a statewide water awareness campaign was created named Colorado Water 2012.

It is important to mention the organizations and legislation celebrating anniversaries that got the idea of Colorado Water 2012 off the ground:

- 75<sup>th</sup> anniversary of the Colorado Water Conservation Board
- 75<sup>th</sup> anniversary of the Colorado River Water Conservation District
- 75<sup>th</sup> anniversary of the Northern Colorado Water Conservancy District
- 50<sup>th</sup> anniversary of the Fryingpan-Arkansas Project
- 10<sup>th</sup> anniversary of the Colorado Foundation for Water Education

In addition to these anniversaries, more and more significant anniversaries came out of the woodwork, such as the 40<sup>th</sup> anniversary of the Clean Water Act, the 100<sup>th</sup> anniversary of the Rio Grande Reservoir, and the 50<sup>th</sup> anniversary of the Bear Creek Water and Sanitation District that were recognized. The Colorado Foundation for Water Education was not only



celebrating ten years but also took on the responsibility to spearhead the entire campaign.

Water 2012, as it was known, aimed to bring awareness to water as a precious resource through activities and events held across the state. In order to do this, six committees were assembled. Each committee brought different qualities to the table with different focuses, but with one common goal: to celebrate water in Colorado through fun educational activities. Each committee focused on a task such as assembling a Water 2012 Book Club and conducting author presentations, circulating informational displays to Colorado libraries and museums, and installing rain gauges in Colorado schools. In addition to the committees, Water 2012 had hundreds of partners located all over the state conducting their own events with a Water 2012 presence. In total there were over 400 Water 2012 related events in the Year of Water.





1



2



3

1. Some Water 2012 swag created by different partners throughout the year. Photo by Nona Shipmen
2. Volunteers and committee leader, Marcee Camenson, pose while wearing their Fort Collins Water Festival/Water 2012 t-shirts. Courtesy of Marcee Camenson
3. Featured Water 2012 Book Club authors Jon Waterman, Justice Greg Hobbs, and Craig Childs discuss their book club selections at Colorado Water Congress. Photo by Alyssa Quinn
4. To celebrate their 10<sup>th</sup> anniversary, the Colorado Foundation for Water Education hosted two bike tours along the South Platte River with Water 2012. Courtesy of the Colorado Foundation for Water Education



4

Now you may ask, “What does ‘Water 2012 related event’ mean?” With the help of the Art Institute of Colorado, Water 2012 created an overall look including signature icons, a logo,

and marketing materials. These elements were made available to all Water 2012 partners to use as they wished in accordance with Water 2012’s list of goals. “Plagiarism” was

literally the name of the game. So a Water 2012 related event was an event or activity that wasn’t specifically executed by a committee but by a partner organization that included

the Water 2012 logo on a t shirt, flier, or water bottle for example. And there were hundreds of these events. You may even have some Water 2012 paraphernalia that the Water 2012 key players have never seen!

One of Water 2012's major goals was to expose 500,000 people to its message. This was recorded through feedback surveys, face to face discussions, pictures, and event materials. By September 2012, the campaign was on the verge of exceeding that goal, and a major contributor to that success was media exposure. Through the tireless work of partners and volunteers, Water 2012 spawned a 52 week series of articles in the Pueblo Chieftain and the Valley Courier, a weekly series that began in June in the Grand Junction Free Press, and dozens of other mentions in news articles, blogs, and social media. In addition to the news articles, Water 2012 was given the opportunity to create a radio PSA for the West Slope in June. Although 2012 had been declared the Year of Water by Governor Hickenlooper, the Senate, and communities all over Colorado, Mother Nature had a different plan for water, and the state was dealing with a drought. In order to recognize the drought and use it as a learning opportunity, the PSA was focused on the drought and how the average Coloradan could understand what was happening. The PSA played 6-10 times a day on four different radio stations for the month of June. A full list of article and blog mentions is available on the Water 2012 website ([Water2012.org](http://Water2012.org)).

Though Water 2012 surpassed many of its goals throughout the year, every project has struggles. There were parts of the state with little to no involvement, finding funding for a grassroots campaign was sometimes difficult, and not all media channels were interested in featuring a water campaign when they could feature

a "sexier" topic. One major struggle Water 2012 faced was reaching the general public. The campaign first aimed all its tools on reaching the average Coloradan but several months into 2012, it was clear that the campaign was far more successful reaching people already involved in the water community and with an initial interest in water. So the campaign re-focused. It became less about throwing messages to the public and more about providing educators, water conservancy districts, and the like with materials to give to their communities. The Water

---

**2012 began like no other year before, destined to be a year of unprecedented collaboration, volunteerism, and educational efforts.**

---

2012 Speakers Bureau presented to leaders of communities such as at Rotary Club meetings, Chambers of Commerce, and Progressive 15 gatherings; the K-12 Committee, in collaboration with CoCoRaHS, taught teachers how to use rain gauges and provided a lesson plan; one of the six traveling educational displays was made available to requesting organizations for events such as water festivals. With a campaign on a limited schedule and with limited resources, it was hard to make an impact on people who knew little or cared little about water. But hopefully, through re-focusing campaign efforts on providing the providers, an impression was made on the general public and will continue through the developing Value of Water campaign ([coloradowaterwise.org/campaign](http://coloradowaterwise.org/campaign)).

In October 2012 an end of year survey was distributed to more than 500 people to gauge overall impressions. The responses collected were diverse

from long time members of the water community to average Coloradans who had attended an event and taken an interest in Water 2012. Generally the opinions and impressions were positive and appreciative. One improvement suggested by several survey takers was to reach outside the water community but that was, clearly, a struggle the campaign faced. Others were concerned the campaign was too focused on educators and did not have a big enough reach or deep enough connection. But with the struggles came unexpected benefits from the campaign. Through the survey results it came to light that many people felt that the campaign allowed them to develop professional relationships with people and organizations they otherwise would not have started. Water 2012 can only hope that those people continue to utilize those connections to create more educational activities and ongoing water stewardship.

2012 began like no other year before; destined to be a year of unprecedented collaboration, volunteerism, and educational efforts. On December 31, 2012 Colorado Water 2012 will have come to an end, but the good times don't have to end there. To keep the momentum going and to celebrate a successful Year of Water, Water 2012 will be hosting a celebratory luncheon on January 30, 2013 at the Marriott Denver Tech Center. Lunch will be \$25 but the laughs and memories are priceless! You can reserve your spot at [cwatercongress.org/annualconvention](http://cwatercongress.org/annualconvention). In conclusion, Colorado Water 2012 would like to send a huge thank you to every person who volunteered their time and efforts, those who financially sponsored the campaign, and those who attended an event. Without their endless contributions and support of Water 2012, none of it would have been possible.



*Anne Casey, Youth Development Education Specialist,  
Colorado State University Extension*

Colorado State University (CSU) Extension and The Colorado Water Institute are partnering with the Colorado Water Conservation Board to offer a unique new water education program to high schools students called the WRECKing Crew, short for Water Resource Education Curriculum Crew.

This program is designed to accomplish two goals:

1. Reduce water usage at participating schools through the streamlining of their landscape irrigation system with the use of LISA (Landscape Irrigation Self Audit) Kits, a tool developed by CSUE Water Resource Specialists and to promote best practices for water conservation for common activities
2. Provide a hands-on student-led STEM (science, technology, engineering, and math) enrichment project that incorporates opportunity for skills development, campus improvement, and community service

Decreasing scores on international tests of science and math competencies (TIMSS and PISA) since the 1980s have spurred a number of efforts to improve education in the STEM areas. Studies indicate that students learn more and retain it longer when they are engaged in real world experiential activities. In addition, concerns about increasing water consumption by a growing population require fostering new consumption habits in our communities. The WRECKing Crew provides a vehicle to accomplish both objectives.

Designed as a weekly one hour, year-long project, this program has been adopted by three high schools in the Fountain Creek/Arkansas River basins under the leadership of: Nate Chisholm, Environmental Science teacher at the Air Academy High School in Colorado Springs, Fran Weber, Honors Biology

teacher at Pueblo West High School in Pueblo West, and Alec Walter, Biology teacher at County High School/SEBS in Pueblo. As an inter-curricular program, it supports Colorado Academic Standards in Science, Math, English, and History. The program also has the additional bonus of reducing the school's water bill, the savings on which the participating students will be given partial authority on how to re-allocate for other school purposes.

During the course of the three years, the program progresses from local water issues to global ones. First-year participants entering the program will concentrate their attention on their own campuses first. Using tools developed by CSU Extension Water Resource Specialists and climatologists, (LISA Kits, Colorado Agricultural Meteorological Network (CoAgMet), and Community Collaborative Rain Hail and Snow Network (CoCoRaHS)), students will design experiments, collect and analyze data, and finally implement a more efficient water usage plan for their schools. To date these students have conducted a survey of student water awareness, preformed a campus water audit, and created a map of their school grounds within their watersheds using ArcGIS Online mapping software. They will be encouraged to use these tools and skills to audit their own homes, as well, and bring awareness of water issues to their neighborhoods.

In the second year of the program these students continue their water education by learning about the historical issues concerning water in Colorado and the Western Region of the U.S., including water diversion projects, dams and reservoirs, and irrigation systems. They will study the natural history of native plants and grasses and the ecosystems that depend on them. Applying this knowledge to the campus landscaping will allow

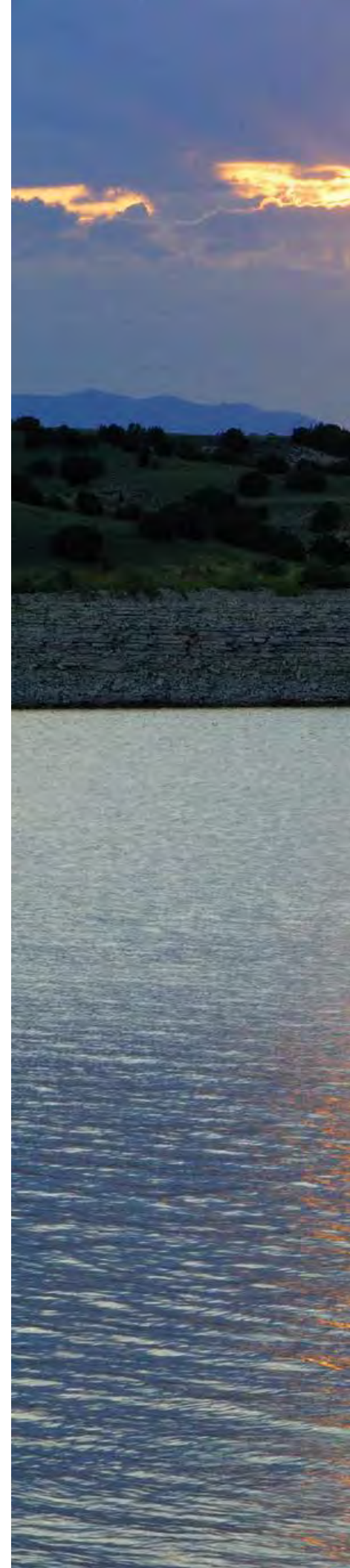



Lake Pueblo  
Photo by Les Barstow

them to make good recommendations for water-wise plantings and turf grasses. The WRECKing Crew teams have visited demonstration xeriscape gardens at the Colorado Springs Utilities Conservation and Environmental Center, 2855 Mesa Road in Colorado Springs, and the Southeastern Colorado Water Conservancy District Xeriscape Garden, 31717 United Avenue in Pueblo, guided by Perry Cabot, CSU Extension Water Specialist. Field trips that are planned for the future include a visit to the Arkansas Valley Research Center to familiarize students with agricultural water issues and a camping trip to Lake Pueblo State Park to learn about water diversion projects and dams.

Third year participants will continue to expand their research to include global solutions to water problems. They will study how other countries use water and meet their water needs. Their studies will focus on water technologies, how they have changed and what is in store for the future. At this point they will be very familiar with their own campus and be able to consider the possibility of incorporating new technologies to enhance their school's environment. While there is no formal program for graduates of the program, they will be expected to become teachers and record keepers. In this way the program becomes self-sustaining.

This program supports both water conservation goals and educational goals in STEM. Through experiential, inquiry-based projects students will gain valuable analytical skills and develop an understanding of resource stewardship. This program is sustainable, replicable, and community-based. The desired outcome of the program is to generate greater interest in STEM careers with links to water conservation, natural and water resources management, watershed studies, and climatology.

Throughout the program, teachers and CSU Extension collaborators, Anne Casey, CSU Extension Education Specialist,

Perry Cabot, CSU Extension Water Specialist, and Shelby Will, CSU-Pueblo Biology student intern, are using feedback from teachers and students to create a Colorado-specific water education curriculum for use by high schools throughout Colorado. Teachers in the program attend two professional development sessions each year, in addition to participating in optional curriculum writing sessions. This group is combing the available literature for best practices in water education to build a curriculum that presents the best in water conservation principles delivered in the context of the research-based 4-H extension Essential Elements of youth development. The Essential Elements of youth development form the basis of all 4-H programs and include providing opportunities that allow students to see themselves as active participants in the future as well as opportunities for self-determination, mastery of a skill, engagement in learning, and to value and practice service to others.

One important benefit of the program for schools is the increased awareness among students of campus facilities issues. It is hoped that through this exposure, students will become more invested in their campus buildings and grounds, having developed a sense of ownership and pride in their school's appearance and workings. Another hope is an increased interest in STEM careers, especially in the field of hydrology. According to the Bureau of Labor Statistics, job growth in that area is expected to grow by 18 percent with many of those jobs being located in Colorado, which has the highest average annual wage in that profession at \$94,670.

CSU Extension is excited to be partnering with these outstanding students and teachers on the WRECKing Crew through the generous support from the Colorado Water Conservation Board. We look forward to seeing how these students "wreck" old out-dated water systems on their campuses and bring in their own fresh water-saving ideas.



# Colorado Water Conservation Board 2012 Drought Conference



*Taryn Finnessey, Drought and Climate Change Specialist, State of Colorado*

The 2012 Colorado Water Conservation Board (CWCB) State Drought Conference: Building a Drought Resilient Economy Through Innovation was held September 19 and 20 in Denver. This two-day conference highlighted the most innovative approaches to drought preparedness and brought attention to how those innovations contribute to an economy more resilient to the devastating effects of this natural disaster. Although drought has a much slower onset than other natural disasters, it still brings economic consequences that can devastate a community. In 2012, nearly every county in Colorado was designated as a primary disaster area for drought, and the wildfire season proved to be the most costly in history. The agricultural as well as the tourism and recreation industries, the first and second largest contributors to Colorado's economy, respectively, are impacted deeply by drought as are natural environments, municipalities, and local businesses. A goal of the conference was to put forth an agenda that would help communities address drought concerns in new and efficient ways. Representatives from a multitude of industries presented, including finance, recreation, development, energy, agriculture, and emergency management; all offered different views of how they are impacted by drought and how they are able to address those concerns.

While it was a Colorado drought conference, presenters from other western states also talked about their recent experiences with the impacts of drought as well. Representatives from ski areas and the energy sector discussed their approaches to drought response, while environmental representatives presented mechanisms

to adapt to drought and climate change yet still protect our natural resources. Innovations on the business side were also examined from Colorado's unique beer brewing industry to agricultural range management in the San Luis Valley.

In addition to more than forty presenters, the conference attendees also heard from three keynote speakers. Entrepreneur and philanthropist John Paul DeJoria spoke about his investments in sustainability through his companies Paul Mitchell Hair Systems and Patrón Spirits, as well as his involvement domestically and abroad in advancements to help less developed regions gain improved access to clean water and nutrition. Author and Colorado resident Steve Maxwell spoke about his recent book *The Future of Water*, in which he looks at major challenges facing our water resources in the decades to come and empowers us to change the future of water. Last, but certainly not least, Governor John Hickenlooper spoke about how his administration is trying to address challenges to ensure that generations of future Coloradoans can both enjoy the natural beauty of Colorado and maintain a high quality of life with adequate water availability.

United States Secretary of Agriculture Tom Vilsack and Colorado Commissioner of Agriculture John Salazar were on hand the second day of the conference to announce the creation of a new Colorado conservation project. The project will enhance water quality, reduce erosion, improve wildlife habitat, and conserve energy in portions of the Rio Grande watershed within Colorado. Secretary Vilsack said the "USDA is proud to work with the state of Colorado to enroll up to 40,000 acres of eligible

irrigated cropland in an effort to address critical water conservation and other natural resource issues within portions of the Rio Grande watershed." The program is part of the Conservation Reserve Enhancement Program (CREP), in which participants will receive compensation and incentives for voluntarily enrolling irrigated cropland into contracts and installing the approved conservation practices.

Feedback on the conference has been extremely positive and CWCB feels that the event was successful in raising awareness about the importance of taking an innovative, proactive approach to drought preparedness as a means to build a more drought resilient economy. Conference evaluations show that attendees overall were very satisfied. Average overall satisfaction ranked 4.43 out of five; the conference also met advertised objectives (4.26). Drought Connections to our Larger Economies, Vulnerability and Economic Impacts: Urban Environments, and Role of Water & Technology in Agricultural Production were among the highest rated presentations. More than half of the evaluation respondents said that they would like to see a state drought conference convened every two to three years. Local and regional topics were the most recommended additions for future events.

If you were unable to attend the conference but are interested in learning more, presentations as well as audio are available on the CWCB website at:

<http://cwcb.state.co.us/water-management/drought/Pages/2012CWCBStatewideDroughtConference.aspx>



# WATER & MARCH 22-23, 2012 SUSTAINABILITY

## THURSDAY EVENT

### MEETING THE GLOBAL CHALLENGES OF WATER SCARCITY

**MARCH 22 - 5:00PM**  
NORTH BALLROOM, LORY STUDENT CENTER

## KEYNOTE SPEAKER

**BRIAN RICHTER**  
Global Freshwater Strategies  
The Nature Conservancy

## FRIDAY EVENT

### WATER SUSTAINABILITY IN THE 21ST CENTURY WHY THE WORLD NEEDS WHAT CSU HAS

**MARCH 23 - 10:00-12:00PM**  
CHEROKEE PARK BALLROOM, LSC

**BRIAN RICHTER**  
Global Freshwater Strategies  
The Nature Conservancy

## FACULTY PANELISTS

**LEROY POFF**  
DEPARTMENT OF BIOLOGY

**KURT FAUSCH**  
DEPARTMENT OF FISH, WILDLIFE, AND CONSERVATION BIOLOGY

**BRIAN BLEDSOE**  
DEPARTMENT OF CIVIL AND ENVIRONMENTAL ENGINEERING

**GENE KELLY**  
DEPARTMENT OF SOIL AND CROP SCIENCES

## sponsors

The Colorado State University Water Café is an interdisciplinary, interactive series designed to examine critical water issues and the University's roles in their solutions.

Colorado State University  
WATER CENTER

SCHOOL OF GLOBAL  
ENVIRONMENTAL  
SUSTAINABILITY

Colorado  
State  
University

[www.sustainability.colostate.edu](http://www.sustainability.colostate.edu)

# GRAD592

## Interdisciplinary Water Resources Seminar

Fall 2012 Theme: **Addressing Global Water Resource Challenges with Local Expertise**

Mondays at 4:00 PM, Building NATRS 109

Aug 20	John Stednick Erin Donnelly	Environmental Flows; Or Can Groundwater Pumping Grow More Sturgeon?
Aug 27	Susan De Long Jeremy Chignell	Energy Recovery From Wastewater: New Trends and Possibilities
Sept 10	Brian Bledsoe Joel Sholtes	River Management in a Changing Climate: Tools for Planning Under Uncertainty
Sept 17	Larry Roesner Sybil Sharvelle	Integrated Urban Water Management
Sept 24	Kurt Fausch James Roberts	Ecological Futures for Native Trout of the Interior West in a Changing Climate: Are We in Hot Water Yet?
Oct 1	Patty Rettig	Using the Water Resources Archive for Research, Teaching and Scholarship
Oct 8	Patrick Byrne Steve Becker	Improving Drought Tolerance in Great Plains Wheat Cultivars with Synthetic Hexaploid Wheat
Oct 15	Allan Andales Neil Hansen Kendall DeJonge	Addressing Water Scarcity Through Limited Irrigation Cropping: Field Experiments and Modeling
Oct 22	Susan De Long Maria Renno	Development of Sustainable Water Treatment Technologies
Oct 29	William Bauerle Grace Lloyd	Measurement and Modeling of Physiological Responses to Soil Moisture Deficits: Applications to Irrigation Scheduling, Plant Breeding, and Global Climate Models
Nov 5	Mark Fiege	Using Digital History for Education About Local Water Resources
Nov 12	Melinda Laituri Faith Sternlieb	Spanning Boundaries Across the Colorado River Basin: A Geospatial Analysis of Agricultural Water Governance
Nov 26	Jorge Ramirez	Vulnerability of US Water Supply to Hydroeconomic and Climate Variability
Dec 3	LeRoy Poff	Using Environmental Flows to Stem Species Invasion of Western Rivers in a Period of Rapid Climate Change

Students wishing to obtain 1 credit for the seminar may sign up for Water Resources Seminar (CRN 67067) GRAD 592 Section 001. The Fall 2012 seminar will be held Monday afternoons at 4-5pm in Natural Resources Room 109.

**Faculty and guests are welcome to attend and participate.**

For more information, contact Reagan Waskom at [reagan.waskom@colostate.edu](mailto:reagan.waskom@colostate.edu) or visit the CWI website. Sponsored by CSU Water Center & School of Global Environmental Sustainability





*Colorado Water*  
 Volume 29, Issue 2  
 Horticulture



*Colorado Water*  
 Volume 29, Issue 3  
 Student Research



*Colorado Water*  
 Volume 29, Issue 4  
 Ground Water



*Colorado Water*  
 Volume 29, Issue 5  
 Energy and Water

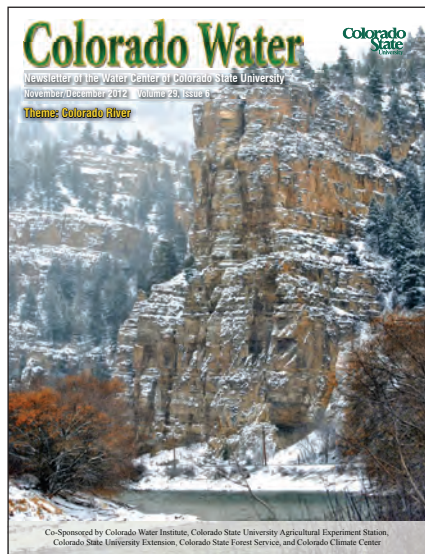

*Colorado Water*  
 Volume 29, Issue 6  
 Colorado River



*Colorado Water*  
 Volume 30, Issue 1  
 Water Education



**Other Colorado Water Institute Research and  
Activity Reports**

# CSU Water Scientists Part of Key State Agency Trio

## Answering Some of Colorado's Big Water Resource Questions

*Denis Reich and Perry Cabot, Extension Water Resources Specialists, Colorado Water Institute*



*Allan Andales, Soil and Crop Sciences, Colorado State University*

*Timothy Gates, Civil and Environmental Engineering, Colorado State University*

By the time this is printed, Colorado's 1177-Roundtable process will be digesting the second of its now annual state summits held in the Denver area on March 1. The summit convenes some of the best water minds in the state to collectively review the challenge of meeting Colorado's future water demand. Since the initial summit in 2011, the phrase "four-legged stool" has become somewhat of a catch phrase at Roundtable meetings in Colorado's various river basins. It's a term coined to describe the four strategies that most regional water leaders agree are needed to address the state's future municipal water deficit or "gap": New Supply, Conservation, Agricultural Transfers, and Identified Projects and Processes. The Roundtables' current philosophy subscribes to a balanced contribution from all four "legs" so all Coloradans can enjoy a safe and reliable water supply in perpetuity.

There's also a three-legged stool working on the objective of secure water resources for all Coloradans, now and into the future. It's perhaps not obvious to the water community, but its significance and contribution is real. It's the relationship between three of the state's institutions that are most directly focused on water-related investigations: the Colorado Water Conservation Board (CWCB), the Colorado Department of Public

Health and Environment (CDPHE), and Colorado State University (CSU).<sup>1</sup> As questions continue to be asked of the state's water supply and quality, this relationship will continue to play a role in the major water concerns for Colorado.

A major metric for the strength of this relationship is the number and value of projects that CSU staff and faculty are seeing sponsored by CWCB and CDPHE. At the time of writing, CSU was under contract with CWCB for 11 current projects for a total value of \$1,017,659, with at least three additional projects pending. With CDPHE's Water Quality Control Division (WQCD), CSU principal investigators (PIs) account for one project under contract for \$501,735 with one project pending.<sup>2</sup> CDPHE also funds the state nonpoint source (NPS) pollution program coordinator through the Colorado Water Institute at CSU. Together this is about 16 percent of the combined annual budget of the Roundtable process (\$7 million<sup>3</sup>) and the state's NPS allocation (\$2 million<sup>4</sup>). None of these figures account for the many additional CWCB and CDPHE sponsored projects that CSU staff partner on as Co-Principal Investigators or the completed work that these three agencies have collaborated on in the past. The financial weight of such a healthy list

of projects is strong evidence that this three-agency relationship is engaged and productive.

"The Colorado Water Conservation Board and Colorado State University enjoy a very positive relationship with each other," remarks Todd Doherty of the Colorado Water Conservation Board. Doherty manages two grant programs than have seeded partnerships with CSU personnel on numerous projects, such as the Roundtables' Water Supply Reserve Account and the Alternative Agricultural Water Transfer Methods program. "This relationship," he adds, "has helped bring the CWCB together with researchers and academics on water resource management issues that otherwise might not have occurred."

A good case study for some of this work is the Lower Arkansas River Valley where a number of programs have benefited from CWCB and CDPHE support. If there were a state scale for water scarcity and quality concerns (think the travelers alert we hear at airports), the Lower Arkansas probably would show up as dark orange. This is a region wrestling not only with the side-effects of irrigated land dry-up or "buy and dry" and river compact obligations with Kansas, but also with serious water quality concerns—especially

1. Projects funded by CWCB often involve cooperation with the Colorado Division of Water Resources (CDWR). The Division of Wildlife and State Parks also has a significant role in state water due its broad aquatic life and water-based recreational interests, but its scope is relatively narrow.

2. Source: Colorado State University Office of Sponsored Programs.

3. CWCB. Oct 2011. "Water Supply Reserve Account Annual Report." DNR Report to the respective House of Representatives and Senate committees for Colorado's consumptive and non-consumptive water needs.

4. 2011NPS Colorado 319 program funding announcement: <http://npscolorado.com/2011%20Announcement.pdf>



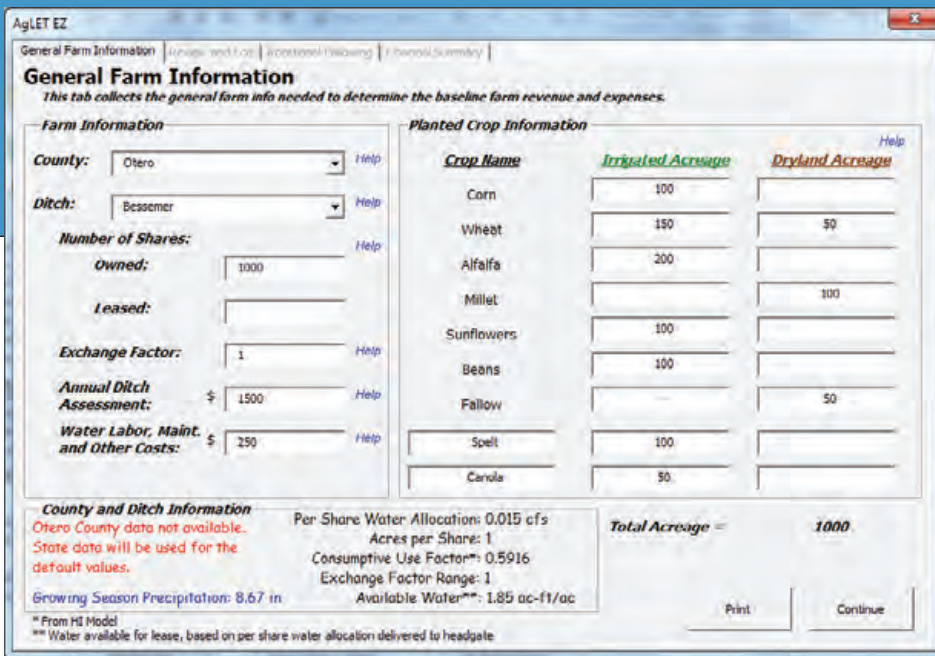

Figure 1. The AgLet EZ software user interface for optimizing the use of irrigation water leasing.

salinity and selenium. CSU, CWCB, and CDPHE have been cooperatively seeking to answer the challenging questions these problems present for a number of irrigation seasons, and they're starting to bear fruit.

In an attempt to alter the historic trends towards “buy-and-dry,” and instead to support strategies to keep agriculture viable, several fallowing and leasing projects centered at the Rocky Ford Research Center have been commissioned. Since 2009, this CWCB-funded \$92,000 three-year project has explored the profitability and stewardship potential of cropping systems that fallow proportions of land to incorporate potential water leasing arrangements. Such lease-fallow arrangements allow temporary water transfers to be controlled by the water rights holders in the Lower Arkansas Valley, thus helping satiate the growing thirst of front-range municipalities while preserving productive irrigated

land. Mike Bartolo and Jim Valliant, research scientists at the Rocky Ford Agricultural Experiment Station, have been the primary partners working through CWCB's Alternative Agricultural Water Transfers Methods Program<sup>5</sup> to host this critical research. An important product of the study has been an Excel®-based lease-fallow simulator, developed in coordination with Harvey Economics and James Pritchett. This Agricultural Leasing Evaluation Tool, known as “AgLet,” is an irrigator-focused software program that optimizes crop and fallow mixes based on market prices for leased water and commodities. Under the supervision of Perry Cabot and Caleb Erkman, the project team is developing an “EZ” version (Figure 1) that includes a user-friendly platform.

At the conclusion of the Colorado vs. Kansas litigation<sup>6</sup> on the Arkansas River compact, the Special Master accepted a new method for calculating

potential evapotranspiration (ET) in the computer model that is used to determine compact compliance. This new method involves the use of the Penman-Monteith equation. The resulting Penman-Monteith reference (potential) ET number is then multiplied with a crop coefficient for the ET of a specific crop. To better understand more precisely the implications of using this new ET method for determining compact compliance, CWCB funded the installation and operation of two precision weighing lysimeters<sup>7</sup> at Rocky Ford.

Allan Andales of CSU's Soil and Crop Sciences has led the project partnering with other CSU personnel, the Arkansas Valley Research Center, and the Colorado Division of Water Resources. A four-year \$375,000 project has been supporting the day-to-day operation and maintenance of one large and one small reference weighing lysimeter for determining local crop coefficients and for comparing physically-measured local ET to Penman-Monteith ET calculations (Figure 2). 2011 was the first year of simultaneous measurement of alfalfa ET on both lysimeters. This data will begin the process of formulating Lower Arkansas Basin crop coefficients that will improve consumptive use estimates that are used to ensure compact compliance. Better estimates of crop consumptive use can also help improve local irrigation water

5. <http://cwcb.state.co.us/LoansGrants/alternative-agricultural-water-transfer-methods-grants/Pages/main.aspx>

6. Montgomery, D. Oct 2003. “Lessons Learned from the Arkansas River Case.” Keynote Presentation – South Platte River Forum. [http://wsnet.colostate.edu/cwis31/ColoradoWater/Images/Newsletters/2003/CW\\_20\\_6.pdf](http://wsnet.colostate.edu/cwis31/ColoradoWater/Images/Newsletters/2003/CW_20_6.pdf)

7. A lysimeter is a means of precisely quantifying crop water use by accounting for weight changes in a known mass of soil (a “monolith”) growing a specific crop.



Figure 2. A view at the Arkansas Valley Research Center of the large lysimeter and associated sensors.

management, such as irrigation scheduling.

Timothy Gates of CSU's Civil and Environmental Engineering Department will this year conclude a \$501-thousand dollar 3-year phase of research targeted on selenium and salt fate and transport in the Lower Arkansas River Valley, with 40 percent matching funds provided primarily by the Colorado Agricultural Experiment Station at CSU. The local Pierre shale soils are rich in selenium and salts that, upon contact with irrigation water, dissolve and concentrate in the groundwater aquifer and flow into the Arkansas River. Apart from the salinity challenge this presents for eastern plains and Kansan irrigators, there are aquatic life implications as well. Selenium is essential for most forms of life, even humans, but each species usually has an acceptable range of concentrations for healthy intake. Outside this range selenium can become particularly disruptive to physical development. Fish are highly sensitive to the

slightest increases above background selenium levels. Scientists from the United States Department of the Interior are on record attributing population problems for a number of fish species in Colorado to above normal selenium concentrations in fish habitat reaches.<sup>8</sup>

The work of Gates and his team is aimed at reaching an understanding of the physical and chemical processes that influence salt and selenium mobilization. The resulting data are essential for designing agricultural best management practices (BMPs) that potentially reduce or eliminate contaminant loading. "We have enjoyed a long and productive relationship with Gates in the Lower Arkansas and a number of other CSU faculty," says Greg Naugle, Restoration and Protection Unit Manager at CDPHE's Water Quality Control Division. "Dr. Gates' work," Naugle continues, "will allow for large-scale and cost-effective remediation of selenium concerns."

Results of related work (some funded prior to this CDPHE project) suggest that groundwater salt movement and accumulation is inflicting damage on some agricultural ground, evidenced by water logging and high salt levels in otherwise productive soils. More recent determinations confirm the long held suspicion that nitrogen-based fertilizers have the potential to chemically accelerate selenium loading rates and slow compliance progress for the Arkansas river with the state selenium standard (4.7 ppb) – posing another challenge for the CSU and CDPHE partnership to address in their pursuit of preserving Arkansas Valley agriculture and mitigation for selenium pollution.

All of these projects provide a foundation for relevant work in other river basins around the state. For example, fallowing schemes are very much a part of the picture in the South Platte and Republican River Basins, and selenium is already a big piece of a Programmatic Biological Opinion for endangered fish species recovery in the Lower Gunnison River Basin. The less obvious component is the relationships that develop between staff members from these agencies as a result of these projects. This often results in informal problem solving outside of the scope of specific projects, adding value to the overall service that CWCB, CDPHE, and CSU are tasked with providing to the state's water-using community.

8. Lemley, DA. 1987. "Aquatic Cycling of Selenium: Implications for Fish and Wildlife." US-DOI Fish and wildlife Leaflet 12: <http://www.cerc.usgs.gov/pubs/center/pdfDocs/90562.PDF>. Also: Hamilton, SJ; et al. 2002. "Toxicity of selenium and other elements in food organisms to razorback sucker larvae." *Aquat Toxicol.* 2002 Sep 24;59(3-4):253-81.

9. Gates, T., Garcia, L., and Labadie, J. 2006. "Toward Optimal Water Management in Colorado's Lower Arkansas River Valley: Monitoring and Modeling to Enhance Agriculture and Environment." CWI Report: 205. CSU AES: TR06-10. Morway, E., and Gates, T. 2012. "Regional Assessment of Soil Water Salinity Across an Intensively Irrigated River Valley." *Journal of Irrigation and Drainage Engineering*, 138(5): In Press.

10. Gates, T. et al. 2009. "Assessing Selenium Contamination in the Irrigated Stream-Aquifer System of the Arkansas River, Colorado." *Journal of Environmental Quality*, 38:2344-2356. Bailey, R., Hunter, W., and Gates, T. 2012. "The Influence of Nitrate on Selenium in Irrigated Agricultural Groundwater Systems." *Journal of Environmental Quality*, 41: In Press.





*Twin Lakes Reservoir.*  
Photo by Bill Cotton

## Variables Controlling Basin Scale Sediment Yields to Reservoirs in Dry Lands of the Western U.S. and Central Turkey

*Umit Duru, Ph.D. Candidate, Geosciences, Colorado State University*  
*Faculty Advisor: Ellen Wohl*

### Introduction

Reservoirs around the world experience problems with sediment filling, which results in loss of storage capacity and operating potential. Sediment accumulation in reservoirs has environmental and economic consequences, especially in semiarid regions where reservoirs were mostly built for irrigation and water supply, as well as generating electricity or flood control. In some cases, the sediment delivery is large compared with the reservoir capacity, and reservoir capacity and useful life are depleted faster than planned. Also, in many regions, reservoirs have already been constructed in the most desirable areas. If these existing reservoirs completely fill with sediment, new reservoirs would be constructed in less desirable and more expensive areas.

Sediment input to reservoirs likely reflects several potential controls (e.g., drainage area, relief, lithology, land use, disturbances such as fire or deforestation) on basin-scale sediment yields in arid and semiarid regions. The smallest sediment particles may not be kept within the reservoir for a long time, but may instead be discharged downstream without settling in the reservoir. Larger particles may be retained in a reservoir, depending on how completely suspended sediment settles out in the reservoir. Furthermore, during peak flow seasons, inflowing water with huge volumes of sediment can enter a large reservoir and not be subsequently disturbed. To overcome the effect of sediment deposition, a portion of the volume is reserved for sediment storage in large reservoirs, which requires extra volume for

the reservoir and increases the construction expenses.

Sediment accumulation also occurs throughout the reservoir. As the useful storage capacity starts to be depleted, the reservoir becomes insufficient to maintain the intended purposes. For example, 600,000 cubic meters of sediment have filled Strontia Springs Reservoir in Colorado, in large part due to the 2002 Hayman Fire and, to a lesser extent, the 1996 Buffalo Creek Fire. The fires scorched the vegetation on the land upstream from the reservoir.

Previous work in the western U.S. and central Turkey thus suggests that topography, land cover, and disturbances such as wild fire influence sediment yield, but it remains unclear how the relative importance of these factors varies at temporal and spatial scales that are particularly relevant to reservoirs in the region, namely



50-100 years and 1,000-7,000 km<sup>2</sup>, respectively. The primary objective of my work is to assess the relative importance of several potential control variables in terms of influence on sediment yield in the specific study areas. Potential control variables include lithology, topography, land cover, land use, and disturbance history. A second objective is to develop a sediment yield model based on statistical analyses of correlations among the potential control variables and sediment yield. The final objective is to evaluate regional differences in correlations between potential control variables and sediment yield among Colorado, other portions of the western U.S., and central Turkey. These objectives will be evaluated by testing the following hypotheses:

1. Sediment yield correlates most strongly with disturbance history, and to a lesser extent with lithology, topography, land cover, drainage density, and land use.
2. The relative importance of potential control variables will be consistent among diverse arid/semiarid regions of moderate to high relief (the Colorado Front Range, other portions of the western U.S., and the Central Anatolian Plateau of Turkey)

Hypotheses 1 and 2 will be tested by statistically evaluating correlations among (i) sediment input and temporally variable control variables (land cover, disturbance), either at annual intervals or averaged over time intervals dictated by the availability of information on land cover

- and disturbance for each reservoir and for the entire set of reservoirs, and (ii) average sediment input and all control variables for the entire set of reservoirs.
3. Sediment yield will not be evenly spread across the contributing basin upstream from a reservoir. This hypothesis is based on the fact that it might be possible to identify which tributary potentially brings more sediment input to the reservoirs based on variable characteristics such as land cover, natural disasters, and topography in the basin.
  4. A correlation exists between reservoir size or shape and volume of sediment accumulated per year (i.e., total sediment volume normalized by time interval of accumulation).

## STUDY LOCATIONS

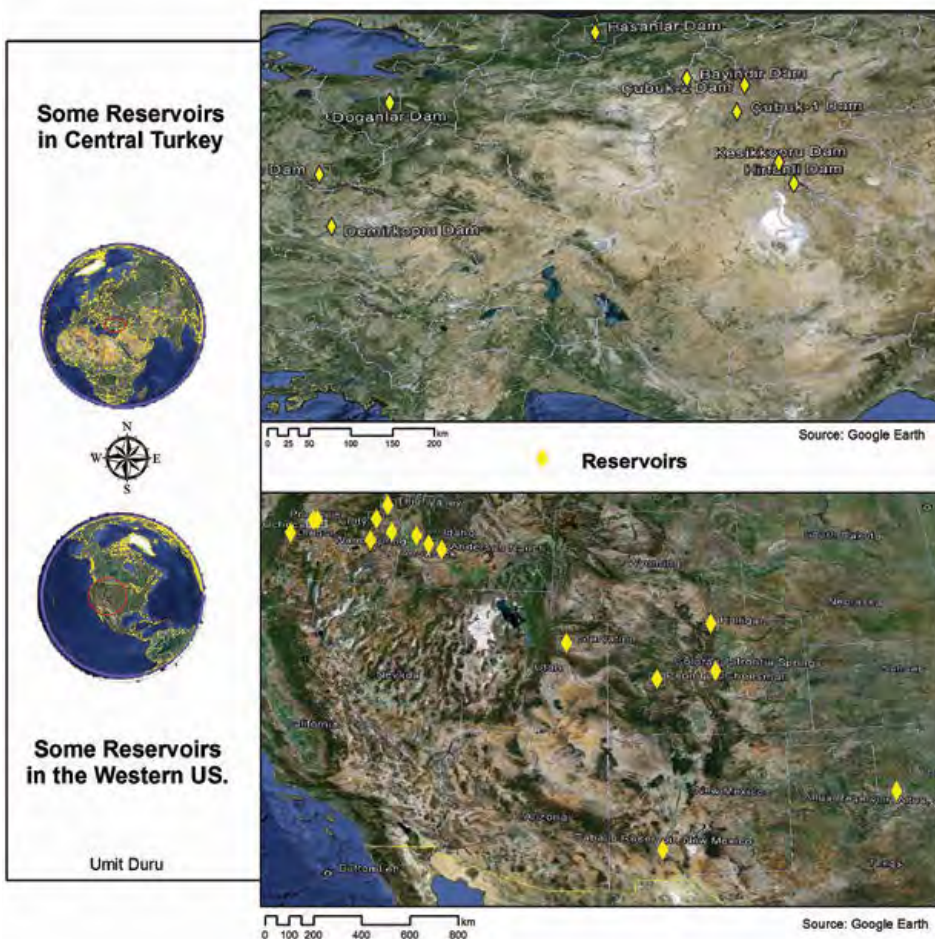

Locations of selected reservoirs in the U.S. and Turkey.

## Study Location

The research focuses on the Colorado Front Range, other sites in the arid/semiarid portions of the western U.S. for which suitable reservoir data are available, and the Central Anatolian Plateau of Turkey (Figure 1).

First, three reservoirs (Halligan, Cheesman, and Strontia) that have the most available data were selected for study in the Front Range. Second, I used the Reservoir Sedimentation Information System (RESIS) II database of the Army Corps of Engineers, Bureau of Reclamation, and U.S. Geological Survey to choose additional reservoirs that met three criteria: arid or semiarid climate, mountainous or hilly terrain, in the western United States. From this database, I identified 16 additional reservoirs that met these criteria. Third, I have selected reservoirs in Turkey for which suitable sedimentation data are available and which are comparable to those in the western U.S. based on climate, topography, and drainage area.



## Reservoirs across the United States

Halligan Reservoir, CO	Cascade, ID	Prineville, OR
Cheesman Lake, CO	Caballo, NM	Thief Valley, OR
Strontia Reservoir, CO	El Vado, NM	Unity, OR
Paonia, CO	Altus, OK	Warm Springs, OR
Anderson Ranch, ID	Agency Valley, OR	Starvation, UT
Arrowrock, ID	Bully Creek, OR	
Black Canyon, ID	Ochoco, OR	

*Blue Mesa Reservoir.*  
Photo by Bill Cotton

## Reservoirs across Central Turkey

Hirfanli, Kirsehir	Cayoren, Balikesir	Cubuk 1, Ankara
Kesikkopru, Ankara	Doganci, Bursa	Cubuk 2, Ankara
Bayindir, Ankara	Hasanlar, Duzce	Demirkopru, Manisa

Some of the reservoirs listed above have limited data on reservoir operations and sedimentation over time. Numerous conversations with water resource managers and requests for information have indicated that data on sediment yield or patterns of sediment accumulation within reservoirs since the time of reservoir construction are very limited. These conversations also indicate that we are not likely to receive permission to conduct bathymetric surveys of reservoirs for which original bottom topography data (i.e., bottom topography at time of reservoir construction) are available. To date, I have been able to obtain data for nine reservoirs and 1:250,000 scale digital maps for these reservoirs in central Turkey, three reservoirs in Colorado, and 10 reservoirs in the western U.S. Climate and hydrologic conditions are similar within the

regions in which these reservoirs are located. I am continuing to contact water resources managers in an effort to identify additional reservoirs for which either (i) sedimentation data over time are available or (ii) original bottom topography data are available and bathymetric surveys will be permitted.

### Method

For each reservoir chosen for inclusion in this study, I will complete the following analyses:

1. I will characterize variables potentially influencing sediment yield, including catchment geology, drainage area, topography, annual precipitation, land cover and disturbance history, history of reservoir construction and operation, and initial bottom topography

and subsequent sediment accumulation.

2. I will use GIS software to characterize the variables and to statistically evaluate correlations between potential control variables and sediment yield via stepwise linear regression and other statistical approaches.
3. I will undertake these analyses for each reservoir individually, and then for progressively larger subsets of all of the reservoirs (i.e., Colorado Front Range, other sites in western U.S., Turkey, and all sites combined). Most of the empirical erosion rate approaches are based on the universal soil loss equation (USLE), MUSLE (modified USLE), sediment yield as a function of drainage area, and sediment yield as a function of drainage characteristics.



# Large Aperture Scintillometers for Evapotranspiration Evaluation

*Evan Rambikur, MS Candidate, Civil and Environmental Engineering, Colorado State University  
Faculty Advisor: José L. Chávez*

## Introduction

How do we effectively manage application of irrigation water for crop production in arid and semi-arid environments? One of the primary inputs necessary for knowing appropriate timing and amounts of irrigation is actual evapotranspiration (ET). For practical applications, ET can be estimated using a reference ET value (e.g., alfalfa,  $ET_p$ ) and a crop coefficient ( $K_c$ ). The value of  $ET_p$  is computed using weather data from a local standard weather station, and  $K_c$  values for different crop types are published in the literature. On a research basis, different methods for estimation/measurement of actual ET have emerged including scintillometry, which uses electromagnetic radiation transmission to capture information on the turbulence in the atmospheric boundary (near-surface) layer. For the specific case of the large aperture scintillometer (LAS), estimates for the surface sensible heat flux can be obtained for representative path lengths up to 4.5 km (2.8 mi.). Sensible heat flux (energy) occurs as a result of air temperature gradients between the land surface and some height within the boundary layer (e.g., two m). Since ET is also a process that uses available energy at the land/crop canopy surface, researchers can take advantage of a land surface energy balance in conjunction with LAS measurements to indirectly estimate (vegetative) ET rates. Thus, ET estimates using an LAS are

obtained from LAS sensible heat flux (H) and ancillary measurement of net radiation ( $R_n$ ) and soil heat flux (G).

In this study, LAS technology was tested at two different locations in the Arkansas Valley, Colorado. Three LAS systems (LAS model, Kipp and Zonen B.V., Delft, The Netherlands) were deployed during the 2011 study period. An LAS system operates by emitting a near-infrared light beam from a transmitter to a receiver, which is set up at least 250 m (820 ft) away. The transmitter and receiver have the same aperture diameter and must be aligned with each other. For the optimum (performance evaluation) case study, the LAS should be set up over a horizontally uniform terrain at least 1.5 m (five ft) from the ground or crop canopy surface. It is worth noting that the Kipp and Zonen LAS has been criticized in the literature for having issues with inter-sensor variability and inherent (design) biases. This study tested the performance of the Kipp and Zonen LAS for predominantly dry and irrigated surfaces in order to more comprehensively evaluate the LAS method of ET estimation. The evaluation of the LAS results was performed using concurrent heat flux measurements made with an Eddy Covariance system at both the dry and irrigated sites. The Eddy Covariance (EC) instrumentation consisted of a 3D sonic anemometer (CSAT3, CSI, Logan, UT) and a krypton hygrometer (KH20, CSI, Logan, UT).

The 3D sonic anemometer provides information on wind speed in three orthogonal directions (i.e., x, y, and z), as well as sonic (air) temperature, and vapor pressure is measured by the hygrometer. The EC system yields direct estimates of sensible heat and ET fluxes.

## Field Campaign

During the 2011 summer, a short-term experiment was conducted with three LAS units operating over a uniform, dry grassland area in order to assess the LAS inter-sensor consistency. Following this experiment, two of the LAS units were removed with one of them (LAS 2) being re-located to the Colorado State University (CSU) Arkansas Valley Research Center (AVRC), while one unit (LAS 1) remained at the grassland site (LAS 3 was moved to another location near Iliff, CO). The EC instrumentation was also set up at the grassland site for some time, overlapping the period of the LAS inter-comparison study. Eventually, the EC instrumentation was moved to the AVRC, providing a reference for LAS 2. At both sites, sensors were installed to measure air temperature, relative humidity, and horizontal wind speed. These sensors were necessary for processing the LAS data. At the dry grassland site, soil water content sensors were installed at two locations in the near surface soil along with soil temperature sensors and soil heat flux plates, in order to capture the heat flux into the soil (G).

Image 3. LAS 1 receiver at the dry grassland site, along with net radiometer (left) and ancillary sensors and data collection equipment.

Photo by Evan Rambikur



(Left to right) Abhinaya Subedi, Stuart Joy, and Mcebisi Mkhwanazi measure the height of a LAS transmitter tripod at the dry grassland site.

Photo by Evan Rambikur

Net radiation ( $R_n$ ) sensors were also installed at the same two locations on site. At the AVRC, LAS 2 was installed with a path length spanning two irrigated alfalfa fields. There were four available stations for measurements of  $R_n$  and G at the AVRC. In addition, eight soil water content sensors (ACC, TDT, Acclima, Inc., Meridian, ID) were installed at four depths and two locations during the study period. These were installed to estimate ET from two neighboring corn fields south of the LAS path. Unfortunately, the data from these sensors were unreliable, and therefore no further analysis with these data was made. The alfalfa in both fields was harvested about three weeks following the LAS installation, and reached a height of approximately 40 cm (16 in) near the end of the study period. Due to the nature of the surface (furrow) irrigation timing for both alfalfa fields, the alfalfa growth conditions were generally not homogeneous.

## Results

Data were collected periodically from both sites and processed using standard algorithms in order to

obtain time series flux estimates. The data were processed to produce 30 minute averages of sensible heat (H) and evaporative heat (ET) flux. For the LAS inter-comparison, the H fluxes were compared and for the LAS to EC comparison, both H and ET fluxes were compared.

## LAS Inter-comparison

In regard to LAS consistency, based on the results observed at the grassland site, it is considered that the deviation in H between LAS units is dependent on inherent bias and conditional bias. For part of the study when the LAS units were well aligned, the mean bias deviation, normalized by the mean absolute value of the LAS H reference ( $MBE/|\bar{O}|$ ), ranged between six and 11 percent. This relative deviation corresponds to the assumed inherent bias. After a slip in alignment, the scatter and deviation in H increased between the LAS units. The estimated misalignment-induced error increased the mean bias to a maximum observed value of 24 percent ( $MBE/|\bar{O}|$ ). Note that LAS 2 almost completely lost alignment for approximately half of the study.

This misalignment is assumed to have occurred due to strong, stormy winds, which caused a physical shift in the alignment of the transmitter and/or receiver.

## LAS to EC Comparison

At the dry grassland site, the sensible heat flux (H) obtained with the LAS correlated fairly well with the corresponding H obtained with the EC system. It was observed that the H from each LAS was approximately equal to or larger than the H from the EC. The coefficient of determination ( $r^2$ ; for the linear regression of LAS to EC H) was better than 0.9 for all LAS units. Further, the ET derived from the LAS was consistently larger than the ET from the EC for the study period at the dry grassland site. At the AVRC site, H from the LAS was generally larger than H from the EC. However, the correlation between LAS and EC H values was not as consistent as was observed for the dry grassland site. Furthermore, at the AVRC, the magnitude of the ET derived from the LAS was generally similar to that of the EC system, albeit with some observed scatter. For the AVRC site, the heterogeneous surface conditions (crop type, growth, surface wetness) must be considered for appropriate understanding of the heat flux results. It was observed that H from the LAS and H from the EC correlated better when the wind direction was from the east/southeast direction (during the daytime). This result suggests that the heat flux source areas contributing to the LAS and EC fluxes were similar for this wind direction. During these periods of better H correlation, the ET derived from the LAS was generally greater than or equal to the ET from the EC.

## Discussion

Comments on the LAS performance are based on the assumption of



validity of the EC-measured H and ET. Based on the results observed in this study, it can be concluded that, in general, the LAS-predicted sensible heat fluxes correlated well with EC-predicted H. However, the correlation was impacted by apparent LAS receiver and transmitter inherent bias and misalignment issues. The assumed inherent bias issues may have actually been a result of setup issues which were manifested in a different power requirement for each LAS, and would thus be a correctable (and not inherent) bias. Further, the conclusion of good LAS H performance relies on the assumption (above) that the disagreement between LAS- and EC-derived H at the AVRC site can be explained by differences in the heat flux source areas. Despite the fair agreement of H fluxes between the LAS and EC, the poor correlation between LAS- and EC-derived ET is discouraging, which was especially apparent for the dry grassland site results. Nonetheless, this result reflects on the accuracy/spatial representativeness of the  $R_n$  and G measurements and the

validity of the land surface energy balance model rather than on the ability of the LAS to predict H. Therefore, it is tentatively concluded that the LAS can predict H with reasonable accuracy in both dry and irrigated environments, but that caution must be taken in further predicting ET as a residual of the energy balance. This subsequently limits the validity of the LAS energy balance method for estimation of crop ET for irrigation management or validation of other ET estimation methods.

### Acknowledgements

The investigator and advisor would like to acknowledge and thank the Colorado Water Institute (CWI) for sponsoring this study. We are grateful to the CWI for supporting graduate



Advisor José Chávez and Investigator Evan Rambikur.

Photo by Abhinaya Subedi

research. We also are thankful to the Colorado State University Colorado Agricultural Experiment Station for their support. In addition, we want to extend our appreciation to the following individuals, who in one way or another participated in the study: Allan Andales, Michael Bartolo, Lane Simmons, Gale Allen, Darell Fontane, and Stuart Joy.

*LAS 2 receiver at the AVRC site with data logger enclosure and laptop in the foreground. Alfalfa field was being cut (harvested).*

Photo by Evan Rambikur



# Novel Technique for Evaluation of Relationships Between Phytoplankton and Dissolved Organic Material

Alia Khan, MS Candidate, Civil and Environmental Engineering, University of Colorado-Boulder  
Faculty Advisor: Diane McKnight

Maintaining adequate supplies of clean drinking water is vital to human health. Technological advancements in water treatment allow the removal and treatment of some pollutants and pathogenic bacteria. However, disinfectants such as chlorine can react with natural organic matter (NOM), which is measured as dissolved organic carbon (DOC) concentration, in source waters to create disinfection byproducts (DBPs), some of which are known carcinogens. In recent years, documented rises in DOC concentrations have occurred across the northeastern United States as a response to the amelioration of acid rain. In Colorado, changes in DOC concentrations in the future may be driven by increasing growth of algae, a large source of DOC, due to a longer period of ice-free conditions on lakes and reservoirs under a changing climate and increasing nutrient inputs from atmospheric deposition and other anthropogenic sources.

These changes may present challenges to ensure safe drinking water as a result of increased DOC in Colorado. Removal of the DBPs post

treatment is possible, but is often difficult and costly for drinking water utilities. Furthermore, because the formation of chlorinated disinfection by-products have been directly correlated with DOC levels, prevention of elevated DOC levels pre-treatment could be more efficient for drinking water utilities.

In the summer of 2010, the Colorado Department of Public Health and Environment (CDPHE) conducted a High Quality Water Supply study to assess the impact of algal growth in Colorado lakes and reservoirs on DOC concentrations and the potential to form DBPs. Twenty-eight lakes were sampled during July and August, at the peak of summer stratification, and 10 other drinking water reservoirs were sampled biweekly

from May through September 2010. Chlorophyll-a, an indicator of algal biomass, was used to assess the relationship between algal concentrations and DOC concentrations. During the field sampling, additional surface samples were taken and preserved with Lugol's, an iodine based solution, for phytoplankton identification and enumeration with a Fluid Imaging Technologies FlowCAM®. Funding from the Colorado Water Research Institute supported the development of a protocol to analyze the phytoplankton samples.

Identification of phytoplankton species and relative abundances can help understand the drivers of the phytoplankton dynamics and chlorophyll levels aiding in further comprehension for protecting source water quality in lakes and reservoirs. Unlike traditional microscopy, the FlowCAM® enables rapid monitoring of particles in fluid by combining flow cytometry with microscopy. Flow cytometry is the process of quantifying and phenotypically identifying cells suspended in a fluid by passing them through a laser beam and capturing the amount of



Adviser Diane McKnight and student Alia Khan, discuss how different phytoplankton species found in the samples may impact the DOM quality of the respective lake sample. The species in this picture is *annabeana*, a filamentous cyanobacteria found in high abundance in some of the samples.

Courtesy of Alia Khan



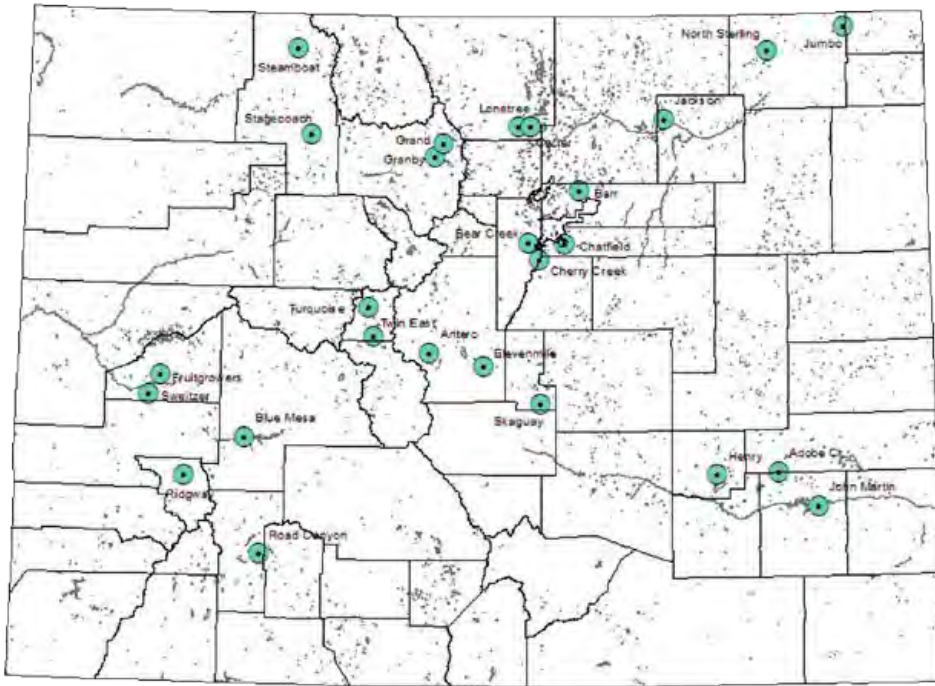

Geographic distribution of Colorado lakes and reservoirs sampled for the study.

light scattered by every particle. The FlowCAM<sup>®</sup> automatically counts and images each particle, while also evaluating characteristics of the digital image, such as shape and intensity. Such imaging microscopes are becoming used more frequently by water treatment plants in order to monitor algal activity in source water lakes and reservoirs, such as in the case of invasive species.

A newly developed protocol was needed to take advantage of the capability of this instrument's potential for new and novel applications to ongoing research on the ecology of alpine and sub-alpine lakes and reservoirs. A method has been identified to routinely analyze the samples from the High Quality Water Study, which may be representative of the range of phytoplankton

communities occurring in Colorado. First, 150mL of the 500mL grab sample was transferred to a settling tube for 24 hours. Next, 130 mL of the sample was aspirated from the top of the sample in order to not disturb the settled particles. The sample was then transferred to a 50ml centrifuge tube. If the sample looked visibly cloudy, it was filtered with a 100um mesh net to avoid clogging in the flow cell. The 10X objective was used with a 100um flowcell. Acetone was run for five minutes to clean the flowcell and tubing. The FlowCAM<sup>®</sup> was then focused using a small volume of spare sample. A 2mL of sub-sample was then run through the FlowCAM<sup>®</sup>. After the sample finished running, image library files were made through the interactive data platform, and sorted based on image characteristics

associated with each of the dominant algal species. Total particles counts were also noted.

Results show that Cyanobacteria, diatoms, and green algae are the most abundant algal groups present. In the samples with the highest chlorophyll a concentrations the phytoplankton community was dominated by filamentous cyanobacteria.

The results from the analysis of the phytoplankton using the FlowCAM<sup>®</sup> are being analyzed to understand the statistical relationships between the phytoplankton species, chlorophyll-a, nutrient levels, physical characteristics of the lake, and DOC concentrations. These results will be the basis of a MS Thesis in the Environmental Studies Department at University of Colorado – Boulder.

## Acknowledgements

Thanks to the Colorado Water Institute for funding to support the development of a protocol for the Fluid Images FlowCAM for phytoplankton analysis of Colorado lakes and reservoirs. We also appreciate access to phytoplankton samples collected for the High Quality Water Study from the Colorado Department Public Health and Environment to assess algal impacts on disinfection byproduct formation. Lastly thanks to collaborators Prof. Fernando Rosario, Prof. Scott Summers, and Amanda Hohner at the Department of Civil, Environmental and Architectural Engineering at the University of Colorado.

*Cyanobacteria (left) and diatoms were two of the most common types of algae found in the study.*

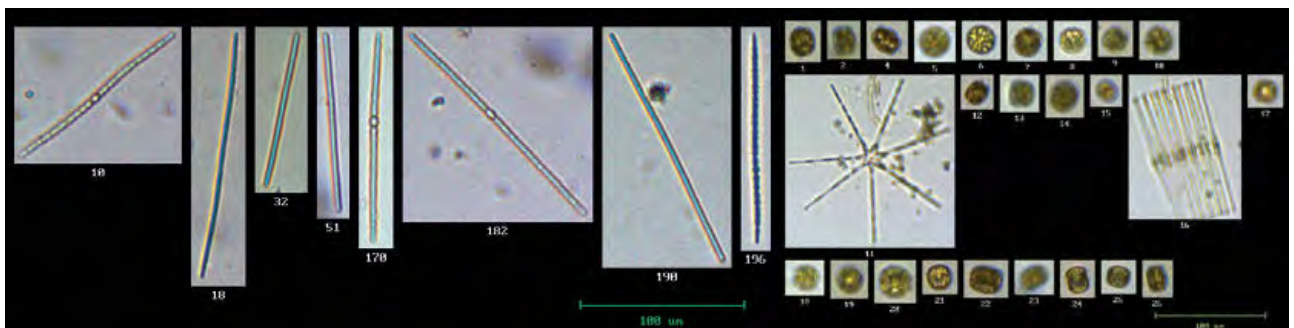

# Combined Source Infrastructure Assessment Model

Anne Maurer, MS Candidate, Civil and Environmental Engineering, Colorado State University  
Faculty Advisor: Tom Sale

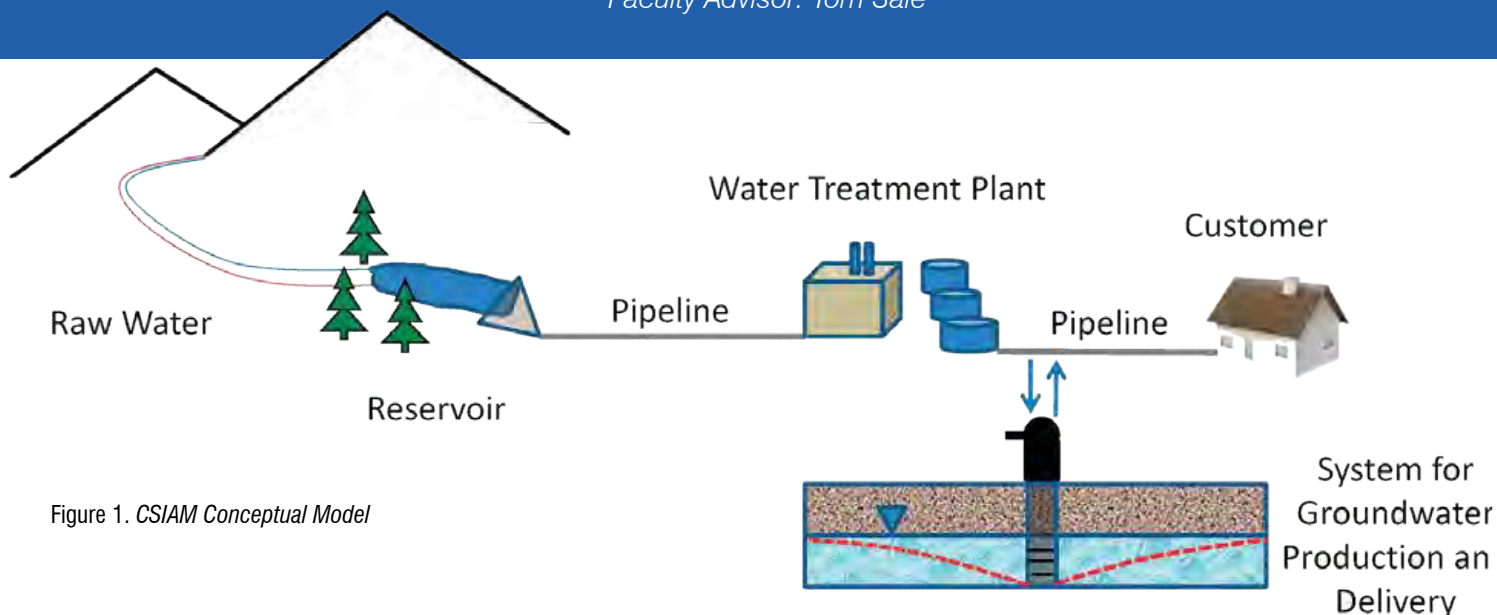

Figure 1. CSIAM Conceptual Model

## Purpose of Study

The world is facing the critical problems of increasing population, climate change, and intensifying competition for water resources. With all of this, integrated utilization of surface and groundwater is becoming an ever more important strategy for sustaining water

production needed to address irrigation, domestic supply, and industrial demands. The term “conjunctive use” is used to describe the coordinated management and development of surface and groundwater. Conjunctive use includes the ability to store and/or utilize surplus water from one source

to meet the deficit of another source. Unfortunately, design and analysis of costs associated with conjunctive use projects can be difficult. Challenges include 1) appropriate sizing of water storage, water treatment, and well fields under conditions of evolving demands; 2) resolving timing of surface water use, groundwater use, and groundwater storage; and 3) efficiently developing estimates of costs associated with a range of options.

The purpose of the study was to develop a Combined Source Infrastructure Assessment Model (CSIAM) that can be used to 1) resolve appropriate infrastructure and operations for combined source water systems and 2) develop feasibility level cost estimates.

General approaches to conjunctive use include combined use of surface and groundwater with and without groundwater recharge. The primary advantages to systems with groundwater recharge include an ability



Anne Maurer with her faculty advisor, Tom Sale, Civil and Environmental Engineering, CSU.  
Courtesy of Anne Maurer



to “bank” water in aquifers during periods when surplus surface water is available, and to reduce the necessary capacities of surface water structures (e.g., water treatment plants) to meet peak demands.<sup>1</sup> A central tenant of the model is to recharge groundwater

when surplus surface water is available. This is based on minimizing the size of surface water reservoirs and, correspondingly, minimizing water losses to seepage and evaporation. Funding for the project was provided by the Colorado Water

Institute and the Town of Castle Rock, Colorado.

## Research Objectives

The objective of this research is to develop a model that can assist with design and analysis of costs associated with conjunctive use strategies. The vision of the model is that of a general tool that can be used for a wide variety of water supply options. Figure 1 represents a conceptual view of the combined source system that the model is based on.

The research objectives for this study included:

1. Development of both a deterministic and stochastic hydraulic model that determines long-term water demands, surface reservoir volumes, volume of water delivered to a surface water treatment plant, number of wells, injection/recovery volumes from wells, and resolution of required infrastructure needed for combined source system operation
2. Development of a cost model based on the hydraulic model that estimates the capital costs, operation and maintenance costs, life-cycle costs, and present value costs of the combined source system being evaluated
3. Application of the model to determine the least-cost option that maximizes reliability of the combined source system by testing different surface water treatment plant sizes.

The town of Castle Rock was used as a test case for the CSIAM.<sup>2</sup> The town is located in the high plains of central Colorado at the base of the Front Range. Historically, the Castle Rock has relied primarily on groundwater from the Denver Basin aquifers.

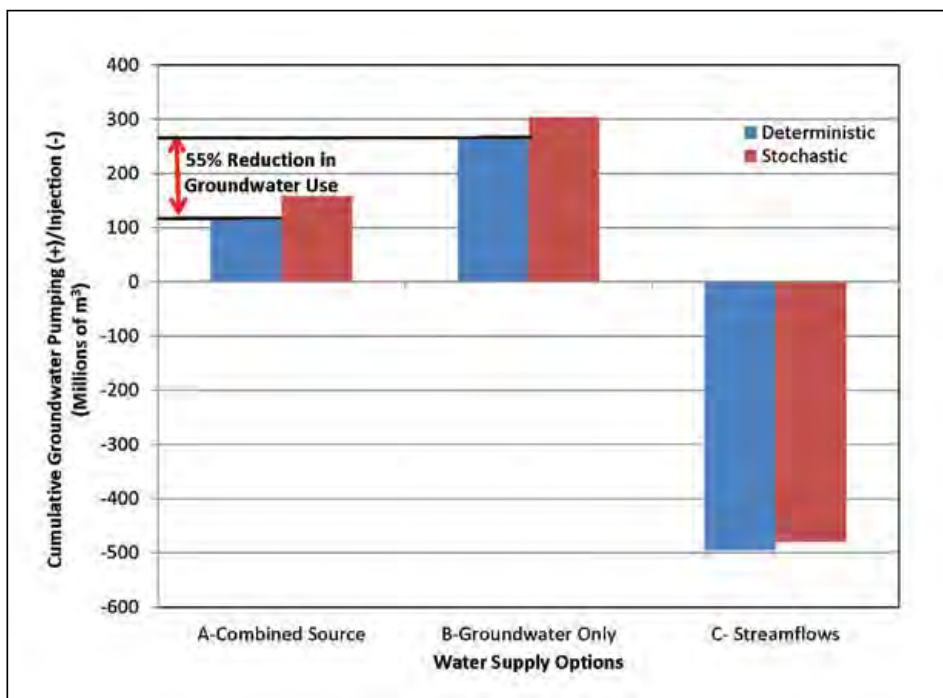

Figure 2. Comparison of Cumulative Pumping (+)/Injection (-) Volumes for Each Scenario

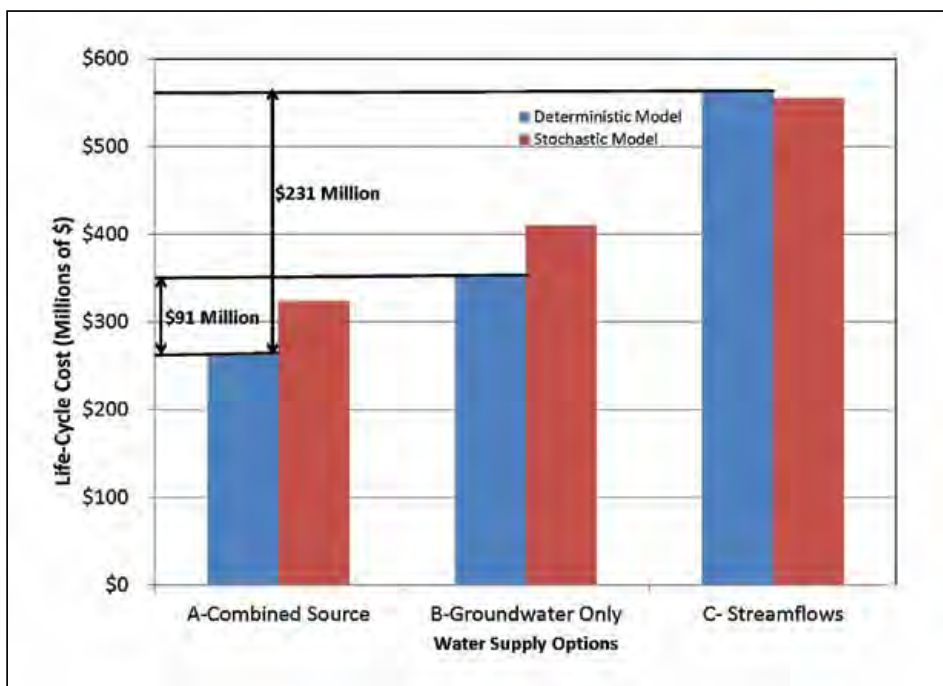

Figure 3. Comparison of Life-Cycle Costs for Each Scenario

1. Pyne, R. D. G. (2005). Aquifer Storage Recovery: A Guide to Groundwater Recharge through Wells, ASR Press.

2. CH2M Hill, Inc. (2006). Town of Castle Rock Water Facilities Master Plan. Castle Rock.

Three future water use scenarios are considered, including:

- Scenario A: Use of groundwater, treated wastewater, and return flows (treated surface water collected downstream of the town's wastewater treatment plant)
- Scenario B: Use of groundwater only
- Scenario C: Use of a hypothetical new surface water source

While the town of Castle Rock provides a basis for applying the model, the results should not be viewed as having direct bearing on future actions in the town of Castle Rock. Many of the key issues that will ultimately drive the town's water

supply plans are not included in this analysis.

## Results

Each scenario was evaluated using the deterministic and stochastic version of CSIAM. Figure 2 presents a comparison of the cumulative groundwater use for a 30-year period. Figure 3 presents life cycle costs for a 30-year period. Figures 4 and 5, respectively, present the number of pumping and injections well needed. Results indicate that combined use (Scenario A) results in a 55 percent reduction in cumulative groundwater pumping relative to a groundwater-only system (Scenarios B). Furthermore, Scenario A is \$91 million less expensive than Scenario B. Another key result is that Scenario

A is \$231 million less expensive than the surface water-only option (Scenario C).

## Conclusion

The CSIAM provides a basis for resolving infrastructure components and costs associated with combined source water systems. Per the test case, potential benefits of combined source systems include reduced use of groundwater and lower costs relative to solely relying on groundwater. Furthermore, the test case indicates that the combined source system has a lower cost than solely relying on surface water. A comprehensive presentation of the CSIAM, methods, assumption and results is presented in Maurer (2012).<sup>3</sup>

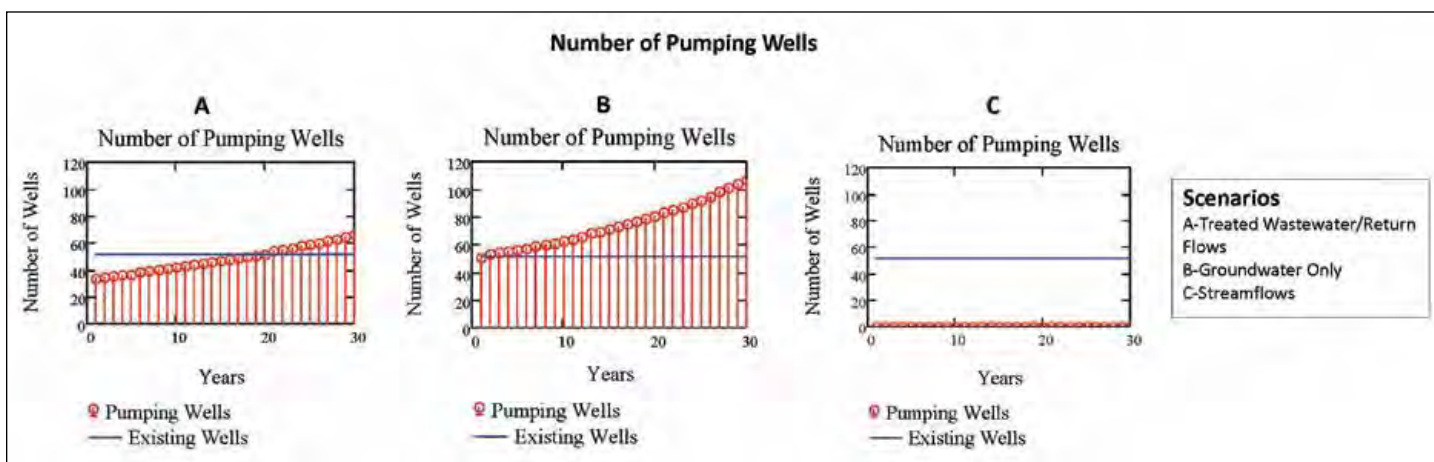

Figure 4. Number of Pumping Wells for Each Scenario

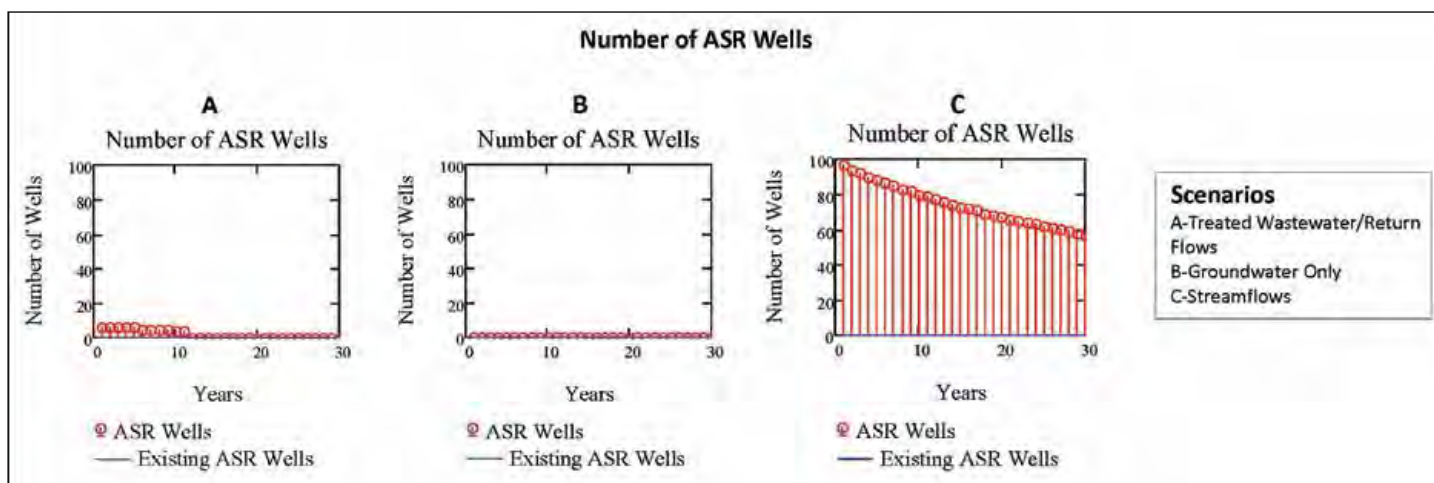

Figure 5. Number of ASR Wells for Each Scenario

3. Maurer, A. (2012). Combined Source Infrastructure Assessment Model. (Master's Thesis) Colorado State University.





Figure 2. Irrigation practices in the Arkansas River Valley.  
Photo by Bill Cotton

## Nutrient Management Practices and Groundwater Protection Assessing Adoption by Colorado Producers



Troy Bauder, *Extension Water Quality Specialist, Colorado State University*  
Catherine M.H. Keske and Erik Wardle, *Department of Soil and Crop Sciences, Colorado State University*

According to the U.S. Census Bureau, the Earth's estimated human population has surpassed seven billion. It is certain that each and every one of these people will require food and clean water for survival. Nutrient use in agriculture is closely tied to providing both of these basic needs. Agricultural productivity critically depends upon adequate soil nutrients. Replenishment of soil system nutrients removed by crop production is not only necessary for agricultural productivity, it is also essential for the sustainability of the soil resource. However, these soil nutrients must be appropriately managed in order to protect water quality. This article summarizes recent findings regarding Colorado agriculture soil nutrient management

and the costs of adopting nutrient management practices.

### Nutrients in Cropping Systems and the Environment

In the context of agricultural production, the nutrients nitrogen (N) and phosphorus (P) are typically referred to as "macronutrients" due to the large amounts necessary for crop production relative to the other 16 essential nutrients for plants. While N is ubiquitous in the environment as a stable gas (N<sub>2</sub>), reactive Nitrogen (Nr) forms of N such as nitrate and ammonia are most limiting for biological systems. In most systems, Nr can be a potential pollutant in both surface and groundwater. Due to solubility and use as a plant nutrient, the nitrate ion (NO<sub>3</sub><sup>-</sup>) form of nitrogen has been

a primary concern. While critical to increased plant growth, water quality impairments from N and P have been well-documented and researched in many environments and cropping systems.

### Colorado Policies and Educational Programs

Groundwater contamination from nitrate is currently a recognized issue related to agricultural nutrients in some areas of Colorado. Beginning in the late 1980s, sampling began to show certain regions of the state where elevated nitrate-nitrogen concentrations above the EPA drinking water standard of 10 mg/L (ppm) of nitrate-nitrogen could limit the use of groundwater resources for drinking water supplies. As concern

over these findings increased, in 1990 the Colorado General Assembly passed proactive legislation for addressing nitrate contamination in groundwater. This legislation was written as an amendment to the Water Quality Control Act, and established what would later become the Agricultural Chemicals and Groundwater Protection Program (Groundwater Program). This multi-agency program is led by the Colorado Department of Agriculture (CDA), who partners with Colorado State University Extension and the Colorado Department of Public Health and Environment, to achieve the following program goals: 1) remedy areas of nonpoint source groundwater impairment, 2) prevent new contamination, and 3) understand trends in groundwater vulnerability and quality. The Groundwater Program has used a combination of three approaches to achieve these goals: targeted regulation, education through demonstration and outreach, and groundwater monitoring.

## Costs of Adopting Nutrient Management Practices and Current Trends

In an effort to understand current adoption of nutrient best management practices (BMPs) by Colorado agricultural producers, the Groundwater Program conducts periodic assessments of trends and costs of nutrient management practices. As follows is a summary of methodology and results from a 2011 study.

The 2011 assessment consisted of a mail-back survey that queried 2,000 irrigating agricultural producers about BMP adoption rates and costs for the 2010 growing season and calendar year. The survey was pilot tested with 16 producers, extension specialists, agency personnel, and

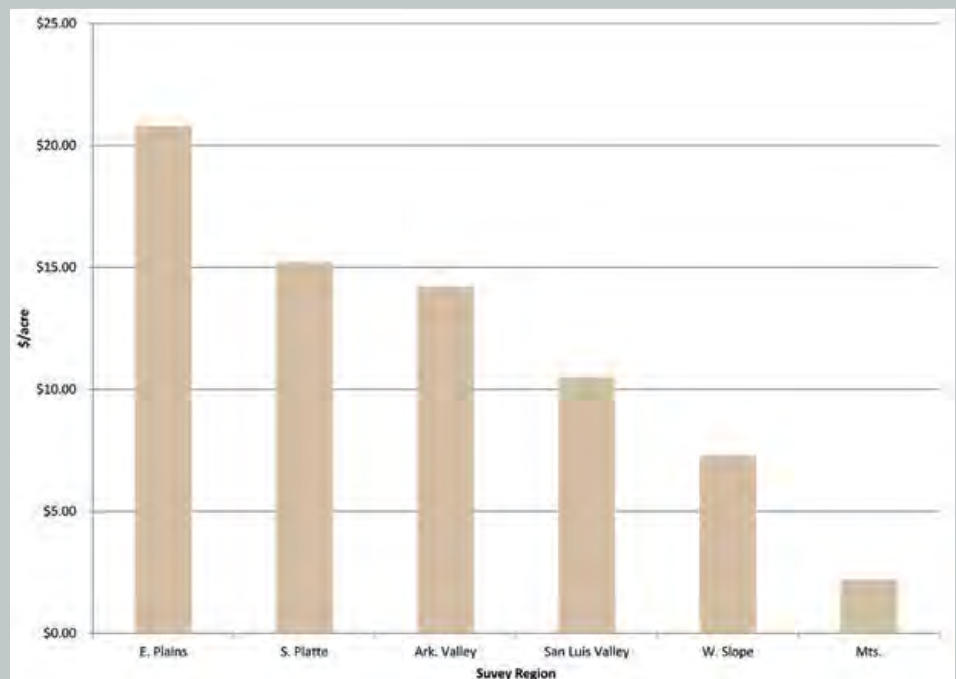

Figure 1. Average annual expenditures on nutrient management practices

university faculty during development. Survey questions focused on determining which BMPs producers were using to determine their nutrient rate, form, timing and placement. In addition, practices that are generally termed 'precision agriculture' were queried to better understand how producers are incorporating this new technology into their nutrient management. Producers were also asked about nutrient management practices that reduce off-field nutrient transport, recordkeeping and cost of BMP implementation.

The survey sample was drawn from farm operators utilizing 100 acres or more of irrigated land for production. The National Agricultural Statistics Service (NASS) stratified the sample of Colorado irrigators by county. Producer identities were anonymous to researchers at all times, as surveys were mailed directly to producers by NASS. In order to ensure a successful response rate, widely recognized survey design methodologies were followed. Surveys were initially mailed in February 2011, and later in March to those who did not respond

to the first mailing. Producers who did not complete and return the second mailing were contacted by the NASS call center to increase response rate.

The final overall response rate was 44.8 percent. To control for the diversity of cropping practices in Colorado, survey responses were grouped into six geographic regions based upon county. This regionalization also allows for comparison to regional data presented in previous Colorado surveys conducted in 1997 and 2002. A few highlights of the survey are provided in the following table and figure. A complete report will be published in a CWI bulletin soon.

Among the sampled producers, certain BMPs, such as soil testing in the E. Plains and S. Platte regions showed very high adoption rates (Table 1). Results indicate that this basic BMP is well accepted by irrigating producers in these areas to help determine the correct amount and type of nutrient required to achieve high crop yields. In contrast, plant tissue testing is adopted at a

	Region of Colorado <sup>1</sup>					
	Ark. Valley	E. Plains	Mts.	S. Platte	San Luis Valley	W. Slope
Soil Test Analysis	41.1%	86.2%	21.2%	75.4%	50.0%	44.7%
Split Apply N <sup>2</sup>	46.3%	72.5%	2.5%	43.1%	38.7%	21.8%
Keep Written Records	32.1%	67.0%	26.3%	52.1%	49.1%	30.6%
Establish Yield Goals	30.4%	51.1%	14.1%	41.2%	30.6%	15.9%
Use Paid Crop Consultants for Advice	14.3%	47.9%	1.0%	22.8%	23.2%	1.9%
Deep Soil Test	12.5%	36.2%	0.0%	26.6%	18.6%	5.9%
Plant Tissue Samples	5.4%	22.3%	4.0%	12.3%	20.4%	4.7%
<sup>1</sup> Respondents were asked to indicate multiple management practices incorporated therefore response estimates calculated across region will not sum to 100.						
<sup>2</sup> Refers to applying N fertilizer in two or more doses, typically one of these is during the growing season to maximize efficiency						

Table 1. Percentage of respondents incorporating selected nutrient management practices

lower rate across all regions since the practice is typically limited to certain higher value crops. Record keeping, which is required to qualify in some USDA cost sharing programs, has been adopted at a rate of less than 50 percent in four of six regions. However, this is still a higher rate than reported in a previous survey. The percent of producers using paid crop consultants to determine fertilizer rates is highest in areas of higher value crops and where crop consultants are actively seeking clients.

Figure 1 shows expenses the respondents reported for costs to manage nutrients during the 2010 cropping season. These included nutrient management BMPs and other practices, such as conservation tillage, that prevent nutrient losses from fields. These costs varied among regions similar to patterns seen with BMP adoption, with the exception being the Arkansas Valley (figure 2). It is important to point out that many of these costs also

have benefits, such as improved yield or reduced fertilizer expenses, but others do not have net return for the producer. In many cases, cost-sharing programs from the USDA Natural Resources Conservation Service and other programs can help producers with these expenses and improve adoption.

A key result from this survey is that nutrient BMP adoption and expenditures on BMPs varies widely by region of the state. These differences are expected, as Colorado's irrigated farming regions are diverse in terms of crop and livestock systems utilized, irrigation systems and water sources, nutrient type and amount applied, input costs, and management styles. Additionally, crop landscapes vary from high altitude mountain hay meadows to intensive vegetable row crops in some river valleys. In general, nutrient BMP adoption is highest within the regions where fertilizer and manure nutrients are utilized more and in areas with higher value crops.

## Summary

Supplemental nutrients, particularly N and P, are critical components of highly productive, profitable irrigated agriculture and to meet the food intake requirements of an increasing global population. This study found that most of the Colorado producers who responded to our survey are implementing some level of nutrient management practices to enhance nutrient use efficiency and prevent losses from irrigated fields. The BMPs with higher rates of adoption tend to be those with lower costs or are cost neutral to the producer, while others may require incentive programs to achieve higher levels of adoption. Ultimately, the decision on whether to implement a BMP or suite of BMPs can only be made at the local watershed scale, incorporating local knowledge of field conditions and cropping systems.

Contact Troy Bauder, Extension Specialist 970-491-4923.  
[Troy.Bauder@colostate.edu](mailto:Troy.Bauder@colostate.edu)



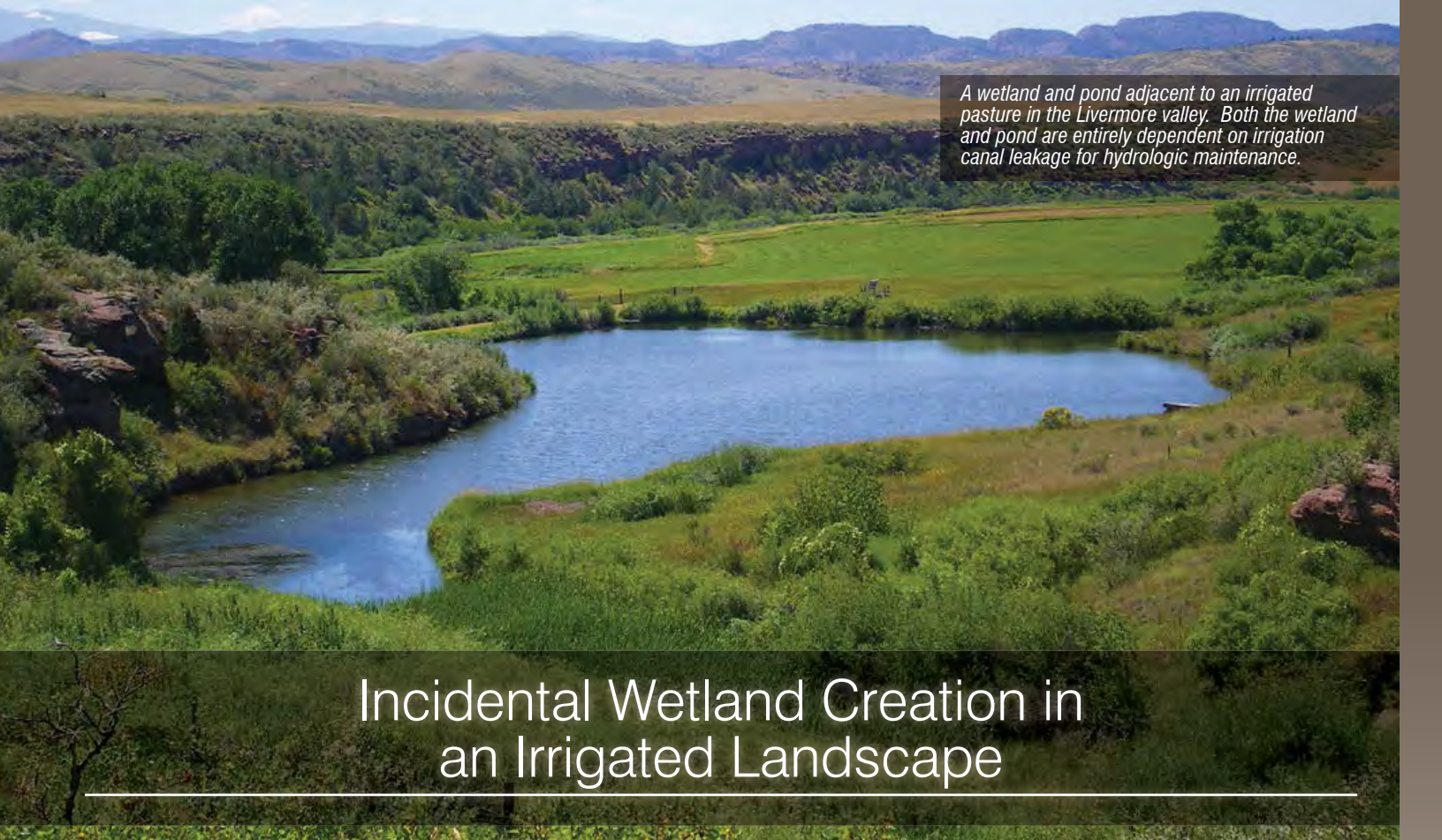

A wetland and pond adjacent to an irrigated pasture in the Livermore valley. Both the wetland and pond are entirely dependent on irrigation canal leakage for hydrologic maintenance.

# Incidental Wetland Creation in an Irrigated Landscape



Jeremy Sueltenfuss, MS Candidate, Ecology, Colorado State University  
Faculty Advisors: Rick Knight, Reagan Waskom, and David Cooper

## Introduction

Agricultural productivity in the semi-arid American West has relied on irrigation for centuries. Early irrigation efforts were often located in floodplains adjacent to rivers and utilized small, hand dug canals to irrigate pastures (Morgan 1993). As larger areas of land were settled, canals became larger and longer, and transported water to uplands far from the original water source. Irrigated land in the West has continued to expand from three million hectares (ha) in 1900 (Pisani 2002) to over 17 million ha of irrigated land today (Golleson and Quinby 2000).

Irrigation canals across the American West are known to have water losses up to 50 percent due to leakage (Luckey and Cannia 2006). Though the negative impacts of water diversions on rivers are well

documented (Strange et al. 1999), the environmental changes created by irrigation canal leakage remain understudied. Although some authors have suggested a direct competition for water between irrigated agriculture and wetland ecosystems (Lemly et al. 2000), others have mentioned the possibility of canal leakage creating and maintaining wetland and riparian habitat (Kendy 2006).

Wetlands are an important part of a landscape, yet estimates of historical wetland loss due to river diversions and land conversion in some western states range between 50 and 90 percent (Yuhus 1996). Because wetlands provide habitat to a disproportionate number of animal species and perform essential ecosystem services related to water quantity and quality (Zedler 2003), understanding the influence of irrigation canals on the hydrologic regime of wetlands is necessary for future water planning

and wetland conservation. The present study sought to answer the following questions: (i) Are there hydrologic processes linking canals and reservoirs to wetlands, and (ii) What types of wetlands are supported by irrigation canals?

## Study Area

North Poudre Irrigation Company (NPIC) is one of many irrigation water delivery companies in northern Colorado. Located in the South Platte River Basin on the plains and foothills north of Fort Collins, Colorado, NPIC has a total service area of 23,300 ha and delivers water to 9,700 ha of irrigated land utilizing 16 holding reservoirs and approximately 250 km of canals (Figure 1), 89 percent of which are unlined earthen canals that have been in place for over a century. Water diverted from the North Fork and main stem of the Cache la Poudre River is transported through



the canal system from April through September to upland areas away from river corridors. In 2010, NPIC diverted approximately 89,400 acre feet, 45 percent of which was lost to evaporation and canal seepage (pers. comm. NPIC manager). Previously measured NPIC canal water losses range from zero percent to 50 percent per canal (Riverside Technology, Inc. 2005).

## Methods

### Wetland Mapping

Wetlands were mapped using National Wetland Inventory maps from 1975 and were refined using aerial images in ArcMap 10. The hydrologic source of each mapped wetland was visually determined with aerial photographs by tracing surface water flow paths or subsurface flow paths as detected by increased primary productivity back to a source.

Vegetation was characterized using aerial images for every wetland in the study area. Because aerial images were not precise enough to identify vegetation to the species level, vegetation was separated into three broader categories: “Marsh” communities visible in the image as tall, dense stands of *Typha latifolia*, “Meadow” communities visible as shorter stands of sedges such as *Carex*

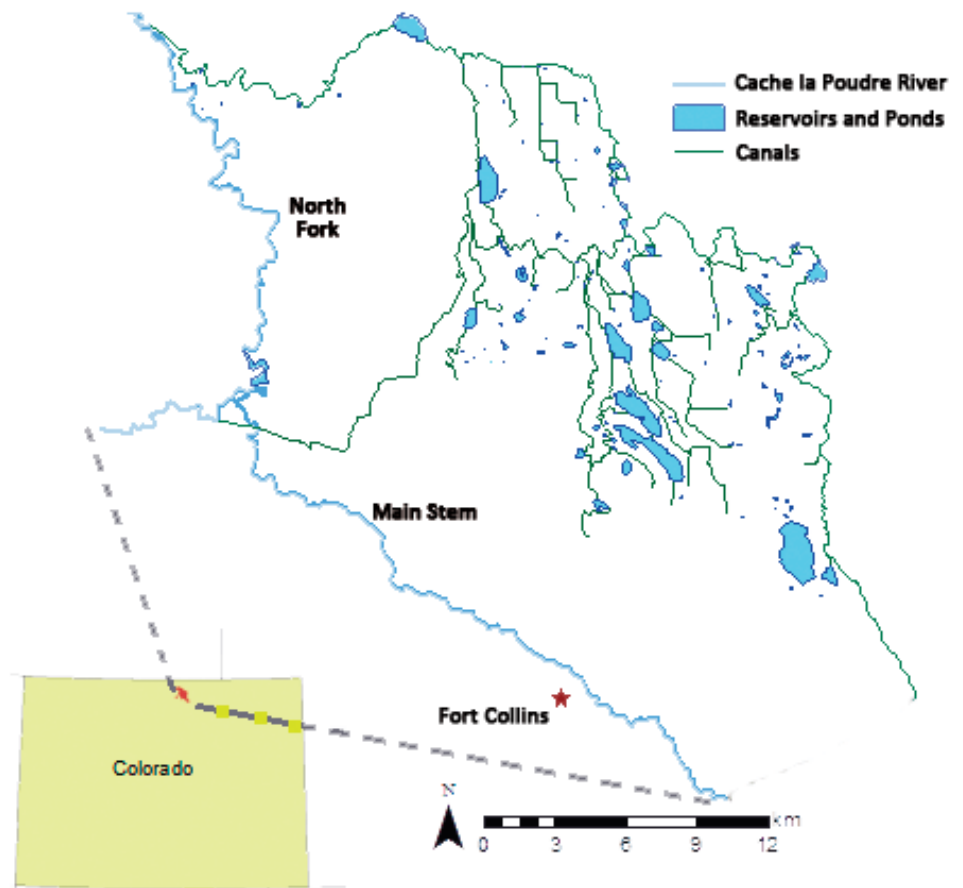

Figure 1. Study area map of North Poudre Irrigation Company canals and reservoirs adjacent to the Cache la Poudre River in northern Colorado.

*spp.*, and “Salt flats” visible due to the presence of white salt on the land surface with sparse vegetation such as *Atriplex spp.*

### Wetland Hydrology

A total of 70 monitoring wells were installed in 20 wetlands throughout the NPIC service area. Wells were dug to approximately one meter

depth, cased with 1.5 inches schedule 40 PVC pipe with holes drilled approximately every five centimeters and backfilled with native soil. Water tables were measured approximately every two weeks from May through November 2011. Pressure transducers (In-Situ Rugged Troll 100) were installed in six monitoring wells to record hourly water table depths. Wetland water table fluctuations were compared to both daily canal flow and precipitation. Daily canal flow was estimated from daily irrigation order records from NPIC customers along each canal. Precipitation data were collected from six precipitation stations in the Community Collaborative Rain, Hail & Snow Network ([www.cocorahs.org](http://www.cocorahs.org)).

## Results

### Wetland Mapping

A total of 176 wetlands covering 652.3 ha were mapped within the NPIC



Aerial image of an irrigation canal transporting water across a semi-arid landscape. Various points of water leakage in the canal lead to the flow of water down the landscape, converging to create wetland habitat in topographic depressions.



boundary. Of these, 56 wetlands covering 173.7 ha were associated with irrigation canal leakage (Table 1). According to previously measured canal water loss data, 50.6 percent of canals had high percent water loss greater than 17 percent, 36.5 percent of canals had moderate water loss between seven percent and 17 percent, and 12.8 percent of canals had low water loss less than seven percent. The majority of wetlands associated with canals were below high water loss canals with percent water losses greater than 17 percent. Along with canal seepage, seepage from pond and reservoir dams was a major hydrologic source for wetlands, sustaining 52 wetlands totaling 186.7 ha. Within the study area, agricultural water storage, conveyance losses, and application were visually attributable for 89 percent of the number of wetlands, and 92 percent of the total wetland area.

Within the study area, 43 percent (279 ha) of the wetland vegetation was marsh, 40 percent (263 ha) meadow, and 17 percent (111 ha) salt flats.

### Wetland Hydrology

Wetland water table depths adjacent to canals with high water loss were heavily influenced by changes in canal flow (Table 2). The highest wetland water table depth change recorded

from when a canal was flowing to when it stopped flowing was 131.4 cm. The Buckeye Main canal recorded the highest flows through the irrigation season, and its interaction with an adjacent wetland serves as an example consistent with most instrumented wetlands. Groundwater levels in this wetland immediately adjacent to the Buckeye Main canal increased as canal flow increased throughout the summer. Once the canal stopped transporting water in the fall, the water table in the wetland declined by 60 cm (Figure 2), with very little response to precipitation throughout the year. The trend of decreasing wetland water tables following the drying of irrigation canals was seen in the majority of instrumented wetlands.

### Discussion

The functions of agricultural ditches running through areas already saturated and those traveling across arid land are fundamentally different. For already saturated land, ditches are used to lower water tables and manipulate them for the benefit of crops, often leading to a decline in wetland area (Krause et al. 2007). In arid and semi-arid regions, ditches are used to convey water from river corridors, groundwater pumping stations, and reservoirs to uplands

where it is applied to arid lands. Although intended to irrigate arid lands to produce livestock forage and crops, not all diverted water is consumptively used by plants (Fernald et al. 2010). As seen in this study, excess water that leaks from canals and dams, as well as the over-application of water to fields, creates a large amount of wetlands on previously arid land.

The transport of water from streams and reservoirs in irrigation canals and ditches, some with seepage rates exceeding 50 percent, and the excessive amount of water applied to some irrigated fields has resulted in the unintentional creation of a wide range of wetland types in this study area, and likely in many parts of the western U.S. as well. Though some authors suggest that competition for water occurs between wetlands and agriculture (Lemly et al. 2000), irrigated agriculture appears to have played an important role in the redistribution of water and the creation and maintenance of a large proportion of the total wetland area in many western landscapes (Peck et al. 2001).

Non-riparian wetlands have groundwater as a primary water source (Mitsch and Gosselink 2000) and are generally independent of precipitation in arid regions (Laubhan

Table 1. Census of mapped wetland attributes corresponding to their hydrologic source. Canals are separated by percent water loss as previously measured from Riverside, Inc. The number of wetlands, the total wetland area, and average wetland size are reported for each infrastructure category. "Intentional Water Delivery" refers to managed wetlands with water deliveries. The hydrologic source for 18 wetlands located below multiple irrigation canals could not be determined, and are reported as "unknown source, below canal." Only two wetlands were located above irrigation canals. "Tail water" refers to wetlands located at the low point of irrigated fields. "Pond/reservoir outlet" refers to wetlands downhill of ponds or reservoirs. "Reservoir Fringe" refers to wetlands along the banks of NPIC reservoirs.

Wetland hydrologic source	# Wetlands	Total Wetland Area (ha)	Average Wetland Size (ha)
<7% Loss Canal	3	7.1	2.4
7-17% Loss Canal	17	31.8	1.9
>17% Loss Canal	36	134.8	3.7
Intentional Water Delivery	12	98.5	8.2
Unknown Source, Below Canal	18	51.1	2.8
Above Canal	2	1.1	0.5
Tail Water	7	13.1	1.9
Pond/Reservoir Outlet	52	186.7	3.6
Reservoir Fringe	29	128.1	4.5

2004). Kendy et al. (2004) found that changes in groundwater had large impacts on wetland ecosystems. Canals may therefore act analogously to streams in arid regions, and influence or control water table position through the subsurface movement of water from the canal to surrounding areas (Francis et al. 2010). Because canal seepage can raise local water tables (Harvey and Sibray 2001), the current wetland distribution in many agricultural areas is likely a result of the location and functioning of the irrigation infrastructure (Kendy 2006).

Hydrologic regime is often identified as the key determinant of wetland structure and function (Mitsch and Gosselink 2000). This study has highlighted the importance of canal seepage in influencing the hydrologic regime of wetlands and its control over the types of wetlands in an agricultural landscape. Similar to previous accounts (Crifasi 2005) many wetlands in this study were found on hill slopes directly below irrigation canals and were dominated by wet meadow plant species, including members of the genera *Juncus* and *Carex*. Slope wetlands are often the first wetland type to be lost due to land use change (Skalbeck et al. 2008), but are thought to support high biodiversity (Stein et al. 2004), and may be some of the more resistant wetlands to future climate change (Winter 2000). Wetlands that have been created by irrigation water may be indistinguishable in form and floristic composition from wetlands with more natural water sources (Peck and Lovvorn 2001) and may provide greater ecosystem services due to their longer hydroperiods (Kendy 2006), such as biodiversity support (Rumble et al. 2004), flood abatement (Zedler 2003), and water quality improvements (Fennessy and Craft 2011). Lining canals, transferring irrigation water to cities, or altering

current irrigation practices in the name of increased efficiency could therefore have detrimental impacts on both wetland functions (Fernald and Guldan 2006) and biodiversity (DiNatale et al. 2008).

## Conclusions

Water in the American West is a limited resource, and its use is contentious between agriculture, growing municipalities, and the

environment. Though agricultural practices are often viewed as inefficient, large wetland complexes are maintained through seepage from canals, pond and reservoir dams, and tailwater from irrigated fields, as well as through interactions with shallow aquifers. Because water quality and biodiversity support are growing concerns in many landscapes, future work should focus on the functions and services of agricultural wetlands, as well comparisons between the

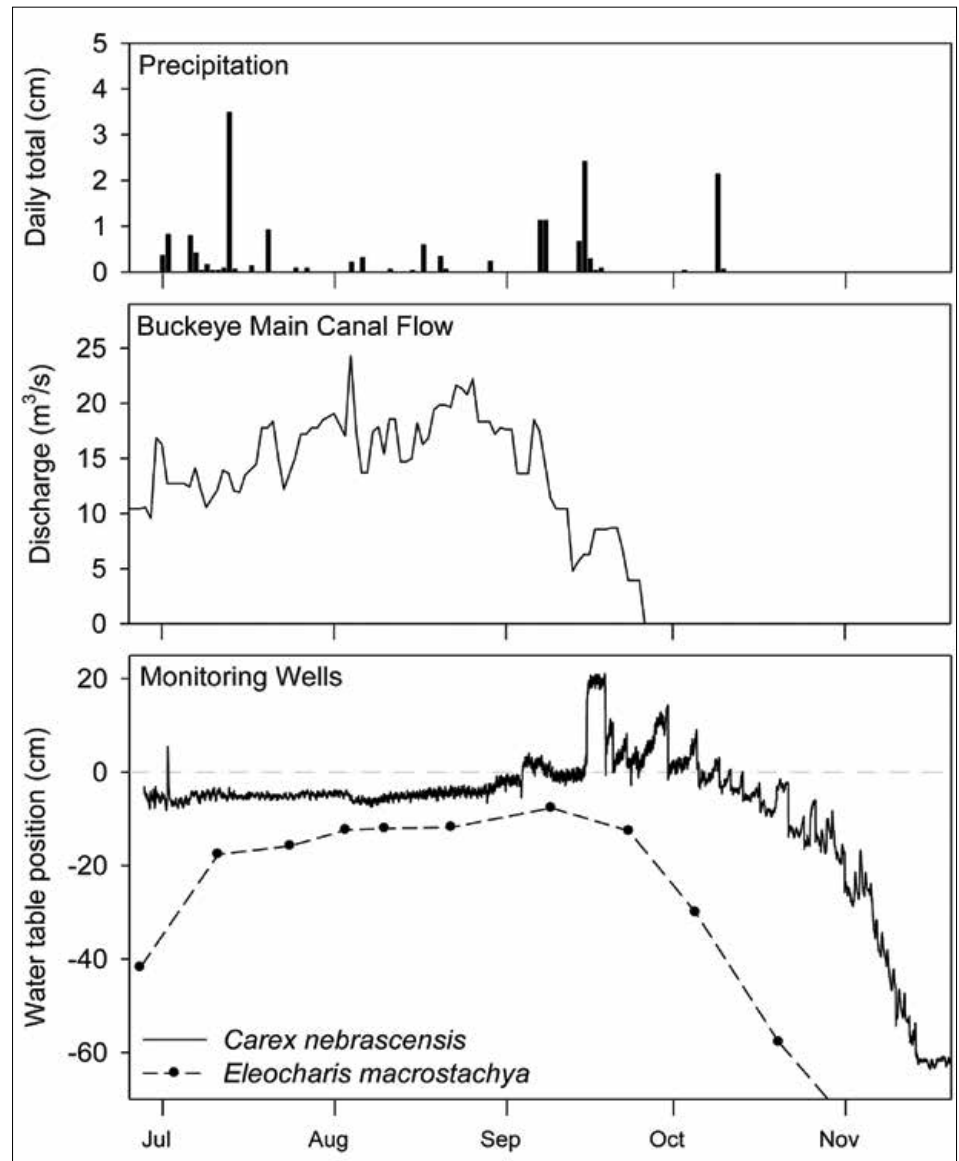

Figure 2. The effect of daily precipitation and adjacent canal flow on water tables from one wetland. Monitoring wells were located in two vegetation communities in a wetland adjacent to the Buckeye Main canal during the summer of 2011. The dominant plant species occurring at each well is used as that well's name. Water levels represent hourly data within a *Carex nebrascensis* community (solid line) and bi-weekly data within an *Eleocharis macrostachya* community (dashed line). Points along the dashed line represent specific measurements. A 50 day lag occurred between the declining flow in the canal and the declining groundwater level for the *C. nebrascensis* community, with a shorter lag for the *E. macrostachya* community.

Infrastructure Category	Category Amount	Instrumented Wetlands	
		Distance to Source (m)	Water Table Change (cm)
< 7% Loss Canal	32.2 km	13.5	83
	13% of total	135	50.6
7-17% Loss Canal	91.5 km	30.2	None
	36% of total	9.8	None
> 17% Loss Canal	127 km	41.7	None
	51% of total	16.6	103.6
		13.2	14.6
		10.3	12.4
		6.8	17.7
		10.7	51.3
		11.7	None
		50	131.4
		58.8	59.3
		23.9	102.7
		70	120.5
		15.7	52.7
Pond/Reservoir	1571.2 ha	16.4	None
	Surface area	20.8	None
		49.4	None

location of historic wetlands and those currently in existence. Water transfers and changing agricultural practices to increase water efficiency put existing wetlands at risk, necessitating an understanding of policy and management implications on agricultural wetland ecosystems. Current wetlands may only be as permanent as the irrigation practices that sustain them.

---

References available upon request.

*Table 2. Characteristics of NPIC canals and reservoirs as well as the instrumented wetlands associated with them. The length of each canal and the percent of total canals are reported for each canal percent loss category as well as the total surface area of ponds and reservoirs. Characteristics of the instrumented wetlands associated with each category include the distance to the associated category as well as the wetland water table response to the stopping of the adjacent canal flow. Note that most wetlands had changes in water table position in response to changes in canal flow.*

# Report on Arkansas River Valley Irrigation Available

The Colorado Water Institute (CWI) Completion Report 221, *Irrigation Practices, Water Consumption, & Return Flows in Colorado's Lower Arkansas River Valley: Field and Model Investigations*, has been released and made available (see below for more information). The report is based on field investigations taking place over the 2004-2008 growing seasons in the Lower Arkansas River Valley of Colorado. The study's main purpose was to describe and compare surface irrigation and sprinkler irrigation practices and their interaction with the larger stream-aquifer system of the Lower Arkansas River Valley. Primary funding came via grants from the Colorado Water Conservation Board, the Colorado Division of Water Resources, the Colorado Department of Public Health and Environment, the Southeastern Colorado Water Conservancy District, the Lower Arkansas Valley Water Conservancy District, and the Colorado Agricultural Experiment Station.

## Summary

*By Timothy K. Gates, Luis A. Garcia, Ryan A. Hemphill, Eric D. Morway, and Aymn Elhaddad*

The LARV in Colorado has a long history of rich agricultural production, but is facing the challenges of soil salinity and waterlogging from saline shallow groundwater tables, high concentrations of salts and minerals in the river and its tributaries, water lost to non-beneficial consumption, and competition from municipal water demands. Significant improvements to the irrigated stream-aquifer system are possible, but they are constrained by

the need to comply with the Arkansas River Compact. Making the best decisions about system improvements and ensuring compact compliance require thorough baseline data on irrigation practices in the LARV. This report summarizes the methods, analysis, results, and implications of an extensive irrigation monitoring study conducted by Colorado State University (CSU) during the 2004-2008 irrigation seasons in representative study regions upstream and downstream of John Martin Reservoir (referenced herein as Upstream and Downstream). A total of 61 fields (33 surface-irrigated, 28 sprinkler irrigated) were investigated. Results from 523 monitored irrigation events on these fields are presented. Data and modeling results from more extensive studies conducted by CSU between 1999 and 2008 also are provided.

Data on applied irrigation, field surface water runoff, precipitation, crop evapotranspiration (ET), irrigation water salinity, soil water salinity, depth and salinity of groundwater tables, upflux from shallow groundwater, crop yield, return flows to streams, and salt loads to streams are presented. Deep percolation and application efficiency for irrigation events on each field are estimated using a water balance method implemented within the CSU Integrated Decision Support Consumptive Use (IDSCU) Model. Tailwater runoff (surface water runoff at the end of a field) fraction ranges from zero to 69 percent on surface irrigated fields, averaging about eight percent, while deep percolation fraction ranges from zero to 90 percent, averaging about 24 percent. Application efficiency ranges from two to 100 percent on surface irrigated fields, with an average of about 68 percent. No significant

runoff is observed on sprinkler-irrigated fields, and estimated deep percolation typically is negligible. On sprinkler-irrigated fields average application efficiency is about 82 percent, but in many cases these fields are under-irrigated. Upflux from shallow groundwater tables below irrigated fields is estimated to average about six percent of crop ET, ranging between zero percent and 40 percent. Average measured total dissolved solids concentration of applied surface irrigation water is 532 mg/L Upstream and 1,154 mg/L Downstream. Average estimated salt load applied per surface irrigation event is 997 lb/acre Upstream and 2,480 lb/acre Downstream. Average estimated salt load applied per sprinkler irrigation event is 1,217 lb/acre Upstream and 446 lb/acre Downstream. Soil saturated paste electrical conductivity averaged over all Upstream fields ranges from 3.7-4.7 deciSeimens per meter (dS/m) over the monitored seasons and from 4.5-6.4 dS/m over Downstream fields. Water table depth averaged over Upstream fields varies from 7.8-12.1 feet over the monitored seasons and average specific conductance (EC) of groundwater varies from 1.8-2.3 dS/m. Water table depth averaged over Downstream fields varies from 12.6-15.0 feet with average EC from 2.3-3.0 dS/m. Analysis reveals trends of decreasing crop ET with increasing soil salinity on several investigated fields. Trends of decreasing relative crop yield with increasing soil salinity on corn and alfalfa fields also are detected.

Calibrated regional groundwater models indicate an average recharge rate to shallow groundwater of 0.10 in/day and 0.06 in/day over modeled irrigation seasons 1999-2007 Upstream and 2002-2007





## Irrigation Practices, Water Consumption, & Return Flows in Colorado's Lower Arkansas River Valley

Colorado  
State  
University

Field and Model Investigations

By Timothy K. Gates, Luis A. Garcia, Ryan A. Hemphill, Eric D. Morway, and Aymn Elhaddad

Completion Report No. 221

CAES Report No. TR12-10



Downstream, respectively. Upflux to non-beneficial ET in the regions is estimated to be about 26,000 ac-ft/year Upstream and 35,000 ac-ft/year Downstream, with an approximation for the entire LARV being 82,000 ac-ft/year. Average groundwater return flow rate to the Arkansas River within the Upstream and Downstream regions is estimated

as 30.9 ac-ft/day per mile and 12 ac-ft/day per mile along the river, respectively. Salt load in return flow to the river over the modeled years is estimated at about 93 tons/week per mile Upstream and about 62 tons/week per mile Downstream.

The significance and implications of these findings are discussed. Also, a number of specific questions of

concern to water managers and regulatory agencies are addressed.

*The full report will can be accessed at [www.cwi.colostate.edu](http://www.cwi.colostate.edu), or obtain a hard copy by contacting the Colorado Water Institute, E102 Engineering, 1033 Campus Delivery, Fort Collins, CO 80523-1033, 970-491-6308, or [cwi@colostate.edu](mailto:cwi@colostate.edu).*



# Guiding Landowners and Agencies Dealing with Domestic Energy Development in the Northern Plains and Mountains

*Julie Kallenberger, Assistant Regional Water Coordinator, Colorado Water Institute  
Troy Bauder, Water Quality Specialist, Department of Soil and Crop Sciences, Colorado State University  
Reagan Waskom, Director, Colorado Water Institute  
Jim Bauder, Professor Emeritus/Adjunct, Montana State University  
Ginger Paige, Professor, University of Wyoming*

As recently as a decade ago, the impacts of oil and natural gas development on water resources were mainly confined to issues related to off-shore drilling for oil, ruptured pipelines, and grounded oil tankers. Today, new terms, like coalbed methane (CBM), coal seam natural gas, and drilling and extraction practices, like horizontal drilling and fracking (formally known as hydraulic fracturing), are gaining a lot of attention, particularly in the Northern Plains and Mountains (NPM) Region. Much of this attention is due to better understanding of the potential for oil and gas resource development

to affect land and water resources by industry, society, and regulatory agencies.

Regarding the current thrust of unconventional oil and gas development in the NPM Region, landowners frequently voice concerns about whether fracking can or will contaminate their domestic water supplies. Irrigators wonder whether discharge of CBM-produced water will cause changes in irrigation water quality and regulatory, and governmental agencies need to know what values should be assigned to water quality parameters to assure protection of water resources.

The NPM Regional Water Program, a USDA sponsored partnership of six land-grant universities, initiated a project to help guide landowners and agencies dealing with the impacts of domestic energy development on their land and water supply. The activities performed in this project have led to the development of a widely-viewed informational video documentary, online educational tools, stakeholder forums, conferences, regional workshops, and productive collaborative partnerships among landowners, governmental agencies, and oil and gas companies.



*Sodicity and salinity impacts to corn crop irrigated with river water downstream of CBM discharge area.*

Photo by Troy Bauder, Colorado State University



## Advances in Oil and Gas Extraction Technologies and Impacts on Regional Water Supplies

In the mid-1990s, the natural gas industry developed efficient processes for locating and extracting CBM from shallow coal deposits throughout the Intermountain West. A significant increase in natural gas prices prompted the drilling and development of nearly 31,000 CBM wells in the NPM Region by 2010. Concurrently, the increase in crude oil prices prompted expanded exploration and drilling for oil and natural gas reserves. This expanded drilling was complemented by new drilling techniques and improved methods for withdrawing natural gas and crude oil from underground oil reserves.

The two most noteworthy advances have been horizontal drilling and improved hydraulic fracturing, a process whereby industry-proprietary chemicals, mixed with large volumes of water and sand, are injected into underground geologic formations to open and expand pores and channels so that oil and gas can more readily flow to the well cavity. Additionally driving the oil and gas development industry has been the discovery of large, prolific oil and gas reserves contained in the Niobrara and Bakken shale deposits, underlying southeast Wyoming, northeast Colorado, northeast Montana, and northwest North Dakota. Extraction of CBM requires pumping and disposing of often large volumes of water from coalbeds. This water ranges in quality from nearly fresh to brackish and saline. Pumping and discharge of water from CBM operations onto the landscape and into storage impoundments and rivers has increased dramatically in the past decade.

The discharge and disposal of CBM produced water was found to alter the

quality of some streams, rivers, and groundwater. Research has documented that CBM production water can often negatively alter soil properties as well. Each of these circumstances can pose a threat to the quality of water used for irrigation, livestock watering, range land, and aquatic habitat sustainability. Additionally, severance of mineral rights from surface rights often means that landowners, whether dealing with CBM or unconventional oil/gas drilling, have little control over drilling operations and must rely on surface use agreements and negotiations with gas and oil production companies to guide operations on the landscape.

### Educational Resources

The NPM Regional Water Team responded to needs of landowners, concerned citizens, and governmental agencies and administrations by:

- Researching impacts of CBM produced water discharges on irrigation water quality and management alternatives on semi-arid landscapes and irrigation water
- Developing educational resources for landowners, regulatory and natural resource management agency personnel, litigants, attorneys, consultants, scientists, students, the media, educators, and policy makers
- Transferring science-based information to the general public, media, landowners potentially impacted by CBM extraction, and other decision makers



Sampling CBM discharge water in the Raton Basin of Colorado.  
Photo by Troy Bauder, Colorado State University

The team and their partners developed a *Land & Water Inventory Guide for Landowners in Areas of CBM Development* which has been used to educate landowners concerning CBM issues and assist with monitoring and assessment of impacts to land and water resources. Team members also produced *Prairies and Pipelines*, a public television documentary that addresses the science and social issues behind CBM recovery and associated water management. Also, inquiries from private well owners, Extension field staff, and EPA Region 8 staff prompted the development of a comprehensive website on the hydraulic fracturing extraction processes and potential implications for water resources. This website provides information about drilling and hydraulic fracturing techniques, water quality testing, surface use agreements, perspectives on water quality and quantity, and potential health issues related to hydraulic fracturing.

For additional information about the NPM Regional Water Program and these resources please visit [www.region8water.org](http://www.region8water.org) and <http://waterquality.montana.edu/docs/methane.shtml>.

# Paleohydrology of the Lower Colorado River Basin and Implications for Water Supply Availability

Jeff Lukas, Western Water Assessment, University of Colorado

Lisa Wade<sup>1</sup>, Department of Civil and Environmental Engineering, University of Colorado

Balaji Rajagopalan, Department of Civil and Environmental Engineering, University of Colorado

## Introduction

As the annual demand on the Colorado River system approaches the annual supply, the contribution from the Lower Colorado River Basin (LCRB)—on average about 15 percent of total system flows—becomes more critical. In fall 2010, our research team began a project to develop new paleo-reconstructions of LCRB hydrologic variability from tree-ring records, and incorporate them into an assessment of water supply risk for the Colorado River Basin. This project was primarily motivated by the interests of the Colorado River District, which is responsible for the conservation, use, protection, and development of Colorado's apportionment of the Colorado River. The project was carried out with funding from the Colorado Water Institute, the Colorado River District, the Western Water Assessment, and graduate student support from the Department of Civil and Environmental Engineering, University of Colorado.

The general framework of the project was to (1) develop naturalized flow records for the Gila and non-Gila subbasins of the LCRB (Figure 1); (2) compile existing tree-ring data for the LCRB (described in the April 2011 article); (3) generate tree-ring reconstructions of streamflow using multiple methods; and (4) use the reconstructions to inform improved system risk modeling of the entire Colorado River Basin. A previous article for Colorado Water (April 2011) described in some detail the context, objectives, and methods of

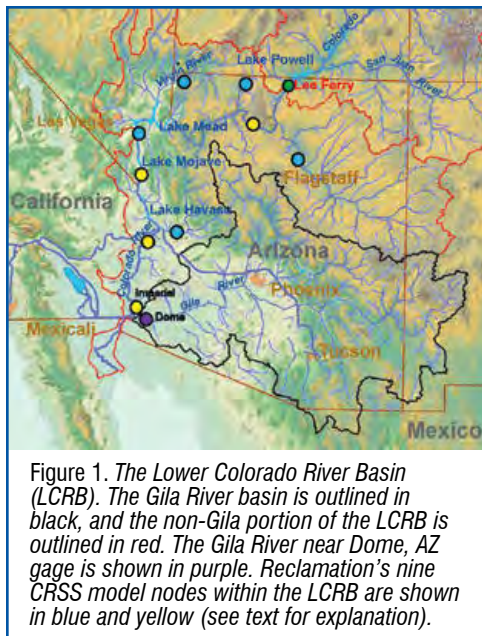

the project, so we will not repeat that information here.

## Results

The results for the main components of the project are described below.

*Analyses of gaged flows in the LCRB and development or selection of naturalized annual flow records for the historic period (~1906 to present) to use as targets for the paleohydrologic reconstructions for these two locations:*

- *The flow for the Gila River near its confluence with the Colorado*
- *The intervening flow on the Colorado River between Lee Ferry and Imperial Dam*

The hydrology of the Gila River is almost entirely modified by reservoir operations and depletions before it joins the Colorado River, and these modifications began in the

first decade of the 1900s (Figure 2). Several headwater gages on the mainstem Gila and its major tributaries (Salt River, Verde River, Tonto Creek) are above the dams, and most diversions and remain mainly natural (Figure 2). In 1946, the Bureau of Reclamation developed estimates of natural flow at gages downstream of the dams and diversions, including Dome, Arizona (the closest gage to the mouth), for the period 1897–1943. After extensive analysis of the gaged records for the Gila River Basin, we developed a local polynomial regression model between the Bureau of Reclamation-estimated naturalized flow at Dome for the 1897–1943 period and the near-natural gaged flows at the headwater gages. The modeled estimated natural flows for the Gila near Dome cover the period 1915–2010. We also retained the gaged flows at Dome as a calibration series since they represent the inputs to the Colorado from the Gila under current managed conditions and are more relevant for the system risk modeling as we implemented it.

The naturalized intervening flow on the Colorado River between Lee Ferry and Imperial Dam proved to be an elusive quantity. Reclamation maintains a natural flow dataset of the Colorado River and major tributaries (see Figure 1) for the 29 input nodes for their Colorado River Simulation System (CRSS) model, but for the nine nodes in the LCRB, these flows have not been explicitly naturalized, and some may contain artifacts of the water-balance modeling used to reconcile the total flows entering the

<sup>1</sup> Current affiliation: Riverside Technology, Inc., Fort Collins



top of the LCRB with those gaged at the bottom (Imperial Dam). In fact, we discovered that of the nine LCRB nodes, flows from 1906–2008 at five of the nodes (shown in blue in Figure 1) were well-correlated with observed precipitation and streamflow in adjacent basins, while the flows at the other four nodes (shown in yellow) were essentially uncorrelated with observed hydroclimate. We found also that the total flows at the five “good” nodes were well-correlated with flows simulated by Reclamation using the VIC hydrology model. Thus, we retained only the flows at the five good nodes to represent the Lee Ferry to Imperial reach, for calibration with the tree-ring data, recognizing that the magnitudes of the total flow at all nine nodes will require further investigation. Reclamation engineers have indicated to us that as a followup to the Colorado River Basin Study, they will revisit their natural flows data for the LCRB.

*Generation and evaluation of tree-ring reconstructions for Gila flows and the mainstem intervening flows using multiple methods*

Tree-ring paleohydrologic reconstructions have been generated using many different statistical approaches, all of which have particular strengths and weaknesses. The most common approach has been multiple linear regression (MLR); thus, to establish a baseline for comparison with new approaches, we used two variants of forward-stepwise MLR, with and without Principal Components Analysis (PCA). We also used Lowess regression, which uses a smoothed-and-fitted-curve relationship instead of a linear relationship, and a recently-developed non-parametric K-nearest-neighbors (K-NN) method.

We also implemented two new statistical methods for tree-ring reconstruction of streamflow. For the first method, Local Poly, we employed

a cluster analysis on our regional network of tree-ring chronologies to identify spatially coherent subregions that have a common climate signal, then performed PCA on the clusters to obtain the main modes of variability. The main modes are used as predictors in a local polynomial model, within a Generalized Linear Model (GLM) framework, fit to the observed natural streamflows. This approach is similar to the K-NN resampling method but has the ability to produce flows beyond the range of the observed data while also capturing non-linearities. The second method introduces the extreme value analysis (EVA) peaks-over-threshold (POT) method to tree-ring reconstructions of streamflow. The EVA-POT models the probability of threshold exceedance, and the magnitude of exceedances, and is especially suited for reconstructing intermittent streamflow, such the gaged flows at the mouth of the Gila River.

The tree-ring reconstructions of Gila River natural flows using five different methods explain between 41 percent and 61 percent of the variance, respectively, in the observed flows. They all capture the low flows better than the high flows, as is typical for tree-ring reconstructions, and they track each other very well both during the observed period (Figure 2) and the longer

paleo-period (Figure 3), testifying that the underlying tree-ring information is robust to the statistical method used. The Local Poly and Lowess methods are able to express larger magnitudes in high-flow years than the MLR reconstructions. Across the methods, mean reconstructed flows are generally lower before 1900 than after 1900, and the 20th century also appears to be anomalous compared to preceding three centuries in having two multidecadal wet periods. We used three methods to reconstruct the mainstem Colorado River intervening flow, with lower explained variance (37 percent–52 percent) than with the Gila, probably reflecting the aforementioned issues with the observed natural flow record used to calibrate the reconstructions. As with the Gila, the mainstem low flows are reconstructed more accurately than the high flows.

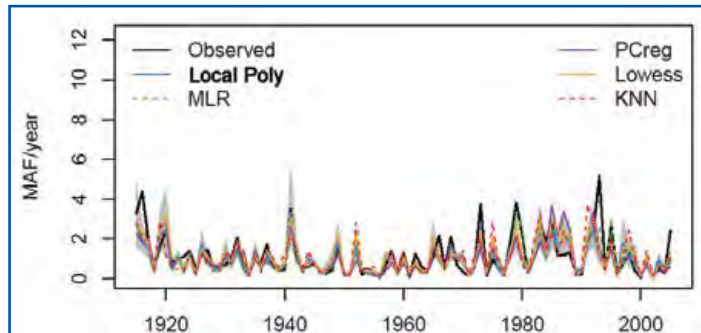

Figure 2. Five different methods for tree-ring reconstruction of natural annual streamflows (1915–2005; colored lines) for the Gila River near Dome, AZ, compared with the estimated natural streamflows (“Observed”). The “Local Poly” model (blue line) also has gray shading showing the five and 95 percent confidence intervals around that reconstruction.

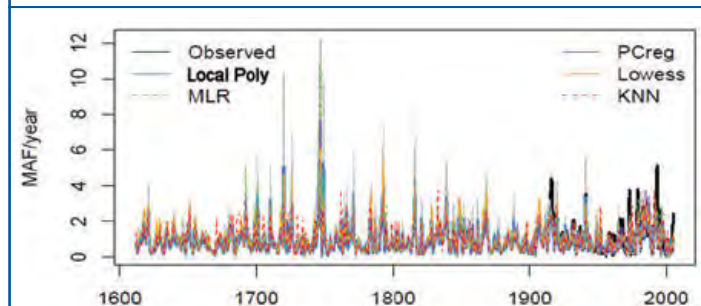
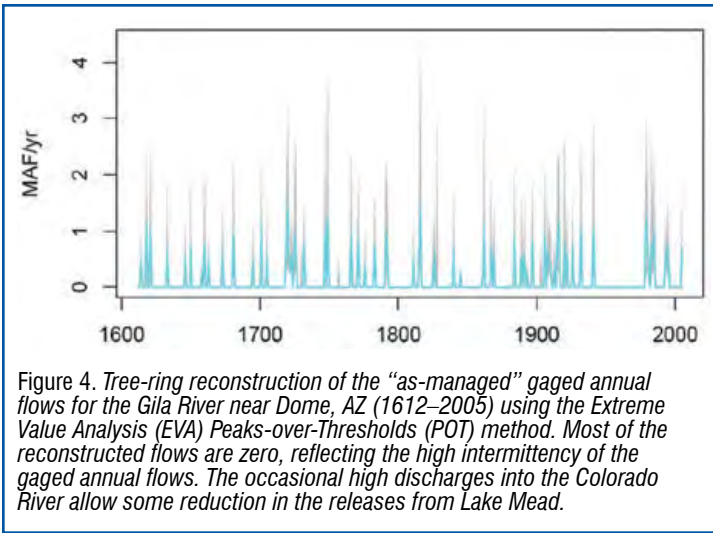

Figure 3. Same as Figure 2, but showing the full common length (1612–2005) of the five tree-ring reconstructions of natural flows for the Gila River near Dome, AZ. Note that the reconstructions show several annual flows higher than any observed flow, and that the 1900s were unusual in having two sustained wet periods.



The EVA reconstruction of the gaged Gila River flow shows that highly intermittent annual flow series, with above-zero flows in less than half of all years, can be effectively reconstructed using tree rings (Figure 4). Note the dense cluster of high flows in the early 20th century compared to the preceding 300 years. In total, these new reconstructions for the LCRB also demonstrate that long-term hydrologic variability in the LCRB is different enough from the variability in the Upper Colorado River Basin to justify including the former in system risk assessment as a complement to the latter.

*Performed system response analysis using the new LCRB reconstructions as input to a modification of the Rajagopalan et al. water-balance “bathtub” model of the Colorado River Basin*

The water-balance model is simple yet representative of the water resources system in the basin, and has been previously used to investigate the risk of active system storage (60 million acre-feet; MAF) being depleted under different scenarios. For this project, the model setup was modified to so that variability in LCRB flow was consistent with the new paleo-reconstructions, and so that periodic inflows from the Gila River could serve to reduce the releases needed from Lake Mead. As in a previous

study, the water-balance model was driven by natural variability alone and with two climate change scenarios (progressive flow reductions), under two different reservoir operation rules and demand management

alternatives, for a total of 12 scenarios.

We found that the periodic Gila River discharges do provide measurable mitigation of water supply risk. They reduce the Colorado River system risk slightly under all scenarios. Figure 5 shows the evolution of cumulative probability of storage depletion by 2057 for four of the 12 scenarios, and the difference when each scenario is run with and without the Gila River inflows. Furthermore, including the Gila reduces the average shortage volume per year, increases the storage volume in the system, and reduces the average number of shortages. An important caveat is that the modeling assumed that 100 percent of the Gila

River inflows (up to 1.5 MAF/year, the delivery obligation to Mexico) can be used to reduce Lake Mead releases. In practice, due to flow timing and water quality issues, the substitution achieved has been much less than 100 percent. But the modeling result points to the potential for more deliberate management of Gila inflows to reduce system risk.

## Summary

The project was successful in its objectives of (1) robustly representing the long-term hydrologic variability of the LCRB using multiple statistical methods, including two promising new approaches, and (2) incorporating that variability into Colorado River Basin system risk modeling. We have found that the variability of LCRB flows does matter to the system, and that in particular the Gila River can have a measurable impact on system risk due to its periodic, significant discharges into the mainstem. Potential follow-up work could be focused two different tracks: improving the estimates of natural flows for both the Gila and the LCRB mainstem, and investigating the feasibility of actively managing Gila River inflows for risk reduction.

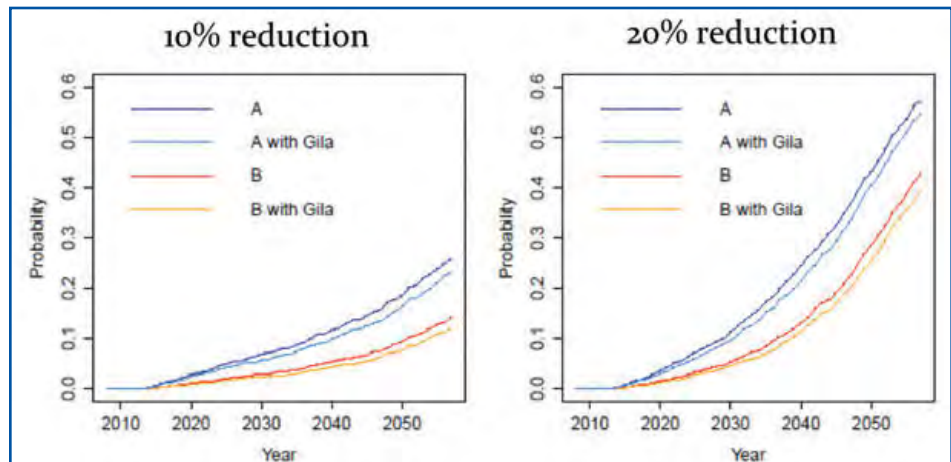

Figure 5. Probability of depletion of aggregate Colorado River Basin system storage, as modeled under four scenarios: reduction in flows of 10 percent (left panel) or 20 percent (right panel) by 2057 due to climate change; (A) the current (2007) policy for implementing Lower Basin shortages or (B) a more aggressive policy for implementing shortages; and (all scenarios) basin demands increasing per Reclamation projections from the 2007 EIS. Each scenario was then run with and without periodic Gila inflows. In all four scenarios, the Gila inflows measurably reduce overall system risk.



# Mapping Irrigated Agriculture in the Colorado River Basin

Melinda Laituri, Department of Ecosystem Science and Sustainability, Colorado State University  
Faith Sternlieb, Research Associate, Colorado Water Institute

The Geospatial Centroid at Colorado State University (CSU) ([gis.colostate.edu](http://gis.colostate.edu)) was funded by The Nature Conservancy (TNC) to develop a geospatial database of existing irrigated agriculture in the Colorado River Basin (CRB). The CRB includes 246,000 square miles that produce 15 percent of the nation's crops from approximately 1.8 million acres of irrigated agriculture—a key component of consumptive use. This project has run in parallel with other CRB projects. The Environmental Defense Fund funded the Agricultural Water Governance Mapping project, and the U.S. Department of Agriculture funded a research project on agricultural water, both of which are described in this issue. We are exploring ways to integrate the entire suite of publicly available data collected from these projects into a singular dataset with the long term aim of delivering the data online. Such a dataset is unique in that data from multiple sources (i.e., U.S. Bureau of Reclamation [USBR], U.S. Geological Survey [USGS], National Agricultural Statistics Service, and agricultural water supply organizations of all basin states) and multiple themes, such as governance, agricultural lands, and hydrology, will be collected and organized to create a value-added dataset of the CRB.

The objective for the TNC project was to create comprehensive spatial coverage depicting the extent of irrigated agriculture, to uniformly map irrigated crops using existing data from the USBR, and to identify gaps in the spatial data. The database produced for this report juxtaposes the extent of irrigated agriculture across the landscape with the size and extent of the entire CRB.

Table 1. Existing data collected for CRB Irrigated Agriculture mapping. Refer to *Demonstration Mapping for Increasing Agricultural Water Security across the Colorado River Basin, January 2012*, prepared for The Nature Conservancy by Ownby and Laituri for metadata.

Data	Source	Year
Upper Colorado River Basin Consumptive Use and Loss Data: Irrigation by Status and Type <sup>1</sup>	Bureau of Reclamation	Five year reporting cycles: 1990 – 1995 <sup>2</sup> 1996 – 2000 2001 – 2005
Irrigated Parcels from Division 4 (Gunnison), Division 5 (Colorado), Division 6 (Yampa/White), Division 7 (San Juan/Dolores)	Colorado Decision Support System	2005
Lower Colorado River Basin Consumptive Use and Loss Data: Crops (by season) <sup>3</sup>	Bureau of Reclamation	2005
Cropland Data Layer <sup>4</sup>	USDA - NASS	2010
Salinity Control Projects (Colorado only)	Bureau of Reclamation	2009
Salinity thresholds Irrigated Agriculture	SPARROW <sup>5</sup>	2009
303d listed streams	Environmental Protection Agency	2008
Selenium Areas <sup>6</sup>	USGS	1999

<sup>1</sup> Irrigation is mapped according to status or type in the UCRB. Status refers to lands that are fallow or irrigated. Irrigation type refers to general type: flood, sprinkler, or unknown. The BoR has generated or obtained new irrigated crop acreage estimates for all UCRB states for at least one year within each 5-year reporting period.

<sup>2</sup> The 1990-1995 irrigated crop layer was an early effort to map irrigation using a consistent methodology across the UCRB. Since then, BoR has produced crop maps of only portions of the UCRB that have not been mapped by their respective states.

<sup>3</sup> The Lower Colorado River Accounting System (LCRAS) is used to inform the CUL reports and was developed to refine estimates of agricultural consumptive use, based on ET and water balance. A GIS database is developed from the processing and interpretation of remotely sensed data. In addition, BoR collects ground reference survey data for approximately 12% of irrigated fields in study area, selecting survey sites in each major irrigated area.

<sup>4</sup> The CDL does not include irrigation or seasonal information explicitly.

<sup>5</sup> The 2009 dissolved-solids SPARROW (Spatially Referenced Regressions on Watershed Attributes) model was developed for the Upper CRB as a spatially explicit estimation of salinity loading. The current SPARROW model uses the 1991 climate year and the BoR 1990-1995 extent of irrigated lands layer.

<sup>6</sup> Selenium pollution data are from the USGS report – Areas Susceptible to Irrigation-Induced Selenium Contamination of Water and Biota in the Western United States.

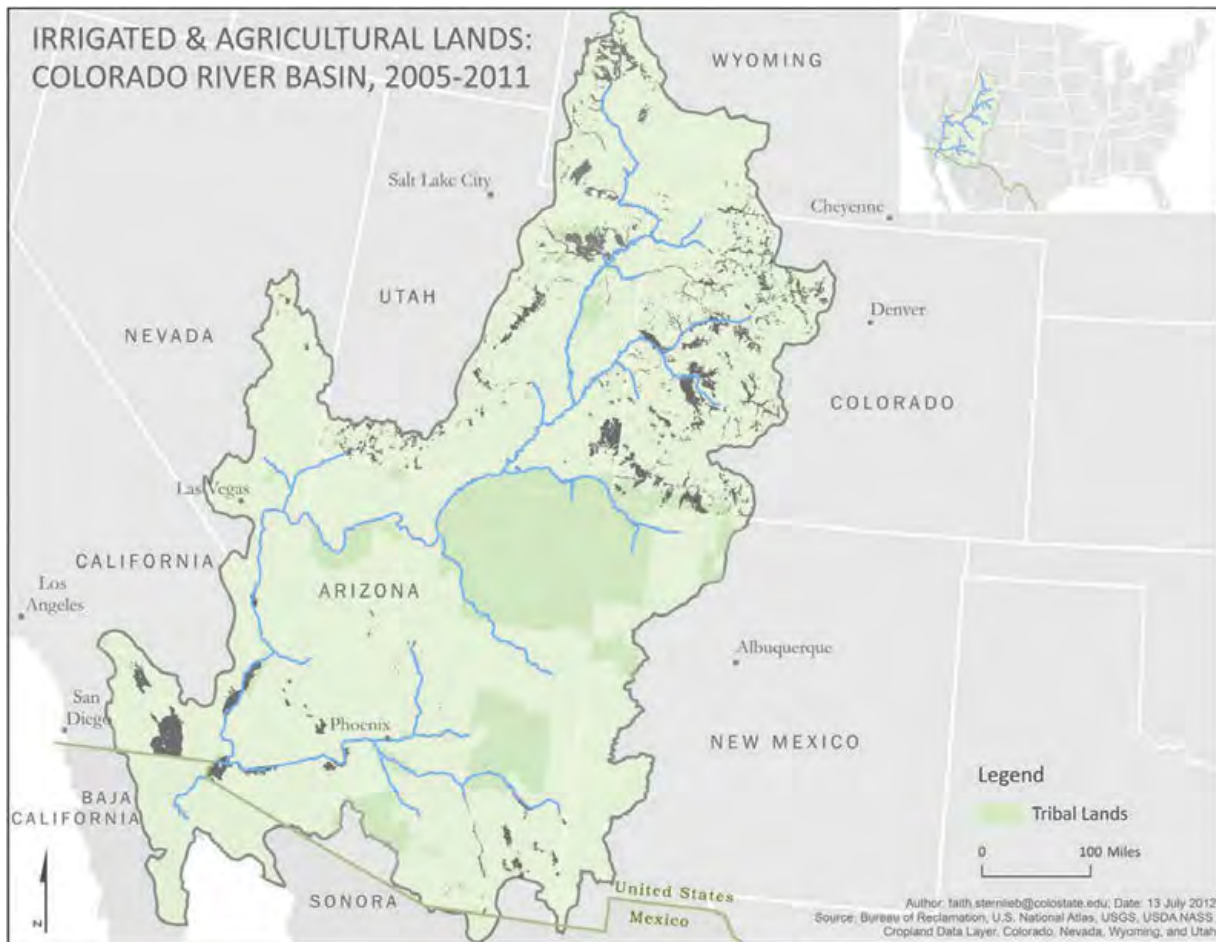

Figure 1. Irrigated and agricultural lands of CRB, including the extent of both irrigated and dryland agriculture based on additional data collected from 2011.

The database is made up of the following data derived from multiple sources. Base layers downloaded from the National Atlas include the Colorado River and its tributaries, the USBR management boundary, the boundary between the Upper and Lower Colorado river basins, state and county boundaries, and eight digit hydrologic units obtained from the USGS National Water Information System. A spatial and temporal database (Table 1) was created of digital data (1990-2005) provided by the USBR using the Consumptive Uses and Losses Reports (CULRs) in the Upper Colorado River Basin (UCRB). Spatial data were also provided by the USBR of irrigation for the lower main stem of the Colorado River. These data layers were compared with other data from USDA—Cropland Data Layer (CDL) and data from the Colorado Water Conservation Board’s Colorado Decision Support System (CDSS). Additionally, USGS salinity

and USBR selenium data for the Upper Colorado River Basin (UCRB) were examined. The EPA’s 303d listed streams were also incorporated into the database.

The products created from this research include both a query-able ArcGIS geodatabase and an interactive set of PDF maps. In May, a workshop at CSU utilized the projection-based Google Liquid Galaxy (<http://lib.colostate.edu/services/computers/google-liquid-galaxy>) to present the results to TNC, USGS, the Environmental Defense Fund, and CSU. Since completion of this project, additional agricultural information has been added that encompasses dryland agriculture across the entire basin, including irrigated agricultural lands (Figure 1).

There were several challenges associated with the development of this dataset. The USBR does not create maps of irrigated agriculture as part of

their CULRs in either the Upper or Lower Basins. Rather, the spatial information about irrigated agriculture is used in analysis to inform the accounting for consumptive use, presented in tabular format. Creating spatial products from the USBR data is inherently imperfect as these data are a snapshot in time, where often further accounting metrics are assigned to determine the areal extent of

irrigated agriculture from other data sources (i.e., Census of Agriculture) for an output that is not spatial but tabular. Additionally, the USBR’s accounting of irrigated agriculture is an estimation built upon best available data collected from a variety of sources. In constructing this dataset, the data were stitched together across the entire CRB and amalgamated and standardized to present a holistic snapshot of the CRB.

USBR methods of data collection for the CULR are different for the Upper and Lower basins. In the Upper Basin, states estimate their consumptive uses and losses of CRB water using methods different from those used by the USBR and between states, so estimates may differ between entities. The CULR use USBR methodologies to estimate consumptive uses and losses based on the modified Blaney Criddle method for all Upper Basin states with the exception of New Mexico. The

USBR uses a process to further refine their statistics on irrigated agriculture in which data are collected from the USDA Census of Agriculture (COA) that is conducted every five years and state's annual County Agricultural Statistics (CAS). In the Lower Basin, the USBR accounts for use on the main stem using a "diversion minus flow" methodology for all water users within the Lower Basin states, as published in Water Accounting Reports and the CULR. Until 2000, the CULR included irrigated acreage and estimated consumptive use and losses in the Lower Basin tributaries. The USBR recognizes that there are discrepancies

between the various accounting approaches and are seeking to resolve these discrepancies in both the Upper and Lower basins.

To map irrigated agriculture, a common crop type classification was developed to map crop types across the entire basin and to compare against the crop types from the CDL and CDSS. This Common Classification was adapted from the classification procedures developed for the South Platte Decision Support System in Colorado (Table 2). Without the Common Classification, crop types would be classified differently between the Upper and Lower Basins. The data were reclassified

to represent consistency of crop types across the basin, and assumptions have been made in re-categorizing data. For example, the original CDL classification included 91 different crop types within the basin that were reclassified for this project by aggregation (such as pasture, hay) or exclusion (such as dryland agricultural crops; crops not found in the CRB) into the 10 crop types of the Common Classification System.

Changes are underway with respect to mapping the CRB irrigated lands. For example, the USGS is developing a spatial dataset from the mid to late 2000s of irrigation for the Upper CRB. This mapping will be used to improve the outputs from the SPARROW model, will refine the extent of irrigation in the Upper CRB by status and type, and will be used as a baseline for monitoring change in salinity loading from irrigation. Also, the USBR is working on changing procedures for estimating evapotranspiration in the UCRB from crop maps combined with surface weather information to remote sensing-based energy balance models for 2006-2010. However, relationships between crop types will need to be made explicit to estimate consumptive water used by agriculture.

Collection of agricultural data for the CRB has continued after the completion of the TNC project. Efforts to include recent, available data from various entities are essential to creating a current and holistic database of the CRB. Governmental organizations in partnership with universities are developing classification techniques utilizing remotely sensed data with the long term aim of creating real-time representation of irrigated agriculture in the CRB. If you are interested in learning more or would like to include your data in the CRB database, please contact Melinda Laituri, [melinda.laituri@colostate.edu](mailto:melinda.laituri@colostate.edu).

Table 2. Common Crop Classification used for the CRB. adapted from Schneider, Martin, and Woodward, 2006, SPDSS Memorandum 89.2 – Crop and Land Use Classification Procedures for Year 2001.

Crop	Characteristics
Alfalfa	A flowering plant cultivated as an important forage crop in Colorado. It usually greens up during April and early May and is harvested 3-4 times during the growing season that ends in early October.
Bluegrass/Sod	A lawn grass, which comprises less than 2% of total irrigated area in Water Divisions 4-7 in Colorado. Sod or turf is grass used to establish lawns. This comprises a negligible portion of the irrigated areas in Water Divisions 4-7 in Colorado.
Corn	Includes corn used for grain or silage. Planted between late April to early May and harvested from September through November. Includes sorghum and sudan.
Cotton	Cotton
Dry Beans	Includes pinto beans, white beans, and others. Planted between May to early June and harvested from late August to late September.
Grass Pastures	Includes pastures with cultivated grass and hay. It greens up in spring and early summer
Orchard	May include Ground Cover. Apples, peaches, plums, and grapes are the major crops grown in orchards in the region.
Small Grains	Includes winter wheat, spring wheat, oats, barley, rye, and millet. Winter wheat is planted in September of the previous year and is harvested around early July. Oats and barley are planted in March or early April and harvested in July.
Vegetables	Includes a variety of crops such as potatoes, squash, onions, pumpkins, lettuce, spinach, and broccoli.
Other	Includes everything else: Aquaculture, Blueberries, Camellina, Clover/Wildflowers, Cranberries, Herbs, Hops, Mint, Other Crops, Rice, Sugarbeets, Sugarcane, Sunflower, Vetch.



# Mapping Agricultural Water Governance in the Colorado River Basin

Faith Sternlieb, Ph.D. Candidate, Geosciences, Colorado State University

Melinda Laituri, Department of Ecosystem Science and Sustainability, Colorado State University

## Introduction

Emerging cooperative arrangements for water use, development, and conservation in the Colorado River Basin (CRB) indicate changes in both the political and environmental climate. These arrangements are geographically taking shape at the intersections of hydrologic, political, and social boundaries. Water agencies and organizations (e.g. private/public, national/local, governmental/non-governmental, etc.) are struggling with ways to address these complexities and, as a result, are creating new rules and arrangements that necessitate new datasets and visualization techniques. Agricultural (Ag) water supply organizations are central actors in new arrangements because they hold 70-80 percent of the water rights. In order to better understand these new rules and arrangements and how they affect Ag water supply organizations, the development of a geospatial database will facilitate the analysis of linkages between sectors and political jurisdictions at multiple scales that intersect with hydrologic adaptations throughout the basin. These intersections will identify locations where strategic arrangements with Ag already exist and where new arrangements may flourish.

This paper describes the process, evolution, and continued development of a basin-wide geospatial database describing agricultural water governance (complimentary to the project “Addressing Water for Agriculture in the Colorado River Basin,” this issue). For the purposes of this article, Ag water governance is the interface between Ag, hydrological, and human systems where formal and informal policies, rules, and

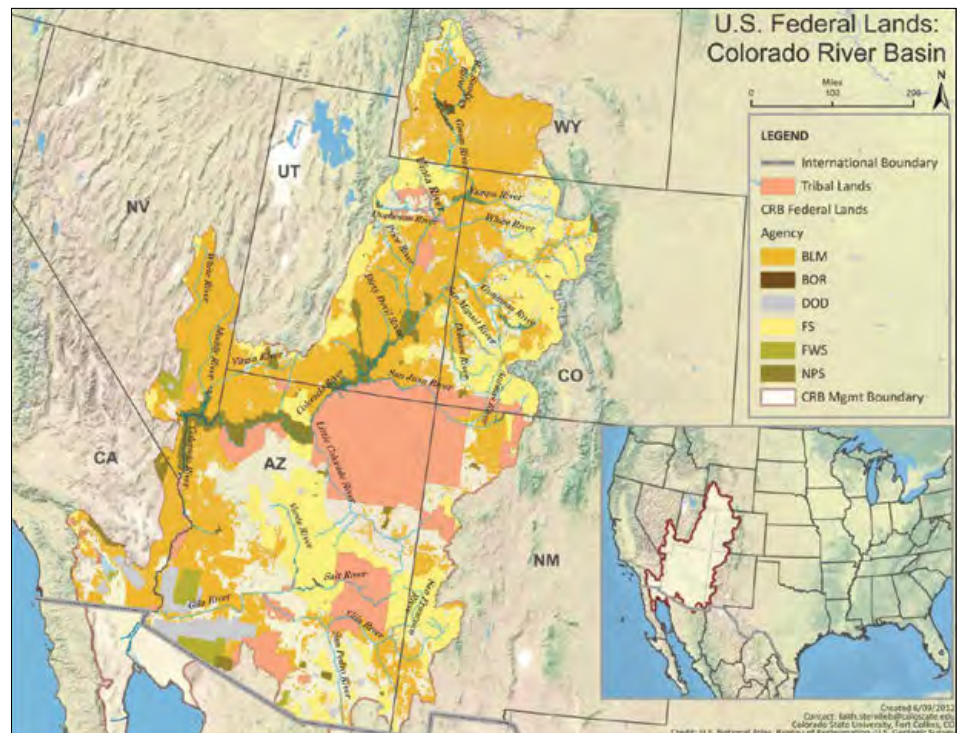

Figure 1. This map layout demonstrates U.S. Federal and Tribal Lands in the Colorado River Basin overlaid on a topographic basemap.

practices shape human interaction with the environment. The Colorado River Basin Agricultural Water Governance database is an effort to collect data about governance and heighten awareness about the changing circumstances of decision-making about water for Ag in the CRB. The aim of this project is to compile data for the entire CRB in one place to provide an online clearinghouse that will inform stakeholders, water users, and decision makers about Ag water in the basin.

## Geography

The CRB encompasses seven U.S. states (Arizona, California, Colorado, Nevada, New Mexico, Utah and Wyoming), two Mexican states (Baja California and Sonora), and at least 43 U.S. tribes (not including Mexican indigenous tribes). The Colorado River boundary in Figure 1 is defined by the

Bureau of Reclamation. The length of the Colorado River when measured from the Green River, Wyoming is 1,700 miles (2,736 km) long or 1,400 miles long when measured from Rocky Mountain National Park (43°09'13"N 109°40'18"W) to the mouth of the Gulf of California otherwise known as the Sea of Cortez (31°39'N 114°38'W). The drainage basin encompasses an area of 246,000 square miles (637,137.08 square km). The hydrology of the river is highly controlled through a series of dams and reservoirs which harnesses water for energy, consumptive, and non-consumptive purposes in the basin. Ninety percent of native in-stream flows originate from snowmelt of the Green (Wyoming), Gunnison and San Juan Rivers (Colorado). The current average flows are estimated at 14.7 million acre feet, and the total storage capacity is at 60 million acre feet. The majority of

Table 1. Federal agencies and their classifications under the Department of the Interior (DOI) that own and administer land in the Colorado River Basin: Bureau of Land Management (BLM), Bureau of Reclamation (BOR), Department of Defense (DOD), the Forest Service (FS), Fish and Wildlife Service (FWS), and the National Park Service (NPS).

DOI Agencies	Federal Lands Classification	Area in Miles <sup>2</sup>	% of Land in the CRB*
BLM	National Conservation Areas, National Monuments, National Recreational Areas, Public Domain Land, Wilderness, Wilderness Study Areas	82,920	34%
BOR		1,173	< 1%
DOD	Air Force, Army Corps of Engineers, Marine Corps, Navy	5,596	2.3%
FS	National Forests, National Recreation Areas, Wilderness, Wilderness Study Area	47,014	19%
FWS	National Wildlife Refuges, Wilderness	3,739	1.5%
NPS	National Historic Parks, National Historic Sites, National Memorials, National Monuments, National Parks, National Preserves, National Recreation Areas, Wilderness, Wilderness Study Areas	8,805	3.5%
	<b>TOTAL</b>	<b>149,247</b>	<b>60.8%</b>

\* These percentages are based on the Bureau of Reclamation Colorado River Basin management boundary, obtained from the BOR Lower Basin Office, which includes the Mexican portion of the basin. The area is estimated to encompass 246,000 mi<sup>2</sup>.

Table 2. Due to the complexity of overlapping jurisdictional boundaries in the Colorado River Basin, identifying boundary types and governance layers clarifies how decisions are made and who is affected by those decisions.

Boundary Type	Governance Layer	Description
Physical	Hydrologic Unit Code	Based on natural drainage systems defined by the National Hydrology Dataset (USGS)
	Hydrographic	Based on drainage basin delineated by each state and tribe
Administrative	Legislative	Based on federal, state and tribal laws and policies
	Judicial	Based on U.S. Federal, District and Appellate Court system
	Political	Based on governmental jurisdictions (federal, state, tribe, county, municipality, city)
Sector	Agricultural Water Supply Organization	Based on state statute and organizations' bylaws

outflows include trans-basin diversions (San Juan Chama, Central Utah Project, NCWCD/Big-Thompson, Colorado River Aqueduct/All American Canal, Fryingpan/Arkansas) and evaporation from major reservoirs.

The majority of land (60.8 percent) in the CRB is owned and administered by the U.S. federal government and under the jurisdiction of the Department of the Interior (DOI) of federal agencies (Figure 1, Table 1).

Tribal lands constitute 16 percent or 40,462 square miles (104,797 square km) of the CRB and are federal lands that are overseen by the Bureau of Indian Affairs (BIA) but administered independently as sovereign nations by the respective tribal governments. Although farmers and ranchers depend on the federal lands for grazing their livestock, all of the farming and Ag production takes place on the remaining private lands. The federal agency that has the largest presence in the CRB for water supply is the Bureau of Reclamation. In light of their water management responsibilities, the bureau holds the least amount of land (less than one percent).

## Geospatial Database Development

The geospatial database is currently under development. Much of the spatial data for the CRB is accessible online but is dispersed on the internet through various non-governmental organizations and governmental agencies. In addition, some of the data may or may not be available for download and/or viewed. Challenges in creating such a geodatabase include data collection and compilation from multiple sources (some of which are private and hold proprietary information) at multiple scales and for different purposes. Compounding the challenges are the different types of data such as satellite imagery, paper maps, historical records, and field data collection, as well as techniques used to collect data including global positioning systems, surveying instruments, and photogrammetry, among others. Finally, data collection at a coarse versus fine resolution, disparate standards for metadata, and minimal coordination in data collection efforts make it difficult to mainstream datasets.

The spatial data is organized in "governance layers" which describe physical and administrative jurisdictions as well as jurisdictions



that are socially and/or hydrologically organized. Governance layers are defined by two key components: 1) mandated or naturally occurring geographic boundaries and 2) decisions made based on those boundaries. Each governance layer may be represented in a geospatial database by a geospatial file. Each jurisdiction is governed by distinct rules, actors, and cultural, social, and behavioral codes. By overlaying governance layers in a geographic information system (GIS), jurisdictions overlap, affecting multiple levels of decision-making. Governance layers describe the complexity of water governance in the CRB because they demonstrate overlapping organizations and arrangements as well as the norms and behaviors of actors who have different and sometimes opposing claims in the use, management, and development of water resources.

Special districts such as Ag water supply organizations are central to water development in the CRB. Such service and supply organizations can be classified in two types: 1) private owned by shareholders, and 2) public, which are federal, state, or quasi-governmental. Private Service and Supply Organizations are water utilities, mutual water companies, carrier ditch companies, and mutual ditch and irrigation companies. Public Service and supply organizations are municipalities, irrigation districts, conservancy districts, conservation districts, reclamation districts, water control districts, fresh water supply districts, and municipal water districts. “Water supply organizations such as irrigation and conservancy districts are formed primarily to raise revenue (by property taxation and bond sales) and to construct and operate irrigation projects. Some [organizations] contract with the federal government to administer government-financed reclamation projects” (Getches 2009, p. 453).

Data collection has become more prevalent, and an increasing number

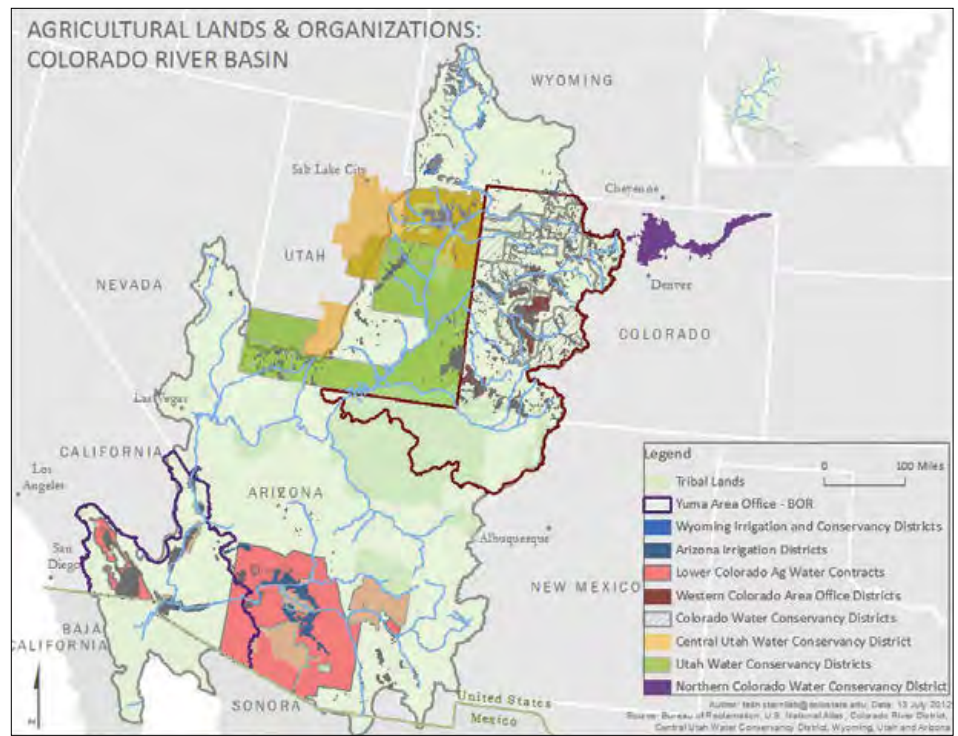

Figure 2. Irrigated and agricultural lands overlaying Ag water supply organizations in the CRB. Ag water supply organizations represented are those that have: a) contracts with the Bureau of Reclamation, b) subcontractors for Colorado River water through Bureau projects (e.g., irrigation districts that have subcontracts for Central Arizona Project water), or c) entities responsible for water supply through state legislature (e.g. Water Conservancy Districts in Utah).

of organizations are collecting data and producing reports, resulting in fragmented datasets. This is especially true in the CRB. Data have been collected continuously from different governmental agencies, CRB states, Ag water supply organizations, and non-profit organizations, as well as local public and private entities. This data collection exercise has been conducted in parallel with The Nature Conservancy-funded project discussed in this issue. Geospatial data includes:

- Hydrologic boundaries defined both by state and by hydrologic unit
- Boundaries for Ag water jurisdictions within the basin including but not limited to Bureau of Reclamation projects (including infrastructure), irrigation districts, water conservancy districts, conservation districts (relating to water management and administration), water users associations, and private irrigation and ditch companies

- Boundaries that demonstrate environmentally sensitive areas such as salinity control areas, wild and scenic stretches of the Colorado River and tributaries, and areas where endangered species are of concern or are actively being protected

Spatial data in the database also includes governance layers describing Mexican jurisdictions. In addition, we are in the process of integrating data on Ag and irrigated lands collected as part a project of The Nature Conservancy in collaboration with CSU (see article on Ag lands in the Colorado River Basin in this issue) and the Geospatial Centroid. Data on Ag water supply organizations together with Ag lands are being compiled to create one comprehensive geospatial database for the CRB (Figure 2).

## Future Research

The Agricultural Water Governance project on CRB and The Nature Conservancy’s project on irrigated

Ag in the CRB combine two datasets that have never before been created. To demonstrate this dataset, an interactive geospatial database is under development. The aim of compiling this dataset is to capture Ag water supply organizations that use Colorado River water and deliver the information through a basin-wide database accessible to water users. The breadth,

depth and purpose of the database are dependent in part on the contributions and sharing of information and data by Ag water users in the CRB and will be useful to them as the water landscape in the CRB changes. Complimentary information about Ag water supply organizations including water rights, contracts, and federal and state policies will be collected and compiled to add

value to the dataset. Representing this information spatially will complement the water quality/availability data that has been collected, processed, and made available. The best available data has been collected. If you are interested in more information about this project or would like to include your data in this database, please contact Faith: [Faith.Sternlieb@colostate.edu](mailto:Faith.Sternlieb@colostate.edu).

---

# Addressing Water for Agriculture in the Colorado River Basin: A Project Progress Report

*Peter Leigh Taylor, Department of Sociology, Colorado State University*  
*MaryLou Smith, Policy and Collaboration Specialist, Colorado Water Institute*  
*Julie Kallenberger, Assistant Regional Water Coordinator, Colorado Water Institute*  
*Faith Sternlieb, Research Associate, Colorado Water Institute*  
*Reagan Waskom, Director, Colorado Water Institute*

Colorado State University's Colorado Water Institute (CWI) is spearheading a U.S. Department of Agriculture-funded research project on water for agriculture in the Colorado River Basin (CRB). Carried out in partnership with the seven CRB land-grant universities—Colorado State University, University of Arizona, University of California, University of Nevada, New Mexico State University, Utah State University, and University of Wyoming (Figure 1)—we want to find out what farmers, ranchers, and water managers are thinking about the current and future status of their agricultural water. Through this project, we hope to identify ways in which land-grant universities can

better assist agricultural water users and managers with the challenges they are facing.

Here, we briefly report on our progress with the research, which includes in-depth exploratory interviews and survey and mapping activities.

## The Interviews

We have completed in-depth telephone interviews with more than sixty farmers, ranchers, and water managers in all seven CRB states. Our other university partners helped us identify areas of high significance for agricultural water within each state and assisted us in contacting potential interviewees. We asked interviewees open ended questions about what

they felt were the main pressures, if any, on agricultural water, how farmers were responding, how they saw the future of agricultural water, and how land-grant universities might help. Although we are in the process of analyzing the rich information from these discussions, below we provide some preliminary thoughts on what we have learned.

## The Survey

The project team will be administering an online survey of farmers and ranchers in selected counties of Colorado and Arizona who use Colorado River water. The survey will address similar topics as those covered in the interviews, but will gather information from a



*The CRB Land-Grant Universities Team at a February 2012 Workshop in Tucson.*  
Photo by Sam Fernald



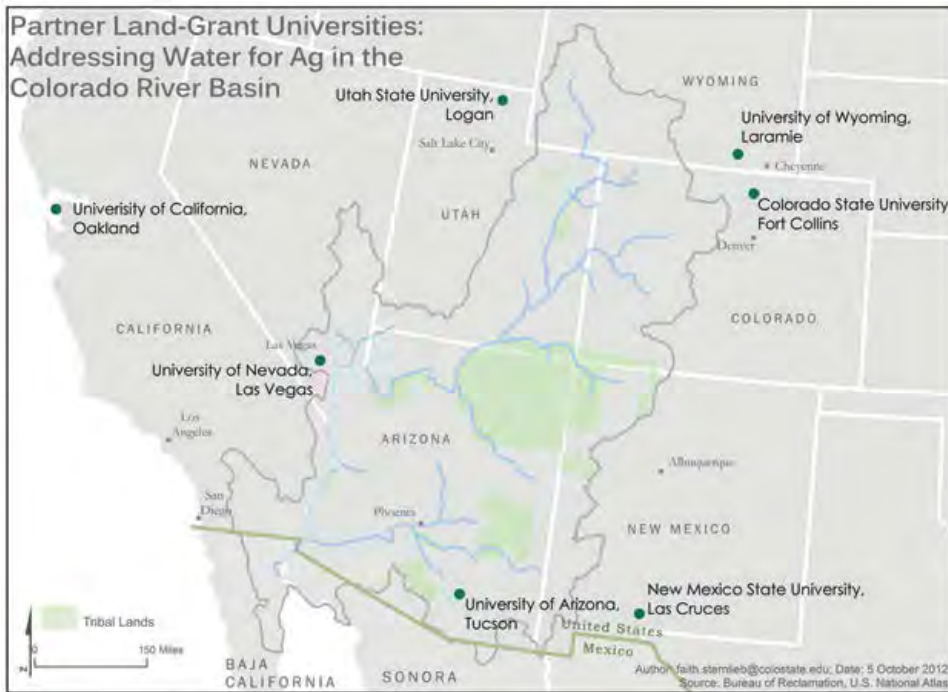

Figure 1. Addressing Water for Ag project team members' Land Grant Universities

broader audience in order to help formulate collective solutions to keep irrigated agriculture viable in the Colorado River Basin. The survey seeks to:

- (a) Identify what CRB agricultural water users think about the current and future state of their water supplies and production activities
- (b) Identify and compare the attitudes, beliefs, and perceptions held by agricultural water users towards the changes and pressures they are/are not facing with their water supplies, changes in water law and policy, and how to meet future water demands
- (c) Gather data on agricultural producers' interest and involvement in temporary and permanent agriculture water transfers and water banks
- (d) Identify how agricultural producers work cooperatively with other agricultural and non-agricultural stakeholders
- (e) Identify how land-grant universities can better assist farmers and ranchers with the challenges

they are facing, or will be facing with regard to their agricultural water

- (f) Gather ideas for projects, partnerships, and other initiatives to work with agricultural producers to help address the challenges they are facing with regard to their water and operations

## The GIS Mapping Activities

The project team conducted a mapping exercise in December 2011 with approximately 40 agricultural representatives from the CRB. A geospatial database is being created to help us better understand how agricultural water is administrated and managed in the seven CRB states. Data collected includes:

- Political jurisdictions including counties, states, tribal lands, counties, and municipalities
- Hydrologic boundaries defined both by state and by hydrologic unit
- Agricultural water jurisdictions within the basin including Bureau of Reclamation projects, irrigation districts, water conservancy districts and conservation

districts, water users associations, and private irrigation and ditch companies

- Environmentally sensitive areas such as salinity control areas, designated wild and scenic stretches of the Colorado River and tributaries, and areas where endangered species are identified as of concern or are actively being protected

Maps have also been an integral part of the interview process. With help from water leaders in each state, we created maps to help us locate areas where agricultural water is especially important and where we needed to interview individuals and key water organizations' representatives (see Figure 2 for interviewee locations). Though the interviewees' identities are confidential, during the interviews we referenced digital maps showing local political jurisdictions, waterways and other features to help us locate our discussion in the complex geographic space occupied by the interviewees.

All of the base maps were created from a comprehensive geospatial database of the CRB that is being developed under the direction of Melinda Laituri (see both articles on agricultural water governance and agricultural lands in this issue).

## Preliminary Results from the Interviews

Agricultural water users across the CRB are of course, very diverse. They operate across geographical contexts that vary from Upper to Lower Basin, high-altitude to sea level areas, and from forested to semiarid regions. They engage in a wide range of agricultural activities, from cattle ranching and cropping of pasture, alfalfa, and small grains, to high value vegetables, fruits, nuts, and more. Agricultural water users





Figure 2. Pushpins indicate where interviews were conducted with agricultural water managers, users, and their respective agricultural water supply organizations.

and managers operate under the 1922 Colorado River Compact and the Law of the River, yet each state provides distinctive frameworks for agricultural water use, management, and transfer. Agricultural water users and managers operate in a complex set of organizational contexts, from individual surface water diverters and groundwater users to ditch companies, irrigation districts, and water conservancy districts. Nevertheless, agricultural water users and managers report a number of common challenges (though their experience of them is shaped by geographic location, the history and seniority of their water rights, the type of agriculture and ranching, the proximity of urban areas and other competing water users, etc.).

These common challenges include uncertain water supplies, extended drought and the threat of climate change, and competition and conflicts with other water users within

agriculture and from energy, environmental, recreational, and municipal/industrial sectors. Many respondents have talked about the need for storage to manage effectively for multiple use and conservation but often express concern about the barriers posed by negative public views of storage and time-consuming and expensive permitting processes. Conjunctive management of surface and

groundwater poses increasingly complex problems of water access and management. Many have commented on how government regulatory frameworks, especially the Endangered Species Act, the National Environmental Protection Act, the Clean Water Act, and health and safety regulations, have fundamentally changed not only how water is used, but agricultural production itself. Many farmers have expressed concern about the need to strengthen public understanding of the importance of agriculture for a secure and healthy food supply. Many also have observed that the key role irrigated agriculture plays in creating ecological and amenity values is not well understood by many in the environmental and recreation communities. Others have remarked on the increasingly litigious environments in which discussions of water are occurring and suggested that more real progress can be made when people can stay out of court. Our interviewees have also

spoken, often with great poignancy, about uncertain futures for family farms and agribusinesses as younger generations choose not to continue in agriculture. Numerous interviewees have spoken of farming's future as one integrated with growing cities, with fewer traditional operations and many smaller "amenity" farms. Some farmers spoke of selling parts of their land and water rights to developers or even acting themselves as development investors, with returns reinvested in agriculture elsewhere or in helping secure their retirement.

It seems clear that agricultural water users are not affected the same way by the challenges facing them today. Many interviewees describe themselves as positioned to move ahead and either surmount these challenges or adapt to them in new and productive ways. These well-positioned users of agricultural water are found in all parts of the CRB represented by our interviews. Yet agriculture and agricultural water is described as strongest where geographic and climatic conditions allow highly productive agriculture with year-round, high-value commercial cropping. Water users with the most senior water rights are more cushioned from the uncertainties of an intensively used river and of supplies threatened by extended drought and predicted climate change. Though having urban areas nearby generally results in significant pressures from non-agricultural water demands, transportation and communication infrastructure also mean lower costs of production and marketing. Significantly, it is in these areas that interviewees spoke more consistently of new generations entering farming, ranching and related agribusiness.

Agricultural water users working in geographical areas where climatic and soil conditions pose higher obstacles to productivity, shorter growing

seasons, and greater isolation from markets face special challenges in adapting to new water pressures. More of these respondents spoke poignantly about their sense of the threats to a traditional farming way of life, as their children seek futures outside of agriculture. Yet these interviewees are clearly not giving up; on the contrary, they express deep commitments to what is in many cases, multi-generational investments in their land, water and agricultural way of life. They also express a strong commitment to providing food for our society, and their concern for national food security. Moreover, they are working hard to develop innovative ways to protect their water and their communities.

Indeed, interviewees throughout the CRB have talked about innovative strategies they are developing to overcome or adapt to pressures on agricultural water. In many areas, as in California, Arizona, and Colorado, agricultural water users and managers have embarked on new agreements with large urban water users to develop water supplies for multiple objectives, including urban, environmental, recreation, and agriculture. Several water managers have described their organizations' services to multiple user groups and their need to plan for more urban and municipal demands while maintaining support for agriculture. In several areas, such as Wyoming, Colorado, and New Mexico, multi-stakeholder forums and organizations have formed to try to manage conflicting claims and perspectives on water by bringing agriculture, environmental, recreation, and other groups to the negotiating table. These initiatives are not easy and have had mixed results, but

participants in successful experiences have spoken of what can be achieved with key visionary leaders, a focus on common interests of all parties in healthy local economies and riparian ecologies, willingness of all user groups to compromise, and a commitment to generating concrete results quickly, even if on a small scale. Other innovative responses reported by interviewees include diverse groundwater recharge programs, formal and informal water banking, and a range of leasing mechanisms. Numerous interviewees have reported on innovative approaches to planning storage as a key to developing secure future supplies of water for multiple uses, including agriculture, environmental, and recreational uses.

### What Needs to be Done?

Our interviewees have spoken of possible paths to a positive future for agricultural water. They suggest that the broader public might be helped to better understand the importance of irrigated agriculture, not just for securing high quality and safe food for our nation, but also for creating significant environmental and amenity values. As one Wyoming rancher put it, "This is an oasis in the

high desert. But God didn't make the oasis. It's man-made. It takes lots of water, diverted regularly in almost impossible quantities to keep it that way." Interviewees remarked that regulatory frameworks could better recognize both the continuing need for a viable agriculture throughout the CRB as well as its obstacles. Competing water users/stakeholders could develop more effective ways to negotiate based on understanding if not agreement with other perspectives and the need for a strong agriculture in the future.

### What is the Role of Land-grant Universities?

Most interviewees have expressed positive views of land-grant universities. They speak of the Extension agents who help them improve efficiency of irrigation technology and water management, introduce new seeds, and implement better soil practices. Interestingly, although most of our open-ended questions about the agricultural water community's challenges stimulated discussion of issues that are largely political, economic, social, and cultural in nature, relatively few respondents had experience with universities helping with these issues. This suggests to us that land-grant universities have an opportunity to bring to bear new kinds of social science research and outreach on the problems facing agricultural water users and managers, in addition to their traditional strengths in natural science and more technical disciplines.

Results from the Addressing Water for Agriculture in the Colorado River Basin project will be summarized and posted on the project website ([www.CRBwater.colostate.edu](http://www.CRBwater.colostate.edu)) in the spring of 2013.



*The Water for Agriculture Interview Team at CSU.*

Photo by Bridget Julian





## 30 Years of Salinity Programming—What Does it Mean for the Colorado Today?

*Denis Reich, Water Resources Specialist, CSU Extension, Colorado Water Institute*

For anyone who's driven past the Bookcliffs desert near the Grand Junction airport in the spring, salt is a common sight. The streaks of white are sometimes as thick as heavy frost on the adobe hills. This is Colorado River Basin salt at its most visible. The less obvious behind-the-scenes story is soil borne salt's contamination of our most famous Western river. The response, the Colorado River Salinity Control Program, has been one of the most involved yet successful water quality programs in United States history.

With an average of about 10 inches of precipitation per year, the tight clay soils of Western Colorado's arid agricultural valleys—such the Grand and Uncompahgre—see few downpours or sustained showers. This prolonged lack of water has historically not been enough to penetrate below the surface and flush the resident mineralized

salts—the same that surface in the adobes each spring—out of the clay subsoil and downstream.

With the arrival of Europeans to Western Colorado, irrigated agriculture effectively raised the average application of water from a few inches to a few feet. As canals and headgates were installed, the desert bloomed. Less dramatic were the millions of tons of otherwise dormant salt that irrigation water, percolating deep into the soil, began quietly releasing into rivers. It took a few decades, but once reclamation activities (e.g., reservoir filling and increased water availability) peaked in the 1960s downstream users in the lower basin began to notice.

By 1970 Colorado River users from the United States and Mexico were raising concerns over salinity. Levels of 800<sup>1</sup> ppm (as TDS) and

higher were becoming the norm in California and Arizona irrigation water, rendering it harmful to many crops. The formation of the Environmental Protection Agency and a fear of being regulated with state-line limits encouraged the seven basin states to work with federal agencies to draft special salinity legislation for the Colorado River. In 1974, the Colorado River Basin Salinity Control Act was passed by Congress.

The act was amended several times (1984, 1995, 1996, and 2008) and now exists as the Colorado River Basin Salinity Control Program, or “Salinity Program.” The Salinity Program is a unique and successful collaboration<sup>2</sup> between the Department of Interior (Bureau of Reclamation, Bureau of Land Management, and the Geological Survey), the Department of Agriculture (Natural Resources

<sup>1</sup> Drinking water typically has <500 mg/L TDS and Seawater >30,000 mg/L TDS. Most crop damage starts to occur once water in the root zone reaches 700 mg/L TDS or higher – this is often a function of soil and water salinity.

<sup>2</sup> There are three stakeholder groups that manage and inform the Salinity Program: the Salinity Forum—the basin states representatives; the Federal Advisory Committee—where the forum and federal agencies consult on federal salinity expenses; and the technical workgroup that advises the two policy-making groups.

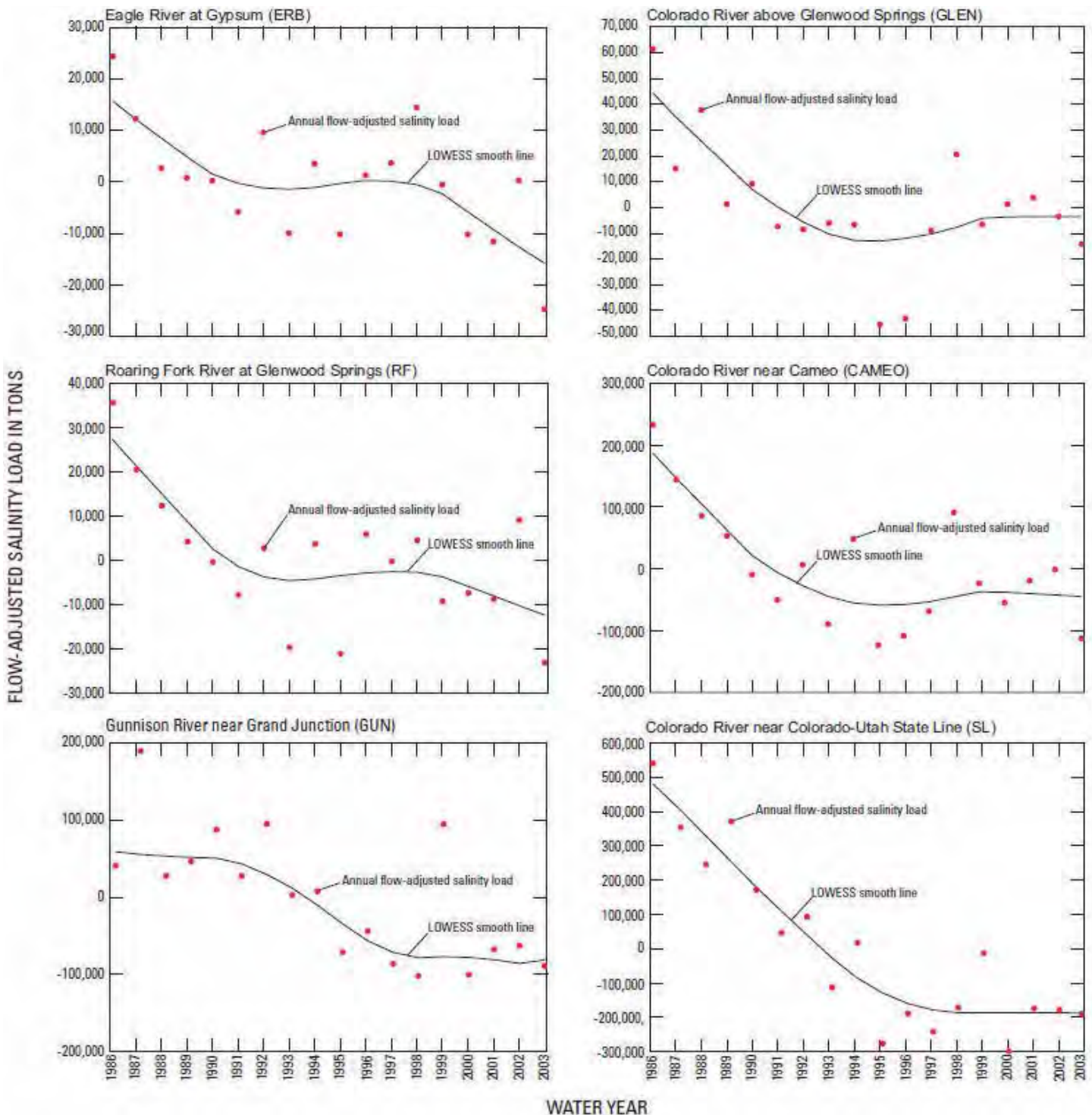

Figure 1. Flow adjusted (LOWESS curves) salinity loads from various gages on the Colorado River in Colorado showing the impact of the Salinity Program on levels of dissolved salt (TDS). Water Years 1986 to 2003.

Courtesy Leib and Bauch, USGS Scientific Investigations Report 2007-5288

Conservation Service), the Basin States, and most importantly private landowners voluntarily participating in cost share and incentive payments.

In 2010 the Grand Valley Unit of the Colorado River Salinity Control Program achieved its target of 132,000 tons per year of salt prevented

from reaching the river through on-farm irrigation improvements. This represents 30 years of sustained effort on the part of Colorado's Natural Resources Conservation Service (NRCS) and key partners like Reclamation. Recently retired Assistant State Conservationist Frank

Riggle has had more experience than most when it comes to on-farm salinity control.

"The Salinity Program is unique," says Riggle. "I don't think there's another water quality program anywhere that has seen this amount of work done across such a large area for this long



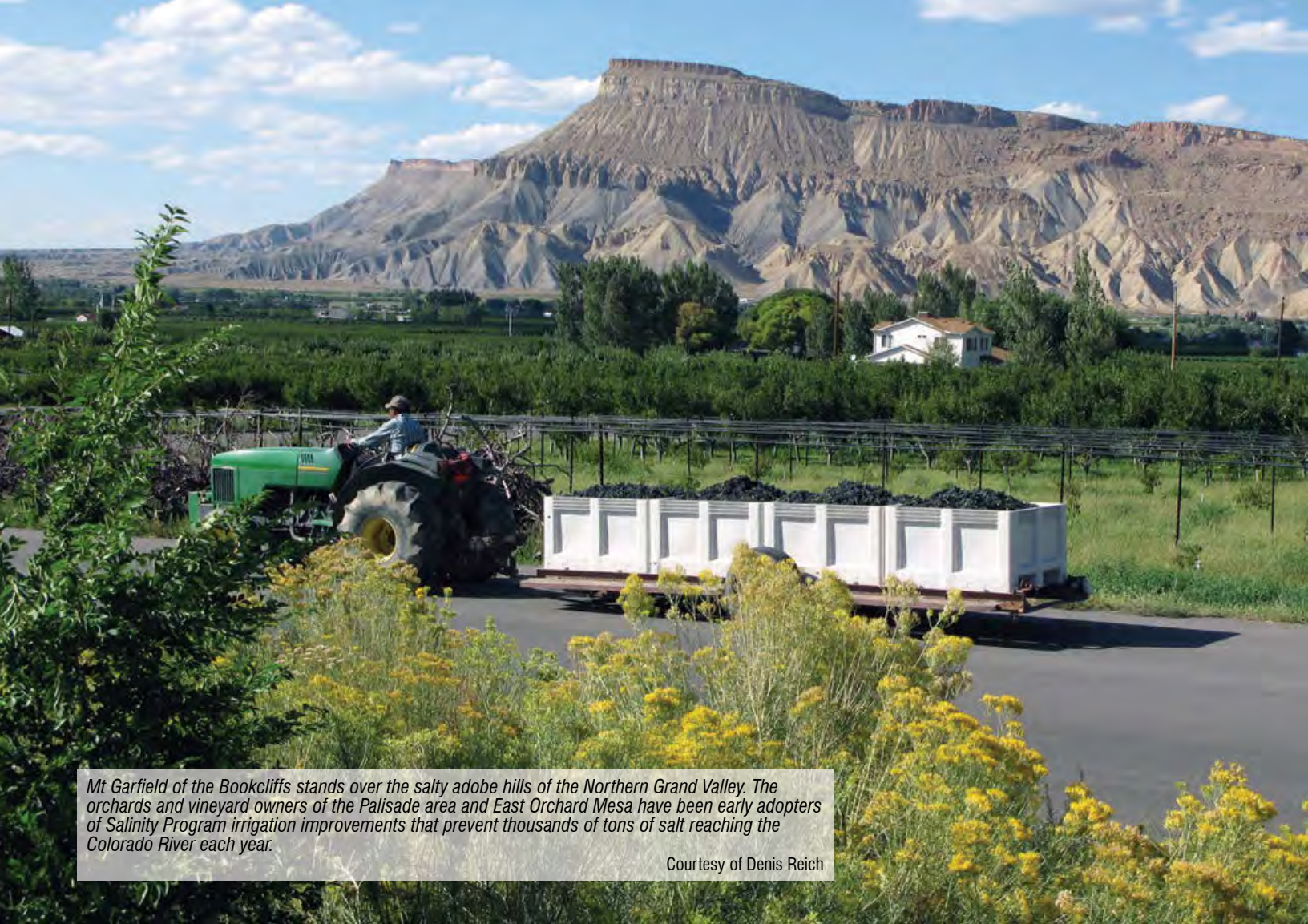

*Mt Garfield of the Bookcliffs stands over the salty adobe hills of the Northern Grand Valley. The orchards and vineyard owners of the Palisade area and East Orchard Mesa have been early adopters of Salinity Program irrigation improvements that prevent thousands of tons of salt reaching the Colorado River each year.*

Courtesy of Denis Reich

a period with such a significant and measureable impact. Quite a feat,” he continues, “for a river the size and magnitude of the Colorado” (see Figure 1). The Program’s success has since become a model for public/private partnerships tackling large scale natural resource problems.

In addition to the nonpoint source problem, some of the larger point source salt problems have also been tackled by the program. Natural saline springs such as those used to feed the Glenwood Hot Springs Pool are the major salt contributors to the river. At the point of the program’s inception, nearly 10 million tons of dissolved salts were passing annually below Hoover Dam. The Salinity

Program has traditionally focused on mitigating the agricultural portion of this load. Irrigation on the eastern edges of the Colorado Plateau is responsible for almost half of the salt contributions to the system.<sup>3</sup>

The largest point source project completed so far is the Reclamation owned and operated deep well brine injection system near Paradox, Colorado. It is estimated that the Paradox injection well project successfully prevents approximately 110,000 tons of salt per year from entering the Colorado River system by capturing shallow saline groundwater that is tributary to the Dolores River and disposing of this brine over 14,000 feet below the surface into a

geologically confined layer. However, the injection well is now approaching or even exceeding its design life, and the receiving zone is close to full, which is reflected in increasing pumping pressures needed to bury the offending water. Whether to drill a second well in a new location or try a new strategy such as membrane treatment and evaporation ponds is under consideration via an alternatives NEPA analysis being performed by Reclamation.

In a sense the Salinity Program is now at a crossroads. “The low hanging fruit has already been picked,” reflects MaryLou Smith of the Colorado Water Institute. Smith is a subcontractor with URS Engineering on a

<sup>3</sup> The Environmental Protection Agency has identified that 62 percent of the salt load contributions into Hoover Dam are from natural sources.





new multidisciplinary project, "Comprehensive Planning Studies for Salinity control measures in the Upper Colorado River Basin." Working with URS Engineers under the leadership of Dave Merritt, Smith is interviewing farmers and identifying barriers to user participation in remaining cost effective salt control projects. "By learning more about what is preventing some

farmers and irrigation companies from participating in the Salinity Program, administrators will have the opportunity to tweak the program for improved impact," says Smith.

The rising cost of salt control clearly underlies many of the obstacles to participation. "Western Colorado agricultural producers and water users have benefitted from the Salinity Program, but moving forward in the era of financial constraints is quite a challenge" observes Dave Kanzer, Colorado River District Senior Water Resources Engineer and Salinity Program workgroup member. "Therefore, we anxiously await results from the 'planning studies' project to help us improve the implementation and success rate of the Salinity Program. It's a program that is essential to wise water use in the Upper Colorado River basin," concludes Kanzer.

Steve Gunderson, Director of the Water Quality Control Division at the Colorado Department of Public Health and Environment agrees. "The Salinity Program has not outlived its usefulness," says Gunderson. "The Lower Basin states are still very much invested in Salinity mitigation and in the Upper Basin we have come to depend on the multiple benefits of the Salinity Program such as Selenium control." In a sense selenium is the new salinity. Found with mineralized salt in some shale soils, it's highly concentrated in Western Colorado, particularly the Lower Gunnison Basin. It contaminates the river at very low concentrations, not harmful to crops or humans, but surprisingly destructive to many forms of aquatic life, some of which are endangered. Thanks in part to salinity program funded control projects, concentrations of dissolved selenium are dropping towards, and in some cases even below, the state standard of 4.6 parts per billion.

Thanks to its continued success, the Salinity Program continues to be a benchmark for water quality programs across the United States and around the globe. While funding to other natural resources collaborative processes are particularly vulnerable given the current economic climate, the Salinity Program has found ways to adapt and remain viable in spite of these pressures. In 2013 there will be a celebration in Grand Junction for the Grand Valley exceeding its target for removal. It should be the first of many to come.

## Acknowledgements

Thanks also to Travis James of NRCS in the Salt Lake Reclamation office, and Terry Stroh and Dan Crabtree of the Bureau of Reclamation Upper Colorado Regional Office in Grand Junction for their assistance with this article.



*Bad experiences with the first pivot sprinklers in the 1980s have delayed adoption of newer technologies among row-crop farmers in the salt affected areas of the Upper Colorado. This producer adjusts an emitter on a more modern pivot, which runs on lower pressures—around 30 psi—producing smaller droplet sizes, which greatly improves infiltration and crop water uptake.*

Courtesy of Denis Reich

# USGS Summer Intern Program

None.

<b>Student Support</b>					
<b>Category</b>	<b>Section 104 Base Grant</b>	<b>Section 104 NCGP Award</b>	<b>NIWR-USGS Internship</b>	<b>Supplemental Awards</b>	<b>Total</b>
<b>Undergraduate</b>	7	0	1	5	13
<b>Masters</b>	4	1	1	5	11
<b>Ph.D.</b>	4	1	0	3	8
<b>Post-Doc.</b>	0	0	0	0	0
<b>Total</b>	15	2	2	13	32



# Notable Awards and Achievements

- Kurt Fausch Presenter at NDSU Distinguished Water Seminar
  - Upper Yampa Scholarships Announced
- 

## Awards and Achievements

### **Kurt Fausch Presenter at NDSU Distinguished Water Seminar**

Dr. Kurt Fausch of the Colorado State University Department of Fish, Wildlife, and Conservation Biology was invited to present the 2nd Distinguished Water Seminar at North Dakota State University (NDSU) on Feb. 21, 2012, titled, “Linked for Life: The importance of sustaining hidden connections for conservation in streams.” A main focus of his talk was how human impacts like nonnative fish invasions and riparian grazing alter key linkages between streams and riparian zones that sustain not only stream fish but also birds, bats, lizards, and spiders in the riparian zone. The invited seminar was sponsored by the North Dakota Water Resources Research Institute, the NDSU Environmental & Conservation Sciences Graduate Program, and the Department of Biological Sciences. For more information, visit <http://www.ndsu.edu/wrri/Image/Flyerfinal.pdf>.

### **Upper Yampa Scholarships Announced**

The Upper Yampa Water Conservancy District John Fetcher Scholarship provides financial assistance to a committed and talented student who is pursuing a water-related career in any major at a public university within the state of Colorado. Congratulations to this year’s scholarship recipients, Tyra Monger and Benjamin Von Thaden.

Tyra Monger  
University: Mesa State College  
Anticipated Graduation: 2014  
Major: Environmental Science and Technology  
Areas of Interest: Watershed

“Being raised on a cattle and hay ranch outside of Hayden, I understand the value of water. I also have understood and been schooled in the value of being a great steward of the land/water. Once I have graduated from Colorado Mesa University, I am hoping to find a career working in Colorado. Being an outdoors person and being able to maintain the environment have been my lifelong dreams. Currently I am an Environmental Science/Technology major with a Watershed minor. I believe that these programs will become an ever more important field of study to our country and economy. One of the hopes for my future is to return to Routt County to volunteer to further nourish 4-H programs. 4-H provides skills to young adults that can be used throughout their lives as they fulfill their careers. I hope to also be able to help on my family ranch.”

Benjamin Von Thaden  
University: Colorado State University  
Anticipated Graduation: 2013  
Major: Watershed Science

Areas of Interest: Water quality monitoring, snow hydrology, water allocation, climate change, and water-related recreation

“I feel very privileged to have been raised in Routt County and I can definitely see myself living and working in the Yampa River Basin in the future. In 2009 I participated in a Tamarisk removal trip on the Yampa River through Dinosaur National Monument. The trip was very eye opening for me and I would like to do more work, and possibly research, in the fight against invasive species such as Tamarisk and Russian Olive in the Colorado River Basin. After I graduate I plan on joining Engineers Without Borders and traveling around South America to help create better access to safe drinking water and improve sanitation. When I was a sophomore at the Lowell Whiteman School I traveled with the school to Bolivia for my foreign trip. As a service project my group installed a water filter, utilizing rocks, gravel, sand, clay, and silt, to provide safe drinking water to a small village close to Rurrenbaque, Bolivia, in the Amazon Basin. It was an amazing experience to help these less-fortunate people by providing safe drinking water, and I feel I have an obligation to participate in similar projects in the future, hopefully on a larger scale. I have learned that water-related problems are often times very complex and do not have a simple solution, but require collaboration between many groups and industries. While I am not sure of the exact direction that my career will take, I am very excited about having a career in the water industry.”

## **Publications from Prior Years**

1. 2005CO117B ("Occurrence and Fate of Organic Wastewater Contaminants in Onsite Wastewater Systems and Implications for Water Quality Management") - Water Resources Research Institute Reports - Borch, Thomas, Yun-Ya Yang, James L. Gray, Edward T. Furlong, Jessica G. Davis, Rhiannon C. ReVello. 2012, Steroid Hormone Runoff from Agricultural Test Plots Applied with Municipal Biosolids, Colorado Water Institute, Colorado State University, Fort Collins, CO. 9 pages.