

## PORTABLE CIRCULAR SAWS

### I. INTRODUCTION

#### A. Background Information

Estimates from the NEISS data for 1986, indicate about 41,000 emergency room treated injuries occurred involving either powered portable circular saws, or powered stationary circular saws. These injuries resulted in hospitalization rates that were estimated at almost twice the average for all injuries reported through the NEISS system. From 1984 to 1986, a yearly average of 10 deaths (excluding electrocutions) was reported to CPSC associated with powered circular saws.

Hazards associated with these saws involved blade contact, kickback, inadvertent starting, and thrown objects. Some contributing factors appear to be location of switches, blade guard functions, and pinching of material being cut.

We plan to study in detail all accidents associated with operating portable circular saws, for the purpose of evaluating the effectiveness of existing voluntary standards.

#### B. Study Description

Include all incidents of injury involving portable circular saws in active operation. This will include incidents of blade contact, being struck by thrown objects, clothing being caught in moving parts, or contact with other non-moving surfaces or parts. Incidents not to be included would involve those where the saw is not in operation, such as walking by and hitting the saw, or other injuries not related to saw use or maintenance.

Figure 1 of attachment 1 illustrates the configuration of the typical portable circular saw. This power tool is generally electrically powered. It is designed to cut sheet material (plywood, masonite, particle board, etc.), planks and dimensional material (2x4, 2x6, 4x4, etc.), primarily wood.

A special configuration of the portable circular saw occasionally encountered in consumer use is the Worm-drive Saw. This saw differs from the typical circular saw in appearance and in the design of the blade drive system. In appearance, the circular blade on a worm-drive saw is located well forward of blade location on the typical circular saw. As the name indicates, a worm gear drive system is used to transfer the motor torque to the driven blade.

In addition to the features illustrated in Figure 1, circular saws may also have accessories such as rip guides, protractor gauges and crosscut guides for use during specific cutting operations.

the saw blade on the circular saw is readily removable and a wide variety of blade designs have been developed both for specific cutting operations and for various materials in addition to wood. Figure 2 presents information on Typical Blade Types and their usage.

### C. Specific Items of Interest

Provide all information on saw brand, model, age, condition, type of blade, safety features, location of controls/switches, and consumer use patterns. Photograph saw, environment, and a reenactment of victim's position at the time of accident. This guideline was developed to provide general assistance when conducting investigations related to power saw incidents. Do not limit your responses solely to the information requested in this guideline. If any other pertinent information is discovered, include it!

---

## II. INSTRUCTIONS FOR COLLECTING SPECIFIC INFORMATION

### A. Synopsis

Provide a complete and concise account of the accident including the product(s) involved, who was injured, what the injury was, where the accident occurred, and the severity of the injury.

### B. Description of the Product

#### 1. Task

- Explain in a step-by-step manner the tasks required to set up and use the saw (i.e., plug in wall, turn on switch, adjust blade, etc.). See Figure 3 on Types of Saw Cuts.
- Describe in detail the exact task being performed by the victim (i.e., ripping, crosscutting, miter cutting, bevel crosscutting, bevel ripping).
- Provide details of victim's exact position while

performing the task. This should include position of hands, feet, and relation between saw and material being cut.

- Indicate if any problems existed with material being cut, which may have contributed to the accident sequence (i.e., knots in the wood, board bouncing or shifting, binding, etc.).
- Determine width, length, thickness and type of stock being cut.
- Indicate how stock was supported, and how stable.
- Specify if any safety devices were being used at the time of the accident, such as a lower blade guard or an off-on safety switch. If not used, state reason. If used, did any safety device malfunction? How?

## 2. Product

- Give complete description of the saw; include brand, model, age (motor horsepower, amps, and rpms), general condition, location and type controls, and if any modification or repairs were made to the saw. Include brand and type of blade.
- List presence of all safety devices on the saw, and their condition.
- Pay particular attention to the blade guard, tell if it was in good condition and operating as intended. (If not, give reason--spring broken, gummed up, dirty, etc.)
- Provide diameter and condition of blade being used (sharp, dull, teeth missing, rust or residue on blade, etc.).
- State type of blade used (crosscut, rip, combination, etc.). Also, state number of teeth and diameter of blade (see Figures 2 and 2A).
- State whether the plate/shoe of the saw was adjusted to a proper blade depth for the thickness of the stock being cut.
- Indicate if saw has a blade bolt that functions as a blade clutch. If present, was the blade bolt adjusted too tight, adjusted too loose, or adjusted correctly to allow blade to slip if an obstruction occurs.

- Explain how blade angle was adjusted.
- Indicate the location of the off-on switch, relative to the location of the blade.
- List location and wording of any safety, warning, caution or operating labels or information displayed on saw.
- State if the saw came assembled, or had to be assembled. If not assembled, indicate who assembled the saw and if set-up instructions, such as squaring and aligning the blade were followed.
- Indicate any saw preparation for this operation, for example, mounted new blade on saw.
- Indicate what maintenance was performed on the saw and by whom.
- Indicate any modifications/repairs to saw.

C. Description of Accident Environment

- Describe sequence of events leading to the accident, including all relevant information on environmental factors, usage or any abuse, and location of saw.
- Detail aspects of lighting, its location and intensity.
- Provide details of area around saw, considering free movement for operator.
- Re-enact the accident scenario. Give a complete and concise description of the accident, including events before the accident, during the accident and after the accident.

D. Description of the Injured Person(s)

- Detail information on user's experience\* with, knowledge of the saw (e.g., advise whether warning labels or instructions were read and understood).

\* User experience is an area which needs some careful attention. In most cases, the victim has used the saw many times before without incident. Probe with general questions to determine the victim's general condition, and determine what was different on the day of the accident. Consider fatigue, lack of attention, hurrying, etc.

- Have victim describe his/her impressions relating to the saw's weight (heavy, light, hard to balance, etc.).

- Ask questions concerning the user's feelings towards the saw and task being performed (e.g., consider afraid of saw, feels it dangerous, thinks nothing about it, respects its potential for injury and is careful in its use, etc.).
- Describe injuries sustained, their severity, treatment required, and prognosis for recovery.
- Give victim's height, weight, age, and general health.
- State if any protective clothing or equipment was used, and what type.

E. Product Safety Standards

- Check all labeling for any indications (e.g., UL or other listing of certifications) that the saw involved in the accident meets a voluntary standard. Thoroughly document (with photographs as appropriate) all such indications. If no indications of applicable standards are found, include a statement indicating this in the investigation report.
- If there are indications of an applicable voluntary standard, include in the report all available information which might help determine whether the saw violates any applicable section of the standard.

**III. INSTRUCTIONS FOR PHOTOGRAPHING AND/OR DIAGRAMING ACCIDENT SCENE AND FACTORS RELATED TO THE ACCIDENT**

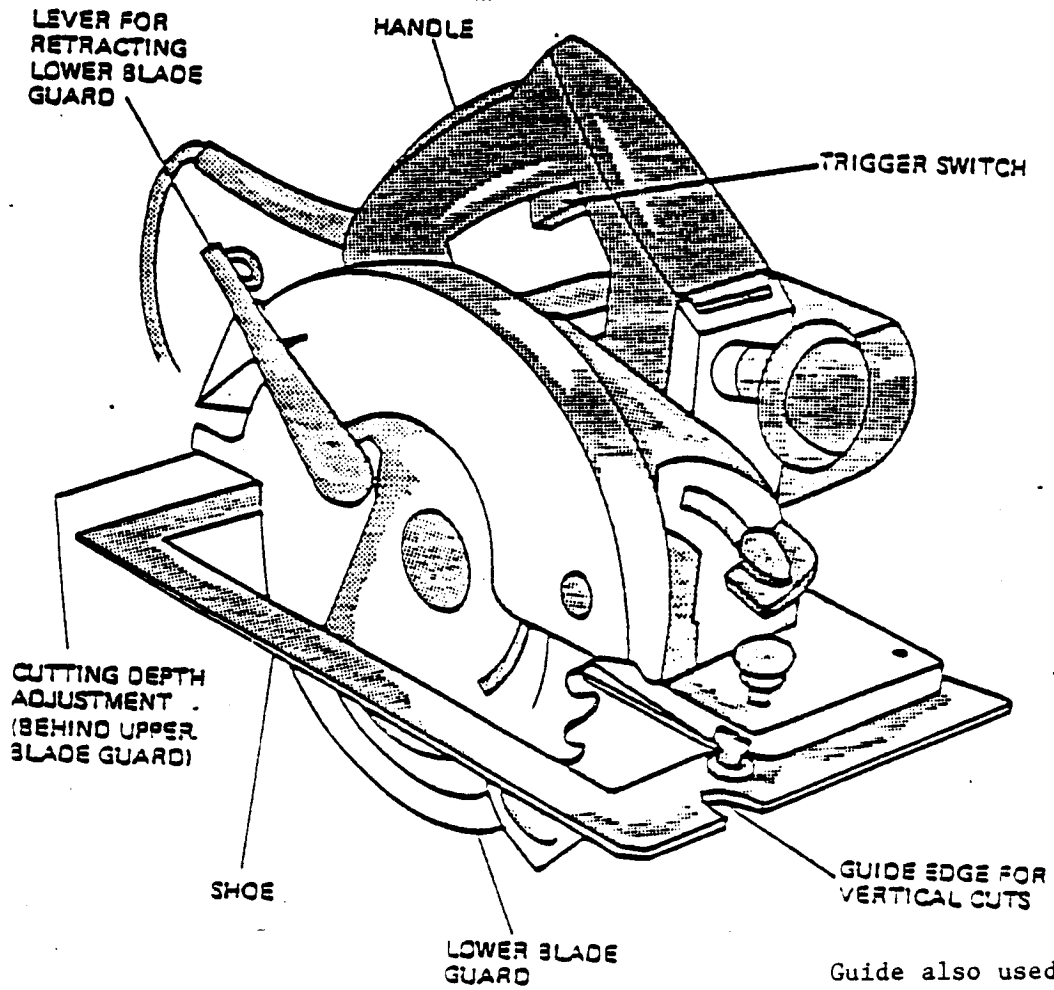
- Photograph the saw showing front, side, and top views and how the stock was supported.
- Provide close-up photos of labels, controls, safety devices or guards, and off-on switches.
- Have victim pose for a photo which depicts his/her position, as well as the position of the material being cut, at the time of the accident.
- Include close-up of photo of the blade involved, which shows the type and size of the teeth.

**IV. INSTRUCTIONS FOR OBTAINING SAMPLES AND DOCUMENTS RELATED TO THE INVESTIGATION**

- Photocopy the owner's manual and attach it to the report.

- Complete any unanswered questions from the telephone investigation, also verify the responses given (annotate discrepancies on form).
- Obtain all information requested in guideline and attach the guideline to the report.


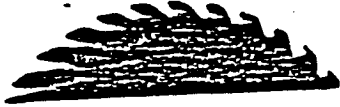


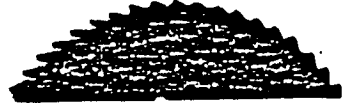



FIGURE 1. CIRCULAR HANDSAW



Guide also used to align blade with the line of the desired cut.

Figure 2. Circular Saws

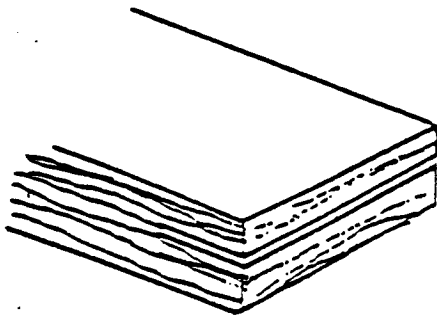
Typical Blade Types and Usage

<u>Type</u>	<u>Use</u>	<u>Typical Profile</u>
Cross-cut Blade	Cutting across the grain of the wood	
Rip - Blade	Cutting with the grain of the wood	
Combination Blade	General ripping and cross-cutting	
Plywood	Fine finish cuts in plywood	
Flooring	Sizing hardwood flooring	
Hollow Ground Planer	Fine end grain cuts	
Carbide Tipped	Cutting problem materials such as plywood, masonite, particle or flakeboard etc.	(various shapes to tooth configuration)  

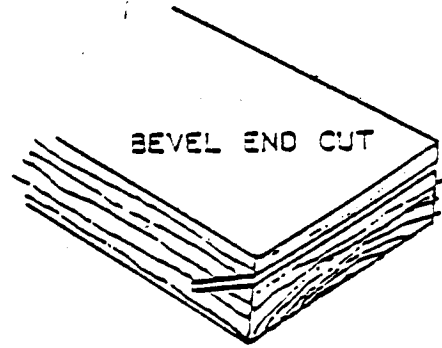


Attachment 3

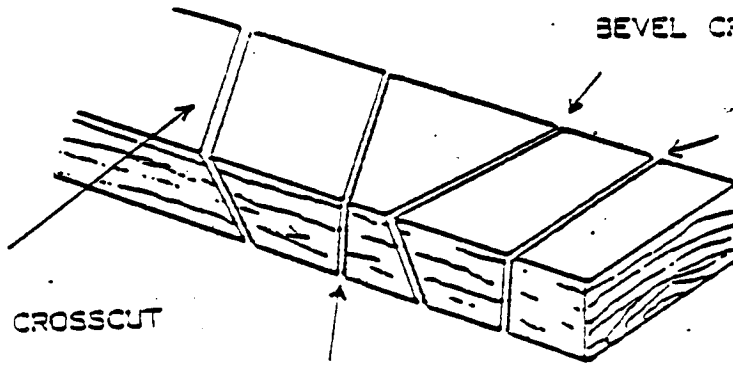
Figure 3. Types of Saw Cuts



STRAIGHT END CUT



BEVEL END CUT

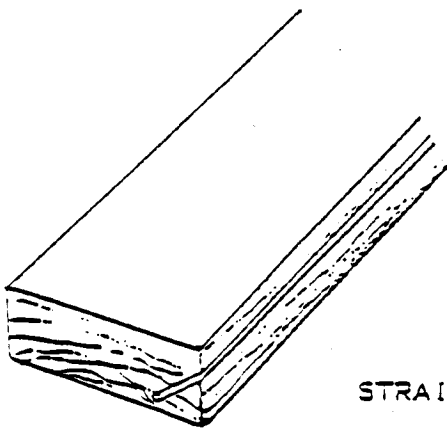


COMPOUND CROSSCUT

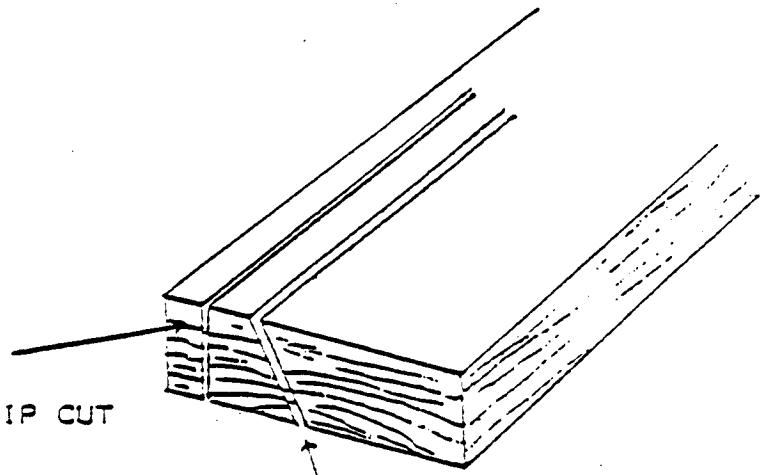
MITER CROSSCUT

BEVEL CROSSCUT

STRAIGHT CROSSCUT



BEVEL EDGE CUT



BEVEL RIP CUT

STRAIGHT RIP CUT