



## Investigation Guideline

**PRODUCT: HOME ELECTRICAL DISTRIBUTION SYSTEM COMPONENTS  
PANELBOARDS AND CIRCUIT BREAKERS**

**Appendix: # 131**

**Date: October 2, 2003**

### **I. INTRODUCTION**

Use this guideline as an aid for conducting investigations of panelboard and circuit breaker fires and fire hazards. The data collected may be drawn from a variety of sources, for instance, from: interviews, news clips, fire investigation reports, other official reports, and other relevant materials. Attach supporting documents and the data record sheet to the Epidemiologic Investigation Report Form 182 along with the narrative. CPSC staff is interested in obtaining samples of panelboards and circuit breakers that have caused fires.

The purpose of this investigation is to learn more about the characteristics of the panelboards and circuit breakers that start fires and the circumstances under which such fires occur. The causes of panelboard and circuit breaker fires may be many and varied; we would like as much detail as possible regarding the cause for each case. We are interested in data that capture (1) the physical characteristics of the panelboard/circuit breaker and (2) the design or installation features that may have contributed to the failure of the panelboard/circuit breaker. We are interested in any information that is relevant to understanding the cause of the fire or fire hazard as well as climate information in the immediate environment of the panelboard/circuit breaker.

Please remember that no guideline can cover all the pertinent factors that may apply to a particular incident. Include an explanation of any relevant factors in your narrative, even when these factors have not been specifically mentioned in this guideline.

#### **A. Background Information**

According to the 1998 Residential Fire Loss Estimates, electrical distribution equipment accounted for 38,800 fires, 1,230 civilian injuries, and 280 civilian deaths. A portion of these fires, deaths and injuries were caused by failures occurring in panelboards and circuit breakers.

#### **B. Product Description**

The National Electrical Code (NEC) definition of a panelboard is *a single panel or group of panel units designed for assembly in the form of a single panel, including buses and automatic*



## Investigation Guideline

*overcurrent devices, and equipped with or without switches for the control of light, heat, or power circuits; designed to be placed in a cabinet or cutout box placed in or against a wall, partition, or other support; and accessible only from the front.*

*A circuit breaker is a device designed to open and close a circuit by nonautomatic means and to open the circuit automatically on a predetermined overcurrent without damage to itself when properly applied within its rating (NEC).*

### **Panelboard**

Panelboards are commonly known as breaker boxes. They are sometimes even called fuse boxes even though they may or may not contain any fuses. The industry defines residential panelboards as load centers.

A panelboard consists of three major components, the enclosure, the interior, and the trim. The graphic below identifies all of the major components. The circuit breakers mount to the interior as shown later. The graphics contained throughout this document represent a typical construction. There are many variations but the concepts are the same.

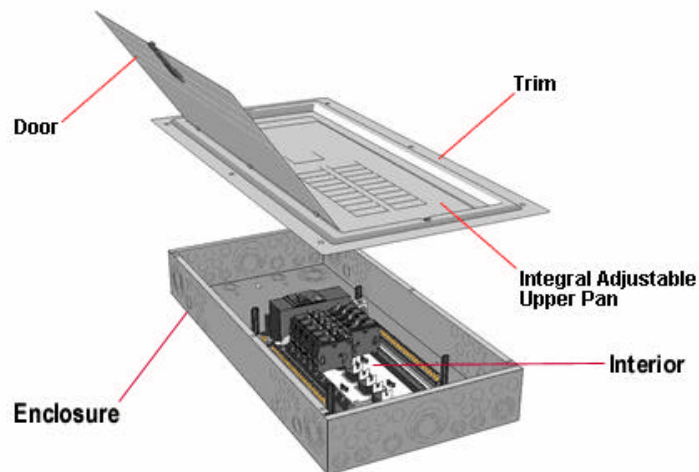

### **Types of Panelboards/Circuit breakers:**

- **Service Entrance Equipment vs. Subpanel:** Service Entrance Equipment is the panelboard that is connected directly to the electrical cable (Service Entrance Cable) that comes from the electric meter. In addition, the NEC requires that the neutral must be attached to the ground in Service Entrance Equipment. A Subpanel is a panelboard that



## Investigation Guideline

receives power from the service entrance panelboard. The NEC prohibits attaching the neutral to the ground in a Subpanel.

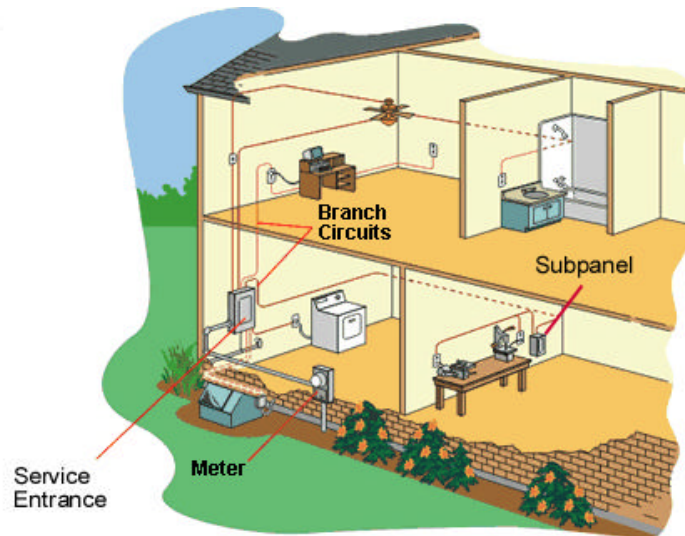

- **Main Lug Only Panelboard:** This type of panelboard has two large wire connectors (main lugs) for the power supply wires. This type of panelboard is typically used as a subpanel. The graphic below shows the interior of a Main Lug Only Panelboard.

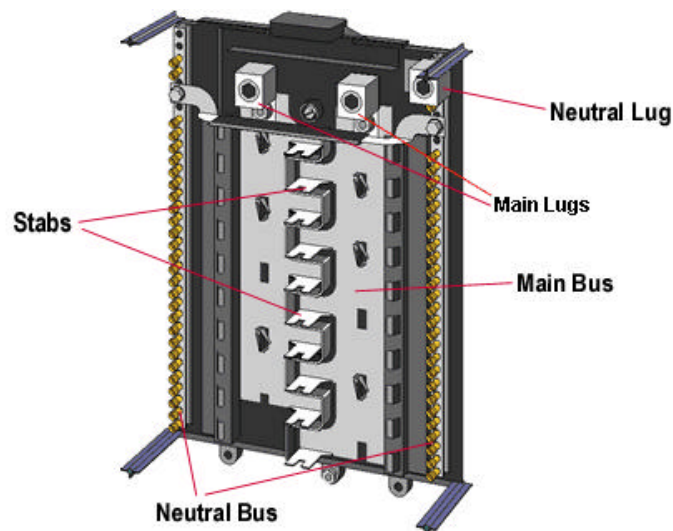

- **Main Breaker Panelboard:** This type of panelboard has an additional large two-pole breaker that transfers power to the main bus. This additional breaker, located away from the



## Investigation Guideline

remaining breakers, can sometimes identify this type of panelboard. This type of panelboard is typically used as service entrance equipment.

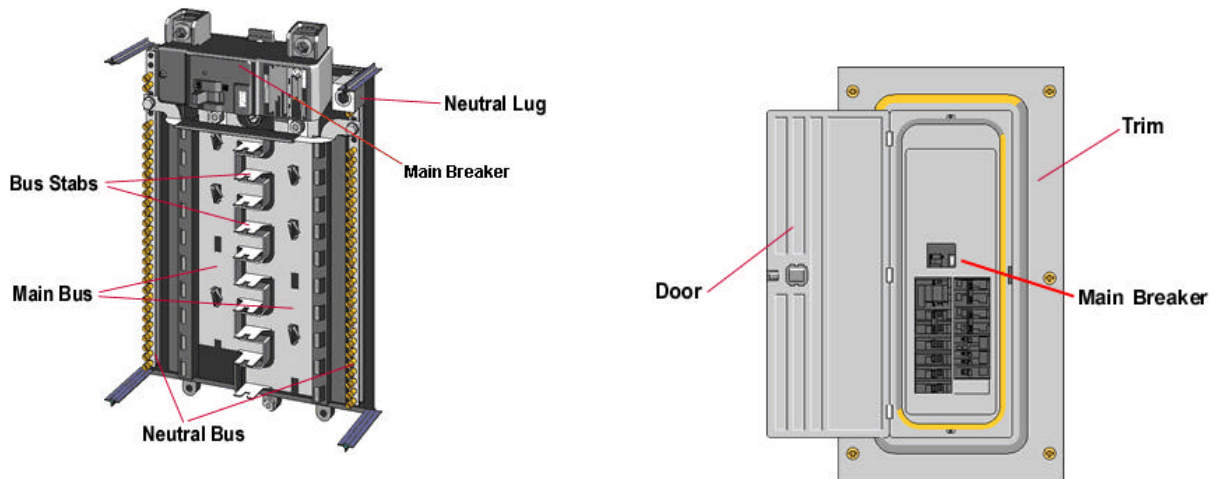

- **Split-Bus Panelboard:** This type of panelboard has two separate buses. One of the circuit breakers on the first bus transfers power to the second bus. The image below illustrates a split-bus panelboard interior. According to the NEC, a Split-Bus panelboard must have six or fewer switches that will turn off all electrical power and can only be used as Service Entrance Equipment. As can be seen in the illustration, one of the six two-pole breakers supplies power to the separated bus. Split-Bus panelboards are very rare in today's market. However, many older homes have Split-Bus panelboards.



## Investigation Guideline

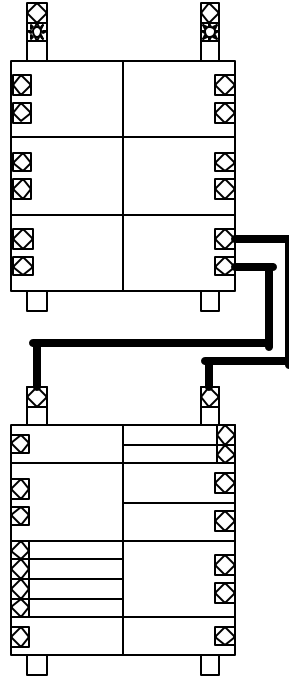

- **Circuit Breakers, etc.:** There are a wide variety of circuit breakers and devices that can be added to a panelboard. The illustration below shows some possibilities. Each will be discussed individually.

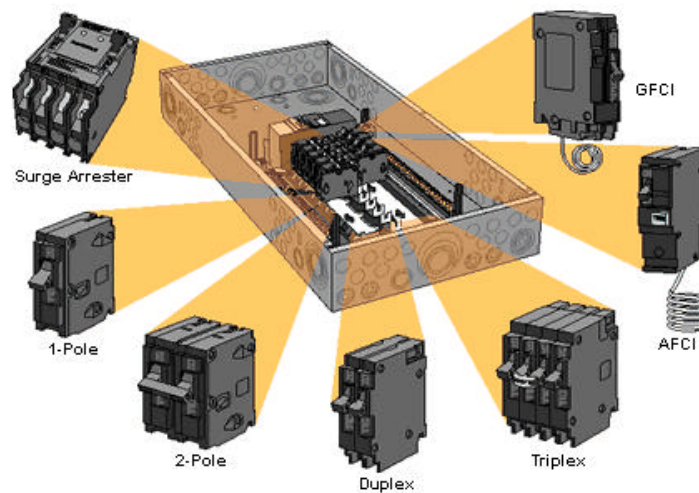



## Investigation Guideline

- ◆ **1-Pole Circuit Breaker:** This type of circuit breaker fits on one space in the panelboard and operates a 120-volt circuit, i.e., lights or receptacles. The image below depicts how a 1-pole circuit breaker fits onto a panelboard. Note how the breaker attaches to one of the fork-shaped stabs. All other circuit breakers discussed will attach in a similar manner.

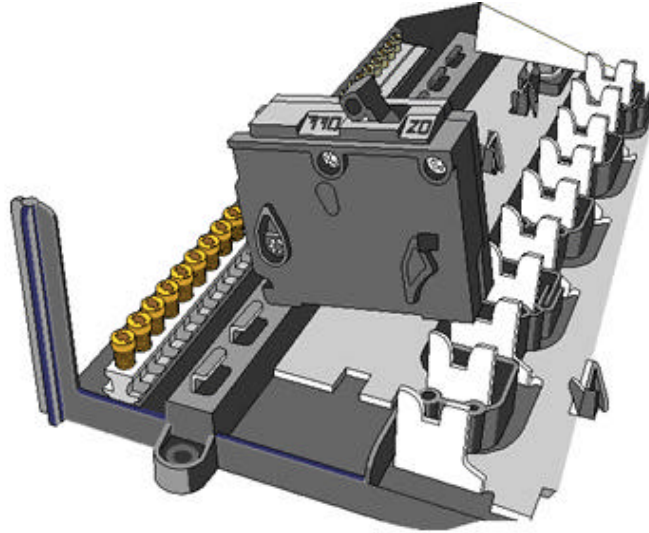

- ◆ **2-Pole Circuit Breaker:** This type of breaker fits on two spaces or stabs in the panelboard and operates a 240-volt circuit, i.e., an air conditioning unit or an electric dryer.

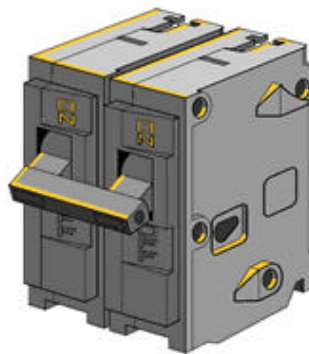

- ◆ **Duplex Circuit Breaker:** This type of breaker fits on one space or stab in the panelboard and operates two 120-volt circuits. The NEC limits the number of poles allowed in a panelboard to 42. Certain panelboards are classified as circuit limiting. This



## Investigation Guideline

means that they will not allow more than the maximum amount of poles to be installed in the panelboard. Certain mechanical steps have been taken to accomplish circuit limiting. A duplex circuit breaker counts as two poles, the same as a 2-pole circuit breaker. The image below shows how this is accomplished using notched and unnotched bus stabs on the panelboard and rejection tabs on the duplex circuit breakers.

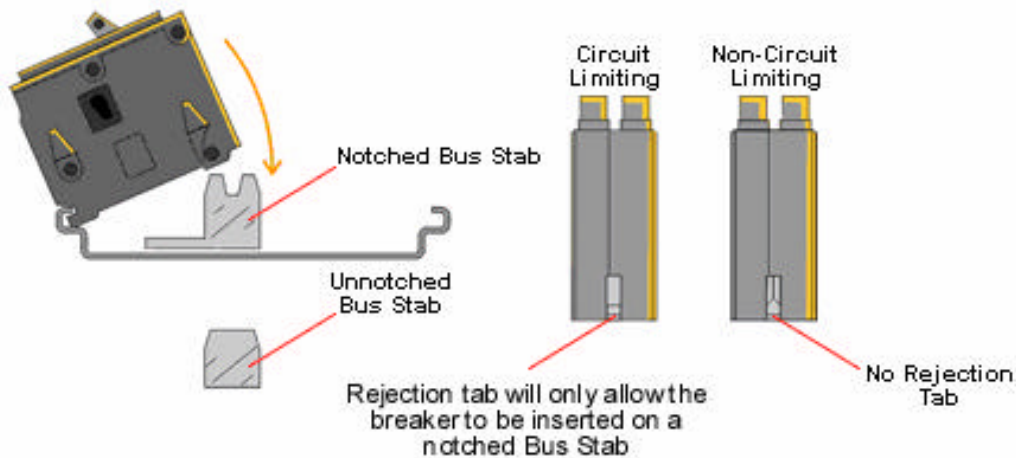

- ◆ **Quadrapole Circuit Breaker:** This breaker fits on two spaces or stabs in the panelboard and counts as four poles. This breaker can be configured multiple ways. The breaker could have four individual 120-volt circuits (four separate switch handles), two 120-volt circuits and one 240-volt circuit (the two center switch handles are tied together), or two 240-volt circuits (the two center switch handles are tied together and the two outside switch handles are tied together). The graphic below shows a Quadrapole circuit breaker configured as two 120-volt circuits and one 240-volt circuit.



## Investigation Guideline

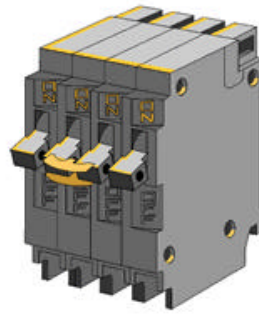

- ◆ **AFCI Circuit Breaker:** This type of breaker is a specialty breaker that continuously monitors the circuit for arcs. If it senses an arcing condition, it opens the circuit. It also performs the function of a regular circuit breaker. This type of breaker comes in both 1- and 2-pole configurations. An AFCI circuit breaker looks like a GFCI circuit breaker (discussed below). The label will indicate whether it is an AFCI or GFCI circuit breaker. There are also combination AFCI/GFCI circuit breakers that perform both functions and will be labeled as such.



The coiled wire is attached to the neutral bus when installed in the panelboard

- ◆ **GFCI Circuit Breaker:** This specialty breaker monitors the circuit for ground faults and opens the circuit when one is found. It also operates as a standard breaker and comes in





## Investigation Guideline

both 1- and 2-pole configurations. The image below shows how both AFCIs and GFCIs are mounted in a panelboard.

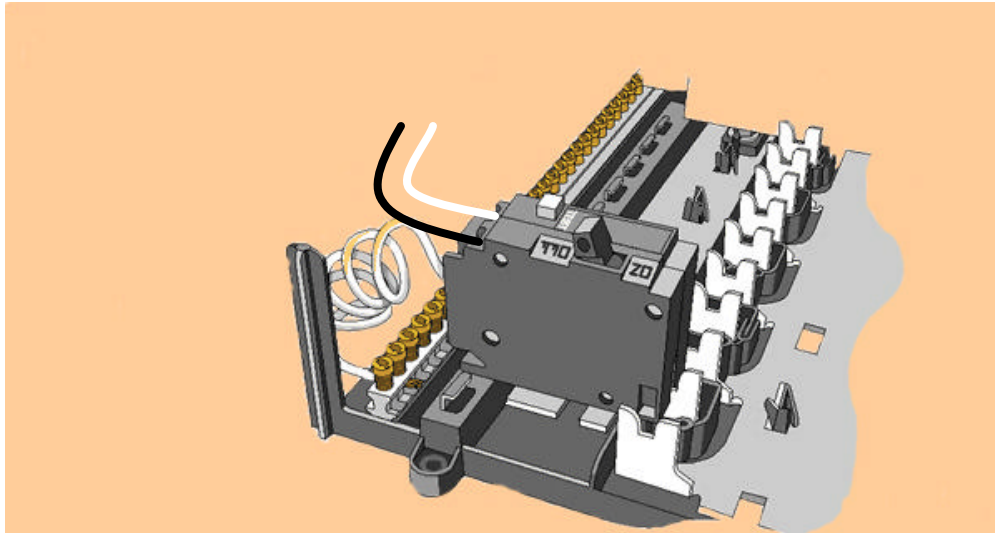

- ◆ **Summary of Circuit Breakers:** There are a wide variety of circuit breakers that can be used in panelboards. The table below shows a summary of the breakers discussed above.

| Type        | Characteristics                         | Spaces | Poles  | Typical Use  |
|-------------|---|--------|--------|--|
| Single Pole | 1 switch                                | 1      | 1      | Lighting, Receptacle Circuits                                  |
| Double Pole | 2 connected switches                    | 2      | 2      | Electric Clothes Dryers, Ranges, A/C Units, Heating            |
| Duplex      | 2 switches                              | 1      | 2      | Same as single pole  |
| Quadrapole  | 4 switches (various configurations)     | 2      | 4      | Same as both single and double pole depending on configuration |
| GFCI        | “Test” Button and additional white wire | 1 or 2 | 1 or 2 | Kitchen, Bathroom, and Outdoor Receptacles                     |
| AFCI        | “Test” Button and additional white wire | 1 or 2 | 1 or 2 | Required in Bedrooms per NEC 2002.                             |

### C. Specific Items of Interest



## Investigation Guideline

CPSC staff wants to learn as much as possible about the physical panelboard/circuit breaker and the circumstances that led to the fire. Contact Ted Gordon at the lab or Dean LaRue at headquarters to determine the need for sample collection of the fire-damaged panelboard/circuit breaker and/or identical exemplars.

Photograph the panelboard label if available. It is encouraged that a zoomed-in panoramic sequence of photographs of the label be taken. The writing on the labels is small and will be hard to read on a photograph of the entire label. The photograph below shows an example of a panelboard label.

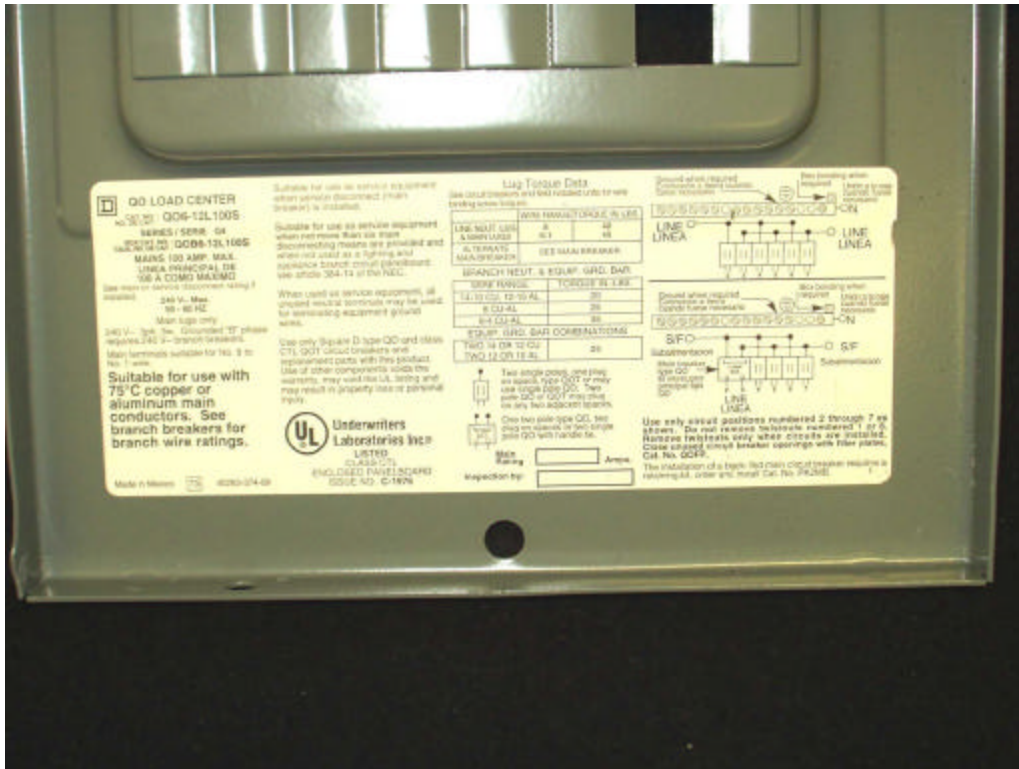

Circuit breaker labels vary drastically between manufacturers. Some lend themselves to photography and others do not. It is better to write down the information on the breaker label rather than try to photograph it. The image below shows various breakers and the location of the label.



## Investigation Guideline

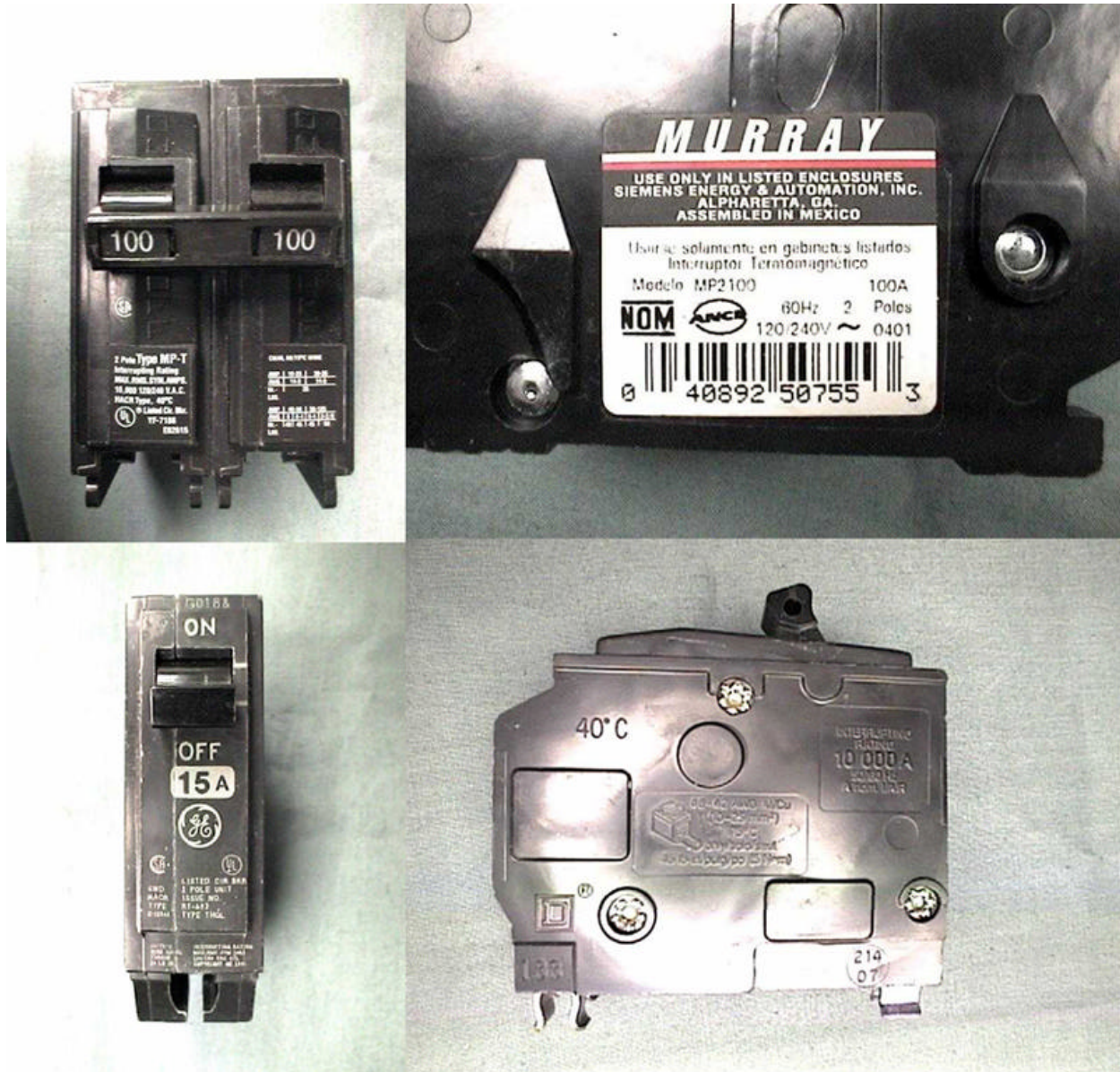

Describe the environment/climate where the panelboard was located. Was the structure ever flooded?

### **D. Headquarters Contacts**

Risana Chowdhury, EPHA, 301 504-7334, [rchowdhury@cpsc.gov](mailto:rchowdhury@cpsc.gov)

Dean LaRue, ES, 301 504-7573, [dlarue@cpsc.gov](mailto:dlarue@cpsc.gov)



## Investigation Guideline

Richard Stern, CRC, 301 504-7620, [rstern@cpsc.gov](mailto:rstern@cpsc.gov)

### **E. Laboratory Contact**

Ted Gordon, 301-424-6421 ext 113. [tgordon@cpsc.gov](mailto:tgordon@cpsc.gov)

## **II. INSTRUCTIONS FOR COLLECTING SPECIFIC INFORMATION**

### **A. Synopsis**

Write a synopsis of the sequence of events that occurred prior to, during, and subsequent to the fire. Specify the source of the ignition, the products involved, the extent of damage, and the nature of all injuries and deaths. Use the product code 4063 and use keywords *panelboard* and *circuit breaker* to ease the computer-based data retrieval process.

### **B. Description of the Incident Environment**

**PRE-INCIDENT:** Describe the structure where the panelboard/circuit breaker fire occurred. What was the age and renovation history of the structure and the panelboard/circuit breakers. Where was the panelboard located? Had there been problems with the unit before?

Describe the sequence of events that led up to the fire. Describe the course of activities directly prior to the panelboard/circuit breaker failure and the course of events directly prior to the fire breaking out. Include the major appliances in use at the time, for instance, the furnace, clothes dryer, and air conditioner, and whether the panelboard/circuit breaker was installed within the wall. Also note the weather conditions immediately prior to the incident.

**INCIDENT:** Describe the suspected cause of the panelboard/circuit breaker failure. State who made the determination of cause. Determine exactly what happened to precipitate the fire. Describe the way the fire unfolded.

- Did anyone witness the fire event? Was anyone in the room with the panelboard/circuit breaker when the fire started? Did anyone enter the room when the fire was already in progress?
- Once the fire started, did the user try to extinguish the fire him/herself? If so, how successful was the attempt? What means did s/he use to extinguish the fire? And, was the fire department called? Did the fire department respond? If so, what was the extent of the fire department's involvement?



## Investigation Guideline

**POST-INCIDENT:** Describe any damage done to the area where the panelboard/circuit breaker was located, e.g., burn marks, scorch marks, blistering, etc.

- Recount who was injured and how badly. Did anyone require hospital care? Was anyone permanently injured? Did anyone die? Please record the age, sex, and general health of the injured persons. Briefly describe the treatments the injuries required and whether any permanent injuries were incurred.
- How severe was the property damage and loss? Please provide an estimated dollar value for destroyed or damaged property and possessions and the source of the estimate.
- Did the panelboard/circuit breaker have a label with instructions for use? If so, what can the user remember about the label?

### **C. Description of Product**

(Full description of the physical panelboard/circuit breaker taken on the data record sheet.)

- Describe use patterns and characteristics.
- What company manufactured the panelboard and circuit breakers? What were the model numbers?
- When was the panelboard installed? What is the maintenance history of the panelboard/circuit breakers?
- If it has not been destroyed during the incident a good photograph or a drawing of the circuit directory would be helpful. The circuit directory is typically located on the inside of the hinged door. The image below represents a circuit directory. If possible, identify each of the types of circuit breakers and associate them with loads on the circuit directory. List the rating of each circuit breaker. The rating can usually be found on the end of the circuit breaker switch. If the circuit directory has been destroyed or is unavailable for any reason, inquire about the loads connected to the circuit breakers and make a circuit directory.



## Investigation Guideline

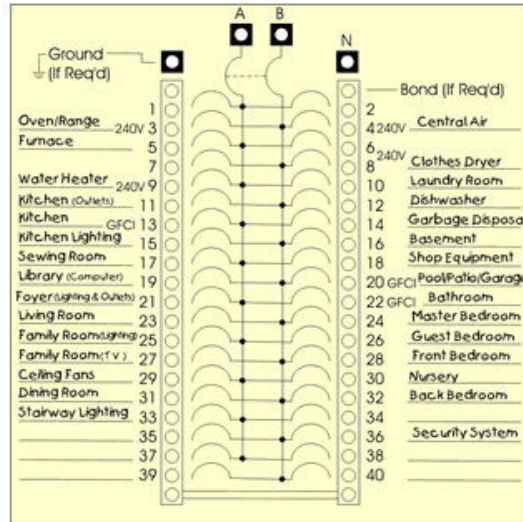

- Describe how the panelboard was installed and the material it was attached to. For example, flush or surface mounted and drywall, concrete block, etc. The image below shows a flush-mounted panelboard.

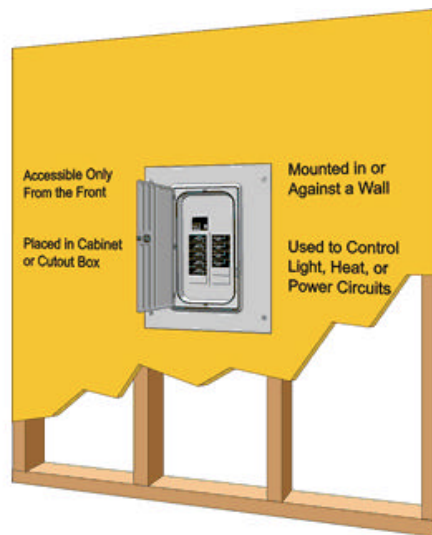

- Did the consumer notice any unusual characteristics about the way the panelboard/circuit breaker performed? For instance, did circuits trip often, did the panelboard/circuit breaker ever seem warm? If so, which circuits tripped or breakers felt warm?
- Where was the panelboard located?



## Investigation Guideline

**WARNING:** If conducting an on-site investigation, do not disturb or otherwise attempt to disassemble the panelboard or associated electrical equipment. It is possible for such equipment to sustain internal damage that may not be visually obvious. Parts of such equipment may be energized even if other investigators have taken what they believe to be the steps necessary to remove power. Examples: turning the "main breaker" off in a panelboard does not de-energize the main wire connectors and the wires which bring power into the panelboard, or a part of the breaker could be defective such that part of the panelboard remains energized even though the breaker handle is in the "off" position. Any attempt to remove the covers on such equipment, or to turn circuit breakers on or off, may lead to a catastrophic fault causing personal injury and possible ignition of surrounding combustible materials. Items in the data record sheet that require access to the interior portions of electrical equipment are to be addressed either by obtaining the information from the fire investigators, electricians, or others involved in the investigation and repair of incident damage, or when accompanied by a qualified electrician who will disassemble the equipment if necessary for your inspection. In many cases, you will be limited to recording and photographing markings which appear on the outside and inside of the hinged door of a panelboard, and the "faces" of the panelboard/circuit breakers visible when the door is opened.

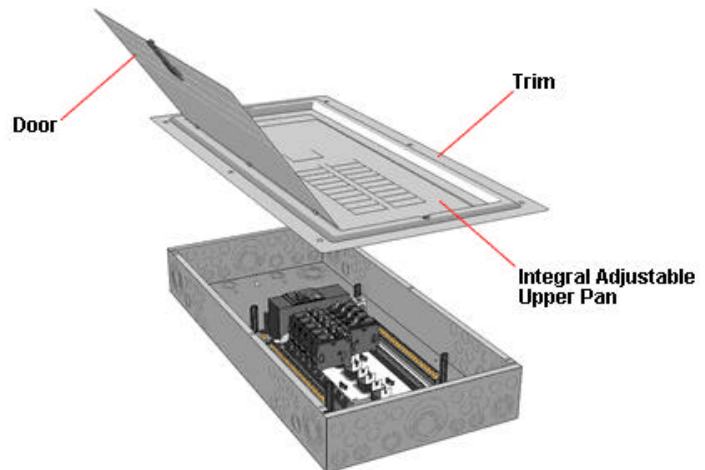

### **D. Product Safety Standards**

UL 67 – *Panelboards*

UL 489 – *Molded-Case Circuit Breakers, and Circuit-Breaker Enclosures*

### **III. PHOTOGRAPHS /DIAGRAMS OF INCIDENT SCENE**

If the incident sample of the panelboard/circuit breaker or any remnants is available, conduct an investigation. As many photographs as possible should be taken or obtained in order to document the condition of the panelboard before it is removed. Those photographs should include close-ups of any markings/labels on or inside the panelboard as well as a sufficient number from different angles to illustrate where and how the panelboard was installed and the damage that was done to the building by the panelboard failure. If the user took pictures or videotapes of the panelboard/circuit breakers, obtain copies of those pictures or videotapes. Diagram the room where the panelboard/circuit breaker was located, if possible.



## Investigation Guideline

### IV. OBTAINING SAMPLES AND DOCUMENTS RELATED TO THE INVESTIGATION

- **Samples:** Panelboard and circuit breaker samples are critical to the investigation. However, due to the nature of panelboard failures and the cost of the equipment, the best samples will be the most difficult to collect. Severely damaged panelboards will be the most readily available for collection but will provide the least amount of information as to the cause of the failure. Nevertheless, it is important to collect these samples when available.

Incidents where the failure was detected early and minimal damage to the panelboard occurred would provide the most useful information but it will be more difficult to collect the sample. Usually, the owner of the panelboard will want to repair the damaged portion of the panelboard and reuse the undamaged circuit breakers. In some cases, purchasing the sample may be necessary. Contact those listed in item 11 of the Data Record Sheet to determine whether the sample should be purchased or not.

When a sample is collected, it is important to retrieve all parts of the panelboard including all of the circuit breakers by cutting the wires approximately six inches away from the panelboard enclosure. This should not be a problem for severely damaged samples but for moderately damaged samples, an additional cost to replace the panelboard, circuit breakers, and wiring may be required.

Package the sample in a manner that will not further damage the sample or lose any loose parts.

- **Documents:** Obtain copies of the fire incident report, insurance documents, and any other investigative reports of the incident. If the incident site is a school, church, or some other type of institution, attempt to obtain their official records

### V. CORONER'S REPORT AND DEATH CERTIFICATE

In cases that involve a death or deaths, procure the coroner's report and the death certificate.





## Investigation Guideline

### DATA RECORD SHEET FOR PANELBOARD AND CIRCUIT BREAKER FIRES AND SHOCK

1. Task number \_\_\_\_\_
2. Date of incident \_\_\_\_\_
3. Characteristics of panelboard:
  - a. Panelboard enclosure dimensions: height \_\_\_\_\_ width \_\_\_\_\_ depth \_\_\_\_\_
  - b. Manufacturer: \_\_\_\_\_
  - c. Model number: \_\_\_\_\_
  - d. What kind of bus, i.e., copper or aluminum? \_\_\_\_\_
  - e. Use of panelboard (i.e., service entrance, subpanel): \_\_\_\_\_
    - i. If service entrance, what kind of wire was supplying the panelboard, i.e. copper or aluminum? \_\_\_\_\_
      - 1) If the wire was aluminum, was it compact or concentric? (ask the electrician) \_\_\_\_\_
      - 2) Was the service entrance cable actually cable or was it individual wires? \_\_\_\_\_
    - ii. If service entrance, was the panelboard properly bonded? \_\_\_\_\_
    - iii. If service entrance, was the neutral properly grounded? \_\_\_\_\_
    - iv. If a subpanel, was the panelboard properly bonded? \_\_\_\_\_
    - v. If a subpanel, was the neutral grounded? (It should not be) \_\_\_\_\_
  - f. How many poles were installed in the panelboard? \_\_\_\_\_
  - g. Location of the panelboard: \_\_\_\_\_
  - h. Type of surface panelboard was mounted to: \_\_\_\_\_
4. Were all the circuit breakers of the same manufacturer as the panelboard? It is possible that the circuit breakers were from another manufacturer. \_\_\_\_\_
5. If it is obvious that certain circuit breakers were involved in the incident, collect the following information for each circuit breaker:
  - a. Manufacturer \_\_\_\_\_
  - b. Model number \_\_\_\_\_
  - c. Type of circuit breaker, i.e., single pole, double pole, etc. \_\_\_\_\_
    - i. If the circuit breaker was supplying a 240-volt circuit, was the circuit breaker common-trip or handle-tie? \_\_\_\_\_
  - d. Electrical rating (amps) \_\_\_\_\_
  - e. Load that was connected to the circuit breaker \_\_\_\_\_
6. Did the panelboard have a label? \_\_\_\_\_



## Investigation Guideline

- a. If yes, what did it say and where was it located? If label is available, get photographs.  
\_\_\_\_\_  
\_\_\_\_\_
7. Where were the panelboard and circuit breakers purchased? \_\_\_\_\_  
\_\_\_\_\_
8. Had there been any additions, modifications, or repairs made to the panelboard/circuit breakers prior to the incident? \_\_\_\_\_  
a. If so, what? \_\_\_\_\_  
\_\_\_\_\_
- b. By whom? \_\_\_\_\_
9. Contact the person(s) who did the work described in Item 7 to determine the reason(s) for the work. If repairs were necessary to correct a prior incident, obtain a detailed explanation of the repairperson's opinion as to the cause of the previous incident. Obtain any information which may be available to support that opinion, e.g., an invoice listing the parts that were replaced, etc. \_\_\_\_\_  
\_\_\_\_\_  
\_\_\_\_\_
10. For the incident under investigation, determine if the fire investigators, electricians, or other involved in the investigation or repair of the incident damage have developed opinions on the cause(s) of the incident. Obtain a detailed explanation of the opinion(s) and the information on which the opinion(s) is/are based. \_\_\_\_\_  
\_\_\_\_\_  
\_\_\_\_\_
11. Is a sample available? If so, contact Ted Gordon 301 424-6421 ext 113 to determine the need for sample collection. Back-up contacts: Dean LaRue 301 504-7573 and Richard Stern 301 504-7620. \_\_\_\_\_
12. Was there a smoke detector in the home? \_\_\_\_\_  
a. If yes, where was it? \_\_\_\_\_  
b. Did it sound an alarm? \_\_\_\_\_
13. Was there a sprinkler system in the home? \_\_\_\_\_  
a. If yes, did it operate? \_\_\_\_\_
14. Identify the source(s) of information used to answer the above questions \_\_\_\_\_  
\_\_\_\_\_

