

# CDC Tuberculosis Surveillance Data Training

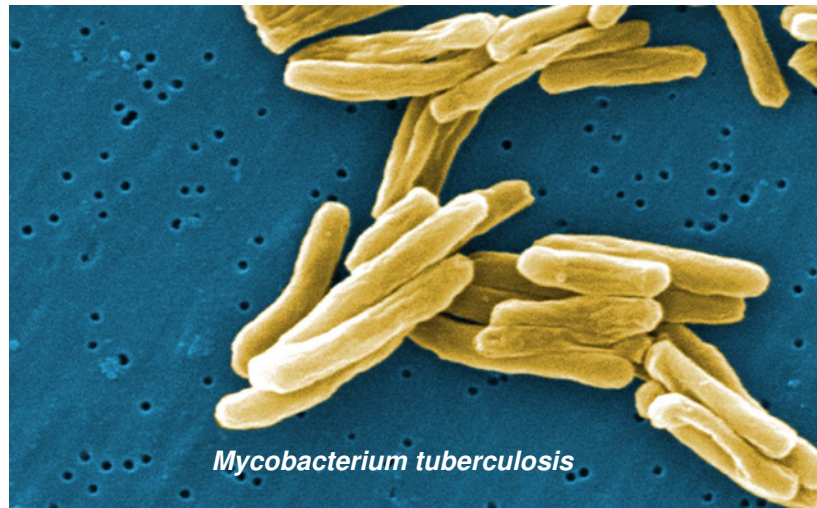

## Report of Verified Case of Tuberculosis (RVCT)

### Instruction Manual

This manual includes the instructions for how to complete each item on the RVCT. It can be used as a reference guide when completing the RVCT. The exercises from the RVCT Self-Study Modules that are used to practice completing the RVCT are not included in this manual.

June, 2009



**U.S. Department of Health and Human Services**  
**Centers for Disease Control and Prevention**  
National Center for HIV/AIDS, Viral Hepatitis, STD, and TB Prevention  
Division of Tuberculosis Elimination



## **This document was prepared by**

*The Report of a Verified Case of Tuberculosis (RVCT) Instructions and Self-Study Modules were prepared by the following branches within the Centers for Disease Control and Prevention (CDC), Division of Tuberculosis Elimination:*

### **Surveillance, Epidemiology, and Outbreak Investigations Branch**

Elvin Magee, MPH, MS  
Lilia P. Manangan, RN, MPH  
Carla Winston, PhD  
Valerie Robison, DDS, MPH, PhD  
Thomas R. Navin, MD

### **Communications, Education, and Behavioral Studies Branch**

Cheryl Tryon, MS  
Peri Hopkins, MPH  
Trang Nguyen, MPH  
Sarah Segerlind, MPH  
Teresa Goss  
Sherry Brown  
Blen Mekuria, BA

### **Field Services and Evaluation Branch**

Alstead Forbes  
Bruce Health

*Others contributing to the production of this publication:*

#### **CDC Reviewers**

Phil LoBue, MD, FACP, FCCP  
John Jereb, MD  
Sundari Mase, MD, MPH  
Wanda Walton, PhD, MEd  
Kashef Ijaz, MD, MPH  
Amera Khan, MPH  
Ann Lanner, BA  
Marie S. Morgan, BA, ELS  
Robert Pratt, BS  
Lori Armstrong, PhD  
Carla Jeffries, MPH  
Jose Becerra, MD, MPH  
Allison Maiuri, MPH  
Ijeoma Agulefo, MPH  
Glenda T. Newell, CSA

### **National Center for Health Marketing, Division of Creative Services**

Sarah Cote  
Howard Hall

**RVCT Revision Work Group  
Members, 2001-2007**

Janice Boutotte, PhD, RN  
N. Alex Bowler, MPH, FACHE  
James Cobb  
Theresa Crisp, MPH  
Mayleen Jack Ekiek, MD  
Kimberly Field, RN, PHN, MSN  
Michael E Fleenor, MD, MPH  
Lorena Jeske, RN, MN  
Stephen E. Hughes, PhD  
Scott Jones  
Yvonne Luster-Harvey, MPH  
Debbie Merz, MS  
Masahiro Narita, MD  
Mary Naughton, MD, MPH  
Lynelle Phillips, RN, MPH  
Shameer Poonja, MPH  
Carol Pozsik, RN, MPH  
Randall Reves, MD, MSc  
Maria G. Rodriguez  
Diana Schneider, DrPH, MA  
Barbara Seaworth, MD  
Sharon Sharnprapai, MS  
Muriel Silin, MPH  
Wendy Mills Sutherland, MPH  
Jacinthe Thomas, MPH  
Janice Westenhouse, MPH

**RVCT**

**Reviewers**

Cecilia Teresa T. Arciaga  
Sherri Austin  
Angelito Bravo, MD  
Gayle L. Canfield, RN  
Smita G. Chatterjee, MS  
Christine A. Feaster, M(ASCP)<sup>CM</sup>, M(NRM)  
Kitty B. Herrin, MA, PHD  
Pat F. Infield, RN  
Harvey L. Marx, Jr.  
Sandra A. Morris, MPH  
Kathleen Moser, MD, MPH  
Ellen Murray, RN, BSN  
Rebbie M. Ortega  
Lillian T. Pirog, RN, BS, PNP  
Vicki Randle, MPH, RN  
Paul Regan, PHA  
Kristina Schaller  
Gladys Simon  
Barbara Simpkins  
Mary K. Sisk, RN, CIC  
Sarah Macinski Sperry, MS  
Richard A. Stevens, DrPH, MPH, MSHSA, MS  
Barbara L. Stone, MSPH  
Jason Stout, MD  
Sharon J. Thompson, RN  
Marie P. Villa, RN  
Terri Wilson  
Josephine L. Yumul, MSc  
Edward Zuroweste, MD

*CDC would also like to thank all of the  
state and local health departments  
whose staff participated in the field tests.*

# Contents

Highlighted items = more complicated

<b>Introduction</b>				<b>Page</b>
Background				8
Overview of the RVCT Form				10
What Is New in the RVCT				15
Overview of the RVCT Instructions				16
RVCT Training Materials				17
			* Status of Item	
			New	Revised
			No Change	Page
<b>RVCT (page 1)</b>				<b>20</b>
1 – Date Reported		R		21
2 – Date Submitted		R		24
3 – Case Numbers		R		25
4 – Reporting Address for Case Counting			NC	30
5 – Count Status	N			35
6 – Date Counted		R		38
7 – Previous Diagnosis of TB Disease			NC	39
8 – Date of Birth			NC	41
9 – Sex at Birth			NC	42
10 – Ethnicity			NC	43
11 – Race			NC	44
12 – Country of Birth		R		46
13 – Month-Year Arrived in U.S.			NC	49
14 – Pediatric TB Patients (<15 years old)	N			50
15 – Status at TB Diagnosis		R		52
16 – Site of TB Disease		R		54
<b>RVCT (page 2)</b>				<b>56</b>
17 – Sputum Smear		R		57
18 – Sputum Culture		R		59
19 – Smear/Pathology/Cytology of Tissue and Other Body Fluids		R		61
20 – Culture of Tissue and Other Body Fluids		R		64
21 – Nucleic Acid Amplification Test Result	N			67
22A – Initial Chest Radiograph		R		70
22B – Initial Chest CT Scan or Other Chest Imaging Study	N			72
23 – Tuberculin (Mantoux) Skin Test at Diagnosis		R		74
24 – Interferon Gamma Release Assay for <i>Mycobacterium tuberculosis</i> at Diagnosis	N			77
25 – Primary Reason Evaluated for TB Disease	N			79

\* Status of item refers to whether the items in the revised 2009 RVCT form are new, revised, or have no change.

	Status of Item			Page
	New	Revised	No Change	
<b>RVCT (page 3)</b>				82
26 – HIV Status at Time of Diagnosis		R		83
27 – Homeless Within Past Year			NC	85
28 – Resident of Correctional Facility at Time of Diagnosis		R		87
29 – Resident of Long-Term Care Facility at Time of Diagnosis			NC	89
30 – Primary Occupation Within Past Year		R		92
31 – Injecting Drug Use Within Past Year			NC	94
32 – Non-Injecting Drug Use Within Past Year			NC	95
33 – Excess Alcohol Use Within Past Year			NC	97
34 – Additional TB Risk Factors	N			98
35 – Immigration Status at First Entry to the U.S.	N			101
36 – Date Therapy Started			NC	104
37 – Initial Drug Regimen		R		105
<b>Initial Drug Susceptibility Report Follow Up Report–1</b>				106
38 – Genotyping Accession Number	N			107
39 – Initial Drug Susceptibility Testing		R		109
40 – Initial Drug Susceptibility Results		R		111
<b>Case Completion Report Follow Up Report–2</b>				114
41 – Sputum Culture Conversion Documented		R		116
42 – Moved	N			118
43 – Date Therapy Stopped			NC	122
44 – Reason Therapy Stopped or Never Started		R		124
45 – Reason Therapy Extended > 12 Months	N			127
46 – Type of Outpatient Health Care Provider		R		128
47 – Directly Observed Therapy (DOT)		R		130
48 – Final Drug Susceptibility Testing		R		132
49 – Final Drug Susceptibility Results		R		134
<b>Appendices</b>				136
Appendix A – Tuberculosis Case Definition for Public Health Surveillance				137
Appendix B – Recommendations for Reporting and Counting Tuberculosis Cases				138
Appendix C – Anatomic Codes				148
Appendix D – Reporting Area Codes				150
Appendix E – Country Codes				151
Appendix F – Glossary				157

**Note:** Use of trade names in this publication is for identification purposes only and does not imply endorsement by the Centers for Disease Control and Prevention.

# Introduction

This section provides an introduction to the Report of Verified Case of Tuberculosis and an overview of the form, the instructions, as well as information on continuing education, and additional materials.

Report of Verified Case of Tuberculosis - Page 1. This form includes patient information, a grid for recording drug resistance patterns (Isoniazid, Rifampin, Ethambutol, Pyrazinamide, Fluoroquinolones, and Second-line drugs), and sections for reporting TB disease history, HIV status, and TB treatment history.

Report of Verified Case of Tuberculosis - Page 2. This form contains sections for reporting TB disease history (A, B, C, D, E, F, G, H, I, J, K, L, M, N, O, P, Q, R, S, T, U, V, W, X, Y, Z), HIV status (A, B, C, D, E, F, G, H, I, J, K, L, M, N, O, P, Q, R, S, T, U, V, W, X, Y, Z), and TB treatment history (A, B, C, D, E, F, G, H, I, J, K, L, M, N, O, P, Q, R, S, T, U, V, W, X, Y, Z).

Report of Verified Case of Tuberculosis - Page 3. This form includes sections for reporting TB disease history (A, B, C, D, E, F, G, H, I, J, K, L, M, N, O, P, Q, R, S, T, U, V, W, X, Y, Z), HIV status (A, B, C, D, E, F, G, H, I, J, K, L, M, N, O, P, Q, R, S, T, U, V, W, X, Y, Z), and TB treatment history (A, B, C, D, E, F, G, H, I, J, K, L, M, N, O, P, Q, R, S, T, U, V, W, X, Y, Z).

Report of Verified Case of Tuberculosis - Page 4. This form includes sections for Initial Drug Susceptibility Report (A, B, C, D, E, F, G, H, I, J, K, L, M, N, O, P, Q, R, S, T, U, V, W, X, Y, Z) and Summary Report for all culture-positive cases (A, B, C, D, E, F, G, H, I, J, K, L, M, N, O, P, Q, R, S, T, U, V, W, X, Y, Z).

Report of Verified Case of Tuberculosis - Page 5. This form includes sections for Case Completion Report - Continued (A, B, C, D, E, F, G, H, I, J, K, L, M, N, O, P, Q, R, S, T, U, V, W, X, Y, Z) and Summary Report for all culture-positive cases (A, B, C, D, E, F, G, H, I, J, K, L, M, N, O, P, Q, R, S, T, U, V, W, X, Y, Z).

Report of Verified Case of Tuberculosis - Page 6. This form includes sections for Case Completion Report - Continued (A, B, C, D, E, F, G, H, I, J, K, L, M, N, O, P, Q, R, S, T, U, V, W, X, Y, Z) and Summary Report for all culture-positive cases (A, B, C, D, E, F, G, H, I, J, K, L, M, N, O, P, Q, R, S, T, U, V, W, X, Y, Z).

## Introduction Contents

---

Section	Page
<b>Introduction</b>	<b>8</b>
Background	8
Tuberculosis Surveillance Data	8
Impact of RVCT Data	8
Quality Assurance	9
<b>Overview of the RVCT Form</b>	<b>10</b>
Required and Recommended Uses of the RVCT	10
RVCT Form	11
RVCT Items	13
Unknown Dates	13
Pending vs. Unknown Information	13
Updating of Forms	13
Additional Reporting Forms	14
Data Entry and Security	14
Patient Confidentiality	14
<b>What Is New in the RVCT</b>	<b>15</b>
New and Updated Variables	15
Recurrences of TB	16
<b>Overview of the RVCT Instructions</b>	<b>16</b>
<b>RVCT Training Materials</b>	<b>17</b>
RVCT Self-Study Modules	17
Continuing Education	18
How to View or Order Materials	18

## Introduction

---

### Background

---

Tuberculosis (TB) is a nationally notifiable disease, in that reporting is mandated in all states. In 1953, a national surveillance system was established to collect information on new cases of active TB. Since 1985, all states have been reporting TB cases to the Centers for Disease Control and Prevention (CDC) using the Report of Verified Case of Tuberculosis (RVCT), the national TB surveillance form. Data are collected by state and local TB programs and submitted electronically to CDC, Division of Tuberculosis Elimination (DTBE). These data are used to monitor national TB trends, identify priority needs, and create the DTBE annual surveillance report, *Reported Tuberculosis in the United States*.

To control and eventually eliminate TB, state and local TB control programs must be able to monitor trends in TB disease in high-risk populations, as well as identify new patterns of disease and possible outbreaks. The last major revision of the RVCT was completed in 1993. Since 2001, members of a DTBE-sponsored work group consisting of nearly 30 public health professionals from 15 TB control programs, DTBE, and the National TB Controllers Association (NTCA) have been working to revise the RVCT. Modifications to the RVCT data collection now accommodate the changing epidemiology of TB in terms of risk factors, new drug treatments, and enhanced laboratory capacity for diagnostic tests.

**Note:** A case of TB is defined as an episode of TB disease in a person meeting the laboratory or clinical criteria for TB as defined in Appendix A – Tuberculosis Case Definition for Public Health Surveillance.

### Tuberculosis Surveillance Data

---

Some states may use a modified version of the RVCT or a data collection tool that is unique to their jurisdiction. These forms are used to collect the same data contained in the RVCT. However, just as the actual RVCT form is not sent to CDC, neither are these locally defined variables or additional data. CDC should never receive names of persons with TB. Names are retained by the state or local health department. Locally assigned numbers and characters are used for case identification and are included in **Case Numbers** (item 3) for use by CDC. See **Case Numbers** (item 3) for more information.

### Impact of RVCT Data

---

The revised RVCT will assist TB control programs in gathering accurate and useful data. The additions and changes made to the variables of the RVCT will enable programs to capture data that are more inclusive of a variety of risk factors. These additional data will be essential to efficient and effective TB program management. The following table illustrates how the revised RVCT data can improve TB programs, and the consequences of having inaccurate or incomplete data.



## Impact of Revised RVCT Data

Benefits of RVCT Data	Consequences of Inaccurate, Incomplete, or Unknown RVCT Data
<ul style="list-style-type: none"><li>• Increased ability to assess program performance, completeness of data collection, and accuracy of reporting</li><li>• Improved data for program planning and policy development (e.g., personnel, resources, funding)</li><li>• Facilitation of patient services (e.g., quality of care, continuity of care, sharing of accurate information with patient and health facilities)</li></ul>	<ul style="list-style-type: none"><li>• Inaccurate follow-up of services to patients</li><li>• Inadequate resources (e.g., funding, staff, facilities, drugs, and supplies)</li><li>• Inaccurate evaluation and policy development</li><li>• Misrepresentation of the public health burden of TB</li><li>• Inability to measure TB program indicators that are based on surveillance data</li></ul>

## Quality Assurance

Assuring data completeness and quality is encouraged for all case reporting. Each reporting area should develop its own policy or procedure for reviewing and updating incomplete or incorrect data. These procedures should ensure that the data are collected and entered in the surveillance system accurately.

Although health departments share TB surveillance data with CDC, the responsibility and authority for TB surveillance rests with the health department. States vary in the structure and organization of their surveillance systems, and often in the completeness or quality assurance of their case reporting. As with any reportable disease, the completeness of TB reporting reflects how actively health departments solicit case report information. Historically, disease surveillance systems have been categorized as passive or active.

- **Passive surveillance**  
Health departments passively receive case reports from health care providers, depending on the health care providers to know and comply with reporting requirements.
- **Active surveillance**  
Health departments actively contact and interact with health care facilities or individual providers to stimulate disease reporting, sometimes directly assuming the primary responsibility of reporting cases from large or high-volume institutions.

CDC provides funding and technical assistance to health departments to actively stimulate TB case reporting, and has encouraged them to take an active rather than passive approach to TB surveillance. Health departments are encouraged to identify local or private health care facilities that serve TB patients. Health departments are also encouraged to use other data sources to identify TB cases, including death certificates and laboratory reports.

## Overview of the RVCT Form

The RVCT form is designed for the collection of information on cases of TB. The expanded RVCT was approved by the Office of Management and Budget (OMB) in 2008 to become effective January 2009.

**Note:** On the RVCT form and throughout this document, the term *state* is used to refer to the reporting jurisdiction (or count authority), though not all jurisdictions are states.

### Required and Recommended Uses of the RVCT

The following table indicates the required and recommended uses of the RVCT.

Required Use of the RVCT	Additional Recommended Uses of the RVCT	Possible Use of the RVCT for a Suspected Case of TB
The RVCT <b>must</b> be completed for <b>all verified cases of TB</b> that are to be included in the reporting area's annual morbidity count.	CDC <b>recommends</b> the use of RVCT forms for the collection of data on the following: <ul style="list-style-type: none"> <li>• Transfer TB cases (e.g., TB cases counted in another state or country)</li> <li>• TB cases that recur <b>within</b> 12 months after the completion of therapy</li> </ul>	Reporting areas <b>may</b> also use the RVCT forms for the collection of data on a suspected case of TB or on a patient with latent TB infection (LTBI).

For the purposes of surveillance, a case of TB is defined on the basis of laboratory and/or clinical evidence of active disease due to *M. tuberculosis* complex. For more information on the case definition of *M. tuberculosis* complex, see Appendix A – Tuberculosis Case Definition for Public Health Surveillance.

**Note:** The instructions contained in this document do **not** apply to suspected cases of TB or to patients with latent TB infection (LTBI).

## RVCT Form

---

The expanded RVCT form comprises three data collection reports, which are printed in triplicate on carbonless paper:

1. Report of Verified Case of Tuberculosis: Complete this form for all patients with a verified case of TB.
2. Initial Drug Susceptibility Report (Follow-Up Report 1): Complete this form for all patients who had a culture that was positive for *M. tuberculosis* complex.
3. Case Completion Report (Follow-Up Report 2): Complete this form for all patients who were alive when TB was diagnosed.

The two follow-up reports supplement the Report of Verified Case of Tuberculosis.

The three reports in the RVCT form are

- **Not necessarily completed for all patients**
- **Not completed all at one time.**

The following table provides a description of each report, for whom it is completed, and when it is completed.

**Note:** It is strongly recommended that the hard copy of the RVCT form be completed by a health care provider and maintained in the TB patient's medical record in a secured (locked) area.

# The Three Reports Comprising the RVCT Form

## Report of Verified Case of Tuberculosis

- Includes data about patient demographics, laboratory results, and risk associated with TB
- Complete for **all patients with a verified case of TB disease**
- Complete **over time (evaluation process and treatment)** as the information from the patient, the laboratory reports, and medical records become available

### Page 1 (Items 1 – 16)

### Page 2 (Items 17 – 25)

### Page 3 (Items 26 – 37)

## Initial Drug Susceptibility Report (Follow Up Report - 1)

- Includes genotyping information and drug susceptibility testing results
- Complete for **all patients who had a positive culture result for *Mycobacterium tuberculosis* complex**
- Do not complete for patients with negative culture or no results for culture
- Complete after susceptibility test results are received

### Page 1 (Items 38 – 40)

## Case Completion Report (Follow Up Report - 2)

- Includes treatment outcomes collected
- Complete for **all patients who were alive when TB was diagnosed**
- Complete after treatment ends; the case completion report is due no later than 2 years after the initial RVCT

### Page 1 (Items 41 – 46)

### Page 2 (Items 47 – 49)

## RVCT Items

---

The revised RVCT form includes 49 items. The characteristics are varied; for example,

- Some items include one variable response
- Some items include more than one response (e.g., Items 3 and 4)
- Each item is delineated in its own box
- Some boxes are grouped together in larger boxes to visually and logically organize the space

Items are not necessarily listed in the order in which you might receive the information

Data are entered on the RVCT form in several ways:

1. Writing in dates and other numbers (e.g., Items 1, 2, and 3)
2. Checking boxes (e.g., Items 9, 10, and 11)
  - a. Select one
  - b. Select all that apply
3. Writing in specific information (e.g., Items 12, 14)
4. Writing in comments (e.g., page 3, Follow Up Report–1, or Follow Up Report–2)

## Unknown Dates

---

There are several items that include dates. When entering dates on the form, use “99” for an unknown month or day, and “9999” for an unknown year. This may vary from what will be entered into a computer software program.

- 03 **99** 2009 – for March, unknown day, in 2009
- **99 99** 2009 – for unknown month and day in 2009
- 01 02 **9999** – for January 2, in a year that is unknown

**Note:** For each item that includes dates, read the instructions carefully about entering month, day, and year. Some items (e.g., **Date Reported**, Item 1) require that the actual month and year **always** need to be entered. For those items, the actual month (not 99) should be entered, and the actual year (not 9999) should be entered.

## Pending vs. Unknown Information

---

Leave the item blank if the information requested is pending (or missing). If a valid value cannot be determined and there is no check-box labeled Unknown, write the word *Unknown* inside the box that encloses the numbered item. This unknown notation will help the person entering the data in the software to know that the person who completed the form attempted to collect the information but was not able to do so. The data entry person will thus be better able to distinguish between data that are unknown and data that are pending (missing). CDC encourages active surveillance or collection of all applicable information. Therefore “unknown” information should be rare.

## Updating of Forms

---

It may be necessary to update RVCT forms if a case is reopened (e.g., a patient who had been lost to follow-up is found) or if previously unavailable information is obtained. CDC recommends highlighting such changes on the hard copy to facilitate data entry into the software system designated by your jurisdiction. When updated data are entered in an electronic record, the new data will automatically overwrite the old data.

## Additional Reporting Forms

---

If the reporting area has its own TB case reporting form and uses it to complete the RVCT variables, the staff should carefully review the RVCT variables and the instructions in this document to ensure that variables on the reporting area's form match those on the RVCT form.

## Data Entry and Security

---

Data obtained from RVCT forms are entered in the software system designated by your jurisdiction and then transmitted electronically to CDC.

Data security is the responsibility of the state or local health department. **Completed RVCT forms should never be sent to CDC.**

Access to the RVCT forms and data entry software should be restricted to individuals authorized to perform TB surveillance activities. Hard copies should be stored in a secured (locked) area. Access to the approved data entry software and local databases should be controlled through the use of a local user identification (user ID) and password. All other electronic surveillance files should also be protected with passwords known only to designated surveillance staff.

## Patient Confidentiality

---

**Case numbers must not include personal identifiers.** Do not use names, initials, Social Security numbers, addresses, telephone numbers, or other information that could identify a patient.

Because of the sensitive nature of some of the data collected, CDC has provided an Assurance of Confidentiality for the expanded surveillance system. Information on the RVCT forms and in the TB surveillance databases that would permit identification of any individual will be held in confidence and will not be released without the consent of the individual, in accordance with sections 306 and 308(d) of the Public Health Services Act (42 U.S.C. 242k and 242m).

Local patient identifier information, although collected by state and local health departments, is not reported to CDC. Surveillance information reported to CDC is used for statistical and analytic summaries in which no individual can be identified and for special investigations of the natural history and epidemiology of TB.

## What Is New in the RVCT

---

The RVCT form has items that are either new or revised from the previous RVCT that was published in 1993. To help orient previous RVCT users to the new items, the table of contents (at the beginning of this document) indicates which items are new, revised, or unchanged.

The RVCT **State Case Number** (item 3), also known as the RVCT number, has been standardized by adding a 4-digit code for year and a 2-character (alpha) code for state (or jurisdictional code for jurisdictions that are not states) to the 9-character alphanumeric local identifier, so that each state case number is unique for year and state. The additions to the State Case Number will help when trying to identify a TB patient who has been transferred from one health jurisdiction (e.g., state) to another, and when trying to link TB cases (e.g., recurrences, contact investigations).

### New and Updated Variables

---

Eleven new variables were added to improve data collection. These variables (items) are indicated in the table below.

#### New Variables in the Revised RVCT

Item #	New Variables
5	Count status
14	Pediatric TB patients
21	Nucleic acid amplification test
22B	Initial chest CT scan or other chest imaging study
24	Interferon gamma release assay
25	Primary reason evaluated for TB disease
34	Additional TB risk factors
35	Immigration status
38	Genotyping accession number
42	Moved
45	Reason therapy was extended for more than 12 months

A new variable called **Count Status** (item 5) was added to separate counted and noncountable TB cases. Data can now be collected on noncountable TB cases to help identify specific cases for analysis and help measure TB morbidity and case management burden. Noncountable cases are verified TB cases that cannot be counted because they do **not** meet the surveillance definition of a countable case.

Additional new variables include TB risk factors, such as diabetes, end-stage renal disease, immunosuppressive therapy, and the use of tumor necrosis factor-alpha antagonists.

Other variables have been updated to reflect the changing field of TB epidemiology and to collect more accurate data on TB cases. Modified variables include the addition of dates of tuberculin skin testing (item 23) and of specimen collection for other diagnostic tests, along with result dates by laboratory type (items 17–21 for smear and culture results).

## Recurrences of TB

The new variable, **Count Status** (item 5), allows data collection on the recurrence (more than one separate and distinct episode) of TB. Most recurrences occur within 6–12 months after the completion of therapy. For surveillance purposes, a description of how this is counted is illustrated in the following table.

### Counting Reported TB Cases

**A patient may have more than 1 discrete (separate and distinct) episode of TB disease**

TB Disease Recurs Within a Consecutive 12-month Period After the Patient Completed Therapy	TB Disease Recurs More Than 12 Months After the Patient Completed Therapy
Recurrence is considered the same episode (count only 1 episode as a case for that year; within a 12-month period, <b>not</b> calendar year).	Recurrence is considered a separate episode.
Do <b>not</b> count as a new case.	Count as a new case.

More information about recurrences of TB is provided in **Case Number** (item 3).

## Overview of the RVCT Instructions

The RVCT instructions provide information on how to complete the 49 items on the RVCT form. The instructions provide details about each item, explain the nuances of how to answer the items, and also provide examples to illustrate how to apply the instructions for entering data for a TB case. The instructions are available in two formats.

- The Report of Verified Case of Tuberculosis Instruction Manual** (this manual)  
This document includes only the instructions (i.e., the exercises are not included) for each item on the RVCT. It can be used as a reference tool by those who complete the RVCT. For downloading the RVCT Instruction Manual from the internet, see the section below on “Additional RVCT Materials.”
- The Report of Verified Case of Tuberculosis Self-Study Modules**  
In the modules, the instructions are integrated with exercises (study questions and case studies). This provides an opportunity to practice applying the instructions to life-like situations. For more information, see the section below on “Additional RVCT Materials.”



## RVCT Training Materials

---

To help health care staff learn how to accurately complete the RVCT the following training materials have been developed:

- **RVCT Self-Study Modules Participant Manual**
- **RVCT Self-Study Modules Facilitator Manual**
- **RVCT Instruction Manual** (this manual, it includes instructions only)
- **RVCT Self-Study Modules Exercises** (exercises only)
- **RVCT Materials Description**
- **RVCT Materials CD ROM**

### RVCT Self-Study Modules

---

The Report of Verified Case of Tuberculosis Self-Study Modules are described below.

- **RVCT Self-Study Modules**

The modules consist of the following components:

- **Instructions for how to complete each item on the RVCT** (the same instructions as are in this manual)  
Each item in the RVCT has detailed instructions that explain how to complete the item. **It is very important to read the instructions for an item before answering the study questions.** The instructions provide information on how to interpret the items and options, and provide examples that illustrate how to answer in specified situations.
- **Exercises**  
The instructions for each item are followed by exercises that will help you apply the instructions to life-like situations and practice completing the RVCT.

The modules can be used in the following ways:

- 1. For individuals to learn in a self-study format**

Health care workers can use the modules according to their needs

- Working through them at their own pace
  - Completing the whole set of modules without interruption
  - Completing one module at a time (e.g., one module per day)
- Using the modules as a reference

- 2. As part of a 2-day facilitator-led training course**

The self-study modules can be used as part of a training course that is led by a facilitator.

- Participants work through the modules
- Facilitators lead group discussions about the instructions and the exercises, and engage the participants in learning how to use the RVCT

A facilitator's guide is available that includes information on the best way to teach the RVCT training course to others.

## Continuing Education

---

Continuing education units are available free of charge for the RVCT Self-Study Modules. For more information, see the Introduction section in the modules or visit the CDC web site, [www.cdc.gov/tb](http://www.cdc.gov/tb).

## How to View or Order RVCT Materials

---

The chart on the next page describes the RVCT materials in detail and indicates how they can be used, lists the available file formats, and describes how the materials can be ordered and downloaded. There are no charges for ordering the materials from CDC.

**List of RVCT Training Materials**  
(There are no charges for these materials)

Note: the spaces in the FTP URL

FTP site to download RVCT materials: [ftp://ftp.cdc.gov/pub/Software/TIMS/2009 RVCT Documentation/RVCT Training Materials/](ftp://ftp.cdc.gov/pub/Software/TIMS/2009_RVCT_Documentation/RVCT_Training_Materials/)  
 CDC/DTBE web site to view and download RVCT materials: [www.cdc.gov/tb](http://www.cdc.gov/tb)

Materials	Description	File Formats Available		How to Order
		On FTP site and CD ROM	On CDC/DTBE web site	
<b>RVCT Self-Study Modules Participant Manual (with CD ROM)</b>	Print-based modules to help health care staff learn how to accurately complete the RVCT. Includes <ul style="list-style-type: none"> <li>• Instructions for how to complete each item on the RVCT</li> <li>• Exercises that will help participants apply the instructions to life-like situations</li> </ul> Can be used as self-study or part of a training course.	PDF	PDF	E-mail or Fax RVCT Materials Order Form (see form for instructions)
<b>RVCT Self-Study Modules Facilitator Manual (with CD ROM)</b>	Print-based modules for facilitators who will teach health care staff how to complete the RVCT. Contains the same content as the RVCT Self-Study Modules Participant Manual plus training materials for facilitators. <ul style="list-style-type: none"> <li>• Instructions for how to complete each item on the RVCT</li> <li>• Exercises that will help participants apply the instructions to life-like situations</li> <li>• Facilitator guide, answers to exercises, and other training documents</li> </ul>	PDF of manual. Various formats for other training documents		E-mail or Fax RVCT Materials Order Form (see form for instructions)
<b>RVCT Instruction Manual</b>	Print-based document includes instructions for how to complete each item on the RVCT. Can be used as a reference guide when completing the RVCT. (Does <b>not</b> include the exercises from the Self-Study Modules.)	PDF	PDF	
<b>RVCT Self-Study Modules Exercises</b>	Print-based document includes <b>only</b> the exercises (with answers) used in the Self-Study Modules Participant Manual. (Does <b>not</b> include the instructions for how to complete each item on the RVCT.) Exercises can be used and adapted by local jurisdictions.	Microsoft Word		(Available only on the FTP site or CD ROM)
<b>RVCT Materials Description</b>	Description of the RVCT materials	PDF	HTML	
<b>RVCT Materials Order Form</b>	Form used to order the RVCT materials from CDC.	Microsoft Word		E-mail or Fax RVCT Materials Order Form (see form for instructions)
<b>RVCT Materials CD ROM</b>	For those who want to order the CD ROM <b>only</b> . Includes the electronic files of the following documents: <ul style="list-style-type: none"> <li>• RVCT Participant Manual</li> <li>• RVCT Facilitator Manual and training materials</li> <li>• RVCT Instruction Manual</li> <li>• RVCT Self-Study Module Exercises</li> <li>• RVCT Materials Description</li> <li>• RVCT Materials Order Form</li> </ul>	Various formats		E-mail or Fax RVCT Materials Order Form (see form for instructions)

# RVCT (page 1 of 3) Items 1 – 16

The RVCT report includes the first three pages of the RVCT data collection form. **Complete this report for all patients with a verified case of TB disease.** Page 1 of the RVCT report provides instructions for completing items 1 – 16. This first page of the report includes data about patient demographics and site of disease.

Patient's Name _____ (last) _____ (first) _____ (middle) Street Address _____ (zip code) _____ (zip code) _____ (zip code)		<b>REPORT OF VERIFIED CASE OF TUBERCULOSIS</b>
<b>REPORT OF VERIFIED CASE OF TUBERCULOSIS</b> <span style="float: right; font-size: small;">U.S. DEPARTMENT OF HEALTH AND HUMAN SERVICES FORM APPROVED CMS 10-00002-01-00000101</span>		
<b>1. Date Reported</b> Month _____ Day _____ Year _____ _____	<b>3. Case Numbers</b> Year Reported (YYYY) _____ State Code _____ Locally Assigned Identification Number _____ State Case Number _____ City/County Case Number _____ Reason: _____ Linking State Case Number _____ Linking State Case Number _____	
<b>2. Date Submitted</b> Month _____ Day _____ Year _____ _____	_____	
<b>4. Reporting Address for Case Counting</b> City _____ Within City Units (select one) <input type="checkbox"/> Yes <input type="checkbox"/> No County _____ ZIP CODE _____		<b>9. Date of Birth</b> Month _____ Day _____ Year _____ <b>9. Sex at Birth (select one)</b> <input type="checkbox"/> Male <input type="checkbox"/> Female <b>10. Ethnicity (select one)</b> <input type="checkbox"/> Hispanic or Latino <input type="checkbox"/> Not Hispanic or Latino
<b>5. Count Status (select one)</b> <input type="checkbox"/> Countable TB Case Count as a TB case <b>Noncountable TB Case</b> <input type="checkbox"/> Verified Case: Counted by another U.S. area (e.g., county, state) <input type="checkbox"/> Verified Case: TB treatment initiated in another country Specify _____ <input type="checkbox"/> Verified Case: Recurrent TB within 12 months after completion of therapy		<b>11. Race (select one or more)</b> <input type="checkbox"/> American Indian or Alaska Native <input type="checkbox"/> Asian: Specify _____ <input type="checkbox"/> Black or African American <input type="checkbox"/> Native Hawaiian or Other Pacific Islander Specify _____ <input type="checkbox"/> White
<b>6. Date Counted</b> Month _____ Day _____ Year _____ _____	<b>7. Previous Diagnosis of TB Disease (select one)</b> <input type="checkbox"/> Yes <input type="checkbox"/> No If YES, enter year of previous TB disease diagnosis: _____	
<b>12. Country of Birth</b> "U.S.-born" (or born abroad to a parent who was a U.S. citizen) (select one) <input type="checkbox"/> Yes <input type="checkbox"/> No Country of birth: Specify _____		<b>13. Month-Year Arrived in U.S.</b> Month _____ Year _____
<b>14. Pediatric TB Patients (&lt;15 years old)</b> Country of Birth for Primary Guardian(s): Specify _____ Guardian 1 _____ Guardian 2 _____ Patient lived outside U.S. for >2 months? <input type="checkbox"/> Yes <input type="checkbox"/> No <input type="checkbox"/> Unknown If YES, list countries, specify: _____		<b>15. Status at TB Diagnosis (select one)</b> <input type="checkbox"/> Alive <input type="checkbox"/> Dead If DEAD, enter date of death: _____ If DEAD, was TB a cause of death? (select one) <input type="checkbox"/> Yes <input type="checkbox"/> No <input type="checkbox"/> Unknown
<b>16. Site of TB Disease (select all that apply)</b> <input type="checkbox"/> Pulmonary <input type="checkbox"/> Bone and/or Joint <input type="checkbox"/> Pleural <input type="checkbox"/> Gastrointestinal <input type="checkbox"/> Lymphatic: Cervical <input type="checkbox"/> Meningeal <input type="checkbox"/> Lymphatic: Intrathoracic <input type="checkbox"/> Peritoneal <input type="checkbox"/> Lymphatic: Axillary <input type="checkbox"/> Other: Enter anatomic code(s) (see list) _____ <input type="checkbox"/> Lymphatic: Other <input type="checkbox"/> Site not stated <input type="checkbox"/> Lymphatic: Unknown <input type="checkbox"/> Laryngeal		_____ _____ _____
Public reporting burden of this collection of information is estimated to average 30 minutes per response, including the time for reviewing instructions, searching existing data sources, gathering and maintaining the data needed and completing and reviewing the collection of information. An agency may not conduct or sponsor, and a person is not required to respond to a collection of information unless it displays a currently valid OMB control number. Send comments regarding this burden estimate or any other aspect of this collection of information, including suggestions for reducing this burden to OIG, Project Clearance Office, 1200 Clifton Road, NE, Atlanta, GA 30333, ATTN: PRA (paperwork) project. Do not send the completed form to this address.		
Information contained on this form which would permit identification of any individual has been collected with a guarantee that it will be held in strict confidence, will be used only for surveillance purposes, and will not be disclosed or released without the consent of the individual in accordance with Section 306(j) of the Public Health Service Act (42 U.S.C. 2626j).		
CDC 10-11A Rev 06/03 (base) 01/11/11	1st Page	REPORT OF VERIFIED CASE OF TUBERCULOSIS Page 1 of 3

# 1. Date Reported

**1. Date Reported**

Month
Day
Year

**Primary Purpose:** Case management. Data are used to determine when the health department or counting authority was first notified that a person may have TB. This is important in contact investigations.

**Note:** Item 1 requires that the actual month and year **always** be entered. The actual month (not 99) should be entered and the actual year (not 9999) should be entered.

	Description	Comment
<p><b>Month, day, and year</b> (e.g., 01/17/2009)</p>	<p>Date that a health department (e.g., local, county, state) first <b>suspected</b> that the patient may have TB.</p> <p><b>or</b></p> <p>Date the health department received notification (verbal or written) from a health care provider that a patient was <b>suspected of having TB</b>.</p>	<p>If the day is unknown, enter 99 as the default value (e.g., 01/99/2009).</p> <p>In this item, the <b>actual month and year always need to be entered</b>. Do <b>not</b> use 99 for the month or 9999 for the year.</p>

**Comment: Date Reported**

If the patient had a previous diagnosis of tuberculosis, **Date Reported** applies to the current TB episode.

**Note:** On the form and throughout this document, the term *state* is used to refer to the reporting jurisdiction (or count authority), though all jurisdictions are **not** states.

## Comparison of Date Reported (Item 1), Date Submitted (Item 2), and Date Counted (Item 6)

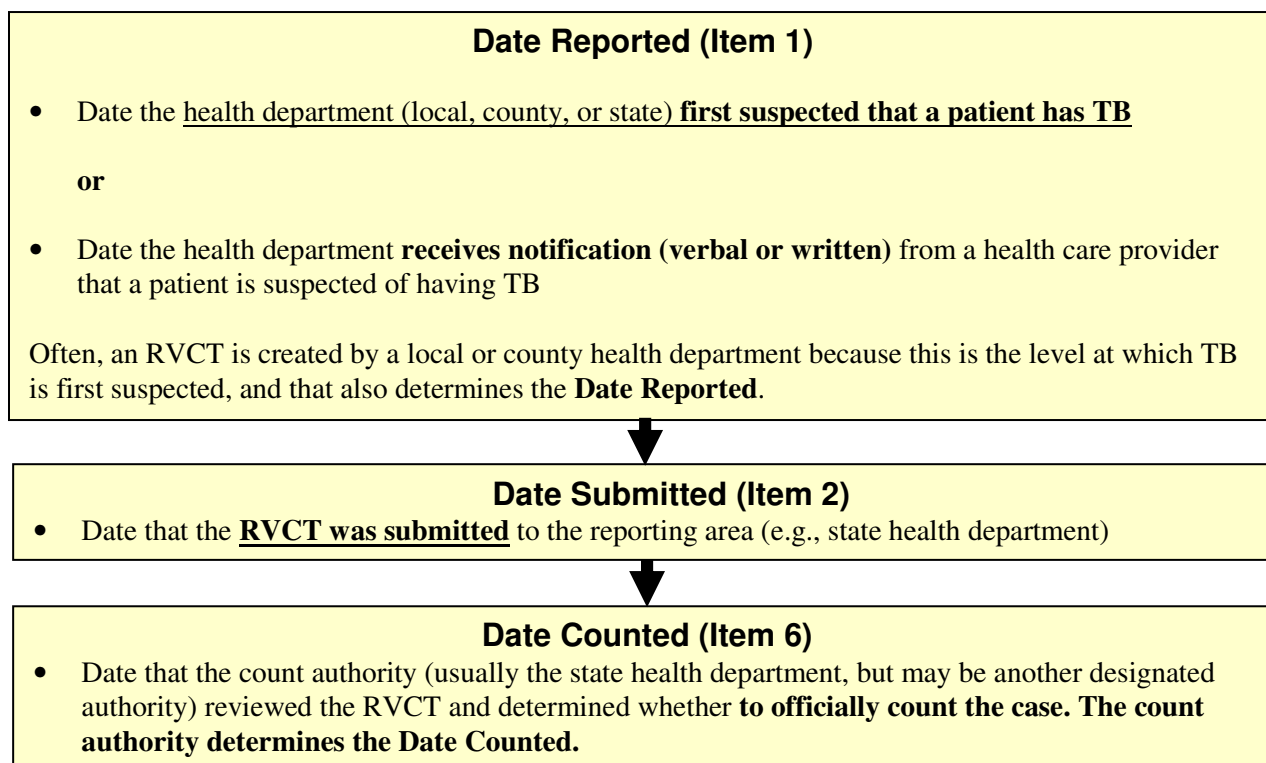

**Comment: Sequence of dates**

The **Date Reported** (item 1) usually occurs before the **Date Submitted** (item 2). But sometimes they can occur on the same date. The **Date Submitted** usually occurs before the **Date Counted** (item 6). But all 3 dates could occur on the same date if the count authority determines that it is a case of TB on the same day as the **Date Reported** and **Date Submitted**.

**Comment: Who determines the dates**

In most reporting areas (e.g., state), the state health department has count authority and reviews the RVCT to determine whether to officially count the case (**Date Counted**). However, a few states have granted local or county health departments count authority. In these states, the local or county health departments determine the **Date Counted** (see **Date Submitted** [item 2] and **Date Counted** [item 6]).

### Summary of Date Reported, Date Submitted, and Date Counted

Type of Date	Who/What	Description of Action
<b>Date Reported</b> (item 1)	<b>TB suspect</b>	<b>Reported</b> to the health department (either by the health department itself or another health care provider)
<b>Date Submitted</b> (item 2)	<b>RVCT form</b>	<b>Submitted</b> to the reporting area (e.g., state health department)
<b>Date Counted</b> (item 6)	<b>TB Case</b>	<b>Counted as a case of TB</b> (by the count authority)

**Comment: Date Reported**

Often, an RVCT is created by a local or county health department because this is the level at which TB is first suspected, and determines **Date Reported** (item 1). If a health care provider suspects that the patient may have TB and then notifies the local or county health department, the **Date Reported** is the date the health department received the report (verbal or written notification) from the health care provider.

**Example: Year Reported**

A case reported in December may not be counted until the next year. For example, if a case is reported in December 2008 but not counted until January 2009, the Year Reported for the **case number** would be 2008.

## 2. Date Submitted

2. Date Submitted									
Month		Day		Year					
<input type="text"/>	<input type="text"/>	<input type="text"/>	<input type="text"/>	<input type="text"/>	<input type="text"/>	<input type="text"/>	<input type="text"/>	<input type="text"/>	<input type="text"/>

**Primary Purpose:** Programmatic function. Data are used to evaluate the time between case report and submission to the health department or count authority.

	Description	Comment
<b>Month, day, and year</b> (e.g., 01/17/2009)	Date the RVCT form was submitted to the reporting area (e.g., state health department).	If the day is unknown, enter 99 as the default value (e.g., 01/99/2009).  ( <b>Note:</b> this may vary from what will be entered into a computer software program)

### Summary of Date Reported, Date Submitted, and Date Counted

Type of Date	Who/What	Description of Action
<b>Date Reported</b> (item 1)	<b>TB suspect</b>	<b>Reported</b> to the health department (either by the health department itself or another health care provider)
<b>Date Submitted</b> (item 2)	<b>RVCT form</b>	<b>Submitted</b> to the reporting area (e.g., state health department)
<b>Date Counted</b> (item 6)	<b>TB Case</b>	<b>Counted as a Case of TB</b> (by the count authority)

#### **Comment: Date Submitted**

In most cases, the RVCT is completed by the health department (local or county) and submitted to the reporting area (state health department). In some locations, the RVCT may be completed and the case counted at the state level.

**Note:** On the RVCT form and throughout this document, the term *state* is used to refer to the reporting jurisdiction (or count authority), though not all jurisdictions are states.



### 3. Case Numbers

3. Case Numbers			
	Year Reported (YYYY)	State Code	Locally Assigned Identification Number
State Case Number	<input type="text"/>	<input type="text"/>	<input type="text"/>
City/County Case Number	<input type="text"/>	<input type="text"/>	<input type="text"/>
Linking State Case Number	<input type="text"/>	<input type="text"/>	<input type="text"/> Reason: <input type="text"/>
Linking State Case Number	<input type="text"/>	<input type="text"/>	<input type="text"/> Reason: <input type="text"/>

**Primary Purpose:** Surveillance. A unique number is assigned to each case without personal identifiers.

**Note:** On the form and throughout this document, the term *state* is used to refer to the reporting jurisdiction (or count authority), though not all jurisdictions are states.

#### State Case Number

The **State Case Number** is the **official identification number for the case**. If additional communication about a record is required between CDC and a reporting area, this number is used to identify the record. The **State Case Number** is commonly known as the RVCT number.

#### City/County Case Number

List the **City/County Case Number**. Every case reported, whether from a city/county or state surveillance system, must have a unique case number for identification purposes.

#### Comment: Case Numbers

A single case may be assigned identical **City/County Case** and **State Case Numbers**. A **City/County Case Number** may not be assigned to more than one case during a calendar year. Similarly, a **State Case Number** may not be assigned to more than one case during a calendar year.

**Note: Case numbers must not include personal identifiers.** To maintain patient confidentiality, do **not** use names (either patient or provider), initials, Social Security numbers, addresses, telephone numbers, or other information that could identify a patient. Case numbers are transmitted to CDC and therefore must not include personal identifying information.

## Assigning case numbers

Both the **State Case Number** and the **City/County Case Number** have 15 alphanumeric characters.

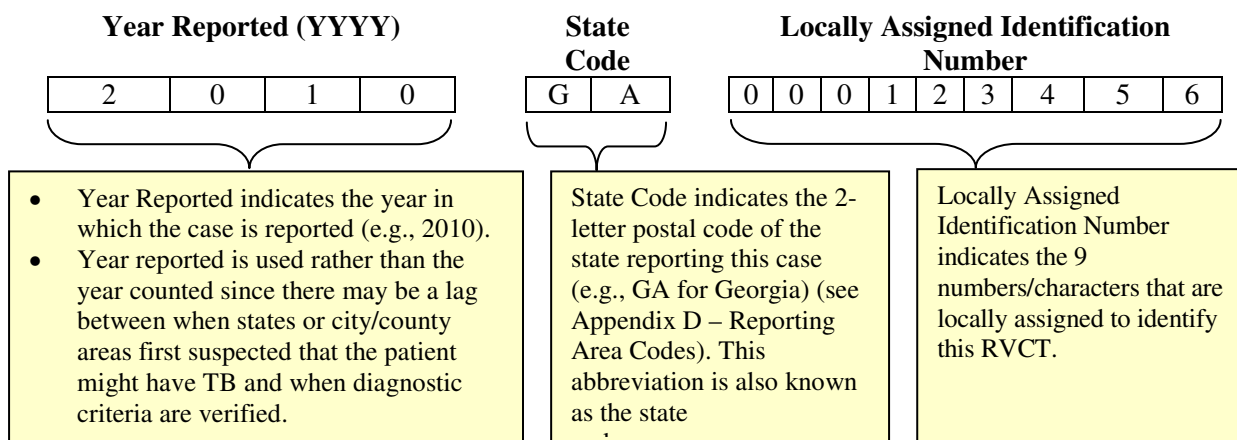

### Example: Year Reported

A case reported in December may not be counted until the next year. For example, if a case is reported in December 2008 but not counted until January 2009, the Year Reported for the **case number** would be 2008.

**Note:** All countable and noncountable TB cases should receive a unique case number. Documenting noncountable cases provides evidence of increased workload or burden to programs when cases are **not** countable.

**Note:** For the purposes of the RVCT Materials, use the codes listed in the appendices. Some software programs used to enter data on the RVCT may **NOT** use the codes listed in the appendices. For example, the Anatomic Codes may be a drop-down item where you choose the actual site rather than enter a code. For more information, see instructions for the software you use.

### Linking State Case Numbers

For the purposes of linking RVCT forms, you **may enter as many as 2 RVCT State Case Numbers** under **Linking State Case Number**.

Under **Reason for Linking Case**, explain the purpose of the link by entering one of the single-digit codes indicated in the table below.

## Rationale for Linking RVCT Forms

Reason Code	Reason for Linking Case
1	Recurrence <b>or</b> Previous diagnosis of TB
2	Epidemiologically linked case, source case, or contact with another case
3	Case transferred from another area

### Examples: Reasons for Linking Case

- **Reason 1 – Recurrence or previous diagnosis of TB\***

If you are completing a “recurrence” RVCT for a diagnosis of TB disease in the same patient that recurred **within** 12 months after the completion of therapy, you must enter the RVCT **State Case Number** of the original TB case under **Linking State Case Number**, and enter 1 as the **Reason** code.

**A previous diagnosis of TB can have occurred any time in the past.**

A patient is considered to have had a previous diagnosis of TB disease if

- TB disease was verified in the past
- or**
- The patient completed therapy (even if the case-to-case interval is within 12 months)\*
- or**
- The patient was lost to supervision for more than 12 months and now has verified disease again.

If a patient had previous TB disease anytime in the past, enter 1 as the **Reason** code.

- **Reason 2 – Epidemiologically linked case, source case, or contact with another case**

If you have identified the source case for the TB case for which you are completing the RVCT and the RVCT **State Case Number** of the source case is available, enter the RVCT **State Case Number** of the source case under **Linking State Case Number**, and enter 2 as the **Reason** code. Another example of an **Epidemiologically linked case** is transmission of TB from one family member to another.

- **Reason 3 – Case transferred from another area**

If you are managing a TB case counted by another area, enter the RVCT **State Case Number** of the case from the transferring jurisdiction under **Linking State Case Number**, and enter 3 as the **Reason** code. Transfer cases are linked when the patient is in therapy and transfers from another reporting area. The patient could have moved or appeared at a health department in another area after being lost to follow-up.

**\*Note:** Recurrent cases within 12 months of completion of therapy should be considered noncountable, regardless of whether the initial and the subsequent genotypes are the same or are different.

**Comment: Recurrence of TB**

A recurrence (more than one separate and distinct episode) is defined as the return of TB disease in a patient whose specimen result can be described by either of the options listed in the table below.

**Specimen Results Required for Recurrence of TB Disease**

<b>Option</b>	<b>Specimen Result at Time of Diagnosis</b>	<b>Specimen Result While Receiving Anti-TB therapy</b>	<b>Specimen Result After Completion of Therapy</b>
<b>Option 1</b>	<b>Culture positive</b>	<b>Becomes and remains culture negative</b>	Becomes culture positive for <i>M. tuberculosis</i> complex, or clinical or radiologic evidence is consistent with TB disease.
<b>Option 2</b>	<b>Smear negative or culture negative</b> (TB diagnosis is based on clinical evidence)	<b>Remains smear negative or culture negative</b>	Becomes culture positive for <i>M. tuberculosis</i> complex, or clinical or radiologic evidence is consistent with TB disease.

The process for reporting a recurrence of TB is illustrated in the table below.

## Process for Reporting a Recurrence of TB

A person may have more than 1 discrete (separate and distinct) episode of TB disease

TB Disease Recurs Within a Consecutive 12-month Period After the Patient Completed Therapy	TB Disease Recurs More Than a Consecutive 12-month Period After the Patient Completed Therapy
Recurrence is considered the same TB episode (count only 1 episode as a case for that year; within a 12-month period, <b>not</b> calendar year).	Recurrence is considered a separate TB episode.
Do <b>not</b> count as a new case.	Count as a new case.
Count only one TB episode as a case for that year (within a 12-month period, <b>not</b> calendar year).	No updates are needed for the initial RVCT form because therapy was completed at least 12 months before the recurrence was diagnosed.
<b>Complete 2 RVCT Forms (Only the initial TB episode is countable)</b>	<b>Complete 2 RVCT Forms (Both TB episodes are countable)</b>
<p><b>1) For the initial countable TB episode:</b></p> <ul style="list-style-type: none"> <li>a) Ensure that <b>Date Therapy Stopped</b> (item 43) reflects a date of therapy completion before TB recurrence.</li> <li>b) Do not update any other variables on the RVCT form.</li> </ul> <p><b>2) For the noncountable TB episode:</b></p> <ul style="list-style-type: none"> <li>a) Use a new RVCT <b>State Case Number</b> (item 3), that is, a number that is different from the <b>State Case Number</b> on the countable TB episode form.</li> <li>b) Enter the countable TB episode <b>State Case Number</b> under <b>Linking State Case Number</b> and specify as <b>Reason 1 – Recurrence or previous diagnosis of TB</b> so that these 2 forms can be linked.</li> <li>c) Check <b>Verified Case: Recurrent TB within 12 months</b> for the variable <b>Count Status</b> (item 5).</li> <li>d) Complete the remainder of the RVCT form as appropriate. This case will not be included in the TB case count of the reporting area, but will provide valuable information on recurrences <b>within</b> 12 months after the completion of therapy. This allows electronic linkage between the countable TB episode and data associated with the recurrence.</li> </ul>	<p><b>1) For the initial countable TB episode:</b></p> <ul style="list-style-type: none"> <li>a.) Do not update any other variables on the RVCT form.</li> </ul> <p><b>2) For the second countable TB episode:</b></p> <ul style="list-style-type: none"> <li>a.) Enter a new RVCT <b>State Case Number</b> (item 3), different from the <b>State Case Number</b> on the initial RVCT form.</li> <li>b.) Enter the initial RVCT <b>State Case Number</b>, if available, under <b>Linking State Case Numbers</b> and specify as <b>Reason 1 – Recurrence or previous diagnosis of TB</b> so that these 2 forms can be linked.</li> <li>c.) Check <b>Count as a TB Case</b> for <b>Count Status</b> (item 5). Do <b>not</b> check <b>Verified Case: Recurrent TB ≤ 12 months</b>.</li> <li>d.) Complete the remainder of the RVCT form as appropriate. This TB case will be counted because, for surveillance purposes, it is considered a separate TB episode. Also, it will provide valuable information on recurrences more than 12 months after the completion of therapy. This allows electronic linkage between the initial TB episode and the new TB episode.</li> </ul>

## 4. Reporting Address for Case Counting

4. Reporting Address for Case Counting	
City	<input type="text"/>
Within City Limits (select one)	<input type="checkbox"/> Yes <input type="checkbox"/> No
County	<input type="text"/>
ZIP CODE	<input type="text"/> - <input type="text"/>

**Primary Purpose:** Programmatic function. Data are used to document the patient's address from the state or jurisdiction that is counting the case.

The Reporting Address for Case Counting is usually the **City, County, and ZIP Code** of the **patient's residence at the time of diagnosis**. But there are exceptions to this, which are indicated in the Guidelines to Determine Reporting Address for Case Counting table below. To the extent possible, the address for case counting should represent the home address (whether permanent or temporary) of the patient. Recommendations for counting reported TB cases are outlined in Appendix B – Recommendations for Reporting and Counting Tuberculosis Cases.

**Note:** For countable and noncountable cases, enter the TB patient's address from the state or jurisdiction that is reporting and documenting the case.

For **Within City Limits** select the best option.

Option (select one)	Description
Yes	Patient lives within the city limits
No	Patient does <b>not</b> live within the city limits

## Guidelines to Determine Reporting Address

	Patient Scenarios	How to Count	Reporting Address
<b>Specific Populations</b> (these groups supersede Specific Locations, but not Other People Entering the United States)	<b>Migrant, immigrant</b> (i.e., resident alien living in the United States), <b>U.S. military personnel, and other transient persons</b>	Count in the area in which he/she lived at the time that the TB diagnostic evaluation was performed or initiated	Enter city, county, and ZIP Code <b>where he/she lives at the time of diagnosis</b>
	<b>Homeless or does not have a fixed residence</b>	Count in area in which he/she was living at the time that the TB diagnostic evaluation was performed or initiated (e.g., the locality of the shelter or area in which the patient was living)	Enter city, county, and ZIP Code <b>of that locality</b>
	<b>Resident of correctional facility at time of TB diagnosis</b> (e.g. local, state, federal, military)	Count in area in which the correctional facility is located at the time that the TB diagnostic evaluation was performed or initiated	Enter city, county, and ZIP Code of the <b>correctional facility</b>
	<b>Resident of long-term care facility at time of TB diagnosis</b>	Count in area in which the long-term care facility is located at the time that the TB diagnostic evaluation was performed or initiated	Enter city, county, and ZIP Code of the <b>long-term care facility</b>
<b>Specific Locations</b>	<b>Receives a new TB diagnosis in the community that he/she considers home</b>	Count in the morbidity count for that area	Enter city, county, and ZIP Code of <b>residence</b>
	<b>Receives a new TB diagnosis, but is an out-of-area resident and will return home for treatment</b>	Count in morbidity count of their home area	Enter city, county, and ZIP Code of his/her <b>home area</b>
	<b>Receives a new TB diagnosis, but is an out-of-area resident and completes therapy where he/she was diagnosed</b>	Count in morbidity count where they live at the time that the TB diagnostic evaluation was performed or initiated	Enter city, county, and ZIP Code <b>where he/she lives at the time of diagnosis</b>
	<b>Staying in a community only for TB diagnosis and hospitalization</b>	Count in the morbidity count of his/her area of residence, <b>not</b> the community where diagnosed and hospitalized.  Communication between health departments may be necessary to decide which jurisdiction will count the case.	Enter city, county, and ZIP Code of his/her <b>home area</b>

<b>Other People Entering the United States</b>	<b>Foreign visitor</b> who receives a TB diagnosis in the United States, is receiving anti-TB therapy, and has been, or plans to remain, in the country for <b>90 days or more</b>	Count in the area in which he/she lived at the time that the TB diagnostic evaluation was performed or initiated	Enter city, county, and ZIP Code of <b>current residence</b>
	<b>Foreign visitor</b> who receives a diagnosis of TB in the United States, is receiving anti-TB therapy, and has been, or plans to remain, in the country for <b>less than 90 days</b>	Should <b>not</b> be included in the count of TB cases in the United States.	Enter city, county, and ZIP Code of <b>current residence</b>
	<b>Receives a diagnosis of TB before arriving in the United States</b>	Should <b>not</b> be included in the count of TB cases in the United States. Submit it as a noncountable case because the case is considered to have occurred in another country, even if therapy is continued or completed in the United States.	Enter city, county, and ZIP Code of <b>current residence</b>

**Comment: People Entering the United States**

For additional information on immigrants, refugees, permanent resident aliens, border crossers, and foreign visitors see Appendix B – Recommendations for Reporting and Counting Tuberculosis Cases.

**Guidelines for classifying transfer cases**

A total of 60 areas are responsible for reporting cases of TB to CDC. These reporting areas are the 50 states, the District of Columbia, New York City, Puerto Rico, American Samoa, the Federated States of Micronesia, Guam, the Republic of the Marshall Islands, the Commonwealth of the Northern Mariana Islands, the Republic of Palau, and the U.S. Virgin Islands. Because of the additional (follow-up) reporting requirements for expanded surveillance, specific instructions are necessary for the completion of forms for patients who move within a reporting area and for those who move from one reporting area to another during treatment.

- To minimize the number of TB patients who are lost to follow-up, update the patient’s street address regularly during treatment.
- Periodically, ask patients whether they anticipate moving so that arrangements can be made to maintain continuity of care and ensure submission of follow-up RVCTs. Encourage patients who anticipate moving to report their new address, so that necessary patient information can be forwarded to health care providers, and to the TB control program in the area to which the patient is moving. Health departments should use the National TB Controllers Association (NTCA) Interjurisdictional Tuberculosis Notification and Follow-up forms to notify TB control program staff in another reporting area that a TB patient is moving to their area.

Communication between TB control programs to ensure continuity of care and submission of follow-up reports regarding a patient who is moving from one area to another should be conducted as efficiently and securely as possible (e.g., telephone, e-mail, fax, express courier).



**Example: Moves within the reporting area**

If a TB patient with an existing RVCT record moves within the reporting area that initially reported the case (e.g., from county A to county B within a state), communication between county or local health departments may be all that is necessary to maintain continuity of care and ensure submission of follow-up reports for the RVCT. In this instance, the responsibility for following the case to closure and for submitting follow-up reports to CDC remains with the initial reporting area (e.g., the state). To avoid duplicate case reporting, the state may need to coordinate the submission of forms with counties A and B so that only one counted case is submitted. County B can complete a noncountable RVCT to gather surveillance data and demonstrate patient management.

**Example: Moves from one reporting area to another**

If a TB patient with an RVCT record moves from one reporting area to another (e.g., from state A [Louisiana] to state B [Georgia]), the responsibility for submitting follow-up reports to CDC remains with the state or reporting area that initially reported the case to CDC and counted it (e.g., state A [Louisiana]). This responsibility remains with the initial area only for surveillance purposes (i.e., to minimize duplication of case reports and to simplify the reporting of the final disposition of the case). In other words, state B will conduct case management and follow-up and will then share follow-up surveillance information with state A, which will officially submit follow-up information to CDC. State B is encouraged to complete an RVCT for a noncountable transfer case.

To facilitate this process, state A should send the NTCA Interjurisdictional Tuberculosis Notification and Follow-up forms to state B and should inform state B that the case has been reported to CDC and counted. State A should also inform state B of the surveillance information that has been reported to CDC and the information that will need to be collected by state B and forwarded to state A for reporting to CDC. State B should use the forms to inform state A when or if the TB patient has been located and to inform state A of the final disposition of the case (e.g., patient completed therapy, patient died).

**Comment: Definition for Migrant/seasonal worker**

A migrant or seasonal worker is a person who is required to be absent from a permanent place of residence for the purpose of seeking employment or who may vary their employment for the purpose of remaining employed while maintaining a permanent place of residence.

**Examples: Migrant/seasonal worker**

- Migratory agricultural worker
- Seasonal agricultural worker
- Migrant factory worker
- Migrant construction worker
- Migrant service industry worker
- Migrant sporting worker (e.g., horse racing, dog racing)

### **Comments: Definitions for Homeless**

There are many definitions for *homeless* (National Coalition for the Homeless). A **homeless** person may be an individual who has

1. No fixed, regular, and adequate nighttime residence  
**and**
2. A primary nighttime residence that is
  - a. A supervised publicly or privately operated shelter designed to provide temporary living accommodations, including welfare hotels, congregate shelters, and transitional housing for the mentally ill  
**or**
  - b. An institution that provides a temporary residence for individuals intended to be institutionalized  
**or**
  - c. A public or private place not designated for, or ordinarily used as, a regular sleeping accommodation for human beings.

A **homeless** person may also be defined as a person who has no home (e.g., is not paying rent, does not own a home, and is not steadily living with relatives or friends). Persons in unstable housing situations (e.g., alternating between multiple residences for short stays of uncertain duration) may also be considered homeless.

A **homeless** person may be a person who lacks customary and regular access to a conventional dwelling or residence. Included as homeless are persons who live on streets or in nonresidential buildings. Also included are residents of homeless shelters and shelters for battered women. Residents of welfare hotels, and single room occupancy (SRO) hotels could also be considered homeless. In the rural setting, where there are usually few shelters, a homeless person may live in non-residential structures, or substandard housing, or with relatives. *Homeless* does not refer to a person who is imprisoned or in a correctional facility.

**Note:** The homeless category is limited to living conditions in the United States and does **not** apply to living in refugee camps outside the United States.

## 5. Count Status

5. Count Status (select one)	
<b>Countable TB Case</b>	
<input type="checkbox"/>	Count as a TB case
<b>Noncountable TB Case</b>	
<input type="checkbox"/>	Verified Case: Counted by another U.S. area (e.g., county, state)
<input type="checkbox"/>	Verified Case: TB treatment initiated in another country Specify _____
<input type="checkbox"/>	Verified Case: Recurrent TB within 12 months after completion of therapy

**Primary Purpose:** Surveillance. Data are used to document the number of TB cases and disease trends that occur in the United States; to determine the burden of TB disease within all areas; and to serve as a basis for allocation of resources, including funding.

In addition to requiring the completion of an RVCT form for all counted TB cases, CDC recommends that a reporting area complete an RVCT form for TB patients being managed in that area but counted by another reporting area, even though the area providing case management cannot include such cases in its annual morbidity count. This will help indicate the burden of disease within all areas. Moreover, CDC recommends that a reporting area complete an RVCT form for TB recurrences which are **within** 12 months after the completion of therapy, which are also not included in the annual morbidity count. For CDC guidelines on counting TB cases, see Appendix B – Recommendations for Reporting and Counting Tuberculosis Cases.

### Countable TB Case

Option	Description
Count as a TB case	Officially counted as a TB case, by the jurisdiction with count authority (usually state health department).
	For a diagnosis to be counted as a TB case, it must meet the following criteria: <ol style="list-style-type: none"> <li>1. Is a verified case of TB (see Case Definition for Tuberculosis below)</li> <li>2. Confirmed that it is <b>NOT</b> counted by another area</li> <li>3. Meets surveillance definition and is <b>NOT</b> a recurrent case (within 12 months of completion of therapy) of TB</li> </ol>

**Note:** A case of TB is defined as an episode of TB disease in a person meeting the laboratory or clinical criteria for TB as defined in Appendix A – Tuberculosis Case Definition for Public Health Surveillance for criteria.

**Note:** Communication between TB control programs to ensure continuity of care and submission of reports regarding a patient who is moving from one area to another should be conducted as securely and efficiently as possible (e.g., telephone, e-mail, secure fax, express courier).

## Noncountable TB Case

If the verified TB case was **not** counted by the jurisdiction with count authority, select one option to indicate the reason the verified TB case was noncountable.

Option (select one)	Description	Comment
<b>Counted by another area (e.g., county, state, or counting authority)</b>	TB case counted by another U.S. area such as a state or other counting authority (e.g., transfer in)	Typically, diagnostic workup has been completed, and patient is receiving anti-TB medications.  Count authority includes the U.S. Territories, U.S. Island Areas, and U.S. Outlying Areas.
<b>TB treatment initiated in another country</b>	TB case counted by another country  Under <b>Specify</b> , enter the country where TB treatment was initiated.	It may be difficult to verify whether a case has been counted in another country because typically, diagnostic work-up may have been completed and patient is receiving anti-TB medications.
<b>Recurrent TB within 12 months after completion of therapy</b>	Complete a new RVCT form because of recurrence <b>within 12 months after the completion of therapy</b> (not when therapy was initiated)	Completing a new RVCT form allows the RVCT forms to be linked and information on the recurrence to be collected.

### Comment: 12 months

The term 12 months refers to 12 consecutive months, not a calendar year.

### Comment: U.S. Territories, U.S. Island Areas, and U.S. Outlying Areas

Counted by another area or counting authority includes the U.S. Territories, U.S. Island Areas, and U.S. Outlying Areas (e.g., Puerto Rico, American Samoa, Federated States of Micronesia, Guam, Republic of the Marshall Islands, Commonwealth of the Northern Mariana Islands, Republic of Palau, U.S. Virgin Islands). These independent countries have Compacts of Free Association with the United States; under these compacts, the countries are fully sovereign in domestic and foreign affairs, but give responsibility for their health, education, defense, and other essential operations to the United States.

## Counting Recurrent TB Cases

A person may have more than 1 discrete (separate and distinct) episode of TB disease

TB Disease Recurs Within a Consecutive 12-month Period After the Patient Completed Therapy	TB Disease Recurs More Than 12 Months After the Patient Completed Therapy
Recurrence is considered the same TB episode (count only 1 episode as a case for that year; within a 12-month period, <b>not</b> calendar year).	Recurrence is considered a separate TB episode.
Do <b>not</b> count as a new case.	Count as a new case.

**Note:** Recurrent cases within 12 months of completion of therapy should be considered noncountable, regardless of whether the initial and the subsequent genotypes are the same or are different.

**Comment: People Entering the United States**

For additional information on immigrants, refugees, permanent resident aliens, border crossers and foreign visitors see Appendix B – Recommendations for Reporting and Counting Tuberculosis Cases.

## 6. Date Counted

6. Date Counted					
Month		Day		Year	
<input type="text"/>	<input type="text"/>	<input type="text"/>	<input type="text"/>	<input type="text"/>	<input type="text"/>

**Primary Purpose:** Surveillance. Data are used by the count authority to tally the official TB case count for the month, quarter, and year.

	Description	Comment
<b>Month, day, and year</b> (e.g., 01/17/2009)	Date that the responsible count authority (usually the state health department, but might be another designated authority) <ul style="list-style-type: none"> <li>Reviewed the RVCT</li> <li>Verified the case as TB</li> </ul> <b>and</b> <ul style="list-style-type: none"> <li>Included it in the official TB case count</li> </ul>	If the day is unknown, enter 99 as the default value (e.g., 01/99/2009).

### Summary of Date Reported, Date Submitted, and Date Counted

Type of Date	Who/What	Description of Action
<b>Date Reported</b> (item 1)	<b>TB suspect</b>	<b>Reported</b> to the health department (either by the health department itself or another health care provider)
<b>Date Submitted</b> (item 2)	<b>RVCT form</b>	<b>Submitted</b> to the reporting area (e.g., state health department)
<b>Date Counted</b> (item 6)	<b>TB case</b>	<b>Counted as a Case of TB</b> (by the count authority)

#### Comment: Pending results

Suspected cases for which bacteriologic results are pending or for which verification of disease is questioned for any reason should be counted only after they are determined to be verified TB cases. This could mean that a case reported in one year may not be counted until the following year.

#### Example: Date Counted

If a case is reported to the health department in December 2008, but bacteriologic or clinical evidence of TB is not available until January 2009, the case should be counted in January 2009 (when TB disease was verified), not in December.

## 7. Previous Diagnosis of TB Disease

<p><b>7. Previous Diagnosis of TB Disease</b> <i>(select one)</i></p> <p><input type="checkbox"/> Yes    <input type="checkbox"/> No</p> <p>If YES, enter year of previous TB disease diagnosis:</p> <table border="1"> <tr> <td style="width: 20px; height: 20px;"></td> <td style="width: 20px; height: 20px;"></td> <td style="width: 20px; height: 20px;"></td> <td style="width: 20px; height: 20px;"></td> </tr> </table>				

**Primary Purpose:** Case management and surveillance. Data are used to evaluate the patient's response to treatment and to analyze drug resistance from a previous episode of TB disease.

Option <i>(select one)</i>	Description	Comment
<b>Yes</b>	<p>Patient has received a previous diagnosis of TB disease.</p> <p>If you selected <b>Yes</b>, enter the <b>year of previous diagnosis of TB disease</b> (e.g., 1985).</p>	<p>Do not enter a previous diagnosis of latent TB infection (LTBI).</p> <p>If the patient had more than 1 previous episode of TB disease, enter the year of the <b>most recent</b> previous episode.</p>
<b>No</b>	Patient has <b>not</b> received a previous diagnosis of <b>TB disease</b> .	

### Comments: Yes

A patient is considered to have had a previous diagnosis of TB disease if

- TB disease was verified in the past
- or**
- The patient completed therapy for TB disease (even if the case-to-case interval is within 12 months)
- or**
- The patient with TB disease was lost to supervision for more than 12 months and now has verified TB disease again.

**Note:** Recurrent cases within 12 months of completion of therapy should be considered noncountable, regardless of whether the initial and the subsequent genotypes are the same or are different.

If the patient had a previous episode of TB that was reported to U.S. surveillance, you should, for the purposes of linking RVCT forms

- Contact the state in which the case was counted to ask for the most recent previous diagnosis
- Enter the most recent previous RVCT **State Case Number** for this case under **Linking State Case Number** (item 3)
- Enter the code for the **Reason** linking is desired (e.g., enter 1 for recurrence or previous diagnosis of TB)

### Documentation of Previous Diagnosis of TB Disease

Often, TB disease is confused with latent TB infection (LTBI), which should not be coded as previous TB disease. Therefore, documentation of the previous episode of TB disease is important. Follow the priority indicated below.

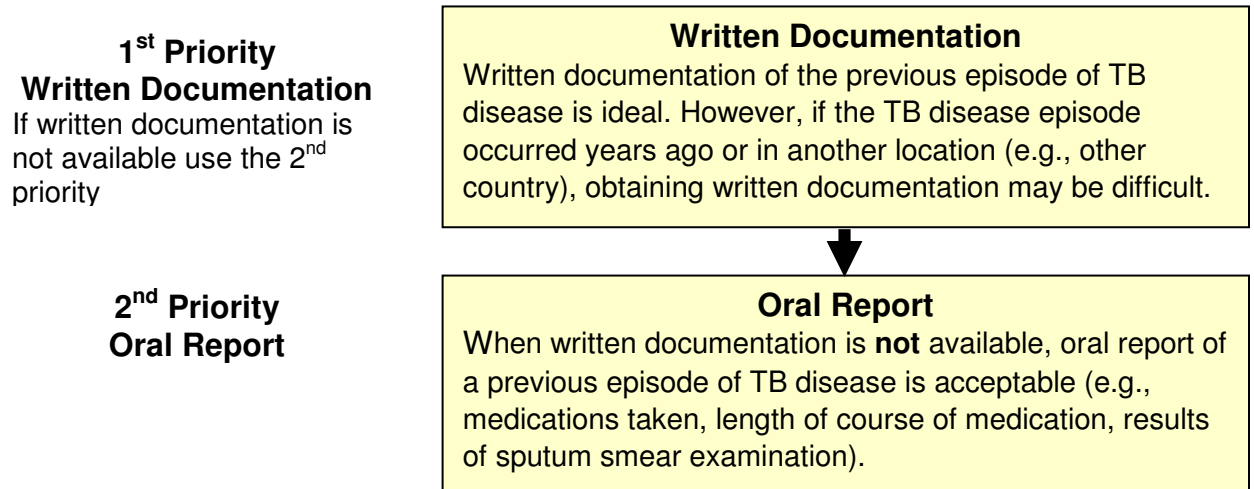



## 8. Date of Birth

8. Date of Birth						
Month		Day		Year		
<input type="text"/>	<input type="text"/>	<input type="text"/>	<input type="text"/>	<input type="text"/>	<input type="text"/>	<input type="text"/>

**Primary Purpose:** Surveillance. Data are used to document patient demographic information.

	Description	Comment
<b>Month, day, and year</b> (e.g., 04/26/1968)	Patient's complete date of birth should be entered (i.e., values should be entered for month, day, and year).	<p>Some societies or cultures throughout the world do not document the day, month, or even the year of birth.</p> <p>If the day is unknown, or the month and the day are unknown, enter 99 as the default value (e.g., 04/99/1968 or 99/99/1968).</p> <p>If the month, day, and year of birth are unknown, enter 99/99/9999.</p>

## 9. Sex at Birth

---

9. Sex at Birth (select one)

Male  Female

**Primary Purpose:** Surveillance. Data are used to document patient demographic information.

Option (select one)	Description
Male	The biological sex of the TB patient was <b>Male</b> at birth.
Female	The biological sex of the TB patient was <b>Female</b> at birth.

## 10. Ethnicity

<p><b>10. Ethnicity</b> <i>(select one)</i></p> <p><input type="checkbox"/> Hispanic or Latino</p> <p><input type="checkbox"/> Not Hispanic or Latino</p>
---

**Primary Purpose:** Surveillance. Data are used to detect high-risk groups for TB by ethnicity.

Option <i>(select one)</i>	Description	Comment
<b>Hispanic or Latino</b>	Patient considers himself or herself Cuban, Mexican, Puerto Rican, South or Central American, or of other Spanish culture or origin, regardless of race.	Some patients prefer the term “Spanish origin” to <b>Hispanic or Latino</b> .
<b>Not Hispanic or Latino</b>	Patient does <b>not</b> consider himself or herself <b>Hispanic or Latino</b> .	

**Comment: Self-identity or self-reporting**

The response to this item should be based on the patient’s self-identity or self-reporting. It should **not** be based on appearance or surname.

**Example: Not Hispanic or Latino but has a Hispanic name**

A patient may have a Hispanic name, but may not be Hispanic or Latino. For example, if a woman who is not Hispanic marries a Hispanic man, she may self-report as “Not Hispanic or Latino.” Similarly, people from the Philippines may have Hispanic names, but self-report as “Not Hispanic.”

# 11. Race

<p><b>11. Race</b> (select one or more)</p> <p><input type="checkbox"/> American Indian or Alaska Native</p> <p><input type="checkbox"/> Asian: <i>Specify</i> _____</p> <p><input type="checkbox"/> Black or African American</p> <p><input type="checkbox"/> Native Hawaiian or Other Pacific Islander: <i>Specify</i> _____</p> <p><input type="checkbox"/> White</p>
--

**Primary Purpose:** Surveillance. Data are used to detect high-risk groups for TB by race.

<b>Option</b> (select one or more)	<b>Description</b>
<b>American Indian or Alaska Native</b>	Patient has origins in <b>any</b> of the original peoples of North and South America (including Central America).
<b>Asian</b>	Patient has origins in <b>any</b> of the original peoples of the Far East, Southeast Asia, or the Indian subcontinent (e.g., including Bangladesh, Cambodia, China, India, Indonesia, Japan, Korea, Malaysia, Nepal, Pakistan, the Philippine Islands, Thailand, and Vietnam).
<b>Black or African American</b>	Patient has origins in <b>any</b> of the black racial groups of Africa.
<b>Native Hawaiian or Other Pacific Islander</b>	Patient has origins in <b>any</b> of the original peoples of Hawaii, Guam, American Samoa, or other Pacific Islands.
<b>White</b>	Patient has origins in <b>any</b> of the original peoples of Europe, the Middle East, or North Africa.

**Comment: Self-identity or self-reporting**

The response to this item should be based on the patient’s self-identity or self-reporting. Therefore, patients should be offered the option of selecting more than one racial designation.

**Comment: Asian or Native Hawaiian or Other Pacific Islander**

If you selected **Asian** or **Native Hawaiian or Other Pacific Islander**, use the National Electronic Disease Surveillance System (NEDSS) Person Race Categories to complete **Specify**. The chart below indicates who is considered Asian and who is considered Native Hawaiian or Other Pacific Islander.

**National Electronic Disease Surveillance System (NEDSS)  
 Person Race Categories for Asian and for  
 Native Hawaiian or Other Pacific Islander\***

<b>Asian</b>		<b>Native Hawaiian or Other Pacific Islander</b>	
Asian Indian	Laotian	Carolinian	New Hebrides
Bangladeshi	Madagascar	Chamorro	Other Pacific Islander
Bhutanese	Malaysian	Chuukese	Palauan
Burmese	Maldivian	Fijian	Papua New Guinean
Cambodian	Nepalese	Guamanian	Pohnpeian
Chinese	Okinawan	Kiribati	Polynesian
Filipino	Pakistani	Kosraean	Saipanese
Hmong	Singaporean	Mariana Islander	Samoan
Indonesian	Sri Lankan	Marshallese	Solomon Islander
Iwo Jiman	Taiwanese	Melanesian	Tahitian
Japanese	Thai	Micronesian	Tokelauan
Korean	Vietnamese	Native Hawaiian	Tongan
			Yapese

\*From NEDSS Logical Data Model Data Dictionary: Appendix B, 1. Standardized Vocabulary, 1.4 Person Race Categories and Codes ([http://www.cdc.gov/nedss/DataModels/NEDSS\\_LDM\\_Dictionary\\_II.pdf](http://www.cdc.gov/nedss/DataModels/NEDSS_LDM_Dictionary_II.pdf); last updated 11-19-2001)

# 12. Country of Birth

<p><b>12. Country of Birth</b></p> <p>"U.S.-born" (or born abroad to a parent who was a U.S. citizen)          (select one) <input type="checkbox"/> Yes <input type="checkbox"/> No</p> <p>Country of birth: <i>Specify</i> _____</p>
--

**Primary Purpose:** Surveillance. Data are used to determine the rate of TB among "U.S.-born" and foreign-born persons and to identify persons from countries with a high rate of TB.

**Note:** This portion of the RVCT asks 2 questions to help classify a person based on where the person was born.

- **"U.S.-born."** The U.S. Census Bureau defines a "U.S.-born" person to be someone born in 1 of the 50 states or the District of Columbia, or someone born outside the United States to at least one parent who was a U.S. citizen. In order to be consistent with the U.S. Census Bureau and to be able to apply census bureau population data to calculate TB rates, CDC uses the same definition for "U.S.-born."
- **Country of birth.** In order to distinguish persons who were born in another country (whether or not they had a parent who was a U.S. citizen) from those who were born in the United States, this question simply asks to record the actual country of birth. Therefore, a patient who was born in France and whose father was a U.S. citizen would be "U.S.-born" and their country of birth would be France.

**"U.S.-born" (or born abroad to a parent who was a U.S. citizen)**

OPTION (select one)	Description	Comment
Yes	If the person was born <ul style="list-style-type: none"> <li>• In 1 of the 50 U.S. states or the District of Columbia,</li> <li><b>or</b></li> <li>• Abroad to a parent who was a U.S. citizen.</li> </ul>	"U.S.-born" does <b>not</b> mean the same as U.S. citizen, and it does not necessarily mean that the person was born in the United States.  <b>Not</b> all U.S. citizens (e.g., naturalized citizens) are "U.S.-born."
No	If the person was born <ul style="list-style-type: none"> <li>• Abroad</li> <li><b>and</b></li> <li>• Neither parent was a U.S. citizen.</li> </ul>	Select for any country other than the United States.

## Country of birth

	Description
<b>Country of birth (specify)</b> (e.g., United States, Mexico, China)	Enter the name of the country in which the person was actually born.  Fill this out for all patients (whether they were “U.S.-born” or not).

## Examples of U.S.-Born

Patient		Description	Father		Mother	
U.S.-born			U.S. citizen		U.S. citizen	
Yes	No		Yes	No	Yes	No
Yes		Born in 1 of the 50 states or the District of Columbia	Yes		Yes	
Yes		Born in 1 of the 50 states or the District of Columbia		No		No
Yes		Born in another country	Yes		Yes	
Yes		Born in another country	Yes			No
Yes		Born in another country		No	Yes	
	No	Born in another country		No		No

**Note:** People born in Puerto Rico, Guam, the U.S. Virgin Islands, or the Commonwealth of the Northern Mariana Islands are U.S. citizens, but are **only considered “U.S.-born”** if they are born to a parent who is a U.S. citizen.

### Comment: “U.S.-born”

If the patient was born in 1 of the 50 states or the District of Columbia, or born abroad to a parent who was a U.S. citizen (either the mother or father or both parents), the patient is considered “U.S.-born.” Select Yes for “U.S.-born.” For country of birth, enter the name of the country where the person was actually born.

#### Example: “U.S.-born” and actually born in 1 of the 50 states or the District of Columbia

If the person was actually born in 1 of the 50 states or the District of Columbia, enter

- “U.S.-born” – Yes
- Country of birth – United States

#### Example: “U.S.-born” and actually born in another country

If the patient is born in Haiti, his mother is Haitian, but his father is a U.S. citizen, enter

- “U.S.-born” – Yes
- Country of birth – Haiti

**Example: “U.S.-born” and born to parents who were born in Puerto Rico, Guam, the U.S. Virgin Islands, or the Commonwealth of the Mariana Islands** (people born in these countries are U.S. citizens)

If the patient was born in Puerto Rico and both parents were born in Puerto Rico (therefore U.S. citizens), enter

- “U.S.-born” – Yes
- Country of birth – Puerto Rico

**Comment: Not “U.S.-born” and born in any country other than the U.S.**

If the patient was born in a country other than the United States to parents who were **not** “U.S. citizens,” enter

- “U.S.-born” – No
- Country of birth – name of the country where the person was actually born

**Example: Not “U.S.-born” but born in Puerto Rico, Guam, the U.S. Virgin Islands, or the Commonwealth of the Mariana Islands** (people born in these countries are U.S. citizens but not necessarily U.S.-born)

If the patient was born in Puerto Rico and but neither parent was a U.S. citizen, enter

- “U.S.-born” - No
- Country of birth – Puerto Rico

**Example: Not “U.S.-born” and born to parents who are not U.S. citizens**

If the patient was born in Russia and both parents are Russian citizens, enter

- “U.S.-born” - No
- Country of birth – Russia



## 13. Month-Year Arrived in U.S.

13. Month-Year Arrived in U.S.					
Month		Year			
<input type="text"/>	<input type="text"/>	<input type="text"/>	<input type="text"/>	<input type="text"/>	<input type="text"/>

**Primary Purpose:** Programmatic function. Data are used to guide TB programs in developing strategies for TB prevention and control for persons born outside the U.S.

	Description	Comment
<b>Month and year</b> (e.g., 02/1975)	When the patient <b>first</b> arrived in the United States (1 of the 50 states or the District of Columbia).	Complete this item if the patient was born in another country.  If month is unknown, enter 99 as the default value (e.g., 99/1975).  If neither month nor year is known, enter 99/9999.
<b>Leave item blank</b>	If patient was born in 1 of the 50 states or the District of Columbia.	

**Comment: If the patient was born abroad to a parent who was a U.S. citizen**

If a patient was born abroad to a parent who was a U.S. citizen, enter the month and year that the patient first arrived in the United States (1 of the 50 states or the District of Columbia).

**Example: If the patient was born abroad to a parent who was a U.S. citizen**

If a patient was born in Germany to a parent who was a U.S. citizen, enter the month and year that the patient first arrived in the United States (1 of the 50 states or the District of Columbia).

**Example: If the patient was born abroad to a parent who was a U.S. citizen**

If a patient was born in Puerto Rico to a parent who was a U.S. citizen, enter the month and year that the patient first arrived in the United States (1 of the 50 states or the District of Columbia).

**Example: Date that a patient first arrived from another country who enters on student visa**

If a patient is a citizen from another country and comes to the United States (1 of the 50 states or the District of Columbia) on a student visa and returns home, and then later returns to the United States, the date when the patient first arrived in the United States as a student would be the date that should be entered, even if the patient doesn't return for many years.

## 14. Pediatric TB Patients (<15 years old)

<b>14. Pediatric TB Patients (&lt;15 years old)</b> Country of Birth for Primary Guardian(s): <i>Specify</i> Guardian 1 _____ Guardian 2 _____ Patient lived outside U.S. for >2 months? <input type="checkbox"/> Yes <input type="checkbox"/> No <input type="checkbox"/> Unknown (select one) If YES, list countries, <i>specify</i> : _____		
--	--	--

**Primary Purpose:** Surveillance. Data are used to capture risk factors for guardians born in countries that have a high burden of TB and when pediatric patients live in TB endemic countries.

To better capture important information about pediatric TB patients (<15 years old), this variable provides information on country of birth for primary guardians (or primary care givers) of the pediatric patient and whether the patient lived outside the United States (1 of the 50 states or the District of Columbia) for an **uninterrupted** period of more than 2 months.

**Note: Pediatric TB Patients** (item 14) should be completed for all pediatric patients. For all pediatric patients, ask the country of birth for parents or primary guardians and whether the patient has lived outside the United States for >2 months consecutively.

Complete this item for **all pediatric** TB patients (<15 years old).

	Description
<b>Country of birth for the primary guardians</b> (e.g., mother, father, adoptive or foster parent, grandparent)	Enter the names of the countries where the primary guardians were actually born.  Enter as many as 2 parents or primary guardians.

Complete this item for **all pediatric** TB patients (<15 years old).

Option (select one)	Description	Comment
<b>Yes</b>	Pediatric patient lived outside the United States (1 of the 50 states or the District of Columbia) for an <b>uninterrupted</b> period of more than 2 months.	Although it may be difficult to determine the exact amount of uninterrupted time that a patient lived outside the United States, check <b>Yes</b> and enter the names of the countries if the period is believed to be more than 8 consecutive weeks (2 months).
<b>No</b>	Pediatric patient did <b>not</b> live outside the United States for an <b>uninterrupted</b> period of more than 2 months.	

<b>Unknown</b>	It is <b>not</b> known whether the pediatric patient lived outside the United States for an <b>uninterrupted</b> period of <b>more than 2 months</b> .	
----------------	--	--

**Comment: Lived outside the United States**

Lived outside the United States refers to the place where a person stayed or slept most of the time, or the place the person considered home during the stated period.

If you selected **Yes**, enter the following information.

	<b>Description</b>	<b>Comment</b>
<b>Countries</b> <i>(specify)</i>	Enter the names of the countries where the pediatric patient lived.	Enter as many as <b>3 non-U.S. countries</b> in which the patient most recently lived for a total of <b>more than 2 uninterrupted months</b> .

**Example: Yes, Lived outside the United States in as many as 3 countries for a total of more than 2 uninterrupted months**

From January 1 to March 15, the patient lived outside the United States

- Lived in Zambia for 10 weeks, then
- Returned to the United States

**Example: Yes, Lived outside the United States in as many as 3 countries for a total of more than 2 uninterrupted months**

From January 1 to March 15 the patient lived outside the United States

- Lived in Zambia for 4 weeks, then
- Lived in South Africa for 3 weeks, then
- Lived in Botswana 3 weeks, then
- Returned to the United States

**Example: No, Lived outside the United States in as many as 3 countries for a total of more than 2 months, but travel was interrupted**

From January 1 – March 15 the patient lived outside the United States

- Lived in Zambia for 5 weeks, then
- Returned to the United States for 2 weeks, then
- Lived in South Africa for 5 weeks, then
- Returned to the United States

## 15. Status at TB Diagnosis

15. Status at TB Diagnosis (select one)

Alive  Dead

If DEAD, enter date of death:      Month      Day      Year

If DEAD, was TB a cause of death? (select one)

Yes  No  Unknown

**Primary Purpose:** Surveillance. Data are used to examine mortality and to determine if TB was a cause of death.

Option (select one)	Description	Comment
<b>Alive</b>	<p>Patient was alive at time</p> <ul style="list-style-type: none"> <li>Laboratory results confirming a TB diagnosis (e.g., positive culture or nucleic acid amplification [NAA] test result consistent with TB) were known to the provider</li> <li><b>or</b></li> <li>TB medications were started</li> </ul>	<p>If the patient</p> <ul style="list-style-type: none"> <li>Was known to be culture or NAA test result positive consistent with TB prior to the date of death but did not start TB therapy per ATS/CDC/IDSA guidelines, classify the patient as alive at TB diagnosis</li> <li>Started empiric therapy for TB disease (per ATS/CDC/IDSA guidelines), but TB was not verified until after the patient's death, classify as alive at TB diagnosis</li> <li>Started TB therapy, regardless of laboratory or clinical confirmation for TB diagnosis, classify the patient as alive at TB diagnosis</li> </ul>
<b>Dead</b>	<p>Patient was deceased at the time laboratory results confirming a TB diagnosis (e.g., positive culture or NAA test result consistent with TB) were known to the provider</p>	<ul style="list-style-type: none"> <li>If diagnostic specimens were collected for evaluation of TB prior to death, but positive results to make a diagnosis of TB were not available until after death, and patient did not start TB therapy, classify as dead at TB diagnosis</li> <li>If TB diagnosis was made after death based on a constellation of clinical and other findings (e.g., symptoms, TST, and imaging studies) in the absence of laboratory confirmation, and the patient did not start therapy, classify as dead at TB diagnosis</li> <li>If patient was receiving treatment for latent TB infection at death because active TB disease was not suspected, and TB was diagnosed after death, classify as dead at TB diagnosis</li> <li>If patient was diagnosed at autopsy, classify as dead at TB diagnosis</li> </ul>

**Comment:**

If a person dies while taking isoniazid as preventive therapy for latent TB infection, and this person is found after death to have had TB disease, he/she should be classified as **Dead** at TB diagnosis.

If you selected **Dead** at TB diagnosis, enter **date of death**.

	Description	Comment
<b>Date of death</b> (e.g., 01/17/2005)	Month, day, and year patient died	If day is unknown, enter 99 as the default value (e.g., 01/99/2005).

If you selected **Dead** at TB diagnosis, was **TB a cause of death**?

Option (select one)	Description	Comment
<b>Yes</b> (related to TB disease)	<b>TB was</b> <ul style="list-style-type: none"> <li>• The immediate cause</li> <li><b>or</b></li> <li>• An underlying cause</li> <li><b>or</b></li> <li>• Another significant condition contributing to death (even if TB was <b>not</b> the main cause of death)</li> </ul>	<p>Written documentation of the cause of death (e.g., death certificate, autopsy report, medical record) is recommended. However, oral information from a reliable source (e.g., a health care provider) will be accepted.</p> <p>A death certificate is <b>not</b> necessarily required to complete this field. In some cases deaths may be certified before receipt of results of</p> <ul style="list-style-type: none"> <li>• Positive <i>M. tuberculosis</i> culture</li> <li><b>or</b></li> <li>• Other findings consistent with TB</li> </ul> <p>If the patient died as a result of a surgical procedure that was indicated for TB, or TB complicated a surgical procedure <b>not</b> related to TB.</p>
<b>No</b> (unrelated to TB disease)	<b>TB was not</b> <ul style="list-style-type: none"> <li>• The immediate cause</li> <li><b>or</b></li> <li>• An underlying cause</li> <li><b>or</b></li> <li>• Another significant condition contributing to death</li> </ul>	
<b>Unknown</b>	Cause of death is <b>not</b> known.	Every effort should be made to determine if death was related to TB disease before classifying as unknown.

**Note:** This should reflect current or active TB disease (not LTBI) whenever death certificate or death documentation is used.

# 16. Site of TB Disease

**16. Site of TB Disease** (select all that apply)

<input type="checkbox"/> Pulmonary	<input type="checkbox"/> Bone and/or Joint
<input type="checkbox"/> Pleural	<input type="checkbox"/> Genitourinary
<input type="checkbox"/> Lymphatic: Cervical	<input type="checkbox"/> Meningeal
<input type="checkbox"/> Lymphatic: Intrathoracic	<input type="checkbox"/> Peritoneal
<input type="checkbox"/> Lymphatic: Axillary	<input type="checkbox"/> Other: Enter anatomic code(s)
<input type="checkbox"/> Lymphatic: Other	<input type="checkbox"/> Site not stated
<input type="checkbox"/> Lymphatic: Unknown	
<input type="checkbox"/> Laryngeal	

{ 1    
 (see list): 2    
 3

**Primary Purpose:** Surveillance. Data are used to document site of TB disease.

Option (select all that apply)	Description	Comment
<b>Pulmonary, pleural, lymphatic, etc.</b>	Select boxes corresponding to the site(s) of TB disease.	
<b>Other: enter anatomic code(s)</b>	If site of TB disease is a <b>site other than those listed</b> , enter the anatomic code(s) (see Appendix C – Anatomic Codes). You may enter as many as 3 <b>Other</b> anatomic codes.	Refer to the listings for site of TB disease and anatomic codes. In Appendix C – Anatomic Codes, anatomic codes for <b>Other</b> are marked with an asterisk (*). Select <b>only</b> from sites marked with an asterisk (*). Anatomic codes without an asterisk are parts of organ systems corresponding to <b>Site of TB Disease</b> .
<b>Site not stated</b>		If you selected Site not stated, do <b>not</b> check any other box.

**Note:** For the purposes of the RVCT training materials, use the codes listed in the appendices. Some software programs used to enter data on the RVCT may **NOT** use the codes listed in the appendices. For example, the Anatomic Codes may be a drop-down item where you choose the actual site rather than enter a code. For more information, see instructions for the software you use.

**Comment: If more than 1 organ or disease site is involved**

If there is evidence that more than 1 organ or disease site is involved, check all involved sites of disease.

**Comment: Lymphatic intrathoracic**

Lymphatic intrathoracic includes hilar, bronchial, mediastinal, peritracheal, and other lymph nodes within the thorax.

**Comment: Miliary TB**

Unlike the previous RVCT form, the new form has no place to select miliary TB in **Site of Disease** (item 16). If the report of the initial chest radiograph or the initial chest CT scan indicates “miliary TB or a miliary or bilateral micronodular pattern,” record this finding under **Initial Chest Radiograph** (item 22A) or **Initial Chest CT Scan or Other Chest Imaging Study** (item 22B), respectively. However, pulmonary should be selected as **Site of Disease** (item 16) if the chest x-ray or CT scan shows evidence of nodules consistent with miliary TB.

Miliary TB is a serious type of tuberculosis infection. It is a clinical or radiologic finding, rather than a site of disease. Miliary TB is the result of a TB lung infection eroding into the bloodstream and from there disseminating throughout the body to multiple organs. It appears on radiograph as a great number of small (1- to 2-mm), well-defined nodules that look like millet seeds scattered throughout the lungs, hence the name “miliary.”

# RVCT (page 2 of 3) Items 17 – 25

Page 2 of the RVCT report includes instructions for completing items 17 – 25. It includes data about laboratory results and primary reason the patient was evaluated for TB disease.

Patient's Name _____ <small>(Last) (First)</small>	State Case No. _____ <small>(M.I.)</small>	<b>REPORT OF VERIFIED CASE OF TUBERCULOSIS</b>
<b>REPORT OF VERIFIED CASE OF TUBERCULOSIS</b>		
<b>17. Sputum Smear (select one)</b> <input type="checkbox"/> Positive <input type="checkbox"/> Not Done <input type="checkbox"/> Negative <input type="checkbox"/> Unknown		
Date Collected: _____ <small>Month Day Year</small>		
<b>18. Sputum Culture (select one)</b> <input type="checkbox"/> Positive <input type="checkbox"/> Not Done <input type="checkbox"/> Negative <input type="checkbox"/> Unknown		
Date Collected: _____ <small>Month Day Year</small>		
Date Result Reported: _____ <small>Month Day Year</small>		
Reporting Laboratory Type (select one): <input type="checkbox"/> Public Health Laboratory <input type="checkbox"/> Commercial Laboratory <input type="checkbox"/> Other		
<b>19. Smear/Pathology/Cytology of Tissue and Other Body Fluids (select one)</b> <input type="checkbox"/> Positive <input type="checkbox"/> Not Done <input type="checkbox"/> Negative <input type="checkbox"/> Unknown		
Date Collected: _____ <small>Month Day Year</small>		
Enter anatomic code (see list): _____ <small>(see list)</small>		Type of exam (select all that apply): <input type="checkbox"/> Smear <input type="checkbox"/> Pathology/Cytology
<b>20. Culture of Tissue and Other Body Fluids (select one)</b> <input type="checkbox"/> Positive <input type="checkbox"/> Not Done <input type="checkbox"/> Negative <input type="checkbox"/> Unknown		
Date Collected: _____ <small>Month Day Year</small>		
Enter anatomic code (see list): _____ <small>(see list)</small>		Date Result Reported: _____ <small>Month Day Year</small>
Reporting Laboratory Type (select one): <input type="checkbox"/> Public Health Laboratory <input type="checkbox"/> Commercial Laboratory <input type="checkbox"/> Other		
<b>21. Nucleic Acid Amplification Test Result (select one)</b> <input type="checkbox"/> Positive <input type="checkbox"/> Not Done <input type="checkbox"/> Negative <input type="checkbox"/> Unknown <input type="checkbox"/> Indeterminate		
Date Collected: _____ <small>Month Day Year</small>		
Date Result Reported: _____ <small>Month Day Year</small>		
Enter specimen type: <input type="checkbox"/> Sputum OR If not Sputum, enter anatomic code (see list): _____		Reporting Laboratory Type (select one): <input type="checkbox"/> Public Health Laboratory <input type="checkbox"/> Commercial Laboratory <input type="checkbox"/> Other
<b>Initial Chest Radiograph and Other Chest Imaging Study</b>		
<b>22A. Initial Chest Radiograph (select one)</b> <input type="checkbox"/> Normal <input type="checkbox"/> Abnormal* (consistent with TB) <input type="checkbox"/> Not Done <input type="checkbox"/> Unknown * For ABNORMAL Initial Chest Radiograph: Evidence of a cavity (select one): <input type="checkbox"/> Yes <input type="checkbox"/> No <input type="checkbox"/> Unknown Evidence of miliary TB (select one): <input type="checkbox"/> Yes <input type="checkbox"/> No <input type="checkbox"/> Unknown		
<b>22B. Initial Chest CT Scan or Other Chest Imaging Study (select one)</b> <input type="checkbox"/> Normal <input type="checkbox"/> Abnormal* (consistent with TB) <input type="checkbox"/> Not Done <input type="checkbox"/> Unknown * For ABNORMAL Initial Chest CT Scan or Other Chest Imaging Study: Evidence of a cavity (select one): <input type="checkbox"/> Yes <input type="checkbox"/> No <input type="checkbox"/> Unknown Evidence of miliary TB (select one): <input type="checkbox"/> Yes <input type="checkbox"/> No <input type="checkbox"/> Unknown		
<b>23. Tuberculin (Mantoux) Skin Test at Diagnosis (select one)</b> <input type="checkbox"/> Positive <input type="checkbox"/> Not Done <input type="checkbox"/> Negative <input type="checkbox"/> Unknown		<b>25. Primary Reason Evaluated for TB Disease (select one)</b> <input type="checkbox"/> TB Symptoms <input type="checkbox"/> Abnormal Chest Radiograph (consistent with TB) <input type="checkbox"/> Contact Investigation <input type="checkbox"/> Targeted Testing <input type="checkbox"/> Health Care Worker <input type="checkbox"/> Employment/Administrative Testing <input type="checkbox"/> Immigration Medical Exam <input type="checkbox"/> Incidental Lab Result <input type="checkbox"/> Unknown
Date Tuberculin Skin Test (TST) Placed: _____ <small>Month Day Year</small>		
<b>24. Interferon Gamma Release Assay for Mycobacterium tuberculosis at Diagnosis (select one)</b> <input type="checkbox"/> Positive <input type="checkbox"/> Not Done <input type="checkbox"/> Negative <input type="checkbox"/> Unknown <input type="checkbox"/> Indeterminate		
Date Collected: _____ <small>Month Day Year</small>		
Test type: _____ Specify: _____		
<small>CDC 72.9A Rev 09/15/2008 CS121321 1st Copy REPORT OF VERIFIED CASE OF TUBERCULOSIS Page 2 of 3</small>		



## 17. Sputum Smear

<b>17. Sputum Smear</b> <i>(select one)</i> <input type="checkbox"/> Positive <input type="checkbox"/> Not Done <input type="checkbox"/> Negative <input type="checkbox"/> Unknown	Date Collected: Month    Day    Year <input type="text"/> <input type="text"/> <input type="text"/> <input type="text"/> <input type="text"/> <input type="text"/> <input type="text"/> <input type="text"/>
--	--

**Primary Purpose:** Case management and surveillance. This result is one factor in determining whether the patient's disease meets the public health definition of TB.

Option <i>(select one)</i>	Description	Comment
<b>Positive</b>	The result of <b>any</b> sputum examination was positive for acid-fast bacilli (AFB).	
<b>Negative</b>	Results of <b>all</b> examinations were negative.	
<b>Not done</b>	Sputum smear examination is known <b>not</b> to have been done.	
<b>Unknown</b>	It is <b>not</b> known whether a sputum smear examination was performed. <b>or</b> Results are <b>not</b> known for a reason other than pending results (e.g., result was lost or specimen was contaminated, and no other specimen can be obtained).	If an initial sputum specimen was collected and results are unknown, but results later become known, update the results.

### Comments: Sputum

Sputum includes spontaneous and induced sputum. Do **not** include the results of microscopic examination of pulmonary secretions obtained by tracheal suction, bronchoscopy procedures (e.g., bronchial washing or lavage, scrapings, biopsies), or gastric aspiration. See **Smear/Pathology/Cytology of Tissue and Other Body Fluids** (item 19).

Sputum should have been collected during the diagnostic evaluation or shortly thereafter. Do **not** record specimens collected after the patient has received treatment for more than 2 weeks.

For **Positive** or **Negative** results of sputum smear examinations, enter the following information.

	Description	Comment
<b>Date collected</b>	Month, day, and year the first sputum specimen with a <b>positive</b> result was <b>collected</b> (e.g., 01/17/2009)	If several sputum examinations were done and the results of 1 or more sputum examinations were <b>positive</b> , enter the date the <b>first</b> sputum specimen with a positive result was collected.
	Month, day, and year the first <b>negative</b> sputum specimen was <b>collected</b> (e.g., 01/17/2009) if all results were negative	If several sputum examinations were done and <b>all</b> results were <b>negative</b> , enter the date the <b>first</b> sputum specimen with a negative result was collected.

## 18. Sputum Culture

<b>18. Sputum Culture</b> ( <i>select one</i> ) <input type="checkbox"/> Positive <input type="checkbox"/> Not Done <input type="checkbox"/> Negative <input type="checkbox"/> Unknown	Date Collected:	Date Result Reported:
	Month    Day    Year <input type="text"/> <input type="text"/> <input type="text"/> <input type="text"/> <input type="text"/>	Month    Day    Year <input type="text"/> <input type="text"/> <input type="text"/> <input type="text"/> <input type="text"/>
Reporting Laboratory Type ( <i>select one</i> ): <input type="checkbox"/> Public Health Laboratory <input type="checkbox"/> Commercial Laboratory <input type="checkbox"/> Other		

**Primary Purpose:** Case management and surveillance. This result is a main factor in determining whether the patient's disease meets the public health definition of TB.

Option ( <i>select one</i> )	Description	Comment
<b>Positive</b>	The result of <b>any</b> (or the only) sputum culture was positive for <i>M. tuberculosis</i> complex.	
<b>Negative</b>	Results of <b>all</b> sputum cultures were negative for <i>M. tuberculosis</i> complex.	
<b>Not done</b>	It is known that the sputum culture was <b>not done</b> .	
<b>Unknown</b>	It is <b>not</b> known whether a sputum culture was performed. <b>or</b> Results are <b>not</b> known for a reason other than pending results (e.g., result was lost or specimen was contaminated, and no other specimen can be obtained).	If an initial sputum specimen was collected and results are unknown, but results later become known, update the results.

### Comment: Sputum

Sputum includes spontaneous and induced sputum. **Do not include** the culture results of pulmonary secretions obtained by tracheal suction, bronchoscopy procedures (e.g., bronchial washing or lavage, scrapings, biopsies), or gastric aspiration. For more information, see **Culture of Tissue and Other Body Fluids** (item 20).

Sputum should have been collected during diagnostic work-up or shortly thereafter. Do **not** record specimens collected after the patient has received treatment more than 2 weeks.

For **positive** or **negative** results of sputum cultures, enter the following information.

	Description	Comment
<b>Date collected</b>	Month, day, and year the first sputum specimen with a <b>positive</b> culture result was <b>collected</b> (e.g., 01/17/2009)	If several sputum cultures were performed and the results of 1 or more were <b>positive</b> for <i>M. tuberculosis</i> complex, enter the date the <b>first</b> sputum culture with a positive result was collected.
	Month, day, and year the first sputum specimen with a <b>negative</b> culture result was <b>collected</b> (e.g., 01/17/2009) if all results were negative	If several sputum cultures were done and <b>all</b> results were <b>negative</b> , enter the date the <b>first</b> sputum specimen with a negative result was collected.

For the **first** sputum culture reported **positive** for *M. tuberculosis* complex, enter the following information.

	Description	Comment
<b>Date result reported</b>	Month, day, and year the laboratory reported the result (e.g., 01/17/2009)	This date can be found on the laboratory report as the date the report is released or made available.  If the day is unknown, enter 99 as the default value (e.g., 01/99/2009).

For **positive** culture results, select the option that best describes the **reporting laboratory type**.

Option (select one)	Description	Comment
<b>Public health laboratory</b>	Any laboratory associated with a local or a state health department	
<b>Commercial laboratory</b>	Any laboratory that charges a fee for each specimen processed or test performed	
<b>Other</b>	Any other laboratory that is <b>not</b> considered a <b>public health laboratory</b> or a <b>commercial laboratory</b>	<b>Hospital laboratories</b> (e.g., National Jewish Health hospital laboratory) or <b>laboratories associated with federal public health agencies</b> (e.g., Centers for Disease Control and Prevention, Veterans Administration, Indian Health Service [IHS], Tribal Health Department, or Bureau of Prisons)  National Jewish Health hospital laboratory sometimes charges for services, but for the purposes of the RVCT it is categorized as "Other."

## 19. Smear/Pathology/Cytology of Tissue and Other Body Fluids

19. Smear/Pathology/Cytology of Tissue and Other Body Fluids (select one)			
<input type="checkbox"/> Positive	<input type="checkbox"/> Not Done	Date Collected:	Enter anatomic code
<input type="checkbox"/> Negative	<input type="checkbox"/> Unknown	Month      Day      Year	(see list):
		<input type="text"/> <input type="text"/> <input type="text"/> <input type="text"/> <input type="text"/> <input type="text"/>	<input type="text"/> <input type="text"/>
		Type of exam (select all that apply):	
		<input type="checkbox"/> Smear <input type="checkbox"/> Pathology/Cytology	

**Primary Purpose:** Case management and surveillance. This result is a factor in determining whether the patient's disease meets the public health definition of TB.

**Note:** This item is for recording results of a smear, or pathology, or cytology of tissue and/or other body fluids. In this item, "tissue and other body fluids" does **not** include sputum. Examples of tissue and other body fluids are tracheal aspirate, bronchial cells and fluid, urine, bone marrow, lymph node, cerebral spinal fluid, lung tissue or fluid, and pleural fluid that are collected from various procedures (e.g., bronchoscopy, bronchial washing or lavage, biopsy, gastric aspiration, pleural aspiration).

Results from sputum smear examinations and sputum cultures should be entered under **Sputum Smear** (item 17) and **Sputum Culture** (item 18).

Option (select one)	Description	Comment
<b>Positive</b>	<p>Any tissue or body fluid <b>other than sputum</b> that (see <b>Note</b> above)</p> <ul style="list-style-type: none"> <li>Tested positive by smear examination</li> </ul> <p><b>or</b></p> <ul style="list-style-type: none"> <li>Showed granulomas, granulomatous inflammation, or other pathologic or histologic findings consistent with TB disease during a pathologic/cytologic examination. (Such findings are listed on the pathology or the cytology report.)</li> </ul>	<b>Any positive result supersedes a negative result.</b>
<b>Negative</b>	<p>All specimens of tissue or fluid that</p> <ul style="list-style-type: none"> <li>Tested negative by smear examination</li> </ul> <p><b>or</b></p> <ul style="list-style-type: none"> <li>Showed <b>no</b> evidence of granulomas, granulomatous inflammation, or other pathologic or histologic findings consistent with TB disease during a pathologic/cytologic examination. (Such findings are listed on the pathology or the cytology report.)</li> </ul>	
<b>Not done</b>	Examinations of tissue or fluids are known <b>not</b> to have been done.	

<b>Unknown</b>	It is <b>not</b> known whether tissue or fluids <ul style="list-style-type: none"> <li>• Were examined</li> <li><b>or</b></li> <li>• Results are <b>not</b> known for a reason other than pending results (e.g., result was lost or specimen was contaminated, and no other specimen can be obtained).</li> </ul>	If an initial specimen was collected and results are unknown, but results later become known, update the results.
----------------	---	---

**Comment: When to collect specimen**

A smear, or pathology, or cytology specimen should have been collected during diagnostic workup or shortly thereafter. Do **not** record specimens collected after the patient has received treatment more than 2 weeks.

For **positive** or **negative** results of an examination for a smear or, pathology, or cytology of tissue and/or other body fluids, enter the following information.

	<b>Description</b>	<b>Comment</b>
<b>Date collected</b>	Month, day, and year the first specimen with a <b>positive</b> result was <b>collected</b> (e.g., 01/17/2009)	If several specimen (tissue or fluid) examinations were done and the results of 1 or more examinations were <b>positive</b> , enter the date the <b>first</b> specimen with a positive result was collected.
	Month, day, and year the first <b>negative</b> specimen was <b>collected</b> (e.g., 01/17/2009) if all results were negative	If several specimen examinations were done and <b>all</b> results were <b>negative</b> , enter the date the <b>first</b> specimen with a negative result was collected.
<b>Anatomic code</b>	Enter appropriate anatomic code (e.g., 30 for pericardium) from Appendix C – Anatomic Codes.	

**Note:** For the purposes of the RVCT training materials, use the codes listed in the appendices. Some software programs used to enter data on the RVCT may **NOT** use the codes listed in the appendices. For example, the Anatomic Codes may be a drop-down item where you choose the actual site rather than enter a code. For more information, see instructions for the software you use.

For **Type of Exam**, select both of the following if applicable.

Option (select all that apply)	Comment
Smear	Select the type(s) of exam that correspond(s) to the result selected in item 19.
Pathology/cytology	

**Comment: Any positive result supersedes a negative result in reporting TB diagnostic criteria.**

If the results are discrepant (smear negative, pathology positive), then Type of Exam should correspond to the result captured as positive. If both smear and pathology had been positive, both smear and pathology/cytology should be checked under Type of Exam. Likewise, if both smear and pathology had been negative, then both smear and pathology/cytology should be checked under Type of Exam.

**Example: Positive result superseding a negative result**

If the smear results were negative and the pathology was positive, then Type of Exam selected should be Pathology. In this case, smear would not be selected because the result was negative.

### Reporting TB Diagnostic Criteria (Positive Result Supersedes Negative Results)

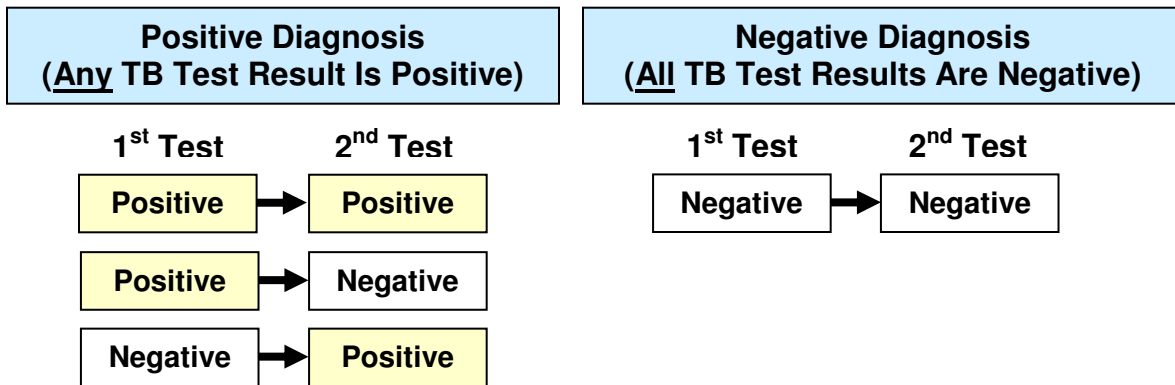

## 20. Culture of Tissue and Other Body Fluids

<b>20. Culture of Tissue and Other Body Fluids</b> (select one)		Date Collected:		Enter anatomic code (see list):		Date Result Reported:		
<input type="checkbox"/> Positive	<input type="checkbox"/> Not Done	Month	Day	Year	<input type="checkbox"/>	Month	Day	Year
<input type="checkbox"/> Negative	<input type="checkbox"/> Unknown	<input type="text"/>	<input type="text"/>	<input type="text"/>	<input type="text"/>	<input type="text"/>	<input type="text"/>	<input type="text"/>
Reporting Laboratory Type (select one):		<input type="checkbox"/> Public Health Laboratory		<input type="checkbox"/> Commercial Laboratory		<input type="checkbox"/> Other		

**Primary Purpose:** Case management and surveillance. This result is a factor in determining whether the patient's disease meets the public health definition of TB.

**Note:** The term "tissue and other body fluids" **does not include** sputum. Examples of tissue and other body fluids are tracheal aspirate, bronchial cells and fluid, urine, bone marrow, lymph node, cerebral spinal fluid, lung tissue or fluid, and pleural fluid collected from various procedures (e.g., bronchoscopy, bronchial washing or lavage, biopsy, gastric aspiration, pleural aspiration). Results from sputum smear examinations and sputum cultures should be entered under **Sputum Smear** (item 17) and **Sputum Culture** (item 18).

Option (select one)	Description	Comment
<b>Positive</b>	The culture results for <b>any</b> tissue or fluid culture <b>other than sputum</b> (see <b>Note</b> above) was positive for <i>M. tuberculosis</i> complex.	If an initial specimen was collected and results are unknown, but results later become known, update the results.  <b>Any positive result supersedes a negative result.</b>
<b>Negative</b>	The culture results for <b>all</b> tissue or fluid cultures, <b>other than sputum</b> cultures, were negative for <i>M. tuberculosis</i> complex.	
<b>Not done</b>	It is known that tissue or fluid cultures were <b>not done</b> .	
<b>Unknown</b>	It is <b>not</b> known whether tissue or fluid cultures were performed <b>or</b> Results are <b>not</b> known for a reason other than pending results (e.g., result was lost or specimen was contaminated, and no other specimen can be obtained).	If an initial specimen was collected and results are unknown, but results later become known, update the results.



**Comment: When to collect specimen**

Specimens of tissue and other body fluids should have been collected during diagnostic workup or shortly thereafter. Do **not** record specimens collected after the patient has received treatment for more than 2 weeks.

For **positive** or **negative** result of tissue or fluid culture, enter the following information.

	Description	Comment
<b>Date collected</b>	Month, day, and year the first specimen with a <b>positive</b> result was <b>collected</b> (e.g., 01/17/2009)	If cultures were performed on several specimens of tissue or fluid and the results of 1 or more were <b>positive</b> for <i>M. tuberculosis</i> complex, enter the date the <b>first specimen with a positive</b> culture result was collected.
	Month, day, and year the first specimen with a <b>negative</b> result was <b>collected</b> (e.g., 1/17/2009) if all results were negative	If several cultures were done and <b>all</b> results were <b>negative</b> , enter the date the <b>first</b> specimen with a negative result was collected.
<b>Anatomic code</b>	Enter appropriate anatomic code (e.g., 30 for pericardium) from Appendix C – Anatomic Codes.	

**Note:** For the purposes of the RVCT training materials, use the codes listed in the appendices. Some software programs used to enter data on the RVCT may **NOT** use the codes listed in the appendices. For example, the Anatomic Codes may be a drop-down item where you choose the actual site rather than enter a code. For more information, see instructions for the software you use.

For the **first** tissue or fluid culture reported to be **positive** for *M. tuberculosis* complex, enter the following information.

	Description	Comment
<b>Date result reported</b>	Month, day, and year the result was reported by the laboratory (e.g., 01/17/2009)	This date can be found on the laboratory report as the date the report is released or made available.  If the day is unknown, enter 99 as the default value (e.g., 01/99/2009).

For **positive** results, select the option that best describes the **reporting laboratory type**.

Option (select one)	Description	Comment
<b>Public health laboratory</b>	Any laboratory associated with a local or a state health department	
<b>Commercial laboratory</b>	Any laboratory that charges a fee for each specimen processed or test performed	
<b>Other</b>	Any other laboratory that is <b>not</b> considered a <b>public health laboratory</b> or a <b>commercial laboratory</b>	Hospital laboratories (e.g., National Jewish Health hospital laboratory) and laboratories associated with federal public health agencies (e.g., Centers for Disease Control and Prevention, Veterans Administration, Indian Health Service [IHS], Tribal Health Department, and Bureau of Prisons)  National Jewish Health hospital laboratory sometimes charges for services, but for the purposes of the RVCT it is categorized as "Other."

## 21. Nucleic Acid Amplification Test Result

**21. Nucleic Acid Amplification Test Result** (select one)

Positive     Not Done  
 Negative     Unknown  
 Indeterminate

Date Collected:

Month:   Day:   Year:

Date Result Reported:

Month:   Day:   Year:

Enter specimen type:  Sputum  
**OR**  
 If not Sputum, enter anatomic code (see list):

Reporting Laboratory Type (select one):

Public Health Laboratory     Commercial Laboratory     Other

**Primary Purpose:** Case management and surveillance. This result is a factor in determining whether the patient's disease meets the public health definition of TB.

Option (select one)	Description	Comment
<b>Positive</b>	Any NAA test result was positive for <i>M. tuberculosis</i> complex.	<b>Any positive result supersedes all other test results</b> (e.g., 1 positive and 2 negatives = positive; 1 indeterminate and 1 negative and 1 positive = positive).
<b>Negative</b>	No NAA test results were positive for <i>M. tuberculosis</i> complex and at least one result was negative.	<b>A negative result supersedes indeterminate</b> (e.g., 1 negative and 1 indeterminate = negative).
<b>Not done</b>	NAA test was <b>not</b> performed.	
<b>Unknown</b>	It is <b>not</b> known whether an NAA test was performed. <b>or</b> NAA test results are <b>not</b> known or result is not known for a reason other than pending results.	If an initial specimen was collected and results are unknown, but results later become known, update the results.
<b>Indeterminate</b>	<b>All</b> NAA tests were indeterminate (e.g., inconclusive, inhibitory).	All tests are indeterminate.

For **positive** or **negative** results of NAA testing, enter the following information.

	Description	Comment
<b>Date collected</b>	Month, day, and year the first sputum specimen with a <b>positive</b> result was <b>collected</b> (e.g., 01/17/2009)	If several specimens were collected and the NAA test results of 1 or more were <b>positive</b> for <i>M. tuberculosis</i> complex, enter the date the <b>first</b> specimen with a positive result was collected.
	Month, day, and year the first sputum specimen with a <b>negative</b> result was <b>collected</b> (e.g., 01/17/2009) if all results were negative	If several specimens were collected and <b>all</b> NAA test results were <b>negative</b> , enter the date the <b>first</b> sputum specimen with a negative result was collected.

Select the **Specimen Type** on which NAA testing was done.

Option (select one)	Description	Comment
<b>Sputum</b>		
<b>Not sputum</b>	Enter appropriate anatomic code (e.g., 30 for pericardium) from Appendix C – Anatomic Codes	

**Note:** For the purposes of the RVCT training materials, use the codes listed in the appendices. Some software programs used to enter data on the RVCT may **NOT** use the codes listed in the appendices. For example, the Anatomic Codes may be a drop-down item where you choose the actual site rather than enter a code. For more information, see instructions for the software you use.

For the **first** NAA test result reported **positive** for *M. tuberculosis* complex, enter the following information.

	Description	Comment
<b>Date result reported</b>	Month, day, and year the result was reported by the laboratory (e.g., 01/17/2009)	This date can be found on the laboratory report as the date the report is released or made available.

For **positive** NAA test results, select the option that best describes the **reporting laboratory type**.

Option (select one)	Description	Comment
<b>Public health laboratory</b>	Any laboratory associated with a local or a state health department	
<b>Commercial laboratory</b>	Any laboratory that charges a fee for each specimen processed or test performed	
<b>Other</b>	Any other laboratory that is <b>not</b> considered a <b>public health laboratory</b> or a <b>commercial laboratory</b>	Hospital laboratories (e.g., National Jewish Health hospital laboratory) and laboratories associated with federal public health agencies (e.g., Centers for Disease Control and Prevention, Veterans Administration, Indian Health Service [IHS], Tribal Health Department, and Bureau of Prisons)

**Comment: Nucleic Acid Amplification Tests**

The *MMWR* report, “Updated Guidelines for the Use of Nucleic Acid Amplification Tests in the Diagnosis of Tuberculosis,” provides information on the NAA tests that have been approved by the Food and Drug Administration for use with AFB smear-positive respiratory specimens. Accessible at [www.cdc.gov/mmwr/preview/mmwrhtml/mm5801a3.htm](http://www.cdc.gov/mmwr/preview/mmwrhtml/mm5801a3.htm).

## 22A. Initial Chest Radiograph

### Initial Chest Radiograph and Other Chest Imaging Study

22A. Initial Chest Radiograph  
(select one)

Normal

Abnormal\* (consistent with TB)

Not Done

Unknown

\* For ABNORMAL Initial Chest Radiograph: Evidence of a cavity (select one):  Yes  No  Unknown

Evidence of miliary TB (select one):  Yes  No  Unknown

**Primary Purpose:** Case management and surveillance. This is part of a diagnostic evaluation used to determine whether the patient's disease meets the public health definition of TB.

Select the result of the **initial** chest radiograph(s) performed during the diagnostic evaluation for TB.

Option (select one)	Description
<b>Normal</b>	Initial chest radiograph(s) showed <b>no</b> abnormalities consistent with TB. This category includes any other abnormalities that are <b>not</b> consistent with TB.
<b>Abnormal (consistent with TB)</b>	<b>Any</b> initial chest radiograph showing abnormalities (e.g., hilar adenopathy, effusion, infiltrate[s], cavity, scarring) consistent with TB.
<b>Not done</b>	It is known that the initial chest radiograph was <b>not done</b> .
<b>Unknown</b>	It is <b>not</b> known whether an initial chest radiograph was done. <b>or</b> Result of initial chest radiograph is <b>not</b> known or result is not known for a reason other than pending results.

For **abnormal** results, select one option for each type of evidence.

	<b>Option</b> <i>(select one)</i>	<b>Description</b>
<b>Evidence of a cavity</b>	<b>Yes</b>	<b>Any</b> initial chest radiograph(s) showing evidence of 1 or more lung cavities
	<b>No</b>	
	<b>Unknown</b>	

	<b>Option</b> <i>(select one)</i>	<b>Description</b>
<b>Evidence of miliary TB</b>	<b>Yes</b>	<b>Any</b> initial chest radiograph(s) showed evidence of miliary disease (e.g., miliary TB, or miliary or bilateral micronodular pattern)
	<b>No</b>	
	<b>Unknown</b>	

**Comment: Miliary TB**

Unlike the previous RVCT form, the new form has no place to select miliary TB in **Site of Disease** (item 16). If the report of the initial chest radiograph or the initial chest CT scan indicates “miliary TB or a miliary or bilateral micronodular pattern,” record this finding under **Initial Chest Radiograph** (item 22A) or **Initial Chest CT Scan or Other Chest Imaging Study** (item 22B), respectively. However, pulmonary should be selected as **Site of Disease** (item 16) if the chest x-ray or CT scan shows evidence of nodules consistent with miliary TB.

Miliary TB is a serious type of tuberculosis infection. It is a clinical or radiologic finding, rather than a site of disease. Miliary TB is the result of a TB lung infection eroding into the bloodstream and from there disseminating throughout the body to multiple organs. It appears on radiograph as a great number of small (1- to 2-mm), well-defined nodules that look like millet seeds scattered throughout the lungs, hence the name “miliary.”

## 22B. Initial Chest CT Scan or Other Chest Imaging Study

22B. Initial Chest CT Scan or Other Chest Imaging Study (select one)

Normal

Abnormal\* (consistent with TB)

Not Done

Unknown

\* For ABNORMAL Initial Chest CT Scan or Other Chest Imaging Study:

Evidence of a cavity (select one):  Yes  No  Unknown

Evidence of miliary TB (select one):  Yes  No  Unknown

**Primary Purpose:** Case management. This is part of a diagnostic evaluation used to determine whether the patient's disease meets the public health definition of TB.

Select the result of the **initial** chest computerized tomography (CT) or other chest imaging study such as magnetic resonance imaging (MRI), performed during the diagnostic evaluation for TB.

Option (select one)	Description
<b>Normal</b>	Initial chest CT scan or other chest imaging study showed no abnormalities consistent with TB. This category includes any other abnormalities that are <b>not</b> consistent with TB.
<b>Abnormal (consistent with TB)</b>	<b>Any</b> initial chest CT scan or other chest imaging study showed abnormality (e.g., hilar adenopathy, effusion, infiltrate[s], cavity, scarring) consistent with TB.
<b>Not done</b>	It is known that the initial chest CT scan or other chest imaging study was <b>not done</b> .
<b>Unknown</b>	It is <b>not</b> known whether an initial chest CT scan or other chest imaging study was done. <b>or</b> Result of initial chest CT scan or other chest imaging study is <b>not</b> known or result is not known for a reason other than pending results.



For **abnormal** chest CT scan or other chest imaging study results, select one option for each type of evidence.

	<b>Option</b> <i>(select one)</i>	<b>Description</b>
<b>Evidence of a cavity</b>	<b>Yes</b>	<b>Any</b> initial chest CT scan or other chest imaging study showed evidence of 1 or more cavities.
	<b>No</b>	
	<b>Unknown</b>	

	<b>Option</b> <i>(select one)</i>	<b>Description</b>
<b>Evidence of miliary TB</b>	<b>Yes</b>	<b>Any</b> initial chest CT scan or other chest imaging study showed evidence of miliary disease (e.g., miliary TB, or miliary or bilateral micronodular pattern).
	<b>No</b>	
	<b>Unknown</b>	

**Comment: Miliary TB**

Unlike the previous RVCT form, the new form has no place to select miliary TB in **Site of Disease** (item 16). If the report of the initial chest radiograph or the initial chest CT scan indicates “miliary TB or a miliary or bilateral micronodular pattern,” record this finding under **Initial Chest Radiograph** (item 22A) or **Initial Chest CT Scan or Other Chest Imaging Study** (item 22B), respectively. However, pulmonary should be selected as **Site of Disease** (item 16) if the chest x-ray or CT scan shows evidence of nodules consistent with miliary TB.

Miliary TB is a serious type of tuberculosis infection. It is a clinical or radiologic finding, rather than a site of disease. Miliary TB is the result of a TB lung infection eroding into the bloodstream and from there disseminating throughout the body to multiple organs. It appears on radiograph as a great number of small (1- to 2-mm), well-defined nodules that look like millet seeds scattered throughout the lungs, hence the name “miliary.”

## 23. Tuberculin (Mantoux) Skin Test at Diagnosis

<b>23. Tuberculin (Mantoux) Skin Test at Diagnosis</b> <i>(select one)</i>			
<input type="checkbox"/> Positive	<input type="checkbox"/> Not Done	Date Tuberculin Skin Test (TST) Placed:	Millimeters (mm) of induration:
<input type="checkbox"/> Negative	<input type="checkbox"/> Unknown	<div style="display: flex; justify-content: space-around; font-size: 0.8em;"> <span>Month</span> <span>Day</span> <span>Year</span> </div> <div style="display: flex; justify-content: space-around; text-align: center;"> <input style="width: 30px; height: 20px;" type="text"/> <input style="width: 30px; height: 20px;" type="text"/> <input style="width: 30px; height: 20px;" type="text"/> <input style="width: 30px; height: 20px;" type="text"/> </div>	<div style="display: flex; justify-content: center; text-align: center;"> <input style="width: 30px; height: 20px;" type="text"/> <input style="width: 30px; height: 20px;" type="text"/> </div>

**Primary Purpose:** Case management. This result helps guide clinicians in diagnosing TB infection and is a factor in determining whether the patient's disease meets the public health definition of TB.

**Positive** or **negative** result of the tuberculin skin test (TST) should be interpreted according to Table 7 of the currently accepted guidelines ([www.cdc.gov/mmwr/PDF/rr/rr4906.pdf](http://www.cdc.gov/mmwr/PDF/rr/rr4906.pdf)).

### Guidelines for Entering TST Results



Enter	Do Not Enter
Results from a TST performed during the current diagnostic evaluation	A patient's <b>undocumented</b> self-report of a previous positive result is <b>not</b> acceptable
<b>May enter previous positive test result</b> <ul style="list-style-type: none"> <li>If patient had tested <b>positive</b> to a previous TST <b>and</b></li> <li>The previous positive result is <b>documented</b> in the medical record.</li> </ul>	A previous <b>negative</b> TST result (reported by the patient or documented or both) is also <b>not</b> acceptable

Option <i>(select one)</i>	Description
<b>Positive</b>	Meets the criteria for a positive TST result.
<b>Negative</b>	Result of TST did <b>not</b> meet current criteria for a positive test result.
<b>Not done</b>	TST was <b>not</b> performed <b>or</b> Patient reports a positive result of an earlier TST, but it cannot be documented, <b>and</b> now the patient refuses a TST.
<b>Unknown</b>	It is <b>not</b> known whether a TST was performed <b>or</b> result is not known for a reason other than pending results.

For **positive** or **negative** TST results, enter the following information.

	<b>Description</b>	<b>Comment</b>
<b>Date TST placed</b>	Month, day, and year the TST was placed (e.g., 01/17/2009)	If the month or day is unknown, enter 99 as the default value (e.g., 01/99/2009).  Year must be recorded. Do <b>not</b> use 9999 for the year.
<b>Millimeters (mm) of induration</b>	Measurement (in millimeters, mm) of the induration (e.g., 05 mm)	If the millimeters of the induration are not expressed, enter 99 as the default value.

## Interpreting the TST Reaction

		
<b>5 or more millimeters</b>	<b>10 or more millimeters</b>	<b>15 or more millimeters</b>
<p>An induration of <b>5 or more millimeters</b> is considered <b>positive</b> for</p> <ul style="list-style-type: none"> <li>• People living with HIV</li> <li>• Recent contacts of persons with infectious TB</li> <li>• People who have previously had TB disease</li> <li>• Patients with organ transplants and other immunosuppressed patients (including patients taking a prolonged course of oral or intravenous corticosteroids or TNF-<math>\alpha</math> antagonists)</li> </ul>	<p>An induration of <b>10 or more millimeters</b> is considered <b>positive</b> for</p> <ul style="list-style-type: none"> <li>• People who have come to the U.S. within the last 5 years from areas of the world where TB is common (for example, Asia, Africa, Eastern Europe, Russia, or Latin America)</li> <li>• People who inject illegal drugs</li> <li>• Mycobacteriology lab workers</li> <li>• People who live or work in high-risk congregate settings</li> <li>• People with certain medical conditions that place them at high risk for TB (silicosis, diabetes mellitus, severe kidney disease, certain types of cancer, and certain intestinal conditions)</li> <li>• Children younger than 4 years</li> <li>• Infants, children, and adolescents exposed to adults in high-risk categories</li> </ul>	<p>An induration of <b>15 or more millimeters</b> is considered <b>positive</b> for</p> <ul style="list-style-type: none"> <li>• People with no known risk factors for TB</li> </ul>

## 24. Interferon Gamma Release Assay for *Mycobacterium tuberculosis* at Diagnosis

<p><b>24. Interferon Gamma Release Assay for <i>Mycobacterium tuberculosis</i> at Diagnosis</b> (select one)</p> <p><input type="checkbox"/> Positive    <input type="checkbox"/> Not Done</p> <p><input type="checkbox"/> Negative    <input type="checkbox"/> Unknown</p> <p><input type="checkbox"/> Indeterminate</p>	<p>Date Collected:</p> <p>Month    Day    Year</p> <p><input type="text"/> <input type="text"/>    <input type="text"/> <input type="text"/>    <input type="text"/> <input type="text"/> <input type="text"/></p> <p>Test type: Specify _____</p>
---	--

**Primary Purpose:** Case management. This result helps guide clinicians in diagnosing TB infection and is a factor in determining whether the patient’s disease meets the public health definition of TB.

Interferon gamma release assays (IGRAs) are blood tests for detecting *M. tuberculosis* infection. This variable applies to an IGRA performed during the diagnostic evaluation.

Option (select one)	Description	Comment
<b>Positive</b>	<b>Any</b> IGRA result was interpreted as “ <i>M. tuberculosis</i> infection is likely.”	<b>Any positive result supersedes all other test results</b> (e.g., 1 positive and 2 negatives = positive; 1 indeterminate and 1 negative and 1 positive = positive).
<b>Negative</b>	<b>All</b> IGRA results were interpreted as “ <i>M. tuberculosis</i> infection is unlikely.”	<b>A negative result supersedes indeterminate</b> (e.g., 1 negative and 1 indeterminate = negative).
<b>Not done</b>	IGRA was <b>not</b> performed.	
<b>Unknown</b>	It is <b>not</b> known whether IGRA was performed. <b>or</b> IGRA results are <b>not</b> known, or result is not known for a reason other than pending results.	
<b>Indeterminate</b>	IGRA results could <b>not</b> be determined to be positive or negative.	

For **positive** or **negative** results of IGRA, enter the following information.

	Description	Comment
<b>Date collected</b>	Month, day, and year the blood sample was <b>collected</b> (e.g., 01/17/2009)	If several blood tests were performed and the results of one or more tests were <b>positive</b> for <i>M. tuberculosis</i> complex, enter the date the <b>first</b> blood test with a positive result was collected.
<b>Test type</b> ( <i>specify</i> )	Specify the blood test performed [e.g., QuantiFERON <sup>®</sup> -TB Gold test (QFT-G)]	If more than 1 test was performed, enter the name of the test used for the specimen for which you entered the result.

## 25. Primary Reason Evaluated for TB Disease

**25. Primary Reason Evaluated for TB Disease**  
(select one)

TB Symptoms

Abnormal Chest Radiograph (consistent with TB)

Contact Investigation

Targeted Testing

Health Care Worker

Employment/Administrative Testing

Immigration Medical Exam

Incidental Lab Result

Unknown

**Primary Purpose:** Programmatic function. Data are helpful in assessing how a TB case was found.

Select the **single primary or initial reason** the patient was evaluated for TB disease. The definition of “primary or initial reason” is the situation or reason that led to the initial suspicion that the patient might have TB disease. If the patient was referred for evaluation, but the reason for the evaluation is unknown, try to determine that reason.

Option (select one)	Description	Comment
<b>TB symptoms</b>	Signs and symptoms consistent with TB (e.g., prolonged persistent cough, fever, lymphadenopathy, night sweats, weight loss)	Select if patient seeks medical attention because of symptoms. Do <b>not</b> select if symptoms discovered during a screening program.
<b>Abnormal chest radiograph</b>	Incidental chest radiograph consistent with TB disease	Reason for the chest radiograph should be independent of the other choices listed and should not have been the result of suspicion of TB disease.
<b>Contact investigation</b>	Result of a contact investigation or source case finding	
<b>Targeted testing</b>	Positive result of tuberculin skin test (TST) or interferon gamma release assay (IGRA) administered because the patient was <b>specifically</b> considered as high risk for TB (e.g., persons from area of the world with high rate of TB) or as part of a testing program focused on specific groups at risk for TB	Do <b>not</b> select if another reason (e.g., contact investigation, immigration medical examination, employment/administrative testing, or health care worker status) is more appropriate (see other choices).

<b>Health care worker</b>	Positive result of TST or IGRA administered because the patient was a health care worker	Refers to all paid and unpaid persons working in health care settings who have the potential for exposure to <i>M. tuberculosis</i> .  For health care workers being evaluated for TB disease, health care worker supersedes targeted testing and employment/administrative testing. Other situations (e.g., TB symptoms, contact investigation) supersede health care worker.
<b>Employment/administrative testing</b>	Results from routine physical examination <b>before or periodically during</b> employment, TST or IGRA required by employer, or primary or secondary school program for routine TST	Reflects an administrative requirement (e.g., a TST program applied to all 5th graders in a school or to all job applicants) rather than testing of a group considered at high risk. If TST or IGRA was performed because the person was considered at high risk, select targeted testing or a more appropriate category, such as health care worker. If employment was health care–related, <b>select health care worker rather than employment/administrative testing.</b>
<b>Immigration medical exam</b>	Findings of a medical examination that was part of the immigration application process	A medical examination is mandatory for specific categories of persons seeking admission to the United States (e.g., immigrants, refugees, asylees). These medical examinations may be performed <b>overseas or in the United States</b> depending on the situation. In addition, a medical examination may be required for some persons applying for nonimmigrant visas or special status (e.g., parolees) for temporary admission to the United States.
<b>Incidental lab result</b>	The clinical evaluation was for something other than TB (e.g., bronchoscopy or autopsy). Specimens were collected and submitted for evaluation of TB and other diseases for diagnostic completeness. TB was not expected.	
<b>Unknown</b>	Reason for evaluating the patient <b>not</b> known	



**Example: TB Symptoms**

If a TB patient seeks medical care because of TB symptoms, select **TB Symptoms** as the primary reason for the evaluation. If, however, a TB patient was initially encountered via a contact investigation and during that investigation was also noted to have TB symptoms, select **Contact Investigation** as the primary reason for the evaluation.

**Example: Abnormal Chest Radiograph**

If the chest radiograph was performed during a workup for TB disease because of a positive TST result obtained during targeted testing, select **Targeted Testing**. However, if a chest radiograph was performed as part of preoperative testing (TB disease was not suspected), select **Abnormal Chest Radiograph**.

**Examples: Health Care Worker**

Includes full time, part-time, temporary, or contract staff. Examples include:

- Physicians
- Nurses
- Health aides
- Dental workers
- Health technicians
- Staff in laboratories and morgues
- Emergency medical personnel
- Students enrolled in health care programs
- Persons who deliver health care in the community (e.g., public health nurse, visiting nurse, outreach worker)
- Persons not involved directly in patient care, but potentially at risk for occupational exposure (e.g., correctional facility staff, volunteers; outreach workers; dietary/nutritional, housekeeping, maintenance, clerical, janitorial staff, administrative staff and supervisors)



## 26. HIV Status at Time of Diagnosis

26. HIV Status at Time of Diagnosis (select one)

Negative       Indeterminate       Not Offered       Unknown  
 Positive       Refused       Test Done, Results Unknown

If POSITIVE, enter:

State HIV/AIDS Patient Number:

City/County HIV/AIDS Patient Number:

**Primary Purpose:** Case management and surveillance. Data are used to determine TB/HIV co-morbidity.

**Note:** CDC recommends that **all** persons receive HIV testing at the time of TB diagnostic evaluation or TB diagnosis. Refer to the CDC public health surveillance definition of HIV infection (<http://www.cdc.gov/mmwr/preview/mmwrhtml/rr4813a2.htm>).

**Note:** Documentation of an HIV test result is needed. This documentation from a hospital, clinic, or private provider, should be written evidence of the test result, or it can be notes in the medical record. The test result should have been determined within the specified time indicated in the instructions below.

Option (select one)	Description	Comment
<b>Negative</b>	Documented negative result of HIV test at the time of TB diagnostic evaluation or at TB diagnosis or earlier, but not exceeding 1 year	Undocumented report is <b>not</b> acceptable.
<b>Positive</b>	Laboratory result interpreted as positive according to published criteria <b>or</b> Documented positive result of an earlier HIV test or documented earlier diagnosis of HIV infection or AIDS	Undocumented report is <b>not</b> acceptable.
<b>Indeterminate</b>	Documented indeterminate result of an HIV test at the time of TB diagnostic evaluation or TB diagnosis	Undocumented report is <b>not</b> acceptable.
<b>Refused</b>	HIV testing offered but declined at the time of the TB diagnostic evaluation or TB diagnosis	
<b>Not offered</b>	HIV testing <b>not</b> offered at the time of the TB diagnostic evaluation or TB diagnosis	
<b>Test done, results unknown</b>	HIV test performed at the time of the TB diagnostic evaluation or TB diagnosis, but the results <b>not</b> known to the TB program, or result is not known for a reason other than pending results.	

<b>Unknown</b>	<b>Not known whether the patient</b> <ul style="list-style-type: none"> <li>• Has had an HIV test</li> <li>• Was ever offered a test</li> <li>• Was referred for HIV counseling and testing (e.g. anonymous testing center, private testing center)</li> </ul>	
----------------	--	--

**Comments: Negative HIV status**

- Undocumented patient report that an HIV test result was negative is **not** acceptable. Such patients should be offered the opportunity to be tested for HIV.
- If a patient has had a negative test result, regardless of when the HIV test was performed, the patient should be offered HIV testing at the time of TB diagnostic evaluation or TB diagnosis.
- If the patient had received HIV testing **less than 1 year before the TB diagnostic evaluation or TB diagnosis**, the documented results were negative for HIV infection, and the patient reports no risk factor for HIV, check **Negative** for this item.
- A documented negative HIV test from 1 year ago or longer is **not** valid for checking **Negative**.

**Note:** Update this item if additional information is obtained during the course of treatment.

For **Positive** HIV status at the time of TB diagnosis, enter the following information.

<b>Description</b>	
<b>State HIV/AIDS patient number</b>	Can be obtained from the state or local HIV/AIDS surveillance program
<b>City/county HIV/AIDS patient number</b>	Can be obtained from the state or local HIV/AIDS surveillance program

## 27. Homeless Within Past Year

<p><b>27. Homeless Within Past Year</b> (select one)</p> <p><input type="checkbox"/> No    <input type="checkbox"/> Yes    <input type="checkbox"/> Unknown</p>
---

**Primary Purpose:** Surveillance. Data are used to determine the extent to which recent homelessness is associated with TB disease.

Option (select one)	Description
<b>No</b>	<b>Not</b> homeless during the 12 months before the TB diagnostic evaluation was performed or initiated
<b>Yes</b>	Homeless at <b>any time</b> during the 12 months before the TB diagnostic evaluation was performed or initiated
<b>Unknown</b>	<b>Not</b> known whether the patient was homeless during the 12 months before the TB diagnostic evaluation was performed or initiated

### Comments: Definitions for Homeless

There are many definitions for *homeless* (National Coalition for the Homeless). A **homeless** person may be an individual who has

1. No fixed, regular, and adequate nighttime residence  
**and**
2. A primary nighttime residence that is
  - a. A supervised publicly or privately operated shelter designed to provide temporary living accommodations, including welfare hotels, congregate shelters, and transitional housing for the mentally ill  
**or**
  - b. An institution that provides a temporary residence for individuals intended to be institutionalized  
**or**
  - c. A public or private place not designated for, or ordinarily used as, a regular sleeping accommodation for human beings.

A **homeless** person may also be defined as a person who has no home (e.g., is not paying rent, does not own a home, and is not steadily living with relatives or friends). Persons in unstable housing situations (e.g., alternating between multiple residences for short stays of uncertain duration) may also be considered homeless.

A **homeless** person may be a person who lacks customary and regular access to a conventional dwelling or residence. Included as homeless are persons who live on streets or in nonresidential buildings. Also included are residents of homeless shelters and shelters for battered women. Residents of welfare hotels and single room occupancy (SRO) hotels could also be considered homeless. In the rural setting, where there are usually few shelters, a homeless person may live in non-residential structures, or substandard housing, or with relatives. *Homeless* does not refer to a person who is imprisoned or in a correctional facility.

**Note:** The homeless category is limited to living conditions in the United States and does **not** apply to living in refugee camps outside the United States.

**Note:** Update this item if additional information is obtained during the course of treatment.

## 28. Resident of Correctional Facility at Time of Diagnosis

<b>28. Resident of Correctional Facility at Time of Diagnosis</b> ( <i>select one</i> ) <input type="checkbox"/> No <input type="checkbox"/> Yes <input type="checkbox"/> Unknown			
If YES, ( <i>select one</i> ):		If YES, under custody of Immigration and Customs Enforcement? ( <i>select one</i> )	
<input type="checkbox"/> Federal Prison	<input type="checkbox"/> Local Jail	<input type="checkbox"/> Other Correctional Facility	<input type="checkbox"/> No
<input type="checkbox"/> State Prison	<input type="checkbox"/> Juvenile Correction Facility	<input type="checkbox"/> Unknown	<input type="checkbox"/> Yes

**Primary Purpose:** Surveillance. Data are used to determine if residence in a correctional facility is associated with TB disease.

**Note:** Direct the questions regarding classification of a specific correctional facility (federal, state, local, juvenile, or other) to the Department of Corrections in your state.

Option ( <i>select one</i> )	Description
<b>No</b>	<b>Not</b> an inmate when the TB diagnostic evaluation was performed or initiated
<b>Yes</b>	An inmate of a correctional facility when the TB diagnostic evaluation was performed or initiated
<b>Unknown</b>	<b>Not</b> known whether the patient was an inmate when the TB diagnostic evaluation was performed or initiated

If you selected **Yes**, indicate the type of correctional facility where the patient was an inmate. If the TB patient was a resident of more than 1 facility during the diagnostic evaluation, select the facility where the initial TB diagnostic evaluation was performed.

Option ( <i>select one</i> )	Description
<b>Federal prison</b>	Confinement facility administered by a federal agency; includes privately operated federal correctional facilities
<b>State prison</b>	Confinement facility administered by a state agency; includes privately operated state correctional facilities
<b>Local jail</b>	Confinement facility usually administered by a local law enforcement agency, intended for adults but sometimes also containing juveniles; holds persons detained pending adjudication and/or persons committed after adjudication, typically for sentences of 1 year or less
<b>Juvenile correctional facility</b>	Public or private residential facility; includes juvenile detention centers, reception and diagnostic centers, ranches, camps, farms, boot camps, residential treatment centers, and halfway houses or group homes designated specifically for juveniles

<b>Other correctional facility</b>	Includes Immigration and Customs Enforcement (ICE) detention centers, Indian reservation facilities (e.g., tribal jails), military stockades and jails, federal park police facilities, police lockups (temporary holding facilities for persons who have <b>not</b> been formally charged in court), or other correctional facilities that are <b>not</b> included in the other specific choices
<b>Unknown</b>	Inmate when the TB diagnostic evaluation was performed, but the type of correctional facility is <b>not</b> known

**Comment: Correctional facility at time of diagnosis**

If a patient is an inmate at a correctional facility and goes to a hospital for TB diagnostic evaluation, you would select

- Yes, an inmate of a correctional facility when the TB diagnostic evaluation was performed
- The type of correctional facility (rather than the hospital) where he/she resided at time of diagnostic evaluation

**Comment: Local Jail**

Excludes temporary holding facilities, or lockups, that do not hold persons after they have been formally charged in court. Includes city and county jails and privately operated local correctional facilities. Report federal and state prisoners who are boarded at local jails as residents of the local jail.

**Comment: Juvenile Correctional Facility**

Includes juveniles charged or adjudicated as delinquents, juveniles who are not delinquents or criminal offenders (e.g., runaways, truants, incorrigibles, curfew violators), and juveniles committed or detained for treatment of abuse, dependency, neglect, or other reasons. Report juveniles who are boarded at federal or state prisons or local jails as residents of the facility at which they are boarded.

If you selected **Yes**, indicate whether this patient was **under custody of Immigration and Customs Enforcement (ICE)**.

<b>Option</b> <i>(select one)</i>	<b>Comment</b>
<b>No</b>	Response indicates whether the patient was under the custody of ICE at the time of diagnosis. Persons in ICE custody can be housed in standalone ICE detention centers, or other correctional facilities (e.g., federal or state prison, local jail) when a standalone ICE detention center is not available.
<b>Yes</b>	

**Note:** Update this item if additional information is obtained during the course of treatment.



## 29. Resident of Long-Term Care Facility at Time of Diagnosis

<b>29. Resident of Long-Term Care Facility at Time of Diagnosis</b> (select one) <input type="checkbox"/> No <input type="checkbox"/> Yes <input type="checkbox"/> Unknown			
If YES, (select one):			
<input type="checkbox"/> Nursing Home	<input type="checkbox"/> Residential Facility	<input type="checkbox"/> Alcohol or Drug Treatment Facility	<input type="checkbox"/> Unknown
<input type="checkbox"/> Hospital-Based Facility	<input type="checkbox"/> Mental Health Residential Facility	<input type="checkbox"/> Other Long-Term Care Facility	

**Primary Purpose:** Surveillance. Data are used to determine if residence in a long-term care facility is associated with TB disease.

**Note:** The state licensing agency for long-term care facilities can assist in determining the category under which a facility is classified.

Option (select one)	Description
<b>No</b>	<b>Not</b> a resident of a long-term care facility when the TB diagnostic evaluation was performed
<b>Yes</b>	Resident of a long-term care facility when the TB diagnostic evaluation was performed
<b>Unknown</b>	<b>Not</b> known whether the patient was a resident of a long-term care facility when the TB diagnostic evaluation was performed

If you selected **Yes**, indicate the type of long-term care facility of which the patient was a resident. If the TB patient was a resident of more than 1 facility during the diagnostic evaluation, select the facility where most of the TB diagnostic evaluation was performed.

Option (select one)	Description	Comment
<b>Nursing home</b>	Freestanding facility with 3 or more beds (i.e., is classified as a residential facility or congregate residential setting) that provides nursing care services (e.g., nursing or medical care and/or supervision of medications that may be self-administered)	Facilities may be certified by Medicare or Medicaid or may be licensed by the state as a nursing home (e.g., skilled nursing facility, intermediate care facility, nursing care unit of a retirement center)
<b>Hospital-based facility</b>	Distinct unit with 3 or more beds that is physically attached to, or managed by, a hospital	Facilities may be certified by Medicare or Medicaid or may be licensed by the state.

<b>Residential facility</b>	Facility with 3 or more beds (i.e., is classified as a residential facility or congregate residential setting) and meets both of the following criteria:  1. Not classified as a nursing home or hospital-based facility, as described above  <b>and</b>  2. Provides personal care or supervision (not nursing care services) to its residents, in addition to room and board (e.g., help with bathing, dressing, eating, walking, shopping)	This might be an assisted living facility.
<b>Mental health residential facility</b>	Facility that provides 24-hour care in a hospital, residential treatment, or supportive setting	Include state and local mental hospitals, private psychiatric hospitals, general hospitals, the Department of Veterans Affairs (VA), residential treatment centers for emotionally disturbed children, and multiservice mental health organizations with residential treatment programs.  <b>For other federal mental health residential facilities, select “Other long-term care facility.”</b> Examples include the Department of Defense, Bureau of Prisons, Public Health Service, Indian Health Service, and Indian reservation facilities that are <b>not</b> federal.
<b>Alcohol or drug treatment facility</b>	Only long-term rehabilitation or residential facilities designated for treatment of <b>30 days or longer</b>	Exclude all ambulatory or outpatient facilities, detoxification units, and facilities designated for fewer than 30 days of treatment. The state agency responsible for alcohol and drug treatment can assist in determining whether a facility is considered residential.
<b>Other long-term care facility</b>	A facility <b>not</b> mentioned above that is designated for treatment of <b>30 days or longer and facility type is not Unknown</b>	
<b>Unknown</b>	Patient known to be a resident of a long-term care facility, but the type of facility is <b>not</b> known	

**Examples: Residential Facility**

- Assisted living facilities
- Homes for mentally retarded or developmentally disabled persons
- Boarding and care homes (e.g., residential care homes, group homes, homes for the aged, family care homes, adult foster care homes, personal care homes, adult congregate living facilities, residential community care facilities, domiciliary care homes)

**Examples: Mental Health Residential Facility**

- State and local mental hospitals
- Private psychiatric hospitals
- General hospitals (not federal) with separate psychiatric services
- Department of Veterans Affairs (VA) medical centers
- Residential treatment centers for emotionally disturbed children
- Multiservice mental health organizations with residential treatment programs

**Note:** Update this item if additional information is obtained during the course of treatment.

## 30. Primary Occupation Within the Past Year

30. Primary Occupation Within the Past Year (select one)			
<input type="checkbox"/> Health Care Worker	<input type="checkbox"/> Migrant/Seasonal Worker	<input type="checkbox"/> Retired	<input type="checkbox"/> Not Seeking Employment (e.g. student, homemaker, disabled person)
<input type="checkbox"/> Correctional Facility Employee	<input type="checkbox"/> Other Occupation	<input type="checkbox"/> Unemployed	<input type="checkbox"/> Unknown

**Primary Purpose:** Surveillance. Data are used to determine if certain primary occupations are associated with TB disease.

Select one option that best describes the patient’s occupation within the 12 months before the diagnostic TB evaluation. If the patient held more than 1 occupation during that period, select the longest-held occupation or the occupation to which the patient devoted more time (i.e., the patient’s **primary** occupation). For example, if the patient was a full-time health care worker and a student (e.g., taking night classes), the patient’s primary occupation would be **Health Care Worker**.

Option (select one)	Description
<b>Health care worker</b>	Paid or unpaid person working in a health care setting, with potential for exposure to <i>M. tuberculosis</i> . For health care workers being evaluated for TB disease, <b>health care worker supersedes correctional facility or other occupations.</b>
<b>Correctional facility employee</b>	Person working in a correctional facility; not a health care worker
<b>Migrant/seasonal worker</b>	Person who is required to be absent from a permanent place of residence for the purpose of seeking employment, or who may vary their employment for the purpose of remaining employed while maintaining a permanent place of residence
<b>Other occupation</b>	Person employed for pay or income in any occupation that is <b>not</b> included in the options listed above
<b>Retired</b>	Person who was retired during the 12 months before the TB diagnostic evaluation
<b>Unemployed</b>	Person <b>not</b> employed during the 12 months before the TB diagnostic evaluation
<b>Not seeking employment</b>	Person not seeking employment, such as infant, child, student, homemaker, person receiving permanent disability benefits, or person who was institutionalized
<b>Unknown</b>	Person whose employment status is <b>not</b> known

**Examples: Health Care Worker**

Includes full time, part-time, temporary, or contract staff. Examples include:

- Physicians
- Nurses
- Health Aides
- Dental workers
- Health Technicians
- Staff in laboratories and morgues
- Emergency medical personnel
- Students
- Persons who deliver health care in the community (e.g., public health nurse, visiting nurse, outreach worker)
- Persons not involved directly in patient care, but potentially at risk for occupational exposure (e.g., volunteers; outreach workers; dietary/nutritional, housekeeping, maintenance, clerical, janitorial, administrative and supervisory staff)

**Examples: Correctional Facility Employee**

- Federal or state prison
- Local jail
- Juvenile correctional facility
- Immigration and Customs Enforcement (ICE) detention center or other correctional facility (See **Resident of Correctional Facility** [item 28].)
- Paid or unpaid persons working in correctional facilities, with potential for exposure to *M. tuberculosis* complex (e.g., volunteers; outreach workers; dietary/nutritional, housekeeping, maintenance, clerical, and janitorial staff)

**Examples: Migrant/Seasonal Worker**

- Migratory agricultural worker
- Seasonal agricultural worker
- Migrant factory worker
- Migrant construction worker
- Migrant service industry worker
- Migrant sporting worker (e.g., horse racing, dog racing)

**Comment: Unemployed**

Select **Unemployed** if a person not included in the preceding list was unemployed for most of the past 12 months. Do not select this option for a person who was unemployed for a short time (e.g., 1 week during the past 12 months).

**Note:** Update this item if additional information is obtained during the course of treatment.

## 31. Injecting Drug Use Within Past Year

<p><b>31. Injecting Drug Use Within Past Year</b> (select one)</p> <p><input type="checkbox"/> No    <input type="checkbox"/> Yes    <input type="checkbox"/> Unknown</p>
---

**Primary Purpose:** Surveillance. Data are used to determine the extent to which injecting drug use is associated with TB.

Option (select one)	Description
No	Patient has <b>not</b> injected drugs within the past 12 months.
Yes	Patient is known to have injected drugs within the past 12 months
Unknown	It is <b>not</b> known whether the patient injected drugs within the past 12 months

### Comment: Injecting Drug Use

Medical documentation or other indications of enrollment in a drug treatment program (e.g., methadone detoxification; methadone maintenance; outpatient, residential, or inpatient treatment, halfway house; prison or jail treatment; Narcotics Anonymous, Cocaine Anonymous, or other self-help program), medical or laboratory documentation of injection drug use (e.g., urine testing), or physical evidence (e.g., needle tracks) may be useful in answering this question. Because many patients respond negatively during the interview, it may be necessary to ask the patient about drug use at multiple visits.

### Comment: Definition of Injecting Drug Use

Injecting drug use involves the use of hypodermic needles and syringes for the injection of drugs not prescribed by a health care provider. Route of administration may be intravenous, subcutaneous (e.g., skin popping), or intramuscular.

**Note:** Update this item if additional information is obtained during the course of treatment.

### Examples: Commonly injected drugs

- Heroin and other opiates (e.g., Demerol, Dilaudid, morphine, opium)
- Cocaine (e.g., speedball)
- Methamphetamines
- Amphetamines
- Other stimulants
- Phencyclidine (PCP, also known as angel dust)
- Other hallucinogens
- Barbiturates
- Steroids
- Other hormones
- Fentanyl

## 32. Non-Injecting Drug Use Within Past Year

32. Non-Injecting Drug Use Within Past Year  
(select one)  
 No     Yes     Unknown

**Primary Purpose:** Surveillance. Data are used to determine the extent to which non-injecting drug use is associated with TB.

Option (select one)	Description
No	Patient has <b>no</b> history of using non-injecting drugs within the past 12 months
Yes	It is known that the patient has used non-injecting drugs within the past 12 months.
Unknown	It is <b>not</b> known whether the patient used non-injecting drugs within the past 12 months.

### Comment: Non-Injecting Drug Use

A history of enrollment in a drug treatment program (e.g., outpatient, residential, or inpatient treatment; halfway house; prison or jail treatment; Cocaine Anonymous or other self-help program), as well as medical or laboratory documentation of drug use (e.g., urine testing), may be useful in answering this question. Because many patients respond negatively during the interview, it may be necessary to ask the patient about drug use at multiple visits.

### Comment: Definition of Non-Injecting Drug Use

Non-injecting drug use involves the use of licensed or prescription drugs or illegal drugs that were not injected and were not prescribed for the patient by a health care provider. The drugs may be ingested, inhaled, sniffed, or smoked.

**Note:** Update this item if additional information is obtained during the course of treatment.

**Examples: Non-injecting drugs**

- Heroin or other opiates (e.g., Demerol, Percocet, codeine, Dilaudid, MS Contin, nonprescription methadone)
- Cocaine (e.g., snorted) and crack (e.g., smoked)
- Ingested amphetamines (e.g., speed, uppers, bennies)
- Xanax, Ativan, Valium, or other benzodiazepams
- Phencyclidine (PCP), ketamine, LSD, or other hallucinogens
- Barbiturates
- Marijuana (e.g., pot, weed, grass, reefers), hashish
- Inhalants (e.g., nitrous [whippets] oxide, poppers, rush, huff, gasoline, spray paint, butane)
- Steroids

**Note:** Alcohol is **not** included as a non-injecting drug (see **Excess Alcohol Use within Past Year** [item 33]).



## 33. Excess Alcohol Use Within Past Year

<p>33. Excess Alcohol Use Within Past Year (select one)</p> <p><input type="checkbox"/> No    <input type="checkbox"/> Yes    <input type="checkbox"/> Unknown</p>
--

**Primary Purpose:** Surveillance. Data are used to determine the extent to which excess alcohol use is associated with TB.

Option (select one)	Description
No	Patient has <b>not</b> used alcohol to excess within the past 12 months.
Yes	Patient has used alcohol to excess within the past 12 months.
Unknown	It is <b>not</b> known whether the patient used alcohol to excess within the past 12 months.

**Comment:**

This information is collected because the patient is in a high risk group for TB. The patient's response to this question is sought as an indicator of recent excess alcohol use. Because many patients respond negatively during the interview, it may be necessary to ask the patient, at multiple visits, about excess use.

**Note:** Update this item if additional information is obtained during the course of treatment.

**Definition of Excess Alcohol Use:** There is no standard definition. Excess alcohol use can be assessed by various methods. Examples of reliable indicators of excess alcohol use include:

- Participation in self-help programs (e.g., Alcoholics Anonymous) or alcohol treatment programs
- Medical record documentation of excess alcohol use or hospitalization for alcohol-related medical conditions (e.g., delirium tremens [DTs], pancreatitis, cirrhosis)
- More than one arrest for intoxication or drunk and disorderly behavior. This can be found by asking the patient, or contacting the local correctional facility regarding charges.

The National Household Survey on Drug Abuse defines heavy alcohol use as “five or more drinks on the same occasion on each of 5 or more days in the past 30 days.” Numerous screening instruments (e.g., CAGE, AUDIT, MAST) can be helpful in identifying persons who may use alcohol to excess.

A standard drink in the United States is equal to 13.7 grams (0.6 ounces) of pure alcohol or

- 12 ounces of beer
- 8 ounces of malt liquor
- 5 ounces of wine
- 1.5 ounces or a “shot” of 80-proof distilled spirits or liquor (e.g., gin, rum, vodka, or whiskey)

## 34. Additional TB Risk Factors

### 34. Additional TB Risk Factors (select all that apply)

- Contact of MDR-TB Patient (2 years or less)   
  Incomplete LTBI Therapy   
  Diabetes Mellitus   
  Other Specify \_\_\_\_\_  
 Contact of Infectious TB Patient (2 years or less)   
  TNF- $\alpha$  Antagonist Therapy   
  End-Stage Renal Disease   
  None  
 Missed Contact (2 years or less)   
  Post-organ Transplantation   
  Immunosuppression (not HIV/AIDS)

**Primary Purpose:** Surveillance. Data are used to evaluate how these additional risk factors are associated with TB disease.

Select **all** additional TB risk factors that the TB patient may have. Document additional TB risk factors from the medical records or a reliable source (e.g., health care provider). Undocumented reporting (e.g., oral report from the patient or person other than a medical health care provider) is **not** acceptable.

**Note:** Other specific TB risk factors (e.g., occupation, HIV infection) are collected through other items of the RVCT.

Option (select all that apply)	Description
<b>Contact of MDR TB patient (2 years or less)</b>	Patient for whom the RVCT form is being completed is a contact of a patient with multidrug-resistant (MDR) TB, within 2 years or less, regardless of whether the patient with MDR TB was infectious.
<b>Contact of infectious TB patient (2 years or less)</b>	Patient for whom the RVCT form is being completed is a contact of an infectious TB patient within 2 years or less.
<b>Missed contact (2 years or less)</b>	Patient for whom the RVCT form is being completed is a contact of a known TB patient, but was not evaluated or diagnosed with LTBI or TB at that time (within 2 years or less of current diagnosis).
<b>Incomplete LTBI treatment</b>	Patient had a previous diagnosis of latent TB infection (LTBI) and did <b>not</b> complete treatment for LTBI.
<b>Tumor necrosis factor-alpha (TNF-<math>\alpha</math>) antagonist therapy</b>	Patient had recently received, or was receiving, TNF- $\alpha$ antagonist therapy at the time of TB diagnosis.
<b>Post-organ transplantation</b>	Patient has received a solid organ transplant (e.g., kidney, heart).
<b>Diabetes mellitus</b>	Patient has a diagnosis of diabetes mellitus (Type I or Type II) either before or at the time of TB diagnosis.
<b>End-stage renal disease</b>	Patient had end-stage renal disease or chronic renal failure at the time of TB diagnosis.

<b>Immunosuppression</b>	Patient had immunosuppression due to either a medical condition or medication, such as hematologic or reticuloendothelial malignancies (e.g., leukemia, Hodgkin’s lymphoma, carcinoma of the head or neck), or immunosuppressive therapy, such as prolonged use of high-dose adrenocorticosteroids (e.g., prednisone).
<b>Other</b>	Patient had a risk factor <b>not</b> included in the preceding choices (e.g., undernutrition due to intestinal bypass surgery for obesity, gastrectomy, jejunioileal bypass, chronic malabsorption syndromes; silicosis; travel to a TB-endemic country).
<b>None</b>	No TB risk factors could be identified.

**Comments: Contact of MDR TB Patient**

- MDR TB is defined as resistance to at least isoniazid and rifampin.
- If a patient with MDR TB was the only known contact for the patient for whom you are completing the RVCT, select **Contact of MDR TB Patient** and do **not** select **Contact of Infectious TB Patient**. The association between the TB patients may have been found through investigation (e.g., a formal contact investigation) or identified as an incidental finding.
- The contact with the patient with MDR TB must have been within the last 2 years.
- If the patient with MDR TB has an RVCT number, enter that number as the **Linking State Case Number** (item 3), and enter reason 2 - Epidemiologically Linked Case.

**Comments: Contact of Infectious TB Patient**

- If the infectious TB patient is known to have had MDR TB, and the TB patient for whom the RVCT form is being completed was not a contact of any other infectious TB patient, select only **Contact of MDR TB Patient** (do **not** select **Contact of Infectious TB Patient**).
- The association between the TB patients may have been found through investigation (e.g., a formal contact investigation) or as an incidental finding. The contact with an infectious TB patient must have been within the last 2 years.
- If the infectious TB patient has an RVCT number, enter that number as the **Linking State Case Number** (item 3), and enter reason 2 - Epidemiologically Linked Case

**Comment: Missed Contact**

The contact must have been within the last 2 years. Do **not** select this option for TB patients identified as having TB disease during, or as a result of, a contact investigation: such patients are **not** missed contacts. Here, the intention is to record information about patients whose TB could have been prevented if they had been identified before developing TB disease.

**Comment: Incomplete LTBI Treatment**

The intention is to record information about a patient who started treatment for LTBI. However, the patient did not complete a full course of treatment.

**Comment: Tumor Necrosis Factor-alpha (TNF- $\alpha$ ) Antagonist Therapy**

The Food and Drug Administration (FDA) has approved TNF- $\alpha$  antagonist therapy for treatment of rheumatoid arthritis and other selected autoimmune diseases. The FDA has also recently determined that TB disease is a potential adverse reaction to treatment with TNF- $\alpha$  antagonists. The three TNF- $\alpha$  antagonists currently approved by the FDA are infliximab (Remicade<sup>®</sup>), etanercept (Enbrel<sup>®</sup>), and adalimumab (Humira<sup>®</sup>).

**Comments: Immunosuppression**

- If the TB patient has diabetes mellitus or end-stage renal disease, check **Diabetes Mellitus** or **End-Stage Renal Disease** or both (do **not** select **Immunosuppression** unless the patient has another immunosuppressive condition).
- If the patient is infected with HIV, complete **HIV Status at Time of Diagnosis** (item 26) (do **not** select **Immunosuppression** unless the patient has another immunosuppressive condition).

**Comments: Other**

Do **not** include risk factors identified in items 27–33:

- **Being homeless within past year** (item 27)
- Residence status at diagnosis
  - **Correctional facility** (item 28)
  - **Long-term care facility** (item 29)
- **Primary occupation within past year** (item 30)
- **Drug or excess alcohol use within past year** (items 31–33)

On the line labeled *Specify*, write comments regarding **Other** reasons.

## 35. Immigration Status at First Entry to the U.S.

### 35. Immigration Status at First Entry to the U.S. (select one)

- Not Applicable
- "U.S.-born" (or born abroad to a parent who was a U.S. citizen)
  - Born in 1 of the U.S. Territories, U.S. Island Areas, or U.S. Outlying Areas
- Immigrant Visa     Tourist Visa     Asylee or Parolee  
 Student Visa     Family/Fiancé Visa     Other Immigration Status  
 Employment Visa     Refugee     Unknown

**Primary Purpose:** Surveillance. Data are used to observe the association between immigration status and TB.

Option	Description
Not applicable	<p><b>Patient was</b></p> <ul style="list-style-type: none"> <li>• <b>"U.S.-born"</b> <ul style="list-style-type: none"> <li>○ Born in 1 of the 50 states or the District of Columbia</li> <li><b>or</b></li> <li>○ Born abroad to a parent who was a U.S. citizen (e.g., born on a military installation)</li> </ul>           (See Item 12 for complete instructions on "U.S.-born")         </li> <li>• <b>Born in 1 of the U.S. Territories, U.S. Island Areas, or U.S. Outlying Areas</b> <ul style="list-style-type: none"> <li>○ American Samoa, Federated States of Micronesia, Republic of the Marshall Islands, Commonwealth of the Northern Mariana Islands, Republic of Palau, Guam, Puerto Rico, or the U.S. Virgin Islands</li> </ul> </li> </ul>

If you did **not** select **Not Applicable**, select one option to indicate the patient's immigration status at first entry to the United States.

**Note:** If the patient had a visa at first entry to the United States, specify the type of visa. Oral information from a reliable source is acceptable.

There are 2 main types of legal immigration status: permanent (immigrants) and nonimmigrant (persons with a visa issued for specific purpose and period).

1. Permanent residents (immigrants) are issued an alien resident card (i.e., green card) and should carry this card with them.
2. Nonimmigrants with visas (e.g., student, tourist, employment, V visa, K visa) should be aware of their visa type, which is stated in their passport (I-94 arrival document stapled in passport).

Refugees are separate from the 2 main categories above: they should have an arrival document (I-94) showing their status as refugees and they should carry this card with them.

Option (select one)	Description
<b>Immigrant visa</b>	<p>For foreign-born TB patients who first entered the United States with permanent resident status (immigrants).</p> <p>For foreign-born pediatric TB patients who are adopted by U.S. citizens, the patients enter the U.S. on an immigrant visa.</p>
<b>Student visa</b>	<p>For foreign-born TB patients who first entered the United States with a student visa. This is a nonimmigrant visa and is obtained by an alien coming to the United States for a specific period to pursue a full course of study in an approved institution.</p>
<b>Employment visa</b>	<p>For foreign-born patients who first entered the United States with a nonimmigrant employment visa (an alien coming to the United States to work for a specific period). There are many categories of nonimmigrant employment visas (category depends upon the type of work).</p>
<b>Tourist visa</b>	<p>For foreign-born TB patients who first entered the United States for a specific period for business or pleasure. This is a nonimmigrant visa.</p>
<b>Family/ fiancé visa</b>	<p>For foreign-born TB patients who first entered the United States with a V visa or a K visa.</p>
<b>Refugee</b>	<p>For foreign-born TB patients who first entered the United States as refugees.</p>
<b>Asylee or parolee</b>	<p>For foreign-born patients who first entered the United States seeking asylum or who are parolees.</p>
<b>Other immigration status</b>	<p>For foreign-born TB patients who first entered the United States with a status that is <b>not</b> Immigrant, Refugee, Asylee, Parolee, Student, Tourist, Employment, with a V visa or a K visa, and whose status is <b>not</b> Unknown. This includes foreign-born persons who were not required to obtain a visa (e.g., foreign-born visitors from specific countries, such as Canada, that are part of the U.S. visa waiver program and thus are not required to obtain visas if visiting the United States for short periods [e.g., ≤90 days]) or those who entered the United States with no official immigration status (e.g., they were “undocumented”).</p>
<b>Unknown</b>	<p>For jurisdictions with directives or policies that forbid asking TB patients their immigration status</p> <ul style="list-style-type: none"> <li>• Foreign-born TB patients who <ul style="list-style-type: none"> <li>○ Do not know their immigration status at first entry to the United States</li> <li>○ May have had a visa at entry to the United States, but the type of visa is unknown</li> </ul> </li> <li>• Patients who refuse to respond</li> </ul>

**Note:** For jurisdictions with directives or policies that forbid asking TB patients their immigration status, please check **Unknown**.

**Comments: Family/Fiancé Visa**

- The V visa (in the nonimmigrant category) allows the spouse or child of a U.S. legal permanent resident to live and work in the United States.
- The K visa (in the nonimmigrant category) allows the fiancé of a U.S. citizen to enter the United States for a specific period and specifically for the purpose of marriage.

**Comment: Refugee**

A refugee is a foreign-born person who is in a country other than his or her country of nationality and who is unable or unwilling to return to that country because of persecution or a well-founded fear of persecution.

**Comments: Asylee and Parolee**

An asylee is a foreign-born person in the United States who is unable or unwilling to return to his or her country of nationality because of persecution or a well-founded fear of persecution. An asylee meets the same criteria as those for a refugee; the only difference is the person's location at the time of application—the potential asylee is in the United States or applying for admission at a port of entry, and the potential refugee is outside the United States.

A parolee is a foreign-born person allowed to enter the United States for urgent humanitarian reasons or because entry is determined to be of significant public benefit.

**Comment: Born in 1 of the U.S. Territories, U.S. Island Areas, or U.S. Outlying Areas** (American Samoa, Federated States of Micronesia, Republic of the Marshall Islands, Commonwealth of the Northern Mariana Islands, Republic of Palau, Guam, Puerto Rico, or the U.S. Virgin Islands)

**Example: For born in 1 of the U.S. Territories, U.S. Island Areas, or U.S. Outlying Areas select not applicable for**

- Entering the United States
- or**
- Entering one of the other U.S. Territories, U.S. Island Areas, or U.S. Outlying Areas

## 36. Date Therapy Started

36. Date Therapy Started						
Month		Day		Year		
<input type="text"/>	<input type="text"/>	<input type="text"/>	<input type="text"/>	<input type="text"/>	<input type="text"/>	<input type="text"/>

**Primary Purpose:** Programmatic function. Data are used for calculating program management indicators.

	Description	Comment
Month, day, and year (e.g., 01/17/2009)	Date the patient began <b>multidrug therapy</b> for <b>TB disease</b> or <b>suspected TB disease</b>	This may be one of several dates, ideally, when the patient first ingested medication if documented in a medical record.  If the month or day is unknown, enter 99 as the default value (e.g., 01/99/2009).

**Date Therapy Started** is the month, day, and year the patient began multidrug therapy for TB disease or suspected TB disease. Patient history without medical documentation is not acceptable and should be entered as unknown. Enter a date according to the following chart:

### Hierarchy of Determining Date Therapy Started

(Base decision on documented evidence)

**Preferred  
Date Therapy Started**  
If this date is not known  
choose the next alternative

**Next Alternative  
Date Therapy Started**  
If this date is not known  
choose the last alternative

**Last Alternative  
Date Therapy Started**

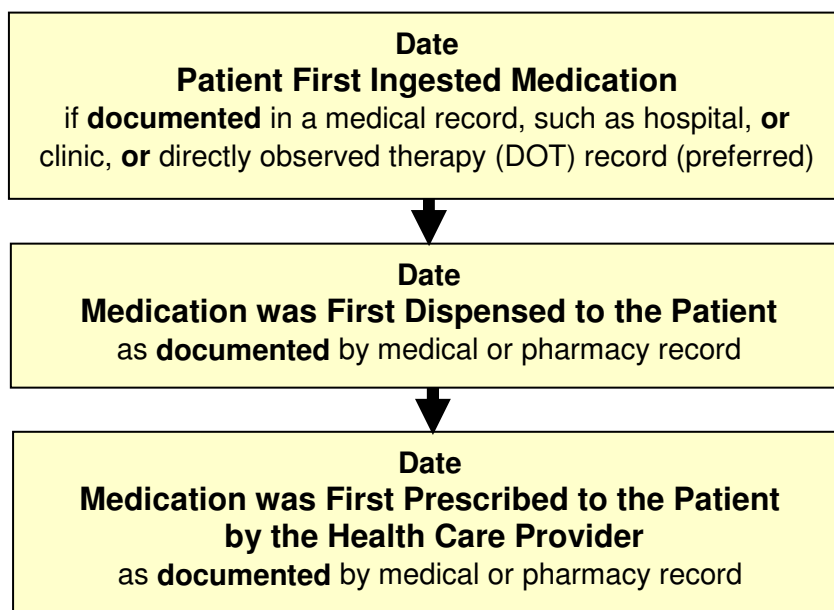



## 37. Initial Drug Regimen

37. Initial Drug Regimen (select one option for each drug)											
	No	Yes	Unk		No	Yes	Unk		No	Yes	Unk
Isoniazid	<input type="checkbox"/>	<input type="checkbox"/>	<input type="checkbox"/>	Ethionamide	<input type="checkbox"/>	<input type="checkbox"/>	<input type="checkbox"/>	Moxifloxacin	<input type="checkbox"/>	<input type="checkbox"/>	<input type="checkbox"/>
Rifampin	<input type="checkbox"/>	<input type="checkbox"/>	<input type="checkbox"/>	Amikacin	<input type="checkbox"/>	<input type="checkbox"/>	<input type="checkbox"/>	Cycloserine	<input type="checkbox"/>	<input type="checkbox"/>	<input type="checkbox"/>
Pyrazinamide	<input type="checkbox"/>	<input type="checkbox"/>	<input type="checkbox"/>	Kanamycin	<input type="checkbox"/>	<input type="checkbox"/>	<input type="checkbox"/>	Para-Amino Salicylic Acid	<input type="checkbox"/>	<input type="checkbox"/>	<input type="checkbox"/>
Ethambutol	<input type="checkbox"/>	<input type="checkbox"/>	<input type="checkbox"/>	Capreomycin	<input type="checkbox"/>	<input type="checkbox"/>	<input type="checkbox"/>	Other	<input type="checkbox"/>	<input type="checkbox"/>	<input type="checkbox"/>
Streptomycin	<input type="checkbox"/>	<input type="checkbox"/>	<input type="checkbox"/>	Ciprofloxacin	<input type="checkbox"/>	<input type="checkbox"/>	<input type="checkbox"/>	Specify _____			
Rifabutin	<input type="checkbox"/>	<input type="checkbox"/>	<input type="checkbox"/>	Levofloxacin	<input type="checkbox"/>	<input type="checkbox"/>	<input type="checkbox"/>	Other	<input type="checkbox"/>	<input type="checkbox"/>	<input type="checkbox"/>
Rifapentine	<input type="checkbox"/>	<input type="checkbox"/>	<input type="checkbox"/>	Ofloxacin	<input type="checkbox"/>	<input type="checkbox"/>	<input type="checkbox"/>	Specify _____			

**Primary Purpose:** Programmatic function. Data are used for calculating program management indicators.

Select an option for **each** drug listed.

Option (select one)	Description	Comment
<b>No</b>	Drug is known to <b>not</b> be part of the initial regimen.	
<b>Yes</b>	Drug is known to be part of the initial regimen.  <b>Yes</b> indicates that the drug was <b>initially</b> prescribed for treatment of TB disease and was taken for at least 2 weeks. The 2-week requirement should eliminate most of the record updates necessitated by changes in regimen after treatment has begun.	If you <b>cannot</b> determine the initial regimen of at least 2 weeks' duration, select <b>Yes</b> for the initial drugs known to have been prescribed.
<b>Unknown</b>	It is <b>not</b> known whether the drug was part of the initial regimen.	

### Comment: Combination drugs

For combination drugs, select **Yes** for each drug that is a component of the combination drug.

For example

- Rifamate is a combination of isoniazid and rifampin
- Rifater is a combination of isoniazid, rifampin, and pyrazinamide

### Example: Combination drugs

For Rifamate, select **Yes** for isoniazid and **Yes** for rifampin.

**Note:** For **Other**, enter only anti-TB drugs (do **not** include pyridoxine, vitamin B6).

# Initial Drug Susceptibility Report (Follow Up Report – 1)

## (page 1 of 1)

### Items 38 – 40

Page 1 of the Initial Drug Susceptibility Report (Follow Up Report – 1) provides instructions for completing items 38 – 40. This page is a follow-up report to the RVCT and includes data about genotyping, as well as initial drug susceptibility testing and results.

**Complete this report only for cases with positive culture results for *M. tuberculosis* complex.** Complete and submit this report as soon as initial drug susceptibility results are available. Copy patient name and address from page 1 of the RVCT. The patient name and address are retained at the local level for identification purposes; they are not sent to CDC. Enter **Year Counted**, **State Case Number**, and **City/County Case Number** for data entry purposes.

Patient's Name \_\_\_\_\_ (Last) \_\_\_\_\_ (First) \_\_\_\_\_ (MI)

Street Address \_\_\_\_\_ (Number, Street, City, State) \_\_\_\_\_ (ZIP CODE)

**REPORT OF VERIFIED CASE  
OF TUBERCULOSIS**

**REPORT OF VERIFIED CASE OF TUBERCULOSIS**

U.S. DEPARTMENT OF HEALTH AND HUMAN SERVICES  
CENTERS FOR DISEASE CONTROL  
AND PREVENTION (CDC)  
ATLANTA, GEORGIA 30333  
FORM APPROVED OMB NO. 0920-0028 Exp. Date 05/31/2011

**Initial Drug Susceptibility Report (Follow Up Report – 1)**

Year Counted									
State Case Number									
City/County Case Number									

**Submit this report for all culture-positive cases.**

**38. Genotyping Accession Number**

Isolate submitted for genotyping (select one):  No  Yes

If YES, genotyping accession number for episode: \_\_\_\_\_

**39. Initial Drug Susceptibility Testing**

Was drug susceptibility testing done? (select one)  No  Yes  Unknown

*If NO or UNKNOWN, do not complete the rest of Follow Up Report – 1*

If YES, enter date FIRST specimen collected on which initial drug susceptibility testing was done: \_\_\_\_\_ Enter specimen type:  Sputum  
OR  
If not Sputum, enter anatomic code (see list): \_\_\_\_\_

**40. Initial Drug Susceptibility Results (select one option for each drug)**

	Resistant	Susceptible	Not Done	Unknown		Resistant	Susceptible	Not Done	Unknown
Isoniazid	<input type="checkbox"/>	<input type="checkbox"/>	<input type="checkbox"/>	<input type="checkbox"/>	Capreomycin	<input type="checkbox"/>	<input type="checkbox"/>	<input type="checkbox"/>	<input type="checkbox"/>
Rifampin	<input type="checkbox"/>	<input type="checkbox"/>	<input type="checkbox"/>	<input type="checkbox"/>	Ciprofloxacin	<input type="checkbox"/>	<input type="checkbox"/>	<input type="checkbox"/>	<input type="checkbox"/>
Pyrazinamide	<input type="checkbox"/>	<input type="checkbox"/>	<input type="checkbox"/>	<input type="checkbox"/>	Levofloxacin	<input type="checkbox"/>	<input type="checkbox"/>	<input type="checkbox"/>	<input type="checkbox"/>
Ethambutol	<input type="checkbox"/>	<input type="checkbox"/>	<input type="checkbox"/>	<input type="checkbox"/>	Ofloxacin	<input type="checkbox"/>	<input type="checkbox"/>	<input type="checkbox"/>	<input type="checkbox"/>
Streptomycin	<input type="checkbox"/>	<input type="checkbox"/>	<input type="checkbox"/>	<input type="checkbox"/>	Moxifloxacin	<input type="checkbox"/>	<input type="checkbox"/>	<input type="checkbox"/>	<input type="checkbox"/>
Rifabutin	<input type="checkbox"/>	<input type="checkbox"/>	<input type="checkbox"/>	<input type="checkbox"/>	Other Quinolones	<input type="checkbox"/>	<input type="checkbox"/>	<input type="checkbox"/>	<input type="checkbox"/>
Rifapentine	<input type="checkbox"/>	<input type="checkbox"/>	<input type="checkbox"/>	<input type="checkbox"/>	Cycloserine	<input type="checkbox"/>	<input type="checkbox"/>	<input type="checkbox"/>	<input type="checkbox"/>
Ethionamide	<input type="checkbox"/>	<input type="checkbox"/>	<input type="checkbox"/>	<input type="checkbox"/>	Para-Amino Salicylic Acid	<input type="checkbox"/>	<input type="checkbox"/>	<input type="checkbox"/>	<input type="checkbox"/>
Amikacin	<input type="checkbox"/>	<input type="checkbox"/>	<input type="checkbox"/>	<input type="checkbox"/>	Other	<input type="checkbox"/>	<input type="checkbox"/>	<input type="checkbox"/>	<input type="checkbox"/>
Kanamycin	<input type="checkbox"/>	<input type="checkbox"/>	<input type="checkbox"/>	<input type="checkbox"/>	Specify _____	<input type="checkbox"/>	<input type="checkbox"/>	<input type="checkbox"/>	<input type="checkbox"/>
					Other	<input type="checkbox"/>	<input type="checkbox"/>	<input type="checkbox"/>	<input type="checkbox"/>
					Specify _____	<input type="checkbox"/>	<input type="checkbox"/>	<input type="checkbox"/>	<input type="checkbox"/>

**Comments:**

\_\_\_\_\_

\_\_\_\_\_

\_\_\_\_\_

Public reporting burden of this collection of information is estimated to average 35 minutes per response, including the time for reviewing instructions, searching existing data sources, gathering and maintaining the data needed and completing and reviewing the collection of information. An agency may not conduct or sponsor and a person is not required to respond to a collection of information unless it displays a currently valid OMB control number. Send comments regarding this burden estimate or any other aspect of this collection of information, including suggestions for reducing this burden to CDC, Project Clearance Officer, 1600 Clifton Road, MS D-74, Atlanta, GA 30333, ATTN: PRA (0920-0028). Do not send the completed form to this address.

Information contained on this form which would permit identification of any individual has been collected with a guarantee that it will be held in strict confidence, will be used only for surveillance purposes, and will not be disclosed or released without the consent of the individual in accordance with Section 306(d) of the Public Health Service Act (42 U.S.C. 242m).

CDC 72-8B Rev 09/15/2009 CS121321 1st Copy REPORT OF VERIFIED CASE OF TUBERCULOSIS Follow Up Report -1 / Page 1 of 1

106

## 38. Genotyping Accession Number

**38. Genotyping Accession Number**  
 Isolate submitted for genotyping (*select one*):  No  Yes  
 If YES, genotyping accession number for episode:

**Primary Purpose:** Surveillance. Data are used to link genotyping results with RVCT data.

Option ( <i>select one</i> )	Description	Comment
No	No isolate was submitted for genotyping.	No does not indicate that no results were received or that “untypeable” results were reported.
Yes	Isolate was submitted for genotyping, regardless of genotyping results.	

If you selected **Yes**, enter the following information.

	Description	Comment
<b>Genotyping accession number</b>	The genotyping accession number for the current TB episode. This number is assigned by the genotyping reference laboratory.	If multiple isolates have been submitted for one patient, please consult with your laboratorian or genotyping surveillance coordinator to determine the correct genotyping accession number for the current episode.

**Comment: Genotyping accession number**

In 2004, CDC established the National Tuberculosis Genotyping Service (NTGS). The goal was to genotype one *M. tuberculosis* isolate from every culture-confirmed TB case in the United States. The genotyping accession number is the number assigned by the genotyping reference laboratory. Under current contracts, the numbers are formatted in the following table.

## Genotyping Accession Number

<b>Sample Laboratories Performing Genotyping Service</b>	<b>Format for Genotyping Accession Number</b>	<b>Sample</b>
<b>California lab</b>	YY (the 2-digit year), followed by L and 4 digits	05L1234
<b>Michigan lab</b>	YY (the 2-digit year), followed by RF and 4 digits	06RF5678
<b>CDC lab</b>	YY (the 2-digit year), followed by a hyphen and 6 digits	06-012345

When entering the genotyping accession number, begin at the first box and continue to fill to the right. Include all hyphens and letters. Do not add zeros in the remaining boxes (beyond the number provided by the reference lab).

## 39. Initial Drug Susceptibility Testing

<b>39. Initial Drug Susceptibility Testing</b>	
Was drug susceptibility testing done? (select one) <input type="checkbox"/> No <input type="checkbox"/> Yes <input type="checkbox"/> Unknown	
If NO or UNKNOWN, do not complete the rest of Follow Up Report –1	
If YES, enter date FIRST isolate collected for which drug susceptibility testing was done:	Enter specimen type: <input type="checkbox"/> Sputum
Month                      Day                      Year	<b>OR</b>
<input type="text"/> <input type="text"/> <input type="text"/> <input type="text"/> <input type="text"/> <input type="text"/> <input type="text"/> <input type="text"/>	If not Sputum, enter anatomic code (see list): <input type="text"/> <input type="text"/>

**Primary Purpose:** Programmatic function. Data are used to monitor the rate of susceptibility testing and calculate indicators.

Option (select one)	Description
<b>No</b>	Initial drug susceptibility testing was <b>not</b> performed.
<b>Yes</b>	An initial isolate was obtained, submitted for drug susceptibility testing, and results are available.
<b>Unknown</b>	It is <b>not</b> known whether initial drug susceptibility testing was performed.

### Comments:

If drug susceptibility testing was performed on multiple initial isolates, select one of the following (there is no hierarchy for selecting these options):

- The isolate associated with the primary, or major, site of disease
- or**
- The initial isolate from the major site of disease that yields the best or most information concerning drug susceptibility results
- or**
- The initial culture-positive isolate.

**Note:** If the answer is **No** or **Unknown**, do **not** complete the remainder of this form (Initial Drug Susceptibility Report [Follow Up Report–1]).

If you selected **Yes**, enter the following information.

	Description	Comment
<b>Date first specimen for which drug susceptibility testing was done</b>	Month, day, and year the <b>first</b> specimen was <b>collected</b> (e.g., 01/17/2009)	If the month or day is unknown, enter 99 as the default value (e.g., 01/99/2009).

Select the **specimen type** on which initial drug susceptibility testing was performed.

Option (select one)	Description
<b>Sputum</b>	
<b>Not sputum</b>	Enter appropriate anatomic code (e.g., 30 for pericarditis) from the Anatomic Code list (see Appendix C – Anatomic Codes).

**Note:** For the purposes of the RVCT training materials, use the codes listed in the appendices. Some software programs used to enter data on the RVCT may **NOT** use the codes listed in the appendices. For example, the Anatomic Codes may be a drop-down item, where you choose the actual site rather than enter a code. For more information, see instructions for the software you use.

## 40. Initial Drug Susceptibility Results

40. Initial Drug Susceptibility Results (select one option for each drug)									
	Resistant	Susceptible	Not Done	Unknown		Resistant	Susceptible	Not Done	Unknown
Isoniazid	<input type="checkbox"/>	<input type="checkbox"/>	<input type="checkbox"/>	<input type="checkbox"/>	Capreomycin	<input type="checkbox"/>	<input type="checkbox"/>	<input type="checkbox"/>	<input type="checkbox"/>
Rifampin	<input type="checkbox"/>	<input type="checkbox"/>	<input type="checkbox"/>	<input type="checkbox"/>	Ciprofloxacin	<input type="checkbox"/>	<input type="checkbox"/>	<input type="checkbox"/>	<input type="checkbox"/>
Pyrazinamide	<input type="checkbox"/>	<input type="checkbox"/>	<input type="checkbox"/>	<input type="checkbox"/>	Levofloxacin	<input type="checkbox"/>	<input type="checkbox"/>	<input type="checkbox"/>	<input type="checkbox"/>
Ethambutol	<input type="checkbox"/>	<input type="checkbox"/>	<input type="checkbox"/>	<input type="checkbox"/>	Ofloxacin	<input type="checkbox"/>	<input type="checkbox"/>	<input type="checkbox"/>	<input type="checkbox"/>
Streptomycin	<input type="checkbox"/>	<input type="checkbox"/>	<input type="checkbox"/>	<input type="checkbox"/>	Moxifloxacin	<input type="checkbox"/>	<input type="checkbox"/>	<input type="checkbox"/>	<input type="checkbox"/>
Rifabutin	<input type="checkbox"/>	<input type="checkbox"/>	<input type="checkbox"/>	<input type="checkbox"/>	Other Quinolones	<input type="checkbox"/>	<input type="checkbox"/>	<input type="checkbox"/>	<input type="checkbox"/>
Rifapentine	<input type="checkbox"/>	<input type="checkbox"/>	<input type="checkbox"/>	<input type="checkbox"/>	Cycloserine	<input type="checkbox"/>	<input type="checkbox"/>	<input type="checkbox"/>	<input type="checkbox"/>
Ethionamide	<input type="checkbox"/>	<input type="checkbox"/>	<input type="checkbox"/>	<input type="checkbox"/>	Para-Amino Salicylic Acid	<input type="checkbox"/>	<input type="checkbox"/>	<input type="checkbox"/>	<input type="checkbox"/>
Amikacin	<input type="checkbox"/>	<input type="checkbox"/>	<input type="checkbox"/>	<input type="checkbox"/>	Other	<input type="checkbox"/>	<input type="checkbox"/>	<input type="checkbox"/>	<input type="checkbox"/>
Kanamycin	<input type="checkbox"/>	<input type="checkbox"/>	<input type="checkbox"/>	<input type="checkbox"/>	Specify _____				
					Other	<input type="checkbox"/>	<input type="checkbox"/>	<input type="checkbox"/>	<input type="checkbox"/>
					Specify _____				

**Primary Purpose:** Programmatic function. Data are used to monitor trends in drug resistance and calculate indicators.

Record the results of initial drug susceptibility testing on the first specimen on which drug susceptibility testing was performed. If drug susceptibility testing was performed on multiple initial isolates, select one of the following (there is no hierarchy for selecting these options):

- The isolate associated with the primary, or major, site of disease
- or**
- The initial isolate from the major site of disease that yields the best or most information concerning drug susceptibility results
- or**
- The initial culture-positive isolate.

**Note:** Report results from conventional drug susceptibility tests (DST) only. Do **not** report rapid DST test results (molecular beacon, molecular line probe assays, or other molecular tests).

## First-line and Second-line Anti-TB Drugs

First-line Drugs	Second-line Drugs			
<ul style="list-style-type: none"> <li>• Isoniazid</li> <li>• Rifampin</li> <li>• Pyrazinamide</li> <li>• Ethambutol</li> </ul>	<ul style="list-style-type: none"> <li>• Streptomycin</li> <li>• Rifabutin</li> <li>• Rifapentine</li> <li>• Ethionamide</li> </ul>	<ul style="list-style-type: none"> <li>• Amikacin</li> <li>• Kanamycin</li> <li>• Capreomycin</li> <li>• Ciprofloxacin</li> </ul>	<ul style="list-style-type: none"> <li>• Levofloxacin</li> <li>• Ofloxacin</li> <li>• Moxifloxacin</li> <li>• Other Quinolones</li> </ul>	<ul style="list-style-type: none"> <li>• Cycloserine</li> <li>• Para-Amino Salicylic Acid</li> <li>• Other</li> </ul>

### Comments:

- If drug susceptibility testing for first-line anti-TB drugs was performed on a specific specimen and resistance to one or more drugs was noted, thus prompting drug susceptibility testing for second-line anti-TB drugs, this testing should be done on the same specimen. Enter both first- and second-line testing results for this variable, even if the results are received at different times.
- If the same specimen is used for drug susceptibility testing for second-line anti-TB drugs after testing for first-line anti-TB drugs, update these variables when results become available.
- If a second specimen is needed for drug susceptibility testing for second-line anti-TB drugs, the second specimen should be collected as soon as possible after the first specimen was collected for drug susceptibility testing for first-line anti-TB drugs (i.e., interval between specimen collections should be less than 4 weeks). Update these variables when results become available.

For **each** drug listed, select one of the options listed below.

Option (select one)	Description
<b>Resistant</b>	Drug has <b>any</b> degree of resistance (even partial resistance, resistance at a low concentration of the drug, or a result other than completely susceptible).
<b>Susceptible</b>	Select only if completely susceptible.
<b>Not done</b>	Susceptibility testing was <b>not</b> done for this drug.
<b>Unknown</b>	It is <b>not</b> known whether the test was performed. <b>or</b> Results are <b>not</b> available or result is not known for a reason other than pending results.

**Note: Other Quinolones** excludes ciprofloxacin, levofloxacin, moxifloxacin, and ofloxacin because they are listed on the form.

Use the space at the bottom of the form to write comments (e.g., name of the laboratory that performed drug susceptibility testing) regarding the case of TB reported on this form (Initial Drug Susceptibility Report).

If radiometric and conventional results on the same specimen differ (e.g., one is resistant, the other is susceptible), discuss the results with your state TB laboratory director and complete the item accordingly.



**Comment: Combination drugs**

For combination drugs (e.g., Rifamate, Rifater), select **Yes** for each drug that is a component of the combination drug.

For example

- Rifamate is a combination of isoniazid and rifampin
- Rifater is a combination of isoniazid, rifampin and pyrazinamide

**Example: Rifamate**

For Rifamate, select **Yes** for isoniazid and **Yes** for rifampin.

**Note:** For **Other**, enter only anti-TB drugs (do **not** include pyridoxine, [vitamin B6]).

# Case Completion Report (Follow Up Report – 2)

## Items 41 – 49

Pages 1 and 2 of the Case Completion Report (Follow Up Report – 2) provide instructions for completing items 41 – 49. This 2-page report includes data about treatment outcomes, provider status, and if the patient moved during treatment.

**Complete this form for all patients who were alive at the time of TB diagnosis.** Enter data as soon as information becomes available during patient follow-up. This report should be completed when the case is closed to supervision and is due no later than 2 years after the initial RVCT.

Copy patient name and address from page 1 of the RVCT form. Patient name and address are retained at the local level for identification purposes; they are not sent to CDC. Enter **Year Counted**, **State Case Number**, and **City/County Case Number** for data entry purposes.

(page 1 of 2)

Patient's Name \_\_\_\_\_ (Last) \_\_\_\_\_ (First) \_\_\_\_\_ (MI)

Street Address \_\_\_\_\_ (Street Name, City, State) \_\_\_\_\_ (Zip Code)

**REPORT OF VERIFIED CASE OF TUBERCULOSIS**

**REPORT OF VERIFIED CASE OF TUBERCULOSIS**

U.S. DEPARTMENT OF HEALTH AND HUMAN SERVICES  
CENTERS FOR DISEASE CONTROL AND PREVENTION (CDC)  
ATLANTA, GEORGIA 30333  
FORM APPROVED DATE 03-14-16 V01 Sp. Rev 03/15/2011

**Case Completion Report**

**(Follow Up Report – 2)**

Year Counted									
State Case Number									
City/County Case Number									

**Submit this report for all cases in which the patient was alive at diagnosis.**

**41. Sputum Culture Conversion Documented (select one)**  No  Yes  Unknown

If YES, enter date specimen collected for FIRST consistently negative sputum culture:

Month	Day	Year
<input type="text"/>	<input type="text"/>	<input type="text"/>

If NO, enter reason for not documenting sputum culture conversion (select one):

<input type="checkbox"/> No Follow-up Sputum Despite Induction	<input type="checkbox"/> Patient Refused	<input type="checkbox"/> Patient Lost to Follow-Up
<input type="checkbox"/> No Follow-up Sputum and No Induction	<input type="checkbox"/> Other Specify _____	
<input type="checkbox"/> Died	<input type="checkbox"/> Unknown	

**42. Moved**

Did the patient move during TB therapy? (select one)  No  Yes

If YES, moved to where (select all that apply):

In state, out of jurisdiction (enter city/county) Specify \_\_\_\_\_ Specify \_\_\_\_\_

Out of state (enter state) Specify \_\_\_\_\_ Specify \_\_\_\_\_

Out of the U.S. (enter country) Specify \_\_\_\_\_ Specify \_\_\_\_\_

If moved out of the U.S., international return? (select one)  No  Yes

**43. Date Therapy Stopped**

Month	Day	Year
<input type="text"/>	<input type="text"/>	<input type="text"/>

**44. Reason Therapy Stopped or Never Started (select one)**

<input type="checkbox"/> Completed Therapy	<input type="checkbox"/> Not TB	<small>If DIED, indicate cause of death (select one):</small>
<input type="checkbox"/> Lost	<input type="checkbox"/> Died	<input type="checkbox"/> Related to TB disease
<input type="checkbox"/> Uncooperative or Refused	<input type="checkbox"/> Other	<input type="checkbox"/> Related to TB therapy
<input type="checkbox"/> Adverse Treatment Event	<input type="checkbox"/> Unknown	<input type="checkbox"/> Unrelated to TB disease

**45. Reason Therapy Extended >12 months (select all that apply)**

<input type="checkbox"/> Rifampin Resistance	<input type="checkbox"/> Non-adherence	<input type="checkbox"/> Clinically Indicated – other reasons
<input type="checkbox"/> Adverse Drug Reaction	<input type="checkbox"/> Failure	<input type="checkbox"/> Other Specify _____

**46. Type of Outpatient Health Care Provider (select all that apply)**

<input type="checkbox"/> Local/State Health Department (HD)	<input type="checkbox"/> IHS, Tribal HD, or Tribal Corporation	<input type="checkbox"/> Inpatient Care Only	<input type="checkbox"/> Unknown
<input type="checkbox"/> Private Outpatient	<input type="checkbox"/> Institutional/Correctional	<input type="checkbox"/> Other	

**Comments:**

\_\_\_\_\_

\_\_\_\_\_

\_\_\_\_\_

Public reporting burden of this collection of information is estimated to average 30 minutes per response, including the time for reviewing instructions, searching existing data sources, gathering and maintaining the data needed and completing and reviewing the collection of information. An agency may not conduct or sponsor, and a person is not required to respond to, a collection of information unless it displays a currently valid OMB control number. Send comments regarding this burden estimate or any other aspect of this collection of information, including suggestions for reducing the burden to CDC, Project Operations Office, 1600 Clifton Road, NE, Atlanta, GA 30333, P.O. Box 9912, Atlanta, GA 30366. Do not send the completed form to this address.

Information contained on this form which would permit identification of any individual has been collected with a guarantee that it will be held in strict confidence, will be used only for surveillance purposes, and will not be disclosed or released without the consent of the individual in accordance with Section 306(a) of the Public Health Service Act (as U.S.C. 2635).

CDC 75-102 Rev. 04/2016 (03/2016)

1st Copy      REPORT OF VERIFIED CASE OF TUBERCULOSIS      Follow Up Report - 2 / Page 1 of 2

Patient's Name \_\_\_\_\_ (Last) (First) (MI) State Case No. \_\_\_\_\_

REPORT OF VERIFIED CASE OF TUBERCULOSIS



REPORT OF VERIFIED CASE OF TUBERCULOSIS

U.S. DEPARTMENT OF HEALTH AND HUMAN SERVICES  
CENTERS FOR DISEASE CONTROL AND PREVENTION (CDC)  
ATLANTA, GEORGIA 30333  
FORM APPROVED OMB NO. 0920-0028 Exp. Date 06/01/2011

Case Completion Report - Continued

(Follow Up Report - 2)

47. Directly Observed Therapy (DOT) (select one)

No, Totally Self-Administered

Yes, Totally Directly Observed

Yes, Both Directly Observed and Self-Administered

Unknown

Number of weeks of directly observed therapy (DOT)

48. Final Drug Susceptibility Testing

Was follow-up drug susceptibility testing done? (select one)  No  Yes  Unknown

If NO or UNKNOWN, do not complete the rest of Follow Up Report -2

If YES, enter date FINAL specimen collected on which drug susceptibility testing was done:

Enter specimen type:  Sputum  
OR  
If not Sputum, enter anatomic code (see list):

49. Final Drug Susceptibility Results (select one option for each drug)

	Resistant	Susceptible	Not Done	Unknown		Resistant	Susceptible	Not Done	Unknown
Isoniazid	<input type="checkbox"/>	<input type="checkbox"/>	<input type="checkbox"/>	<input type="checkbox"/>	Capreomycin	<input type="checkbox"/>	<input type="checkbox"/>	<input type="checkbox"/>	<input type="checkbox"/>
Rifampin	<input type="checkbox"/>	<input type="checkbox"/>	<input type="checkbox"/>	<input type="checkbox"/>	Ciprofloxacin	<input type="checkbox"/>	<input type="checkbox"/>	<input type="checkbox"/>	<input type="checkbox"/>
Pyrazinamide	<input type="checkbox"/>	<input type="checkbox"/>	<input type="checkbox"/>	<input type="checkbox"/>	Levofloxacin	<input type="checkbox"/>	<input type="checkbox"/>	<input type="checkbox"/>	<input type="checkbox"/>
Ethambutol	<input type="checkbox"/>	<input type="checkbox"/>	<input type="checkbox"/>	<input type="checkbox"/>	Ofloxacin	<input type="checkbox"/>	<input type="checkbox"/>	<input type="checkbox"/>	<input type="checkbox"/>
Streptomycin	<input type="checkbox"/>	<input type="checkbox"/>	<input type="checkbox"/>	<input type="checkbox"/>	Moxifloxacin	<input type="checkbox"/>	<input type="checkbox"/>	<input type="checkbox"/>	<input type="checkbox"/>
Rifabutin	<input type="checkbox"/>	<input type="checkbox"/>	<input type="checkbox"/>	<input type="checkbox"/>	Other Quinolones	<input type="checkbox"/>	<input type="checkbox"/>	<input type="checkbox"/>	<input type="checkbox"/>
Rifapentine	<input type="checkbox"/>	<input type="checkbox"/>	<input type="checkbox"/>	<input type="checkbox"/>	Cycloserine	<input type="checkbox"/>	<input type="checkbox"/>	<input type="checkbox"/>	<input type="checkbox"/>
Ethionamide	<input type="checkbox"/>	<input type="checkbox"/>	<input type="checkbox"/>	<input type="checkbox"/>	Para-Amino Salicylic Acid	<input type="checkbox"/>	<input type="checkbox"/>	<input type="checkbox"/>	<input type="checkbox"/>
Amikacin	<input type="checkbox"/>	<input type="checkbox"/>	<input type="checkbox"/>	<input type="checkbox"/>	Other	<input type="checkbox"/>	<input type="checkbox"/>	<input type="checkbox"/>	<input type="checkbox"/>
Kanamycin	<input type="checkbox"/>	<input type="checkbox"/>	<input type="checkbox"/>	<input type="checkbox"/>	Specify _____				
					Other	<input type="checkbox"/>	<input type="checkbox"/>	<input type="checkbox"/>	<input type="checkbox"/>
					Specify _____				

Comments:

\_\_\_\_\_

\_\_\_\_\_

\_\_\_\_\_

\_\_\_\_\_

\_\_\_\_\_

\_\_\_\_\_

\_\_\_\_\_

Public reporting burden of this collection of information is estimated to average 35 minutes per response, including the time for reviewing instructions, searching existing data sources, gathering and maintaining the data needed and completing and reviewing the collection of information. An agency may not conduct or sponsor, and a person is not required to respond to a collection of information unless it displays a currently valid OMB control number. Send comments regarding this burden estimate or any other aspect of this collection of information, including suggestions for reducing this burden to CDC, Project Clearance Office, 1600 Clifton Road, MS D-74, Atlanta, GA 30333, ATTN: PRA (920-0028). Do not send the completed form to this address.

Information contained on this form which would permit identification of any individual has been collected with a guarantee that it will be held in strict confidence, will be used only for surveillance purposes, and will not be disclosed or released without the consent of the individual in accordance with Section 305(j) of the Public Health Service Act (42 U.S.C. 242m).

## 41. Sputum Culture Conversion Documented

**41. Sputum Culture Conversion Documented** (select one)  No  Yes  Unknown

If YES, enter date specimen collected for FIRST consistently negative sputum culture:

Month   Day   Year

If NO, enter reason for not documenting sputum culture conversion (select one):

No Follow-up Sputum Despite Induction  Patient Refused  Patient Lost to Follow-Up

No Follow-up Sputum and No Induction  Other Specify \_\_\_\_\_

Died  Unknown

**Primary Purpose:** Programmatic function. Data are used to monitor the rate of sputum culture conversion.

**Provide information on sputum culture conversion only for patients with initially positive sputum cultures.** Sources for documentation of sputum culture conversion include patient medical records and laboratory reports.

**Note: Do NOT complete this item for patients whose –**

- Sputum culture was **not** indicated as positive in **Sputum Culture** (item 18).
- Initial sputum specimen did **not** test positive and whose other pulmonary specimens (e.g., bronchoscopy fluid) tested positive in **Culture of Tissue and Other Body Fluids** (item 20).

Option (select one)	Description	Comment
<b>No</b>	Initial sputum specimen was culture-positive; no later specimens were culture-negative (e.g., all follow-up cultures were positive, patient could not produce sputum after therapy started, or no follow-up sputum cultures were obtained).	
<b>Yes</b>	Initial sputum specimen was culture-positive, followed by at least 1 negative sputum culture.	There should be <b>no</b> positive cultures after the negative culture(s).
<b>Unknown</b>	Results of <b>all</b> follow-up cultures are <b>not</b> known. <b>or</b> It is <b>not</b> known whether follow-up cultures were done.	

If you selected **Yes**, enter the following information.

	Description	Comment
<b>Date specimen collected for FIRST consistently negative sputum culture</b>	Month, day, and year when the first of the consistently negative sputum specimens was <b>collected</b> (e.g., 01/17/2009).	<p>Complete <b>only</b> for patients who had 1 or more positive sputum cultures and who subsequently had at least 1 documented negative culture.</p> <p>This date should be at least 1 week after the last positive culture result. There should be no positive cultures after this date.</p> <p>This information may be available from medical records or laboratory reports.</p> <p>If the month or day is unknown, enter 99 as the default value (e.g., 01/99/2009).</p>

If you selected **No**, select one reason for **not documenting sputum culture conversion**.

Option (select one)	Description
<b>No follow-up sputum despite induction</b>	Repeat sputum collection was attempted (including induced sputum collection), but because of clinical improvement, patient was <b>not</b> able to produce sputum.
<b>No follow-up sputum and no induction</b>	Induction was <b>not</b> attempted (e.g., the health care provider did not order a repeat specimen, or there were no facilities or equipment for induction).
<b>Died</b>	Patient died before having an opportunity to submit sputum to document whether the sputum culture had converted.
<b>Patient lost to follow-up</b>	Patient was lost to follow-up before having an opportunity to submit a sputum to document whether the sputum culture had converted.
<b>Patient refused</b>	Patient refused to provide a sputum specimen for a repeat culture.
<b>Other</b> (specify)	A reason <b>not</b> included in the above choices (e.g., treatment failed, or the patient moved outside the United States).
<b>Unknown</b>	It is <b>not</b> known why a repeat sputum culture was <b>not</b> obtained.

## 42. Moved

<b>42. Moved</b>	
Did the patient move during TB therapy? (select one) <input type="checkbox"/> No <input type="checkbox"/> Yes	
If YES, moved to where (select all that apply):	
<input type="checkbox"/> In state, out of jurisdiction (enter city/county) Specify _____	Specify _____
<input type="checkbox"/> Out of state (enter state) Specify _____	Specify _____
<input type="checkbox"/> Out of the U.S. (enter country) Specify _____	Specify _____
If moved out of the U.S., transnational referral? (select one) <input type="checkbox"/> No <input type="checkbox"/> Yes	

**Primary Purpose:** Programmatic function. Data are used to facilitate efficient communication between TB control programs in providing continuity of care for the patient.

This variable is used to record whether the patient moved during TB therapy. The responsibility for follow-up reporting generally remains with the reporting area that initially reported the case to CDC and counted it. (For a detailed description of the responsibility for submitting follow-up reports to CDC, see the instructions for **Reporting Address for Case Counting** [item 4].)

**Definition of Moved:** Relocated, the result of which is a change in local health department jurisdictions.

Option (select one)	Description
No	Patient did <b>not</b> move. <b>or</b> Patient moved <b>within</b> the same local health department jurisdiction.
Yes	Patient moved to an area where <b>another</b> jurisdiction must now provide or coordinate TB care.

If you selected **Yes**, select all the options that apply to the area **to which the patient moved**.

<b>Option</b> <i>(select all that apply)</i>	<b>Description</b>	<b>COMMENT</b>
<b>In-state, out-of jurisdiction</b> <i>(specify)</i>	<p>Patient moved within the state, but out of the local health department jurisdiction, such as moved to different county or city.</p> <p>Enter the city or county health department jurisdiction to which the patient moved.</p>	If the patient moved more than twice, enter the first 2 moves.
<b>Out of state</b> <i>(specify)</i>	<p>Patient moved from 1 of the 50 U.S. states or the District of Columbia to</p> <ul style="list-style-type: none"> <li>• Another state (e.g., moved from Georgia to Alabama)</li> </ul> <p><b>or</b></p> <ul style="list-style-type: none"> <li>• A U.S. Territory, U.S. Island Area, or U.S. Outlying Area</li> </ul> <hr/> <p>Patient moved from a U.S. Territory, U.S. Island Area, or U.S. Outlying Area to</p> <ul style="list-style-type: none"> <li>• One of the 50 U.S. states or the District of Columbia</li> </ul> <p><b>or</b></p> <ul style="list-style-type: none"> <li>• A U.S. Territory, U.S. Island Area, or U.S. Outlying Area</li> </ul> <p>Enter the name of the state or reporting area to which the patient moved.</p>	If the patient moved more than twice, enter the first 2 moves.

<b>Out of the U.S.</b> <i>(specify)</i>	Patient moved from the United States to <ul style="list-style-type: none"> <li>• Another country (<b>other than a</b> U.S. Territory, U.S. Island Area, or U.S. Outlying Area)</li> </ul>	If the patient moved more than twice, enter the first 2 moves.
	Moved from a U.S. Territory, U.S. Island Area, or U.S. Outlying Area to <ul style="list-style-type: none"> <li>• Another country (<b>other than the</b> United States or another U.S. Territory, U.S. Island Area, or U.S. Outlying Area)</li> </ul> <p>Enter the name of the country to which the patient moved.</p>	

If patient moved **out of the U.S.**, select one option to indicate whether a **transnational referral** was made.

<b>Option</b> <i>(select all that apply)</i>	<b>Description</b>	<b>Comment</b>
<b>No</b>	Referral was not made to a TB program or physician outside the United States.	Transnational referral includes participation in programs such as <ul style="list-style-type: none"> <li>• TBNet</li> <li>• CureTB</li> <li>• Immigration and Customs Enforcement (ICE)</li> </ul>
<b>Yes</b>	Referral was made to a TB program or physician outside the United States.	Communication between programs is important <ul style="list-style-type: none"> <li>• To help ensure case management after deportation</li> <li>• For completing a case management transfer and obtaining information from TB programs and/or physicians outside the United States for case completion</li> </ul> <p>For more information, visit the CDC/DTBE web site on the Process for Notification of TB Cases at <a href="http://www.cdc.gov/tb/pubs/international/default.htm">www.cdc.gov/tb/pubs/international/default.htm</a></p>



**Example: Moved within a county, parish, or within a state**

A move could be within a county, parish, or even within a state provided that the same health department jurisdiction is primarily responsible for providing the TB case management, completing the RVCT, and ensuring the completion of treatment.

**Example: New York City**

New York State and New York City (NYC) are separate TB reporting areas that report TB cases directly to CDC. If a patient moves from New York State to NYC or vice versa, the move is considered “in-state, out of jurisdiction.” Select **In-state, out-of jurisdiction**.

**Example: Reporting from one of the U.S. Territories, U.S. Island Areas, or U.S. Outlying Areas**

If you are reporting from one of the U.S. Territories, U.S. Island Areas, or U.S. Outlying Areas (American Samoa, Federated States of Micronesia, Guam, Republic of the Marshall Islands, Commonwealth of the Northern Mariana Islands, Republic of Palau, Puerto Rico, or U.S. Virgin Islands), select **Out of state** if a patient moves out of your reporting area to the United States or to another U.S. Territory, U.S. Island Area, or U.S. Outlying Area.

However, if a patient moves from your jurisdiction to a country other than the United States or another U.S. Territory, U.S. Island Area, or U.S. Outlying Area, select **Out of the U.S.**

**Examples of Moved**

<b>Moved</b>		<b>Select</b>
<b>From</b>	<b>To</b>	
Dallas County, Texas	Harris County, Texas	In-state, out-of jurisdiction
Denali Borough, Alaska	Bethel Borough, Alaska	In-state, out-of jurisdiction
Orleans Parish, Louisiana	Vernon Parish, Louisiana	In-state, out-of jurisdiction
Chuuk, Federated States of Micronesia (FSM)	Yap, FSM	In-state, out-of jurisdiction
California	Hawaii	Out of state
Washington, D.C.	Baltimore, Maryland	Out of state
California	Guam	Out of state
Guam	Palau	Out of state
Guam	Hawaii	Out of state
Chuuk, FSM	Guam	Out of state
Chuuk, FSM	California	Out of state
Puerto Rico	Florida	Out of state
Guam	China	Out of the U.S.
California	China	Out of the U.S.

## 43. Date Therapy Stopped

43. Date Therapy Stopped						
Month		Day		Year		
<input type="text"/>	<input type="text"/>	<input type="text"/>	<input type="text"/>	<input type="text"/>	<input type="text"/>	<input type="text"/>

**Primary Purpose:** Programmatic function. Data are used to monitor completion of therapy within a specified time.

	Description	Comment
<b>Month, day, and year</b> (e.g., 01/17/2005)	Date the patient stopped taking therapy for TB disease or suspected TB disease	This may be one of several dates, ideally, when the patient last ingested medication if documented in a medical record.  If the month or day is unknown, enter 99 as the default value (e.g., 01/99/2005).

### Comment: Date Therapy Stopped

The interval between **Date Therapy Started** (item 36) and **Date Therapy Stopped** (item 43) is meant to encompass the entire period (including interruptions in therapy) that the patient was receiving medication to treat TB disease or suspected TB disease. **Patient self-report without medical documentation is not acceptable.** Although there may be interruptions in anti-TB drug therapy, enter the final documented date on which the patient last ingested medication for TB disease or suspected TB. For patients being treated for TB disease or suspected TB disease, enter **Date Therapy Stopped**, according to the following chart:

### Hierarchy for Determining Date Therapy Stopped (for entire treatment period)

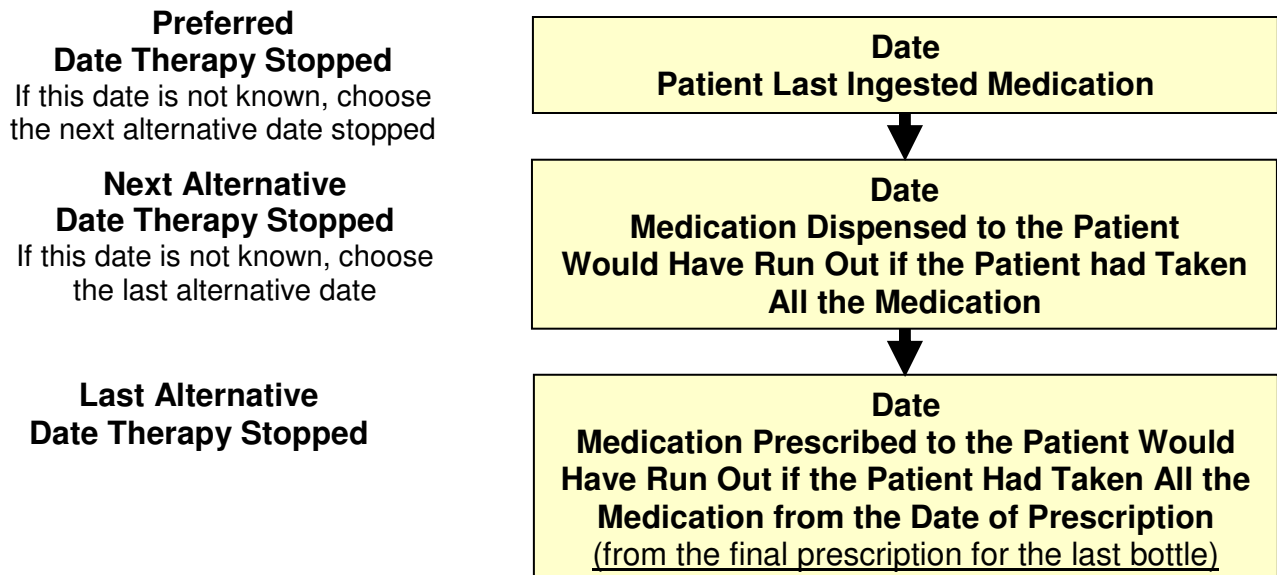

**Comment: Update the date that therapy was stopped**

Update the date therapy was stopped only if a patient was lost to follow-up and then returns and completes therapy.

**Comment: Reopened case**

If a case is reopened (e.g., patient who has been lost to follow-up is found, restarts therapy, and then completes therapy), update this form (Case Completion Report [Follow Up – Report 2]) to reflect that the patient completed therapy.

## 44. Reason Therapy Stopped or Never Started

<b>44. Reason Therapy Stopped or Never Started</b> (select one)			
<input type="checkbox"/> Completed Therapy	<input type="checkbox"/> Not TB	If DIED, indicate cause of death (select one):	
<input type="checkbox"/> Lost	<input type="checkbox"/> Died	<input type="checkbox"/> Related to TB disease	<input type="checkbox"/> Unrelated to TB disease
<input type="checkbox"/> Uncooperative or Refused	<input type="checkbox"/> Other	<input type="checkbox"/> Related to TB therapy	<input type="checkbox"/> Unknown
<input type="checkbox"/> Adverse Treatment Event	<input type="checkbox"/> Unknown		

**Primary Purpose:** Programmatic function. Data are used to document treatment outcome.

Complete this item when the patient completes therapy or the case is closed. Select the primary reason that TB therapy was ended and not resumed, or was never started.

Option (select one)	Description
<b>Completed therapy</b>	Patient completed the prescribed course of therapy per the medical record as recorded by the clinician caring for the patient.
<b>Lost</b>	Patient could not be located before the start or the completion of treatment (e.g., the patient moved to an <b>unknown</b> location, or the forwarding address is known but the patient was not found at that address).  Code patients who move outside the United States and cannot be followed up as <b>Other</b> .
<b>Uncooperative or refused</b>	Patient refused to complete therapy (e.g., stopped taking drugs).
<b>Adverse treatment event</b>	Therapy was <b>permanently</b> stopped because of an adverse event due to anti-TB medications. Select this option only if the patient lived.  If the patient died because of an adverse TB treatment event, select <ul style="list-style-type: none"> <li>• <b>Died</b> as the Reason Therapy Stopped <b>and then select</b></li> <li>• <b>Related to TB Therapy for Cause of Death</b> even if the patient stopped TB therapy prior to the death due to an adverse treatment event.</li> </ul> This is a determination that has to be made by the clinician.
<b>Not TB</b>	Completed diagnostic evaluation did not substantiate the diagnosis of TB (e.g., <i>M. avium</i> was isolated from a clinical specimen).
<b>Died</b>	Patient was alive at diagnosis but died before the start or completion of treatment. This also applies to a patient classified as alive for <b>Status at TB Diagnosis</b> (item 15) if the patient was taking at least 2 anti-TB drugs before the day of death, even though the TB case was not verified and counted until after death.

<b>Other</b>	Therapy was discontinued for a known reason <b>not</b> included in the above choices and is <b>not Unknown</b> , (e.g., patient moved outside the United States, or patient moved from state A to state B, and state A notified state B, but state B never followed up).
<b>Unknown</b>	Reason that therapy was stopped is <b>not</b> known.

**Comment: Reopen a case**

If a case is reopened (e.g., patient who has been lost to follow-up is found within 12 months of when the patient was lost, restarts therapy, and then completes therapy), update this form (Case Completion Report [Follow Up – Report 2]) to reflect that the patient completed therapy.

If you selected **Died**, indicate one **Cause of Death**.

<b>Option</b> (select one)	<b>Description</b>	<b>Comment</b>
<b>Related to TB disease</b>	TB was <ul style="list-style-type: none"> <li>• The immediate cause</li> <li><b>or</b></li> <li>• An underlying cause</li> <li><b>or</b></li> <li>• Another significant condition contributing to death (even if TB was not the main cause of death)</li> </ul>	<p>Written documentation of the cause of death (e.g., death certificate, autopsy report, medical records) is recommended. However, oral information from a reliable source (e.g., a health care provider) will be accepted.</p> <p>A death certificate is <b>not</b> necessarily required to complete this field. In some cases deaths may be certified before receipt of results of</p> <ul style="list-style-type: none"> <li>• Positive <i>M. tuberculosis</i> culture</li> <li><b>or</b></li> <li>• Other findings consistent with TB</li> </ul> <p>Classify as related to TB disease if the patient died as a result of a surgical procedure for which</p> <ul style="list-style-type: none"> <li>• The primary indication was the diagnosis of TB</li> <li><b>or</b></li> <li>• TB complicated a surgical procedure <b>not</b> related to TB (e.g., heart surgery)</li> </ul> <p>Criteria for determining the cause of death related to TB disease should be specified by the clinician.</p>
<b>Related to TB therapy</b>	TB therapy (e.g., adverse treatment event) was related to the cause of death.	Criteria for determining the cause of death related to TB therapy should be specified by the clinician.

<b>Unrelated to TB disease</b>	TB was <b>not</b> <ul style="list-style-type: none"> <li>• The immediate cause</li> <li><b>or</b></li> <li>• An underlying cause</li> <li><b>or</b></li> <li>• Another significant condition contributing to death</li> </ul>	
<b>Unknown</b>	Cause of death is <b>not</b> known.	Every effort should be made to determine if death was related to TB disease before classifying as unknown.

**Note:** Update this item if additional information is obtained.

## 45. Reason Therapy Extended >12 Months

45. Reason Therapy Extended >12 months (select all that apply)		
<input type="checkbox"/> Rifampin Resistance	<input type="checkbox"/> Non-adherence	<input type="checkbox"/> Clinically Indicated – other reasons
<input type="checkbox"/> Adverse Drug Reaction	<input type="checkbox"/> Failure	<input type="checkbox"/> Other Specify _____

**Primary Purpose:** Program function. Data are used to document reason for extended treatment and to calculate program indicators.

Use the information entered for **Date Therapy Started** (item 36) and **Date Therapy Stopped** (item 43) to calculate the length of anti-TB therapy. Sources for the reason(s) therapy was extended include patient medical records, patient interview, and health care provider interview.

Option (select all that apply)	Description	Comment
<b>Rifampin resistance</b>	Patient had drug-resistant TB that would require a treatment protocol lasting more than 12 months (e.g., resistance to at least rifampin) according to the ATS/CDC/IDSA Official Joint Statement on the Treatment of TB.	
<b>Adverse drug reaction</b>	Patient had a significant adverse drug reaction or experienced an adverse treatment event due to anti-TB medications that prolonged therapy.	
<b>Non-adherence</b>	There were barriers to the patient's adherence to anti-TB therapy (e.g., treatment interruption), or the patient's lack of adherence resulted in extension of therapy beyond 12 months.	
<b>Failure</b>	A sputum specimen tested positive 4 or more months after treatment began.	Criteria for determining failure should be specified by the clinician.
<b>Clinically indicated—other reasons</b>	Clinical indications ( <b>other than adverse drug reactions</b> ) include central nervous system TB (e.g., meningitis), severe liver disease, or other criteria as specified by the clinician.	
<b>Other</b>	Reason does <b>not</b> include any of the choices listed above.	Use additional space at the bottom of the page to write comments regarding <b>Other</b> reasons.

## 46. Type of Outpatient Health Care Provider

46. Type of Outpatient Health Care Provider (select all that apply)

Local/State Health Department (HD)     
 IHS, Tribal HD, or Tribal Corporation     
 Inpatient Care Only     
 Unknown

Private Outpatient     
 Institutional/Correctional     
 Other

**Primary Purpose:** Programmatic function. Data are used to guide TB programs in allocating resources.

Definition for **Type of Outpatient Health Care Provider:** setting or affiliation of the provider who has primary responsibility for clinical outpatient decision making (excluding diagnostic workup, contact investigations, anti-TB medications, and directly observed therapy [DOT]).

**Note:**

- *Outpatient* refers to a setting that is not a hospital and that does not provide acute care, such as a clinic or a physician's office.
- *Inpatient* refers to a hospital or acute-care setting.

Here, these terms refer to the physician, not to the patient. These terms also denote the type of services that are provided. Some institutions, such as a hospital, correctional facility, or long-term care facility, may have both outpatient and inpatient settings.

Option (select all that apply)	Description
<b>Local/state health department (HD)</b>	Includes a TB program or a health clinic of a health department.
<b>Private outpatient</b>	Includes private physician or health care provider, health maintenance organization (HMO), and private managed health care provider.
<b>IHS, tribal HD, or tribal corporation</b>	Primary responsibility for clinical outpatient decision making rests with the Indian Health Service (IHS); a tribal health department, such as the American Indian or Alaska Native Tribal Health Department; or a tribal corporation, such as the Tribal Healthcare Corporation.
<b>Institutional/correctional</b>	Includes nursing homes and assisted living facilities, and all types of correctional facilities.
<b>Inpatient care only</b>	Patient did <b>not</b> receive outpatient TB care. Care provided in a hospital.
<b>Other</b>	The provider is <b>not</b> included in the other categories and is <b>not Unknown</b> (e.g., state TB chest hospital providing outpatient care, city/county/state-owned hospitals that are not part of the health department providing outpatient care, private hospital providing outpatient care, Veterans Administration hospital, federal program, military facility, or community-based organization [CBO]).



<b>Unknown</b>	Type of health care provider is <b>not</b> known. If you select <b>Unknown</b> , do <b>not</b> select any other option for type of health care provider.
----------------	--

**Comment: Private outpatient**

This category includes the private provider who has the primary responsibility for clinical outpatient decision making for a TB patient, even though the TB control program or local/state health department may be periodically contacting the private provider for the purpose of completing the RVCT and ensuring proper TB case management.

**Comment: Inpatient care only**

Examples of inpatient care only include

- TB diagnosed at autopsy
- Patients who were in the hospital but died before receiving outpatient TB care
- Patients who received all of their TB care as an inpatient in a hospital

**Comment: Multiple options**

If a patient first received care from a private health care provider, but after a time (e.g., 3 months) lost his or her medical insurance and began receiving care from the local or state health department, select both **Private** and **Local/State Health Department**.

## 47. Directly Observed Therapy (DOT)

### 47. Directly Observed Therapy (DOT) (select one)

- No, Totally Self-Administered  
 Yes, Totally Directly Observed  
 Yes, Both Directly Observed and Self-Administered  
 Unknown

Number of weeks of directly observed therapy (DOT)

--	--	--

**Primary Purpose:** Case management. Data are used to document administration of TB medications.

Directly observed therapy (DOT), or supervised therapy, involves the direct visual observation by a health care provider (e.g., public health nurse, outreach worker, nurse, nurse's aide) or other reliable trained person (e.g., worker in a homeless shelter) of a patient's ingestion of medication. Delivering medication to a patient without visual confirmation of ingestion does not constitute DOT. However, a live video camera confirmation of ingestion of medicine of **carefully selected patients** (e.g., stable and compliant) constitutes DOT.

Anti-TB medication may be

- 1) Self-administered (e.g., patient ingests medication dose[s] **without** direct visual observation by a health care provider or other reliable person)
- or**
- 2) Given by using DOT
- or**
- 3) A combination of self-administered and given by using DOT

Option (select one)	Description
<b>No, totally self-administered</b>	No doses of medication were given under direct supervision.
<b>Yes, totally directly observed</b>	Response applies if DOT was used for <b>all</b> doses for a patient who was taking medication 1–5 times a week. Response <b>also applies</b> if the patient was taking medication 7 times a week and DOT was used for at least 5 of those doses (i.e., patient self-administered the dose[s] during weekends and holidays).
<b>Yes, both directly observed and self-administered</b>	Response applies if the patient self-administered <b>any</b> dose while taking medication 1–5 times a week. Response does <b>not</b> apply if the patient was taking medication 7 times a week and DOT was used for at least 5 of those doses (i.e., patient self-administered the dose[s] during weekends and holidays).  Response also applies if patient took several months of self-administered therapy and several months of DOT.
<b>Unknown</b>	It is <b>not</b> known whether any doses were given under direct supervision.

If you selected any **Yes** option, enter the **Number of weeks of directly observed therapy (DOT)**.

<b>Option</b> <i>(select one)</i>	<b>Description</b>	<b>Comment</b>
<b>Number of weeks of directly observed therapy (DOT)</b>	Based on the total number of regimen-appropriate weeks and doses ingested under directly observed supervision (e.g., 026)	The total number of DOT weeks must be less than or equal to the time between <b>Date Therapy Started</b> (item 36) and <b>Date Therapy Stopped</b> (item 43).

To calculate **Number of weeks of directly observed therapy (DOT weeks)**, use the following methods:

- **Review the patient’s medication records to determine the number of doses given by DOT each week**  
Review the patient’s medication records to determine the number of doses given by DOT each week, or 7-day period. The number of days in a week is 7, but the calculation of DOT (or medication) weeks should be independent of, or not restricted to, calendar weeks (i.e., Sunday through Saturday).
- **Example: Medication week**  
A medication week can be, for example, Monday through Sunday or Wednesday through Tuesday, as long as the week consists of 7 consecutive days.
- **Missed DOT dose**  
If a patient misses a DOT dose or there is a holiday during a medication week (i.e., DOT cannot be given that week), as long as DOT is used when the missed dose(s) is made up at the end of therapy, the dose(s) given at the end of therapy can be combined with the last “partial DOT week” and counted as a “full DOT week.”
- **Count as a DOT week**  
Count as a DOT week any week during which DOT was used for every dose for a patient who was taking medication 1–5 times a week. If the patient was taking medication 7 times a week, DOT must have been used for at least 5 doses.

Often, the health department or the person completing the RVCT form does not have direct access to the entire patient medical record or medication log because the TB patient is or was cared for by a provider other than the health department (e.g., private health care provider). A private health care provider usually does not provide DOT; rather, a public health care provider (e.g., public health nurse) provides DOT and maintains the medication log and medication dosage calendar. The health department periodically follows up with the provider, and when therapy is completed or the case is closed, the health department usually completes a “close-out” form. In such instances, the health department should request a copy of the medication log or review the log with the person who provided DOT (e.g., public health nurse) to determine the amount of medication that was given by DOT.

## 48. Final Drug Susceptibility Testing

<b>48. Final Drug Susceptibility Testing</b> Was follow-up drug susceptibility testing done? (select one) <input type="checkbox"/> No <input type="checkbox"/> Yes <input type="checkbox"/> Unknown <i>If NO or UNKNOWN, do not complete the rest of Follow Up Report –2</i>	
If YES, enter date FINAL isolate collected for which drug susceptibility testing was done: Month      Day      Year <input type="text"/> <input type="text"/> <input type="text"/> <input type="text"/> <input type="text"/> <input type="text"/> <input type="text"/> <input type="text"/>	Enter specimen type: <input type="checkbox"/> Sputum <b>OR</b> If not Sputum, enter anatomic code (see list): <input type="text"/> <input type="text"/>

**Primary Purpose:** Surveillance. Data are used to observe trends in drug-resistant TB and to learn about its epidemiology.

Option (select one)	Description
<b>No</b>	Follow-up drug susceptibility testing was <b>not</b> performed.
<b>Yes</b>	Drug susceptibility testing was performed on a specimen that was collected 30 or more days after the specimen on which initial drug susceptibility testing was performed.
<b>Unknown</b>	It is <b>not</b> known whether follow-up drug susceptibility testing was performed.

**Comment:**

This variable will help assess the frequency of acquired drug resistance.

If you selected **Yes**, enter the following information.

	Description	Comment
<b>Date FINAL specimen collected on which drug susceptibility testing was done</b>	Month, day, and year (e.g., 01/17/2009)	This date should be 30 or more days after the collection date of the initial specimen on which drug susceptibility testing was done (item 39). This information is usually available from medical records or laboratory reports.  If the month or day is unknown, enter 99 as the default value (e.g., 01/99/2009).

Select the **Specimen Type** on which the final drug susceptibility testing was done.

<b>Option</b> <i>(select one)</i>	<b>Description</b>
<b>Sputum</b>	
<b>Not sputum</b>	Enter appropriate anatomic code (e.g., 30 for pericarditis) from Appendix C – Anatomic Codes

## 49. Final Drug Susceptibility Results

49. Final Drug Susceptibility Results (select one option for each drug)									
	Resistant	Susceptible	Not Done	Unknown		Resistant	Susceptible	Not Done	Unknown
Isoniazid	<input type="checkbox"/>	<input type="checkbox"/>	<input type="checkbox"/>	<input type="checkbox"/>	Capreomycin	<input type="checkbox"/>	<input type="checkbox"/>	<input type="checkbox"/>	<input type="checkbox"/>
Rifampin	<input type="checkbox"/>	<input type="checkbox"/>	<input type="checkbox"/>	<input type="checkbox"/>	Ciprofloxacin	<input type="checkbox"/>	<input type="checkbox"/>	<input type="checkbox"/>	<input type="checkbox"/>
Pyrazinamide	<input type="checkbox"/>	<input type="checkbox"/>	<input type="checkbox"/>	<input type="checkbox"/>	Levofloxacin	<input type="checkbox"/>	<input type="checkbox"/>	<input type="checkbox"/>	<input type="checkbox"/>
Ethambutol	<input type="checkbox"/>	<input type="checkbox"/>	<input type="checkbox"/>	<input type="checkbox"/>	Ofloxacin	<input type="checkbox"/>	<input type="checkbox"/>	<input type="checkbox"/>	<input type="checkbox"/>
Streptomycin	<input type="checkbox"/>	<input type="checkbox"/>	<input type="checkbox"/>	<input type="checkbox"/>	Moxifloxacin	<input type="checkbox"/>	<input type="checkbox"/>	<input type="checkbox"/>	<input type="checkbox"/>
Rifabutin	<input type="checkbox"/>	<input type="checkbox"/>	<input type="checkbox"/>	<input type="checkbox"/>	Other Quinolones	<input type="checkbox"/>	<input type="checkbox"/>	<input type="checkbox"/>	<input type="checkbox"/>
Rifapentine	<input type="checkbox"/>	<input type="checkbox"/>	<input type="checkbox"/>	<input type="checkbox"/>	Cycloserine	<input type="checkbox"/>	<input type="checkbox"/>	<input type="checkbox"/>	<input type="checkbox"/>
Ethionamide	<input type="checkbox"/>	<input type="checkbox"/>	<input type="checkbox"/>	<input type="checkbox"/>	Para-Amino Salicylic Acid	<input type="checkbox"/>	<input type="checkbox"/>	<input type="checkbox"/>	<input type="checkbox"/>
Amikacin	<input type="checkbox"/>	<input type="checkbox"/>	<input type="checkbox"/>	<input type="checkbox"/>	Other	<input type="checkbox"/>	<input type="checkbox"/>	<input type="checkbox"/>	<input type="checkbox"/>
Kanamycin	<input type="checkbox"/>	<input type="checkbox"/>	<input type="checkbox"/>	<input type="checkbox"/>	Specify _____				
					Other	<input type="checkbox"/>	<input type="checkbox"/>	<input type="checkbox"/>	<input type="checkbox"/>
					Specify _____				

**Primary Purpose:** Programmatic function. Data are used to monitor trends in drug resistance.

Record results for the **final** specimen on which drug susceptibility testing was performed. Drug susceptibility testing procedures should comply with approved and accepted guidelines. If drug susceptibility testing was performed on multiple specimens, select the most appropriate specimen: the one associated with the primary, or major, site of disease; the final specimen from the major site of disease that yields the best or most information concerning drug susceptibility results; or the final specimen that tested positive.

For **each** drug listed, select one option from the following.

Option (select one)	Description
<b>Resistant</b>	Drug has <b>any</b> degree of resistance (even partial resistance or resistance at a low concentration of the drug, or other than completely susceptible result).
<b>Susceptible</b>	Select only if completely susceptible.
<b>Not done</b>	Susceptibility testing was <b>not</b> done for this drug.
<b>Unknown</b>	It is <b>not</b> known whether the test was performed. <b>or</b> Results were <b>not</b> available or result is not known for a reason other than pending results.

**Note: Other Quinolones** excludes ciprofloxacin, levofloxacin, moxifloxacin, and ofloxacin because they are listed on the form.

Use the space at the bottom of the form to write comments (e.g., name of the laboratory that performed drug susceptibility testing) regarding the case of TB reported on this form (Case Completion Report).

If radiometric and conventional results on the same specimen differ (e.g., one is resistant, the other is susceptible), discuss the results with your state TB laboratory director and complete the item accordingly.

## **Appendices**

---

The following appendices provide information and codes that are used to complete the RVCT:

- **Appendix A – Tuberculosis Case Definition for Public Health Surveillance**
- **Appendix B – Recommendations for Reporting and Counting Tuberculosis Cases**
- **Appendix C – Anatomic Codes**
- **Appendix D – Reporting Area Codes**
- **Appendix E – Country Codes**
- **Appendix F – Glossary**



## **Appendix A**

### **Tuberculosis Case Definition for Public Health Surveillance**

---

(Revised May 13, 2009)

#### **Clinical description**

A chronic bacterial infection caused by *Mycobacterium tuberculosis*, usually characterized pathologically by the formation of granulomas. The most common site of infection is the lung, but other organs may be involved.

#### **Clinical case definition**

A case that meets **all** of the following criteria:

- A positive tuberculin skin test result or positive interferon gamma release assay for *M. tuberculosis*
- Other signs and symptoms compatible with tuberculosis (TB) (e.g., abnormal chest radiograph, abnormal chest computerized tomography scan or other chest imaging study, or clinical evidence of current disease)
- Treatment with two or more anti-TB medications
- A completed diagnostic evaluation

#### **Laboratory criteria for diagnosis**

- Isolation of *M. tuberculosis* complex from a clinical specimen,\*  
**or**
- Demonstration of *M. tuberculosis* complex from a clinical specimen by nucleic acid amplification test,†  
**or**
- Demonstration of acid-fast bacilli in a clinical specimen when a culture has not been or cannot be obtained or is falsely negative or contaminated.

#### **Case classification**

Confirmed: a case that meets the clinical case definition or is laboratory confirmed

#### **Comment**

A case should not be counted twice within any consecutive 12-month period. However, a case occurring in a patient who had previously had verified TB disease should be reported and counted again if more than 12 months have elapsed since the patient completed therapy. A case should also be reported and counted again if the patient was lost to supervision for greater than 12 months and TB disease can be verified again. Mycobacterial diseases other than those caused by *M. tuberculosis* complex should not be counted in tuberculosis morbidity statistics unless there is concurrent tuberculosis.

---

\*Use of rapid identification techniques for *M. tuberculosis* (e.g., DNA probes and mycolic acid high-pressure liquid chromatography performed on a culture from a clinical specimen) are acceptable under this criterion.

†Nucleic acid amplification (NAA) tests must be accompanied by culture for mycobacteria species for clinical purposes. A culture isolate of *M. tuberculosis* complex is required for complete drug susceptibility testing and also genotyping. However, for surveillance purposes, CDC will accept results obtained from NAA tests approved by the Food and Drug Administration (FDA) and used according to the approved product labeling on the package insert, or a test produced and validated in accordance with applicable FDA and Clinical Laboratory Improvement Amendments (CLIA) regulations.

## **Appendix B**

### **Recommendations for Reporting and Counting Tuberculosis Cases**

---

(Revised May 13, 2009)

Since publication of the “Recommendations for Counting Reported Tuberculosis Cases”<sup>1</sup> in July 1997, numerous changes have occurred, and many issues have been raised within the field of tuberculosis (TB) surveillance. This current version updates and supersedes the previous version.

A distinction should be made between **reporting** TB cases to a health department and **counting** TB cases for determining incidence of disease. Throughout each year, TB cases and suspected cases are reported to public health authorities by sources such as clinics, hospitals, laboratories, and health care providers. From these reports, the state or local TB control officer must determine which cases meet the current surveillance definition for TB disease and whether the case is countable. These countable TB cases are then reported to the Centers for Disease Control and Prevention (CDC).

Beginning in 2009, state and local TB control officers may also report to CDC those TB cases that are verified but not countable for morbidity statistics, as a measure of programmatic and case management burden. The noncountable report can include persons with TB disease recurring within a consecutive 12-month period after the patient completed TB therapy.

**I. Reporting TB Cases.** CDC recommends that health care providers and laboratories be required to report all TB cases or suspected cases to state and local health departments based on the current “Tuberculosis Case Definition for Public Health Surveillance” (Appendix A). This notification is essential in order for TB programs to

- Ensure case supervision
- Ensure completion of appropriate therapy
- Ensure completion of contact investigations
- Evaluate program effectiveness
- Assess trends and characteristics of TB morbidity

**II. TB Surveillance.** For purposes of surveillance, a case of TB is defined on the basis of laboratory or clinical evidence of active disease due to *M. tuberculosis* complex.\*

---

\* Because most laboratories use tests that do not routinely distinguish *Mycobacterium tuberculosis* from very closely related species, these laboratories report culture results as being positive or negative for “*Mycobacterium tuberculosis* complex.” Although in almost all cases of human disease, isolates in the *M. tuberculosis* complex are, in fact, *M. tuberculosis*, other species are possible. For example, one study in San Diego found that 6% of human tuberculosis was caused by *Mycobacterium bovis*; cultures from these cases would be reported by most laboratories as being positive for *M. tuberculosis* complex. Other species in the *Mycobacterium tuberculosis* complex include *M. africanum*, *M. microti*, *M. canettii*, *M. caprae*, and *M. pinnipedii*. Although *M. microti*, *M. canettii*, *M. caprae*, and *M. pinnipedii* are newly described species, their inclusion in *M. tuberculosis* complex should not impact public health laboratories or programs, because only a few laboratories identify to the species level. These seven species are almost identical in DNA homology studies. In terms of their ability to cause clinical disease or be transmissible from person to person, *M. bovis*, *M. africanum*, *M. microti*, *M. canettii*, *M. caprae*, and *M. pinnipedii* behave like *M. tuberculosis*; therefore, disease caused by any of the organisms should be reported as TB, using the Report of

Verified Case of Tuberculosis (RVCT). The only exception is the BCG strain of *M. bovis*, which may be isolated from persons who have received the vaccine for protection against TB or as cancer immunotherapy; disease caused by the BCG strain of *M. bovis* should not be reported as TB.

**a. Laboratory Case Definition**

- Isolation of *M. tuberculosis* complex from a clinical specimen. The use of rapid identification techniques for *M. tuberculosis* performed on a culture from a clinical specimen, such as DNA probes and high-pressure liquid chromatography (HPLC), is acceptable under this criterion.

**OR**

- Demonstration of *M. tuberculosis* from a clinical specimen by nucleic acid amplification (NAA) test. NAA tests must be accompanied by cultures of mycobacterial species. However, for surveillance purposes, CDC will accept results obtained from NAA tests approved by the Food and Drug Administration (FDA) and used according to the approved product labeling on the package insert, or a test produced and validated in accordance with applicable FDA and Clinical Laboratory Improvement Amendments (CLIA) regulations.

**OR**

- Demonstration of acid-fast bacilli (AFB) in a clinical specimen when a culture has not been or cannot be obtained or is falsely negative or contaminated; historically this criterion has been most commonly used to diagnose TB in the postmortem setting.

**b. Clinical Case Definition.** In the absence of laboratory confirmation of *M. tuberculosis* complex after a diagnostic process has been completed, persons must have **all** of the following criteria for clinical TB:

- Evidence of TB infection based on a positive tuberculin skin test result or positive interferon gamma release assay for *M. tuberculosis*

**AND**

- One of the following:
  - (1) Signs and symptoms compatible with current TB disease, such as an abnormal chest radiograph or abnormal chest computerized tomography scan or other chest imaging study,

**OR**

- (2) Clinical evidence of current disease (e.g., fever, night sweats, cough, weight loss, hemoptysis)

**AND**

- Current treatment with two or more anti-TB medications

**NOTE:** The software for TB surveillance developed by CDC includes a calculated variable called “Vercrit,” for which one of the values is “Provider Diagnosis.” “Provider Diagnosis” is selected when the user chooses to override a “Suspect” default value in the case verification screen as “Verified by Provider Diagnosis.” Thus, “Provider Diagnosis” is not a component of the case definition for TB in the current “Tuberculosis Case Definition for Public Health Surveillance” (Appendix A). CDC’s national morbidity reports have traditionally included all TB cases that are considered verified by the reporting areas, without a requirement that cases meet the published case definition.

**III. Counting TB Cases.** Cases that meet the current CDC surveillance case definition for verified TB are counted by 52 reporting areas with count authority (50 states, District of Columbia, and New York City) to determine annual incidence for the United States. The remaining 8 reporting areas (American Samoa, Federated States of Micronesia, Guam, Marshall Islands, Northern Mariana Islands, Puerto Rico, Republic of Palau, and U.S. Virgin Islands) report cases to CDC but are not included in the annual incidence for the United States. The laboratory and clinical case definitions are the two diagnostic categories used in the CDC “Tuberculosis Case Definition for Public Health Surveillance.”

Most verified TB cases are accepted for counting based on laboratory confirmation of *M. tuberculosis* complex from a clinical specimen.

A person may have more than one discrete (separate and distinct) episode of TB. If disease recurs in a person **within** any 12-consecutive-month period after the patient completed therapy, count only one episode as a case. However, if TB disease recurs in a person, **and** if more than 12 months have elapsed since the person completed TB therapy or was lost to supervision, the TB case is considered a separate episode and should be counted as a new case.

Mycobacterial diseases other than those caused by *M. tuberculosis* complex should not be counted in TB morbidity statistics unless there is concurrent TB.

**a. Verified TB Cases**

**COUNT**

Count only verified TB cases that meet the laboratory or clinical case definitions (see Section II). The diagnosis of TB must be verified by the TB control officer or designee. The current CDC surveillance case definition for TB describes and defines the criteria to be used in the case definition for TB disease.

**DO NOT COUNT**

If diagnostic procedures have not been completed, do not count; wait for confirmation of disease. Do not count as a case the patient for which two or more anti-TB medications have been prescribed for preventive therapy for exposure to multidrug-resistant (MDR) TB, or while the diagnosis is still pending.

**b. Nontuberculous Mycobacterial Diseases (NTM)**

**COUNT**

An episode of TB disease diagnosed concurrently with another nontuberculous mycobacterial disease should be counted as a TB case.

**DO NOT COUNT**

Disease attributed to or caused by nontuberculous mycobacteria alone should not be counted as a TB case.

**c. TB Cases Reported at Death**

**COUNT**

TB cases first reported to the health department at the time of a person's death are counted as incident cases, provided the person had current disease at the time of death. The TB control officer should verify the diagnosis of TB.

**DO NOT COUNT**

Do not count as a case of TB if there is no evidence of current disease at the time of death or at autopsy.

**d. Immigrants, Refugees, Permanent Resident Aliens, Border Crossers,\* and Foreign Visitors<sup>2</sup>**

**COUNT**

Immigrants and refugees who are examined after arriving in the United States and diagnosed with clinically active TB requiring anti-TB medications should be reported and counted by the locality of their current residence at the time of diagnosis regardless of citizenship status.

Border crossers\* who are diagnosed with TB and plan to receive anti-TB therapy from a locality in the United States for 90 days or more should be reported and counted by the locality where they receive anti-TB therapy.

Foreign visitors (e.g., students, commercial representatives, and diplomatic personnel) who are diagnosed with TB, are receiving anti-TB therapy, **and** have been, or plan to remain in, the United States for 90 days or more should be reported and counted by the locality of current residence.

*\*Border crosser — defined, by the U.S. Citizenship and Immigration Services (USCIS)<sup>2</sup> as “an alien resident of the United States reentering the country after an absence of less than six months in Canada or Mexico, or a nonresident alien entering the United States across the Canadian border for stays of no more than six months, or across the Mexican border for stays of no more than 72 hours.” Border crossers may go back and forth across the border many times in a short period.*

**DO NOT COUNT**

Any person who was diagnosed and started on anti-TB drugs in another country should not be counted as a new case but should be reported as a verified noncountable TB case.

Border crossers\* and foreign visitors who are diagnosed with TB and receive anti-TB therapy from a locality in the United States for less than 90 days but plan to return to their native country to continue therapy should not be reported or counted by the locality where they receive anti-TB therapy.

**e. Out-of-State or Out-of-Area Residents**

**COUNT**

A person's TB case should be counted by the locality in which he or she resides at the time of diagnosis. TB in a person who has no address should be counted by the locality that diagnosed and is treating the TB. The TB control officer should notify the appropriate out-of-state or out-of-area TB control officer of the person's home locality to (1) determine whether the case has already been counted to avoid "double counting," and (2) agree on which TB control office should count the case if it has not yet been counted.

**DO NOT COUNT**

Do not count a case in a newly diagnosed TB patient who is an out-of-area resident and whose TB has already been counted by the out-of-area TB control office.

**f. Migrants and Other Transients**

**COUNT**

Persons without any fixed U.S. residence are considered to be the public health responsibility of their present locality and their TB case should be reported and counted where diagnosed.

**DO NOT COUNT**

Cases in transient TB patients should not be counted when there is evidence that they have already been counted by another locality.

**g. Federal Facilities (e.g., Military and Veterans Administration Facilities)**

**COUNT**

Cases in military personnel, dependents, or veterans should be reported and counted by the locality where the persons are residing in the United States at the time of diagnosis and initiation of treatment.

However, if military personnel or dependents are discovered to have TB at a military base outside the United States but are referred elsewhere for treatment (e.g., a military base located within the United States), the TB case should be reported and counted where treated and not where the diagnosis was made.

**DO NOT COUNT**

Do not count if the case was already counted by another locality in the United States.

**h. Indian Health Service**

**COUNT**

TB should be reported to the local health authority (e.g., state or county) and counted where diagnosed and treatment initiated. However, for a specific group such as the Navajo Nation, which is geographically located in multiple states, health departments should discuss each case and determine which locality should count the case.

**DO NOT COUNT**

Do not count if the case was already counted by another locality.

**i. Correctional Facilities (e.g., Local, State, Federal, and Military)**

**COUNT**

Persons who reside in local, state, federal, or military correctional facilities may frequently be transferred or relocated within and/or between various correctional facilities. TB in these persons should be reported to the local health authority and counted by the locality where the diagnosis was made and treatment plans were initiated.

**DO NOT COUNT**

Do not count correctional facility residents' TB cases that were counted elsewhere by another locality or correctional facility, even if treatment continues at another locale or correctional facility.

**j. Peace Corps, Missionaries, and Other Citizens Residing Outside the United States**

**DO NOT COUNT**

TB in persons diagnosed outside the United States should not be counted. TB in these persons should be counted by the country in which they are residing, regardless of their plans to return to the United States for further work-up or treatment.

**IV. Suggested Administrative Practices**

To promote uniformity in TB case counting, the following administrative procedures are recommended:

- (a) All TB cases verified by the 52 reporting areas with count authority (50 states, District of Columbia, and New York City) during the calendar year (by December 31) will be included in the annual U.S. incidence count for that year. All tuberculosis cases verified during the calendar year by a reporting area with count authority from one of the remaining 8 reporting areas (American Samoa, Federated States of Micronesia, Guam, Marshall Islands,

Northern Mariana Islands, Puerto Rico, Republic of Palau, and U.S. Virgin Islands) are also counted but are not included in the annual incidence for the United States. Cases for which bacteriologic results are pending or for which confirmation of disease is questionable for any other reason should not be counted until their status is clearly determined; they should be counted at the time they meet the criteria for counting. This means that a case reported in one calendar year could be included in the morbidity count for the following year. The reporting area with count authority should ensure that there is agreement between final local and state TB figures reported to CDC. Currently, some reporting areas may not use this suggested protocol. Some of these areas may wait until the beginning of the following year when they have received and processed all of the TB cases for inclusion in the annual case count for the previous year. If reporting areas decide to revise their protocols, they should be aware that their TB trends may change.

- (b) TB is occasionally reported to health departments over the telephone, by letter or fax, or on forms other than the Report of Verified Case of Tuberculosis (RVCT). Such information should be accepted as an official morbidity report if sufficient details are provided; otherwise, the notification should be used as an indicator of a possible TB case (suspect) which should be investigated promptly for confirmation.

## V. TB Surveillance Definitions

**Case** - an episode of TB disease in a person meeting the laboratory or clinical criteria for TB as defined in the document “Tuberculosis Case Definition for Public Health Surveillance” (see Section II for criteria).

**Suspect** - a person for whom there is a high index of suspicion for active TB (e.g., a known contact to an active TB case or a person with signs or symptoms consistent with TB) who is currently under evaluation for TB disease.

**Verification of a TB case** - the process whereby a TB case, after the diagnostic evaluation is complete, is reviewed at the local level (e.g., state or county) by a TB control official who is familiar with TB surveillance definitions; if all the criteria for a TB case are met, the TB case is then verified and eligible for counting.

**Counting of a TB case** - the process whereby a reporting area with count authority evaluates verified TB cases against count criteria (e.g., assesses for case duplication). These cases are then counted for morbidity in that locality (e.g., state or county) and reported to CDC for national morbidity counting. Noncountable, verified cases may also be sent to CDC.

***Mycobacterium tuberculosis complex*** (*M. tuberculosis complex*) - Because most laboratories use tests that do not routinely distinguish *Mycobacterium tuberculosis* from very closely related species, these laboratories report culture results as being positive or negative for “*Mycobacterium tuberculosis complex*.” Although in almost all cases of human disease, isolates in the *M. tuberculosis complex* are, in fact, *M. tuberculosis*, other species are possible. For example,



one study in San Diego found that 6% of human tuberculosis was caused by *Mycobacterium bovis*; cultures from these cases would be reported by most laboratories as being positive for *M. tuberculosis* complex. Other species in the *Mycobacterium tuberculosis* complex include *M. africanum*, *M. microti*, *M. canettii*, *M. caprae*, and *M. pinnipedii*. Although *M. microti*, *M. canettii*, *M. caprae*, and *M. pinnipedii* are newly described species, their inclusion in *M. tuberculosis* complex should not impact public health laboratories or programs because only a few laboratories identify to the species level. These seven species are almost identical in DNA homology studies. In terms of their ability to cause clinical disease or be transmissible from person to person, *M. bovis*, *M. africanum*, *M. microti*, *M. canetti*, *M. caprae*, and *M. pinnipedii* behave like *M. tuberculosis*; therefore, disease caused by any of the organisms should be reported as TB, using the Report of Verified Case of Tuberculosis (RVCT). The only exception is the BCG strain of *M. bovis*, which may be isolated from persons who have received the vaccine for protection against TB or as cancer immunotherapy; disease caused by the BCG strain of *M. bovis* should not be reported as TB.

**Nontuberculous mycobacteria (NTM)** - mycobacteria other than *Mycobacterium tuberculosis* complex that can cause human infection or disease. Common nontuberculous mycobacteria include *M. avium* complex or MAC (*M. avium*, *M. intracellulare*), *M. kansasii*, *M. marinum*, *M. scrofulaceum*, *M. chelonae*, *M. fortuitum*, and *M. simiae*. Other terms have been used to represent NTM, including MOTT (mycobacteria other than TB) and “atypical” mycobacteria.

**Reporting area** - areas responsible for counting and reporting verified TB cases to CDC. Currently there are 60 reporting areas: the 50 states, District of Columbia, New York City, American Samoa, Federated States of Micronesia, Guam, Marshall Islands, Northern Mariana Islands, Puerto Rico, Republic of Palau, and U.S. Virgin Islands. The annual incidence of tuberculosis for the United States is based on 52 reporting areas (the 50 states, District of Columbia, and New York City).

**Alien** - defined by the U.S. Citizenship and Immigration Services (USCIS)<sup>2</sup> as “any person not a citizen or national of the United States.”

**Border crosser** - defined, by the U.S. Citizenship and Immigration Services (USCIS)<sup>2</sup> as “an alien resident of the United States reentering the country after an absence of less than six months in Canada or Mexico, or a nonresident alien entering the United States across the Canadian border for stays of no more than six months, or across the Mexican border for stays of no more than 72 hours.” Border crossers may go back and forth across the border many times in a short period.

**Class A TB with waiver**<sup>3</sup>

All applicants who have tuberculosis disease and have been granted a waiver.

### **Class B1 TB, Pulmonary<sup>3</sup>**

#### **No treatment**

- Applicants who have medical history, physical exam, HIV, or CXR findings suggestive of pulmonary TB but have negative AFB sputum smears and cultures and are not diagnosed with TB or can wait to have TB treatment started after immigration.

#### **Completed treatment**

- Applicants who were diagnosed with pulmonary TB and successfully completed directly observed therapy prior to immigration. The cover sheet should indicate if the initial sputum smears and cultures were positive and if drug susceptibility testing results are available.

### **Class B1 TB, Extrapulmonary<sup>3</sup>**

Applicants with evidence of extrapulmonary TB. Document the anatomic site of infection.

### **Class B2 TB, Latent TB Infection (LTBI) Evaluation<sup>3</sup>**

Applicants who have a tuberculin skin test  $\geq 10$  mm but otherwise have a negative evaluation for TB. The size of the TST reaction, the applicant's status with respect to LTBI treatment, and the medication(s) used should be documented. For applicants who had more than one TST, whether the applicant converted the TST should be documented (i.e., initial TST  $< 10$  mm but subsequent TST  $\geq 10$  mm).

### **Class B3 TB, Contact Evaluation<sup>3</sup>**

Applicants who are a recent contact of a known tuberculosis case. The size of the applicant's TST reaction should be documented. Information about the source case, name, alien number, relationship to contact, and type of tuberculosis should also be documented.

**Immigrant** - defined by the USCIS<sup>2</sup> as "an alien admitted to the United States as a lawful permanent resident. Immigrants are those persons lawfully accorded the privilege of residing permanently in the United States. They may be issued immigrant visas by the Department of State overseas or adjusted to permanent resident status by the USCIS of the United States."

**Permanent Resident Alien** - see Immigrant.

**Waivers<sup>3</sup>** - A provision allows applicants undergoing pulmonary or laryngeal tuberculosis treatment to petition for a Class A TB with waiver. Waivers should be pursued for any immigrant or refugee who has a complicated clinical course and would benefit from receiving treatment of their tuberculosis in the United States. Applicants diagnosed with tuberculosis disease who are both smear- and culture-negative and will be traveling to the United States prior to start of treatment do not need to complete the waiver process.

## **References**

1. *Recommendations for Counting Reported TB Cases*. Atlanta: CDC, July 1997.
2. U.S. Department of Homeland Security, U.S. Citizenship and Immigration Services; <http://uscis.gov>. Accessed March 2009.
3. *2007 Technical Instructions for Tuberculosis Screening and Treatment for Panel Physicians*. Atlanta: CDC, Division of Global Migration and Quarantine. [http://www.cdc.gov/ncidod/dq/panel\\_2007.htm](http://www.cdc.gov/ncidod/dq/panel_2007.htm). Accessed March 2009.

## Appendix C Anatomic Codes

Anatomic Code	Anatomic Code
<b>Dermal System</b> 00 * Skin and skin appendages 01 * Subcutaneous Tissue 02 * Breast 03 Milk	<b>Cardiovascular System</b> 30 * Pericardium 31 * Heart 32 * Cardiac valve 33 Pericardial fluid 34 * Blood vessel
<b>Hematopoietic System</b> 04 * Bone marrow 05 * Spleen 06 * Blood	<b>Gastrointestinal System</b> 35 * Mouth 36 * Lip 37 * Tongue 38 * Tooth, gum, and supporting structures of the tooth 39 * Salivary gland 40 * Liver 41 * Gallbladder 42 * Extrahepatic bile duct 43 * Pancreas 44 Saliva 45 Bile and pancreatic fluid 46 * Pharynx, oropharynx, and hypopharynx 47 * Tonsils and adenoids 48 * Esophagus 49 * Stomach 50 * Small intestine - duodenum 51 * Small intestine - jejunum & ileum 52 * Appendix 53 * Colon 54 * Rectum 55 * Anus 56 Gastric aspirate 57 Gastrointestinal contents (feces) 58 Omentum and peritoneum 59 Peritoneal fluid
<b>Lymphatic System</b> 07 Lymph node	
<b>Musculoskeletal System</b> 08 Bone, NOS (Not Otherwise Specified) 09 Skeletal system (Bones of head, ribcage, and vertebral column) 10 Skeletal system (Bones of shoulder, girdle, pelvis, and extremities) 11 Soft tissue, NOS (Not Otherwise Specified) 12 Soft tissue (Muscles of head, neck, mouth, and upper extremity) 13 Soft tissue (Muscles of trunk, perineum, and lower extremity) 14 Tendon and tendon sheath 15 Ligament and fascia 16 Joints (Synovial tissue) 17 Synovial fluid	
<b>Respiratory System</b> 18 * Nose 19 * Accessory Sinus 20 * Nasopharynx 21 * Epiglottis 22 * Trachea 23 Bronchus 24 Bronchiole 25 Lung 26 Pleura 27 Upper respiratory fluids or tracheal fluids 28 Bronchial fluid 29 Pleural fluid	

\* Only codes marked with an asterisk (\*) should be used when a **Site of Disease** (item 16) is **Other**.

<b>Urogenital System</b> <b>60</b> Kidney <b>61</b> Renal pelvis <b>62</b> Ureter <b>63</b> Urinary bladder <b>64</b> Urethra <b>65</b> Penis <b>66</b> Prostate and seminal vesicle <b>67</b> Testis <b>68</b> Epididymis, vas deferens, spermatic cord, and scrotum <b>69</b> Urine <b>70</b> Male genital fluids <b>71</b> Vulva, labia, clitoris, and Bartholin's gland <b>72</b> Vagina <b>73</b> Uterus <b>74</b> Cervix <b>75</b> Endometrium <b>76</b> Myometrium <b>77</b> Fallopian tube, broad ligament, parametrium, and parovarian region <b>78</b> Ovary <b>79</b> Female genital fluids	<b>Fetal Structures</b> <b>80</b> * Placenta, umbilical cord, and implantation site <b>81</b> * Fetus and embryo
	<b>Endocrine System</b> <b>82</b> * Pituitary gland <b>83</b> * Adrenal gland <b>84</b> * Thyroid or parathyroid gland(s) <b>85</b> * Thymus
	<b>Neurological System</b> <b>86</b> CSF (Cerebral spinal fluid) <b>87</b> Meninges, dural sinus, choroid plexus <b>88</b> * Brain <b>89</b> * Spinal cord <b>90</b> * Cranial, spinal, and peripheral nerve <b>91</b> * Eye and ear appendages <b>92</b> * Ear and mastoid cells
	<b>Other</b> <b>93</b> Pus <b>94</b> * Other <b>95</b> Multiple Sites <b>99</b> Unknown

\* Only codes marked with an asterisk (\*) should be used when a **Site of Disease** (item 16) is **Other**.

## Appendix D Reporting Area Codes

### Reporting Area Codes

Name	Alpha	Code
Alabama	AL	01
Alaska	AK	02
Arizona	AZ	04
Arkansas	AR	05
California	CA	06
Colorado	CO	08
Connecticut	CT	09
Delaware	DE	10
Florida	FL	12
Georgia	GA	13
Hawaii	HI	15
Idaho	ID	16
Illinois	IL	17
Indiana	IN	18
Iowa	IA	19
Kansas	KS	20
Kentucky	KY	21
Louisiana	LA	22
Maine	ME	23
Maryland	MD	24
Massachusetts	MA	25
Michigan	MI	26
Minnesota	MN	27
Mississippi	MS	28
Missouri	MO	29
Montana	MT	30

Name	Alpha	Code
Nebraska	NE	31
Nevada	NV	32
New Hampshire	NH	33
New Jersey	NJ	34
New Mexico	NM	35
New York	NY	36
New York City	NO	975772
North Carolina	NC	37
North Dakota	ND	38
Ohio	OH	39
Oklahoma	OK	40
Oregon	OR	41
Pennsylvania	PA	42
Rhode Island	RI	44
South Carolina	SC	45
South Dakota	SD	46
Tennessee	TN	47
Texas	TX	48
Utah	UT	49
Vermont	VT	50
Virginia	VA	51
Washington	WA	53
Washington D.C.	DC	11
West Virginia	WV	54
Wisconsin	WI	55
Wyoming	WY	56

### U.S. Island Reporting Area Codes

For information on citizenship and “U.S.-born” for the U.S. Island Areas see Country of Birth (item 12)

Name	Alpha	Code
American Samoa	AQ	60
Federated States of Micronesia	FM	64
Guam	GU	66
Northern Mariana Islands	CQ	69

Name	Alpha	Code
Palau	PS	70
Puerto Rico	PR	72
Republic of Marshall Islands	RM	68
Virgin Islands	VQ	78

## Appendix E Country Codes

Country	Alpha Code
Afghanistan	AFG
Albania	ALB
Algeria	DZA
American Samoa	ASM
Andorra	AND
Angola	AGO
Anguilla	AIA
Antarctica	ATA
Antigua and Barbuda	ATG
Argentina	ARG
Armenia	ARM
Aruba	ABW
Ashmore and Cartier Islands	AT
Australia	AUS
Austria	AUT
Azerbaijan	AZE
Bahamas, The	BHS
Bahrain	BHR
Baker Island	FQ
Bangladesh	BGD
Barbados	BRB
Bassas Da India	BS
Belarus	BLR
Belgium	BEL
Belize	BLZ
Benin	BEN
Bermuda	BMU
Bhutan	BTN
Bolivia	BOL
Bosnia and Herzegovina	BIH
Botswana	BWA
Bouvet Island	BVT
British Indian Ocean Territory	IOT
Brazil	BRA
British Virgin Islands	VGB
Brunei	BRN
Bulgaria	BGR
Burkina (Upper Volta)	BFA
Burma	BUMM
Burundi	BDI
Cambodia	KHM
Cameroon	CMR
Canada	CAN
Cape Verde	CPV
Cayman Islands	CYM

<b>Country</b>	<b>Alpha Code</b>
Central African Republic	CAF
Chad	TCD
Chile	CHL
China	CHN
Christmas Island	CXR
Clipperton Island	IP
Cocos (Keeling) Islands	CCK
Colombia	COL
Comoros	COM
Congo	COG
Cook Islands	COK
Coral Sea Islands	CR
Costa Rica	CRI
Croatia	HRV
Cuba	CUB
Cyprus	CYP
Czech Republic	CZE
Czechoslovakia	CSHH
Denmark	DNK
Djibouti	DJI
Dominica	DMA
Dominican Republic	DOM
Ecuador	ECU
Egypt	EGY
El Salvador	SLV
Equatorial Guinea	GNQ
Eritrea	ERI
Estonia	EST
Ethiopia	ETH
Europa Island	EU
Falkland Islands (Malvinas)	FLK
Faroe Islands	FRO
Federated States of Micronesia	FSM
Fiji	FJI
Finland	FIN
French Southern and Antarctic Lands	ATF
France	FRA
French Guiana	GUF
French Polynesia	PYF
Gabon	GAB
Gambia, The	GMB
Gaza Strip	GZ
Georgia	GEO
Germany	DEU
Ghana	GHA
Gibraltar	GIB
Glorioso Islands	GO
Greece	GRC
Greenland	GRL
Grenada	GRD



<b>Country</b>	<b>Alpha Code</b>
Guadeloupe	GLP
Guam	GUM
Guatemala	GTM
Guernsey	GGY
Guinea	GIN
Guinea-Bissau	GNB
Guyana	GUY
Haiti	HTI
Heard Island and McDonald Islands	HMD
Honduras	HND
Hong Kong	HKG
Howland Island	HQ
Hungary	HUN
Iceland	ISL
India	IND
Indonesia	IDN
Iran	IRN
Iraq	IRQ
Iraq-Saudi Arabia Neutral Zone	NTHH
Ireland	IRL
Israel	ISR
Italy	ITA
Ivory Coast	CIV
Jamaica	JAM
Jan Mayen	JN
Japan	JPN
Jarvis Island	DQ
Jersey	JEY
Johnston Atoll	JQ
Jordan	JOR
Juan De Nova Island	JU
Kazakhstan	KAZ
Kenya	KEN
Kingman Reef	KQ
Kiribati	KIR
Korea, Republic of	KOR
Korea, Democratic People's Republic	PRK
Kuwait	KWT
Kyrgyzstan	KGZ
Laos	LAO
Latvia	LVA
Lebanon	LBN
Lesotho	LSO
Liberia	LBR
Libya	LYB
Liechtenstein	LIE
Lithuania	LTU
Luxembourg	LUX
Macau	MAC
Macedonia	MKD

<b>Country</b>	<b>Alpha Code</b>
Madagascar	MDG
Malawi	MWI
Malaysia	MYS
Maldives	MDV
Mali	MLI
Malta	MLT
Man, Isle of	IMN
Marshall Islands	MHL
Martinique	MTQ
Mauritania	MRT
Mauritius	MUS
Mayotte	MYT
Mexico	MEX
Midway Island	MIUM
Moldova	MDA
Monaco	MCO
Mongolia	MNG
Montenegro	MNE
Montserrat	MSR
Morocco	MAR
Mozambique	MOZ
Myanmar	MMR
Namibia	NAM
Nauru	NRU
Navassa Island	BQ
Nepal	NPL
Netherlands	NLD
Netherlands Antilles	ANT
New Caledonia	NCL
New Zealand	NZL
Nicaragua	NIC
Niger	NER
Nigeria	NGA
Niue	NIU
Norfolk Island	NFK
Northern Mariana Islands	MNP
Norway	NOR
Not Specified	NI
Oman	OMN
Pakistan	PAK
Palau	PLW
Palmyra Atoll	LQ
Panama	PAN
Papua New Guinea	PNG
Paracel Islands	PF
Paraguay	PRY
Peru	PER
Philippines	PHL
Pitcairn Islands	PCN
Poland	POL

<b>Country</b>	<b>Alpha Code</b>
Portugal	PRT
Portuguese Timor	TPTL
Puerto Rico	PRI
Qatar	QAT
Reunion	REU
Romania	ROU
Russia	RUS
Rwanda	RWA
South Georgia/South Sandwich Islands	SGS
San Marino	SMR
Sao Tome and Principe	STP
Saudi Arabia	SAU
Senegal	SEN
Serbia	SRB
Seychelles	SYC
Sierra Leone	SLE
Singapore	SGP
Slovak Republic	SVK
Slovenia	SVN
Solomon Islands	SLB
Somalia	SOM
South Africa	ZAF
Soviet Union	SUHH
Spain	ESP
Spratly Islands	PG
Sri Lanka	LKA
St Lucia	LCA
St. Helena	SHN
St. Kitts and Nevis	KNA
St. Pierre and Miquelon	SPM
St. Vincent/Grenadines	VCT
Sudan	SDN
Suriname	SUR
Svalbard	SJM
Swaziland	SWZ
Sweden	SWE
Switzerland	CHE
Syria	SYR
Taiwan	TWN
Tajikistan	TJK
Tanzania, United Republic of	TZA
Thailand	THA
Timor-Leste	TLS
Togo	TGO
Tokelau	TKL
Tonga, Kingdom of	TON
Trinidad and Tobago	TTO
Tromelin Island	TE
Tunisia	TUN
Turkey	TUR

<b>Country</b>	<b>Alpha Code</b>
<b>Turkmenistan</b>	<b>TKM</b>
<b>Turks and Caicos Islands</b>	<b>TCA</b>
<b>Tuvalu</b>	<b>TUV</b>
<b>U.S. Minor Outlying Islands</b>	<b>UMI</b>
<b>Uganda</b>	<b>UGA</b>
<b>Ukraine</b>	<b>UKR</b>
<b>United Arab Emirates</b>	<b>ARE</b>
<b>United Kingdom</b>	<b>GBR</b>
<b>United States</b>	<b>USA</b>
<b>Uruguay</b>	<b>URY</b>
<b>U.S. Miscellaneous Pacific Islands</b>	<b>PUUM</b>
<b>Uzbekistan</b>	<b>UZB</b>
<b>Vanuatu (New Hebrides)</b>	<b>VUT</b>
<b>Vatican City</b>	<b>VAT</b>
<b>Venezuela</b>	<b>VEN</b>
<b>Vietnam</b>	<b>VNM</b>
<b>Virgin Islands</b>	<b>VIR</b>
<b>Wake Island</b>	<b>WKUM</b>
<b>Wallis and Futuna</b>	<b>WLF</b>
<b>West Bank</b>	<b>WE</b>
<b>Western Sahara</b>	<b>ESH</b>
<b>Western Samoa</b>	<b>WSM</b>
<b>Yemen</b>	<b>YEM</b>
<b>Yugoslavia</b>	<b>YUCS</b>
<b>Zaire</b>	<b>ZRCD</b>
<b>Zambia</b>	<b>ZMB</b>
<b>Zimbabwe</b>	<b>ZWE</b>

## Appendix F Glossary

Term	Definition
<b>Acid-fast bacilli (AFB)</b>	Microorganisms that when stained, retain color even after they have been washed in an acid solution; may be detected under a microscope in a stained smear.
<b>Active case finding</b>	Looking for undiagnosed cases by screening a population.
<b>Active TB disease</b>	An illness, caused by bacteria called <i>Mycobacterium tuberculosis</i> , in which tuberculosis (TB) bacteria are multiplying and attacking parts of the body, most commonly the lungs. A person with active TB disease is capable of spreading the disease to others if the TB bacteria are active in the lungs or throat. The symptoms of active TB disease include weakness, weight loss, fever, no appetite, chills, and sweating at night. Other symptoms may include a bad cough, pain in the chest, and coughing up blood.
<b>Adherence to treatment</b>	Following the recommended course of treatment by taking all the prescribed medications for the entire length of time necessary.
<b>Adverse effect</b>	Negative side effect resulting from the use of a drug (for example, hepatitis, nausea, headache).
<b>Bronchoscopy</b>	A procedure used to obtain pulmonary secretions or lung tissue with an instrument called a bronchoscope.
<b>Case management</b>	A system in which a specific health department employee is assigned primary responsibility for the patient, systematic regular review of patient progress is conducted, and plans are made to address any barriers to adherence.
<b>Case rate</b>	The number of cases that occur during a certain time period, divided by the size of the population during that time period; the case rate is often expressed in terms of a population size of 100,000 persons.
<b>Case reporting</b>	Informing the state or local health department when a new case (an occurrence) of TB disease has been diagnosed or is suspected.
<b>Cavity</b>	A hollow space within the lung, visible on a chest x-ray or CT scan.
<b>Clinical evaluation</b>	An evaluation done to find out whether a patient has symptoms of TB disease or is responding to treatment; also done to check for adverse reaction to TB medications.
<b>Clinician</b>	A physician, physician's assistant, or nurse.
<b>Congregate setting</b>	A setting in which a group of usually unrelated persons reside in close physical proximity. These settings may include hospitals, long-term care facilities, assisted living facilities, correctional facilities, or homeless shelters (see residential facilities).

<b>Contact investigation</b>	A procedure for interviewing a person who has TB disease to determine who may have been exposed to TB. People who have been exposed to TB are tested for latent TB infection (LTBI) and TB disease.
<b>Contacts</b>	People exposed to someone with infectious TB disease, generally including family members, roommates or housemates, close friends, coworkers, classmates, and others.
<b>Country of birth</b>	The country where a person was born.
<b>Culture</b>	To grow organisms on media (substances containing nutrients) so that they or the product of this process can be identified.
<b>Daily regimen</b>	A treatment schedule in which the patient takes a dose of each prescribed medication every day.
<b>Diabetes mellitus</b>	A disease in which the body's ability to use sugar is altered.
<b>Diagnostic evaluation</b>	An evaluation used to diagnose TB disease; includes a medical history, a chest x-ray, the collection of specimens for bacteriologic examination, and possibly a tuberculin skin test or an interferon-gamma release assay such as the QuantiFERON <sup>®</sup> -TB Gold test.
<b>Directly observed therapy (DOT)</b>	A designated person watches the TB patient swallow each dose of the prescribed drugs.
<b>Drug susceptibility test</b>	A laboratory method for finding drug resistance in a microorganism.
<b>Drug-resistant TB</b>	TB caused by organisms that are able to grow in the presence of a particular drug; TB that is resistant to at least one first-line antituberculosis drug.
<b>End-stage renal disease (ESRD)</b>	A condition when chronic kidney failure has progressed to the point where kidney function is less than 10% of normal; requires dialysis or transplantation; also known as stage 5 chronic kidney disease. The most common cause of ESRD in the United States is diabetes.
<b>Ethambutol (EMB)</b>	A drug used to treat TB disease; may cause vision problems. Ethambutol should be used cautiously in children who are too young to be monitored for changes in their vision.
<b>Extrapulmonary TB</b>	TB disease that occurs in places other than the lungs, such as the lymph nodes, the pleura, the brain, the kidneys, or the bones; most types of extrapulmonary TB are not infectious.
<b>First-line TB drugs</b>	The initial drugs used for treating TB disease. Include isoniazid (INH), rifampin (RIF), pyrazinamide (PZA), and either ethambutol (EMB). or streptomycin (SM).
<b>Foreign-born persons</b>	People born outside of the United States.
<b>HIV</b>	Human immunodeficiency virus, the virus that causes AIDS.

<b>Immunosuppressive therapy</b>	Therapy that suppresses or weakens the immune system.
<b>Interferon-gamma (IFN-<math>\gamma</math>)</b>	Protein that is normally produced by the body in response to infection.
<b>Interferon-gamma release assay (IGRA)</b>	A type of blood test that measures a person's immune reactivity to <i>M. tuberculosis</i> by measuring release of IFN- $\gamma$ . In the U.S., QuantiFERON <sup>®</sup> -TB Gold, QuantiFERON <sup>®</sup> -TB Gold In-Tube, and T-SPOT <sup>®</sup> .TB are currently available IGRAs.
<b>Isolate</b>	A sample from a specimen that was identified as a certain organism such as <i>M. tuberculosis</i> complex.
<b>Isoniazid (INH)</b>	A drug that is used for treating LTBI and one of the drugs used to treat TB disease; although relatively safe, it may cause hepatitis and other severe adverse reaction in some patients.
<b>Latent TB infection (LTBI)</b>	Refers to the condition when a person is infected with tubercle bacilli, but TB disease has not developed. Persons with LTBI do not have TB disease symptoms and they cannot spread TB germs to others. Persons with LTBI usually have a positive result to the Mantoux tuberculin skin test or an interferon-gamma release assay.
<b>LTBI treatment</b>	Medication that is given to people who have latent TB infection to prevent them from developing TB disease.
<b>Mantoux tuberculin skin test (TST)</b>	A method of testing for TB infection; a needle and syringe are used to inject 0.1 ml of 5 tuberculin units of liquid tuberculin between the layers of the skin (intradermally), usually on the forearm; the reaction to this test, a palpable swollen area (induration), is measured 48 to 72 hours after the injection and is interpreted as positive or negative depending on the size of the reaction and the patient's risk factors for TB.
<b>Miliary TB</b>	Miliary TB is a serious type of tuberculosis infection. It is a histological or radiologic finding, rather than a site of disease. It appears on radiograph as a great number of small, well-defined nodules that look like millet seeds scattered throughout the lungs, hence the name "miliary."
<b>Multidrug-resistant TB (MDR TB)</b>	Resistant to at least the drugs isoniazid and rifampin; MDR TB is more difficult to treat than drug-susceptible TB.
<b><i>Mycobacterium tuberculosis</i></b>	One of the organisms causing TB in humans, and sometimes called the tubercle bacillus; belongs to a group of bacteria called mycobacteria.
<b><i>Mycobacterium tuberculosis</i> complex</b>	A group of closely related mycobacteria that can cause active TB (e.g., <i>M. tuberculosis</i> , <i>M. bovis</i> , and <i>M. africanum</i> ). Most TB in the United States is caused by <i>M. tuberculosis</i> .
<b>Nucleic acid amplification (NAA)</b>	A technique that amplifies (copies) DNA or RNA segments, in order to directly identify microorganisms in sputum specimens.

<b>Pulmonary TB</b>	TB disease that occurs in the lungs, typically causing a cough and an abnormal chest x-ray. Pulmonary TB is usually infectious if untreated. Most TB cases reported in the United States are pulmonary TB.
<b>Pyridoxine</b>	Another name for vitamin B6; it is given to prevent peripheral neuropathy; should always be given to pregnant and breastfeeding women on isoniazid.
<b>QuantiFERON®-TB Gold test (QFT-G)</b>	A blood test used for diagnosing infection with <i>M. tuberculosis</i> . The QFT-G measures a patient's immune reactivity to <i>M. tuberculosis</i> by measuring the response to TB proteins when they are mixed with a small amount of blood (see IGRAs).
<b>Recurrence</b>	A patient who has either a <ul style="list-style-type: none"> <li>• Negative culture result while receiving anti-TB therapy, but at some point after therapy is completed, either the culture result becomes positive for <i>M. tuberculosis</i> or the patient has clinical or radiologic deterioration that is consistent with TB disease.</li> </ul> <p><b>or</b></p> <ul style="list-style-type: none"> <li>• Negative smear and culture result (e.g., clinical case) at diagnosis and while receiving anti-TB therapy, but at some point after therapy is completed, either the patient has a culture result that is positive for <i>M. tuberculosis</i> or has clinical or radiologic deterioration that is consistent with TB disease.</li> </ul>
<b>Rifabutin</b>	A drug used to treat TB disease; used as a substitute for rifampin (RIF) in the treatment of all forms of TB.
<b>Rifampin</b>	A drug used to treat TB disease; also used for LTBI treatment. Rifampin has several possible side effects (for example, hepatitis, turning body fluids orange, and drug interactions).
<b>Rifapentine</b>	A drug used to treat TB disease; used once weekly with isoniazid during the continuation phase with selected HIV-negative patients.
<b>Second-line TB drugs</b>	Drugs used to treat TB that is resistant to first-line TB drugs (for example, capreomycin, kanamycin, ethionamide, cycloserine, ciprofloxacin, amikacin).
<b>Smear</b>	A specimen that has been smeared onto a glass slide, stained, washed in an acid solution, and then placed under the microscope for examination; used to detect acid-fast bacilli in a specimen.
<b>Specimen</b>	A sample collected from a person for testing.
<b>Sputum</b>	Phlegm from deep in the lungs, collected in a sterile container for processing and examination.
<b>Susceptibility</b>	An organism's ability to be killed by a particular drug.
<b>Suspect</b>	A person for whom there is a high index of suspicion for active TB (e.g., a known contact to an active TB case or to a person with signs or symptoms consistent with TB) who is currently under evaluation for TB disease.



<b>XDR TB</b>	The occurrence of TB in persons whose <i>M. tuberculosis</i> isolates are resistant to isoniazid and rifampin, plus resistant to any fluoroquinolone and at least one of three injectable second-line drugs (i.e., amikacin, kanamycin, or capreomycin).
---------------	--

**For more information, contact**



**U.S. Department of Health and Human Services**  
**Centers for Disease Control and Prevention**  
National Center for HIV/AIDS, Viral Hepatitis, STD, and TB Prevention  
Division of Tuberculosis Elimination  
1600 Clifton Road N.E.  
MS E-10  
Atlanta, GA 30333



Phone (404) 639-8120  
Fax: (404) 639-8959