

MANDATORY QUINQUENNIAL REPORT TO THE FEDERAL RESERVE BANK OF NEW YORK

**FOREIGN-RESIDENTS' HOLDINGS OF
U.S. SECURITIES,
INCLUDING SELECTED MONEY MARKET
INSTRUMENTS (SHL)**

As of the last day of June 2014

**Mandatory Report
Response Required By Law
(22 U.S.C. 3101 et seq.)**

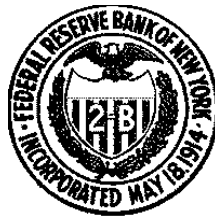

**Department of the Treasury
Federal Reserve Bank of New York
Board of Governors of the Federal Reserve System
February 2014**

TABLE OF CONTENTS

	Page
I. INTRODUCTION	1-3
A. PURPOSE	1
B. AUTHORITY	1
C. CONFIDENTIALITY OF DATA REPORTED	2
D. PENALTIES FOR FAILURE TO REPORT	2
E. PAPERWORK REDUCTION ACT NOTICE	2
II. GENERAL INSTRUCTIONS	4-7
A. WHO MUST REPORT	4
B. CONSOLIDATION RULES	5
C. REPORTING DATES	5
D. SUBMISSION INSTRUCTIONS AND CONTACT INFORMATION	6
III. WHAT SECURITIES MUST BE REPORTED	8-18
A. FOREIGN-RESIDENT OWNERSHIP	8
B. REPORTABLE U.S. SECURITIES	9
C. DO NOT REPORT	10
D. ASSET-BACKED SECURITIES	11
E. FUNDS AND RELATED EQUITY OWNERSHIP	11
F. SECURITIES INVOLVED IN REPURCHASE AND SECURITIES LENDING ARRANGEMENTS	14
G. STRIPPED SECURITIES	14
H. U.S. GOVERNMENT AGENCIES OR FEDERALLY SPONSORED ENTERPRISES	15
I. DIRECT INVESTMENT	15
J. SECURITIES HELD BY U.S. CENTRAL SECURITIES DEPOSITORIES	16
K. LIMITED PARTNERSHIPS	16
L. ACCOUNTING RULES, VALUATION OF SECURITIES, AND CALCULATION OF U.S. DOLLAR VALUES	16
M. DATA RETENTION PERIOD	17
N. REVIEW OF DATA AND REQUEST FOR REVISED DATA	17
IV. LINE-BY-LINE INSTRUCTIONS FOR SCHEDULE 1-REPORTER CONTACT IDENTIFICATION AND SUMMARY OF FINANCIAL INFORMATION	19-21
V. LINE-BY-LINE INSTRUCTIONS FOR SCHEDULE 2-DETAILS OF SECURITIES	22-27

APPENDICES

A. SAMPLE REPORTING SCHEDULES	29-33
SCHEDULE 1- REPORTER CONTACT IDENTIFICATION AND SUMMARY OF FINANCIAL INFORMATION	Schedule 1, Page 1 of 3 Schedule 1, Page 2 of 3 Schedule 1, Page 3 of 3
SCHEDULE 2- DETAILS OF SECURITIES	Schedule 2, Page 1 of 2 Schedule 2, Page 2 of 2
B. FLOWCHARTS	34-37
SHOWING REPORTING RESPONSIBILITY	35-36
DETERMINING REPORTABLE SECURITIES	37
C. GEOGRAPHICAL CLASSIFICATION	38
D. INTERNATIONAL AND REGIONAL ORGANIZATIONS	39
E. FOREIGN OFFICIAL INSTITUTIONS	40
F. LIST OF CURRENCY CODES	41-42
G. GLOSSARY	43
H. TECHNICAL INFORMATION FOR ELECTRONIC SUBMISSION	44-55
I. LIST OF FEDERAL AGENCIES AND FEDERALLY SPONSORED ENTERPRISES	56

I. INTRODUCTION

A. PURPOSE

The Department of the Treasury, with the assistance of the Board of Governors of the Federal Reserve System and the Federal Reserve Bank of New York (FRBNY), is conducting a mandatory quinquennial survey of holdings of U.S. securities, including selected money markets instruments, by foreign residents as of June 30, 2014. The data will be collected by the FRBNY, acting as fiscal agent for the Department of the Treasury. The data collected will be used by the U.S. Government in the computation of the U.S. balance of payments accounts and the U.S. international investment position, and in the formulation of international economic and financial policies. These data also will be used to provide aggregate information to the public on these foreign portfolio investments and to meet international reporting commitments.

In order to reduce reporting burden and costs to the government, there will be a substantial reduction in the number of reporters in four out of every five years. A benchmark survey (Form SHL) of all significant U.S.-resident custodians and issuers will continue to be held approximately every five years. In non-benchmark years, the annual survey (Form SHLA) will require reports from only the very largest U.S.-resident custodians and issuers. The data reported under these annual surveys (Form SHLA) will be used in conjunction with the results of the previous benchmark survey to compute estimates for the non-benchmark years.

The determination of who must report on the annual reports (Form SHLA) will be based upon the data submitted during the previous benchmark survey and the Aggregate Holdings of Long-Term Securities by U.S. and Foreign Residents (TIC SLT) report as of December of the preceding year. Designated U.S.-resident custodians and issuers will be required to file detailed security data on Schedule 2, in the same manner as they did on the June 30, 2009 benchmark survey.

B. AUTHORITY

This mandatory survey is conducted under the authority of the *International Investment and Trade in Services Survey Act (22 U.S.C. 3101 et seq., [the Act])* and Executive *Order 11961* of January 19, 1977. The Act specifies that the President has the authority to conduct a regular data collection program, including such studies and reports as may be necessary and feasible, to secure current information on

international investment, including (but not limited to) such information as may be necessary for computing and analyzing the balance of payments accounts and the international investment position of the United States (22 U.S.C. 3103). In *Executive Order 11961 §2*, the President designated the Secretary of the Treasury to be responsible for collecting data on portfolio investment required by the Act.

C. CONFIDENTIALITY OF DATA REPORTED

The information collected by this survey may be used only for analytical and statistical purposes and to enforce the Act. Access to the information is available only to officials and employees (including consultants and contractors and their employees) designated to perform functions under the Act. Persons having access to individual company information submitted pursuant to the Act are subject to penalties for unauthorized disclosure (22 U.S.C. §3104 and 18 U.S.C. §1905). The results of this survey will be made available to the general public at an aggregated level so that neither the U.S. persons or organizations providing information nor individual or organizational ownership of U.S. securities can be identified.

D. PENALTIES FOR FAILURE TO REPORT

Reporting as directed in this package is mandatory for any U.S.-resident person or entity subject to the reporting requirements set forth in the report instructions. Failure by an entity to provide timely and accurate data can result in a civil penalty of not less than \$2,500 and not more than \$25,000, or injunctive relief ordering such person to comply, or both (22 U.S.C. §3105 (a) and (b)).

Willfully failing to submit any required information under the Act can result in a fine of not more than \$10,000; and, if an individual, may result in imprisonment for not more than a year, or both. Any officer, director, employee or agent who knowingly participates in such violation, upon conviction, may be punished by a like fine, imprisonment, or both (22 U.S.C. §3105 (c)).

E. PAPERWORK REDUCTION ACT NOTICE

This report titled "Foreign Holdings of U.S. Securities, Including Selected Money Market Instruments" in the Federal Register Notice of (need to add date when known) has been reviewed and approved by the Office of Management and Budget in accordance with the *Paperwork Reduction Act of 1995* and assigned OMB Control Number 1505-0123. The purpose is to collect accurate and complete data that will enable

the Treasury Department to fulfill its responsibility under the Act. The estimated average burden associated with this collection of information is 486 hours per report for each U.S.-resident custodian reporting detailed information on Schedule 2, and 110 hours per report for each U.S.-resident issuer of U.S. securities providing detailed information on Schedule 2. The amount of time required to complete the report will vary depending on the amount of data to report. Comments concerning the accuracy of these burden estimates and suggestions for reducing the reporting burden should be directed to:

Administrator, International Portfolio Investment Data Systems

U.S. Department of the Treasury

1500 Pennsylvania Avenue NW, Room 4410@1440NYA

Washington, DC 20220

or

The Office of Management and Budget

Paperwork Reduction Project (1505-0123)

Washington, DC 20503

No person is required to respond to any U.S. Government collection of information unless it displays a currently valid OMB control number.

II. GENERAL INSTRUCTIONS

A. WHO MUST REPORT

All U.S.-resident entities that receive a copy of this report booklet must submit a Schedule 1, regardless of the size of their consolidated holdings.¹

All U.S.-resident entities must report detailed information on Schedule 2, unless the total fair (market) value of the reportable U.S. securities owned by foreign residents is less than \$100 million as of the close of business on June 30, 2014.

To determine if your entity must also submit data on Schedule 2, you must:

1. identify all U.S.-resident business lines or entities (units) of your entity that may have reportable U.S. security data;
2. consolidate the reportable U.S. security data for all of these U.S.-resident units of your entity (see the Consolidation Rules section); and
3. determine if you have exceeded this report's exemption level (\$100 million). If so, your entity is responsible for submitting Schedule 2 data.

Types of reporting entities include U.S.-resident custodians (including U.S.-resident central securities depositories) and U.S.-resident issuers. Entities that provide multiple services (i.e., provide custodial services and issue securities) should report securities that meet the reporting criteria for each role and ensure that securities are not double counted.

- **U.S.-resident custodians, including brokers and dealers,** must report all U.S. securities they hold in custody (or manage the safekeeping of) for the account of foreign residents (including their own foreign branches, subsidiaries, and affiliates). These securities must be reported by the U.S.-resident custodian even if the securities are in turn held at DTC, Euroclear, or another central securities depository, since the central securities depository knows only that it is holding securities on behalf of the U.S.-resident custodian, whereas the U.S.-resident custodian knows that it is holding these securities on behalf of a foreign resident. However, if a U.S.-resident custodian uses a U.S.-resident sub-custodian, the custodian should report if (and only if), it does not maintain separate accounts at and disclose the clients to the sub-custodian. (If the custodian does maintain separate accounts at and disclose the clients to the sub-custodian, it should not report, to prevent double counting.)
- **U.S.-resident central securities depositories,** must report all U.S. securities they hold in custody (or manage the safekeeping of) directly on behalf of foreign residents with which they have

¹ All entities must submit this report if they exceed the exemption level, whether or not they have been mailed this report package by the Federal Reserve Bank of New York. Reporting requirements for this report have been published in the Federal Register, which constitutes legal notification of the requirement to complete this report.

established direct relationships, including foreign-resident brokers, dealers, exchanges, and central securities depositories.

- **U.S.-resident issuers**, must report all securities issued by U.S.-resident units , which are:
 1. owned by foreign residents for which neither a U.S.-resident custodian nor a U.S. resident central securities depository is used. Transfer or paying agents should be able to provide the U.S.-resident issuer with this information;
 2. in book entry form that are held at a foreign-resident central securities depository; or
 3. bearer securities.

Please refer to Section III, What Securities Must Be Reported, to identify reportable U.S. securities.

B. CONSOLIDATION RULES

U.S.-resident organizations, including bank holding companies (BHC) and financial holding companies (FHC), should include all reportable securities for all U.S.-resident parts of their organization, including all U.S.-resident branches and subsidiaries. U.S. residents include entities located in the Commonwealth of Puerto Rico and the U.S. territories. Please see Appendix G for the complete definition of United States. It is the responsibility of the U.S. parent entity in each organization to ensure that its report includes all applicable entities within its organization.

Securities issued by U.S.-resident trusts and special purpose entities (SPEs) for which the reporter is the trustee or primary beneficiary should be included. Shares of U.S.-resident funds that are managed by the reporting entity should be included unless a U.S.-resident custodian other than the reporting entity is used.

U.S. branches and agencies of a foreign bank located in the same state and within the same Federal Reserve District should submit a consolidated report for these offices. U.S. branches and agencies of a foreign bank that are located in either different states or different Federal Reserve Districts, should submit separate reports.

C. REPORTING DATES

Report data as of the last business day of June. All data should be submitted to the Federal Reserve Bank of New York no later than the last business day of August.

D. SUBMISSION INSTRUCTIONS AND CONTACT INFORMATION

If your organization is submitting 200 or more Schedule 2 records, the Schedule 2 data must be submitted electronically. The format for submitting Schedule 1 data is dependent on how the Schedule 2 data are submitted.

Option 1:

- Submit both Schedules 1 and 2 data using the Federal Reserve System's Internet Electronic Submission (IESUB) system. IESUB is fast, easy to use and secure. IESUB provides a confirmation of data receipt at the Federal Reserve Bank of New York and performs a number of validity checks of your file format. For more information on how to submit data using the IESUB system, contact the SHL staff at 212-720-6300 or at SHLA.Help@ny.frb.org. Alternatively, additional information and an application to register for IESUB can be obtained at the link for IESUB in the upper right corner of the following webpage:

<http://www.treasury.gov/resource-center/data-chart-center/tic/Pages/forms-sh.aspx>

Completed applications should be sent to:

Federal Reserve Bank of New York
Statistics Function, 4th Floor
33 Liberty Street
New York, NY 10045-0001
or faxed to 1-212-720-2598

Option 2:

- Submit Schedule 2 data on compact disk(s) CD(s) in the format specified in Appendix H. Schedule 1 must be filed on paper and must be submitted in the same package as the Schedule 2 data.

If your organization is submitting less than 200 Schedule 2 records, these records may be submitted using the IESUB system on CD(s) using the format specified in Appendix H or on paper, using the form contained in Appendix A.

Reports and CDs can be mailed or sent by courier to:

Federal Reserve Bank of New York
Statistics Function, 4th Floor
33 Liberty Street

New York, NY 10045-0001

Please contact FRBNY staff with questions pertaining to the report or if any of the following conditions apply:

1. Your entity requires additional time to complete your report.
2. Your entity received a copy of the report booklet and is not the U.S. parent entity in your organization.
3. Your entity cannot submit a single report for its entire organization.
4. Your reporter contact information or technical contact information changes after you submit your Schedule 1 report.

FRBNY staff can be reached at:

- Phone: 212-720-6300 or 646-720-6300
- Email: SHLA.Help@ny.frb.org

Additional copies of the reporting forms and instructions may be printed from the Internet at:
<http://www.treasury.gov/resource-center/data-chart-center/tic/Pages/forms-sh.aspx>

III. WHAT SECURITIES MUST BE REPORTED

This report collects information on securities issued by U.S.-residents that are owned by foreign residents, including U.S. equities, U.S. short-term debt securities (including selected money market instruments), U.S. long-term debt securities, and U.S. asset-backed debt securities.

Reportable securities may be traded or issued in the United States or in foreign countries, and may be denominated in any currency. Neither the country in which the securities are traded or issued, nor the currency in which the securities are denominated, is relevant in determining whether the securities are reportable. Securities held as part of a direct investment relationship should not be reported. (See Section III.I.)

A. FOREIGN-RESIDENT OWNERSHIP

Securities are considered to be foreign owned if, according to the reporter's records, the holder of record is not a resident of the United States. In addition, all outstanding bearer bonds should be assumed to be owned by foreign residents and reported by the U.S.-resident issuer. Bearer bonds should also be reported by U.S.-resident custodians, but only if the reporter's records indicate a foreign-resident owner (or foreign-resident custodian).

The following are considered to be foreign residents:

- Residents of foreign countries, including foreign-resident custodians and foreign-resident central securities depositories. (These include residents of Canada, Mexico, and offshore centers.)
- International organizations with extra-territorial status (even if located in the United States), such as the International Bank for Reconstruction and Development (World Bank), the International Monetary Fund (IMF) and the Inter-American Development Bank.² (See Appendix D for a complete list of these organizations.)
- Foreign subsidiaries of U.S. entities and foreign-resident branches of U.S. banks.
- Offshore and other non-U.S. funds.
- Entities or individuals that file an IRS Form W-8, indicating that they are foreign residents. Please note that there may be exceptions (such as Puerto Rico). However, if an IRS Form is not available, the mailing address can be used to determine residency.

² Pension plans of international and regional organizations, if located in the United States, are U.S.-resident entities; therefore, any securities owned by these pension plans should be excluded from this report.

B. REPORTABLE U.S. SECURITIES

U.S. securities are securities issued by U.S.-resident entities, with the exception of Depositary Receipts (DRs) that are backed by foreign securities and securities issued by international organizations that have extra-territorial status, such as the World Bank and the Inter-American Development Bank. U.S. securities can be issued in any country, denominated in any currency, and traded on any exchange.

U.S.-resident entities include U.S.-resident branches of foreign banks and U.S.-resident subsidiaries of foreign companies. Securities issued by foreign branches or subsidiaries of U.S. entities are not U.S. securities unless, due to merger, reorganization, or default, a U.S.-resident entity assumes direct responsibility for the payment of a previously foreign security.

Reportable securities include:

Equity Securities

- Common stock
- Preferred stock (participating and nonparticipating preference shares)
- Restricted stock
- U.S.-resident fund shares (open-end and closed-end), REITS, money market mutual funds, index-linked equity securities including unit investment trusts (including SPDRs, DIAMONDS, etc.)
- All other equity, including shares or units of ownership in unincorporated business enterprises, such as limited partnerships

Debt Securities

- Debt, registered and bearer, including bonds and notes (unstripped and stripped) and bonds with multiple call options
- Convertible debt and debt with attached warrants
- Zero-coupon debt and discount notes
- Index-linked debt securities (e.g., property index certificates)
- Commercial paper (including asset-backed commercial paper)
- Bankers' acceptances and trade acceptances
- Negotiable certificates of deposit, bank notes, and deposit notes
- Notes, including those issued under note issuance facilities and revolving underwriting facilities,

medium-term notes, promissory notes, deep-discounted, currency-linked (e.g., dual-currency), floating rate notes (FRN), such as perpetual notes (PRN), variable rate notes (VRN), structured FRN, reverse FRN, collared FRN, step up recovery FR (SURF), and range/corridor/accrual notes

- Asset-backed securities (see Section III.D)
- All other long-term and short-term debt securities

(Note: U.S. debt securities that are still outstanding as of June 30 should be reported even if the maturity date has passed.)

C. DO NOT REPORT

Do not report any:

- Derivative contracts (including futures, forwards, swaps, options and warrants) meeting the definition of a derivative under FAS 133. Embedded derivatives that are not bifurcated under FAS 133 should be included in the value of the host contract. However, if an embedded derivative is bifurcated the derivative should be excluded from the report.
- Securities which have been temporarily received as collateral under resale agreements or similar financing agreements (see Section III.F)
- Loans and loan participation certificates
- Letters of credit
- Non-negotiable certificates of deposit
- Bank deposits, including time (except for negotiable CDs) and demand deposits
- Annuities, including variable rate annuities
- Foreign securities, including :
 1. Depository receipts (DRs) backed by foreign securities, including ADRs (American Depositary Receipts), ADSs (American Depositary Shares), GDRs (Global Depositary Receipts), and IDRs (International Depositary Receipts).
 2. Securities issued by international and regional organizations with extra-territorial status, such as the International Bank for Reconstruction and Development (IBRD or World Bank) or the Inter-American Development Bank (IDB). (See Appendix D for a list of these organizations.)
 3. Securities issued in the United States by foreign-resident entities (e.g., Canadian or Mexican entities), even if they are denominated in U.S. dollars and traded on U.S. securities exchanges.
 4. Securities issued by foreign subsidiaries of U.S. entities (e.g., GMAC Canada) or foreign branches of U.S. banks, even if they are guaranteed by the U.S. parent company, or issued in the United

States.

5. Securities issued by foreign-resident entities under Section 144A of the SEC Act.
6. Securities issued by corporations that were incorporated outside of the United States by the report as of date, including companies incorporated offshore in countries such as the Cayman Islands and Bermuda.

D. ASSET-BACKED SECURITIES

Asset-backed securities (ABS) are securitized interests in a pool of assets, which give the purchaser a claim against the cash flows generated by the underlying assets. Securities backed by revolving credits, such as pools of credit card receivables, are reported as ABS if the return to the owner is based upon these credits, (i.e., the credits do not merely serve as collateral). Foreign-owned ABS should be reported if the issuer securitizing the assets is a U.S. resident. The underlying asset should not be used to determine if the ABS are reportable.

Include as ABS all collateralized mortgage obligations (CMOs), collateralized bond obligations (CBOs), collateralized loan obligations (CLOs), collateralized debt obligations (CDOs), and other securities backed by pools of:

- mortgages;
- credit card receivables;
- automobile loans;
- consumer and personal loans;
- commercial and industrial loans and other whole loans; and
- other assets.

E. FUNDS AND RELATED EQUITY OWNERSHIP

1. Report foreign-residents' ownership of shares/units of funds and investment trusts legally established in the United States (U.S.-resident funds) as equity securities. All foreign-residents' ownership of U.S.-resident fund shares should be assigned security type = 3 (fund shares), and not categorized as a debt security, regardless of the types of securities held by the fund.

For purposes of this report, funds include all investment vehicles that pool investors' money and invest

the pooled money in one or more of a variety of assets. Funds include, but are not limited to:

- mutual funds (including both open-end and closed-end mutual funds);
- money market funds;
- investment trusts;
- index-linked funds;
- exchange-traded funds (ETFs);
- hedge funds; and
- common trust funds.

The determination of whether a fund's shares are a U.S. security is based on the country in which the fund is legally established, not based on the residence of the issuers of the securities the fund purchases. For example, if a foreign resident owns shares in a fund organized in New York, these shares are reportable U.S. securities, whether or not the fund purchases foreign securities. Conversely, foreign-resident ownership of shares of "offshore" or other foreign-resident funds that purchase U.S. securities should not be reported.

Many funds established outside of the United States have names that are similar to U.S.-resident fund names. This often occurs when the fund is managed by a group that also manages many U.S.-resident funds and therefore may be thought of as managing only U.S.-resident funds. If there is doubt as to whether the investment should be classified as a fund or whether a fund is U.S. or foreign, please contact FRBNY staff at 212-720-6300 or 646-720-6300.

2. Report the ownership of U.S. securities by foreign-resident funds.

Although ownership of shares of foreign-resident funds are excluded from this report, any U.S. securities owned by foreign-resident funds for their portfolio are reportable. These are distinct investments and, therefore, are not duplicate reporting. U.S. securities owned by foreign-resident funds should be classified as either equity, debt, or asset-backed securities, as indicated in Section III.B.

3. Reporting guidelines for Hedge Funds and other alternative investments

Investment advisors, managers or similar types of legal entities that create master and feeder funds both outside and inside the U.S. should report as follows:

1. . Investments between the U.S. and foreigner entities (affiliates) that the investment manager establishes, is portfolio investment and should be reported on this report.

Example 1

A U.S. investment manager creates a U.S. Master Fund, a Cayman Feeder Fund, and a U.S. Feeder Fund. The investments between the manager and the foreign feeder funds are direct investments. However, the investment that the foreign feeder fund has in the master fund is portfolio investment and should be reported in the TIC system. Purchase and sales of the master fund shares by the foreign feeder fund should be reported on the TIC S by the U.S. based master fund and the master fund should report the ownership of their "shares" by the foreign feeder funds as issuer of the "domestic security" on the TIC SHL (A) report. If a U.S. custodian is involved in the holding the "domestic security" then the reporting responsibility would be on the U.S. custodian to report on the TIC SHL (A).

Example 2

A foreign hedge fund creates a U.S. based Master Fund, a Cayman Feeder Fund, and a U.S. Feeder Fund. The investments between the hedge fund and the U.S. feeder funds are direct investments. However, the investment that the foreign feeder fund has in the master fund is portfolio investment and should be reported in the TIC system. Purchase and sales of the master fund shares by the foreign feeder fund should be reported on the TIC S by the U.S. based master fund and the master fund should also report the ownership of their "shares" by the foreign feeder funds as issuer of the "domestic security" on the TIC SHL (A) report. If a U.S. custodian is involved in the holding the "domestic security" then the reporting responsibility would be on the U.S. custodian to report on the TIC SHL (A).

2. Exclude any investment between the entity that formed the funds (as a general partner) and all the entities it creates. These are direct investment and should be reported to the Bureau of Economic Analysis

Note: The descriptions of the various examples are based on common master/feeder fund structures. It is possible for there to be different types of structures when creating these funds and they may be called different names by some entities. Ultimately, if the investment is not Direct Investment then it will fall into the category of portfolio investment and needs to be reported as part of the TIC system.

F. SECURITIES INVOLVED IN REPURCHASE AND SECURITIES LENDING ARRANGEMENTS

A repurchase agreement (repo) is an arrangement involving the sale of securities at a specified price with a commitment to repurchase the same or similar securities at a specified price on a future date. A reverse repo is an agreement whereby a security is purchased at a specified price with a commitment to resell the same or similar securities at a specified price on a specified future date. Securities lending/borrowing arrangements are agreements whereby the ownership of a security is transferred in return for collateral, usually another security or cash, under condition that the security or similar security will revert to its original owner at a future date.

Securities "sold" by foreign residents under repurchase agreements or buy/sell back agreements, lent under securities lending arrangements, or delivered out as collateral as part of a reverse repurchase agreement or security borrowing agreement should be reported as if the securities were continuously held by the foreign resident. That is, the security lender's U.S. custodian should report the U.S. security as if no repurchase agreement or buy/sell back agreement occurred.

Securities temporarily acquired by foreign residents as collateral under reverse repurchase agreements, securities lending or borrowing arrangements, or buy/sell back agreements should NOT be reported. That is, the security borrower's U.S. custodian should exclude the U.S. security as if no resale agreement or buy/sell back agreement occurred.

However, if cash was temporarily received as collateral and was used to purchase securities, those securities should be reported.

G. STRIPPED SECURITIES

Separate Trading of Registered Interest and Principal Securities (STRIPS) and other similar instruments are securities that have been transformed from a principal amount with periodic interest coupons into a series of zero-coupon securities, with the range of maturities matching the coupon payment dates and the redemption date of the principal amount.

The residency of the STRIPS and similar instruments is the residence of the entity that issued the stripped security. However, the type of issuer of STRIPS and similar instruments is based upon the type of issuer of the underlying security. For example, U.S. Treasury STRIPS should be classified as U.S. Treasury

securities even though the Treasury does not issue or sell STRIPS directly to investors. In addition, all CATS, TIGRS, COUGARS, and LIONS should also be classified as U.S. Treasury securities.

Foreign holdings of stripped securities where the underlying security is not an ABS, both the interest-only (IO) component and the principal-only (PO) component, should be reported as security type = 10 (bond or note, stripped).

Foreign holdings of stripped securities where the underlying security is an ABS, tranches of stripped ABS, any IO component, and any PO component, should be reported as security type = 12 (asset-backed security).

H. U.S. GOVERNMENT AGENCIES OR FEDERALLY SPONSORED ENTERPRISES

Securities that are issued by U.S. government agencies or federally sponsored enterprises and owned by foreign residents are reportable. In addition, foreign owned securities that are issued by a U.S.-resident entity and guaranteed by U.S. government agencies or federally sponsored enterprises are reportable. For purposes of Schedule 2, item 9 (type of issuer), all these securities should be coded as type 2 (agencies). For example, securities that are guaranteed by the Government National Mortgage Association (GNMA) or the Small Business Administration (SBA) should be reported as U.S. government agency securities.

I. DIRECT INVESTMENT

A direct investment relationship exists when a U.S. company owns 10% or more of the voting equity securities of an incorporated foreign business (or an equivalent interest in an unincorporated foreign business, including a branch), or when a foreign company owns 10% or more of the voting equity securities of an incorporated U.S. business (or an equivalent interest in an unincorporated U.S. business, including a branch). Limited partners in a limited partnership do not have voting rights and therefore cannot have direct investment. (See Section III.K) If a direct investment relationship exists, then in general, all financial positions between the firms are considered direct investment. If a direct investment relationship exists between non-banking entities, all securities held by the parent entity that were issued by the affiliate of the parent are considered direct investment. **However, if one of the entities is a banking or securities brokerage firm, the inter-company holdings are considered direct investment only if they provide permanent capital.** All holdings known to be direct investment should be excluded from this report.

J. SECURITIES HELD BY U.S. CENTRAL SECURITIES DEPOSITORIES

U.S.-resident central securities depositories must report all U.S. securities they are holding in custody (or managing the safekeeping of) **directly** on behalf of foreign residents, such as foreign-resident brokers and dealers who may be members of the depository, or foreign-resident securities exchanges or depositories that have established direct relationships with the U.S.-resident central securities depository.

U.S.-resident custodians should report all U.S. securities that are shown on their records as being owned by foreign residents (or held in custody by its foreign-resident custodian) even if the safekeeping or settlement of the security is done at a U.S.-resident central securities depository.

K. LIMITED PARTNERSHIPS

Foreign-resident limited partner ownership interests in U.S.-resident limited partnerships should be reported as security type = 4 (other equity). Limited partners' ownership interests do not carry voting rights; therefore, all ownership interests, even those greater than 10%, are reportable. The Number of Shares field on Schedule 2 (item 18) should be defaulted to the value reported in the US\$ Market Value field (item 16) because limited partnerships do not issue shares.

General partner ownership interests are always considered to be direct investment and all such interests should be excluded from this report.

L. ACCOUNTING RULES, VALUATION OF SECURITIES, AND CALCULATION OF U.S. DOLLAR VALUES

Accounting Rules

All securities should be reported using settlement date accounting. Gross long positions should be reported. Do not net any short positions from long positions. Do not enter decimals or negative values in any cells.

Valuation of Securities

Report the fair value of securities as of close of business on the last business day of June. The fair value follows the definition of FAS 157.

U.S.-resident custodians should, at a minimum, report the fair value to the extent that it is available as part of the services provided to their customers, even if the price available is for a date prior to the last business day of June. If there is doubt as to whether to report the available fair value or to report a fair value of zero, please contact FRBNY report staff at 212-720-6300 or 646-720-6300.

For ABS, the value of the unpaid principal amount outstanding at close of business on the last business day of June should be reported; if principal has been repaid, this value will **not** be the same as the original face value, revalued at end-period market prices.

Foreign Currency Denominated Securities – CALCULATION OF U.S. DOLLAR VALUES

If the security is not denominated in U.S. dollars (US\$) and a U.S. dollar fair (market) value is not available in your system, convert the foreign currency denominated fair (market) value into US\$ using the spot exchange rate as of the close of business on the last business day of June. If you need assistance locating an exchange rate, please contact FRBNY staff at 212-720-6300 or 646-720-6300.

If the exchange rate is normally quoted in units of foreign currency per US\$, such as ¥105.75/US\$, divide foreign currency values by the foreign exchange rate to obtain the US\$ values. For example, if the value of a U.S. security issued in Japan is ¥ 200,000, and the exchange rate is ¥105.75/US\$, divide ¥ 200,000 by 105.75 to obtain US\$ 1,891.

If the exchange rate is normally quoted in US\$ per units of the foreign currency, such as US\$1.75/UK£, multiply foreign currency values by the US\$ exchange rate value of the foreign currency to obtain the US\$ values. For example, if the value of a U.S. security issued in the United Kingdom is UK £1,000 and the exchange rate is US\$1.75/UK£, multiply UK £1,000 by 1.75 to obtain US\$ 1,750.

M. DATA RETENTION PERIOD

All data used to create this report must be retained by the reporter for a period of 36 months from the date of the report's submission.

N. REVIEW OF DATA AND REQUEST FOR REVISED DATA

Data submitted on the reporting schedules are reviewed by FRBNY staff. As a result of this review, the reporter may be asked by FRBNY staff to provide supplemental information, including reasons for significant data changes between reporting periods, or corrected data. In addition, FRBNY staff may request: (1) information to ensure that all reportable U.S. securities have been reported; (2) information to ensure that all reported U.S. securities are owned by foreign residents (or held by foreign-resident custodians or foreign-resident central securities depositories); or (3) other information that helps to explain or corroborate the submitted data.

Reporters filing data on electronic media that are not formatted per the specifications in Appendix H will be required to resubmit the data in the proper format.

Each quarter, FRBNY staff obtains a list of debt securities issued abroad by U.S. companies. Experience has shown that most such issues are largely or completely foreign held. FRBNY staff will compare this information with the reports submitted by U.S.-resident issuers of foreign placed debt securities to ensure that foreign-issued securities are being properly reported. FRBNY will ask the issuers of such securities for additional information in cases of apparent under- or over-reporting.

IV. LINE-BY-LINE INSTRUCTIONS FOR SCHEDULE 1- REPORTER CONTACT IDENTIFICATION AND SUMMARY OF FINANCIAL INFORMATION

A Schedule 1 must be completed by all entities that receive this report booklet. This schedule is used to provide basic identifying information and summaries of data reported on Schedule 2 records. Please type or print all information.

(Please enter your ten-digit Reporter Identification Number at the top of each page of Schedule 1.)

REPORTER CONTACT IDENTIFICATION AND SUMMARY OF FINANCIAL INFORMATION

- 1. Reporter Identification Number** - Enter the ten-digit Reporter Identification Number that is printed on the top of the mailing label on your institution's report booklet. If you do not know the Reporter Identification Number for your entity, please contact FRBNY staff at 212-720-6300 or 646-720-6300.
- 2. Organization Name and Address** - Include the full legal name and mailing address of the reporting entity.
- 3. Reporting Status** - Select "1" only if the consolidated totals of reportable securities do not exceed the report's exemption level. All other entities should select "2" and file the appropriate Schedule 2 records.
- 4. Reporter Type** - Enter one of the following that best describes your organization

1 = Bank
2 = Mutual fund or investment trust
3 = Insurance company

4 = Other financial organization
5 = Non-financial organization
6 = Foundation, trust, estate

7 = Institution of higher learning (e.g., university)
8 = Other (not listed above)

A Bank is any depository institution (i.e., an institution that takes deposits), a bank holding company, or a financial holding company organized under Regulation Y of the Federal Reserve Act.

An Other Financial Organization is any other entity that acts as a financial intermediary or financial service organization, such as a finance company or a broker/dealer, which is operated separately from an entity in one of the other categories listed above.

A Non-Financial Organization is an entity that conducts commercial, industrial, or trade activities.

5. **Name of Contact** - Enter the name of the person who will be the primary contact for this report and can answer questions about the data reported.
- 6-9. Enter the job title, telephone number, fax number, and email address of the primary contact identified in item 5.
10. **Name of Service Provider or Vendor Used** - If a service provider or vendor was used to prepare the data reported, enter the name of the service provider.
11. **Name of Technical Contact Person** - Enter the name of a person who will serve as a contact should any technical issues, such as incorrect file formats, arise.
- 12-14. Enter the job title, telephone number, and email address of the technical contact person identified in item 11.
15. **Valuation Technique** - For each reporting unit, describe the valuation technique(s) used to calculate the reported market values. If securities are automatically valued at zero after a specified time period of inactivity, please specify the time period and whether this applies to the security or to the client's holdings of the security. Also, please specify how securities not actively traded on the report date and those with internally generated security identification numbers are valued. If your organization has more than four reporting units, please attach additional copies of Schedule 1, page 2, with item 15 completed.

SUMMARY OF SCHEDULE 2 INFORMATION

This section contains summary data for the information reported on Schedule 2 records. If your entity submits Schedule 2 data on multiple media, the summary Schedule 2 data should represent aggregate data across all media for the same reporter identification number.

16. **Total Number of Schedule 2 records Submitted** - Enter the total number of Schedule 2 records submitted.
17. **Total U.S. \$ Fair (Market) Value of All Equity Securities reported on Schedule 2 records** - Enter the sum of the U.S.\$ fair (market) value of all equity security records (records with Schedule 2, Item 10 = 1, 2, 3, or 4), rounded to the nearest U.S. dollar.
18. **Total U.S. \$ Fair (Market) Value of All Short-Term Debt Securities (excluding asset-backed securities) reported on Schedule 2 records** - Enter the sum of the U.S. \$ fair (market) value of all such security records (records with Schedule 2, Item 10 = 5, 6, 7, 8, 9, 10, or 11 and Schedule 2, Item 12 = 1), rounded to the nearest U.S. dollar.

19. **Total U.S. \$ Fair (Market) Value of All Long-Term Debt Securities (excluding asset-backed securities) reported on Schedule 2 records** - Enter the sum of the U.S. \$ fair (market) value of all such security records (records with Schedule 2, Item 10 = 5, 6, 7, 8, 9, 10, or 11 and Schedule 2, Item 12 = 2), rounded to the nearest U.S. dollar.
20. **Total U.S. \$ Fair (Market) Value of All Asset-Backed Securities reported on Schedule 2 records** - Enter the sum of the U.S. \$ fair (market) value of all such security records (records with Schedule 2, Item 10 = 12), rounded to the nearest U.S. dollar.

CERTIFICATION INFORMATION

This section must be completed by all reporters.

By signing and dating the certification, the Certifier acknowledges that:

- He/she has read and understood the reporting requirements of this report;
- He/she is aware that both civil and criminal penalties may be imposed for filing a false report; and
- He/she is sufficiently knowledgeable about the activities and functions of this entity that he/she can knowingly and with reasonable confidence certify that the information provided in this report is both accurate and complete.

21-24. Enter the name, job title, telephone number, and email address of the person in your organization who certifies that the information provided is complete and accurate. Also sign and date the form.

V. LINE-BY-LINE INSTRUCTIONS FOR SCHEDULE 2 - DETAILS OF SECURITIES

(Please enter your ten-digit Reporter Identification Number at the top of each page of Schedule 2.)

1. **Reporter Identification Number** - Enter the ten-digit Reporter Identification Number that is printed on the mailing label on the report booklet. If you do not know the Reporter Identification Number for your entity, please contact FRBNY staff at 212-720-6300 or 646-720-63002. **Sequence Number** - Enter the sequence number of this record, right justified. The first record should be assigned sequence number 1 and each subsequent Schedule 2 record should be sequentially numbered.
3. **Reporting Unit Code** - If data being submitted are collected from multiple databases or reporting systems, please report an internal code that will enable you to identify the database or system from which the information on this Schedule 2 came. This information will greatly reduce the costs of identifying and fixing any reporting errors that may occur.
- 3a. **Name of Reporting Unit** - Enter a description or name of the reporting unit or area that corresponds to the code reported in item 3.
4. **Custodian/Issuer Code** - Enter "1" if your entity did not issue this security. Enter "2" for issuer if your entity issued this security (even if you are also acting as the custodian).
5. **Security ID** - Enter the security ID code used to identify the security reported on this Schedule 2. CUSIP codes are strongly preferred. If the CUSIP is not available, please try to provide the ISIN, CINS, or Common code. **Do not use internally generated codes unless this security has not been assigned a code by any recognized numbering agency (e.g., limited partnerships).** Records for securities for which a portion is restricted and a portion is not restricted should be reported with the numbering agency code assigned to the unrestricted portion. If excessive internal codes are used, we may have to contact your institution to help identify characteristics of certain individual securities. **Please include the security ID's check digit and exclude any internal coding characters added to the CUSIP or other numbering agency code.**
6. **Security ID System** - Select the appropriate number from the list shown on the form. For example, if the security ID number entered in Item 5 is a CUSIP number, enter "1"; if it is a CINS, enter "3." If the security ID system used is not listed, enter a code of "9" (Other) and provide the name of the organization generating the code in item 6a.
- 6a. **Comment Line** - If you entered a code of "9" (Other) in item 6 you must provide the name of the organization generating the security ID code.
7. **Security Description** - Briefly describe the security, providing any relevant descriptive information available. Ideally, this would include the type of security, the maturity date if debt or ABS, and: (a)

for preferred stock the annual dividend; (b) for debt securities, the interest rate; (c) for floating rate notes, how the interest rate is calculated (e.g., Libor plus 1.5); and (d) for stripped securities the type of security/tranche. This information is particularly important for securities with an internally generated or other security ID not generated by a recognized numbering agency, (i.e., security ID system codes = 8 or 9).

8. **Name of Issuer** - Enter the name of the entity that issued the security. Please try to provide the full legal name of the issuer. For branches of banks, please provide the location of the branch.
9. **Type of Issuer** - Enter "1" if the security was issued by the United States government. Enter "2" if the security was issued or guaranteed by a federal agency (e.g., Government National Mortgage Association (GNMA)) or issued by or guaranteed by a federally sponsored enterprise (e.g., Federal National Mortgage Association (FNMA)). See Appendix I for a list of these entities. Enter "3" if the security was issued by a state or local government (e.g., New York State bonds). Enter "4" otherwise.
10. **Security Type** - Enter the security type code from the list below that most closely describes the type of security being reported. **See the glossary for definitions of these security types.**

Equity	Debt (excluding asset-backed securities)	Asset-backed securities
1. Common stock	5. Commercial paper	9. Bond or note, unstripped
2. Preferred stock	6. Negotiable CD	10. Bond or note, stripped
3. Fund shares	7. Convertible debt security	11. All other debt
4. All other equity	8. Zero-coupon bond or note	12. Asset-backed security

Type 1 should be used to report all common stock, including restricted common shares.

Type 2 should be used to report all preferred stock, including participating preference shares, nonparticipating preference shares, convertible preferred stock, and restricted preferred shares.

Type 3 should be used to report all shares of funds, including funds that invest primarily or exclusively in money market instruments and in long-term debt, exchange traded funds, open-end and closed-end mutual funds, and unit investment trusts. (See Section III.E)

Type 4 should be used to report all other types of equity, including foreign-resident limited partner ownership of U.S.-resident limited partnerships and any other form of equity not specified in security types 1, 2, and 3.

Type 5 should be used to report all commercial paper, including asset-backed commercial paper.

Type 6 should be used to report long-term and short-term negotiable certificates of deposits, including negotiable bank notes and negotiable deposit notes issued by U.S. institutions, including U.S. branches of U.S. or foreign banks. Non-negotiable certificates of deposit are not reportable.

Type 7 should be used to report all convertible debt securities, including convertible bonds and zero-coupon convertible debt. However, non-convertible debt securities with embedded warrants or options should be reported as either type 8 (if a zero-coupon bond or note) or type 9.

Type 8 should be used to report bonds and notes that do not provide interest payments, such as discount notes. However: (1) zero-coupon convertible debt should be reported as type 7; (2) stripped non-asset-backed securities, both the interest-only (IO) and principal-only (PO) components, should be reported as type 10; (3) U.S. Treasury bills should be reported as type 11; and (4) stripped asset-backed securities, the tranches, and the IO and PO components, should be reported as type 12.

Type 9 should be used to report bonds or notes that: (1) cannot be converted to equity securities, (2) provide interest payments, (3) have not been stripped (i.e., not an IO or PO), and (4) do not give the owner a claim against the cash flows generated by the underlying assets (i.e., ABS). These bonds and notes are commonly referred to as "straight debt."

Type 10 should be used to report all components of stripped securities, including the IO and PO components. However, all tranches of stripped asset-backed securities should be reported as type 12.

Type 11 should include all debt other than asset-backed securities that is not covered in types 5-10, including U.S. Treasury bills.

Type 12 should include only short-term and long-term securities that represent securitized interests in a pool of assets and give the investor a claim against the cash flows generated by the underlying assets. All tranches of stripped asset-backed securities, as well as unstripped asset-backed securities, should be reported as type 12. Debt which is collateralized by assets (real or financial), but only give the investor a claim against the underlying interest if the issuer defaults, should be reported as types 5-11, as appropriate.

11. Intentionally Left Blank

12. Term Indicator (debt, including ABS, only; based on original maturity) - Enter "**1**" (short-term) if the period from the issue date to the maturity date is one year or less. Enter "**2**" if the period from the security issue date to the maturity date is more than one year. If there are multiple issue

dates or redemption dates, enter "2" (long-term) if the period between the initial issue date and the longest redemption date is more than one year. Perpetual debt should also be classified as long-term.

13. **Currency of Denomination** - Enter the ISO code from Appendix F that corresponds to the currency in which the security is denominated.
14. **Country of Foreign Holder** - Enter the country code from Appendix C that corresponds to the country of residence of the owner of the security. If the country of residence of the owner is not known, report the country of residence of the foreign-resident custodian or foreign-resident central securities depository. Positions of international and multinational regional organizations, whether located in the United States or elsewhere, should be reported opposite the classification "International," if worldwide, or opposite the classifications "European," "Latin American," "Caribbean," "Asian," "African," or "Middle Eastern" regional organizations as indicated in Appendix D. If no country information is available (as will often be the case with bearer bonds), enter code 88862. If an excessive number of "country unknowns" is reported for securities other than bearer bonds, we will contact your institution for further information.

15. Type of Foreign Holder

Enter "1" if the owner is an official institution (see Appendix D or E) **even** if the account is held in the name of a foreign custodian or other foreign nominee.

Enter "2" if the account is in the name of one or more individuals (natural persons).

Enter "3" for all other owners, including personal trusts and other investment vehicles even if the beneficial owner is an individual.

16. **U.S. \$ Fair (Market) Value of Foreign Owned U.S. Security** - Enter the U.S. \$ fair (market) value of foreign-residents' ownership of this security, rounded to the nearest U.S. dollar. (See Section III.L, Valuation of Securities, for more information on how to calculate the fair (market) value.)

- 16a. **Fair (Market) Value in Currency of Denomination of Foreign Owned U.S. Security** - Enter the fair (market) value of foreign-residents' ownership of this security, rounded to the nearest currency unit. For ABS, the fair (market) value should be calculated based on the remaining principal outstanding (item 23) rather than the original face value. If the currency of issue is US\$, report the same value as in item 16. (See Section III.L, Valuation of Securities, for more information on how to calculate the fair (market) value.)

17. Intentionally Left Blank

FOR EQUITY TYPE SECURITIES ONLY

18. **Number of Shares** - Enter the number of shares owned by foreigners, including fractional shares, rounded to the nearest share. Wherever possible, combine partial shares with other ownership shares

of the same security to reduce reporting disparities introduced by rounding partial shares. Securities for which the amount foreign owned is zero should not be reported.

FOR SHORT-TERM AND LONG-TERM DEBT SECURITIES EXCLUDING ASSET-BACKED SECURITIES

19. **Face Value in Currency of Denomination** - For both short-term and long-term securities, enter the face value owned by foreigners in the currency of denomination, rounded to the nearest whole currency unit. If a security is traded in units, then calculate the face value as: (face value of each unit) * (the number of units) and report the result in this field. Securities for which the amount foreign owned is zero should not be reported.
20. **Issue Date** - Enter the issue date of this security in MMDDYYYY format. For example, if the security was issued on October 4, 1985, enter 10041985. If there are multiple issue dates, enter the first such issue date.
21. **Maturity Date** - Enter the final maturity date (when all remaining principal and interest are due) of this security in MMDDYYYY format. For example, if the security's final maturity date is January 5, 2010, enter 01052010. For perpetual debt, report a maturity date of 12319999.

FOR SHORT-TERM AND LONG-TERM ASSET-BACKED SECURITIES ONLY

22. **Original Face Value in Currency of Denomination** - Enter the original face value owned by foreigners in the currency of denomination, rounded to the nearest whole currency unit. This is the value that is (would have been) outstanding if no principal has been (had been) repaid. If a security is traded in units, then calculate the original face value as: (original face value of each unit) * (the number of units) and report the result in this field.
23. **Remaining Principal Outstanding in Currency of Denomination** - Enter the remaining principal outstanding owned by foreigners as of last business day of June in the currency of denomination, rounded to the nearest whole currency unit. This will equal the original face value if no principal has been repaid.

The remaining principal outstanding should be calculated by multiplying the original face value (item 22) by the factor value as of June 30, 2004. If a security is traded in units, then calculate the remaining principal outstanding as: (original face value of each unit) * (the number of units) * (factor value). If the factor value is not available as of the last business day of June, use the closest factor

value prior to the last business day of June. Securities for which the amount foreign owned is zero should not be reported.

24. **Issue Date** - Enter the issue date of this security in MMDDYYYY format. For example, if the security was issued on October 4, 1985, enter 10041985. If there are multiple issue dates, enter the first such issue date.
25. **Maturity Date** - Enter the final maturity date (when all remaining principal and interest are due) of this security in MMDDYYYY format. For example, if the security's final maturity date is January 5, 2010, enter 01052010.

APPENDIX A

Quinquennial Report of Foreign Holdings of U.S. Securities, Including Selected Money Market Instruments (SHL)

SCHEDULE 1: REPORTER CONTACT IDENTIFICATION AND SUMMARY OF FINANCIAL INFORMATION

1. Reporter Identification Number: Enter your 10-digit reporter identification number... [grid]

(Please type or print.)

2. Company Name: _____

Street Address: _____

City: _____ State: _____ Zip Code: _____

3. Reporting Status: Please enter one of the following... [checkbox]
1 = Exempt - Under the exemption level
2 = Not Exempt - Schedule 2 records being submitted

4. Reporter Type: Please enter one of the following that best describes your firm... [checkbox]
1 = Bank 4 = Other financial organization 7 = Institution of higher learning (e.g., university)
2 = Mutual fund or investment trust 5 = Non-financial organization 8 = Other (not listed above)
3 = Insurance company 6 = Foundation, trust, estate

Please provide a contact in your organization that can respond to inquiries on questions raised on the data reported. If you would like to provide more than one contact name, please attach additional copies of page 1, Schedule 1, with items 5 through 9 completed. (Please type or print.)

5. Name: _____ 6. Title: _____

7. Telephone Number: _____ 8. Fax Number: _____

9. Email Address: _____

10. Name of Service Provider or Vendor Used (if applicable): _____

Please provide a technical contact at your organization who can respond to inquiries on file formats or electronic transmission issues. (Please type or print.)

11. Name: _____ 12. Title: _____

13. Telephone Number: _____ 14. Email Address: _____

Please enter your 10-digit Reporter Identification Number.....

--	--	--	--	--	--	--	--	--	--

15. Valuation Technique(s) Used to Determine Market Values

For each reporting unit, please describe the valuation technique(s) used to determine reported market values. If securities are automatically valued at zero after a specified time period of inactivity, please specify the time period and whether this applies to the security or to the client's holdings of the security. Also, please specify how securities not actively traded on the report date and those with internally generated security identification numbers are valued.

Reporting Unit Valuation Description

--	--	--

--	--	--

--	--	--

--	--	--

Reporter Identification Number: Enter your 10-digit reporter identification number.....

SUMMARY OF SCHEDULE 2 INFORMATION

- 16. Total number of Schedule 2 Records submitted....., ,
- 17. Total US\$ Fair (Market) Value of All Equity Securities, , , ,
Reported on Schedule 2 Records
- 18. Total US\$ Fair (Market) Value of All Short-Term Debt Securities..., , , ,
(Excluding Asset-Backed Securities) Reported on Schedule 2 Records
- 19. Total US\$ Fair (Market) Value of All Long-Term Debt Securities..., , , ,
(Excluding Asset-Backed Securities) Reported on Schedule 2 Records
- 20. Total US\$ Fair (Market) Value of All Asset-Backed Securities....., , , ,
Reported on Schedule 2 Records

CERTIFICATION INFORMATION

By signing the certification below you acknowledge that:

- You have read and understood the reporting requirements of this report;
- You are aware that both civil and criminal penalties may be imposed for filing a false report; and
- You are sufficiently knowledgeable about the activities and functions of your organization that you can knowingly and with reasonable confidence certify that the information provided in this report is both accurate and complete.

Certifier's Signature: _____ Date Signed: _____

(Please type or print.)

21. Certifier's Name: _____

22. Certifier's Title: _____

23. Certifier's Telephone Number: _____

24. Certifier's Email Address: _____

Quinquennial Report of Foreign Holdings of U.S. Securities, Including Selected Money Market Instruments (SHL)

SCHEDULE 2: DETAILS OF SECURITIES

1. Reporter Identification Number: Enter your 10-digit reporter identification number... [grid]

2. Sequence Number: Start with 1 and sequentially number each Schedule 2 record submitted... [grid], [grid], [grid]

3. Reporting Unit Code: [grid]

3a. Name of Reporting Unit: _____

4. Issuer Code: _____ [checkbox]
1 = Custodian (did not issue security) 2 = Issuer

5. Security ID: [grid]

6. Security ID System: Please enter one of the following... [checkbox]
1 = CUSIP 2 = ISIN 3 = CINS 4 = Common Code 8 = Internally Generated 9 = Other (provide answer to 6a)

6a. For code of Other (9) enter the name of the organization or system that assigned the Security ID: _____

7. Security Description: _____

8. Name of Issuer: _____

9. Type of Issuer: Please enter one of the following... [checkbox]
1 = United States Department of the Treasury 2 = Other Federal agency or federally sponsored enterprise 3 = State or local government, including their subdivisions 4 = Other

10. Security Type: Please enter one of the following... [grid]
Equity Debt (excluding asset-backed securities) Asset-Backed Securities
1 = Common stock 2 = Preferred stock 3 = Fund shares 4 = All other equity
5 = Commercial paper 6 = Negotiable CD 7 = Convertible debt security 8 = Zero-coupon bond or note
9 = Bond or note, unstripped 10 = Bond or note, stripped 11 = All other debt 12 = Asset-backed security

11. Intentionally Left Blank _____

12. Term Indicator (debt, including ABS, only; based on original maturity)... [checkbox]
1 = Short Term 2 = Long Term

13. Currency of Denomination: [grid]
Enter the code from Appendix F for the currency in which the security was issued.

14. Country of Foreign Holder: [grid]
Enter the code from Appendix C for the country of residence of the entity that owns the security (or its foreign-resident custodian or foreign-resident central securities depository)

15. Type of Foreign Holder: (See Appendix D and E) [checkbox]
1 = Official 2 = Individual 3 = Other

Reporter Identification Number: Enter your 10-digit reporter identification number.....

16. US \$ Fair (Market) Value of Foreign Owned U.S. Security..... , , ,
(Note: field length for electronic file is 16)

16a. Fair (Market) Value in Currency of Denomination of Foreign Owned..... , , ,
U.S. Security (Note: field length for electronic file is 25)

17. Intentionally Left Blank

FOR EQUITY TYPE SECURITIES ONLY

(Security Type 1, 2, 3 or 4)

18. Number of Shares: Enter the number of shares rounded to the nearest share..... , , ,

FOR SHORT-TERM AND LONG-TERM DEBT SECURITIES EXCLUDING ASSET-BACKED SECURITIES

(Security Type 5, 6, 7, 8, 9, 10 or 11)

19. Face Value in Currency of Denomination , , , ,
(Note: field length for electronic file is 25)

20. Issue Date: MMDDYYYY format (including leading zeros).....

21. Maturity Date: MMDDYYYY format (including leading zeros).....

FOR SHORT-TERM AND LONG-TERM ASSET-BACKED SECURITIES ONLY

(Security Type 12)

22. Original Face Value in Currency of Denomination: , , , ,
Enter value that would have been outstanding if no principal had been repaid. (Note: field length for electronic file is 25)

23. Remaining Principal Outstanding in Currency of Denomination: , , , ,
Enter the remaining principal outstanding as of last business day of June in the currency of denomination. (Note: field length for electronic file is 25)

24. Issue Date: MMDDYYYY format (including leading zeros).....

25. Maturity Date: MMDDYYYY format (including leading zeros).....

APPENDIX B

FLOWCHARTS SHOWING REPORTING RESPONSIBILITY

A. FLOWCHART FOR U.S.-RESIDENT CUSTODIANS (all securities, including all book-entry securities held at a U.S.-resident central securities depository)

1. A foreign-resident investor or custodian uses U.S.-resident custodian to hold U.S. securities for its account and the U.S.-resident custodian does not use a U.S. resident sub-custodian.

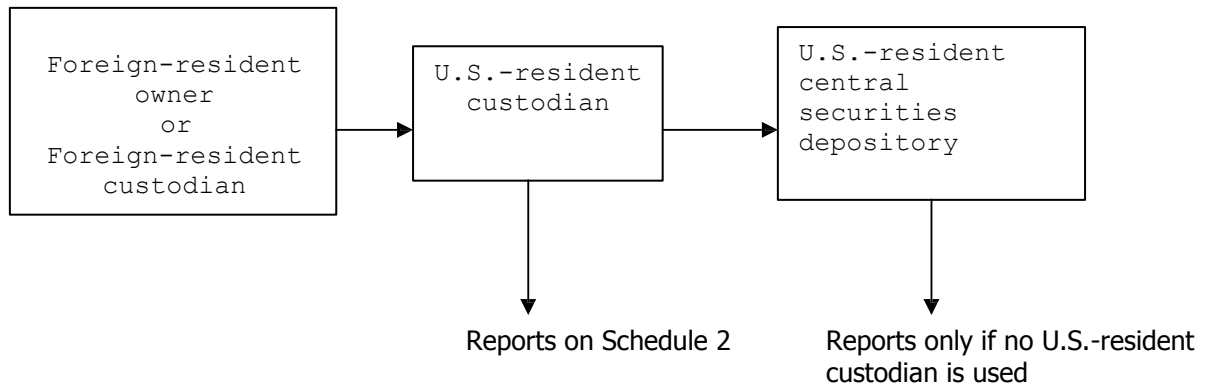

2. A foreign-resident investor or custodian uses U.S.-resident custodian to hold U.S. securities for its account and the U.S.-resident custodian uses a U.S. resident sub-custodian.

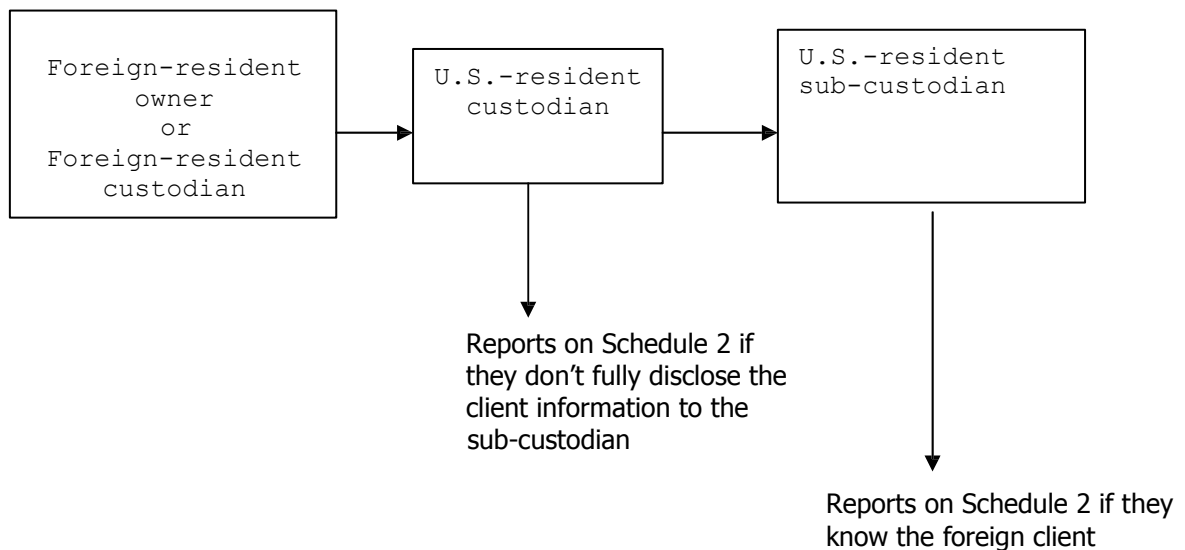

B. FLOWCHART FOR U.S.-RESIDENT ISSUERS (registered securities, including all book-entry securities not issued directly into a foreign market)

U.S. registered security is held directly by a foreigner (i.e., no U.S.-resident custodian and no U.S.-resident central securities depository is used).

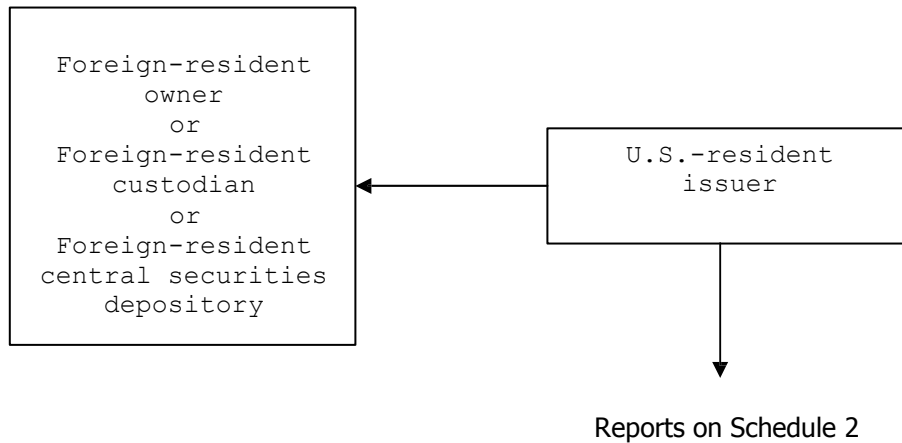

C. FLOWCHART FOR SECURITIES ISSUED DIRECTLY INTO THE FOREIGN MARKET

Issuers should assume that the entire issue is held directly by foreign residents. U.S.-resident custodians should report all securities held in custody that are foreign owned.

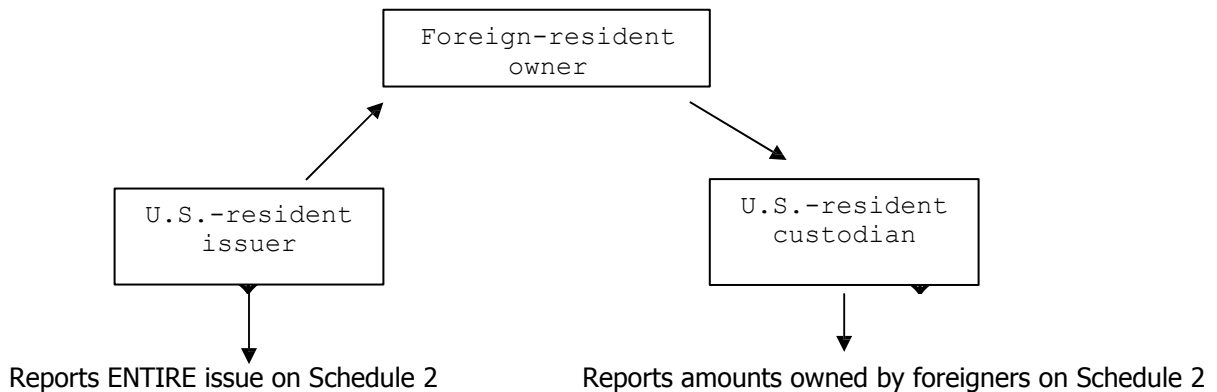

Note: FRBNY eliminates double reporting on a security-by-security basis. Custodial information is used to provide information on the geographical distribution of the owners of these securities.

FLOWCHART FOR DETERMINING REPORTABLE SECURITIES

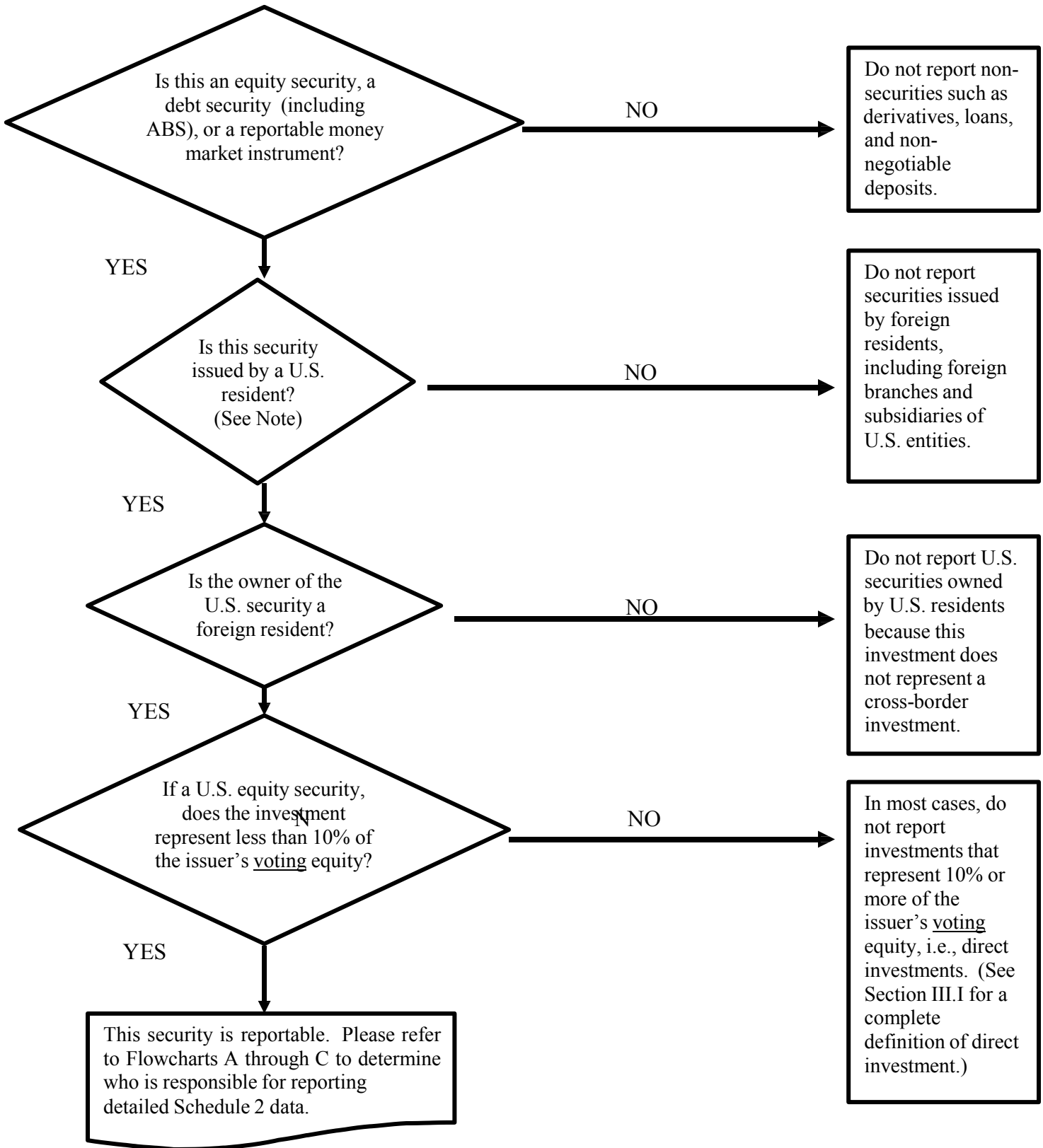

Note: Depository receipts/shares backed by foreign securities are considered “foreign.” In addition, all securities issued by the multinational organizations listed in Appendix Dare considered foreign.

APPENDIX C: GEOGRAPHICAL CLASSIFICATION

DEPARTMENT OF THE TREASURY

CODES FOR COUNTRIES & AREAS TO BE USED FOR PURPOSES OF REPORTING ON TREASURY INTERNATIONAL CAPITAL FORMS

The most recent version of this appendix is now a separate document.

A copy is on the TIC website, in column A of the webpage at:

<http://www.treasury.gov/resource-center/data-chart-center/tic/Pages/foihome.aspx>

APPENDIX D: INTERNATIONAL & REGIONAL ORGANIZATIONS

DEPARTMENT OF THE TREASURY

CODES FOR INTERNATIONAL & REGIONAL ORGANIZATIONS TO BE USED FOR PURPOSES OF REPORTING ON TREASURY INTERNATIONAL CAPITAL FORMS

The most recent version of this appendix is now a separate document.

A copy is on the TIC website, in column A.1 (pages 11-13 of the file) of the webpage at:

<http://www.treasury.gov/resource-center/data-chart-center/tic/Pages/foihome.aspx>

APPENDIX E: FOREIGN OFFICIAL INSTITUTIONS

DEPARTMENT OF THE TREASURY

**CODES FOR CERTAIN FOREIGN INSTITUTIONS CLASSIFIED AS OFFICIAL,
A LIST TO BE USED ONLY FOR PURPOSES OF REPORTING ON
TREASURY INTERNATIONAL CAPITAL FORMS**

The most recent version of this appendix is now a separate document.

A copy is on the TIC website, in column B of the webpage at:

<http://www.treasury.gov/resource-center/data-chart-center/tic/Pages/foihome.aspx>

APPENDIX F: LIST OF CURRENCY CODES

Code	Currency	Code	Currency
AFN	Afghanistan Afghani	CYP	Cyprus Pound
ALL	Albanian Lek	CZK	Czech Koruna
DZD	Algerian Dinar	DKK	Danish Krone
ADP	Andorran Peseta	DJF	Djibouti Franc
AOR	Angolan Kwanza Reajustado	DOP	Dominican Peso
ARS	Argentine Peso	XCD	East Caribbean Dollar
AMD	Armenian Dram	EGP	Egyptian Pound
AWG	Aruban Guilder	SVC	El Salvador Colon
AUD	Australian Dollar	ERN	Eritrea Nakfa
I AZM	Azerbaijani New Manat	EEK	Estonia Kroon
BSD	Bahamian Dollar	ETB	Ethiopian Birr
BHD	Bahraini Dinar	EUR	European Union Euro
BDT	Bangladeshi Taka	FKP	Falkland Islands Pound
BBD	Barbados Dollar	FJD	Fiji Dollar
BYR	Belarussian Ruble	GMD	Gambia Dalasi
BZD	Belize Dollar	GEL	Georgia Lari
BMD	Bermudian Dollar	GHC	Ghana Cedi
BTN	Bhutan Ngultrum	GIP	Gibraltar Pound
BOB	Bolivian Boliviano	GTQ	Guatemala Quetzal
BWP	Botswana Pula	GWP	Guinea-Bissau Peso
I BAM	Bosnia & Herzegovina Convertible Marks	GNF	Guinea Franc
BRL	Brazilian Real	GYD	Guyana Dollar
BND	Brunei Dollar	HTG	Haitian Gourde
BGN	Bulgarian Lev	HNL	Honduras Lempira
BIF	Burundi Franc	HKD	Hong Kong Dollar
KHR	Cambodian Riel	HUF	Hungarian Forint
CAD	Canadian Dollar	I SK	Iceland Krona
CVE	Cape Verde Escudo	INR	Indian Rupee
KYD	Cayman Islands Dollar	IDR	Indonesian Rupiah
XOF	CFA Franc BCEAO	IRR	Iranian Rial
XAF	CFA Franc BEAC	IQD	Iraqi Dinar
XPF	CFP Franc	JMD	Jamaican Dollar
CLP	Chilean Peso	JPY	Japanese Yen
CNY	Chinese Yuan Renminbi	JOD	Jordanian Dinar
COP	Colombian Peso	KZT	Kazakhstan Tenge
KMF	Comoro Franc	KES	Kenyan Shilling
CDF	Congolais Franc	KWD	Kuwaiti Dinar
CRC	Costa Rican Colon	KGS	Kyrgyzstan Som
HRK	Croatian Kuna	LAK	Laos Kip
CUP	Cuban Peso	LVL	Latvian Lats

Code	Currency	Code	Currency
LBP	Lebanese Pound	STD	Sao Tome & Principe Dora
LSL	Lesotho Lote	SAR	Saudi Arabian Riyal
LRD	Liberian Dollar	SCR	Seychelles Rupee
LYD	Libyan Dinar	SLL	Sierra Leone Leone
LTL	Lithuanian Litas	SGD	Singapore Dollar
MOP	Macau SAR Pataca	SKK	Slovak Koruna
MKD	Macedonian Denar	SIT	Slovenia Tolar
MGF	Malagasy Franc	SBD	Solomon Islands Dollar
MWK	Malawi Kwacha	SOS	Somali Shilling
MYR	Malaysian Ringgit	ZAR	South African Rand
MVR	Maldives Rufiyaa	KRW	South Korean Won
MTL	Maltese Lira	LKR	Sri Lanka Rupee
MRO	Mauritania Ouguiya	SDD	Sudanese Dinar
MUR	Mauritius Rupee	SRG	Suriname Guilder
MXN	Mexican Peso	SZL	Swziland Lilangeni
MDL	Moldovan Leu	SEK	Swedish Krona
MNT	Mongolian Tugrik	CHF	Swiss Franc
MAD	Moroccan Dirham	SYP	Syrian Pound
I MZM	Mozambique New Metical	TWD	Taiwan New Dollar
MMK	Myanmar Kyat	TJS	Tajikistan Somoni
NAD	Namibia Dollar	TZS	Tanzanian Shilling
NPR	Nepalese Rupee	THB	Thailand Baht
ANG	Netherlands Antillean Guilder	TOP	Tongan Pa'anga
ILS	New Israeli Shekel	TTD	Trinidad and Tobago Dollar
TWD	New Taiwan Dollar	TND	Tunisian Dinar
NZD	New Zealand Dollar	TRY	Turkish Yani
NIO	Nicaraguan Cordoba Oro	TMM	Turkmenistan Manat
NGN	Nigerian Naira	UGX	Uganda New Shilling
KPW	North Korean Won	UAH	Ukrainian Hryvnia
NOK	Norwegian Krone	AED	United Arab Emirates
OMR	Omani Rial	USD	United States Dollar
PKR	Pakistani Rupee	UYU	Uruguayo Peso
PAB	Panamanian Balboa	UZS	Uzbekistan Sum
PGK	Papua New Guinea Kina	VUV	Vanuatu Vatu
PYG	Paraguay Guarani	VEB	Venezuelan Bolivar
PEN	Peruvian New Sol	VND	Vietnamese Dong
PHP	Philippine Peso	YER	Yemeni Rial
PLN	Polish Zloty	YUM	Yugoslavian Dinar
GBP	Pound Sterling	ZMK	Zambian Kwacha
QAR	Qatari Rial		
ROL	Romanian Leu		
RUB	Russian Ruble		
RWF	Rwanda Franc		
SHP	Saint Helena Pound		
WST	Samoan Tala		

APPENDIX G: GLOSSARY

DEPARTMENT OF THE TREASURY

The most recent version of this appendix is now a separate document.

A copy is on the TIC website, next to these instructions, at:

<http://www.treasury.gov/resource-center/data-chart-center/tic/Pages/forms-s.aspx>

and also at:

<http://www.treasury.gov/ticdata/Publish/ticglossary-june2014.pdf>

APPENDIX H

Technical Information for Electronic Submission

Included in this appendix are instructions for how to properly prepare data in a file for submission. Your entity must retain a copy of the data for a period of 24 months from the date of the report's submission.

I. Requirements for submitting data via IESUB

- ✓ Each file should contain data for only one Reporter Identification Number. If your entity will be reporting using multiple Reporter Identification Numbers, the data pertaining to each Reporter Identification Number must be reported in a separate file.
- ✓ Your entity must agree to the Terms and Use for Internet Reporting. This information can be found at the link for IESUB in the upper right corner of the following webpage:
<http://www.treasury.gov/resource-center/data-chart-center/tic/Pages/forms-sh.aspx>
- ✓ Your entity must have a connection to the Internet that supports the World Wide Web (WWW). Your connection must not block or disable JavaScript.
- ✓ Your entity must have a web browser program (Microsoft Internet Explorer 5.5 or higher) that supports 128-bit Secure Sockets Layer (SSL) encryption. 128-bit encryption is used for all communication between you and the Federal Reserve System.
- ✓ All Schedule 1 information must be data entered before Schedule 2 data can be submitted.
- ✓ All files must be text files and have file names ending with .TXT (e.g., Schedue_2_Company_Name.TXT)

II. Requirements for submitting data via CD

- ✓ Each CD (media) should contain data for only one Reporter Identification Number. If your entity will be reporting using multiple Reporter Identification Numbers, the data pertaining to each Reporter Identification Number must be reported on separate media.
- ✓ Each media for a particular Reporter Identification Number must be accompanied by a paper

format Schedule 1.

- ✓ A dump or print out that includes at least the first ten detail records should accompany each media.
- ✓ Include a printout of the command string used to create the file if the file was created directly from the mainframe.
- ✓ Include any special instructions on how to unload the file.
- ✓ All Schedule 2 data must be provided in a standard DOS, ASCII flat file the following media:
 - Standard 700 MB CD(s)

Data must be submitted by August 29, 2014 to:

Federal Reserve Bank of New York
Statistics Function, 4th Floor
33 Liberty Street
New York, NY 10045-0001

Should you have any questions concerning the instructions in this appendix, please contact the FRBNY automation staff at 212-720-1989 or 646-720-1989.

III. Electronic File Formats for both IESUB and CD Submissions

Reporters must use either a semicolon-delimited format or positional format. The layouts and examples of each follows.

Semicolon Delimited Format

Data Field and Instructions	Field Format	Schedule 2 Item Number
Reporter Identification Number	N10 1	
Delimiter Sem	i-colon	
Sequence Number (value from 1 - maximum number of records)	N7 2	
Delimiter Sem	i-colon	
Reporting Unit	N3 3	
Delimiter Sem	i-colon	
Name of Reporting Unit	A80 3a	
Delimiter Sem	i-colon	
Custodian/Issuer Code	A1 4	
Delimiter Sem	i-colon	
Security ID	A12 5	
Delimiter Sem	i-colon	
Security ID System (Refer to Schedule 2, Page 1)	N1 6	
Delimiter Sem	i-colon	
Security ID System Description	A80 6a	
Delimiter Sem	i-colon	
Security Description	A80 7	
Delimiter Sem	i-colon	
Name of Issuer	A80 8	
Delimiter Sem	i-colon	
Type of Issuer (Refer to Schedule 2, Page 1)	N1 9	
Delimiter Sem	i-colon	
Security Type (Refer to Schedule 2, Page 1)	N2 10	
Delimiter Sem	i-colon	
Intentionally Left Blank	N1 11	
Delimiter Sem	i-colon	
Term Indicator (Debt and ABS Only; Otherwise Leave Null)	N1 12	
Delimiter Sem	i-colon	
Currency of Denomination (Refer to Appendix F)	A3 13	
Delimiter Sem	i-colon	
Country of Foreign Holder (Refer to Appendix D and E)	N5 14	
Delimiter Sem	i-colon	
Type of Foreign Holder (Refer to Appendix D and E)	N1 15	
Delimiter Sem	i-colon	
US\$ Fair (Market) Value of Foreign Security Owned	N16 16	16a
Delimiter Sem	i-colon	
Fair (Market) Value of Security Owned Denominated in the Currency of Issue	N25	
Delimiter Sem	i-colon	
Intentionally Left Blank	N1 17	
Delimiter Sem	i-colon	
Number of Shares (Equity only; Otherwise Null)	N11 18	
Delimiter Sem	i-colon	

Face Value in Currency of Denomination (non-ABS debt only; Otherwise Null)	N25 19	
Delimiter Sem	i-colon	
Issue Date (MMDDYYYY) (non-ABS debt only; Otherwise Null)	N8 20	
Delimiter Sem	i-colon	
Maturity Date (MMDDYYYY) (non-ABS debt only; Otherwise Null)	N8 21	
Delimiter Sem	i-colon	
Original Face Value in Currency of Denomination (ABS only; Otherwise Null)	N25 22	
Delimiter Sem	i-colon	
Remaining Principal Outstanding in Currency of Denomination (ABS only; Otherwise Null)	N25 23	
Delimiter Sem	i-colon	
Issue Date (MMDDYYYY) (ABS only; Otherwise Null)	N8 24	
Delimiter Sem	i-colon	
Maturity Date (MMDDYYYY) (ABS only; Otherwise Null)	N8 25	

Data Specifications

In addition to the instructions in the above table, follow these instructions:

- Semi-colons must be used as space-delimiters between fields.
- No special characters should be present in numeric fields (e.g. currency signs, commas, negative signs, slashes, etc.).
- All numeric fields should be unpacked, unsigned and with leading zeros.
- A format specification of N12 is numeric, with length of up to 12.
- A format specification of A80 is alphanumeric, with length of up to 80.
- Issue Date and Maturity Date fields should be in the format of MMDDYYYY with leading zero for months January-September and for the 1st to the 9th day of the month (e.g. 01092004 = January 9, 2004).

External Label (Affix to media, not to cover)

Company Name

Reporter Identification Number as assigned by the FRBNY

Data processing Contact Name and Telephone Number

CD Identification Number (as identified in your records)

Total Number of CD: 1 of ____

Contents: 2014 Report of Foreign Holdings of U.S. Securities, Including Selected Money Market Securities (SHL)

Sample Equity Record

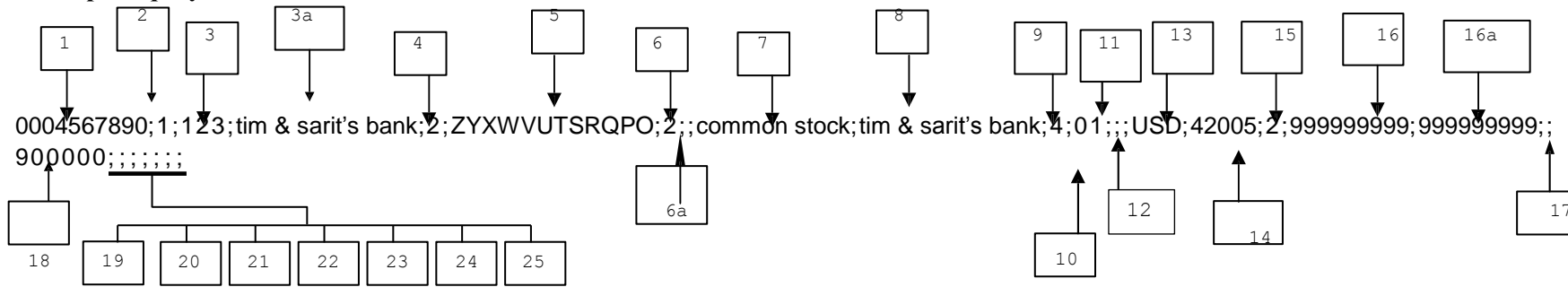

1. Reporter Identification Number = 0004567890 (MUST be exactly ten characters)
2. Sequence Number (can also be of format: 0000001)
3. Reporting Unit Code (internal code to identify the area within your organization that the data came from)
- 3a. Name of Reporting Unit (can be up to 80 characters in length)
4. Custodian / Issuer Code (1 = Custodian; 2 = Issuer)
5. Security ID (can be up to 12 characters in length)
6. Security ID System
- 6a. For Security ID System of "Other" (9) enter the name of the organization or system that assigned the Security ID
7. Security Description (can be up to 80 characters in length)
8. Name of Issuer (can be up to 80 characters in length)
9. Type of Issuer (use issuer types listed on Schedule 2, Page 1)
10. Security Type (use security types listed on Schedule 2, Page 1)
11. Intentionally Left Blank
12. Term Indicator (debt and ABS only; based on original maturity)
13. Currency of Denomination (use currency codes listed in Appendix F)
14. Country of Foreign Holder (use country codes listed in Appendix C)
15. Type of Foreign Holder (See Appendix D and E)
16. US\$ Fair (Market) Value of Foreign Owned U.S. Security (can be up to 16 characters in length)
- 16a. Fair (Market) Value in Currency of Denomination of Foreign Owned U.S. Security (can be up to 25 characters in length)
17. Intentionally Left Blank
18. Number of Shares – rounded to the nearest share (can be up to 11 characters in length)
19. Face Value in Currency of Denomination – must be null for an equity record
20. Issue Date: MMDDYYYY format – must be null for an equity record
21. Maturity Date: MMDDYYYY format – must be null for an equity record
22. Original Face Value in Currency Denomination – must be null for an equity record
23. Remaining Principal Outstanding in Currency of Denomination – must be null for an equity record
24. Issue Date: MMDDYYYY format – must be null for an equity record
25. Maturity Date: MMDDYYYY format – must be null for an equity record

Null Field

Null Field

Note: Null fields are to be included. They are represented by the inclusion of a delimiter as if a value were present. e.g. - ;desc; ;

Sample Asset-Backed Long-term Debt Record

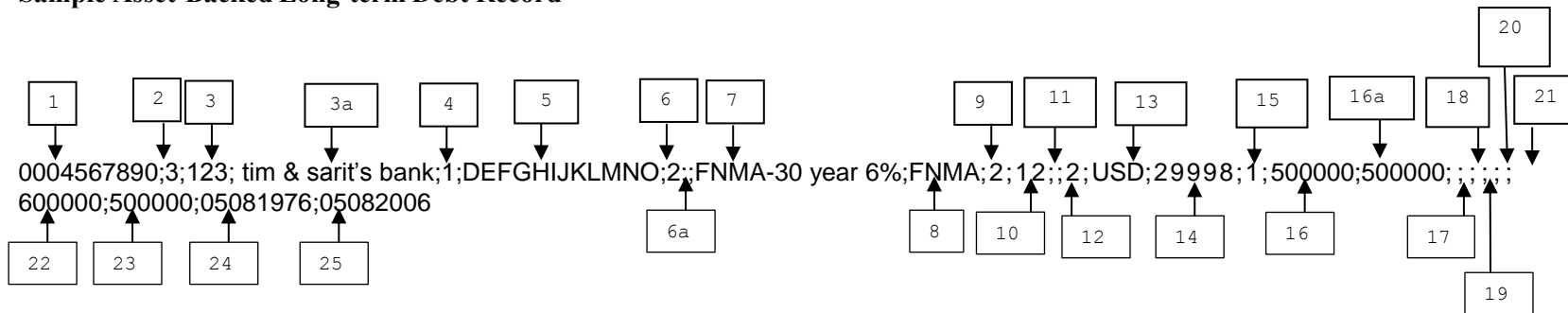

1. Reporter Identification Number = 0004567890 (MUST be exactly ten characters)
2. Sequence Number (can also be of format: 0000003)
3. Reporting Unit Code (internal code to identify the area within your organization that the data came from)
- 3a. Name of Reporting Unit (can be up to 80 characters in length)
4. Custodian / Issuer Code (1 = Custodian; 2 = Issuer)
5. Security ID (can be up to 12 characters in length)
6. Security ID System
- 6a. For Security ID System of "Other" (9) enter the name of the organization or system that assigned the Security ID
7. Security Description (can be up to 80 characters in length)
8. Name of Issuer (can be up to 80 characters in length)
9. Type of Issuer (use issuer types listed on Schedule 2, Page 1)
10. Security Type (use security types listed on Schedule 2, Page 1)
11. Intentionally Left Blank
12. Term Indicator (debt and ABS only; based on original maturity)
13. Currency of Denomination (use currency codes listed in Appendix F)
14. Country of Foreign Holder (use country codes listed in Appendix C)
15. Type of Foreign Holder (See Appendix D and E)
16. US\$ Fair (Market) Value of Foreign Owned U.S. Security (can be up to 16 characters in length)
- 16a. Fair (Market) Value in Currency of Denomination of Foreign Owned U.S. Security (can be up to 25 characters in length)
17. Intentionally Left Blank
18. Number of Shares – must be null for any record other than equity
19. Face Value in Currency of Denomination – must be null for any record other than non-asset backed debt
20. Issue Date: MMDDYYYY format – must be null for any record other than non-asset backed debt
21. Maturity Date: MMDDYYYY format – must be null for any record other than non-asset backed debt
22. Original Face Value in Currency Denomination (can be up to 25 characters in length)
23. Remaining Principal Outstanding in Currency of Denomination (can be up to 25 characters in length)
24. Issue Date: MMDDYYYY format (e.g., 05081976 = May 8, 1976)
25. Maturity Date: MMDDYYYY format (e.g., 05082006 = May 8, 2006)

Null field

Note: Null fields are to be included. They are represented by the inclusion of a delimiter as if a value were present. e.g. - ;desc; ;

Sample Short-term/Long-term Debt Record (excluding Asset-Backed securities)

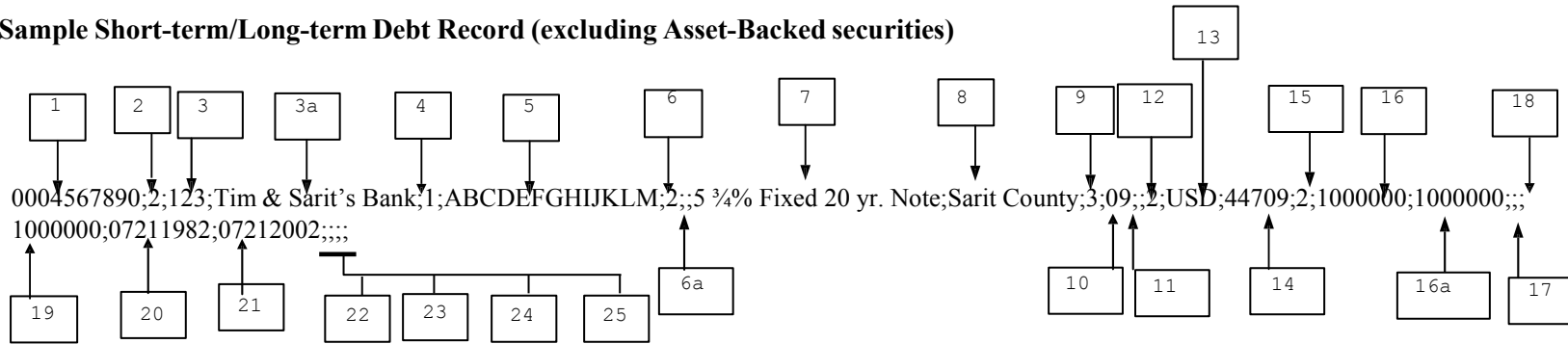

1. Reporter Identification Number = 0004567890 (MUST be exactly ten characters)
2. Sequence Number (can also be of format: 0000002)
3. Reporting Unit Code (internal code to identify the area within your organization that the data came from)
- 3a. Name of Reporting Unit (can be up to 80 characters in length)
4. Custodian / Issuer Code (1 = Custodian; 2 = Issuer)
5. Security ID (can be up to 12 characters in length)
6. Security ID System
- 6a. For Security ID System of "Other" (9) enter the name of the organization or system that assigned the Security ID
7. Security Description (can be up to 80 characters in length)
8. Name of Issuer (can be up to 80 characters in length)
9. Type of Issuer (use issuer types listed on Schedule 2, Page 1)
10. Security Type (use security types listed on Schedule 2, Page 1)
11. Intentionally Left Blank
12. Term Indicator (debt and ABS only; based on original maturity)
13. Currency of Denomination (use currency codes listed in Appendix F)
14. Country of Foreign Holder (use country codes listed in Appendix C)
15. Type of Foreign Holder (See Appendix D and E)
16. US\$ Fair (Market) Value of Foreign Owned U.S. Security (can be up to 16 characters in length)
- 16a. Fair (Market) Value in Currency of Denomination of Foreign Owned U.S. Security (can be up to 25 characters in length)
17. Intentionally Left Blank
18. Number of Shares – must be null for any record other than equity
19. Face Value in Currency of Denomination (can be up to 25 characters in length)
20. Issue Date: MMDDYYYY format (e.g., 07211982 = July 21, 1982)
21. Maturity Date: MMDDYYYY format (e.g., 07212005 = July 21, 2005)
22. Original Face Value in Currency Denomination – must be null for any record other than asset-backed debt
23. Remaining Principal Outstanding in Currency of Denomination – must be null for any record other than asset-backed debt
24. Issue Date: MMDDYYYY – must be null for any record other than asset-backed debt
25. Maturity Date: MMDDYYYY – must be null for any record other than asset-backed debt

Null Field

Note: Null fields are to be included. They are represented by the inclusion of a delimiter as if a value were present. e.g. - ;desc;.

Positional Format (Record length = 555 characters)

Position	Data Field and Instructions	Field Format	Schedule 2 Item
1-10	Reporter Identification Number	N10	1
11	Filler (space)	Space	
12-18	Sequence Number (value from 1 - maximum number of records)	N7	2
19	Filler (space)	Space	
20-22	Reporting Unit Code	N3	3
23	Filler (space)	Space	
24-103	Name of Reporting Unit	A80	3a
104	Filler (space)	Space	
105	Custodian/Issuer Code	A1	4
106	Filler (space)	Space	
107-118	Security ID	A12	5
119	Filler (space)	Space	
120	Security ID System (Refer to Schedule 2, Page 1)	N1	6
121	Filler (space)	Space	
122-201	Security ID System Description (Null Unless Item 6 = 9 – Other)	A80	6a
202	Filler (space)	Space	
203-282	Security Description	A80	7
283	Filler (space)	Space	
284-363	Name of Issuer	A80	8
364	Filler (space)	Space	
365	Type of Issuer (Refer to Schedule 2, Page 1)	N1	9
366	Filler (space)	Space	
367-368	Security Type (Refer to Schedule 2, Page 1)	N2	10
369	Filler (space)	Space	
370	Intentionally Left Blank	N1	11
371	Filler (space)	Space	
372	Term Indicator (Debt and ABS Only; Otherwise Leave Null)	N1	12
373	Filler (space)	Space	
374-376	Currency of Denomination (Refer to Appendix F)	A3	13
377	Filler (space)	Space	
378-382	Country of Foreign Holder (Refer to Appendix C)	N5	14
383	Filler (space)	Space	
384	Type of Foreign Holder (Refer to Appendix D and E)	N1	15
385	Filler (space)	Space	
386-401	US\$ Fair (Market) Value of Foreign Security Owned	N16	16
402	Filler (space)	Space	
403-427	Fair (Market) Value of Security Owned Denominated in the Currency of Issue	N25	16a
428	Filler (space)	Space	
429	Intentionally Left Blank	N1	17
430	Filler (space)	Space	
431-441	Number of Shares (Equity only; Otherwise Null)	N11	18
442	Filler (space)	Space	
443-467	Face Value in Currency of Denomination (non-ABS debt only; Otherwise Null)	N25	19
468	Filler (space)	Space	

469-476	Issue Date (MMDDYYYY) (non-ABS debt only; Otherwise Null)	N8	20
477	Filler (space)	Space	
478-485	Maturity Date (MMDDYYYY) (non-ABS debt only; Otherwise Null)	N8	21
486	Filler (space)	Space	
487-511	Original Face Value in Currency of Denomination (ABS only; Otherwise Null)	N25	22
512	Filler (space)	Space	
513-537	Remaining Principal Outstanding in Currency of Denomination (ABS only; Otherwise Null)	N25	23
538	Filler (space)	Space	
539-546	Issue Date (MMDDYYYY) (ABS only; Otherwise Null)	N8	24
547	Filler (space)	Space	
548-555	Maturity Date (MMDDYYYY) (ABS only; Otherwise Null)	N8	25

555 character logical records blocked at 60 logical records or a block size of 33,300 bytes.

Data Specifications

In addition to the instructions in the above table, follow these instructions:

- No special characters should be present in numeric fields (e.g. currency signs, commas, negative signs, slashes, etc.).
- All numeric fields should be unpacked, unsigned, **right** justified with leading zeros, e.g., COBOL PIC 9(12). A format specification of N12 is numeric, with length of up to 12.
- Alphanumeric data should be **left** justified and blank filled, e.g., COBOL PIC X(50). A format specification of A80 is alphanumeric, with length of up to 80.
- Issue Date and Maturity Date fields should be in the format of MMDDYYYY with leading zero for months January-September and for the 1st to the 9th day of the month (e.g., 01092004 = January 9, 2004)
- The filler should be a space, e.g., in COBOL PIC X value spaces.
- Columns corresponding to null or not applicable items should be space filled

External Label for CD submissions (affix to media, not to cover)

Company Name

Reporter Identification Number as assigned by the FRBNY Data

Processing Contact Name and Telephone Number

CD Identification Number (as identified in your records)

Total Number of CD: 1 or ___

Creation Date

Contents: 2014 Report of Foreign Holdings of U.S. Securities, Including Selected Money Market
Securities (SHL)

APPENDIX I

LIST OF FEDERAL AGENCIES AND FEDERALLY SPONSORED ENTERPRISES

A. U.S. FEDERAL GOVERNMENT AGENCIES and CORPORATIONS

Architect of the Capital
Commodity Credit Corporation (CCC)
Department of Agriculture, including former Rural Electrification Administration (REA),
and former Farmers Housing Administration (FmHA).
Department of Defense and Military Services (e.g. Air Force)
Department of Housing and Urban Development (HUD)
Department of Interior
Export-Import Bank of the United States (Ex-Im Bank)
Federal Communication Commission (FCC)
Farm Credit System Financial Assistance Corporation (FCSFAC)
Federal Deposit Insurance Corporation (FDIC), including FSLIC Resolution Fund
Federal Housing Administration (FHA)
Financing Corporation (FICO)
General Services Administration (GSA)
Government National Mortgage Association (GNMA or Ginnie Mae)
Maritime Administration
National Archives and Records Administration (NARA)
National Consumer Cooperative Bank
Overseas Private Investment Corporation (OPIC)
Resolution Funding Corporation (REFCORP)
Rural Telephone Bank
Small Business Administration (SBA)
Tennessee Valley Authority (TVA), including lease obligations
Washington Metropolitan Area Transit Authority (WMATA)

B. FEDERALLY SPONSORED ENTERPRISES

Farm Credit System:
 Agricultural Credit Bank (ACB)
 Farm Credit Banks (FCB)
Federal Agricultural Mortgage Corporation (FAMC or Farmer Mac)
Federal Home Loan Banks (FHLB)
Federal Home Loan Mortgage Corporation (FHLMC or Freddie Mac)
Federal National Mortgage Association (FNMA or Fannie Mae)