

RECOMMENDATION ITU-R M.541-9*

Operational procedures for the use of digital selective-calling equipment in the maritime mobile service

(1978-1982-1986-1990-1992-1994-1995-1996-1997-2004)

Summary

The Recommendation contains the operational procedures for digital selective-calling (DSC) equipment whose technical characteristics are given in Recommendation ITU-R M.493. The Recommendation contains five annexes. In Annexes 1 and 2 the provisions and procedures are described for distress, urgency and safety calls and for routine calls, respectively. In Annexes 3 and 4 the operational procedures for ships and for coast stations are described and Annex 5 lists the frequencies to be used for DSC.

The ITU Radiocommunication Assembly,

considering

- a) that digital selective-calling (DSC) will be used as described in Recommendation ITU-R M.493;
- b) that the requirements of Chapter IV of the International Convention for the Safety of Life at Sea (SOLAS), 1974, as amended, for the Global Maritime Distress and Safety System (GMDSS) are based on the use of DSC for distress alerting and calling and that operational procedures are necessary for the use of that system;
- c) that, as far as is practicable, operational procedures in all frequency bands and for all types of communications should be similar;
- d) that DSC may provide a useful supplementary means of transmitting a distress alert in addition to the provisions of transmitting the distress alert by existing methods and procedures in the Radio Regulations (RR);
- e) that conditions when alarms have to be actuated should be specified,

recommends

- 1 that the technical characteristics of equipment used for DSC in the maritime mobile service should be in conformity with the relevant ITU-R Recommendations;
- 2 that the operational procedures to be observed in the MF, HF and VHF bands for DSC should be in accordance with Annex 1 for distress and safety calls and Annex 2 for other calls;
- 3 that provisions should be made at stations equipped for DSC for:
 - 3.1 the manual entry of address, type of call, category and various messages into a DSC sequence;
 - 3.2 the verification and if necessary the correction of such manually formed sequences;

* This Recommendation should be brought to the attention of the International Maritime Organization (IMO) and the ITU Telecommunication Standardization Sector (ITU-T).

3.3 a specific aural alarm and visual indication to indicate receipt of a distress or urgency call or a call having distress category. It should not be possible to disable this alarm and indication. Provisions should be made to ensure that they can be reset only manually;

3.4 aural alarm(s) and visual indication for calls other than distress and urgency. The aural alarm(s) may be capable of being disabled;

3.5 such visual indicators to indicate:

3.5.1 type of received call address (to all stations, to a group of stations, geographical, individual);

3.5.2 category;

3.5.3 identity of calling station;

3.5.4 numerical or alpha-numerical type of information, e.g. frequency information and telecommand;

3.5.5 type of “end of sequence” character;

3.5.6 detection of errors, if any;

3.6 monitoring the DSC channel to determine the presence of a signal and, except for distress, urgency, and non-test safety calls, provide facilities for automatically preventing the transmission of a DSC call until the channel is free;

4 that the equipment should be simple to operate;

5 that the operational procedures given in Annexes 3 and 4, which are based on the relevant procedures from Annexes 1 and 2 and from the RR, be used as guidance for ships and coast stations;

6 that the frequencies used for distress and safety purposes using DSC are those contained in Annex 5 to this Recommendation (see RR Appendix 15).

NOTE 1 – The following definitions are used throughout this Recommendation:

Single frequency: the same frequency is used for transmission and reception.

Paired frequencies: frequencies which are associated in pairs; each pair consisting of one transmitting and one receiving frequency.

International DSC frequencies: those frequencies designated in the RR for exclusive use for DSC on an international basis.

National DSC frequencies: those frequencies assigned to individual coast stations or a group of stations on which DSC is permitted (this may include working frequencies as well as calling frequencies). The use of these frequencies must be in accordance with the RR.

Automatic DSC operation at a ship station: a mode of operation employing automatic tunable transmitters and receivers, suitable for unattended operation, which provide for automatic call acknowledgements upon reception of a DSC and automatic transfer to the appropriate working frequencies.

Call attempt: one or a limited number of call sequences directed to the same stations on one or more frequencies and within a relatively short time period (e.g. a few minutes). A call attempt is considered unsuccessful if a calling sequence contains the symbol RQ at the end of the sequence and no acknowledgement is received in this time interval.

Annex 1

Provisions and procedures for distress, urgency and safety calls

1 Introduction

The terrestrial elements of the GMDSS adopted by the 1988 Amendments to the International Convention for SOLAS, 1974, are based on the use of DSC for distress and safety communications.

1.1 Method of calling

The provisions of RR Chapter VII are applicable to the use of DSC in cases of distress, urgency or safety.

2 DSC distress alert

The DSC distress alert provides for alerting, self-identification, ship's position including time, and nature of distress as defined in the RR (See RR Chapter VII).

3 Procedures for DSC distress alerts

3.1 Transmission by a mobile unit in distress

3.1.1 The DSC equipment should be capable of being preset to transmit the distress alert on at least one distress alerting frequency.

3.1.2 The distress alert shall be composed in accordance with Recommendation ITU-R M.493; the ship's position information, the time at which it was taken and the nature of distress should be entered as appropriate. If the position of the ship cannot be entered, then the position information signals shall be transmitted automatically as the digit 9 repeated ten times. If the time cannot be included, then the time information signals shall be transmitted automatically as the digit 8 repeated four times.

3.1.3 Distress alert attempt

At MF and HF a distress alert attempt may be transmitted as a single frequency or a multi-frequency call attempt. At VHF only single frequency call attempts are used.

3.1.3.1 Single frequency call attempt

A distress alert attempt should be transmitted as 5 consecutive calls on one frequency. To avoid call collision and the loss of acknowledgements, this call attempt may be transmitted on the same frequency again after a random delay of between 3½ and 4½ min from the beginning of the initial call. This allows acknowledgements arriving randomly to be received without being blocked by retransmission. The random delay should be generated automatically for each repeated transmission, however it should be possible to override the automatic repeat manually.

At MF and HF, single frequency call attempts may be repeated on different frequencies after a random delay of between 3½ and 4½ min from the beginning of the initial call. However, if a station is capable of receiving acknowledgements continuously on all distress frequencies except for the transmit frequency in use, then single frequency call attempts may be repeated on different frequencies without this delay.

3.1.3.2 Multi-frequency call attempt

A distress alert attempt may be transmitted as up to 6 consecutive (see Note 1) calls dispersed over a maximum of 6 distress frequencies (1 at MF and 5 at HF). Stations transmitting multi-frequency distress alert attempts should be able to receive acknowledgements continuously on all frequencies except for the transmit frequency in use, or be able to complete the call attempt within 1 min.

Multi-frequency call attempts may be repeated after a random delay of between 3½ and 4½ min from the beginning of the previous call attempt.

NOTE 1 – A VHF call may be transmitted simultaneously with an MF/HF call.

3.1.4 Distress

In the case of distress the operator should:

3.1.4.1 enter the desired mode of the subsequent communication and if time permits, enter the ship's position and time (see Note 1) it was taken and the nature of distress (see Note 1);

NOTE 1 – If these are not provided automatically.

3.1.4.2 select the distress frequency(ies) to be used (see Note 1 of § 3.1.4.1);

3.1.4.3 activate the distress alert attempt by a dedicated distress button.

3.2 Reception

The DSC equipment should be capable of maintaining a reliable watch on a 24-hour basis on appropriate DSC distress alerting frequencies.

3.3 Acknowledgement of distress alerts

Acknowledgements of distress alerts should be initiated manually.

Acknowledgements should be transmitted on the same frequency as the distress alert was received.

3.3.1 Distress alerts should normally be acknowledged by DSC only by appropriate coast stations. Coast stations should, in addition, set watch on radiotelephony and, if the “mode of subsequent communication” signal in the received distress alert indicates teleprinter, also on narrow-band direct-printing (NBDP) (see Recommendation ITU-R M.493). In both cases, the radiotelephone and NBDP frequencies should be those associated with the frequency on which the distress alert was received.

3.3.2 Acknowledgements by coast stations of DSC distress alerts transmitted on MF or HF should be initiated with a minimum delay of 1 min after receipt of a distress alert, and normally within a maximum delay of 2¾ min. This allows all calls within a single frequency or multi-frequency call attempt to be completed and should allow sufficient time for coast stations to respond to the distress alert. Acknowledgements by coast stations on VHF should be transmitted as soon as practicable.

3.3.3 The acknowledgement of a distress alert consists of a single DSC acknowledgement call which should be addressed to “all ships” and include the identification (see Recommendation ITU-R M.493) of the ship whose distress alert is being acknowledged.

3.3.4 Ships receiving a DSC distress alert from another ship should set watch on an associated radiotelephone distress and safety traffic frequency and acknowledge the call by radiotelephony.

If a ship station continues to receive a DSC distress alert on an MF or VHF channel, a DSC acknowledgement should be transmitted to terminate the call only after consulting with a Rescue Coordination Centre or a Coast Station and being directed to do so.

3.3.5 The automatic repetition of a distress alert attempt should be terminated automatically on receipt of a DSC distress acknowledgement.

3.3.6 When distress, urgency, and safety traffic cannot be successfully conducted using radiotelephony, an affected station may indicate its intention to conduct subsequent communications on the associated frequency for NBDP telegraphy.

3.4 Distress relays

Distress relay calls should be initiated manually.

3.4.1 A distress relay call should use the telecommand signal “distress relay” in accordance with Recommendation ITU-R M.493 and the calling attempt should follow the procedures described in § 3.1.3 to 3.1.3.2 for distress alerts, except that the alert is sent manually as a single call on a single frequency.

3.4.2 Any ship, receiving a distress alert on an HF channel which is not acknowledged by a coast station within 5 min, should transmit a distress relay call to the appropriate coast station.

3.4.3 Distress relay calls transmitted by coast stations, or by ship stations addressed to more than one vessel, should be acknowledged by ship stations using radiotelephony. Distress relay calls transmitted by ship stations should be acknowledged by a coast station transmitting a “distress relay acknowledgement” call in accordance with the procedures for distress acknowledgements given in § 3.3 to 3.3.3.

4 Procedures for DSC urgency and safety calls

4.1 DSC, on the distress and safety calling frequencies, should be used by coast stations to advise shipping, and by ships to advise coast stations and/or ship stations, of the impending transmission of urgency, vital navigational and safety messages, except where the transmissions take place at routine times. The call should indicate the working frequency which will be used for the subsequent transmission of an urgent, vital navigational or safety message.

4.2 The announcement and identification of medical transports should be carried out by DSC techniques, using appropriate distress and safety calling frequencies. Such calls should use the category “urgency”, and telecommand “medical transport” and be addressed to all ships at VHF and Geographic Area at MF/HF.

4.3 The operational procedures for urgency and safety calls should be in accordance with the relevant parts of Annex 3, § 2.1 or 2.2 and 3.1. or 3.2.

5 Testing the equipment used for distress and safety calls

Testing on the exclusive DSC distress and safety calling frequencies should be avoided as far as possible by using other methods. VHF, MF and HF test calls should be in accordance with Recommendation ITU-R M.493 (see Table 4.7) and the call may be acknowledged by the called station. Normally there would be no further communication between the two stations involved.

Annex 2

Provisions and procedures for routine calls

1 Frequency/channels

1.1 As a rule, paired frequencies should be used at HF and MF, in which case an acknowledgement is transmitted on the frequency paired with the frequency of the received call. In exceptional cases for national purposes a single frequency may be used. If the same call is received on several calling channels, the most appropriate shall be chosen to transmit the acknowledgement. A single frequency channel should be used at VHF.

1.2 International calling

The paired frequencies listed in RR Appendix 17, Part A and in Annex 5 of this Recommendation should be used for international DSC calling.

1.2.1 At HF and MF international DSC frequencies should only be used for shore-to-ship calls and for the associated call acknowledgements from ships fitted for automatic DSC operation where it is known that the ships concerned are not listening to the coast station’s national frequencies.

1.2.2 All ship-to-shore DSC calling at HF and MF should preferably be done on the coast station's national frequencies.

1.3 National calling

Coast stations should avoid using the international DSC frequencies for calls that may be placed using national frequencies.

1.3.1 Ship stations should keep watch on appropriate national and international channels. (Appropriate measures should be taken for an even loading of national and international channels.)

1.3.2 Administrations are urged to find methods and negotiate terms to improve the utilization of the DSC channels available, e.g.:

- coordinated and/or joint use of coast station transmitters;
- optimizing the probability of successful calls by providing information to ships on suitable frequencies (channels) to be watched and by information from ships to a selected number of coast stations on the channels watched on-board.

1.4 Method of calling

1.4.1 The procedures set out in this section are applicable to the use of DSC techniques, except in cases of distress, urgency or safety, to which the provisions of RR Chapter VII are applicable.

1.4.2 The call shall contain information indicating the station or stations to which the call is directed, and the identification of the calling station.

1.4.3 The call should also contain information indicating the type of communication to be set up and may include supplementary information such as a proposed working frequency or channel; this information shall always be included in calls from coast stations, which shall have priority for that purpose.

1.4.4 An appropriate digital selective calling channel chosen in accordance with the provisions of RR Nos. 52.128 to 52.137 or Nos. 52.145 to 52.153, as appropriate, shall be used for the call.

2 Operating procedures

The technical format of the call sequence shall be in conformity with the relevant ITU-R Recommendations.

The reply to a DSC requesting an acknowledgement shall be made by transmitting an appropriate acknowledgement using DSC techniques.

Acknowledgements may be initiated either manually or automatically. When an acknowledgement can be transmitted automatically, it shall be in conformity with the relevant ITU-R Recommendations.

The technical format of the acknowledgement sequence shall be in conformity with the relevant ITU-R Recommendations.

For communication between a coast station and a ship station, the coast station shall finally decide the working frequency or channel to be used.

The forwarding traffic and the control for working for radiotelephony shall be carried out in accordance with Recommendation ITU-R M.1171.

A typical DSC calling and acknowledgement sequence contains the following signals (see Recommendation ITU-R M.493).

Composition of a typical routine DSC calling and acknowledgement sequence

<i>Signal</i>	<i>Method of composition</i>
– format specifier	operator selected
– address	operator entered
– category (routine)	automatically selected
– self-identification	pre-programmed
– telecommand information	seleccionada por el operador
– frequency information (if appropriate)	operator selected or entered
– telephone number (semi-automatic/automatic ship-to-shore connections only)	operator entered
– end of sequence signal	automatically selected.

2.1 Coast station initiates call to ship station (see Note 1)

Figures 1 and 2 illustrate the procedures below in flow chart and by time sequence diagram respectively

NOTE 1 – See Recommendations ITU-R M.689 and ITU-R M.1082 for further details of procedures applicable only to the semi-automatic/automatic services.

2.1.2 If a direct connection exists between the calling subscriber and the coast station, the coast station asks the calling subscriber for the approximate position of the ship.

2.1.3 If the ship's position cannot be indicated by the caller, the coast station operator tries to find the location in the information available at the coast station.

2.1.4 The coast station checks to see whether the call would be more appropriate through another coast station (see § 1.3.2).

2.1.5 The coast station checks to see whether the transmission of a DSC is inappropriate or restricted (e.g. ship not fitted with DSC or barred).

2.1.6 Assuming a DSC is appropriate the coast station composes the calling sequence as follows:

- selects format specifier,
- enters address of the ship,
- selects category,
- selects telecommand information,
- inserts working frequency information in the message part of the sequence, if appropriate,
- usually selects “end of sequence” signal “RQ”. However, if the coast station knows that the ship station cannot respond or the call is to a group of ships the frequency is omitted and the end of sequence signal should be 127, in which case the following procedures (§ 2.1.13 to 2.1.15) relating to an acknowledgement are not applicable.

FIGURE 1
Flow chart of operational procedures for calling in the shore-to-ship direction

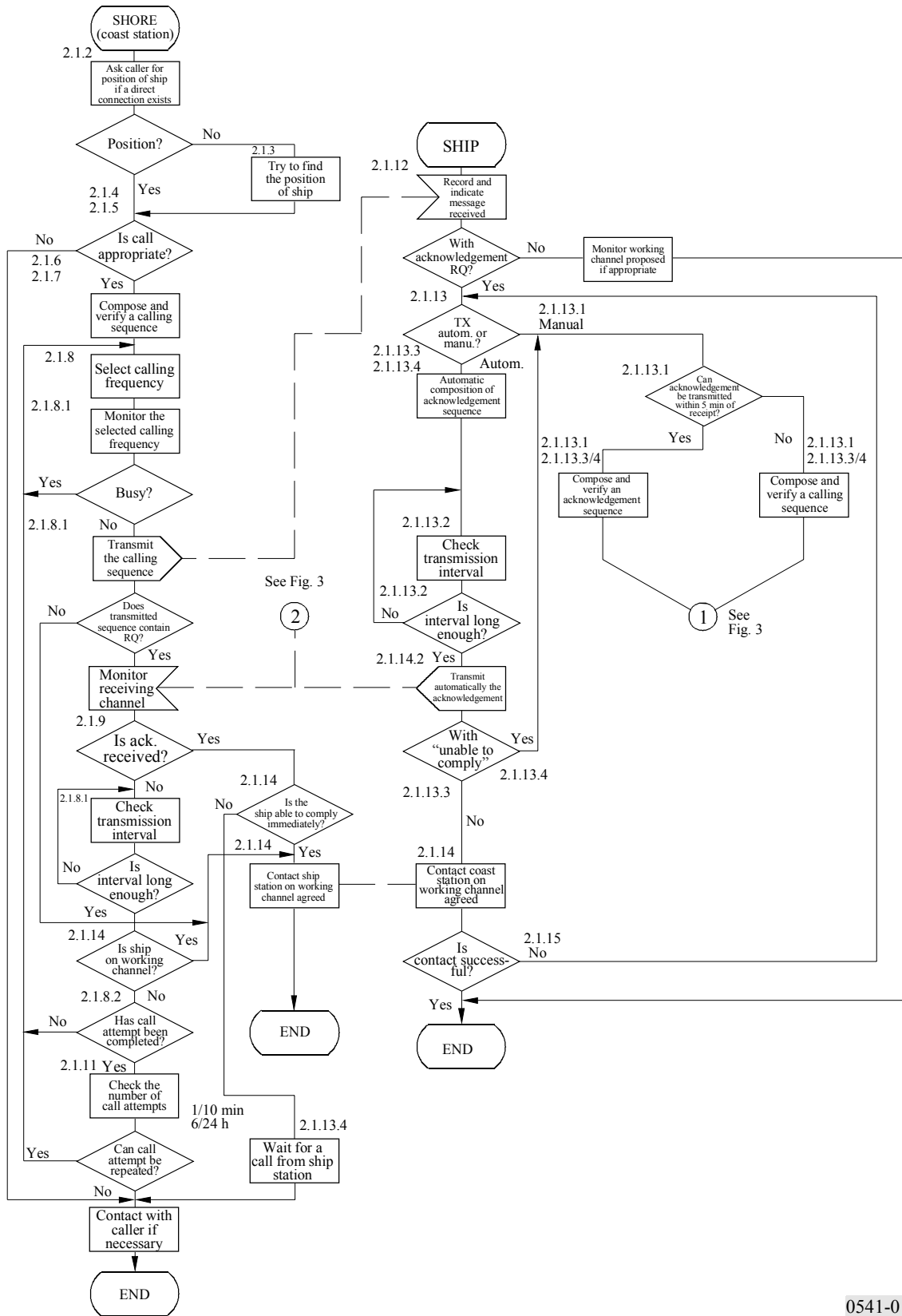
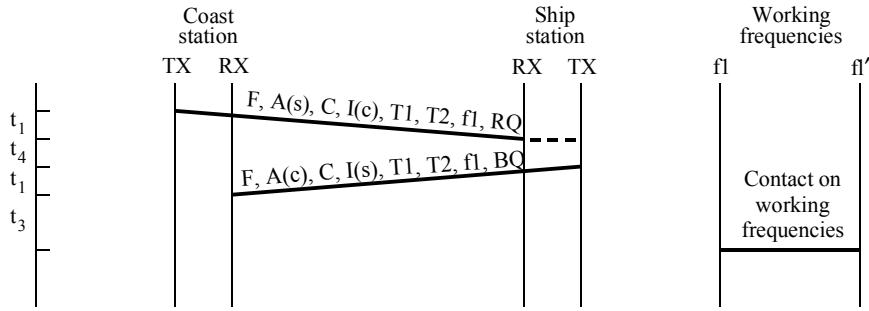
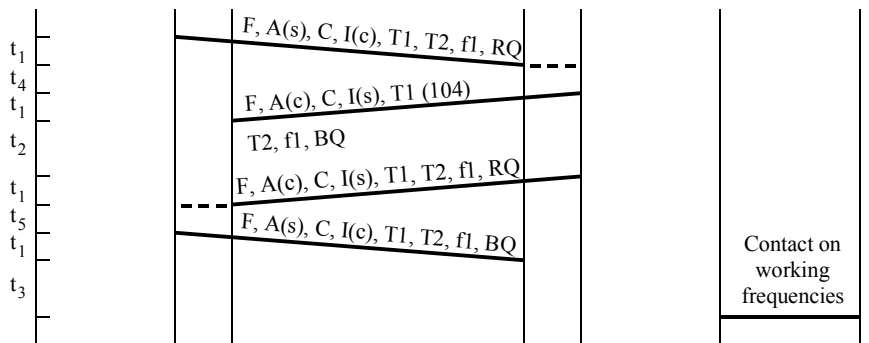

FIGURE 2

Examples of timing diagrams for calling in shore-to-ship direction



a) Automated transmitter (able to comply)



b) Automated transmitter (unable to comply)

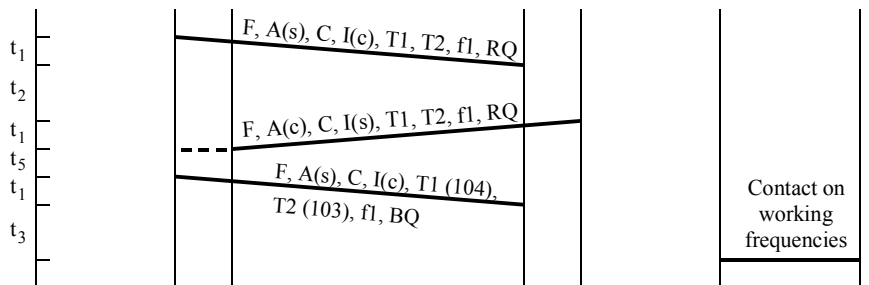

c) Ship transmitter not automated. Ship makes a delayed (>5 min) response to coast station and encounters queue on working frequency

- | | | |
|---|---------|--|
| t ₁ : transmission time of a DSC sequence | F | : format specifier |
| t ₂ : interval between the DSC reception at the ship and transmission from the ship after the operator's appearance in the radio room (from several minutes up to several hours) | A | : called station address |
| t ₃ : transition time from calling to working frequency including, if necessary, the time for working channel clearing (queue waiting time) | I | : calling station self-identification |
| t ₄ : as defined in § 2.1.13.2 | C | : category |
| t ₅ : time for coast station to prepare acknowledgement (see § 2.2.6) | T1 | : first telecommand signal, (104) indicates unable to comply |
| | T2 | : second telecommand signal, (103) indicates queue |
| | f1, f1' | : working frequencies |
| | RQ, BQ | : end of sequence signals |
- } suffix (c) or (s) indicates coast station or ship station respectively

2.1.7 The coast station verifies the calling sequence.

The call shall be transmitted once on a single appropriate calling channel or frequency only. Only in exceptional circumstances may a call be transmitted simultaneously on more than one frequency.

2.1.8 The coast station operator chooses the calling frequencies which are most suitable for the ship's location.

2.1.8.1 After checking as far as possible that there are no calls in progress, the coast station operator initiates the transmission of the sequence on one of the frequencies chosen. Transmission on any one frequency should be limited to no more than 2 call sequences separated by intervals of at least 45 s to allow for reception of an acknowledgement from the ship.

2.1.8.2 If appropriate, a "call attempt" may be transmitted, which may include the transmission of the same call sequence on other frequencies (if necessary with a change of working frequency information to correspond to the same band as the calling frequency) made in turn at intervals of not less than 5 min, following the same pattern as in § 2.1.8.1.

2.1.9 If an acknowledgement is received further transmission of the call sequence should not take place.

The coast station shall then prepare to transmit traffic on the working channel or frequency it has proposed.

2.1.10 The acknowledgement of the received call should only be transmitted upon receipt of a calling sequence which terminates with an acknowledgement request.

2.1.11 When a station called does not reply, the call attempt should not normally be repeated until after an interval of at least 15 min. The same call attempt should not be repeated more than five times every 24 h. The aggregate of the times for which frequencies are occupied in one call attempt, should normally not exceed 1 min.

The following procedures apply at the ship:

2.1.12 Upon receipt of a calling sequence at the ship station, the received message should be displayed.

2.1.13 When a received call sequence contains an end of sequence signal "RQ", an acknowledgement sequence should be composed and transmitted.

The format specifier and category information should be identical to that in the received calling sequence.

2.1.13.1 If the ship station is not equipped for automatic DSC operation, the ship's operator initiates an acknowledgement to the coast station after a delay of at least 5 s but no later than 4½ min of receiving the calling sequence, using the ship-to-shore calling procedures detailed in § 2.2. However the transmitted sequence should contain a "BQ" end of sequence signal in place of the "RQ" signal.

If such an acknowledgement cannot be transmitted within 5 min of receiving the calling sequence then the ship station should instead transmit a calling sequence to the coast station using the ship-to-shore calling procedure detailed in § 2.2.

2.1.13.2 If the ship is equipped for automatic DSC operation, the ship station automatically transmits an acknowledgement with an end of sequence signal "BQ". The start of the transmission of this acknowledgement sequence should be within 30 s for HF and MF or within 3 s for VHF after the reception of the complete call sequence.

2.1.13.3 If the ship is able to comply immediately the acknowledgement sequence should include a telecommand signal which is identical to that received in the calling sequence indicating that it is able to comply.

If no working frequency was proposed in the call, the ship station should include a proposal for a working frequency in its acknowledgement.

2.1.13.4 If the ship is not able to comply immediately the acknowledgement sequence should include the telecommand signal 104 (unable to comply), with a second telecommand signal giving additional information (see Recommendation ITU-R M.493).

At some later time when the ship is able to accept the traffic being offered, the ship's operator initiates a call to the coast station using the ship-to-shore calling procedures detailed in § 2.2.

2.1.14 If a call is acknowledged indicating ability to comply immediately and communication between coast station and ship station on the working channel agreed is established, the DSC call procedure is considered to be completed.

2.1.15 If the ship station transmits an acknowledgement which is not received by the coast station then this will result in the coast station repeating the call (in accordance with § 2.1.11). In this event the ship station should transmit a new acknowledgement. If no repeated call is received the ship station should transmit an acknowledgement or calling sequence in accordance with § 2.1.13.1.

2.2 Ship station initiates call to coast station (see Note 1)

Figures 3 and 4 illustrate the procedures below in flow chart and by time sequence diagram respectively.

This procedure should also be followed both as a delayed response to a call received earlier from the coast station (see § 2.1.13.1) and to initiate traffic from the ship station.

NOTE 1 – See Recommendations ITU-R M.689 and ITU-R M.1082 for further details of procedures applicable only to the semi-automatic/automatic services.

2.2.1 The ship composes the calling sequence as follows:

- operator selects the format specifier,
- operator enters address,
- automatically selected category,
- pre-programmed self-identification,
- operator selects the telecommand information,
- operator inserts (selects or enters) working frequency, or enters position (for MF/HF only) information in the message part of the sequence if appropriate,
- operator enters telephone number required (semi-automatic/automatic connections only),
- automatically selected “end of sequence” signal RQ.

FIGURE 3
Flow chart of operational procedures for calling in the ship-to-shore direction

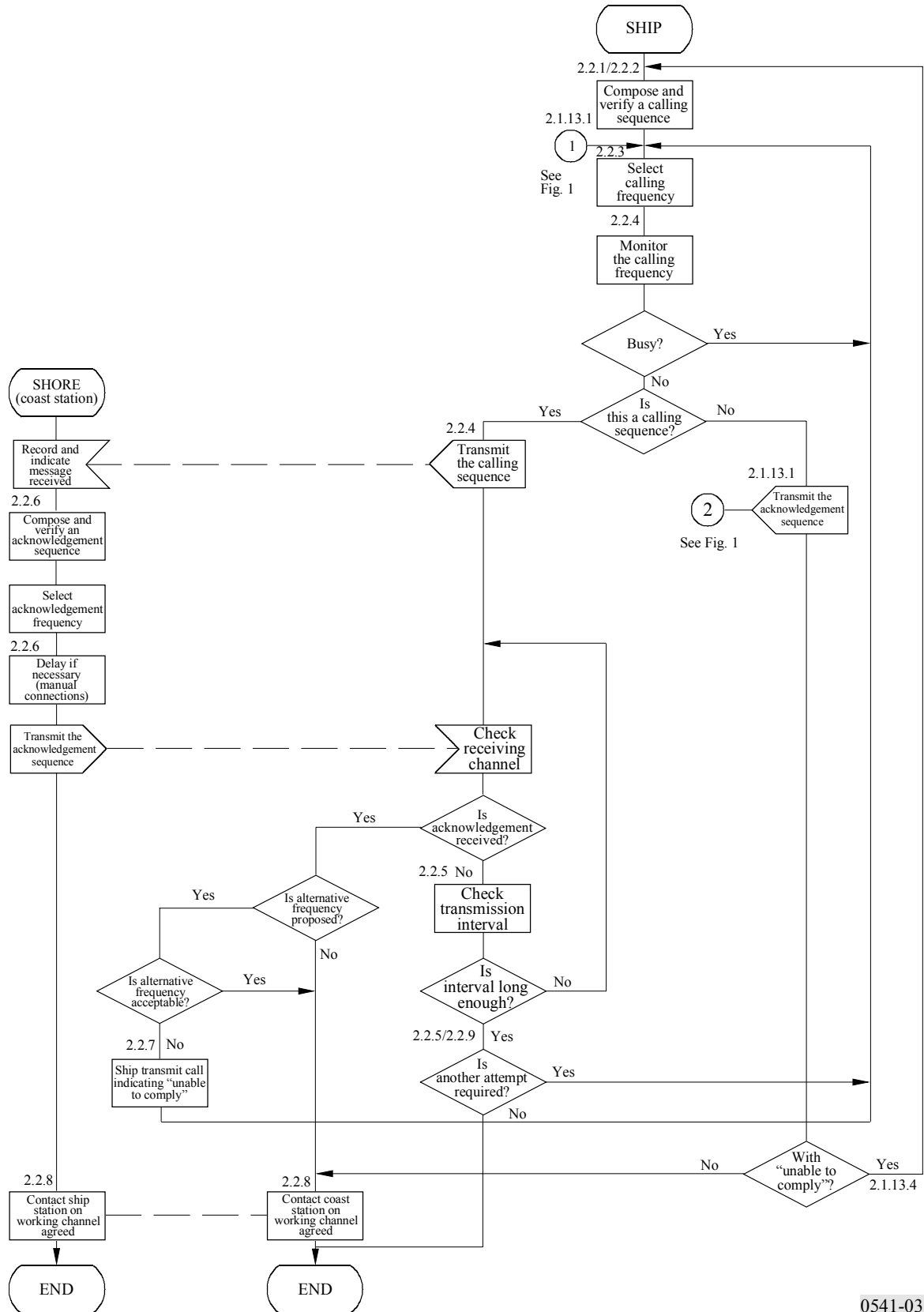
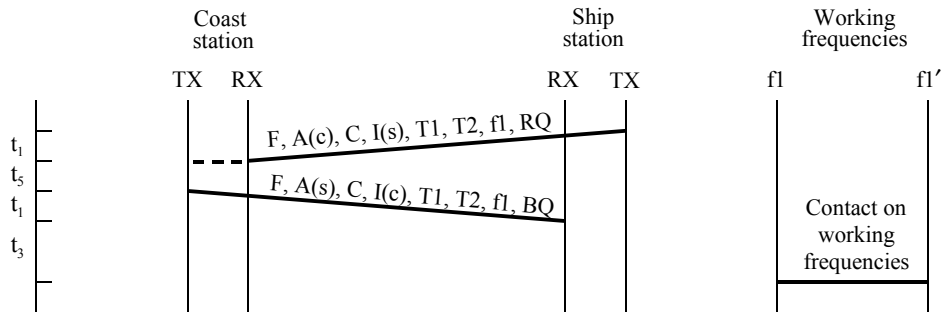
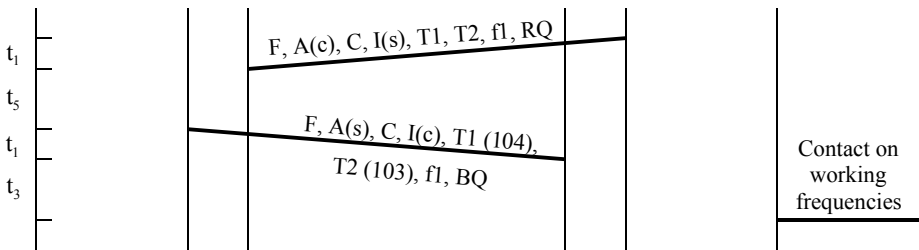

FIGURE 4
Examples of timing diagrams for calling in ship-to-shore direction



a) Able to comply immediately



b) Queue exists on working frequency

- t_1 : transmission time of a DSC sequence
- t_3 : transition time from calling to working frequency including, if necessary, the time for working channel clearing (queue waiting time)
- t_5 : time for coast station to prepare acknowledgement (see § 2.2.6)
- F : format specifier
- A : called station address
- I : calling station self-identification
- C : category
- T1 : first telecommand signal, (104) indicates unable to comply
- T2 : second telecommand signal, (103) indicates queue
- f_1, f_1' : working frequencies
- RQ, BQ : end of sequence signals

0541-04

2.2.2 The ship verifies the calling sequence.

2.2.3 The ship selects the single most appropriate calling frequency preferably using the coast station's nationally assigned calling channels, for which purpose it shall send a single calling sequence on the selected frequency.

2.2.4 The ship initiates the transmission of the sequence on the frequency selected after checking as far as possible that there are no calls in progress on that frequency.

FIGURE 5
Composition procedures for calling and acknowledgement sequences
 (for calls other than distress and safety)

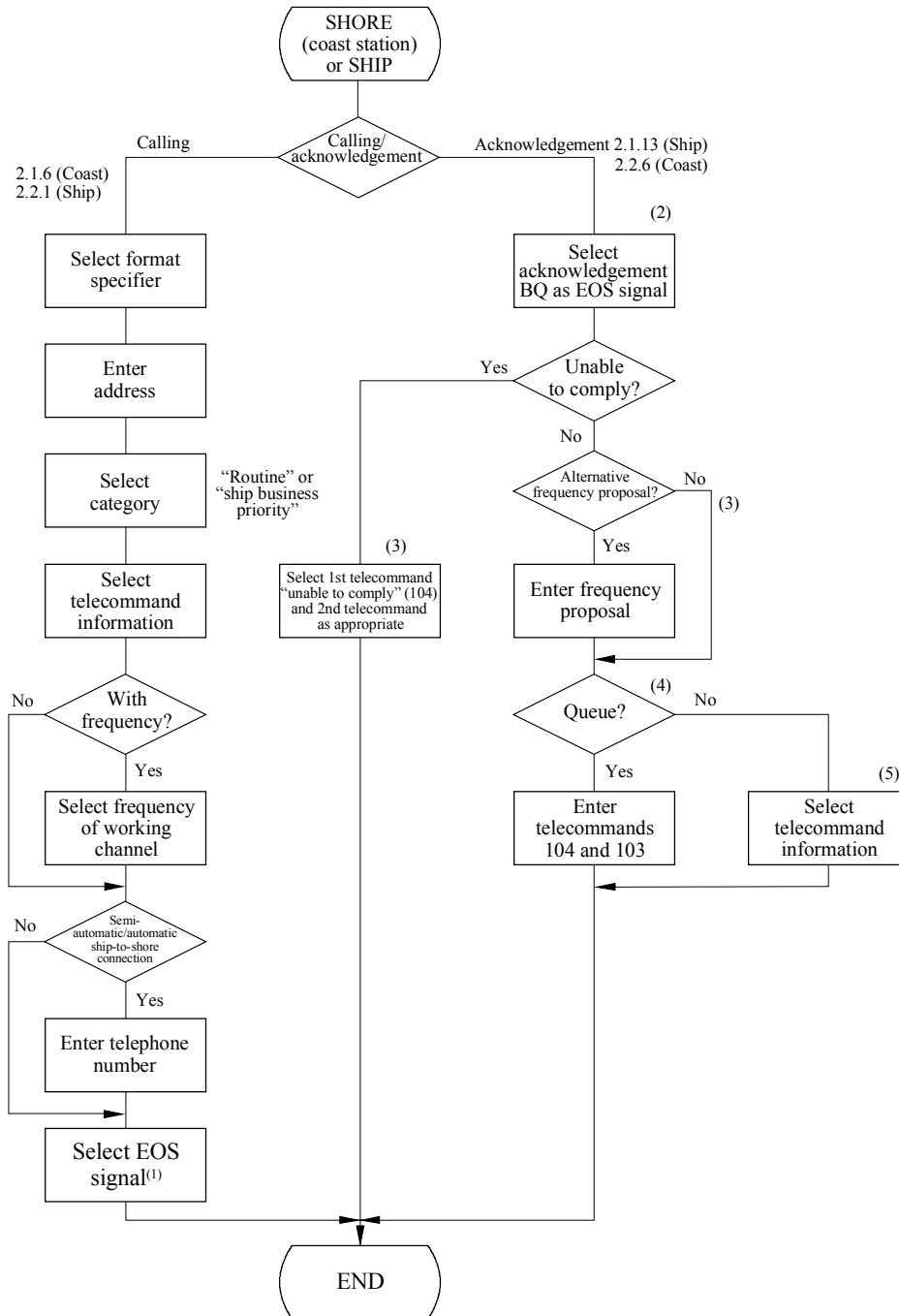

- (1) Normally acknowledgement RQ may automatically be selected as an EOS signal of a calling sequence to an individual station.
- (2) The format specifier and the category are automatically transferred from the received call. The self-ID in the received sequence is automatically transferred into the address part of acknowledgement sequence by selecting acknowledgement BQ.
- (3) The frequency information is automatically transferred from the received call.
- (4) This procedure is only for coast stations.
- (5) When able to comply, and no queue exists, then the telecommand information is automatically transferred from the received call.

2.2.5 If a called station does not reply, the call sequence from the ship station should not normally be repeated until after an interval of at least 5 min for manual connections, or 5 s or 25 s in the case of semi-automatic/automatic VHF or MF/HF connections respectively. These repetitions may be made on alternative frequencies if appropriate. Any subsequent repetitions to the same coast station should not be made until at least 15 min have elapsed.

2.2.6 The coast station should transmit an acknowledgement sequence (after checking as far as possible that there are no calls in progress on the frequency selected), after a delay of at least 5 s but not later than 4½ min for manual connections, or, within 3 s for semi-automatic/automatic connections, containing the format specifier, the address of the ship, the category, the coast station self-identification and:

- if able to comply immediately on the working frequency suggested, the same telecommand and frequency information as in the call request;
- if no working frequency was suggested by the ship station then the acknowledgement sequence should include a channel/frequency proposal;
- if not able to comply on the working frequency suggested but able to comply immediately on an alternative frequency, the same telecommand information as in the call request but an alternative working frequency;
- if unable to comply immediately the telecommand signal 104 with a second telecommand signal giving additional information. For manual connections only, this second telecommand signal may include a queue indication.

The end of sequence signal BQ should also be included.

2.2.7 For manual connections, if a working frequency is proposed in accordance with § 2.2.6 but this is not acceptable to the ship station, then the ship station should immediately transmit a new call requesting an alternative frequency.

2.2.8 If an acknowledgement is received further transmission of the call sequence should not take place. On receipt of an acknowledgement which indicates ability to comply, the DSC procedures are complete and both coast station and ship station should communicate on the working frequencies agreed with no further exchange of DSC calls.

2.2.9 If the coast station transmits an acknowledgement which is not received at the ship station then the ship station should repeat the call in accordance with § 2.2.5.

2.3 Ship station initiates call to ship station

The ship-to-ship procedures should be similar to those given in § 2.2, where the receiving ship station complies with the procedures given for coast stations, as appropriate, except that, with respect to § 2.2.1, the calling ship should always insert working frequency information in the message part of the calling sequence.

Annex 3

Operational procedures for ships for DSC communications on MF, HF and VHF

Introduction

Procedures for DSC communications on MF and VHF are described in § 1 to 5 below.

The procedures for DSC communications on HF are in general the same as for MF and VHF. Special conditions to be taken into account when making DSC communications on HF are described in § 6 below.

1 Distress

1.1 Transmission of DSC distress alert

A distress alert should be transmitted if, in the opinion of the Master, the ship or a person is in distress and requires immediate assistance.

A DSC distress alert should as far as possible include the ship's last known position and the time (in UTC) when it was valid. The position and the time may be included automatically by the ship's navigational equipment or may be inserted manually.

The DSC distress alert is transmitted as follows:

- tune the transmitter to the DSC distress channel (2 187.5 kHz on MF, channel 70 on VHF (see Note 1)).

NOTE 1 – Some maritime MF radiotelephony transmitters shall be tuned to a frequency 1 700 Hz lower than 2 187.5 kHz, i.e. 2 185.8 kHz, in order to transmit the DSC distress alert on 2 187.5 kHz;

- if time permits, key in or select on the DSC equipment keyboard
 - the nature of distress,
 - the ship's last known position (latitude and longitude),
 - the time (in UTC) the position was valid,
 - type of subsequent distress communication (telephony),

in accordance with the DSC equipment manufacturer's instructions;

- transmit the DSC distress alert;
- prepare for the subsequent distress traffic by tuning the transmitter and the radiotelephony receiver to the distress traffic channel in the same band, i.e. 2 182 kHz on MF, channel 16 on VHF, while waiting for the DSC distress acknowledgement.

1.2 Actions on receipt of a distress alert

Ships receiving a DSC distress alert from another ship should normally not acknowledge the distress alert by DSC since acknowledgement of a DSC distress alert by use of DSC is normally made by coast stations only (see Annex 1 § 3.3.4 and Annex 3 § 6.1.4).

If a ship station continues to receive a DSC distress alert on an MF or VHF channel, a DSC acknowledgement should be transmitted to terminate the call only after consulting with a Rescue Coordination Centre or a Coast Station and being directed to do so.

Ships receiving a DSC distress alert from another ship should also defer the acknowledgement of the distress alert by radiotelephony for a short interval, if the ship is within an area covered by one or more coast stations, in order to give the coast station time to acknowledge the DSC distress alert first.

Ships receiving a DSC distress alert from another ship shall:

- watch for the reception of a distress acknowledgement on the distress channel (2 187.5 kHz on MF and channel 70 on VHF);
- prepare for receiving the subsequent distress communication by tuning the radiotelephony receiver to the distress traffic frequency in the same band in which the DSC distress alert was received, i.e. 2 182 kHz on MF, channel 16 on VHF;
- acknowledge the receipt of the distress alert by transmitting the following by radiotelephony on the distress traffic frequency in the same band in which the DSC distress alert was received, i.e. 2 182 kHz on MF, channel 16 on VHF:
 - “MAYDAY”,
 - the 9-digit identity of the ship in distress, repeated 3 times,
 - “this is”,
 - the 9-digit identity or the call sign or other identification of own ship, repeated 3 times,
 - “RECEIVED MAYDAY”.

1.3 Distress traffic

On receipt of a DSC distress acknowledgement the ship in distress should commence the distress traffic by radiotelephony on the distress traffic frequency (2 182 kHz on MF, channel 16 on VHF) as follows:

- “MAYDAY”,
- “this is”,
- the 9-digit identity *and* the call sign or other identification of the ship,
- the ship’s position in latitude and longitude or other reference to a known geographical location,
- the nature of distress and assistance wanted,
- any other information which might facilitate the rescue.

1.4 Transmission of a DSC distress relay call

In no case is a ship permitted to transmit an all ships DSC distress relay call on receipt of a DSC distress alert on either VHF or MF channels. If no aural watch is present on the relative channel (2 182 kHz on MF, channel 16 on VHF), the coast station should be contacted by sending an individual DSC distress relay call.

1.4.1 Transmission of a DSC distress relay call on behalf of someone else

A ship knowing that another ship is in distress shall transmit a DSC distress relay call if:

- the ship in distress is not itself able to transmit the distress alert,
- the Master of the ship considers that further help is necessary.

The DSC distress relay call is transmitted as follows:

- tune the transmitter to the DSC distress channel (2 187.5 kHz on MF, channel 70 on VHF),
- select the distress relay call format on the DSC equipment,
- key in or select on the DSC equipment keyboard:
 - All Ships Call (VHF). Geographic Area Call (MF/HF) or the 9-digit identity of the appropriate coast station,
 - the 9-digit identity of the ship in distress, if known,
 - the nature of distress,
 - the latest position of the ship in distress, if known,
 - the time (in UTC) the position was valid (if known),
 - type of subsequent distress communication (telephony);
- transmit the DSC distress relay call;
- prepare for the subsequent distress traffic by tuning the transmitter and the radiotelephony receiver to the distress traffic channel in the same band, i.e. 2 182 kHz on MF and channel 16 on VHF, while waiting for the DSC distress acknowledgement.

1.5 Acknowledgement of a DSC distress relay call received from a coast station

Coast stations, after having received and acknowledged a DSC distress alert, may if necessary, retransmit the information received as a DSC distress relay call, addressed to all ships (VHF only), all ships in a specific geographical area (MF/HF only), or a specific ship.

Ships receiving a distress relay call transmitted by a coast station shall not use DSC to acknowledge the call, but should acknowledge the receipt of the call by radiotelephony on the distress traffic channel in the same band in which the relay call was received, i.e. 2 182 kHz on MF, channel 16 on VHF.

Acknowledge the receipt of the distress relay call by transmitting the following by radiotelephony on the distress traffic frequency in the same band in which the DSC distress relay call was received:

- “MAYDAY” RELAY,
- the 9-digit identity or the call sign or other identification of the calling coast station,
- “this is”,
- the 9-digit identity or call sign or other identification of own ship,
- “RECEIVED MAYDAY RELAY”.

1.6 Acknowledgement of a DSC distress relay call received from another ship

Ships receiving a distress relay call from another ship shall follow the same procedure as for acknowledgement of a distress alert, i.e. the procedure given in § 1.2 above.

1.7 Cancellation of an inadvertent distress alert

A station transmitting an inadvertent distress alert shall cancel the distress alert using the following procedure:

1.7.1 Immediately cancel the distress alert aurally over the telephony distress traffic channel associated with each DSC channel on which the “distress alert” was transmitted.

1.7.2 Monitor the telephony distress traffic channel associated with the DSC channel on which the distress was transmitted, and respond to any communications concerning that distress alert as appropriate.

2 Urgency

2.1 Transmission of urgency messages

Transmission of urgency messages shall be carried out in two steps:

- announcement of the urgency message,
- transmission of the urgency message.

The announcement is carried out by transmission of a DSC urgency call on the DSC distress calling channel (2 187.5 kHz on MF, channel 70 on VHF).

The urgency message is transmitted on the distress traffic channel (2 182 kHz on MF, channel 16 on VHF).

The DSC urgency call may be addressed to all stations at VHF, or a geographic area at MF/HF, or to a specific station. The frequency on which the urgency message will be transmitted shall be included in the DSC urgency call.

The transmission of an urgency message is thus carried out as follows:

Announcement:

- tune the transmitter to the DSC distress calling channel (2 187.5 kHz on MF, channel 70 on VHF);
- select the appropriate calling format on the DSC equipment (all ships (VHF only), geographical area (MF/HF only) or individual);
- key in or select on the DSC equipment keyboard:
 - specific area or 9-digit identity of the specific station, if appropriate,
 - the category of the call (urgency),
 - the frequency or channel on which the urgency message will be transmitted,
 - the type of communication in which the urgency message will be given (radiotelephony),in accordance with the DSC equipment manufacturer's instructions;
- transmit the DSC urgency call.

Transmission of the urgency message:

- tune the transmitter to the frequency or channel indicated in the DSC urgency call;
- transmit the urgency message as follows:
 - “PAN PAN”, repeated 3 times,
 - “ALL STATIONS” or called station, repeated 3 times,
 - “this is”,
 - the 9-digit identity *and* the call sign or other identification of own ship,
 - the text of the urgency message.

2.2 Reception of an urgency message

Ships receiving a DSC urgency call announcing an urgency message addressed to more than one station shall NOT acknowledge the receipt of the DSC call, but should tune the radiotelephony receiver to the frequency indicated in the call and listen to the urgency message.

3 Safety

3.1 Transmission of safety messages

Transmission of safety messages shall be carried out in two steps:

- announcement of the safety message,
- transmission of the safety message.

The announcement is carried out by transmission of a DSC safety call on the DSC distress calling channel (2 187.5 kHz on MF, channel 70 on VHF).

The safety message is normally transmitted on the distress and safety traffic channel in the same band in which the DSC call was sent, i.e. 2 182 kHz on MF, channel 16 on VHF.

The DSC safety call may be addressed to all ships (VHF only), ships in a specific geographical area (MF/HF only), or to a specific station.

The frequency on which the safety message will be transmitted shall be included in the DSC call.

The transmission of a safety message is thus carried out as follows:

Announcement:

- tune the transmitter to the DSC distress calling channel (2 187.5 kHz on MF, channel 70 on VHF);
- select the appropriate calling format on the DSC equipment (all ships (VHF only), geographical area (MF/HF only), or individual);
- key in or select on the DSC equipment keyboard:
 - specific area or 9-digit identity of specific station, if appropriate,
 - the category of the call (safety),
 - the frequency or channel on which the safety message will be transmitted,
 - the type of communication in which the safety message will be given (radiotelephony), in accordance with the DSC equipment manufacturer's instructions;
- transmit the DSC safety call.

Transmission of the safety message:

- tune the transmitter to the frequency or channel indicated in the DSC safety call;
- transmit the safety message as follows:
 - “SECURITE”, repeated 3 times,
 - “ALL STATIONS” or called station, repeated 3 times,
 - “this is”,
 - the 9-digit identity *and* the call sign or other identification of own ship,
 - the text of the safety message.

3.2 Reception of a safety message

Ships receiving a DSC safety call announcing a safety message addressed to more than one station shall NOT acknowledge the receipt of the DSC safety call, but should tune the radiotelephony receiver to the frequency indicated in the call and listen to the safety message.

4 Public correspondence

4.1 DSC channels for public correspondence

4.1.1 VHF

The VHF DSC channel 70 is used for DSC for distress and safety purposes as well as for DSC for public correspondence.

4.1.2 MF

International and national DSC channels separate from the DSC distress and safety calling channel 2 187.5 kHz are used for digital selective-calling on MF for public correspondence.

Ships calling a coast station by DSC on MF for public correspondence should preferably use the coast station's national DSC channel.

The international DSC channel for public correspondence may as a general rule be used between ships and coast stations of different nationality. The ships transmitting frequency is 2 189.5 kHz, and the receiving frequency is 2 177 kHz.

The frequency 2 177 kHz is also used for DSC between ships for general communication.

4.2 Transmission of a DSC call for public correspondence to a coast station or another ship

A DSC call for public correspondence to a coast station or another ship is transmitted as follows:

- tune the transmitter to the relevant DSC channel;
- select the format for calling a specific station on the DSC equipment;
- key in or select on the DSC equipment keyboard:
 - the 9-digit identity of the station to be called,
 - the category of the call (routine),
 - the type of the subsequent communication (normally radiotelephony),
 - a proposed working channel if calling another ship. A proposal for a working channel should NOT be included in calls to a coast station; the coast station will in its DSC acknowledgement indicate a vacant working channel,
- in accordance with the DSC equipment manufacturer's instructions;
- transmit the DSC call.

4.3 Repeating a call

A DSC call for public correspondence may be repeated on the same or another DSC channel, if no acknowledgement is received within 5 min.

Further call attempts should be delayed at least 15 min, if acknowledgement is still not received.

4.4 Acknowledgement of a received call and preparation for reception of the traffic

On receipt of a DSC call from a coast station or another ship, a DSC acknowledgement is transmitted as follows:

- tune the transmitter to the transmit frequency of the DSC channel on which the call was received,
- select the acknowledgement format on the DSC equipment,
- transmit an acknowledgement indicating whether the ship is able to communicate as proposed in the call (type of communication and working frequency),
- if able to communicate as indicated, tune the transmitter and the radiotelephony receiver to the indicated working channel and prepare to receive the traffic.

4.5 Reception of acknowledgement and further actions

When receiving an acknowledgement indicating that the called station is able to receive the traffic, prepare to transmit the traffic as follows:

- tune the transmitter and receiver to the indicated working channel;
- commence the communication on the working channel by:
 - the 9-digit identity or call sign or other identification of the called station,
 - “this is”,
 - the 9-digit identity or call sign or other identification of own ship.

It will normally rest with the ship to call again a little later in case the acknowledgement from the coast station indicates that the coast station is not able to receive the traffic immediately.

In case the ship, in response to a call to another ship, receives an acknowledgement indicating that the other ship is not able to receive the traffic immediately, it will normally rest with the called ship to transmit a call to the calling ship when ready to receive the traffic.

5 Testing the equipment used for distress and safety

Testing on the exclusive DSC distress and safety calling frequency 2 187.5 kHz should be avoided as far as possible by using other methods.

Test calls should be transmitted by the ship station and acknowledged by the called station. Normally there would be no further communication between the two stations involved.

A VHF and MF test call to a station is transmitted as follows:

- tune the transmitter to the DSC distress and safety calling frequency (i.e. channel 70 and 2 187.5 kHz),
- key in or select the format for the test call on the DSC equipment in accordance with the DSC equipment manufacturer’s instructions,
- key in the 9-digit identity of the station to be called,
- transmit the DSC call after checking as far as possible that no calls are in progress on the frequency,
- wait for acknowledgement.

6 Special conditions and procedures for DSC communication on HF

General

The procedures for DSC communication on HF are – with some additions described in § 6.1 to 6.3 below – equal to the corresponding procedures for DSC communications on MF/VHF.

Due regard to the special conditions described in § 6.1 to 6.3 should be given when making DSC communications on HF.

6.1 Distress

6.1.1 Transmission of DSC distress alert

DSC distress alert should be sent to coast stations – e.g. in A3 and A4 sea areas on HF – and on MF and/or VHF to other ships in the vicinity.

The DSC distress alert should as far as possible include the ship's last known position and the time (in UTC) it was valid. If the position and time is not inserted automatically from the ship's navigational equipment, it should be inserted manually.

Ship-to-shore distress alert

Choice of HF band

Propagation characteristics of HF radio waves for the actual season and time of the day should be taken into account when choosing HF bands for transmission of DSC distress alert.

As a general rule the DSC distress channel in the 8 MHz maritime band (8 414.5 kHz) may in many cases be an appropriate first choice.

Transmission of the DSC distress alert in more than one HF band will normally increase the probability of successful reception of the alert by coast stations.

DSC distress alert may be sent on a number of HF bands in two different ways:

- a) either by transmitting the DSC distress alert on one HF band, and waiting a few minutes for receiving acknowledgement by a coast station;

if no acknowledgement is received within 3 min, the process is repeated by transmitting the DSC distress alert on another appropriate HF band etc.;
- b) or by transmitting the DSC distress alert at a number of HF bands with no, or only very short, pauses between the calls, without waiting for acknowledgement between the calls.

It is recommended to follow procedure a) in all cases, where time permits to do so; this will make it easier to choose the appropriate HF band for commencement of the subsequent communication with the coast station on the corresponding distress traffic channel.

Transmitting the DSC distress alert (see Note 1):

- tune the transmitter to the chosen HF DSC distress channel (4 207.5, 6 312, 8 414.5, 12 577, 16 804.5 kHz) (see Note 2);
- follow the instructions for keying in or selection of relevant information on the DSC equipment keyboard as described in § 1.1;
- transmit the DSC distress alert.

NOTE 1 – Ship-to-ship distress alert should normally be made on MF and/or VHF, using the procedures for transmission of DSC distress alert on MF/VHF described in § 1.1.

NOTE 2 – Some maritime HF transmitters shall be tuned to a frequency 1 700 Hz lower than the DSC frequencies given above in order to transmit the DSC distress alert on the correct frequency.

In special cases, for example in tropical zones, transmission of DSC distress alert on HF may, in addition to ship-to-shore alerting, also be useful for ship-to-ship alerting.

6.1.2 Preparation for the subsequent distress traffic

After having transmitted the DSC distress alert on appropriate DSC distress channels (HF, MF and/or VHF), prepare for the subsequent distress traffic by tuning the radiocommunication set(s) (HF, MF and/or VHF as appropriate) to the corresponding distress traffic channel(s).

Where multiple frequency call attempts are transmitted the corresponding distress traffic frequency should be 8 291 kHz.

If method b) described in § 6.1.1 has been used for transmission of DSC distress alert on a number of HF bands:

- take into account in which HF band(s) acknowledgement has been successfully received from a coast station;
- if acknowledgements have been received on more than one HF band, commence the transmission of distress traffic on one of these bands, but if no response is received from a coast station then the other bands should be used in turn.

The distress traffic frequencies are (see RR Appendix 15, Table 15-1):

HF (kHz):

Telephony	4 125	6 215	8 291	12 290	16 420
Telex	4 177.5	6 268	8 376.5	12 520	16 695

MF (kHz):

Telephony	2 182
Telex	2 174.5

VHF: Channel 16 (156.800 MHz).

6.1.3 Distress traffic

The procedures described in § 1.3 are used when the distress traffic on MF/HF is carried out by *radiotelephony*.

The following procedures shall be used in cases where the distress traffic on MF/HF is carried out by *radiotelex*:

- The forward error correcting (FEC) mode shall be used;
- all messages shall be preceded by:
 - at least one carriage return,
 - line feed,
 - one letter shift,
 - the distress signal MAYDAY;

- The ship in distress should commence the distress telex traffic on the appropriate distress telex traffic channel as follows:
 - carriage return, line feed, letter shift,
 - the distress signal “MAYDAY”,
 - “this is”,
 - the 9-digit identity and call sign or other identification of the ship,
 - the ship’s position if not included in the DSC distress alert,
 - the nature of distress,
 - any other information which might facilitate the rescue.

6.1.4 Actions on reception of a DSC distress alert on HF from another ship

Ships receiving a DSC distress alert on HF from another ship shall *not* acknowledge the alert, but should:

- watch for reception of a DSC distress acknowledgement from a coast station;
- while waiting for reception of a DSC distress acknowledgement from a coast station:
 - prepare for reception of the subsequent distress communication by tuning the HF radiocommunication set (transmitter and receiver) to the relevant distress traffic channel in the same HF band in which the DSC distress alert was received, observing the following conditions:
 - if radiotelephony mode was indicated in the DSC distress alert, the HF radiocommunication set should be tuned to the radiotelephony distress traffic channel in the HF band concerned;
 - if telex mode was indicated in the DSC distress alert, the HF radiocommunication set should be tuned to the radiotelex distress traffic channel in the HF band concerned. Ships able to do so should additionally watch the corresponding radiotelephony distress channel;
 - if the DSC distress alert was received on more than one HF band, the radiocommunication set should be tuned to the relevant distress traffic channel in the HF band considered to be the best one in the actual case. If the DSC distress alert was received successfully on the 8 MHz band, this band may in many cases be an appropriate first choice;
 - if no distress traffic is received on the HF channel within 1 to 2 min, tune the HF radiocommunication set to the relevant distress traffic channel in another HF band deemed appropriate in the actual case;
 - if no DSC distress acknowledgement is received from a coast station within 5 min, and no distress communication is observed going on between a coast station and the ship in distress:
 - inform a Rescue Coordination Centre (RCC) via appropriate radiocommunications means,
 - transmit a DSC distress relay call.

6.1.5 Transmission of DSC distress relay call

In case it is considered appropriate to transmit a DSC distress relay call:

- distress relay calls on HF should be initiated manually;
- tune the transmitter(s) to the relevant DSC distress channel, following the procedures described in § 6.1.1 above (except the call is sent manually as a single call on a single frequency);
- follow the instructions for keying in or selection of call format and relevant information on the DSC equipment keyboard as described in § 1.4;
- transmit the DSC distress relay call.

6.1.6 Acknowledgement of a HF DSC distress relay call received from a coast station

Ships receiving a DSC distress relay call from a coast station on HF, addressed to all ships within a specified area, should NOT acknowledge the receipt of the relay alert by DSC, but by *radiotelephony* on the telephony distress traffic channel in the same band(s) in which the DSC distress relay call was received.

6.2 Urgency

Transmission of urgency messages on HF should normally be addressed:

- either to all ships within a specified geographical area,
- or to a specific coast station.

Announcement of the urgency message is carried out by transmission of a DSC call with category urgency on the appropriate DSC distress channel.

The transmission of the urgency message itself on HF is carried out by radiotelephony or radiotelex on the appropriate distress traffic channel in the same band in which the DSC announcement was transmitted.

6.2.1 Transmission of DSC announcement of an urgency message on HF

- choose the HF band considered to be the most appropriate, taking into account propagation characteristics for HF radio waves at the actual season and time of the day; the 8 MHz band may in many cases be an appropriate first choice;
- tune the HF transmitter to the DSC distress channel in the chosen HF band;
- key in or select call format for either geographical area call or individual call on the DSC equipment, as appropriate;
- in case of area call, key in specification of the relevant geographical area;
- follow the instructions for keying in or selection of relevant information on the DSC equipment keyboard as described in § 2.1, including type of communication in which the urgency message will be transmitted (radiotelephony or radiotelex);
- transmit the DSC call; and
- if the DSC call is addressed to a specific coast station, wait for DSC acknowledgement from the coast station. If acknowledgement is not received within a few minutes, repeat the DSC call on another HF frequency deemed appropriate.

6.2.2 Transmission of the urgency message and subsequent action

- tune the HF transmitter to the distress traffic channel (telephony or telex) indicated in the DSC announcement;
- if the urgency message is to be transmitted using *radiotelephony*, follow the procedure described in § 2.1;
- if the urgency message is to be transmitted by *radiotelex*, the following procedure shall be used:
 - use the forward error correcting (FEC) mode unless the message is addressed to a single station whose radiotelex identity number is known;
 - commence the telex message by:
 - at least one carriage return, line feed, one letter shift,
 - the urgency signal “PAN PAN”,
 - “this is”,
 - the 9-digit identity of the ship and the call sign or other identification of the ship,
 - the text of the urgency message.

Announcement and transmission of urgency messages addressed to all HF equipped ships within a specified area may be repeated on a number of HF bands as deemed appropriate in the actual situation.

6.3 Safety

The procedures for transmission of DSC safety announcement and for transmission of the safety message are the same as for urgency messages, described in § 6.2, *except* that:

- in the DSC announcement, the category SAFETY shall be used,
- in the safety message, the safety signal “SECURITE” shall be used instead of the urgency signal “PAN PAN”.

Annex 4

Operational procedures for coast stations for DSC communications on MF, HF and VHF

Introduction

Procedures for DSC communications on MF and VHF are described in § 1 to 5 below.

The procedures for DSC communications on HF are in general the same as for MF and VHF. Special conditions to be taken into account when making DSC communications on HF are described in § 6 below.

1 Distress (see Note 1)

1.1 Reception of a DSC distress alert

The transmission of a distress alert indicates that a mobile unit (a ship, aircraft or other vehicle) or a person is in distress and requires immediate assistance. The distress alert is a digital selective call using a distress call format.

Coast stations in receipt of a distress alert shall ensure that it is routed as soon as possible to an RCC. The receipt of a distress alert is to be acknowledged as soon as possible by the appropriate coast station.

NOTE 1 – These procedures assume that the RCC is sited remotely from the DSC coast station; where this is not the case, appropriate amendments should be made locally.

1.2 Acknowledgement of a DSC distress alert

The coast station shall transmit the acknowledgement on the distress calling frequency on which the call was received and should address it to all ships. The acknowledgement shall include the identification of the ship whose distress alert is being acknowledged.

The acknowledgement of a DSC distress alert is transmitted as follows:

- use a transmitter which is tuned to the frequency on which the distress alert was received;
- in accordance with the DSC equipment manufacturer's instructions, key in or select on the DSC equipment keyboard (see Note 1):
 - distress alert acknowledgement,
 - 9-digit identity of the ship in distress,
 - nature of distress,
 - distress coordinates,
 - the time (in UTC) when the position was valid.

NOTE 1 – Some or all of this information might be included automatically by the equipment;

- transmit the acknowledgement;
- prepare to handle the subsequent distress traffic by setting watch on radiotelephony and, if the "mode of subsequent communication" signal in the received distress alert indicates teleprinter, also on NBDP, if the coast station is fitted with NBDP. In both cases, the radiotelephone and NBDP frequencies should be those associated with the frequency on which the distress alert was received (on MF 2 182 kHz for radiotelephony and 2 174.5 kHz for NBDP, on VHF 156.8 MHz/channel 16 for radiotelephony; there is no frequency for NBDP on VHF).

1.3 Transmission of a DSC distress relay call

Coast stations shall initiate and transmit a distress relay call in any of the following cases:

- when the distress of the mobile unit has been notified to the coast station by other means and a broadcast alert to shipping is required by the RCC; and
- when the person responsible for the coast station considers that further help is necessary (close cooperation with the appropriate RCC is recommended under such conditions).

In the cases mentioned above, the coast station shall transmit a shore-to-ship distress relay call addressed, as appropriate, to all ships (VHF only), to a geographical area (MF/HF only) or to a specific ship.

The distress relay call shall contain the identification of the mobile unit in distress, its position and other information which might facilitate rescue.

The distress relay call is transmitted as follows:

- use a transmitter which is tuned to the frequency for DSC distress alerts (2 187.5 kHz on MF, 156.525 MHz/channel 70 on VHF);
- in accordance with the DSC equipment manufacturer's instructions, key in or select on the DSC equipment keyboard (see Note 1 of § 1.2 of this Annex):
 - distress relay call,
 - the format specifier (all ships (VHF only), geographical area (MF/HF only), or individual station),
 - if appropriate, the address of the ship, or geographical area,
 - 9-digit identity of the ship in distress, if known,
 - nature of distress,
 - distress coordinates,
 - the time (in UTC) when the position was valid;
- transmit the distress relay call;
- prepare for the reception of the acknowledgements by ship stations and for handling the subsequent distress traffic by switching over to the distress traffic channel in the same band, i.e. 2 182 kHz on MF, 156.8 MHz/channel 16 on VHF.

1.4 Reception of a distress relay call

If the distress relay call is received from a ship station, coast stations on receipt of the distress relay call shall ensure that the call is routed as soon as possible to an RCC. The receipt of the distress relay call is to be acknowledged as soon as possible by the appropriate coast station using a DSC distress relay acknowledgement addressed to the ship station. If the distress relay call is received from a coast station, other coast stations will normally not have to take further action.

2 Urgency

2.1 Transmission of a DSC announcement

The announcement of the urgency message shall be made on one or more of the distress and safety calling frequencies using DSC and the urgency call format.

The DSC urgency call may be addressed to all ships (VHF only), to a geographical area (MF/HF only), or to a specific ship. The frequency on which the urgency message will be transmitted after the announcement shall be included in the DSC urgency call.

The DSC urgency call is transmitted as follows:

- use a transmitter which is tuned to the frequency for DSC distress calls (2 187.5 kHz on MF, 156.525 MHz /channel 70 on VHF);
- in accordance with the DSC equipment manufacturer's instructions, key in or select on the DSC equipment keyboard (see Note 1 of § 1.2 of this Annex):
 - the format specifier (all ships call (VHF), geographical area (MF/HF only), or individual station),
 - if appropriate, the address of the ship, or geographical area,
 - the category of the call (urgency),
 - the frequency or channel on which the urgency message will be transmitted,
 - the type of communication in which the urgency message will be transmitted (radiotelephony);
- transmit the DSC urgency call.

After the DSC announcement, the urgency message will be transmitted on the frequency indicated in the DSC call.

3 Safety

3.1 Transmission of a DSC announcement

The announcement of the safety message shall be made on one or more of the distress and safety calling frequencies using DSC and the safety call format.

The DSC safety call may be addressed to all ships (VHF only), to a geographical area (MF/HF only), or to a specific ship. The frequency on which the safety message will be transmitted after the announcement shall be included in the DSC safety call.

The DSC safety call is transmitted as follows:

- use a transmitter which is tuned to the frequency for DSC distress alerts (2 187.5 kHz on MF, 156.525 MHz/channel 70 on VHF);
- in accordance with the DSC equipment manufacturer's instructions, key in or select on the DSC equipment keyboard (see Note 1 of § 1.2 of this Annex):
 - the format specifier (all ships call (VHF only), geographical area (MF/HF only), or individual station),
 - if appropriate, the address of the ship, or geographical area,
 - the category of the call (safety),
 - the frequency or channel on which the safety message will be transmitted,
 - the type of communication in which the safety message will be transmitted (radiotelephony);
- transmit the DSC safety call.

After the DSC announcement, the safety message will be transmitted on the frequency indicated in the DSC call.

4 Public correspondence

4.1 DSC frequencies/channels for public correspondence

4.1.1 VHF

The frequency 156.525 MHz/channel 70 is used for DSC for distress and safety purposes. It may also be used for calling purposes other than distress and safety, e.g. public correspondence.

4.1.2 MF

For public correspondence national and international frequencies are used which are different from the frequencies used for distress and safety purposes.

When calling ship stations by DSC, coast stations should use for the call, in the order of preference:

- a national DSC channel on which the coast station is maintaining watch;
- the international DSC calling channel, with the coast station transmitting on 2 177 kHz and receiving on 2 189.5 kHz. In order to reduce interference on this channel, it may be used as a general rule by coast stations to call ships of another nationality, or in cases where it is not known on which DSC frequencies the ship station is maintaining watch.

4.2 Transmission of a DSC call to a ship

The DSC call is transmitted as follows:

- use a transmitter which is tuned to the appropriate calling frequency;
- in accordance with the DSC equipment manufacturer's instructions, key in or select on the DSC equipment keyboard (see Note 1 of § 1.2 of this Annex):
 - the 9-digit identity of the ship to be called,
 - the category of the call routine,
 - the type of subsequent communication (radiotelephony),
 - working frequency information;
- after checking as far as possible that there are no calls in progress, transmit the DSC call.

4.3 Repeating a call

Coast stations may transmit the call twice on the same calling frequency with an interval of at least 45 s between the two calls, provided that they receive no acknowledgement within that interval.

If the station called does not acknowledge the call after the second transmission, the call may be transmitted again on the same frequency after a period of at least 30 min or on another calling frequency after a period of at least 5 min.

4.4 Preparation for exchange of traffic

On receipt of a DSC acknowledgement with the indication that the called ship station can use the proposed working frequency, the coast station transfers to the working frequency or channel and prepares to receive the traffic.

4.5 Acknowledgement of a received DSC call

Acknowledgements shall normally be transmitted on the frequency paired with the frequency of the received call. If the same call is received on several calling channels, the most appropriate channel shall be chosen for transmission of the acknowledgement.

The acknowledgement of a DSC call is transmitted as follows:

- use a transmitter which is tuned to the appropriate frequency;
- in accordance with the DSC equipment manufacturer's instructions, key in or select on the DSC equipment keyboard (see Note 1 of § 1.2 of this Annex):
 - the format specifier (individual station),
 - 9-digit identity of the calling ship,
 - the category of the call routine,
 - if able to comply immediately on the working frequency suggested by the ship station, the same frequency information as in the received call,
 - if no working frequency was suggested by the calling ship station, then the acknowledgement should include a channel/frequency proposal,
 - if not able to comply on the working frequency suggested, but able to comply immediately on an alternative frequency, the alternative working frequency,
 - if unable to comply immediately the appropriate information in that regard;
- transmit the acknowledgement (after checking as far as possible that there are no calls in progress on the frequency selected) after a delay of at least 5 s, but not later than 4½ min.

After having transmitted the acknowledgement, the coast station transfers to the working frequency or channel and prepares to receive the traffic.

5 Testing the equipment used for distress and safety calls

Perform VHF, MF and HF test calls in accordance with Recommendation ITU-R M.493, Table 4.7.

Acknowledgement of a DSC test call

The coast station should acknowledge test calls.

6 Special conditions and procedures for DSC communication on HF

General

The procedures for DSC communication on HF are – with some additions described in § 6.1 to 6.3 below – equal to the corresponding procedures for DSC communications on MF/VHF.

Due regard to the special conditions described in § 6.1 to 6.3 should be given when making DSC communications on HF.

6.1 Distress

6.1.1 Reception and acknowledgement of a DSC distress alert on HF

Ships in distress may in some cases transmit the DSC distress alert on a number of HF bands with only short intervals between the individual calls.

The coast station shall transmit DSC acknowledgement on all HF DSC distress channels on which the DSC distress alert was received in order to ensure as far as possible that the acknowledgement is received by the ship in distress and by all ships which received the DSC distress alert.

6.1.2 Distress traffic

The distress traffic should, as a general rule, be initiated on the appropriate distress traffic channel (radiotelephony or NBDP) in the same band in which the DSC distress alert was received.

For distress traffic by NBDP the following rules apply:

- all messages shall be preceded by at least one carriage return, line feed, one letter shift and the distress signal MAYDAY;
- FEC broadcast mode should be used.

6.1.3 Transmission of DSC distress relay call on HF

HF propagation characteristics should be taken into account when choosing HF band(s) for transmission of DSC distress relay call.

IMO Convention ships equipped with HF DSC for distress and safety purposes are required to keep continuous automatic DSC watch on the DSC distress channel in the 8 MHz band and on at least one of the other HF DSC distress channels.

In order to avoid creating on board ships uncertainty regarding on which band the subsequent establishment of contact and distress traffic should be initiated, the HF DSC distress relay call should be transmitted on one HF band at a time and the subsequent communication with responding ships be established before eventually repeating the DSC distress relay call on another HF band.

6.2 Urgency

6.2.1 Transmission of urgency announcement and message on HF

For urgency messages by NBDP the following apply:

- the urgency message shall be preceded by at least one carriage return, line feed, one letter shift, the urgency signal PAN PAN and the identification of the coast station;
- FEC broadcast mode should normally be used.

ARQ mode should be used only when considered advantageous to do so in the actual situation and provided that the radiotelex number of the ship is known.

6.3 Safety

6.3.1 Transmission of safety announcements and messages on HF

For safety messages by NBDP the following apply:

- the safety message shall be preceded by at least one carriage return, line feed, one letter shift, the safety signal SECURITE and the identification of the coast station;
 - FEC broadcast mode should normally be used.
- ARQ mode should be used only when considered advantageous to do so in the actual situation and provided that the radiotelex number of the ship is known.

Annex 5

Frequencies used for DSC

1 The frequencies used for distress, urgency, and safety purposes using DSC are as follows (RR Appendix 15):

2 187.5	kHz
4 207.5	kHz
6 312	kHz
8 414.5	kHz
12 577	kHz
16 804.5	kHz
156.525	MHz (Note 1)

NOTE 1 – The frequency 156.525 MHz may also be used for DSC purposes other than distress, urgency, and safety.

2 The frequencies assignable on an international basis to ship and coast stations for DSC, for purposes other than distress, urgency, and safety, are as follows (see Note 2):

2.1 Ship stations (see Note 2)

458.5			kHz
2 177 (Note 3)	2 189.5		kHz
4 208	4 208.5	4 209	kHz
6 312.5	6 313	6 313.5	kHz
8 415	8 415.5	8 416	kHz
12 577.5	12 578	12 578.5	kHz
16 805	16 805.5	16 806	kHz
18 898.5	18 899	18 899.5	kHz
22 374.5	22 375	22 375.5	kHz
25 208.5	25 209	25 209.5	kHz
		156.525	MHz

2.2 Coast stations (see Note 2)

455.5			kHz
2 177			kHz
4 219.5	4 220	4 220.5	kHz
6 331	6 331.5	6 332	kHz
8 436.5	8 437	8 437.5	kHz
12 657	12 657.5	12 658	kHz
16 903	16 903.5	16 904	kHz
19 703.5	19 704	19 704.5	kHz
22 444	22 444.5	22 445	kHz
26 121	26 121.5	26 122	kHz
		156.525	MHz

NOTE 2 – The following (kHz) paired frequencies (for ship/coast stations) 4 208/4 219.5, 6 312.5/6 331, 8 45/8 436.5, 12 577.5/12 657, 16 805/16 903, 18 898.5/19 703.5, 22 374.5/22 444 and 25 208.5/26 121 are the first choice international frequencies for DSC (See RR Appendix 17, Part A, footnote j) and l).

NOTE 3 – The frequency 2 177 kHz is available to ship stations for intership calling only.

3 In addition to the frequencies listed in § 2 above, appropriate working frequencies in the following bands may be used for DSC (see RR Chapter II, Article 5):

415-526.5	kHz	(Regions 1 and 3)
415-525	kHz	(Region 2)
1 606.5-3 400	kHz	(Regions 1 and 3)
1 605.5-3 400	kHz	(Region 2) (For the band 1 605-1 625 kHz, see RR No. 5.89)
4 000-27 500	kHz	
156-174	MHz	
