

**ORDER**

6050.32B

**SPECTRUM MANAGEMENT REGULATIONS  
AND PROCEDURES MANUAL**



**November 17, 2005**

**DEPARTMENT OF TRANSPORTATION  
FEDERAL AVIATION ADMINISTRATION**



U.S. DEPARTMENT OF TRANSPORTATION  
FEDERAL AVIATION ADMINISTRATION

**ORDER**  
**6050.32B**

Effective Date:  
11/17/05

**SUBJ:** Spectrum Management Regulations and Procedures Manual

---

The radio spectrum is both a precious and limited National resource. Within the Federal Aviation Administration (FAA), Technical Operations ATC Spectrum Engineering Services is the sole authority for the spectrum allocation for new systems during equipment research and design as well as the FAA's single point-of-contact for coordination of operating frequencies with other Federal agencies and civil organizations.

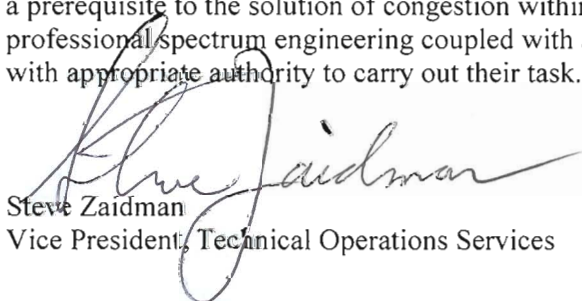
Each country exercises its own sovereign rights in its use of the spectrum. Because radio transmission cannot be limited to a national border, international agreements and management practices are necessary. It is of utmost importance that we manage the radio spectrum efficiently and effectively in order to support air traffic requirements of our National Airspace System (NAS).

This order on spectrum policy and management is for the purpose of presenting spectrum engineering policy, guidance, and criteria to spectrum engineers. It is an update of technical information from many sources and offers the spectrum engineer a widely based tool necessary to manage the radio spectrum used to support the NAS.

Dissemination of this order throughout the Agency and to interfacing organizations will provide various offices a single source of knowledge of the functions and responsibilities of international and national regulation of the radio spectrum.

The magnitude of spectrum utilization in terms of amount and variety of equipment, power, emission characteristics, time-on-the-air, and geographical coverage is rapidly increasing and will continue to do so. Congestion, especially in the navigational aids and air/ground communications frequency bands, is a persistent problem that can lead to interference and, thus, the limiting or denial of required services. Conflicts in communications, radar, and navigational aids usually can be resolved; but resolution often requires time, money, and modification of service requirements. In peacetime, this may be simply annoying. In a national emergency, it could be devastating.

A communications, navigational aid, or radar facility out-of-service for interference is just as useless as one out for technical defects. Efficient, effective, and informed management of the spectrum is a prerequisite to the solution of congestion within FAA's purview. This can only be accomplished by professional spectrum engineering coupled with a dedicated staff of spectrum engineers and managers with appropriate authority to carry out their task.

  
Steve Zaidman  
Vice President, Technical Operations Services

---

Distribution: A-WYZ-1; A-X(AF/AT)-2;  
A-FOF-O (SUPV)

Initiated By: Tech Ops ATC Spectrum  
Engineering Services (ASR-1)

**TABLE OF CONTENTS**

*Paragraph*.....*Page*

**CHAPTER 1. GENERAL**

1. Purpose..... 1  
 2. Distribution ..... 1  
 3. Cancellation ..... 1  
 4. Explanation of Changes ..... 1  
 5. Forms ..... 2  
 6. thru 199. Reserved ..... 2

**CHAPTER 2. THE RADIO FREQUENCY (RF) SPECTRUM**

200. RF Spectrum ..... 7  
 201. Makeup of the Spectrum ..... 7  
 202. Spectrum Limitation Considerations ..... 7  
 203. thru 299. Reserved ..... 9

**CHAPTER 3. HISTORY, AUTHORITIES AND RESPONSIBILITIES**

300. General Considerations ..... 17  
 301. International Organizations..... 17  
     Figure 3-1. Partial Organizational Chart of the ITU ..... 18  
     Figure 3-2a. ICAO Assembly Organization Chart..... 20  
     Figure 3-2b. ICAO Secretariat Organization Chart ..... 20  
 302. National Organizations - General ..... 21  
     Figure 3-3. Federal Communications Commission ..... 22  
     Figure 3-4. National Telecommunications and Information Administration..... 24  
     Figure 3-5. Partial Organization Chart of the IRAC ..... 25  
     Figure 3-6. AAG Controlled Bands ..... 26  
     Figure 3-7. Bands Under Coordination Control of FAA Field Coordinators ..... 27  
     Figure 3-8. Technical Operations ATC Spectrum Engineering Services ..... 28  
     Figure 3-9. Summary of Frequency Bands Supporting Aviation..... 29  
 303. Technical Operations ATC Spectrum Engineering Services ..... 30  
 304. Service Area Frequency Management Office (FMO)..... 30  
 305. thru 399. Reserved ..... 31

**CHAPTER 4. SPECTRUM MANAGEMENT EVALUATION CRITERIA**

400. General..... 33  
 401. Criteria ..... 33  
 402. Subjects of Evaluation ..... 33  
 403. thru 499. Reserved ..... 35

**CHAPTER 5. FREQUENCY COORDINATION**

500. General..... 41  
 501. Headquarters ..... 41  
 502. Field-Headquarters..... 41

503.	Field-External .....	41
504.	Field-Special .....	42
	Figure 5-1. Sample Memorandum To Aviation Event Sponsor.....	44
505.	Field-Internal.....	46
506.	Documents .....	47
507. thru 599.	Reserved .....	48

## **CHAPTER 6. TRANSMITTER AUTHORIZATION DOCUMENTS AND CALL LETTER ASSIGNMENTS**

600.	Purpose.....	53
601.	Facility Transmitting Authorization Document (FTA).....	53
	Figure 6-1. FAA Form 6050-1. Facility Transmitting Authorization (Reduced) .....	54
	Figure 6-2. TIOA Forms For Mobile/Portable/Handheld Transmitters .....	54
602.	Requests For Frequency Action .....	55
	Figure 6-3. Sample of a Typical Service Area Frequency Request Form (Reduced).....	55
603.	Call Letter Assignment .....	56
604.	Land Mobile Call Signs .....	56
	Figure 6-4. User Organization Identifiers .....	57
605.	Station Identification Requirements.....	57
606. thru 699.	Reserved .....	57

## **CHAPTER 7. HIGH FREQUENCY ASSIGNMENT PROCEDURES**

700.	General.....	63
	Figure 7-1. Ionospheric Layers Illustrated .....	64
701.	International HF Requirements .....	64
702.	National HF Requirements.....	65
	Figure 7-2. NRCS Frequencies .....	65
703.	HF Engineering .....	66
704.	Assigned vs. Window Frequency.....	66
705.	Propagation and Circuit Reliability.....	66
706.	Sunspot Numbers .....	66
707.	Solar Flare/Storm Reporting Procedures .....	67
	Figure 7-3. Smoothed Monthly Sunspot Numbers Jan 1749 - Apr 1996.....	67
708. thru 799.	Reserved .....	67

## **CHAPTER 8. AIRSPACE EVALUATION**

800.	General.....	71
801.	Part 77 .....	71
802.	Title 49, Section 44718 .....	72
803.	Intranet Obstruction Evaluation/Airport Airspace Analysis (IOE/AAA) Web-based System	72
804.	Washington Headquarters Reviews .....	72
805.	Electromagnetic Evaluation .....	73
806.	Airspace Analysis Model (AAM).....	73
807.	Determinations .....	74
808.	Non-Broadcast Evaluations.....	74
809. thru 899.	Reserved .....	76

## **CHAPTER 9. VHF/UHF AIR/GROUND COMMUNICATIONS FREQUENCY ENGINEERING**

900.	Purpose.....	81
901.	Communications Frequency Allocations .....	81
902.	Basic Principles of Communications Frequency Engineering.....	81
903.	Special Issues To Be Considered .....	82
904.	Automatic Terminal Information Service (ATIS) Voice Outlet Assignment Criteria.....	82
905.	AWOS/ASOS Frequency Assignment Criteria .....	83
906.	Backup Communications .....	84
907.	Temporary Assignments .....	85
908. thru 999.	Reserved .....	86

## **CHAPTER 10. NAVIGATIONAL AID (NAVAID) FREQUENCY ENGINEERING**

1000.	Purpose.....	91
1001.	NAVAID Frequency Allocation .....	91
	Figure 10-1. NAVAID Band Use .....	91
1002.	Basic Principles of NAVAID Frequency Engineering .....	91
1003.	NAVAID Frequency Engineering Methods.....	92
1004.	Equivalent Signal Ratio (ESR) .....	92
1005.	Expanded Service Volume (ESV).....	92
1006.	Special Issues To Be Considered .....	92
1007. thru 1099.	Reserved .....	94

## **CHAPTER 11. LOW/MEDIUM FREQUENCY (L/MF) GROUND NAVIGATIONAL AIDS**

1100.	Purpose.....	99
1101.	General Considerations .....	99
1102.	Frequency Allocation For L/MF Facilities .....	100
	Figure 11-1. L/MF NAVAID Frequency Allocations.....	101
1103.	Engineering Considerations For L/MF Frequency Selection.....	102
	Figure 11-2. Estimated Ground Conductivity in the United States.....	103
1104.	Basic Tools.....	104
	Figure 11-3. Coverage and Interference Prediction Curves.....	105
1105.	Engineering Procedures .....	106
1106.	Practical Example .....	107
	Figure 11-4. Geographic Separation Example .....	107
1107.	Airborne Measurements.....	108
1108. thru 1199.	Reserved .....	108

## **CHAPTER 12. MICROWAVE DATA/COMMUNICATIONS LINKS FREQUENCY ENGINEERING**

1200.	Purpose.....	111
1201.	Frequency Bands Available For Radio Links .....	111
	Figure 12-1. Bands Currently Used by FAA For Radio Links .....	111
1202.	International Coordination Requirements .....	112
1203.	Technical Standards For Links .....	112
1204.	The General Procedure For Microwave Link Intersite Frequency Engineering.....	112
	Figure 12-2. Typical Parabolic Microwave Antenna Radiation Pattern .....	114
	Figure 12-3. Power Budget Study For a Microwave Link.....	116
1205.	Frequency Engineering For the 932-935 and 941-944 MHz Bands .....	117
1206.	Frequency Engineering For the 1710-1850 MHz Band.....	117

1207.	Frequency Engineering For RCL in the 7125-8500 MHz Band .....	118
	Figure 12-4. Example of Tests 4 and 5 Prohibited Zones.....	119
	Figure 12-5. Standard RCL Frequency Family For 7125-8400 MHz.....	120
	Figure 12-6. Sample of Frequency Selection, Test 4 and 5 .....	121
1208.	Frequency Engineering For the LDRCL in the 7125-8500 MHz Band.....	121
1209.	Frequency Engineering For the 14.5000-14.7145 and 15.1365-15.3500 GHz Bands .....	122
	Figure 12-7. Current TML Channelization Plan.....	123
1210.	Frequency Engineering for LDRCL For the 21.2-23.6 GHz Band.....	124
	Figure 12-8. 21.2-23.6 GHz LDRCL Frequency Assignment Plan.....	124
1211.	Special Path Considerations.....	124
	Figure 12-9. Space Diversity .....	125
	Figure 12-10. Frequency Diversity .....	125
	Figure 12-11. Hybrid Frequency/Space Diversity .....	126
1212.	Paths With Passive Reflectors.....	126
	Figure 12-12. Periscope or Top Reflector Antenna System.....	127
	Figure 12-13. Single Billboard Passive Antenna .....	127
	Figure 12-14. Double Billboard Passive Antenna.....	128
1213.	Mapping.....	128
1214. thru 1299.	Reserved .....	128

### **CHAPTER 13. RADAR AND AIR TRAFFIC CONTROL RADAR BEACON SYSTEM (ATCRBS) FREQUENCY ENGINEERING**

1300.	Policy .....	137
1301.	General Assignment Procedures.....	138
1302.	PRR Assignment of ATCRBS .....	139
	Figure 13-1. Display Time Exposure For a Radial Flight Showing Ringaround.....	140
	Figure 13-2. Display View of a Real and a False Target.....	141
1303.	PRR Assignment Process.....	141
	Figure 13-3. Radar and Associated Beacon Capabilities .....	144
1304.	Frequency Assignment Process in the Radar Frequency Bands .....	144
	Figure 13-4. Radar Frequency-Distance Separation Criteria.....	145
1305.	Frequency Assignments in the 1215-1390- MHz Band.....	145
	Figure 13-5. ARSR-1/2 Staggered PRR and PRT Values (High).....	146
	Figure 13-6. ARSR-1/2 Staggered PRR and PRT Values (Low) .....	147
	Figure 13-7. ARSR-3 PRR Capabilities .....	149
	Figure 13-8. ARSR-3 Average VIP PRTs .....	150
	Figure 13-9. ARSR-4 Crystal Oscillator, Stabilized Local Oscillator (STALO) and Transmit Frequencies .....	151
1306.	Frequency Assignment Process in the 2700-3000 MHz Band.....	152
	Figure 13-10. ASR-7E Primary Radar Frequency Pairs .....	153
	Figure 13-11. ASR-7 and Associated Beacon Staggered PRR and PRT .....	154
	Figure 13-12. ASR-8 and Associated Beacon Staggered PRR and PRT .....	155
	Figure 13-13. Typical ASR-8 Receiver Susceptibility Pass Band.....	156
	Figure 13-14. ASR-9 Radar and Beacon PRRs .....	157
1307.	Frequency Assignments in the 5600-5650 MHz Band .....	158
1308.	Frequency Assignments in the 9000-9200 MHz Band .....	158
1309.	Frequency Assignments in the 15.7-16.2 GHz Band.....	159
1310. thru 1399.	Reserved .....	159

### **CHAPTER 14. RADIO FREQUENCY INTERFERENCE**

1400.	Interference Problems .....	167
1401.	Interference Reporting .....	167
1402.	Administrative Procedures .....	168
1403.	Internal Procedures .....	170
1404.	Interference Locating Equipment.....	170
1405.	Interference Locating Techniques.....	172
	Figure 14-1. Image Frequency Relationships .....	175
1406.	Direction Finding (Below 1000 MHz).....	178
1407.	Direction Finding (Above 1000 MHz).....	180
	Figure 14-2. Radar Interference DF Example.....	181
1408.	"Running Rabbit" Interference.....	181
	Figure 14-3. Running Rabbits Patterns .....	182
1409.	Electronic Attack (EA).....	183
1410.	Power Line Interference.....	183
1411.	Digital Radio Systems.....	184
1412.	ELT Problems .....	184
1413.	Records of Unusual Previous Cases .....	184
1414. thru 1499.	Reserved .....	184

## **CHAPTER 15. RADIO FREQUENCY INTERFERENCE MONITORING VANS (RFI VANS)**

1500.	Introduction.....	189
	Figure 15-1. RFIM Functional Block Diagram.....	189
1501.	Control and Responsibility .....	190
1502.	RFI Van Use .....	190
1503.	Instrumentation .....	190
1504.	RFI Van System Operation.....	193
	Figure 15-2. MCS Canned Measurements Startup Screen.....	193
1505.	Radar and ATRBS Antenna Pattern Recording .....	194
	Figure 15-3. Recording Setup and Sample tape.....	194
	Figure 15-4. Examples of Antenna Patterns On CCSA Printouts.....	196
1506.	High-Speed Recorder Calibration and Operation .....	197
1507.	Spectrum Analysis .....	198
	Figure 15-5. Photo of Spectrum From a Spectrum Analyzer.....	198
	Figure 15-6. CCSA-Produced Radar Spectrum Plot.....	199
	Figure 15-7. A DC Bucking Voltage System For X-Y Plotters.....	200
	Figure 15-8. Sample Spectrum Plot of a Rotating Radar.....	202
1508.	Frequency Measurements .....	202
1509.	Off-The-Air PRR Measurement.....	203
	Figure 15-9. Block Diagram of One Method of Measuring PRR.....	204
	Figure 15-10. Scope Displays For Correct and Incorrect Measurement.....	205
1510. thru 1599.	Reserved .....	205

## **CHAPTER 16. IONIZED AND NONIONIZED RADIATION MEASUREMENTS**

1600.	Purpose.....	215
1601.	General.....	215
	Figure 16-1. Process for Obtaining a Radiation Hazard Measurement.....	216
1602.	Importance of Measurements.....	217
1603.	FMO Participation Limitation.....	217

1604.	Importance of Accuracy .....	217
1605.	Instrument Calibration .....	217
1606.	Availability .....	217
1607.	Ramifications .....	218
1608.	Measurement Philosophy .....	218
1609.	Measurement Considerations .....	218
1610.	Measurement Standards and Procedures .....	219
1611.	Ionized Radiation Measurement Procedures .....	220
1612.	Non-Ionized Radiation Measurement and Procedures .....	221
	Figure 16-2. Radars Used by FAA With Power Densities >MPE .....	224
1613.	Measurement Considerations and Reference Data .....	225
	Figure 16-3. Non-Ionizing MPE – Uncontrolled Environment .....	226
	Figure 16-4. Non-Ionizing MPE – Controlled Environment .....	227
	Figure 16-5. Ionizing TLV .....	228
	Figure 16-6a. Letter of Agreement Safety Program Responsibilities .....	229
	Figure 16-6b. Letter of Agreement Safety Program Responsibilities .....	230
	Figure 16-6c. Letter of Agreement Safety Program Responsibilities .....	231
	Figure 16-6d. Letter of Agreement Safety Program Responsibilities .....	232
1614. thru 1699.	Reserved .....	232

## **CHAPTER 17. LAND MOBILE AND OTHER FM COMMUNICATIONS SYSTEMS FREQUENCY ENGINEERING**

1700.	General .....	235
1701.	Frequency Engineering .....	235
1702.	Systems Basics .....	235
1703.	C3/NRCS .....	235
	Figure 17-1. C3/NRCS Communications Frequency Plan .....	235
	Figure 17-2. Example of a Repeater/Base/Portable/Mobile FM System .....	236
1704.	RF Voice/Data Link Systems .....	237
1705.	Miscellaneous Radio Links .....	237
1706.	Narrow Band Requirements .....	238
1707. thru 1799.	Reserved .....	238

## **CHAPTER 18. ELECTRONIC ATTACK (EA) EVALUATIONS**

1800.	Purpose .....	241
1801.	Definitions .....	241
1802.	Applicable Regulations and Documents .....	242
1803.	Responsibilities .....	242
1804.	Analysis of EA Request .....	243
1805.	Conclusions .....	244
1806.	Operational Band and Channel Codes .....	244
	Figure 18-1. Frequency Band Designations .....	245
1807.	Frequency Band Correlation .....	246
	Figure 18-2. Frequency Band Correlation .....	246
1808.	EA Coordination Requirements by Frequency Band .....	246
	Figure 18-3a. Coordination Level Required by Channel and Frequency .....	247
	Figure 18-3b. Coordination Level Required by Channel and Frequency .....	248
	Figure 18-3c. Coordination Level Required by Channel and Frequency .....	249



Figure 18-3d. Coordination Level Required by Channel and Frequency ..... 250  
 Figure 18-3e. Coordination Level Required by Channel and Frequency ..... 251  
 Figure 18-3f. Coordination Level Required by Channel and Frequency ..... 252  
 Figure 18-3g. Coordination Level Required by Channel and Frequency ..... 253  
 Figure 18-3h. Coordination Level Required by Channel and Frequency ..... 254  
 Figure 18-3i. Coordination Level Required by Channel and Frequency ..... 255  
 1809. thru 1899. Reserved ..... 255

**CHAPTER 19. AUTOMATED ENGINEERING**

1900. Purpose ..... 261  
 1901. Automated Frequency Manager (AFM) ..... 261  
 1902. AFM Agenda System ..... 261  
 1903. Airspace Analysis Model (AAM) ..... 261  
 1904. RFI and RADHAZ Data Base ..... 261  
 1905. Expanded Service Volume (ESV) Management System (ESVMS) ..... 261  
 1906. Radio Coverage Analysis System (RCAS) ..... 261  
 1907. Overview of the AFM ..... 262  
 1908. AFM Agenda System ..... 263  
 1909. Airspace Analysis Model (AAM) ..... 264  
 1910. RFI and RADHAZ Support ..... 265  
 1911. ESV ..... 267  
 1912. thru 1999. Reserved ..... 267

**APPENDIX 1. AIRSPACE EVALUATION**

**SECTION 1. BACKGROUND AND PROCEDURES**

1. Introduction ..... 1  
 2. Background ..... 1  
 3. FM Broadcast Tolerances ..... 1  
     Figure 1. FM Channels and Center Frequencies ..... 2  
     Figure 2. Spurious Emission Level of an FM Broadcast Transmitter  
         on 107.9 MHz ..... 4  
 4. TV Broadcast Tolerances ..... 4  
 5. AM and Other Non-Broadcast Station Standards ..... 5  
 6. Standard FPSVs For FAA Facilities ..... 5  
     Figure 3. TV Channels and Associated Frequencies ..... 6  
     Figure 4. Idealized Standard TV Channel Spectrum ..... 7  
 7. Evaluation Procedure Outline ..... 7  
 8. Data Assembly ..... 7  
     Figure 5. Evaluation Procedure Outline Chart ..... 8  
 9. Intermod Study ..... 9  
 10. Ground Facilities ..... 9  
     Figure 6. Typical FAA VHF and UHF RCF Ground Antenna Gain Vs. Frequency Plots ..... 11  
     Figure 7. Example of Plot For Calculating Slant Range ..... 13  
 11. Airborne Receivers ..... 13  
 12. Samples ..... 14  
     Figure 8. Relative Gain of Airborne COMM and NAV Antennas ..... 15  
     Figure 9a. FAA Form 7460-1, Notice of Proposed Construction or Alteration ..... 16  
     Figure 9b. Addenda to FAA Form 74670-1 Notice of Proposed Construction or

Alteration ..... 17  
 Figures 10. thru 14. Reserved ..... 17  
 13. thru 16. Reserved ..... 17

**SECTION 2. ENGINEERING PROCEDURES FOR OE CASES FOR FM BROADCAST AND ILS/VOR**

17. Purpose..... 23  
 18. OE Case Evaluation Procedure ..... 23  
     Figure 15. Sample OE Case Worksheet For FM..... 24  
     Figure 16. Sample PC CIRCLE Report ..... 26  
     Figure 17. Sample GROUND.WK1 Report..... 27  
 19. Example of AAM Program For FM/ILS..... 28  
     Figure 18. AAM Program Sample Search Plot..... 29  
     Figure 19a. AAM Program Sample RFI.PRT Printout ..... 30  
     Figure 19b. AAM Program Sample RFI.PRT Printout (continued) ..... 31  
     Figure 20. AAM Sample Plot of Predicted RFI - Horizontal - KHTN ..... 32  
     Figure 21. AAM Sample Plot of Predicted RFI - Horizontal - PROP ..... 33  
     Figure 22. AAM Sample Plot of Predicted RFI - Vertical - KHTN ..... 34  
     Figure 23. AAM Sample Plot of Predicted RFI - Vertical - PROP ..... 35  
     Figures 24. thru 30. Reserved ..... 35  
 20. thru 24. Reserved ..... 35

**SECTION 3. ENGINEERING PROCEDURES FOR OBSTRUCTION EVALUATION (OE) CASES OF NON-FM BROADCAST**

25. Status..... 41  
 26. Non-FM BC Study Procedures ..... 41  
 27. A Non-FM BC Example ..... 42  
     Figure 31. Sample Non-FM Worksheet..... 43  
     Figure 32. Paragraph 26 a. (1) Example GROUND.WK1 Printout..... 44  
     Figure 33. Paragraph 26 a. (3) Example IM Program Configuration ..... 45  
     Figure 34. Paragraph 26 a. (4) Example of IM Program Printout..... 45

**APPENDIX 2. TECHNICAL DATA FOR VHF/UHF COMMUNICATIONS FREQUENCY ENGINEERING**

Figure 1. VHF Allocations - 118-137 MHz..... 1  
 1. VHF/UHF Frequency Engineering ..... 2  
 2. FPSV ..... 2  
     Figure 2. FPSVs..... 2  
     Figure 3. High Altitude Enroute and Local Control FPSVs to Approximate Scale and As Normally Shown Pictorially..... 3  
     Figure 4. Example of En Route Dimensions..... 3  
     Figure 5. Typical Terminal FPSV Dimensions..... 4  
 3. ATC Assignment Criteria ..... 5  
 4. RLOS ..... 5  
     Figure 6. Comparison of Distance to Horizon From the Same Altitude Between Actual and Hypothetical 4/3 Earth Radius..... 6  
 5. Intersite Frequency Engineering Procedures ..... 7  
     Figure 7. Cochannel Configuration For Undesired/Desired Distance Ratio..... 7

6.	Intersite Cochannel Analysis By the Table Method .....	8
	Figure 8. Mileage Separation Tables For Usual FPSVs .....	8
7.	Adjacent Channel Considerations.....	8
	Figure 9. Adjacent Channel Vertical Separation.....	9
	Figure 10. 1st Adjacent Channel Separation Required .....	10
8.	Intersite Cochannel Analysis .....	10
	Figure 11. Cochannel Analysis by Calculation.....	11
	Figure 12. Comparison of D/U and Distance Between Facilities With One Tailored Service Volume.....	11
9.	Cosite Interference Considerations .....	11
10.	Limits of Coverage Charts .....	12
	Figure 13. Limits of Coverage - VHF - Antenna Height = 10' .....	13
	Figure 14. Limits of Coverage - VHF - Antenna Height = 25' .....	14
	Figure 15. Limits of Coverage - VHF - Antenna Height = 50' .....	15
	Figure 16. Limits of Coverage - VHF - Antenna Height = 75' .....	16
	Figure 17. Limits of Coverage - VHF - Antenna Height = 100' .....	17
	Figure 18. Limits of Coverage - VHF - Antenna Height = 150' .....	18
	Figure 19. Limits of Coverage - UHF - Antenna Height = 10' .....	19
	Figure 20. Limits of Coverage - UHF - Antenna Height = 20' .....	20
	Figure 21. Limits of Coverage - UHF - Antenna Height = 30' .....	21
	Figure 22. Limits of Coverage - UHF - Antenna Height = 40' .....	22
	Figure 23. Limits of Coverage - UHF - Antenna Height = 50' .....	23
	Figure 24. Limits of Coverage - UHF - Antenna Height = 75' .....	24

**APPENDIX 3. NAVAID FREQUENCY ENGINEERING DATA AND PROCEDURES**

**SECTION 1. FREQUENCY/CHANNELIZATION CHART**

Figure 1a.	Channel and Frequency Pairing With DME Pulse Time/Codes .....	1
Figure 1b.	Channel and Frequency Pairing With DME Pulse Time/Codes (cont'd).....	2
Figure 1c.	Channel and Frequency Pairing With DME Pulse Time/Codes (cont'd).....	3
Figure 1d.	Channel and Frequency Pairing With DME Pulse Time/Codes (cont'd).....	4
Figure 1e.	Channel and Frequency Pairing With DME Pulse Time/Codes (cont'd).....	5
Figure 1f.	Channel and Frequency Pairing With DME Pulse Time/Codes (cont'd) .....	6

**SECTION 2. VOR AND DME/TACAN FREQUENCY ENGINEERING**

1.	Frequency Engineering .....	7
	Figure 2. FPSV's For VOR, DME/TACAN.....	8
2.	Frequency Engineering Procedures .....	8
3.	Intersite Analysis By the Table Method For VOR.....	9
4.	Intersite Analysis By the Table Method For DME/TACAN .....	9
5.	DME/TACAN Required Separation .....	9
6.	Use of the Larger Separation Requirement.....	10
7.	Permissible Use of Tables.....	10
	Figure 3. VOR/VOR Cochannel Separations.....	10
	Figure 4. VOR/VOR Interim 1st Adjacent Channel -50 kHz- Separations .....	11
	Figure 5. VOR/VOR Final 1st Adjacent Channel -50 kHz- Separations.....	11

	Figure 6. VOR/VOR 2nd Adjacent Channel -100 kHz- Separations.....	12
	Figure 7. VOR/LOC Interim 1st Adjacent Channel -50 kHz- separations .....	12
	Figure 8. VOR/LOC Final 1st Adjacent Channel -50 kHz- Separations .....	13
	Figure 9. DME/TACAN Cochannel Separations.....	13
	Figure 10. DME/TACAN 1st Adjacent Channel Separations .....	14
8.	Intersite Analysis By the Calculation Method .....	14
	Figure 11. VOR, DME and TACAN Antenna Gain Figures .....	15
9.	Sample of Cochannel Intersite Analysis By the Calculation Method.....	16
	Figure 12. VORTAC Cochannel Intersite Analysis Plot .....	16
10.	Intersite Analysis of Adjacent Channels .....	17
	Figure 13. VORTAC 2nd Adjacent Channel Intersite Analysis .....	17
11.	Differences In Site Elevation .....	18
12. thru 13.	Reserved .....	18
	Figure 14. VOR Facility Separation Curves For ESR = +14 dB .....	19
	Figure 15. VOR Facility Separation Curves For ESR = +17 dB .....	20
	Figure 16. VOR Facility Separation Curves For ESR = +20 dB .....	21
	Figure 17. VOR Facility Separation Curves For ESR = +23 dB .....	22
	Figure 18. VOR Facility Separation Curves For ESR = +26 dB .....	23
	Figure 19. VOR Facility Separation Curves For ESR = +29 dB .....	24
	Figure 20. VOR Facility Separation Curves For ESR = +32 dB .....	25
	Figure 21. ESR Ratio - VOR/VOR @ 1,000'.....	26
	Figure 22. ESR Ratio - VOR/VOR @ 5,000'.....	27
	Figure 23. ESR Ratio - VOR/VOR @ 10,000'.....	28
	Figure 24. ESR Ratio - VOR/VOR @ 15,000'.....	29
	Figure 25. ESR Ratio - VOR/VOR @ 18,000'.....	30
	Figure 26. ESR Ratio - VOR/VOR @ 20,000'.....	31
	Figure 27. ESR Ratio - VOR/VOR @ 30,000'.....	32
	Figure 28. ESR Ratio - VOR/VOR @ 40,000'.....	33
	Figure 29. ESR Ratio - VOR/VOR @ 50,000'.....	34
	Figure 30. ESR Ratio - VOR/LOC. VOR Is Desired @ 1,000' .....	35
	Figure 31. ESR Ratio - VOR/LOC. VOR Is Desired @ 5,000' .....	36
	Figure 32. ESR Ratio - VOR/LOC. VOR Is Desired @ 10,000' .....	37
	Figure 33. ESR Ratio - VOR/LOC. VOR Is Desired @ 15,000' .....	38
	Figure 34. ESR Ratio - VOR/LOC. VOR Is Desired @ 18,000' .....	39
	Figure 35. ESR Ratio - VOR/LOC. VOR Is Desired @ 20,000' .....	40
	Figure 36. ESR Ratio - VOR/LOC. VOR Is Desired @ 30,000' .....	41
	Figure 37. ESR Ratio - VOR/LOC. VOR Is Desired @ 40,000' .....	42
	Figure 38. ESR Ratio - VOR/LOC. VOR Is Desired @ 50,000' .....	43
	Figure 39. DME/TACAN Facility Separation Curves For ESR = +2 dB.....	44
	Figure 40. DME/TACAN Facility Separation Curves For ESR = +5 dB.....	45
	Figure 41. DME/TACAN Facility Separation Curves For ESR = +8 dB.....	46
	Figure 42. DME/TACAN Facility Separation Curves For ESR = +11 dB.....	47
	Figure 43. DME/TACAN Facility Separation Curves For ESR = +14 dB.....	48
	Figure 44. DME/TACAN Facility Separation Curves For ESR = +17 dB.....	49
	Figure 45. DME/TACAN Facility Separation Curves For ESR = +20 dB.....	50
	Figure 46. ESR Ratio - DME/TACAN to DME/TACAN @ 1,000'.....	51
	Figure 47. ESR Ratio - DME/TACAN to DME/TACAN @ 18,000'.....	52
	Figures 48 thru 60. Reserved .....	52

**SECTION 3. ILS AND DME FREQUENCY ENGINEERING**

14.	Frequency Engineering For ILS and DME.....	61
	Figure 61. LOC Front Course FPSV.....	61
	Figure 62. LOC Back Course FPSVs.....	62
	Figure 63. FPSV For ILS GS.....	63
	Figure 64. FPSVs For DMEs Associated With ILS.....	63
15.	Frequency Engineering Procedures.....	64
16.	Intersite Analysis By the Table Method For ILS LOCs.....	65
17.	Intersite Analysis By the Table Method For ILS-DME.....	65
18.	ILS-DME Required Separation.....	65
19.	Use of The Larger Separation Requirement.....	66
20.	ILS Associated DME Adjacent Channel Undesired.....	66
	Figure 65. LOC Separation Distances Defined.....	66
	Figure 66. LOC/LOC Cochannel Radii Separations.....	67
	Figure 67. LOC/LOC 1st Adjacent Channel - 50 kHz - Separations - Interim.....	67
	Figure 68. LOC/LOC 1st Adjacent Channel - 50 kHz - Separations - Final.....	68
	Figure 69. LOC/VOR 1st Adjacent Channel - 50 kHz - Separations - Interim.....	68
	Figure 70. LOC/VOR 1st Adjacent Channel - 50 kHz - Separations - Final.....	69
	Figure 71. LOC/VOR 2nd Adjacent Channel - 100 kHz - Separations.....	69
	Figure 72. ILS-DME Cochannel Separations.....	70
	Figure 73. ILS-DME 1st Adjacent Channel Separations.....	70
21.	Intersite analysis of ILS by Calculation Method.....	71
	Figure 74. LOC Antenna Gains and Graph Reference.....	72
	Figure 75. Critical Point Separation Distance.....	73
22.	Special Consideration For ILSs on Opposite Ends of a Runway.....	73
	Figure 76. LOC Intersite Analysis By Calculation.....	74
23.	LOC Calculation Example.....	74
	Figure 77. DME and TACAN Antenna Gain Figures.....	76
	Figure 78. DME Intersite Analysis by Calculation.....	76
24.	DME Calculation Example.....	77
25.	ILS Markers.....	78
26. thru 30.	Reserved.....	78
	Figure 79. LOC Facility Separation Curves For ESR = -52 dB.....	79
	Figure 80. LOC Facility Separation Curves For ESR = -49 dB.....	80
	Figure 81. LOC Facility Separation Curves For ESR = -46 dB.....	81
	Figure 82. LOC Facility Separation Curves For ESR = -43 dB.....	82
	Figure 83. LOC Facility Separation Curves For ESR = -40 dB.....	83
	Figure 84. LOC Facility Separation Curves For ESR = -37 dB.....	84
	Figure 85. LOC Facility Separation Curves For ESR = -34 dB.....	85
	Figure 86. LOC Facility Separation Curves For ESR = -31 dB.....	86
	Figure 87. LOC Facility Separation Curves For ESR = -28 dB.....	87
	Figure 88. LOC Facility Separation Curves For ESR = -25 dB.....	88
	Figure 89. LOC Facility Separation Curves For ESR = -22 dB.....	89
	Figure 90. LOC Facility Separation Curves For ESR = -19 dB.....	90
	Figure 91. LOC Facility Separation Curves For ESR = -16 dB.....	91
	Figure 92. LOC Facility Separation Curves For ESR = -13 dB.....	92
	Figure 93. LOC Facility Separation Curves For ESR = -10 dB.....	93
	Figure 94. LOC Facility Separation Curves For ESR = -7 dB.....	94
	Figure 95. LOC Facility Separation Curves For ESR = -4 dB.....	95

Figure 96. LOC Facility Separation Curves For ESR = -1 dB.....	96
Figure 97. LOC Facility Separation Curves For ESR = +2 dB.....	97
Figure 98. LOC Facility Separation Curves For ESR = +5 dB.....	98
Figure 99. LOC Facility Separation Curves For ESR = +8 dB.....	99
Figure 100. LOC Facility Separation Curves For ESR = +11 dB.....	100
Figure 101. LOC Facility Separation Curves For ESR = +14 dB.....	101
Figure 102. LOC Facility Separation Curves For ESR = +17 dB.....	102
Figure 103. LOC Facility Separation Curves For ESR = +20 dB.....	103
Figure 104. LOC Facility Separation Curves For ESR = +23 dB.....	104
Figure 105. LOC Facility Separation Curves For ESR = +26 dB.....	105
Figure 106. LOC Facility Separation Curves For ESR = +29 dB.....	106
Figure 107. LOC Facility Separation Curves For ESR = +32 dB.....	107
Figure 108. ESR ratio - LOC/VOR. LOC Is Desired Facility @ 1,000'.....	108
Figure 109. ESR ratio - LOC/VOR. LOC Is Desired Facility @ 4,500'.....	109
Figure 110. ESR ratio - LOC/VOR. LOC Is Desired Facility @ 6,250'.....	110
Figure 111. LOC LPD (14-10) and (20-10) Antenna Radiation Patterns.....	111
Figure 112. LOC V Ring Antenna Radiation Pattern.....	112
Figure 113. LOC Travelling Wave - 8 el Antenna Radiation Pattern.....	113
Figure 114. LOC Travelling Wave - 14 el Antenna Radiation Pattern.....	114
Figure 115. LOC LPD 8 El Antenna Radiation Pattern.....	115
Figure 116. LOC LPD 14 el Antenna Radiation Pattern.....	116
Figure 117. LOC LPD GRN-29 Antenna Radiation Pattern.....	117
Figure 118. LOC Travelling Wave 14/6 Antenna Radiation Pattern.....	118
Figure 119. LOC Parabolic Narrow Antenna Radiation Pattern.....	119
Figure 120. LOC Parabolic Wide Antenna Radiation Pattern.....	120
Figure 121. LOC MRN-7 Dipole Antenna Radiation Pattern.....	121
Figure 122. LOC Redlich LPD (14-10) Antenna Radiation Pattern.....	122
Figure 123. LOC Mod. V Ring Antenna Radiation Pattern.....	123
Figure 124. LOC 1201 Dipole Antenna Radiation Pattern.....	124
Figure 125. LOC 1203 Dipole Antenna Radiation Pattern.....	125
Figure 126. LOC 1204 Dipole Antenna Radiation Pattern.....	126
Figure 127. LOC 1261 Dipole Antenna Radiation Pattern.....	127
Figure 128. LOC STAN37 Dipole Antenna Radiation Pattern.....	128
Figure 129. LOC Twin Tee Antenna Radiation Pattern.....	129
Figure 130. LOC Standard 14 el V-Ring Antenna Radiation Pattern.....	130
Figure 131. DME Unidirectional Antenna Radiation Pattern.....	131
Figure 132. DME Bi-directional Antenna Radiation Pattern.....	132
Figures 133. thru 140. Reserved.....	132

#### **SECTION 4. CHECKING AN FAA PROPOSED ILS FREQUENCY WITH THE AAM**

31. ILS Frequency Study Procedure.....	139
32. Step By Step Study Procedure.....	139
33. Study Results.....	140
34. thru 40. Reserved.....	140
Figure 141a. AAM Printout Page 1.....	141
Figure 141b. AAM Printout Page 2.....	142
Figure 142a. AAM Printout Page 1.....	143
Figure 142b. AAM Printout Page 2.....	144
Figure 142c. AAM Printout Page 3.....	145
Figure 142d. AAM Printout Page 4.....	146

Figure 142e. AAM Printout Page 5 .....	147
Figure 142f. AAM Printout Page 6.....	148
Figures 143. thru 154. Reserved .....	148

## SECTION 5. NAVAID RECEIVER TEST FACILITIES FREQUENCY ENGINEERING

41. Frequency Engineering For VOT Test Facilities .....	151
42. Frequency Engineering For Secondary Receiver Test Facilities .....	151
43. VOT Frequency Engineering By the Table Method .....	152
Figure 155. Cochannel Separation of VOT and Operating VORs.....	152
Figure 156. LOC Radii Defined, Cochannel.....	152
Figure 157. Cochannel Separation of ILS and ILS-Test.....	153
44. VOT Frequency Engineering By the Calculation Method.....	153
Figure 158. VOR Versus Cochannel VOT By Calculation .....	153
45. thru 50. Reserved .....	154
Figure 159. VOR/VOT Cochannel Facility Separation Curves +14 dBW.....	155
Figure 160. VOR/VOT Cochannel Facility Separation Curves +17 dBW .....	156
Figure 161. VOR/VOT Cochannel Facility Separation Curves +20 dBW .....	157
Figures 162. thru 164. Reserved .....	157

## SECTION 6. ESV FREQUENCY ENGINEERING

51. Frequency Engineering For ESV .....	165
52. Minimum Power Available Requirements.....	165
Figure 165. Power Available Requirements For NAVAID Receivers .....	165
53. An Example Of Power Availability .....	165
Figure 166. Power Available - VOR.....	166
54. The Interrelationship Of the VOR and DME/TACAN ESV .....	166
55. VOR/DME/TACAN ESV Determination Procedure.....	166
Figure 167. Critical Point Measurement of an ESV .....	167
Figure 168. Example of VOR ESV By Calculation.....	167
56. ILS-DME ESV Determination Procedure.....	168
57. ESV Special Considerations .....	168
Figure 169. Sample ESV Record Format.....	169
58. thru 62. Reserved .....	169
Figure 170. Power Available Curves - 100 W - VOR 0-50 nmi.....	170
Figure 171. Power Available Curves - 100 W - VOR 0-220 nmi.....	171
Figure 172. Power Available Curves - 5 kW - TACAN 0-50 nmi.....	172
Figure 173. Power Available Curves - 5 kW - TACAN 0-220 nmi.....	173
Figure 174. Power Available Curves - 100 W - Cardion DME 0-50 nmi.....	174
Figure 175. Power Available Curves - 100 W - Cardion DME 0-220 nmi.....	175
Figure 176. Power Available Curves - 100 W - Montek DME 0-50 nmi .....	176
Figure 177. Power Available Curves - 100 W - Montek DME 0-220 nmi .....	177
Figure 178. Power Available Curves - 1 kW - Cardion DME 0-50 nmi.....	178
Figure 179. Power Available Curves - 1 kW - Cardion DME 0-220- nmi .....	179
Figure 180. Power Available Curves - 1 kW - Montek DME 0-50 nmi .....	180
Figure 181. Power Available Curves - 1 kW - Montek DME 0-220 nmi .....	181
Figure 182. Power Available Curves - 100W - FA10153 DME 0-50 nmi .....	182
Figure 183. Power Available Curves - 100W - FA10153 DME 0-220 nmi .....	183

Figure 184. Power Available Curves - 100W - dBS5100A DME 0-50 nmi..... 184  
 Figure 185. Power Available Curves - 100W - dBS5100A DME 0-220 nmi..... 185  
 Figure 186. Reserved ..... 185

**SECTION 7. MLS AND DME/P FREQUENCY ENGINEERING**

63. Frequency Engineering For MLS and DME/P..... 197  
 Figure 187. FPSV For MLS Approach Azimuth/Data Coverage ..... 197  
 Figure 188. FPSV For MLS Approach Elevation Coverage..... 198  
 Figure 189. FPSV For MLS Back Azimuth/Data Coverage..... 199  
 Figure 190. FPSV For MLS DME/P..... 200  
 Figure 191. Interim MLS Cochannel and Adj. Channel Separation D/U Values ..... 201  
 Figure 192. DME/P Cochannel and Adjacent Channel Separation D/U Values..... 201  
 64. Frequency Engineering Procedures ..... 202  
 65. MLS Intersite Analysis By Table Method ..... 202  
 Figure 193. Interim MLS Cochannel Separation Distance ..... 202  
 66. DME/P Intersite Analysis By Table Method ..... 203  
 Figure 194. MLS DME/P Assignment Criteria..... 203  
 67. thru 70. Reserved. .... 203  
 Figures 195 thru 200 Reserved. .... 203

**SECTION 8. LOCAL AREA AUGMENTATION SYSTEM FREQUENCY ENGINEERING**

71. Frequency Engineering ..... 211  
 Figure 201. LAAS/LAAS/VOR Separation Criteria ..... 211  
 72. Frequency Engineering Procedures ..... 212  
 73. Intersite Analysis by the Table Method for LAAS ..... 212  
 Figure 202. LAAS/LAAS Cochannel Separations..... 212  
 Figure 203. LAAS/VOR Interim 1<sup>st</sup> Adjacent Channel 50 kHz Separations ..... 213  
 Figure 204. LAAS/VOR Final 1<sup>st</sup> Adjacent Channel 50 kHz Separations ..... 213

**APPENDIX 4. TECHNICAL DATA FOR VHF/UHF/SHF LINKS**

Figure 1. Technical Parameters, ATT FR8 RCL ..... 1  
 Figure 2. FR8 Interference Susceptibility Curves..... 2  
 Figure 3. Technical Parameters, TML ..... 3  
 Figure 4. TML Interference Susceptibility Curves ..... 4  
 Figure 5. FAA Low Density RCL Path Design Criteria ..... 5  
 Figure 6. MDR 6X08 Specifications..... 6  
 Figure 7. Nomograph For Free Space Propagation Loss ..... 7  
 Figure 8. Nomograph For Parabolic Antenna Gain ..... 8  
 Figure 9. Available Computer Analysis Models..... 9

**APPENDIX 5. GLOSSARY** (9 pages)..... 1

**APPENDIX 6. EMISSION DESIGNATORS** (2 pages)..... 1

**APPENDIX 7. FORMULAS USED IN THIS ORDER** (1 page) ..... 1



**APPENDIX 8. SOME PROCEDURES FOR RADAR ANTENNA VERTICAL PATTERN MEASUREMENT BY SOLAR MEANS**

1.	General.....	1
2.	Two Methods of Solar Measurements .....	1
3.	Manual Measurement.....	1
	Figure 1. Block Diagram of Manual Measurement .....	2
	Figure 2. Sample Recording With Calibration, Time and Amplitude Markings .....	5
	Figure 3. Sample Plot of Analyzed Recording.....	6
4.	Automated Measurement .....	6
	Figure 4. Automated Radar Antenna Solar Measurement Block Diagram.....	7
5.	Documentation .....	8

## CHAPTER 1. GENERAL

**1. PURPOSE.** This order establishes and describes the spectrum management function in the Federal Aviation Administration (FAA) and delineates policies and procedures for the allocation and engineering of this scarce resource.

**2. DISTRIBUTION.** This order is distributed to the director level in headquarters, the William J. Hughes Technical Center, and the Mike Monroney Aeronautical Center; to division level in the Technical Operations, Enroute and Oceanic, and Terminal Service Areas; and to all field offices with a supervisory distribution.

**3. CANCELLATION.** This order cancels and supersedes Order 6050.32A, dated May 1, 1998.

### **4. EXPLANATION OF CHANGES.**

**a. Many chapters and appendices** have been updated and expanded to reflect, in particular, current FAA policy and ensure appropriate guidance in addressing the broad range of issues related to aeronautical radio frequency spectrum engineering and usage. A number of the more significant changes are highlighted in the following items.

**b. Chapter 8 has been updated** with new guidance on Obstruction Evaluation notification requirements and automation tools.

**c. Chapter 9 has been updated** to include guidance regarding the Sustaining Backup Emergency Communications (BUEC) systems, as well as guidance on temporary frequency assignments for, in particular, Air Shows and Fire Fighting.

**d. Chapters 14 and 15 have been updated** to reflect the current automation and analysis tools to better detect, document, and resolve radio frequency interference (RFI) cases.

**e. Chapter 16 has been expanded** to address guidelines for radiation hazard measurements and related procedures, as a result of the cancellation on April 22, 1999, of FAA Order 3910.3A, Radiation Health Hazards and Protection, dated October 19, 1983.

**f. Chapter 17 has been updated** to reflect new frequency allotments, a new channel plan, additional fixed communications systems, and new transmit emission standards.

**g. Chapter 19 has been renamed** to Automated Engineering (previously Automated Frequency Manager (AFM)) and expanded to more broadly reflect the increased use of automation in satisfying spectrum engineering and analysis functions.

**h. Appendix 2 has been updated** to reflect new policy changes to the engineering criteria and frequency uses that have been developed for the Air-Ground VHF Communications frequency bands.

**i. A new Appendix 3, Section 8 has been added** to address Local Area Augmentation System (LAAS) frequency engineering.

**5. FORMS.** The following forms may be obtained from the FAA Depot through normal supply channels (see the latest edition of Order 1330.3):

**a. FAA Form 6050-1**, Facility Transmitting Authorization, NSN 0052-00-688-6001; unit of issue: sheet.

**b. FAA Form 6050-2**, Transmitter Identification and Operation Authorization, NSN 0052-00-694-9000; unit of issue: sheet.

**c. FAA Form 6050-4**, Expanded Service Volume Request, NSN 0052-00-845-6000, unit of issue: set.

**6. thru 199. RESERVED.**

## CHAPTER 2. THE RADIO FREQUENCY (RF) SPECTRUM

**200. RF SPECTRUM.** The RF or electromagnetic spectrum is a finite natural resource used by every country in the world. The internationally used frequency unit is the "Hertz," named for an early pioneer in spectrum research. The Hertz (Hz) is defined as one cycle per second (cps), with further prefixes from the Greek to indicate multipliers. One thousand Hz is defined as 1 kiloHertz (kHz), one million Hz is 1 MegaHertz (MHz) and one billion Hz is 1 GigaHertz (GHz), etc. The electromagnetic spectrum emissions of interest, which are called the radio frequency bands, begin at 10 kHz and end at 300 GHz. Above 300 GHz are visible light, X-rays, gamma rays and other electromagnetic phenomena.

### **201. MAKEUP OF THE SPECTRUM.**

**a. By international agreement,** the radio spectrum is divided into major bands in frequency decimal multiples of three. The radio spectrum was originally defined in terms of metric system wavelengths. The three multiple came into use because the speed of light and electromagnetic propagation is about 300 million meters per second in free space. The length of a full wavelength is  $3 \times 10^8$  meters per second (m/s) divided by the frequency in Hz. Noting this frequency/wavelength relationship, a frequency of 3 MHz calculates to 100 meters for a full wavelength.

**b. These decade bands of frequencies** have international defined names, using common terms. For example, the band of frequencies from 30 kHz to 300 kHz is named Low Frequency (LF) and 300 kHz to 3 MHz is designated Medium Frequency (MF). The bands continue from LF and MF to High (HF), Very High (VHF), Ultra High (UHF) and Super High (SHF) with continuations above and below these ranges. The frequency band names are divided by decimal breaks defined in wavelengths; e.g., 300 kHz is 1000 meters, 3,000 kHz is 100 meters, etc. The United States uses frequency in Hz as the unit for specific administrative tracking of spectrum assignments.

### **202. SPECTRUM LIMITATION CONSIDERATIONS.**

**a. Aeronautical safety systems shall be accommodated** in aeronautical spectrum which is specifically allocated for the service being satisfied and which is used exclusively by aeronautical safety systems. This ensures protection from non-aeronautical users so that the high levels of integrity and availability required by civil aviation can be met.

**b. Congestion** within the available spectrum is not the only factor limiting its use. First and primarily are the international agreements and treaties to which the United States is a signatory. These matters are covered in detail in chapter 3. Second is the necessary frequency bandwidth required to convey the transmitted information. Other considerations are spectrum efficiency, propagation, capacity, equipment, economics and interference.

**c. International agreements** divide the spectrum into bands for either exclusive or shared use by a specific service. The aeronautical service is just one of many defined services which have allocations in specific and limited bands. The aeronautical mobile (R) and aeronautical radionavigation services are directly related to safety of life and property in the air. Therefore, most such bands are allocated exclusively worldwide, where the operations deal directly with operation of aircraft. Ancillary aeronautical services, such as fixed microwave point-to-point systems, are shared with other users.

**d. Aeronautical service frequency bands** are distributed throughout the radio spectrum.

**e. Propagation characteristics** play a major role in the limitations on use of the assigned spectrum. LF and MF operate primarily on groundwave and can cover hundreds or thousands of miles day or night quite reliably. HF uses the ionosphere to reflect signals for great distances around the earth, but are greatly affected by day-to-night and seasonal changes. Beginning around the VHF band, "radio line-of-sight" (RLOS) propagation conditions exist. RLOS extends the visual line-of-sight distance by virtue of the phenomenon that radio waves "bend" near large objects such as the earth. See the Appendix 2 for details. At VHF frequencies and above, radio signals travel in a straight line, modified by the bending of the path due to the RLOS effect. Large metallic or electrically-conducting objects such as steel buildings will attenuate, retard or deflect the signal's path. Signal reflection occurs under some conditions, but it is not considered as a reliable path except where the reflector is a part of the planned path.

**f. Technical equipment**, particularly its changing style as the state-of-the-art progresses, places severe restrictions on the spectrum engineer in engineering frequencies. For example, the original channel assignments in the VHF communications band were every 200 kHz on the odd frequencies between 118.1 and 126.9 MHz, e.g., 118.1, 118.3, etc. Congestion required narrowing the channels to 100 kHz so frequencies could then be assigned on every decimal frequency, 118.1, 118.2, etc. While technically the number of channels doubled per MHz, all could not be used simply. There were still thousands of 200 kHz channeled transceivers in use. It took years of education and finally agency orders to permit the spectrum engineer full use of the 100 kHz channels. Subsequent congestion brought further reduction to 50 kHz, then currently to 25 kHz channels, yet protection for a "grandfather" period for older operating equipment always must be given.

**g. Economics** also has a very big impact on the spectrum engineer's ability to engineer frequencies. As described in subparagraph e, even though revised frequency engineering allocations establishes additional channels, they may not necessarily be able to be used. Whether airline or a private aircraft owner, the ability to meet all the requirements for new equipment to meet technological advances is limited by the ability to pay for it.

**h. Interference** can be defined as any undesired signal or energy which prohibits or degrades the normal reception of the desired signal. It can be divided into three broad categories; adjacent channel or cochannel radio sources, man-made electrical noise, and natural solar and atmospheric noise.

(1) **Adjacent channel or cochannel** interference is caused by undesired radio transmissions which the receiving device is unable to separate from the desired transmission. Adjacent channel interference is caused by emitters using nearby channels and occurs because of the inability of the pass band of the victim receiver to discriminate against near-frequency signals. Cochannel interference is caused by emitters using the same frequency which are too close geographically. Proven radio frequency spectrum engineering criteria are used by the spectrum engineer to establish an interference-free assigned frequency.

(2) **Man-made interference** is the most common and most insidious. The sources are limitless, from "plastic welders," to electric motors of all types, to the incidental and spurious radiation of other transmitters. In addition, there are cases of intentional interference, so-called "bogus" or "phantom" controllers, which FAA must investigate (and prosecute) with the help of other agencies.

(3) **Solar and atmospheric noise** are outside human control. The sun emits an enormous amount of energy throughout the spectrum, varying in day-to-day intensity and frequency. In frequencies through VHF, solar radiation and atmospheric noise such as lightning and precipitation static are significant. From UHF and above, noise generated internally in equipment is the controlling factor.

(4) **Intermodulation** is defined as the presence of unwanted signals at the output of a less-than-ideal amplifier resulting from modulation of the components of a complex waveform by each other in a nonlinear system. When two or more signals are applied to a nonlinear device, a mixing or intermodulation action results and signals are produced, having frequencies equal to the sums and differences of the original input signals, among other signals. An otherwise linear device may be driven into nonlinear operation in the presence of strong external signal levels. Although most cases occur in receivers, problems do occur when two or more transmitters start radiating a mixed frequency created when a mix occurs in their final amplifiers, particularly when their antennas are in close proximity. Detailed information will be found in Appendix 2.

(5) **Desensitization** is the deterioration of reception of a desired signal due to the proximity of a very strong signal. The source of the problem could be of any frequency theoretically, but in practice, communications frequencies usually are effected only by very strong signals below about 1 GHz. The strong signal drives the receiver into non-linear function, desensitizing normal reception as well as generating many unwanted spurious signals within the receiver.

**203. thru 299. RESERVED.**

## CHAPTER 3. HISTORY, AUTHORITIES, AND RESPONSIBILITIES

**300. GENERAL CONSIDERATIONS.** The FAA, as one of the major users of the RF spectrum in the United States, has an important national role in the management of frequencies. In turn, the nation has a major responsibility to the rest of the world in the orderly development and application of the RF spectrum within the international community. To acquaint the reader with the need for effective spectrum management within the agency, this chapter presents an historical background of the development and current national and international administrative authorities and responsibilities. Although it complicates the task, agency spectrum management is bound by many international treaties, as well as the regulatory framework imposed by the dual spectrum control entities in the United States: the Federal Communications Commission (FCC) and the National Telecommunications and Information Administration (NTIA).

### **301. INTERNATIONAL ORGANIZATIONS.**

#### **a. International Telecommunication Union (ITU).**

**(1) ITU.** The ITU is an arm of the United Nations, with its headquarters in Geneva, Switzerland. It is the fundamental authority for spectrum allocation and management. The ITU currently has a membership of nearly 190 nations, and 650 Sector Members (companies). The organization is one of the oldest international groups in existence. In 1932, it became the successor to the International Telegraph Union that was created in 1865.

**(2) ITU Authority.** The ITU expresses its authority through the same channels as any other multilateral treaty system. Regulations adopted by this international body must then be ratified further and signed by the various administrations (nations) represented. These regulations are developed at conferences and through negotiation where representatives of member nations formulate recommendations that are presented to the plenary body in session for formal voting action leading to adoption. The adopted policies are then published and include detailed regulations and policies in such areas as terminology, assignment and use of frequencies, band allocations, frequency registration, technical specifications, measures against interference, administrative provisions for stations and distress and safety procedures.

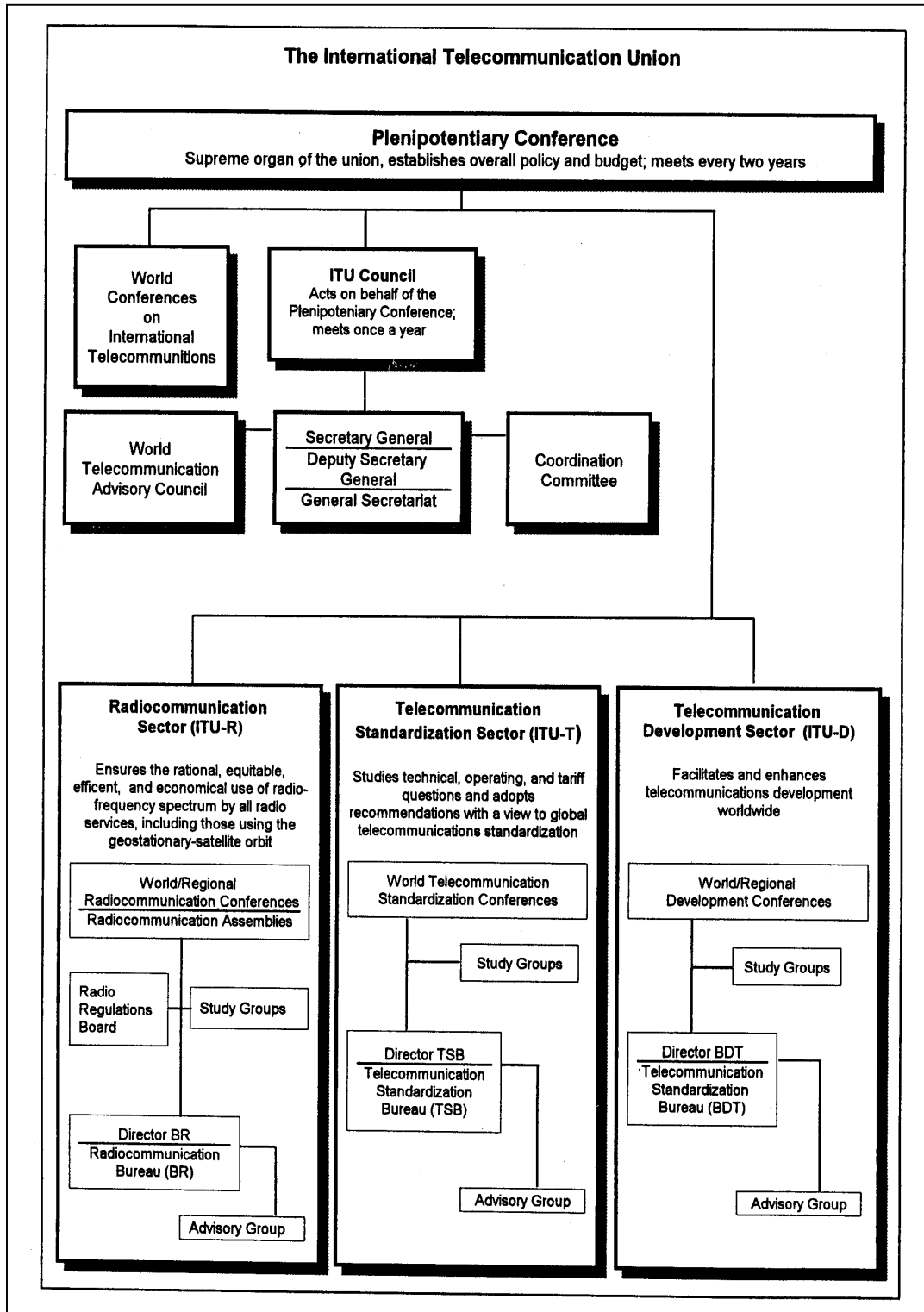
**(3) Structure of the Union.** An organizational diagram of the ITU, showing major functions of concern to the FAA, is presented in figure 3-1. Some major activities and elements of the Union are as follows:

**(a) Plenipotentiary Conference.** Meeting at intervals of normally not less than 5 years, the Plenipotentiary Conference determines the general policies for fulfilling the purposes of the Union. It reviews the work of the Union and revises the Convention (organization definition) if considered necessary.

**(b) World Radiocommunication Conference (WRC).** A WRC is normally convened every three to four years to consider specific radiocommunication matters. A WRC may revise the Radio Regulations, or deal with any radiocommunication matter of worldwide character in accordance with its agenda. The Radio Regulations constitute an international treaty on radiocommunication and cover the use of the radio frequency spectrum by radiocommunication services.

**(c) Council.** The Council sets the final agenda for a WRC, normally two years before the conference is held.

**FIGURE 3-1. PARTIAL ORGANIZATIONAL CHART OF THE ITU**





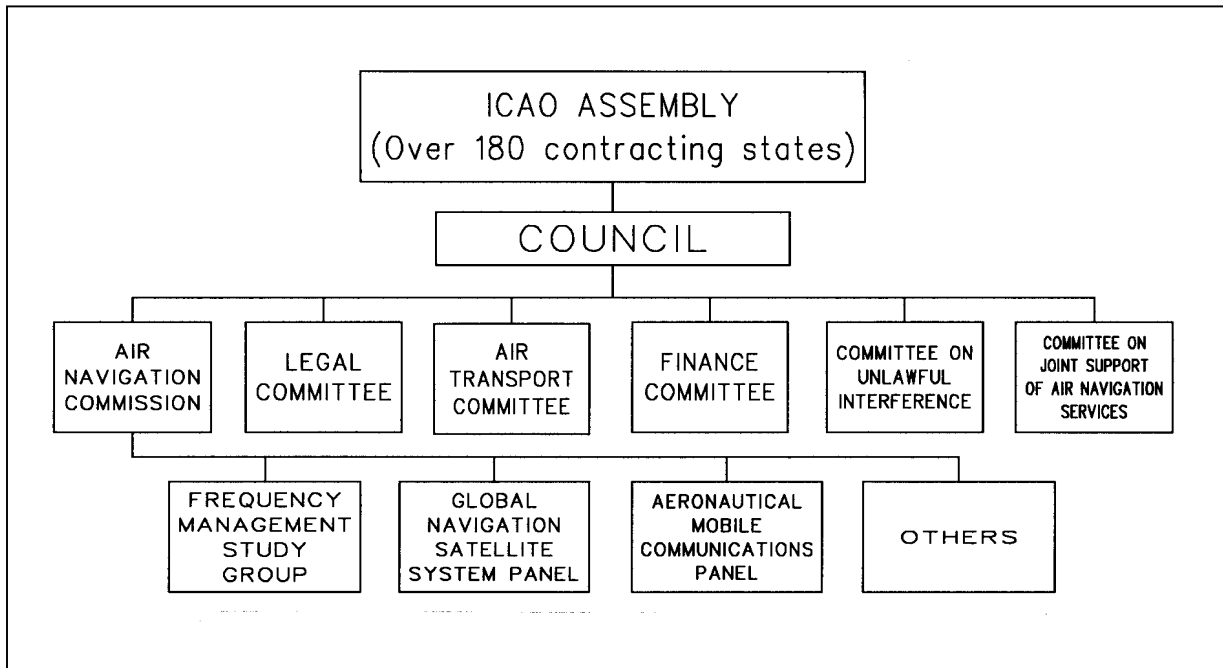
**(d) Secretary General.** The Secretary General is responsible to the Council for external relations, public information and other directed functions. The office provides secretarial services for all conferences and publishes the monthly journal services in several languages for distribution to member nations.

**(e) Radiocommunication Sector.** The Radiocommunication Sector is one of three major Sectors directly under the authority of the Plenipotentiary Conference and the Council. Its primary functions are to provide for international frequency registration, technical and administrative support to radiocommunication study groups, to provide conference and assembly support and to provide seminars and training.

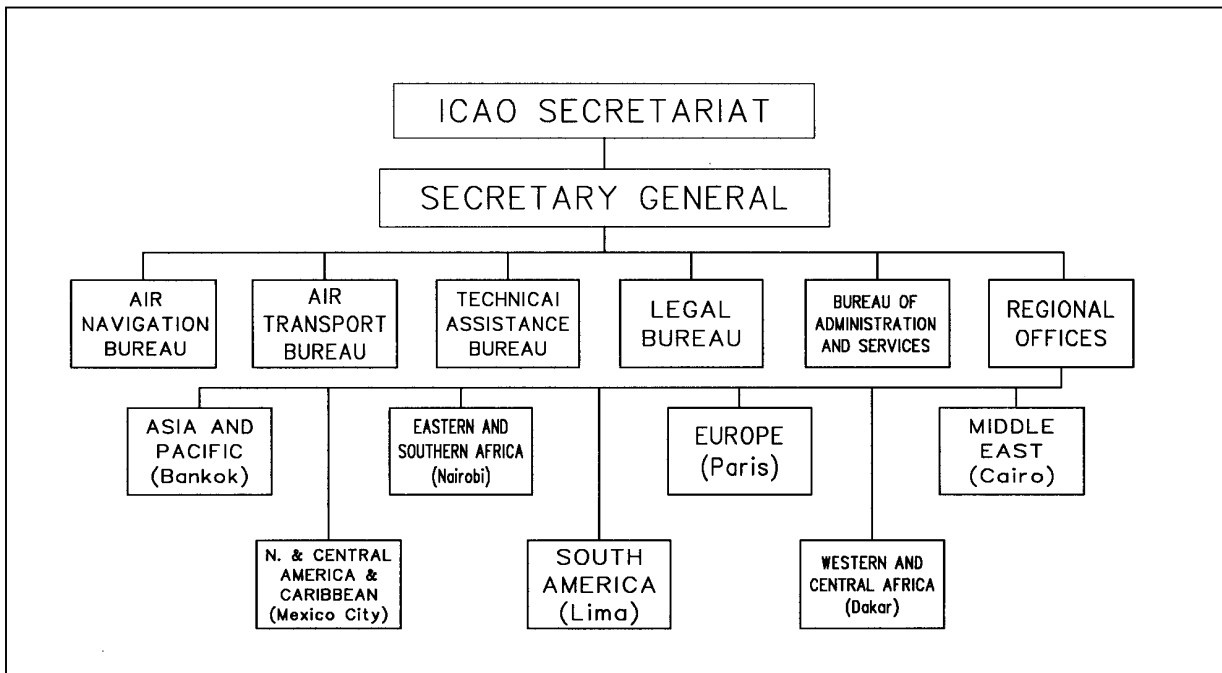
**b. International Civil Aviation Organization (ICAO).** ICAO is to the international scene as FAA is to the national, except that it is only advisory, without authority to enforce its recommendations. Member nations, including the United States, strive for strict adherence to ICAO standards. See figure 3-2. The following is a summary of the ICAO goals:

- (1) **Ensure safe and orderly growth** of international aviation throughout the world.
- (2) **Encourage the arts of aircraft design** and operation for peaceful purposes.
- (3) **Encourage the development of airways**, airports and air navigation facilities for international civil aviation.
- (4) **Meet the needs of the people** of the world for safe, regular, efficient and economical air transport.
- (5) **Prevent economic waste** caused by unreasonable competition.
- (6) **Ensure that rights** of contracting nations are respected fully and those nations given equal opportunity.
- (7) **Promote safety of flight** in international air navigation.
- (8) **Annexes to the ICAO Convention** (the "Chicago Convention" which established ICAO) establish international standards and recommended practices (SARPs) for aeronautical requirements such as licensing, airworthiness, security, air traffic, search and rescue, communications, etc. "Standards" are necessary for the safety or regularity of international aviation and "recommended practices" are desirable for the safety or regularity of international aviation.

**FIGURE 3-2a. ICAO ASSEMBLY ORGANIZATION CHART**



**FIGURE 3-2b. ICAO SECRETARIAT ORGANIZATION CHART**



**(9) ICAO operates and functions as follows:**

**(a) The Assembly** is the sovereign body of ICAO and includes over 180 Contracting States. It meets at least once every three years and handles broad policy issues. Each contracting State has one vote on an issue.

**(b) The Council** is the governing body of ICAO. It is a resident body comprised of 33 representatives from Member States elected by the Assembly for three-year terms. One of the primary duties of the Council is to adopt SARP's and incorporate these as Annexes to the Convention to achieve international uniformity/standardization and improve air safety, efficiency and regularity of flight. The U.S. has had a representative member on the Council since the beginning of ICAO.

**(c) The Air Navigation Commission (ANC)** is comprised of 15 qualified technical experts from Member States appointed by the Council. ANC is responsible for examining, coordination and planning all of ICAO's work in the air navigation field and is the principal body concerned with developing SARPs. The ANC forms panels and study groups consisting of outside technical experts to study specific issues and make recommendations to the Council. A technical expert nominated by the U.S. has been a member of the Commission since the beginning of ICAO. This expert has historically had an FAA background.

**1. While Headquarters Monitors** work on nearly all ICAO Panels, the two which routinely address radio spectrum issues and on which Headquarters participates, are the Aeronautical Mobile Communications Panel (AMCP) and the Global Navigation Satellite System Panel (GNSSP). Working Group F of the AMCP addresses aeronautical radio spectrum issues in general, and develops the ICAO position for WRCs.

**2. AMCP studies** aeronautical mobile communications issues and develops SARPs for air-ground communications, satellite communications and associated systems. GNSSP is developing the SARPs for the future Global Navigation Satellite System (GNSS).

**(d) The Air Transport Committee** normally does not address radio spectrum issues. It is comprised of representatives from Member States who are appointed by the Council. Its work includes research and recommendations such as policy guidance on airport and route facility economics and management. It considers air transport issues in global conferences. The Air Transport Committee also forms panels and study groups to process its work.

**(e) The Secretariat** serves as ICAO's permanent administrative body. The Secretariat staff maintains ICAO documents and its bodies include the Air Navigation Bureau, the Aviation Security Branch and the Technical Assistance Bureau. The Secretariat also administers the Seven Regional ICAO Offices which develop and implement regional aviation initiatives.

**302. NATIONAL ORGANIZATIONS - GENERAL.** Each member nation of ITU is free to set up its own procedures for authorizing the use of the spectrum within its nation, but consistent with the international table of allocations approved by the last ITU conference. Exceptions may be taken to specific allocations, but a member nation must notify ITU and be subject to conflicting use by other member nations following the allocations.

**a. United States International Relations.** In the United States, the State Department is responsible for the international representation of the United States in ITU (as well as ICAO) forums, utilizing the full technical and administrative support by all concerned United States agencies. The State Department acts as the ITU voting member. The vote represents the consensus of an extensive NTIA/FCC preparatory process, or when a consensus cannot be reached, the official position of the President. The State Department provides the liaison between the United States and other governments when conflicts arise over application of the ITU Radio Regulations.

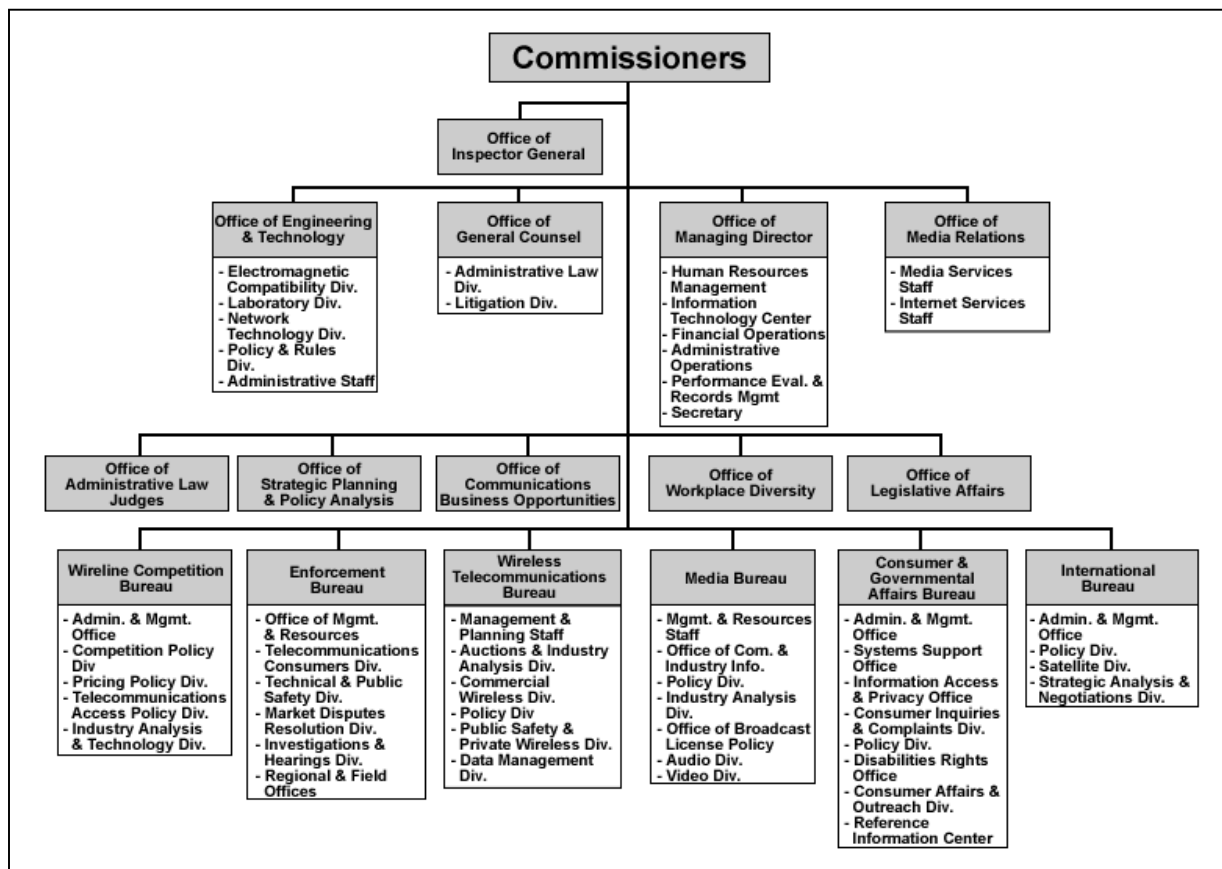
**b. United States Domestic Structure.** The Communications Act of 1934, as amended, established a dual system of control of the spectrum within the United States. The FCC administers all the spectrum assigned to and operated by non-Federal agencies. The Act also specifies that all Federal agencies will have their spectrum needs administered and authorized by a separate agency, currently the NTIA in the Department of Commerce (DOC). Both agencies, FCC and NTIA, work together to formulate recommendations for national control of the spectrum, as well as supply the Department of State with a consensual position for international conferences.

**c. FCC.**

**(1) Jurisdiction.** The FCC has jurisdiction over all non-Federal Government spectrum and spectrum users in the United States. This includes not only broadcast, amateur, industrial, and civil aviation as it applies to licensing the operators and equipment, but also State and municipal government entities as well.

**(3) Organization.** The Commission is composed of five commissioners, appointed by the President with the advice and consent of the Senate. They serve 5-year staggered terms, so one term expires each year. There can be no more than three commissioners from the same political party. One of the members is appointed by the President to be Chair. A simplified block diagram of FCC organization is found in figure 3-3.

**FIGURE 3-3. FEDERAL COMMUNICATIONS COMMISSION**

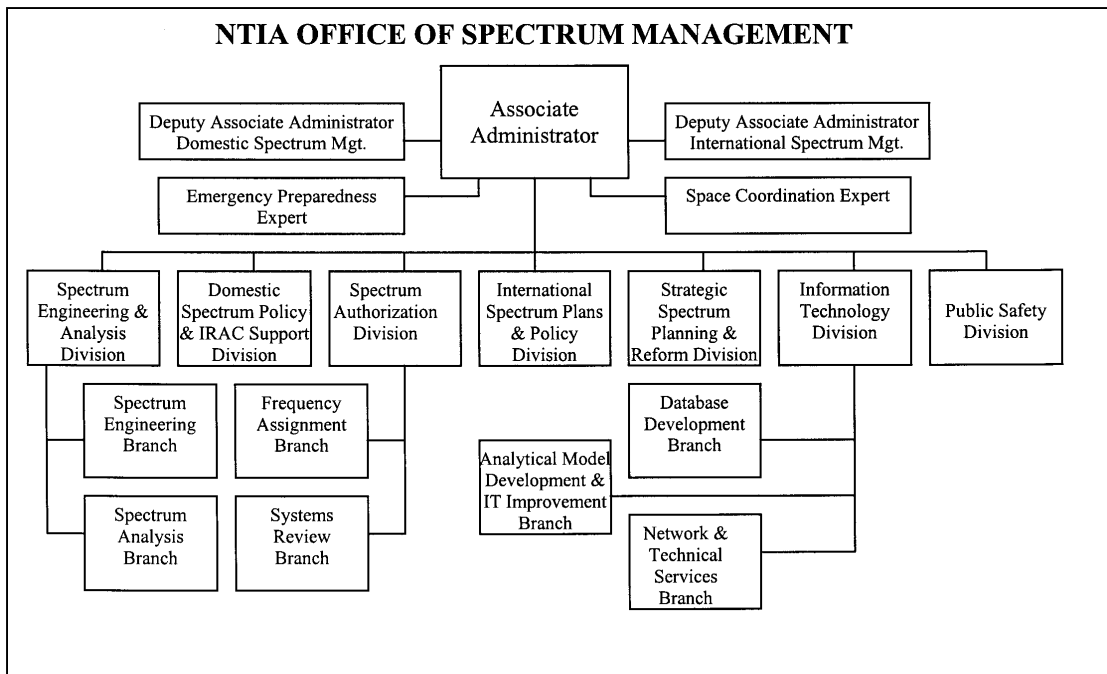
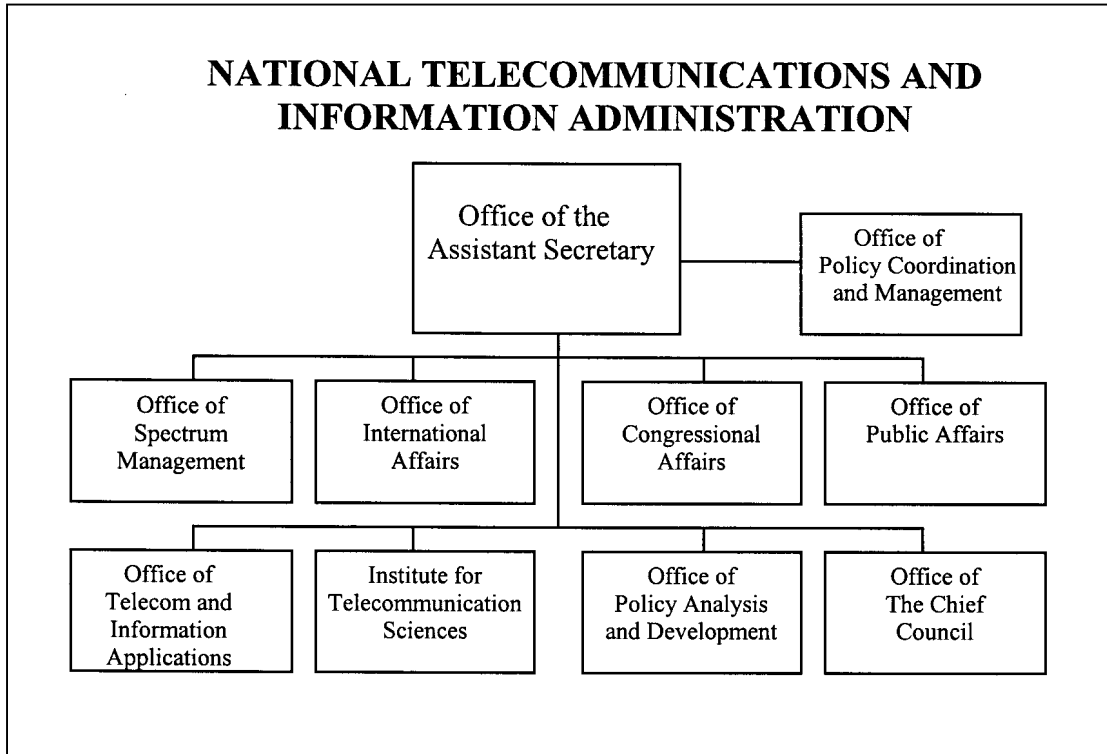


**d. NTIA.**

**(1) Jurisdiction.** NTIA has authority and responsibility for use of the Federal portion of the spectrum by all Federal agencies, including the DOD and the FAA. It is empowered by the same Act as FCC, but has only the Federal agencies' spectra to administer. NTIA and FCC work closely together, since a good portion of the radio spectrum is shared between Federal and non-Federal users requiring joint action. A block diagram of NTIA is shown in figure 3-4.

**(2) Responsibilities.** NTIA is responsible for administering that portion of the spectrum allocated to Federal use. It is empowered to authorize Federal agencies, which demonstrate appropriate needs and satisfy specific requirements, to use the spectrum. They can also withdraw that authorization or modify it if required. NTIA is also bound by the ITU Radio Regulations. FAA's interface with NTIA is normally only at the Washington level.

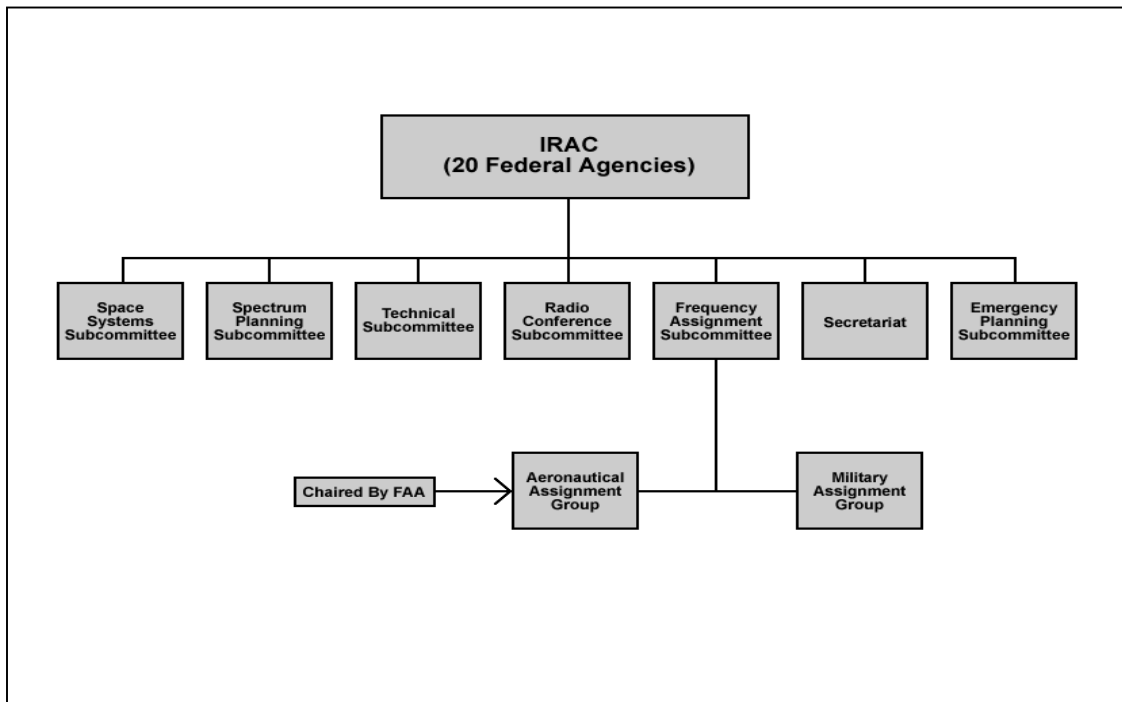
**FIGURE 3-4. NATIONAL TELECOMMUNICATIONS AND INFORMATION ADMINISTRATION**



**(3) Organization.** The NTIA Administrator serves as the Special Assistant to the President for Telecommunications. NTIA is currently located in Washington in the DOC. It has no field offices, but in effect does have various "field representatives" in other agencies in the field. For instance, each FAA service area Frequency Management Officer (FMO) is the NTIA's field coordinator for all radar beacons and all radars within certain radar bands. This includes military and non-Federal radars and radar beacons.

**(a) Interdepartment Radio Advisory Committee (IRAC).** The IRAC, chaired by the NTIA Deputy Associate Administrator for Domestic Spectrum Management, is one of the most important bodies which interfaces with FAA frequency management. Authorization for all FAA frequencies, including our Land Mobile networks comes through IRAC from NTIA. The IRAC is the working arm of NTIA, composed of 20 members, each an agency of the Federal Government, including FAA. See figure 3-5. FAA participates and provides technical expertise to all subcommittees of the IRAC.

**FIGURE 3-5. PARTIAL ORGANIZATION CHART OF THE IRAC**



**(b) Spectrum Planning Subcommittee (SPS).** The SPS carries out IRAC functions which relate to planning for the use of the electromagnetic spectrum. This includes the apportionment of spectrum space for the support of established or anticipated radio services, as well as the apportionment of spectrum space between or among Government and non-Government activities.

**(c) Technical Subcommittee (TSC).** The TSC is a subcommittee of IRAC which examines the technical aspects of the use of the electromagnetic spectrum.

**(d) Radio Conference Subcommittee (RCS).** The RCS advises the IRAC in those functions relating to preparing for ITU radio conferences. This includes the development of recommended U.S. proposals and positions.

(e) **Emergency Planning Subcommittee (EPS).** In general, the EPS formulates, guides, and reviews National Security Emergency Preparedness (NSEP) planning for Federal spectrum-dependent systems.

(f) **Space Systems Subcommittee (SSS).** The SSS, chaired by the NTIA, is responsible to the IRAC for international registration of Government within the ITU forum.

(g) **Frequency Assignment Subcommittee (FAS).** The FAS is an IRAC subcommittee, which operates to accomplish all the engineering and coordination for each agency's frequency requests. To facilitate its work, FAS has specialized groups to assist with the enormous task of checking and coordinating every frequency request. The following are the two most important groups to FAA:

**1. Aeronautical Assignment Group (AAG).** The AAG, chaired by the FAA, handles only those frequencies which deal with aeronautical services, both Federal and non-Federal. In so doing, it can tentatively "authorize" frequencies in that service directly to the FMO in the service area after assuring the request meets all IRAC and FAA requirements. Aeronautical frequencies approved by AAG must be approved by the FAS before they become final. The frequency bands under AAG control are shown in figure 3-6.

**FIGURE 3-6. AAG CONTROLLED BANDS**

190-285 kHz
285-435 kHz*
510-535 kHz*
74.8-75.2 MHz
108-121.9375 MHz inclusive
123.5875-128.8125 MHz inclusive
132.0125-136.0000 MHz inclusive
328.6-335.4 MHz
978-1020 MHz inclusive
1030 MHz
1031-1087 MHz inclusive
1090 MHz
1104-1146 MHz inclusive
1157-1213 MHz inclusive
5000-5250 MHz inclusive
*In these bands, only applications for stations in the Aeronautical Radionavigation Service shall be sent to the AAG.

**2. Military Assignment Group (MAG).** The MAG does the same work as AAG, except for the military fixed and mobile communications bands controlled by DOD, 225.000-328.600 MHz and 335.400-399.950 MHz only. FAA requests for use of those frequencies for A/G facilities must go through MAG for initial approval.

(h) **Field Coordinators.** Because the IRAC lacks expertise in some areas, it needs field assistance in its enormous task of coordinating some operations. As a result, the FAA and the DOD Area Frequency Coordinators (AFC) are tasked with pre-coordination of some portions of the spectrum before the frequency request is submitted to FAS or IRAC.



**1. FAA Field Coordinators** have responsibility for coordinating certain radar frequency bands. This entails the FMOs having to engineer each new radar or beacon request proposed for operation in their service area, whether civilian test, military, other Federal agency use or FAA. Once the frequency or (in the case of radar beacon) the Pulse Repetition Rate (PRR) has been engineered, it must be given to Technical Operations ATC Spectrum Engineering Services for submission to IRAC through channels. Those bands are shown in figure 3-7.

**FIGURE 3-7. BANDS UNDER COORDINATION CONTROL OF FAA FIELD COORDINATORS**

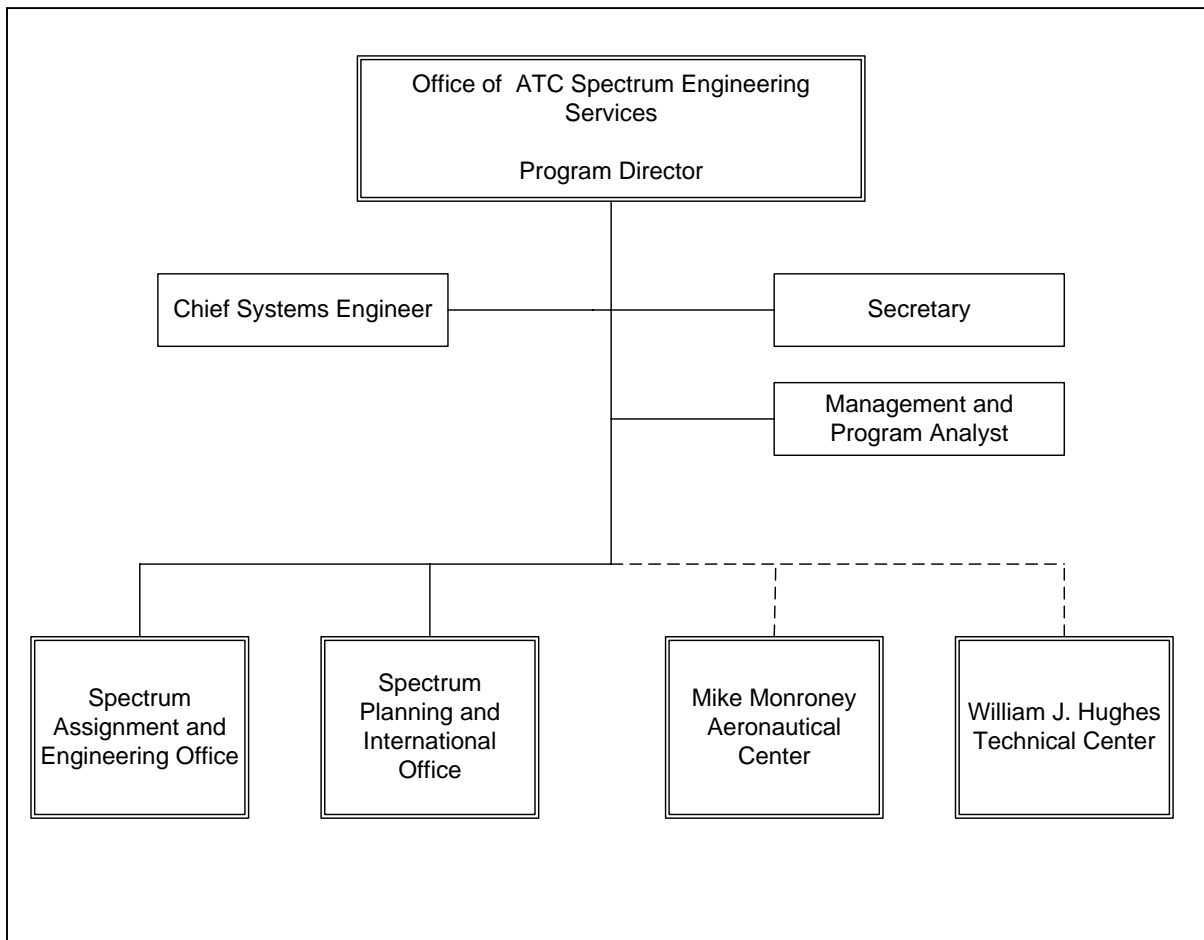
1030 MHz	Airborne Radar Beacons (Interrogators)
1090 MHz	Ground Transponders
1215-1400 MHz	Radar (typically en route radar)
2700-2900 MHz	Radar (typically terminal and weather radar)
9000-9200 MHz	Radar (typically DOD precision approach radar)

**2. DOD AFCs** have a similar responsibility but for the telemetry bands 1435-1535 MHz and 2310-2390 MHz. FAA does not use these bands. DOD AFC responsibilities are covered in the NTIA Manual, chapter 8.

**(4) Spectrum chart.** A wall size detailed graphic representation of the full spectrum is published by NTIA and is available from Technical Operations ATC Spectrum Engineering Services upon request.

**e. FAA.** The spectrum management function in FAA is totally within the purview of Technical Operations ATC Spectrum Engineering Services. The latest edition of Orders 1100.1, FAA Organization - Policies and Standards, 1100.2, Organization - FAA Headquarters and 1100.5, FAA Organization - Field delineate the specific functions of the office. Figure 3-8 provides a block diagram of Technical Operations ATC Spectrum Engineering Services. Figure 3-9 lists the bands of frequencies with which FAA is concerned.

**FIGURE 3-8. TECHNICAL OPERATIONS ATC SPECTRUM ENGINEERING SERVICES**



**FIGURE 3-9. SUMMARY OF FREQUENCY BANDS SUPPORTING AVIATION**

	9 - 14 kHz	OMEGA Navigation System
	90 - 110 kHz	LORAN C Navigation System
*	190 - 435 kHz	Nondirectional Beacon
*	510 - 535 kHz	Nondirectional Beacon
	2100 - 28,000 kHz	High Frequency Communications
*	74.8 - 75.2 MHz	NAVAID (Marker Beacon)
*	108 - 112 MHz	NAVAID (VOR, ILS Localizer)
*	112 - 118 MHz	NAVAID (VOR, LASS and SCAT-I)
*	118 - 137 MHz	VHF Air/Ground Communications
	62 - 174 MHz	Fixed, mobile Communications
	225.0 - 328.6 MHz	UHF Air/Ground Communications
*	328.6 - 335.4 MHz	NAVAID (ILS Glide Slope)
	335.4 - 399.9 MHz	UHF Air/Ground Communications
	406.0 - 406.1 MHz	Satellite Emergency Position Indicating Radio Bcn
	406.1 - 420.0 MHz	Fixed, Mobile Communications
	932 - 935 MHz	Fixed Communications
	941 - 944 MHz	Fixed Communications
*	960 - 1215 MHz	NAVAID (TACAN/DME, etc.)
*	978 MHz	ADS-B (UAT)
*	**	1030 MHz Radar Beacon, TCAS, Mode S
*	**	1090 MHz Radar Beacon, TCAS, Mode S
*		1176.45 MHz Planned Global Positioning System (L5)
		1227.6 MHz Global Positioning System (L2)
**		1215 - 1390 MHz Air Route Surveillance Radar
		1544 - 1545 MHz Emergency Mobile Satellite Communications
		1545 - 1559 MHz Aeronautical Mobile Satellite (R) (Downlink)
		1559 - 1610 MHz GPS (L1), GLONASS
		1645.5 - 1646.5 MHz Emergency Mobile Satellite Communications
		1646.6 - 1660.5 MHz Aeronautical Mobile Satellite (R) (Uplink)
		1710 - 1850 MHz Low Density Microwave Link
**		2700 - 2900 MHz Airport Surveillance Radar, Weather Radar
		2900 - 3000 MHz Weather Radar
		3700 - 4200 MHz ANICS (commercial satellite downlink)
		4200 - 4400 MHz Airborne Radio altimeter
*		5000 - 5250 MHz NAVAID (Microwave Landing System)
		5350 - 5470 MHz Airborne Radar and Associated Airborne Beacon
		5600 - 5650 MHz Terminal Doppler Weather Radar
		5925 - 6425 MHz ANICS (commercial satellite uplink)
		7125 - 8500 MHz Radio Communications Link
		8750 - 8850 MHz Airborne Doppler Radar
**		9000 - 9200 MHz Military Precision Approach Radar
		9300 - 9500 MHz Airborne Radar and Associated Airborne Beacon
		11.70 - 12.20 GHz FAATSAT (commercial satellite downlink)
		13.25 - 13.40 GHz Airborne Doppler Radar
		14.00 - 14.50 GHz FAATSAT (commercial satellite uplink)
		14.50 - 15.35 GHz Television (Video) Microwave Link
		15.70 - 16.20 GHz Airport Surface Detection Equipment (ASDE III)
		21.20 - 23.60 GHz Microwave Link (Multi-use)
		24.45 - 24.65 GHz Airport Surface Detection System (ASDE II)

\* denotes AAG bands engineered by FAA; see NTIA Manual

\*\* denotes those bands for which FAA is national coordinator; see NTIA Manual

**303. TECHNICAL OPERATIONS ATC SPECTRUM ENGINEERING SERVICES.** The following are the major assigned functions for Technical Operations ATC Spectrum Engineering Services:

- a. Focal point** within the FAA for all radio spectrum matters. Develops and executes FAA radio frequency spectrum policy, plans and standards.
- b. Engineers, obtains authorizations** and protects those frequency assignments necessary to satisfy the requirements of the National Airspace System (NAS).
- c. Provides engineering support** to service area and field facilities in the resolution and prevention of radio frequency interference to NAS facilities.
- d. Manages** the classified frequency management data and associated secure computer facility at Headquarters.
- e. Performs engineering analysis** of frequency assignment proposals by Government agencies, the FCC (for non-Government aviation use), Canada, Mexico and other countries to determine the impact on the NAS, and to preclude radio frequency interference to NAS facilities and services.
- f. Represents the agency** on the IRAC and other Government and industry spectrum management committees and working groups and Federal advisory committees which address spectrum issues.
- g. Serves as the manager** of aeronautical frequencies in the United States. Manages and engineers those aeronautical frequencies identified for AAG management and chairs that group. In addition, the NTIA has delegated band coordinator responsibilities to the FAA for radar (1215-1390, 2700-2900 and 9000-9200 MHz bands) and the radar beacon (1030/1090 MHz) systems.
- h. Assists in developing** the United States' position and inputs for use in various international meetings. Represents the United States at those ITU and ICAO meetings that require frequency management technical expertise and which address or impact civil aviation matters.
- I. Maintains** the FAA radio frequency portion of the Federal Government's recovery communications (RCOM) mobilization plans.
- j. Conducts engineering studies** relating to incorporation of future communications, navigation and surveillance (CNS) systems within assigned portions of the radio spectrum in accordance with the NAS Capital Investment Plan (CIP) and FAA Research, Engineering and Development Plan.
- k. Executes** the electromagnetic radiation hazard measurement program, both ionizing and non-ionizing, for all FAA equipment and systems.
- l. Administers** the electromagnetic compatibility portion of the agency's airspace case program.

**304. SERVICE AREA FREQUENCY MANAGEMENT OFFICE (FMO).** The following are the major functions assigned to the service area frequency management office:

- a. Serves** as the focal point within the service area for all frequency matters.
- b. Investigates and resolves Radio Frequency Interference (RFI)** problems.

**c. Validates and forwards** frequency requirements with specific recommended frequencies to Technical Operations ATC Spectrum Engineering Services.

**d. Performs** electromagnetic compatibility studies.

**e. Performs** radiation hazard measurements.

**f. Controls and maintains** the service area RFI Monitoring Van(s) (RFIM Van).

**305. thru 399. RESERVED.**

## CHAPTER 4. SPECTRUM MANAGEMENT EVALUATION CRITERIA

**400. GENERAL.** This chapter provides the evaluation criteria to measure the field level spectrum management function effectiveness.

**401. CRITERIA.** The service area spectrum management function evaluations shall be conducted in accordance with the latest edition of Order 1800.14, Airway Facilities Evaluation Program.

**402. SUBJECTS OF EVALUATION.** The FAA service area spectrum management office performance shall be measured against the following evaluation criteria.

**a. Compliance With Standards and Guidelines.** Service area spectrum management personnel shall be familiar with and strictly apply as appropriate, ITU, ICAO, FCC, NTIA and FAA published regulations governing frequency matters.

**b. Efficiency and Economy.**

(1) **Personnel functions** shall be defined by workload description statements, which accurately define the work performed by the FMO, that accompany the generic position descriptions.

(2) **Cross-training** shall be accomplished to provide essential coverage of specialized areas.

(3) **Economy** of personnel and material shall be pursued actively in all operational phases.

**c. Spectrum Engineering.**

(1) **Frequencies** shall be engineered properly (prior to formal assignment) with respect to radiation, propagation, emission and power factors, including engineering consideration of protection from potential interference.

(2) **The FMO** shall be the focal point and provide guidance and expertise in frequency matters to all service area elements.

(3) **Guidance** shall be provided to the service area's planning elements in advance of programming actions concerning the spectrum bands to be used, radiated power and emission characteristics of the new facilities and any limitations which appear because of legal or technical restrictions. Likewise, timely spectrum engineering guidance shall be provided to non-Federal entities, other Federal agencies and DOD elements desiring to establish aeronautical systems.

(4) **Service area radiating systems** shall be evaluated periodically, consistent with established review plans, for compliance with emission and performance standards, with deviations and recommendations reported for correction.

(5) **The FMO will coordinate** with DOD organizations within their service areas as necessary, to ensure that electronic attack activity (including chaff operations, electronic jamming, etc.), does not impact the NAS.

(6) **Airspace cases will be analyzed** in such a manner as to ensure that non-Federal users do not cause interference to critical aeronautical facilities.

(7) **The FMO shall conduct** electromagnetic compatibility studies, as necessary, to determine the effect of proposed systems on current NAS systems.

(8) **The FMO should participate** in the site selection and installation planning for all new NAS facilities and systems.

(9) **The FMO should visit** service area centers and TRACONs periodically in order to review requirements for radio spectrum to support NAS operations.

**d. Interference resolution.**

(1) **Frequency interference problems** to the NAS from any source shall receive priority attention and be corrected in minimum time.

(2) **Close working relationships** shall be established with other agency elements in Technical Operations Services, Enroute and Oceanic Services, Terminal Services, Flight Standards (FS), and Airports, as well as local FCC and DOD frequency personnel, to assure rapid correction of interference problems.

(3) **Every effort shall be made** to terminate or correct an interfering device in lieu of a frequency change to solve a problem.

(4) **Appropriate data on incidents** shall be entered into the RFI data base and engineering reports shall be prepared, describing problems, their resolution and recommendations regarding action to be taken to preclude recurrence. Copies of the reports shall be furnished to all entities involved and Technical Operations ATC Spectrum Engineering Services.

(5) **FMO offices** shall have operable mobile and portable electronic interference detection equipment in addition to an RFIM van. Calibration shall be maintained for all critical equipment.

**e. Frequency assignment records.**

(1) **The Government Master File (GMF)** shall be kept current.

(2) **Frequency utilization** shall be reviewed periodically, consistent with established review plans. The reports on the reviews shall include followup actions taken.

(3) **Frequency Transmitting Authorizations (FTA)** for all FAA transmitters shall be issued by the FMO to the appropriate FAA authority for posting. When visiting a facility, the FMO should review the FTA for posting and accuracy.

(4) **Procedures** shall be established that use the available automated capabilities to determine quickly the status of all frequency assignment actions.

(5) **Filing procedures** shall be established to assure rapid retrieval of correspondence and record information.

**f. Planning.**

(1) **Arrangements** shall be made to assure that FMOs receive information regarding frequency requirements for new facilities as soon as known, to assure the availability of frequencies.

(2) **FMO staff members** shall maintain awareness of new system developments and techniques to provide information to planning offices.

(3) **Frequency assignment** shall be obtained in time to enable installation personnel to order necessary crystals, filters, etc., prior to scheduled installations.

(4) **Maintain an awareness** of the current status of projects to ensure that frequency records are kept updated.

**g. Coordination.**

(1) **Channels of communication** shall be established and maintained with appropriate military representatives and offices, FCC district and monitoring offices, other Federal spectrum users, interference resolution organizations and representatives of non-Federal aviation industry spectrum users.

(2) **Other FAA entities**, such as Enroute and Oceanic Services, Terminal Services, FS, and non-Fed Coordinator shall be apprised of FMO functions and capabilities.

(3) **Coordination requirements** for frequency matters in ITU, IRAC, ICAO and FCC regulations and procedures shall be adhered to.

(4) **Procedures** shall be established and maintained to assure close coordination with adjacent service areas.

**h. Radiation Hazard Survey.** The FMO is the single point-of-contact in the service area for performing designated radiation hazard measurements, both ionizing and non-ionizing, and is responsible for the definitive measurements of radiation levels. (See Chapter 16).

(1) **FMOs shall conduct** radiation hazard measurements and prepare reports as required.

(2) **Technical Operations ATC Facilities, Environmental, Energy Conservation, and Occupational Safety and Health (EEOSH) Services** has overall program management responsibility for environmental hazards, including radiation hazards.

(3) **In addition**, the following functions are assigned to FMOs through Order 3900.19B:

(a) **Coordinate and consult** with the Industrial Hygiene Program Manager in providing advice and information on matters pertaining to radiation health hazards in FAA operations.

(b) **Coordinate** with the Industrial Hygiene Program Manager, the Industrial Investigations Program Manager and the Safety and Health Managers in responding promptly to reports of radiation health hazards.

(c) **Perform** radiation health hazards surveys on new and modified facilities that house equipment, systems or substances capable of producing external ionizing or non-ionizing radiation fields, and others as required.

**403. thru 499. RESERVED.**



## CHAPTER 5. FREQUENCY COORDINATION

### 500. GENERAL.

**a. Any frequency assignment** MUST be coordinated before it can be processed and authorized. The very nature of radio signal radiation makes it a candidate for interference to another frequency, thus all interested parties must be in agreement before a reliable frequency can be assured. There are five major areas of coordination within the FAA spectrum management function. They are headquarters, field-headquarters, field-external, field-special and field-internal. Each has its own requirements and peculiarities, thus requires separate explanation.

**b. As a general policy**, only one frequency will be assigned for each individual requirement. For example, only one VHF A/G communications (COMM) frequency will be assigned for each Air Route Traffic Control Center (ARTCC) sector. Frequencies designated as "back-up" or "spare" are not authorized.

**501. HEADQUARTERS.** All coordination with other Federal agencies, except as discussed in paragraphs 503 through 505, and any with foreign governments, is accomplished only by Technical Operations ATC Spectrum Engineering Services. Numerous coordination procedures have been developed for various frequency usages and are listed in the NTIA Manual of Regulations and Procedures for Federal Radio Frequency Management (NTIA Manual) in paragraph 8.3. This includes the east coast National Radio Quiet Zone (NRQZ).

**502. FIELD-HEADQUARTERS.** For new programs and systems, Technical Operations ATC Spectrum Engineering Services engineers may do the initial planning, engineering frequency applications. All routine aeronautical COMM, NAV and radar frequencies are engineered in the field and then forwarded to Technical Operations ATC Spectrum Engineering Services prior to being forwarded to Frequency Assignment Subcommittee for approval and eventual inclusion in the Government Master File.

**503. FIELD-EXTERNAL.** In general, the FMO is urged to form a close working relationship with the field representatives of agencies with whom the FMO will work. A partial list of such agencies and the FMO's responsibilities are as follows:

**a. Inter-service area Work Force Support.** Service areas can better adjust to peak workload conditions by establishing a seamless environment so that service areas can provide support to each other to accomplish functions as peaks occur. This inter-service area support would be provided at the request of the service areas needing the support. Headquarters may, in some cases, provide funding for this support.

**b. FCC Field Office.** The FMO should become well acquainted with the Engineer in Charge of any FCC Field Office(s) in the FMO's service area. Interference dealing with a non-Federal transmitter will be coordinated with the local FCC. All communications with the local FCC representatives shall go through the regional FMO.

**c. DOD AFC.** DOD has established AFCs within designated areas of the United States and possessions. These AFCs represent DOD in their respective areas and have coordination authority over all the military services in their areas. If any DOD AFC has area encompassing any of the FMO's service area, it is imperative that the FMO become well acquainted with the AFC, since all military frequency coordination with FAA within the AFC's area of responsibility will be with the DOD AFC. See NTIA Manual, Chapter 8 and Annex D, for areas of responsibility, contacts, and telephone numbers.

**d. Military AFCs.** The three main military departments, Army, Navy and Air Force, have their own service coordinators. Each service has a specific area of influence and each area is spelled out in the NTIA Manual,

Annex D. Just as with the DOD AFCs, it is important that the FMO become acquainted with these officials whose control areas are within the various service areas.

**e. United States Forest Service (USFS) and Bureau of Land Management (BLM).** The person who has frequency coordination responsibility in USFS and the BLM in each service area is one that each FMO should know. In those service areas where forest fires are a problem, requests will be coming in at odd times for VHF COMM frequencies to use for the duration of a fire for communication with water-drop aircraft. Knowing the contact in advance is a great time saver.

**f. Search and Rescue (SAR) Groups.** There are a large number of SAR groups in the country. Most are state or municipal governments, but a few are citizens groups who are interested in volunteering in searches for lost or downed aircraft. They are the ones who will request temporary frequency authorizations for Emergency Locator Transmitter (ELT) tests.

**g. Local Aviation Groups.** Local aviation groups are a source of information and frequently come to the FMO for assistance with new frequency requirements. For instance, an airport owner wanting a new Aeronautical Advisory Station (Unicom) frequency will come to the FMO. In addition, these groups have a lot of general information that can benefit the FMO. Included in this category are AOPA, ATA, Civil Air Patrol (CAP) and similar organizations.

**h. Other Federal Agencies.** It is to the advantage of the FMO to be involved with other Federal agencies in the service area that use the radio spectrum. A good working relationship with other agencies is to the benefit of all. When another Federal agency causes interference to FAA frequencies, contact with the local agency's technical personnel will bring much faster resolution to the problem than trying to resolve the problem at the national level.

**504. FIELD-SPECIAL.** The FMO may receive special requests not covered by the normal processes. In such cases, the FMO must take particular care in fulfilling them and should consider all parameters before acting or referring to headquarters. When action is taken, Technical Operations ATC Spectrum Engineering Services shall be notified promptly if the FMO has taken or is contemplating taking action. Some of these actions are:

**a. ELT Tests.** Various SAR groups wish to train their pilots at periodic intervals. To do so, they use an ELT, hidden by one of their group in some relatively remote area to test how long it takes for the pilots to locate it from the air, using whatever direction-finding equipment or techniques they have at their disposal. Refer to subparagraphs (1) and (2) below for the procedure on how to accommodate these requests.

**(1) The ELT test frequency** is 121.775 MHz, as specified in Advisory Circular 91-44. Training SHALL NOT be conducted on 121.5 MHz or 243.0 MHz.

**(2) When a group wishes to conduct ELT training,** they shall contact the FMO and provide the following information:

**(a) Date and time** of the test.

**(b) Site coordinates.**

**(c) Organization name** and the name of a responsible person in the organization.

**(d) A telephone number** will be attended during the entire ELT test so that in the event of emergency or unacceptable interference, the test can be terminated quickly.

**b. Forest Firefighting Frequencies.** USFS and BLM have interagency agreements with FAA for temporary use of A/G COMM frequencies to communicate with water-dropping aircraft during a forest fire. Some states also have firefighting aircraft and may contact FAA. The detailed procedure is left to the individual FMO. It is not uncommon for the firefighting agency to call the FAA duty officer Sunday midnight (or other inconvenient hours) requesting FAA permission to use a VHF COMM frequency. In addition, it is FAA's responsibility to publish the firefighting director's contact frequency in the NOTAM that establishes the temporary flight restrictions (TFR) for firefighting operations. This is to allow media aircraft access to the area to collect news information.

(1) **The fire services** have proved beyond a doubt that the first 15 minutes of a fire determines whether it can be controlled promptly. The FMO should have a list of available frequencies at ready access, which means that the FMO and staff engineers will have them at home, too. The requesting agency should be advised at the time of authorization to call the FMO or the duty officer as soon as the frequency is no longer needed.

(2) **The FMO shall forward** a completed frequency assignment to Technical Operations ATC Spectrum Engineering Services, and may notify Technical Operations ATC Spectrum Engineering Services by phone of any frequency use that has been authorized.

**c. Fly-ins.** Various groups request Terminal Services to provide a temporary control tower for special events of usually one to three days duration. To do that, Terminal Services must be provided with frequencies for the temporary tower or other requirements. On occasion, this might be a UHF frequency, if military aircraft are involved. Mostly, however, the request from Terminal Services will ask for a local control and a ground control frequency. The frequency 123.1 MHz may be used for a tempo control tower when coordinated with SAR, if air safety considerations are met.

(1) **Initial contact** between the aviation event sponsor and the FAA is normally with either the Flight Standards District Office (FSDO) or Area Director of Terminal Operations for the geographic service area of concern at least 45 days prior to the event. If temporary use of frequencies for control of the event's air traffic is needed, or if the assigned frequencies at the air show's location will be used differently than presently authorized, the Area Director of Terminal Operations for the geographic service area of concern or Flight Standards Field Office (FSFO), as appropriate, will contact the service area FMO for advice, or the sponsor may contact the service area FMO directly.

(2) **The aviation event sponsor** may have proposed frequencies desired for use, for example, either FCC-controlled frequencies in the 122.8-123.0 MHz band for non-FAA use (UNICOM), (MULTICOM) or specific FAA air traffic control frequencies. The FMO will advise the aviation event sponsor whether the proposed frequencies are acceptable and whether the frequencies being proposed are too congested to allow proper control of the aviation event. If the sponsor has no recommended frequencies or has chosen frequencies which are not acceptable to the FAA, then the FMO will advise the FSFO with a service area coordination number [for an example, see subparagraph (3)] and temporary frequencies, as needed.

(3) **A coordination number** (for example, GL T030043) will be provided to the event sponsor for each frequency which is coordinated for the event use. The FMO will enter the temporary frequencies into the automated frequency management system to document their use. The frequency assignment will include both start and stop dates for the new assignment.

(4) **The FMO will forward** a memorandum to the aviation event sponsor noting the coordination and frequencies to be proposed to the FCC for use. A courtesy copy of this document will be provided to Technical Operations ATC Spectrum Engineering Services. An example of such a memorandum is shown in Figure 5-1.

**FIGURE 5-1. SAMPLE MEMORANDUM TO AVIATION EVENT SPONSOR**

<p>Subject: Coordination of Frequencies for Special Aeronautical Events</p> <p>From: Service Area Frequency Management Office</p> <p>To: Aviation Special Event Sponsor</p> <p>As coordinated on (date), this office has no objections to your use of the following frequency for use at (name) air show. The following applies:</p> <p>Frequency Coordinated:</p> <p>Power/Emission:</p> <p>Description of Antenna:</p> <p>Location of Transmitter (include geographical coordinates):</p> <p>Class of Station:</p> <p>Dates/Times to be Used:</p> <p>FAA Service Area Coordination Number:</p> <p>In order to obtain Special Temporary Authority to use this frequency, you must submit a request to the Federal Communications Commission (FCC) via the FCC internet address (currently <a href="http://wireless.fcc.gov/">http://wireless.fcc.gov/</a>), and follow the directions under “online filing”, in order for them to review your application. Please cite the above FAA Service Area Coordination Number on your application documents to expedite FCC processing.</p> <p>Please contact (name) at FAA (Service Area) Frequency Management Office, (telephone), if you have further questions.</p> <p>(Signature)</p> <p>cc: Area Director of Terminal Operations; Service Area Non-Fed Coordinator; HQ FAA/Technical Operations ATC Spectrum Engineering Services</p>
--

(5) **After coordination** with the FAA service area FMO, the sponsor will be expected to submit all required forms and fees to the FCC for a special temporary authority (STA) for use of the coordinated frequencies as required by the FCC rules. The sponsor may do this either by letter, telegram, fax or e-mail.

(6) **Upon receipt of the memorandum** from the service area, Technical Operations ATC Spectrum Engineering Services will coordinate with the FCC and, in addition, will forward a memorandum to the FCC Licensing Division, Gettysburg, Pennsylvania, noting the FAA service area coordination number and stating that FAA has no objection to the temporary use of the frequencies for the aviation event.

(7) **In most cases**, the FCC will issue the STA to the sponsor no later than 15 days prior to the event provided that all required forms and fees are received at their office within 30 days of the event.

**d. Non-Federal Requirements.**

(1) **FCC licenses all non-Federal NAVAID and air-to-ground (A/G) COMM facilities.** The owner or sponsor of the facility must obtain airspace and frequency approval by FAA while processing the application for a transmitting license through FCC. The following is the order of priority for assigning frequencies to non-Federal facilities after airspace approval has been granted.

(a) **Public use airport tower or NAVAID** providing Instrument Flight Rules (IFR) service.

(b) **Private use airport tower or NAVAID** providing IFR service.

(c) **Public or private use Visual Flight Rules (VFR)** or en route advisory service.

(2) **FAA must advise sponsors** in subparagraph (c) above that frequency assignments can be taken away from the facility with a one year notice to satisfy a more critical requirement. The sponsor must also be advised that, if frequency changes are required to assign a channel to the facility, the sponsor must reimburse FAA for the cost of the changes.

(3) **Non-Federal NAVAIDs** must be in the NAS. If it is to be private, the applicant shall be advised that a proposed frequency will be engineered if possible. However, since it is not in the NAS, it is subject to withdrawal for a NAS facility, if the frequency is required at a later date. Lastly, the applicant must be advised in writing that if a frequency is engineered, it will be reserved for only one year. After that, it will be withdrawn if not used. Extensions can be given only upon a showing of definite progress in procuring FCC license and equipment delivery. Flight Standards has to concur with the request. If the NAVAID is a Compass Locator (COMLO), the power limit is 25 watts (W). If a VOR or ILS, the power and service volume will be of terminal class.

(4) **If a COMM frequency**, it also is reserved for only one year. The power limit shall be 10 W.

(5) **Equipment shall be FCC type-approved** and the applicant shall be so advised.

(6) **Licenses for Non-Federal radio navigation aids.**

(a) **Proponent actions:**

**1. The proponent** fills out an FAA Form 7460-1 and submits it to the appropriate service area Non-Fed Coordinator.

**2. At the same time**, the proponent submits an FCC Form 406 (Application for License) to the FCC Licensing Division at Gettysburg, Pennsylvania.

**(b) Service area actions:**

**1. Upon receipt** of the FAA Form 7460-1 from the proponent, the FAA service area Non-Fed Coordinator will forward the request to Air Traffic Organization System Operations Services.

**2. Air Traffic Organization System Operations Services** will initiate an airspace case (as needed) and register the proponent with Aeronautical Information Management (AIM) in System Operations Airspace and AIM.

**3. Air Traffic Organization System Operations Services** returns the FAA Form 7460-1 to the service area Non-Fed Coordinator who then submits the form to the service area FMO.

**4. The Service Area FMO** engineers the appropriate frequency, prepares a temporary frequency application and forwards it to FAA Headquarters. At the same time, the FMO also extracts the applicable information from the FAA Form 7460-1 to prepare a memorandum to the FCC indicating the status of the proponent's request.

**(c) FCC actions:**

**1. The FCC Licensing Division** receives the FCC memorandum, logs it for tracking purposes and forwards it to FCC Headquarters.

**2. FCC Headquarters** processes the memorandum and forwards it to FAA Headquarters.

**(d) FAA Headquarters actions:**

**1. FAA engineers** and selects a frequency to satisfy the requirement (based on the temporary frequency assigned by the service area FMO) and forwards the application to NTIA for approval.

**2. FAA electronically forwards** a copy of the FCC memorandum, with the coordinated frequency, to FCC Headquarters.

**3. When the frequency application** is approved by NTIA, the FCC Licensing Division issues the license to the proponent.

**e. Electronic Attack (EA) Missions.** EA missions are military exercises whereby electromagnetic signals are radiated intentionally to cause interference to other military units being tested for EA defense. See chapter 18 for a detailed discussion.

**f. Unusual Request.** Unusual requests will be received from time to time, and there is no way to cover them all here. When not covered by specific instructions herein or by headquarters directive, all requests for unusual needs should be telephoned or faxed to Technical Operations ATC Spectrum Engineering Services.

**505. FIELD-INTERNAL.** All of the foregoing paragraphs in this chapter have dealt mostly with coordination outside the service area office. But coordination within the service area office is as essential as outside. The style of frequency coordination will vary with the service area because of the various configurations of the spectrum management functions. At least the following shall be included:

**a. Air Traffic.** Except for a few land mobile system needs, all frequencies engineered are to meet an air traffic service need. Thus the FMO must coordinate closely with Enroute and Oceanic Services, and Terminal Services, personnel as appropriate. This is not only to meet the current need, but also to be aware of service planning so that efficient spectrum usage in the future may be taken into account.

**b. Flight Standards.** The same logic applies here, particularly as it relates to NAVAIDs. But if FS needs to change a route or vector, an Expanded Service Volume (ESV) or even a new NAVAID may be required. Frequent meetings with FS personnel are recommended.

**c. New requirements for COMM, NAVAID, and radar facilities.** Attendance at program review meetings within the Service Area office and at System Management Offices (SMO) by the FMO is essential to provide as much advance notice as possible of new facilities and programs to permit advanced planning.

**d. Adjacent Service Areas.** FMOs should coordinate frequently with their counterparts in adjacent service areas. This is particularly important when a planned facility's interference range infringes upon an adjacent service area's territory. When a frequency request is filed with Technical Operations ATC Spectrum Engineering Services, it is assumed that the FMO has coordinated with any affected adjacent service areas.

**506. DOCUMENTATION.** The FMO is required to have many sources of documentation in order to effectively coordinate. At least the orders and documents listed in subparagraphs a.- u. below, as applicable, shall be maintained by the FMO.

**a. NTIA Manual Of Regulations and Procedures For Federal Radio Frequency Management.**

**b. FCC Rules and Regulations.**

**c. ICAO Annex 10.**

**d. Government Master File on CD-ROM**

**e. FCC Aeronautical Frequency List** (see CFR 47, Part 87 -- Aviation Services).

**f. The Daily National Automated Performance Reporting System** (NAPRS) data report.

**g. Aeronautical Information Manual.**

**h. ITU Radio Regulations.**

**i. Military Joint ECM Regulation, CJCSI, Performing Electronic Warfare in the United States and Canada.**

**j. The latest edition of Order 7610.4, Special Military Operations.**

**k. The latest edition of Order 7400.2, Procedures for Handling Airspace Matters.**

**m Federal Aviation Act of 1958, revised April 1981.**

**n. The latest edition of the Federal Aviation Regulations, Part 77.**

**o. The latest edition of Order 7350.6, Locations Identifier Handbook.**





- p. The latest edition of Order 1380.40, Airway Facilities SMO Level Staffing Standard System.**
- q. Sectional Aeronautical Charts.**
- r. VFR Terminal Area Charts.**
- s. Airport Facility Directory.**
- t. U. S. Terminal Procedures.**
- u. DOD Flight Information publications.**

**507. thru 599. RESERVED.**

## CHAPTER 6. TRANSMITTING AUTHORIZATION DOCUMENTS AND CALL LETTER ASSIGNMENTS

**600. PURPOSE.** This chapter describes the procedures for issuing and posting transmitter authorization documents and the guidelines for assigning call signs to all transmitters.

**601. FACILITY TRANSMITTING AUTHORIZATION DOCUMENT (FTA).** All transmitters authorized must have appropriate documentation posted for identification and certification purposes. In FAA, there are two basic forms, a certificate style and a metallic label.

**a. For all fixed, base, and land transmitters,** the certificate is used. Currently, it is FAA Form 6050-1, Facility Transmitting Authorization. See figure 6-1.


**(1) Each facility** shall have its own document and its unique document number for file purposes. The number shall consist of two letters identifying the service area, followed by a number. The letters and numbers will remain for that site as long as the site exists. Whenever there are modifications to any assignment at that facility, a new document shall be issued, with an added letter starting with "A." When the assignments are subsequently modified, documents will contain sequential sub-letters, "B," "C," etc. until "Z." After "Z," the letter will start again at "A." The original document shall be posted at the site.

**(2) The Automated Frequency Management program (AFM)** now in use for frequency request/authorization will generate one FTA for each facility. This program will contain a database of all FTA's issued.

**(3) Emission designators** for major FAA systems can be found in the appendix.

**b. For all mobile transmitters,** the identification label, FAA Form 6050-2, Transmitter Identification and Operation Authorization (TIOA), shall be used. For hand held transceivers, either the Form 6050-2 or a smaller equivalent may be used. The call letters of the unit will be typed or inked on it before applying to the transmitter. Because the metallic labels stick very firmly, any changes in call letters should be accomplished by placing the replacement label directly over the old one. The procedure for assignment of call letters will be covered later. If the unit is transferred to a different organization or shipped to the FAA Depot for exchange and repair, a new identification label will be issued. A sample of both TIOA forms is shown in figure 6-2.

**FIGURE 6-1. FAA FORM 6050-1, FACILITY TRANSMITTING AUTHORIZATION (REDUCED)**

		UNITED STATES OF AMERICA DEPARTMENT OF TRANSPORTATION FEDERAL AVIATION ADMINISTRATION						AUTHORIZATION NUMBER CE 1	
		<h2 style="margin: 0;">FACILITY TRANSMITTING AUTHORIZATION</h2> <p style="margin: 0;">In accordance with authority granted the Federal Aviation Administration by the National Telecommunications &amp; Information Administration through the Interdepartmental Radio Advisory Committee, this Authorization is issued for the operation of this facility.</p>							
FACILITY: CAPE GIRARDEAU, MO				COORDINATES: 37 13'18"N 089 33'25"W					
FREQUENCY	FAC. TYPE	MAX. POWER	CLASS	TYPE OF SERVICE	COST CENTER	IDENT	FAA SERIAL	MISCELLANEOUS REMARKS	
109.500 MHz		15.0 W	RLL	LOCALIZER			723617	RWY=10	
993.000 MHz	DME	100.0 W	RN	LOC DME		CGI	784521	RWY=10	
20 May 1996		Central			1 of 1				
EFFECTIVE DATE		FAA REGION			FREQUENCY MANAGEMENT OFFICER			PAGE	

FAA Form 6050-1 (10-95)

NSN: 0052-00-888-6001

**FIGURE 6-2. TIOA FORM FOR MOBILE/PORTABLE/HANDHELD TRANSMITTERS**



**602. REQUESTS FOR FREQUENCY ACTION.** Frequency requests from entities within the service area should be standardized for record purposes. This will assure the FMO receives all the information needed with the request. A sample service area form is shown in figure 6-3.

**FIGURE 6-3. SAMPLE OF TYPICAL SERVICE AREA FREQUENCY REQUEST FORM (REDUCED)**

To be completed by the Frequency Manager only			
GMF S/N		REGIONAL S/N	
FREQUENCY		EMISSION	
STATION CLASS		DATE ENTERED INTO SYSTEM	

Submit To Frequency Management

Detailed Instructions Below

NEW FACILITY

RELOCATION

CHANGE

DELETE

REQUEST DATE: 4-15-98                      DATE REQUIRED: ASAP  
 ORIGINATOR: Khanh Tran                      PHONE: 310-348-5485  
 ROUTING SYMBOL AWP-454.14                      PROJECT/JOB NJT

**FACILITY:**

Type of Facility RTR                      ID MPA  
 Location Mill Valley CA                      Control Station NCT  
 Hours of Operation 24                      Service Area Radius in Miles 60  
 Generic Location \_\_\_\_\_                      Service Alt (MSL) 18,000'

General Comments Two more frequencies needed at this site. One UHF and One VHF. One suggestion is to relocate 288.3 from Stockton, or NGZ frequencies 279.5 or 385.4 decomm from Bay Tracon. Try 120.95 from MOD or 127.75 from SCK.

**TRANSMITTER:**

Manufacturer Motorola                      Model Number CM-200  
 Type of Facility (VOR, DME, COM, etc. RTR  
 Type of Modulation:  
 AM     FM     PULSE: Rate \_\_\_\_\_ Width \_\_\_\_\_  
 Number of \_\_\_\_\_ Bandwidth/Deviation \_\_\_\_\_  
 Channels \_\_\_\_\_  
 Power Output 10 Watts

**TRANSMIT ANTENNA:**

Manufacturer TACO                      Model D2276/D2277                      Type Collinear  
 Directional     Non-Directional                      Polarization \_\_\_\_\_ Azimuth \_\_\_\_\_  
 Latitude 37° 55' 39.0"                      Longitude 122° 35' 15.0"  
 Site Elevation (MSL) 2604 ft. Antenna Height 20 ft. Gain 1 db

**RECEIVER:**

Manufacturer: Motorola                      Model Number CM-200  
 Receiver Location: \_\_\_\_\_ Co-located With \_\_\_\_\_

**Receive Antenna:**

Manufacturer: \_\_\_\_\_ Model Number: \_\_\_\_\_  
 Directional     Non-Directional                      Polarization Vert Azimuth \_\_\_\_\_  
 Latitude: 37° 55' 39.0"                      Longitude: 122° 35' 15.0"  
 Site Elevation (MSL) 2604 ft. Antenna Height 20 ft. Gain 1 db

**603. CALL LETTER ASSIGNMENT.** All transmitters that are in use shall be identified by assigned call letters to meet international requirements, to help users know with whom they are communicating and to identify signals in case of interference.

**a. Most NAVAIDS are identified** in accordance with Order 7350.6, Location Identifier Handbook.

**b. Communications facilities** are voice identified by facility; e.g., "Denver Tower," "Kansas City Center," etc.

**c. HF, VHF, and UHF non-aeronautical** service voice transmitters are identified by standardized alpha-numeric call signs. They are the systems described in Chapter 17, Land Mobile and Other FM Communications Systems Frequency Engineering.

**(1) HF call signs** will be issued by Technical Operations ATC Spectrum Engineering Services in accordance with the standard operating procedure "Procedure for Assigning Call Signs," a policy letter to the service areas.

**(2) VHF/UHF Land Mobile** call systems shall be managed and issued by the FMO in accordance with paragraphs 604 and 605.

**604. LAND MOBILE CALL SIGNS.** Land mobile call signs shall be formulated and assigned in accordance with subparagraphs a. through e., below.

**a. FM Repeater stations** call signs shall consist of the prefix "FAA" followed by the repeater's three- or four-character facility identifier, as shown in the Facility Master File (FMF).

**b. FM Base, Mobile, and Portable** transmitters call signs shall consist of the most commonly recognized area identifier where the station is located, followed by a user identifier issued according to figure 6-4.

**c. Stations located at a service area office** use the service area identifier. Special organizations will be identified as follows:

Washington Headquarters	AHQ
Metropolitan Wash. Airports	MWA
FAA William J. Hughes Technical Center	ACT
Mike Monroney Aeronautical Center	AAC

**FIGURE 6-4. USER ORGANIZATION IDENTIFIERS**

Organization	Identifier
Washington headquarters, FAA William J. Huges Technical Center, Mike Monroney Aeronautical Center, Regional Administrator, Regional Communications Control Center	001-099
Flight Standards	100-199
Civil Aviation Security	200-299
Aircraft Certification	300-399
Technical Operations Divisions	400-499
Technical Operations SMOs	500-999

**d. An alphabetic character** following the user identifier will identify the station type thus:

B - Base station

M - Mobile station

P - Portable (e.g., handheld)

X - Other (e.g., portable repeater)

**e. For example:** DCA 618M would identify a Technical Operations SMO mobile radio at Washington National Airport.

**605. STATION IDENTIFICATION REQUIREMENTS.** Technically, mobile units communicating with each other or a base station in simplex need not identify if the associated base station identifies. But since much of mobile communication is through a repeater, and identification must be used during that time, it should become standard to use the assigned call sign during every communication. The NTIA Manual paragraph 6.5.2 states, "Each station shall transmit its assigned call sign on each frequency in use at the beginning and end of operation, and at least once an hour. More frequent identification may be made if delay to traffic will not result." Fixed, Land and Mobile (including hand-held) stations must identify this way. Repeater transmitters are presently identified by the voice identification of the stations being repeated. In the future, repeaters will have automatic Morse code or digital identifiers installed which will contain the call assigned by the FMO as described in this chapter.

**606. thru 699. RESERVED.**

## CHAPTER 7. HIGH FREQUENCY ASSIGNMENT PROCEDURES

### 700. GENERAL.

**a. HF by definition** covers from 3 to 30 MHz. It is that portion of the spectrum that has the potential for providing communications worldwide. For this reason, HF is often referred to as a "poor man's satellite." The availability of signal reception anywhere in the world depends on many conditions. The time of day, time of year, time of the 11-year sunspot cycle, and the frequency itself are all determining factors. Up to 30 MHz, the higher the frequency, the further a signal can be received in daytime. But at night, most signals above 15 MHz are RLOS or ground wave propagation. This is due to the nature of the signal as it reflects off one of the various layers of ionosphere from about 50 to around 200 miles above the earth. These reflective layers, known originally as the Kennelly-Heaviside Layers for their discoverers, are now generally referred to as "ionospheric layers." There are five identified layers that are a consideration in HF radio propagation. See Figure 7-1. Through improvements in technology, many of the factors that need to be considered have been automated (including the development and use of automated HF data link) and HF is becoming a much more reliable means of communication. Due to the increase in reliability and the high cost of satellite service, the demand for HF is increasing.

**b. At night**, lacking the sun's heating of the various ionospheric layers, most layers will not reflect the higher frequencies. It is common for HF systems to have "day" and "night" frequency pairs or "families of frequencies" spread throughout the HF frequency band so that communications can be established during a variety of propagation conditions. Headquarters has assigned families of five or more frequencies throughout the HF band for use by FAA. One circuit might use an 8 MHz frequency at nighttime and a 16 MHz frequency during the daytime to cover the United States.

(1) **The D layer** averages 45-55 miles above the earth. Its density, thus its ability to reflect radio signals, varies with the sun's height during the day. The rise and fall of the D layer (sunrise to sunset) determines the lowest usable frequency (LUF) that will support propagation between two selected fixed points at a given time. This layer is most significant below 5 MHz. This layer permits long-distance reception of AM Broadcast stations at night.

(2) **The E layer** averages 65-75 miles above the earth. This layer affects mid-range HF frequencies in daylight hours.

(3) **The Es layer**, usually called the sporadic-E layer, drifts erratically and unpredictably about 70 miles above the earth. It is significant only for frequencies of around 20 MHz and higher.

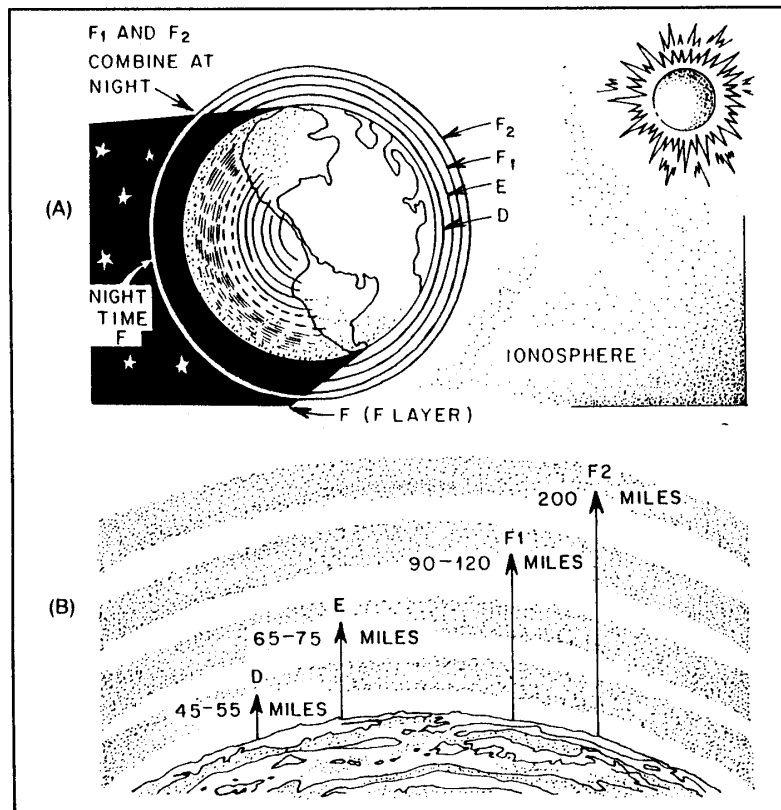
(4) **The F1 layer** averages 90-120 miles above the earth. It is also dependent upon the sun for its existence. The F1 layer disintegrates and melds with the F2 layer after sunset.

(5) **The F2 layer** averages 200 miles above the earth and is the most important layer for long range propagation. It permits reflection of signals that can be received for thousands of miles.

**c. The term maximum usable frequency (MUF)** refers to the highest frequency that will permit satisfactory propagation of radio signals between two fixed points at a given time. MUF varies diurnally, seasonally and with the sunspot cycle. The HF frequencies that propagate best are between LUF (lowest usable frequency) and MUF, although the frequency for optimum transmission (FOT) is about 20 percent below MUF. See subparagraphs a. and b., above.

d. A more detailed description of the ionospheric layers can be found in the *ARRL Handbook for The Radio Amateur*.

FIGURE 7-1. IONOSPHERIC LAYERS ILLUSTRATED



Courtesy ARRL Handbook

**701. INTERNATIONAL HF REQUIREMENTS.** The HF services available to support the NAS international requirements are the Aeronautical Mobile (R) and Fixed services. The HF Aeronautical Mobile (R) service provides A/G communications for flights operating in international airspace beyond the VHF range of air traffic control (ATC) ground stations. The A/G communications in support of the ATC function is provided by Aeronautical Radio, Inc. (ARINC), under contract to FAA. The ground-to-air communications service is a broadcast service, providing meteorological information to enroute aircraft (VOLMET), and is provided by FAA. Frequency assignments are in accordance with ITU Appendix 27, Frequency Allotment Plan for the Aeronautical Mobile (R) Service and Related Information, from those allotted to Major World Air Route Areas (MWARA), Regional and Domestic Air Route Area (RDARA), and VOLMET, respectively. Aeronautical HF communication is not permitted over the continental U.S. when VHF communications are available, except in times of emergency.



**702. NATIONAL HF REQUIREMENTS.** Additional HF services are required to satisfy national (domestic) requirements.

**a. HF Aeronautical Mobile (R) service** provides A/G communications in the State of Alaska via FAA FSSs. Frequency assignments are made in accordance with ITU, Appendix 27 from those allotted to RDARA and the Annex to the NTIA manual.

**b. HF Fixed service** provides point-to-point (PTP) communications primarily in support of the National Radio Communications System (NRCS), known internally as Command and Control Communications (C3). Frequency assignments in this service are made in accordance with the NTIA Manual, Table of Frequency Allocations. See figure 7-2 for authorized NRCS frequencies. Refer to the individual station's FTA for details of the assignment.

**FIGURE 7-2. NRCS FREQUENCIES**

CHNL	FREQ (kHz)	NOTES	CHNL	FREQ (kHz)	NOTES
00	4055.0	USB (East. U.S.)	18	15851.0	LSB (West. U.S.)
01	4055.0	LSB (West. U.S.)	19	16348.0	USB; LSB
02	4625.0	USB; LSB	20	19410.0	USB (East. U.S.)
03	5860.0	USB	21	19410.0	LSB (West. U.S.)
04	6870.0	USB (West. U.S.)	22	20852.0	USB; LSB
05	6870.0	LSB (East. U.S.)	23	24550.0	USB (West. U.S.)
06	7475.0	USB; LSB	24	24550.0	LSB (East. U.S.)
07	7611.0	USB (East. U.S.)	none	3428.0	USB; A/G FIFO use
08	7611.0	LSB (West. U.S.)	none	5571.0	USB; A/G FIFO use
09	8125.0	USB (East. U.S.)	25	8912.0	USB; A/G FIFO use
10	8125.0	LSB (West. U.S.)	26	11288.0	USB; A/G FIFO use
11	9914.0	USB; LSB	27	13312.0	USB; A/G FIFO use
12	11637.0	USB (East. U.S.)	28	17964.0	USB; A/G FIFO use
13	11637.0	LSB (West. U.S.)	none	2866.0	USB; A/G Alaska only
14	13457.0	USB (West. U.S.)	none	3449.0	USB; A/G Alaska only
15	13457.0	LSB (East. U.S.)	none	8855.0	USB; A/G Alaska only
16	13630.0	USB; LSB	none	11375.0	USB; A/G Alaska only
17	15851.0	USB (East. U.S.)			

NOTES:

1. USB - upper sideband operation
2. LSB - lower sideband operation
3. Eastern U.S. is defined as East of the Mississippi River
4. Western U.S. is defined as West of the Mississippi River

**703. HF ENGINEERING.** For new HF requirements, Technical Operations ATC Spectrum Engineering Services normally does the HF engineering. Service areas may be asked to provide the following information to process the frequency assignment.

- a. **Station Class (STC)**
- b. **Emission (EMS)**
- c. **Power (PWR)**
- d. **Transmit/Receive State (XSC/RSC)**
- e. **Transmit/Receive Antenna Location (XAL/RAL)**
- f. **Transmit/Receive Antenna Latitude (XLA/RLA)**
- g. **Transmit/Receive Antenna Longitude (XLG/RLG)**
- h. **Transmit/Receive Antenna Dimensions (XAD/RAD - gain only)**
- i. **Transmit Azimuth (XAZ)**
- j. **Authorized Area of Operation (\*RAD)**
- k. **Number of Stations and System Name/Identifier (\*NRM)**
- l. **FACID Sort**

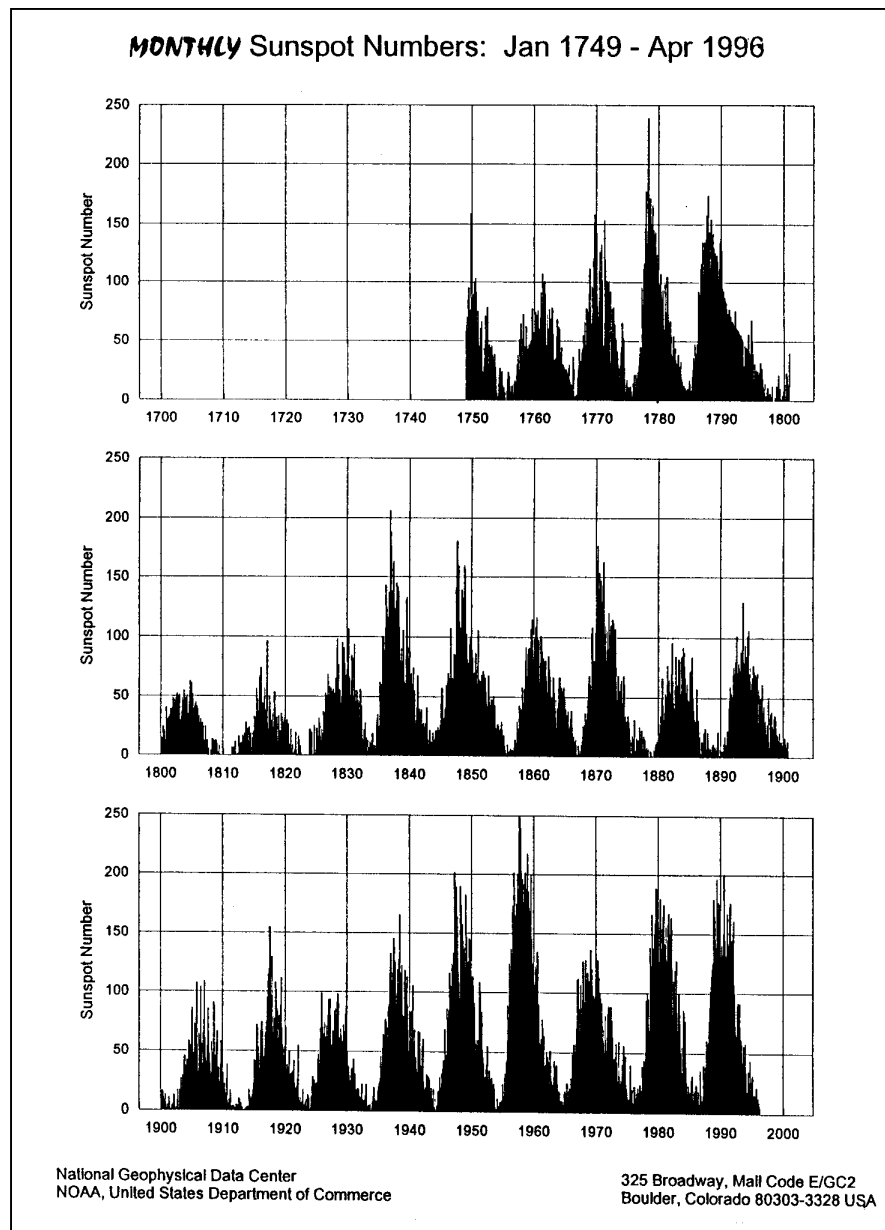
**704. ASSIGNED VS. WINDOW FREQUENCY.** The Frequency Transmit Authorization (FTA) that is issued by the service area should contain the window frequency (the frequency that is dialed into the radio) for each HF frequency assignment that is to support a single side band operation. The assigned frequency is required to reflect the center of the occupied bandwidth, but for a single sideband assignment, this is not the frequency that the radio is tuned to. For an Upper Side Band (USB) assignment, the window frequency is equal to the assigned frequency minus one-half of the assigned bandwidth (e.g. the window frequency for an USB frequency assignment of 5572.4 kHz with a 2.8 kHz bandwidth is  $5572.4 - 1.4 = 5571$  kHz. Therefore, when the radio is tuned to 5571 kHz the transmitted information is contained between 5571 kHz and 5573.8 kHz with the center of the bandwidth -5572.4 kHz - being the assigned frequency. For a Lower Side Band (LSB) frequency assignment, the window frequency would be the assigned frequency plus one-half of the assigned bandwidth.

**705. PROPAGATION AND CIRCUIT RELIABILITY.** There are several computer models that will reasonably predict HF radio signal propagation via ionospheric sky wave paths. These models have many parameters, but are mainly predicated on sunspot activity.

**706. SUNSPOT NUMBERS.** Sunspot numbers are the number of sunspots observed over a specific period of the approximate 11-year cycle. The National Institute of Standards and Technology (NIST) observation group determines the level of effect. The HF MUF varies due to many factors (see paragraph 700), including sunspot activity. The more sunspot activity, the more the ionosphere is ionized, the denser the layer and the higher the MUF. The reverse is true as sunspot activity decreases. A plotted graph of observed sunspots for 1749-1996 is shown in figure 7-3.

**707. SOLAR FLARE/STORM REPORTING PROCEDURES.** The NIST provides solar flare alerts to FAA through Technical Operations ATC Spectrum Engineering Services, who in turn, passes them to FMOs. Although the heaviest effect is upon HF, VHF as well as hard-wired data circuits are affected due to the increased earth magnetic currents. The usual VHF effect on communications is a squelch break, followed by a "hissing" noise.

**FIGURE 7-3. MONTHLY SUNSPOT NUMBERS JAN 1749 - APR 1996**



**708. thru 799. RESERVED.**

## CHAPTER 8. AIRSPACE EVALUATION

**800. GENERAL.** The FAA conducts aeronautical studies of objects affecting navigable airspace. Obstacle Evaluation Services (within Air Traffic Organization System Operations Services) personnel administer the Obstruction Evaluation/Airport Airspace Analysis (OE/AAA) program with the coordinated assistance of Airports, Technical Operations Services (including Aviation System Standards), Military, and Flight Standards (FS) personnel. The guidelines, procedures and standards as to what constitutes an obstruction and requires notice to the FAA are established by Title 14, Code of Federal Regulations (CFR) Part 77.

**801. PART 77.** Part 77 establishes the standards for determining obstructions in navigable airspace. It also outlines the procedures for providing notification requirements to the FAA Administrator of proposed construction or alteration to man-made structures affecting the National Airspace System (NAS). Aeronautical evaluations are conducted to determine the effect of the construction on flight procedures, airport surfaces, and communication, radio-navigational aids and/or surveillance facilities. Procedures for petitioning an FAA determination on a study is addressed in Part 77, which may include public hearings on the effect of the proposed construction on air navigation.

**a. The authority to conduct** aeronautical studies of objects affecting navigable airspace is delegated to the service area offices. The program is administered by service area Obstacle Evaluation Services personnel. The FMO shall evaluate the aeronautical effect from electromagnetic radiation and possible interference, including physical obstructions to both ground facilities and aircraft. The results of this evaluation will be submitted to Obstacle Evaluation Services. Similar studies shall be conducted by Enroute and Oceanic Services, Terminal Services, Airports, FS, Military, Technical Operations Aviation System Standards, and other Technical Operations organizations. The compilation of each division's responses to the study, plus any public comment, will be coordinated into the final determination by Air Traffic Organization System Operations Services.

**b. Part 77** requires that sponsors of construction or alteration to man-made structures file notice with the FAA if their projects meet or exceed the criteria contained in Part 77.

**c. Public Law 100-223, Section 206** states that man-made structures being investigated under Part 77 should be considered as obstacles to the NAS if they could cause interference to CNS systems. Accordingly, the following notice requirements should also be adhered to by a proponent and requires the proponent to file a notice with the FAA.

**(1) Construction of new or modification of an existing facility**, i.e., building, antenna structure, or any other manmade structure, which supports a radiating element(s) for the purpose of radio frequency transmission operating on the following frequencies:

- |                     |                     |                     |
|---------------------|---------------------|---------------------|
| (a) 54 – 108 MHz    | (b) 150 – 216 MHz   | (c) 406 – 430 MHz   |
| (d) 931 – 940 MHz   | (e) 952 – 960 MHz   | (f) 1390 – 1400 MHz |
| (g) 2500 – 2700 MHz | (h) 3700 – 4200 MHz | (i) 5000 – 5650 MHz |
| (j) 5925 – 6525 MHz | (k) 7450 – 8550 MHz | (l) 14.2 – 14.4 GHz |
| (m) 21.2 – 23.6 GHz |                     |                     |

(2) **Any changes or modifications** to radio frequency systems, when specified in the original FAA determination, including:

(a) **Change in the authorized frequency.**

(b) **Addition of new frequencies.**

(c) **Increase in effective radiated power (ERP)** equal to or greater than 3 decibels (db).

(d) **Modification of radiating elements** such as:

**1.** Antenna mounting location(s) if increased 100 feet or more, irrespective of whether the overall height is increased.

**2.** **Changes in antenna specifications** (including gain, beam-width, polarization, pattern).

**3.** **Change in antenna azimuth/bearing (if directional antenna).**

**802. Title 49, Section 44718.** By regulation or order when necessary, the Secretary of Transportation shall require a person to give adequate public notice, in the form and way the Secretary prescribes, of the construction of any structure or landfill that may result in an obstruction of the navigable airspace or an interference with air navigation facilities and equipment or navigable airspace. An aeronautical study shall be conducted to determine the extent of the adverse impact, if any, on the safe and efficient use of such airspace, facilities or equipment. It also provides for aeronautical studies regarding an existing object. The service area FMO shall evaluate these cases for hazardous electromagnetic effect in the same manner described in paragraph 801a. Aeronautical studies will be handled directly with the proponent by System Operations Services, who will keep Technical Operations ATC Spectrum Engineering Services informed of all action.

**803. INTRANET OBSTRUCTION EVALUATION/AIRPORT AIRSPACE ANALYSIS (iOE/AAA) WEB-BASED SYSTEM.** The iOE/AAA is a national, web-enabled application that allows data sharing, and communication between and among FAA service areas and employees. The iOE/AAA system replaces the previous procedure in determining the potential effects of various types of man-made structures in the NAS. Commercial and/or government entities submit construction plans to the FAA regarding new or existing structures obstructions. Obstruction Evaluation Services personnel will then input the data into the iOE/AAA system to evaluate the potential effects to the NAS, based on criteria indicated in FAA Order 7400.2 ("Procedures for Handling Airspace Matters"). FMOs shall use the iOE/AAA system to track each case study which is routed to them through the system, and will provide an EMI and obstruction analysis response in a timely manner.

**804. WASHINGTON HEADQUARTERS REVIEWS.** The sponsor of any proposed construction or alteration, or any person who stated a substantive aeronautical comment on a proposal in an aeronautical study, may petition the Administrator for a discretionary review of a determination, revision or extension of a determination issued by the service area Obstacle Evaluation Services organization. The authority to grant a review is delegated to System Operations Services. Such petitions are processed and coordinated by the Airspace and Rules Division within System Operations Services. Once granted, discretionary review is conducted by the various Washington Headquarters services in the same manner as the original service area evaluation. Based upon review, analysis and evaluation of the service area's report of the aeronautical study, briefs, and related submissions by any interested party, the Airspace and Rules Division within System Operations Services prepares a notice affirming, revising, or reversing the original determination for the signature of the Vice-President for System Operations Services.

**805. ELECTROMAGNETIC EVALUATION.** The electromagnetic evaluation of a proposed construction or alteration to any man-made structure or facility must be detailed and consistent. Particular attention should be given to high power AM, FM, and TV broadcast proponents, as well as, several other frequency bands, administered by the FCC, that are adjacent to or co-channel with FAA authorized frequencies.

**a. The evaluation should begin** by gathering all pertinent data required. Through the use of various programs and on-line databases available in the AFM, a listing of all ground aeronautical receivers and transmitters and all commercial broadcast transmitters should be compiled. This list must include frequency, geographic coordinates, emitter effective radiated power (ERP), and elevations. Consideration must be given to overall terrain height, antenna height, and the proximity of any existing commercial transmitters.

**b. When plotting the chart,** locations of Instrument Landing System (ILS) Frequency Protected Service Volumes (FPSV), ESVs, Markers, VHF Omnidirectional Radio Range (VOR), air-to-ground communications (COMM) and surveillance facilities should be noted. In some cases, facilities within a 30 nautical mile (nmi) radius or more of the proposed site may need to be accounted for.

**c. An intermodulation (IM) study** utilizing the frequencies compiled is the next step. The study should include at least third order calculations. If hazardous intermodulation products result, the Venn diagram procedure detailed in Appendix 1 of this order must be used to determine where it exists for all situations except those involving FM broadcast stations to ILS localizers and VORs. The predicted area of intermodulation must fall in the FPSV for a hazard to exist.

**d. Brute force** for COMM facilities is also calculated using the Venn diagram method. If an aircraft enters this area, the broadband radio frequency (RF) section of the receiver will be driven into non-linearity regardless of transmitted frequency and desensitization will result.

**e. The Airspace Analysis Model (AAM)** will be used to evaluate the effects of FM broadcast signals on ILS localizer, VOR and COMM signals received by airborne receivers, as well as by ground receivers in the case of COMM. This includes intermodulation, receiver front-end overload and adjacent channel interference.

**f. Signal levels** at the input of FAA ground receivers should be calculated for both out-of-band and in-band (spurious) signals.

**g. A very important part** of this entire evaluation is a vertical profile plot of the proposed site and affected facilities. In many cases, it will be necessary for the FMO to obtain the antenna radiation patterns (horizontal and vertical) from the proponent. All calculations are based on an isotropic radiator. Use of the actual antenna radiation pattern provides a more realistic evaluation.

**h. The complete and detailed procedure** along with several examples of an airspace evaluation is contained in Appendix 3 of this order.

**806. The AAM** was designed to assist the FMO in determining the effects of various radio frequency emitters on aircraft navigation and communications facilities. The model determines the effects of FM broadcast stations on ILS localizer and VOR signals. It allows the selection of a proponent FM station to provide a complete compatibility analysis between the proponent and any selected localizer within 30 nmi of the proponent. It is available for download at the Technical Operations ATC Spectrum Engineering Services website.

**a. The AAM computes the boundaries** of a three-dimensional service volume for the specified facility. It then generates a test grid inside the service volume at specified horizontal and vertical increments. The field strength for the proponent station is computed at each point on this grid and compared to threshold criteria that have been shown in bench measurements to cause brute force interference in typical receivers. All possible

2- and 3-frequency third order IM products involving the proponent and other FM transmitters are computed and the combined field strength of the stations contributing to each product is compared to other threshold criteria.

**b. The output of the AAM** is a series of plot files of predicted interference points within the designated service volumes. The files may be plotted to a terminal screen, a printer or a plotter. The AAM will also indicate if no interference potential exists. A complete technical description of the AAM is available when the AAM is downloaded for use.

**807. DETERMINATIONS.** After the engineering evaluation has been performed, it is necessary to determine whether the predicted interference (if any) is a hazard to air navigation.

**a. In a 1985 letter** from the Chairman of the FCC to the Administrator of the FAA, it was agreed that in certain situations where there is insufficient scientific information upon which to make a conclusive determination, that certain limiting conditions would be added directly to new or modified station authorizations. These limiting conditions that are set forth in the "conditional statement" are as follows:

*Upon receipt of notification from the Federal Communications Commission that harmful interference is being caused by the licensee's (permittee's) transmitter, the licensee (permittee) shall either immediately reduce the power to the point of no interference, cease operation or take such immediate corrective action as is necessary to eliminate the harmful interference. This condition expires after 1 year of interference-free operation.*

**b. This includes the following situations:**

**(1) VHF-TV broadcast proponents** that appear to be a hazard based on the current electromagnetic interference prediction data and methods.

**(2) FM broadcast proponents** proposing to relocate and/or modify an existing FM station resulting in an equal or lesser interference problem than presently exists. This can include a change in location, power, frequency, antenna height or antenna type.

**(3) Interference is predicted** in an area inside the service volume where an aircraft cannot possibly fly due to terrain, physical obstructions, and/or effects of EMI.

**808. NON-BROADCAST EVALUATIONS.** There are special considerations given to certain non-broadcast transmitters. These procedures are covered under a joint public notice issued by FAA and FCC and a joint agency policy for Technical Operations Services and Air Traffic Organization System Operations Services. The public notice is quoted verbatim as subparagraph a, below. The agency policy is summarized in subparagraph b, below.

**a. Joint FAA/FCC public notice:**

*The Federal Aviation Administration (FAA) and the Federal Communications Commission (FCC) have reached an agreement to simplify the handling of electromagnetic interference (EMI) issues with respect to AM broadcast stations, fixed microwave transmitters, and cellular radiotelephone fixed transmitters. The FAA's concern in this area arises from the possibility that such transmitters might be installed too close to remotely controlled aeronautical receivers so as to disrupt air traffic control communications and navigational aids.*

*It has been agreed that the FAA will not issue a hazard determination to those applicants for licenses involving cellular fixed transmitters, fixed microwave transmitter, or AM broadcast transmitters that invite potential EMI, nor, will the FAA request the applicants to use filtering*

*beyond what is normally required by FCC rules. Rather, the FAA will include the following language in a Determination of No Hazard, assuming that physical obstruction is not an issue.*

*FAA facilities critical to aviation safety are located (distance) from your proposed transmitter site. You may cause harmful interference to these facilities if your equipment meets only minimum FCC standards for spurious emissions. Before you begin any transmission from your facility, contact (name and phone number of local FAA contact) to arrange procedures to verify that no interference is caused.*

*FCC requirements in:*

- 47 CFR 73.44 (c) (in the case of AM broadcast stations)*
- 47 CFR 22.907 (c) (in the case of fixed cellular transmitters)*
- 47 CFR 21.106 (c) (in the case of common carrier fixed microwave transmitters)*
- 47 CFR 74.23 (a) (in the case of broadcast auxiliary transmitters)*
- 47 CFR 94.71 (d) (in the case of operational fixed service transmitters)*

*indicate that the licensees may need to employ extra filtering or take other measures if their transmissions disrupt other services. The commission requires its licensees to cooperate fully with other Federal agencies (users in other services) in this case the FAA, to eliminate any harmful interference covered by the above requirements.*

*This agreement does not affect the requirement of an FCC applicant to notify the FAA of proposed construction or modification of towers under existing FAA and FCC rules. Facilities located near airports raise concerns about possible interference to aircraft and will be handled under existing procedures.*

*This agreement should speed the authorization of service for licensees in the above categories. Both agencies agree that this special case of potential interference to ground based receivers from transmitters at widely differing frequencies can be adequately handled by requiring the licensee (applicant) to shut down if EMI is present due to the use of the transmitter.*

**b. The policy for use of the new statement** for AM broadcast, cellular, PCS, and microwave transmitters which are a potential for electromagnetic interference (EMI) is as follows:

**(1) The FMO shall not recommend that a** Determination of Hazard be issued when an AM broadcast, cellular, PCS, or microwave transmitter evaluation indicates the possibility of EMI to an FAA facility.

**(2) The current procedures** for determining whether the proposed facility will exceed the limits of -4 dBm for out-of-band or -104 dBm for in-band shall be used for evaluation.

**(3) If no problem is predicted,** the FMO shall so notify the service area Obstacle Evaluation Services entity involved.

**(4) If a problem is predicted,** instead of either recommending a hazard be written or telling the proponent that additional attenuation will be required, Obstacle Evaluation Services will be provided with the name of the service area FMO whom the proponent must contact to arrange procedures to verify that no interference is caused. This initial verification is done during the CP phase of the FCC licensing process. FCC rules require that during this period, all interference must be eliminated before the applicant can receive a transmitting license.



(5) **Upon notification by the proponent** of the intent to turn on a new transmitter, the service area FMO will contact the System Management Office that is responsible for the facility where the problem has been predicted. The following is the required procedure:

(a) **The System Management Office will coordinate** the turn-on for testing of the new facility with the proponent to ensure that all FAA personnel are aware of the existence of the new potential for interference and make whatever arrangements they feel are necessary to adequately monitor any suspected EMI to FAA equipment.

(b) **These arrangements can include** having a technician at the site to monitor the equipment, advising Obstacle Evaluation Services of the potential for interference and to be aware of it, or even simply noting the new facility in case interference is reported in normal day-to-day operations.

(c) **If interference is detected**, the System Management Office will immediately notify the proponent, who will shut down the interfering transmitter. The System Management Office will also notify the service area FMO who in turn will contact the local FCC office.

(d) **The FCC will**, at this point, use their own existing procedures to bring the proponent into compliance with the applicable FCC requirements.

(e) **Only in the rarest situations** would a proposal be submitted for one of these services at a location that could endanger FAA facilities. Such a condition (such as a high power AM BC transmitter located in close proximity to an airport or navigational aid) would be so obvious to the reviewing official that it would be accorded special attention beyond the requirements of the notice.

**809. thru 899. RESERVED.**

## CHAPTER 9. VHF/UHF AIR/GROUND COMMUNICATIONS FREQUENCY ENGINEERING

**900. PURPOSE.** The purpose of this chapter is to present an overview of the frequency engineering necessary for A/G communications in the VHF and UHF bands. The detailed frequency engineering for this function is found in Appendix 2.

**901. COMMUNICATIONS FREQUENCY ALLOCATIONS.** All voice communications for ATC utilizes AM in the bands:

118.000 - 136.975 MHz\*

225.000 - 328.600 MHz#

335.400 - 400.000 MHz#

\* Portions are not available to FAA. See Appendix 2.

# Only some frequencies are usable by FAA air traffic control communications (pilot-to-controller) with military aircraft.

**902. BASIC PRINCIPLES OF COMMUNICATIONS FREQUENCY ENGINEERING.** Due to the fixed number of frequencies available for communications facilities, each communications frequency is reused as often as possible throughout the country. Communications frequency engineering provides an interference-free environment for each facility within its FPSV. There are several different functions for communications and each has its own FPSV, defined in the appendix. Communications frequency engineering involves three analysis disciplines: intersite (cochannel), adjacent channel and cosite.

**a. Intersite analysis** is necessary to prevent radio frequency interference (RFI) between facilities providing service on the same frequency at different geographic locations. The basic factors considered in intersite analysis are the Radio Line of Sight (RLOS) and the ratio between Desired (D) and Undesired (U) signal levels (D/U), as seen at the airborne receiver input. As discussed in Appendix 2, the ratio of the desired and undesired signals can be calculated using path loss between the desired signal source and the undesired signal source at the critical point on the FPSVs associated with the two facilities being analyzed. All cochannel communications frequency assignments shall be engineered to meet a D/U distance ratio of 5:1 (a signal D/U ratio of 14 dB), and all cochannel broadcast transmitters shall be beyond RLOS to any point within the FPSV.

**b. Adjacent channel analysis** is necessary to prevent RFI resulting from the close location of two FPSVs with frequency separations of only 25 kHz. Since some frequency separation does exist, path loss is not as critical as in the intersite analysis above. The basic method is to separate FPSVs so that they do not overlap, plus a small additional protective distance (see the appendix for a complete discussion). For adjacent channels separated by 25 kHz, the FPSVs shall be geographically separated by a minimum of 0.6 nmi horizontally or 7,000 feet vertically. For adjacent channels separated by 50 kHz or more, no geographic separation shall be required between the FPSVs.

**c. Cosite analysis** is necessary to prevent RFI resulting from the interaction of transmitter and receivers at or near the same site, which may be far removed in frequency. These sources can be FAA equipment in the same building, or high power or broad-spectrum emissions such as AM/FM/TV broadcast stations from a few miles away. Cosite RFI includes intermodulation, spurious emission, cross-modulation, harmonic, image, and overload interference. A discussion of cosite interference is found in Appendix 2.

**903. SPECIAL ISSUES TO BE CONSIDERED.**

**a. Ground transmitter power** is normally at a level of 10 watts (W). The need for higher power must be justified in the FMO's application for a frequency approval.

**b. UHF coverage** is less than VHF, even for the same power. When the service radius exceeds 100 nmi, power available (limits of coverage) curves must be checked carefully.

**c. Aircraft transmitter power** differs between aircraft. For practical frequency engineering, all aircraft are assumed to have the same output Effective Isotropic Radiated Power (EIRP) as that of the ground transmitter.

**d. FM and TV broadcast interference**, primarily from receiver overload (desensitization) is an increasing concern. The FMO shall carefully check the proximity for the presence of such transmitters during frequency engineering process. This is discussed in detail in the appendix.

**e. Slant range** is the actual distance between the ground transmitter and an aircraft at any critical point, with the radial distance and the altitude of the aircraft each forming a leg of a triangle. The hypotenuse is the actual distance, or slant range. However, because of the shape of most FPSVs, there is negligible difference between the slant range and the ground radial distance, so the service radius is always considered as a ground radial.

**f. Antenna coverage** is affected by lobing of antenna radiation. Within limits, the lower the VHF or UHF antenna with respect to ground level, the better the overall coverage. This is very evident in Appendix 2.

**g. At some "problem" sites**, e.g., where there is limited real estate for adequate antenna separation or other constraints, FMOs may be required to consider multicouplers and/or combiners to prevent frequency interference. The following policy addresses the use of multicouplers and/or combiners.

**(1) Technical Operations ATC Spectrum Engineering Services will manage** the overall program for requirements and budgetary purposes.

**(2) FMOs will validate** the requirements for multicoupler/combiners at sites within their service areas in coordination with the concerned Regional Associate Program Managers (RAPM).

**(3) FMOs must carefully specify** requirements for multicouplers and combiners. Whereas multicouplers are somewhat flexible in their potential for retuning to meet changing requirements, the combiner can tune only within a very narrow range of operating frequencies.

**(4) FMOs shall note use** of multicouplers/combiners in the GMF remarks section using the appropriate format.

**904. AUTOMATIC TERMINAL INFORMATION SERVICE (ATIS) VOICE OUTLET ASSIGNMENT CRITERIA.** The following criteria will be used to the maximum extent possible in selecting ATIS voice outlets:

**a. Priority for selecting a frequency** to support ATIS broadcasts:

**(1) VOR** or VOR with tactical air navigation capability (VORTAC), except if they are Doppler-type, provided the VOR or VORTAC is located within three nautical miles of the airport. This only applies to those VORs that do not currently provide other broadcast signals such as Enroute Flight Advisory System (EFAS).

**(2) VOR test facility (VOT)** for departure ATIS only.

(3) **A 25 kHz discrete VHF air-ground frequency** (for service to the military, any 25 kHz discrete UHF air-ground communications channel in the band 225-400 MHz).

**b. Power output of an ATIS** operating on a discrete VHF or UHF channel should not exceed 10 W.

**c. Service volume of an ATIS** operating on a discrete VHF or UHF channel must be consistent with the Terminal Radar Approach Control (TRACON) airspace, and is normally limited to 60 nmi and 25,000 feet above ground level (AGL). The concerned service area air traffic organization must approve requirements in excess of this value.

**d. Frequency protection ratio (D/U)** for an ATIS operating on a discrete VHF or UHF channel shall be a minimum of:

(1) **14 dB** from an aircraft at the edge of the ATIS service volume to another cochannel ATIS, Automated Weather Observing System (AWOS) or Automated Surface Observation System (ASOS).

(2) **Beyond RLOS** separation from a potential interferer at the edge of an FPSV to the transmitter site of the ATIS.

**NOTE:** The minimum separation is inclusive, i.e., both (1) and (2) must be met.

**e. If the proposed ATIS facility does not conform** to subparagraphs (1) through (4) above, the FAA may not assign the system a broadcast frequency.

**905. AWOS/ASOS FREQUENCY ASSIGNMENT CRITERIA.** (These criteria also apply to other weather broadcast services under different names.) The following criteria shall be used to the maximum extent possible in selecting AWOS/ASOS voice outlets:

**a. Priority** for selecting a frequency to support AWOS/ASOS broadcasts:

(1) **At airports with towers**, use the existing ATIS voice outlet, if available. If the tower operates part-time, the AWOS/ASOS shall operate independently of the ATIS during non-operational hours.

(2) **At airports without ATIS**, use a non-Doppler VOR or VORTAC site if it is within 3 nmi of the AWOS/ASOS facility. This only applies to those VORs that do not currently use the facility for other broadcast signals such as EFAS.

(3) **If no ATIS or VOR is available**, the AWOS/ASOS facility shall be assigned an available 25 kHz air/ground frequency, with first consideration given to (a) or (b) below.

(a) **120.000 MHz is available** for AWOS/ASOS requirements at non-air traffic control tower locations, and at air traffic control tower locations if the AWOS/ASOS transmit antenna is located at least 2,000 feet from the tower cab.

(b) **The frequencies 121.425, 121.450, 121.550, and 121.575 MHz** (i.e., guard band frequencies for 121.500 MHz) are available for FAA AWOS/ASOS installations, subject to stringent emission mask requirements. These frequencies shall not be used to satisfy non-FAA requirements unless coordination is undertaken with Technical Operations ATC Spectrum Engineering Services to ensure that special action is taken to implement sufficiently stringent emission masks, as part of the transmitter specifications, and on-going maintenance procedures to satisfy the special requirements of using these frequencies.

**b. If a Nondirectional Beacon (NDB) is available and desired,** the AWOS/ASOS may be broadcast over the NDB, when the AWOS/ASOS facility will be within 3 nmi of the NDB. This does not apply to two-frequency NDBs that are not capable of voice transmission. The NDB frequency must be in the 325-415 kHz range to support voice.

**c. Power output of an AWOS/ASOS** operating on a discrete VHF channel should not exceed 2.5 W.

**d. Service volume of an AWOS/ASOS** operating on a discrete VHF shall not be less than 15 nmi and 5,000 feet AGL and is normally limited to 25 nmi and 10,000 feet AGL. Requirements in excess of this value must be approved by the concerned service area air traffic organization. Under no circumstances shall the radius of the service volume exceed the terminal control area.

**e. Frequency protection ratio (D/U)** for an AWOS/ASOS operating on a discrete VHF channel shall be a minimum of:

(1) **14 dB from an aircraft** at the edge of the AWOS/ASOS service volume to another co-channel ATIS, AWOS or ASOS.

(2) **Beyond RLOS** separation from a potential interferer at the edge of an FPSV to the transmitter site of the AWOS/ASOS. **NOTE:** The minimum separation is inclusive, i.e., both (1) and (2) must be met.

**f. If the proposed AWOS/ASOS** facility does not conform to the criteria in subparagraphs a. through e. above, the FAA may not assign the system a broadcast frequency.

**906. BACKUP COMMUNICATIONS.** In many cases, backup communications facilities are maintained to preclude a total loss of services at air traffic control facilities. In the enroute environment the Backup Emergency Communications system (BUEC) has been in place for many years. In the large TRACON environment there are now many facilities with Emergency Communications Systems (ECS) that function much like the enroute BUEC systems. Many airports also separate their primary and secondary radios to eliminate single points of failure in their communications system. Additionally, most towers have portable battery operated radios for emergencies.

**a. The enroute BUEC** radio system is changing from a system that used a few strategically located tunable radios to provide backup service for the enroute facilities to a system that has a dedicated fixed tuned radio for each enroute sector. This new Sustaining BUEC system is being implemented within the Sustaining BUEC program.

(1) **The tunable BUEC** system has been scheduled for de-commissioning and removal by early 2006. It was typically located at enroute radar sites because of the access to the FAA microwave backbone as an alternative means of connecting to the ARTCCs. These tunable BUEC radios were not easily colocated with most fixed tuned FAA radios, because they were more susceptible to cosite RFI than the fixed tuned FAA radios.

(2) **The Sustaining BUEC** system provides a dedicated backup radio tuned to the ATC sector frequency for each primary transmitter supporting a sector. The FMOs shall ensure that the site selected for the location of the Sustaining BUEC radio provides the necessary coverage for the sector or portions of the sector that the primary facility covers, and must satisfy the full frequency engineering criteria for a Remote Control Air/Ground (RCAG) frequency assignment. A Sustaining BUEC shall not be colocated in the same facility as the primary radio. Any exceptions to these requirements must be justified by waivers jointly approved by Technical Operations, and Enroute and Oceanic Services.

**b. The large TRACON ECS system** is much like the Sustaining BUEC system. The FMOs shall ensure that the site selected for the location of the ECS radio provides the necessary coverage for the airspace that the primary facility covers and must satisfy the full frequency engineering criteria for a Remote Transmitter/Receiver (RTR) frequency assignment. An ECS radio shall not be collocated in the same facility as the primary radio. Any exceptions to these requirements must be justified by waivers jointly approved by Technical Operations and Terminal Services.

**c. When the main and standby radios** are located in separate facilities on an airport, both radios shall have their own GMF assignment. The two assignments shall be select keyed with each other and labeled as the main or standby radio in the "Remarks" section of the GMF record.

**d. The portable battery operated emergency radios** used in towers are not normally listed in the GMF.

**e. Dedicated back up or emergency frequencies** (excluding 121.500 and 243.000 MHz) shall not be allowed at any location.

**907. TEMPORARY ASSIGNMENTS.** Requests to provide temporary frequency assignments for air shows, fire fighting, military exercises, and other events are a normal part of the FMO duties. Each of these situations is different and requires the FMO to understand the function of each temporary frequency requested.

**a. Air Shows** are common events typically occurring during the summer months. The aircraft coordination at air shows fall into one of three basic categories: FAA controllers in temporary towers, military controllers in temporary towers, and non-Fed air boss' coordinating aerial activities. In all cases, the FMO shall review the frequency requests to ensure the radius, flight level, function, and numbers of frequencies are consistent with the delegated airspace, types of aircraft, and size of the facility. Military aircraft shall use UHF frequencies unless there is only a single VHF frequency for the air show. Separate VHF frequencies for military aircraft shall not be issued. Extra or spare frequencies shall not be issued. The Search and Rescue frequency 123.100 MHz may be issued as an air show frequency with the understanding that the air show may be preempted if a Search and Rescue operation occurs in the vicinity of the air show.

**(1) For the case with FAA controllers in temporary towers,** the FMO shall engineer the appropriate frequencies and enter them into the AFM using an air show temporary (AS T) prefix for the serial number. The temporary assignment shall contain the start and stop date for the air show (a day or two may be added to the beginning and/or end of the scheduled air show duration to accommodate practice days and/or arrival and departure coordination if requested). All temporary air show assignments shall be deleted from the AFM once the air show dates are past.

**(2) For the case of military controllers in temporary towers,** the FMO shall follow the procedure for FAA controllers but shall not release the frequencies to the requestor. The FMO shall instruct the requestor that frequencies have been reserved for the air show and tell the requestor that they must obtain a temporary assignment for the air show frequencies through the appropriate DOD National Frequency Management Office. Once Technical Operations ATC Spectrum Engineering Services has received a temporary frequency request for the air show from the appropriate DOD National Frequency Management Office, the frequencies will be released.

**(3) For the case of non-Fed air boss' coordinating the aerial activities,** these requestors should normally be referred to the FCC. The FCC will typically authorize the use of an FCC controlled frequency for the air show. However, there are cases where the FCC frequencies are too congested for use by a non-Fed air boss, and it is prudent to allow an ATC frequency to be used for the air show. As in the case of the military controllers, the FMO shall not release the frequency to the requestor. The requestor must obtain a temporary license from the FCC for the air show. The FAA will give the frequency to the FCC when the temporary request is processed.

For some special events (e.g., Oshkosh or Sun-N-Fun) permanent frequencies may be assigned and placed in the GMF. These assignments require the prior concurrence of Director of Technical Operations ATC Spectrum Engineering Services and must be clearly labeled as frequencies for the special event. The FMO should be aware of these permanent frequencies and use them to meet other temporary requirements whenever possible.

**b. Fire Fighting** frequencies are assigned to assist various agencies involved in aerial fire fighting activities. All fire fighting frequencies are coordinated through the National Interagency Fire Center (NIFC). Requests from individual agencies, states, or local governments should be referred to NIFC. In the more fire prone (i.e. Western) portions of the United States, fire fighting sectors have been established to coordinate fire fighting activities. A fire fighting frequency is typically assigned to each of these sectors to allow immediate response to any reported fire. The frequencies for these sectors should be reused as often as possible realizing that fire fighting aircraft typically operate within 1000 feet of the ground. This frequency is typically assigned for the entire fire season (April-October). The FMOs may set aside a second frequency for each of these sectors to be available for quick release if fire activity escalates in a particular area. As fire activity increases, additional project fire frequencies may be engineered for specific fire efforts. Once these project fires are contained these frequencies should be released back to the FAA. In addition, tanker base frequencies are also issued for the fire season. All fire fighting frequencies shall be placed into the AFM using the fire fighting temporary prefix (FFT) and shall have a current year serial number. All other fire fighting assignments shall be deleted from AFM.

**c. Military exercises** often involve requests for VHF and UHF air/ground frequencies. The FMO must carefully evaluate the request presented from the military and should discuss the exercise with the concerned service area air traffic organization. Most military exercises are normally to support military training and do not justify the use of VHF air/ground frequencies; however, in some of these cases, a single VHF air/ground frequency may be issued for the exercise. In a few cases, the military exercise involves the delegation of airspace to the military to provide ATC services to everyone in that airspace. If the delegated airspace is open to the flying public, then paired VHF air/ground frequencies are required for each UHF frequency. The use of contracted civil aircraft and COTS training aircraft that do not have UHF radios does not justify the use of 118.000-137.000 MHz frequencies in military exercises. The FMO shall engineer the military exercise frequencies and enter them into AFM using the appropriate military temporary prefix (AR T, AF T, N T) but shall not release the frequencies to the requestor. The FMO shall instruct the requestor that frequencies have been reserved and tell the requestor that they must obtain a temporary assignment for the exercise through the appropriate DOD National Frequency Management Office. Once Technical Operations ATC Spectrum Engineering Services has received a temporary frequency request from the appropriate DOD National Frequency Management Office, the frequencies will be released.

**d. Other temporary assignments may arise** as seasonal activities or search and rescue training. For search and rescue training, the frequency 122.900 MHz is specified in the FCC rules for use by the Civil Air Patrol and state or local agencies engaged in search and rescue training. These groups should not use 123.100 MHz for training. For guidance on other temporary VHF and UHF air/ground communications requests contact the Technical Operations ATC Spectrum Engineering Services National VHF and/or UHF frequency band manager.

**908 thru 999. RESERVED.**

## CHAPTER 10. NAVIGATIONAL AID (NAVAID) FREQUENCY ENGINEERING

**1000. PURPOSE.** The purpose of this chapter is to present an overview of the frequency engineering necessary for ILS [including Transponder Landing System (TLS)], VOR, VHF Omnidirectional Radio Range Test (VOT), Area VOT (AVOT), Distance Measuring Equipment, Normal (DME/N), Precision Distance Measuring Equipment, Precision (DME/P), Tactical Air Navigation (TACAN), Microwave Landing System (MLS), Local Area Augmentation System (LAAS), Wide Area Augmentation System (WAAS), Automatic Dependant Surveillance - Broadcast (ADS-B) and the Global Positioning System (GPS). The detailed frequency engineering for these NAVAID facilities is discussed in Appendix 3.

**1001. NAVAID FREQUENCY ALLOCATION.** NAVAID facilities are dependent upon the use of the RF spectrum. A summary of the present international and national frequency allocations for NAVAID is shown in figure 10-1.

**FIGURE 10-1. NAVAID BAND USE**

FACILITY TYPE	FREQUENCY BAND (MHZ)
ILS LOCALIZER (LOC)	108.1 - 111.95
LAAS	112.0 - 117.975
ILS GLIDESLOPE (GS)	328.6 - 335.40
ILS MARKER BEACON	75
ADS-B	978.0
VOR, VOT, AVOT	108.00 - 117.975
DME/N, DME/P, TACAN	960.0 - 1215.0
MLS	5031.0 - 5090.7
GPS L5	1176.45
GPS L1	1575.42

**1002. BASIC PRINCIPLES OF NAVAID FREQUENCY ENGINEERING.** Due to the fixed number of frequencies available for NAVAID facilities, each NAVAID frequency is reused as often as possible throughout the country. NAVAID frequency engineering provides an interference-free assigned environment for each NAVAID facility within its FPSV. Each type of NAVAID has its own characteristic FPSV, and each is defined in Appendix 3. NAVAID frequency engineering involves two frequency analyses: intersite and cosite.

**a. Intersite Analysis** is necessary to prevent RFI between facilities on the same and adjacent frequencies providing service in different or adjacent areas. The basic factor considered in intersite analysis is the D/U ratio, as seen at the airborne NAVAID receiver input. All NAVAID frequency assignments must meet certain D/U ratio values (see Appendix 3). For example, a VOR assignment must meet 23 dB ratio for cochannel D/U within its FPSV. The 23 dB ratio is based upon the ICAO standard of required 20 dB D/U ratio, with the addition of a 3 dB factor to allow for the facility power decreasing 3 dB before its monitor shuts it down. The required D/U ratios for each type of VHF/UHF/SHF NAVAID for cochannel and adjacent channels are provided in Appendix 3.



**b. Cosite Analysis** is necessary to prevent RFI resulting from the interaction of transmitters and receivers at or near the same site. Cosite RFI includes intermodulation products, cross-modulation, receiver desensitization (overload), adjacent channel signals, harmonics and AM/FM/TV interference.

**1003. NAVAID FREQUENCY ENGINEERING METHODS.** The cosite analysis procedure is discussed in Appendix 3. It will not be repeated in this chapter. As for intersite analysis, there are two basic methods for determining whether a proposed frequency meets the required D/U ratio criteria.

**a. Method 1: Use of Reference Tables.** A series of reference tables will be found in Appendix 3, which shows conservative worst-case separation distances required for each NAVAID type. If the proposed new facility meets all the separation requirements of appropriate reference tables, no further search is necessary, and the frequency application may be prepared. This method is discussed in detail in Appendix 3.

**b. Method 2: Calculation of Required Separation.** In frequency-congested areas, it is necessary to use a more accurate and detailed method of determining the required separation distance. The calculation method takes the following equipment parameters into consideration and the required D/U ratio is adjusted accordingly:

(1) **Transmitter power.**

(2) **Antenna gain.**

(3) **Antenna directivity.**

(4) **Antenna orientation.**

**1004. EQUIVALENT SIGNAL RATIO (ESR).** The adjusted D/U ratio is called ESR. A series of curves based on this ESR will be found in Appendix 3, showing the required separation distance. The detailed procedure for calculating the ESR and using the curves is discussed in Appendix 3.

**1005. EXPANDED SERVICE VOLUME (ESV).** An ESV is a special volume of airspace outside of the normally specified FPSV. Each ESV is engineered using the same criteria as for the FPSV. In addition to meeting the required D/U ratio criteria, each ESV shall also meet certain minimum signal strength requirements as prescribed in Appendix 3. Since ESVs are not registered in the NTIA GMF, Technical Operations ATC Spectrum Engineering Services maintains a separate data base within the AFM for all ESVs used in the NAS. The detailed procedures for engineering ESVs and updating the ESV data base are discussed in Appendix 3.

#### **1006. SPECIAL ISSUES TO BE CONSIDERED.**

**a. NAVAID 50 kHz Assignments.** Since some general aviation aircraft may not yet be equipped with 50 kHz (200-channel) navigation receivers, every effort shall be made to find a 100 kHz assignment for a NAVAID facility before assigning a 50 kHz channel.

**b. Paired NAVAID Assignments.** To minimize a potential safety hazard, frequency protection shall be provided for all services associated with a facility, even if only one service is installed. When an ILS LOC is assigned, the associated DME frequency shall be frequency protected even if no DME is installed. The same holds true for VOR/DME/TACAN and MLS/DME/P and MLS/DME/N.

**c. Localizer Receiver Desensitization Due to In-Band Localizer Signals.** Interference between localizers serving different runways at the same airport is possible depending on the configuration of the runways and the distance between the two systems. When an aircraft on approach passes through a strong radiation field of a

localizer serving a reverse or an adjacent runway, the ILS siting criteria (FAA Order 6750.16) requires that a positive interlock device be installed to prevent both systems from transmitting simultaneously. FMOs may be asked to evaluate waivers to this siting policy at airports where more efficient use of runways is required. The FMO must analyze the specific situation and geometry so that airborne ILS avionics are not desensitized due to other localizers at the airport. The following policy is provided:

(1) **An undesired localizer signal** level of -33 dBm will not be exceeded within the FPSV of a collocated ILS.

(2) **Calculations** will be done using the free space formula.

**d. VOR/DME/TACAN Collocation Assignments.** Some VOR/DME/TACAN facilities that were in place in 1980 were engineered under criteria slightly different than that shown in Appendix 3. As such, any installations, which have passed flight inspection satisfactorily in the past, shall be considered as conforming to these criteria. However, any new facility frequency engineered shall adhere to the criteria presented in Appendix 3.

(1) **The greater distance separation** of the individual frequency paired VOR/DME/TACAN shall be used. In facilities of equal power, the criteria charts and graphs will show that the DME/TACAN required separation is greater than that of any paired VOR for most conditions.

(2) **In all cases**, the GREATER requirement shall be used as minimum separation for the frequency pair, regardless of whether both paired facilities are installed.

**e. DME at ILS Locations.** ILS/DMEs generally require separation distances far beyond that provided for the LOCs due to the DME's separation criteria and omnidirectional antenna pattern. Therefore, it is important to ensure that when engineering an ILS LOC frequency, its associated DME meets the required separation, even if no DME is installed. In frequency congested areas, the frequency protection for the DME may not be possible without using 50 kHz NAVAID frequencies. If the DME is not actually installed, the DME frequency protection may be waived through the normal NAS Change Proposal (NCP) process.

**f. DME/P and DME/N at MLS Locations.** The conditions are the same as with DME at ILS locations.

**g. Potential FM/TV Interference.** Because of an abundance of FM and TV high power transmitters around the country, an approach or an airway may place an aircraft over or very near one of these transmitters. Their overwhelming power, frequently on the order of a megawatt or more ERP, can cause severe overloading of the front end of aircraft receivers, and thus the loss or deterioration of NAVAID reception. A routine item to be checked for problems in a frequency study shall include the verification of nearby FM or TV transmitters. Of particular concern are the FM transmitters near the upper end of the FM broadcast band because it is immediately adjacent to the 108.0-117.975 MHz NAVAID band. All new ILS and VOR proposals will be evaluated using the AAM to determine the potential for any interference from FM and TV Broadcast stations. See Appendix 1 for further discussion of FM/TV interference.

**h. Collocated NAVAIDS.** At some sites, a VOR/DME/TACAN or ILS/DME paired facilities may not be actually collocated. To meet ICAO and FAA standards, such paired facilities must be installed within the distances specified in the Appendix 3, or else the two facilities may not be frequency paired. An ILS/DME may be collocated with either the LOC or the GS transmitters.

**i. Terrain Shielding.** A transmitter's signal strength in space can be affected by the shielding of terrain, buildings, vegetation, etc. This can have an impact on the D/U signal ratios in space. If shielding is severe, it may be possible to provide the required D/U signal ratios with less than the recommended station separation. The use of terrain shielding, as a way to decrease the separation requirement, should be treated on a case-by-case basis through sound engineering judgment. This facility must be flight checked with satisfactory results and documented through the normal NCP process.

**j. LAAS** spectrum support will be referred to Technical Operations ATC Spectrum Engineering Services for engineering and assignment action.

**k. ADS-B** currently uses the Universal Access Transceiver (UAT) and transmits on 978.0 MHz. The UAT transmits ADS-B data air-to-air for cockpit display and air-to-ground for use by ATC. The UAT may receive ground-to-air Flight Information Service (FIS) and Traffic Information Service (TIS) data for cockpit display.

**l. WAAS** transmits on GPS frequency L1 from geosynchronous satellites that cover the continental U.S. (excluding Alaska).

**m. GPS frequency L5** is expected to be implemented starting with the Wide Area Augmentation System (WAAS) geostationary satellites by 2007, with the GPS constellation implementation to follow in the 2010-2015 time frame. Since L5 transmits on 1176.45 MHz, it was previously considered that some TACAN/DME frequency changes might need to be made to accommodate L5. However, after considerable study it has been concluded that no TACAN/DME frequency changes will be required in the NAS to provide satisfactory L5 operation.

**1007. thru 1099. RESERVED.**

## CHAPTER 11. LOW/MEDIUM FREQUENCY (L/MF) GROUND NAVIGATIONAL AIDS

**1100. PURPOSE.** The purpose of this chapter is to describe the necessary techniques and actions required to provide a frequency for a low/medium frequency (L/MF) NAVAID. L/MF includes Compass Locator (COMLO) and Nondirectional Beacon (NDB), also known as a "Homer."

**a. The COMLO is an NDB,** usually of low power, strategically located on an ILS approach path to provide L/MF azimuth guidance to an airport, in addition to the more precise guidance of the ILS LOC. COMLOs are normally collocated with ILS Outer Markers (OM) and Middle Markers (MM), and referred to as "LOM" and "LMM," respectively. The LOM transmits, in Morse code, the first two letters of the associated ILS identifier. The LMM transmits the last two letters of the associated ILS identifier. For example, COMLOs installed with the Los Angeles, CA (LAX) ILS would be "LA" for the LOM and "AX" for the LMM. To the extent possible, the frequencies of the LOM and LMM shall not be separated less than 15 kHz nor more than 25 kHz.

**b. The NDB** is a free-standing nondirectional radio beacon designed to provide navigational service over a specified radial distance from the facility. It can have power from 10 W to 1000 W, typically 25 W, depending on the need. It should be noted that due to very heavy congestion in this band, the FMO shall do everything possible, by coordinating with the concerned service area air traffic organization and FS, to engineer the lowest possible emitted power to cover the requirement. The Aeronautical Information Management (AIM) in System Operations Airspace and AIM is responsible for the coordination of requests for three-letter location identifiers. Coordination with this organization is accomplished by each service area through the concerned air traffic organization.

### 1101. GENERAL CONSIDERATIONS.

**a. NDB and COMLO** are treated the same for frequency assignment purposes. For simplicity, only the term NDB will be used hereafter when it is intended to refer to both.

**b. An NDB frequency selection model** is available on the AFM for engineering NDB requirements.

**c. A required signal level** of 70 microvolts per meter (uv/m), which is also 37 dB above one microvolt per meter (dBuv/m), is the standard set for the signal required at all points on the outer limits of the NDB FPSV. If the NDB transmitter power decreases by 3 dB, the resultant signal would be equivalent to 50 uv/m at all points on the outer limits of the NDB FPSV. At this point, the remote NDB alarm is triggered.

**d. The D/U signal level standard** for an NDB is 15 dB. This provides an assured 12 dB protection of the FPSV when the desired signal decreases 3 dB from the normal operating power. At this point, the system should alarm.

**e. Channelization of the band is 1 kHz.** First adjacent channel is 1 kHz removed, second adjacent is 2 kHz removed, etc.

**f. The mode of radiation** is considered to be ground wave, while acknowledging that, particularly at night, sky wave does enter into propagation mode.

**g. The FPSV** is considered to be a cylindrical volume of airspace, centered on the NDB, with no upper altitude limit. Since the ground wave is the principal radiation factor, the signal level in any given direction is a function of the antenna efficiency, the ground system associated with the antenna and the ground conductivity medium through which the signal passes to get to the point under consideration.

**h. NDB FPSV's** are classified as follows:

- |     |   |               |
|-----|---|---------------|
| (1) | <b>LOM/LMM</b>                                    | 15 nmi radius |
| (2) | <b>MH</b> (less than 50 W)                        | 25 nmi radius |
| (3) | <b>H</b> (50 w or more, but<br>less than 2,000 W) | 50 nmi radius |
| (4) | <b>HH</b> (2,000 W or more)                       | 75 nmi radius |

**i. An NDB's primary function is as a NAVAID.** However, voice modulation is permitted in addition to the required Morse code identifier only on a secondary basis, and then only when it causes no interference to any other facility as a result of the additional voice modulation.

**j. An NDB for non-Federal use,** which requires a frequency request through FCC, has the same priority as an FAA or other Federal agency facility, provided that the proposed NDB has an FAA approved procedure on it. Any other non-Federal use is on a secondary basis, assignable only if:

(1) **The facility could be accommodated** without moving or otherwise affecting FAA facilities in any way.

(2) **FAA concurrence** with use of the frequency is contingent upon the frequency being withdrawn upon notice by FAA in writing at any time it is needed for a facility which has a procedure and is in the NAS.

**k. Permissible power** is that normal power level which just meets the level required to assure 70 uv/m at the circumference of the FPSV. In some unique instances, due principally to poor ground conductivity, it may be impossible to meet the signal level requirement at some azimuths. In this case, an option, if FS and the concerned air traffic organization concur, could be to commission with restrictions.

**l. There is little difference** in the signal level between ground and any altitude normally flown by aircraft within the FPSV specified. As a general rule, the signal level measured at any altitude is considered to be the same as found at ground level and all other altitudes at that azimuth.

**m. A dual carrier NDB** has an upper sideband (only) with full carrier. It radiates a Continuous Wave (CW) carrier on the assigned frequency. The identification signal is provided by an on/off keying of a second carrier, transmitted at a frequency equal to the first carrier frequency plus the frequency of the modulation tone. For example, at a carrier frequency of 200 kHz, the second carrier would be at 200.4 kHz (for a 400 Hz identifier) and at 201.02 kHz (for a 1020 Hz identifier). For purposes of registering in the GMF, the emission designator would be 500HXXA and the center frequency would be 200.2 kHz (for a 400 Hz identifier) and 1.112XXA emission designator and 200.51 kHz center frequency (for a 1020 Hz identifier).

**1102. FREQUENCY ALLOCATION FOR L/MF FACILITIES.** The frequencies allocated for L/MF use are shown in figure 11-1.

**FIGURE 11-1. L/MF NAVAID FREQUENCY ALLOCATIONS**

Frequency (kHz)	Limitations & Comments
190 - 200	AR Primary
200 - 275	AR Primary; AM Secondary
275 - 285	AR Primary; AM Secondary; MR Secondary
285 - 325	MR Primary; AR Secondary
325 - 335	AR Primary; AM Secondary; MR Secondary
335 - 405	AR Primary; AM Secondary
405 - 415	R Primary; AM Secondary
415 - 435	MM Primary; AR Primary
510 - 525	AR Primary; MM Primary
525 - 535	AR Primary; M Primary

**KEY**

AR - Aeronautical Radionavigation (FAA & Non-Fed. NDB's)  
MR - Maritime Radionavigation  
R - Radionavigation  
MM - Maritime Mobile  
M - Mobile

(For detailed definitions, see NTIA Manual, Chapter 6.)

**a. NDB voice** is not permitted in the bands 190-199.9, 285-324.9, and 415-535 kHz.

**b. The band 525-535 kHz** use by Mobile Service is limited to the Travelers' Information Service (TIS), operating on 530 kHz. Voice modulation of NDB's is not permitted in this band. AR stations are authorized for off-shore use only, on a non-interference basis to TIS.

**c. Maritime radiobeacons** in the 285-325 kHz band segment will not be used for aeronautical operations. In addition, FMO's will avoid use of the 285-325 kHz band segment for aeronautical radiobeacons because of the incompatibility between aeronautical NDB receivers and the maritime NDB's which transmit DGPS signals for use by maritime users.

**1103. ENGINEERING CONSIDERATIONS FOR L/MF FREQUENCY SELECTION.** It is unfortunate, but frequency engineering for L/MF facilities is not a straight-forward technical operation. There are several reasons for this.

**a. L/MF propagation** is not an omnidirectional straight line decay of signal situation. Since ground wave is involved to a considerable degree with the conductivity of the ground in each azimuth direction, there can be wide variations of signal strength in different directions from a single antenna.

(1) **An antenna near a body of water**, particularly ocean water, will have greatly increased radiation in the azimuths covered by the ocean, while inland azimuths will retard radiation due to signal losses caused by poorer conducting earth. As an example, an NDB on the northern Florida east coast will have very efficient radiation into the Atlantic Ocean. But because the ground conductivity is very poor there, signals radiated to the west would be much reduced.

(2) **A specific example** would be that at 50 nmi to the west, a signal of 20 uv/m would be measured from a 25 W NDB. The same signal measured eastward to sea (assuming the NDB to be on or very close to the beach) would produce 70 uv/m, or an approximately 11 dB stronger signal.

(3) **Night-effect** can occur because an NDB radiates both a ground wave and a sky wave. The ground wave is usable for navigation within the operational service volume. The sky wave is radiated up into space and reflected back to earth by the ionosphere. This reflection results in the presence of an attenuated sky wave at varying distances from the NDB ground station. The distance and the amount of attenuation are determined by the height and density of the ionosphere and the angles at which the radiated sky wave strikes the ionosphere. Sky wave field strength is subject to changes in the ionosphere. This is similar to the conditions for HF described in chapter 7. These changes occur as a function of the time of day, time of year and phase of the solar cycle. At night, the reflective property of the ionosphere increases for L/MF and the lower HF bands resulting in a sky wave field strength that can be substantially larger than during the day.

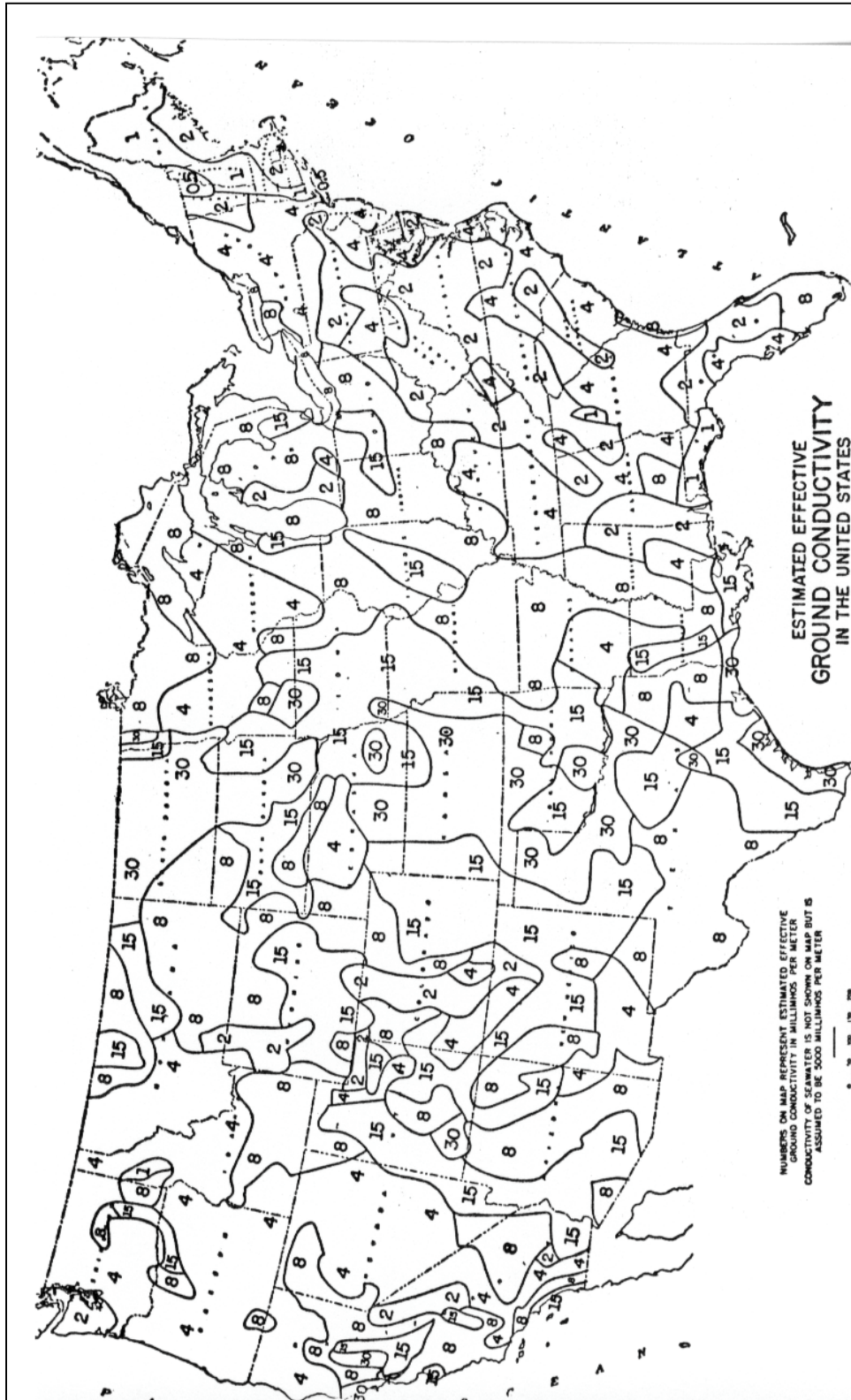
**b. A ground system** consisting of four copper wires, equally spaced radially about the base of the antenna, would give a smaller signal at any given point as compared to the same antenna with 30 equally-spaced copper radials.

**c. There are no "standard" antennas**, so whatever antenna is installed will affect the radiation efficiency. The most common antennas used are the symmetrical "T" and the top loaded vertical or "Top Hat."

**d. Ground conductivity charts** are only approximate, and the various curves used are an average of empirical data.

**e. With all those limitations**, it can be seen that the process which will be described is only an estimate of the level of signal to be expected at the periphery of the FPSV.

FIGURE 11-2. ESTIMATED GROUND CONDUCTIVITY IN THE UNITED STATES





**1104. BASIC TOOLS.** The basic tools used in engineering frequencies for L/MF are the ground conductivity map and the prediction curves.

**a. The Ground Conductivity Map.** Refer to figure 11-2. The conterminous U.S. (CONUS) is divided up into small "jig-saw" segments with numbers in each piece. Those numbers are the numerical value of "millimho/m" (mm/m) and represent units of reluctance, the unit used to represent average electrical conductive quality of the ground in the area. A value of 1 to 4 is poor; 8 is good; 15 and 30 are so good that they are practically indistinguishable from sea water. Sea water, the reference at 4,000, is the ideal. These values will be more meaningful when they are compared with the other tool, the coverage and interference prediction curves.

**b. Prediction Curves.** Refer to figure 11-3. These curves are designed to give the user a predicted level of signal at a given distance from the transmitter. The three shaded curves are for "poor" ground at 1 to 4 mm/m, "good" ground at 8 mm/m and sea water at 4000 mm/m. Conductivity values between 1 and 4000 must be interpolated.

(1) **There is a frequency factor** in the curves. The frequency range covered is over 2:1. Conductivity varies with frequency so that the left side of each curve is 400 kHz and the right side is 200 kHz. Frequencies in between must be interpolated.

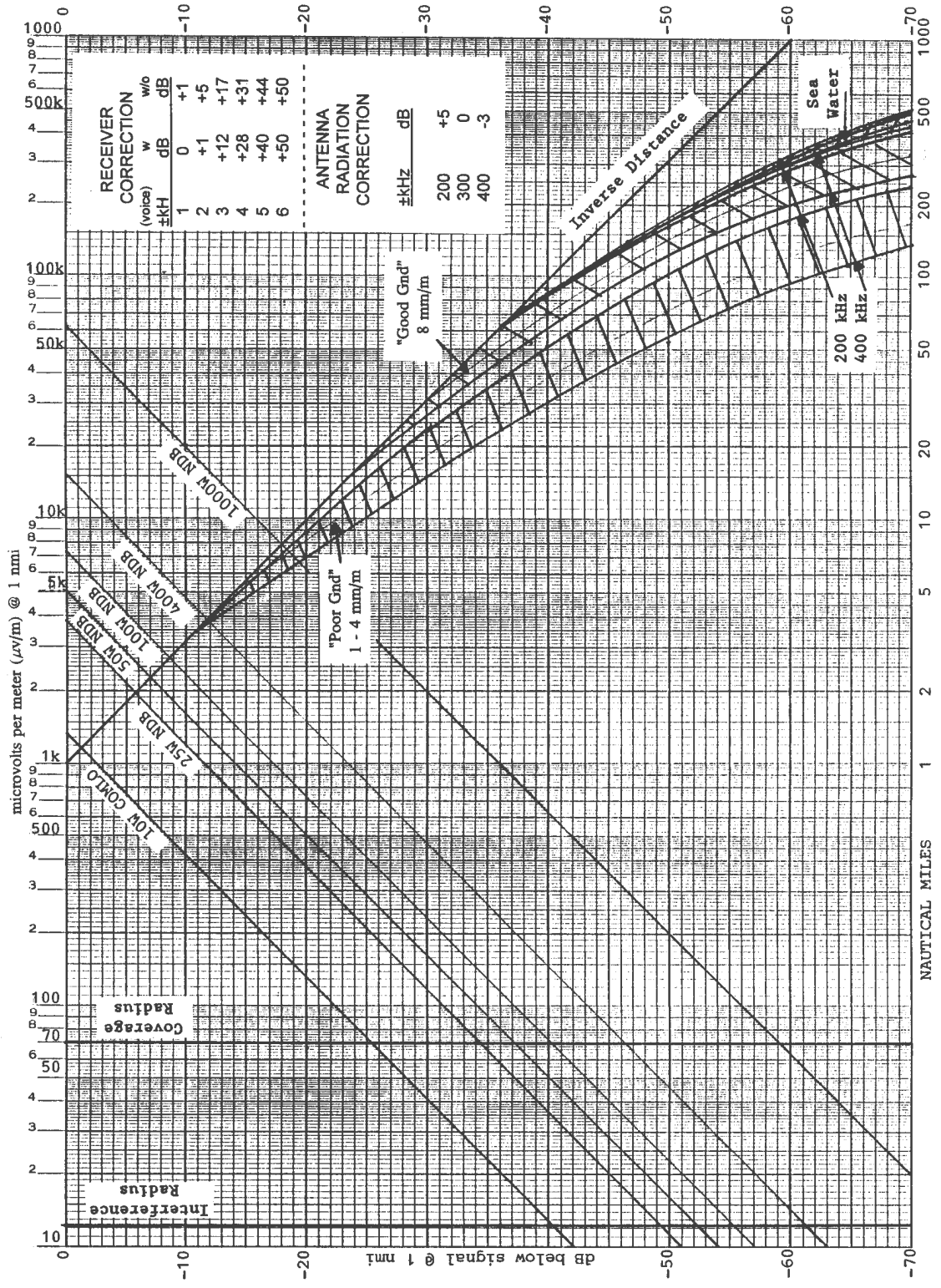
(2) **The curves are normalized** to 300 kHz and so have an antenna efficiency factor which is shown between 200 kHz and 400 kHz. The antenna radiation correction factor for frequencies in between must be interpolated.

(3) **There are corrections** for receiver intermediate frequency (IF) selectivity. While newer receivers will have quite sharp IF selectivity, until such time as the large majority of airborne receivers are of that group, the receiver correction values shown on the chart shall be used.

(4) **Typical facility types**, as related to average radiation level from usual antennas, are shown as a series of parallel straight lines. Where the line intersects the 0 dB abscissa, the indicated  $\mu\text{v}/\text{m}$  value (good only on the "0 dB" line) is that predicted at 1 nmi.

(5) **The vertical scale** for the abscissas is the dB value below signal voltage level at 1 nmi. For instance, the 25 W NDB line shows an expected level of 3700  $\mu\text{v}/\text{m}$  at 1 nmi. Its intersection with the 70  $\mu\text{v}/\text{m}$  service radius at the -34.5 dB abscissa, when followed to the inverse distance line, indicates that a level of 70  $\mu\text{v}/\text{m}$  would occur over perfectly-conducting ground at 50 nmi. In propagation, field voltage decays inversely as the distance. Power varies inversely as the square of the distance. A signal voltage at 2 nmi is 6 dB less than that signal level at 1 nmi. The "inverse distance" line runs from 1  $\text{mv}/\text{m}$  to 1000  $\text{mv}/\text{m}$ . The distance and voltage are inversely proportional and their ratio is 1000:1. It can be seen that  $\text{dB} = 20 \log (E1/E2) = 20 \log 1000 = 20 \times 3 = 60 \text{ dB}$ . The inverse distance line is from 0 to -60 dB.

FIGURE 11-3. COVERAGE AND INTERFERENCE PREDICTION CURVES



**1105. ENGINEERING PROCEDURES.**

**a. Conductivity.** Required facility geographical separation ( $S$ ) is calculated by using figures 11-2 and 11-3. Figure 11-2 shows the ground conductivity in mm/m which determines which curves to use in figure 11-3.

**b. Separation Distance ( $S$ ).** ( $S$ ) is the minimum distance required between facilities to prevent interference and is defined as:

$$(S) = d_D + d_U$$

where  $d_D$  = distance from the desired facility to the edge of its service volume

$d_U$  = distance from the undesired facility to the edge of the desired service volume

**c. Calculation of Required Separation Distance.**

(1) **Find the facility service volume  $d_D$**  in nmi on the bottom of figure 11-3. Move up to intersect the appropriate ground conductivity curve from figure 11-2, interpolating for frequency. Note the attenuation value in dB at the left of figure 11-3.

(2) **Add the antenna radiation correction factor** shown in figure 11-3 to the dB value in subparagraph 1.

(3) **Algebraically add the correction factor** to subparagraph 2 for difference in facility power. For example, if the undesired facility is 50 W and the desired facility is 25 W, add -3 dB.

(4) **Add the receiver correction value** to subparagraph 3 when the undesired station is within  $\pm 6$  kHz of the desired station. The "Undesired receiver correction with voice" shall be used first. If a frequency cannot be engineered using that value, the "Undesired receiver correction without voice" may be used only if the desired station does not have transmit voice.

(5) **Algebraically add -15 dB** to the value obtained in subpara. 4; this gives the D/U ratio of 15 dB required.

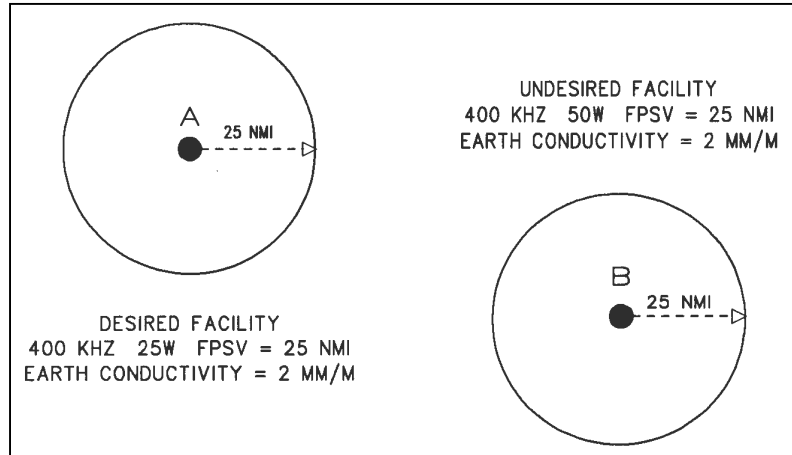
(6) **Use the dB attenuation value** obtained in subparagraph 5 and find this level at the left of figure 11-3. Move across to intersect the appropriate conductivity curves. This intersection determines  $d_U$  in nmi from the bottom scale.

(7) **Add  $d_D$  and  $d_U$**  to obtain the required separation ( $S$ ) distance necessary for the desired facility to have a minimum of 15 D/U.

(8) **Determine the required ( $S$ )** for the undesired facility in the same manner (now the undesired is the desired and vice versa).

**1106. PRACTICAL EXAMPLE.** See figure 11-4.

**FIGURE 11-4. GEOGRAPHIC SEPARATION EXAMPLE**



**a. Station A**, the desired station, is on 400 kHz, power 25 W, FPSV 25 nmi, with conductivity of 2 mm/m.

**b. Station B**, the undesired station, is on 400 kHz, power 50 W, FPSV 25 nmi, also 2 mm/m.

**c. Calculating Station A Distances.**

(1) **Find the facility  $d_D$**  of 25 nmi FPSV at the bottom of figure 11-3. Move up and intersect the 400 kHz 2 mm/m curve. Note the attenuation value of -37.5 dB at the side of the graph.

(2) **Algebraically add -3 dB** radiation correction factor to the value of subparagraph 1:  $-37.5 + (-3) = -40.5$  dB.

(3) **Determine the dB power difference:**  $P_D/P_U = 25/50$ .  $10 \log \frac{1}{2} = -3$  dB. Add that value to the value of subparagraph 2:  $-40.5 - 3 = -43.5$  dB.

(4) **Determine the receiver correction value.** In this example, the stations are on the same frequency, receiver correction is 0 dB, so the value remains -43.5 dB.

(5) **Algebraically add -15 dB** to the value obtained in subparagraph 4:  $-43.5 + (-15) = -58.5$  dB.

(6) **Find the value -58.5 dB** at the left of figure 11-3 and move across to intersect the 400 kHz curve for 2 mm/m. From the scale at the bottom of the graph, note the value is 90 nmi.

(7) **Add  $d_D + d_U = 25 + 90 = 115$  nmi**, the required separation for (S).

**d. Calculating Station B Distances.**

(1) **Find the facility FPSV  $d_D$**  of 25 NM at the bottom of figure 11-3. Move up and intersect the 400 kHz 2mm/m curve. Note the attenuation value of -37.5 dB. See subparagraph c(1).

(2) **Algebraically add -3 dB antenna radiation correction factor** to value of subparagraph 1:  
 $-37.5 + (-3) = -40.5$  dB.

(3) **Determine the dB power difference:**  $P_D/P_U = 50/25$ .  $10 \log 2 = +3$  dB. Add that +3 db to the value of subparagraph. 2:  $-40.5 + 3 = -37.5$  dB.

(4) **Determine the receiver correction factor** to be 0 dB, so the value remains at -37.5 dB.

(5) **Algebraically add -15 dB** to the value in subparagraph 4:  $-37.5 + (-15) = -52.5$  dB.

(6) **Find the value -52.5 dB** on the side of figure 11-3 and move across to intersect the 400 kHz 2 mm/m curve. Note the value is 65 nmi.

(7) **Add  $d_D + d_U = 25 + 65 = 90$  nmi**, the required (S).

(8) **Compare the required separations** for each calculation. Note that the larger requirement is 115 nmi, and the larger is always used.

**1107. AIRBORNE MEASUREMENTS.**

**a. The same kind of measurements** (for the proposed facility) could be made from a flight inspection aircraft. The problem is in the receiving antenna in the aircraft. A calibrated loop remains as a calibrated entity only as long as its surroundings are nominal, or at least not changing. With a loop on an aircraft, any change of aircraft position with respect to the plane of the loop which has to be maximized with respect to the signal source will nullify its calibration. The cost of using a flight inspection aircraft is prohibitive to be used as a "study" vehicle.

**b. A FAA Study** covering a comparison of airborne and ground measurement was completed in 1980. A thorough report of that study is available for FMO consideration in Report No. FAA-R-6050.2, Low Frequency Beacon Signal Strength Determination, dated January 1980.

**1108.-1199. RESERVED.**

**CHAPTER 12. MICROWAVE DATA/COMMUNICATIONS LINKS  
FREQUENCY ENGINEERING**

**1200. PURPOSE.** This chapter and its associated appendix provide the criteria for the engineering of frequencies for each of the type of links indicated in the title. It does not supersede or replace existing maintenance or installation instructions, but rather provides only that technical data required to provide the frequency engineering necessary for each facility. Coordination between the frequency engineer and the installation staff is essential to assure system viability.

**1201. FREQUENCY BANDS AVAILABLE FOR RADIO LINKS.** Radio frequency link engineering involves two frequency analyses, cosite and intersite. The following bands are available for links as indicated.

**FIGURE 12-1. BANDS CURRENTLY USED BY FAA FOR RADIO LINKS**

162-174 MHz	Land Mobile*	Very congested band
406.1-420 MHz	Land Mobile*	Very congested band
932-935 MHz	Fixed Station	LDRCL
941-944 MHz	Fixed Station	LDRCL
1710-1850 MHz	Fixed Station**	LDRCL
7125-8500 MHz	Fixed Station	Radio Communications Link (RCL)
14.4-15.35 GHz	Fixed Station	TV Microwave Link (TML)
21.2-23.6 GHz	Fixed Station	Microwave links
* Specific frequencies are allotted for fixed operations such as Low Level Windshear systems (LLWAS), RMM, MALSR, etc. (See chapter 17.)		
** New requirements for radio links will not be satisfied in the 1710-1850 band.		

**a. The band 7125-8500 MHz** is broken up by segments allocated to space communications. Only the subbands 7125-7250, 7300-7900, and 8025-8500 MHz are available for fixed PTP links.

**NOTE:** The FR8 RCL will not operate in the 8400 to 8500 MHz band.

**b. The band 14.5-15.35 GHz** is broken into three sections. The portion 14.7145-15.1365 GHz is allocated to other services on a primary basis. This subband must be avoided in planning Television Microwave Link (TML) systems.

**c. Because of the wide variety** of microwave equipment used by FAA, detailed engineering criteria are not provided for all such systems. Detailed engineering criteria are provided for the FR8 because of its extensive use. In general, when doing spectrum engineering for microwave systems, the intersite engineering should be done first, since it is straightforward. When analyzing the cosite situation, care must be taken that image frequencies of the system are considered. The appropriate manufacturer's equipment specifications should be consulted and the general procedures of paragraph 1204 followed.

**1202. INTERNATIONAL COORDINATION REQUIREMENTS.** When systems are to be designed for use within 100 nmi of the Canadian or Mexican borders, Technical Operations ATC Spectrum Engineering Services should be notified very early in the project. There are international agreements with Canada and Mexico that require coordination. Early coordination can prevent having to vacate a planned frequency group when it is found to conflict with their operations.

**1203. TECHNICAL STANDARDS FOR LINKS.** See Chapter 5 of the NTIA manual. Technical data for FAS applications for U/SHF systems are found in appendix 4.

**1204. THE GENERAL PROCEDURE FOR MICROWAVE LINK INTERSITE FREQUENCY ENGINEERING** is basically an orderly step-by-step compilation of all the parameters of all potentially competing systems. It simply consists of carefully examining every parameter that would affect the overall RF path from a transmitter output to a receiver input. Essentially, the frequency is unimportant to the procedure because the procedure is the same for 900 MHz as it is for 21 GHz. While Technical Operations ATC Facilities sets the physical path, the frequency engineer must check the spectrum compatibility both as a potential interferer to other established systems (culprit) and as a potential receiver of RFI from other systems (victim). See figure 12-3. The following is a general discussion of the detailed procedure followed by a simple format that is intended to assist in assuring that all parameters are considered as well as providing a study record of each system analysis.

**a. While the actual site path will be engineered by Technical Operations ATC Facilities,** the frequency engineer must be sufficiently familiar with certain of the engineering parameters to assure that the frequencies engineered will work with the system.

**b. Cosite considerations.** Of particular importance are other microwave systems. For instance, the second harmonic of much of the 7125-8500 MHz band falls into the 14.50-15.35 GHz band. FAA is not always able to site its equipment on an exclusive FAA site, thus any other users' equipment must be considered.

**c. Intersite and near parallel path considerations.** The site shall be frequency engineered by checking the GMF carefully for the full bandwidth of FAA's equipment and add to that the bandwidth of any other user's equipment operating in the area. The parameters for determining the signal level at a victim receiver include the proximity of frequency, receiver band pass characteristics, and the geographical location of the victim receiver. Determination of the required azimuth separation from other users is also a matter of parameters as described in paragraph d.

**d. From the transmitter end,** there are several parameters to be considered.

(1) **Transmitter output power,** specified in dBm, normally a positive value.

(2) **Wave guide (feed line) power loss,** in dB, always a negative value.

(3) **Antenna gain** in dB is always a positive value. However, the value for any given azimuth can vary considerably from other azimuths. At microwave frequencies for links, high gain directional antennas are required. The main beam peak gain is often in the range of 30 dB to 40 dB. However, only a few degrees off the azimuth of the main beam, the gain is reduced considerably, to as much as -20 to -30 dB. It is essential that the radiation pattern specified by the antenna manufacturer be available for determining the gain in a particular azimuth.

**(4) Parabolic antenna gain calculations** are approximated by a simple formula. Parabolic antennas are considered to be between 55 percent and 65 percent efficient. This general formula is for nonstandard size reflectors and for frequencies not commonly used for RCL and TML. A nomograph for parabolic antenna gains is found in appendix 4. Assuming the nominal 55 percent value, the gain would be:

$$G_{dB} = 20 \log D + 20 \log f + 7.5$$

Where:

- $G_{dB}$  = gain over isotropic, in dBi  
 $f$  = frequency in GHz  
 $D$  = parabolic reflector diameter, in feet

Assuming a 6 foot diameter reflector at 7.700 GHz,

$$\begin{aligned} G &= 15.56 + 17.73 + 7.5 \\ &= \mathbf{40.79 \text{ dBi, or approximately 41 dBi}} \end{aligned}$$

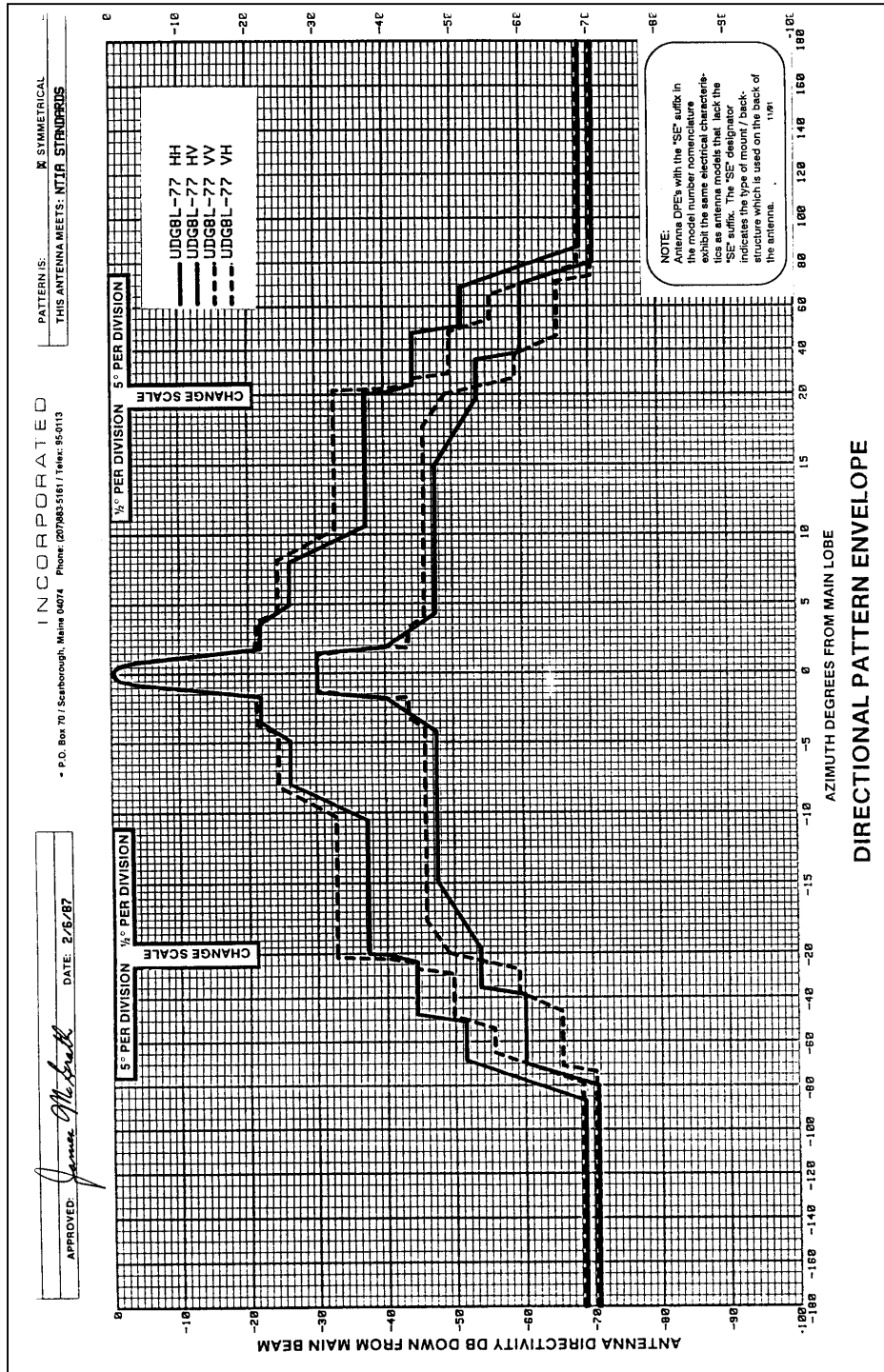
**(a) The forward gain** of a high directional antenna is usually specified by the manufacturer in decibels above an isotropic antenna (dBi) or decibels above a dipole antenna (dBd), with dBd representing a value of 2.1 dB above dBi.

**(b) The radiation pattern** plot is usually shown in the manufacturer's instruction book or specification sheet. This plot may be polar or linear, but both are shown with the main beam at 0 dB and all side lobes shown as values less than the main beam reference gain value.

**(c) The actual gain** of the antenna at any given azimuth other than the primary main beam is that value shown on the plot for the selected azimuth subtracted from the rated main beam gain. For instance, a certain parabolic antenna is rated by the manufacturer at 43 dBd gain. The plot normally shows the main beam at 0 degrees, which represents the 43 dBd gain value. See figure 12-2. Use the HH plot, the upper solid line curve. Looking at the plot at 15 degrees (the azimuth of the victim receiver), it is noted that at that azimuth, a minor lobe has a value of -37 dBd. Thus, the gain in the direction of 15 degrees from the azimuth of the main beam would be a value of  $43 - 37 = 6$  dBd. That value of 6 dBd is what is used as the "main beam" gain for subparagraph (3) above.



FIGURE 12-2. TYPICAL PARABOLIC MICROWAVE ANTENNA RADIATION PATTERN



e. It is necessary to calculate propagation loss as a parameter in assuring that the transmitter (Tx) power, the antenna gain, minus the free space loss, plus the receiver (Rx) sensitivity all add up to a usable path. This calculation is needed to determine the level of suspected signal in the vicinity of any competing user on the frequency engineered, for compatibility. Free space propagation loss is not obtainable on the earth, due to

atmospheric losses, reflections, etc. But using the basic free space propagation loss formula is as good an approximation as can be gained without actually putting a signal on the air and measuring it at the receiving location. That free space loss formula is:

$$L_{fs} \text{ (dB)} = 37.8 + 20 \log f + 20 \log d$$

where:  $L_{fs}$  = free space loss, in dB

$f$  = frequency, in MHz

$d$  = distance in nmi  
(for statute miles, the constant 37.8 changes to 36.6)

Assuming a 30 nmi path at 7700 MHz,

$$\begin{aligned} L_{fs} &= 37.8 + 77.7 + 29.5 \\ &= \mathbf{145 \text{ dB}} \end{aligned}$$

**f. A nomograph for space loss** is found in appendix 4.

**g. From the receiver end**, there are other parameters to be considered.

**(1) The receiver minimum signal level** required for satisfactory operation. This value should have already been determined by Technical Operations ATC Facilities in their siting study to assure adequate signal at the receiver at all times. This level is always a negative dBm value and is specified by the manufacturer.

**(2) The receiver system interference susceptibility level** is specified by the manufacturer in the system instruction manual or specification sheet. This value is usually in the form of a graph curve with dBm level on the y axis and frequency on the x axis. See Appendix 4 for typical curves. This value in dBm is the value that must ultimately be checked against the culprit's signal level at the victim receiver input terminals to determine whether RFI is anticipated.

**(3) The receiving antenna gain** in dB at the azimuth of the culprit incoming signal. That gain is determined in the same manner as for the transmitting antenna in subparagraph a. (3), above.

**(4) The receiving wave guide (feed line) loss**, always a negative value, in dB. This is determined from the wave guide or feed line manufacturer's specification sheet.

**h. The path fade margin** is the one variable in the parameters. It is the loss of signal level at the receiver from variable propagation losses, such as atmospheric moisture, air particle content, etc. The manufacturer of the system will specify the path margin normally required to assure adequate signal from the desired source to the desired receiver. While there is some variance among manufacturers and with frequency (higher bands are more subject to these path fade problems), a manufacturer frequently will specify a 10 dB fade margin. That is, under normal conditions, to assure that the minimum required signal is received by the desired receiver from the desired transmitter during path fade conditions, an additional level of protection is engineered into the siting of the units of the system. In this frequency compatibility study, however, a 15 dB D/U protection value shall be used which includes the path fade and other parameters not absolute. See figure 12-3.

**FIGURE 12-3. POWER BUDGET STUDY FOR A MICROWAVE LINK**

- |   |               |
|---|---------------|
| 1. Undesired transmitter power  | (+) _____ dBm |
| 2. Undesired transmitter wave guide or feed line loss                                     | (-) _____ dB  |
| 3. Undesired transmitter antenna gain in the direction of the desired receiver. [1204 d.] |               |
| a. Main beam gain of the antenna  | (+) _____ dB  |
| b. Off-azimuth loss in the direction of the desired                                       | (-) _____ dB  |
| c. Total undesired antenna gain in the direction of desired (sum of a. and b. above)      | (±) _____ dB  |
| 4. Free space propagation loss. [1204 e.]   | (-) _____ dB  |
| 5. Desired receiver antenna gain in the direction of the undesired transmitter. [1204 g.] |               |
| a. Main beam gain of the antenna  | (+) _____ dB  |
| b. Off-azimuth loss in the direction of the undesired                                     | (-) _____ dB  |
| c. Total desired antenna gain in the direction of undesired (sum of a. and b. above)      | (±) _____ dB  |
| 6. Desired receiver wave guide or feed line loss  | (-) _____ dB  |
| _____   |               |
| 7. Undesired signal level at desired receiver input <b>(TOTAL)</b>                        | (±) _____ dBm |
| 8. Desired receiver RFI susceptibility level. [1204 g.]                                   | (-) _____ dBm |
| 9. Difference between 7. and 8.   | (±) _____ dB  |

The value of item 9 must be -15 dB or less (more negative) for interference-free operation of the link. A 15 dB safety margin, over and above all other calculations, should be provided for the receiver, to assure a positive D/U ratio under all conditions, including path fades.

**i. Desired versus Undesired.** When engineering a link frequency for FAA, the FAA transmitter is the "undesired" culprit. All other receivers in place within RLOS (or at least 40 nmi) and within frequency range must be checked as the "desired" or victim. When checking the FAA receiver situation, any other system transmitter within the same bounds is the culprit. For both situations, FAA as a victim and a culprit, adequate protection must be shown before the frequency(ies) can be submitted to Technical Operations ATC Spectrum Engineering Services for approval. If another agency is proposing a new system and an FAA system is within interference bounds, the other agency must assure protection. In some bands, that agency is required to coordinate with the FAA to verify protection assurance. Even in the bands not requiring FAS coordination notices, verify before approving or coordinating the proposal.

**j. The most practical method** to accomplish the study is to use these tools:

(1) **A topographical or sectional map** permits plotting and verification of the systems accurately by coordinates. It is then easy to draw a straight line between the two systems and measure the azimuth deviation from the respective antennas' azimuths heading for their own system.

(2) **The AFM CIRCLE program** will permit quick and easy access to all systems within the frequency and distance ranges desired for the study.

(3) **The AFM bearing/distance program** will also provide quick and accurate azimuths and distances between culprit and victim sites.

(4) **Note that the final selection** of the frequency(ies) may depend on terrain factors which are not easily quantified but which may be apparent from a site survey or analysis of a topographical map.

(5) **Use the format of figure 12-3** to determine the power budget and the D/U ratio.

**k. Many FAA microwave systems use digital radios.** It should be noted that nominally up to 10 dB of additional margin may be required for digital receivers as compared to an equivalent analog receiver.

#### **1205. FREQUENCY ENGINEERING FOR THE 932-935 AND 941-944 MHZ BANDS.**

Engineering of LDRCL in these bands is straightforward. The channeling plans for these bands and other constraints on their use are found in NTIA Manual, Chapters 4 and 5. Cosite and intersite engineering will utilize procedures found in paragraph 1204, as well as criteria in NTIA Manual, Chapters 4 and 5.

**1206. FREQUENCY ENGINEERING FOR THE 1710-1850 MHZ BAND.** As directed by Title VI of the Omnibus Budget Reconciliation Act of 1993 (OBRA-93), Title III of the Balanced Budget Act of 1997 (BBA-97), and the Strom Thurmond National Defense Authorization Act for Fiscal year 1999 (NDAA-99), the 1710-1755 MHz portion of this band will be auctioned and transferred to the private sector. Therefore, there will be no further FAA assignments in the 1710-1755 MHz band. No standard frequency plan exists for this band. Refer to Paragraph 1204 for a general analysis of microwave link engineering.

**a. Cosite frequency engineering.**

(1) **Transmitter-to-transmitter** (Tx/Tx) frequency separation shall be at least 30 MHz.

(2) **Transmitter-to-receiver** (Tx/Rx) frequency separation shall be at least 40 MHz.

(3) **Receiver-to-receiver** (Rx/Rx) frequency separation shall be at least 15 MHz.

**b. Intersite frequency engineering.** To assure that other microwave systems in the area do not cause interference (or in order to determine that FAA systems will not cause interference to other agencies' systems), the following procedure shall be used.

(1) **Using the AFM CIRCLE program**, determine all microwave systems within at least 60 nmi of the proposed site.

(2) **Using the AFM bearing/distance program**, and taking into account the beam widths of the respective transmit and receive antennas, determine all microwave systems which could be an interference source or victim of the proposed site.

(3) **Using the procedure** given in figure 12-3, determine whether potential interferers or victims should be further analyzed.

**1207. FREQUENCY ENGINEERING FOR RCL IN THE 7125-8500 MHZ BAND.** This process consists of two separate criteria. The first considers the FR8 equipment requirements. Note that the FR8 equipment is limited to 7125-8400 MHz. The second concerns microwave link general engineering and is discussed in paragraph 1204.

**a. Cosite frequency engineering.**

(1) **The FR8 equipment** frequency selection criteria consists of seven tests. These test apply to the Tx's and Rx's using a common wave guide and antenna configuration.

**Test 1. Space bands** - must be located outside of bands 7250-7300 and 7900-8025 MHz.

**Test 2. Rx local oscillator (LO)** - must be within the band 7125-8400 MHz.

**Test 3. Tx/Tx and Rx/Rx separation** - a minimum of 60 MHz.

**Test 4. Tx/Rx separation** - Tx frequency must have at least 80 MHz separation from the Rx input frequency. If the Rx is at 8200, then a Tx is not permitted between 8120-8280, based on this test.

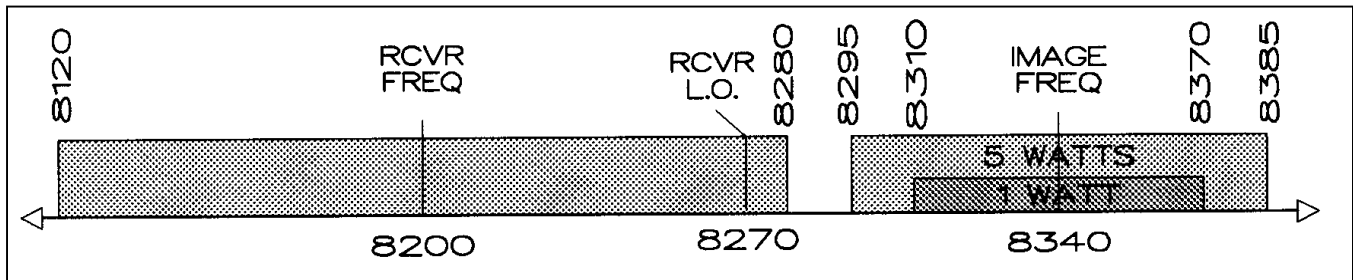
**Test 5. Image frequency protection** - **For a 1 W Tx**, the Tx output frequency must have at least 30 MHz separation from the image frequency; i.e., if the Rx is at 8200 and the Rx LO at 8270, then the Rx image frequency is 8340. The Tx must then not be within the 8310-8370 range, based on this test. For a low side Rx LO at 8130, the Rx image frequency is 8060. A Tx is not permitted within the 8030-8090 range, based on this test. **For a 5 W Tx**, the Tx output frequency must have at least 45 MHz separation from the Rx image frequency. **If an enhanced Rx RF input is installed**, both 1 W and 5 W Tx's output frequency must have at least 15 MHz separation from the Rx image frequency. See figure 12-4.

**Test 6. The transmitter local oscillator (Tx LO)** must be >30 MHz from other Rx(s) within the hop.

NOTE: TX LO = RX LO, i.e. TX = 8270, TX LO = 8270; no other RX permitted between 8240-8300.

**Test 7. For a 1 W Tx**, a third-order intermodulation products frequency is not permitted within 15 MHz of the Rx input frequencies. **For a 5 W Tx**, a third-order intermodulation products frequency is not permitted within 30 MHz of the Rx input frequencies.

FIGURE 12-4. EXAMPLE OF TESTS 4 AND 5 PROHIBITED ZONES



(2) Once the 7 tests in subparagraph (1) above have been satisfied for the Tx's and Rx's on a common antenna, the back-to-back coupling must be considered. Back-to-back coupling is the fraction of power received by a second antenna located on the same tower but facing in a different direction from the Tx antenna and using a separate wave guide. The following specifications assume an angular azimuth separation of at least 15 degrees.

(a) For a 1 W Tx with a standard antenna, the Tx output frequencies must be separated from other cosite Rx frequencies by at least 40 MHz.

(b) For a 5 W Tx with a standard antenna, 45 MHz.

(c) For a 1 W or 5 W Tx with a high performance antenna, 25 MHz.

**b. Intersite frequency engineering.** Use the same procedure as described in paragraph 1204.

(1). The antenna front-to-back ratio must also be considered. That ratio is defined as the ratio of the power transmitted by the front side of the antenna to the power transmitted by the back. For a 1 W or 5 W Tx with a standard antenna, the transmitted frequencies must be separated from other cosite frequencies by at least 30 MHz; with a high performance antenna, 10 MHz.

(2) The standard RCL frequency family is shown in figures 12-5 and 12-6.

(3) The preferred LO frequency is indicated following the operating frequency. The "+" indicates the LO is on the high side of the operating frequency, the "—", the low side.

**FIGURE 12-5. STANDARD RCL FREQUENCY FAMILY FOR 7125-8400 MHz**

	Direction A	Direction B
A.	7160 + 7340 —*	7430 + 7605 —
B.	7205 + 7385 —*	7475 +* 7650 —
C.	7185 + 7365 +	7695 —** 7630 +
D.	7230 + 7135 +	7495 — 7580 +
D.	7230 + 7320 —*	7495 +* 7580 —
E.	7685 — 7805 +	8170 + 8290 —
E.	7685 — 7805 +	8170 + 8045 +
F.	7745 + 7865 —	8230 — 8350 —
F.	7745 + 7865 —	8230 — 8105 +
G.	7725 + 7845 —	8210 + 8330 —
G.	7725 + 7845 —	8210 + 8085 +
H.	7785 + 8270 —	8145 — 8390 +
J.	7765 + 7885 —	8250 — 8370 —
J.	7765 + 7885 —	8250 — 8125 +
K.	7705 + 7825 +	8190 + 8310 -
K.	7705 + 7825 +	8190 + 8065 +

Notes:

- (1) \* Indicates a "flopped" LO. This option was not initially manufactured for this LO, but it can be ordered.
- (2) \*\* Indicates a new frequency, not previously assigned to the RML standard family.
- (3) Direction A or B is a set of Tx's and Rx's in one direction of a hop.
- (4) Before using the above sets of frequencies together within the same link or on parallel links, they must be checked for back-to-back and front-to-back separations.
- (5) The table does not assume or imply exclusive FAA use.
- (6) See figure 12-6 for examples of selection and tests. Frequencies are taken from the standard chart. Test 4 results show Tx frequencies do not fall on critical frequencies. Test 5 results show Tx frequencies fall outside image band plus separation band.
- (7) The symbols "+" or "—" indicate that the preferred LO is located on the high or low side of the operating frequency, respectively.

**FIGURE 12-6. SAMPLE OF FREQUENCY SELECTION, TEST 4 AND 5**

	-----Test 4 -----
-----> Tx 7160 +	Rx 1 = 7430    Rx 2 = 7605
-----> Tx 7340 —	-80           +80
<----- Rx 7430 +	7350           7685
<----- Rx 7605 —	(image is on the <u>opposite</u> side)
	-----Test 5-----
	Tx 1 = 7430 +    Rx 2 = 7605 —
(Image band 140 MHz)	+140                   -140
(30 MHz reqd sep.)	+ 30                   -30
	7600                   7435

c. **Hybrid frequency/space diversity.** See paragraph 1211.

**1208. FREQUENCY ENGINEERING FOR LDRCL IN THE 7125-8500 MHZ BAND.** This considers the ALCATEL MDR-6000 equipment requirements.

a. **Cosite frequency engineering.**

(1) **The ALCATEL equipment** frequency selection criteria consists of 6 tests. These tests apply to the Tx's and Rx's using a common wave guide and antenna configuration.

**Test 1. Space bands** - must be located outside of bands 7250-7300 and 7900-8025 MHz.

**Test 2. Rx local oscillator (LO)** - must be within the band 7125-8500 MHz.

**Test 3. Tx-to-Tx frequency separation** must be 46 MHz or greater.

**Test 4. Rx-to-Rx frequency separation** must be 46 MHz or greater.

**Test 5. Tx-to-Rx frequency separation.** The Tx frequency must have at least 115 MHz separation from the Rx input frequency.

**Test 6. A third-order intermodulation** product is not permitted within 15 MHz of the Rx input frequency.

(2) **Once the 6 tests in subparagraph (1) above have been satisfied** for the Tx's and Rx's on a common antenna, the back-to-back coupling must be considered. Back-to-back coupling is the fraction of power received by a second antenna located on the same tower but facing in a different direction from the Tx antenna and using a separate wave guide. The following specifications assume an angular azimuth separation of at least 15 degrees.

(a) **It is recommended** that the Tx output frequencies must be separated from the other cosite frequencies by at least 33 MHz.



**b. Intersite frequency engineering.** Use the same procedure as described in paragraph 1204.

**c. Hybrid frequency/space diversity.** See paragraph 1211.

**1209. FREQUENCY ENGINEERING FOR THE 14.5000-14.7145 AND 15.1365-15.3500 GHZ BANDS.**

**a. Cosite frequency engineering** is unnecessary. FAA only uses this band for one-way links to support Digital Bright Radar Indicator Tower Equipment (DBRITE).

**b. Intersite frequency engineering.** This frequency band and associated equipment are normally limited to a 20 mile one-way path with not more than two repeaters. See paragraph 1204.

**c. The frequency family plans** are shown in figures 12-7.

**d. The TML equipment frequency coverage** limitation prohibits use of the TML equipment between 15.25-15.35 GHz.

**FIGURE 12-7. CURRENT TML CHANNELIZATION PLAN**

MHz	MHz	MHz	MHz
14501.25*	15141.25*	14606.25	15246.25
14503.75	15143.75	14608.75	15248.75
14506.25	15146.25	14611.25	15251.25**
14508.75	15148.75	14613.75	15253.75**
14511.25	15151.25	14616.25	15256.25**
14513.75	15153.75	14618.75	15258.75**
14516.25	15156.25	14621.25	15261.25**
14518.75	15158.75	14623.75	15263.75**
14521.25	15161.25	14626.25	15266.25**
14523.75	15163.75	14628.75	15268.75**
14526.25	15166.25	14631.25	15271.25**
14528.75	15168.75	14633.75	15273.75**
14531.25	15171.25	14636.25	14276.25**
14533.75	15173.75	14638.75	15278.75**
14536.25	15176.25	14641.25	15281.25**
14538.75	15178.75	14643.75	15283.75**
14541.25	15181.25	14646.25	15286.25**
14543.75	15183.75	14648.75	15288.75**
14546.25	15186.25	14651.25	15291.25**
14548.75	15188.75	14653.75	15293.75**
14551.25	15191.25	14656.25	15296.25**
14553.75	14193.75	14658.75	15298.75**
14556.25	15196.25	14661.25	15301.25**
14558.75	15198.75	14663.75	15303.75**
14561.25	15201.25	14666.25	15306.25**
14563.75	15203.75	14668.75	15308.75**
14566.25	15206.25	14671.25	15311.25**
14568.75	15208.75	14673.75	15313.75**
14571.25	15211.25	14676.25	15316.25**
14573.75	15213.75	14678.75	15318.75**
14576.25	15216.25	14681.25	15321.25**
14578.75	15218.75	14683.75	15323.75**
14581.25	15221.25	14686.25	15326.25**
14583.75	15223.75	14688.75	15328.75**
14586.25	15226.25	14691.25	15331.25**
14588.75	15228.75	14693.75	15323.75**
14591.25	15231.25	14696.25	15336.25**
14593.75	15233.75	14698.75	15338.75**
14596.25	15236.25	14701.25	15341.25**
14598.75	15238.75	14703.75	15343.75**
14601.25	15241.25	14706.25	15346.25**
14603.75	15243.75	14708.75*	15348.75**

\* These frequencies cannot be used for bandwidths greater than 2.5 MHz. Total number of channels is 168.

\*\* Due to TML equipment limitations, these frequencies are not usable.

From the radar end, use a 14 GHz frequency. If a repeater is necessary, use the paired 15 GHz frequency for the repeater. If another repeater is required, use another 14 GHz frequency; do not exceed two repeaters.

**1210. FREQUENCY ENGINEERING FOR LDRCL IN THE 21.2-23.6 GHZ BAND.** This band has a very short propagation characteristic and can be optimally engineered by assuring that cochannel operations are not within 10 nmi. The frequency plan for LDRCL in this band is shown in figure 12-8.

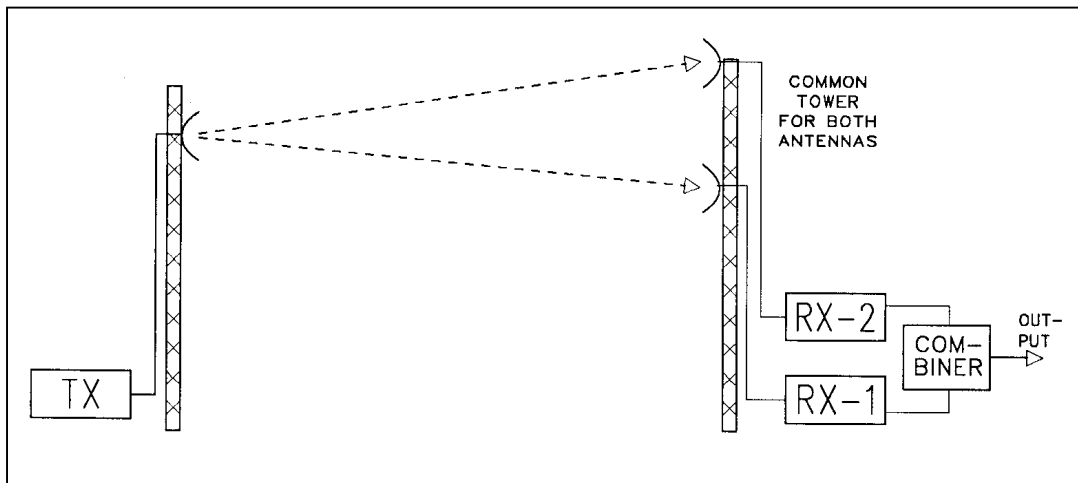
**a. Cosite frequency engineering.** For cosite operation, ensure a Tx-Rx frequency separation of at least 1.2 GHz and a Tx-Tx frequency separation of at least 50 MHz.

**b. Intersite frequency engineering.** See paragraph 1204, except limit search to RLOS.

**FIGURE 12-8. 21.2-23.6 GHZ LDRCL FREQUENCY ASSIGNMENT PLAN**

Freq 1 (GHz)	Paired with	Freq 2 (GHz)
21.225		22.425
21.275		22.475
21.325		22.525
21.375		22.575
21.425		22.625
21.475		22.675
21.525		22.725
21.575		22.775
21.625		22.825
21.675		22.875
21.725		22.925
21.775		22.975
21.825		23.025
21.875		23.075
21.925		23.125
21.975		23.175
22.025		23.225
22.075		23.275
22.125		23.325
22.175		23.375
22.225		23.425
22.275		23.475
22.325		23.525
22.375		23.575

**1211. SPECIAL PATH CONSIDERATIONS.** Although the problem occurs most often on the southern portions of the east and west coast of the contiguous United States and Hawaii, varying path propagation can present real difficulties. There are two ways to alleviate the problem. One is space diversity and the other is frequency diversity. Because space diversity takes no additional frequencies, it is preferable. See figure 12-9. In addition, for digital systems, a hybrid combination of both space and frequency diversity can be provided. See subparagraph c.

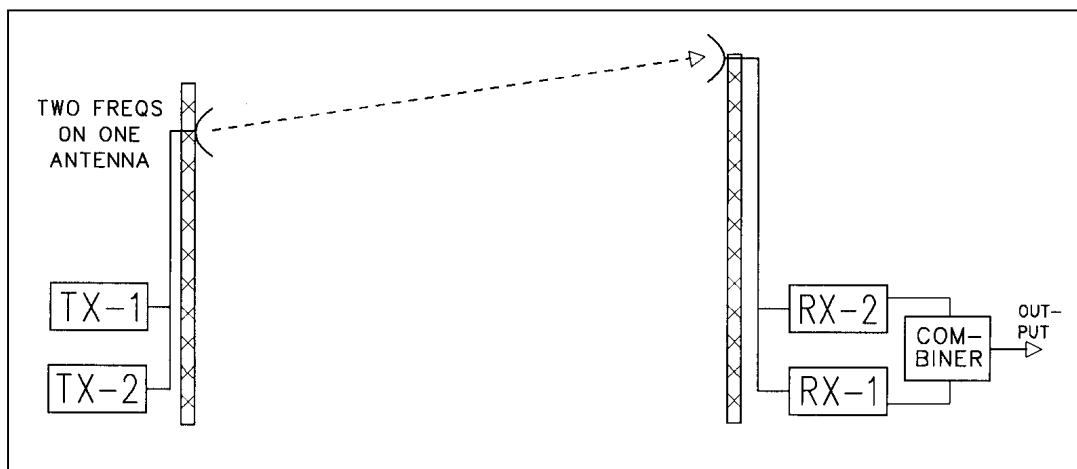
**FIGURE 12-9. SPACE DIVERSITY**

**a. Space diversity** is an effective method to counter multipath fading. It relies on the height dependence of the maxima and minima of the multipath interference patterns. By using the combined or switched output of two antennas separated vertically by many wavelengths, significant improvement can be achieved.

(1) **If the antennas have sufficient separation**, fades on one path will be accompanied by an enhanced signal on the other path. Vertical antenna separation of 30 to 35 feet for RCL and 25 to 35 feet for TML should be adequate. Best performance will be obtained if the second antenna is placed directly above the original clear path antenna. However, tower height restrictions or costs may prohibit this option.

(2) **Satisfactory performance** can usually be obtained when the spacing between antennas is split above and below the original clear path. In this case, it will be necessary to check for problems due to nearby obstacles close to the lower antenna path to assure a still clear path.

(3) **To have space diversity** in one direction of the link, the spaced antennas are associated with the Tx's. For more severe fading problems, spaced antennas are placed at both ends of the link.

**FIGURE 12-10. FREQUENCY DIVERSITY**

**b. The RCL and LDRCL** use frequency diversity. A diagram of such a system is shown in figure 12-10.

c. A hybrid system of combined frequency/space diversity for digital systems for the 7125-8500 MHz band also can be provided.

(1) In a hybrid diversity configuration, one antenna is installed at one end of the path (Site A) and two antennas are installed at the other end of the path (Site B). Two different frequencies are transmitted from the common antenna at Site A and they are received on the two different antennas at Site B. As a result, the direction of transmission from A to B is similar to normal space diversity. In the reverse direction, one frequency is transmitted from the top and the other from the bottom antenna. Both frequencies are received at the common antenna Site A and switched to the appropriate receiver.

(2) In both directions of transmission, there is a physical separation between the propagation paths. There is a true space diversity improvement in both directions. Since the different paths also operate at different frequencies, there is also frequency diversity improvement.

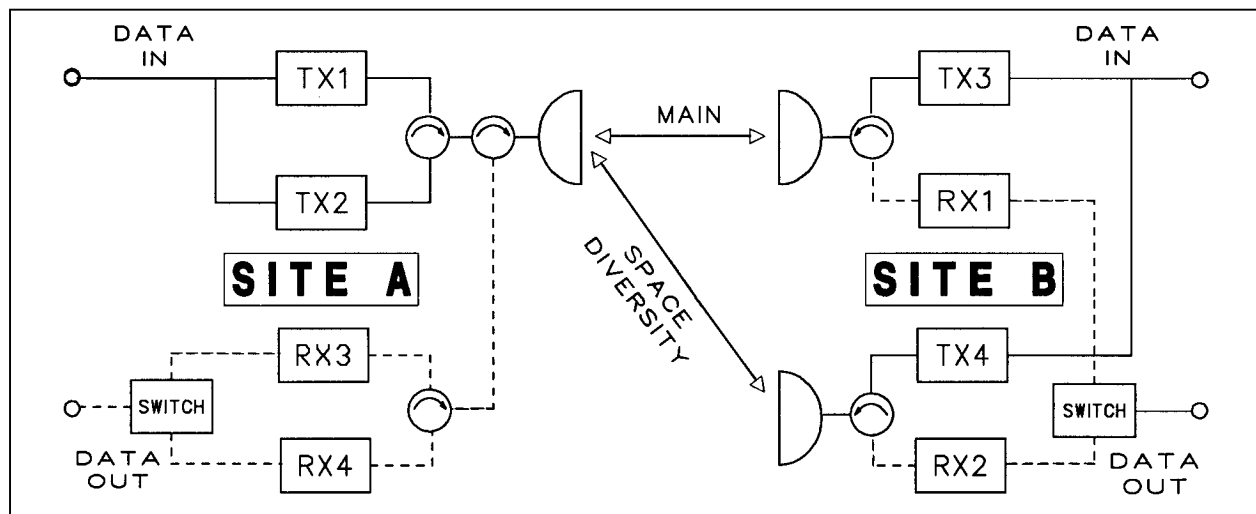
(3) Cosite frequency engineering for the digital hybrid system is different from analog engineering.

(a) Transmitter to transmitter (Tx/Tx) frequency separation shall be equal to or greater than 50 MHz.

(b) Receiver to receiver (Rx/Rx) frequency separation shall be equal to or greater than 50 MHz.

(c) Transmitter to receiver (Tx/Rx) frequency separation shall be equal to or greater than 115 MHz.

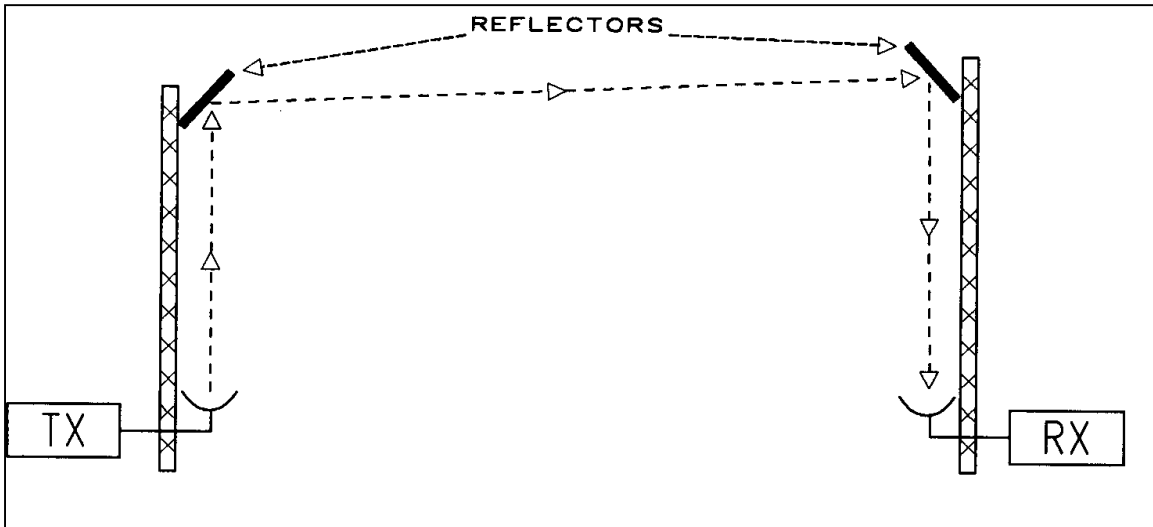
FIGURE 12-11. HYBRID FREQUENCY/SPACE DIVERSITY



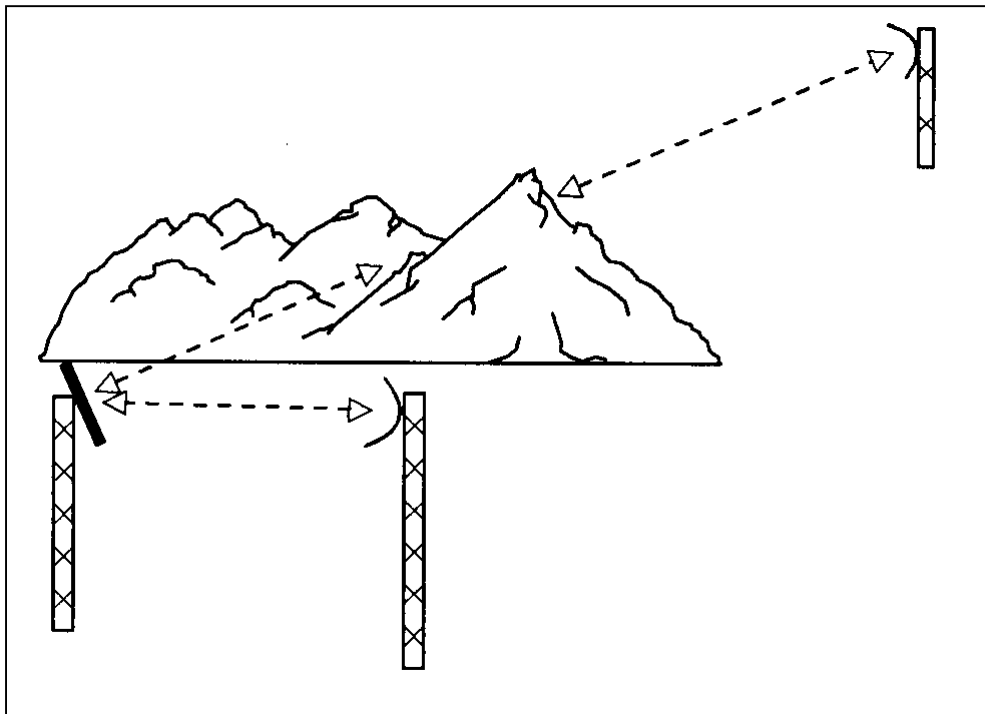
**1212. PATHS WITH PASSIVE REFLECTORS.** Reflectors are a way to direct the beam path to where it is needed while avoiding obstructions, or where considerable height is needed to avoid a long wave guide run.

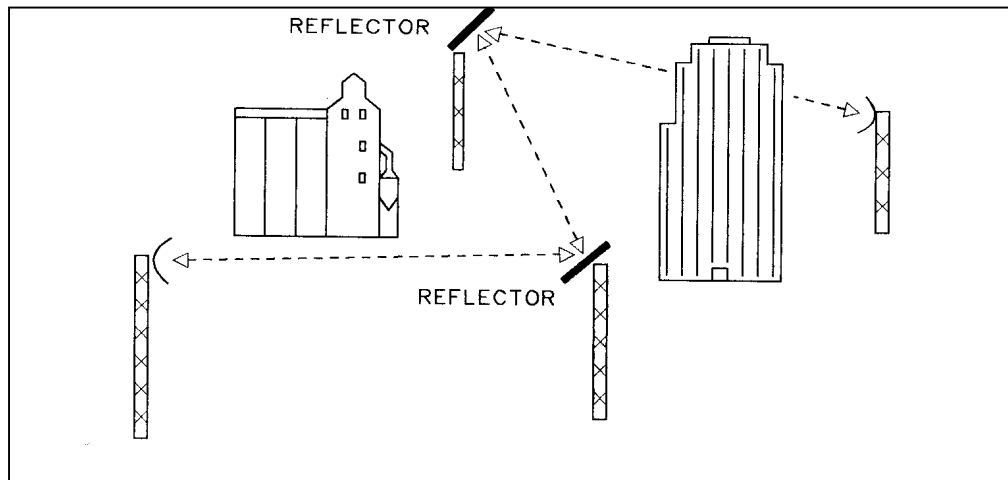
a. A **periscope antenna** is shown in figure 12-12. A parabolic antenna is positioned to beam upwards to illuminate a passive reflector at the top of the tower. This avoids problems and costs associated with long runs of wave guide with minimal change in net gain. When properly designed, only first Fresnel zone energy is reflected, thus avoiding phase cancellation from the out-of-phase second zone energy. The design produces a sharper beam with 2 or 3 dB gain.

**FIGURE 12-12. PERISCOPE OR TOP REFLECTOR ANTENNA SYSTEM**



**FIGURE 12-13. SINGLE BILLBOARD PASSIVE ANTENNA**



**FIGURE 12-14. DOUBLE BILLBOARD PASSIVE ANTENNA**

**b. Billboard passive repeaters** are used for links where terrain, foliage or man-made obstacles prevent a direct RLOS between desired sites. Figure 12-13 depicts single and figure 12-14 depicts double billboard configurations. Here again, both the original and reflected paths must be considered, both for satellite conflict and for the possibility of line-of-sight interference to another user on the same path. That is, not only the billboard reflected path must be checked, but also the azimuth "direct" path of the transmitted signal as it points at the billboard reflector. In Figure 12-13, that is the Tx/Rx azimuths between the billboard tower and the foreground tower as well as the azimuths through the mountains path.

### 1213. MAPPING.

**a. Link systems** can become very complex, particularly if there are repeaters, or if any reflectors are used. Research for any new FAA systems must first look at other FAA and other systems to assure compatibility. It is necessary to establish some form of maps on which to plot all regional systems.

**b. The format** is not specified, but some form of map records for all regional link system shall be maintained. Aeronautical sectional or local maps are excellent, because they have accurate coordinates on them, and make plotting of sites easy.

### 1214. thru 1299. RESERVED.

## **CHAPTER 13. RADAR AND AIR TRAFFIC CONTROL RADAR BEACON SYSTEM (ATCRB S) FREQUENCY ENGINEERING**

**1300. POLICY.** Technical Operations ATC Spectrum Engineering Services completes all initial frequency engineering for new radar systems. The regional FMO completes subsequent frequency changes as a result of RFI or relocations, modifications, five/ten year reviews, and coordination of other agencies requests to transmit in the radar frequency bands.

**a. FAA is designated by NTIA as the national coordinator** for 1030/1090 MHz and the 1215-1390 MHz, 2700-2900 MHz and 9000-9200 MHz bands. As national coordinator, all users must coordinate with the FAA for systems in these bands. Upon coordinating with a field user of these systems, the service area FMO will enter a coordination record into the automated frequency management (AFM) system pending database to "reserve" the frequency for the user. These coordinated requirements will be forwarded to Technical Operations ATC Spectrum Engineering Services by setting the status of the record to "MN". Technical Operations ATC Spectrum Engineering Services will review these records, make any necessary changes to the proposed operation, and then set the record to a status of "MA" to indicate the concurrence of Technical Operations ATC Spectrum Engineering Services. Once the record is set to "MA" status, the regional FMO can then pass on to the field user the FAA's concurrence along with any necessary changes or restrictions to the proposed operation. The coordinated record will be purged from the pending database once the assignment has been registered in the Government Master File.

**b. FAA, as Chair of the AAG,** is also responsible for the proper engineering and management of the 1030/1090 MHz pair. Upon coordination with users for new requirements on these frequencies, the FMO will enter a coordination record, as is done for the above radar bands, in order to reserve the frequency and the PRR.

**(1) All Mode-S systems** require a Site Identification (ID), or II code assigned. Using the properly assigned Site ID code is critical to prevent aircraft from being locked out from responding to other interrogations. Requests to use Mode-S will be forwarded to Technical Operations ATC Spectrum Engineering Services, who will engineer a Site ID.

**(2) All Mode-4 requests** will be forwarded to Technical Operations ATC Spectrum Engineering Services for support. The DOD uses Mode-4 when interrogating on 1030 MHz to determine if an aircraft is friendly. This mode of operation, however, suppresses civil transponders preventing civil aircraft from responding to legitimate interrogations by air traffic control. Caution must be exercised before approving any use of 1030 MHz by the military to ensure that the military will not be operating in Mode-4. Mode-4 operations are often indicated by a pulse duration of 0.5 microseconds as opposed to the standard ATCRBS 0.8 microseconds. If the use of Mode-4 is required, the request should be forwarded to Technical Operations ATC Spectrum Engineering Services.

**c. Next Generation (NEXRAD) (WSR-88D) and Terminal Doppler Weather Radar (TDWR)** systems operate in the 2700-3000 MHz and 5600-5650 MHz band respectively. All new frequencies to support these systems will be engineered by Technical Operations ATC Spectrum Engineering Services. The service area FMO will still do five-year reviews and any necessary modifications to these frequency assignments.

**d. Airport Surface Detection Equipment (ASDE) models X and 3** operate in the 9.0-9.2 GHz and 15.7-16.2 GHz band respectively. Technical Operations ATC Spectrum Engineering Services will engineer all new frequencies to support these systems. The service area FMO will still do five-year reviews and any necessary modifications to these frequency assignments.



**1301. GENERAL ASSIGNMENT PROCEDURES.**

**a. The selection of a frequency** for an Air Route Surveillance Radar (ARSR) that operates in the 1215-1390 MHz band, or Airport Surveillance Radar (ASR) that operates in the 2700-2900 MHz band, is similar to the problem of squeezing a COMM or NAVAID facility into an already crowded spectrum. The major difference is the large bandwidths and power required. For instance, an ARSR-1 or ARSR-2 has an emitted spectrum that extends considerably beyond the -20 dB bandwidth that is defined in the emission designator. Although the spectrum beyond the -20 dB bandwidth is over 40 dB suppressed and meets the NTIA standard, that broad spectrum can be a problem to adjacent channel users.

**b. Radar receivers** also have a decided effect on the assignment process. Even though a receiver may seem to have a band pass that is extremely wide by COMM or NAVAID standards, the narrowest band pass possible is implemented to detect the weak return signals required for radar reception. If it is an established radar system, it must be protected by any assignment of a new facility.

**c. Most radars** have two separate transmitters and receivers, although some radars operate only one transmit and receive (T/R) channel at a time. The other channel is normally tuned to another frequency and is used as a backup or an alternate system. For interference protection and to realize the benefits of frequency diversity, it is desirable to separate the two frequencies as far as possible within the band. While as much frequency separation as possible is the goal, in most areas of the country, frequency congestion is so severe that the two channels must be assigned frequencies with only a few MHz of frequency separation. Since the unused channel is kept "hot," some frequency separation is necessary to prevent interference to the operating channel.

**d. Duplex radars** operate both channels simultaneously, although their actual transmitting time is usually separated in time so that the transmitted pulse of one is off while the transmitted pulse of the other is firing. The difficulty for the FMO is that a minimum frequency separation between the two channels is required (see paragraphs 1304-1308 for individual radar's minimum frequency separation).

**e. The pulse repetition rate (PRR)** is the number of pulses of energy per second (pps) transmitted by the system and normally is the trigger for the associated ATCRBS interrogator.

**f. The pulse repetition time (PRT)** is that time in microseconds (usec) between the start of any two consecutive radar pulses. In numerical terms,  $PRT = 1/PRR$  and  $PRR = 1/PRT$ .

**g. Radar Beacon Systems** have changed over time from the original concept of simple detecting and ranging. The addition of a nondirectional but lower power simultaneously transmitting set of pulses has been used to reduce false targets caused by various sources. The system is called Side Lobe Suppression (SLS), and a later version, Improved SLS (ISLS). With the implementation of Specialized ATCRBS with discrete address capability (Mode S) and other monopulse radars, "sum and difference" patterns on the directional antenna are being used to enhance accuracy.

**h. Other devices** such as a Beacon False Target Eliminator (BFTE) and a "defruiter" to eliminate electronically undesired responses called False Returns Unsynchronized In Time (FRUIT) have had varying degrees of success. Newer versions that include Mode-S capability allow beacon systems to access a single aircraft through selective addressing.

**i. The FMO also should be aware** of airborne radar and altimeter frequency bands, such as 4200-4400 MHz, 5350-5470 MHz, 9300-9500 MHz and 13.25-13.45 GHz. From time to time, the FMO may be asked to assist in elimination of RFI for such systems.

**1302. PRR ASSIGNMENT OF ATCRBS.**

**a. The ATCRBS is the heart** of the entire NAS surveillance system. Unfortunately, ATCRBS operates through a single pair of frequencies: 1030 MHz (ground-to-air) and 1090 MHz (air-to-ground). The only method for discriminating between each ATCRBS facility is by the PRR (noting that ATCRBS PRR is really interrogations per second and not pulses per second). It is only through the use of different PRRs that all these systems can operate simultaneously. Since all the military IFF systems also operate on the same frequency pair, the critical task of engineering individual PRRs can be readily understood.

**b. The best current method** to keep PRRs from interfering with one another is to use a staggered PRR. It works on the basis of a crystal controlled clock generating a fixed time base. Prearranged programming selects a PRT in sequence, followed by another but different period, and so on for 4, 5, 6 or 7 periods before repeating the whole sequence. Each such stagger system has several stagger groups. By staggering PRRs, the chance of hitting the exact time of an emitted pulse of another 1030 MHz interrogator is enormously decreased. The stagger sequence for ARSRs and ASRs and their associated ATCRBS are shown in various figures in later paragraphs and tables.

**c. The necessity for separating PRRs** is that should two interrogators transmit at the same PRR and both illuminate the same aircraft simultaneously, both radars will receive both reflections and produce a real and a false target, separated by the time and azimuth difference between the two reflections.

**d. ATCRBS is normally associated with FAA ASR and ARSR radars**, but at times, ATCRBS is a stand-alone system. ATCRBS also has been called Secondary Radar (SECRA), Secondary Surveillance Radar (SSR), Radar Beacon (Beacon), interrogator (ground), transponder (aircraft) and the military versions Identification, Friend or Foe (IFF) and the DOD Selective Identification Feature (SIF) modified IFF. In ATC functions, the ATCRBS is sometimes tied to a primary radar and its PRR is equal to or a submultiple of the primary's PRR. In the case of staggered PRR, there is a basic clock relationship between the primary radar and the interrogator.

**e. There are a number of problems** which may be considered as "interference" in the broad sense. The FMO must be aware of them and their consequences as part of the PRR selection process and interference reporting.

(1) **Ringaround** is an aircraft transponder being interrogated by antenna side lobes causing elongated targets on the radar scope, as shown in figure 13-1. The effect is reduced or eliminated by sidelobe suppression (SLS).

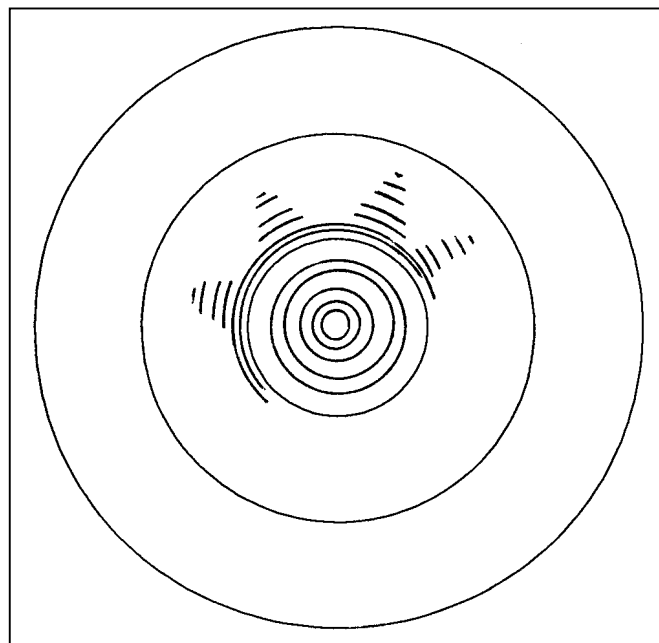
(2) **False targets** can be caused by either synchronous airborne replies to another beacon or reflections of the main beam energy. Aircraft transponders can reply to more than one interrogator and thus the beacon ground system can receive signals with various PRRs. A defruiter will eliminate nonsynchronous PRR FRUIT, but it will not reject synchronous PRR replies, so that false targets may appear on the display. This problem can best be controlled by geographical separation of similar PRR beacon systems. False targets are also caused by reflections of the main beam signal off large metal objects (e.g., a hangar), such that an aircraft outside the main beam is interrogated (see figure 13-2). SLS and interrogator power reduction will help reduce this phenomenon. (See Orders 6310.6, Primary/Secondary Terminal Radar Siting Handbook; 6340.15, Primary/Secondary En Route Radar Siting Handbook; 6360.12, ATCRBS Performance Handbook.)

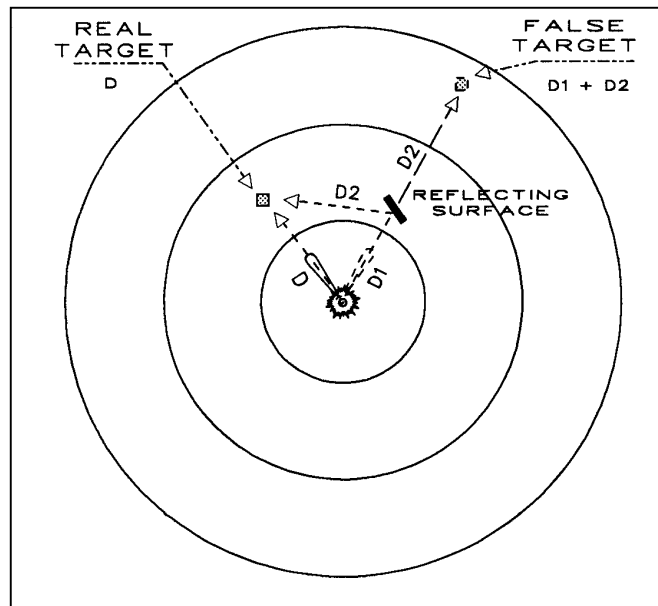
(3) **"Second time around" signals** are those which show up on the scope even though they are beyond the distance of the actual target. It is caused by the interrogator signal going beyond its intended range and being received during the "next" receive pulse period of the radar, thus showing in the designed range, but actually being at a much greater distance. Various stagger and other fixes have eliminated most of this problem, but it does occur on occasions.

(4) **Broken or serrated targets** can be caused by synchronous PRR and by overinterrogation, causing reduction in sensitivity such that only the strongest interrogation will be answered. It is best controlled by low PRR assignments, proper PRR separation, and interrogator power reduction.

(5) **Defective responses** can plague the FMO which are not actual interference from another source. The ability to diagnose the difference is an art that comes from training and experience. Technical Operations ATC Spectrum Engineering Services can supply data. A good information source is the radar engineering group in the service area office.

**FIGURE 13-1. DISPLAY TIME EXPOSURE FOR A RADIAL FLIGHT SHOWING RINGAROUND**



**FIGURE 13-2. DISPLAY VIEW OF A REAL AND A FALSE TARGET**

**f. From the radar engineer's perspective**, the highest possible PRR is desirable so that the hits-per-scan can be high. That function is an important parameter in radar operation. But from the FMO's view, the lowest PRR is ideal, to keep the ATCRBS spectrum as free from congestion as possible.

**g. Care must be taken** to separate assigned PRRs by a sufficient amount to assure noninterference. This is really a function of time and thus is a pulse period variant. But in the 350-370 pps non-stagger range of the ARSR-1 and -2, a PRR difference of 5 pps is sufficient. The standard PRRs for these radars are 350, 355, 360, 365 and 370 pps. Non-stagger radar beacons associated with ASR types normally use a PRR from 323-400 pps, e.g., ASR-8.

**h. The same frequency pair (1030/1090 MHz)** is also used by DOD IFF/SIF. But many of their older radars have PRRs that come out in odd numbers and decimals, due to the multivibrator oscillators used to generate the PRR. There is another problem with that type of radar. Besides drifting some because it is not crystal controlled, such military radars operate on harmonics of the oscillator. As a result, PRR can be transmitted at a much higher or lower rate than authorized, if the Nth harmonic is inadvertently tuned up. This has happened in the past. Hopefully, this will gradually diminish as old radars are phased out and newer stable and staggered PRRs are introduced in the new equipment.

**1303. PRR ASSIGNMENT PROCESS.** There is a series of procedures and precautions involved in making a new or modified PRR assignment.

**a. The FAA is designated by the NTIA** as the national coordinator for the 1030/1090 MHz frequency pair. This includes DOD as well as non-Federal users. Non-Federal users include contractors developing and testing radars for the Federal Government. All non-Federal assignments and any DOD assignment that is not being used exclusively for air traffic control are considered experimental.

**b. New PRR requests** require careful review of the location, equipment type, and PRR parameters requested. This will consist primarily of consulting the geographic/PRR list retained in the FMO's office, following the steps

outlined in paragraph “d” below, and utilizing these guidelines:

(1) **When a PRR is engineered for a non-FAA requestor**, the requestor shall be advised of the FMO's recommended PRR. The requestor's IRAC or FCC application must show that coordination has been effected with the FMO.

(2) **When a PRR is engineered for an FAA facility**, an IRAC application will be filed in the usual manner.

(3) **If a suitable PRR is not found**, the FMO shall notify the requestor of the problem, advising the requestor that it will be necessary to adjust parameters so that another search may be made. To the extent possible, the FMO should offer suggestions about what parameters can be changed to allow a PRR to be assigned. Advise Technical Operations ATC Spectrum Engineering Services if no PRR can be found.

**c. The national standard maximum PRR is 450 pps and must not be exceeded.**

**d. Interrogator PRR Engineering procedures:**

(1) **Beacon paired with a primary radar:**

(a) **The first step** in engineering a beacon PRR is to determine what PRRs the beacon system is capable of accepting. If the beacon uses a staggered PRR, get the stagger sequences that the system is capable of.

(b) **The second step** is to find the average PRT if the system is staggered. If the system has only a single fixed PRR, then skip this step; otherwise, you have to calculate the average PRR. If the stagger rates are expressed as PRRs (i.e a four time stagger of 223/320/267/350), then each PRR will need to be converted to a PRT (1/PRR), the PRTs added up, divided by the number of PRRs in the stagger sequence, take the reciprocal of the quotient, and then multiply by  $(1 \times 10^6)$ . For example, using the four time stagger sequence provided in the example above:

$$1/223 = .0044843, \text{ or } 4484.3 \text{ usec}$$

$$1/320 = .0031250, \text{ or } 3125.0 \text{ usec}$$

$$1/267 = .0037453, \text{ or } 3745.3 \text{ usec}$$

$$1/350 = .0028571, \text{ or } 2857.1 \text{ usec}$$

$$4484.3 + 3125.0 + 3745.3 + 2857.1 = 14211.7 \text{ usec}$$

$$14211.7 / 4 = 3552.925 \text{ usec}$$

$$1 / 3552.925 = .000298247 (1 \times 10^6) = 298.247 \text{ average Pulses Per Second}$$

**Note:** The average PRR is not calculated by just adding the PRRs and dividing by the stagger rate.

(c) **The third step** is to determine whether the new interrogator is an ARSR-4 (250 nmi), en route (200 nmi), or a terminal (60 nmi) facility.

(1) **ARSR-4 facilities** shall be assigned PRTs that differ by at least 25 usec from any other ARSR-4 facility within 500 nmi, from any other en route facility within 400 nmi, and any terminal facility within 350 nmi.

(2) **En route radars** shall be assigned PRTs that differ by at least 25 usec from any other en route facility's PRT within 360 nmi, and terminal facilities within 300 nmi. At least 25 usec of PRT separation needs to be maintained between the enroute radar and any ARSR-4 within 400 nmi.

(3) **Terminal radars** shall be assigned PRTs that differ by at least 25 usec from any other terminal facility's PRT within 200 nmi, en route facilities within 300 nmi, and ARSR-4 facilities within 350 nmi..

**NOTE:** For radar systems that use a staggered PRR, use the PRT of the average PRR as calculated in the second step above. It is this PRT that you base the 25 usec of separation on - not each PRT in the stagger sequence.

(4) **A stand-alone beacon** uses the same procedure. Just base the 25 usec separation criteria on the range of the beacon.

**e. ATCRBS or IFF/SIF interrogator power** must be reduced to the lowest possible level. The higher the power, the more aircraft are interrogated and generate replies, cluttering the ATCRBS environment. In practice, it has been found that 60 to 100 W is sufficient for most 60 nmi terminal systems. The maximum permissible power that can be used by en route radars such as the ARSR series is 52.5 dBW (approximately 1,500W). However, with the advent of the FAA William J. Hughes Technical Center (FAATC) Dipole Feed (NADIF) antenna and later other models, a power of only 250 W will still provide good system coverage while reducing overinterrogation of the system. DOD IFF/SIF systems frequently try to use 500 to 1,000 W. The FMO must ensure that only the minimum power needed to do the job is all that is used, whether it is associated with ARSR, ASR, DOD radar or stand-alone. A minimum signal level of -74 dBm is all that is needed to interrogate an aircraft transponder.

**f. Special care** must be taken when dealing with some DOD radars whose antennas have very broad beam widths. Some systems, particularly older models or those used in training have small antennas for portability. This helps them in rapidly moving the equipment around, but unfortunately the result of the smaller antenna is a much broader beam width. Instead of 1E or 2E maximum beam width of FAA ATCRBS antennas, some of the older military portable units have as much as 8E beam width. This multiplies the number and duration of interrogations of aircraft, adding unnecessary congestion. NTIA does not yet have antenna beam width standards (see NTIA Manual).

**g. DOD training maneuvers** may present the FMO with interference problems. While the FMO does not have the authority to specify beam widths, NTIA requires that the FMO be advised when maneuvers are to be held in an FMO's service area. An alert is thus received to the possibility of ATCRBS interference through overinterrogation. The FMO will coordinate the DOD training radar usage, e.g., power, PRR, etc., and seek the advice of Technical Operations ATC Spectrum Engineering Services as needed. If the DOD is requesting to use Mode-4, then forward the request to Technical Operations ATC Spectrum Engineering Services for support. In the event of an actual problem of this kind, the FMO shall immediately contact the appropriate DOD AFC and Technical Operations ATC Spectrum Engineering Services.

**h. Radar Beacon Performance Monitors (RBPM)**, which are also called "parrots", are often associated with ATCBI systems. These systems operate on 1090 MHz and require an assignment. The purpose is to provide a known fixed return to the beacon system for calibration. Mode-S systems usually have two parrots associated with the system. Often these systems are located very close to the ATCBI and require only minimal power. Assignments to support a parrot should include the delay characteristics in microseconds and nautical miles if a delay line is inserted in the system. The beacon code used and the altitude setting of the parrot should also be in the assignment. Altitude settings must be maintained to either 60,000 feet or above, or below sea level to prevent interference to TCAS.

**FIGURE 13-3. RADAR AND ASSOCIATED BEACON CAPABILITIES**

RADAR	PRR CAPABILITIES	ASSOCIATED BEACON PRR
AN/CPN-4	1500	300
AN/FPN-47	See ASR-5	See ASR-5
AN/FPS-7	244	Same as primary radar
AN/FPS-18	1200	300
AN/FPS-20, -20A	350, 355, 360, 365, 370	Same as primary radar
AN/FPS-64, -65, -66, -67	340, 345, 350, 355 360, 365, 370	Same as primary radar
AN/GPS-4	360	Same as primary radar
AN/GPN-12	See ASR-7	See ASR-7
AN/GPN-20	See ASR-8	See ASR-8
AN/GPN-30	See ASR-11	See ASR-11
AN/MPN-13, -14	1100	275 (4:1 countdown from primary)
AN/MPS-11	360	Same as primary radar
AN/TPS-43	227, 250, 278 (3X stagger)	Same as primary radar
AN/TPS-43E	245, 250, 258 (6X stagger: 245.1, 235.3, 227.3, 278.6, 263.9, 258.4)	Same as primary radar
ARSR-1, -2	See figures 13-5, -6	Same as primary
ARSR-3	See figures 13-7, -8	Same as primary
ARSR-4	See figure 13-9	Same as primary
ASR-4, -5, -6	810, 900, 1125, 1140, 155, 1170, 1185	3:1 countdown from primary
ASR-7	See figures 13-10, -11	See figures 13-10, -11
ASR-8	See figure 13-12	See figure 13-12
ASR-9	See figure 13-14	See figure 13-14
ASR-11	722, 788, 935, 1005 (4X stagger)	Assign fixed PRR of at least 200 PPS (PRR is independent from primary. Assign PRR's as close to 200 PPS as possible.)

**1304. FREQUENCY ASSIGNMENT PROCESS IN THE RADAR FREQUENCY BANDS:** The below engineering criteria is the “rule-of-thumb” frequency and distance separation to use when supporting radar systems between 1215-1390 MHz, 2700-3000 MHz, 5600-5650 MHz, 9000-9200 MHz, and 15.7-16.2 GHz:

**FIGURE 13-4. RADAR FREQUENCY-DISTANCE SEPARATION CRITERIA**

<b>Distance in NMI</b>	<b>Required Frequency Separation in MHz</b>
<b>1 – 2.5</b>	<b>30</b>
<b>2.5 – 5</b>	<b>25</b>
<b>5 – 10</b>	<b>23</b>
<b>10 – 50</b>	<b>20</b>
<b>50 – 100</b>	<b>10</b>
<b>100 – 150</b>	<b>5</b>
<b>Over 150</b>	<b>0</b>

**a. These are general criteria** that were developed years ago based on testing. Since they were developed, there have been many changes in the way radar systems perform. Time has proven, however, that with few exceptions, these criteria work to protect cochannel and adjacent channel radar systems from interference. If a frequency cannot be found using these criteria, forward the requirement to Technical Operations ATC Spectrum Engineering Services and a more in depth analysis will be performed.

**b. One source of interference** that is sometimes encountered, but protection cannot be granted from, is the propagation affect of ducting. Ducting sometimes affects radar systems that have 600 nmi of separation. There is not enough spectrum to reduce the frequency reuse rate to 600 nmi. If ducting between two systems is a consistent problem, frequency reassignments will be considered.

**1305. FREQUENCY ASSIGNMENTS IN THE 1215-1390 MHZ BAND.** This band is used by the FAA to support en route radar facilities for air traffic control and assignments must be confined to the 1240-1370 MHz frequency band. This sub-band of the 1215-1390 MHz is allocated for aeronautical radionavigation and, generally speaking, receives better protection from interference. When making assignments in this band, the second harmonic may fall in the 2700-2900 MHz terminal radar band and so must be given consideration. If a frequency is required to support an en route radar facility and cannot be accommodated in the 1240-1370 MHz band, forward the requirement to Technical Operations ATC Spectrum Engineering Services.

**a. The band 1240-1370 MHz.** The majority of radars in this band are the FAA ARSR-1, -2, -3 and -4 and FPS series. The ARSR-1, -2 and FPS series radars have two channels each which may be assigned frequencies within 5-10 MHz since only one channel transmits at a time. The ARSR-3 is a duplex radar and requires two frequencies substantially separated (about 25 MHz) within the band. The ARSR-4 is a duplex radar which requires two frequencies, but the choice of frequencies are limited to those in the ARSR-4 crystal sets. When one frequency is selected, the second frequency is automatically paired 82.85 MHz away.

**(1) The ARSR-1, -2, and FPS series** are very high power and long range radars. To the extent the terrain permits, they are sited on a clear, high point of terrain. This, of course, extends their RLOS to other long range radars. In the plains area, this is not as much a problem as in the West or East.

**(a) Frequency separation** between these radars is usually satisfactory at 5 MHz for 100 nmi and 10 MHz for 50 nmi. See figure 13-4. These long range radars (200 nmi range) are usually not sited closer than about 100 nmi, unless terrain factors require closer siting. In these few cases, it will be necessary to give a wider frequency separation.



(b) **Band pass filters** may have to be used on some older ARSRs to reduce the emitted spectrum to prevent interference to other nearby radars, or even to the ARSRs associated ATCRBS. Contact Technical Operations ATC Spectrum Engineering Services for details.

(c) **ARSR-1/2 staggered PRR's.** Figures 13-5 and 13-6 provide the average PRRs and stagger PRTs for the ARSR-1/2 radars. The ARSR-1/2 normally uses the high (noted as "H" in the figure) rate PRR sequences, while the low rate (noted as "L" in the figure) sequences are available as a modification to the ARSR-1/2. Both low and high rates are available for the FPS type radars.

**FIGURE 13-5. ARSR-1/2 STAGGERED PRR AND PRT VALUES (HIGH)**

Num	HIGH/ LOW	Avg PRR (Hz)	Pulse Repetition Time (PRT) in $\mu$ s					
			PRT1	PRT2	AVG PRT3	PRT4	PRT5	PRT
00	H	352.61	2647	2836	2761	2609	3327	2836
01	H	354.48	2633	2821	2595	3310	3310	2821
02	H	356.38	2619	2806	2731	2582	3292	2806
03	H	359.29	2605	2791	2716	2568	3275	2791
04	H	360.23	2591	2776	2702	2654	3257	2776
05	H	362.19	2577	2761	2699	2540	3239	2761
06	H	364.17	2563	2746	2673	2526	3222	2746
07	H	366.17	2549	2731	2658	2513	3204	2731
08	H	368.19	2535	2716	2643	2499	3187	2716
09	H	370.23	2521	2701	2629	2485	3169	2701

**FIGURE 13-6. ARSR-1/2 STAGGERED PRR AND PRT VALUES (LOW)**

Num High/ Low	Avg PRR  (Hz)	Pulse Repetition Time (PRT) in us					
		PRT1	PRT2	PRT3	PRT4	PRT5	PRT
00 L	279.88	3115	3939	3207	3481	4123	3573
01 L	281.06	3102	3923	3193	3467	4105	3557
02 L	282.33	3088	3905	3179	3451	4087	3542
03 L	283.53	3075	3889	3165	3437	4069	3527
04 L	284.82	3051	3871	3151	3421	4051	3511
05 L	286.12	3046	3853	3137	3405	4033	3495
06 L	287.36	3034	3837	3123	3391	4015	3480
07 L	288.68	3020	3819	3109	3375	3997	3464
08 L	289.94	3008	3803	3095	3361	3979	3449
09 L	291.29	2993	3785	3081	3345	3961	3433
10 L	292.65	2979	3767	3067	3329	3943	3417
11 L	293.94	2966	3751	3053	3315	3925	3402
12 L	295.33	2952	3733	3039	3299	3907	3386
13 L	296.65	2939	3717	3025	3285	3889	3371
14 L	298.06	2925	3699	3011	3269	3871	3355
15 L	299.49	2911	3681	2997	3253	3853	3339
16 L	300.84	2898	3665	2983	3239	3835	3324
17 L	302.30	2884	3647	2969	3223	3817	3308
18 L	303.67	2871	3631	2955	3209	3799	3293
19 L	305.16	2857	3613	2941	3193	3781	3277
20 L	306.65	2843	3595	2927	3177	3763	3261
21 L	308.07	2830	3579	2913	3163	3745	3246
22 L	309.60	2816	3561	2899	3147	3727	3230
23 L	311.04	2803	3545	2885	3133	3709	3215
24 L	312.60	2789	3527	2871	3117	3691	3199
25 L	314.17	2775	3509	2857	3101	3673	3183
26 L	315.66	2762	3493	2843	3087	3655	3168
27 L	318.78	2735	3459	2815	3057	3619	3136
29 L	320.41	2721	3441	2801	3041	3601	3121
30 L	322.06	2707	3423	2787	3025	3583	3105
31 L	323.62	2694	3407	2773	3011	3565	3090
32 L	325.31	2680	3389	2759	2995	3547	3074
33 L	326.90	2667	3373	2745	2981	3529	3059
34 L	328.62	2653	3355	2731	2965	3511	3043
35 L	330.36	2639	3337	2717	2949	3493	3027
36 L	332.01	2626	3321	2703	2935	3475	3012
37 L	333.78	2612	3303	2689	2919	3457	2996
38 L	335.46	2599	3287	2675	2905	3439	2981
39 L	337.27	2585	3269	2661	2889	3421	2965
40 L	339.10	2571	3251	2647	2873	3403	2949
41 L	340.83	2558	3235	2633	2859	3385	2934
42 L	342.70	2544	3217	2618	2843	3367	2918
43 L	344.47	2531	3201	2605	2829	3349	2903
44 L	346.38	2517	3183	2591	2813	3331	2887
45 L	348.31	2503	3165	2577	2797	3313	2871
46 L	350.14	2489	3149	2563	2783	3295	2856

(2) **The ARSR-3** is a simplex radar requiring a pair of frequencies, one for each channel. Although they are time sequenced to operate from different time zeros, the two assigned frequencies should be separated at a minimum of 25 MHz. This could entail shifting other radars in the area to other frequencies in the band. Technical Operations ATC Spectrum Engineering Services engineers the frequency pairs.

(a) **The ARSR-3 associated beacon** uses an identical staggered or nonstaggered trigger used by the ARSR-3 itself. Four fixed pulse repetition rates are available from a front panel selection. However, the PRT is expressed in nmi with the basic rate designated as "A." For example:  $A = 238 \text{ nmi} = 238 \times 12.355 \text{ usec} = 2,940.5 \text{ usec}$ . Note that theoretically it would take a radar signal 12.355 usecs to go out 1 nmi, hit a target and return the 1 nmi. If a value for "A" is chosen between 222 and 261 nmi, the four fixed intervals are selected automatically by the following trigger sequence:

$A + 16, A, A - 8$  and  $A - 16$ . For example:  $A = 238 \text{ nmi}$ ; the four fixed PRRs would be equivalent to 254, 238, 230 and 222 nmi.

(b) **The staggered trigger sequence** selected depends on the nmi range selected for "A." There are three stagger sequences available, known as Variable Interpulse Periods (VIP). They are VIP-8, VIP-7, and VIP-5 (see figures 13-7 and 13-8). If "A" is between 235 and 261 nmi, the sequence is VIP-8; if between 228 and 235 nmi, VIP-7; if between 222 and 228 nmi, VIP-5. The VIP number indicates the number of different pulse intervals.

**FIGURE 13-7. ARSR-3 PRR CAPABILITIES****ARSR-3 OPERATIONAL PRR MODES**

1. Stagger trigger (Normal selection)
2. Nonstagger trigger (Special)

**STAGGER/NONSTAGGER TRIGGER PRR**

**Stagger Trigger PRR** (three trigger sequences, determined by value of "A" in nmi)

**VIP-8** - "A" = any nmi integer between 235 and 261

Sequence: A-32 nmi, A+24 nmi, A-16 nmi, A+8 nmi, A-8 nmi,  
A+16 nmi, A-24 nmi, A+32 nmi. (eight different PRTs)

**VIP-7** - "A" = any nmi integer between 228 and 235

Sequence: A-24 nmi, A+24 nmi, A-16 nmi, A+8 nmi, A-8 nmi,  
A-8 nmi, A±0 nmi, A-24 nmi, A+40 nmi. (nine different PRTs)

**VIP-5** - "A" = any nmi integer between 222 and 228

Sequence: A-16 nmi, A+8 nmi, A+16 nmi, A+24 nmi, A-16 nmi,  
A-8 nmi, A-16 nmi, A+40 nmi. (eight different PRTs)

**Non-stagger PRR** (four trigger sequences, determined by value of "A" in nmi)

"A" = any nmi integer between 222 and 261

Sequence: A+16 nmi, A ±0 nmi, A-8 nmi, A-16 nmi.

**FIGURE 13-8. ARSR-3 AVERAGE VIP PRTS**

NMI	AVG PRT (usec)	AVG PRR (pps)	NMI	AVG PRT (usec)	AVG PRR (pps)
<u>VIP-8</u>					
235	2904.43	344	249	3077.47	325
236	2916.79	343	250	3089.83	324
237	2929.15	341	251	3102.19	322
238	2941.51	340	252	3114.55	321
239	2953.87	339	253	3126.91	320
240	2966.23	337	254	3139.27	319
241	2978.59	336	255	3151.63	317
242	2990.95	334	256	3163.99	316
243	3003.31	333	257	3176.35	315
244	3015.67	332	258	3188.71	314
245	3028.03	330	259	3201.07	312
246	3040.39	329	260	3213.43	311
247	3052.75	328	261	3225.79	310
248	3065.11	326			
<u>VIP-7</u>					
228	2816.94	355	233	2866.38	349
229	2829.30	353	234	2827.74	347
230	2841.66	352	235	2891.10	346
231	2854.02	350			
<u>VIP-5</u>					
222	2742.81	365	226	2792.25	358
223	2755.17	363	227	2804.61	357
224	2767.53	361	228	2816.97	355
225	2779.89	360			

(3) The ARSR-4 is a duplex radar with two separate frequencies within the band which are paired using the pairing scheme in figure 13-9. Although the ARSR-4 can operate and frequency hop throughout the 1215-1400 MHz band, day-to-day frequency assignments/operations are confined to two frequencies in the spectrum allocated for aeronautical radio navigation between 1240-1370 MHz.

**FIGURE 13-9. ARSR-4 CRYSTAL OSCILLATOR, STABILIZED LOCAL OSCILLATOR (STALO) AND TRANSMIT FREQUENCIES**

<b>ODD GROUP CRYSTALS (MHz)</b>						
XTAL NO.	OSC. FREQ.	STALO FREQ.	SET 1		SET 2	
			LOWER	UPPER	LOWER	HIGHER
01	45.5929	1458.97	1215.58	1298.94	1255.94	1308.79
03	45.7548	1464.15	1220.76	1303.62	1231.12	1313.97
05	46.2402	1479.69	1236.29	1319.15	1246.65	1329.51
07	46.4021	1484.87	1241.47	1324.33	1251.83	1334.69
09	46.8876	1500.40	1257.01	1339.87	1267.37	1350.22
11	47.0494	1505.58	1262.19	1345.04	1272.54	1355.40
13	47.5349	1521.12	1277.72	1360.58	1288.08	1370.94
15	47.6967	1526.29	1282.90	1365.76	1293.26	1376.12
17	48.1822	1541.83	1298.44	1381.29	1308.79	1391.65
19	48.3440	1547.01	1303.62	1386.47	1313.97	1396.83
<b>EVEN GROUP CRYSTALS (MHz)</b>						
02	45.6738	1461.56	1218.17	1301.03	1228.53	1311.38
04	45.8357	1466.74	1223.35	1306.21	1233.71	1316.56
06	46.3212	1482.28	1238.88	1321.74	1249.24	1332.10
08	46.4830	1487.46	1244.06	1326.92	1254.42	1337.28
10	49.9685	1502.99	1259.60	1342.46	1269.96	1352.81
12	47.1303	1508.17	1264.78	1347.63	1275.13	1357.99
14	47.6158	1523.71	1280.31	1363.17	1290.67	1373.53
16	47.7776	1528.88	1285.49	1368.35	1295.85	1378.71
18	48.2631	1544.42	1301.03	1383.88	1311.38	1394.24
20	48.4250	1549.60	1306.21	1389.06	1316.56	1399.42

**b. The bands 1215-1240 and 1370-1390 MHz.** Radars assigned in these bands will be primarily for DOD use. In these cases, the FMO has the same responsibility under NTIA directive to provide just as adequate interference protection to DOD/DOD radars as provided for DOD/FAA adjacent systems. The FMO should work very closely with the appropriate DOD AFC to provide the best separation possible commensurate with good spectrum utilization and conservation.

**1306. FREQUENCY ASSIGNMENTS IN THE 2700-3000 MHZ BAND.** This band is not exclusive to FAA. The 2900-3000 MHz portion is used by NWS solely for the NEXRAD weather radar. The FAA is designated by NTIA as the field coordinator for the 2700-2900 MHz portion of the band which is for aeronautical radionavigation services, meteorological aids and the DOD area surveillance radars. Because of this field coordination authority, the FMO selects and recommends frequencies in the 2700-2900 MHz band for all agencies which have a requirement to use this band. Subsequently, the agency, not the FAA, is required to process their frequency request through NTIA for formal assignment with the proper FAA coordination note.

**a. FAA 2700-3000 MHz assignments.**

(1) **In general**, if a radar frequency being considered is not within RLOS to any other radar within  $\pm 10$  MHz, the assignment should be acceptable. Reflections from mountainous terrain could cause interference, so two radars within reflection range should be separated 5 to 10 MHz to prevent problems. Consideration should also be given to the second harmonic of enroute radars operating in the 1240-1370 MHz band. If one of the radars is not crystal controlled, periodic frequency checks should be made of to prevent gradual drift onto the other radar's frequency.

(2) **A diplex radar** is designed to take advantage of the differences in propagation between two separated frequencies, and thus it is desirable to separate the two frequencies as much as possible.

(a) The ASR-7 is a duplex radar but only on the channels shown in figure 13-10.

**FIGURE 13-10. ASR-7E PRIMARY RADAR FREQUENCY PAIRS**

<u>Channel A (MHz)</u>	<u>Channel B (MHz)</u>
2705	2855
2710	2770
2710	2795
2715	2820
2720	2780
2720	2785
2725	2860
2730	2790
2740	2800
2750	2810
2755	2850
2760	2820
2760	2850
2765	2880
2770	2830
2770	2850
2780	2840
2790	2850
2800	2860
2810	2870
2820	2750
2820	2880
2820	2890
2830	2890
2830	2895



(b) The PRR/PRT stagger sequences are shown in Figure 13-11.

**FIGURE 13-11. ASR-7 AND ASSOCIATED BEACON STAGGERED PRR AND PRT**

EQP	SET	PRR	PRT	PRR	PRT	PRR	PRT	PRR	PRT	PRR	PRT	PRR	PRT	PRR	PRT	PRR	PRT
RDR	P	1200	833	1173	853	1120	893	1050	953	950	1053	713	1403	---	---	---	---
BCN	P	554	1806	530	1886	436	2296	350	2859	447	2236	542	1846	525	1906	320	3129
RDR	Q	1188	841	1161	862	1109	902	1039	963	940	1064	706	1417	---	---	---	---
BCN	Q	548	1825	525	1905	431	2319	346	2889	443	2258	536	1865	519	1926	316	3160
RDR	R	1176	850	1150	870	1098	911	1029	972	931	1074	699	1431	---	---	---	---
BCN	R	543	1842	520	1924	427	2342	343	2916	438	2281	531	1883	514	1943	313	3192
RDR	S	1164	858	1138	879	1086	920	1019	982	921	1085	692	1445	---	---	---	---
BCN	S	537	1861	515	1943	423	2365	339	2946	434	2303	526	1902	509	1964	310	3223
RDR	T	1152	866	1126	887	1075	929	1008	991	912	1095	684	1459	---	---	---	---
BCN	T	532	1878	510	1961	419	2388	336	2973	430	2325	521	1920	545	1982	307	3254
RDR	U	1140	875	1114	896	1064	938	996	1001	902	1106	677	1473	---	---	---	---
BCN	U	527	1897	505	1981	415	2411	333	3003	426	2348	516	1939	449	2002	304	3286

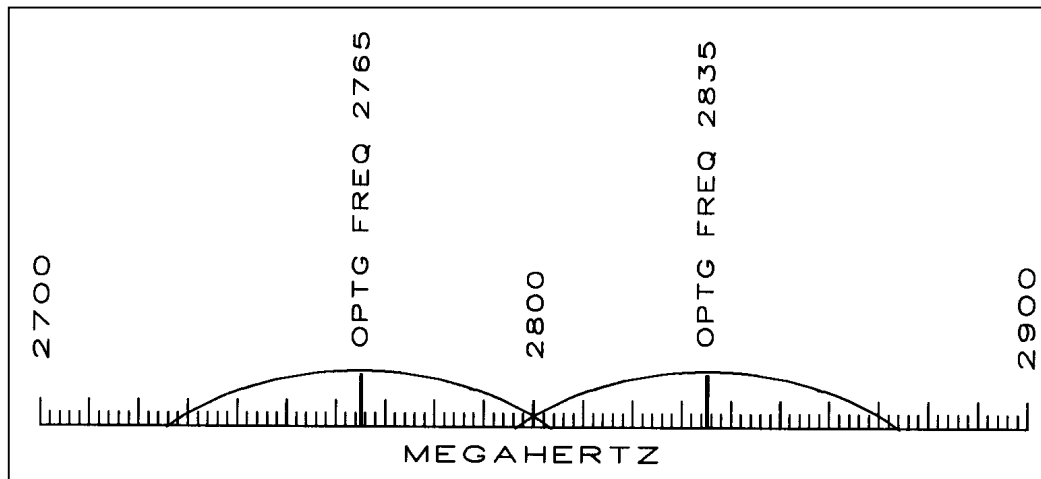
Notes: PRR in pps  
PRT in usec  
RDR = radar  
BCN = beacon interrogator  
Primary ASR-7 is 6X stagger; associated beacon is 8X stagger

AVERAGE PRR's		
Set	Bcn Avg	Radar Avg
P	445	1002
Q	441	992
R	438	982
S	432	973
T	428	964
U	424	954

(c) **The ASR-8 dual channel radar** presents special problems in providing paired frequencies for it. The emitted spectrum of the transmitter is about  $\pm 10$  MHz, about the same as the ASR-7. Associated PRR/PRT stagger sequences are shown in figure 13-12. But the big problem is the receiver band pass. Each receiver is approximately  $\pm 40$  MHz wide. In addition, there is a manufacturer's limitation that the individual channels must be separated by an amount greater than 60 MHz. See figure 13-13. To fit ASR-8 duplex frequencies into an already congested environment presents the FMO with a very difficult task. Because changing a frequency in an ASR-8 requires replacing a whole transmitter package that includes oscillators and diplexer, a frequency change will be considered only as a last resort for an RFI problem remedy. Any ASR-8 frequency problem should be referred to Technical Operations ATC Spectrum Engineering Services.

**FIGURE 13-12. ASR-8 AND ASSOCIATED BEACON STAGGERED PRR AND PRT**

PRR DESIG- NATION	AVG RADAR PRR	BEACON PRR 3:1 CNTDWN PPS / $\Phi$ SEC	RADAR 4X STAGGER SEQUENCE PRT ( $\Phi$ SEC)			
BASIC	1040	347 / 2883	830	1177	876	961
0.5	1035	345 / 2898	835	1182	881	966
1.0	1030	343 / 2913	840	1187	886	971
1.5	1025	342 / 2928	845	1192	891	976
2.0	1020	340 / 2940	849	1197	896	980
2.5	1015	338 / 2958	855	1202	901	986
3.0	1010	337 / 2970	859	1206	905	990
3.5	1005	335 / 2985	864	1211	910	995
4.0	1000	333 / 3000	868	1216	915	1000
4.5	995	332 / 3015	874	1221	920	1005
5.0	991	330 / 3027	878	1225	924	1009
5.5	986	328 / 3042	882	1229	929	1014
6.0	981	327 / 3057	887	1234	934	1019
6.5	977	325 / 3072	892	1239	939	1024
7.0	973	324 / 3084	897	1244	943	1028

**FIGURE 13-13. TYPICAL ASR-8 RECEIVER SUSCEPTIBILITY PASS BAND**

(d) **The ASR-9 radar** is a single channel/dual frequency terminal radar. Only one channel, manually selectable by the operator, is on the air at any one time. Available crystals allow tuning throughout the band in 1 MHz increments between 2703-2987 MHz. PRR stagger sequences are shown in figure 13-14. While it is possible to have the ASR-9 channels as little as 10 MHz apart, it is advantageous to separate the channels by at least 50 MHz in order to allow frequency diversity to mitigate radio interference and anomalous propagation.

**FIGURE 13-14. ASR-9 RADAR AND BEACON PRRS**

<b>BEACON PRR, NORMAL MODE</b>									
	<b>Staggered PRR (per CPI pair)</b>							<b>Average PRR (per CPI pair)</b>	
								<b>BCN</b>	<b>RADAR</b>
00	440	440	514	514	342	514	330	429	1172
01	434	434	506	506	338	506	326	423	1156
02	434	434	506	506	338	506	326	423	1156
03	431	431	503	503	335	503	323	420	1148
04	428	428	499	499	333	499	321	417	1140
05	425	425	496	496	331	496	319	414	1132
06	422	422	493	493	328	493	317	411	1124
07	419	419	489	489	326	489	315	408	1116
08	417	417	486	486	324	486	312	406	1109
09	414	414	483	483	322	483	310	403	1101
10	411	411	479	479	320	479	308	400	1094
11	408	408	476	476	318	476	306	397	1087
12	406	406	473	473	315	473	304	395	1080
13	403	403	470	470	313	470	302	392	1073
14	400	400	467	467	311	467	300	390	1066
15	398	398	464	464	309	464	298	387	1059
<b>BEACON PRR, VIP MODE</b>									
	<b>Staggered PRR, (per CPI pair)</b>							<b>Average PRR, (per CPI pair)</b>	
16	436	433	513	512	340	511	329	426	1164
17	433	430	510	508	337	507	327	423	1156
18	430	427	506	505	335	504	325	420	1147
19	427	424	503	501	333	500	322	417	1140
20	424	421	499	498	330	497	320	414	1131
21	421	419	494	496	328	493	318	411	1124
22	418	416	492	491	326	490	316	408	1116
23	415	413	489	487	324	487	314	406	1108
24	413	410	486	484	322	483	312	403	1101
25	410	407	482	481	319	480	309	400	1094
26	407	405	479	478	317	477	307	398	1087
27	404	402	476	475	315	474	305	395	1080
28	402	400	473	471	313	471	303	392	1072

(e) **The ASR-11** radar is a duplex radar that requires two frequency pairs for operation. The two frequency pairs may be selected from anywhere within the 2702.6 – 2897.5 MHz tuning range, but must be separated by at least 30 MHz. Each pair consists of two frequencies that are +/- 0.5 MHz offset from the main carrier. The carrier frequency is what is assigned so each ASR-11 will only have two frequency assignments even though it operates on four frequencies. An assignment of 2730 MHz, for example, will result in actual operations being on 2729.5 MHz and 2730.5 MHz, but only an assignment on 2730 MHz is needed. The second assigned frequency in this example must be at least 30 MHz from 2730 MHz. This assignment process is permitted by NTIA because of the EMC emission level provisions and the purity of the transmissions. The ASR-11 uses a four times stagger that is not adjustable. The average PRF for all ASR-11s is 856 PPS. The associated monopulse

beacon system is independent of the ASR-11 and accepts a fixed PRF assignment between 200 and 450 PPS. Due to the increased accuracy that is realized by a monopulse beacon, however, PRR assignments will be as close to 200 PPS as possible to reduce the amount of FRUIT produced by 1030 MHz interrogations.

**b. Non-FAA 2700-2900 MHz assignments.**

(1) **NWS Radars.** Some of the older style weather radars operated by the NWS such as WSR-57 and WSR-74 still operate in this band. They are tunable but have rather poor spectra. Generally speaking, separation from FAA ASR series, except ASR-8, needs to be about 20 MHz within RLOS. In the case of the ASR-8, a clear band  $\pm 40$  MHz for each channel frequency is required. Because of the relatively unstable operating parameters of those older radars, they need to be checked on a case-by-case basis. Joint DOD/FAA/NWS NEXRAD, also known as WSR-88D, is replacing the entire NWS inventory. NEXRAD installations must be coordinated carefully between FAA/NWS, particularly, the site locations.

(2) **DOD Radars.** Most of the DOD permanent requirements in this band will be for radars that are the DOD equivalents of FAA radars, such as the AN/GPN12 (ASR-7), AN/GPN20/GPN27 (ASR-8), and AN/GPN-30 (ASR-11). Assuming these are in ATC use around military bases, the FMO shall give the same protection and availability as FAA and NWS radars. Should the request be for tactical or training purposes, that function is secondary to all others and may be accommodated only if there is space without crowding or moving any of the ATC or NWS radars.

(3) **Non-FAA/non-NWS/non-DOD Radars.** This group will consist primarily of non-federal radars and usually will be experimental systems to develop air traffic control radar, tactical systems, or radar systems for foreign sale. These requirements will be secondary and handled on a case-by-case basis, in coordination with Technical Operations ATC Spectrum Engineering Services.

**1307. FREQUENCY ASSIGNMENTS IN THE 5600-5650 MHZ BAND.** TDWR presently is the only radar that FAA operates in this band. The band is shared with various weather radars operated by the DOD, NWS, and commercial weather radar systems usually associated with local new television stations. TDWRs are normally sited off the airport in order to provide better surveillance in the area of that airport. Therefore, in some cases, TDWRs are located adjacent to public facilities, and FMOs need to take special care that pre-commissioning radiation measurements are known and documented. When engineering an operating frequency for the TDWR, a circle search using the GMF and taking into account assigned frequencies as low as 5.4 GHz must be made in order to ensure compatibility with existing radars in the band 5.600-5.650 GHz as well as wide band radars operated by other agencies in the spectrum below 5.6 GHz. In addition, when siting TDWRs, in the vicinity of ASRs, the second harmonic relationship between 2.700-2.900 GHz band and the 5.600-5.650 GHz band must be considered.

**1308. FREQUENCY ASSIGNMENTS IN THE 9000-9200 MHZ BAND.** FAA operates the ASDE-X radar system in this band. Although the ASDE-X system can operate on up to four frequencies in the band, minimum performance standards can be met on two frequencies. The band is also used by the military for Precision Approach Radar (PAR). When making assignments for an ASDE-X system, a distance of 18 nmi between the ASDE-X and PAR is usually sufficient. If the proposed separation between systems is less than 18 nmi, then forward the requirement to Technical Operations ATC Spectrum Engineering Services for a more in-depth analysis. For PAR and other military operations in this band, the FMO engineers and recommends a frequency for the DOD requestor, just as with the other bands in this chapter. However, since the FMO normally is not familiar with these DOD radars, it is best to coordinate with the appropriate DOD AFC and use the DOD's expertise in this area as FAA's recommendation. Should any user of this band contact the FMO reporting interference, the FMO shall take the lead in resolution of the problem as the NTIA designated field coordinator for this band.

**1309. FREQUENCY ASSIGNMENTS IN THE 15.7-16.2 GHZ BAND.** This band is used by FAA for ASDE-3 but is shared with and subject to coordination with DOD as coequal. Non-Federal users are permitted in this band on a noninterference basis to ASDE-3. For all ASDE-3 frequency assignments, the FMO shall coordinate with Technical Operations ATC Spectrum Engineering Services.

**1310. thru 1399. RESERVED.**

## CHAPTER 14. RADIO FREQUENCY INTERFERENCE

**1400. INTERFERENCE PROBLEMS.** Effective reporting and timely awareness of a Radio Frequency Interference (RFI) problem is essential before a resolution approach can take place. To resolve RFI, the Frequency Management Officer (FMO) must be resourceful and have a wealth of analytical experience and good technical references. This chapter is a good reference and it outlines the general procedures to follow in the resolution of RFI to National Airspace System (NAS) services. For all reported events of RFI it is critical that the service area FMO do a thorough desktop analysis of the situation to determine the approach to a potential solution and the resources that will be required. An additional reference guide for applying radio interference investigation techniques is the *Radio Frequency Interference (RFI) Detection, Analysis and Resolution* textbook, prepared for Technical Operations ATC Spectrum Engineering Services. This pamphlet is supplied to Technical Operations Services specialists and service area FMOs during the Radio Frequency Interference Resolution training course (Course # 45018) and further copies are available upon request.

**1401. INTERFERENCE REPORTING.** Whether the RFI problem is resolved locally or not, the RFI event must be reported to Technical Operations ATC Spectrum Engineering Services. On a regular basis, Technical Operations ATC Spectrum Engineering Services receives inquiries, congressional and otherwise, concerning ongoing interference problems affecting NAS services. Headquarters must be in a position to promptly reply on the status of any problem at any time. Order 6050.22C prescribes policies and procedures for reporting and investigating intentional interference (phantom controllers incidents). The following general guidelines shall be used for RFI reporting:

**a. Use of the Maintenance Management System (MMS):** System Management Office (SMO) or Systems Operations Center (SOC) specialists are required to perform MMS log entries. FAA Form 6050-3, Frequency Interference Report is no longer required.

**b. Facility service event associated with the RFI:** The National Airspace Performance Reporting System (NAPRS) Interrupt Report (LIR) or Administrative Report (LAD) log entry shall be used.

**c. Facility service interruption associated with the RFI:** The NAPRS LIR Line/Frequency (LLF) log entry shall be used. For NO service interruption the LAD log entry shall be used.

**d. For the LIR/LLF and LAD:**

(1) **Enter 84** in the CODE CAT field (LIR/LLF). **Enter 07** in the CODE CAT field (LAD)

(2) **Enter the duration of the RFI** in the OPEN/START and ENTRY/CLOSE fields.

(3) **Enter the affected frequencies** and channels in the appropriate data fields.

(4) **Enter a brief description** of the interference and information regarding any actions started or completed in the COMMENTS field. Additional comments may be added by supporting organizations, e.g., SMO, service area FMO, etc.

**e. Separate logs:** If required, separate or associated logs should be created for each RFI incident and linked to the parent log via the RELATED LOG ID field referencing the record or log ID number of the parent log.

**f. MMS Report format:** This information is available in detail in FAA Order 6000.48, General Maintenance Handbook for Automated Logging.

**g. Use of the Spectrum Management Data Base (SMDb):** Radio Frequency Interference events not logged in the MMS system by SMO or SOC field specialists must be logged in the National Airspace System (NAS) RFI or Global Positioning System (GPS) RFI modules of the SMDb system. The SMDb is available over the FAA intranet secured network at <http://asr.faa.gov/>. Authorized users navigate via the FAA intranet to the Technical

Operations ATC Spectrum Engineering Services website link, the SMDb NAS RFI and GPS RFI reporting tools become available. A system User Identification (USER ID) and password is required for access to these secured areas of the database. No USER ID is required to access the online HELP link, which provides the SMDb System User Manual for detailed instructions on how to create and record a particular RFI event.

**h. Service Area FMO upward reporting.** The nature and particularly the impact and importance of an RFI problem must be carefully weighed. If there is a reasonable chance that the RFI might be of immediate interest to headquarters, Technical Operations ATC Spectrum Engineering Services shall be advised immediately. The following types of RFI incidents require the Technical Operations ATC Spectrum Engineering Services liaison at the FAA National Operations Control Center (NOCC) in Herndon, VA, to be contacted with the following information:

- (1) **Problems** with equipment design or design deficiency.
- (2) **Problems** dealing with major or hub airports.
- (3) **Problems** indicating FAA and FCC/NTIA frequency standards are in conflict.
- (4) **Any interference** receiving media attention.
- (5) **Any interference** connected with an accident or incident.
- (6) **Any interference**, which might arouse political or aviation community interest.
- (7) **Any interference** causing a facility to be shut down or restricted.
- (8) **Any interference** to high frequency (HF) assignments.
- (9) **Any interference** attributable to testing, either by another entity or through FAA procedures (e.g., maintenance or others).

**1402. ADMINISTRATIVE PROCEDURES.** Determining the source or cause of interference to NAS services determines the administrative procedures required for quick resolution.

**a. Unknown source:** An in-depth desk analysis is the first step in determining the source of RFI. RFI sources begin as an unknown source until positive correlation can be made with a commercial, civil government or military establishment. While reports are being obtained, the FMO shall use any available automation analysis tools to reduce the area from where a culprit source may be radiating the RFI. Technical Operations ATC Spectrum Engineering Services makes available the Radio Coverage Analysis System (RCAS), Airspace Analysis Model (AAM), Space Loss Calculator (SLC), and Aircraft Situation Display (ASD) automation tools. These tools combined with effective reporting data bases will assist in narrowing the potential geographical location of the RFI source and provide valuable information for a possible airborne mission. In addition, the FMO shall contact the Technical Operations ATC Spectrum Engineering Services liaison at the NOCC for additional expertise in conducting the desk analysis. The Technical Operations ATC Spectrum Engineering Services Liaison may establish teleconferences with concerned air traffic organization personnel to obtain additional RFI reports from facilities or pilots.

**b. Non-Government source:** The Federal Communications Commission (FCC) is the government agency that has regulatory oversight on non-government sources. The appropriate local FCC Field Office shall be contacted by the FAA service area FMO for proper coordination. When a private proponent has been determined as the source, careful judgment must be exercised in approaching the owner of the establishment or equipment. The FCC should be contacted first for awareness and coordination. The FCC may exercise administrative or other legal procedures depending on their history records on the proponent. In addition, the Technical Operations ATC Spectrum Engineering Services liaison to the NOCC shall be contacted in the event that the FCC national



Communications Crises Control Center (CCCC) support is necessary. For situations regarding intentional interference the guidelines in Order 6050.22 shall be followed.

**c. Government source:** RFI incidents caused by another government organization shall be resolved and coordinated locally to the extent possible with the government agency's technical representative responsible for the operation of the offending equipment. If unsuccessful notify the Technical Operations ATC Spectrum Engineering Services liaison at the NOCC with all necessary details related to the identified RFI problem and let the national liaison coordinate resolution at the FAA headquarters level. Service area FMO personnel are encouraged to participate in local state government frequency management meetings and forums to establish good working agreements.

**d. Airborne RFI investigation support:** The service area FMO will be the focal point authorized to make requests for airborne RFI investigation support. The FMO shall coordinate the airborne RFI investigation through the national Technical Operations ATC Spectrum Engineering Services liaison at the NOCC. A simple electronic mail message describing the nature of the pilots-only reported RFI should be sent by service area FMOs to the Technical Operations ATC Spectrum Engineering Services NOCC liaison to quickly initiate the coordination process. The electronic mail request shall be followed with a formal memo to the Directors of Technical Operations ATC Spectrum Engineering Services and Technical Operations Aviation System Standards. The Technical Operations ATC Spectrum Engineering Services intranet website also has an electronic airborne support request form that will allow the service area FMO to initiate coordination for scheduling an aircraft from any location where he/she has access to the FAA network. This tool may be used as an alternative to electronic mail for requesting airborne RFI investigation support.

**(1) Technical Operations ATC Spectrum Engineering Services NOCC Liaison:** The specialist at this office will gather all pertinent RFI problem data from the service area FMO, SOC, SMO, or concerned air traffic organization facility. After sufficient data to initiate an RFI investigation flight pattern is obtained, coordination with the Flight Inspection Central Operations (FICO) office is performed via telephone. The FICO will determine the earliest dates, crews and aircraft that will support the airborne RFI mission. This telephone request will be followed up by electronic message with any further details that will aid the flight crew in performing the airborne search.

**(2) Non-FAA aircraft:** Airborne RFI investigations for the restoration of NAS navigation, communication or surveillance services can only be performed under an approved FAA flight program. The Navigational Aids Signal Evaluator Radio Frequency Interference (NASE/RFI) is the Technical Operations Aviation Systems Standards primary approved flight program for airborne RFI investigations. The FAA research and development flight program managed by the William J. Hughes Technical Center is the second alternative. RFI airborne investigations outside an FAA approved flight program require special exceptions and approval from Technical Operations ATC Spectrum Engineering Services. Technical Operations ATC Spectrum Engineering Services may specifically authorize the Ohio University Avionics Engineering Center flight program to execute an airborne RFI investigation when none of the FAA flight program aircraft are available.

**e. Costs Expenditures:** In all RFI investigation cases, accurate records should be kept on the costs and funds expended to investigate the RFI event including man-hours and when applicable, aircraft hourly rate costs. These costs shall be logged in the SMDb costs entry fields.

**f. RFI Suppression Devices:** These types of devices are implemented when frequency management engineering criteria for equipment electromagnetic compatibility at FAA facilities is difficult to attain. These conditions exist when a transmitter is in close physical proximity or in close frequency proximity to a victim receiver. The following FAA policy addresses the use of RFI suppression devices such as multicouplers, combiners, isolators, etc. to resolve cosite problems:

**(1) Technical Operations ATC Spectrum Engineering Services** will manage the overall program for requirements and budgetary purposes.

(2) **FMOs** shall validate the requirements for multicoupler and combiners within their service area in coordination with the Regional Associate Program Managers (RAPM).

(3) **FMOs** must carefully specify requirements for combiners. Combiners have a very narrow range of operating frequencies. Multicouplers are flexible in their potential for retuning to meet changing requirements.

(4) **FMOs** shall note the use of multicouplers or combiners in the GMF remarks section using the appropriate format.

**1403. INTERNAL PROCEDURES.** RFI resolution techniques may vary from service area to service area, depending on the service area organizational structure, policies and the FMO's available RFI mitigation assets. The following procedures are recommended as general guidelines that may be adjusted to meet specific service area needs:

**a. SMO frequency coordinators:** Identify focal points and agreements at the SMO level. Technical Systems Offices (TSO) personnel at the SMO level have been designated as RFI focal points and are good resources.

**b. SMO interference liaisons:** Designate key service area air traffic organization and Technical Operations Services management personnel to coordinate regular meetings and to assure Air Traffic personnel reports any interference to the SMO frequency coordinators focal point promptly.

**c. Service area air traffic organization/Technical Operations Services Outreach:** Establish periodic teleconferences or briefings with service area air traffic organization and Technical Operations Services branches within the service area offices toward increasing RFI impact awareness. The Technical Operations ATC Spectrum Engineering Services liaison at the NOCC provides a daily status of RFI events being tracked in the NAS during the morning national operations teleconference. FMO and SMO participation on this national teleconference is highly encouraged.

**d. Prompt Notification:** Establish a chain of contacts at the SMO and FMO, when an RFI problem has been found to be a defective FAA transmitter. The SMO shall request FMO assistance in certifying the RFI cause. Confirming ON/OFF tests shall be performed; remedial filter recommendations, suggestions and engineering observations using FMO interference locating and measuring equipment shall be completed.

**e. Seamless Service Area Support:** During difficult and critical RFI events requiring additional resources or when FMO personnel shortages impact the service area's ability to resolve RFI, a request for "Seamless Service Area Support" shall be coordinated. The FMO is the focal point to coordinate "Seamless Support." RFI events impacting NAS services shall be given the highest priority and support coordinated with the Technical Operations ATC Spectrum Engineering Services liaison office at the NOCC. The Technical Operations ATC Spectrum Engineering Services management staff will give final "Seamless Support" approval.

**1404. INTERFERENCE LOCATING EQUIPMENT.** Service area FMOs have several types of direction finding equipment utilizing proven signal monitoring technologies. The equipment is used to assist the FMO's skills to resolve RFI. The FAA *Radio Frequency Interference (RFI) Detection, Analysis and Resolution* textbook is a detailed reference source of information on equipment and techniques. Basic general guidelines for resources and equipment are as follows:

**a. Telephone Lists:** Comprehensive lists of contacts are important namely; FCC, other Federal Agencies, other State Agencies, DOD Area Frequency Coordinator (DOD AFC), and private frequency management organizations. Calls to these contacts with a description of the nature of interference assists in the resolution.

**b. Audio Recording:** RFI audible characteristic is very important in identifying interference sources. The sound of the RFI may provide clues to the source identity. Careful listening to the signal or reviewing audio recordings from air traffic facilities can reveal such things as:

(1) **Service:** Police, Taxi Dispatch, Amateur Radio, Paging, Cellular, etc.

(2) **Emission:** Pulse modulation (i.e., radar and other pulse type emissions are recognizable by their characteristic "buzz."), Phase Modulation, Frequency Modulation, etc.

(3) **Nature:** Drifting signals, frequency sweep (i.e., industrial heating device), video field change (i.e., characteristic "hum" change), rhythmic ticking (i.e., timing circuits) musical sound (i.e., varying telemetry signal), etc.

**c. Spectrum Analyzer:** The spectrum analyzer (SA) is an instrument that should be used by properly trained Technical Operations Services specialists. Short duration or "burst" type signals, complex waveforms signals, and signals that drift within a wideband spectrum are some of the measurement benefits the SA provides to the Technical Operations Services specialists. Locating intermittent RFI is particularly time consuming and use of the SA may provide the necessary clues for RFI resolution.

(1) **Overload Caution:** The SA has a wideband front end. When high-level signals are present at the RF front end it can generate internal spurious signals, which may appear as if they were real signals. In addition, false signal levels are displayed due to front end overloading condition. The standard procedure to avoid this problem should always be to use a tunable filter or in-line attenuation pads with the SA. In line attenuator pads or filters may reduce the overall sensitivity of the SA, but will permit on-frequency use while rejecting strong off-frequency sources.

(2) **No Filter Procedure:** The following procedure may prevent the SA overload condition in the presence of high-level signals. Set the SA to monitor the RF signal of interest and note any adjacent signal levels. Insert 10 dB of external attenuation. If all signals presented on the screen are reduced by 10 dB, then the front end is not being overloaded (Note: make sure a wide enough spectrum bandwidth is being measured). If some shown signals drop more than 10 dB, then the front end is being overloaded, and another 10 dB attenuation is required. When a level of additional insertion occurs where every signal drops equally, the integrity of the front end of the SA is assured. (Note: Attenuation reduces the sensitivity of the SA).

**d. Receiver:** This type of equipment provides the highest flexibility for investigating RFI in the NAS. Field strength meter receivers are manufactured with great shielding and bonding for great sensitivity and selectivity. These are costly units and used for specialty applications. Inexpensive general purpose portable receivers may be sufficient for some RFI investigations. In addition, 360, 720 or 760 channel VHF aeronautical transceivers can be reasonably effective in the VHF spectrum under some power line RFI investigations. For best results during RFI investigations, it is recommended that a receiver be used that permits the use of an external antenna, has RF gain control, is shielded, and has a carrier level meter.

**e. Antennas:** Specific types of antennas connected to a receiver for direction-finding (DF) work will provide the Technical Operations Services specialist with a better probability to quickly locate the RFI source. A Loop, Yagi, Log Periodic, or even a simple Dipole, which can be used for DF, will work appropriately if used according to direction finding techniques. Further details are provided in paragraph 1406 b.

**f. Direction Finders:** There are DFs configured for fixed remote site operation and those configured for portable mobile operation. The fixed DF configuration is automated and is available for local or remote operation 24 hours and 7 days a week. Portable DFs are available in manual and automated modes. These are used from a fixed location or while in motion.

(1) **Fixed DF:** Fixed DF facilities are presently limited to high-traffic density areas where RFI has the potential to severely impact NAS services, causing delays and safety risks. They are strategically located to attain triangulation within a geographical area that is within Radio Line of Sight (RLOS) to each of the fixed DF sites. The expansion of fixed DF sites is expected throughout the NAS in the near future.

(2) **Portable DF:** Service area FMOs are the focal point that coordinate the use of portable DFs which can be used in a vehicle while in motion in the manual or automated mode. Technical Operations ATC Spectrum Engineering Services also manages a national handheld and portable direction finder program, which utilizes general purpose receivers and processors specially designed for RFI investigation work. Service area FMOs are also the focal point for coordinating the use of these nationally available portable and handheld DF systems with the Technical Operations ATC Spectrum Engineering Services liaison office at the NOCC.

**g. RFIM Van:** Some RFI events require the use of a vehicle as an efficient tool when used by a proficient operator, especially if the RFI source is suspected to be at some distance from the victim equipment. The ability to take bearings quickly in an automated mode, while traveling, assists in rapid DF triangulation that leads to source location. Service area FMOs are the focal point for coordinating the use of the RFIM van. Further information concerning RFIM vans will be found in Chapter 15.

**1405. INTERFERENCE LOCATING TECHNIQUES.** The techniques for locating an RFI source vary, depending on the nature of the RFI and the personnel seeking resolution. A rule of thumb is that no condition is to be assumed. All possibilities must be considered. Engineers in the radio frequency field have developed some basic techniques over the years. The following paragraphs provide general guidance, listed by the type of system receiving interference.

**a. Ground Communications interference:** This is RFI to FAA equipment use for Air/Ground voice communications in the terminal and en route environments. This equipment experiences the most RFI, which can be classified into three basic types: internal, local, and external.

(1) **Internal interference** is RFI generated within the receiver, normally harmonic or spurious emissions generated by internal crystal oscillators or synthesizers used in the superheterodyne circuitry. This RFI manifests as unmodulated carriers on specific frequencies, appearing constantly. FMOs should examine this possibility prior to seeking for external sources. Aging crystals, oscillator tuning, and change on receiver voltage during routine maintenance can initiate a spurious signal. It is recommended that the antenna be removed from the receiver and the input terminal be grounded. If the signal remains, the source is internal and the receiver should be repaired.

(2) **Local interference** is RFI caused by other signal sources in the same rack, same room, or same building. Signals generated by another transmitter or receiver can cause a receiver response on the assigned frequency. Service area FMOs should carefully assess, when receiving a complaint, if the interference "just" started. It could have been present since installation of the victim receiver or the source transmitter or receiver, but only recently became noticeable. The problem may be masked by normal squelch setting and then become noticeable only when the squelch level is lowered or increased traffic on the frequency causes the squelch to be opened more frequently.

**(a) Intermod:** The potential for intermodulation when engineering the frequencies for a site shall be avoided. Lower order (third or fifth order) intermods may exist below squelch until frequent use of the site frequencies unveils its presence. Intermod is easily recognized by its makeup of a mix of two or more facility frequencies other than the victim frequency. Intermods are covered in Appendices 1 and 2.

**(b) Some Resolutions:**

- 1. Antenna relocation** (vertical or horizontal separation).
- 2. Receiver or transmitter relocation** (to another site).
- 3. Cavity or crystal filter installation** (victim receiver input).
- 4. Cavity and/or ferrite isolator installation** (transmitter outputs).
- 5. Frequency change** (last alternative - may introduce new problems).

**(3) External interference** is RFI caused by a myriad of sources, including such devices as heater thermostats, broken power pole insulators, doorbell transformers, computers, industrial devices using RF energy (i.e., "plastic welders") and almost any conceivable RF source. The problems divide into six major categories: co-channel, adjacent channel, brute force, intermod, image and audio rectification.

**(a) Cochannel interference** is RFI generated when a signal is within the receiver band pass of the assigned frequency. The victim receiver receives a signal at its detector that is processed as a desired signal. The FMO shall carefully identify the signal (voice, pulse, etc). Careful listening of the interference directly or from AT tapes, shall be performed.

**(b) Adjacent Channel interference** is RFI caused by signals much broader and stronger than those in the cochannel case. The receiver band pass is a product of its RF and IF band pass circuits, but they are limited in their curve shape due to the Automatic Gain Control (AGC) function of the receiver. Sometimes the channel assigned above or below the victim frequency causes the problem.

**(c) Brute Force interference**, also known as front-end overload is an exceedingly strong signal which might be anywhere in the radio spectrum. For example, a 50 kilowatt FM broadcast transmitter in the 88 to 108 MHz band a few hundred feet from an FAA receiver can completely overload the receiver. The result is desensitization of the receiver and usually the passing of the FM signal through the receiver. Brute force can also be in-band and near-frequency (i.e., a receiver tuned to 125.575 MHz could be overloaded by a transmitter on 125.60 MHz in the vicinity, assuming its antenna were in proximity). Relocating the transmitter or receiver antenna to achieve 1,000 feet or more separation can cure brute force problems. Installation of a cavity or crystal filter is a good solution as well.

**Note:** This type of problem normally occurs within the same building, or nearby buildings. To minimize brute force (overload) potential, the FAA cosite standard for frequency separation is 0.5 MHz for VHF (118-137 MHz) and 1.0 MHz for UHF (225-400 MHz) for transmitter and receiver antennas within 80 feet of each other.

**(d) Intermodulation (IM) interference** normally occurs in a receiver, caused by a combination of external strong signals (2 or more) which algebraically mix to produce the victim frequency, usually in the first mixer or first amplifier. The receiver responds to the mixed frequency as if it were an "on frequency" signal. Intermods may also occasionally be created within transmitters where they are in close proximity. A spectrum analyzer could be of valuable assistance in determining the interfering signal level.

**1. IM definition:** IM is expressed with formulas where the mathematical relationship of various frequencies results in the operating frequency of to the victim equipment. For example:

$$2^{\text{nd}} \text{ Harmonic IM} = 2F_c; (F_c = \text{Center Frequency})$$

$$2 \times (121.5 \text{ MHz}) = 243.0 \text{ MHz}$$

$$3^{\text{rd}} \text{ Harmonic IM} = 3F_c; (F_c = \text{Center Frequency})$$

$$3 \times (121.5 \text{ MHz}) = 364.5 \text{ MHz}$$

$$\text{Sum/Difference 2 Frequency Third Order IM} = 2F_1 \pm F_2$$

$$2 \times (119.8 \text{ MHz}) - 118.1 \text{ MHz} = 121.5 \text{ MHz}$$

$$2 \times (119.8 \text{ MHz}) + 118.1 \text{ MHz} = 357.7 \text{ MHz}$$

$$\text{Sum/Difference 3 Frequency Third Order IM} = F_1 + F_2 \pm F_3$$

$$118.1 + 124.7 + 121.3 = 364.1 \text{ MHz}$$

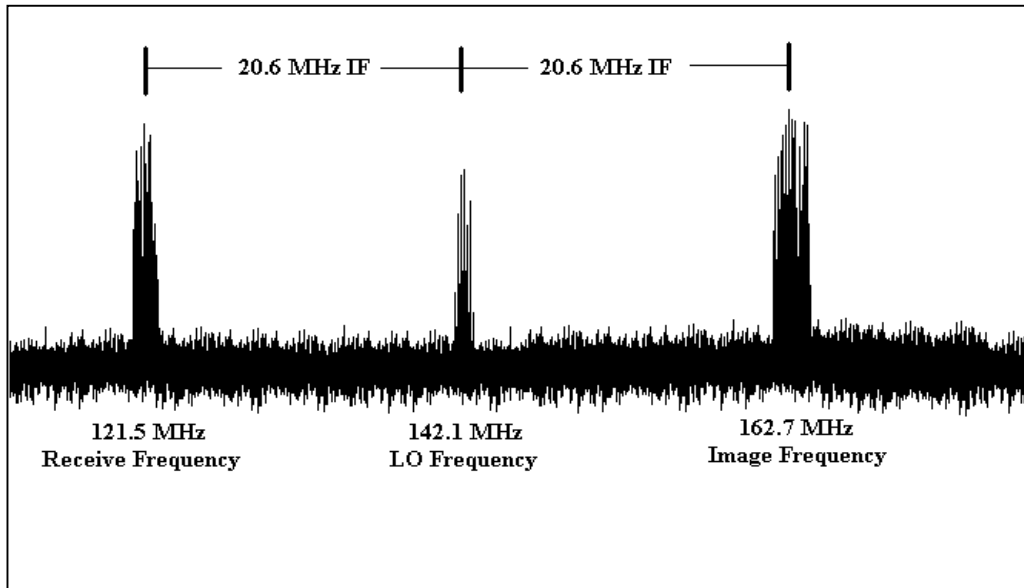
$$118.1 + 124.7 - 121.3 = 121.5 \text{ MHz}$$

**2. Receiver IM Resolution:** One potential solution is to install a band-reject (notch) filter at the input of the victim receiver, tuned to one of the undesired frequencies that generates the IM inside the receiver. This reduces one of the undesired signals below the level at which it drives the victim receiver front end into non-linear operation. A second potential solution would be to use a bandpass filter at the victim receiver, tuned to the victim frequency. This is effective, however, only if the culprit frequencies which cause the intermod, are well removed from the victim frequency. The frequency separation requirement is a function of the bandpass filter selectivity curve.

**3. Transmitter IM Resolution:** Potential solutions are to use bandpass or band-reject filters at the antenna input of the culprit transmitter. Proximity of strong signal causes unwanted mixing in the amplifier or mixer stage of the transmitter. The transmitter final amplifier is driven by these external signals into non-linear operation, generating and radiating the undesired IM (or spurious) signal on the victim frequency. Since a transmitter is actually radiating the IM (or spurious) signal, nothing can be done at the receiver to resolve the problem, only stopping the undesired strong signals from entering the culprit transmitter yields resolution.

(e) **Image interference:** This is caused by a strong external signal which mixes with the local oscillator (LO) in the victim receiver to produce the intermediate frequency (IF) which then is processed by the receiver just as if it were a desired "on frequency" signal.

**1. Case example:** A Flight Service Station (FSS) receiver is tuned to 121.5 MHz. Its Local Oscillator (LO) is 20.6 MHz above the desired frequency (i.e.,  $121.5 + 20.6 = 142.1$  MHz). If a sufficiently strong signal appears at the victim receiver input from a culprit frequency of 162.7 MHz, this signal will get through the first amplifier of the receiver and mix with the 142.1 MHz LO to produce the intermediate frequency (IF) of 20.6 MHz. See figure 14-1 for a graphical illustration. For aviation frequencies, an LO on the low side (i.e.,  $121.5 - 20.6 = 100.9$  MHz) is avoided because the "image" frequency would be 80.3 MHz, close to TV channel 5 video carrier.

**FIGURE 14-1. IMAGE FREQUENCY RELATIONSHIPS**

**2. FAA A/G Radios:** The commonly used VHF/UHF receivers are the ITT GRR-23, GRR-24 and the Motorola CM200V/U units. The GRR LO's are 20.6 MHz above the desired frequency, except for 322 MHz and higher, where they are below. All CM200 series LO's are 45.0 MHz above the desired receive frequency. The CM200 also has a second IF at 456 kHz.

**3. Image RFI Resolution** is to filter out the undesired signal from entering the victim receiver by reducing its level below that to which the receiver will respond. The amount of rejection required will depend on the filter selectivity curve. Other alternatives are to lower the power of the culprit transmitter, install a directional antenna to discriminate against the victim-culprit azimuth or to move one of the sites further away.

**(f) Audio Rectification** is interference whereby an audio amplifier is driven into detection mode by the strength of the culprit signal, usually a nearby high power AM broadcast station. At some strength level, any signal can cause a contact (i.e., a transistor input junction, a poor ground connection, etc.) to act as a diode and rectify the signal, then reradiate the detected signal. The signal may be distorted because it is the increase in intensity from the amplitude modulation that drives the device into detection mode. In these cases, an amplifier may act as a radio receiver. The problem usually is at the input stage where the amplification is the greatest and the rest of the amplifiers merely amplify it.

**1. Resolution:** One potential solution is to bypass the input circuit with a small (0.005 Microfarad) capacitor between the circuit board ground and the closest possible point of input to the amplifier stage, with the shortest possible leads. Also useful is a ferrite bead on the input line wire. If the strong signal is entering the amplifier cabinet by the power line or remote speaker lines, it is recommended to wrap the line through a ferrite ring, which will act as a radio frequency choke. Sometimes merely plugging in the power cord to another outlet circuit will change the level enough to eliminate the rectification. Each case may be unique, however applying these techniques in a logically progressive manner may yield the solution.

**b. Airborne Communications interference** is RFI to aircraft receivers which can be difficult to investigate and locate. Because of RLOS, the RFI source affecting a flying aircraft may be located a hundred miles or more from the area where aircraft are being affected. The following procedure is recommended for investigation and location of such RFI sources.

**(1) Obtain the following data from the service area air traffic facility:**

- (a) Date and time the RFI reports started**
- (b) Aircraft Location** (altitude, latitude, longitude, airline, aircraft type)
- (c) RFI Occurrence** (constant, intermittent, morning, night, weekends)
- (d) RFI Description** (music, voice, squelch breaks, tones)

**(2) Constant RFI:** If the RFI is fairly constant but only one airline reports the problem, suspect their equipment and contact their maintenance department with the information you have obtained from the service area air traffic facility. If several airlines and private pilots have reported the problem then the following is recommended:

**(a) RFI reports data:** Coordinate with the service area air traffic facility to request reports from aircraft at various altitudes in the affected area to monitor the frequency for RFI (targets of opportunity).

**(b) RFI data analysis:** Analyze the data provided by the service area air traffic facility and plot on a high or low aeronautical sectional map the extreme points at which multiple RFI reports have been received.

**(c) Area Reduction:** To the extent possible, use the RLOS generated by each aircraft data point and the Venn diagram techniques to identify an area of less than 50 nmi radius having the majority of RFI complaints. Conduct the following checklist in an attempt to reduce the size of the geographical area to be searched on the ground:

- 1. Altitude** – reports 6,000 ft below local ground level
- 2. Area** – 50 nmi east, west, north to south radials centered on the RFI area
- 3. AGC level** – note on a chart the points where the signal is the strongest
- 4. Triangulation** – estimate a grid where the source may be located
- 5. Repeat steps 1, 2,3 and 4 above** – with reports at 2000 ft, 3000 ft, etc.
- 6. Reduce area** – 20 nmi east-west, north-south. Fine tune estimated area
- 7. Proceed with the ground search** of the area identified in **4** and **6** above.

**(3) Intermittent RFI:** If the RFI is intermittent the problem becomes a greater challenge and may require further assistance at the national level. If several airlines and private pilots have reported the problem, the following is recommended:

**(a) Procedures:** The same techniques described under Constant RFI above are applicable when intermittent RFI is reported. Coordination for an FAA flight check is the same as for Constant RFI. However, the Technical Operations ATC Spectrum Engineering Services liaison at the NOCC may coordinate collaborative



assistance for additional PIREPS reports from a special RFI working group of the Air Lines Pilots Association (ALPA) named "aeroRFI." Additional assistance may be coordinated with the Air Transport Association (ATA), the National Business Aircraft Association (NBAA), and the Aircraft Owners and Pilots Association (AOPA). These organizations can provide VHF A/G data link message reports to the Technical Operations ATC Spectrum Engineering Services NOCC liaison for further analyzing the geographical area of the RFI.

**c. NAVAID interference:** This type of RFI is more difficult to identify and is generally first noted by pilots. Unless the RFI source is a strong signal, there is a possibility that it may not be detected on the ground, except in the immediate vicinity of the source. It may be necessary for the FMO to arrange airborne RFI support with the Technical Operations ATC Spectrum Engineering Services liaison at the NOCC for such investigation.

**(1) Ground VOR RFI:** This problem is mostly local and may be reported principally on an airport. In this case, it would be worth trying a ground search with the RFIM van on and around the airport first, or using a handheld DF system.

**(2) Airborne VOR and LOC RFI:** This problem is frequently from FM broadcast stations, especially if they are in the upper part of the 88 to 108 MHz band, creating brute force and intermod problems in the airborne receiver when the aircraft nears the FM transmitter site. Unless the FM station is clearly identified by the reporting pilot, it will be necessary for the FMO or flight inspection crew to observe reception of the signal in the air. The following steps are recommended:

**(a) Flight Check:** The FMO should join the flight inspection crew to make a definite determination whether a reported interference is really a problem or a problem in the reporting aircraft equipment.

**(b) Air Traffic Check:** Request the appropriate ATCT, TRACON or ARTCC personnel to query aircraft of opportunity to determine whether they notice a reported problem, before investigating a report.

**(c) Confirm Reports:** The FMO must confirm additional reports from aircraft utilizing the NAVAID service. The FMO shall seek for reports issued by other FI crews on the affected NAVAID.

**(3) TACAN RFI:** This type of RFI can be caused in two ways. Airborne reception can be affected by a source of interference somewhere on the ground. The ground based TACAN receiver can also receive interference from any source nearby on the ground or from any airborne source within RLOS. The FMO should work closely with the SMO frequency coordinator or SMO technicians if necessary so that the FMO can determine whether to work with the interrogator or the transponder frequency. Once the local geographical area is known, the FMO should proceed to locate the RFI source, using many of the techniques described in this chapter for interference to air/ground communications systems.

**d. Radar Interference:** This type of RFI requires collaboration with the concerned service area air traffic organization to identify. It is generally first noted by controllers. Interference to primary and its associated beacon present a particular problem in locating an RFI source.

**(1) Primary radar RFI:** Primary radar interference is normally another radar, although occasionally it is a harmonic from a lower frequency transmitter. The FMO should coordinate with SMO technicians to determine the azimuth the interference indicates on the air traffic controller's scope. If the source is another radar, the interference may appear as dotted spirals named "running rabbits," which appear to "run" as the radar rotates. If the FMO has good records from the radar coordination program, the source might be identified by the PRR. There is a method to determine this from the radar scope presentation and it is detailed in paragraph 1408.

**(2) Radar Beacon (ATCRBS or IFF) RFI:** This type of interference is the most difficult of all because all interrogators and transponders work on the same frequency (1030/1090 MHz) and are separated only by PRR. Interference is usually from another interrogator, which could be several hundred miles away. Interference will normally show up as intermittent false targets. This is because two different interrogators can illuminate an aircraft at nearly identical times, resulting in both radars "painting" both replies offset in time.

**(a) Aircraft Location:** It will be necessary to coordinate with the concerned service area air traffic organization to determine in what general area the aircraft are located which are producing the false targets. Once the area is known, monitoring of 1090 MHz should be done, looking for aircraft replies on the same PRR ( $\pm 3$  pps) as the victim radar. From there, it becomes trial and error plus deduction. Attempt to determine the direction of the victim aircraft. The area of search will have to be widened until an interrogator on 1030 MHz can be heard that matches the PRR of the victim. It is then located by DF procedures, as described in paragraph 1407.

**(b) Beacon RFI:** Since another interrogator almost always causes beacon interference, the FMO must exercise patience and diligence to locate it. The use of telephone contacts, particularly with DOD spectrum coordinators and appropriate on/off tests, are clearly indicated before a ground search is begun. Here is where the FMO's PRR coordination records, contacts set up in advance with DOD, other spectrum coordinators, and the telephone are usually the most valuable tools.

**(3) Reflections:** Awareness of reflections from metallic objects such as buildings, fences and the like can cause interference by putting the source radar signal into areas not intended. See paragraph 1302 and figure 13-1.

**1406. DIRECTION FINDING (BELOW 1000 MHz).** After initial investigation procedures by means of telephone points of contact and record searching the next step to locate the potential source of RFI is to use DF equipment and techniques. There are three principal techniques, automatic DF, directional antenna DF, and proximity DF ("hot and cold" method). These techniques may be applied equally when used in an RFIM van, a standard vehicle mounted auto-readout or hand carried portable unit. Further details on these techniques could be found in the *Radio Frequency Interference (RFI) Detection, Analysis and Resolution* pamphlet referenced in paragraph 1400. This pamphlet could be obtained from Technical Operations ATC Spectrum Engineering Services in Washington, DC.

**a. Automatic DF:** Equipment and techniques of this type uses a set of ground plane vertical aerials, switched at a rapid rate, with a representative display of the incoming signal by compass rose showing a line of bearing strobe or numerical digital azimuth readout. Some automated systems make use of a computer, which allows for electronic data storage for later retrieval and analysis of the data. With automatic DF systems, the FMO follows the direction indicated by the line of bearing (LOB) on the display until the source is located. Caution needs to be exercised when using these automatic DF systems since many false bearings may appear on the display due to signal reflections. It is recommended that the FMO continue to obtain LOBs while mobile to get out of zones that caused the reflections.

**(1) RFID System:** This is a portable unit that operates under the concept of a single channel Watson-Watt system that modulates the carrier with AM sidebands carrying the DF information. The RFID utilizes a series of multi-element adcock antennas for DF directional information where most of the processing is performed. In addition, the system is fully controlled by a laptop computer making it capable of unattended operation.

**(2) PIMDS System:** Like the RFID, this unit also operates under the concept of a single channel Watson-Watt system. The unit has RF combining circuits including the Sum/Diff Hybrids, and circuits that create the N-S, E-W, and Sense antenna patterns from the array inputs. In this unit, modulators and Gain/Phase equalization circuits modulate the N-S and E-W signals with low frequency tones, combining them with the sense signal. The gain and phase vs. sense values are equalized over the frequency range to provide very accurate lines of bearing readings. This system is self-sustaining and does not require a laptop computer to operate. However, the computer can be added and unattended data collection can be performed.

**b. Directional Antenna DF:** This type of equipment and techniques are frequently used because of the great availability of the equipment and its relatively low cost. The antenna is connected to a general-purpose monitoring receiver, which should include tuning in the aeronautical navigation and communications radio spectrum. For better results the equipment should have a signal strength meter. If a meter is not available, the aural signal intensity variance heard over the monitoring receiver speaker can be used. When a loop or dipole antenna is utilized, a signal null with respect to the source is of interest, because the null is much narrower (sharper) than the maximum signal reading. For a Yagi, Horn, or other high gain type antenna, the maximum signal reading is of interest. This is because of the radiation pattern of these particular types of antennas. The maximum lobe signal reading provides an unambiguous direction. However, the nulls in these kinds of antennas are varied and not diametrically opposed, so they may create confusion in determining the actual bearing. Technical Operations ATC Spectrum Engineering Services manages the K95-100 series handheld system. This system is the most widely used by AF specialists and is available through the FAA Logistics Center.

**(1) Loop Antenna:** Electrically one half wave or less, the minimum signal is perpendicular to the plane of the loop. That is, when the loop is rotated, the signal meter or audio level will vary so that looking through the loop when the signal is nulled (i.e., at minimum level), it will indicate the bearing direction of the signal being received. A loop bearing is bi-directional. Since the loop null is symmetrical (when used within its design parameters), the source can be either in front or behind the loop. The procedure to determine the true direction to the source, after the first bearing has been taken, is to move at a right angle between one hundred and a thousand feet from the first bearing. Take another bearing. If the source is less than two miles away, the second bearing will cross the first bearing and thus establish a true direction ahead or behind. A third right angle measurement may be required if the source is at a considerable distance. Next, travel to the general area where the bearings intersect and take a third or fourth bearing. When this bearing is plotted, it should create a triangle with the first two. The source should be in or near the area enclosed by the triangle. Continuing triangulation will narrow the search area.

**(2) Dipole Antenna:** The handling process is similar to the one described for the Loop antenna but the indication is reversed. A dipole minimum or null is off the ends of the dipole, along its parallel plane. In effect, the dipole null is in the direction of (points to) the source. Because it is not electrostatically shielded like a loop, a dipole is subject to many more reflections. Caution must be exercised in following the bearings. Making frequent stops for additional bearing is recommended. Like the loop, the dipole is bi-directional. If it is not adjusted to resonant length it may not have symmetrical nulls. It is recommended that a chart showing the resonant length with respect to frequency be carried so that the dipole can be adjusted accordingly.

**(3) Monopole (Whip) Antenna:** The procedure is the same as the dipole. A whip is normally attached to the receiver antenna input connector. The receiver or antenna is rotated so that the plane of the whip is horizontal. It is then used just as a less effective dipole. A whip can be used satisfactorily, if the signal is reasonably strong, or the receiver is very sensitive. In addition, a certain amount of directivity can be obtained by holding the receiver and antenna in front of the operator. As the operator rotates about on his/her vertical axis, one null may be more noticeable ("deeper") than the other. If this is the case, body mass is absorbing some of the VHF signal when it is behind the operator, so the "deeper" null could indicate the signal source is behind the operator.

**(4) Yagi Antenna:** A corner reflector or other multi-element type antenna is unidirectional. A signal strength meter on the receiver or other level readout must be used. The maximum received signal is of interest and used to determine a bearing to the source. The broad radiation pattern ("nose") of the beam can be centered when a meter is used or other type of signal level readout. Nulls are asymmetrical, thus unusable. There are three advantages to a Yagi, corner reflector or beam antenna; (a) each produces gain, (b) each is unidirectional, and (c) each is polarized. Polarization allows for rotating the antenna on its directional axis to determine the signal source polarity or minimize reception of cross-polarity undesired signals.

**(5) Log Periodic:** The procedure is the same as the Yagi antenna. This is also a multi-element type antenna that provides unidirectional characteristics. The same procedures used for the Yagi antenna for determining the bearing to the source apply to the Log Periodic.

**(6) All Antennas:** The antennas mentioned in this paragraph are effective. All should be operated away from metal or other RF reflective surfaces to prevent any reflections from giving erroneous or ambiguous bearings. It is recommended that 15 to 20 feet separation be maintained for a vehicle and up to 500 feet from a building. The loop is least affected due to its electrostatic shield. However, unless it is resonant at the frequency, it will provide some signal reduction over a dipole. Its static field shielding makes it superior for close proximity work. It is frequently beneficial to start with a dipole or Yagi until sufficient signal is received to use a loop.

**c. Proximity DF ("Hot and Cold"):** This technique is useful but a very time consuming and limited procedure. The technique consists of carrying a monitoring receiver either physically or in a vehicle, tuned to the frequency experiencing the interference. By trial and error, an area of maximum signal detected can be identified by observing the signal strength meter on the receiver as the unit is moved about. If the receiver has no meter or a meter is not available with suitable RF gain control, the alternative is to detune the receiver intentionally in the presence of a strong signal, which will give the appearance of a weaker signal to the receiver. By careful position selection or choice of moving from location to location, selective detuning, and other intuitive judgment the source could be located.

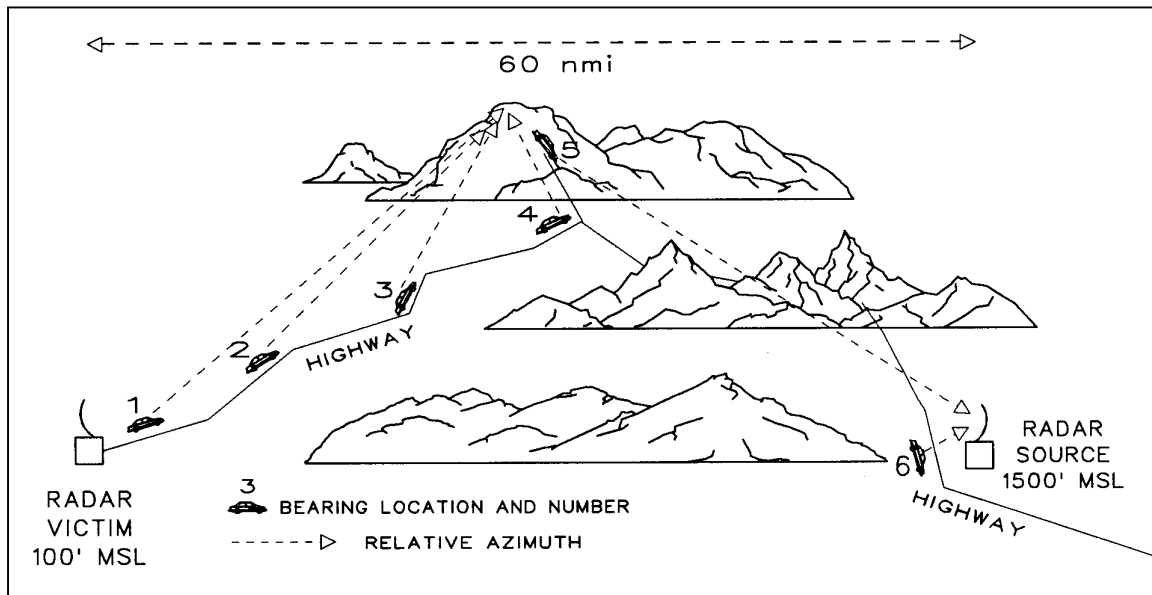
**1407. DIRECTION FINDING (ABOVE 1000 MHz).** Microwave DF techniques are normally in the TACAN, Radar, MLS or RCL radio spectrum bands. There is no fine line at 1000 MHz. However, dipole and loop antennas become progressively ineffective for DF work above about 600 MHz and Yagis above 1,000 MHz. Log Periodic (LP) are more effective and Horn antennas start around 1000 MHz (1 GHz). These or helical equivalents are normally used, and because of antenna pattern configuration, the maximum signal is used for DF work. The new and future aeronautical navigation satellite service such as the Global Positioning System (GPS) will operate in the L band spectrum making the Log Periodic and Horn antennas the instruments of choice for DF work.

**a. TACAN Type Signal:** For this type of signal or other steady state emission, the source is located by triangulation as described in paragraph 1406. A Horn or Helical antenna is unidirectional, so even the first bearing taken indicates the initial unidirectional approach (allowing for reflections). A Horn is polarized (either vertically or horizontally), so it must be rotated on its directional axis to determine the polarization of the incoming signal. A Helical is not polarization sensitive, except where the source is reverse helical. In this case, the received signal is greatly attenuated by the reverse polarization of the receiving antenna.

**b. Rotating Radar Type Signals:** If the RFI signal is a rotating radar, the DF procedure is more complex. Because the DF receiver is illuminated for only milliseconds every 4 to 12 seconds on the average, some means is required to denote small differences in received signal as the Horn direction is changed. If a field strength meter is used, the direct peak detection hold function should be used, since each illumination peak will be held for a few seconds. This allows visual noting and will permit signal level differences as small as 1 dB to be seen. If a general-purpose receiver is used, a high-speed recorder such as the TechniRite Model 711 attached to the Y output or detected signal will permit the same observation in real time.

**(1) Horn/Helical Antennas:** The horn or helical antennas should be positioned every 10° to 15° at a time and the received level noted. It is recommended to measure two or three passes at each azimuth before shifting the antenna. This will allow peculiar propagation such as beam fly-through by passing aircraft to be averaged out. Peak azimuth readings should not be assumed as the bearing. A complete 360° check should be performed. The first peak measured may be a reflection or a minor lobe of the receive antenna. The real peak should stand out significantly. Another aid in discriminating between direct and reflected signals is that at microwave frequencies, reflected signals off flat surfaces shift polarity 90°, but reflections off rough surfaces such as mountains, may change anywhere between 0° and 90°.

FIGURE 14-2. RADAR INTERFERENCE DF EXAMPLE

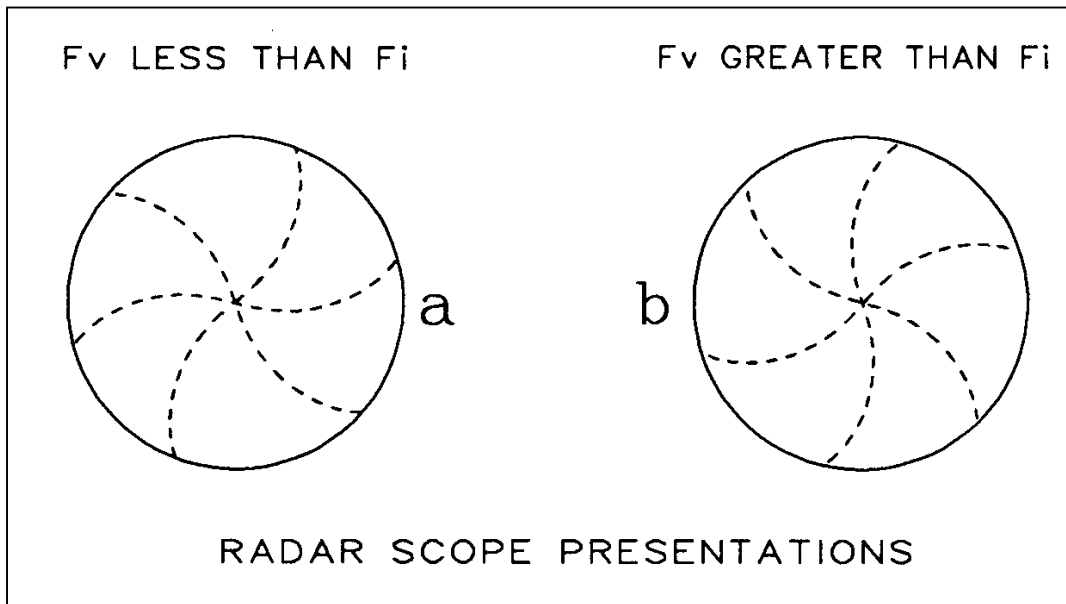


(2) **Radar RFI Example:** A radar interference signal might be chased for miles in a continuing direction, only to find it to change abruptly concurrent with a marked increase in received signal strength. An actual example is shown in figure 14-2. The original bearings (1) through (4) in figure 14-2 all showed the same general area source and for 30 nmi converged on a point. This was because at the lower elevations, the only signal that the victim radar and the DF equipped vehicle could receive was that reflected from the mountain. But upon arrival near the converging point, the bearing suddenly shifted and the level greatly increased. The DF equipped vehicle's receiver was now high enough to see over the hills that blocked direct reception of the interferer site. The victim radar received its interference by reflection from the large 10,000 foot mountain.

**1408. "RUNNING RABBIT" INTERFERENCE.** Paragraph 1405 mentions the type of interference that occurs when two search radars of fixed PRR's are operated in proximity. The dotted line spirals, running out from or into the center of the radarscope display indicate this type of radar interference. It most likely would happen near a military base or training area where transient troop groups make frequent changes of radars. There is a formula which will allow the FMO to determine the PRR of the interferer radar, since the FAA PRR will be known.

**a. Parameters:** The first parameter needed is to determine whether the "rabbits," which actually are presentations of the difference in PRRs, are faster or slower than the FAA victim radar. The second parameter is the number of "rabbits" per radar sweep. The patterns for each condition are shown in figure 14-3. Shown below is the calculation for an interferer's PRR.

**FIGURE 14-3. RUNNING RABBITS PATTERNS**



**b. When the PRR's are fairly close,**

$$f_i = f_v \pm RS$$

where;

$f_i$  = PRR of interferer radar in pps

$f_v$  = PRR of victim radar in pps

$R$  = Azimuth scan rate of victim radar in r/s

$S$  = Spirals/revolutions on victim radar scope presentations

**c. For Example:**

$$f_i = f_v \pm RS$$

Victim radar PRR = 360 pps

Victim radar azimuth scan rate = 15 r/min = 0.25 r/s

Victim radarscope presentation shows 6.0 spirals/revolution

thus;

$$f_i = f_v \pm (6.0 \times 0.25)$$

$$f_i = f_v \pm 1.5$$

$f_i = 361.5$ , if the rabbits are as in presentation **a** of figure 14-3.

$f_i = 358.5$ , if the rabbits are as in presentation **b** of figure 14-3.

**1409. ELECTRONIC ATTACK (EA):** DOD conducts frequent flights radiating for EA missions, covering very large geographic areas. In addition, the DOD conducts periodic GPS jamming test emissions. These emissions can be sources of serious RFI problems. The procedures are covered in chapter 18.

**1410. POWER LINE INTERFERENCE.** This type interference is difficult to locate. When power line generates ("carries") interference, it acts as a Beverage antenna and can conduct the RFI for miles along its lines as standing waves. (A Beverage antenna is one straight wire fed at one end that is many wavelengths long, usually 7 or more wavelengths. This configuration results in the antenna main radiation lobe being approximately in the same direction as the wire.) A motor arcing at a farm or factory can be the cause of the RFI. Arcing insulators on the power line are also potential causes. This type of problem is best solved by using a mobile system like the RFIM van or other suitable equipped vehicle and "cruising" the line coming into the facility, and other lines nearby.

**a. Electric Motor Type:** If it sounds like an electric motor, it could be from next door to several miles away, depending on how strong the brush arcing is and the amount of current drawn by the motor. Driving the RFI vehicle along the line feeding the facility will show a gradually increasing/decreasing average signal. Some frequent small increases in noise may be experienced as each power pole is passed. Using hot-and-cold DF techniques may lead into the area or the building with the source, which should be located within a reasonable period of time. When found, it should be brought to the attention of the operator, then of the utility company which supplies the service. Quick resolution may be accomplished when the FMO makes the operator aware of the impact to the safety of the flying public due to this RFI. Only fixing the problem at its source, probably with power line filters or additional or better grounding at the motor, can cure electric motor RF noise. In all cases, the FCC should be notified.

**b. Intermittent Arcing:** If it sounds like intermittent arcing, it probably is a cracked or broken insulator on a pole's crossarm. The utility company should be notified, stressing the aviation safety of life and property risks. The utility company may have an "interference" group, but if so, generally they are understaffed so that resolution may take a long time. The service area FMO should make an effort to locate the problem. If the FMO can locate it and report the pole to the utility company, resolution should be prompt. Since an arcing insulator can lead to a pole fire, a utility company normally will take immediate action. Use of the RFIM van or other suitably equipped vehicle to travel along the line is recommended. In the general area of the defective insulator, there will be a marked increase in RF noise. By carrying the portable receiver, the FMO can check the poles with the highest RF noise radiation. Standing next to the pole, a moderate blow with good-sized hammer will send sufficient vibrations up the pole to rattle the insulators. If the pole struck is the offender, the noise in the receiver will increase momentarily. On occasions, the arcing might even stop for a while until some other vibration sets it off. Once it has been located, note the location and the pole number so that it can be reported to the appropriate utility company.

**c. Ultrasonic Detectors:** If available, an ultrasonic detector is a component of the RFI equipment complement. It is another tool that can be used with great efficiency in locating the arcing spot. After narrowing the area with a vehicle, the ultrasonic detector is pointed at individual cross-arms and insulators from the ground position. Since the detector uses a parabolic reflector, the ultrasonic source can be pinpointed by aural and level meter means via a bore sight, sometimes down to the specific insulator. When located, it should be reported promptly to the utility company with awareness notification to the FCC. Insulator arcing may occur at any time, but frequently starts after a long dry period when dust and dirt accumulate on the surfaces. The first rain, if heavy enough to clean the insulators thoroughly, may clear up the problem for a time. A light first rain after a long dry spell can make matters worse by washing dirt into a crack, setting up an even better arcing path.

**1411. DIGITAL RADIO SYSTEMS.** Commercial digital radio systems, especially microwave links, are being implemented across the country. Because of the decreased resistance of some digital radio receivers to certain types of RFI, FMOs need to be aware that there may be increasing numbers of complaints from commercial vendors concerning RFI to their systems. FMOs receiving such complaints need to first evaluate the accused (FAA) interference source to assure that it is operating within specifications. If the FAA system is within parameters, then the FMO may help the commercial vendor in whatever manner possible, as long as no expense is incurred to the FAA. Special attention shall be taken on the Wide Area Augmentation System (WAAS) and Local Area Augmentation Systems (LAAS). These systems are satellite based navigation digital systems operating at very low-level signals. If the victim is a federal agency, including any of the military armed forces, plan to work with that agency in the same manner, but notify Technical Operations ATC Spectrum Engineering Services early on in the case for possible headquarters support.

**1412. ELT PROBLEMS.** Since their introduction, ELT's have caused a considerable amount of interference by false activations. Since they are on the emergency frequencies 121.5/243.0 MHz, they must be located and shut down quickly to keep the channels clear for legitimate ELT use by downed aircraft. Air traffic control facilities will be the first to know if a false activation occurs, since it mostly occurs on an airport. If it is very strong, the concerned service area air traffic organization should not only notify the Search and Rescue (SAR) personnel, the nearest ARTCC, and the service area duty officer, but also the appropriate SMO and the FMO. Most SMO offices have been supplied with hand carried ELT locators. They or other hand-held DF receivers can be used to locate the offending ELT. The hand-held K95-100 series DF supplied to service area FMOs and SMOs is an effective system for ELT location. Sometimes an accidentally triggered ELT may be in the trunk of a personal car, taken home by the pilot, or (as has happened) been set off by rough handling in shipping. An accidentally triggered ELT may be found at nearly any location, even far away from airports.

**a. Procedure:** The ELT must be silenced as quickly as possible. The FCC can be called for assistance, but this should be as a last resort and only if the FAA personnel cannot locate it themselves. Once found, it must be reported to the duty officer and the appropriate service area air traffic organization manager whose facility first reported it. By national agreement, all ELTs heard are assumed to be a downed aircraft until proven otherwise.

**b. Aircraft ELT:** If the ELT is located in an aircraft, do not enter it. The local General Aviation District Office (GADO) or Air Carrier District Office (ACDO) and the service area duty officer shall be notified as to the aircraft identification. It is their job to contact SAR and the owner of the aircraft to shut it down.

**1413. RECORDS OF UNUSUAL PREVIOUS CASES.** While all cases must be reported (see paragraph 1401), unusual or unique case records can provide a wealth of material which can be used to save time in resolving similar cases. All FMOs are requested to submit brief narrative descriptions of unusual resolved problems to Technical Operations ATC Spectrum Engineering Services so that they can be disseminated to other service area FMOs. The SMDb shall be used as much as possible to record these unusual events. In addition, audio tape recordings should be made of new or unusual cases and forwarded to Technical Operations ATC Spectrum Engineering Services for inclusion in the national RFI sounds bank. This sound bank can be found within the NAS RFI or GPS RFI modules of the SMDb for easy electronic file download. If the source has a particularly unusual video presentation on an oscilloscope or spectrum analyzer, a video tape of the RFI sent to Technical Operations ATC Spectrum Engineering Services would be useful and can be included electronically as part of the SMDb logged event.

**1414. thru 1499. RESERVED**

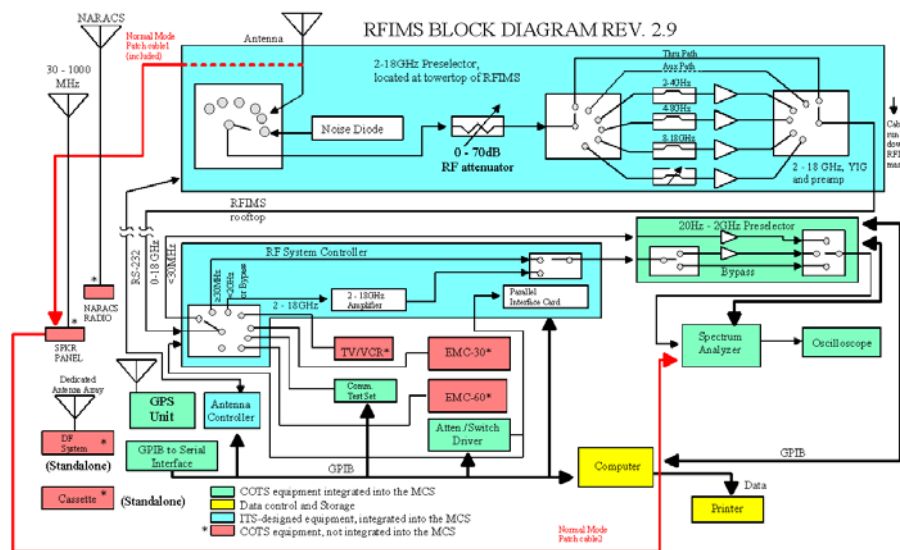


## CHAPTER 15. RADIO FREQUENCY INTERFERENCE MONITORING VANS (RFI VANS)

**1500. INTRODUCTION.** The term "RFI Van" is the name historically used to identify the vehicles with specialized equipment, which are used for the location and resolution of radio frequency interference problems affecting the National Airspace System (NAS). The most recent generation of RFI Vans is known as the Radio Frequency Interference Monitoring System (RFIMs). The RFIMs are operated with or without engineering personnel to perform a certain set of measurements. The RFI Van vehicles have varied from passenger automobiles with basic RFI equipment, to Step Van vehicles, to large trucks with measurement electronic equipment housing power generating system to power it. In this order, the terms "RFI Van" or "Van" encompasses all those vehicles past, present and future including the new generation under the Transportable Interference Monitoring Detection System (TIMDS) program.

**a. The RFI Van:** This is an engineering tool with advanced automation used for the management of the radio spectrum. The RFI Van performs many functions in the Communications Navigation and Surveillance (CNS) area. In addition, Radio Frequency Interference resolution is an important part of its function. Figure 15-1 shows a block diagram of the equipment functionality used in the current RFIM.

**FIGURE 15-1. RFIM FUNCTIONAL BLOCK DIAGRAM**



**b. RFI Van Spectrum Monitoring:** The spectrum used by the FAA has an increasing requirement to be continuously monitored. As more FAA facilities are added to the NAS, and transmitters from other services surround these facilities, the already congested spectrum becomes more crowded. Careful RF engineering must be performed to effectively use the portion of radio spectrum allotted to the FAA. The service area Frequency Management Officer (FMO) uses the capabilities of the RFI Van to monitor the spectrum environment in the service area and engineer its use effectively.

**c. RFI Van National Program:** Technical Operations ATC Spectrum Engineering Services established the Radio Frequency Interference Monitoring (RFIM) System to specify a standard RFI Van configuration for all FAA service areas. This program standardized the style and configuration of the vehicle, equipment and software for the RFI vans based on service area FMO office requirements. In addition, a comprehensive safety modifications program has been implemented for each service area RFI Van. The operation, control and maintenance is currently the responsibility of the service area FMO.

**1501. CONTROL AND RESPONSIBILITY.** The service area Frequency Management Office has full responsibility for the operation and maintenance of the RFI Van assigned to their service area. The FMO schedules calibration of all RFI Van systems on a yearly basis. The FAA William J. Hughes Technical Center has established a national RFI Van modification and test facility in Atlantic City, New Jersey. Improvements, safety modifications, and software changes are coordinated through the RFI Van Engineering Change Proposal (ECP) process.

**a. FMO RFI Van Planning:** The Frequency Management Office plans and schedules the use of the RFI Van for providing electromagnetic radiation measurement and interference detection and location services to organizations having a need for it. System Management Office (SMO), Systems Operations Centers (SOC) or Operations Control Centers (OCC) specialists are required to coordinate with the service area FMO.

**b. FMO RFI Van Familiarization:** The FMO is the FAA representative thoroughly familiar with the technical equipment in the RFI Van, the practical applications of it, and possesses good knowledge of any facility equipment in need of test and measurement for which the RFI Van will be useful.

**c. FMO RFI Van Coordination:** The FMO operates the equipment in the RFI Van, records and analyzes measurement data, evaluates results, and prepares necessary documentation and reports. In addition, the FMO works closely with service area air traffic organization, SMO, and other concerned personnel to uncover, locate, and eliminate harmful interference. The FMO is the focal point for coordination with the FCC and other appropriate agencies in resolving harmful interference problems consistent with agency interests.

**1502. RFI VAN USE.** The RFI Van is outfitted with state of the art measurement equipment and automation tools, which can be used for radio frequency interference location and resolution. A variety of electromagnetic radio spectrum measurements can be accomplished. Some of these uses are:

**a. Antenna Radiation Patterns:** The RFI Van system will measure and plot antenna radiation patterns while the facility under test operates normally.

**b. Interference Detection:** The RFI Van Direction Finding equipment provides Lines of Bearing (LOB) in the direction of an electromagnetic signal source.

**c. Spectral Signature Measurements:** The RFI Van Spectrum Analyzer equipment allows Fast Fourier Transform (FFT) measurements while the facility under test operates normally.

**d. Frequency Measurements:** RFI Van Frequency Counter equipment performs frequency tolerance measurements on facility transmitting equipment without disruption its operation for later adjustments.

**e. Electromagnetic Surveys:** The RFI Van automated software tools allow for electromagnetic compatibility and field strength measurements for facility coverage without disruption.

**f. Radiation Hazard Measurements:** Non-Ionizing radiation (i.e., thermal radiation) measurements can be performed for facility compliance with Occupational and Safety Hazards Administration (OSHA) standards.

**1503. INSTRUMENTATION.** The RFI Van is outfitted with a standard set of equipment and instrumentation to assure the capability of accomplishing the uses and functions listed in paragraph 1502. Additional equipment may be added temporarily at the option of the individual service areas for specific tasks that will require other specialized equipment. However, the core equipment is the following:

**a. Field Strength Meter:** The FAA operates in certain portions of the radio spectrum, so it is essential that FMS equipment be properly calibrated for measuring the spectrum in which FAA operates. The RFI Van FMS measure frequencies from Low Frequency (LF) Non-Directional Beacons (NDB's) through Airport

Surveillance Radars (ASR) and Radio Communication Links (RCL). The Airport Surveillance Detection System (ASDE), Television Microwave Links (TML) and other new facilities can be measured as well. The four field strength measurement ranges are:

- (1) 100 kHz to 30 MHz.
- (2) 30 MHz to 1000 MHz (1GHz).
- (3) 1 GHz to 10 GHz.
- (4) 10 GHz and above.

**b. Spectrum Analyzer (SA):** The RFI Van spectrum analyzer has a measurement frequency range from Very Low Frequency (VLF) 9 kHz to Super High Frequency (SHF) 26 GHz. The spectrum analyzer has X and Y outputs to record received signal spectra on a standard X-Y Plotter. In addition, computer interfaces allow for a standard commercial printer or plotter to be used. The Spectrum Analyzer also comes with the capability to add optional external mixer devices that increases the measuring range to millimeter wave. Like the field strength meter, the SA also must be calibrated so that it can be used in finite field strength and power density measurements.

**c. RF Signal Generator:** The RFI Van is equipped with a signal generator for generating test signals to be performed on site bench measurements of interest. The Signal Generator is capable of generating signals from 500 kHz to 1 GHz.

**d. Frequency Counter:** The RFI Van is equipped with a frequency counter with a range up to 1.5 GHz. This equipment is usable for any counting function, however, it is particularly useful for measuring radar/beacon pulse repetition rates (PRRs) in conjunction with the field strength meter. In addition, it permits direct off-the-air measurements of high-level signals.

**e. Step Attenuator:** The RFI Van has accurate external step attenuators for increasing measurement equipment input attenuation with a range from 0 to 120 dB in 1 dB or 10 dB steps from 500 kHz through 26 GHz. External Step Attenuator purposes are twofold.

- (1) It can be used for dB step calibration of the X-Y Plotter and antenna pattern recordings.
- (2) It can be used to insert basic attenuation before the field strength meter or SA to prevent its overload and operation at its greatest sensitivity, inhibiting AGC action, thus permitting linear readouts.

**f. Antennas, Rotator and Mast:** The RFI Van is equipped with a set of antennas to cover the radio spectrum capable of being measured by the field strength meters and SAs as mentioned in subsections a and b above. Generally, this will be loop antennas for the L/MF frequency range, frequency adjustable Dipoles, Log Periodic or Biconical antennas for 30 to 1000 MHz, and Horn or Helical antennas for 1 GHz and above. Yagi antennas for specific ranges are very effective. An antenna rotator mounted on the roof of the van allows rotating the installed antenna from inside the vehicle for the proper direction or polarization. The RFI Van is also equipped with a pneumatic mast that rises up to 40 feet.

**g. Tunable Filters:** The RFI Van is equipped with filters (i.e., band pass, notch, etc.) for at least the range 100 MHz to 3 GHz. The filters are interfaced or connected in front of the field strength meter or SA to eliminate instrument self spurious signal generated from the presence of very strong environmental signals other than the frequency being measured.

**h. Oscilloscope:** The RFI Van is equipped with a scope for measuring rapid events, particularly rotating radar. It is also used for analyzing detected signals from receivers, field strength meters or SAs.

**i. Audio Tape Recorders:** The RFI Van is equipped with audio tape recorders for recording the sound of received signals. The unit is particularly useful in recording interference signals for evidence and later resolution. The RFI Van computer workstation may also be used for this purpose if a sound card interface is available.

**j. Aviation VHF Transceiver:** The RFI Van is equipped with an air-ground aviation transceiver for communicating with Air Traffic Control Towers (ATCT) and Flight Service Station (FSS) on airports and with Flight Inspection (FI) aircraft during interference locating procedures.

**k. Land Mobile VHF Transceiver:** The RFI Van is equipped with a Frequency Modulated (FM) narrow band transceiver for communicating with SMO personnel at sites under investigation, in some circumstances with FI aircraft, and sometimes with the home base via the NRCS (C<sup>3</sup>) network.

**l. Direction Finder:** The RFI Van is equipped with a direction finder system capable of providing a line of bearing (LOB) in the direction of the source signal. This equipment is extremely useful when detecting and locating signals causing interference to FAA systems.

**m. Printer and X-Y Plotter:** The RFI Van is equipped with a commercially available Laser Jet quality printer. An optional X-Y Plotter may be used by the FMO conducting the measurements.

**n. DC Inverter:** The RFI Van is equipped with a commercially available direct current (DC) to 115 volts (V) alternating current (AC) inverter for powering low-drain ac powered equipment and charging NiCad batteries for accessory equipment in the van. The RFI Van vehicle battery supplies the DC source and is charged or "floated" by the van engine alternator.

**o. Engine Generator:** The RFI Van is equipped with a commercially available gasoline (or diesel) driven generator for 117 V AC of 1.5 to 3.5 kW capacity. This unit is used for supplying ac power to the larger drain units and used when the van is parked with its engine turned off and not charging the RFI Van battery.

**p. Ancillary Items:** Service area Frequency Management Offices may from time to time use a number of ancillary items as follows:

(1) **Step-recovery diode** for extending the frequency meter and generator output to at least 3 GHz for accurate radar and beacon frequency measurements.

(2) **Broadband amplifiers** for at least 100-1,000 MHz, to permit increased signal level to drive the step recovery diode for microwave measurements above 1 GHz.

(3) **Ultrasonic narrow beam detector** for locating specific defective insulators or crossarms on power poles which cause arcing and resultant broadband interference.

(4) **A Citizens Band (CB) transceiver** for receiving road advisories when the RFI van is on long trips. (FMOs are reminded that CB may only be used for receiving information, and not transmitting, unless there is a road emergency involved.)

(5) **Family Radio Service (FRS) FM Transceiver** for intercommunicating with the RFI Van personnel or during interference location coordination.

(6) **Extra Step Attenuator** for additional signal attenuation when in close proximity of high emitters.

(7) **Altimeter and Compass** for altitude and azimuth determination with respect to the measured site.

(8) **A radar beacon transponder** mounted in the van, used only to work with a service area air traffic organization and Flight Standards to positively locate the van on a radar scope when working on radar measurements or interference problems.

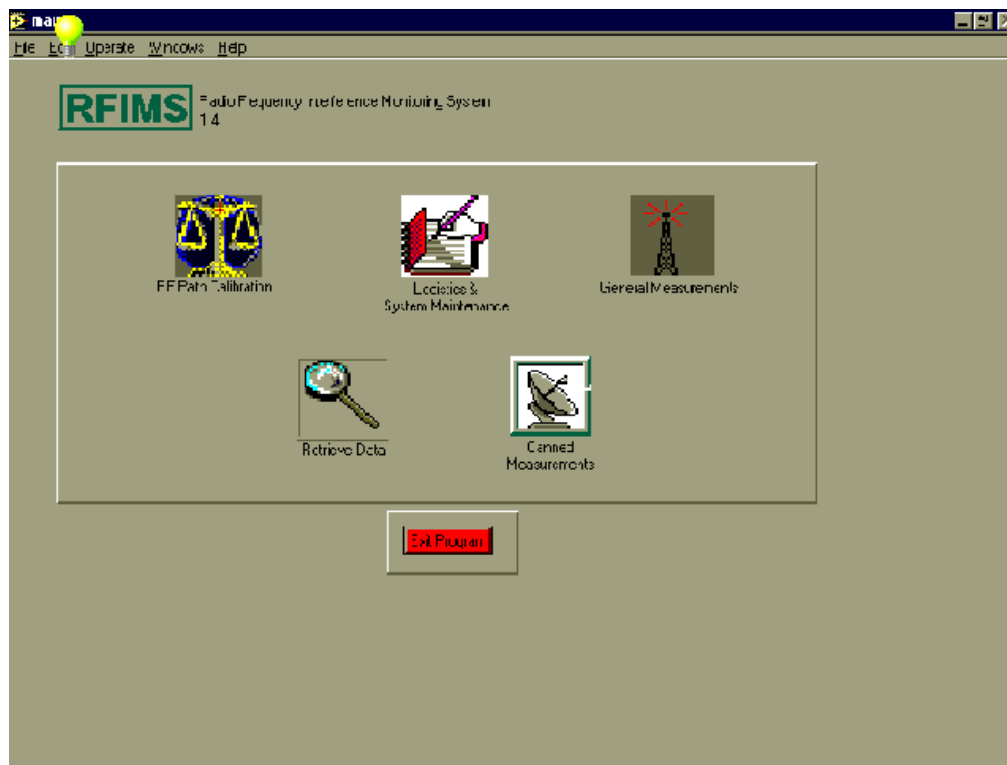
(9) **Global Positioning System receiver** for determination of precise position in latitude and longitude at the location of conducting measurements.

(10) **A cellular telephone** for contacting other agencies such as the Federal Communications Commission or Law Enforcement as deemed necessary.

**1504. RFI VAN SYSTEM OPERATION.** Operating the various systems in the RFI Van requires knowledge, training, and skill. While there are several independent systems, they all merge into one total monitoring and measuring system. The FMO must remember that measurements and follow-on documentation is very important for the various agency and service area programs. The FMO's work may be presented as evidence in court. Thus, all measurements and documentation resulting must be handled within the highest professional standards.

**a. The RFI Van measurement control system (MCS):** The MCS is an easy-to-use program for computer controlled field frequency measurement. A selection of canned measurements is available which requires a minimum of user input. The canned measurements are the simplest way to take RF measurements, and those canned measurements include most of the measurements required by the FAA. The MCS can perform an RF path calibration and use the results to adjust measurement values to account for the changes in system gain at higher frequencies. FMOs may also manually set up the instruments, and then use the MCS software to capture the instrument settings and data on the computer hard drive. The MCS has been written in LabVIEW® 5.0 under the Windows 95® operating system with many menu driven functions. Technical Operations ATC Spectrum Engineering Services has developed a comprehensive training course for the use of this automated tool. The following paragraphs will deal mostly with instruction and examples of each system operation from a general perspective. See Figure 15-2.

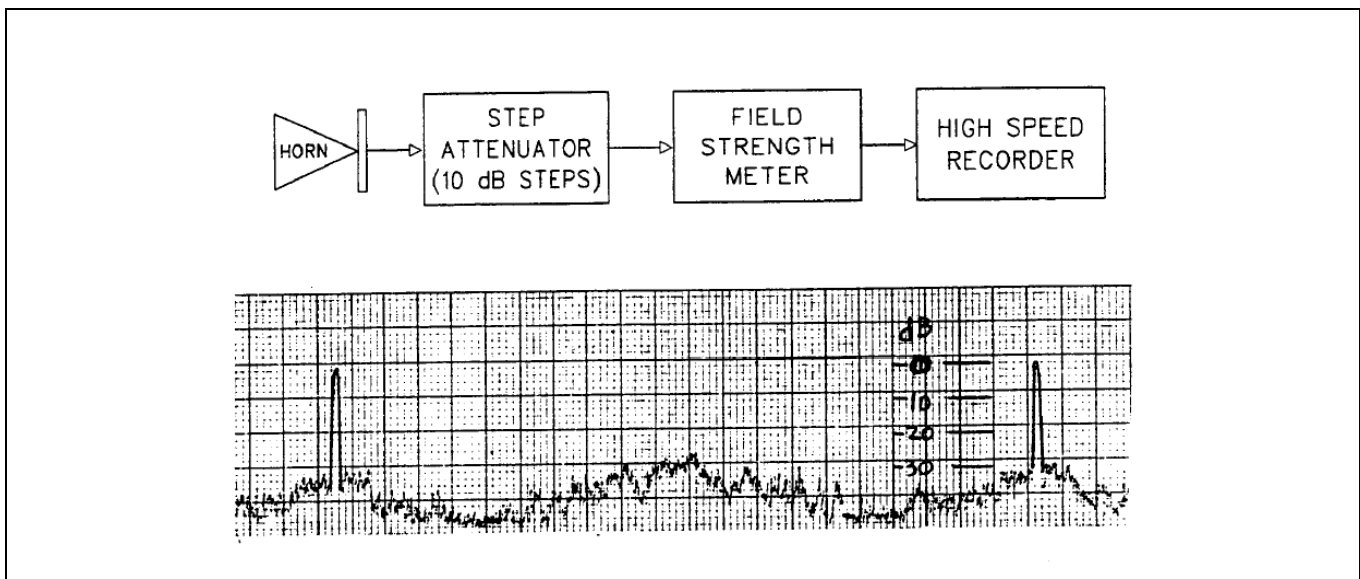
**FIGURE 15-2. MCS CANNED MEASUREMENTS STARTUP SCREEN**



**1505. RADAR AND ATCRBS ANTENNA PATTERN RECORDING.** Radar antenna pattern recording is a valuable product of RFI van measurements. It permits actual radiation pattern recording from any point in space the measuring equipment can be located. It can be accomplished without the radar having to shut down or make any changes in its normal operation, unless the measurements are made to allow various patterns to be measured as the antenna or transmitter functions or hardware are changed. Done correctly, the measurement permits the FMO to determine whether the radar and beacon radiated patterns are normal as well as the directional and nondirectional pattern ratios of SLS operation. The FMO can make this determination on site, within the time it takes to record one revolution of the radar antenna, usually between 5 and 15 seconds. The results then can be transmitted to the site, to the SMO, or the OCC, so that a decision can be made immediately. An SA with printer or a computer controlled spectrum analyzer (CCSA) with a printer provides superior results.

**a. Primary Radar Antenna Pattern Plotting with field strength meter/X-Y plotter:** This is a basic measurement and requires only these devices: a receiver (including an SA), a high-speed recorder, a calibrated step attenuator and a suitable calibrated antenna with a stable mount. **NOTE:** The procedure below is specifically for a field strength meter as the receiver, but use of an SA will be similar except for some steps. Many SAs can be manually tuned which simulates manual tuning of a field strength meter. See figure 15-3.

**FIGURE 15-3. RECORDING SETUP AND SAMPLE TAPE**



**(1) Set the step attenuator** to its highest attenuation (80 to 120 dB) to prevent damage to the field strength meter from high-level signals.

**(2) Connect the appropriate Horn antenna** to the input of the attenuator, with the output of the attenuator connected directly to the input of the field strength meter.

**(3) Set the field strength meter internal attenuators** to zero, to prevent AGC action from giving nonlinear readouts.

**(4) Set the antenna** for proper polarization. If in doubt, try both horizontal and vertical polarization of the horn and use the one giving highest signal level. Usually, there is about a 15 dB difference between correct and reverse polarization indications. Adjust the azimuth to approximately the radar direction.

(5) **Tune in the radar** on the field strength meter. This probably will require carefully reducing the step attenuator in 10 dB steps while tuning the radar frequency. Adjust for on-scale meter and recorder by noting the peak pass recorded on the recorder. The direct peak function of the field strength meter can be used for this careful tuning process if the recorder is turned OFF. If a Spectrum Analyzer is used this step will be equivalent to the Max Peak hold mode.

(6) **Set the field strength meter bandwidth** to 1 MHz or nearest value.

(7) **Carefully rotate the antenna** in azimuth for maximum signal to the field strength meter. This will take a little time since the signal will be varying widely in intensity as the radar rotates. Increase the step attenuation if it becomes necessary to keep an on scale reading.

(8) **Set the field strength meter function** to quasi-peak or slide-back peak. The goal is to obtain a time constant of 10 msec without "dump." **NOTE:** In direct peak function, the EATON NM-65T field strength meter will inject a reverse voltage at the end of the store time to restore the meter to a low value quickly to get ready for the next peak pass. The high-speed recorder will slam against its lower reference level and could be damaged due to the large reverse voltage applied. The field strength meter, with its slow ballistics due to damping, will not be slammed.

(9) **Connect the high-speed recorder** to the Y or signal output of the field strength meter. **NOTE:** If the recorder has been carefully calibrated before, only a quick check of levels would be required. If not, calibration must be done at this time before any of the instrumentation controls are touched. Calibration of the high-speed recorder is discussed in paragraph 1506.

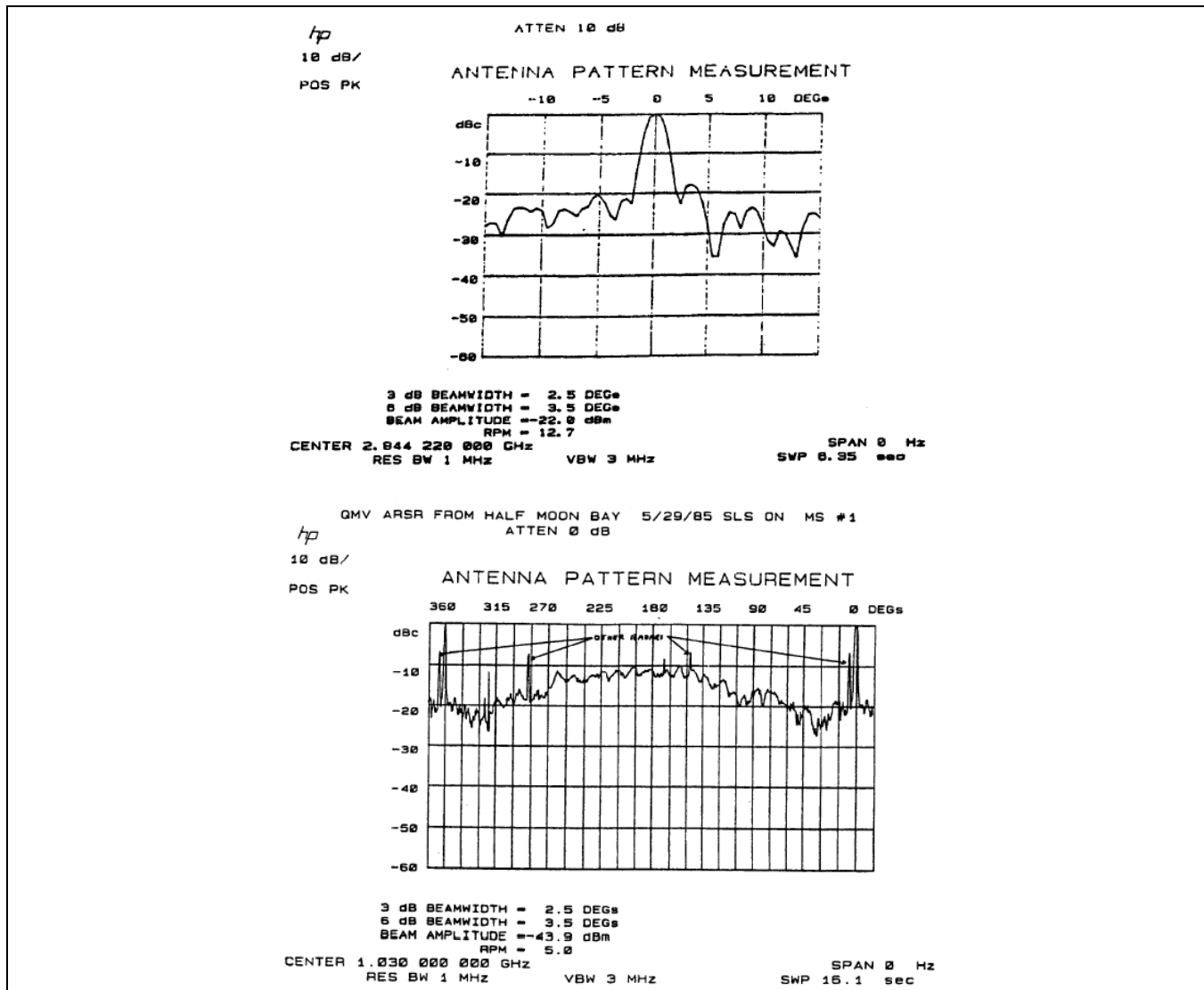
(10) **Adjust the attenuator** so that a near maximum scale reading is received when the radar is "search-lighting" the RFI Van, the maximum signal to be received.

(11) **Record at least one full pass** of radar illumination, with two or three consecutive being preferable to average out any anomalies or reflections in propagation, such as aircraft flying through, a passing vehicle's ignition noise recorded, etc.

(12) **Analyze the recording** briefly and advise Technical Operations Services or service area air traffic organization personnel waiting for the information. Retain the recording for follow-up detailed analysis and documentation.

**b. Primary Radar Antenna Pattern Recording with a CCSA:** When the Computer Controlled Spectrum Analyzer (CCSA) is coupled with a standard printer it will provide superior results. The basic setup is similar to field strength meter/X-Y plotter, except the measurement components are replaced with a Spectrum Analyzer and associated standard printer. The 12 steps listed in paragraph 1505a above are applicable. Careful attention should be taken in the steps regarding preventing overload and nonlinear readout for the SA just like for the field strength meter. The advantage is that the CCSA does its own internal calibration and prints these values as well as the grid scale values on the print out. Expanded prints of the radar beam can easily be obtained by merely programming the CCSA before a recorded or stored pass. Examples of CCSA printouts (reduced from a standard 8½" x 11") are shown in Figure 15-4.

FIGURE 15-4. EXAMPLES OF ANTENNA PATTERNS ON CCSA PRINTOUTS



**c. Beacon Antenna Recordings:** These are done the same way as mentioned in 1505a and 1505b, except for two conditions. The field strength meter or CCSA bandwidth cannot be less than 1 MHz to prevent the possibility of signal processing error due to the difference of pulses transmitted by the directional and omni-directional antennas. Two plots must be made, one immediately after the other, with the SLS omni on, then off. This allows the FMO to assure that there is no "punch through" of the directional signal on the normal SLS radiated pattern.

**d. Pattern Recording Considerations:** The previous list in paragraph 1505a of "how to perform measurements" gives instruction on the actual recording process. However, every bit as important is the special considerations that must be evaluated for each measurement.



**(1) Knowing the monitoring site** location with respect to the radar being measured is very important. Using maps for azimuth and distance and the on board altimeter, a close estimate of location can be obtained. If the RFI Van has a beacon transponder and previous arrangements have been made with the service area air traffic organization, a reading of the transponder's distance and azimuth from the associated radar coupled with the on board altimeter, can give an exact location of the RFI van. Use of a GPS receiver is recommended.

**(2) From the location determination,** the vertical angle between the monitoring site and the radar antenna site can be calculated. This is critically important. If the site is at  $0^\circ$  vertical angle or lower to the calculated vertical angle of the radiated beam, the recording and resultant plot should be considered as reference only. It is useful for checking radiating patterns at later dates, but should not be submitted as the actual pattern. This is because the beam "nose" will be above the recording site, and thus all references to signal levels, which are used to plot the ultimate pattern, will not have the correct "nose" reference and will be faulty. Below  $0^\circ$ , the antenna pattern cuts off rapidly, while above  $0^\circ$  it falls off slowly so that only very little error ensues, even for a few degrees. A site vertical angle of a degree or so above the beam line is best.

**(3) An elevated monitoring position** is essential. However, in mountainous terrain, reflections can lead to false levels at some azimuths with respect to the radar. When in mountains, make a second recording a few feet or a few hundred feet away, to assure the first site was a valid non-reflective site and vice versa. A quick comparison of the two recordings can determine any appreciable differences.

**(4) When a good monitoring site** is not available, alternatives must be considered. Sometimes the top of a building can provide a suitable site, if the measurement is made from the roof edge nearest the radar to reduce or eliminate reflections. If the radar antenna is not mounted too high, a "cherry picker" can be used to get to the proper height. In this case care must be taken to assure that the field strength meter is properly shielded to provide a sufficient dynamic range of recording. Verify by placing a metallic cover cap or shorted coaxial connector over the antenna input terminal. If a signal level is recorded it should be due to leakage. If that peak level with the cap over the input terminal is 40 dB or more below the level indicated with the Horn antenna connected normally, the recording can be considered accurate, at least down to that level. If none of these alternatives are possible, then the situation of a "reference only" recording must be considered. Helicopters and aircraft have been tried, but have not given good results due to the instability of the measurement platform for the period of antenna revolution.

**1506. HIGH-SPEED RECORDER CALIBRATION AND OPERATION.** The following are the general recommended procedures: (See figure 15-3)

**a. Calibration.** Setting the zero and span controls is necessary to establish levels that can be relied upon from measurement to measurement. A calibration can be accomplished right on the tape itself. This is done by using the incoming signal, which is recorded as the source for calibration of this recording only. After normal pattern recording, slow the tape speed to the slowest practical. While the tape is recording, insert successive 10 dB steps of attenuation between each illumination so that each pass represents 10 dB less level. Adjust the span control so that the 10 dB marks coincide with the tape horizontal lines.

**b. Operation.** Depending on the speed of antenna rotation, the tape pull rate should be 25 or 50 mm/sec. This allows a good resolution of higher speed ASR plots, while still not making the ARSR plots too long physically. If the recorder has easily changed speed ratios, it is most beneficial to be able to reduce the rate to 5 mm/sec or so when calibrating or tuning the system. This allows accuracy in reading the peak recorded, yet does not waste yards of tape for those functions. If speed change is not easily done, the recorder can be turned off between radar passes for calibrating, to save recording tape.

**c. Documentation.** While the FMO now has a completed tape, it should be incorporated into a technical report of the operation. Reproduce the tape as recorded, but include calibration marks so that anyone can read it. In addition, affix an identification label, which includes date, time, location, source and any other pertinent data.

The calibration should be shown directly on the tape, with the "nose" of the pass indicating 0 dB and other declining dB levels as minus, e.g., -10 dB, -20 dB.

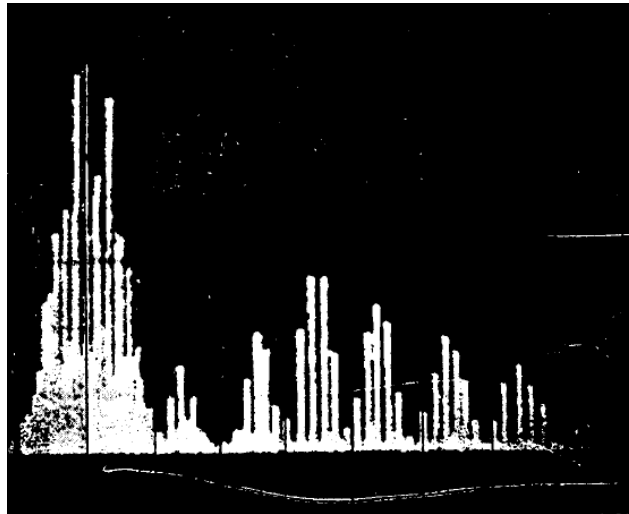
**1507. SPECTRUM ANALYSIS.** Spectrum Analysis of any segment of the radio spectrum is valuable for planning and problem solving and can be done in three ways. One uses a spectrum analyzer with photographs taken of the scope presentation. The second uses a field strength meter and X-Y plotter. The third uses the CCSA system to do it all.

**a. Spectrum Analyzer Photographing:** Taking a photograph of a rotating radar is relatively easy to obtain, but generally does not yield as high a resolution as capturing the data with X-Y Plotter or Computer Controlled SA printer. The following steps are recommended:

**(1) If the antenna is stationary,** plotting is easy. Merely scan the portion of the spectrum desired. Then use a scope camera and take a picture of the spectrum appearing on the screen, but allow aperture opening long enough to obtain a full scope sweep.

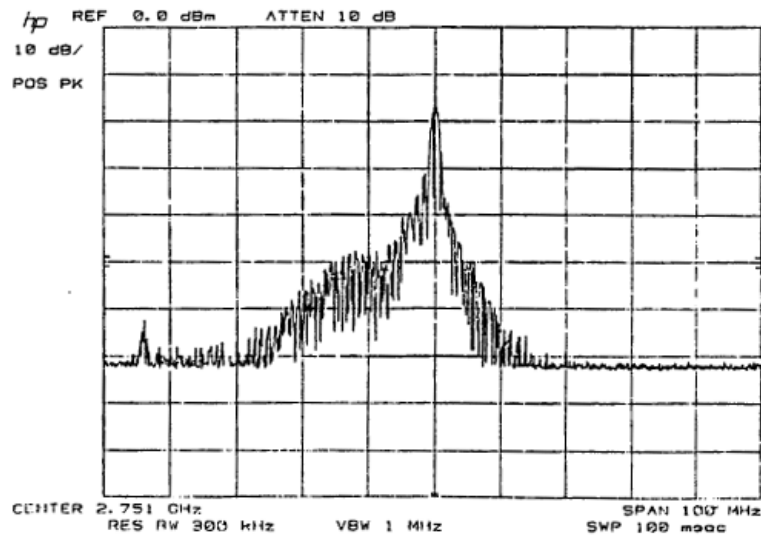
**(2) If the antenna is rotating,** it will be necessary to perform two steps. Allow several passes to accumulate on the screen in the storage mode before taking the scope picture. Open the camera shutter while it is on the scope and allow several passes (6 to 10 is recommended) to allow the camera to act as the storage medium. An example of a spectrum picture from a spectrum analyzer is shown in figure 15-5.

**FIGURE 15-5. PHOTO OF SPECTRUM FROM A SPECTRUM ANALYZER**



**b. Computer Controlled Spectrum Analyzer:** There are great advantages in using this approach. The results are readily seen in the reduced size spectrum plot shown in figure 15-6. Here, the amplitude (Y axis), frequency range (X axis), bandwidth, storage time, and all essential parameters are transmitted to the computer via a computer interface. Upon command, it simply stores, then prints or plots the results.

**FIGURE 15-6. CCSA PRODUCED RADAR SPECTRUM PLOT**



**c. X-Y Plotter Recordings:** These are much more complicated to do, but provide much greater resolution, particularly if a CCSA system is not available. However, the process of setup is complex and requires some explanation.

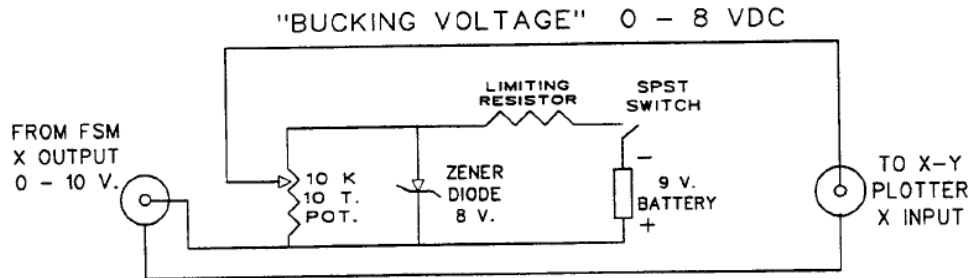
(1) **The X-Y Plotter** essentially takes an X-axis variable voltage to provide the frequency base of an X-Y plot. As the field strength meter is tuned from a reference frequency to a higher frequency, the X output voltage increases in a linear manner with respect to frequency. Once the frequency range to be scanned is established, the FMO must then set up the plotter so that its baseline represents a calibrated frequency line.

(2) **Most field strength meters** have variable output X voltage directly proportional to frequency. That is, on a 1 to 10 GHz frequency range, the field strength meter linearly provides 1 to 10 V dc for the X-Y plotter X-axis. The problem is that the X-Y plotter normally has only a 0 to 1 V recording range and a dc "bucking voltage" capability is required to permit zeroing the left edge of the plot when the field strength meter X output voltage is greater than 1 V.

(a) **Assume an ASR spectrum is to be plotted** and it is desired to plot from 2650 to 2950 MHz. That means that when the field strength meter tunes from 2650 to 2950 MHz to cover the whole page, the X voltage supplied the X-Y plotter will be 2.65 to 2.95 V dc, respectively. But since the X-Y plotter is designed to only handle 0-1 V dc and it can only "buck" 1 V dc, the recording would be impossible. The recorder would be hard against the right margin trying to reach a nonexistent 2+ V position.

(b) **The solution** is to provide an in-line variable "bucking" voltage. This can be accomplished by placing a 10/1 voltage divider across the X output of the field strength meter. But this is not the most recommended approach. Some X-Y plotters draw significant current through their X inputs, since it is only a variable voltage divider in the first place. Any additional voltage divider then would be very nonlinear.

(c) **A better solution** is to build a stable and variable "bucking" voltage source to be placed in line with the X output of the field strength meter. The basic dc sources can either be an ac driven transformer low ripple dc supply, or a simple battery with a Zener diode. With the battery, of course, provision must be made for shutting off the battery when not in use. A schematic diagram of a suitable "bucking" device is shown in figure 15-7.

**FIGURE 15-7. A DC BUCKING VOLTAGE SYSTEM FOR X-Y PLOTTERS**

**d. Calibration:** Calibration of an X-Y plot is a process that takes some time, but takes less as the FMO becomes familiar with it.

- (1) **Connect** the "bucking" voltage in reverse series.
- (2) **Turn on the field strength meter** and tune to the LOWEST frequency to be scanned V.
- (3) **Connect the X and Y outputs** of the field strength meter to the X-Yplotter.

(4) **Turn on the X-Y plotter** with the pen lifted. Unless by chance the "bucking" voltage and field strength meter X output voltage are nearly identical, the pen will go hard left or right. Immediately adjust the bucking voltage control to bring the pen on scale.

(5) **Use the X-Y plotter zero control** as a vernier to put the pen on the zero left hand mark of the paper being recorded upon.

- (6) **Tune the field strength meter** to the HIGHEST frequency to be plotted.

(7) **Now adjust the X-Y plotter span control** so that the pen is on the right hand mark of the paper to be recorded upon.

(8) **Tune the field strength meter** to the LOWEST frequency to be recorded again and note the position of the pen. Most likely, it no longer will be on the zero mark previously set. This is because there is some interdependence between the two controls.

(9) **Tuning the field strength meter** between the two limits of frequency to be recorded, carefully "jockey" the zero and span controls until the pen exactly coincides with the frequency span of the field strength meter between minimum and maximum frequencies to be recorded.

(10) **To improve the frequency accuracy** of the base line of the plot, it is wise to inject a small signal from the signal generator into the field strength meter to positively locate an accurate frequency mark on the plot. For instance, if 2700-2900 MHz were being recorded, it would be wise to inject alternately 2700 MHz then 2900 MHz with the "jockeying" so that the two ends are accurately marked. With the linearity of the X output, the frequency marks from the grid paper on the plotter can be assumed to be reasonably accurate.

**e. Y Axis Setup:** The following steps are recommended:

- (1) **Set the field strength meter function to "Log".**

(2) **With the field strength meter tuned off frequency** or the input temporarily disconnected so that the pen will drop down to its lowest voltage level to be recorded, adjust the Y axis zero control so that the pen is a quarter of an inch or so above the bottom line on the grid paper.

(3) **With the pen still up**, carefully tune the field strength meter to the center of the radar frequency.

(4) **Adjust the X-Y plotter Y output control** so the peak of the pen sweep on illumination by the radar goes up to 75 or 80 percent of full scale.

(5) **Set the IF bandwidth** to 0.5 or 1.0 MHz.

(6) **Tune the field strength meter** to the lowest frequency to be recorded (all the way to the left of the paper grid) and recheck the X-axis zero level to assure no drift has occurred while setting up. Readjust zero and span if necessary.

**f. Plotting:** The following steps are recommended for the plot:

(1) **Tune the field strength meter to the start frequency** and lower the pen to the paper. Allow sufficient time for at least one pass of the radar beam.

(2) **Carefully move** the tuning a very small increment and wait for another pass. It is important not to move the tuning while the beam is illuminating the van. Time the moves so that they are made near the back lobe pass. It is essential that once a plot has begun, tuning be continued in the same direction. There are both electrical and mechanical backlash, however small.

(3) **Continue advancing the frequency** in very small increments until a definite pass is indicated. Then move in increments small enough to give the resolution desired. When tuning is nearing the peak, reduce the advances to very small amounts, about the width of a pen stroke, to assure a very high-resolution plot.

(4) **Continue** to the end of the plot space. Lift the pen.

(5) **When the plot is completed**, tune the field strength meter back past the peak. Then carefully approaching from the same increasing direction, precisely tune in the peak again. **LEAVING ALL OTHER CONTROLS UNTOUCHED**, use only the X zero control to move the pen to almost the left edge of the paper grid.

(6) **Drop the pen onto the paper** for just one pass, then lift it quickly again.

(7) **With the X zero control**, move the pen just slightly to the right.

(8) **Using only the in-line attenuator**, add 10 dB of attenuation.

(9) **Lower the pen** and record one pass. Lift pen. Repeat these sequences until the attenuated peak pass signal is at a very low level, but not lower than -70 dB or so. It will be less if the plot is started well into the emitted spectrum. The plot is now completed.

**g. Documentation:** As with the antenna plots described before, the completed spectrum plot needs to be properly labeled and identified. Frequency marks should be placed at the bottom of the plot, at appropriate locations. Using the amplitude calibration marks, horizontal lines should be drawn to indicate levels. A sample plot is shown in figure 15-8.

**h. Discussion:** Figure 15-8 provides a highly defined emitted spectrum plot, accurately keyed to a frequency base. In essence, the field strength meter has acted as a very slow-moving focal plane shutter camera, imprinting a "slice" view sequentially on the paper. The reason for the on-plot signal source calibration is twofold:

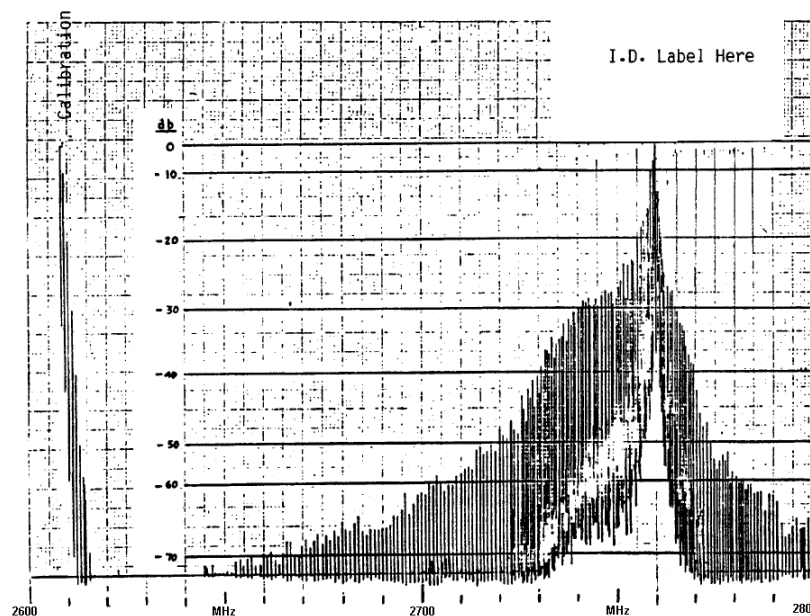
(1) It verifies the accuracy of the spectrum plot at time of review.

(2) It integrates all the limiting factors (any lost signal due to reduced bandwidth, ballistic drag of the plotter pen drive system, etc.) so that the spectrum overall accuracy is assured.

(3) If only 50 to 60 dB dynamic range is required, the 10 dB steps will be quite linear. But if a larger dynamic range is desired, it will be necessary to compress the upper 10 dB, in order to accommodate the wide dynamic range. This is because most field strength meters have only a 60 dB dynamic meter range. There might be small non-linearities noted between 10 dB levels. A check on any steady signal, using a similar on plot calibration verified by comparison with the field strength meter panel meter, may show that the in-line attenuator may not be perfectly linear, but should be  $< \pm 2$  dB.

**i. Signal Stability:** If the signal being plotted has a stable level such as a radar "searchlighting" the RFI Van (or a VOR or TACAN) the same procedure would be used, except the tuning could be done slowly but continuously, completing the plot in a minute or so. If the field strength meter has automatic frequency scan, that could be used, so long as the scan rate is slow enough to allow the damped pen to respond accurately to variations as it is moved across the page.

**FIGURE 15-8. SAMPLE SPECTRUM PLOT OF A ROTATING RADAR**



**1508. FREQUENCY MEASUREMENTS.** Frequencies usually are measured in one of two basic ways. The first is by direct means, the second by indirect means using a transfer standard. Both are easily accomplished with the RFI Van.

**a. Direct Measurements** are done simply by using a frequency counter or frequency meter. The incoming signal is fed to the frequency counter and read directly.

**b. Indirect Measurement** method uses a signal generator or other frequency meter and a receiver or SA. The desired signal is tuned in on the receiver or SA. An accurate calibrated signal source is also fed into the same receiver or SA through a variable attenuator, so that an appropriate ratio between the signal and the generator can be set. By vernier adjustment, the generator is adjusted to exactly the center of the spectrum distribution peak. In cases of a very strong signal to be measured, the signal is centered in the pass band of the receiver or SA scope. The signal is temporarily removed and the generator is fed to the receiver directly. The generator is then centered on the receiver or SA scope and the frequency read from the generator or from another accurately calibrated source measuring the generator. Most CCSA's have frequency measuring functions built in, either a marker with frequency is shown or the center frequency on the screen is measured and printed out in the spectrum plot.

**c. Extended Indirect Measurement** is usually used only for frequencies above 1 GHz, unless a very accurate signal generator is available for the microwave range. Most combination signal generators and frequency meters cover from lower frequencies up to about 1 GHz. To measure frequencies accurately above 1 GHz, the lower frequency generator is used, driving a step-recovery diode. This set up permits abundant harmonic output of the driving generator frequency and carries its level of accuracy. However, a step-recovery diode needs in excess of 1 V of RF to push it into harmonic generation. Using whatever generator is available in the van, add a small microwave amplifier, which in turn drives the diode with 1+ V, which will produce harmonics up to the 10<sup>th</sup>.

**d. Example:** For instance, an accurate measurement of 2755 MHz can be done using the transfer standard method by generating a 275.5 MHz signal, with the output signal at 2755 MHz at the 10<sup>th</sup> harmonic. Other harmonics are generated as well, so care must be taken to ensure the right harmonic is being used. Accuracy of the 2755 MHz signal will be equal to the signal generator, e.g., if the signal generator is accurate to .00001 percent, the 10<sup>th</sup> harmonic will also be accurate to .00001 percent.

**e. Accuracy Resolution:** This factor must be considered. Even though a meter or counter might have a 9 or 10 digit readout, the manufacturer's accuracy specification must be adhered to. A measurement of 10<sup>-8</sup> resolution is meaningless if the instrument is only accurate to 10<sup>-6</sup>. For example, an indicated measurement of 110.05061 MHz on an instrument of only 10<sup>-6</sup> accuracy should be rounded off to 110.051 MHz to be commensurate with the instrument's limit of accuracy.

**1509. OFF THE AIR PRR MEASUREMENT.** Pulse Repetition Rates (PRR) can be measured off-the-air in several ways. The following are recommended:

**a. Direct Pulse Rate Measurements:** Direct pulse rate measurement instruments provide reasonably accurate PRR measurements by sampling a radiated spectrum, removing the pulse elements, and automatically predicting the total rate per second. Sampling rates can be as short as 50 µsecs. These instruments are very expensive.

**b. Detected Pulse Rate Measurements:** The detected pulse rate measurement is commonly used. The process consists of taking detected video from the output of a field strength meter or SA and feeding it directly to a frequency counter. Most simple counters are designed for CW signals and may not respond well to a pulse signal. One way to solve this is to take the detected video and feed it first into a resistor/capacitor (RC) time delay circuit which will somewhat approximate a sine wave, then to the counter so it will read accurately.

**(1) A Time Constant (TC) circuit,** formed by a 10K ohm resistor and a 0.25 microfarad (µfd) capacitor will frequently be sufficient without reducing the signal too much. The FMO should experiment with a steady state pulse signal, while watching it on a scope, varying the TC to produce a reasonable replica of half a sine wave. Signal shaping which will give stable PRR readout is the goal.

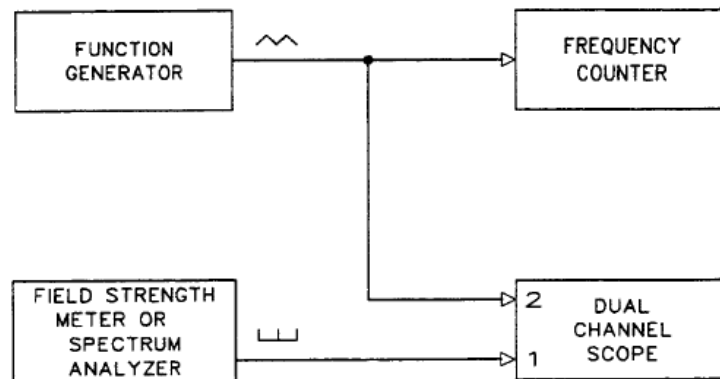
(2) A **varying pulse signal**, such as from a rotating radar, requires that the gate time of the counter be varied so that it does not include the actual searchlighting of the van. This large change in signal level can upset the gate counting cycle and give an unrepeatable PRR.

**c. Oscilloscope PRR Measurements:** These kinds of measurements are also very useful for widely varying amplitudes of signal.

(1) **In one use**, the video output of the field strength meter or receiver is fed to a calibrated scope. The sweep is set to trigger on the leading edge of a pulse. By adjusting the trigger level, a quite stable pulse presentation can be presented on the scope. The pulse period can be determined from the scope graticule and its calibration. The PRR is simply the reciprocal of the period. The accuracy is limited by how accurately the pulse period can be read. For example, a period of 2700  $\mu\text{sec}$  measured would translate into  $1 \div (2700 \times 10^{-6}) = 1 \div .0027 = 370.3$ , or approximately 370 pps.

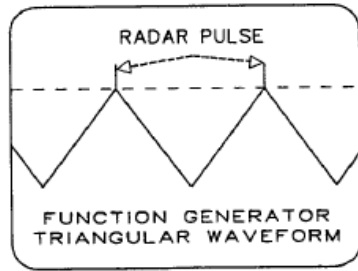
(2) **In another use**, the video output of the field strength meter or SA is fed to channel 1 vertical input of a two-channel scope. Using a function generator set for triangular wave output, connect it to channel 2 vertical input of the scope and a frequency counter. Set the trigger to channel 1. Refer to figure 15-9 for a typical setup. Either use the scope ADD function or position each of the channel presentations so that the detected pulse rides the peak level of the triangular wave. Adjust the triangular wave frequency until two consecutive peaks exactly match two consecutive pulses. Read the PRR from the frequency counter. Figure 15-10 shows correct and incorrect presentations for accurate measurement conditions.

**FIGURE 15-9. BLOCK DIAGRAM OF ONE METHOD OF MEASURING PRR**

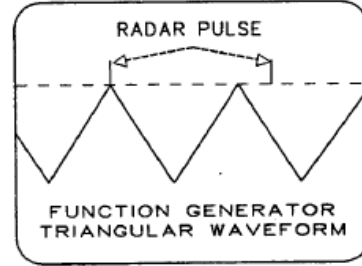




**FIGURE 15-10. SCOPE DISPLAYS FOR CORRECT AND INCORRECT MEASUREMENT**



SCOPE PRESENTATION FOR  
CORRECT MEASUREMENT



SCOPE PRESENTATION FOR  
*INCORRECT MEASUREMENT*

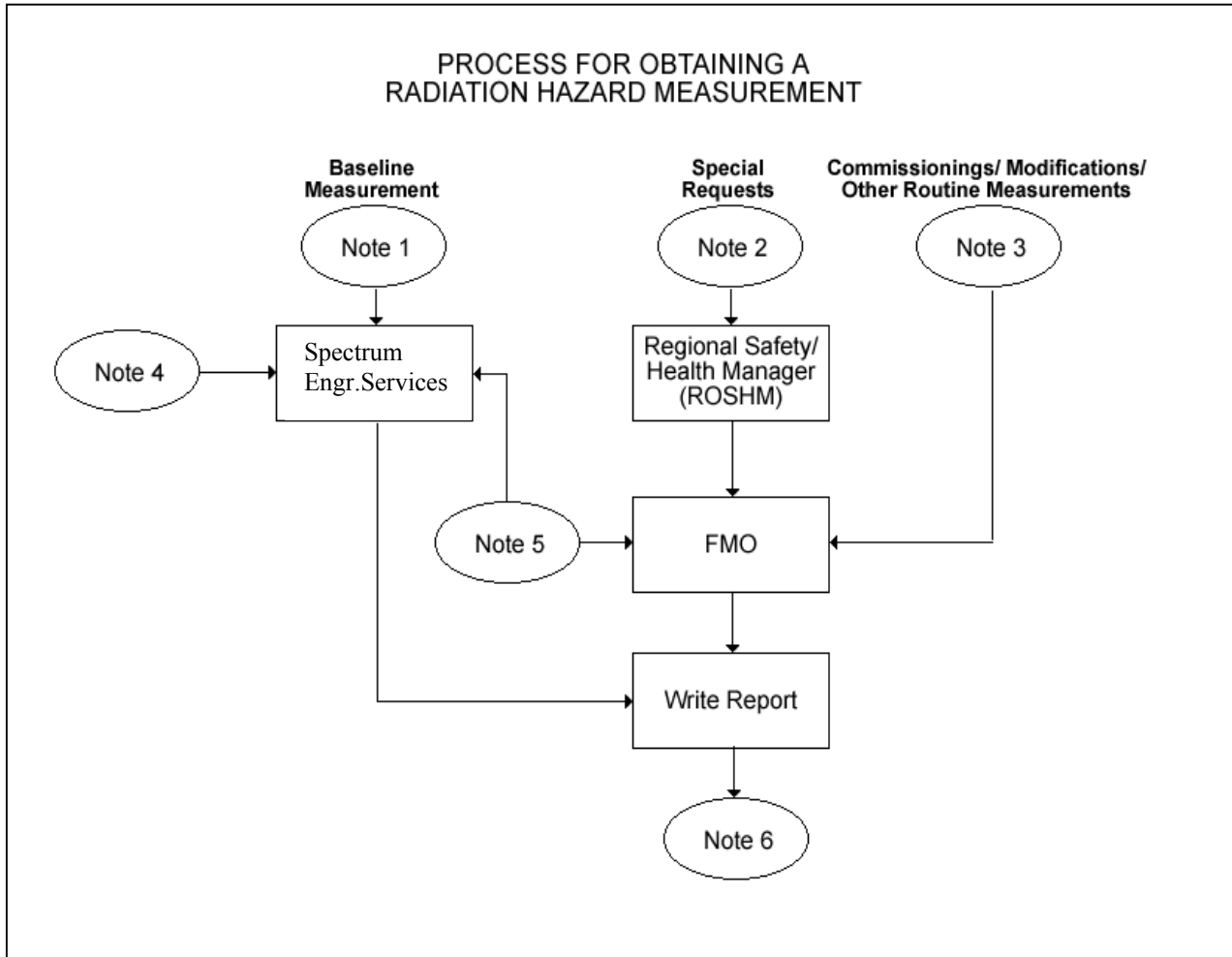
1510. thru 1599. RESERVED

## CHAPTER 16. IONIZED AND NON-IONIZED RADIATION MEASUREMENTS

**1600. PURPOSE.** This chapter specifies the procedures and considerations for ionized and non-ionized radiation measurements to be made by the FMO.

**1601. GENERAL.** Order 3900.19B, the FAA Occupational Safety and Health Program, assigns specific responsibility in the area of radiation safety and provides reference criteria for ionizing and non-ionizing radiation exposure. The FMO is responsible for the actual definitive measurements of radiation levels as specified in Order 3900.19B. Detailed measurement procedures are contained in later sections of this chapter. [Previously, Order 3910.3A, which was cancelled by Order 3900.19B, set Permissible Exposure Limits (PEL) for all Radar, Tactical Air Navigation (TACAN), Air-to-Ground communications (A/G), National Radio Communications System (NCRS), etc., for frequencies from 0.3 MHz – 100 GHz]. Order 3900.19B adopted the most current version of the Institute of Electrical and Electronics Engineers/the American National Standards Institute (IEEE/ANSI) standards (the 1999 Edition of C95.1) for **uncontrolled non-ionizing** environments and the most current version of the American Conference of Government Industrial Hygienists (ACGIH) Threshold Limit Values (TLVs) for Non-Ionizing Radiation for **controlled non-ionizing** environments. In lieu of using the term PEL, the non-ionizing exposure limits are called Maximum Permissible Exposures (MPE) in the 1999 Edition of IEEE/ ANSI C95.1 and the TLVs in the ACGIH document. Both are specified in units of milliwatts per centimeter squared (mW/cm<sup>2</sup>). Order 3900.19B also adopted the latest version of the ACGIH TLVs for **ionizing** radiation. The most current version of these standards available at the time of a survey shall apply.

**a. Technical Operations ATC Spectrum Engineering Services is an important element** within the FAA for performing radiation hazard measurements, both ionizing and non-ionizing. Technical Operations ATC Facilities, Environmental, Energy Conservation, and Occupational Safety and Health (EEOSH) Services will perform routine ionizing and non-ionizing radiation surveys for the purpose of accumulating data to use in the exposure assessments. A Letter of Agreement (LOA) for the division of functional Radiation Safety Program (RSP) Responsibilities was developed and agreed upon in September 2002 between the former FAA organizations Spectrum Policy and Management Program (ASR) and the Resources Management Program (AFZ). An update of this LOA is presented in figure 16-6 for reference. Figure 16-1 provides an outline of the process to be followed in making a radiation hazard measurement, consistent with the LOA.

**FIGURE 16-1. PROCESS FOR OBTAINING A RADIATION HAZARD MEASUREMENT**

**Note 1.** Appropriate HQ Program Office will request Technical Operations ATC Spectrum Engineering Services to conduct a baseline measurement.

**Note 2.** All requests for special RADHAZ measurements, other than those for commissioning, baseline, and routine will be referred to the ROSHM who will then refer to their service area FMO.

**Note 3.** For commissioning and/or equipment modifications, the appropriate service area program office will request that the service area FMO conduct a RADHAZ measurement.

**Note 4.** Technical Operations ATC Spectrum Engineering Services will either conduct the measurement or determine what resource to use to conduct it: the Mike Monroney Aeronautical Center, the William J. Hughes Technical Center, the service area FMO, or contractor. All measurements will be coordinated with Environmental, Energy Conservation, and Occupational Safety and Health (EEOSH) Services. Refer to the Letter of Agreement, 7-29-05 (figure 16-6), Technical Operations ATC Facilities item number 4, for Environmental, Energy Conservation, and Occupational Safety and Health (EEOSH) Services measurements.

**(Notes continued on next page)**

**(FIGURE 16-1 notes, continued)**

**Note 5.** Upon receipt of a special request for a RADHAZ measurement, the FMO will work with Technical Operations ATC Spectrum Engineering Services. For commissioning or equipment modifications, the FMO will notify Technical Operations ATC Spectrum Engineering Services and conduct the measurement.

**Note 6.** The following offices will receive a copy of the report: Technical Operations ATC Spectrum Engineering Services, Environmental, Energy Conservation, and Occupational Safety and Health (EEOSH) Services, the ROSHM, and the SMO. Technical Operations ATC Spectrum Engineering Services and/or the FMO will immediately notify Environmental, Energy Conservation, and Occupational Safety and Health (EEOSH) Services and the ROSHM when the measurements indicate radiation at or above the "Action" levels. Environmental, Energy Conservation, and Occupational Safety and Health (EEOSH) Services will initiate medical interpretation and related follow-on actions.

**b. Technical Operations ATC Spectrum Engineering Services will be responsible** for ensuring the ability to perform radiation measurements in a timely manner, to include training of Technical Operations ATC Spectrum Engineering Services engineers and service area FMOs.

**c. Environmental, Energy Conservation, and Occupational Safety and Health (EEOSH) Services has overall program management responsibility** for environmental hazards, including radiation hazards.

**d. On an infrequent basis,** it may be necessary for the FMO to perform a radar antenna pattern measurement by solar means in order to advise on the radar antenna tilt angle to resolve RADHAZ issues. Refer to appendix 8 for detailed instruction on how to perform these measurements.

**1602. IMPORTANCE OF MEASUREMENTS.** The importance of this function cannot be overemphasized. The results of the FMO's measurements can affect the safety, health, and in extreme cases, the life of a person who shall work or be in the area being measured. The latest edition of ORDER 3900.19B SHALL BE UNDERSTOOD BY THE FMO AND STAFF. The order is very detailed in its description of the two basic kinds of radiation and the limits in which the human body can safely exist.

**1603. FMO PARTICIPATION LIMITATION.** Only measurements of level are made by the FMO.

**1604. IMPORTANCE OF ACCURACY.** The measurements made by the FMO are only as good as the calibration of the instrumentation used and the accuracy, thoroughness, and professionalism of the FMO or staff engineer making the measurements.

**1605. INSTRUMENT CALIBRATION.** The calibration of instrumentation is the responsibility of the FMO. All instruments involved shall be calibrated at least annually, or more frequently if the manufacturer recommends. In the case of ionized radiation instrumentation (Victoreen 440RF), the built-in calibrator will be used to verify approximate calibration immediately before any measurements of record are made. If the built-in calibrator leads to readings greater or less than 5 percent of the specified, the instrument will not be used for measurement until the manufacturer or a certified field calibration station has recalibrated it.

**1606. AVAILABILITY.** The instruments shall be available at all times, and in condition for immediate use. This means all required batteries are fresh, and internal calibration checks have been made at periodic intervals. When Environmental, Energy Conservation, and Occupational Safety and Health (EEOSH) Services, Program Office, or Flight Surgeon requests a measurement, the FMO response will be commensurate with the urgency of that request. Particularly in the case of a suspected case of employee, general public or visitor radiation, the

measurements shall be made as quickly as possible and the results given verbally to Technical Operations ATC Spectrum Engineering Services and Environmental, Energy Conservation, and Occupational Safety and Health (EEOH) Services, even before the written report is completed. Technical Operations ATC Spectrum Engineering Services also shall be advised of results by email or fax.

**1607. RAMIFICATIONS.** The FMO is charged by directive to be the responsible person in the service area to make all nonroutine radiation hazard (RADHAZ) measurements. *This is not a transferrable responsibility. If the FMO cannot make the measurements for any reason, Technical Operations ATC Spectrum Engineering Services shall be contacted immediately for assistance.*

**a. Any measurement** made as a result of a complaint by any person, FAA or not, of radiation injury from FAA equipment is likely to be used as a basis for liability assessment.

**b. The person making the measurement** may be required to appear as a Federal Government witness at an administrative hearing or trial litigation and may be required to prove expertise based on knowledge and experience in making measurements.

**c. It is imperative that the FMO be thoroughly familiar** with the equipment used. The FMO shall be knowledgeable of the manufacturer's specifications on accuracy, calibration requirements, and procedures for use and overall analysis procedures.

**d. Except under extenuating circumstances, the FMO's RADHAZ equipment shall not be loaned outside the FMO office.**

**e. The FMO shall assure** that all personnel who would use the instruments are thoroughly trained in the use of RADHAZ measurement equipment. The FAA will provide the necessary training. It is highly desirable that regular measurements on NAS equipment, e.g., long-range radars, be done as a proficiency-training requirement.

#### **1608. MEASUREMENT PHILOSOPHY.**

**a.** The FMO is not authorized to make any judgment as to any health hazard or lack thereof. When measurements have been completed, they shall be reported as required, followed by a written report signed by the person actually making the measurements.

**b. Order 3900.19B** specifies that the measurements will be made with the full cooperation and assistance of maintenance and management personnel responsible for the equipment concerned. It is likely that those persons will be watching as the measurements are being made, to see whether the indications might show a hazardous condition. The FMO should be fully open to those persons responsible who watch as to the numeric values obtained. But the FMO or engineer making the measurements shall make no assumptions as to health hazards pro or con. If pressed for comment, the FMO will refer the inquirer to Order 3900.19B, the service area Flight Surgeon or the ROSHM.

#### **1609. MEASUREMENT CONSIDERATIONS.**

**a. Where a radar is rotating,** it will be nearly impossible to receive an average power density level above the MPE. Considering the width of the radar beam and the antenna azimuth rate, a person at a fixed point (unless it was in the immediate vicinity of the radar antenna sail) would receive only that percentage of power equal to the beam width divided by 360, per unit time. For instance, a 2° beam width rotating radar would radiate any given point only 2/360 or 0.55 percent of the power measured at the same point under radar fixed illumination. There is substantial radiation from the side lobes, but normally -30 dB or so down from the main lobe peak.

**b. In the near field**, antenna lobes are not well defined and calculations based on them cannot be totally relied upon. This point is very significant and should be brought out in any report as a result of measurements of a rotating radar.

**c. Use of a field strength meter** for RADHAZ measurements shall be considered only when the level is less than  $1 \text{ mW/cm}^2$ . Greater levels may not be read accurately by the field strength meter due to the limit of the shielding of the field strength meter, or front end overload. In those cases where a field strength meter is used, the "peak hold" mode must be used so that the meter ballistics can be negated by the time hold. Conversion from  $\text{dB}/\mu\text{V}$  to  $\text{mW/cm}^2$  must be accomplished after the field strength meter measurement is completed. For this procedure, refer to the RFI manual described in paragraph 1400.

**d. Persons uninformed about radiation** may become overly concerned when they think they might be in a hazardous field. In this regard, the FMO shall never rely upon inexpensive non-ionized "radiation detectors" which can be bought for only a few dollars. Not only are they without any calibration, they usually are designed to operate on peak power, rather than average. About the only thing that can be said for them, other than they frighten people, is that they usually are very over-sensitive, so that persons using them probably are far safer than they think.

**e. Home made detectors** can be a problem. In one instance, an FAA radar site employee claimed radiation injury from the radar. The employee had constructed a standard Yagi antenna, resonant to the radar frequency, and placed a small NE-2 neon bulb at the feed point. The bulb lit nearly anywhere on the transmitter floor level, whenever the Yagi was pointed upward. Even considering the gain of the constructed Yagi, it took considerable time and effort to show that the bulb was lighting from peak power. Actual calibrated measurements throughout the area showed less than 5 percent of the MPE.

**f. Diversity of opinion** concerning radiation dangers must not in any way distract the FMO from absolutely assuring every reported or suspected radiation hazard is thoroughly investigated and reported as required in Order 3900.19B.

**1610. MEASUREMENT STANDARDS AND PROCEDURES.** Whether ionized or non-ionized, measurement of radiation is really just a form of field strength measurement, with which the FMO is very familiar in spectrum surveillance work. The difference is that in an area where possible health hazard from ionized radiation is being investigated, measurement shall be approached much more carefully than the usual field strength measurement.

**a. Action levels** are those employee exposure levels that trigger the implementation of Chapter 14 of Order 3900.19B and related program guidelines, administered by Environmental, Energy Conservation, and Occupational Safety and Health (EEOH) Services. When these levels are exceeded, additional surveys may be requested and protective steps will be initiated by FAA Safety personnel to ensure worker safety.

**b. The latest approved version** of the MPE Standards for **uncontrolled environments** (at the time of this order, the 1999 Edition of IEEE/ANSI C95.1) shall be used as "action levels" for all environments where there is potential for exposure to **non-ionizing radiation**. If these standards are exceeded, further measurements may be requested by Environmental, Energy Conservation, and Occupational Safety and Health (EEOH) Services to determine whether non-ionizing radiation levels exceed the ACGIH TLVs for controlled environments. The reference standard for **ionizing radiation** is provided by the most current version of the ACGIH TLVs.

**c. All equipment used** will have current calibration (e.g., less than one year since last calibration, or

whatever the manufacturer recommends).

**d. Equipment batteries** will be checked and verified as good, or replaced before measurement.

**e. Persons making the measurements** shall have sufficient experience in making such measurements and/or have completed the Academy RadHaz Course 44516, *Radiation Hazard Theory and Measurement Procedures* and Course 40606, *Radiation Measurement Procedures Lab*. If questions arise concerning procedures, refer to the above course materials.

**f. The FMO surveyor** shall not make any determination whether the noted value of radiation is "safe" or "unsafe." That is for medical personnel and industrial hygienists to determine. However, if measured radiation levels equal or exceed the non-ionizing or ionizing action levels, the appropriate management personnel of the facility being surveyed, the Regional Occupational Safety and Health Manager (ROSHM) or Safety Officer, and the Technical Operations ATC Spectrum Engineering Services shall be advised *immediately* of the level indicated. If appropriate, inside or outside areas should be marked off as easily recognizable as a "do not enter" area by the FMO.

**g. When a measurement is completed**, the FMO shall prepare a report and forward a copy to Technical Operations ATC Spectrum Engineering Services, Environmental, Energy Conservation, and Occupational Safety and Health (EEOSH) Services, the service area Operations Branch, and the System Management Office (SMO) regardless of the level of the radiation measured.

**h. Automated functions** to facilitate the calculation and reporting of radiation measurements are available to support the user, as highlighted in chapter 19, paragraph 1910.

#### **1611. IONIZED RADIATION MEASUREMENT PROCEDURES.**

**a. Ionized radiation** deals with those extremely short wavelengths in the x ray, alpha, beta and gamma ray bands. The instrument supplied to all FMOs, and the only approved instrument is the Victoreen 440RF (Version D). The "RF" portion of the model number indicates that it is shielded for operation in even very high RF fields. Other instruments, especially the CDV-700, shall not be used without consulting Technical Operations ATC Spectrum Engineering Services. While it is accurate for radiation purposes, the CDV-700 is not accurate in the presence of high RF fields as may be encountered in FAA facilities.

##### **b. Calibration and use.**

(1) **The very first action** the measuring engineer shall take is to thoroughly read the instruction book that comes with each instrument. Complete familiarity with its provisions is mandatory before every measurement.

(2) **Next, battery level shall be checked** by the integral meter. If not at an operating level, batteries shall be replaced before the meter is used for measurement.

(3) **Instrument self-calibration is accomplished** by bringing the built-in calibration source into the specified area of the sensing cylinder. Measurements may proceed only if the self-calibration test is satisfactory.

(4) **Turn on the instrument** to its most sensitive level. The circuit should be zeroed, if necessary. Zeroing should be checked at all scale levels.

(5) **The meter should read nearly zero** except for an occasional flick at the lowest scale level, caused by casual neutrons or gamma rays passing through the sensor. If the meter reads considerably upscale, the reason for that level reading shall be determined before any further readings are made. It is important that the instrument is

first turned on well outside any expected measurable radiation area.

(6) **Once the meter is found to be operating normally**, the area that is to be measured will be entered slowly and carefully. Watching the meter, the FMO shall carefully "sweep" the area under measurement, carefully noting and recording all readings above ambient zero level. The engineer accomplishes this by holding the instrument with its ion chamber facing the source to be measured. The instrument is slowly moved over the face of the cabinet or whatever container houses the suspected source. It shall be done slowly because the meter is damped and there is a short delay time before the meter reaches its extremity value, up or down.

(7) **Most likely areas of radiation** will be around windows or door jambs of high power klystron or magnetron tube cabinets, such as those found in TACANs and radars. Entire surfaces of cabinets, including the power supplies, should be systematically swept for readings. X rays are generated by a stream of electrons impinging upon a metal surface under the influence of high voltages, usually in excess of 20 kilovolts.

(8) **During the sweep**, the instrument shall be held well in front of the body, as it is moved toward or into the suspected field. To the extent possible, if less than MPE, put the sensor face as close to the device being measured as possible without touching it.

(9) **Whenever a MPE is approached**, the FMO will advance very slowly up to that limit. Should readings above the MPE be required, the instrument will be placed into those higher fields by means of a pole or other convenient device holding it, so the FMO is not subjected to levels above the MPE. At or above the MPE, the levels vs. distance in inches or feet from the radiating source are very important and should be measured and recorded for the report.

(10) **Paragraph 1608 c. notwithstanding**, if a level exceeding the MPE is found, the FMO shall advise the facility management, the Safety and Environmental Compliance Manager (SECM), and the ROSHM, even if after hours or a non-workday.

(11) **Instrument calibration** should be accomplished at least annually, or at any time its accuracy is questioned.

**1612. NON-IONIZED RADIATION MEASUREMENT AND PROCEDURES.** Non-ionized radiation refers to RF, even though it may be in the Extremely High Frequency (EHF) band, 30-300 GHz. Measurements of RF fields employ resonant loops (LF, MF, and HF), resonant dipoles (VHF and UHF), or isotropic probes for varied levels of high power in SHF and EHF. Measurements are made by field strength meters, calibrated in  $\mu\text{V}/\text{m}$ , dB above  $1 \mu\text{V}$  ( $\text{dB}\mu\text{V}$ ), or power density meters calibrated in  $\text{mW}/\text{cm}^2$ . Field strength meters are typically used for lower level fields. Good treatises on this measurement theory are available in standard electronic engineering handbooks.

**a. The Narda power density meter** is used for power levels of  $1 \text{ mW}/\text{cm}^2$  and greater. The instrument consists of a hand-held calibrated detector circuit with an integral meter. Two associated probes for two different ranges of power have been supplied. One or the other of the probes is used, connected by the supplied cable to the detector. The Narda is usually used in connection with measurement of a high power radar or close proximity measurements of TACAN. Other instruments that could be used are other field strength meters (e.g., Eaton NM-65T, NM-67T, NM-37/57, Electrometrics Models EM-2135 (EMC-60), EM-2125 (EMC-30), EM-2110 (EMC-11), spectrum analyzers (e.g., any of several HP or Tektronix, now used by FAA, or equivalent) with associated antennas, or other FAA approved instrument. Unless otherwise noted, the following direction pertains to the use of the Narda power density meter.

(1) **First, the measuring engineer** is to be thoroughly familiar with the instruction book for the instrument. Familiarity with operation procedures covered in the instruction book may be a matter of inquiry in



any court testimony that could be required.

(2) **The only calibration to be done** is to check battery level and zero the instrument with appropriate probe attached. Proceed only if readings are normal. Note: The calibration/zero procedure is described in the instruction book. The probes need individual instrument insertion calibration for each use. The instruction book contains the procedure. Note that they are very delicate and shall not only be handled with care, but not subjected to levels in excess of their ratings.

(3) **Once calibrated**, the measurement procedure may begin. Using the highest power probe, approach the source to be measured. If it is the radiation from the antenna of a rotating radar, prior arrangements will have to have been made to get radar shutdown so that a steady-state radiation can be obtained for measurement.

(4) **All radar types** currently used by FAA have been measured previously and found well below MPE below the antenna sail. Therefore, initial measurements can be started in the radome or at the pedestal level, so long as the engineer's body does not extend into the plane of the sail area. However, if there is any doubt whatsoever, measurements should be started well below the sail level and gradually moved up into the general area.

(5) **The probes are nondirectional**, except that a signal coming from the direction of the handle would not be measured accurately.

(6) **To use the instrument**, hold the detector in one hand, the probe in the other. Start well outside the expected area of high radiation. Slowly move into the area and "sweep" the suspect area with the probe pointed toward the source. "Toward" means that the probe handle is pointed away from the source. If the source is radar, the radar antenna shall be stopped, and the measurement location searchlighted, if the main beam of the radar is being investigated for radiation level. Hold the probe over the head at a reasonable distance. Using an elevating device such as a "cherry picker," the FMO should slowly move up into the main beam with the probe, while watching the Narda meter. Move the probe through the highest level of indicated radiation, until the level starts dropping.

(7) **Once the MPE is reached**, further intrusion beyond will be by remote means only. The Narda is supplied with a calibrated cable that is intended for this purpose. Use an appropriate non-metallic pole and fashion a lashing or mount for the probe. Using it at the end of the pole, slowly position the probe into the "hot" area being measured. All levels vs. distance shall be accurately measured so that values of distance in feet and inches can be clearly shown on the report.

(8) **If levels are found** to be too low for the scale readings of the highest probe, the engineer should back off from the high density area, change and recalibrate with the lower power probe, then return to the area for measurement.

(9) **For lower density devices**, such as microwave ovens or microwave links, the process will be essentially the same, except the expected power levels will be so low that poles and other "remote reading" assisting devices will not be needed. If the level is below  $1 \text{ mW/cm}^2$ , then a field strength meter may be required, with appropriate antenna. Nonetheless, prudence shall be exercised in approaching the source to be measured.

(a) **If a microwave dish is the source**, the probe can be slowly swept all over the face of the dish, even into the area of the feed horn. Since the average power is being measured from a pulsed source, the probe and associated equipment need a little time to come up to the correct reading. CAUTION: The probe surface must never touch any solid part of a device being measured. In some models, the contact can create an instantaneous static discharge that can destroy the delicate probe.

**(b) If a microwave oven** or similar device is the source, the probe should be swept over the entire cabinet, with particular attention being given to the edges of the door, glass windows and vents. Again, it is imperative that the probe not touch the source.

**(10) Guidance** for the distance vs. power density and MPE in the main beam for the various radars now being used by FAA is found in Order 3900.19B. A chart of current conditions is provided in figure 16-2.

**b. The field strength meter** will be used for lower level measurement areas. The operation of the meters will be in the normal field strength measurement mode and procedure. Since the upper measurement limit of these instruments is well below the "safe" level, use normally will be at considerable distances from any high power source. Since they are capable of being operated on their internal batteries, they are amenable to use in portable conditions.

See also paragraph 1609, (1) (b).

**FIGURE 16-2. RADARS USED BY FAA WITH POWER DENSITIES >MPE**

Radar Type	Transmitter Power		Nominal Frequency MHz	MPE mW/cm <sup>2</sup>	Distance# Ft
	Peak MW	Average W			
AN/FPS-20	2.0	4319	1300	4.3	315
AN/FPS-60 (simplex)	2.0	4319	1300	4.3	315
AN/FPS-60 (duplex)	2.0	8638	1300	4.3	630
AN/FPS-6/90	2.8	2040	2800	9.3	264
ASDE	0.0045	3	15,950	10.0	*
ASR-4,-5,-6.	0.425	403	2800	9.3	29
ASR-7 (AN/GPN12)	0.5	475	2800	9.3	37
ASR-8 (AN/GPN-20/27) (Simplex)	1.4	875	2800	9.3	92
ASR-8 (AN/GPN-20/27) (Diplex)	1.4	1750	2800	9.3	172
ASR-9	1.237	1430	2800	9.3	205
ASR-11	.0229	324	2840	9.5	90
ARSR-1,-2	5.0	3595	1315	4.4	295
ARSR-3 (simplex)	4.6	3140	1315	4.4	230
ARSR-3 (duplex)	4.6	6280	1315	4.4	460
ARSR-4	0.93	558	1315	4.4	260
NEXRAD (WSR-88)	1.0	2000	2850	9.5	172
TDWR	0.31	550	5625	10.0	354

\* MPE not exceeded.

# Calculated distance from antenna to point on main beam axis where power density equals the MPE.

### 1613. MEASUREMENT CONSIDERATIONS AND REFERENCE DATA.

**a. Radiation measurements below 100 MHz** will normally be for a Non-Directional Beacon (NDB) and Compass Locator (COMLO) in the 190-535 kiloHertz (kHz) band, NRCS (See Chapter 7) High Frequency (HF) in the 2-28 MHz band or 75 MHz Marker transmitters. The NRCS HF is Single Sideband (SSB) Suppressed Carrier emission, so measurements must be taken with the transmitter being modulated by a constant tone source to stabilize the SSB radiation, set at what is considered 100 percent power output. In cases of frequencies between 0.1 - 100 MHz, both the electric (E) field and the magnetic (H) field values shall be obtained by measurement. This is to assure compliance in both fields.

The power density (PD) (also S) value in mW/cm<sup>2</sup> is then calculated by using the formulas:

$$\text{E Field: } PD_{\text{mW/cm}^2} = E^2/3770$$

$$\text{H Field: } PD_{\text{mW/cm}^2} = H^2 \times 37.7$$

**b. Radiation measurements taken in the Very High Frequency (VHF) and Ultra High Frequency (UHF) A/G bands** shall be done with tone modulation at 100 percent to assure worst case condition.

**c. Radiation measurements taken of Distance Measuring Equipment (DME) and TACAN** as a pulsed emission requires the measurement to be taken in peak values, then corrected for average values by introducing the duty cycle (DC) factor. For the worst case, the DC is 0.04. Therefore, after the peak reading is obtained, multiply it by 0.04 to get the average power. Only the E field is required.

**d. Radiation measurements for rotating** Airport Surveillance Radar (ASR), Air Route Surveillance Radar (ARSR), Airport Surface Detection Equipment (ASDE), Terminal Doppler Weather Radar (TDWR) and Next Generation Weather Radar (NEXRAD) radars have additional factors to be considered: (a.) the DC, obtained by multiplying the pulse width (PW) (in seconds) times the pulse repetition rate (PRR) in pulses per second (pps); (b.) the Fractional Exposure Time (FET) obtained by dividing the antenna beam width (BW) which is 4 degrees by 360. Thus, FET= 4/360= 0.011.

**(a) For rotating radar**, only the peak E fields, usually in Volts per meter (V/m), need to be measured. The Power Density (S) = (E<sup>2</sup>/3770) x DC x FET (using the peak E field value).

**(b) For radar with antenna stationary** and directly pointed at the point of measurement (searchlighting), only the DC factor is used to determine average power from the measured peak power.

**e. The electromagnetic MPEs for uncontrolled environments** from the 1999 Edition of ANSI/IEEE Standard C95.1 are presented in figure 16-3. It is important to use the most current version of the standard that is available at the time of the survey. The Uncontrolled MPEs shall be used as action levels for all environments where there is a potential for exposure to non-ionizing radiation.

**f. The electromagnetic MPEs for controlled environments** are presented in figure 16-4.

**g.** Figure 16-5 contains the 2001 ACGIH Ionizing Radiation TLVs. These guidelines are updated yearly. It is important to use the most current version of the standards that is available at the time of the survey.

**FIGURE 16-3. NON-IONIZING MPE - UNCONTROLLED ENVIRONMENT**

MAXIMUM PERMISSIBLE EXPOSURE FOR <b>UNCONTROLLED</b> ENVIRONMENTS Electromagnetic fields*					
Frequency Range (MHz)	Electric field Strength (E) (V/m)	Magnetic field Field Strength (H) (A/m)	Power Density (S) E-Field, H-Field (mW/cm <sup>2</sup> )	Averaging Time  E  <sup>2</sup> , S or  H  <sup>2</sup> (Minutes)	
1	2	3	4	5	
0.003 – 0.1	614	163	(100,1000000) <sup>#</sup>	6	6
0.1 – 1.34	614	16.3/f	(1000, 10000/f <sup>2</sup> ) <sup>#</sup>	6	6
1.34 – 3.0	823.8/f	16.3/f	(180/f <sup>2</sup> , 10000/f <sup>2</sup> )	f <sup>2</sup> / 0.3	6
3.0 – 30	823.8/f	16.3/f	(180f <sup>2</sup> , 10000/f <sup>2</sup> )	30	6
30 – 100	27.5	158.3/f <sup>1.668</sup>	(0.2940000/f <sup>3.336</sup> )	30	0.0636f <sup>1.337</sup>
100 – 300	27.5	0.0729	0.2	30	30
300 – 3000	-	-	f/1500	30	
3000 – 15000	-	-	f/1500	90000/f	
15000 – 300000			10	616000/f <sup>1.2</sup>	

Note-f is the frequency in MHz

\* The exposure values in terms of electric and magnetic field strengths are the values obtained by spatially averaging values over an area equivalent to the vertical cross section of the human body (projected area).

# These plane-wave equivalent power density values, although not appropriate for near-field conditions, are commonly used as a convenient comparison with MPEs at higher frequency and are displayed on some instruments in use.

**FIGURE 16-4. NON-IONIZING MPE – CONTROLLED ENVIRONMENT**

MAXIMUM PERMISSIBLE EXPOSURE FOR <b>CONTROLLED</b> ENVIRONMENTS Electromagnetic fields*				
Frequency Range (MHz)	Electric field Strength (E) (V/m)	Magnetic Field Strength (H) (A/m)	Power Density (S) E-Field, H-Field (mW/cm <sup>2</sup> )	Averaging Time  E  <sup>2</sup> ,  H  <sup>2</sup> , or S (Minutes)
1	2	3	4	5
0.003 – 0.1	614	163	(100, 1000000) <sup>#</sup>	6
0.1 – 3.0	614	16.3/f	(1000, 10000/f <sup>2</sup> ) <sup>#</sup>	6
3.0 – 30	1842/f	16.3/f	(900f <sup>2</sup> , 10000/f <sup>2</sup> )	6
30 – 100	61.4	16.3/f	(1.0, 10000/f <sup>2</sup> )	6
100 – 300	61.4	0.163	1.0	6
300 – 3000	-	-	f/300	6
3000 – 15000	-	-	10	6
15000 – 300000	-	-	10	616000/f <sup>1.2</sup>

Note-f is the frequency in MHz

\* The exposure values in terms of electric and magnetic field strengths are the values obtained by spatially averaging values over an area equivalent to the vertical cross section of the human body (projected area).

# These plane-wave equivalent power density values, although not appropriate for near-field conditions, are commonly used as a convenient comparison with MPEs at higher frequency and are displayed on some instruments in use.

**FIGURE 16-5. IONIZING TLV**

<u>TYPE OF EXPOSURE</u>	<u>ANNUAL DOSE LIMIT</u>
Effective Dose	
a) in any single year	50 mSv (millisievert) * <b>(See Note 1)</b>
b) averaged over 5 years	20 mSv per year
Annual Equivalent Dose to:	
a) lens of the eye	150 mSv
b) skin	500 mSv
c) hands and feet	500 mSv
Embryo-Fetus exposures once the pregnancy is known	
•Monthly equivalent dose #	0.5 mSv <b>(See Note 2)</b>
•Dose to the surface of women ' s abdomen (lower trunk)	2 mSv for the remainder of the pregnancy
•Intake of radionuclide	1/20 of Annual Limit on Intake (ALI)
Radon Daughters	4 Working Level Months (WLM)
# Sum of internal and external exposure but excluding doses from natural sources as recommended in National Council on Radiation Protection and Measurements (NCRP)	
* <b>Conversion factors:</b>	10 mSv = 1 Rem = 1000 mR. 1 mSv = 100 mR
<b>Note 1: Action level any single year</b>	<b>Note 2: Action level for pregnant women</b>
50 mSv = 5000 mR Action level = 5000 mR/yr or 2080 hrs/yr Action level = 2.4 mR/hr (approximately)	0.5 mSv = 50 mR Action level = 50 mR/mo or 60 hrs/mo Action level = 0.3125 mR/hr
These action levels are cumulative maximums over a standard work-hour/year of 2080 hours and a standard work-hour/month of 160 hours.	



**FIGURE 16-6a. LETTER OF AGREEMENT SAFETY PROGRAM RESPONSIBILITIES**

Letter of Agreement for  
Division of Functional Radiation Safety Program Responsibilities  
Between Technical Operations ATC Spectrum Engineering Services  
and Technical Operations ATC Facilities

In September 2002, the former Federal Aviation Administration (FAA) organizations, the Resources Management Program, and the Spectrum Policy and Management Program, signed a letter of agreement (LOA) dividing the Radiation Safety Program (RSP) responsibilities that were assigned to the former FAA organization, the Airway Facilities Service, by Chapter 14 of FAA Order 3900.19B: FAA Occupational Safety and Health Program. This LOA replaces the 2002 LOA and highlights the present FAA organizations responsible for the various duties under the RSP. Specifically, it clarifies the duties assigned to Technical Operations ATC Facilities and Technical Operations ATC Spectrum Engineering Services.

Technical Operations ATC Facilities shall:

1. Appoint a Radiation Protection Officer to serve as the Agency focal point for all employee radiation health and safety issues.
2. Serve as the budget advocate for funds to carry out assigned Technical Operations ATC Facilities RSP duties.
3. Perform FAA employee exposure assessments.
4. Perform induced current measurements, dosimetry, measurements of low frequency non-ionizing sources, and other measurements as necessary, that are not performed by Technical Operations ATC Spectrum Engineering Services as established in FAA Order 6050.32, Spectrum Management Regulations and Procedures Manual. These surveys are required to assess employee exposure at FAA communication, navigation and surveillance (CNS) facilities.
5. Perform routine ionizing and non-ionizing radiation surveys to assess FAA employee exposure at CNS facilities.
6. Provide technical assistance to regions in radiation risk management, exposure assessment, and dosimetry as required.

**FIGURE 16-6b. LETTER OF AGREEMENT SAFETY PROGRAM RESPONSIBILITIES**

7. Assist the Office of Environment and Energy (AEE) as co-liaison in coordinating with organizations external to the FAA such as the Occupational Safety and Health Administration (OSHA), National Institute of Occupational Safety and Health (NIOSH), American Conference of Governmental Industrial Hygienists (ACGIH), and the Environmental Protection Agency (EPA), on radiation health and safety issues.
8. Provide assistance to Technical Operations Services organizations to ensure that FAA Maintenance Orders in the 6000 Directives Series and related publications incorporate radiation risk management practices and current FAA radiation protection policies.
9. Ensure that annual field safety assessments of employee work tasks and environments are conducted to identify employees for inclusion in the RSP. Identify new operations, maintenance activities, and modifications to the work environment that may increase the potential for radiation exposure.
10. Implement initial and periodic radiation hazard evaluation training for safety and health professionals and staff. Implement safety awareness training for employees who work in environments where there is the potential for exposure at or above adopted FAA standards. Document all training and maintain all training records for the period required by OSHA.
11. Coordinate with the Office of Aviation Medicine (AAM) when seeking additional health or medical interpretation of any radiation measurement data.
12. Assist AAM to ensure that all exposure records, dosimetry measurement records, and related health and medical records are maintained in accordance with OSHA requirements.
13. Ensure that citizens and FAA employees have access to radiation survey, investigation, and exposure assessment data.
14. Coordinate with Technical Operations ATC Spectrum Engineering Services to obtain radiation hazard measurements on CNS systems in response to employee or union requests.

**FIGURE 16-6c. LETTER OF AGREEMENT SAFETY PROGRAM RESPONSIBILITIES**

15. Provide internal coordination within the FAA on matters relating to radiation exposure assessment.

16. Serve as the point of contact for employee questions related to radiation hazards from equipment that is not part of the FAA's CNS facilities (e.g. microwave ovens, video display terminals, etc.)

17. Develop and provide informational resources on radiation safety to employees upon request.

Technical Operations ATC Spectrum Engineering Services shall:

1. Serve as budget advocate for funds to carry out assigned Technical Operations ATC Spectrum Engineering Services duties.

2. Serve as the focal point for performing ionizing and non-ionizing radiation hazard measurements during the baselining, or commissioning of FAA CNS facilities, or as otherwise required by Order 6050.32, Spectrum Management Regulations and Procedures Manual. Radiation hazard measurements will also be performed in response to employee requests. Written copies of all radiation measurements reports will be provided to Technical Operations ATC Facilities, Environmental, Energy Conservation, and Occupational Safety and Health Services, and the Regional Occupational Safety and Health Managers (ROSHM).

3. If a transmission tube (thyratron, klystron, magnetron, or amplatron) is found to emit radiation above the action level during a Radiation Survey (RS), the following information shall be added to the RS report: tube manufacturer, model, and serial number and current tube operating voltage.

4. Provide technical assistance to the service areas for radiation hazard measurements, defining radiation hazard environments, and radiation survey equipment calibration and maintenance.

**FIGURE 16-6d. LETTER OF AGREEMENT SAFETY PROGRAM RESPONSIBILITIES**

5. Maintain an inventory of Frequency Management Officers' (FMO) radiation hazard measurement equipment that is updated annually. Ensure that radiation survey equipment is calibrated in accordance with manufacturer recommendations.
6. Coordinate with Technical Operations ATC Facilities and organizations external to the FAA such as Interdepartmental Radio Advisory committee (IRAC), Department of Defense (DOD), and the Federal Communications Commission (FCC) on spectrum issues relating to radiation hazards.
7. Periodically update FAA Order 6050.32, spectrum Management Regulations and Procedures Manual, and radiation hazard measurement training to ensure compliance with current radiation standards and policy.
8. Provide the FAA's spectrum engineering staff initial and periodic training in conducting ionizing and non-ionizing radiation hazard measurements of CNS facilities.
9. Make radiation measurement data available to citizens, employees, and FAA service area and headquarters staff.
10. Perform radiation hazard measurements in response to inquiries from other Federal agencies, Congressional Offices, citizens, and other external parties.

Signed by  
Jack Nager  
 Director, ATC Facilities  
 ATC Facilities

Date: 7/29/05

Signed by Jerrold B. Sandors  
 for Oscar Alvarez  
 Acting Director, ATC Spectrum  
 Engineering Services

Date: 7/27/05

1614. thru 1699. RESERVED.

## CHAPTER 17. LAND MOBILE AND OTHER FM COMMUNICATIONS SYSTEMS FREQUENCY ENGINEERING

**1700. GENERAL.** This chapter will present guidance and criteria for engineering frequencies for FAA land mobile and other FM communications systems operating in the Federal Government fixed/mobile bands.

**1701. FREQUENCY ENGINEERING.** The FAA currently uses the bands 162-174 MHz and 406.1-420 MHz for land communications. For a description of how to perform a detailed engineering analysis, refer to the NTIA Manual, annex I.

**a. While no formal criteria for cochannel** and adjacent channel separation exist within FAA, separate cochannel assignments by 100 nmi or RLOS, where possible. For data links, use the same rule unless unique digital coding is available, such as in the Medium Intensity Approach Lighting System with Runway Alignment Indicator Lights (MALSR). In this case, close separation (down to 5 nmi) has been found to work satisfactorily.

**b. No first adjacent channel** (12.5 kHz) protection standard is provided for fixed/land mobile communications systems.

**1702. SYSTEMS BASICS.** FAA FM radio communications systems operating in the land mobile bands are of two major types: repeater/base/portable/mobile voice systems, and voice/data links.

**a. The repeater/base/portable/mobile systems** are voice systems used in support of the National Radio Communications Systems (NRCS), known internally as Command and Control Communications (C3).

**b. The voice/data links** are used for Low Level Wind Shear Alert System (LLWAS), MALSR, Remote Maintenance Monitoring (RMM), Automated Weather Observing System (AWOS), Stand Alone Weather System (SAWS) and other systems that require low capacity fixed RF links.

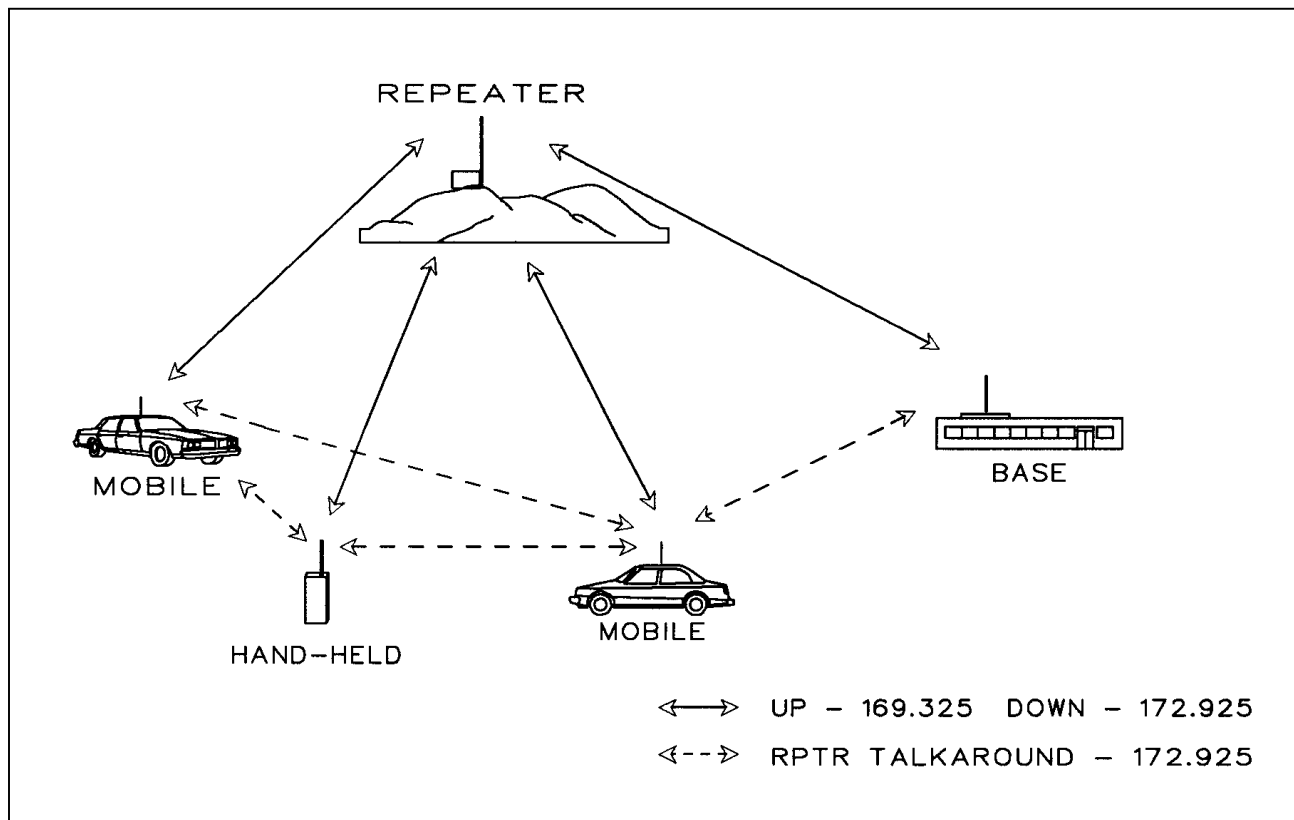
**1703. C3/NRCS.** The C3/NRCS VHF FM COMM frequency plan is as shown in figure 17-1.

**FIGURE 17-1. C3/NRCS COMMUNICATIONS FREQUENCY PLAN**

Channel	Repeater Uplink (MHz)	Repeater Downlink (MHz)
1	169.325	172.925
2	169.350	172.950
3	169.375	172.975
4	169.250	172.850
5	169.275	172.875
6	169.225	172.825
7	172.1250 simplex	
8	172.7375 simplex (except Alaska)	
9	172.1750 simplex	
10	166.1750 simplex	

a. **The NRCS VHF FM system is a three-way voice system.** It can be used either through a repeater (duplex) or unit-to-unit (simplex.) See figure 17-2.

**FIGURE 17-2. EXAMPLE OF A REPEATER/BASE/PORTABLE/MOBILE FM SYSTEM**



b. **Using the repeater**, any base, mobile, portable or hand-held unit may communicate with any other unit within RLOS range of the repeater by utilizing duplex operation. This consists of transmitting on one frequency (uplink) which is automatically repeated on another frequency. This second frequency (downlink) is then transmitted by the repeater and received by the intended unit and all others tuned to the same frequency.

c. **Talkaround** allows unit to unit direct communications without using the repeater. It is defined as simplex operation, where both units within RLOS transmit and receive on a single frequency, in this case the repeater output frequency (downlink). This permits short range communications without activating the repeater while permitting reception of the repeater at any time the units are not engaged in simplex communications (standby).

d. **Tone activated squelch (PL).** The PL acronym comes from the trade name of the first tone-activated squelch system (Motorola's Private Line). PLs are transmitted single tones between 67.0-254.1 Hz (42 total), but they are normally not heard in a commercial FM land mobile system due to the 300-3000 Hz system voice band pass filters built into the equipment. This is intentional, to permit use of control tones without interfering with the voice communications on the same units. They are continuously transmitted when the transmitter is keyed. Upon reception, the tones will open a matching PL squelched receiver, if PL is activated. If PL is activated on a receiver, only stations transmitting the same PL can be heard. The normal PL for the current analog NRCS radios is 136.5 Hz. In a few areas, a second PL may be used.

**1704. RF VOICE/DATA LINK SYSTEMS.**

**a. LLWAS radio links** are used to relay wind speed/direction information from field sensors to a central processor. LLWAS frequency requirements are satisfied within 406.1-420.0 MHz band. Frequencies for LLWAS equipment shall be selected from the following (MHz):

409.1750    410.3000    412.5375    413.5875    414.7875    418.1750

**b. MALSR radio links** are used to control approach lighting from the ATCT when it is not practical to use land lines. The frequency 165.7625 MHz shall be the primary channel for MALSR.

**c. RMM radio links** are used to relay maintenance and control data from a remote site back to a central monitoring point. Frequencies shall be selected from the following (MHz):

408.8250    410.0250    412.9375    412.9875    413.0125  
413.0625    413.6000    417.8250    419.0250

If these specific frequencies are not available, system frequencies should be engineered in accordance with the NTIA Manual supplement for the 406.1-420.0 MHz band.

**d. AWOS radio links** are used to relay weather information from field sensors to a central processor. These links will be operated within the 406.1-420 MHz band on a case-by-case basis.

**e. SAWS radio links** are simplex operating systems used to relay weather data from a remote site to a master station. The frequencies 413.1125 MHz and 414.0125 MHz shall be the primary channels for this facility.

**1705. MISCELLANEOUS RADIO LINKS.** Low capacity RF links may be operated in the band 406.1-420.0 MHz on a case-by-case basis.

**1706. NARROW BAND REQUIREMENTS.** Narrow band transmitter and receiver standards are presented in the NTIA Manual, Chapter 5.3.5.2. The narrow band standards support a 12.5 kHz channel plan, versus the previous 25 kHz channel plan. As of January 1, 2005, all systems implemented in the 162-174 MHz band must meet these standards. All new systems, and after January 1, 2008, all systems implemented in the 406.100-420.000 MHz band must also meet these standards. The following parameters will be affected:

Transmitter:

- Necessary bandwidth
- Unwanted emissions
- Frequency deviation
- Frequency tolerance\*

Receiver

- Necessary bandwidth
- Spurious response attenuation
- Adjacent channel selectivity
- Intermodulation rejection
- Conducted spurious emissions
- Frequency tolerance\*

\*NTIA Manual Section 5.2

**1707. thru 1799. RESERVED.**



## CHAPTER 18. ELECTRONIC ATTACK (EA) EVALUATIONS

### 1800. PURPOSE.

a. **Most RFI experienced by FAA facilities** is of an uncontrollable and unexpected nature. Indeed, in many instances, such RFI is unintended by the operator causing it. In many instances, FAA systems have methods of filtering out this RFI. However, there is one type of RFI which is intended and which the FAA usually has the ability to schedule, relocate or cancel. That type of RFI consists of EA military operations. Unfortunately, EA is sometimes conducted without prior coordination by the military. In this case, the problem has to be handled just as any unexpected RFI.

b. **EA missions are military operations** where electromagnetic signals are radiated intentionally or chaff is dropped to cause RFI to other military units. These missions are conducted on various portions of the spectrum. These radiations can cause severe RFI to FAA facilities, particularly GPS, TACAN and radar. While training in electronic attack and dropping chaff is deemed necessary by the military to keep air crews combat-ready, it can also present a serious hazard to air safety. FAA must carefully review requests for this type of activity. FAA policy on EA activity is summarized below:

(1) **The Technical Operations Services technical analysis** performed by the applicable service area or by Technical Operations ATC Spectrum Engineering Services evaluates the potential for NAS degradation. If the proposed EA mission degrades the NAS, FAA will not concur with the operation. To accommodate DOD EA training requirements, FAA will evaluate the possibility of NOTAMing affected facilities out to service (OTS) during specific mutually agreed upon times, on a case-by-case basis.

(2) **The affected ARTCC** or other designated FAA facility has final authority, based on current air traffic capacity, safety, weather or other valid reason, to allow an EA mission to proceed as scheduled or to refuse concurrence. However, if such refusal occurs after previous national authorization of a military EA activity, then the affected ARTCC or facility shall report such refusal through RFI or MCC reporting channels back to national authorities.

(3) **Technical Operations ATC Spectrum Engineering Services forwards** the coordinated FAA response after the technical Technical Operations Services analysis and coordination with the appropriate air traffic organization. Technical Operations ATC Spectrum Engineering Services also passes on or assigns an administrative EA control number to authorized operations. The military unit will refer to this control number when contacting the ARTCC for final approval to dispense chaff or to conduct other EA activity.

(4) **Technical Operations ATC Spectrum Engineering Services will evaluate** all EA requests which could impact GPS operations (e.g., 1164-1215 MHz and 1559-1610 MHz) and all Joint Tactical Information Distribution System (JTIDS) operations outside the limits set by the DOT/DOD Memorandum of Agreement (MOA) "Civil Use of GPS" (1993) Annex 3 (1999). JTIDS assignments covered by the MOA will be addressed through the frequency assignment process.

### 1801. DEFINITIONS.

a. **A Military Operating Area (MOA)** is the established airspace outside positive control areas to separate/segregate certain nonhazardous military activities from IFR traffic and to identify for VFR traffic where these activities are conducted.

**b. A Restricted Area** is airspace designated under FAR Part 73 within which the flight of the aircraft, while not wholly prohibited, is subject to restriction. Restricted areas are designated when determined necessary to confine or segregate activities considered to be a danger to nonparticipating aircraft.

**c. A Warning Area** is airspace of defined dimensions over international waters that contain activity that may be hazardous to nonparticipating aircraft.

**d. "Stop Buzzer/Chaff" or "Cease Buzzer/Chaff"** are terms normally transmitted over "guard" channels (121.5 MHz and 243.0 MHz) which directs any military unit to stop electronic attack or to stop dropping chaff, as appropriate. It is important to realize that because of its slow fall rate and unpredictable winds, chaff may take several hours to reach the ground, with uncontrollable RFI occurring until the chaff is at ground level.

## 1802. APPLICABLE REGULATIONS AND DOCUMENTS.

**a. Order 7610.11A, Coordinating Electric Attack Mission Requests**, establishes internal FAA coordination procedures. It states that FMOs will coordinate with their respective service area air traffic organizations when reviewing EA proposals and establishes Technical Operations ATC Spectrum Engineering Services as the focal point for sending out the authorization to the military for EA operations after service area analysis is completed.

**b. Order 7610.4, Special Military Operations** describes general guidelines for military units for requesting and performing EA operations.

**c. Order 7400.2, Procedures for Handling Airspace Matters**, is primarily used by military units when they need to establish new special use airspace. It states that desired EA operations shall be considered during the planning stages of expanding or establishing new special use airspace.

**d. DOD Chairman of the Joint Chiefs Staff Manual (CJCSM 3212.02A, Performing Electronic Attack in the United States and Canada for Tests, Training and Exercises)** details EA approval procedures for use by the military services. The military instruction is coordinated with FAA to ensure that these procedures are adequate to protect critical safety communications, navigation and surveillance systems from interference. Figure 18-3 indicates those frequency bands, designated as "National" coordination with a superscript "1," which shall be coordinated and approved by the FAA prior to beginning EA operations. Paragraphs 1806-1808 of this order were extracted from Appendix I of the CJCSM.

**e. DOT/DOD Memorandum of Agreement "Civil Use of GPS" (1993) Annex 3 (1999)**. The 1993 MOA is a broad overarching agreement delineating DOT and DOD responsibilities regarding civil use of GPS as DOD developed and implemented GPS. The Annex 3 implements the actual coordination activities between DOT and DOD to: facilitate coordination to ensure DOD can develop, test, exercise, and train necessary capabilities "without unduly disrupting or degrading civilian uses" as governed by the 1996 Presidential Decision Directive; facilitate timely reporting and resolution of GPS interference; specify jointly acceptable GPS interference analysis tools; and designate Technical Operations ATC Spectrum Engineering Services as the DOT point of contact. DOD is required to submit test requests 60 days prior to the test, and the FAA has 30 days to respond. Annex 3 establishes the organizational responsibilities for GPS interference.

## 1803. RESPONSIBILITIES.

**a. Technical Operations ATC Spectrum Engineering Services shall:**

(1) **Establish guidance** to ensure consistency for authorizing EA activity throughout the service areas.

(2) **Provide the written, consolidated FAA response** and authorization to military EA requests based on FMO analysis and coordination. This response may be transmitted via email, fax or message, depending upon the request.

(3) **Assign an administrative EA control number** for reference, if required. Normally, the submitting military agency assigns a control number to the proposed activity. If this does not occur, then the FAA assigns this number. Such a control number will include a designator indicating the requesting agency, a representation of the fiscal year in which the request is made, and a unique control number. An example of this would be ACC 02-04, where ACC refers to the U.S. Air Force Air Combat Command, 02 refers to FY 2002, and 04 is a number uniquely assigned to this request. To continue this example, NSAWC 02-04 would refer to the fourth test sponsored by the Naval Strike Warfare Center in FY 2002.

**b. Service area FMOs shall:**

(1) **Coordinate with their service area air traffic organizations** and applicable FAA ARTCCs and facilities as needed to determine whether FAA facilities could be impacted by the proposed EA mission.

(2) **Perform a thorough analysis** of the proposed EA impact on FAA systems within their service area.

(3) **Provide a written NAS facilities EA impact analysis** to Technical Operations ATC Spectrum Engineering Services for the proposed EA along with any recommendations for restrictions; e.g., altitude, time of day, prohibited frequencies, etc.

**1804. ANALYSIS OF EA REQUEST.**

**a. The following general policy** outlines the minimum analysis required when evaluating EA proposals.

(1) **FAA does not allow** its systems to experience RFI intentionally because of the possibility of degradation of safety of flight.

(a) **Military entities** are requested to accept restrictions that will allow EA training without RFI to FAA systems.

(b) **In those cases** where FAA allows RFI in order to accommodate military training, affected facilities or Centers will NOTAM the systems OTS, where necessary.

(2) **FAA does not allow EA** training on 1030 MHz, 1090 MHz, 108-137 MHz, 960-1240 MHz, 1559-1610 MHz or 5030-5090 MHz except under highly restrictive and limited instances.

(3) **There are certain frequency bands** that require special consideration because they are used by civil aviation for critical aeronautical radionavigation operations. However, the FAA does not centrally manage them. For example, these bands include 4200-4400 MHz (radar altimeter) and 13.25-13.40 GHz (airborne weather radar). Active EA operations are seldom performed in these bands, but chaff can impact these airborne systems. Care will be taken that chaff operations are not allowed near air routes so that such airborne systems do not receive interference.

**b. The following general procedures** will be used in evaluating EA electronic jamming proposals.

(1) **Determine whether the electronic jamming** is to be done in a frequency band in which FAA supports air traffic services. FAA evaluates only those jamming operations that could cause RFI to FAA operations.

(2) **Determine whether the jamming** is to be done in an area within RLOS of facilities supporting the National Airspace System and in a frequency band of concern to the FAA. **Note:** consider terrain shielding, if applicable.

(3) **Determine whether the power level** will be sufficient to cause RFI to FAA facilities if the jamming is to be within RLOS.

(4) **Determine possible restrictions** (e.g., altitude limitations, possible use of spot frequencies rather than bands, etc.) which could be imposed to allow the jamming.

c. **The following general guidelines** shall be followed when evaluating EA chaff proposals:

(1) **Only consider the primary and "second time around" targets** when evaluating chaff. Experience has shown that "third (or higher) time around" targets are not detected by FAA radars.

(2) **Chaff normally interferes with radar.** However, there is a small possibility that it could cause RFI to microwave systems such as RCL if dropped within 500 feet of the microwave beam.

(3) **Determine whether the chaff** is designed to affect a frequency band in which FAA has radar or microwave facilities.

(4) **If the chaff is designed** to affect a frequency of interest to FAA, determine whether it is to be within RLOS. **Note:** terrain shielding may be considered in this evaluation. See (1) above regarding "second time around."

**1805. CONCLUSIONS.** Analysis of EA operations, both electronic jamming and chaff, is complicated and requires good engineering practices. FAA is committed under Title 49, U.S.C., to provide a safe and efficient NAS. This Act also requires the FAA to make every effort to accommodate necessary military EA training. By careful analysis and proper procedures, FAA can permit most military EA training without impacting aeronautical safety.

**1806. OPERATIONAL BAND AND CHANNEL CODES.** The following bands and channels are set up to give one standard system of frequency band designations for EA operations and to facilitate the operational control of EA. The bands are identified in alphabetical sequence. Each band is divided into 10 numerical channels. The phonetic alphabet and numerical channel numbers are used to identify the EW frequency. During operations, when it becomes necessary to identify an exact frequency, the frequency is specified as a numerical designation (lowest frequency in any channel) plus frequency in MHz above the base frequency. Example for 1315 MHz: DELTA 4 covers the frequency range 1,300-1,400 MHz; 1,315 MHz would therefore be designated DELTA 4 plus 15. See Figure 18-1.

**FIGURE 18-1. FREQUENCY BAND DESIGNATIONS**

<u>Band</u>	<u>Frequency (MHz)</u>	<u>Channel Width (MHz)</u>
A(lpha)	0 – 250	25
B(ravo)	250 – 500	25
C(harlie)	500 - 1,000	50
D(elta)	1,000 - 2,000	100
E(cho)	2,000 - 3,000	100
F(oxtro)	3,000 - 4,000	100
G(olf)	4,000 - 6,000	200
H(otel)	6,000 - 8,000	200
I(ndia)	8,000 - 10,000	200
J(uliet)	10,000 - 20,000	1,000
K(ilo)	20,000 - 40,000	2,000
L(ima)	40,000 - 60,000	2,000
M(ike)	60,000 - 100,000	4,000
N(ovember)	100,000 - 200,000	10,000
O(scar)	200,000 - 300,000	10,000

**1807. FREQUENCY BAND CORRELATION.** Figure 18-2 depicts the correlation between previous frequency band designations (sometimes used by ARTCCs) and band designators defined in this chapter.

**FIGURE 18-2. FREQUENCY BAND CORRELATION**

<b>Frequency Range</b>	<b>EW Frequency Band</b>	<b>* Radar Design Frequency Band</b>
0-250 MHz	A	HF/VHF
250-500 MHz	B	UHF
500-1,000 MHz	C	UHF
1-2 GHz	D	L
2-3 GHz	E	S
3-4 GHz	F	S
4-6 GHz	G	C
6-8 GHz	H	C
8-10 GHz	I	X (8-12.5 GHz)
10-20 GHz	J	Ku (12.5-18 GHz)
20-40 GHz	K	K (18-26.5 GHz)
40-60 GHz	L	Ka (26.5-40 GHz)
60-100 GHz	M	40-100 Millimeter
100-200 GHz	N	Sub-millimeter
200-300 GHz	O	Sub-millimeter

\* Band designations sometimes used by ARTCC

**1808. EA COORDINATION REQUIREMENTS BY FREQUENCY BAND.**

a. Canada: All EA performed in Canada requires national coordination.

b. United States: Figure 18-3 has been coordinated at the national level. The status of the frequency bands for EW in the United States is annotated below as “Local,” “Local (FCC),” or “National.” Each status is defined in the Glossary of this manual and in the procedures in Enclosure C.

c. National Coordination: In Figure 18-3, “National” coordination requires that the request be forwarded to the cognizant Military Department (MILDEP) FMO for coordination. The frequency bands are listed consecutively to include all frequencies for ease of understanding. Obviously, one frequency cannot be both national and local. Therefore, the following rules apply. All frequency bands designated national are inclusive. All “Local” or “Local (FCC)” frequencies adjacent to a national frequency band begin or end at the first increment adjacent to the national frequencies. Local (FCC) frequencies are inclusive when adjacent to a local frequency. For example, in the band 25-50 MHz, all frequencies from 25 MHz through 50 MHz require national coordination; frequencies 50.001 MHz through 53.999 MHz require local coordination; and frequencies 54MHz through 72.999 MHz require local (FCC) coordination. NOTE: The reallocation of federal RF spectrum is an ongoing process. Reallocation may affect testing in some of the spectrum bands listed in Figure 18-3. The

MILDEP FMOs have the latest information on spectrum reallocation actions and will factor this knowledge into the national coordination process.

**FIGURE 18-3a. COORDINATION LEVEL REQUIRED BY CHANNEL AND FREQUENCY**

<b>Channel</b>	<b>(MHz)</b>	<b>United States</b>
A-1	0-25	National
A-2	25-50	National
A-3	50-75.2 [50-54 54-73 73-75.2]	Local Local (FCC) National <sup>1</sup>
A-4	75.2-100 [75.2-75.4 75.4-100]	National Local (FCC)
A-5	100-125 [100-108 108-125]	Local (FCC) National <sup>1</sup>
A-6	125-150 [125-138 138-150]	National <sup>1</sup> Local
A-7	150-175 [150-156 156-158 158-161 161-174 174-175]	Local National Local National Local (FCC)
A-8	175-200	Local (FCC)
A-9	200-225 [200-216 216-222 222-225]	Local (FCC) National Local

**FIGURE 18-3b. COORDINATION LEVEL REQUIRED BY CHANNEL AND FREQUENCY**

<b>Channel</b>	<b>(MHz)</b>	<b>United States</b>
A-10	225-250 [225-242.5 242.5-243.5 243.5-250]	National <sup>1</sup> National (Guard Frequency) <sup>1</sup> National <sup>1</sup>
B-1	250-275	National <sup>1</sup>
B-2	275-300	National <sup>1</sup>
B-3	300-325	National <sup>1</sup>
B-4	325-350	National <sup>1</sup>
B-5	350-375	National <sup>1</sup>
B-6	375-400	National <sup>1</sup>
B-7	400-425 [400-420 420-425]	National Local
B-8	425-450 [425-448 448-450]	Local National
B-9	450-475	National
B-10	475-500	National
C-1	500-550 [500-512 512-550]	National <sup>1</sup> Local (FCC)
C-2	550-600	Local (FCC)
C-3	600-650 [600-608 608-614 614-650]	Local (FCC) National Local (FCC)
C-4	650-700	Local (FCC)
C-5	700-750	Local (FCC)
C-6	750-800	Local (FCC)
C-7	800-850 [800-806 806-850]	Local (FCC) National



**FIGURE 18-3c. COORDINATION LEVEL REQUIRED BY CHANNEL AND FREQUENCY**

<b>Channel</b>	<b>(MHz)</b>	<b>United States</b>
C-8	850-900	National
C-9	900-950 [900-902 902-928 928-950]	National Local National <sup>1</sup>
C-10	950-1,000 [950-960 960-1000]	National National <sup>1</sup>
D-1	1,000-1,100	National <sup>1</sup>
D-2	1,100-1,200	National <sup>1</sup>
D-3	1,200-1,300	National <sup>1</sup>
D-4	1,300-1,400 [1,300-1,390 1,390-1,400]	National <sup>1</sup> National
D-5	1,400-1,500	National <sup>1</sup>
D-6	1,500-1,600	National <sup>1</sup>
D-7	1,600-1,700	National <sup>1</sup>
D-8	1,700-1,800	National
D-9	1,800-1,900	National
D-10	1,900-2,000	National
E-1	2,000-2,100	National
E-2	2,100-2,200	National
E-3	2,200-2,300	National
E-4	2,300-2,400 [2,300-2,305 2,305-2,390 2,390-2,400]	Local National Local
E-5	2,400-2,500 [2,400-2,483.5 2,483.5-2,500]	Local National
E-6	2,500-2,600	National
E-7	2,600-2,700	National

**FIGURE 18-3d. COORDINATION LEVEL REQUIRED BY CHANNEL AND FREQUENCY**

<b>Channel</b>	<b>(MHz)</b>	<b>United States</b>
E-8	2,700-2,800	National <sup>1</sup>
E-9	2,800-2,900	National <sup>1</sup>
E-10	2,900-3,000	National
F-1	3,000-3,100	National
F-2	3,100-3,200	Local
F-3	3,200-3,300	Local
F-4	3,300-3,400	Local
F-5	3,400-3,500	Local
F-6	3,500-3,600	Local
F-7	3,600-3,700 [3,600-3,650 3,650-3,700]	Local National
F-8	3,700-3,800	National
F-9	3,800-3,900	National
F-10	3,900-4,000	National
G-1	4,000-4,200	National
G-2	4,200-4,400	National <sup>1</sup>
G-3	4,400-4,600	Local
G-4	4,600-4,800 [4,600-4,635 4,635-4,685 4,685-4,800]	Local National Local
G-5	4,800-5,000 [4,800-4,990 4,990-5,000]	Local National
G-6	5,000-5,200	National <sup>1</sup>
G-7	5,200-5,400 [5,200-5,250 5,250-5,400]	National <sup>1</sup> Local

**FIGURE 18-3e. COORDINATION LEVEL REQUIRED BY CHANNEL AND FREQUENCY**

<b>Channel</b>	<b>(MHz)</b>	<b>United States</b>
G-8	5,400-5,600	Local
G-9	5,600-5,800 [5,600-5,650 5,650-5,800]	National <sup>1</sup> Local
G-10	5,800-6,000 [5,800-5,850 5,850-6,000]	Local National
H-1	6,000-6,200	National
H-2	6,200-6,400	National
H-3	6,400-6,600	National
H-4	6,600-6,800	National
H-5	6,800-7,000	National
H-6	7,000-7,200	National
H-7	7,200-7,400	National
H-8	7,400-7,600	National
H-9	7,600-7,800	National
H-10	7,800-8,000	National
I-1	8,000-8,200	National
I-2	8,200-8,400	National
I-3	8,400-8,600 [8,400-8,500 8,500-8,600]	National Local
I-4	8,600-8,800	Local
I-5	8,800-9,000	Local
I-6	9,000-9,200	National <sup>1</sup>
I-7	9,200-9,400 [9,200-9,300 9,300-9,400]	Local National
I-8	9,400-9,600 [9,400-9,500 9,500-9,600]	National Local

**FIGURE 18-3f. COORDINATION LEVEL REQUIRED BY CHANNEL AND FREQUENCY**

<b>Channel</b>	<b>(MHz)</b>	<b>United States</b>
I-9	9,600-9,800	Local
I-10	9,800-10,000	Local
J-1	10,000-11,000 [10,000-10,550 10,550-11,000]	Local National
J-2	11,000-12,000 [11,000-11,700 11,700-12,000]	National Local (FCC)
J-3	12,000-13,000	Local (FCC)
J-4	13,000-14,000 [13,000-13,250 13,250-14,000]	Local (FCC) Local <sup>2</sup>
J-5	14,000-15,000	National
J-6	15,000-16,000	National <sup>1</sup>
J-7	16,000-17,000	National <sup>1</sup>
J-8	17,000-18,000 [17,000-17,700 17,700-18,000]	National <sup>1</sup> Local (FCC)
J-9	18,000-19,000	Local (FCC)
J-10	19,000-20,000 [19,000-19,700 19,700-20,000]	Local (FCC) National
K-1	20,000-22,000	National
K-2	22,000-24,000	National
K-3	24,000-26,000 [24,000-24,050 24,050-26,000]	Local National
K-4	26,000-28,000 [26,000-27,500 27,500-28,000]	Local National
K-5	28,000-30,000	National

**FIGURE 18-3g. COORDINATION LEVEL REQUIRED BY CHANNEL AND FREQUENCY**

<b>Channel</b>	<b>(MHz)</b>	<b>United States</b>
K-6	30,000-32,000 [30,000-31,300 31,300-31,800 31,800-32,000]	Local (FCC) National Local
K-7	32,000-34,000	Local
K-8	34,000-36,000	Local
K-9	36,000-38,000	National
K-10	38,000-40,000	National
L-1	40,000-42,000	National
L-2	42,000-44,000 [42,000-42,500 42,500-44,000]	National Local
L-3	44,000-46,000 [44,000-44,500 44,500-46,000]	Local National
L-4	46,000-48,000	National
L-5	48,000-50,000	National
L-6	50,000-52,000 [50,000-51,400 51,400-52,000]	Local National
L-7	52,000-54,000	National
L-8	54,000-56,000	National
L-9	56,000-58,000)	National
L-10	58,000-60,000	National
M-1	60,000-64,000	Local
M-2	64,000-68,000	Local
M-3	68,000-72,000	Local
M-4	72,000-76,000	Local
M-5	76,000-80,000 [76,000-77,000 77,000-80,000]	National Local

**FIGURE 18-3h. COORDINATION LEVEL REQUIRED BY CHANNEL AND FREQUENCY**

<b>Channel</b>	<b>(MHz)</b>	<b>United States</b>
M-6	80,000-84,000	Local
M-7	84,000-88,000 [84,000-86,000 86,000-88,000]	Local National
M-8	88,000-92,000	National
M-9	92,000-96,000	Local
M-10	96,000-100,000	Local
N-1	100,000-110,000 [100,000-100,200 100,200-102,000 102,000-105,000 105,000-110,000]	Local National Local National
N-2	110,000-120,000 [110,000-116,000 116,000-120,000]	National Local
N-3	120,000-130,000	Local
N-4	130,000-140,000	Local
N-5	140,000-150,000	Local
N-6	150,000-160,000	Local
N-7	160,000-170,000 [160,000-164,000 164,000-168,000 168,000-170,000]	Local National Local
N-8	170,000-180,000	Local
N-9	180,000-190,000 [180,000-182,000 182,000-185,000 185,000-190,000]	Local National Local
N-10	190,000-200,000	Local
O-1	200,000-210,000	Local
O-2	210,000-220,000 [210,000-217,000 217,000-220,000]	Local National



**FIGURE 18-3i. COORDINATION LEVEL REQUIRED BY CHANNEL AND FREQUENCY**

<b>Channel</b>	<b>(MHz)</b>	<b>United States</b>
O-3	220,000-230,000	Local
O-4	230,000-240,000 [230,000-231,000 231,000-240,000]	National Local
O-5	240,000-250,000	Local
O-6	250,000-260,000 [250,000-252,000 252,000-260,000]	National Local
O-7	260,000-270,000	Local
O-8	270,000-280,000	Local
O-9	280,000-290,000	Local
O-10	290,000-300,000	Local

<sup>1</sup> FAA coordination required.

<sup>2</sup> Except that national coordination is required for the 13,750-14,000 MHz frequency band within 200 nm of the NASA site at Las Cruces, NM.

**1809. thru 1899. RESERVED.**



## CHAPTER 19. AUTOMATED ENGINEERING

**1900. PURPOSE.** The purpose of this chapter is to present policy and an overview on the use of various computer system elements developed to support FAA spectrum engineering. These system elements facilitate the automation of various engineering functions used by Headquarters to evaluate and make frequency assignments.

**1901. AUTOMATED FREQUENCY MANAGER (AFM).** The AFM system should be used by any FAA spectrum engineer to engineer frequencies, submit or track frequency assignment applications, investigate RFI or analyze the contents of the AFM data base, which includes data obtained from the GMF, FAA pending frequency assignments, and various international, FCC, and ARINC sources. Headquarters is responsible for engineering and recommending approval/disapproval to NTIA for all frequency assignments, both Government and non-Government, delegated to the AAG (see NTIA Manual, Chapter 1), as well as all FAA frequency assignments in all frequency bands. FAA registers all of its own frequency assignments, as well as non-Government frequency assignments in the AAG bands, with the NTIA. The frequency assignments are then incorporated into the GMF. See paragraph 1907. The AFM is also used as a tool for frequency assignment coordination between Government entities requesting frequency assignments in the AAG bands.

**1902. AFM AGENDA SYSTEM.** The AFM Agenda System program is designed to allow Headquarters users to evaluate and vote on frequency assignments in a Windows environment. The program allows users to review and vote on all assignments processed by NTIA. Agenda sections are downloaded from, and voted records returned to, NTIA daily. See paragraph 1908.

**1903. AIRSPACE ANALYSIS MODEL (AAM).** The AAM was designed to assist the FMO in determining the effects of various radio transmitters (in particular FM stations) on aircraft navigation and communications receiver facilities. The model determines the effects of FM broadcast stations on ILS localizer and VOR signals. It allows the selection of a proponent FM station at any location within the U.S. and provides a complete compatibility analysis between the proponent and any selected localizer within 30 nmi of the proponent. See paragraph 1909.

**1904. RFI and RADHAZ DATA BASE.** The Spectrum Management Data Base (SMDb) is used to record RFI events affecting the NAS, and to facilitate the calculation and reporting of radiation measurements. The SMDb significantly enhances the means to address these issues and to share information across the Technical Operations Services organizations. See paragraph 1910.

**1905. EXPANDED SERVICE VOLUME (ESV) MANAGEMENT SYSTEM (ESVMS).** The **ESVMS** is an advanced web-accessible application that provides a set of functions in an easy-to-use interface. This program was developed to improve the processing time for new ESVs and to provide an effective tool in recording and tracking all ESV requests, from origination to final approval and registration into the national ESV data base. It provides for the generation and printing of reports for all Pending, Approved, Disapproved, Cancelled, and Restricted ESVs. See paragraph 1911.

**1906. RADIO COVERAGE ANALYSIS SYSTEM (RCAS).** RCAS is a web-accessible modeling and analysis tool used to perform radio coverage and analysis studies. RCAS allows a visualization of the predicted radio coverage patterns, taking into account terrain data. This tool also facilitates the siting of communications, navigation, and radar equipment. This can be done by overlaying the analysis with state boundaries, sector boundaries, ground features, etc.

## 1907. OVERVIEW OF THE AFM

**a. The AFM.** The AFM software application is an Internet based application consisting of primarily Client, Business/Application, and Data base service/server tiers. Service area users can access the AFM Internet based application via the FAA Network, the Internet via a Secure Socket Layer (SSL) or a secure Virtual Private Network (VPN) connection, as well as a Dial-up Remote Access Server (RAS) connection. Service area users can also run and access program files and the data base locally if necessary.

### b. Uses.

(1) **Create and modify FAA and NG applications**, edit them to ensure they conform to FAA and NTIA standards and send them to NTIA for incorporation into the GMF.

(2) **Track the progress of applications** through the approval process.

(3) **Produce management reports** on the status of the assignment process.

(4) **Produce new FTA forms** as applications are approved.

(5) **Register frequencies** internationally (planned future application).

(6) **Review assignments regularly** (at least every 5 years) to ensure that the frequencies are still in use and the assignments correctly reflect the usage.

(7) **Create and modify DOD and other Government applications** in the AAG bands to test for frequency suitability, i.e., to provide coordination with other agencies.

**c. Frequency engineering.** Each proposed frequency shall be tested to ensure that it meets FAA standards for sufficient signal strength within its FPSV and receives the required protection from interference. The AFM system provides several models for engineering interference-free frequencies. These models protect both the proposed target and all existing sites, i.e., testing is done on the target as both desired and undesired. These models assist the user in engineering and selecting the best frequency to assign for the most efficient use of the spectrum. The model's results detail reasons for failure/interference, thus assisting the user in exploring ways to engineer a successful frequency, e.g., by using filters, changing the power, etc.

(1) **The Air/Ground model** is a tool for engineering frequencies in the 118-137 MHz and 225-400 MHz bands. This model performs the following tests, which are further described in Chapter 9 and Appendix 2.

(a) **A cochannel test protects** against using the same frequency in two coverage areas within interference range of each other.

(b) **An adjacent channel test protects** against using frequencies separated by  $\pm 25$  kHz or  $\pm 50$  kHz from being used in nearby service areas, which otherwise could result in interference.

(c) **A cosite test protects** against the potential for interference from nearby transmitters, which otherwise would be allowed to operate at a frequency separation less than an established minimum, usually  $\pm 500$  kHz for VHF or  $\pm 1$  MHz for UHF.

(2) **The NAVAIDS Model performs** intersite analysis tests in the bands 108.20-117.95 MHz (LOC, VOR/VOT), 328.6-335.4 MHz (GS), 960-1215 MHz (DME/TACAN), and 5031-5091 MHz (MLS). For GS and MLS testing, cochannel and adjacent channel testing involves identifying those sites having interferers within

designated distances. For DME/TACAN, VOR/VOT, and LOC testing, an Equivalent Signal Ratio (ESR) is calculated and the interpolation of appropriate curves is carried out to determine the required separation distance, as described in Chapter 10 and Appendix 3 of this manual. If ESVs are associated with the target or potential interferer, they are also tested. The target's ESV signal strength is also tested. In order to protect paired NAVAID frequencies, dummy assignments have been created for unassigned associated frequencies.

(3) **The NDB model tests** nondirectional beacons in the frequency band 190-535 kHz. All potential interferers within a frequency  $\pm 6$  kHz from the proposed target are tested. The required separation distance is calculated, based upon the prediction curves and calculation methods described in Chapter 11 of this manual.

(4) **Frequency assignments** for fixed, mobile communications, HF communications, radio communications links, and radar are tested by using a generic model, which produces a circle report of potential interferers.

**d. OTHER AFM ENGINEERING FEATURES.** Additional features of the AFM assist spectrum engineers in performing engineering analyses. FCC, ARINC, and international data bases are maintained and are used by the models and browse/query routines.

(1) **Browse and query routines** are provided to assist engineers in analyzing the distribution of frequencies throughout the spectrum.

(2) **A graphics routine** lets users display model and browse/query results on appropriate maps. Users can also choose to map ILS keyholes, glide slope and ESV wedges, DME/VOR circles, and TSV ATC sectors.

(3) **An intermod program** helps engineers investigate possible sources of RFI. The frequencies tested as well as the potential interferer frequencies can be user-entered, selected from a browsed list, and/or selected from a circle report.

(4) **A TSV data base** is periodically updated. The Centrad model lets users modify a pending TSV data base. The A/G model as well as the graphics routines uses these data bases.

(5) **ESV data** can be added to NAVAIDS assignments. The NAVAIDS model is used to test ESVs for signal strength and interference.

(6) **Engineering tools** are also provided. These include bearing/distance calculations and power/density calculations.

(7) **The system documentation** includes formulas used in creating the models and tools. This documentation is included in the on-line help.

**1908. AFM AGENDA SYSTEM.** This system allows FAA Technical Operations ATC Spectrum Engineering Services users to vote on "frequency applications" submitted by other government agencies via records received from the NTIA.

**a. The system is comprised** of three programs: Import, Export, and Vote Agenda.

(1) **Import** is run daily to import all new "sections" of data from NTIA.

(2) **Export** is run daily to export all "voted" applications to NTIA.

(3) **Technical Operations ATC Spectrum Engineering Services** users can run the Vote Agenda program, throughout the day, to review and vote "applications."

**b. Vote Agenda.** Users log into the system using a User ID that identifies which AFM frequency "bands" the user can access and review. A band access table identifies the frequency bands each user can access and it is user modifiable.

### 1909. AIRSPACE ANALYSIS MODEL (AAM)

#### a. Overview of the AAM

(1) **The primary purpose of the AAM** is to serve as a tool to help evaluate the effects of FM broadcast signals on ILS localizer, VOR and COMM signals received by airborne receivers, as well as by ground receivers in the case of COMM. This includes intermodulation, receiver front-end overload and adjacent channel interference.

(2) **This model differs significantly** from earlier methods of analyzing compatibility in that a complete three dimensional analysis is performed. This analysis takes into consideration the vertical radiation patterns of the FM broadcast antennas as well as the vertical structure of the Navaid service volume. The output of this model consists of computer-generated plots, which indicate regions within the Navaid service volume where interference is predicted.

(3) **The AAM consists** of standard RF propagation equations and a quantity of empirical data acquired from various sources involved in the investigation of the compatibility between FM broadcast and aeronautical radio services. The data were obtained from measurements performed on a range of equipment under a variety of conditions. A mathematical representation of the data is used to categorize the immunity performance of a representative receiver under a wide range of signal conditions.

(4) **The potential for RFI** is determined by calculating the signal conditions present at a specific site by identifying the relevant RF emitters in the area, applying standard propagation equations and adjusting for system losses to find the signal levels at the receiver input, and then examining the empirical data to see if the representative receiver would experience interference under those conditions.

#### b. Signal Level Prediction

(1) **The AAM calculates** the signal-in-space conditions by starting with the parameters of the transmitting system and accounting for propagation loss. Transmitting parameters for an FM broadcast station include the transmitter power as well as the vertical and horizontal gain patterns of the transmitting antenna. For aeronautical facilities, the AAM accesses a subset of the GMF to determine the array type of the facility being analyzed and then performs the needed calculations to determine the signal-in-space conditions. For example, signal levels for the localizer are calculated by modeling the free-space, vertical pattern of the localizer as a  $\text{Sin}^2 \theta$  pattern. Ground reflections are modeled by assuming the ground to be an infinite, flat plane with a dielectric constant of 12 and a conductivity of .003 Mhos per meter.

(2) **The signal-in-space value** is then corrected by the losses in the receiving system (including losses due to the frequency-gain response of the receiving antenna) to determine the levels of the signals (both desired and undesired) present at the input to the receiver.

### c. Interference Calculations

(1) **Several receiver models** have been examined through a series of bench measurements taken by the FAA and the FCC. The receivers were chosen to represent a broad cross-section of the existing population. Statistics on the population of receivers and aircraft were obtained from the FAA, the NTSB, the General Aviation Manufacturers Association (GAMA), and the AOPA. The receiver models included in the measurements constitute combined sales of more than 200,000 units spread among the 215,000 active civil aircraft in United States (including air carrier, commuter, and general aviation categories).

(2) **Various combinations** of these receivers were tested for sensitivity to interference by overload/desensitization (type B2), adjacent channel (type A2), and two-signal/three-signal third-order intermodulation (type B1). The results were tabulated and used to develop empirical interference threshold criteria. A step-by-step description of the AAM calculations is shown below.

(a) **The AAM identifies the boundaries** of the FPSV for the aeronautical facility of interest and generates a grid of test locations throughout the area of interest within the FPSV. This grid is on a maximum spacing of 1000' x 1000' centers for the ILS localizer, a maximum spacing of 6076' x 6076' centers for the VOR, and a maximum spacing of 2 percent of the service-volume radius or 9999', whichever is less, for VHF communications facilities (except for ground-based VHF communications facilities which are only examined at the location of the facility).

(b) **The AAM identifies the undesired RF emitter sources** and calculates the field-in-space for every emitter, at every grid location, based on the transmitted power, the radiation patterns of the transmitting antennas, and the propagation losses.

(c) **The AAM adjusts the field-in-space values** for receiving system losses (including the frequency vs. gain response of the receiving antenna and polarization loss) to determine the signal levels at the receiver input for both the undesired signals and the aeronautical signal.

(d) **The AM applies the A2 (adjacent-channel) and B2 (overload/desensitization) interference criteria** at every grid location for every undesired emitter to determine if the representative receiver will experience A2/B2 interference based on the signal levels at that grid location.

(e) **The AAM identifies every relevant RF emitter** (including broadcast and aeronautical facilities) located within 30 nmi of the FPSV boundaries and computes every potential two-signal and three-signal, third-order intermodulation (IM) product. It then identifies every IM product falling within 200 KHz of the aeronautical facility being studied.

(f) **The AAM calculates the signal levels** [using the parameters discussed in step (a) and step (b) above] of every component of every IM product identified in step (e), and applies the B1 (IM) interference criteria to determine if the representative receiver will experience B1 interference based on the signal levels at that grid location.

(g) **A map of the FPSV** is generated containing a plot of every grid location at which interference is predicted to occur.

### 1910. RFI AND RADHAZ SUPPORT

a. **The SMDb provides automated tools** to help satisfy analysis and reporting functions for both RFI and RADHAZ cases, as highlighted in paragraph 1904. The capabilities and operational environment of the SMDb are briefly highlighted below.

**b. The RFI portion of the SMDb** application enables users to record RFI events affecting the airspace for which they manage the radio spectrum. Recording these events is accomplished through an easily accessible application with improved navigation and functionality. This application also allows for the sharing of resolution information across the Technical Operations Services organizations. The RFI portion of the SMDb supports the following:

(1) **Provides a library of audio files** capturing the sound of recorded interferences to be accessed through the FAA intranet 24 hours a day, seven days a week.

(2) **Serves as a reporting system.** Many ad hoc queries can be performed on the data collected in this system.

(4) **RFI reports are entered and viewed** through a number of means. The SMDb is envisioned to be the one place to report, record RFI and collect information concerning ongoing investigations, as well as view historical data on events from previous years. Service areas, as well as Headquarters, can use this repository to view all interference problems and their resolution.

(5) **Uploading any type of file** to be linked with the Interference Record.

(6) **Records** the funds expended to investigate the RFI.

(7) **Add utility screens** for choices which did not previously exist to drop-down boxes in a simple manner, without the use of a programmer. These screens can be accessed from the menu panel.

(8) **Maintain data integrity** through many validations. For example, if the frequency, facility type, and facility identifier do not match the frequency assignment listed in the AFM, the system will not allow an RFI event to be recorded against that facility.

**c. The RADHAZ portion of the SMDb** facilitates the calculation and reporting of Radiation Measurements, from the time of a RADHAZ request through the reporting and approval of the measurements. It is also acts as a repository of all FAA RADHAZ survey reports. The RADHAZ portion of the SMDb supports the following:

(1) **Upload an electronic version of a RADHAZ report** document (scanned or original) to be linked to a facility record and include it in a RADHAZ online repository.

(2) **Download available RADHAZ** reports in online repository for viewing purposes.

(3) **Write and print RADHAZ reports** using a predetermined format, including writing and submitting special request or baseline RADHAZ survey reports.

(4) **Approve and publish reports** by an approving authority, from reports submitted by a user.

(5) **Search and view RADHAZ survey reports** related to a specified facility.

**d. SMDb Operating Environment.** The SMDb resides as a web-based application on the FAA's Intranet. Users access the system using Microsoft Internet Explorer web browser. The SMDb does not have a "client" software application. Most application functions will occur centrally on the server either using the web application server or the data base server. FAA personnel will have access to data in a "real-time" environment. Updates to data made by a user will be instantaneously available to all other users having access to the application.

**1911. ESV**

**a. Background.** ESVs are not registered in the NTIA or GMF. Thus, Technical Operations ATC Spectrum Engineering Services maintains a separate data base within the AFM system for all ESVs used in the NAS. The ESV process previously required the procedures specialist to apply for an ESV by FAA Form 6050-4 that requires FMO and FIFO approval. The development of the ESVMS provides an automated and much more flexible means of processing ESVs.

**b. Capabilities.** The ESVMS enables users to process ESV requests to establish, revise or cancel ESVs. It provides an enhanced workflow with on-line tracking of ESV requests 24 hours a day, seven days a week. During the process, users have the ability to view the status of all ongoing ESV requests through an easily accessible system using intuitive format and navigation. ESVMS gives the user the option of saving an application while it is being worked on and selecting it again, at another time, to complete and send forward in the process. The system offers administrative users the functionality to manage and update user information and privileges. The ESVMS also presents the capability of reporting detailed and summary data.

**c. Operating Environment.** The ESVMS resides on a web application server and operates on the FAA's Intranet. Users may access the system using Microsoft Internet Explorer web browser. The ESV application does not have a "client" software application. Most application functions will occur centrally on the server either using the web application server or the data base server. All concerned FAA entities will have access to data in a "real-time" environment. Updates to data made by any user will be instantaneously available to all other users having access to the ESVMS.

**1912. – 1999. RESERVED**

## APPENDIX 1. AIRSPACE EVALUATION

### SECTION 1. BACKGROUND AND PROCEDURES

**1. INTRODUCTION.** The authority, regulations, and basic procedure for handling airspace evaluations are discussed in chapter 5. This appendix will establish detailed methods for such evaluations.

**2. BACKGROUND.** Due to the rapid growth of both aeronautical and commercial broadcast services, the number of interference cases involving aircraft and commercial broadcast emissions has increased dramatically. Interference is usually most severe at airports with high power FM and TV broadcast facilities nearby.

**a. COMM receivers** experience interference in the form of nuisance background noise, actual broadcast audio, and distorted or garbled reception of desired ground transmissions. NAVAID receivers (VOR and LOC) experience nuisance audio, actual errors in course deviation indicators, and erroneous flag indications. This interference to NAVAID receivers is the most serious. Course deviation errors during an approach and landing, the most critical phase of flight operation, are usually not as evident to the pilot as disrupted communications.

**b. There are many factors** that contribute to this problem. One is the broad power differential between commercial broadcast and aeronautical service transmitters. FM stations may operate at as much as 100 kW and many TV stations operate above the 100 kW level. In contrast, a LOC transmitter is typically operated at only 20 W, plus 12 to 20 dB gain "on course." Outside the LOC antenna's main beam, the EIRP is considerably reduced.

**c. There is no guard band** between the high end of the FM broadcast band (107.9 MHz) and the low end of the aeronautical NAVAID band (108.0 MHz). Spurious emission levels from commercial transmitters are significant as far as 600 kHz off channel. Also, due to operating necessity, the minimum performance standards for aircraft receivers require them to be a broadband device.

**3. FM BROADCAST TOLERANCES.** FCC Rules and Regulations Part 73 authorize the operation of FM broadcast transmitters within certain standards and tolerances.

**a. FMOs should review Part 73** which establishes policy that proponents who either (1) commence program tests, or (2) replace their antennas, or (3) request facility modifications and are issued a new construction permit, must satisfy all complaints of interference to aeronautical facilities during a one year period. Resolution of complaints will be at no cost to the FAA.

**b. FM broadcast stations** operate on 100 channels in the 88-108 MHz band (see figure 1). Channel carriers are 200 kHz apart on odd decimal frequencies. The first assignable channel is 88.1 MHz (Ch 201) and the last is 107.9 MHz (Ch 300). The FCC allocates FM channels to towns and cities across the nation according to a coordinated geographic assignment plan.



**FIGURE 1. FM CHANNELS AND CENTER FREQUENCIES**

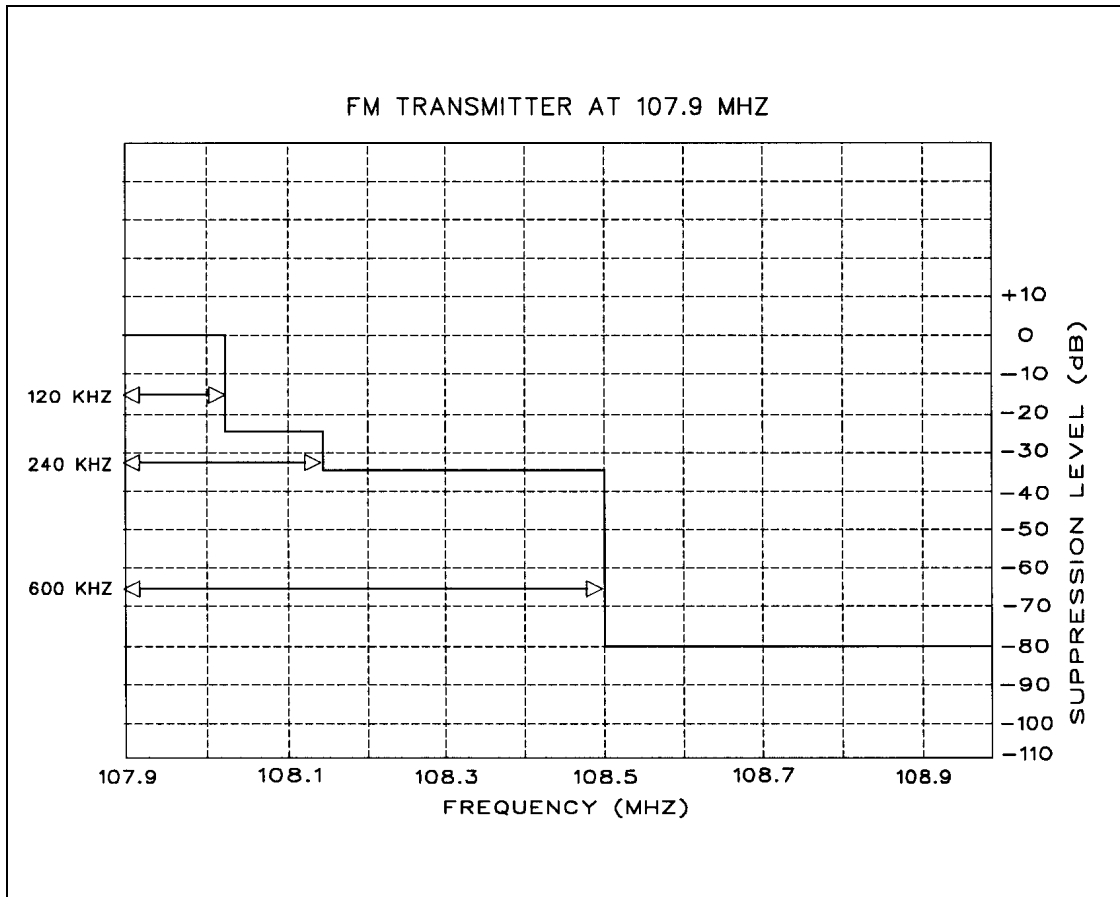
CHNL NO.	FREQ MHZ	CHNL NO.	FREQ MHZ
201	88.1	251	98.1
202	88.3	252	98.3
203	88.5	253	98.5
204	88.7	254	98.7
205	88.9	255	98.9
206	89.1	256	99.1
207	89.3	257	99.3
208	89.5	258	99.5
209	89.7	259	99.7
210	89.9	260	99.9
211	90.1	261	100.1
212	90.3	262	100.3
213	90.5	263	100.5
214	90.7	264	100.7
215	90.9	265	100.9
216	91.1	266	101.1
217	91.3	267	101.3
218	91.5	268	101.5
219	91.7	269	101.7
220	91.9	270	101.9
221	92.1	271	102.1
222	92.3	272	102.3
223	92.5	273	102.5
224	92.7	274	102.7
225	92.9	275	102.9
226	93.1	276	103.1
227	93.3	277	103.3
228	93.5	278	103.5
229	93.7	279	103.7
230	93.9	280	103.9
231	94.1	281	104.1
232	94.3	282	104.3
233	94.5	283	104.5
234	94.7	284	104.7
235	94.9	285	104.9
236	95.1	286	105.1
237	95.3	287	105.3
238	95.5	288	105.5
239	95.7	289	105.7
240	95.9	290	105.9
241	96.1	291	106.1
242	96.3	292	106.3
243	96.5	293	106.5
244	96.7	294	106.7
245	96.9	295	106.9
246	97.1	296	107.1
247	97.3	297	107.3
248	97.5	298	107.5
249	97.7	299	107.7
250	97.9	300	107.9

**c. Maximum spurious emission levels** for FM broadcast stations are:

<u>Any spurious emission removed from the main carrier frequency by:</u>	<u>Must be attenuated below the unmodulated carrier by at least:</u>
120-240 kHz	25 dB
240-600 kHz	35 dB
Beyond 600 kHz	43 dB + 10 Log P or 80 dB, whichever is the lesser (P = power output in watts)

**d. An FM transmitter operates** with a maximum allowable deviation of  $\pm 75$  kHz around the carrier. Actual deviation is governed by the amplitude of the modulating signal and the rate of deviation is determined by the modulating frequency. An infinite number of sidebands theoretically results. Only sidebands down to 1 percent of the carrier amplitude are considered significant. Therefore, the total occupied bandwidth of an FM broadcast emission extends beyond  $\pm 75$  kHz, but is subject to the spurious emission standards stated in subparagraph b. and shown in figure 2.

**FIGURE 2. SPURIOUS EMISSION LEVEL OF AN FM BROADCAST TRANSMITTER ON 107.9 MHZ**



**e. The radiated power of an FM station** is set by FCC standards, according to the class of station and the transmitter antenna height. Power can be up to 600 kW in some cases.

**f. The horizontal radiation pattern** of a typical FM broadcast antenna is considered omnidirectional. The vertical pattern is a function of the gain and number of elements (bays) used by the antenna. Antenna radiation polarization may be horizontal, vertical or both.

**4. TV BROADCAST TOLERANCES.** FCC Rules and Regulations Part 73 authorizes the operation of TV broadcast transmitters within certain standards and tolerances.

**a. TV broadcast stations** operate on 12 VHF channels between 54-216 MHz and 56 UHF channels between 470-806 MHz (see figure 3). Channel carriers are 6 MHz apart. FCC allocates TV channels to towns and cities across the nation according to a coordinated geographic assignment plan.

**b. The visual carrier** is 1.25 MHz ( $\pm 1$  kHz) above the channel lower limit and may be offset by  $\pm 10$  kHz. The aural carrier is 0.25 MHz ( $\pm 1$  kHz) below the upper channel limit (see figure 4).

**c. The minimum radiated power for all classes of TV stations** is 100 W.

**d. Maximum power for TV stations** is set by FCC standards according to the operating frequency (channel), geographical location and transmitter antenna height. Radiated power can reach as high as 5 MW for UHF channels under some conditions.

**e. The TV broadcast transmission** consists of the amplitude modulated visual carrier with a composite picture and synchronizing signals, together with the aural carrier frequency modulated by the audio signal. A vestigial sideband filter reduces the lower sideband width.

**f. Spurious emissions**, including RF harmonics, are required to be maintained at as low a level as the state of the art permits. All emissions removed in frequency in excess of  $\pm 3$  MHz of the respective channel edge shall be attenuated no less than 60 dB below the visual transmitted power. These levels are measured at the output terminals of the transmitter.

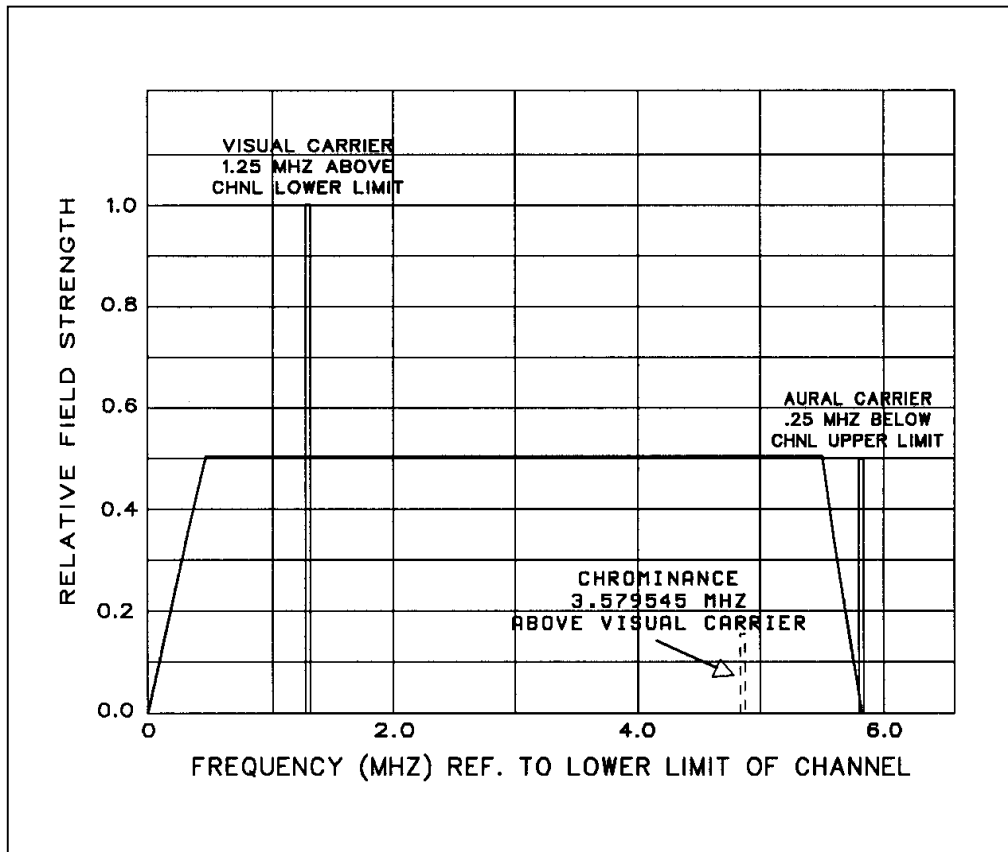
**g. Directional antennas** may be employed to improve coverage. Polarization may be horizontal or circular. The maximum to minimum ratio of radiation in the horizontal plane shall not exceed 10 dB for channels 2-13 and 15 dB for channels 14-69.

**5. AM AND OTHER NONBROADCAST STATION STANDARDS.** Other stations such as AM, cellular, microwave, etc. have different standards. For these facilities, the airspace evaluation is handled differently. Refer to Chapter 8 of this Order, paragraph 808.

**6. STANDARD FPSVS FOR FAA FACILITIES.** The FPSVs for various facilities are discussed in detail in the portions of this order pertaining to specific types of equipment. Of concern in this appendix are the ILS LOC and VOR FPSVs. The standard and optional service volume dimensions for ILSs and VORs are shown in Appendix 3.

**FIGURE 3. TV CHANNELS AND ASSOCIATED FREQUENCIES**

CHNL NO.	FREQ MHZ	CHNL NO.	FREQ MHZ
2	54-60	36	602-608
3	60-66	37	608-614
4	66-72	38	614-620
5	76-82	39	620-626
6	82-88	40	626-632
7	174-180	41	632-638
8	180-186	42	638-644
9	186-192	43	644-650
10	192-198	44	650-656
11	198-204	45	656-662
12	204-210	46	662-668
13	210-216	47	668-674
14	470-476	48	674-680
15	476-482	49	680-686
16	482-488	50	686-692
17	488-494	51	692-698
18	494-500	52	698-704
19	500-506	53	704-710
20	506-512	54	710-716
21	512-518	55	716-722
22	518-524	56	722-728
23	524-530	57	728-734
24	530-536	58	734-740
25	536-542	59	740-746
26	542-548	60	746-752
27	548-554	61	752-758
28	554-560	62	758-764
29	560-566	63	764-770
30	566-572	64	770-776
31	572-578	65	776-782
32	578-584	66	782-788
33	584-590	67	788-794
34	590-596	68	794-800
35	596-602	69	800-806

**FIGURE 4. IDEALIZED STANDARD TV CHANNEL SPECTRUM**

**7. EVALUATION PROCEDURE OUTLINE.** It is essential that airspace case study methods be thorough and consistent from service area to service area. An improper evaluation may cause difficult and lengthy legal proceedings for the agency. The outline presented in figure 5 is a guide for each evaluation.

#### **8. DATA ASSEMBLY.**

**a. It is difficult** to establish specific sources for retrieving the data necessary for an evaluation. Commercial broadcast data exist as hard copy listings and additional information can be obtained through FCC or from the broadcasters themselves. The AM, FM and TV data bases are available through the automated frequency management system (AFM).

**b. When identifying** commercial broadcast stations for an aeronautical study, specific radii have been established for each of the broadcast services based on probability and empirical tests. The greatest potential for interference comes from high power FM, particularly those stations operating at the high end of the FM band.

**c. FAA and non-Fed facilities** may be identified using the CIRCLE program or other search programs available through the AFM. If the proposed construction is an FM transmitter, the search should be for a 30 nmi radius around the new coordinates; if for a TV transmitter, 10 nmi; if for AM, 3 nmi.

**FIGURE 5. EVALUATION PROCEDURE OUTLINE CHART****A. ASSEMBLE DATA**

- 1) Commercial stations
  - a. Frequency
  - b. Coordinates
  - c. Power (EIRP)
  - d. Site elevations
  - e. Antenna height (AGL, AMSL, RCAMSL)
  - f. Antenna types and radiation patterns
- 2) FAA facilities
  - a. Frequency
  - b. Coordinates
  - c. FPSVs
  - d. Site elevations
  - e. Antenna height (AMSL)
  - f. Associated facilities
- 3) Charts
  - a. Low Altitude Sectional Charts
  - b. VFR Terminal Area Chart
  - c. Instrument Approach Plates
  - d. Topographical Maps (if necessary)

**B. INTERMOD STUDY**

- 1) Obtain third order intermod products
- 2) Use bandwidth of FAA facilities (usually  $\pm 100$  kHz NAV and  $\pm 50$  kHz COMM)
- 3) Include facilities within appropriate radii

**C. GROUND FACILITIES**

- 1) Calculate out-of-band signal level
- 2) Calculate in-band signal level
- 3) Include vertical patterns if necessary

**D. AIRBORNE RECEIVERS**

- 1) NAV interference — Use the Airspace Analysis Model to determine interference from FM broadcast stations to ILS localizer signals and VOR.
- 2) COMM interference (include vertical patterns if necessary)
  - a. Calculate brute force radius
  - b. Plot Venn diagrams along with FPSVs
  - c. Calculate intermod radii

**d. Once these transmitters** have been identified, specific data should be compiled for each. These shall include the station frequency, geographic coordinates, power (EIRP), terrain elevation, antenna elevation above mean sea level (AMSL) or above ground level (AGL), radiation center above mean sea level (RCAMSL), radiated power and possibly the radiation pattern of the antenna. When dealing with a TV transmitter, use the visual carrier frequency for all calculations, 1.25 MHz above the bottom frequency of the channel assignment; e.g., CH2 video carrier is 55.25 MHz within channel limits of 54-60 MHz.

**e. The search** should provide frequency, geographic coordinates, power (EIRP), terrain elevations, antenna elevations AGL and AMSL, FPSVs and associated facilities. The CIRCLE program automatically provides all these, plus the distance of each facility from the search coordinates.

**f. NAVAID frequencies** between 108.1-108.9 MHz and FM frequencies between 107.1-107.9 MHz particularly should be scrutinized. If a high power high band FM and a low band NAVAID are located within 30 nmi of each other, the likelihood of interference is high and requires very careful analysis. VHF TV channels 4 and 5 bracket the frequency used for ILS marker transmitters, 75 MHz, so careful analysis is required when these channels are proposed near ILS marker facilities.

**g. AM, TV and non-broadcast sources** should be plotted and studied in accordance with procedures outlined in sections 2 and 3 of this appendix.

**h. FM sources** are covered under the Airspace Analysis Model (AAM) program described in section 2 of this appendix.

## 9. INTERMOD STUDY.

**a. A receiver** will experience intermod interference whenever two or more signals or their integer multiples combine in such a manner that the product is the frequency to which the receiver is tuned ( $f_0$ ). These signals combine in the nonlinear receiver input and other nonlinear external devices to produce sum and difference frequencies through heterodyne action. If a strong signal causes the receiver input to be overdriven, the effect is more pronounced.

**b. These intermod products** are of the following form:

$$Af_1 \pm Bf_2 = f_0 \quad Af_1 + Bf_2 - Cf_3 = f_0 \quad 2Af_1 \pm Bf_2 = f_0$$

**c. The order of the intermod product** is the sum of the coefficients in the formulas (A, B, and C). Products through the third order are of primary concern to airspace studies. Intermod calculations are very tedious. There are several desk calculator and computer programs available that will run all desired orders of intermod by just entering the subject frequencies. Consideration also must be given to the bandwidth of the victim receiver which is  $f_0 \pm$  bandwidth.

## 10. GROUND FACILITIES.

**a. Both VHF and UHF ground receivers** require protection from nearby commercial FM and TV broadcast stations. They may be affected by spurious (in-band) emissions and single frequency overload (out-of-band) interference. The latter is often referred to as "brute force" interference.



**b. The major factors involved** in calculating interference from spurious emissions (in-band) are the receiver sensitivity, the FCC-specified spurious emission limits, and the offending EIRP. Antenna, filter and receiver selectivity have no effect, since the spurious signal is an on-frequency interference. Spurious interference will result if the signal level from the broadcast station at the on-frequency input to the victim receiver exceeds -104 db above one milliwatt (dBm). This is calculated as:

$$LEVEL = EIRP - L_v - L_d - L_p - L_r - S_r$$

**IN-BAND level at victim frequency cannot exceed -104 dBm**

Where:

$EIRP$  = Power of the potential interfering station in dBm.  
 $[EIRP \text{ (in dBm)} = 10 \log (\text{power in kW}) + 62.2]$

$L_v$  = Free space transmission loss in dB at the victim receiver frequency.

$L_d$  = Antenna vertical directivity loss in dB. This term requires antenna pattern data from the proponent. If the value is unknown, use 0 dB.

$L_p$  = Polarization loss between the victim and broadcast antennas in dB. If the broadcast antenna is horizontally polarized,  $L_p = 16$  dB; if circularly polarized, use 0 dB.

$L_r$  = Receiver system on-frequency losses in dB. If value is unknown, use 3 dB.

$S_r$  = FCC spurious emission tolerance in dB. Use 80 dB for FM transmitters and 60 dB for TV transmitters, except where the calculated value is less.

Example of  $S_r$  calculation:

The FCC spurious emission limit for FM is:

**$43 + 10 \log ERP_{(\text{Watts})}$**  or 80 dB, whichever is lesser

For an FM station with an ERP of 10 kW = 10,000 W:

$10 \log 10,000 = 10 \times 4 = 40$

Spurious limit =  $43 + 40 = 83$

(Note that any power >5,000 W would be limited to -80 dB suppression.)

For an FM station with an ERP of 1,000 W:

$10 \log 1,000 = 10 \times 3 = 30$

Spurious limit =  $43 + 30 = 73$

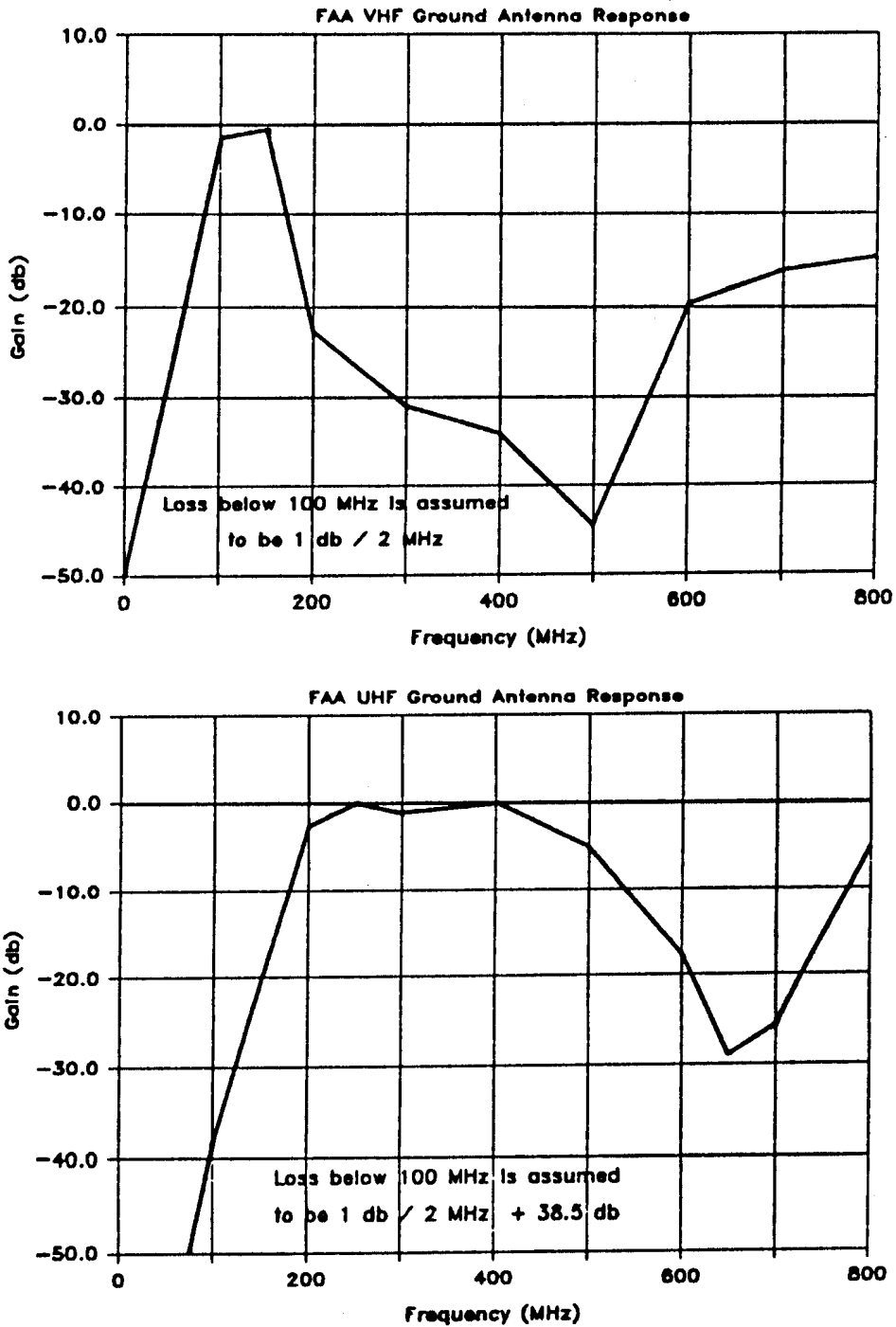
Since  $73 < 80$ , the spurious limit for this station is -73 dB from the main carrier.

For a TV station, the formula is:

**$43 + 10 \log ERP_{(\text{Watts})}$**  or 60 dB, whichever is lesser.

c. **Ground RCF antenna gains** vary considerably over the VHF and UHF range of possible interference. Plots of those gains through 800 MHz are shown in figure 6.

**FIGURE 6. TYPICAL FAA VHF AND UHF RCF GROUND ANTENNA GAIN VS. FREQUENCY PLOTS**



**d. The Intermediate Frequency (IF) selectivity** of a ground receiver will not provide any protection from single frequency front end overload because this effect occurs in the receiver RF section which will respond to most frequencies within the commercial broadcasting bands. Tests have shown that a high power signal at the input to the victim receiver will overload the RF section when it exceeds **-4 dBm**. This level is calculated from the following relationship:

$$LEVEL = EIRP - L_i - L_d - L_p - L_r - L_a$$

*OUT-OF-BAND level cannot exceed -4 dBm*

where:

$EIRP$  = Power of the potential interfering station in dBm.  
 $[EIRP \text{ (in dBm)} = 10 \log (\text{power in kW}) + 62.2]$

$L_i$  = Free space transmission loss in dB at the frequency of the potential interfering station.

$$L_i = 20 \log (\text{freq in MHz} \times D_a \text{ in ft}) - 37.9]$$

$L_d$  = Antenna vertical directivity loss in dB. This term requires antenna pattern data from the proponent. If the value is unknown, use 0 dB.

$L_p$  = Polarization loss between the victim and broadcast antennas in dB. If the broadcast antenna is horizontally polarized,  $L_p = 16$  dB; if circularly polarized, use 0 dB.

$L_r$  = Receiver system on-frequency losses in dB. If value is unknown, use 3 dB.

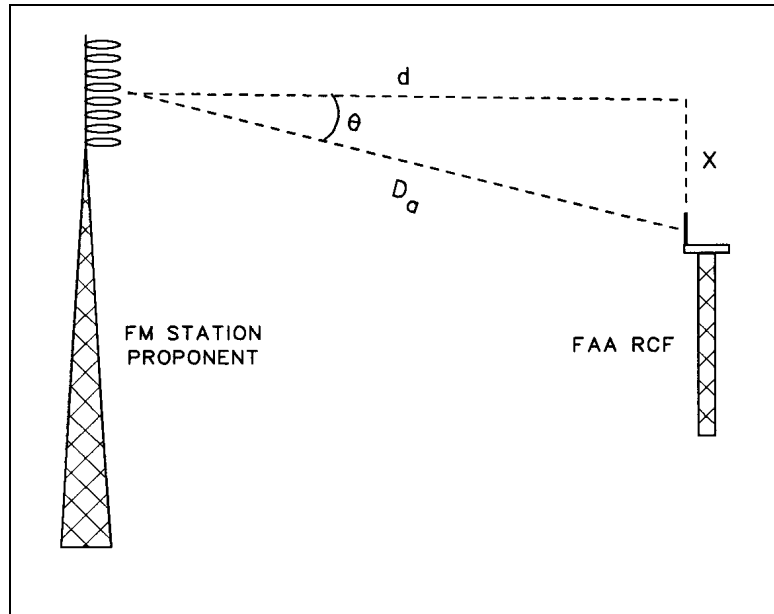
$L_a$  = Typical A/G antenna loss in dB. If unknown, use 3 dB.

**e. The slant range distance  $D_a$**  in feet between antennas is calculated using the Pythagorean theorem. One side of the right triangle is the difference in the antenna heights (AMSL)  $X$  in feet and the other side  $d$  is the distance in feet between the antenna coordinates. The slant distance ( $D_a$ ) will then be the hypotenuse of the triangle. See figure 7. The GROUND.WK1 computer program works this out automatically, or to calculate the distance (in feet) between the antenna coordinates, use the following method:

$$D_a = \sqrt{(d^2 + X^2)}$$

Distances in feet between two locations expressed in coordinates can be determined by any of the great circle distance computer programs readily available, or if close, can be measured by tape.

**FIGURE 7. EXAMPLE OF A PLOT FOR CALCULATING SLANT RANGE**



**11. AIRBORNE RECEIVERS.** Data obtained through a series of bench and flight tests conducted by the FAA at the FAA William J. Hughes Technical Center has established the signal strength levels required for intermod and brute force interference to occur. These data have been incorporated into the AAM which is used for all evaluations of the effects of FM broadcast station on ILS localizers and VORs. Testing to add COMM receivers and other FAA facilities as well as other potential interferers is currently underway. Until that testing is finished, the Venn diagram method described below will be used for all situations not covered by the AAM.

**a. For brute force predictions,** signal levels of **-10 dBm** or greater are necessary. To produce intermod interference, at least one of the combining frequencies must be at a prime level, while the others are at a secondary level. The prime level will overdrive the receiver causing the nonlinearity required for heterodyning. For COMM receivers the prime level is **-10 dBm** and for NAV receivers, **-20 dBm**. In both receivers the secondary level is **-30 dBm**.

**b. Since most commercial stations radiate omnidirectionally,** these power contours can be constructed in the form of Venn diagrams. Wherever the Venn diagrams of prime and secondary signal levels overlap, intermod interference can be expected. Whenever the -10 dBm contour intersects a NAV or COMM FPSV, receiver overload will occur, regardless of the receiver frequency. If the station uses a directional antenna, the Venn diagram would have to be modified to match the contour level of radiation of the particular antenna.

c. **These contour distances** can be calculated using a form of the space loss formula:

$$d = \frac{\text{anti log} \left[ (EIRP - P_r - 37.8 - L_r) / 20 \right]}{f}$$

Where:

*EIRP* = Power of the station in dBm (ERP + 2.2)

*P<sub>r</sub>* = Value of the desired signal strength (-10, -20, -30 dBm)

*L<sub>r</sub>* = Antenna loss of aircraft [See data in subparagraphs (1) and (2)]

37.8 = Free space loss conversion for distance in nmi

*d* = distance of Venn radius in nmi

*f* = station frequency in MHz

**(1) *L<sub>r</sub>* for COMM antennas:**

Above 175 MHz	15 dB
100-108	10 dB
88-108	10 dB + 2 dB/MHz below 100 MHz
Below 88	34 dB + 0.5 dB/MHz below 88 MHz

**(2) *L<sub>r</sub>* for NAV antennas:**

Above 175 MHz	15 dB
88-108	03 dB + 1 dB/MHz below 108 MHz
Below 88	23 dB + 0.5 dB/MHz below 88 MHz

d. **A plot of these functions** is shown in figure 8.

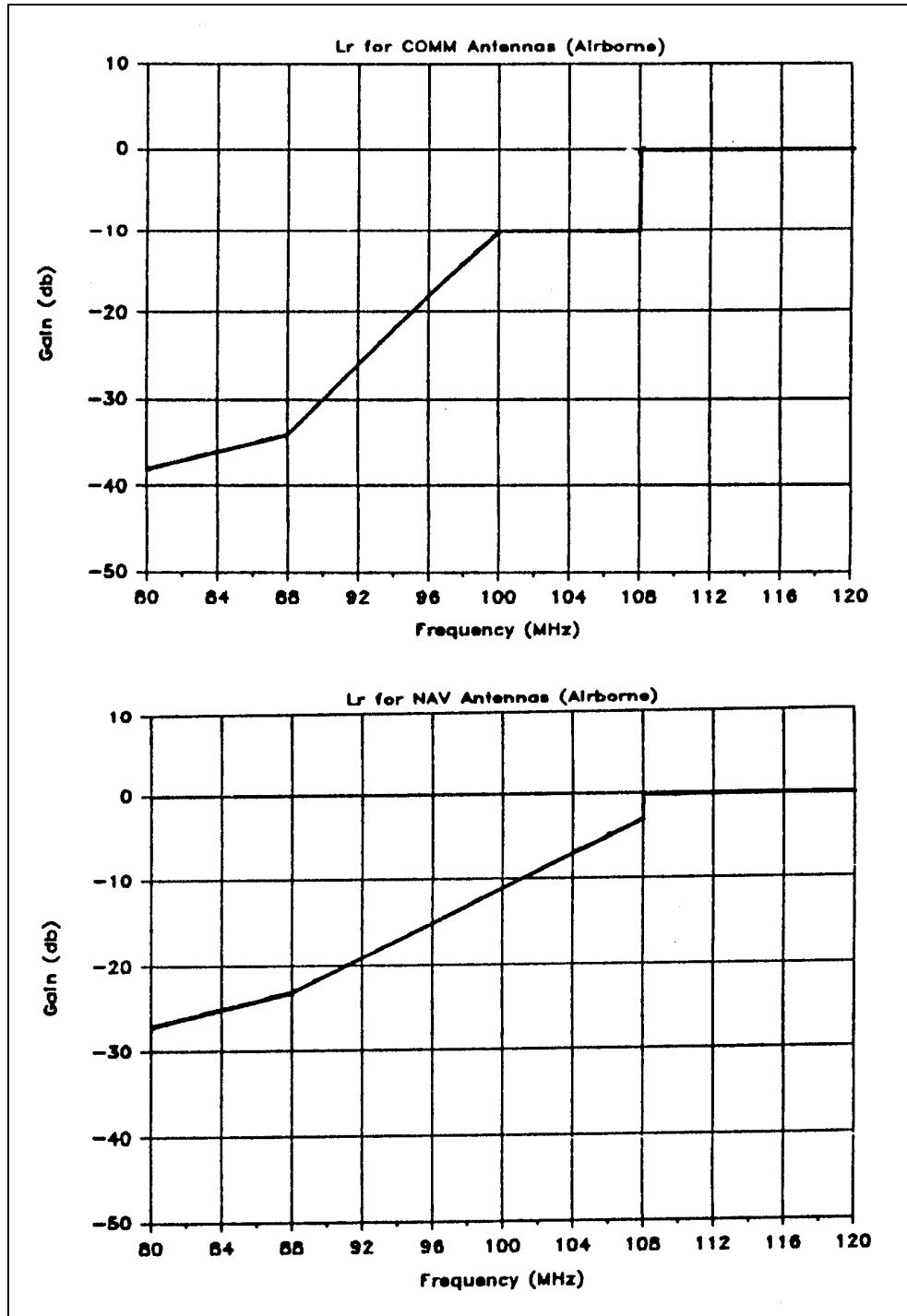
e. **Except for ILS localizer and VOR frequencies**, if IM products exist at any FAA frequency, the Venn diagram procedure must be applied. Plot the locations of the offending stations on a chart along with the location of the FAA facility and/or its FPSV. Calculate the Venn diagram contour distances for prime and secondary levels according to the type of receiver effected. Plot these contours on the chart and note the intersecting areas. If the intersecting areas fall within the FPSV of the victim COMM facility, interference is probable.

f. **The same procedure** is followed for brute force interference. Plot the location of the offending station and construct only the -10 dBm contour. If this contour intersects the FPSV of any COMM or NAV facility, interference is probable while the aircraft is flying through the area. The frequency to which the aircraft receiver is tuned is irrelevant for brute force interference.

g. **The AAM** is to be used for all evaluation of the effects of FM broadcast proponents to ILS localizers and VORs. Detailed instructions on using the AAM as well as technical background on the AAM is contained in the *User's Manual and Technical Reference for the Airspace Analysis Model*. This document is available from Technical Operations ATC Spectrum Engineering Services.

**12. SAMPLES.** Samples of obstruction evaluation (OE) case studies will be found in the following sections 2 and 3 of this appendix. Figure 9 is the form filed by the proponent with typical data inserted.

FIGURE 8. RELATIVE GAIN OF AIRBORNE COMM AND NAV ANTENNAS



**FIGURE 9a. FAA FORM 7460-1, NOTICE OF PROPOSED CONSTRUCTION OR ALTERATION**

<b>DO NOT REMOVE CARBONS</b>		<i>Please Type or Print on This Form</i>	Form Approved OMB NO. 2120-0001
US Department of Transportation Federal Aviation Administration		<b>Notice of Proposed Construction or Alteration</b>	
		Aeronautical Study Number	
<b>1. Nature of Proposal</b> A. Type <input checked="" type="checkbox"/> New Construction <input type="checkbox"/> Alteration * B. Class <input checked="" type="checkbox"/> Permanent <input type="checkbox"/> Temporary (Duration _____ months) C. Work Schedule Dates Beginning <u>FAA approval</u> End <u>90 days</u>		<b>2. Complete Description of Structure</b> Please describe, on a separate sheet of paper if necessary, the proposed construction or alteration. A. For proposals involving transmitting stations, include effective radiated power (ERP) and assigned frequency of all proposed or modified transmitters on the structure. (If not known, give frequency band and maximum ERP). B. For proposals involving overhead wire, transmission lines, etc., include the size and the configuration of the wires and their supporting structures. C. For all proposals, include site orientation, dimensions, and construction materials of the proposed or altered structure. D. <b>Optional</b> — Describe the type of obstruction marking and lighting system desired for your structure. The FAA will recommend appropriate marking and lighting for the structure in accordance with the standards of Advisory Circular AC 70/7460-1. An FAA marking and lighting recommendation will reflect the minimum acceptable level of conspicuity necessary to warn pilots of the presence of an object. However, the FAA, under certain circumstances, will not object to the use of a system (such as a medium intensity flashing white light system or a dual lighting system) other than the recommended standard.	
* If Alteration, provide previous FAA Aeronautical Study Number, if available : _____ <b>3A. Name, address, and telephone number of individual, company corporation, etc. proposing the construction or alteration.</b> (Number, Street, City, State, and Zip Code)  WASR-FM, INC. P. O. BOX 12345 SPRINGFIELD IL 34029 ( 309 ) <u>555-1212</u> Area Code Telephone Number			
<b>3B. Name, address and telephone number of proponent's representative, if different than 3A. above.</b>  Markey Broadcast Engineering Consultants 1060 Coronado St. Marlboro MD 20772 ( 301 ) <u>555-2121</u> Area Code Telephone Number			
<b>4. Location Of Structure</b> A. Coordinates (to hundredths of seconds, if known) Latitude 0   '   " 39 45 06.31 Longitude 0   '   " 89 53 58.06 B. Nearest City or Town and State Springfield IL C. Nearest public or military airport, heliport, flightpark, or seaplane base Springfield Capital Airport (1). Distance to 4B 12 nmi (2). Direction to 4B 305° T. (1). Distance from structure to nearest point of nearest runway 14.5 nmi (2). Direction from structure to airport 128° T. D. Source of coordinate information for item 4A. above. <input checked="" type="checkbox"/> USGS 7.5' Quad Chart <input type="checkbox"/> Survey <input type="checkbox"/> Other Specify _____ Indicate the reference datum of the coordinates, if known. <input type="checkbox"/> NAD 27 <input checked="" type="checkbox"/> NAD 83 <input type="checkbox"/> Other Specify _____ E. Describe, on a separate sheet of paper, the location of the site with respect to highways, streets, airports, prominent terrain features, existing structures, etc. Attach a copy of a U.S. Geological Survey quadrangle map 7.5 minute series (or equivalent) showing the construction site. If available, attach a copy of a documented site survey with the surveyor's certification.		<b>5. Height and Elevation</b> (to nearest foot) A. Elevation of site above mean sea level. 909' B. Height of structure including all appurtenances and lighting above ground or water. 335' C. Overall height above mean sea level (A + B) 1244'	
<b>FAILURE TO PROVIDE ALL REQUESTED INFORMATION MAY DELAY PROCESSING OF YOUR NOTICE</b> Notice is required by Part 77 of the Federal Aviation Regulations (14 C.F.R. Part 77) pursuant to Section 1101 of the Federal Aviation Act of 1958, as amended (49 U.S.C. app. § 1501). Persons who knowingly and willfully violate the Notice requirements of Part 77 are subject to a civil penalty of \$1,000 per day until the notice is received, pursuant to Section 901(a) of the Federal Aviation Act of 1958, as amended (49 U.S.C. app. § 1471(a)) as well as the fine (criminal penalty) of not more than \$500 for the first offense and not more than \$2,000 for subsequent offenses, pursuant to Section 902(a) of the Federal Aviation Act of 1958, as amended (49 U.S.C. app. § 1472(a)).			
<b>I HEREBY CERTIFY that all of the above statements made by me are true, complete, and correct to the best of my knowledge. In addition, I agree to obstruction mark and/or light the structure in accordance with established marking &amp; lighting standards as necessary.</b>			
Date	Typed or Printed Name and Title of Person Filing Notice		Signature
09-23-95	John J. Markey, President		
<b>FOR FAA USE ONLY</b> <span style="float: right;"><i>FAA will either return this form or issue a separate acknowledgement.</i></span>			
<b>The Proposal:</b> <input type="checkbox"/> Does not require a notice to FAA. <input type="checkbox"/> is not identified as an obstruction under any standard of FAR, Part 77, Subpart C, and would not be a hazard to navigation. <input type="checkbox"/> is identified as an obstruction under the standards of FAR, Part 77, Subpart C, but would not be a hazard to navigation. <input type="checkbox"/> Should be obstruction <input type="checkbox"/> marked <input type="checkbox"/> lighted per FAA Advisory Circular 70/7460-1, Chapters _____ <input type="checkbox"/> Obstruction marking and lighting are not necessary.		<b>Supplemental Notice of Construction, FAA Form 7460-2, is required any time the project is abandoned, or</b> <input type="checkbox"/> At least 48 hours before the start of construction. <input type="checkbox"/> Within five days after the construction reaches its greatest height. This determination expires on _____ unless: (a) extended, revised or terminated by the issuing office; (b) the construction is subject to the licensing authority of the Federal Communications Commission (FCC) and an application for a construction permit is made to the FCC on or before the above expiration date. In such cases the determination expires on the date prescribed by the FCC for completion of construction, or on the date the FCC denies the application. NOTE: Request for extension of the effective period of this determination must be postmarked or delivered to the issuing office at least 15 days prior to the expiration date. If the structure is subject to the licensing authority of the FCC, a copy of this determination will be sent to that agency.	
Remarks			
<b>NAD 83 Coordinates</b> (Use these coordinates for any future correspondence with the FAA)		Latitude	Longitude
Issued in	Signature		Date
FAA Form 7460-1 (1-93)		<b>Do Not Remove Carbons</b>	

**FIGURE 9b. ADDENDA TO FAA FORM 7460-1, NOTICE OF PROPOSED  
CONSTRUCTION OR ALTERATION**

Addenda to FAA Form 7460-1 Re: WASR-FM

8-14-95

**MARKEY BROADCAST ENGINEERING CONSULTANTS**  
**1060 Coronado St.**  
**Marlboro, MD 20772**

Re: WASR-FM application for new FM station Antenna Tower.

The proposed antenna is a guyed 335' tower, with 5-bay loop and 5-bay vertical dipole array, side-mounted antennas, with antenna array tops not exceeding the supporting tower height. The proposed Frequency is 103.7 MHz, @ 43 kW ERP.

It is proposed that painting and lighting not be required, as there is a 550' tower 123' due North of the proposed tower, which is painted and lighted per FAA/FCC requirements.

**FIGURES 10. thru 14. RESERVED.**

**13. thru 16. RESERVED.**



## SECTION 2. ENGINEERING PROCEDURES FOR OE CASES FOR FM BROADCAST AND ILS/VOR

**17. PURPOSE.** The purpose of these procedures is to determine whether a new FM broadcast station (88-108 MHz) can be safely operated without causing destructive RFI to an in-place or proposed FAA ILS or VOR. (See appendix 3 for using the AAM to check ILS frequency proposals.)

**a. Both airborne receivers** aboard aircraft and FAA ground receivers are to be considered. The FMO conducts a study, then makes a recommendation to the appropriate service area air traffic organization as to whether to concur or non-concur. Simultaneously, while the FMO is studying the RFI potential, other services in the service area office are studying whether the new tower or structure would have an adverse effect on the safe and efficient use of airspace. A non-concur recommendation can stop the proponent (PROP) from getting FCC approval for the station. The engineering study that results in the decision must be carefully and thoroughly done, since there are considerable political and financial pressures involved.

**b. Referring to the PROP's location,** a check is made to find the nearest FAA or military A/G VHF or UHF communications facility within RLOS. Once located, the FM station's anticipated signal level at that site is determined. The frequencies involved are 118-137 MHz and 225-400 MHz. If the PROP's out-of-band signal level is calculated to exceed -4 dBm, the decision is **non-concur**, because at that level ground receivers will overload and function improperly. If the in-band spurious emission level would exceed -104 dBm, then a **concur with comment** determination is made. This states that the frequency management office will concur **provided** sufficient additional attenuation is provided by the PROP for the above bands to assure that the -104 dBm or better level is met within those bands. See paragraphs 10 and 11, Section 1 of this appendix.

**c. These same levels are used** for other sources of potential RFI, such as Police and Fire transmitters, Radio Paging transmitters and any of the many sources in the FCC's Radio Services. That procedure is covered in Section 3 of this appendix.

**d. The AAM is used for evaluating** the potential interference to ILS/VOR from FM broadcast stations. The AAM negates tedious calculation after all parameters have been inputted.

**18. OE CASE EVALUATION PROCEDURE.** A work sheet is a very handy guide. It assures that all needed functions are accomplished and describes what conditions led to the concur/non-concur decision. See figure 15 for a practical worksheet. To start with, gather the heading information from the Form 7460-1. It is needed in working the AAM. Use the antenna AMSL height from 5C of that form, unless the PROP supplies an antenna drawing with dimensions so that the RCAMSL of the transmitting antenna is specified. Use RCAMSL if it is available.

FIGURE 15. SAMPLE OE CASE WORKSHEET FOR FM

OBSTRUCTION EVALUATION (OE) WORKSHEET FM BROADCAST STATIONS		
DATE	<u>4-15-93</u>	LOCATION <u>MERCED, CA</u> CASE # <u>TEST</u>
PROP COORDINATES:	<u>371644/1203735</u>	ANT MSL <u>620' COR</u>
PROP FREQ	<u>104.7</u> MHz	ERP <u>50</u> kW CALL <u>KHTN</u> FM ANT <u>6-BAY</u>
SCENARIO: PROP proposes to move presently - licensed KHTN to new location. Same power & freq.		
<input type="checkbox"/> NEW INSTALLATION		
<input checked="" type="checkbox"/> MODIFICATION AND/OR RELOCATION OF AN EXISTING STATION		
<input type="checkbox"/> RUN PCCIRCLE REPORT PROGRAM (30 nmi radius).		
<input type="checkbox"/> No VHF/UHF comm frequency within 30 nmi.		
<input checked="" type="checkbox"/> FAA COMM frequency within 118-400 MHz.		
<input checked="" type="checkbox"/> Run GROUND.WK1 program on nearest/lowest frequency for levels.		
<input type="checkbox"/> in-band spurious level < -104 dBm. CONCUR		
<input checked="" type="checkbox"/> out-of-band radiation level < -4 dBm. CONCUR		
<input checked="" type="checkbox"/> in-band spurious level > -104 dBm. CONCUR WITH COMMENT		
<input type="checkbox"/> out-of-band radiation level > -4 dBm. NON-CONCUR		
<input checked="" type="checkbox"/> RUN AIRSPACE ANALYSIS MODEL (AAM)		
<input type="checkbox"/> No ILS within 30 nmi.		
<input checked="" type="checkbox"/> check all ILS'S within 30 nmi radius of PROP.		
<input checked="" type="checkbox"/> print all available charts and plots.		
<input type="checkbox"/> No VOR within 30 nmi.		
<input checked="" type="checkbox"/> check all VOR'S within 30 nmi radius of PROP.		
<input checked="" type="checkbox"/> Run VOR portion of AAM. if a problem, use Venn diagram.		
<input type="checkbox"/> Run IM and FMDESENS programs.		
<input type="checkbox"/> Run OE2.WK1, OE3.WK1, or do a manual Venn diagram.		
<input checked="" type="checkbox"/> PROP IS A MODIFICATION OR RELOCATION. RUN ALL ABOVE PROGRAMS AS APPROPRIATE FOR BOTH PROPOSED AND EXISTING FACILITIES.		
<input checked="" type="checkbox"/> EVALUATE RESULTS:		
<input type="checkbox"/> NEW FACILITY; No points of predicted interference. CONCUR		
<input type="checkbox"/> NEW FACILITY; Exceeds in-band limit only - CONCUR WITH COMMENT.		
<input type="checkbox"/> NEW FACILITY; Interference predicted. NON-CONCUR		
<input type="checkbox"/> MODIFIED FACILITY; Proposed facility clear on its own merit. CONCUR		
<input checked="" type="checkbox"/> MODIFIED FACILITY; Proposed facility's predicted interference is the same or less than the present facility. CONCUR W/COND. STATEMENT		
<input type="checkbox"/> MODIFIED FACILITY; Proposed facility's predicted interference is greater than the present facility. NON-CONCUR		
<input checked="" type="checkbox"/> FINAL RECOMMENDATION <u>CONCUR W/COMMENT; CONCUR W/COND STATEMENT.</u>		

**a. Task 1.** Use the CIRCLE program to obtain a circle search of all FAA and military COMM facilities within 30 nmi of the PROP's location. When the CIRCLE report prints out, look first for the lowest/closest FAA or military VHF frequency. If none is found, then look for the first UHF. In the rare event that no FAA/military ground VHF/UHF COMM is found, then skip Task 2, below, and go on directly to Task 3. Normally there will be a site. Complete the key in front of the appropriate entry for this function in the worksheet. A sample printout is shown in figure 16.

**b. Task 2. Determine the actual levels,** using the GROUND.WRK1 File. Enter the data from the worksheet and antenna data from the graphs within the program. When completed, type "P" and the form will print out on your printer. A sample printout is shown in figure 17. Notice the last two lines on the page. If the calculated values are less than the two maximum permissible values shown, this part of the study is completed. Note that they are negative values, so a lesser value of signal is a greater negative number. Mark the first two keys of the result on the worksheet. If either exceeds, complete that portion of the sub-status statements on the work sheet and be guided accordingly for the final recommendation as to concur/non-concur or concur with comment.

**c. Task 3. Run the AAM program.** Instructions are contained in the *User's Manual and Technical Reference to the Airspace Analysis Model*.

FIGURE 16. SAMPLE PC CIRCLE REPORT

PC Circle Report															
Date: 04-08-93															
Assignments Found Within 15.00(nm) of 371644N, 1203735W															
Source Identifier	Freq. (MHz)	Lat.	Lon.	Dis. (nm)	TC (Deg)	St.	City	XAZ (Deg)	XCL	Gain (dB)	Elev. (ft)	Hght. (ft)	REMO1	Power (KW)	STC
FM KHTN	BPH9203131CA	104.7000	371644N	1203735W	.00	0	CA Los Banos	-	-	-	-	-	APP	50.000	-
FM KVRQ	BPH9108161DA	92.5000	371642N	1203733W	.04	141	CA Atwater	-	-	-	-	-	APP	6.000	-
FM KVRQ	BMPH9001121FC	92.5000	371629N	1203540W	1.55	99	CA Atwater	-	-	-	-	-	CP	3.000	-
FM	RM6606 A	92.5000	371605N	1203538W	1.68	112	CA Atwater	-	-	-	-	-	ADD	.000	-
FM	RM6606 D	92.5000	371728N	1203404W	2.89	75	CA Atwater	-	-	-	-	-	DEL	.000	-
GMF FAA	850657	169.3000	371714N	1203348W	3.05	80	CA MERCED	ND		00	00213	030	0035	.030	FX
GMF FAA	850658	172.9000	371714N	1203348W	3.05	80	CA MERCED	ND		00	00213	030	0035	.030	FB
GMF FAA	730801	109.3000	371733N	1203121W	5.03	80	CA MERCED	138	MCE	12	00151	007	0018	.020	RLL
GMF FAA	801913	991.0000	371734N	1203119W	5.06	80	CA MERCED	ND	MCE	11	00151	020	0018	.100	RL
FM KNTD	BLH841113KKL	95.9000	371857N	1204320W	5.08	295	CA Livingston	-	-	-	-	-	LIC	3.000	-
GMF FAA	922707	132.1750	371720N	1203057W	5.31	83	CA MERCED	ND		00	00151	023	0010,	.005	FAB
GMF FAA	760048	124.8000	371714N	1203048W	5.42	84	CA MERCED	-	-	-	-	-	0045	.010	FAC
GMF FAA	765180	165.7625	371714N	1203048W	5.42	84	CA MERCED	ND		00	00230	059	XXXXX	.010	FX
GMF FAA	730802	332.0000	371649N	1203038W	5.53	89	CA MERCED	-	-	10	00151	030	0010	.005	RLG
GMF FAA	892307	75.0000	371623N	1203003W	6.00	93	CA MERCED	-	-	-	-	-	0001	.004	RLA
GMF AF	782584	109.5000	372153N	1203305W	6.27	34	CA CASTLE	322	AWZ	15	00177	007	0018,	.025	RLL
GMF AF	748086	332.6000	372251N	1203503W	6.44	18	CA CASTLE	142		12	00194	016	0010,	.002	RLG
GMF AF	762358	109.5000	372251N	1203503W	6.44	18	CA CASTLE	142	MER	17	00194	016	0018,	.005	RLL
GMF AF	814902	1030.0000	372234N	1203311W	6.80	30	CA CASTLE	R		22	00190	023	347	.100	RL
GMF AF	891008	1090.0000	372234N	1203311W	6.80	30	CA CASTLE	ND		00	-	-	0001,	.050	RLTM
FM KHTN	BLH800506AGL	104.7000	371129N	1203203W	6.85	139	CA Los Banos	-	-	-	-	-	LIC	50.000	-
GMF AF	841409	120.0500	372237N	1203303W	6.90	31	CA CASTLE	ND		05	00180	026	0020,	.010	FAC
GMF AF	834337	124.8000	372237N	1203303W	6.90	31	CA CASTLE	ND		05	00180	026	0045,	.010	FAC
GMF AF	835573	118.4500	372237N	1203303W	6.90	31	CA CASTLE	ND		03	00180	026	0030,	.010	FAC
GMF AF	756337	126.5000	372237N	1203303W	6.90	31	CA CASTLE	ND		03	00187	079	0045,	.010	FAC
GMF AF	782585	332.6000	372330N	1203436W	7.17	19	CA CASTLE	322		16	00213	030	0010,	.006	RLG
GMF AF	841464	1002.0000	372341N	1203436W	7.34	18	CA CASTLE	ND	MER	05	00194	046	0040,	3.000	RL
GMF AF	841410	120.9500	372333N	1203350W	7.44	23	CA CASTLE	ND		05	00190	026	0020,	.010	FAC
AM	KLOQ	1.5800	371731N	1202603W	9.21	85	-	-	-	-	-	-	-	-	-
AM	BL821130BEKYOS	1.4800	372230N	1202737W	9.80	53	-	-	-	-	-	-	-	-	-
FM KFMK	BMPH9104221GC	98.7000	372231N	1202737W	9.81	53	CA Winton	-	-	-	-	-	CP	4.400	-
FM KABXFM	BLH787B L	97.5000	372231N	1202737W	9.81	53	CA Merced	-	-	-	-	-	LIC	50.000	-
FM KXDE	BPH880301MYC	107.7000	372205N	1202710W	9.86	57	CA Merced	-	-	-	-	-	CP	3.000	-
PND FAA	742411MNA	75.0000	371242N	1202600W	10.06	113	CA MERCED	-	-	-	-	-	0001	.004	RLA
GMF FAA	742411	75.0000	371242N	1202600W	10.06	113	CA MERCED	-	-	-	-	-	0001	.004	RLA
FM KYAJ	BPH910116MTC	94.1000	371705N	1202409W	10.69	88	CA Merced	-	-	-	-	-	CP	3.000	-
GMF FAA	701865	114.2000	371310N	1202401W	11.37	108	CA EL NIDO	ND	HYP	02	00197	020	0040	.100	RLO
GMF FAA	872046	1176.0000	371310N	1202401W	11.37	108	CA EL NIDO	ND	HYP	00	00197	016	0040	1.000	RL
TV SO	BPCT870327KK	693.2500	371511N	1202257W	11.75	97	-	-	-	-	-	-	-	-	-
FM KFIE	BLED890725KEL	106.3000	372534N	1202623W	12.54	45	CA Merced	-	-	-	-	-	LIC	2.950	-
TV 7FD	BLT19207091B	729.2500	372534N	1202623W	12.54	45	-	-	-	-	-	-	-	-	-
FM KFIE	BPH9112101HC	106.3000	372608N	1202623W	12.95	43	CA Merced	-	-	-	-	-	CP	2.500	-
AM	BL861119ABKLBS	1.3300	370551N	1204951W	14.63	221	-	-	-	-	-	-	-	-	-

**FIGURE 17. SAMPLE GROUND.WK1 REPORT**

AIRSPACE NUMBER:			
LOCATION:		DATE:	14-Apr-93
FAA SITE:	-----		
Lat N 34 5 18	Protected frequency	127.0	MHz
Lon W 117 8 15	Antenna height AMSL	1590.0	ft
PROPONENT: PROP	-----		
Lat N 34 5 16	Radiated Power	0.1	Kw
Lon W 117 8 16	Frequency	155.3	MHz
	Antenna height AMSL	1595.0	ft
	Slant Distance: Da =	219.0	ft
	Theta	1.3	deg
-----			
EIRP = Effective Radiated Power of the proponent.			
EIRP = 10 log (power in Kw) + 62.2		50.0	dBm
Lr = Receiver system on frequency losses.			
Use 3 dB if actual value unknown.		3.0	dB
La = Typical ground/air antenna loss.			
Select VHF or UHF graph from menu.		2.0	dB
Lp = Polarization loss between the victim and broadcast antennas. If the broadcast antenna is horizontally polarized, Lp = 16 dB, for vert or circular polarization, Lp = 0 dB.		0.0	dB
Ld = Antenna vertical directivity. This term requires antenna pattern data from the proponent. E = relative E-field at vertical Theta from above. If unknown, enter E = 1.			
Ld = 10 log (E)^2 E = 1		0.0	dB
Sr = FCC spurious emission tolerance. Enter the lesser: 80 dB for FM, 60 dB for TV, or 43 + 10 log ERP in watts = 60.8		60.8	dB
Lv = Free space transmission loss at the victim receive frequency.			
Lv = 20 log (freq. in MHz X Da in ft) - 37		51.9	dB
Li = Free space transmission loss at the frequency of the interfering station.		53.6	dB
-----			
IN-BAND RADIATION (must be less than -104 dBm)			
EIRP - Lv - Ld - Lp - Lr - Sr	----->	-65.7	dBm
OUT-OF-BAND RADIATION (must be less than -4 dBm)			
EIRP - Li - Ld - Lp - Lr - La	----->	-8.6	dBm

## 19. EXAMPLE OF AAM PROGRAM FOR FM/ILS

a. **The following** illustrates a typical OE case study. For the example, FM station KHTN is requesting to move its facilities to another location. Both the present and new location of KHTN must be earmarked as "PROP'S" by placing a "1" in the appropriate column for KHTN.

b. **Using the parameters in figures 9 and 15**, the AAM program will produce a plot of the ILSs that need to be studied (see figure 18). Although all 5 ILSs within 30 nmi shown on the plot must be checked, only MCE is used for this example. Even though the AAM may prompt for the back courses, the *Terminal Procedures* manual should be consulted to verify whether the back course must be evaluated.

c. **After the FM and VOR database has been edited** and the AAM has run this phase, it produces the RFI.PRT which indicates RFI for both the PROP and the present station. See figure 19. Note in the summary at the end of the report that a greater number of IM points exists for KHTN than for the PROP.

d. **Figures 20 and 21** are the horizontal printouts of the predicted RFI. The numbers 1 through 9 and letters a through d indicate the intensity of the predicted RFI. The higher the number (or letter), the higher the intensity. Their locations within the FPSV indicate the predicted RFI location and altitude. Because of the small font size of the numerals or letters, a dot-matrix printer or low dots-per-inch (dpi) printer may not resolve them, but show only dots. No letters or numerals in the printout would indicate no RFI is predicted. The bold lines in these horizontal studies printout pages indicate the altitude "slice" studied, in this case, the default, the bottom of the FPSV.

e. **Figures 22 and 23** are the vertical printouts of the predicted RFI. The numbers and letters represent the same information as in figures 20 and 21. The bold lines in these vertical studies printout pages indicate the azimuth of the vertical "slice."

f. **Based on the MCE analysis data**, a PROP's move to the requested location would reduce the potential RFI to MCE (front course), thus would be advantageous to FAA. The action would be **concur with conditional statement**. That statement would indicate that the move would be satisfactory by reducing the RFI potential. However, if there is increased RFI, the PROP must take steps to remedy the problem at the onset.

g. **The GROUND.WK1 printout** showed that the in-band level of -104 dBm would be exceeded, so an additional **concur with comment** is appropriate which advises the PROP that the spurious emissions must be additionally attenuated to assure the -104 dBm level is not exceeded at the Merced RCF.

**FIGURE 18. AAM PROGRAM SAMPLE SEARCH PLOT**

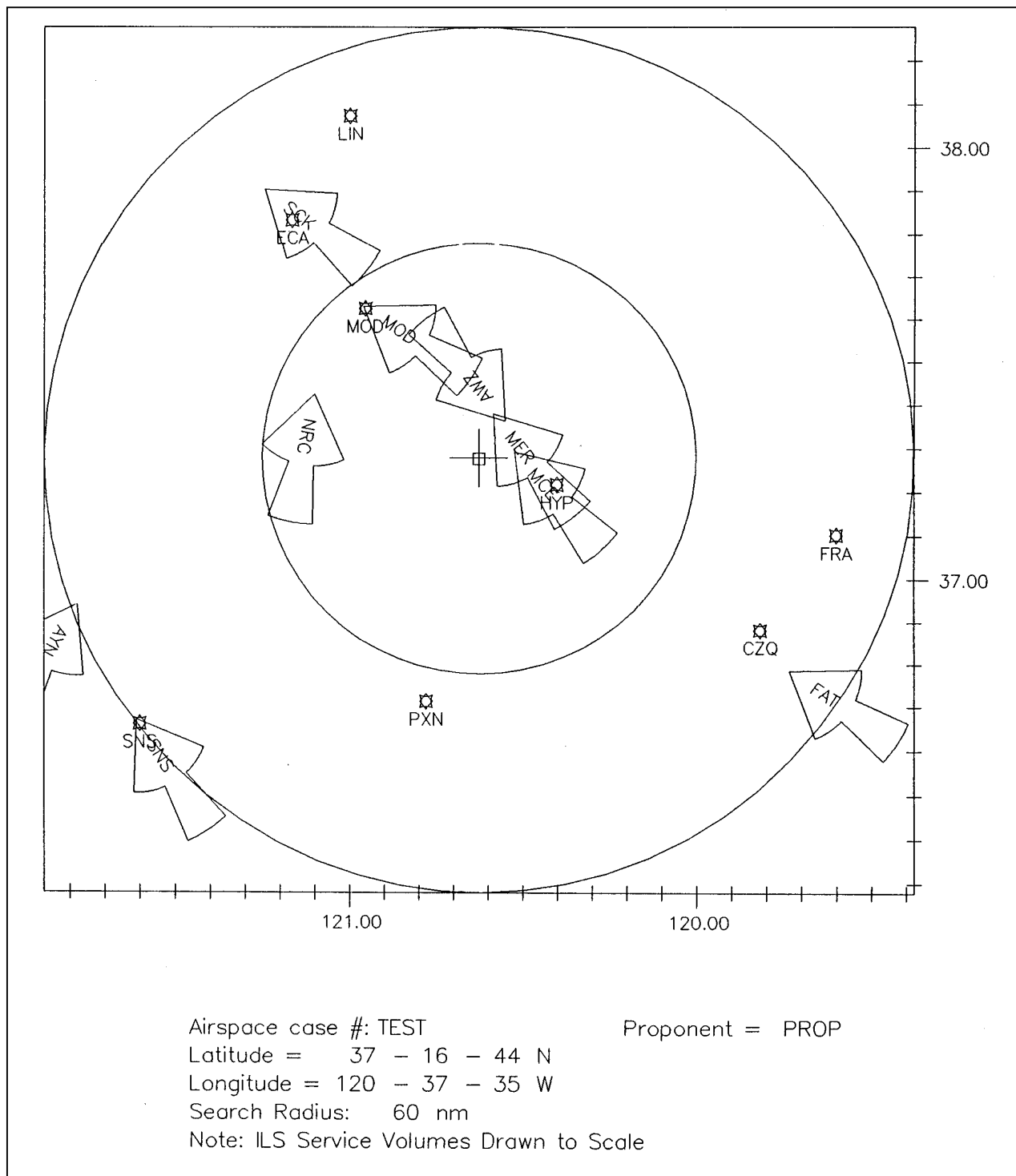


FIGURE 19a. AAM PROGRAM SAMPLE RFI.PRT PRINTOUT

PRINT DATE: 04-08-1993 08:59:16 RFI .PRT TEST										
Airspace case #: TEST						Site: MERCED, CA				
Date: 040893										
Navaid Identifier: MCE										
Navaid Frequency (MHz): 109.30										
Navaid Latitude: 37. 17 33										
Navaid Longitude: 120. 31 21										
Runway Heading (True): 318.0										
Runway Elevation (Ft. MSL): 153.										
Runway Length (Ft): 5903.										
Prop ID Call	Freq	Latitude	Longitude	ERP	Height	Range	Radial Lic	Stat		
Stat	(MHz)			(Kw)	(MSL)	(NM)	(True)			
1	KMPO	88.70	37. 32 0	120. 1 29	2.050	4301.	27.78	238.65	L	
2	KBES	89.50	37. 35 21	120. 57 23	.150	223.	27.28	130.73	C	
3	KEFR	89.90	37. 32 1	120. 1 50	1.800	4364.	27.55	238.32	L	
4	KADV	90.50	37. 36 26	120. 57 26	1.500	207.	28.02	132.36	L	
5	KFSR	90.70	36. 48 42	119. 44 43	2.550	407.	47.09	307.78	L	
6	KBDG	90.90	37. 29 59	120. 49 41	.140	190.	19.15	130.49	L	
7	KCSS	91.90	37. 31 35	120. 51 25	.150	157.	21.24	131.36	C	
8	KXXM	92.10	36. 57 58	120. 2 6	25.000	587.	30.45	310.02	L	
9	KVRQ	92.50	37. 16 42	120. 37 33	6.000	456.	5.01	80.22	A	
10	NEWx	93.30	37. 12 30	120. 15 0	3.000	604.	13.96	291.21	A	
11	KXDA	93.30	37. 13 1	120. 11 57	3.000	676.	16.09	286.36	C	
12	KYAJ	94.10	37. 17 5	120. 24 9	3.000	551.	5.75	274.66	C	
13	KTAA	94.30	36. 42 59	120. 3 51	1.350	692.	40.95	327.57	A	
14	KTAA	94.30	36. 44 29	120. 5 8	3.000	528.	39.14	327.66	L	
15	KDJK	95.10	37. 47 34	120. 31 8	29.500	1421.	30.02	180.33	L	
16	KNT0	95.90	37. 18 57	120. 43 20	3.000	413.	9.63	98.36	L	
17	KUBB	96.30	37. 32 0	120. 1 29	1.900	4390.	27.78	238.65	L	
18	KABX	97.50	37. 22 31	120. 27 37	50.000	692.	5.79	210.86	L	
19	KNAX	97.90	36. 44 9	119. 47 59	48.000	581.	48.11	313.97	L	
20	K251	98.10	36. 44 26	119. 47 39	.250	338.	48.11	313.50	C	
21	KMIX	98.30	37. 34 46	120. 50 48	4.000	515.	23.13	138.11	A	
22	KFMK	98.70	37. 22 31	120. 27 37	4.400	640.	5.79	210.86	C	
23	NEWx	99.30	36. 44 8	119. 47 11	3.000	623.	48.58	313.46	A	
24	NEWx	99.30	36. 46 47	119. 47 37	3.000	604.	46.53	311.39	A	
25	NEWx	99.30	36. 48 13	119. 47 27	3.000	614.	45.70	309.94	A	
26	K257	99.30	37. 18 50	119. 40 8	.010	3471.	40.76	268.20	L	
27	KCIV	99.90	37. 32 0	120. 1 29	1.850	4360.	27.78	238.65	L	
28	KSXY	101.10	36. 55 48	119. 38 27	10.000	1693.	47.46	297.27	L	
29	KAMB	101.50	37. 26 27	120. 8 39	17.000	2113.	20.12	243.74	C	
30	KAMB	101.50	37. 27 59	120. 14 9	50.000	1283.	17.19	232.64	L	
31	NEWx	103.10	36. 47 30	120. 30 0	3.000	551.	30.07	357.95	A	
32	KHOV	103.90	37. 32 0	120. 1 29	.070	4334.	27.78	238.65	C	
*	33	KHTN	104.70	37. 11 29	120. 32 3	50.000	617.	6.09	5.25	L
*	34	PROP	104.70	37. 16 44	120. 37 35	50.000	620.	5.03	80.65	
	35	KVPC	105.50	36. 40 51	120. 9 53	3.000	515.	40.51	334.96	C



**FIGURE 19b. AAM SAMPLE RFLPRT PRINTOUT (Continued)**

PRINT DATE: 04-08-1993 08:59:16 RFI .PRT TEST													
36	KFIE	106.30	37.	25	34	120.	26	23	2.950	771.	8.94	206.22	L
37	KQLB	106.90	36.	55	35	120.	50	42	6.000	843.	26.85	35.09	C
38	KAAT	107.10	37.	25	8	119.	44	4	.280	4337.	38.34	258.59	L
39	KMMM	107.30	36.	55	11	120.	7	3	3.000	561.	29.59	319.09	C
40	KXDE	107.70	37.	22	5	120.	27	10	3.000	571.	5.62	216.27	C
41	VPXN	112.60	36.	42	56	120.	46	44	.050	2076.	36.73	19.54	V
42	VCZQ	112.90	36.	53	1	119.	48	56	.050	377.	41.79	305.94	V
43	VHYP	114.20	37.	13	10	120.	24	1	.050	217.	7.30	306.91	V
44	VMOD	114.60	37.	37	39	120.	57	29	.050	114.	28.88	134.10	V

---

Interference thresholds are computed for receiver locations based on calculated field strength for a 15-Element V-Ring localizer array.

---

Listing of A2/B2 Evaluations

---

Freq (MHz)	ID	Call	Offset (MHz)	#Pts
No A2/B2 points found.				

---

Listing of 2-frequency intermodulation (B1) combinations

---

Freq 1 (MHz)	ID	Call	Freq 2 (MHz)	ID	Call	IMod (MHz)	Offset (KHz)	#Pts
No 2-frequency intermodulation interference found.								

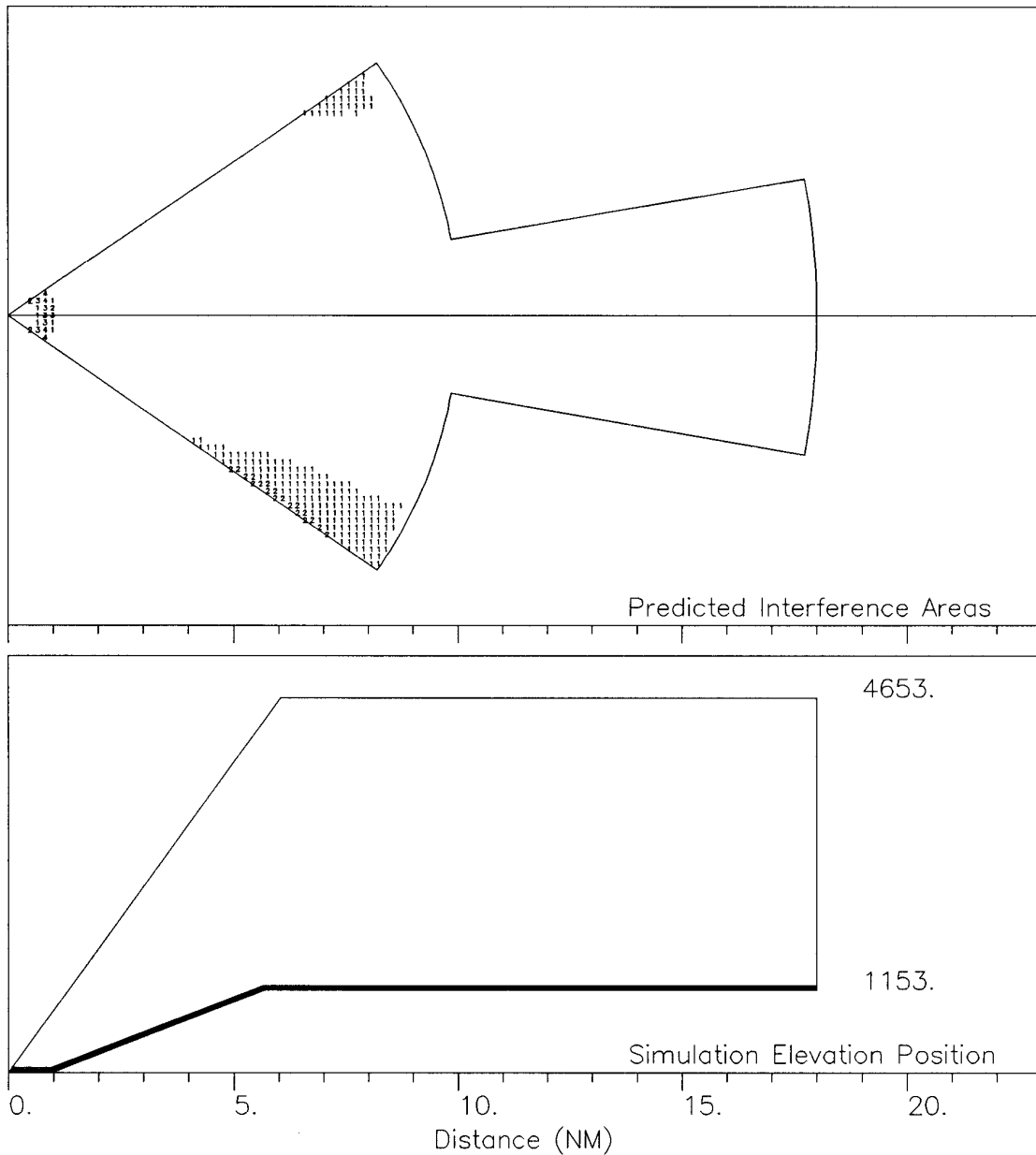
---

Listing of 3-frequency intermodulation (B1) combinations

---

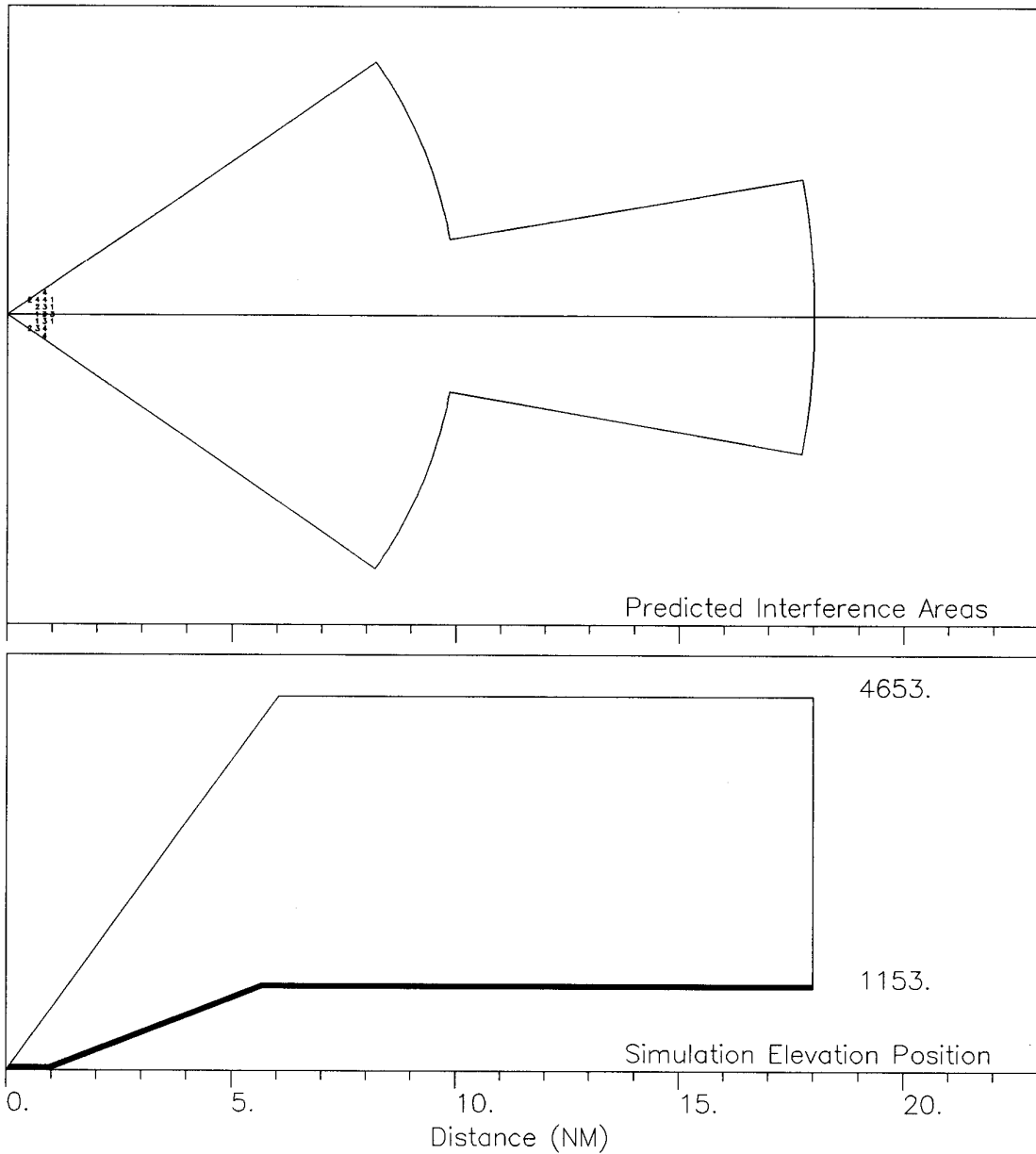
Freq 1 (MHz)	ID	Call	Freq 2 (MHz)	ID	Call	Freq 3 (MHz)	ID	Call	IMod (MHz)	Offset (KHz)	#Pts
107.70	(40)	KXDE	106.30	(36)	KFIE	104.70	(34)	PROP	109.30	0	18
107.70	(40)	KXDE	106.30	(36)	KFIE	104.70	(33)	KHTN	109.30	0	220

**FIGURE 20. AAM SAMPLE PLOT OF PREDICTED RFI - HORIZONTAL - KHTN**



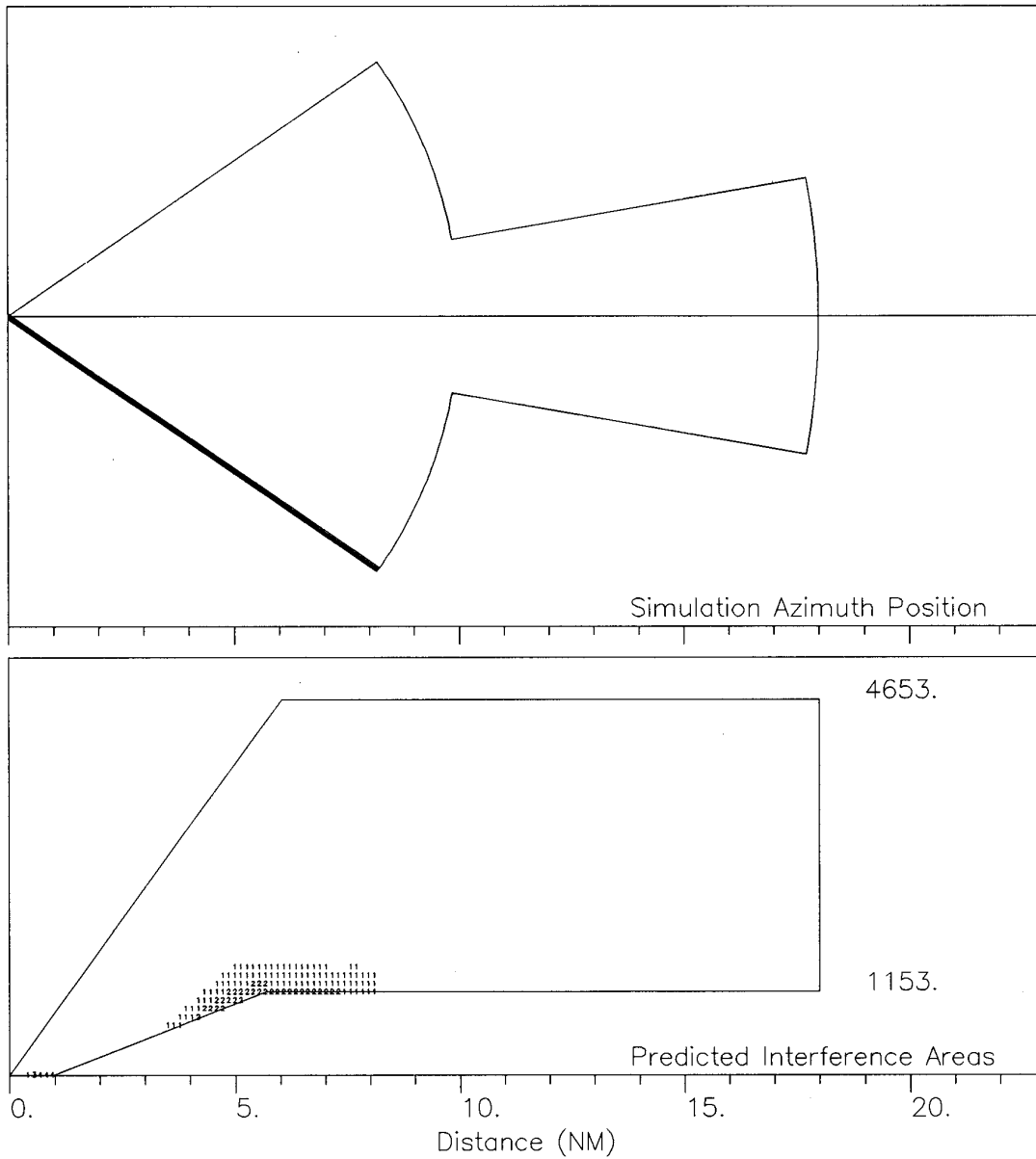
Airspace case #: TEST Site: MERCED, CA  
 Date: 040893 Plot filename: 14\_10\_0X.plt Service Volume Bottom  
 Intermod (B1) plot: KXDE ( 40), KFIE ( 36), & KHTN ( 33)  
 Frequencies: KXDE = 107.70 MHz KFIE = 106.30 MHz KHTN = 104.70 MHz  
 Navaid: MCE Frequency: 109.30 MHz Elevation (Ft. MSL): 153.  
 Runway heading: 318.0

**FIGURE 21. AAM SAMPLE PLOT OF PREDICTED RFI - HORIZONTAL - PROP**



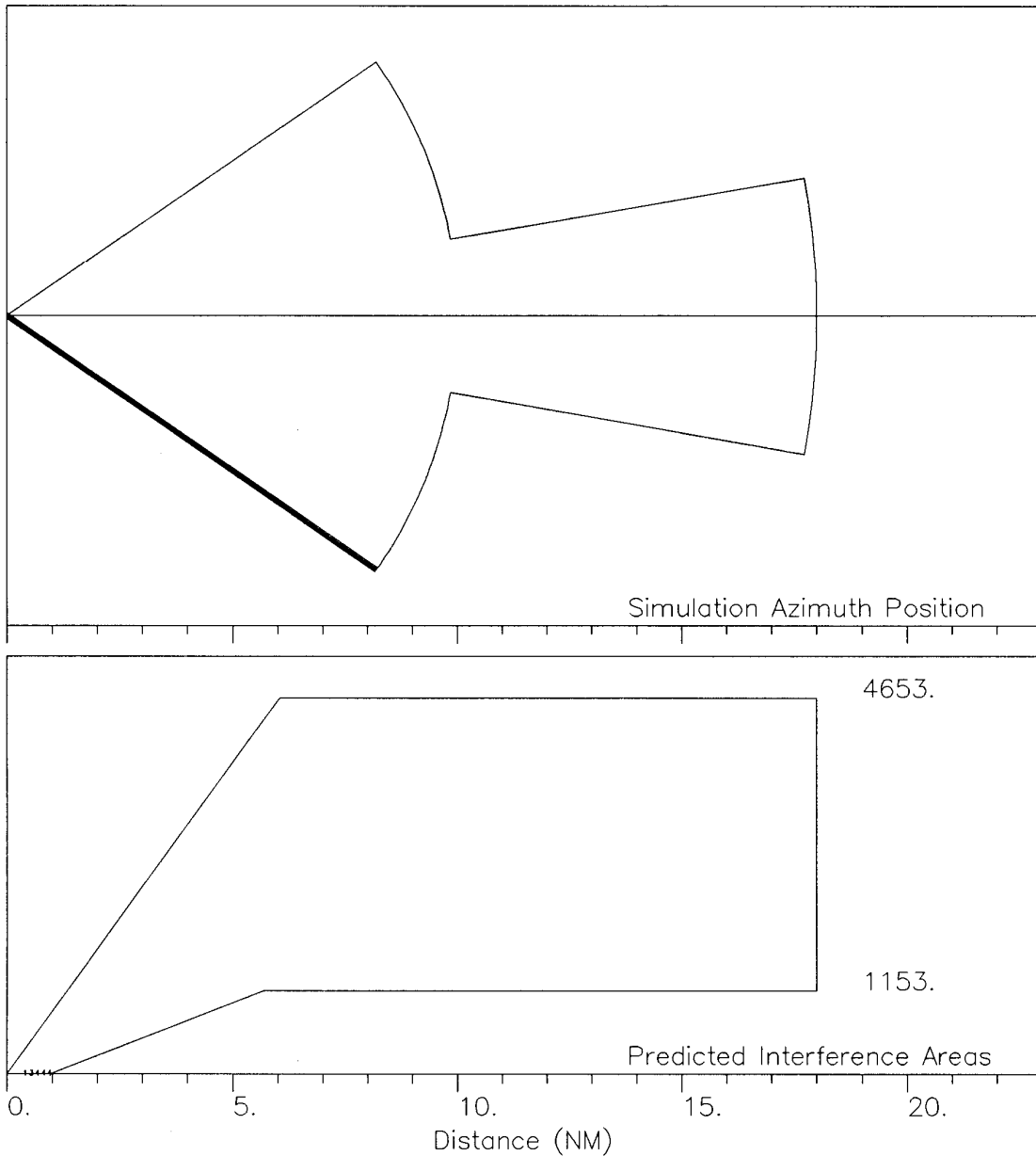
Airspace case #: TEST Site: MERCED, CA  
Date:040893 Plot filename: 14\_10\_0Y.plt Service Volume Bottom  
Intermod (B1) plot: KXDE ( 40), KFIE ( 36), & PROP ( 34)  
Frequencies: KXDE = 107.70 MHz KFIE = 106.30 MHz PROP = 104.70 MHz  
Navaid: MCE Frequency: 109.30 MHz Elevation (Ft. MSL): 153.  
Runway heading: 318.0

**FIGURE 22. AAM SAMPLE PLOT OF PREDICTED RFI - VERTICAL - KHTN**



Airspace case #: TEST Site: MERCED, CA  
Date: 040893 Plot filename: 14\_10\_0X.plt Selected Radial = 359.8  
Intermod (B1) plot: KXDE ( 40), KFIE ( 36), & KHTN ( 33)  
Frequencies: KXDE = 107.70 MHz KFIE = 106.30 MHz KHTN = 104.70 MHz  
Navaid: MCE Frequency: 109.30 MHz Elevation (Ft. MSL): 153.  
Runway heading: 318.0

**FIGURE 23. AAM SAMPLE PLOT OF PREDICTED RFI - VERTICAL - PROP**



Airspace case #: TEST Site: MERCED, CA  
Date: 040893 Plot filename: 14\_10\_0Y.plt Selected Radial = 359.8  
Intermod (B1) plot: KXDE ( 40), KFIE ( 36), & PROP ( 34)  
Frequencies: KXDE = 107.70 MHz KFIE = 106.30 MHz PROP = 104.70 MHz  
Navaid: MCE Frequency: 109.30 MHz Elevation (Ft. MSL): 153.  
Runway heading: 318.0

**FIGURES 24. thru 30. RESERVED**

**20.-24. RESERVED**

### SECTION 3. ENGINEERING PROCEDURES FOR OBSTRUCTION EVALUATION (OE) CASES FOR NON-FM BROADCAST

**25. STATUS.** It is recognized that at the time of this revision of Order 6050.32, a rulemaking was underway which was expected to substantially change this section, with respect to the facilities to be addressed and the procedures to be used. However, since the final results of the rulemaking were not known at the time of this revision, the following procedures are still in effect. Technical Operations ATC Spectrum Engineering Services will advise the FMOs when the final changes have been made and of the changes related to this section.

#### **26. NON-FM BC STUDY PROCEDURES.**

**a. The initial step is the CIRCLE REPORT.** The search radius varies with the service being investigated. The radii are:

- (1) **Cellular telephone** - 2 nmi
- (2) **Land mobile/microwave** - 12 nmi
- (3) **AM Broadcast** - 3 nmi
- (4) **TV Broadcast** - 10 nmi
- (5) **Other** - as appropriate for the service

**b. After the report has been printed,** review it for FAA facilities within the radii shown in subparagraph a. above. The following are the parameters for concur/non-concur statements.

#### **c. Cellular**

- (1) **If source is greater** than 1 nmi, concur.
- (2) **If source is equal to or less** than 1 nmi, check in/out-of-band levels.
- (3) **If in-band/out-of-band levels are exceeded,** proceed per subparagraph i.

#### **d. AM Broadcast**

- (1) **If source is greater** than 1 nmi, concur.
- (2) **If source is equal to or less** than 1 nmi, check in/out-of-band levels.
- (3) **If in-band/out-of-band levels are exceeded,** proceed per subparagraph i.

#### **e. TV Broadcast**

- (1) **If source is greater** than 10 nmi, concur.
- (2) **If source is equal to or less** than 10 nmi, check in/out-of-band levels.
- (3) **If in-band/out-of-band levels are exceeded,** then:

(a) **If VHF-TV**, issue a determination of no hazard with conditional statement.

(b) **If UHF-TV** and the problem cannot be corrected by reducing power, lowering the antenna or moving the site, then issue a determination of no hazard with conditional statement.

**f. Microwave**

(1) **Not in government band**, concur.

(2) **In government band**, check in/out-of-band levels.

(3) **If in-band/out-of-band levels are exceeded**, proceed per subparagraph i.

**g. Land mobile**

(1) **If source is greater** than 12 nmi, concur

(2) **If source is equal to or less** than 12 nmi, check in/out-of-band levels

(a) **If the out-of-band level** is between -4 to -30 dBm, run the INTERMOD program for 118-137 MHz (COMM receivers) to determine whether there will be IM's which will overlap at the receiver site.

(b) **If there is no overlap**, concur.

(c) **If there is overlap**, non-concur.

(d) **If the level is  $\geq$  -4 dBm**, non-concur.

**h. Band levels**

(1) **In-band** spurious level  $<$  -104 dBm - concur

(2) **In-band** spurious level  $\geq$  -104 dBm - concur with comment

(3) **Out-of-band** radiation level  $<$  -4 dBm - concur

(4) **Out-of-band** radiation level  $\geq$  -4 dBm - non-concur

**i. Procedure for AM, cellular and microwave.** Refer to Chapter 8, paragraph 807 of this order for detailed procedures involving AM broadcast and non-broadcast facilities.

**27. A NON-FM BC EXAMPLE.**

**a. The example** is a 60 W Land Mobile transmitter on 155.25 MHz to be located about 200' from an FAA ATCT COMM facility. See sample work sheet figure 31.

(1) **The GROUND.WK1 program** was run, which produced in-band radiation level of -65.7 dBm and out-of-band level of -8.6 dBm. This would require a "concur with comment" letter that essentially states FAA concurrence with the installation provided sufficient spurious suppression is installed to assure a level  $<$  -104 dBm at the FAA band 118-137 MHz. See figure 32.

FIGURE 31. SAMPLE NON-FM WORK SHEET

**OBSTRUCTION EVALUATION (OE) WORKSHEET NON-FM**

DATE 4-14-93 LOCATION TEST CASE # TEST

COORDINATES: 340516/1170816 ANT MSL 1595'

PROPOSED FREQ 155.25 MHz ERP 0.06 kW  NEW  MODIFIED

Scenario:

RUN PC CIRCLE REPORT

CELLULAR (2 NMI)  LAND MOBILE/MICROWAVE (12 NMI)  
 AM BC (3 NMI)  TV BC (10 NMI) (video frequency)  
 OTHER  NO FACILITY WITHIN SEARCH RADIUS

**FAA GROUND RECEIVERS**

CELLULAR > 1 nmi from facility - CONCUR  
 CELLULAR ≤ 1 nmi from facility - check in-band and out-of-band levels

AM BC > 1 nmi from facility - CONCUR  
 AM BC ≤ 1 NMI from facility - check in-band and out-of-band levels

TV BC > 10 nmi from facility - CONCUR  
 TV BC ≤ 10 nmi from facility - check in-band and out-of-band levels

MICROWAVE - not in government band - CONCUR  
 MICROWAVE - in government band - check in-band and out-of-band levels

LAND MOBILE - > 12 nmi - CONCUR  
 LAND MOBILE - ≤ 12 nmi - check in-band and out-of-band levels

out-of-band -4 to -30 dBm - run INTERMOD program  
 intermods within 118-137 MHz band?  
 no - CONCUR  
 yes - check in-band and out-of-band levels

**BAND LEVELS**

In-band spurious level < -104 dBm - CONCUR  
 In-band spurious level ≥ -104 dBm - CONCUR WITH COMMENT  
 Out-of-band radiation level < -4 dBm - CONCUR  
 Out-of-band radiation level ≥ -4 dBm - NON-CONCUR

**AIRBORNE RECEIVERS**

Intermods within 108-137 MHz band?  
 No - CONCUR  
 Yes - run OE2.WK1 OR OE3.WK1 for Venn diagram, hor. & vert.

Final recommendation CONCUR WITH COMMENT



## 32. PARAGRAPH 26 a. (1) EXAMPLE GROUND.WK1 PRINTOUT

AIRSPACE NUMBER:			
LOCATION:		DATE:	14-Apr-93
FAA SITE: -----			
Lat N 34 5 18	Protected frequency	127.0	MHz
Lon W 117 8 15	Antenna height AMSL	1590.0	ft
PROPOSER: PROP -----			
Lat N 34 5 16	Radiated Power	0.1	Kw
Lon W 117 8 16	Frequency	155.3	MHz
	Antenna height AMSL	1595.0	ft
	Slant Distance: Da -	219.0	ft
	Theta	1.3	deg
-----			
EIRP - Effective Radiated Power of the proponent.			
EIRP = 10 log (power in Kw) + 62.2		50.0	dBm
Lr - Receiver system on frequency losses.			
Use 3 dB if actual value unknown.		3.0	dB
La - Typical ground/air antenna loss.			
Select VHF or UHF graph from menu.		2.0	dB
Lp - Polarization loss between the victim and broadcast antennas. If the broadcast antenna is horizontally polarized, Lp = 16 dB, for vert or circular polarization, Lp = 0 dB.		0.0	dB
Ld - Antenna vertical directivity. This term requires antenna pattern data from the proponent. E = relative E-field at vertical Theta from above. If unknown, enter E = 1.			
Ld = 10 log (E)^2      E = 1		0.0	dB
Sr - FCC spurious emission tolerance. Enter the lesser: 80 dB for FM, 60 dB for TV, or 43 + 10 log ERP in watts = 60.8		60.8	dB
Lv - Free space transmission loss at the victim receive frequency.			
Lv = 20 log (freq. in MHz X Da in ft) - 37		51.9	dB
Li - Free space transmission loss at the frequency of the interfering station.		53.6	dB
-----			
IN-BAND RADIATION (must be less than -104 dBm)			
EIRP - Lv - Ld - Lp - Lr - Sr ----->		-65.7	dBm
OUT-OF-BAND RADIATION (must be less than -4 dBm)			
EIRP - Li - Ld - Lp - Lr - La ----->		-8.6	dBm

(2) The -8.6 dBm level was below the -4 dBm maximum level. However, the possibility of -10 dBm and -30 dBm IM levels overlapping at the site needs to be checked.

(3) The IM program was run. The PROP frequency of 155.25 MHz was added in the edit mode before it was run. See figure 33 for the configuration.

**FIGURE 33. PARAGRAPH 26 a. (3) EXAMPLE OF IM PROGRAM CONFIGURATION**

Source	Type	Invol	Cons	Radius nmi
GMF	TX	yes	yes	12
PND	TX	yes	yes	12
AM	TX	yes	yes	2
FM	TX	yes	yes	30
TV	TX	yes	yes	10
CAN	TX	no	no	2

Path/Filename
GMF \GMF\
PND \PND\
AM \FCC\AM\
FM \FCC\FM\
TV \FCC\TV\
CAN \CAN\

(4) In this case, the IM complete report was blank, indicating there were no IMs within the selected range. See figure 34.

**FIGURE 34. PARAGRAPH 26 a. (4) EXAMPLE OF IM PROGRAM PRINTOUT**

Complete Intermodulation Analysis Report				
2H=2f1	2S30=2f1-f2	2S50=3f1-2f2	2S70=4f1-3f2	
3H=3f1	3S30=f1-f2+f3	3S50=2f1-2f2+f3	3S70=4f1-2f2+f3	
Receiver Frequency	<-- f1	Transmitter f2	Frequencies -->	By-Product Frequency Type
			f3	

**(5) Had there been** IMs, the CIRCLE report would have to have been run. An area of one-half mile radius would need to be checked. If any IM overlaps occurred in this area, a Venn diagram would be required to determine whether the -10 dBm and -30 dBm contours of the subject sources would overlap the site. In this unlikely event, a "non-concur" would have to be given.

**b. If the exact distance is known**, the actual loss can be calculated from the modified free space formula found in paragraph 10 b., section 1, of this appendix. Using this formula, the actual loss in dB can be determined. With the PROP EIRP in dBm, the loss can be subtracted and the result in dBm can be compared to the -10 dBm and the -30 dBm limits for ground receivers. This will quickly determine whether the PROP's two critical contours would overlap with any other nearby FAA or broadcast critical contours which would predict RFI at the FAA ground site.

## APPENDIX 2. TECHNICAL DATA FOR VHF/UHF COMMUNICATIONS FREQUENCY ENGINEERING

### FIGURE 1. VHF ALLOCATIONS - 118-137 MHz

118.000—121.400	ATC	122.975—123.000	UNICOM – Uncontrolled Airports
121.425—121.450	Gov AWOS/ASOS	123.025	Helicopter air-to-air
121.475	Band Protection for 121.500	123.050—123.075	UNICOM – Uncontrolled Airports
121.500	Emergency Search and Rescue (ELT operational Check, 5 Sec.)	123.100	SAR; Temp. ATCTs and fly-ins with with SAR coordination
121.525	Band Protection for 121.500	123.125—123.275	Flight Test
121.550—121.575	Gov AWOS/ASOS	123.300	Aviation Support
121.600—121.925	ATC (Old Gnd Cntl Freq Band)	123.325—123.475	Flight Test
121.775	SAR ELT Location training	123.500	Aviation Support
121.950	Aviation Support	123.525—123.575	Flight Test
121.975	FSS Private Aircraft Advisory	123.600—123.650	ATC (Formerly Air Carrier Advisory. FSS Uses to be phased out)
122.000—122.050	EFAS	123.675—126.175	ATC
122.075—122.675	FSS Private Aircraft Advisory	126.200	Military Common (Advisory)
122.700—122.725	UNICOM - Uncontrolled Airports	126.225—128.800	ATC
122.750	Fixed wing aircraft - Air-to-Air	128.825—132.000	Operational Control
122.775	Aviation Support	132.025—134.075	ATC
122.800	UNICOM - Uncontrolled Airports	134.100	Military Common (Advisory)
122.825	Domestic VHF	134.125—135.825	ATC
122.850	MULTICOM	135.850	FAA Flight Inspection
122.875	UNICOM - Domestic VHF	135.875—135.925	ATC
122.900	MULTICOM, SAR training	135.950	FAA Flight Inspection
122.925	MULTICOM - Special Use/ National Resp. Mgt.	135.975—136.400	ATC
122.950	UNICOM - full time ATCT, FSS	136.425—136.475	FIS until 2011
		136.500—136.875	Domestic VHF
		136.900—136.975	International and Domestic VHF

**1. VHF/UHF FREQUENCY ENGINEERING.** Frequencies available to the FMO for engineering VHF assignment are given in figure 1 and UHF ATC frequencies are found in the latest version of the 225-400 MHz channel plan. VHF is used normally for communication with civil aircraft and a limited number of military aircraft. UHF is used only for communication with military aircraft. Military non-ATC communications shall not use VHF ATC frequencies. Military tactical and training (TAC and training) operations and Research, Test, Development, and Evaluation (RTDE) shall not use UHF ATC frequencies.

**a. In en route functions,** a VHF and a UHF frequency are normally paired. In addition, a tactical UHF frequency may be assigned to an en route sector to support military operations.

**b. In terminal functions,** a VHF and a UHF are paired for only some functions.

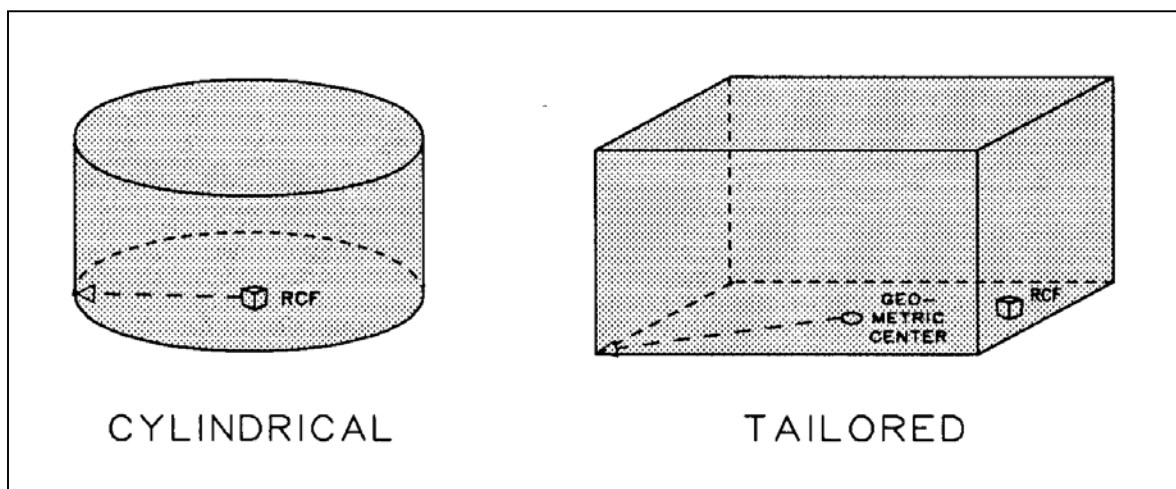
## 2. FPSV.

**a. COMM frequencies** are engineered for distinct volumes of airspace and are guaranteed to be free from a preset level of interference from an undesired source. Each specific function has its own FPSV. Some are cylinders, while others are odd geometric solids. These odd shapes are normally required for en route ATC functions. All FPSVs are valid only within Radio Line Of Sight (RLOS). Refer to paragraph 4 for details.

**b. Cylindrical service volumes (CSV)** are defined as radii in nmi usually centered on the facility, with the maximum altitude of the cylinder defined in feet. These parameters are defined for the various ATC functions in paragraph 2d, below. A sketch of a cylindrical service volume is shown in figure 2.

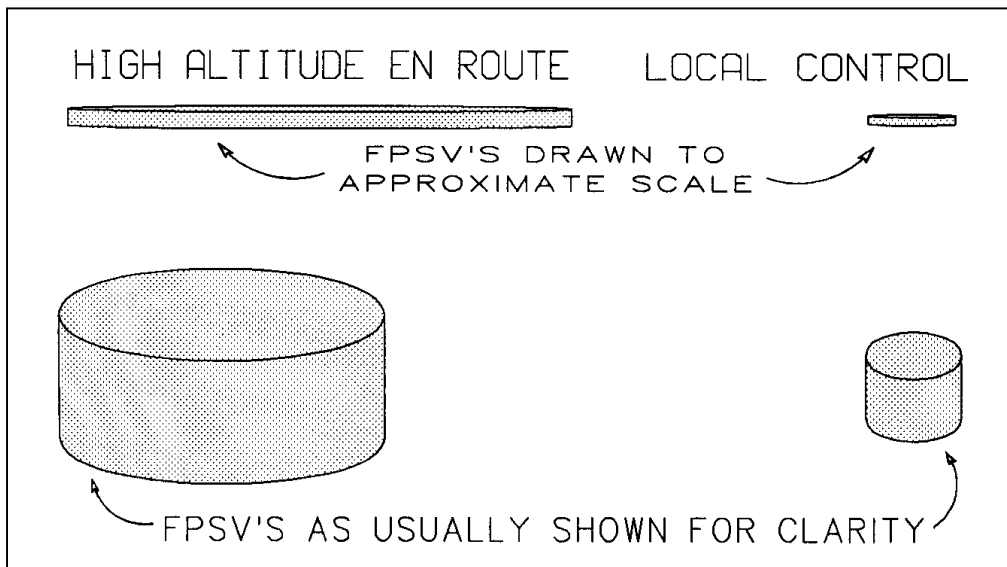
**c. Tailored or "multipoint" service volumes (TSV)** are unique shapes designed to afford necessary coverage within a designed interference-free protection level. The geometric center of the tailored service is the center point for the radius that is the distance to the farthest point of the TSV. A sketch of a typical TSV is also shown in figure 2. The geometric center and radius can be found by using the center point and radius of the smallest circle that will cover all of the TSV.

**FIGURE 2. FPSVs**



d. **FPSV graphic representations** in this manual are drawn for illustrative purposes. They are not drawn to scale, but rather to a standard of clarity. An example of High Altitude En Route and Local Control to scale and as normally drawn is shown in figure 3. In addition, all FPSVs are drawn planar and do not include the curvature of the earth, as also shown in figure 3.

**FIGURE 3. HIGH ALTITUDE ENROUTE AND LOCAL CONTROL FPSVs TO APPROXIMATE SCALE AND AS NORMALLY SHOWN PICTORIALLY**



(1) **ARTCC.** Frequency assignments for ARTCC facilities are located at Remote Control Air/Ground (RCAG) sites. These RCAGs are connected to the ARTCC by telephone lines, microwave or other radio links. They are divided into categories of Low Altitude En Route, High Altitude En Route and Super High Altitude En Route. They normally have tailored or multipoint service volumes, the maximum altitude and radius usually not exceeding the values shown in figure 4. Under no circumstances will an FPSV be approved with a radius greater than the RLOS distance.

**FIGURE 4. EXAMPLE OF EN ROUTE DIMENSIONS**

Service	Altitude (feet)	Radius nmi
Super High En Route	>45,000' AMSL	150
High Enroute	45,000' AMSL	150
Low En Route	24,000' AMSL	75

(2) **ATCT.** These frequencies are usually found in the tower itself or at an RCF on or near the airport it serves. The service volumes normally have cylindrical shapes; the radius and flight levels are shown in figure 5. If there is uncertainty as to an appropriate FPSV for terminal operations, the letter of agreement between the terminal facility and the center will specify the delegated airspace. FPSVs should not exceed the delegated air space. Under no circumstances will an FPSV be approved with a radius greater than the RLOS distance.

**FIGURE 5. TYPICAL TERMINAL FPSV DIMENSIONS**

<u>SERVICE</u>	<u>SMALL</u>	<u>TYPICAL</u>	<u>LARGE</u>
Ground Control	--	100' & 3 nmi	--
Clearance Delivery	--	100' & 3 nmi	--
Local Control	2,500' & 10 nmi	5,000' & 15 nmi	10,000' & 30 nmi
<u>Approach/Departure</u>			
Arrival	7,500' & 30 nmi	10,000' & 45 nmi	24,000' & 55 nmi
Final	3,000' & 15 nmi	4,000' & 20 nmi	5,000' & 25 nmi
Satellite Airport	3,000' & 20 nmi	--	5,000' & 30 nmi
Helicopter	2,500' & 10 nmi	5,000' & 15 nmi	5,000' & 30 nmi
GCA/PAR/SFA (Including pattern)	2,500' & 10 nmi	3,000' & 15 nmi	5,000' & 20 nmi
AWOS/ASOS	5,000' & 15 nmi	--	10,000' & 25 nmi
ATIS	Match or slightly exceed Arrival		25,000' & 60 nmi
Departure ATIS	--	100' & 3 nmi	--

(3) **Flight Service Station (FSS).** FSS frequencies, including low altitude En Route Flight Advisory Service (EFAS), are located either at the FSS or at a nearby RCF. High altitude EFAS channels are assigned on ATC channels. Multiple high altitude EFAS facilities serving the same ARTCC must share a single frequency. FSS frequencies are protected as much as is possible considering that many sites geographically within RLOS use the same frequency. This is normally accomplished by separating FSS cochannel assignments by at least 100 nmi, where possible.

**e. Noncovered Services.** The following VHF aeronautical frequency services are not covered by this appendix, since all are controlled and authorized by FCC. Refer to FCC Part 87 Rules and Regulations for details and frequencies.

- (1) **Aviation Support.** Flying schools, soaring, ballooning, etc.
- (2) **Aeronautical Advisory (UNICOM).** Fixed base operators.
- (3) **MULTICOM.** A special use UNICOM.
- (4) **Flight Test.** Manufacturer's use for flight tests of aircraft or equipment.

- (5) **Operational Control.** Airlines' own use.
- (6) **Search And Rescue.** As name implies.
- (7) **Airport Utility.** Non-FAA vehicles on airports.

**3. ATC ASSIGNMENT CRITERIA.** There are basic criteria for engineering a COMM frequency assignment.

**a. Sufficient signal** must be provided at the aircraft's receiver to ensure satisfactory performance at a point in the FPSV furthest from the ground transmitter. ICAO Standards and Recommended Practices (SARPs) recommends a signal-in-space field strength of  $75 \mu\text{v}/\text{m}$  ( $-109 \text{ dBW}/\text{m}^2$ ), which translates to  $-82.5 \text{ dBm}$ , assuming a 0 dB aircraft antenna gain (ICAO Annex 10, Volume 3, Part 2, Chapter 2). RTCA Minimum Operational Performance Standards (MOPS) specifies that the input to the aircraft receiver should be  $10 \mu\text{v}$  (across a 50 ohm impedance), or  $-87 \text{ dBm}$  (RTCA DO-186a). Therefore, approximately 4.5 dB of margin is provided for the losses between the input to the antenna and the input to the receiver. Such losses include antenna gains of less than 0 dB and cabling losses between the antenna and the input to the receiver. A series of curves for VHF and UHF limits of coverage, for a receiver input power of  $-87 \text{ dBm}$ , are found in figures 13 through 24 of this appendix.

**b. Protection criteria.** ICAO recommends 20 dB desired to undesired (D/U) frequency assignment protection criteria, but has recognized that in areas with severe frequency assignment congestion, such as the Continental U.S., a lesser but safe value of 14 dB D/U can be applied. The 14 dB D/U is applicable for all ATC functions with station class of FA, FAB, FAC and FLU. In addition, a maximum of  $-4 \text{ dBm}$  out-of-band and a maximum of  $-104 \text{ dBm}$  in-band limit protections are provided from external signals.

**c. Transmitter power.** Existing policy on transmitter output power is to use 2.5W for AWOS, ASOS and Automated Remote Radio Access System (ARRAS) operations, and to not exceed 10 W for all other operations. The need for higher power must be justified in the FMO's application for frequency approval.

**d. ATIS, AWOS and ASOS** frequency assignment priorities are described in paragraphs 904 and 905 of this order.

**4. RLOS.** In space, radio signals tend to propagate in a straight line. Near large bodies they tend to "bend" toward the body. In the case of the earth, a sufficiently close approximation of the "effective radio horizon" can be obtained by using the formula in subparagraph a. below which assumes the earth to be  $4/3$  its actual radius, hence the "4/3 radius" phenomenon. The formula approximation assumes a "smooth" earth, since intervening terrain will stop or attenuate VHF and higher signals.



a. **At any given altitude**, a transmitted signal will travel only a specific earth distance before it becomes tangent to the earth's radio horizon. Distances beyond the tangency do not ordinarily receive any VHF or higher signals, except under anomalous propagation. Treatises on RLOS can be found in engineering manuals, such as the *ITT REFERENCE DATA FOR RADIO ENGINEERS*, under radio wave propagation. The formula for RLOS is:

$$RLOS \text{ (statute miles)} = \sqrt{2h}$$

Where:  $h$  = height in feet, AMSL.

+++++

$$RLOS \text{ (nmi)} = 0.87\sqrt{2h} = 1.23\sqrt{h}$$

Where:  $h$  = height in feet, AMSL.

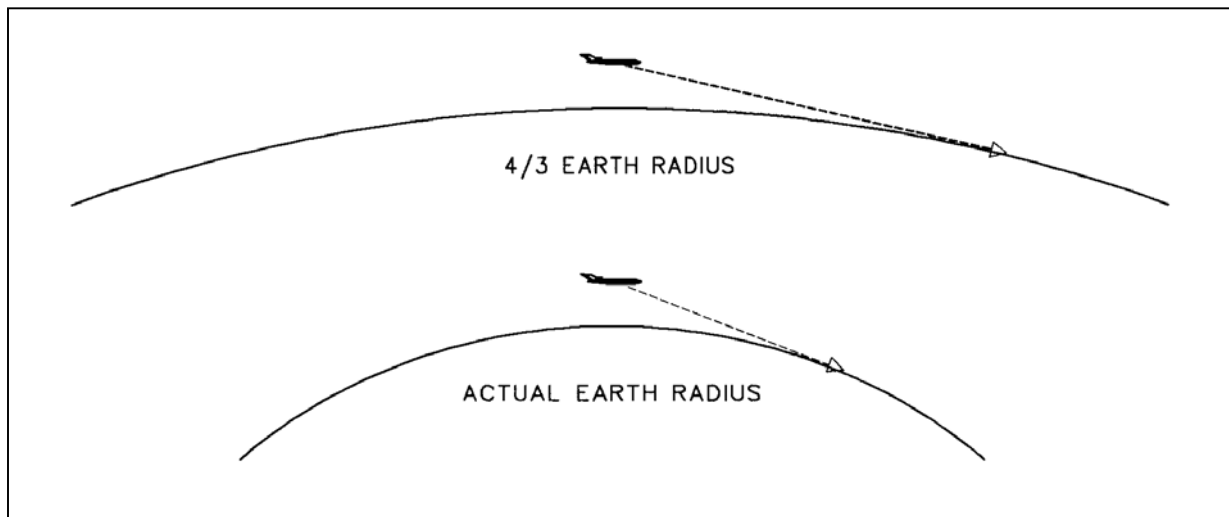
b. **Where two elevated sites are involved**, the formula is:

$$RLOS \text{ (nmi)} = 1.23\sqrt{h1} + 1.23\sqrt{h2}$$

Where  $h1$  and  $h2$  are respective point altitudes, in feet, AMSL.

c. **A sketch of 4/3 earth radius** radio coverage is found in figure 6.

**FIGURE 6. COMPARISON OF DISTANCE TO HORIZON FROM THE SAME ALTITUDE BETWEEN ACTUAL AND HYPOTHETICAL 4/3 EARTH RADIUS**



**5. INTERSITE FREQUENCY ENGINEERING PROCEDURES.** These procedures require the determination that at the worst-case, an aircraft will receive a signal from the desired facility 14 dB stronger than from a cochannel undesired facility, that is,  $D/U = 14$  dB. (Adjacent channel will be covered later in this discussion). The determination is based on the free-space loss formula ( $L_{fs}$ ):

$$L_{fs} \text{ (dB)} = 37.8 + 20 \log f + 20 \log d$$

**NOTE:**  $L_{fs}$  formula is valid only for distances less than RLOS where:

$f$  = frequency in MHz

$d$  = distance in nmi

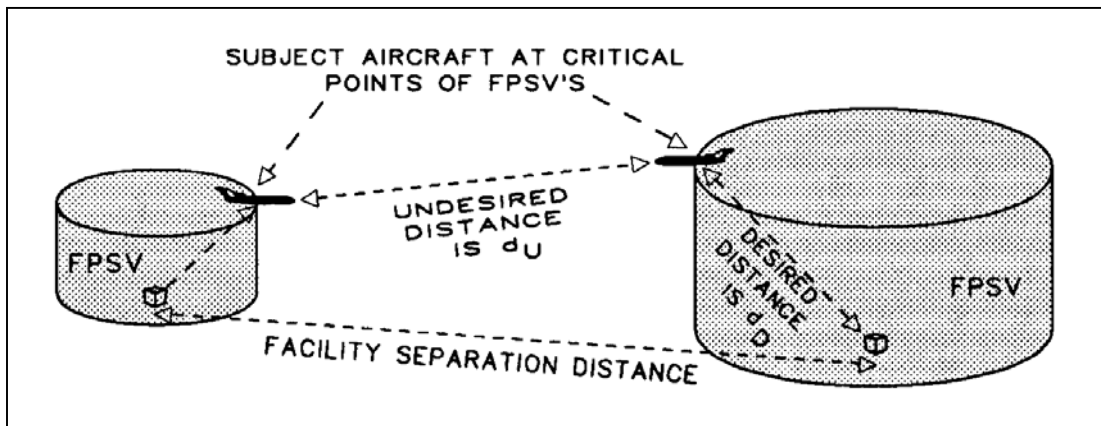
**a. Note that a signal level** only decreases by 6 dB when the distance is doubled, since the signal voltage (thus current) ratio is only halved at twice the distance (i.e.,  $20 \log (2) = 6\text{dB}$ ).

**b. Note that the loss constant** and the  $20 \log f$  variable are fixed when dealing with a cochannel study. Only the  $20 \log d$  varies.

**c. Since the 14 dB D/U is determined** by the ratio of the distances of undesired to desired sources,  $d_U/d_D$ , from the critical point, only the  $20 \log d$  need be used to determine required separation (see figure 7). The signal strength D/U is inversely proportional to the distance ratio (DR) from  $d_U$  to  $d_D$ . The equation becomes  $D/U = 20 \log (d_U/d_D) \geq 14$  dB.

**d. The critical point** is that point on the edge of the FPSV where an aircraft is simultaneously furthest from the desired facility and closest to edge of a cochannel or adjacent channel FPSV, where another aircraft would be the "undesired signal"  $D_U$ .

**FIGURE 7. COCHANNEL CONFIGURATION FOR UNDESIREDD/DESIRED DISTANCE RATIO**



e. In figure 7, to achieve a difference of 14 dB at the critical point, the DR,  $d_U/d_D$ , should be 5 or greater or the antilog of 14 divided by 20.

$$20 \log d_U/d_D = 14$$

$$\log d_U/d_D = 14/20 = 0.7$$

$$\text{antilog } 0.7 = 5.01$$

**NOTE: When  $d_U$  is beyond RLOS, protection will be greater than 14 dB.**

f. To complete the analysis, the configuration must now be analyzed with the desired and undesired stations reversed. For the systems to operate properly without interference, both configurations must meet the cochannel criteria.

**6. INTERSITE COCHANNEL ANALYSIS BY THE TABLE METHOD.** If only cylindrical standard FPSVs are considered, the figure 8 may be used to assure the 14 dB D/U ratio.

**FIGURE 8. MILEAGE SEPARATION TABLES FOR USUAL FPSVs**

FACILITY TYPE	SERVICE RADIUS (Desired)		ACFT TO ACFT SEPARATION (Critical Points)	TOTAL REQUIRED
High Altitude	150	+	525*	675 + R
Approach/Departure	60	+	300	360 + R
Local	30	+	150	180 + R
GCA/PAR/SFA	15	+	75	90 + R

Note: "R" is the service radius in nmi of the competing facility.  
\* Separation modified by RLOS.

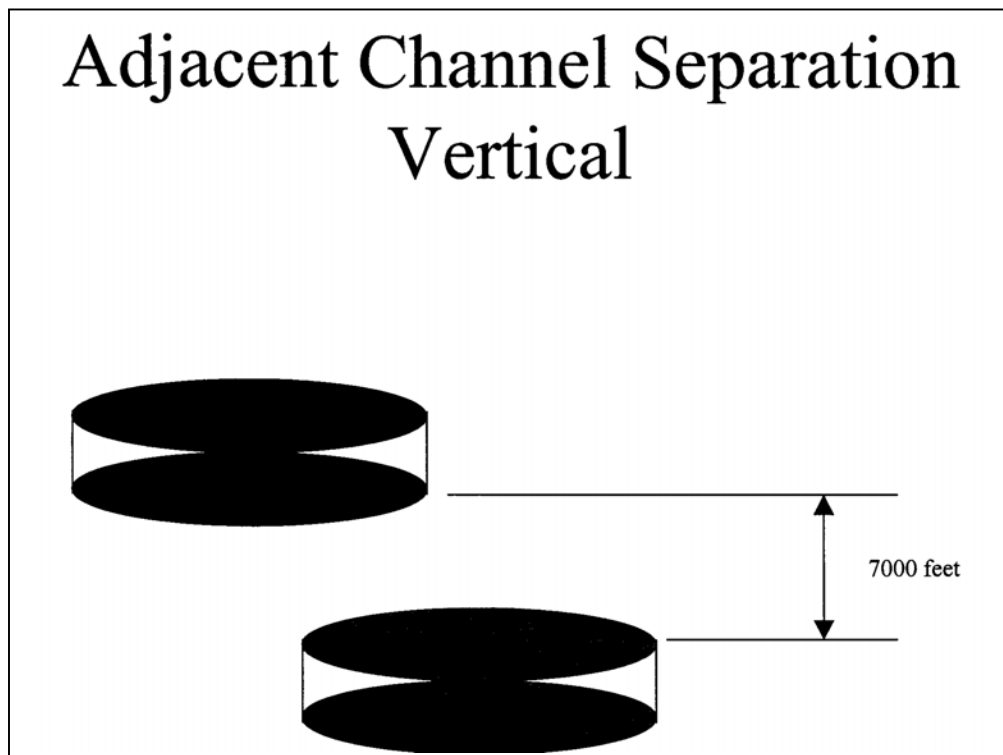
**7. ADJACENT CHANNEL CONSIDERATIONS.** Adjacent-channel signals 25 kHz away are suppressed approximately 60 dB by the bandpass characteristics of the 720 channel receiver. A +14 dB D/U ratio is required on-channel, leaving a net ratio of -46 dB, the value that an adjacent channel signal must not exceed on-channel to maintain the +14 dB D/U ratio. Empirical tests have shown that between 0.5 and 0.6 nmi separation between the undesired signal source and the desired critical point will provide this protection. Since aircraft operating in a difference sector/service may also be separated by 0.5-0.6 nmi in altitude, vertical adjacent channel separation may also be considered. A conservative vertical separation of 7000' has been included in the automated spectrum assignment program. The use of vertical adjacent channel separation requires the proper coding of the lower flight level in high and super high sector assignments. The use of the conservative vertical separation value of 7000' in the model is provided to ensure that adequate adjacent channel separation will be provided while experience is gained with using vertical adjacent channel separation. Figure 9 graphically illustrates vertical adjacent channel separation.

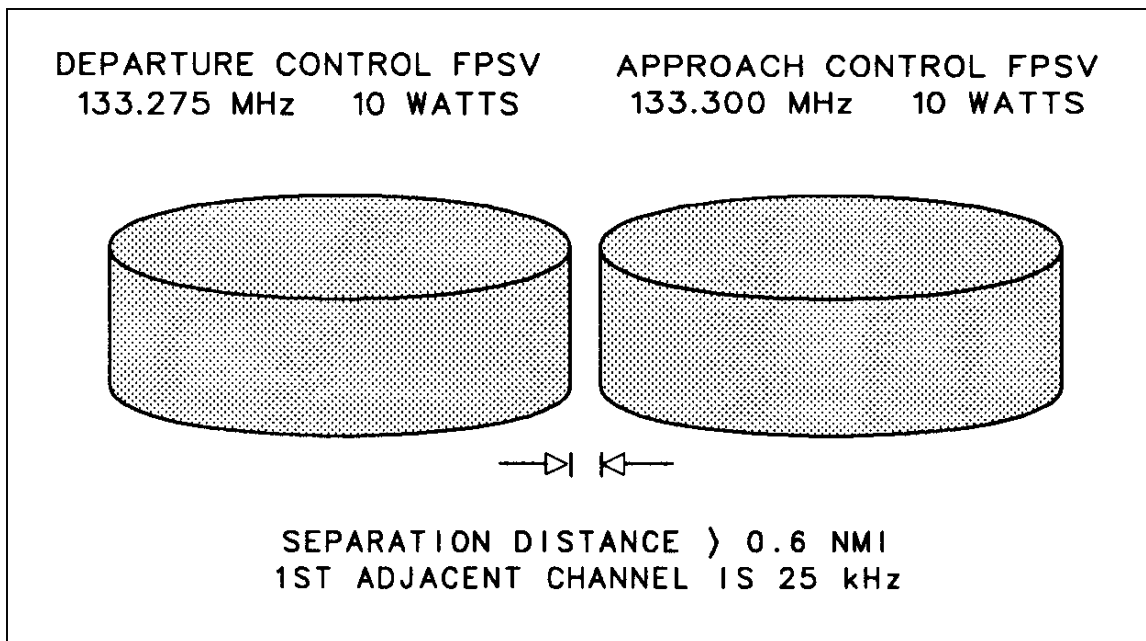
**a. For en route functions,** AT procedures require aircraft to be separated 3 nmi, so that an adjacent-channel aircraft will never be closer than the minimum distance required.

**b. For terminal functions,** aircraft can be much closer, so that a small worst-case protection is required. Any separation greater than 0.6 nmi between edges of adjacent channel FPSVs will provide adequate protection; see the example in figure 10.

**c. 2nd adjacent channel assignments** need no consideration in intersite analysis.

**FIGURE 9. ADJACENT CHANNEL VERTICAL SEPARATION**



**FIGURE 10. 1ST ADJACENT CHANNEL SEPARATION REQUIRED**

## 8. INTERSITE COCHANNEL ANALYSIS.

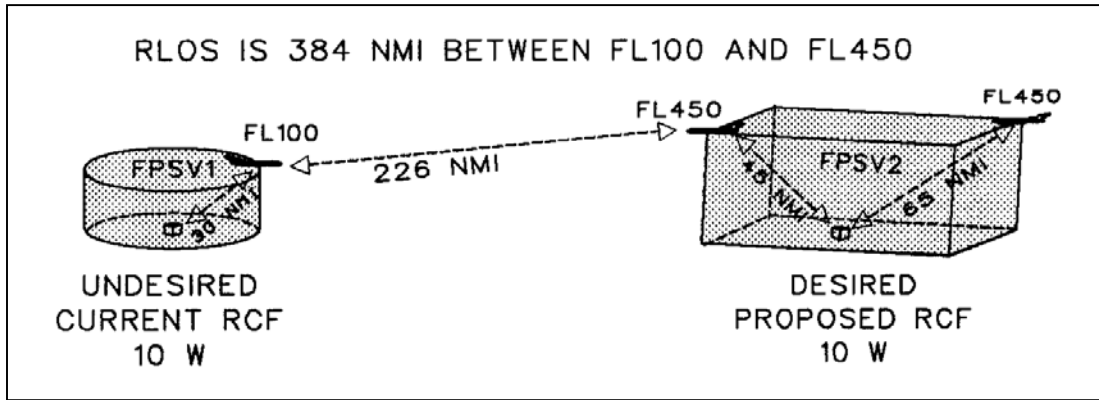
**a. To determine the DR** of any critical point, first determine if  $d_U$  is beyond RLOS using the formula in paragraph 4b. The  $d_U$  for this RLOS criterion is the shortest distance between the two cochannel FPSVs. If  $d_U$  is beyond RLOS, the DR will be greater than 14 dB for both FPSVs. When both cochannel FPSVs are cylindrical and the transmitters are in the center of the FPSVs, the worst-case DR is where the  $d_U$  is the shortest distance between FPSVs and  $d_D$  is the cylinder radius. The configuration is shown in figure 8 and the calculation of DR is shown in paragraph 5d, above.

**b. When the transmitter is not at the center** of the FPSV or the FPSV is tailored and not cylindrical, the worst-case DR can occur when  $d_U$  is not a minimum and  $d_D$  can be the maximum distance between the transmitter and the perimeter of the FPSV. An example of a calculation for a noncylindrical FPSV is demonstrated in figures 11 and 12. The  $d_U$  for the worst-case DR for the cylindrical FPSV1 is the minimum distance between FPSVs which is shown as 226 nmi. The worst-case DR would then be 226 nmi divided by the 30 nmi radius or 7.53. FPSV1 thus passes the DR criteria as the DR is greater than 5. The  $d_U$  for the worst case DR for the noncylindrical FPSV2 occurs where the  $d_U$  is about 330 nmi. With  $d_D$  being 65 nmi, the worst case DR for FPSV2 would be  $330 \div 65$  or 5.08. FPSV2 passes the DR criteria. It is important to consider that all points on a TSV must be checked when using the DR criteria.

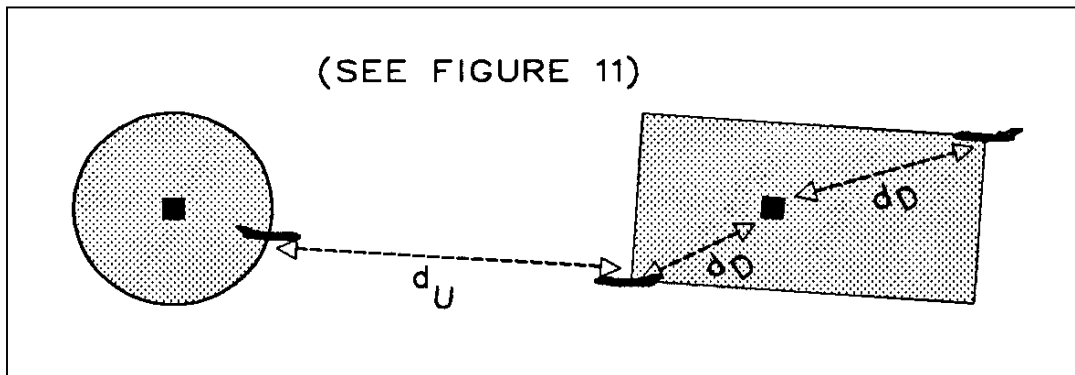
**c. In this example**, a common channel frequency can be used. If either FPSV1 or FPSV2 fails the DR = 5 or 14 dB criterion, then the same frequency cannot be use for both FPSVs. Since the new facility FPSV2 is not a cylindrical FPSV, the worst-case situation is not an "in-line" function. The worst-case DR must be determined by direct map measurement as shown in figure 12. FAA's automatic A/G computer model does the calculation for cylinders or equivalent cylinders with off-center transmitter locations. (NOTE: The AFM uses actual TSV points

to calculate DR if the TSV option is selected.) An equivalent cylinder to a TSV can be overprotected by the computer model and should be further checked by direct map measurement if it fails the computer model's DR.

**FIGURE 11. COCHANNEL ANALYSIS BY CALCULATION**



**FIGURE 12. COMPARISON OF D/U AND DISTANCE BETWEEN FACILITIES WITH ONE TAILORED SERVICE VOLUME**



**9. COSITE INTERFERENCE CONSIDERATIONS.** Cosite interference results from the interaction of transmitters and receivers in close proximity. Usually this means in the same building, or in adjacent buildings up to one mile away for 50 watt transmitters and 2,000' away for 10 watt transmitters, but in the case of high power FM and TV broadcast stations, it can mean several miles away. The appendix contains a discussion of interference involving commercial broadcast stations.

**a. Adjacent sources.** In FAA cosite installations, the standard is a minimum separation of 500 kHz for VHF and 1 MHz for UHF when there is an 8' minimum separation between transmit antennas and an 80' minimum separation between transmit and receive antennas.

**b. Harmonics.** These come from two general sources.

**(1) FAA equipment.** This is usually the second or third harmonic of VHF transmitters afflicting UHF receivers. It is generally quite difficult to operate a receiver on a direct harmonic of a transmitter cosite, even with transmitter band-pass filtering. Direct harmonic operation shall be avoided cosite.

**(2) External sources.** These can come from a variety of sources, FM and TV aural and video spurious emissions and harmonics in VHF and UHF, Land Mobile 35-50 MHz spurious emissions and harmonics in VHF, CB and Amateur in both VHF and UHF. The only ones that can be planned against are the FM and TV harmonics.

**c. Spurious emission.** Any frequency put out by a transmitter which is not the fundamental frequency is spurious. These are normally harmonics, which are easy to plan against, but also there are multiples and odd multiples of crystal oscillators or synthesizer mixers. Receivers also are subject to local oscillator radiation which can affect other receivers in the same rack or room. Principally, "image" interference to receivers, reception of a signal which mixes with the local oscillator to produce the receiver's IF, should be avoided. The FMO should be familiar with IFs used in receivers in a given site so that direct image reception can be avoided.

**d. Intermod.** This is the most common source of cosite interference. It results from the mixing of two or more cosite transmitters which, when added or subtracted from one another in some sequence, produces a resultant frequency equal to one being received elsewhere at the site. Discussion of intermod calculations will be found in paragraph 1405a(3)(d) of this order. FAA policy is to not assign frequencies having third order IM prediction from nearby possible sources..

**e. Image interference.** Interference can be generated by nearby strong signals which produce the IF by mixing with the LO in the receiver. This problem normally occurs only with nearby and/or very strong signal sources. See paragraph 1405a(3)(e) for details.

## 10. LIMITS OF COVERAGE CHARTS.

**a. A sufficient signal level** is required at the aircraft anywhere within the FPSV as described in paragraph 3 of this appendix. A major factor in the coverage is the height of the antenna above effective ground and the roughness of the terrain surrounding the antenna location. Charts showing coverage at the two standard powers of 10 W and 50 W at different antenna heights are shown in figures 13-24.

**b. The Brewster Angle** is the term applied to the effect of lobing of the theoretical "doughnut" radiation pattern around a vertical antenna in space. In practice, most FAA RCF antennas are ground planes, and have a modified radiation pattern just from the plane effect. In addition, there are direct rays from the antenna to the aircraft and rays which are received as a result of reflection from the ground.

**c. Lobing** is caused by the difference in phase of the transmitted signal arriving at the receiving point as a combination of direct rays and reflected rays. Depending on frequency and antenna height above effective ground, these rays can combine to produce an out-of-phase condition resulting in a very low level of signal, or an in-phase condition where the signal level is enhanced. These conditions vary with altitude, distance, power, frequency and ground antenna height above effective ground.

**d. The charts shown in figures 13-24** are intended to indicate the volumes of airspace within which a proposed FPSV or ESV will be provided with the required minimum signal of -87 dBm at the aircraft receiver (RTCA MOPS, DO-186a; see paragraph 3a above). All areas to the left of the respective curves are expected to have the minimum required signal level at any azimuth. However, there are definitely inaccuracies in some areas, particularly at the higher AGL antennas due to a discontinuity of signal levels at some altitudes at some distances.

FIGURE 13. LIMITS OF COVERAGE - VHF - ANTENNA HEIGHT = 10'

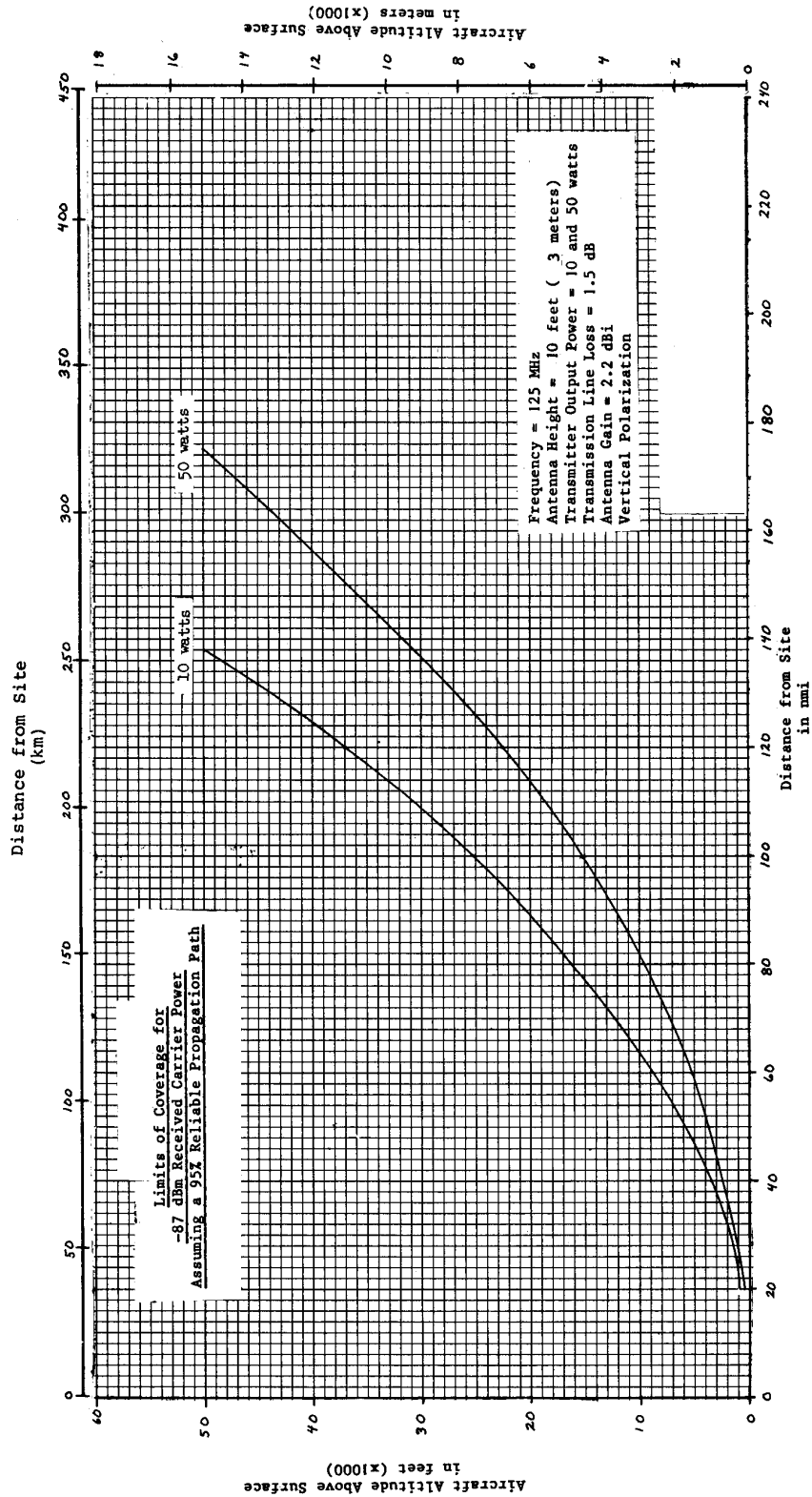




FIGURE 14. LIMITS OF COVERAGE - VHF - ANTENNA HEIGHT = 25'

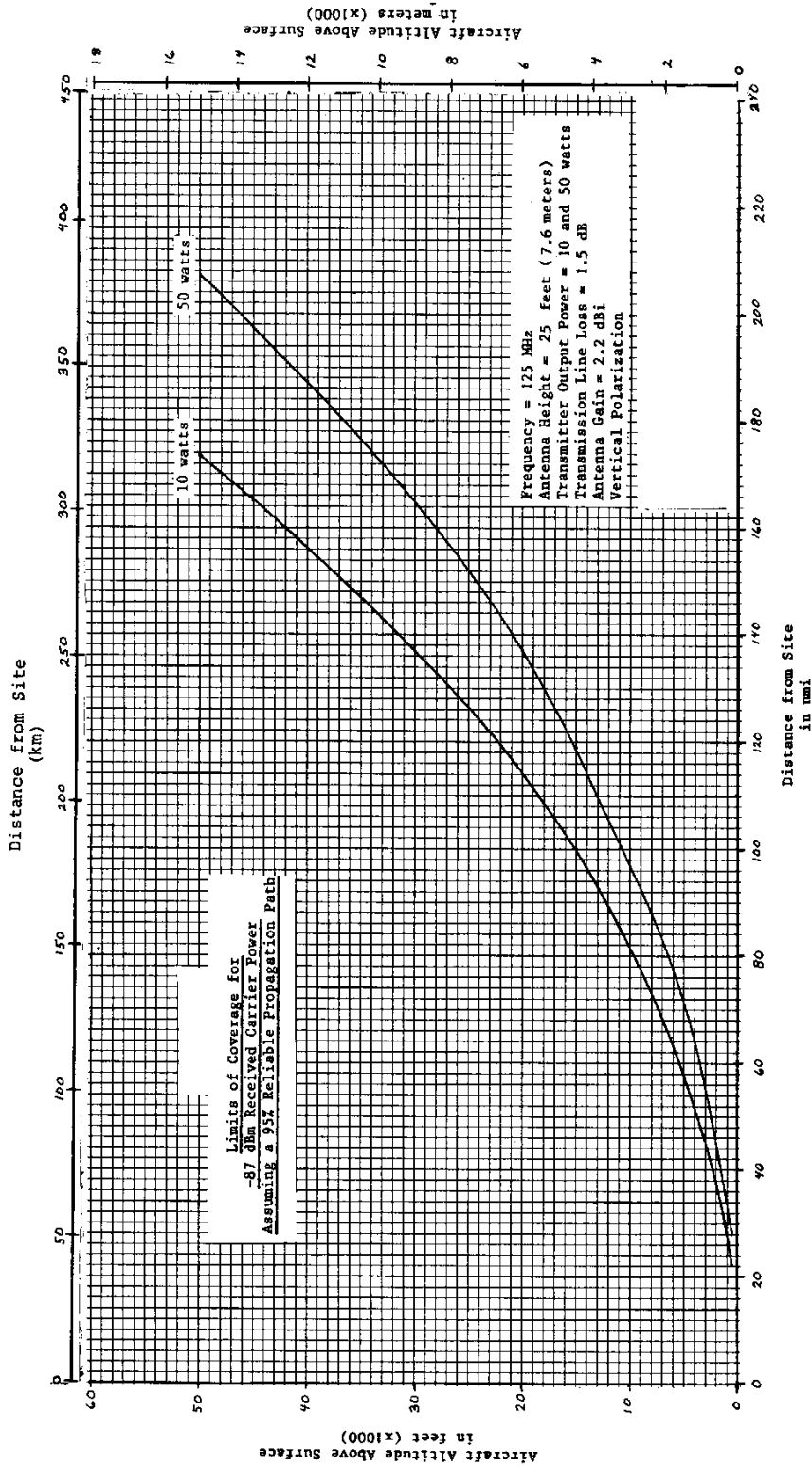


FIGURE 15. LIMITS OF COVERAGE - VHF - ANTENNA HEIGHT = 50'

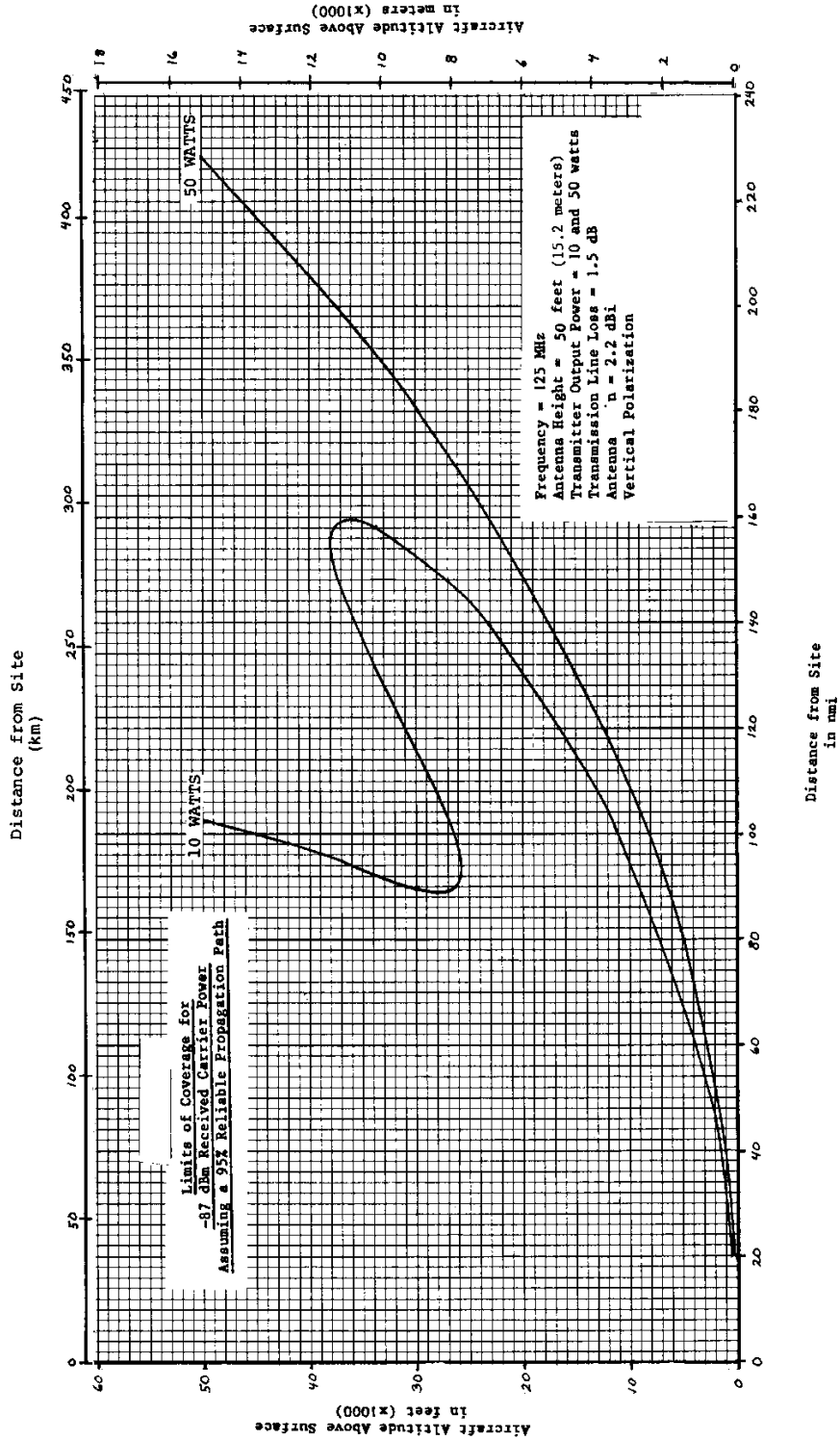


FIGURE 16. LIMITS OF COVERAGE - VHF - ANTENNA HEIGHT = 75'

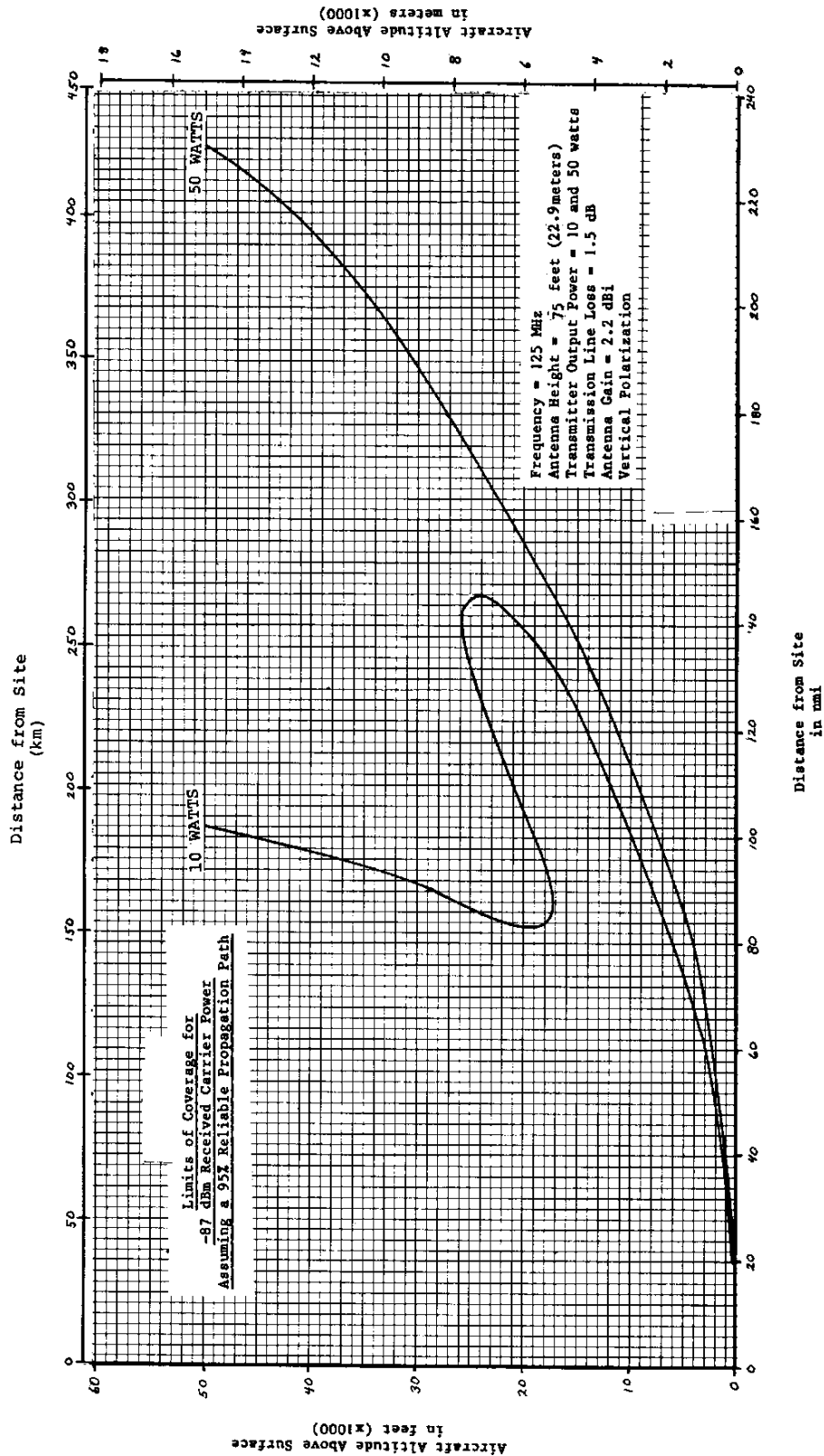


FIGURE 17. LIMITS OF COVERAGE - VHF - ANTENNA HEIGHT = 100'

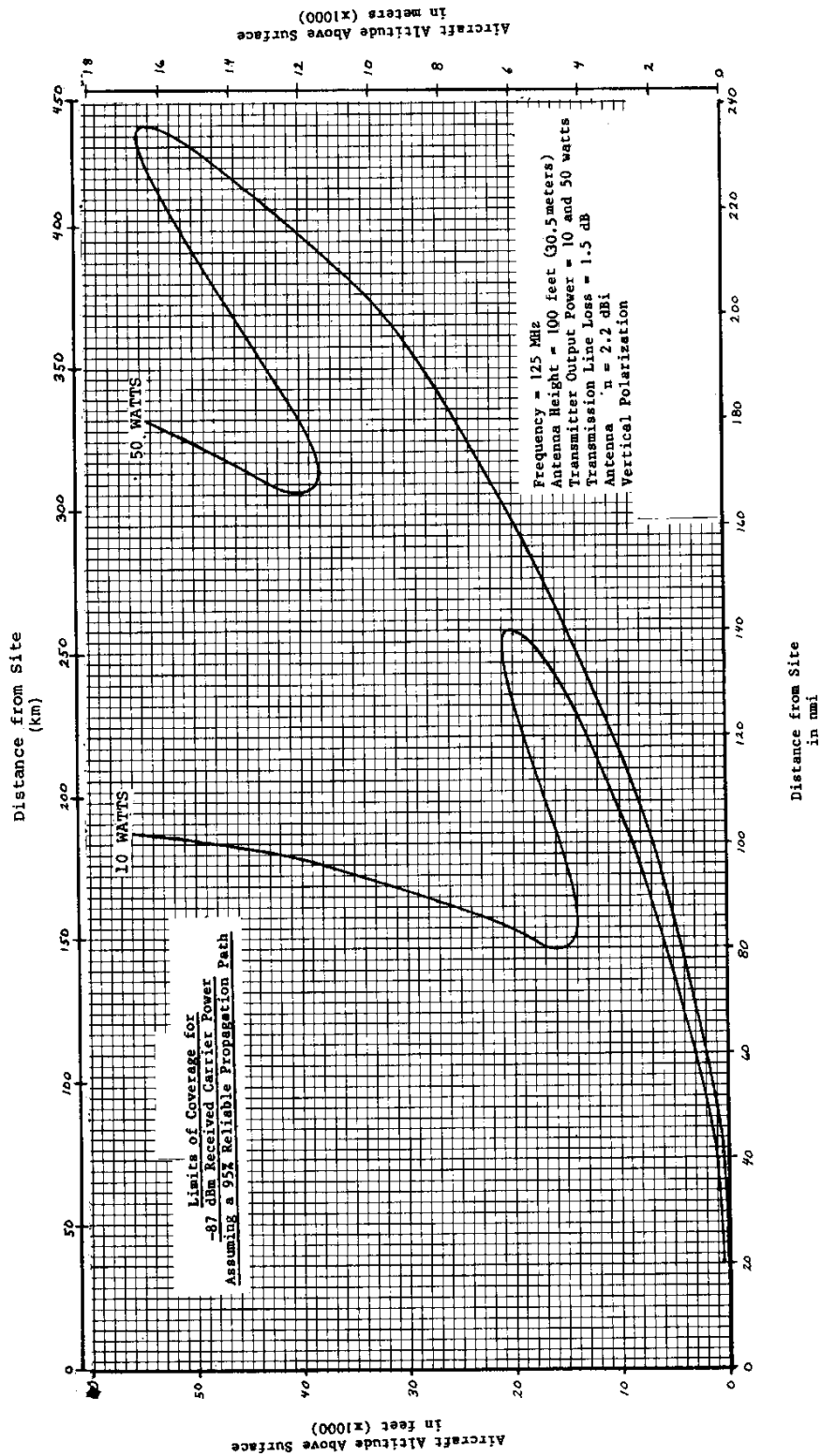


FIGURE 18. LIMITS OF COVERAGE - VHF - ANTENNA HEIGHT = 150'

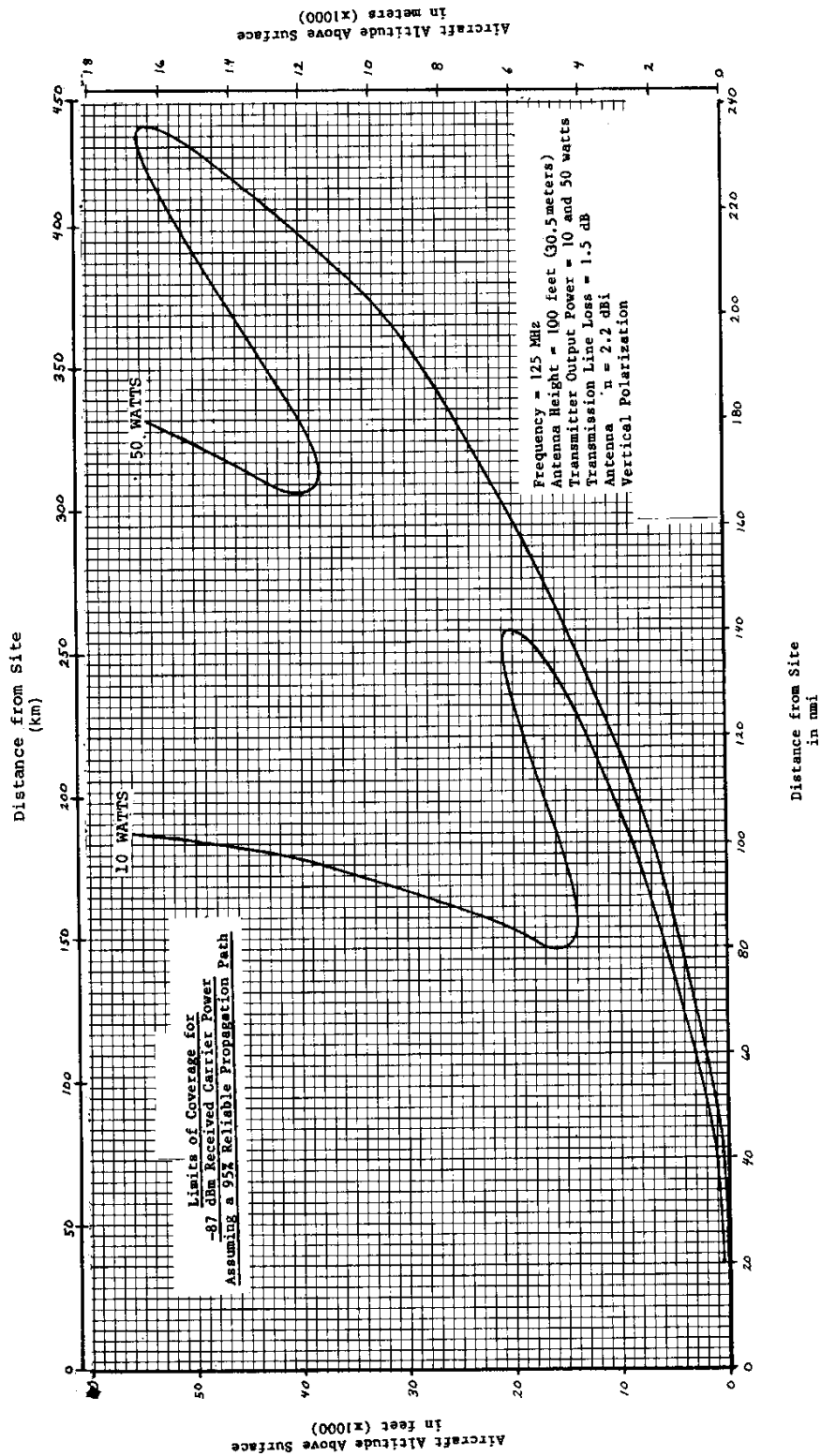


FIGURE 19. LIMITS OF COVERAGE - UHF - ANTENNA HEIGHT = 10'

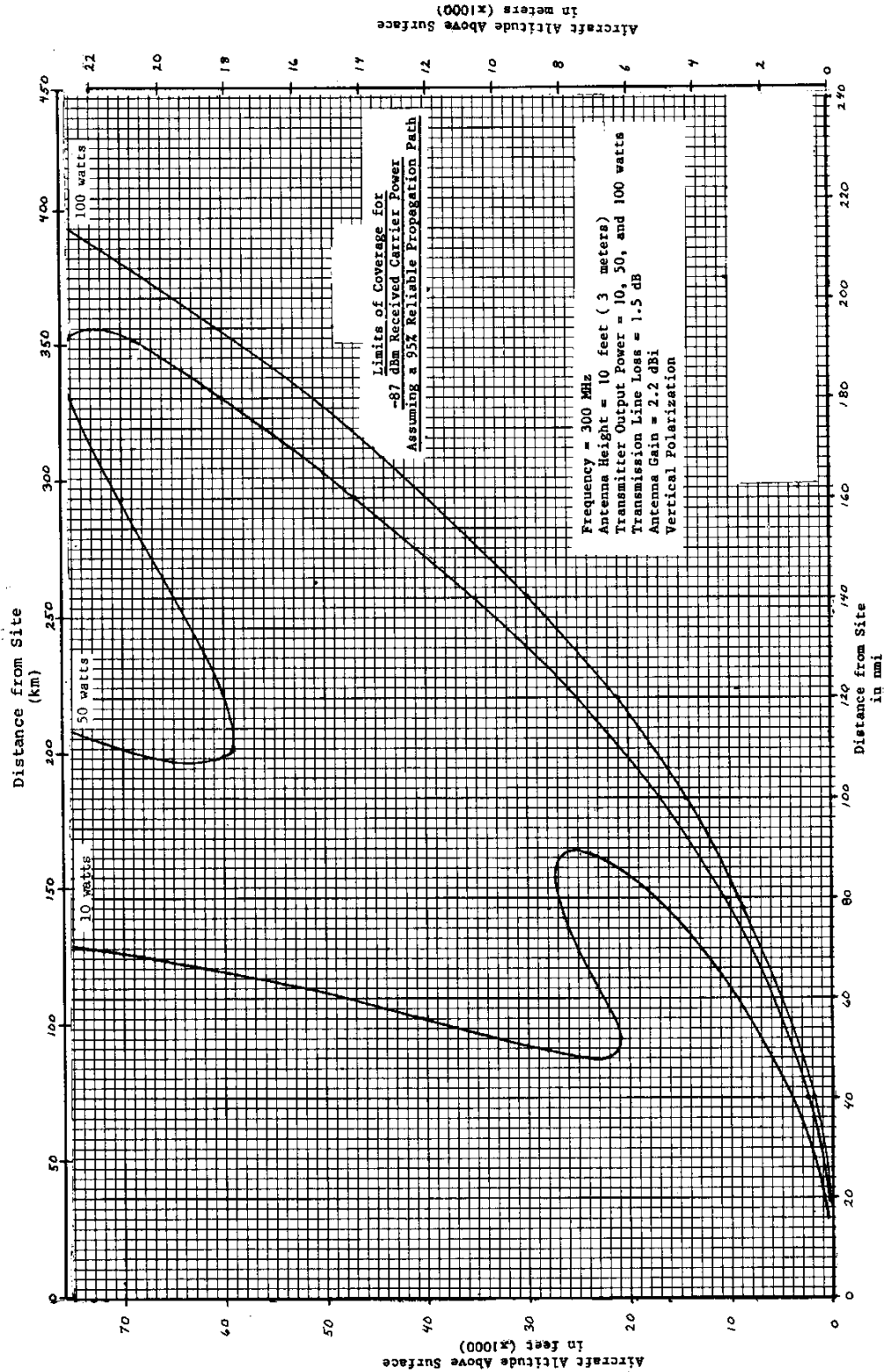


FIGURE 20. LIMITS OF COVERAGE - UHF - ANTENNA HEIGHT = 20'

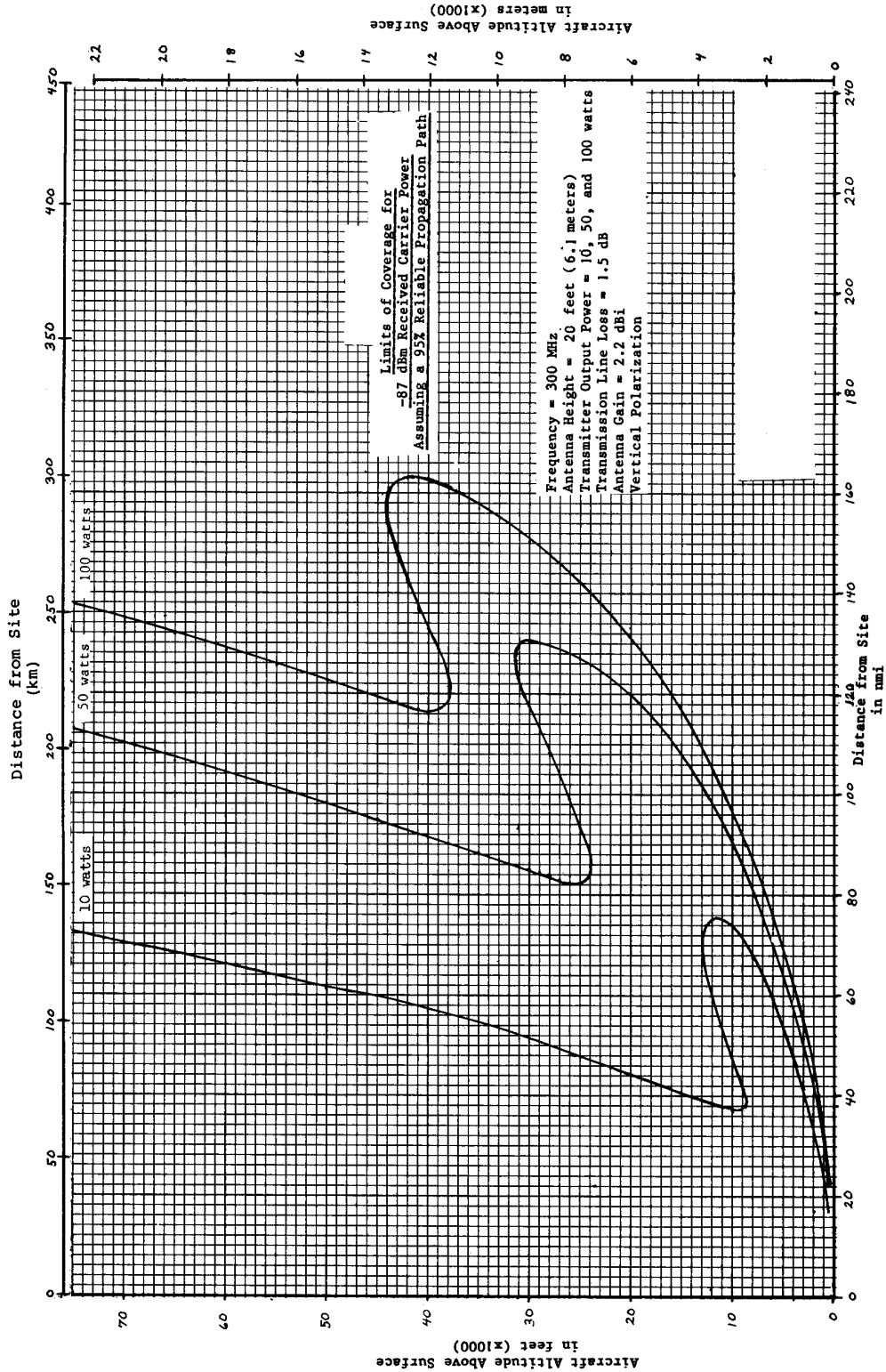


FIGURE 21. LIMITS OF COVERAGE - UHF - ANTENNA HEIGHT = 30'

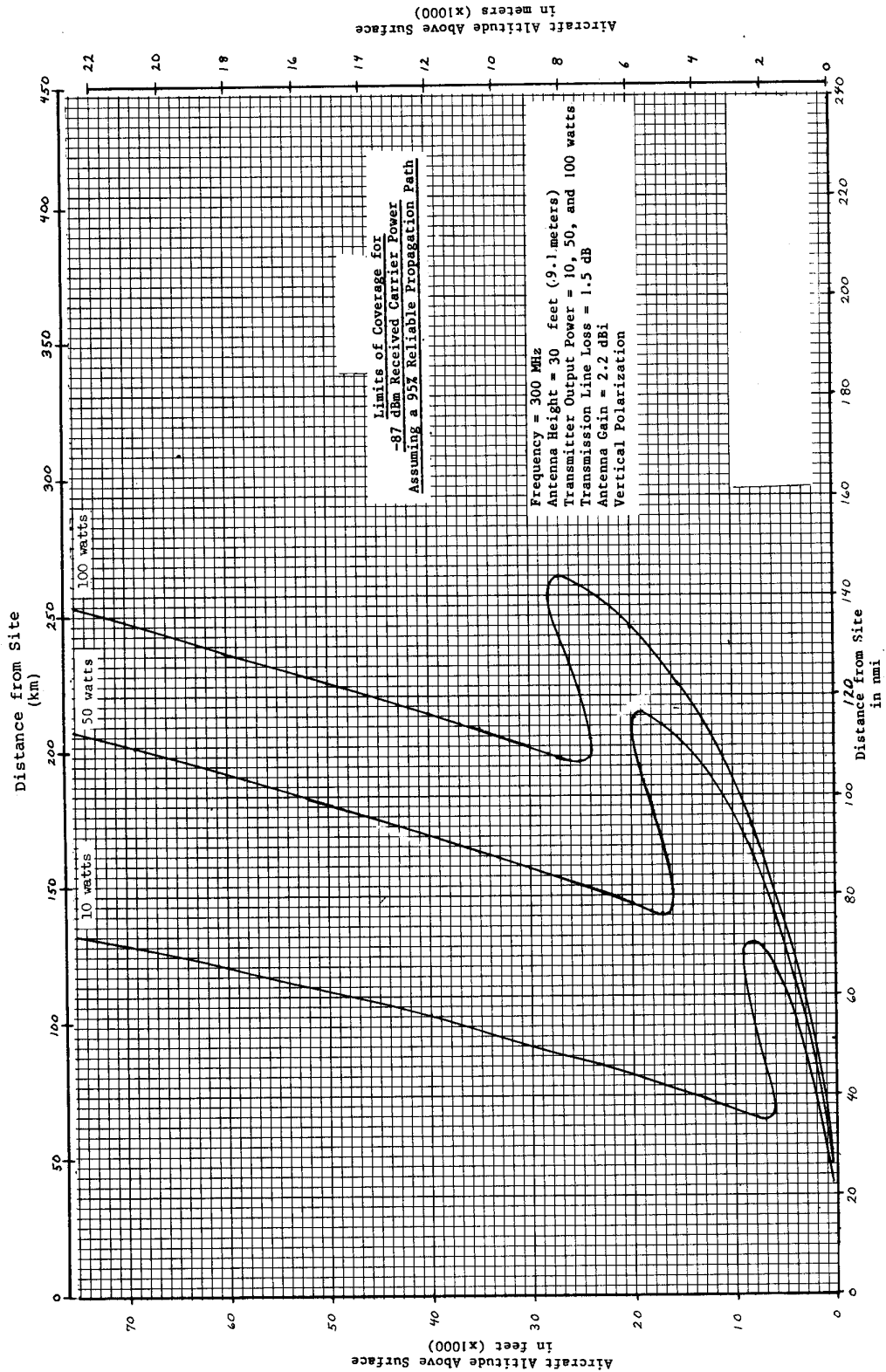




FIGURE 22. LIMITS OF COVERAGE - UHF - ANTENNA HEIGHT = 40'

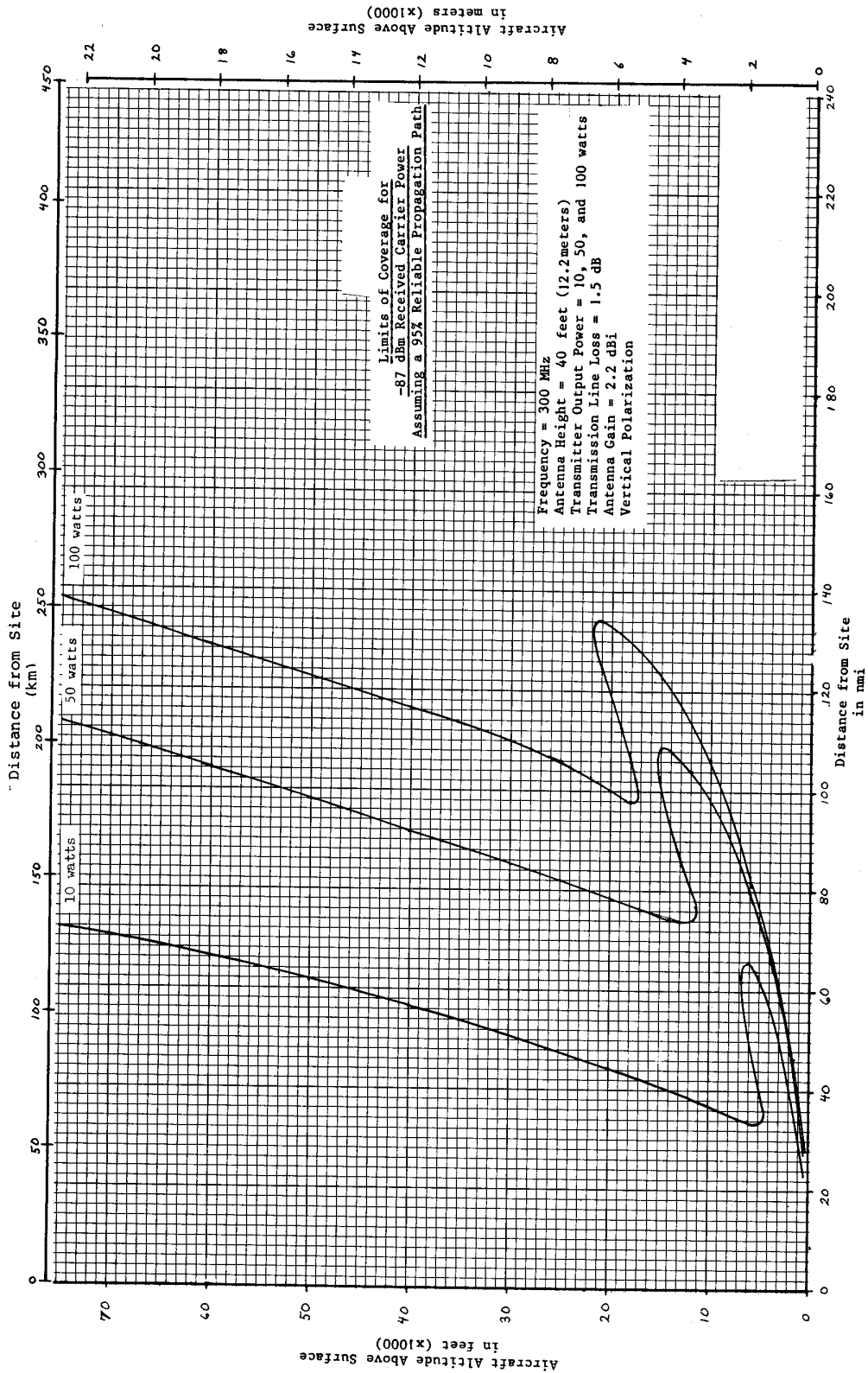


FIGURE 23. LIMITS OF COVERAGE - UHF - ANTENNA HEIGHT 50'

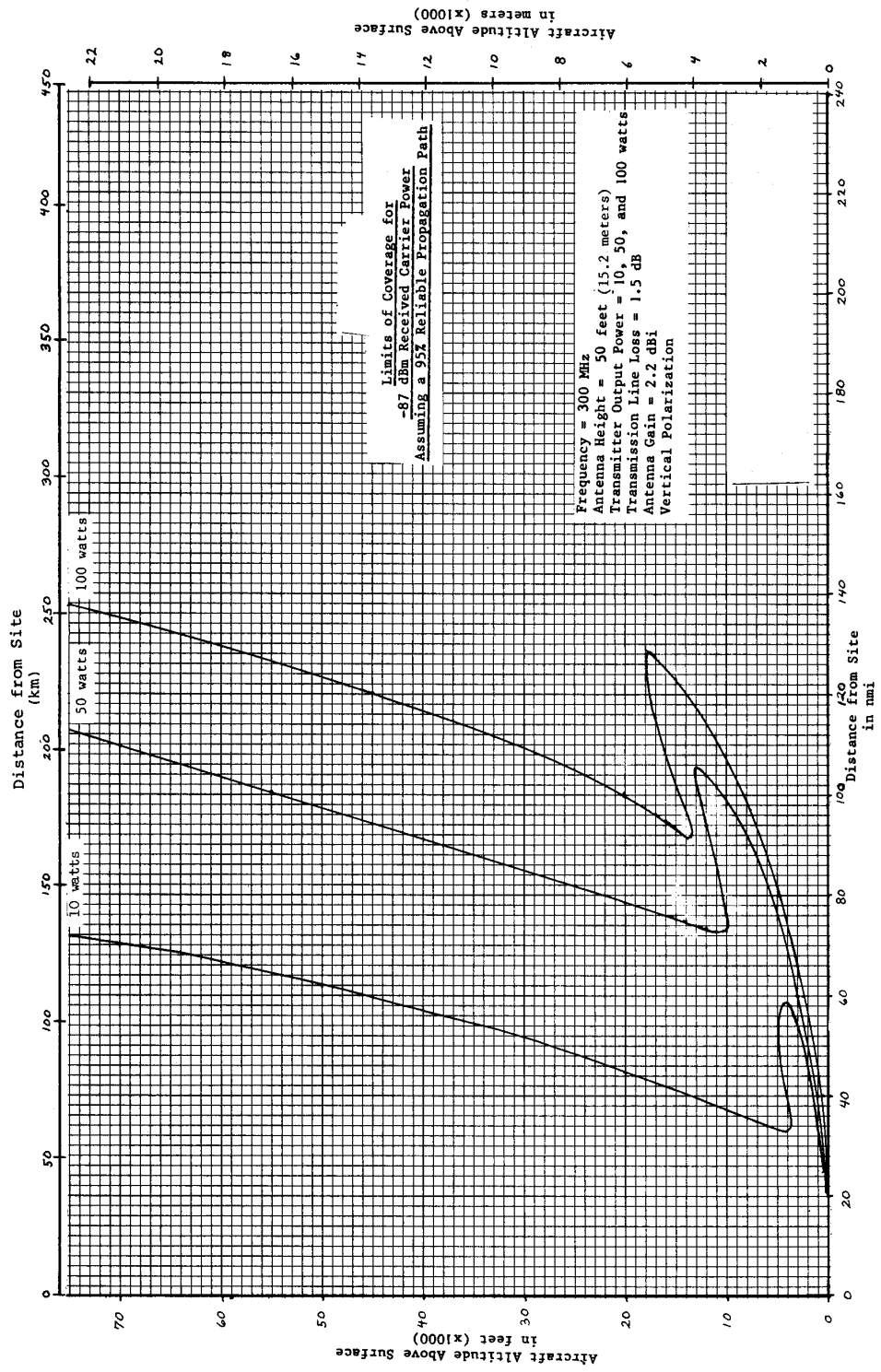
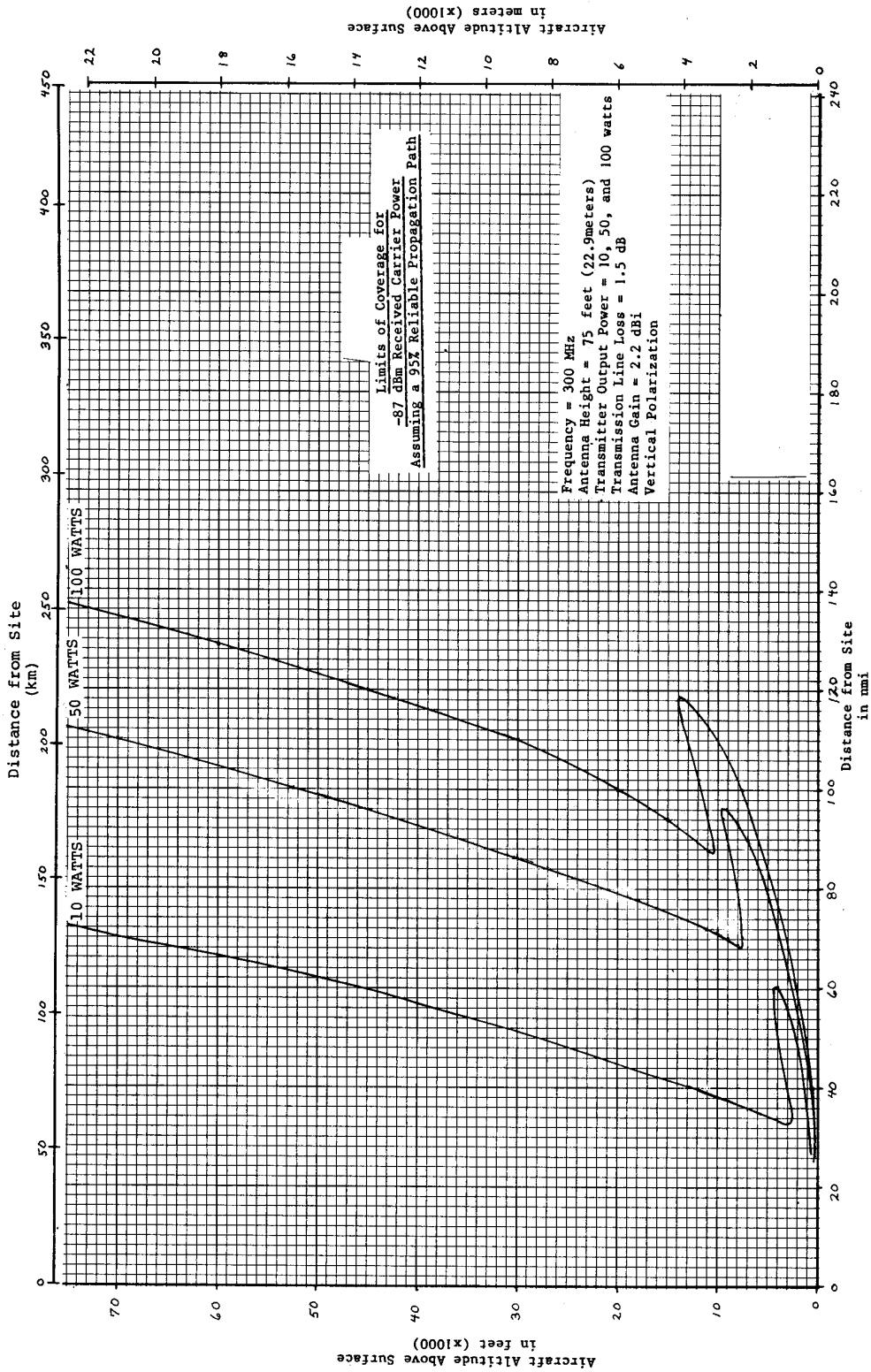


FIGURE 24. LIMITS OF COVERAGE - UHF - ANTENNA HEIGHT = 75'



**APPENDIX 3. NAVAID FREQUENCY ENGINEERING  
DATA AND PROCEDURES**

**SECTION 1 - FREQUENCY/CHANNELIZATION CHART**

**FIGURE 1a. CHANNEL AND FREQUENCY PAIRING WITH DME PULSE TIME/CODES**

DME CHN NO.	-----FREQUENCY---MHz-----				MLS CHN NO.	DME AIRBORNE INTERROGATE				DME GROUND REPLY	
	LOC	GS	VOR	MLS		NORMAL DME FREQ	μs	DME/P IA μs	FA μs	DME FREQ	PC μs
1X	-	-	-	-	-	1025	12	--	--	962	12
1Y	-	-	-	-	-	1025	36	--	--	1088	30
2X	-	-	-	-	-	1026	12	--	--	963	12
2Y	-	-	-	-	-	1026	36	--	--	1089	30
3X	-	-	-	-	-	1027	12	--	--	964	12
3Y	-	-	-	-	-	1027	36	--	--	1090	30
4X	-	-	-	-	-	1028	12	--	--	965	12
4Y	-	-	-	-	-	1028	36	--	--	1091	30
5X	-	-	-	-	-	1029	12	--	--	966	12
5Y	-	-	-	-	-	1029	36	--	--	1092	30
6X	-	-	-	-	-	1030	12	--	--	967	12
6Y	-	-	-	-	-	1030	36	--	--	1093	30
7X	-	-	-	-	-	1031	12	--	--	968	12
7Y	-	-	-	-	-	1031	36	--	--	1094	30
8X	-	-	-	-	-	1032	12	--	--	969	12
8Y	-	-	-	-	-	1032	36	--	--	1095	30
9X	-	-	-	-	-	1033	12	--	--	970	12
9Y	-	-	-	-	-	1033	36	--	--	1096	30
10X	-	-	-	-	-	1034	12	--	--	971	12
10Y	-	-	-	-	-	1034	36	--	--	1097	30
11X	-	-	-	-	-	1035	12	--	--	972	12
11Y	-	-	-	-	-	1035	36	--	--	1098	30
12X	-	-	-	-	-	1036	12	--	--	973	12
12Y	-	-	-	-	-	1036	36	--	--	1099	30
13X	-	-	-	-	-	1037	12	--	--	974	12
13Y	-	-	-	-	-	1037	36	--	--	1100	30
14X	-	-	-	-	-	1038	12	--	--	975	12
14Y	-	-	-	-	-	1038	36	--	--	1101	30
15X	-	-	-	-	-	1039	12	--	--	976	12
15Y	-	-	-	-	-	1039	36	--	--	1102	30
16X	-	-	-	-	-	1040	12	--	--	977	12
16Y	-	-	-	-	-	1040	36	--	--	1103	30
17X	-	-	108.00	-	-	1041	12	--	--	978	12
17Y	-	-	108.05	5043.0	540	1041	36	36	42	1104	30
18X	108.10	334.70	-	5031.0	500	1042	12	12	18	979	12
18Y	108.15	334.55	-	5043.6	542	1042	36	36	42	1105	30
19X	-	-	108.20	-	-	1043	12	--	--	980	12
19Y	-	-	108.25	5044.2	544	1043	36	36	42	1106	30
20X	108.30	334.10	-	5031.6	502	1044	12	12	18	981	12
20Y	108.35	333.95	-	5044.8	546	1044	36	36	42	1107	30

**FIGURE 1b. CHANNEL AND FREQUENCY PAIRING WITH DME PULSE TIME/CODES  
(CONTINUED)**

DME CHN NO.	-----FREQUENCY---MHz-----				MLS CHN NO.	DME AIRBORNE INTERROGATE				DME GROUND REPLY	
	LOC	GS	VOR	MLS		NORMAL DME		DME/P		DME FREQ	PC µs
						FREQ	µs	IA µs	FA µs		
21X	-	-	108.40	-	-	1045	12	--	--	982	12
21Y	-	-	108.45	5045.4	548	1045	36	36	42	1108	30
22X	108.50	329.90	-	5032.2	504	1046	12	12	18	983	12
22Y	108.55	329.75	-	5046.0	550	1046	36	36	42	1109	30
23X	-	-	108.60	-	-	1047	12	--	--	984	12
23Y	-	-	108.65	5046.6	552	1047	36	36	42	1110	30
24X	108.70	330.50	-	5032.8	506	1048	12	12	18	985	12
24Y	108.75	330.35	-	5047.2	554	1048	36	36	42	1111	30
25X	-	-	108.80	-	-	1049	12	--	--	986	12
25Y	-	-	108.85	5047.8	556	1049	36	36	42	1112	30
26X	108.90	329.30	-	5033.4	508	1050	12	12	18	987	12
26Y	108.95	329.15	-	5048.4	558	1050	36	36	42	1113	30
27X	-	-	109.00	-	-	1051	12	--	--	988	12
27Y	-	-	109.05	5049.0	560	1051	36	36	42	1114	30
28X	109.10	331.40	-	5034.0	510	1052	12	12	18	989	12
28Y	109.15	331.25	-	5049.6	562	1052	36	36	42	1115	30
29X	-	-	109.20	-	-	1053	12	--	--	990	12
29Y	-	-	109.25	5050.2	564	1053	36	36	42	1116	30
30X	109.30	332.00	-	5034.6	512	1054	12	12	18	991	12
30Y	109.35	331.85	-	5050.8	566	1054	36	36	42	1117	30
31X	-	-	109.40	-	-	1055	12	--	--	992	12
31Y	-	-	109.45	5051.4	568	1055	36	36	42	1118	30
32X	109.50	332.60	-	5035.2	514	1056	12	12	18	993	12
32Y	109.55	332.45	-	5052.0	570	1056	36	36	42	1119	30
33X	-	-	109.60	-	-	1057	12	--	--	994	12
33Y	-	-	109.65	5052.6	572	1057	36	36	42	1120	30
34X	109.70	333.20	-	5035.8	516	1058	12	12	18	995	12
34Y	109.75	333.05	-	5053.2	574	1058	36	36	42	1121	30
35X	-	-	109.80	-	-	1059	12	--	--	996	12
35Y	-	-	109.85	5053.8	576	1059	36	36	42	1122	30
36X	109.90	333.80	-	5036.4	518	1060	12	12	18	997	12
36Y	109.95	333.65	-	5054.4	578	1060	36	36	42	1123	30
37X	-	-	110.00	-	-	1061	12	--	--	998	12
37Y	-	-	110.05	5055.0	580	1061	36	36	42	1124	30
38X	110.10	334.40	-	5037.0	520	1062	12	12	18	999	12
38Y	110.15	334.25	-	5055.6	582	1062	36	36	42	1125	30
39X	-	-	110.20	-	-	1063	12	--	--	1000	12
39Y	-	-	110.25	5056.2	584	1063	36	36	42	1126	30
40X	110.30	335.00	-	5037.6	522	1064	12	12	18	1001	12
40Y	110.35	334.85	-	5056.8	586	1064	36	36	42	1127	30

**FIGURE 1c. CHANNEL AND FREQUENCY PAIRING WITH DME PULSE TIME/CODES  
(CONTINUED)**

DME CHN NO.	-----FREQUENCY-----MHz-----				MLS CHN NO.	DME AIRBORNE INTERROGATE			DME GROUND REPLY		
	LOC	GS	VOR	MLS		NORMAL DME FREQ	μs	DME/P IA μs	FA μs	DME FREQ	PC μs
41X	-	-	110.40	-	-	1065	12	--	--	1002	12
41Y	-	-	110.45	5057.4	588	1065	36	36	42	1128	30
42X	110.50	329.60	-	5038.2	524	1066	12	12	18	1003	12
42Y	110.55	329.45	-	5058.0	590	1066	36	36	42	1129	30
43X	-	-	110.60	-	-	1067	12	--	--	1004	12
43Y	-	-	110.65	5058.6	592	1067	36	36	42	1130	30
44X	110.70	330.20	-	5038.8	526	1068	12	12	18	1005	12
44Y	110.75	330.05	-	5059.2	594	1068	36	36	42	1131	30
45X	-	-	110.80	-	-	1069	12	--	--	1006	12
45Y	-	-	110.85	5059.8	596	1069	36	36	42	1132	30
46X	110.90	330.80	-	5039.4	528	1070	12	12	18	1007	12
46Y	110.95	330.65	-	5060.4	598	1070	36	36	42	1133	30
47X	-	-	111.00	-	-	1071	12	--	--	1008	12
47Y	-	-	111.05	5061.0	600	1071	36	36	42	1134	30
48X	111.10	331.70	-	5040.0	530	1072	12	12	18	1009	12
48Y	111.15	331.55	-	5061.6	602	1072	36	36	42	1135	30
49X	-	-	111.20	-	-	1073	12	--	--	1010	12
49Y	-	-	111.25	5062.2	604	1073	36	36	42	1136	30
50X	111.30	332.30	-	5040.6	532	1074	12	12	18	1011	12
50Y	111.35	332.15	-	5062.8	606	1074	36	36	42	1137	30
51X	-	-	111.40	-	-	1075	12	--	--	1012	12
51Y	-	-	111.45	5063.4	608	1075	36	36	42	1138	30
52X	111.50	332.90	-	5041.2	534	1076	12	12	18	1013	12
52Y	111.55	332.75	-	5064.0	610	1076	36	36	42	1139	30
53X	-	-	111.60	-	-	1077	12	--	--	1014	12
53Y	-	-	111.65	5064.6	612	1077	36	36	42	1140	30
54X	111.70	333.50	-	5041.8	536	1078	12	12	18	1015	12
54Y	111.75	333.35	-	5065.2	614	1078	36	36	42	1141	30
55X	-	-	111.80	-	-	1079	12	--	--	1016	12
55Y	-	-	111.85	5065.8	616	1079	36	36	42	1142	30
56X	111.90	331.10	-	5042.4	538	1080	12	12	18	1017	12
56Y	111.95	330.95	-	5066.4	618	1080	36	36	42	1143	30
57X	-	-	112.00	-	-	1081	12	--	--	1018	12
57Y	-	-	112.05	-	-	1081	36	--	--	1144	30
58X	-	-	112.10	-	-	1082	12	--	--	1019	12
58Y	-	-	112.15	-	-	1082	36	--	--	1145	30
59X	-	-	112.20	-	-	1083	12	--	--	1020	12
59Y	-	-	112.25	-	-	1083	36	--	--	1146	30
60X	-	-	-	-	-	1084	12	--	--	1021	12
60Y	-	-	-	-	-	1084	36	--	--	1147	30

**FIGURE 1d. CHANNEL AND FREQUENCY PAIRING WITH DME PULSE TIME/CODES  
(CONTINUED)**

DME CHN NO.	-----FREQUENCY-----MHz-----				MLS CHN NO.	DME AIRBORNE INTERROGATE				DME GROUND REPLY	
	LOC	GS	VOR	MLS		NORMAL DME		DME/P		DME FREQ	PC µs
						FREQ	µs	IA µs	FA µs		
61X	-	-	-	-	-	1085	12	--	--	1022	12
61Y	-	-	-	-	-	1085	36	--	--	1148	30
62X	-	-	-	-	-	1086	12	--	--	1023	12
62Y	-	-	-	-	-	1086	36	--	--	1149	30
63X	-	-	-	-	-	1087	12	--	--	1024	12
63Y	-	-	-	-	-	1087	36	--	--	1150	30
64X	-	-	-	-	-	1088	12	--	--	1151	12
64Y	-	-	-	-	-	1088	36	--	--	1025	30
65X	-	-	-	-	-	1089	12	--	--	1152	12
65Y	-	-	-	-	-	1089	36	--	--	1026	30
66X	-	-	-	-	-	1090	12	--	--	1153	12
66Y	-	-	-	-	-	1090	36	--	--	1027	30
67X	-	-	-	-	-	1091	12	--	--	1154	12
67Y	-	-	-	-	-	1091	36	--	--	1028	30
68X	-	-	-	-	-	1092	12	--	--	1155	12
68Y	-	-	-	-	-	1092	36	--	--	1029	30
69X	-	-	-	-	-	1093	12	--	--	1156	12
69Y	-	-	-	-	-	1093	36	--	--	1030	30
70X	-	-	112.30	-	-	1094	12	--	--	1157	12
70Y	-	-	112.35	-	-	1094	36	--	--	1031	30
71X	-	-	112.40	-	-	1095	12	--	--	1158	12
71Y	-	-	112.45	-	-	1095	36	--	--	1032	30
72X	-	-	112.50	-	-	1096	12	--	--	1159	12
72Y	-	-	112.55	-	-	1096	36	--	--	1033	30
73X	-	-	112.60	-	-	1097	12	--	--	1160	12
73Y	-	-	112.65	-	-	1097	36	--	--	1034	30
74X	-	-	112.70	-	-	1098	12	--	--	1161	12
74Y	-	-	112.75	-	-	1098	36	--	--	1035	30
75X	-	-	112.80	-	-	1099	12	--	--	1162	12
75Y	-	-	112.85	-	-	1099	36	--	--	1036	30
76X	-	-	112.90	-	-	1100	12	--	--	1163	12
76Y	-	-	112.95	-	-	1100	36	--	--	1037	30
77X	-	-	113.00	-	-	1101	12	--	--	1164	12
77Y	-	-	113.05	-	-	1101	36	--	--	1038	30
78X	-	-	113.10	-	-	1102	12	--	--	1165	12
78Y	-	-	113.15	-	-	1102	36	--	--	1039	30
79X	-	-	113.20	-	-	1103	12	--	--	1166	12
79Y	-	-	113.25	-	-	1103	36	--	--	1040	30
80X	-	-	113.30	-	-	1104	12	--	--	1167	12
80Y	-	-	113.35	5067.0	620	1104	36	36	42	1041	30

**FIGURE 1e. CHANNEL AND FREQUENCY PAIRING WITH DME PULSE TIME/CODES  
(CONTINUED)**

DME CHN NO.	-----FREQUENCY-----MHz-----				MLS CHN NO.	DME AIRBORNE INTERROGATE			DME GROUND REPLY		
	LOC	GS	VOR	MLS		NORMAL DME FREQ	μs	DME/P IA μs	FA μs	DME FREQ	PC μs
81X	-	-	113.40	-	-	1105	12	--	--	1168	12
81Y	-	-	113.45	5067.6	622	1105	36	36	42	1042	30
82X	-	-	113.50	-	-	1106	12	--	--	1169	12
82Y	-	-	113.55	5068.2	624	1106	36	36	42	1043	30
83X	-	-	113.60	-	-	1107	12	--	--	1170	12
83Y	-	-	113.65	5068.8	626	1107	36	36	42	1044	30
84X	-	-	113.70	-	-	1108	12	--	--	1171	12
84Y	-	-	113.75	5069.4	628	1108	36	36	42	1045	30
85X	-	-	113.80	-	-	1109	12	--	--	1172	12
85Y	-	-	113.85	5070.0	630	1109	36	36	42	1046	30
86X	-	-	113.90	-	-	1110	12	--	--	1173	12
86Y	-	-	113.95	5070.6	632	1110	36	36	42	1047	30
87X	-	-	114.00	-	-	1111	12	--	--	1174	12
87Y	-	-	114.05	5071.2	634	1111	36	36	42	1048	30
88X	-	-	114.10	-	-	1112	12	--	--	1175	12
88Y	-	-	114.15	5071.8	636	1112	36	36	42	1049	30
89X	-	-	114.20	-	-	1113	12	--	--	1176	12
89Y	-	-	114.25	5072.4	638	1113	36	36	42	1050	30
90X	-	-	114.30	-	-	1114	12	--	--	1177	12
90Y	-	-	114.35	5073.0	640	1114	36	36	42	1051	30
91X	-	-	114.40	-	-	1115	12	--	--	1178	12
91Y	-	-	114.45	5073.6	642	1115	36	36	42	1052	30
92X	-	-	114.50	-	-	1116	12	--	--	1179	12
92Y	-	-	114.55	5074.2	644	1116	36	36	42	1053	30
93X	-	-	114.60	-	-	1117	12	--	--	1180	12
93Y	-	-	114.65	5074.8	646	1117	36	36	42	1054	30
94X	-	-	114.70	-	-	1118	12	--	--	1181	12
94Y	-	-	114.75	5075.4	648	1118	36	36	42	1055	30
95X	-	-	114.80	-	-	1119	12	--	--	1182	12
95Y	-	-	114.85	5076.0	650	1119	36	36	42	1056	30
96X	-	-	114.90	-	-	1120	12	--	--	1183	12
96Y	-	-	114.95	5076.6	652	1120	36	36	42	1057	30
97X	-	-	115.00	-	-	1121	12	--	--	1184	12
97Y	-	-	115.05	5077.2	654	1121	36	36	42	1058	30
98X	-	-	115.10	-	-	1122	12	--	--	1185	12
98Y	-	-	115.15	5077.8	656	1122	36	36	42	1059	30
99X	-	-	115.20	-	-	1123	12	--	--	1186	12
99Y	-	-	115.25	5078.4	658	1123	36	36	42	1060	30
100X	-	-	115.30	-	1124	12	--	--	1187	12	
100Y	-	-	115.35	5079.0	660	1124	36	36	42	1061	30



**FIGURE 1f. CHANNEL AND FREQUENCY PAIRING WITH DME PULSE TIME/CODES  
(CONTINUED)**

DME CHN NO.	FREQUENCY---MHz---				MLS CHN NO.	DME AIRBORNE INTERROGATE		DME/P		DME GROUND REPLY	
	LOC	GS	VOR	MLS		NORMAL DME FREQ	μs	IA μs	FA μs	DME FREQ	PC μs
101X	-	-	115.40	-	-	1125	12	--	--	1188	12
101Y	-	-	115.45	5079.6	662	1125	36	36	42	1062	30
102X	-	-	115.50	-	-	1126	12	--	--	1189	12
102Y	-	-	115.55	5080.2	664	1126	36	36	42	1063	30
103X	-	-	115.60	-	-	1127	12	--	--	1190	12
103Y	-	-	115.65	5080.8	666	1127	36	36	42	1064	30
104X	-	-	115.70	-	-	1128	12	--	--	1191	12
104Y	-	-	115.75	5081.4	668	1128	36	36	42	1065	30
105X	-	-	115.80	-	-	1129	12	--	--	1192	12
105Y	-	-	115.85	5082.0	670	1129	36	36	42	1066	30
106X	-	-	115.90	-	-	1130	12	--	--	1193	12
106Y	-	-	115.95	5082.6	672	1130	36	36	42	1067	30
107X	-	-	116.00	-	-	1131	12	--	--	1194	12
107Y	-	-	116.05	5083.2	674	1131	36	36	42	1068	30
108X	-	-	116.10	-	-	1132	12	--	--	1195	12
108Y	-	-	116.15	5083.8	676	1132	36	36	42	1069	30
109X	-	-	116.20	-	-	1133	12	--	--	1196	12
109Y	-	-	116.25	5084.4	678	1133	35	35	42	1070	30
110X	-	-	116.30	-	-	1134	12	--	--	1197	12
110Y	-	-	116.35	5085.0	680	1134	36	36	42	1071	30
111X	-	-	116.40	-	-	1135	12	--	--	1198	12
111Y	-	-	116.45	5085.6	682	1135	36	36	42	1072	30
112X	-	-	116.50	-	-	1136	12	--	--	1199	12
112Y	-	-	116.55	5086.2	684	1136	36	36	42	1073	30
113X	-	-	116.60	-	-	1137	12	--	--	1200	12
113Y	-	-	116.65	5086.8	686	1137	36	36	42	1074	30
114X	-	-	116.70	-	-	1138	12	--	--	1201	12
114Y	-	-	116.75	5087.4	688	1138	36	36	42	1075	30
115X	-	-	116.80	-	-	1139	12	--	--	1202	12
115Y	-	-	116.85	5088.0	690	1139	36	36	42	1076	30
116X	-	-	116.90	-	-	1140	12	--	--	1203	12
116Y	-	-	116.95	5088.6	692	1140	36	36	42	1077	30
117X	-	-	117.00	-	-	1141	12	--	--	1204	12
117Y	-	-	117.05	5089.2	694	1141	36	36	42	1078	30
118X	-	-	117.10	-	-	1142	12	--	--	1205	12
118Y	-	-	117.15	5089.8	696	1142	36	36	42	1079	30
119X	-	-	117.20	-	-	1143	12	--	--	1206	12
119Y	-	-	117.25	5090.4	698	1143	36	36	42	1080	30
120X	-	-	117.30	-	-	1144	12	--	--	1207	12
120Y	-	-	117.35	-	-	1144	36	--	--	1081	30
121X	-	-	117.40	-	-	1145	12	--	--	1208	12
121Y	-	-	117.45	-	-	1145	36	--	--	1082	30
122X	-	-	117.50	-	-	1146	12	--	--	1209	12
122Y	-	-	117.55	-	-	1146	36	--	--	1083	30
123X	-	-	117.60	-	-	1147	12	--	--	1210	12
123Y	-	-	117.65	-	-	1147	36	--	--	1084	30
124X	-	-	117.70	-	-	1148	12	--	--	1211	12
124Y	-	-	117.75	-	-	1148	36	--	--	1085	30
125X	-	-	117.80	-	-	1149	12	--	--	1212	12
125Y	-	-	117.85	-	-	1149	36	--	--	1086	30
126X	-	-	117.90	-	-	1150	12	--	--	1213	12
126Y	-	-	117.95	-	-	1150	36	--	--	1087	30

**SECTION 2. VOR AND DME/TACAN FREQUENCY ENGINEERING**

**1. FREQUENCY ENGINEERING.**

**a. Frequency channelization.** VOR, Distance Measuring Equipment (DME) and Tactical Air Navigation equipment (TACAN) frequencies are listed in figure 1. The frequencies 108.00/978 MHz and 108.05/1104 MHz are specifically designated for radio navigation test generators (ramp testers) and shall not be used for operational VOR and DME/TACAN facilities.

**b. Use of paired channels.** The use of paired frequencies as listed in figure 1 requires that stations be collocated in accordance with one of the following:

(1) **Coaxial collocation.** VOR and TACAN or DME antennas are located on the same vertical axis.

(2) **Offset collocation for:**

(a) **Standard VOR** used in terminal areas for approach procedures, the separation of the VOR antenna and the associated DME or TACAN antenna shall not exceed 100'.

(b) **Doppler VOR** used in terminal areas for approach procedures, the separation of the VOR antenna and the associated DME or TACAN antenna shall not exceed 260'.

(c) **Any non-terminal** procedures, where the highest position-fixing accuracy of the system is required, the antenna separation limits of subparagraphs (a) and (b) apply.

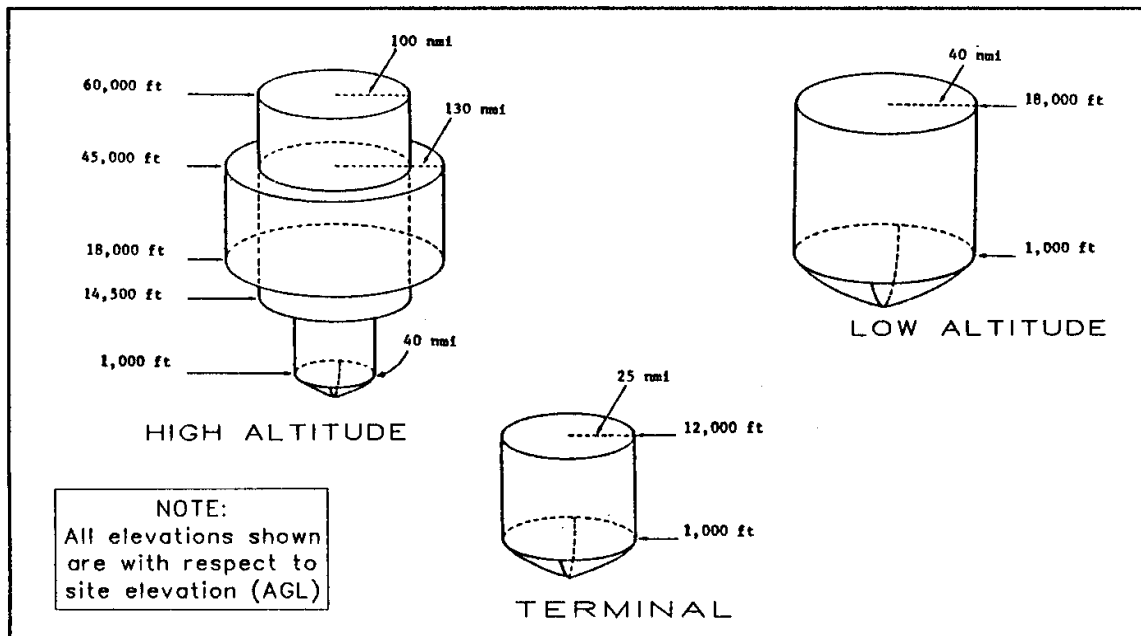
(d) **For all other procedures,** the separation of a VOR antenna and associated DME or TACAN antenna shall not exceed 2,000'.

**c. FPSV's.** The standard circular FPSVs for Terminal (T), Low Altitude (L), and High Altitude (H) VOR-DME/TACAN are shown in figure 2. [Note: These are referenced to site elevation (i.e., FPSV altitudes are in AGL). Adjustments must be made if MSL elevations are needed.]

**d. VOR D/U criteria.** Harmful interference to VOR facilities is avoided by geographically separating cochannel and adjacent-channel assignments. Within each FPSV, the D/U ratio shall be at least the following, on a basis of 95 percent time signal availability.

Cochannel Channel	1st Adjacent Channel (±50 kHz)	2nd Adjacent (±100 kHz)
+23 dB	-4 dB Interim -31 dB Final	-43 dB

**FIGURE 2. FPSVS FOR VOR, DME/TACAN**



(1) A D/U ratio of -4 dB is necessary to assure protection of 100 kHz (100 channel) navigation receivers. This -4 dB D/U ratio is referred to as the interim criterion and shall be used to protect 100 kHz assignments.

(2) A D/U ratio of -31 dB is for 50 kHz (200 channel) navigation receivers. This is referred to as the final criterion and shall be used for 50 kHz assignments.

(3) All the D/U ratio values include a value of +3 dB to take into account transmitter power degradation before system shutdown.

e. **DME/TACAN D/U criteria.** Harmful interference to DME/TACAN facilities is prevented in the same manner as for VOR's in subparagraph d. The +3 dB factor is included and the values are:

Cochannel	1st Adjacent Channel (±1 MHz)	2nd Adjacent Channel (±2 MHz)
+11 dB	-39 dB	-47 dB

**2. FREQUENCY ENGINEERING PROCEDURES.** To ensure that the proposed VOR-DME/TACAN frequencies would provide interference-free operations within their FPSV's, the following analyses must be performed on the proposed frequencies:

**a. Intersite analysis** is used to determine whether the proposed frequencies meet the assignment criteria as specified in subparagraphs 1d and 1e. There are two analysis methods, table and calculation.

**b. In addition, differences in** site elevation calculations are necessary.

**3. INTERSITE ANALYSIS BY THE TABLE METHOD FOR VOR.** Analysis for VOR facilities may be performed on a proposed VOR frequency through the use of the following tables which show conservative/worst-case separation distances required, with respect to VOR/VOR and VOR/adjacent channel LOC:

- a. Figure 3** for VOR/VOR cochannel.
- b. Figure 4** for VOR/VOR 1st adjacent channel (interim).
- c. Figure 5** for VOR/VOR 1st adjacent channel (final).
- d. Figure 6** for VOR/VOR 2nd adjacent channel.
- e. Figure 7** for VOR/LOC Undesired 1st adjacent (interim).
- f. Figure 8** for VOR/LOC Undesired 1st adjacent (final).

**g. Geographical separations** are not required between VOR stations and between VOR and LOC stations which differ in frequency by more than 100 kHz. Therefore, there are no tables for 3rd adjacent channel VOR separations. However, facilities that differ in frequency by 150 kHz or less should not have overlapping FPSVs.

**4. INTERSITE ANALYSIS BY THE TABLE METHOD FOR DME/TACAN.** DME/TACAN facility analysis may be performed on a proposed DME/TACAN frequency through the use of the following tables which show conservative/worst-case separation distances:

- a. Figure 9** for DME/TACAN cochannel, TACAN undesired.
- b. Figure 10** for DME/TACAN 1st adjacent channel, TACAN undesired.

**c. Geographical separations** are not required between DME/TACAN facilities separated more than 1 channel (1 MHz). There are no tables for 2nd adjacent DME/TACAN channels.

**5. DME/TACAN REQUIRED SEPARATION.** In most cases, DME/TACAN facilities, separation is greater than for the frequency-paired VOR facility, even though the FPSVs for like categories (H, L and T) are equal.

**a. For example,** look at the VOR and DME/TACAN tables of mileage separations in figures 3 and 9. From figure 3, it can be seen that two cochannel L-VORs of equal power require 180 nmi separation. From figure 9, two L-DMEs or L-TACANs of equal power require 204 nmi separation. The same holds true for T-VOR and T-DME/TACAN.

**b. For most power difference levels,** the same is true for H-DME/TACAN, but not all.

**c. DME/TACAN spaced 63 MHz.** Interference may occur between DME/TACAN spaced 63 MHz apart. Reply transmissions from Channel 17Y, for instance, could interfere with interrogation signals on Channels 80X and 80Y. This can result in receiver desensitization. To preclude this problem, DME/TACAN ground stations shall not be assigned on frequencies which differ by 63 MHz unless they are separated by at least 15 nmi (28 km).

<u>Channel</u>	<u>Interr. Frequency</u>	<u>Reply Frequency</u>
17Y	1041 MHz	1104 MHz
80X	1104 MHz	1167 MHz
80Y	1104 MHz	1041 MHz

**6. USE OF THE LARGER SEPARATION REQUIREMENT.** In all cases, the larger requirement shall be used, whether it be cochannel or adjacent channel. This requires that in each VOR or DME/TACAN frequency engineering project, a determination must be made as to which has the larger mileage separation requirement, and that value used for the assignment search. This procedure is mandatory whether both of the facilities or only one of them is actually installed.

**7. PERMISSIBLE USE OF TABLES.** If a proposed facility meets all the requirements of all appropriate tables, the frequency request may be submitted. VOR and DME/TACAN separation are shown in figures 3 through 10.

**FIGURE 3. VOR/VOR COCHANNEL SEPARATIONS**

FACIL CLASS  (dB)	VOR DESIRED, VOR UNDESIRED +23 dB PROTECTION						
	-----EIRP RATIO-----						
	+9	+6	+3	±0	-3	-6	-9
	(nmi)						
H-VOR	370	383	390	395	398	402	406
L-VOR	138	152	167	180	195	206	212
T-VOR	090	100	110	122	134	146	161

**FIGURE 4. VOR/VOR INTERIM 1ST ADJACENT CHANNEL -50 kHz- SEPARATIONS**

FACIL CLASS  (dB)	VOR DESIRED, VOR UNDESIRED -4 dB PROTECTION						
	-----EIRP RATIO-----						
	+9	+6	+3	±0	-3	-6	-9
	(nmi)						
H-VOR	233	248	259	270	284	298	305
L-VOR	70	73	76	80	85	89	93
T-VOR	40	42	44	48	51	55	57

**FIGURE 5. VOR/VOR FINAL 1ST ADJACENT CHANNEL -50 kHz- SEPARATIONS**

FACIL CLASS  (dB)	VOR DESIRED, VOR UNDESIRED -31 dB PROTECTION						
	-----EIRP RATIO-----						
	+9	+6	+3	±0	-3	-6	-9
	(nmi)						
H-VOR	143	147	152	158	175	184	195
L-VOR	44	47	50	52	54	57	61
T-VOR	32	33	34	35	36	38	39

**FIGURE 6. VOR/VOR 2ND ADJACENT CHANNEL -100 KHZ- SEPARATIONS**

FACIL CLASS	VOR DESIRED, LOC UNDESIRED -31 dB PROTECTION						
	-----EIRP RATIO-----						
	+9	+6	+3	±0	-3	-6	-9
	(nmi)						
H-VOR	132	135	138	140	143	146	149
L-VOR	43	44	45	46	47	48	50
T-VOR	25	25	26	26	27	28	29

**FIGURE 7. VOR/LOC INTERIM 1ST ADJACENT CHANNEL -50 kHz- SEPARATIONS**

FACIL CLASS	VOR DESIRED, LOC UNDESIRED -4 dB PROTECTION						
	-----EIRP RATIO-----						
	(dB)	+9	+6	+3	±0	-3	-6
	(nmi)						
H-VOR	210	225	238	250	263	275	285
L-VOR	64	67	71	73	77	80	86
T-VOR	37	40	42	44	46	50	51

**FIGURE 8. VOR/LOC FINAL 1ST ADJACENT CHANNEL -50 kHz - SEPARATIONS**

FACIL CLASS	VOR DESIRED, LOC UNDESIRED -31 dB PROTECTION						
	-----EIRP RATIO-----						
	+9	+6	+3	±0	-3	-6	-9
	(nmi)						
H-VOR	145	148	154	161	168	173	181
L-VOR	46	47	49	50	52	54	57
T-VOR	28	28	29	29	31	31	32

**FIGURE 9. DME/TACAN COCHANNEL SEPARATIONS**

DME/TACAN DESIRED, DME/TACAN UNDESIRED +11 dB PROTECTION			
EIRP RATIO D/U DME/TACAN dB	DISTANCE IN NM CLASS OF DESIRED FACILITY		
	H	L	T
+21	220	60	40
+18	260	66	45
+15	310	82	55
+12	339	102	65
+9	379	139	85
+6	385	163	98
+3	388	192	120
±0	390	204	140
-3	392	207	161
-6	394	210	164
-9	396	212	166
-12	398	214	168
-15	401	216	172
-18	406	218	172
-21	411	220	175



**FIGURE 10. DME/TACAN 1ST ADJACENT CHANNEL SEPARATIONS**

DME/TACAN DESIRED, TACAN UNDESIRED -39 dB PROTECTION			
EIRP RATIO D/U DME/TACAN dB	DISTANCE IN NMI CLASS OF DESIRED FACILITY		
	H	L	T
+21 to ±0	145	45	30
-3	145	46	30
-6	148	48	30
-9	159	48	30
-12	163	50	30
-15	175	57	31
-18	194	63	31
-21	208	67	32

**8. INTERSITE ANALYSIS BY THE CALCULATION METHOD.** Intersite analysis may also be performed by calculating ESR and determining the required geographical separation for that ESR through the use of appropriate facility separation curves in figures 14-47.

**a. ESR** is an adjusted D/U ratio due to the differences in carrier power and antenna gain between two stations. It is defined as follows:

$$ESR = D/U - P_D + P_U - A_D + A_U$$

Where:  $D/U$  = required D/U ratio - e.g., +23 dB for cochannel VOR;  
-4 dB for 1st adjacent channel VOR; +11 dB for  
cochannel DME/TACAN, etc.

$P_D$  = carrier power of the desired facility in dBW.

$P_U$  = carrier power of the undesired facility in dBW.

$A_D$  = antenna gain of the desired facility in dB.

$A_U$  = antenna gain of the undesired facility in dB.

**b. If both the desired and undesired facilities have the same carrier power and antenna gain, the ESR value would be +23 dB for cochannel VOR, +11 dB for cochannel DME/TACAN.**

**c. VOR and DME/TACAN antennas**, in most cases, are nondirectional, so the gain is the same in all horizontal directions. However, different models of antennas have somewhat different gains which have to be taken into account as shown in subparagraph a. They are:

**FIGURE 11. VOR, DME, AND TACAN ANTENNA GAIN FIGURES**

	Type	Gain dBd
<b>VOR</b>	FA-none (Four loop)	2
	FA-none (Doppler)	2
	FA-none (Slot)	2
	FA-none (Dipole Array)	4
<b>DME</b>	FA 10153	8
	CA3167	11
	FA8974	11
	FA9639	11
	FA9783	11
	FA-none (MK3)	9
	FA-none (1020 Butler)	9
	FA-none (5351A Aerocom)	9
	5960 (Wilcox)	8
	DB-510A (ASII)	8
	DBSystems Inc. (5100A)	8
<b>TACAN</b>	FA6239/1 or /2 (RTA-2)	7
	FA6339/1 or /2 (Mod RTA-2)	9
	FA6339 (GRN-9 dipole)	6
	FA-none (YN103/4)	9

**d. Using the calculated ESR value** and appropriate facility separation curves, the required geographical separation (S) can be determined. Figures 14 through 20 will be used for VOR cochannel geographical separations; figures 21 through 29 for adjacent channel VOR separations; figures 30 through 38 for adjacent channel LOC separations; figures 39 through 45 for DME/TACAN cochannel separations; and figures 46 and 47 for DME/TACAN adjacent channel separations. Figures 48-60 are reserved.

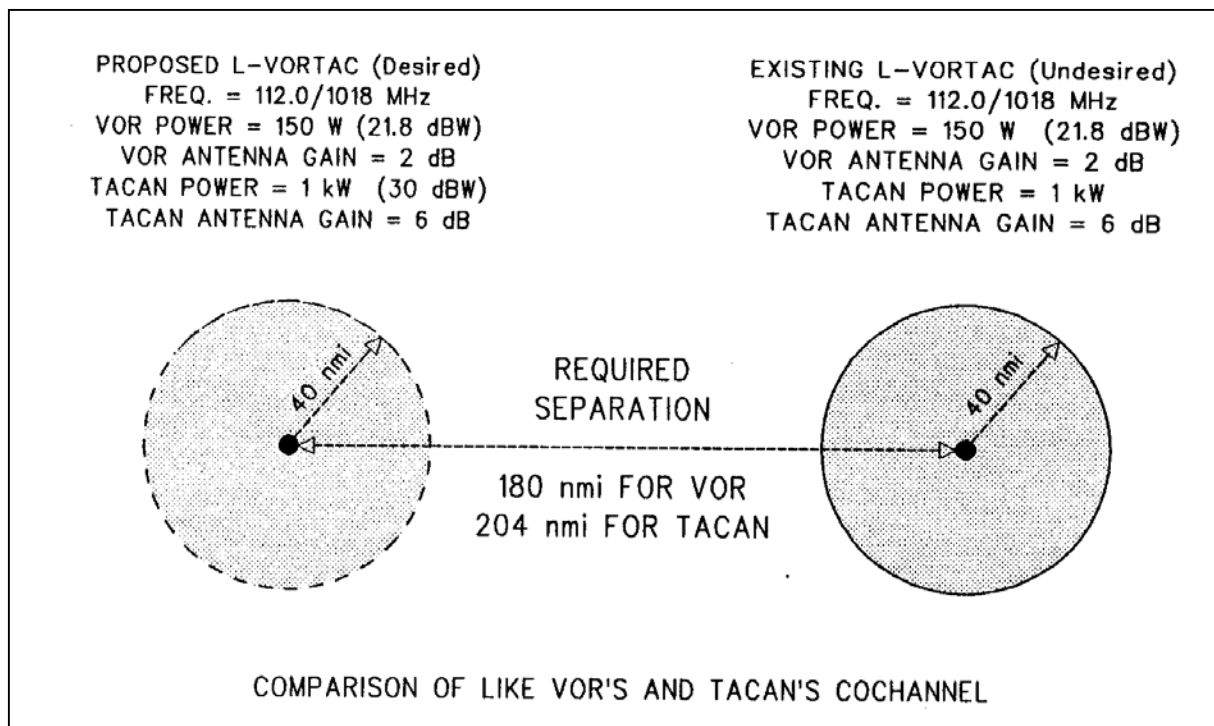
**e. (S) is determined as follows:**

$$(S) = d_D + d_U$$

Where:  $d_D$  = the distance from the desired facility to the critical point where the intersite analysis is being made, i.e., ESV.

$d_U$  = the distance from the critical point to a potential interfering facility.

**9. SAMPLE OF COCHANNEL INTERSITE ANALYSIS BY THE CALCULATION METHOD.**

**FIGURE 12. VORTAC COCHANNEL INTERSITE ANALYSIS PLOT**

- a. Calculate VOR ESR as follows (see Paragraph 8 a):

$$\text{ESR} = +23 \text{ dB} - 21.8 + 21.8 - 2 + 2 = +23 \text{ dB}$$

- b. Use figure 17 (VOR facility separation curves having ESR of +23 dB) to determine (S). The distance  $d_D$  is 40 nmi and the altitude (AGL) is 18,000', since the FPSV of the proposed L-VOR is 40 nmi up to 18,000'. Find the point where the  $d_D$  and the altitude lines intersect. (S) for that point is 180 nmi. The required separation between the proposed VOR and the existing VOR is 180 nmi.

- c. Calculate DME/TACAN ESR as follows:

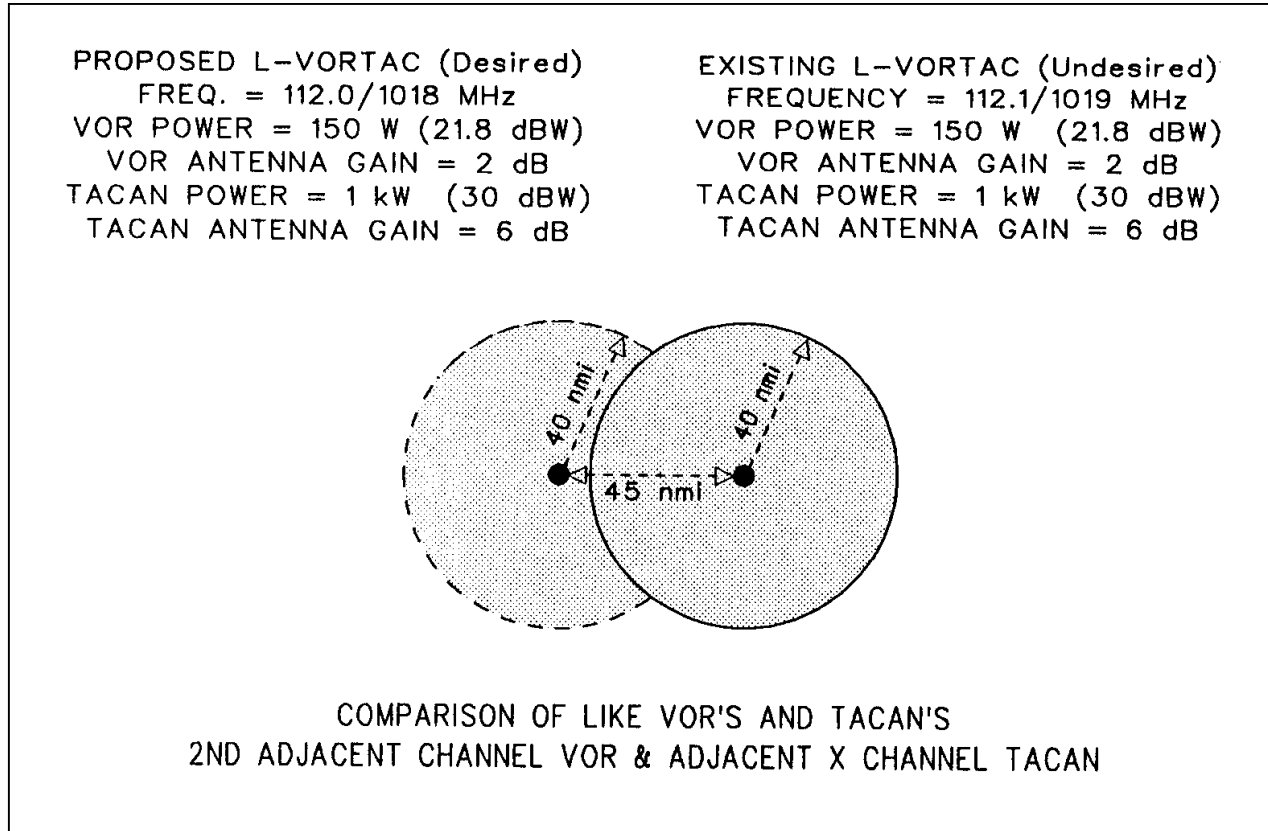
$$\text{ESR} = +11 \text{ dB} - 30 + 30 - 6 + 6 = +11 \text{ dB}$$

- d. Use figure 42 (DME/TACAN facility separation curves having ESR of +11 dB) to determine the required (S).

- e. Determine the same 40 nmi and 18,000' intersect point. The DME/TACAN separation requirement is 204 nmi, which is the greater of the two, so this is the separation requirement.

**10. INTERSITE ANALYSIS OF ADJACENT CHANNELS.** This is done in a similar manner, except a different set of curves is used (see figure 13).

**FIGURE 13. VORTAC 2ND ADJACENT CHANNEL INTERSITE ANALYSIS**



a. Calculate VOR ESR as follows:

$$\text{ESR} = -43 \text{ dB} - 21.8 + 21.8 - 2 + 2 = -43 \text{ dB.}$$

b. Use figure 21 (VOR/VOR facility separation curve at 1,000') to determine the required geographical separation. The distance  $d_D$  is 40 nmi and the ESR is -43 dB. Find the point where the  $d_D$  and the ESR lines intersect. (S) for that point is 45 nmi by interpolation. The required geographical separation between the proposed VOR and the existing VOR on the 2nd adjacent channel is thus 45 nmi. It should be pointed out that the critical point for the 2nd adjacent channel analysis is 40 nmi at 1,000' (the lower edge of the L-VOR FPSV). For cochannel analysis, the higher edge of the FPSV, i. e., 18,000' is the critical point.

c. Use figure 46 (DME/TACAN vs. DME/TACAN facility separation curve at 1,000') to determine required geographical separation. The distance at 40 nmi and 1,000' will be found to be 42 nmi by interpolation. The lower edge of the FPSV is used as in subparagraph b. The VOR separation requirement is the greater, so it will be used.

**11. DIFFERENCES IN SITE ELEVATION.** When VOR facilities differ in site elevations 1000' or more, the station separation required to protect the station with the higher site elevation must be increased as follows:

**H-VOR : 3 nmi for each 1,000' elevation difference**

**L-VOR : 4 nmi " " " " "**

**T-VOR : 7 nmi " " " " "**

**12. thru 13. RESERVED.**

FIGURE 14. VOR FACILITY SEPARATION CURVES FOR ESR = +14 dB

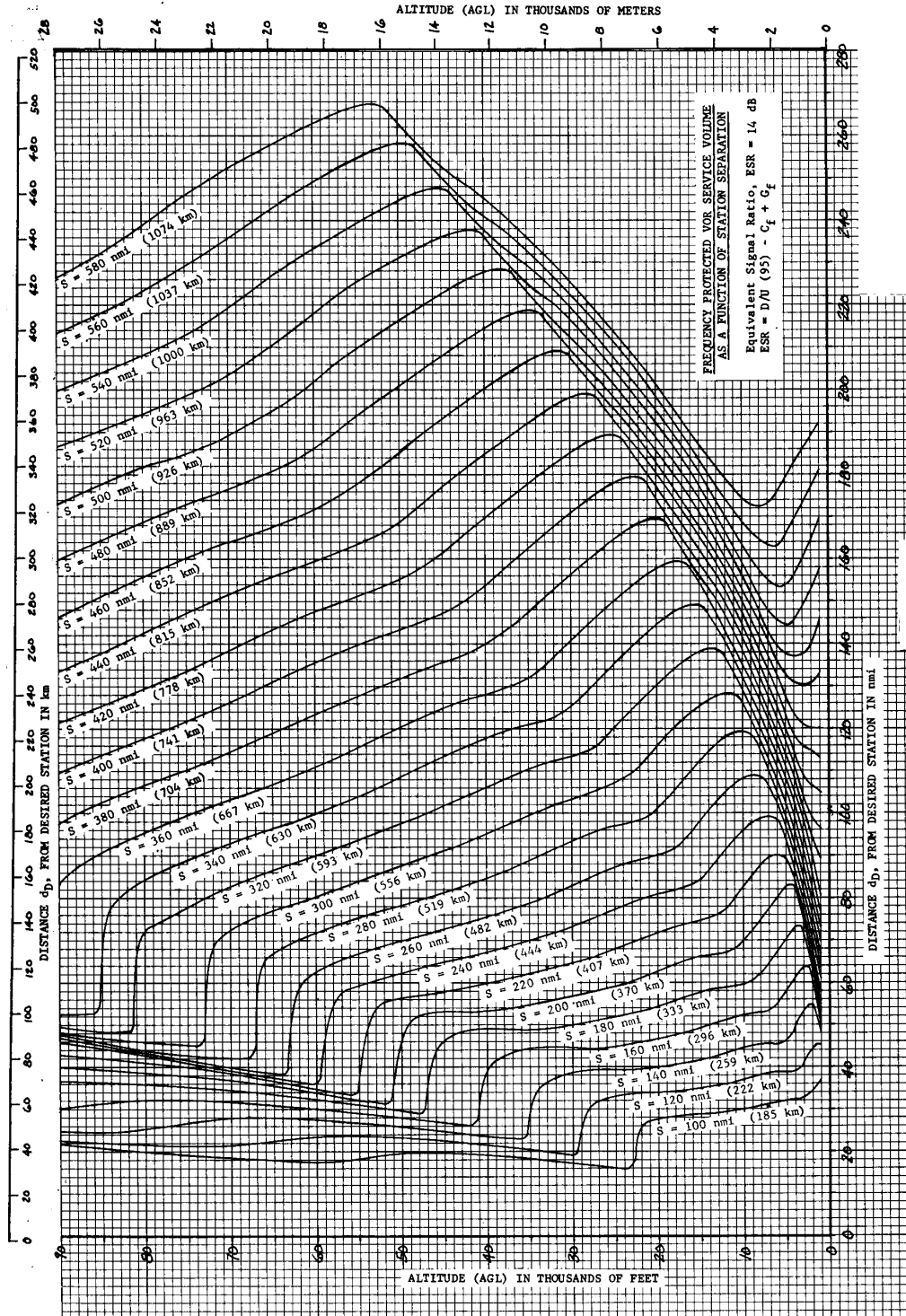


FIGURE 15. VOR FACILITY SEPARATION CURVES FOR ESR = +17 dB

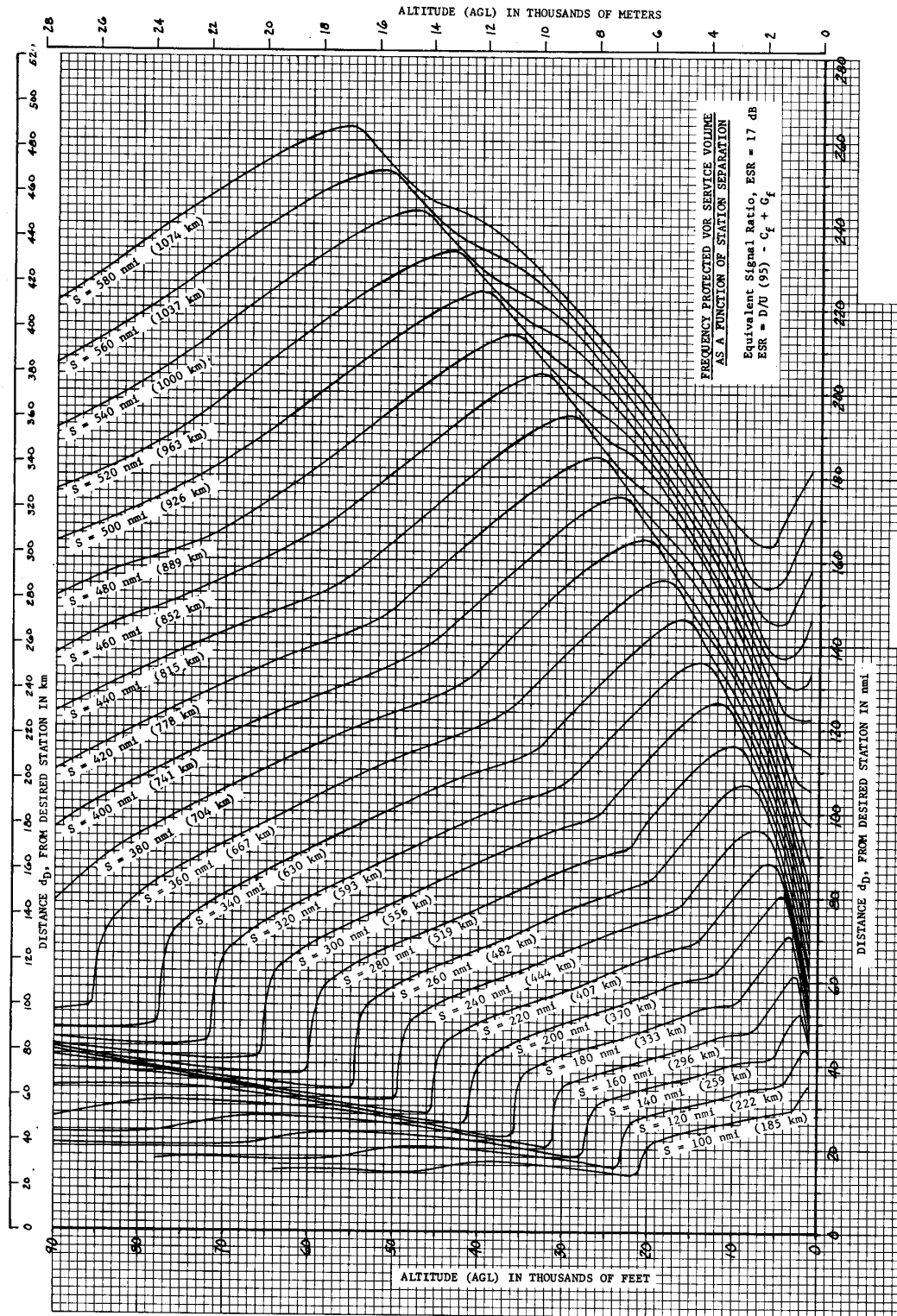


FIGURE 16. VOR FACILITY SEPARATION CURVES FOR ESR = +20 dB

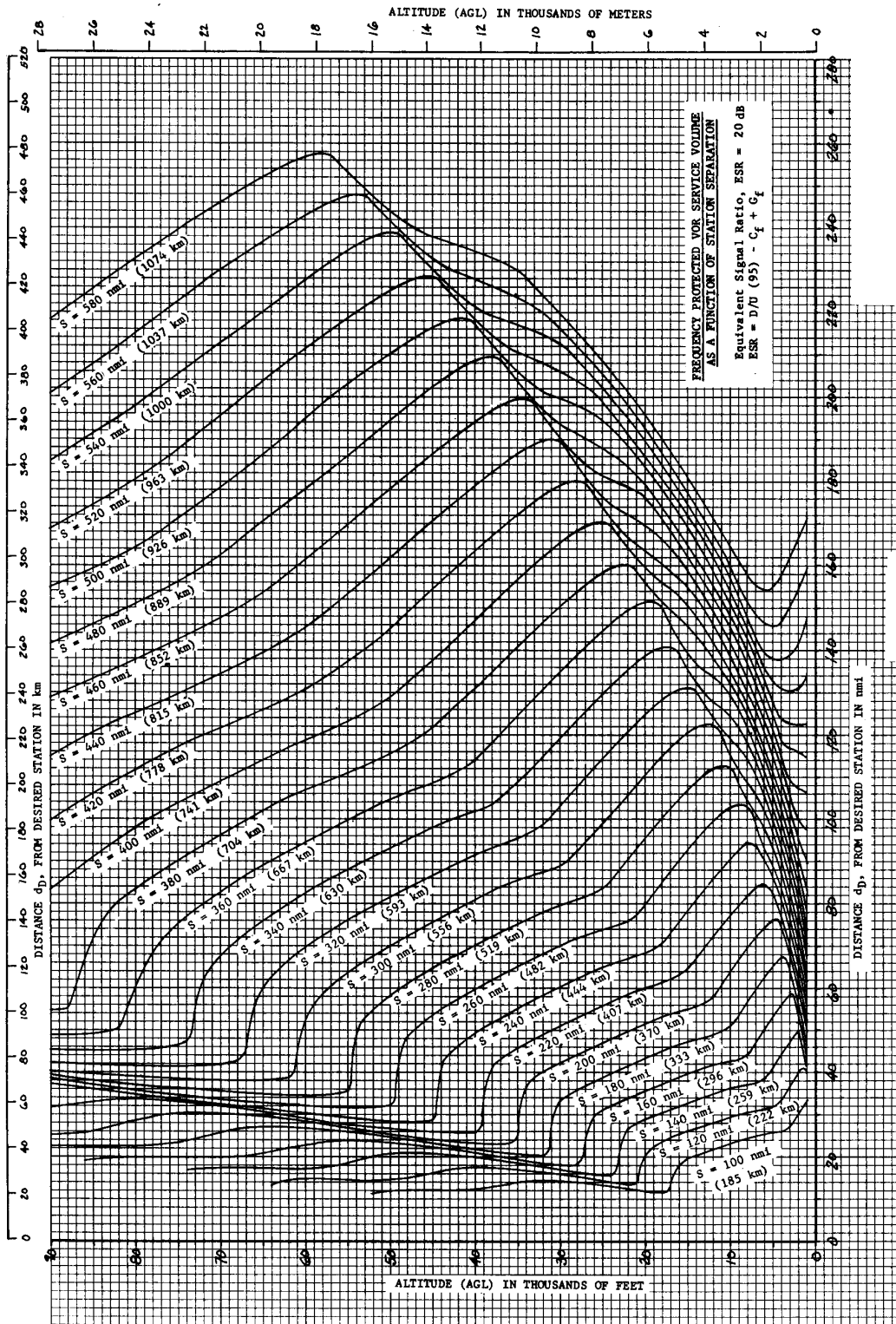
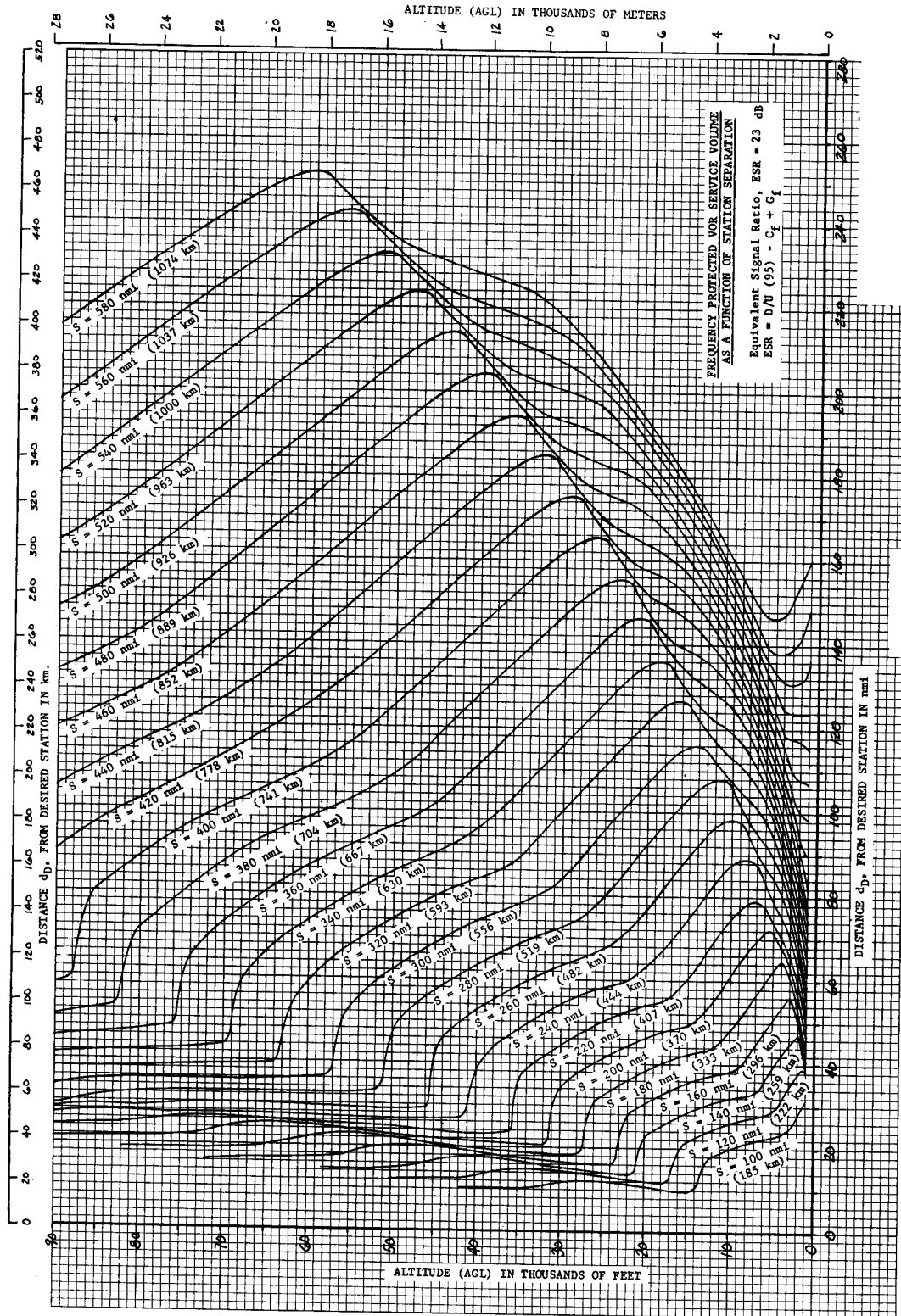




FIGURE 17. VOR FACILITY SEPARATION CURVES FOR ESR = +23 dB



FIGURE

### VOR FACILITY SEPARATION CURVES FOR ESR = +26 dB

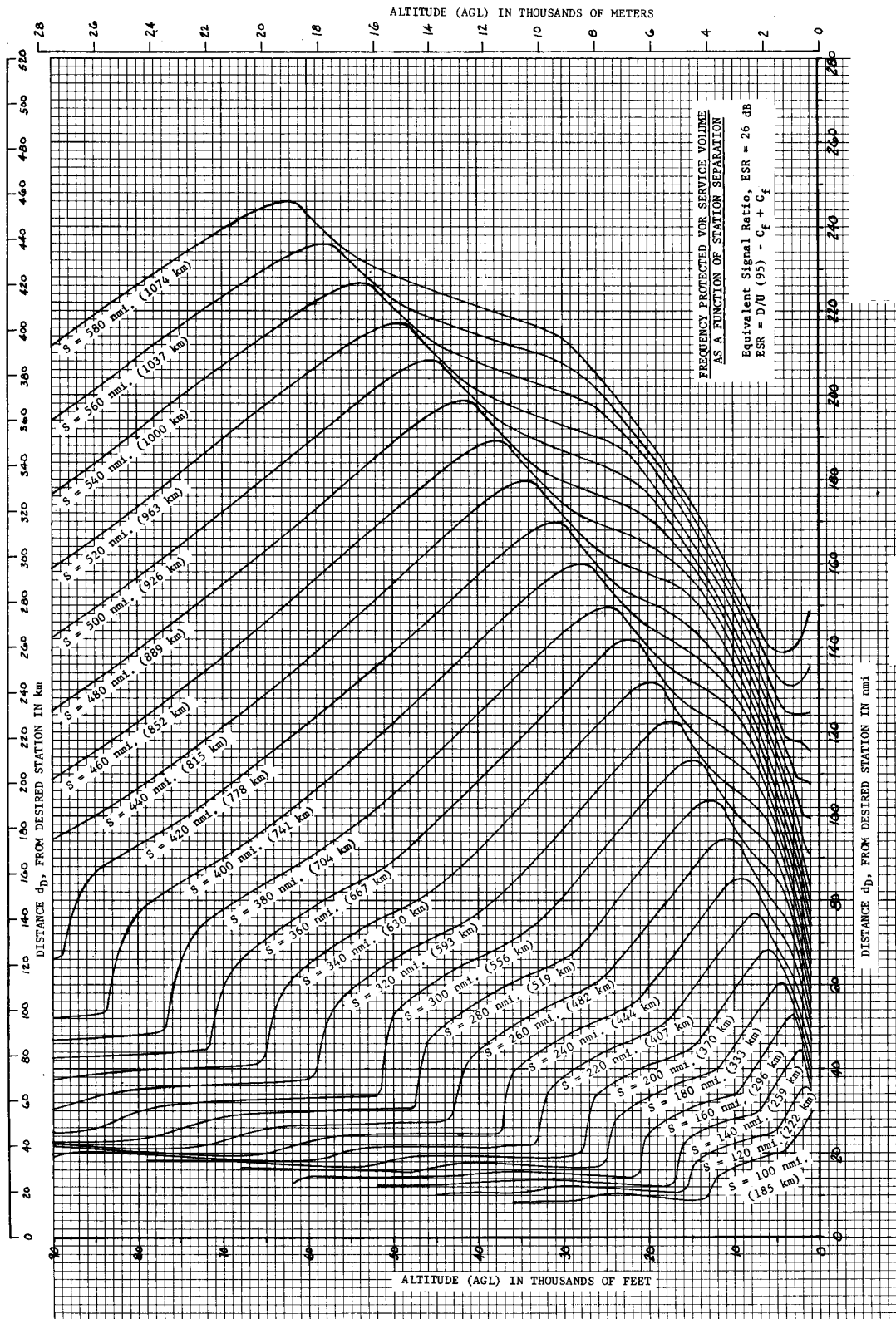


FIGURE VOR

### FACILITY SEPARATION CURVES FOR ESR = +29 dB

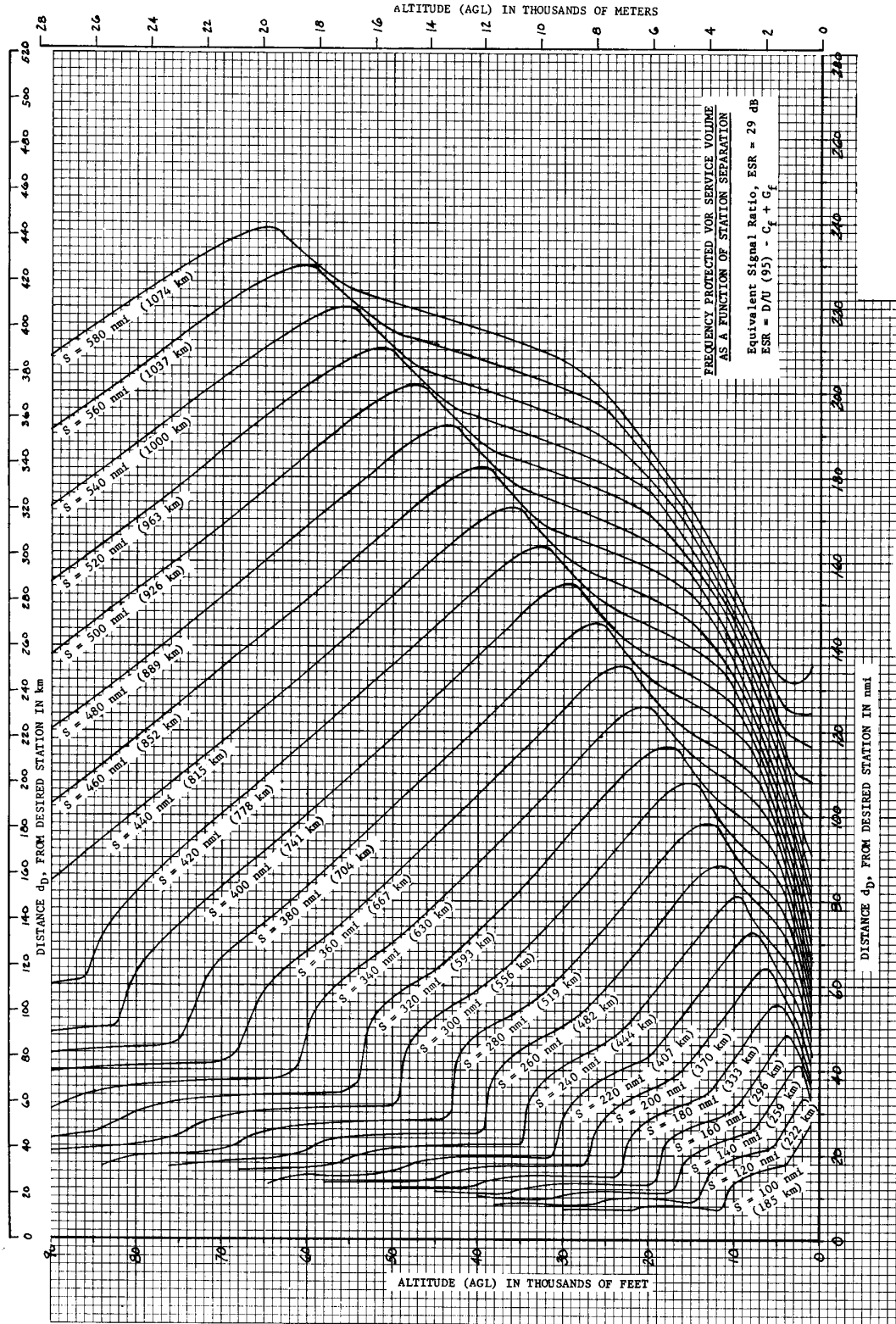


FIGURE 20. VOR FACILITY SEPARATION CURVES FOR ESR = +32 DB

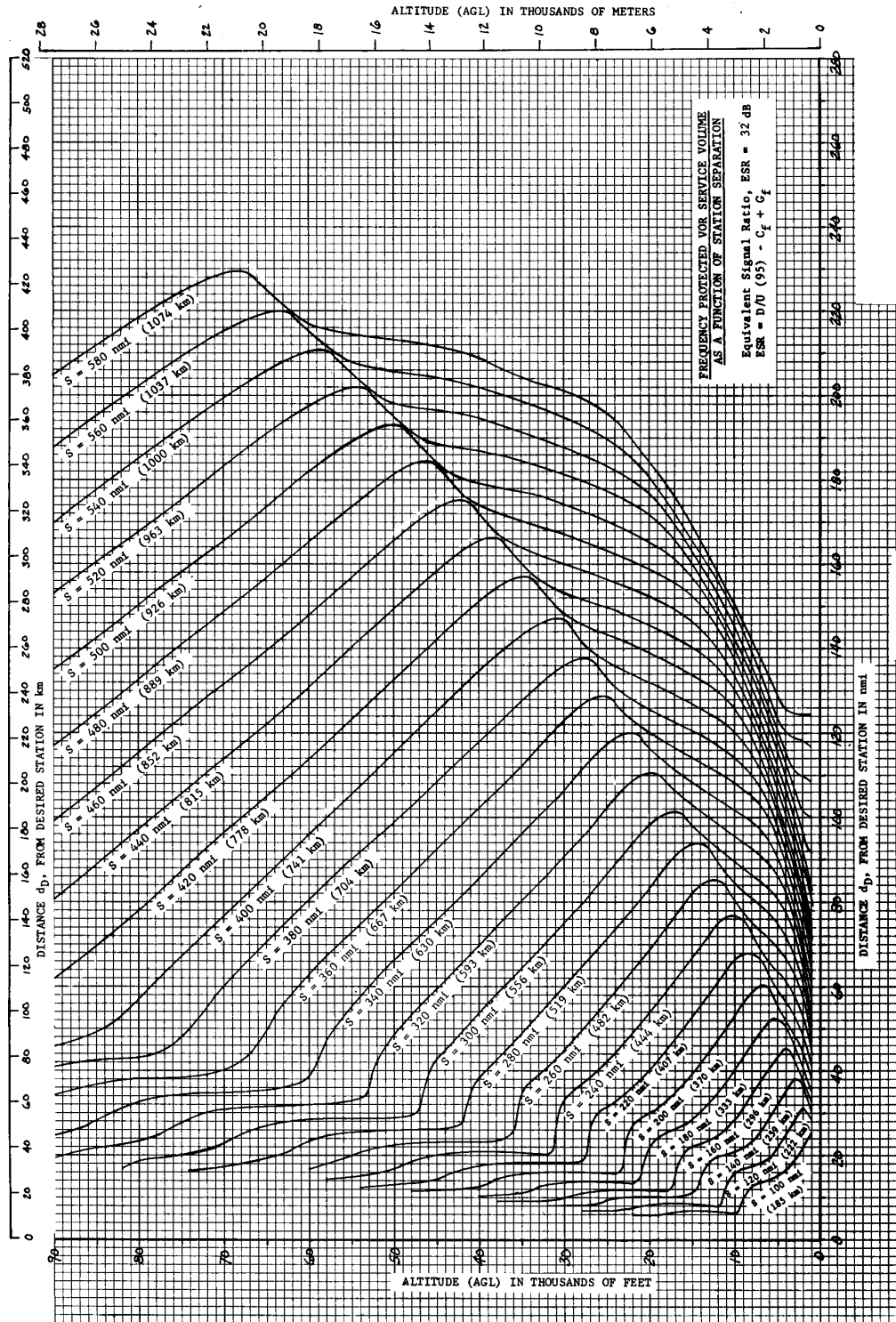
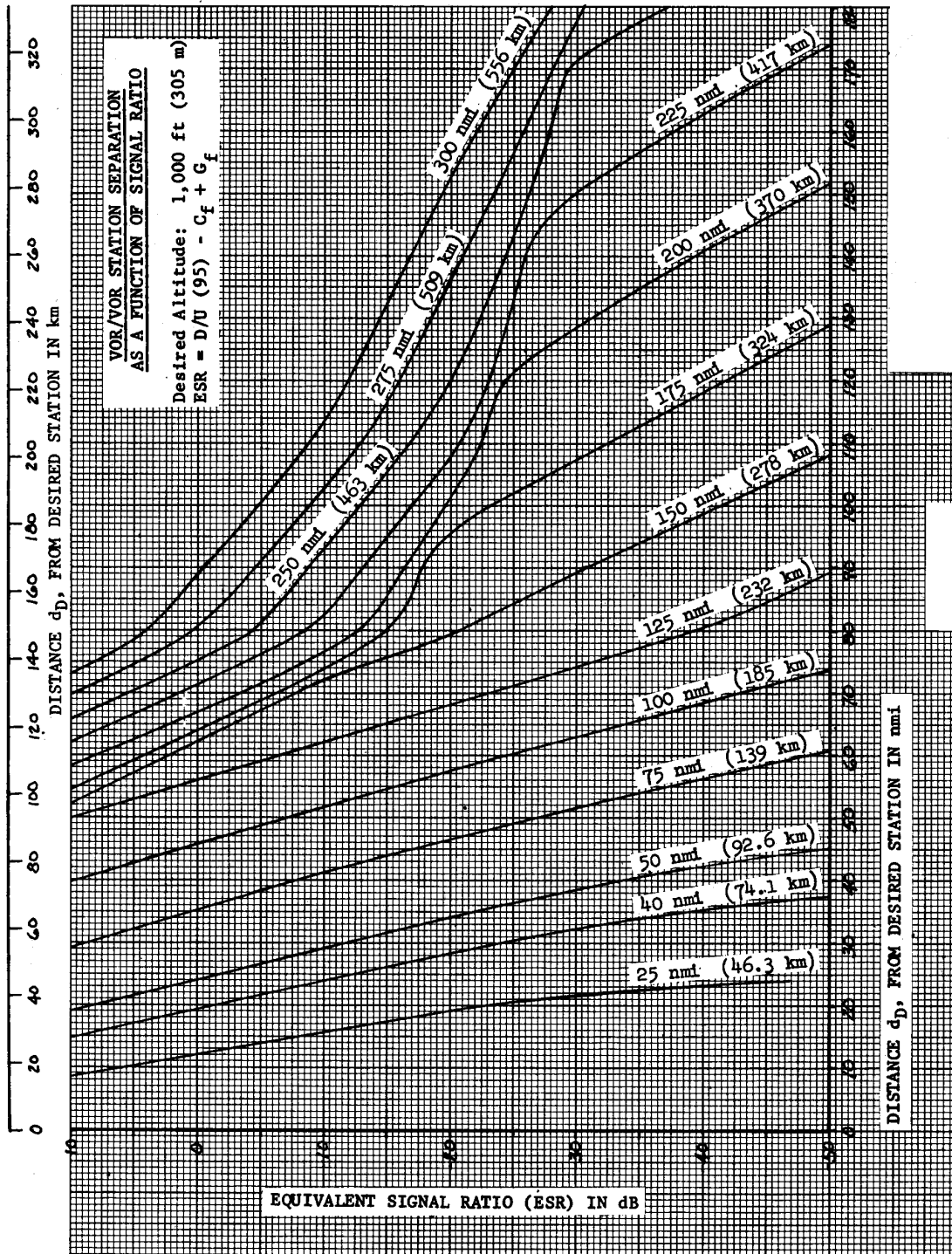


FIGURE 21. ESR RATIO - VOR/VOR @ 1,000'



FIGUR

E 22. ESR RATIO - VOR/VOR @ 5,000'

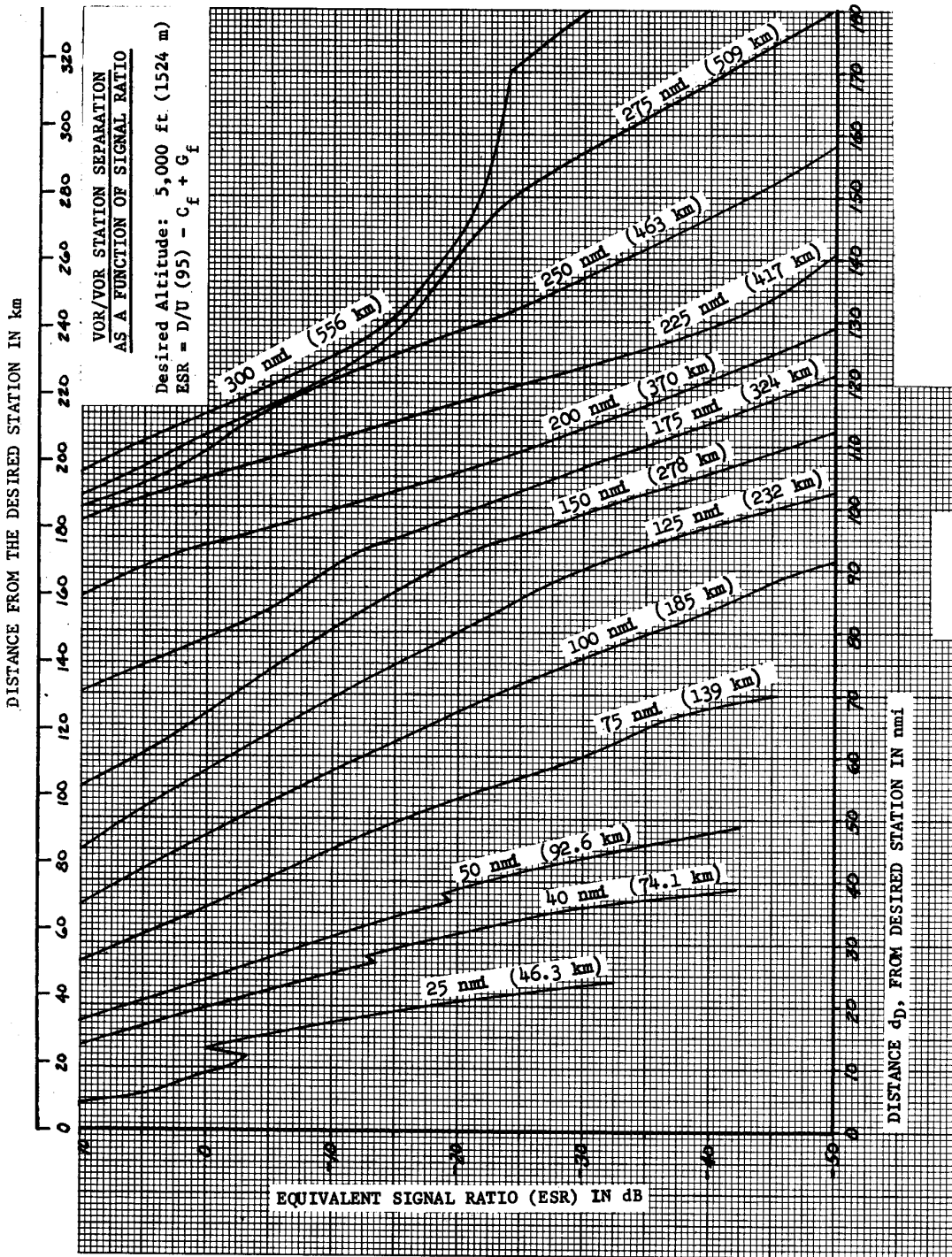


FIGURE 23. ESR RATIO - VOR/VOR @ 10,000'

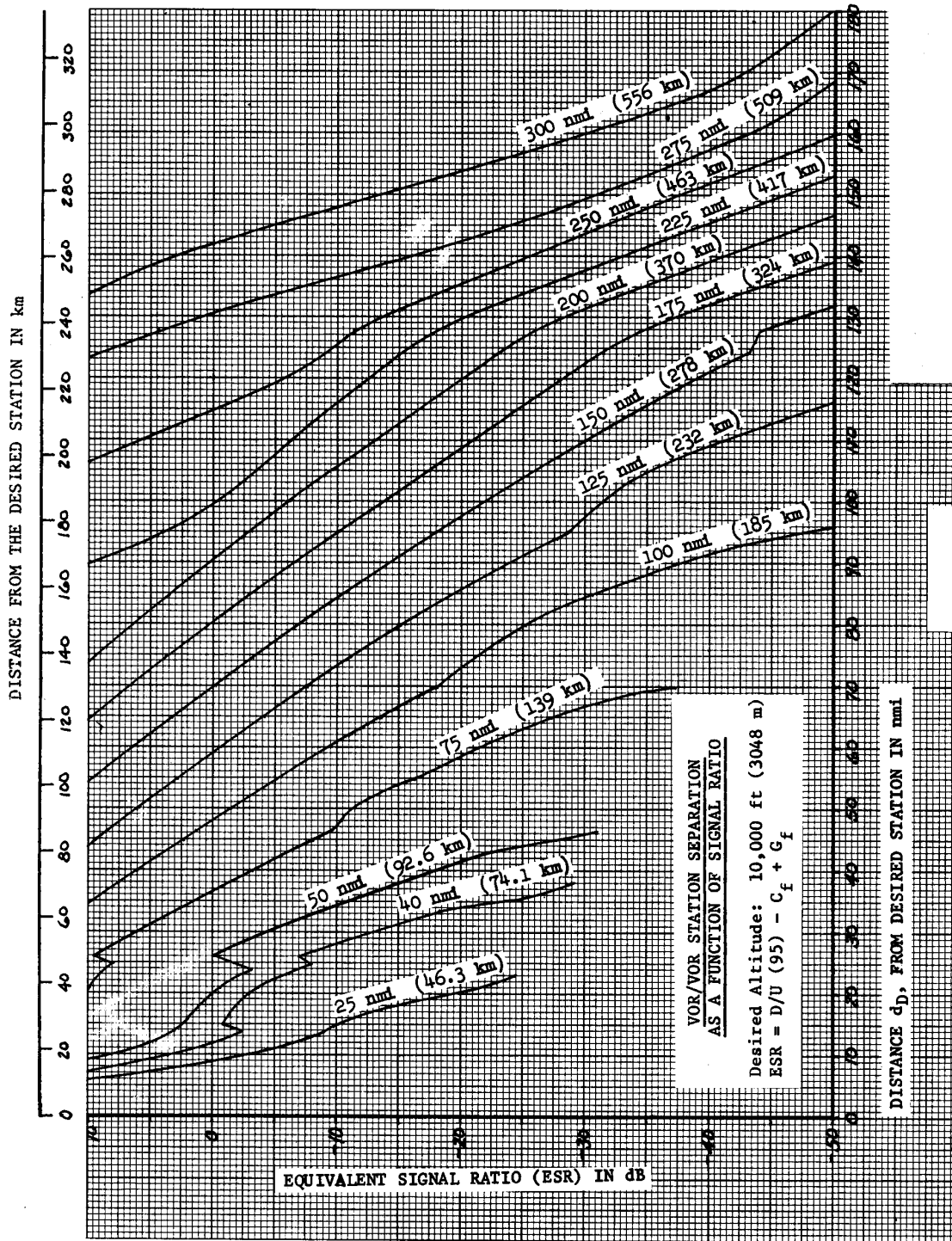


FIGURE 24. ESR RATIO - VOR/VOR @ 15,000'

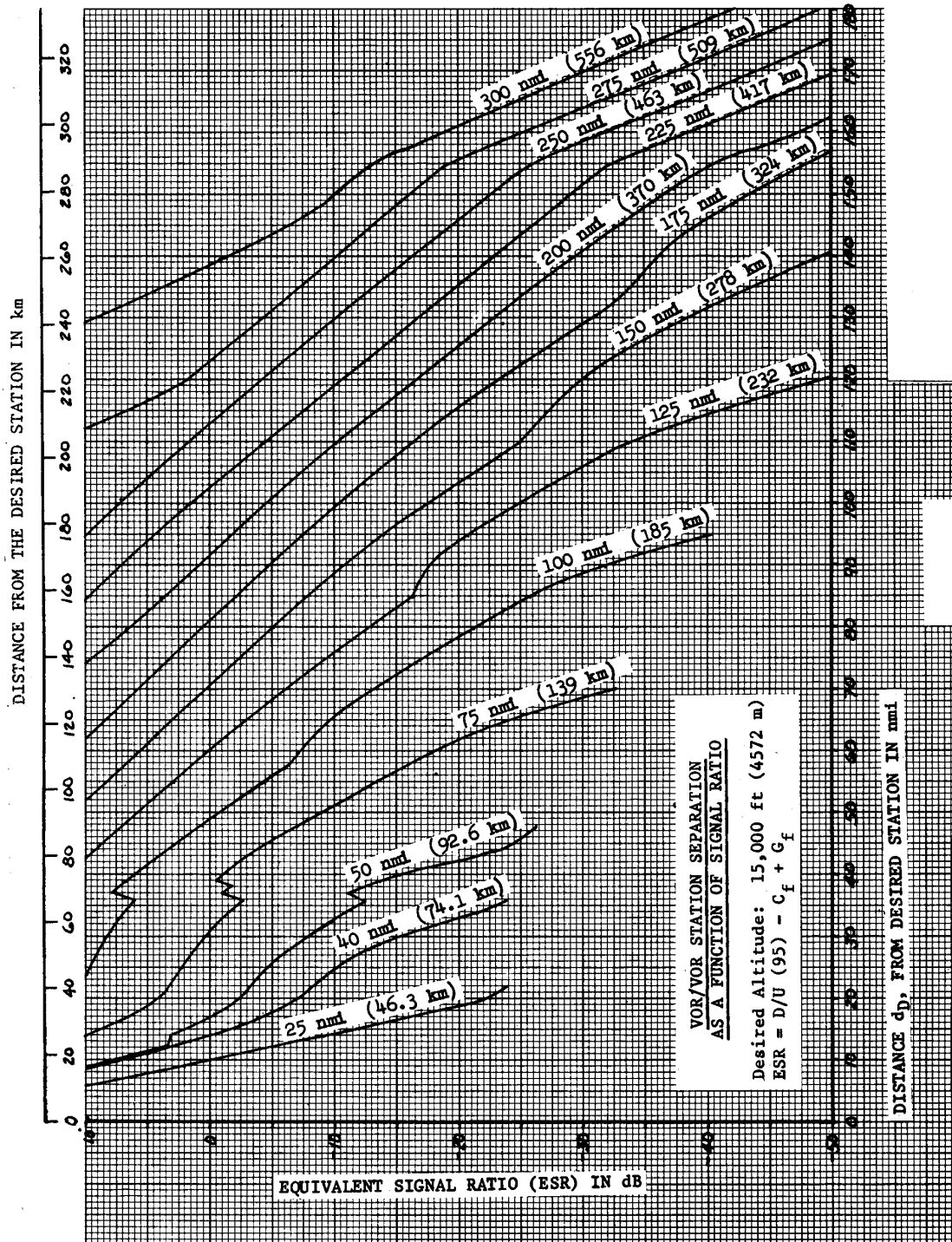




FIGURE 25. ESR RATIO - VOR/VOR @ 18,000'

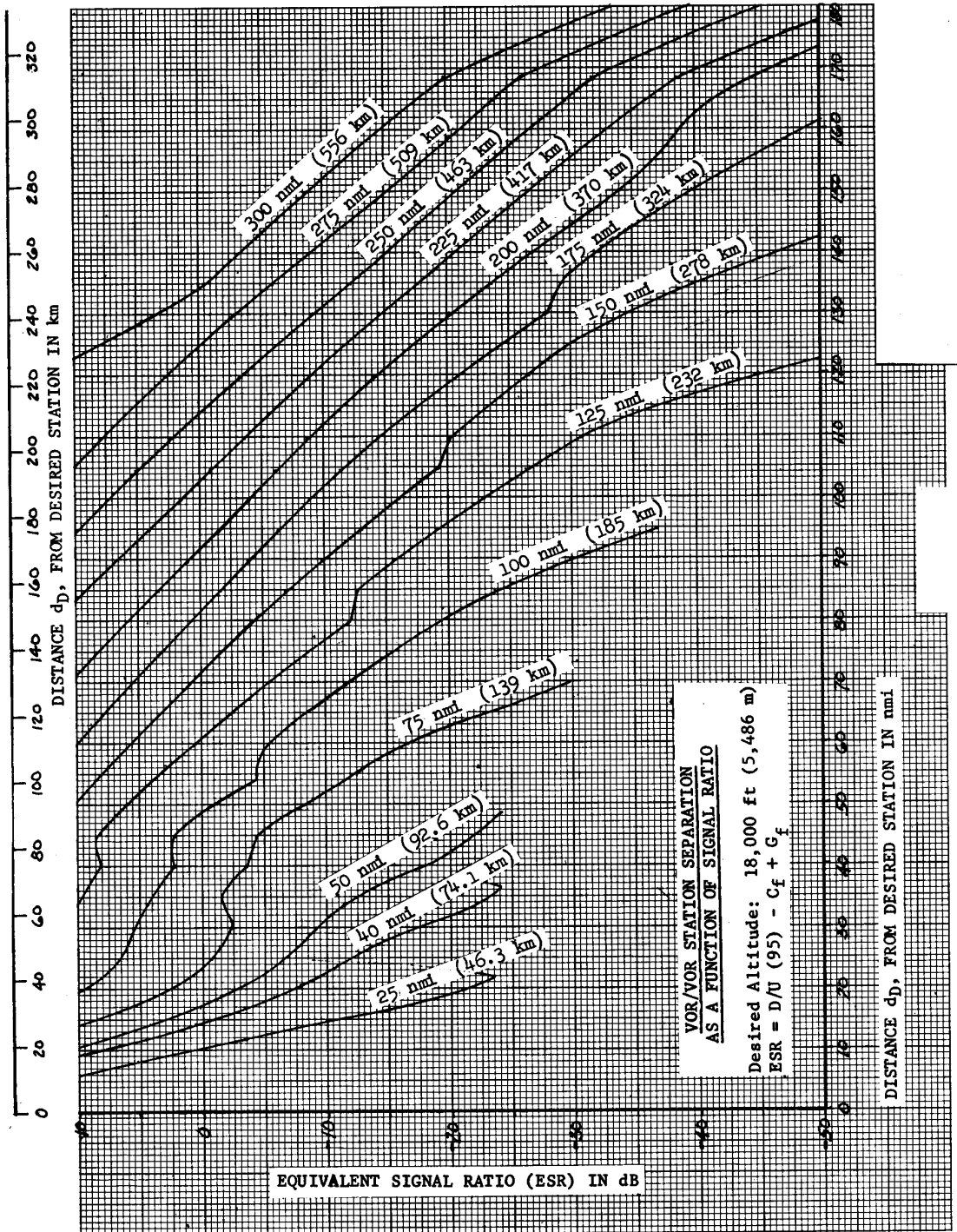
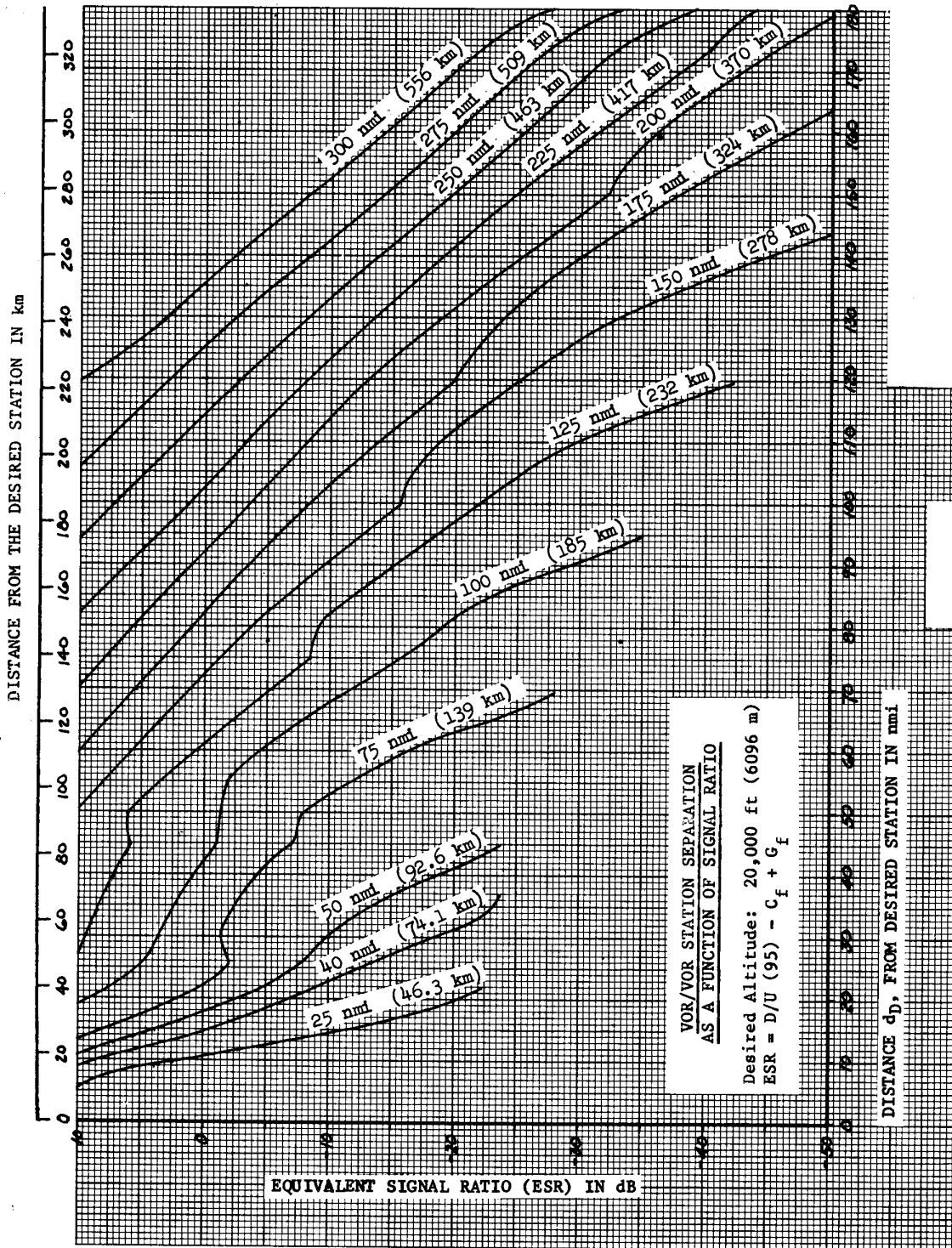


FIGURE 26. ESR RATIO - VOR/VOR @ 20,000'



FIGUR

E 27. ESR RATIO - VOR/VOR @ 30,000'

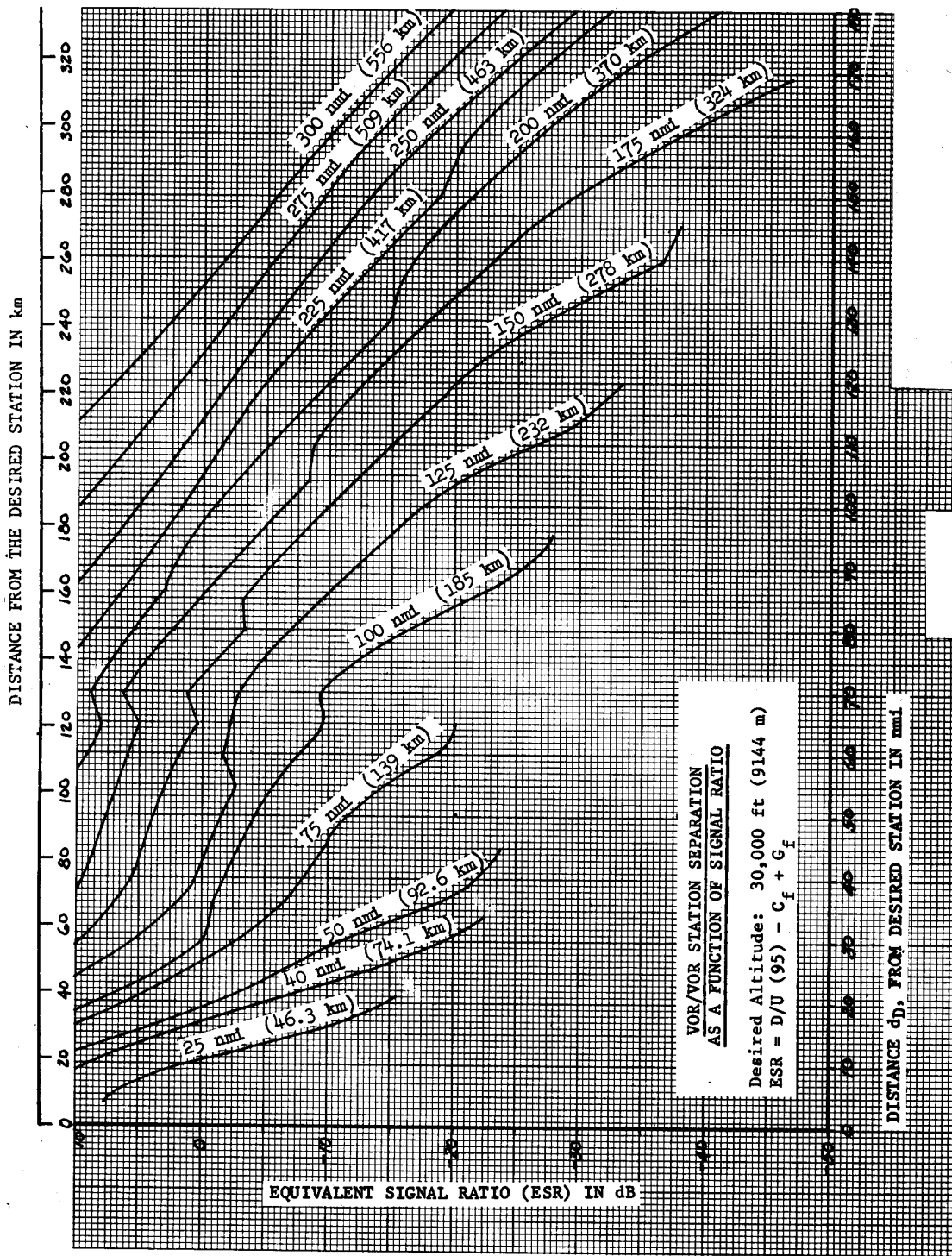
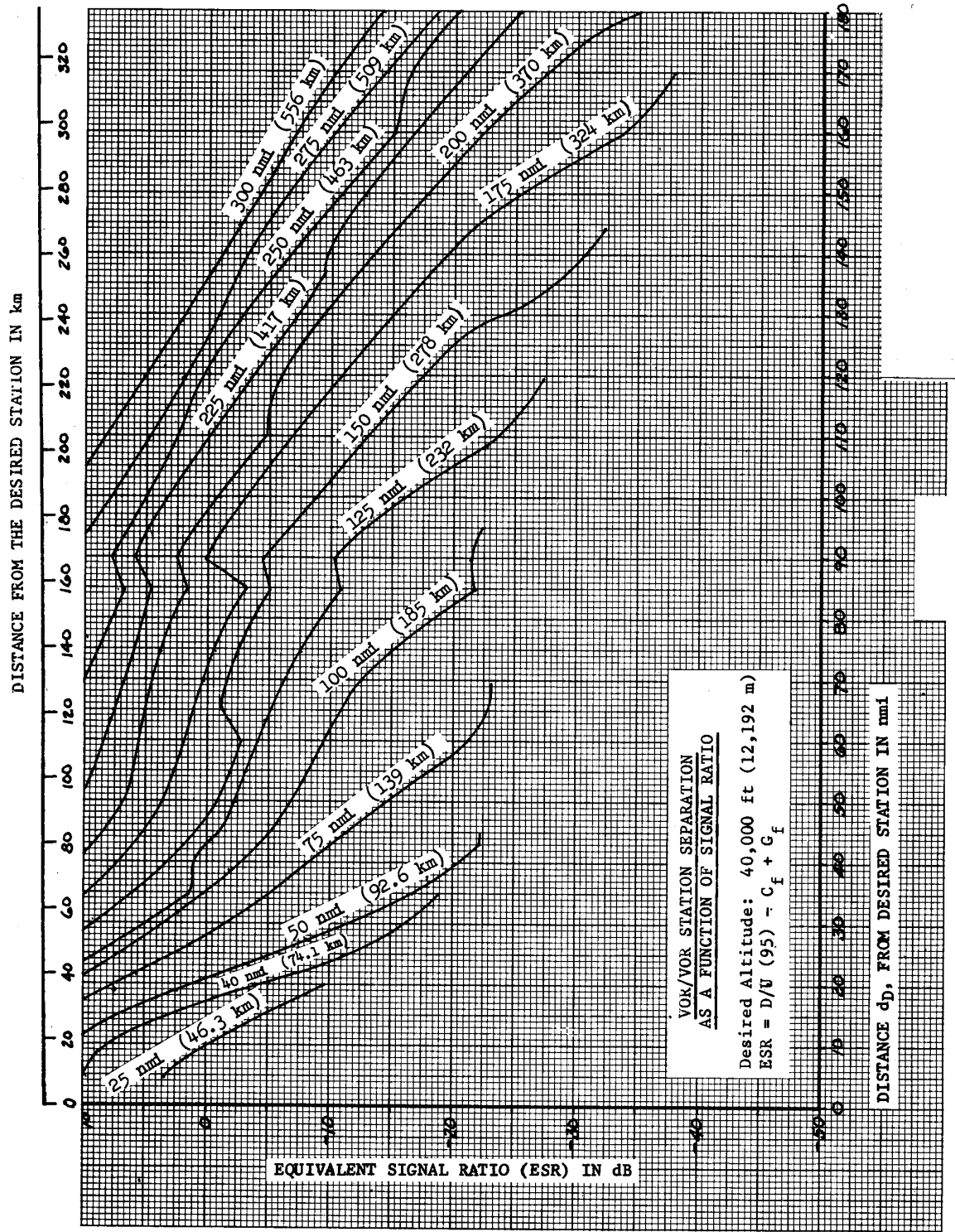
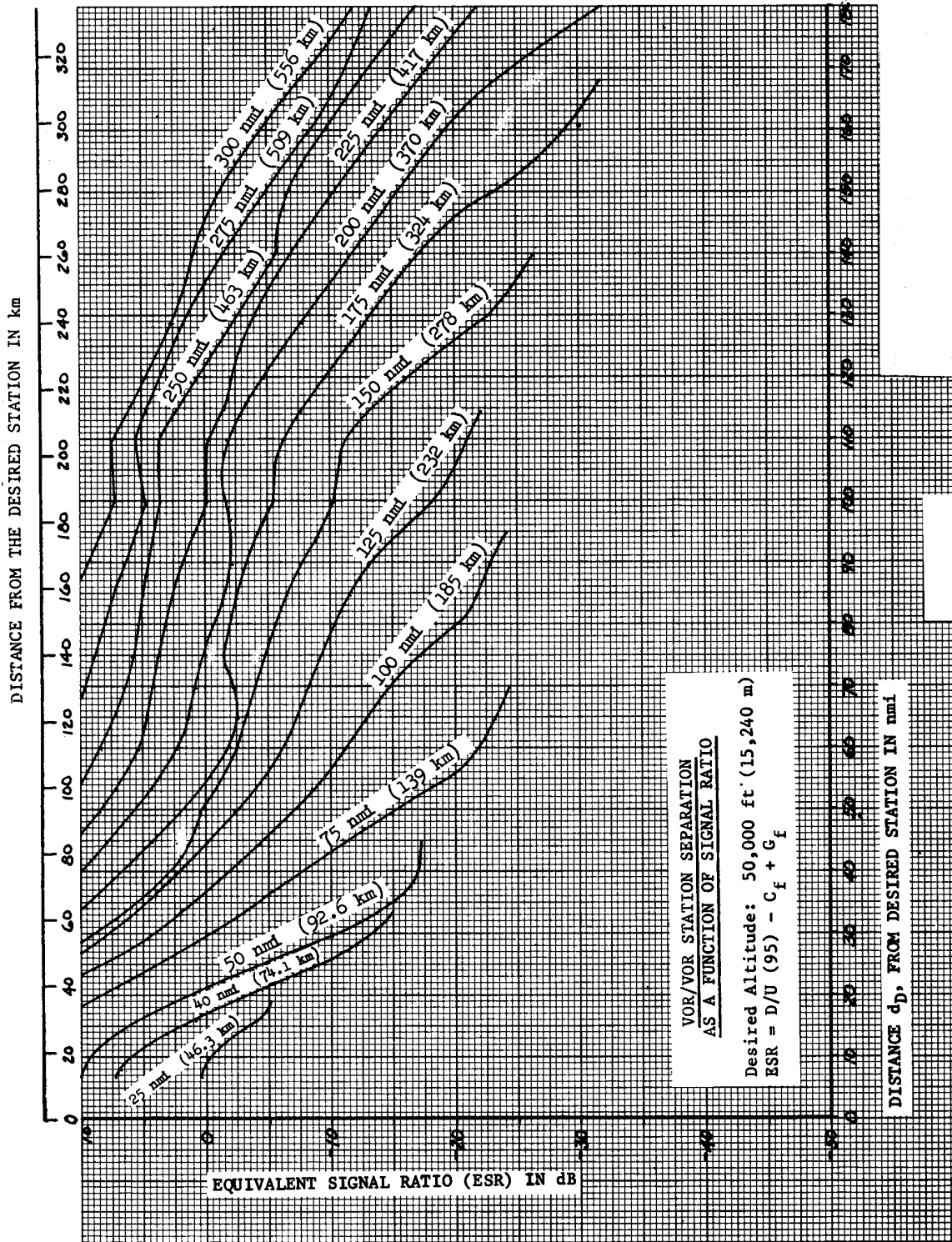


FIGURE 28. ESR RATIO - VOR/VOR @ 40,000'



E 29. ESR RATIO - VOR/VOR @ 50,000'

FIGUR



URE 30. ESR RATIO - VOR/LOC. VOR IS DESIRED @ 1,000'

FIG

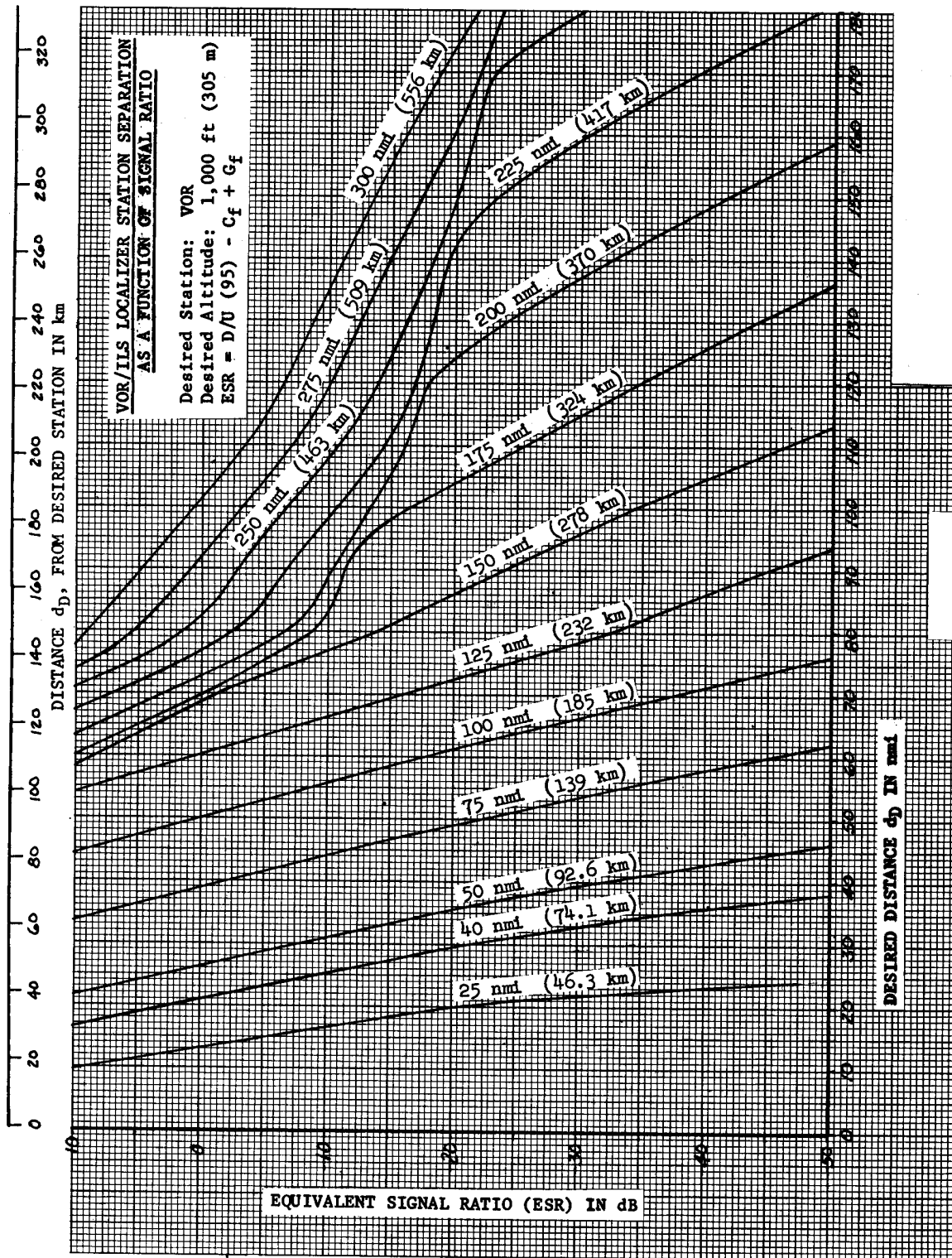


FIGURE 31. ESR RATIO - VOR/LOC. VOR IS DESIRED @ 5,000'

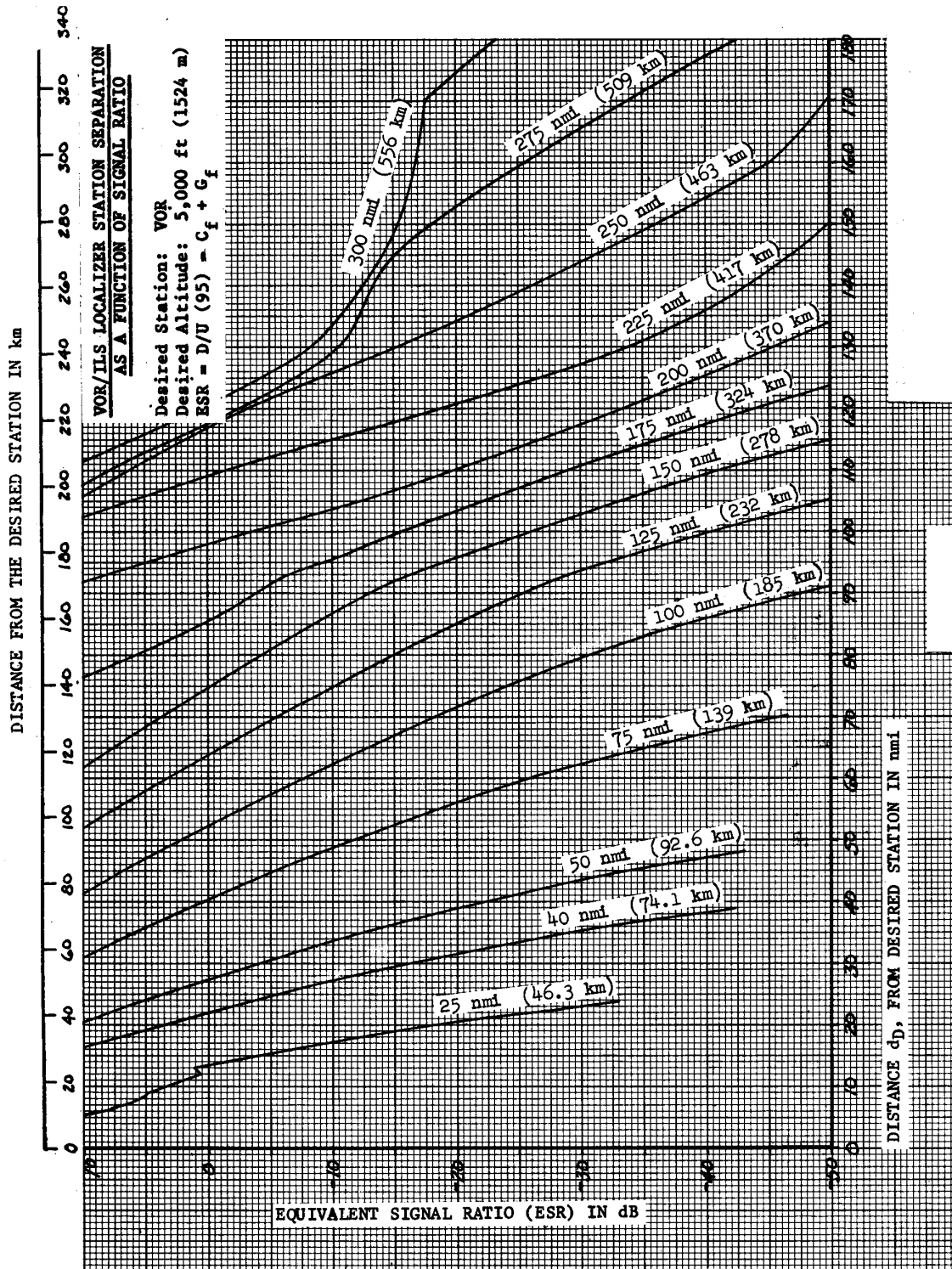
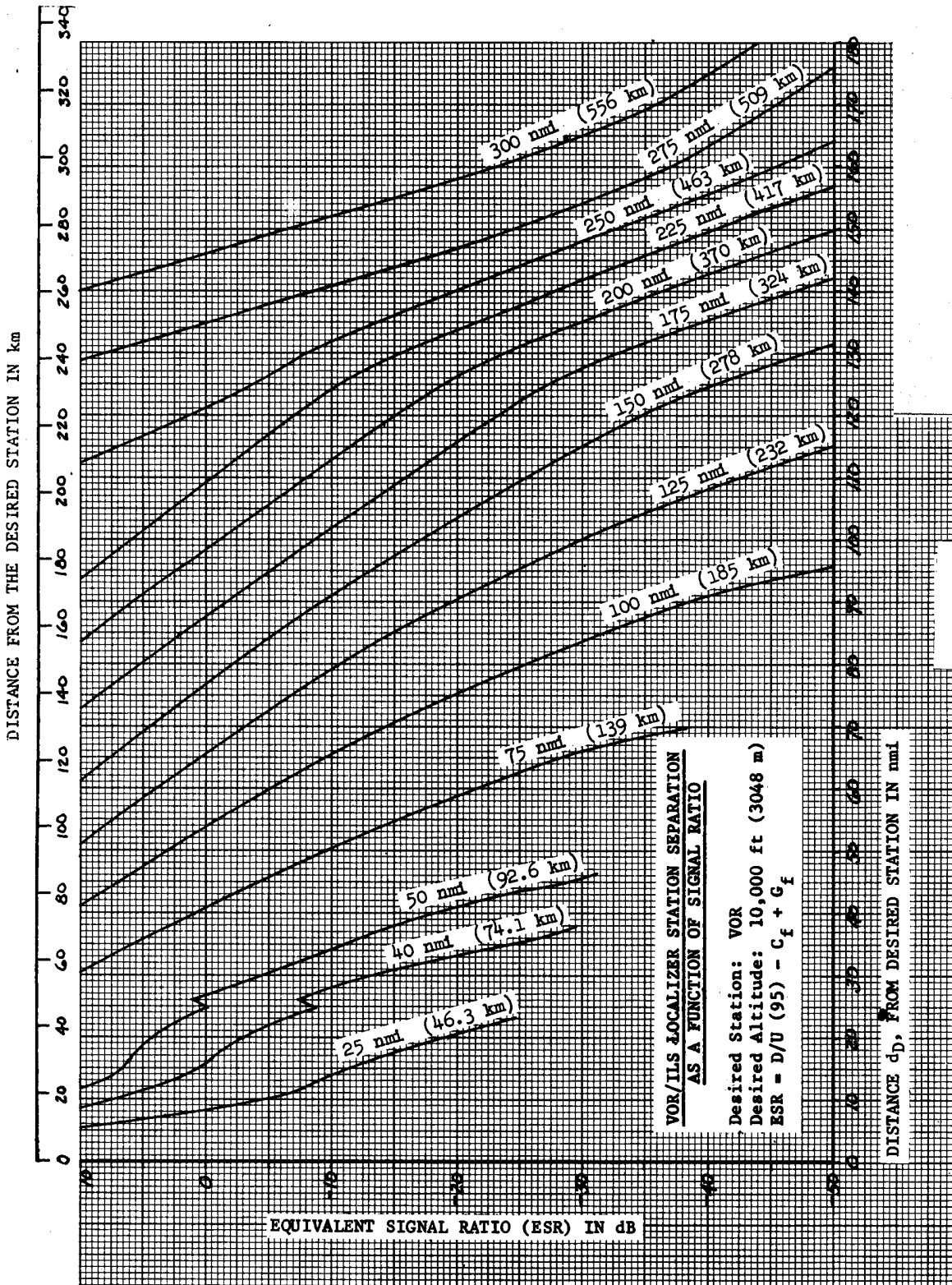


FIGURE 32. ESR RATIO - VOR/LOC. VOR IS DESIRED @ 10,000'



FIG

URE 33. ESR RATIO - VOR/LOC. VOR IS DESIRED @ 15,000'



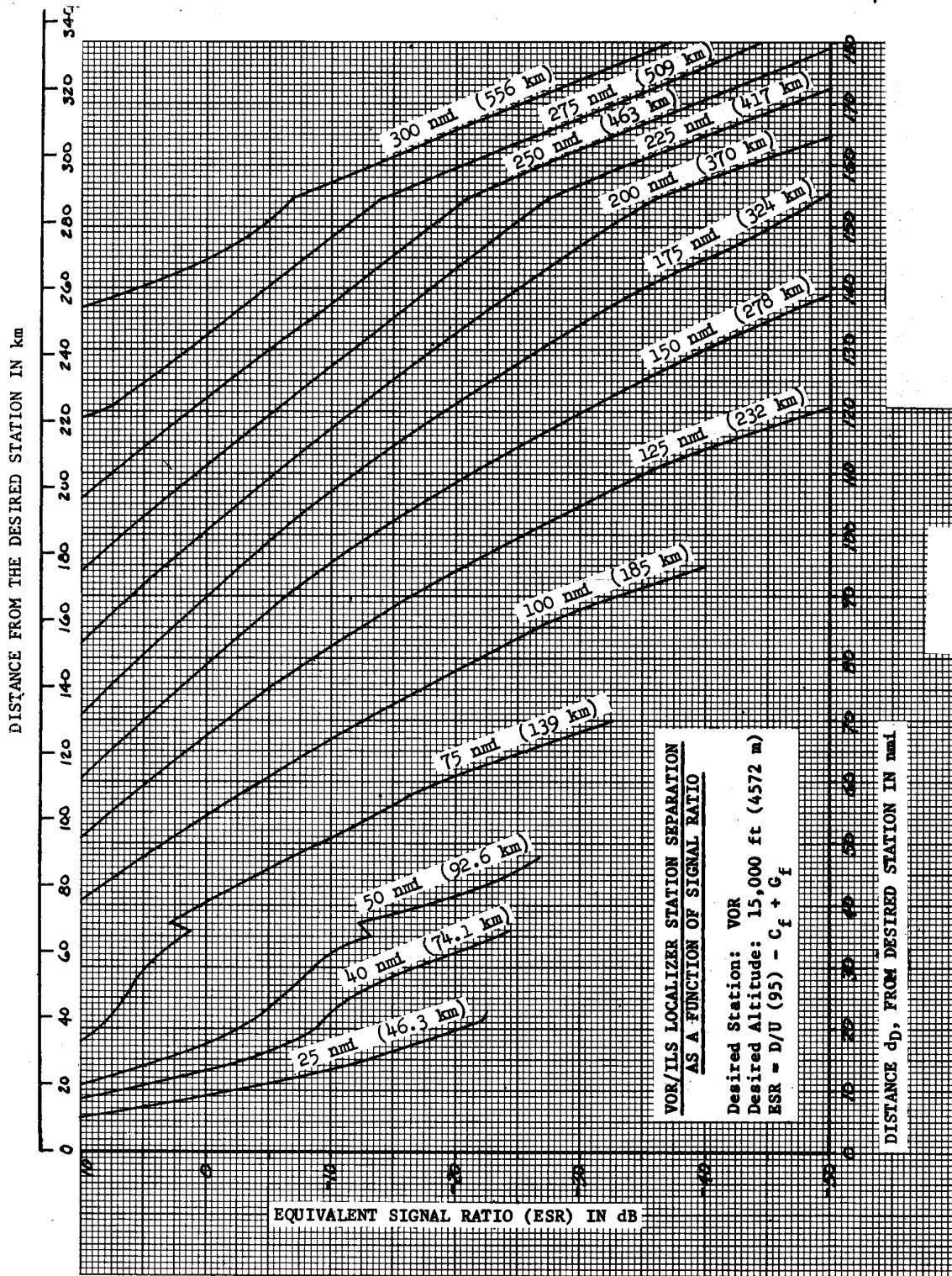


FIGURE 34. ESR RATIO - VOR/LOC. VOR IS DESIRED @ 18,000'

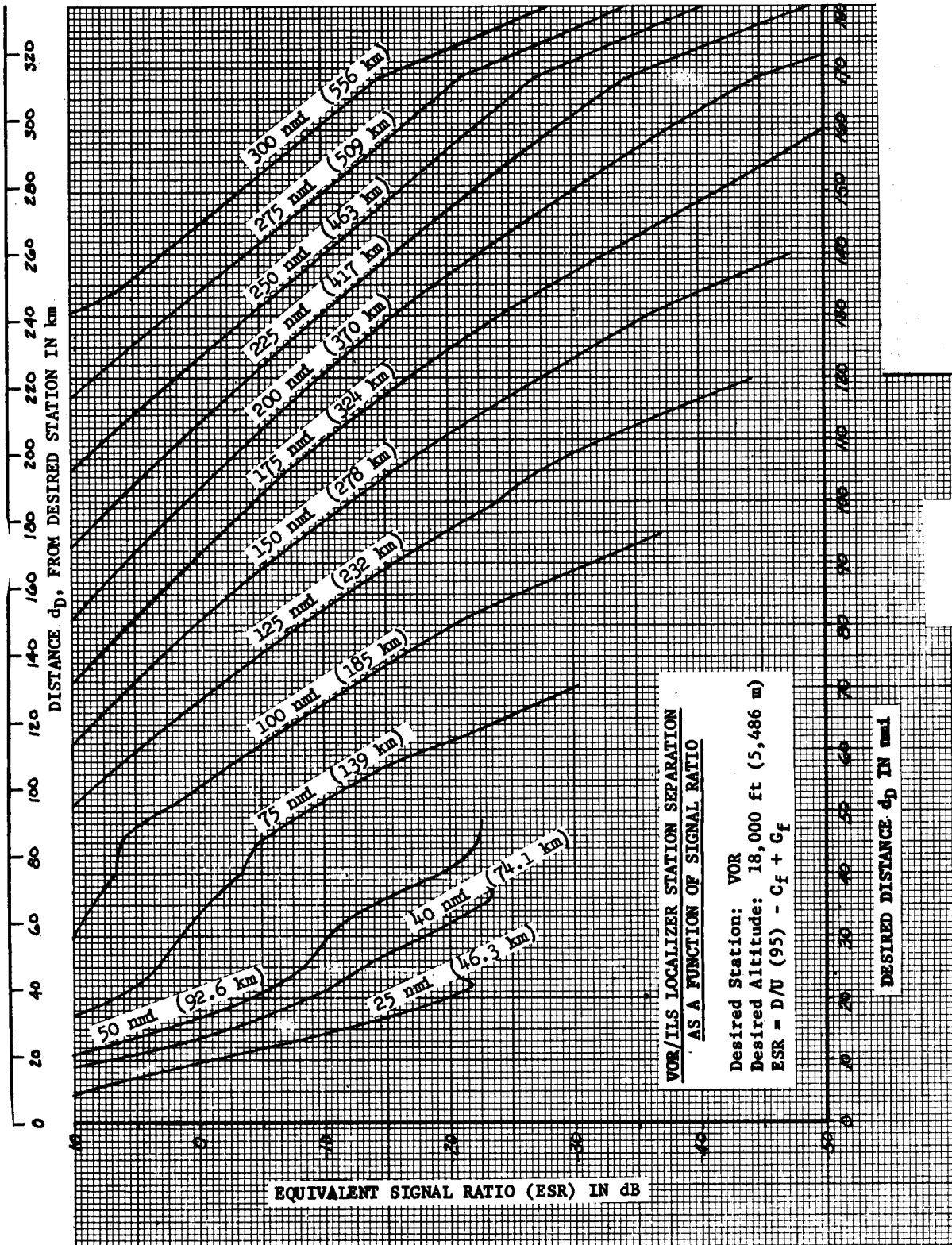
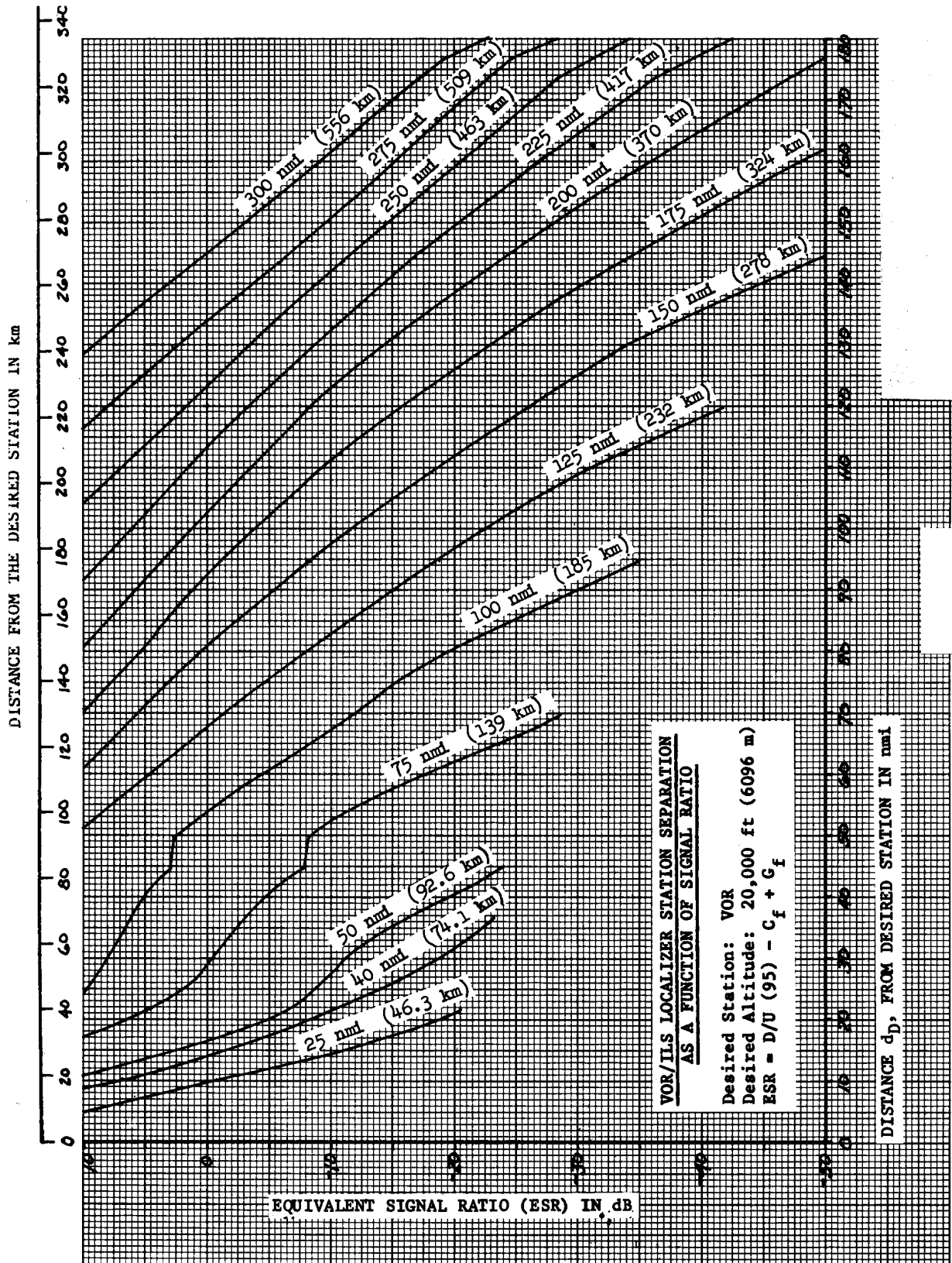


FIGURE 35. ESR RATIO - VOR/LOC. VOR IS DESIRED @ 20,000'



FIGURE

36. ESR RATIO - VOR/LOC. VOR IS DESIRED @ 30,000'

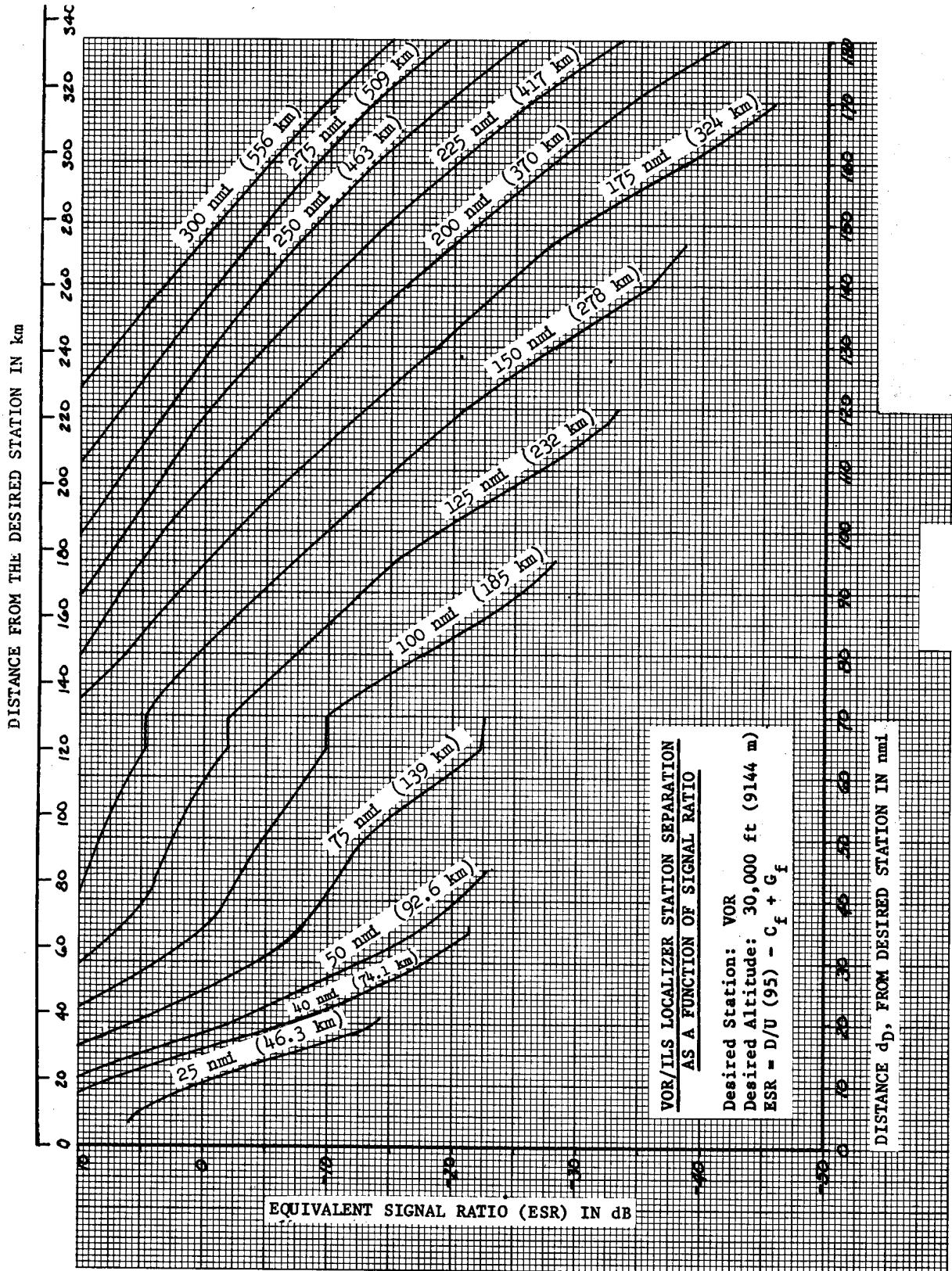


FIGURE 37. ESR RATIO - VOR/LOC. VOR IS DESIRED @ 40,000'

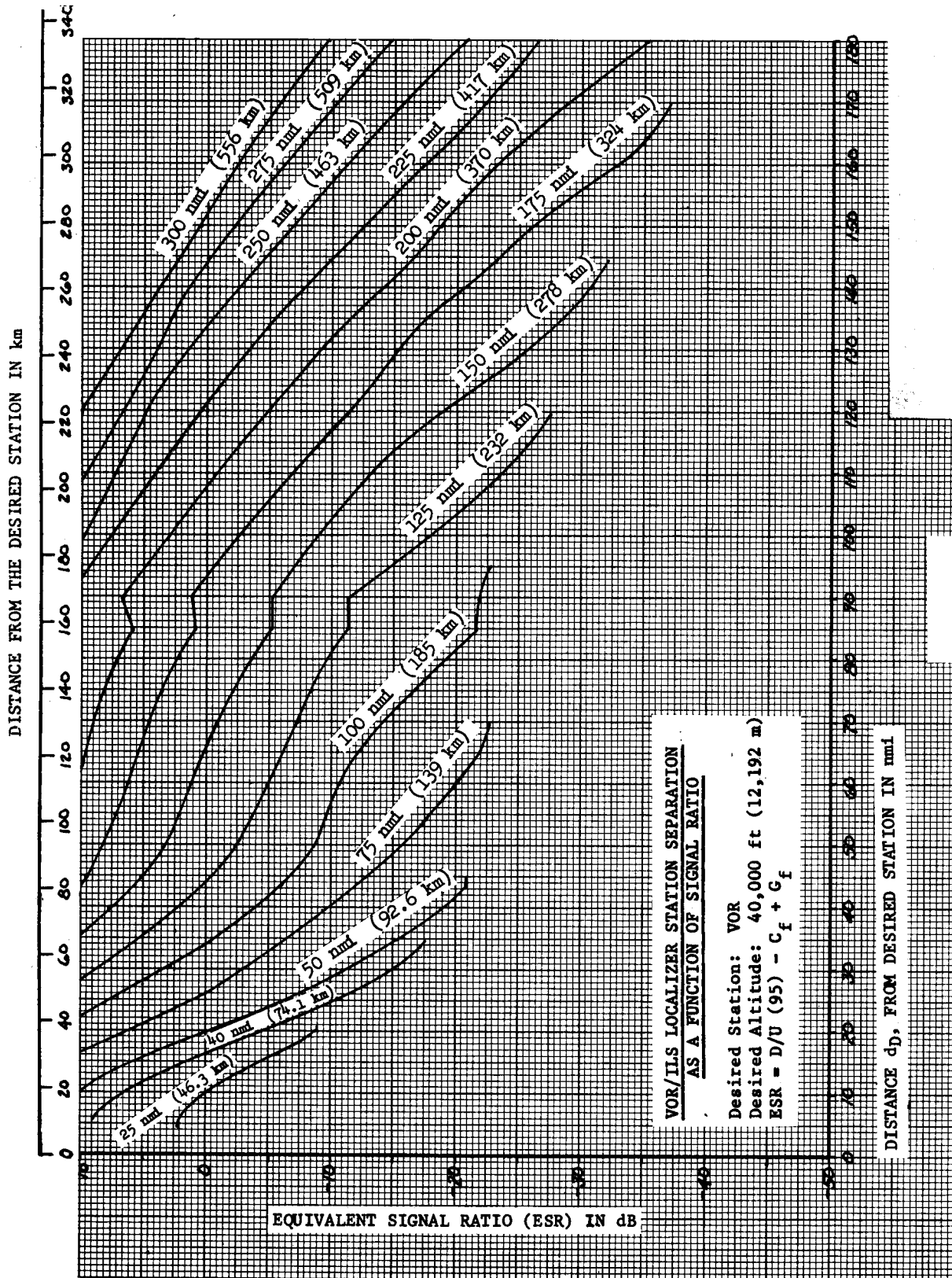


FIGURE 38. ESR RATIO - VOR/LOC. VOR IS DESIRED @ 50,000'

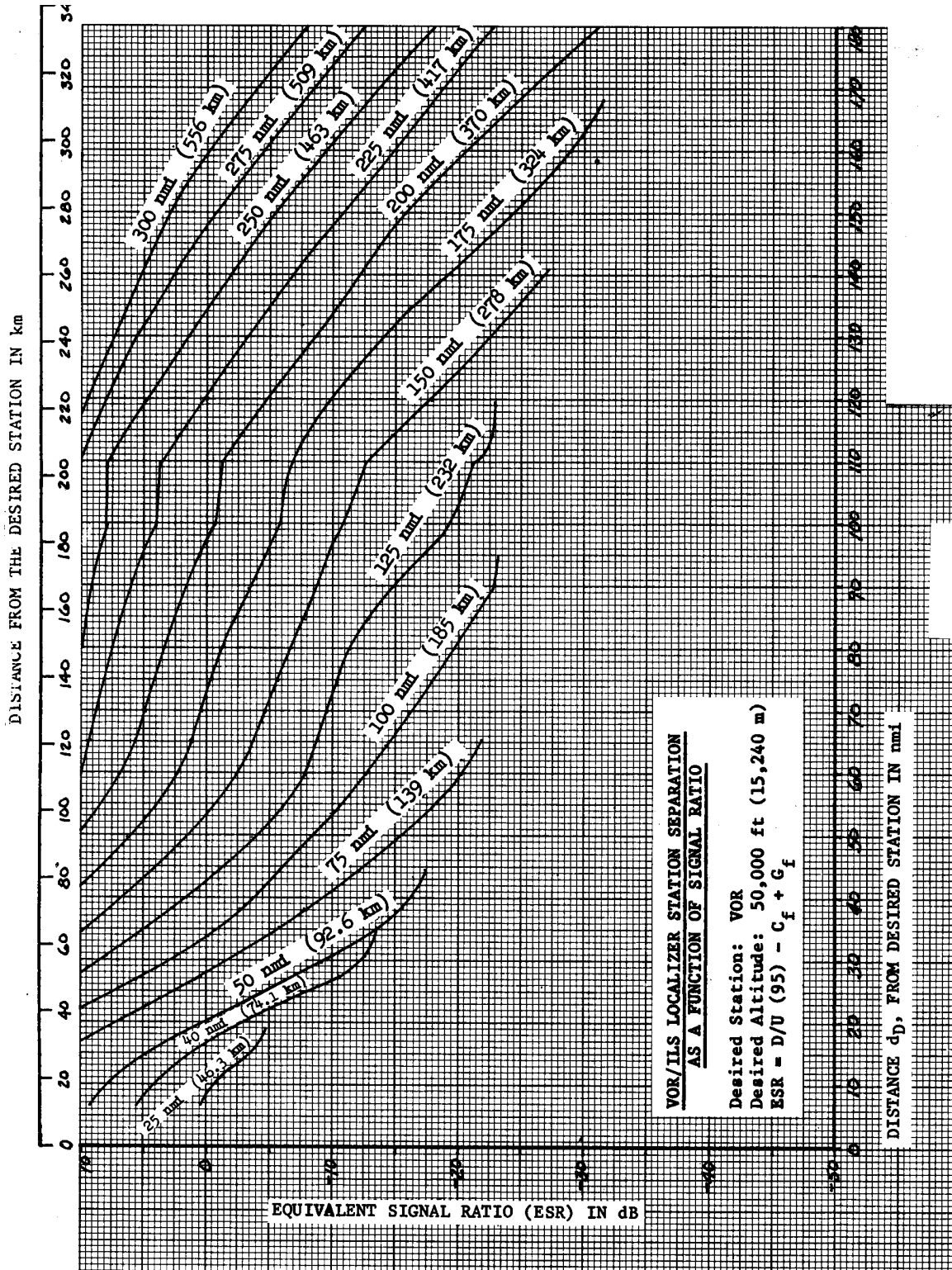
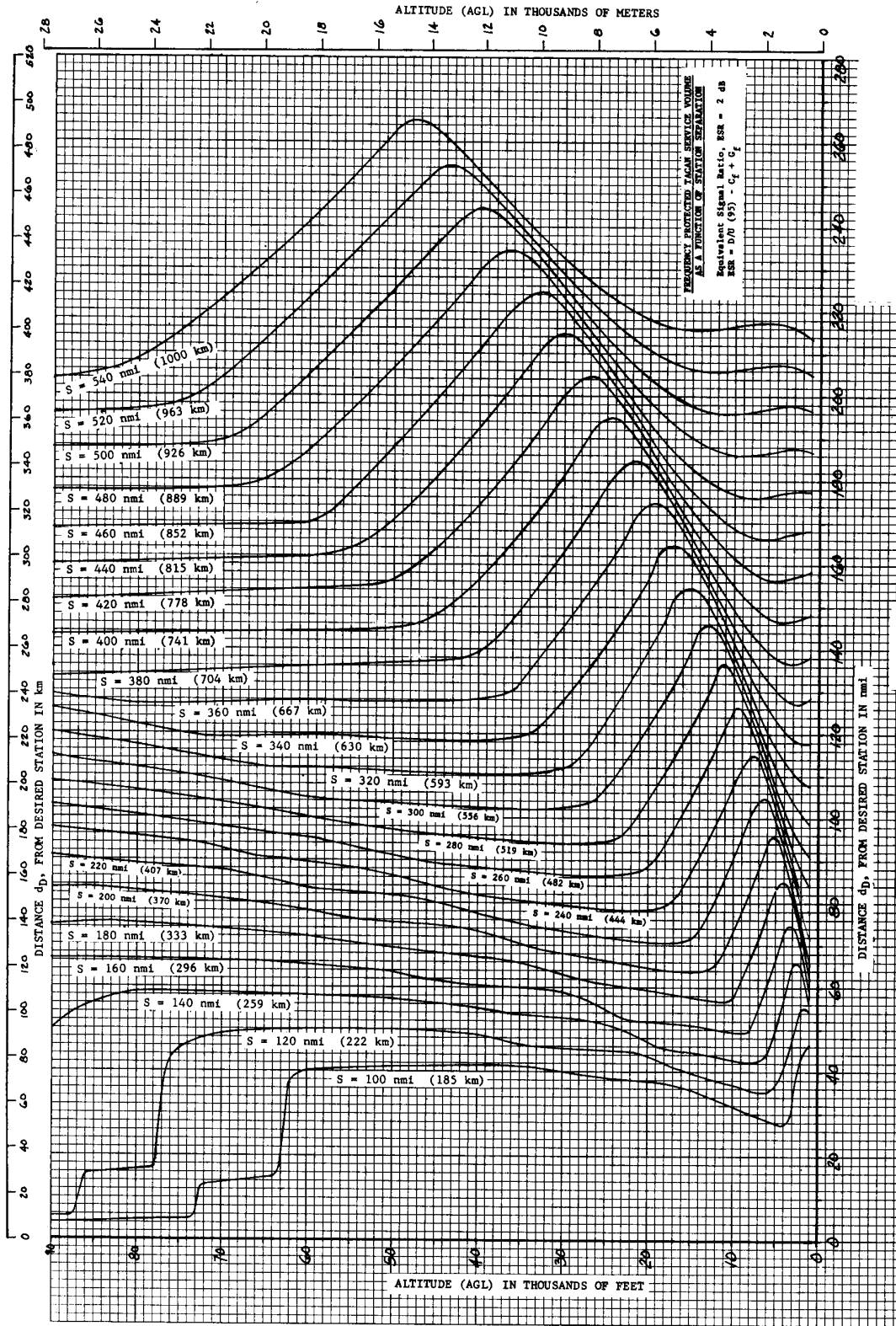


FIGURE 39. DME/TACAN FACILITY SEPARATION CURVES FOR ESR = +2 dB



FIGURE

DME/TACAN FACILITY SEPARATION CURVES FOR ESR = +5 dB

40.

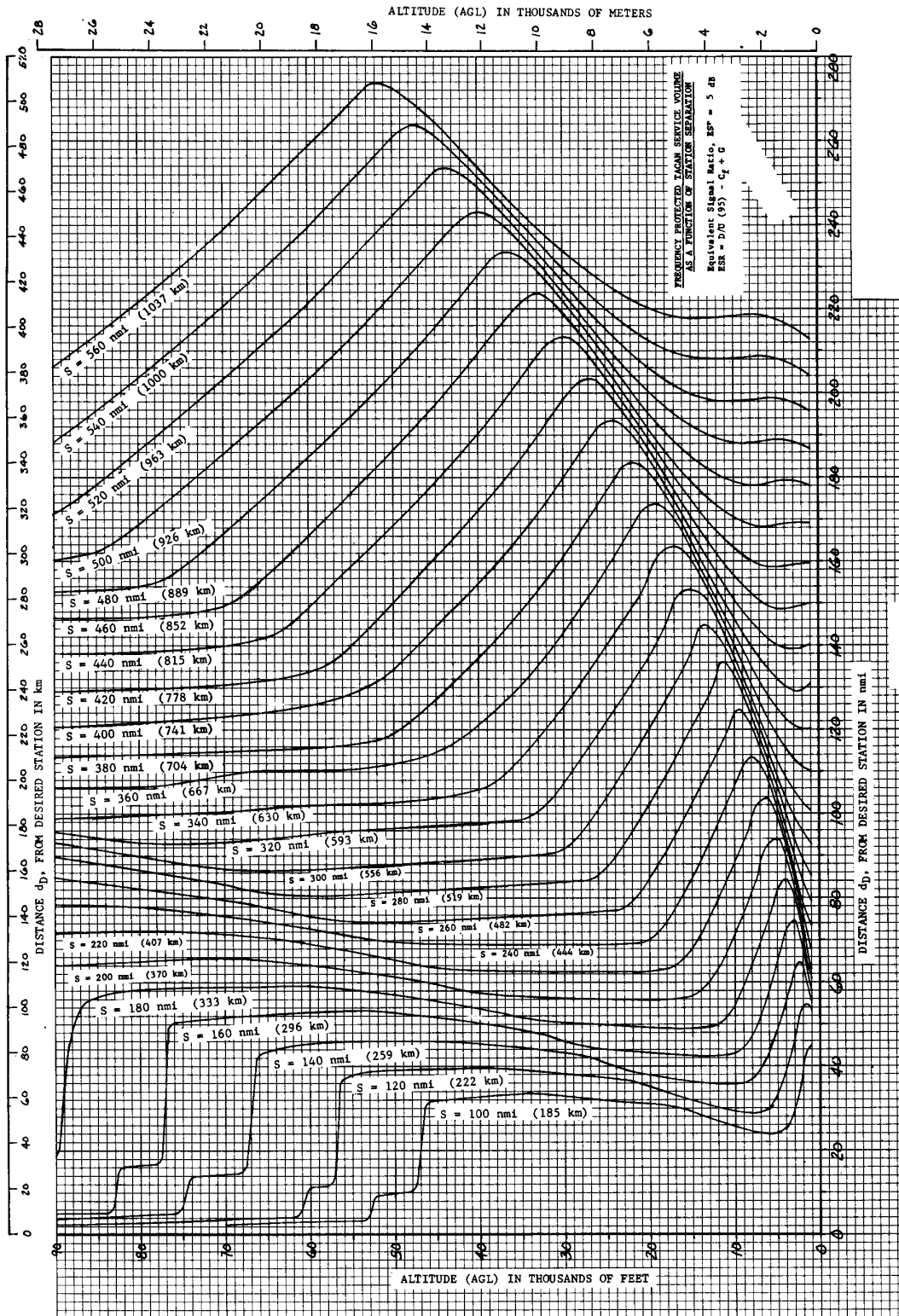
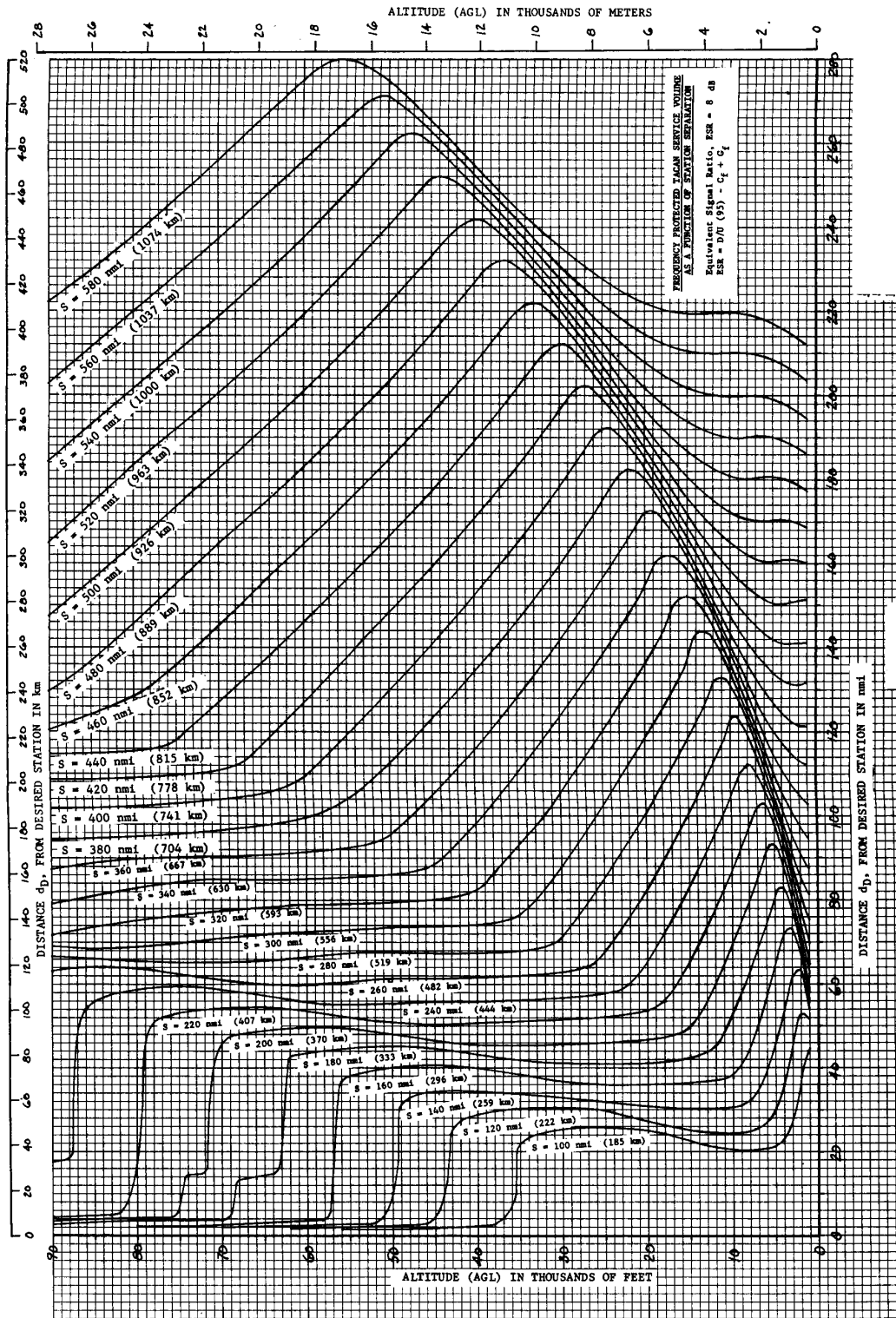


FIGURE 41. DME/TACAN FACILITY SEPARATION CURVES FOR ESR = +8 dB





FIGURE

DME/TACAN FACILITY SEPARATION CURVES FOR ESR= +11 dB

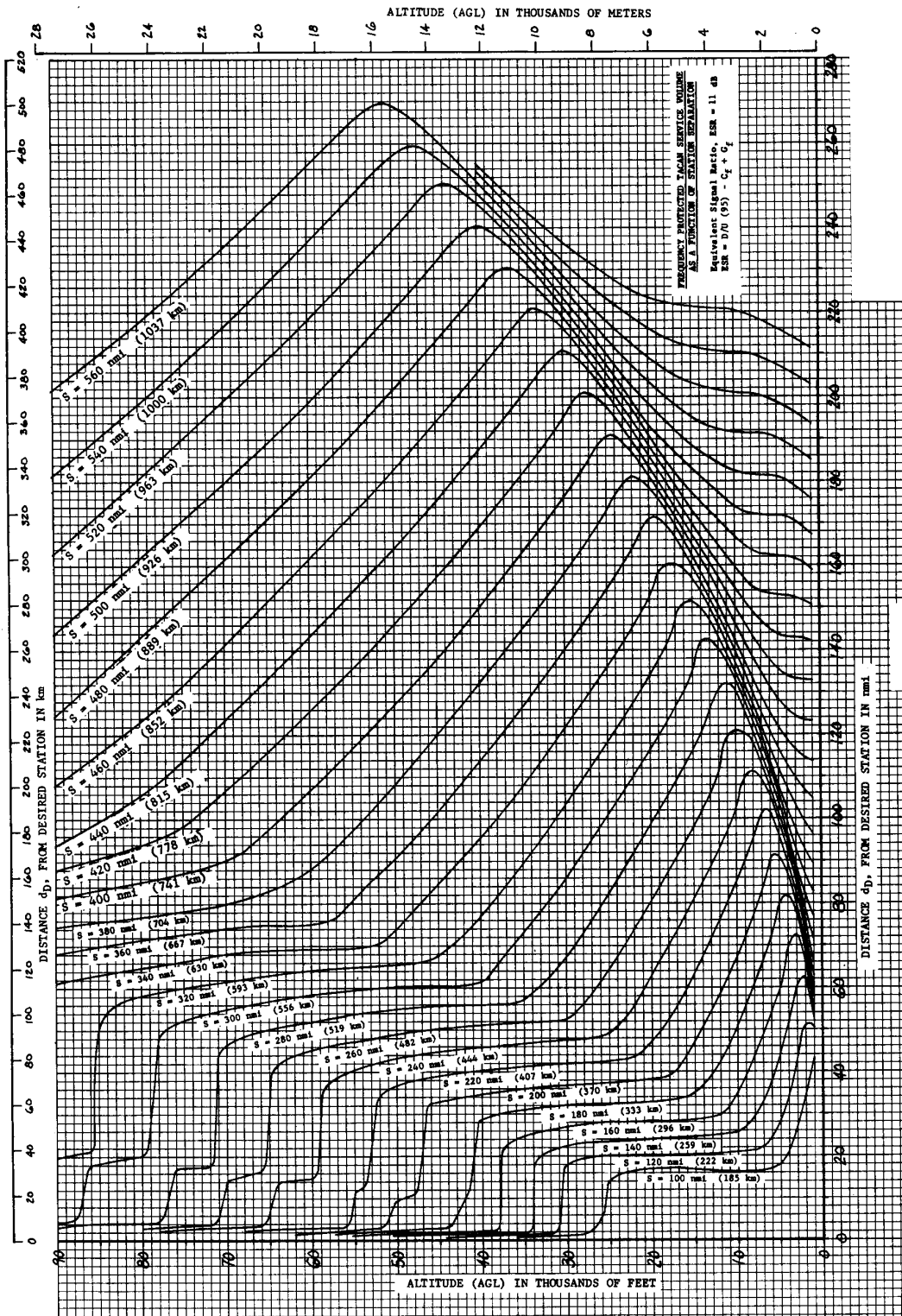


FIGURE 43. DME/TACAN FACILITY SEPARATION CURVES FOR ESR = +14 dB

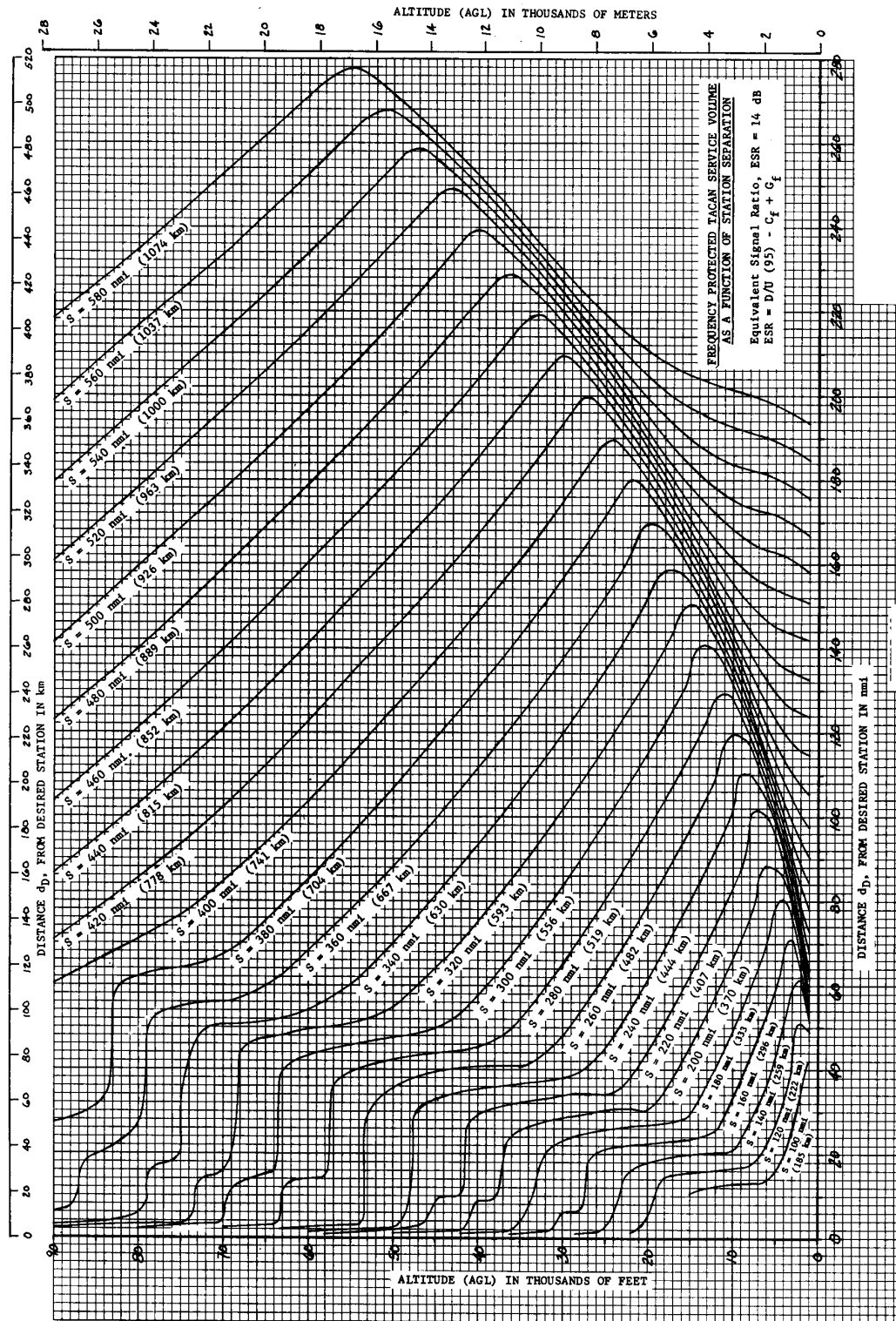


FIGURE 44. DME/TACAN FACILITY SEPARATION CURVES FOR ESR = +17 dB

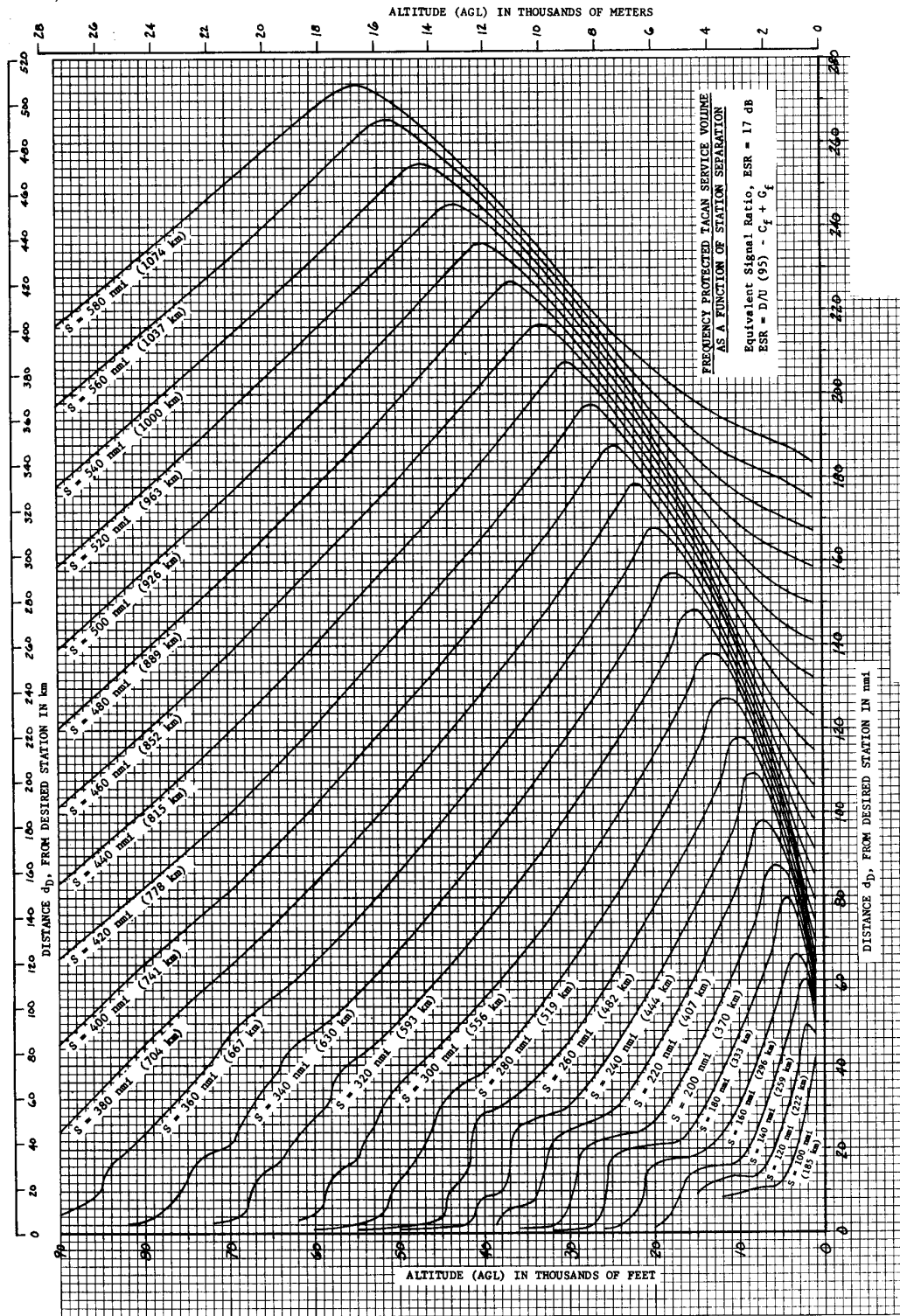


FIGURE 45. DME/TACAN FACILITY SEPARATION CURVES FOR ESR = +20 dB

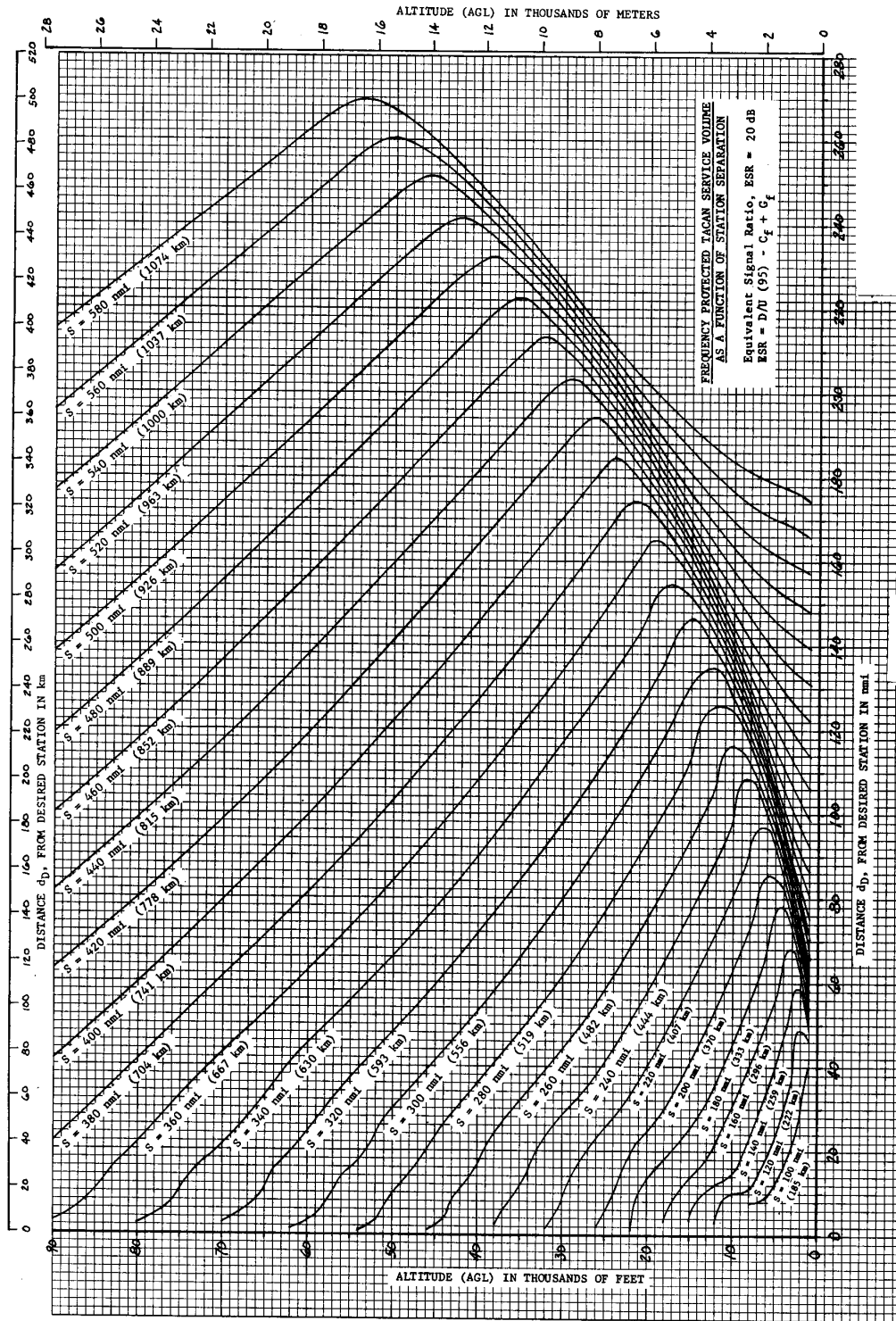


FIGURE 46. ESR RATIO - DME/TACAN TO DME/TACAN @ 1,000'

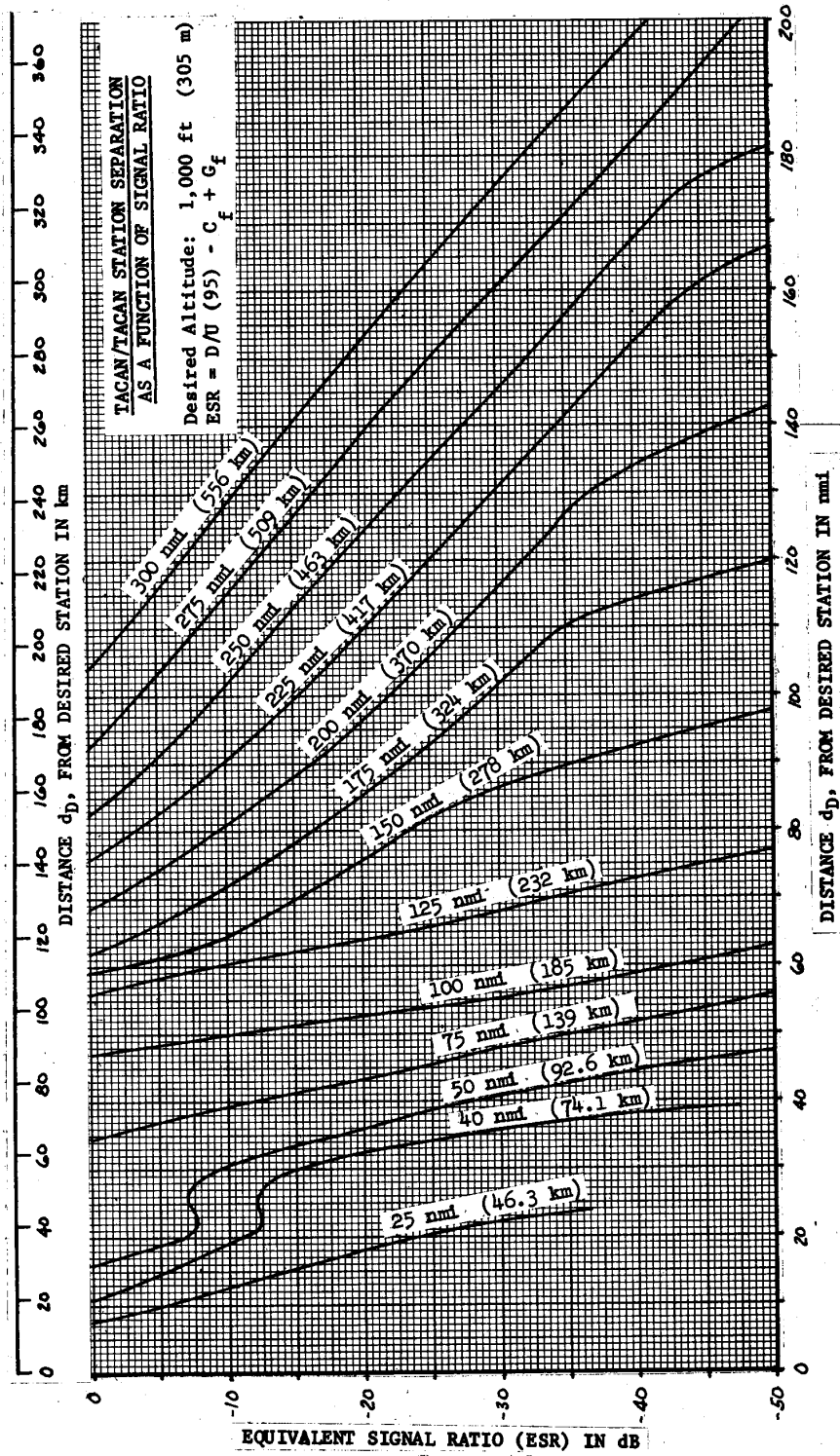
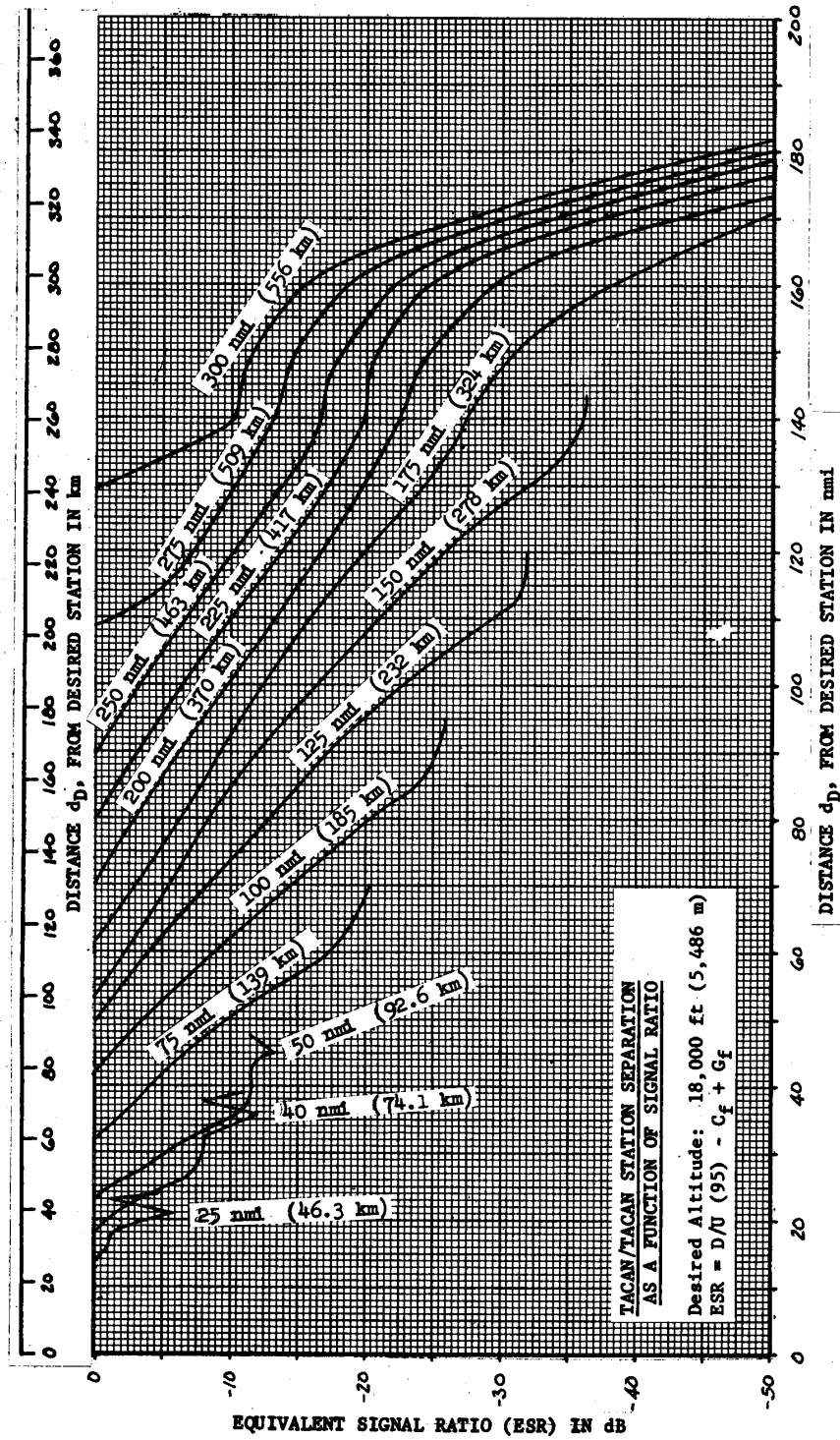


FIGURE 47. ESR RATIO - DME/TACAN TO DME/TACAN @ 18,000'



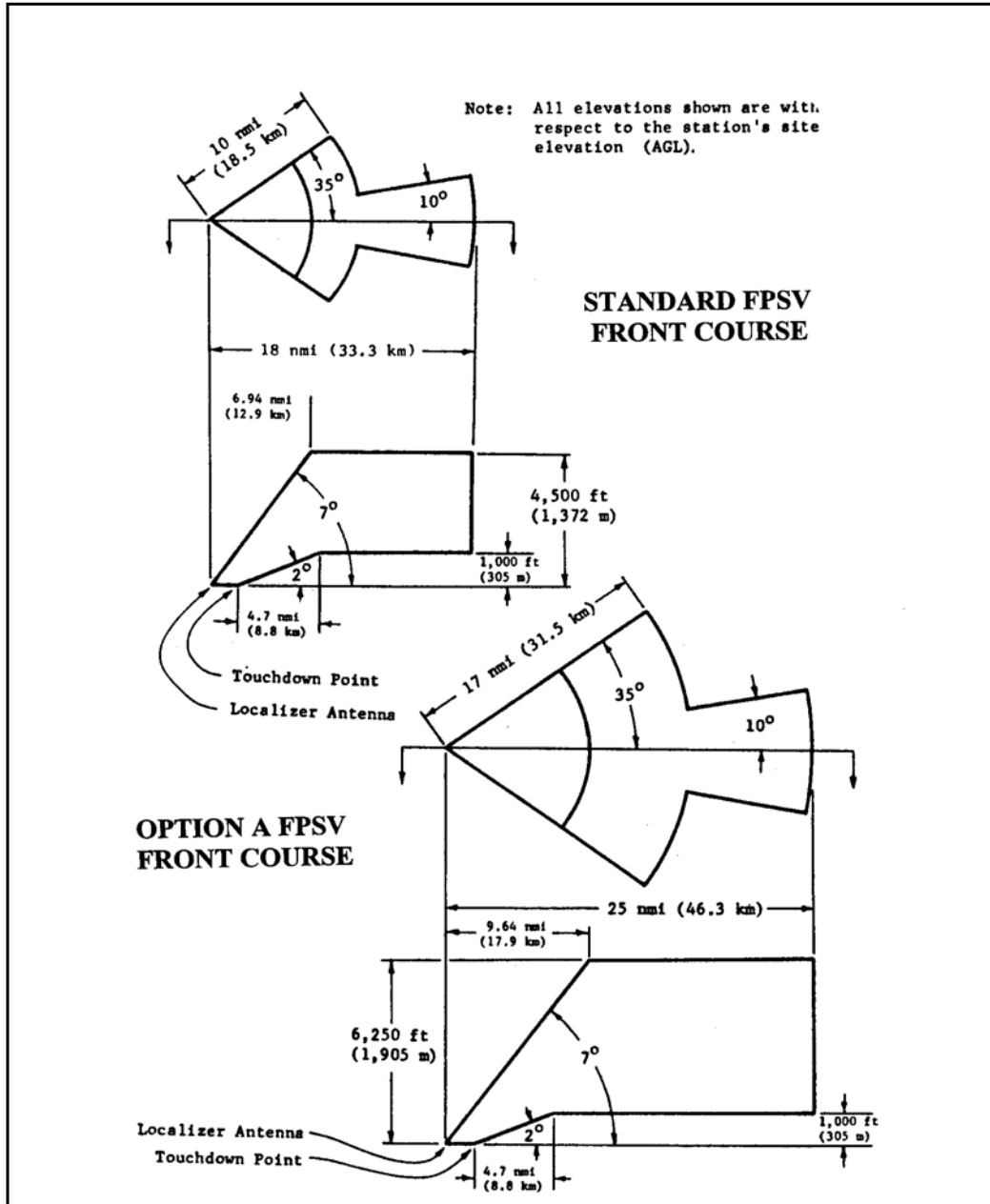
FIGURES 48. thru 60. RESERVED.

**SECTION 3. ILS AND DME FREQUENCY ENGINEERING**

**14. FREQUENCY ENGINEERING FOR ILS AND DME.**

**a. ILS and DME frequencies.** These frequencies and channels are listed in figure 1, section 1. The frequencies 108.10/979 MHz and 108.15/1105 MHz are specifically designated for radio navigation test generators (ramp testers) and shall not be used for operational ILS and DME facilities.

**FIGURE 61. LOC FRONT COURSE FPSVS**





**b. Paired frequencies.** Paired frequencies as listed in figure 1 require that DMEs be located on the airport near the runway for zero range indication or the transponder will be adjusted to indicate zero range.

**c. FPSVs.** FPSVs for the various classes of ILS/DME are shown in figures 61 through 64.

**FIGURE 62. LOC BACK COURSE FPSVS**

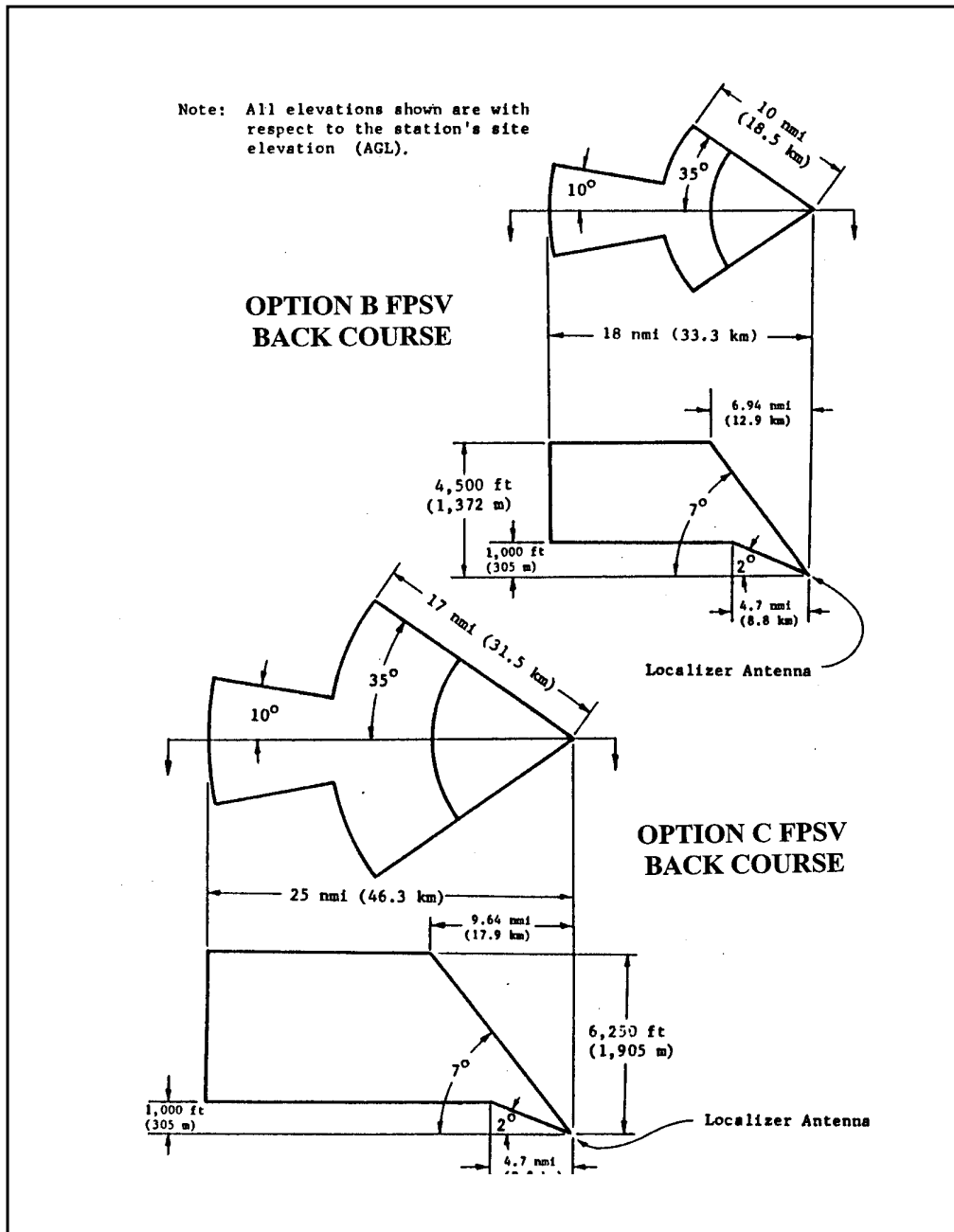


FIGURE 63. FPSV FOR ILS GS

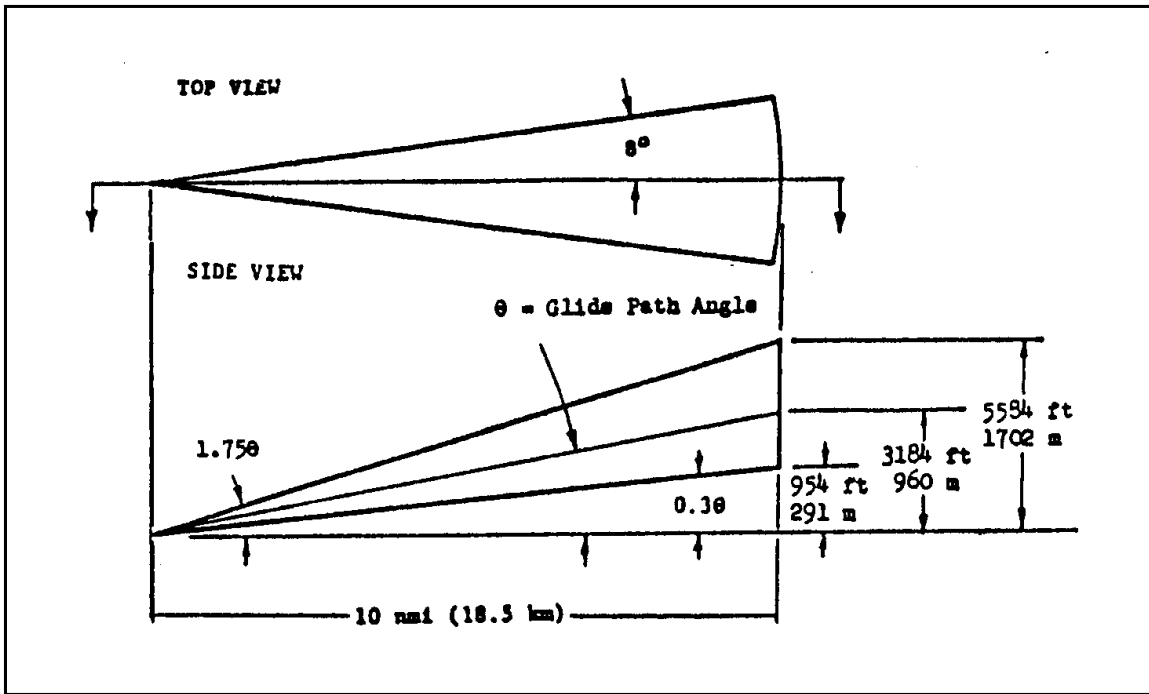
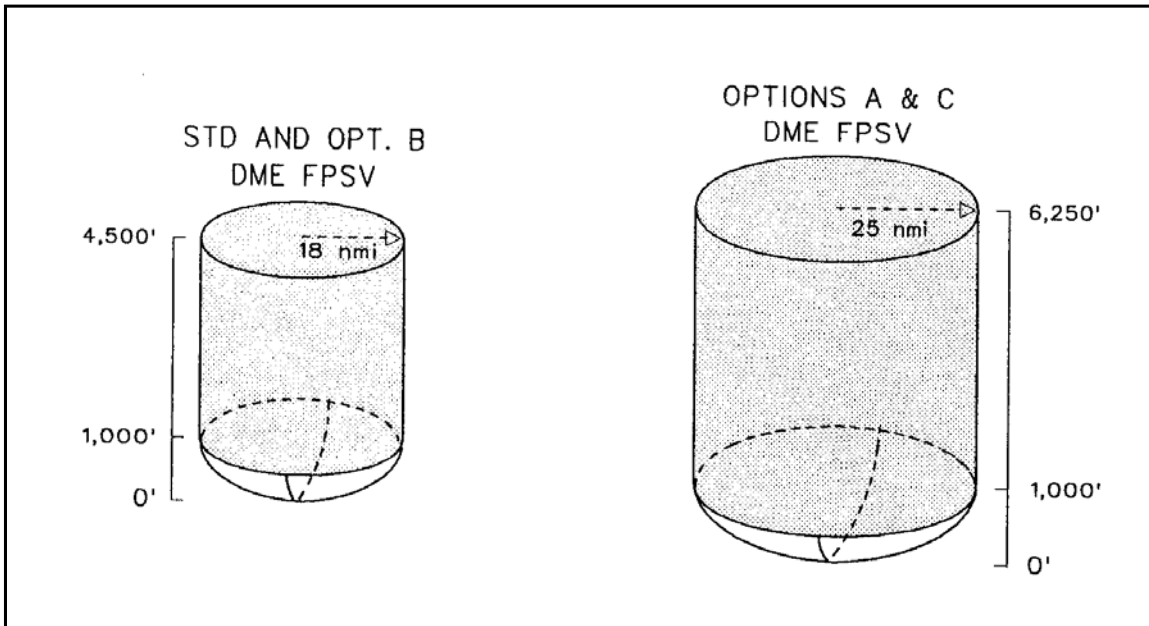


FIGURE 64. FPSVS FOR DMES ASSOCIATED WITH ILS



**d. ILS D/U criteria.** Harmful interference to ILS and associated DME facilities is avoided by geographically separating cochannel and adjacent channel assignments. Within each FPSV, the D/U ratio shall be at least the following, on a basis of 95 percent time signal availability. All D/U ratios include the +3 dB factor per Section 2 paragraph 1b(3).

#### LOC

Cochannel	1st Adjacent Channel (±50 kHz)	2nd Adjacent Channel (±100 kHz)	3rd Adjacent Channel (±150 kHz)
+23 dB	-4 dB Interim -31 dB Final	-43 dB	-47 dB

(1) A D/U ratio of **-4 dB** is necessary to assure protection of 100 kHz (100 channel) navigation receivers. This -4 dB D/U ratio is referred to as the interim criterion and shall be used whenever possible to protect 100 kHz assignments.

(2) A D/U ratio of **-31 dB** is for 50 kHz (200 channel) navigation receivers. This is referred to as the final criterion and shall be used for 50 kHz assignments.

#### GS

Cochannel	1st Adjacent Channel (±150 kHz)	2nd Adjacent Channel (±300 kHz)	3rd Adjacent Channel (±450 kHz)
+23 dB	-17 dB	-37 dB	-37 dB

**e. DME D/U criteria.** Harmful interference to DME is prevented in the same manner as for ILS.

#### DME

Cochannel	1st Adjacent Channel (±1 MHz)	2nd Adjacent Channel (±2 MHz)
+11 dB	-39 dB	-47 dB

**15. FREQUENCY ENGINEERING PROCEDURES.** To ensure that the proposed ILS and DME frequencies will provide interference-free operations within their FPSVs, the following analyses must be performed on the proposed frequencies:

**a. Intersite analysis** is used to determine whether the proposed frequencies meet the assignment criteria specified in paragraphs 14 d. and e. There are two analysis methods — table and calculation.

**b. Cosite analysis** is used to avoid interference caused by interaction between the proposed ILS and DME frequencies and other frequencies, including FM/TV in the vicinity of the proposed site. The cosite analysis procedures are discussed in the appendix.

**c. Other analysis** shall be performed as needed, such as correction for site elevation differences.

**d. Frequency compatibility** with the in-place FM Broadcast environment must be assured. See Section 4 of this appendix for use of the AAM for this function.

**16. INTERSITE ANALYSIS BY THE TABLE METHOD FOR ILS LOCS.** Intersite analysis may be performed on a proposed ILS frequency pair through the use of the tables in figures 66 through 71 which show conservative-worst-case separation distances required with respect to ILS/ILS and ILS/adjacent channel VOR. In addition, the nature of the ILS LOC antenna pattern makes the cochannel and adjacent channel circumferences different. Those diagrams are shown in figure 65.

**a. Figure 66** is for LOC/LOC cochannel.

**b. Figure 67** is for LOC/LOC 1st adjacent channel (interim).

**c. Figure 68** is for LOC/LOC 1st adjacent channel (final).

**d. Figure 69** is for LOC/VOR undesired 1st adjacent. channel (interim).

**e. Figure 70** is for LOC/VOR undesired 1st adjacent channel (final).

**f. Figure 71** is for LOC/VOR undesired 2nd adjacent channel.

**g. Site elevation differences** require some compensation, for cochannel ILS LOCs. For Standard and Option B FPSVs, an additional 6.5 nmi must be added to  $r_1$  for each 1000' of altitude difference. For Options A and C FPSVs, an additional 7 nmi must be added for  $r_1$  and 5.5 nmi for  $r_2$ , for each 1,000'. See figures 65 through 71 for  $r_1$ ,  $r_2$  and  $r_3$  values.

**h. There are no GS tables**, since GS FPSVs are protected by the geographic area covered by the FPSV of the associated LOC. However, there can be one problem which must be checked. In a few cases, LOC 1st adjacent channels are not always paired with matched GS frequencies. See channels 18X, 18Y and 38X in figure 1, section 1. The FMO must assure that a proposed "clear" LOC does not have an associated GS frequency only 150 kHz removed from an ILS at the same airport.

**i. Note that RLOS** is a factor. RLOS for Standard and Option B LOC FPSV is 101 nmi. RLOS for Options A and C LOC FPSV is 123 nmi.

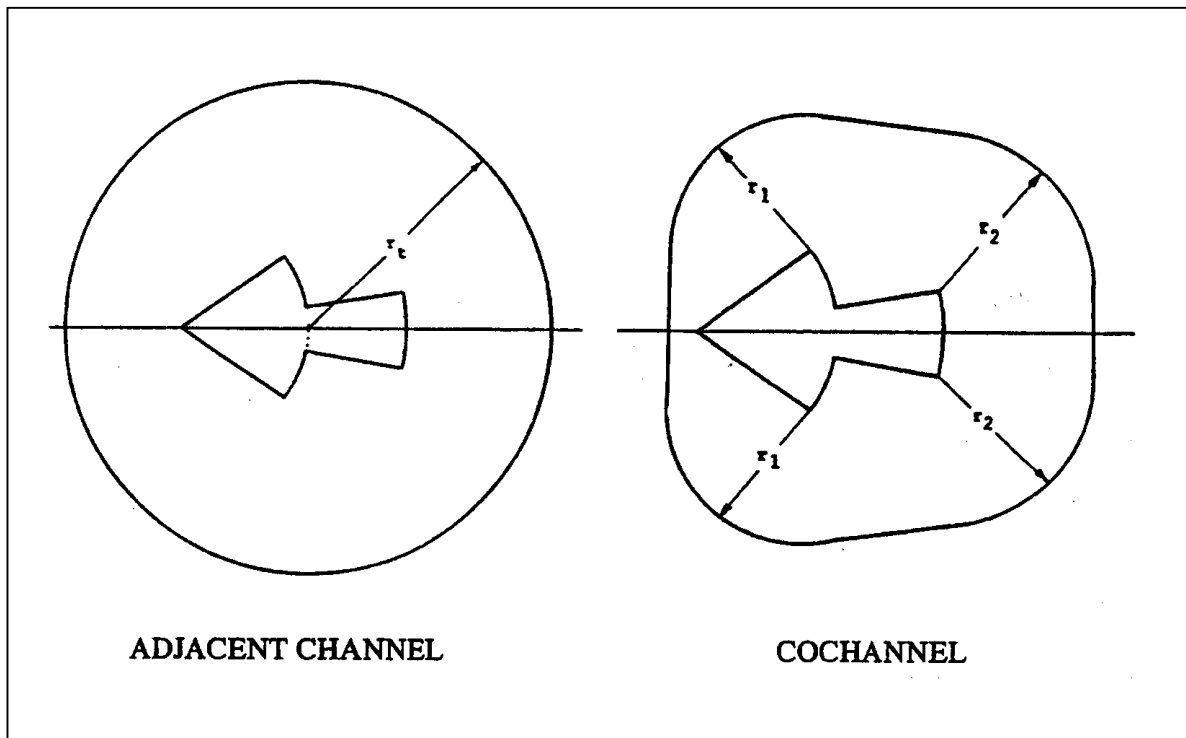
**17. INTERSITE ANALYSIS BY THE TABLE METHOD FOR ILS-DME.** ILS-DME intersite analysis may be performed on a proposed DME frequency through the use of the table in figure 72 for ILS-DME cochannel which show conservative-worst-case separation distances required and figure 73 for ILS-DME with 1st adj. channel TACAN/DME undesired. Geographical separations are not required between DME and TACAN facilities separated more than 1 channel (1 MHz). There are no tables for 2nd adjacent DME/TACAN channels.

**18. ILS-DME REQUIRED SEPARATION.** ILS-DME facilities required separation is greater than for the frequency paired LOC facility. This is clearly evident from comparison of the LOC and DME/TACAN tables for paired frequencies. In addition, any DME associated with an ILS will have a much reduced FPSV, as indicated in figure 64, as compared to those otherwise operating.

**19. USE OF THE LARGER SEPARATION REQUIREMENT.** In all cases, the larger separation requirement shall be used, whether it be cochannel or adjacent channel. This requires that for each ILS frequency engineering project, a determination must be made as to whether the LOC or associated DME has the larger separation requirement.

**20. ILS-ASSOCIATED DME ADJACENT CHANNEL UNDESIRE.** In this case, the facilities will ordinarily be regular L-DME or T-DME of the VOR FPSV size. In these cases, the tables listed in paragraph 17 shall be used. As in all other cases, the larger requirement shall always be used whether cochannel or adjacent channel.

**FIGURE 65. LOC SEPARATION DISTANCES DEFINED**  
(For use with figures 66-71)



**FIGURE 66. LOC/LOC COCHANNEL RADII SEPARATIONS**

<b>LOC DESIRED, LOC UNDESIRED +23 dB PROTECTION</b>						
<b>EIRP RATIO D/U LOC OPTIONS A &amp; C</b>			<b>STD AND OPTION B</b>			
<b>dB</b>	<b>r<sub>1</sub></b>	<b>(nmi) r<sub>2</sub></b>	<b>r<sub>1</sub></b>	<b>(nmi)</b>	<b>r<sub>2</sub></b>	
+18	74	65	47		48	
+15	83	73	53		54	
+12	93	82	61		61	
+9	100	92	69		69	
+6	106	101	78		79	
+3	110	105	85		86	
±0	114	110	90		91	
-3	118	115	95		96	
-6	122	121	100	100		
-9	#	#	100	100		
12	#	#	*		*	

\* = RLOS is 101 nmi for STD and Option B  
# = RLOS is 123 nmi for Options A & C

**FIGURE 67. LOC/LOC 1ST ADJACENT CHANNEL - 50 kHz - SEPARATIONS -- INTERIM**

<b>LOC DESIRED, LOC UNDESIRED -4 dB PROTECTION</b>			
<b>EIRP RATIO D/U LOC/VOR dB</b>	<b>OPTIONS A &amp; C r<sub>t</sub></b>	<b>STANDARD &amp; OPTION B (nmi) r<sub>t</sub></b>	
+18	31	24	
+15	34	26	
+12	37	28	
+9	41	30	
+3	52	36	
±0	57	40	
-9	80	55	
-12	88	62	
-15	97	68	
-18	106	75	

**FIGURE 68. LOC/LOC 1ST ADJACENT CHANNEL - 50 kHz - SEPARATIONS -- FINAL**

<b>LOC DESIRED, LOC UNDESIRED -31 dB PROTECTION</b>			
<b>EIRP RATIO D/U LOC/VOR dB</b>	<b>OPTIONS A &amp; C r<sub>t</sub></b>	<b>STANDARD &amp; OPTION B (nmi)</b>	<b>r<sub>t</sub></b>
+18	17		16
+15	18		17
+12	19		18
+9	20		18
+6	22		19
+3	23		20
±0	25		21
-3	27		22
-6	29		23
-9	31		25
-12	33		27
-15	36		29
-18	39		31

**FIGURE 69. LOC/VOR 1ST ADJACENT CHANNEL - 50 kHz - SEPARATIONS -- INTERIM**

<b>LOC DESIRED, VOR UNDESIRED -4dB PROTECTION</b>			
<b>EIRP RATIO D/U LOC/VOR dB</b>	<b>OPTIONS A &amp; C r<sub>t</sub></b>	<b>STANDARD &amp; OPTION B (nmi)</b>	<b>r<sub>t</sub></b>
+18	35		26
+15	39		28
+12	44		31
+9	49		34
+6	55		38
+3	62		42
±0	70		47
-3	80		53
-6	91		59
-9	103		67
-12	117		79
-15	#		94

# = Beyond RLOS

**FIGURE 70. LOC/VOR 1ST ADJACENT CHANNEL - 50 kHz - SEPARATIONS -- FINAL**

<b>LOC DESIRED, VOR UNDESIRED -31 dB PROTECTION</b>			
<b>EIRP RATIO D/U LOC/VOR dB</b>	<b>OPTIONS A &amp; C r<sub>t</sub></b>	<b>STANDARD &amp; OPTION B (nmi) r<sub>t</sub></b>	
+18	23	14	
+15	24	15	
+12	25	16	
+9	26	17	
+6	27	18	
+3	28	19	
±0	29	20	
-3	30	22	
-6	32	24	
-9	35	26	
-12	38	28	
-15	44	31	
-18	49	34	

**FIGURE 71. LOC/VOR 2nd ADJACENT CHANNEL - 100 kHz - SEPARATIONS**

<b>LOC DESIRED, VOR UNDESIRED -43 dB PROTECTION</b>			
<b>EIRP RATIO D/U LOC/VOR dB</b>	<b>OPTIONS A &amp; C r<sub>t</sub></b>	<b>STANDARD &amp; OPTION B (nmi) r<sub>t</sub></b>	
+18	17	11	
+15	18	12	
+12	19	13	
+9	20	14	
+6	21	15	
+3	22	16	
±0	23	17	
-3	24	18	
-6	25	19	
-9	26	20	
-12	28	21	
-15	30	22	
-18	32	23	



**FIGURE 72. ILS-DME COCHANNEL SEPARATIONS**

<b>ILS-DME DESIRED, ILS-DME UNDESIRED +11 dB PROTECTION</b>	
<b>FACILITY CLASS</b>	<b>SEPARATION DISTANCE (nmi)</b>
STD & OPTION B	101
OPTION A & C	123

**FIGURE 73. ILS-DME 1ST ADJACENT CHANNEL SEPARATIONS**

<b>ILS-DME DESIRED, DME/TACAN UNDESIRED -39 dB PROTECTION</b>			
<b>FACILITY CLASS</b>	<b>SEPARATION DISTANCE (nmi)</b>		
	<b>H</b>	<b>L</b>	<b>T</b>
STANDARD AND ALL OPTIONS	145	45	30

Note: DMEs associated with ILS are all terminal functions of equal power.

**21. INTERSITE ANALYSIS OF ILS BY CALCULATION METHOD.** LOC antennas are highly directional, and introduce an additional factor into the ESR calculation process. That factor is the gain of the antenna system with respect to the desired facility.

**a. ESR** is an adjusted D/U ratio due to the differences in the carrier power and antenna gain between two stations. It is defined as follows:

$$ESR = D/U - P_D + P_U - A_D + A_U + G_U - G_D$$

Where:  $D/U$  = required D/U ratio +23 dB for cochannel LOC;  
 -4 dB for 1st adjacent channel LOC;  
 +11 dB for cochannel DME/TACAN

$P_D$  = carrier power of the desired facility, dBW

$P_U$  = carrier power of the undesired facility, dBW

$A_D$  = antenna gain of the desired facility, dBi

$A_U$  = antenna gain of the undesired facility, dBi

$G_D$  = relative antenna gain (dB) of desired facility,  
 at point of interest, with respect to the  
 main beam antenna gain

$G_U$  = same for undesired facility

**b. Antenna gains** (main beam and relative antenna) for individual types of LOC antennas are shown in figures 74 and 111-130.

**FIGURE 74. LOC ANTENNA GAINS AND GRAPH REFERENCE**

NOMENCLATURE	STYLE	MAINBEAM GAIN dB	FIGURE
MK20, FA9913	LPD (14-10) LPD (20-10)	28 28	111
FA5692, FA5693, FA5707, FA5708, FA8001, FA8002, FA8035, FA8036, FA8038, FA8621, FA8622, FA8719, FA8720, FA8843, FA8844.	V RING	12	112
FA9320	TRVLG WAVE (8 EL)	14	113
FA9325	TRVLG WAVE (14 EL)	17	114
FA9358, FA9708, FA9912 MK2, MK12.	LPD 8 EL ARRAY	17	115
FA9358, FA9708, FA9912 MK2, MK12.	LPD 14 EL ARRAY	20	116
FA9759, AN/GRN29, AN/GRN30	LPD	23	117
AN/GRN_27	TRVLG WAVE (14/6)	17	118
AN/GRN_27 (NARROW)	PARABOLIC	17	119
AN/GRN_27 (WIDE)	PARABOLIC	17	120
AN/MRN7	DIPOLE	12	121
REDLICH	LPD (14-10)	26	122
MODIFIED V RING	MOD V RING	12	123
1201	DIPOLE	16	124
1203	LPD	17	125
1204	DIPOLE	14	126
1261	DIPOLE	15	127
STAN37	DIPOLE	12	128
55	TWIN TEE	13	129
STANDARD 14 EL	V-RING	14.6	130
NOTE: LPD = Log Periodic Dipole			

c. Using the calculated ESR value and appropriate facility separation curves, the required (S) can be determined. Figures 79 through 107 will be used for LOC cochannel separations; figures 108 through 110 for adjacent channel VORs, ILS desired; figures 111 through 130 for ILS antenna radiation pattern charts; and figures 46 and 47 for DME/TACAN adjacent channel ESR curves.

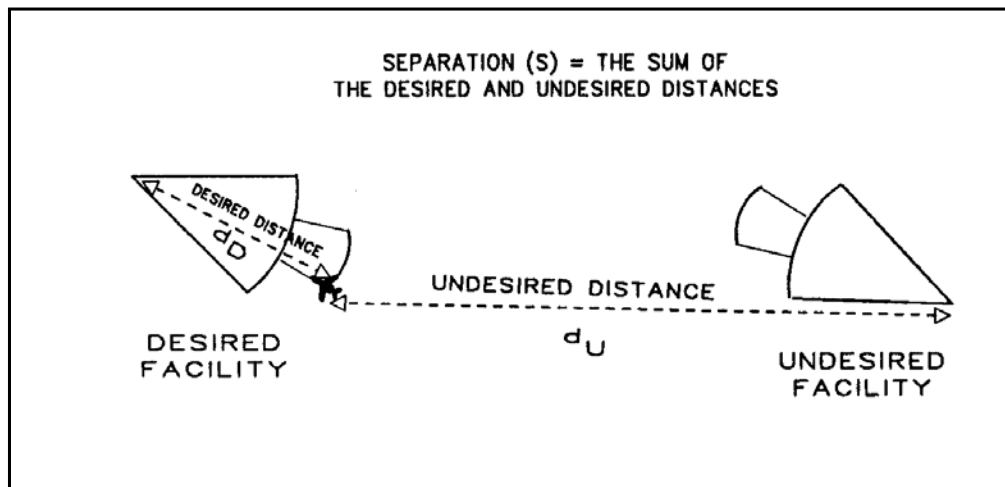
d. (S) is defined as (see figure 75):

$$(S) = d_D + d_U$$

Where:  $d_D$  = the distance from the desired facility to a critical point where the intersite analysis is being made.

$d_U$  = the distance from that point to a potential interfering facility.

**FIGURE 75. CRITICAL POINT SEPARATION DISTANCE**

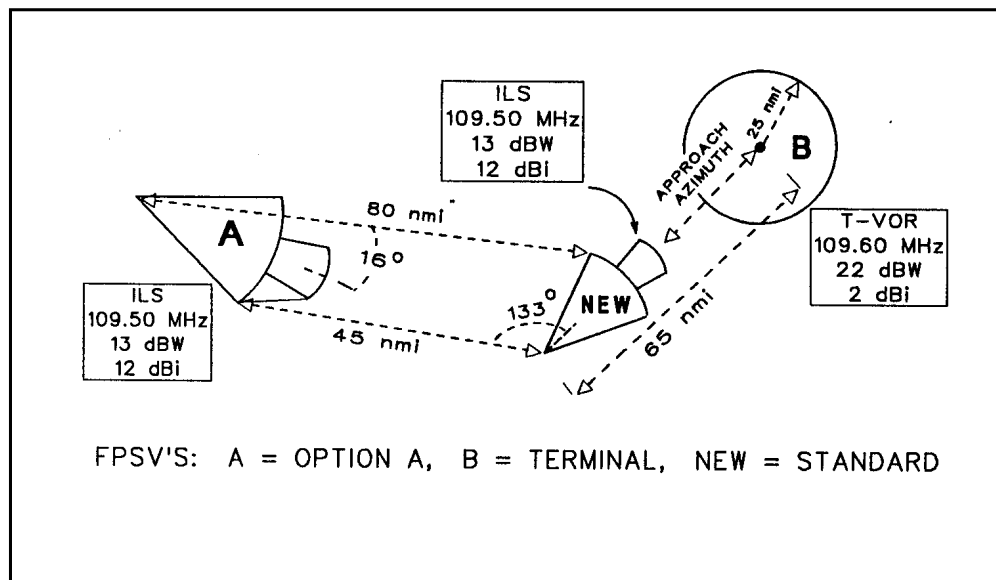


**22. SPECIAL CONSIDERATION FOR ILSs ON OPPOSITE ENDS OF A RUNWAY.** In some congested areas, frequencies may not be available for a new ILS requirement. In that case, consideration must be given to putting the required ILS on the same frequency as the installed one on the opposite end of the runway. If this is necessary, the following restrictions apply:

**a. ILS identification.** Each ILS, which includes any COMLOs and DMEs, if installed, must have separate and distinct identifiers.

**b. Interlock requirements.** Fail-safe interlock systems must be installed to prevent both ILS and any ancillary COMLO and DME from being operated simultaneously.

**c. NOTAM requirement during ILS maintenance.** If radiating a signal during maintenance activities is necessary, the opposite end ILS shall be NOTAMMED out of service as unusable from the Middle Marker inward. Of course, the ILS being maintained must also be NOTAMMED out of service during the maintenance period.

**FIGURE 76. LOC INTERSITE ANALYSIS BY CALCULATION**

**23. LOC CALCULATION EXAMPLE.** Refer to figure 76. The LOC facility separation, ESR, and LOC antenna patterns curves are used in these calculations. They are found in figure 36 and figures 79 through 129.

**a. The facilities are:** A = Option A LOC, 25 nmi @ 6250' on 109.50 MHz, with a standard V-Ring antenna; B = T-VOR on 109.60 MHz; and New (N) is a proposed new standard LOC, 18 nmi @ 4500' on 109.50 MHz, also with a V-Ring antenna.

**b. The proposed LOC** has its main beam pointed directly at the T-VOR site. The FPSV of the T-VOR is 25 nmi at 12,000', and as the larger FPSV, it will be checked first. New is 2nd adjacent channel to B, so  $D/U = -43$  dB. (Para 14 d.)

$$ESR = D/U - P_D + P_U - A_D + A_U + G_U - G_D \text{ (Para 21)}$$

(1) **For B as desired** and N as undesired,

$$\begin{aligned} ESR &= -43 - 22 + 13 - 2 + 12 + 0 - 0 \\ &= -42 \text{ dB} \end{aligned}$$

NOTE: With the nondirectional VOR antenna and the LOC pointed at  $0^\circ$  with respect to the VOR location, both  $G_U$  and  $G_D$  are zero. Refer to figure 30, ESR curves for ILS-VOR @ 1,000 feet; VOR is desired. By interpolation, a 25 nmi FPSV @ -42 dB requires a separation of (S) = 27 nmi. The example shows a distance of 65 nmi, so B is protected.

**(2) For N as desired** and B as undesired, with "desired" roles being reversed,

$$\begin{aligned} \text{ESR} &= -43 - 13 + 22 - 12 + 2 + 0 - 0 \\ &= \mathbf{-44 \text{ dB}} \end{aligned}$$

NOTE: Refer to figure 108. At 18 nmi and -44 dB, (S) = approximately 17 nmi.

Since the actual separation is shown as 65 nmi, that value is  $\gg 17$ , so N is protected.

**(3) For N as desired** and A as undesired,

$$\begin{aligned} \text{ESR} &= +23 - 13 + 13 - 12 + 12 + (-7) - (-10) \\ &= \mathbf{+26 \text{ dB}} \end{aligned}$$

NOTE: N's critical point is 16° off A's main beam and 35° off its own main beam (see figure 112 for  $G_U$  and  $G_D$ ).

**(4) Refer to figure 105**, ILS/ILS facility separation curves for ESR = +26 dB. By interpolation, 10 nmi @ 4,500' yields (S) = 55 nmi. At the critical point on N, an aircraft will be 10 nmi from N and 80 NM from A; (S) = 80 + 10 = 90 nmi. The value 90 > 55, so N will be protected.

**(5) For A as Desired**, and N as Undesired,

$$\begin{aligned} \text{ESR} &= +23 - 13 + 13 - 12 + 12 + (-20) - (-5) \\ &= +23 - 0 - 15 = \mathbf{+8 \text{ dB}} \end{aligned}$$

NOTE: A's critical point is 133° off N's main beam and 10° off its own main beam (fig 112).

**(6) Refer to figure 99**. For 25 nmi @ 6,250', interpolation will show (S) = 67 nmi. A's 25 nmi FPSV plus the 45 nmi separation = 70 nmi. The value 70 > 67; A is protected.

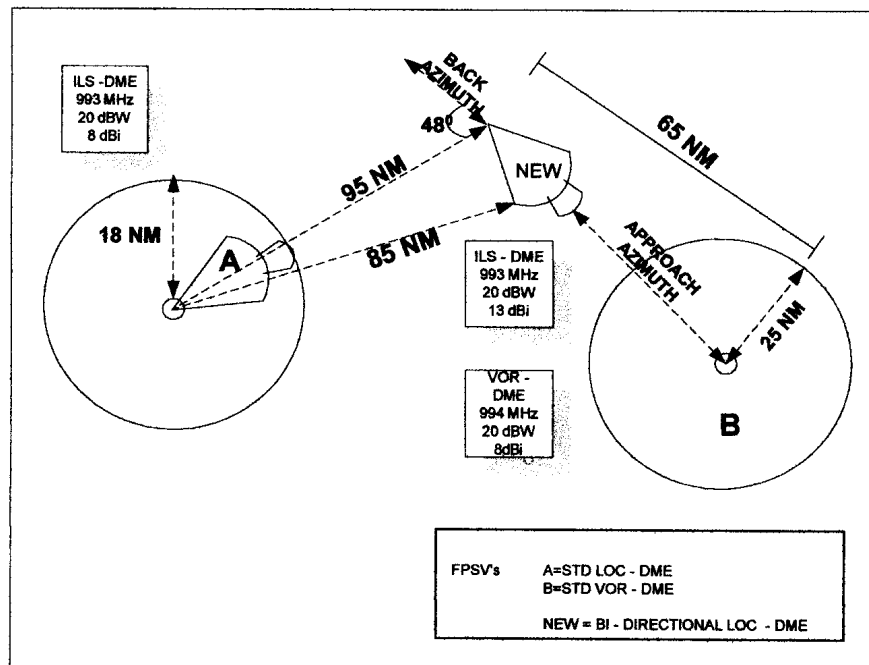
**(7) All four conditions** of cochannel and adjacent channel are satisfied. Unless there is an adjacent channel GS frequency problem (see paragraph 16h), the proposed assignment could be considered safe.

**(8) However, the assignment may not be made until the paired DM channel is checked.**

**FIGURE 77. DME AND TACAN ANTENNA GAIN FIGURES**

	TYPE	GAIN (dB)
	CA3167 (Discone)	11
	FA8974 "	11
D	FA9639 "	11
M	FA9783 "	11
E	M3 "	9
	596B "	9
	1020 "	9
	5351A (Dipole)	10
	5960	8
	FA 10153	8
	DB-510A	8
	1118 (ASII)	8
	5100 A-D UNIDIRECTIONAL	12 (Fig 131)
	510 A BD BIDIRECTIONAL	13 (Fig 132)
T	FA6239 (TRA-2)	7
A	FA6339 (MOD.. TRA-2)	9
C	YNI103A or YNI104A	6
A	AN/GRN9	9
N	GRA047 (Dipole)	6

**FIGURE 78. DME INTERSITE ANALYSIS BY CALCULATION**



**24. DME Calculation Example.** Refer to Figure 78. The DME facility separation, ESR, antenna pattern curves are used in these calculations. They are found in figures 39 through 47.

**a. The facilities are:** A= ILS-DME, 18 NM at 4500' on 993.0 MHz with a standard DME antenna;  
B= T-VOR/DME on 994.0 MHz with a standard DME antenna; N= a proposed new ILS-DME, 18 NM at 4500' with a bi-directional DME antenna.

**b. The proposed directional DME antenna** has its main beam pointed directly at the T-VOR/DME site. The FPSV of the T-VOR/DME is 25 NM at 12,000 feet, and has the larger FPSV. This will be checked first. N is the 1st adjacent channel to B, so D/U= -39 dB. (Paragraph 14e.)

$$\text{ESR} = \text{D/U} - P_D + P_U - A_D + A_U + G_U - G_D \text{ (Paragraph 21a)}$$

(1) **B is desired** and N undesired,

$$\begin{aligned} \text{ESR} &= -39 - 20 + 20 - 8 + 13 - 0 + 0 \\ &= \mathbf{-34 \text{ dB}} \end{aligned}$$

NOTE: With the non-directional VOR/DME antenna and the bi-directional DME pointed at 0° with respect to the VOR/DME location, both  $G_U$  and  $G_D$  are zero. Refer to figure 46 ESR curves for DME/TACAN at 1,000'. The VOR/DME is desired. By interpolation, a 25 NM FPSV at -34 dB requires a separation of (S) = 27 NM. The example shows a distance of 65 NM, B is protected.

(2) **N is desired** and A is undesired.

$$\begin{aligned} \text{ESR} &= +11 - 20 + 20 - 13 + 8 + 0 - (-6.25) \\ &= \mathbf{+12.25 \text{ dB}} \end{aligned}$$

NOTE: N's critical point is 35° off its own main beam. Refer to figure 132.  $G_D$  is -6.5 dB off the main beam,  $G_U$  is 0 dB. Refer to figures 42 and 43 curves for DME/TACAN at ESR = 12.25 dB. By interpolation, a 10 NM FPSV at +12.25 dB requires a separation of (S) = 85 NM.

$$\begin{aligned} (S) &= d_D + d_U \text{ (paragraph 21d)} \\ &= 10 + 95 \\ &= 105 \text{ NM} \geq 85 \text{ NM, N is protected} \end{aligned}$$

(3) **A is desired** and N is undesired

$$\begin{aligned} \text{ESR} &= +11 - 20 + 20 - 8 + 13 + (-9.5) - 0 \\ &= \mathbf{+6.5 \text{ dB}} \end{aligned}$$

Note: A is 48° off the backside of N's bi-directional antenna. Refer to figure 132.  $G_U$  is -9.5 dB off the rear beam,  $G_D$  is 0. Refer to figures 40 and 41 curves for DME/TACAN at ESR = +6.5 dB. By interpolation, an 18 NM FPSV requires a separation of (S) = 92 NM. The example shows a distance of 95 NM, A is protected.



**25. ILS MARKERS.** Markers are continuously operating low power transmitters, with antennas radiating signals in an upward direction in a fan shape. They are to indicate to the pilot flying a course that the aircraft has passed over a particular point on the ground below.

**a. Markers** are located at specified distances from the touchdown point on a runway, and are called "Inner", "Middle", "Outer" and "Back Course" markers (IM, MM, OM and BCM).

**b. Each Marker** has its own distinctive type identification. The exact identification is:

(1) **OM:** — — — — — (continuous dashes @ 400 Hz)

(2) **MM:** ----- (alternating dots and dashes @ 1300 Hz)

(3) **IM:** ..... (continuous dots @ 3000 Hz)

(4) **BCM:** ..... (alternating pairs of dots @ 3000 Hz)

**c. Marker frequency is 75.000 MHz.** It is used for all markers, world-wide. Protection between adjacent area Markers is provided by the narrow upward antenna radiation pattern. Power and pattern are determined by Flight Inspection at the time of commissioning of the facility. Normally, the FMO is not required to do any frequency engineering. Occasionally, parallel runways close together may have the markers tuned offset in frequency to prevent RFI between the sites.

**26. THRU 30. RESERVED.**

**FIGURE 79. LOC FACILITY SEPARATION CURVES FOR ESR = -52 dB**

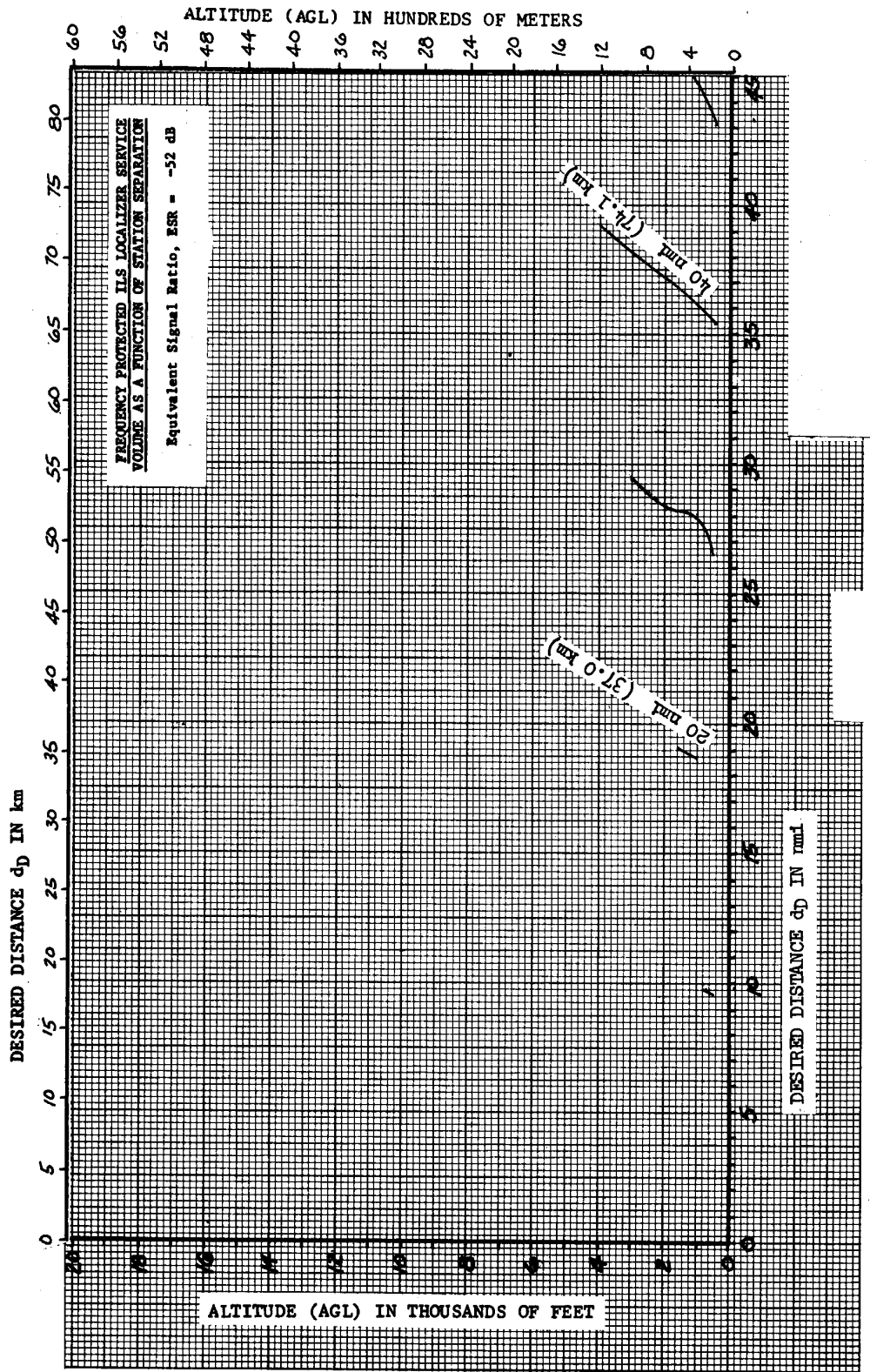


FIGURE 80. LOC FACILITY SEPARATION CURVES FOR ESR = -49 dB

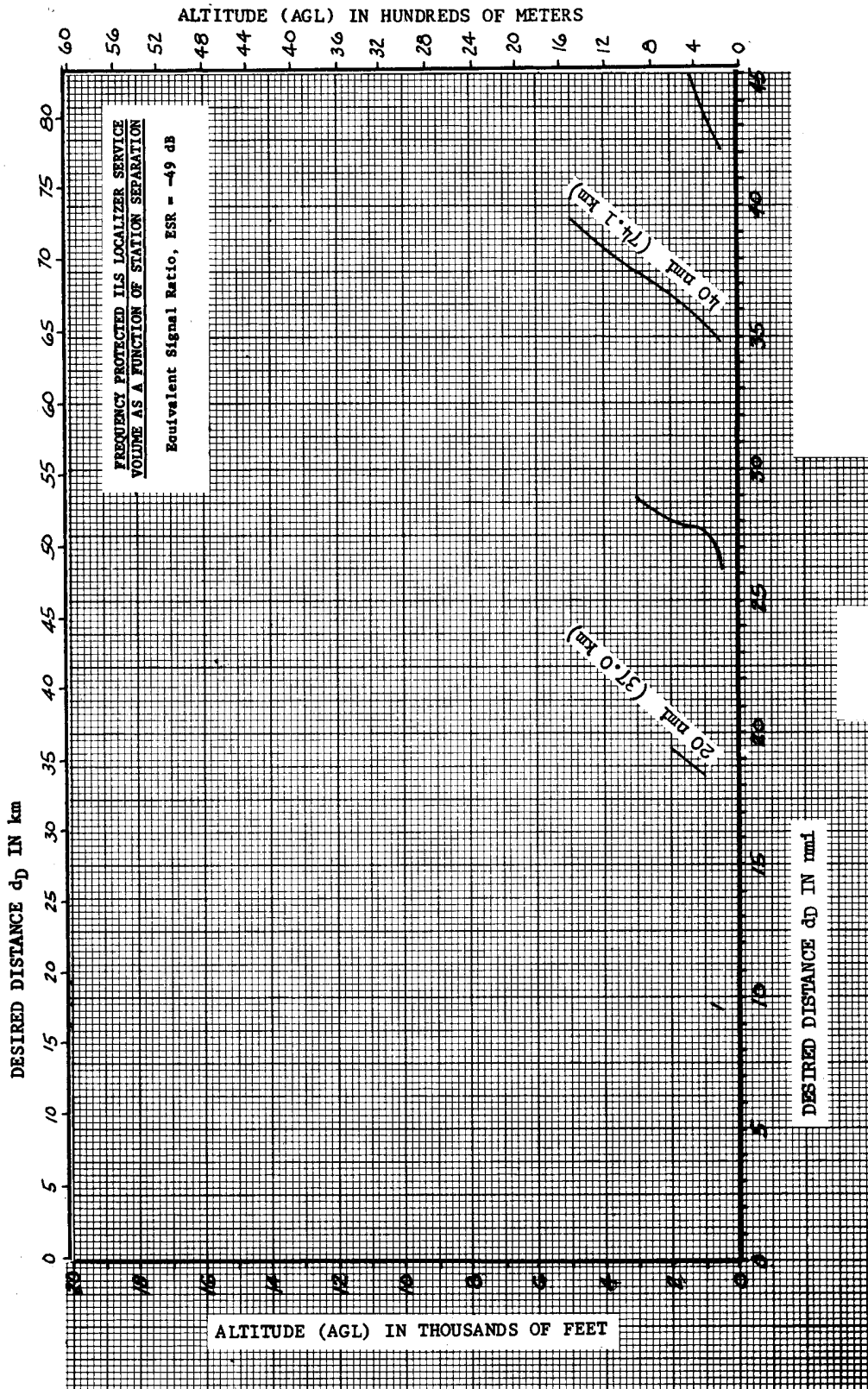


FIGURE 81. LOC FACILITY SEPARATION CURVES FOR ESR = -46 dB

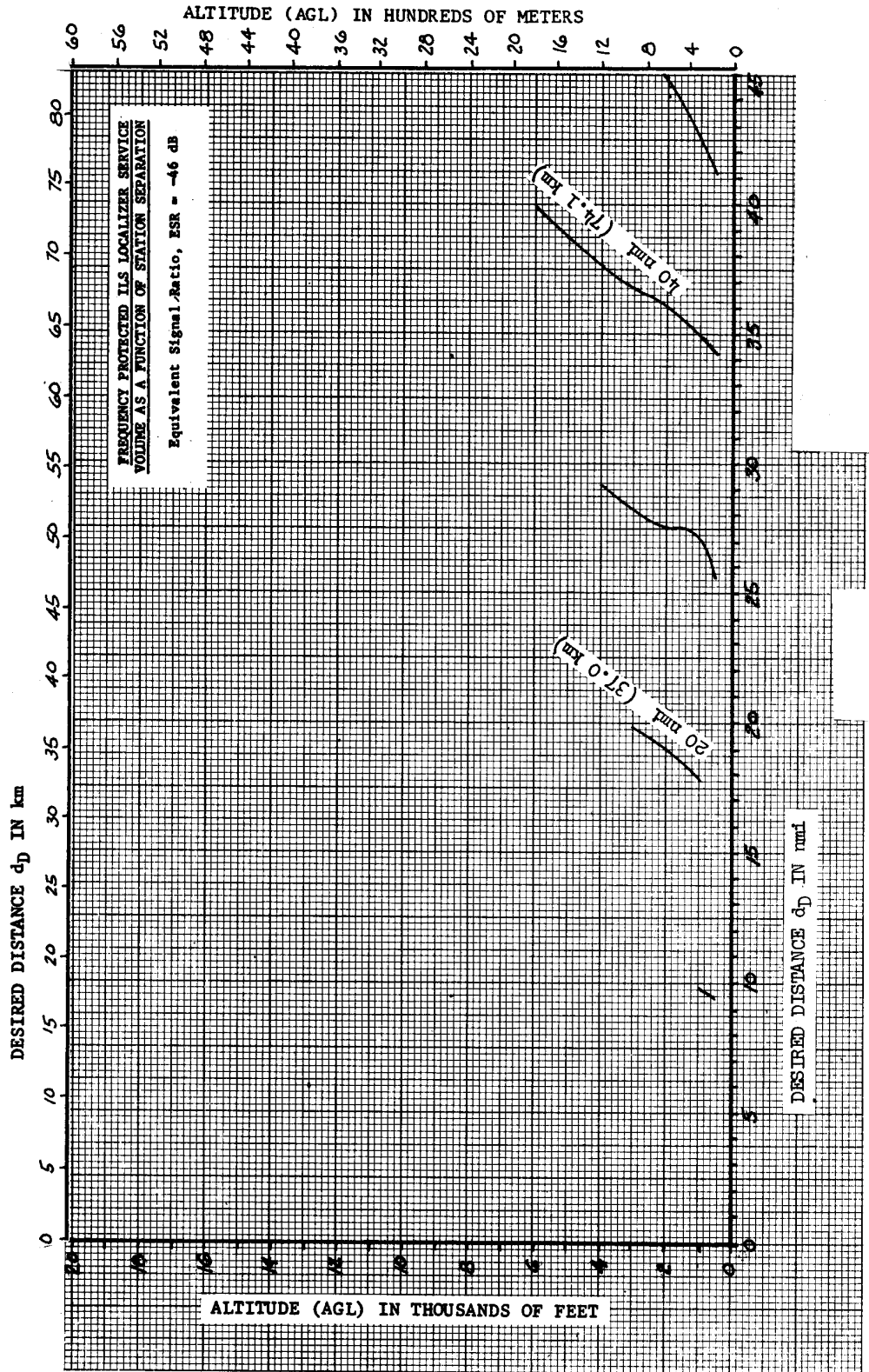


FIGURE 82. LOC FACILITY SEPARATION CURVES FOR ESR = -43 dB

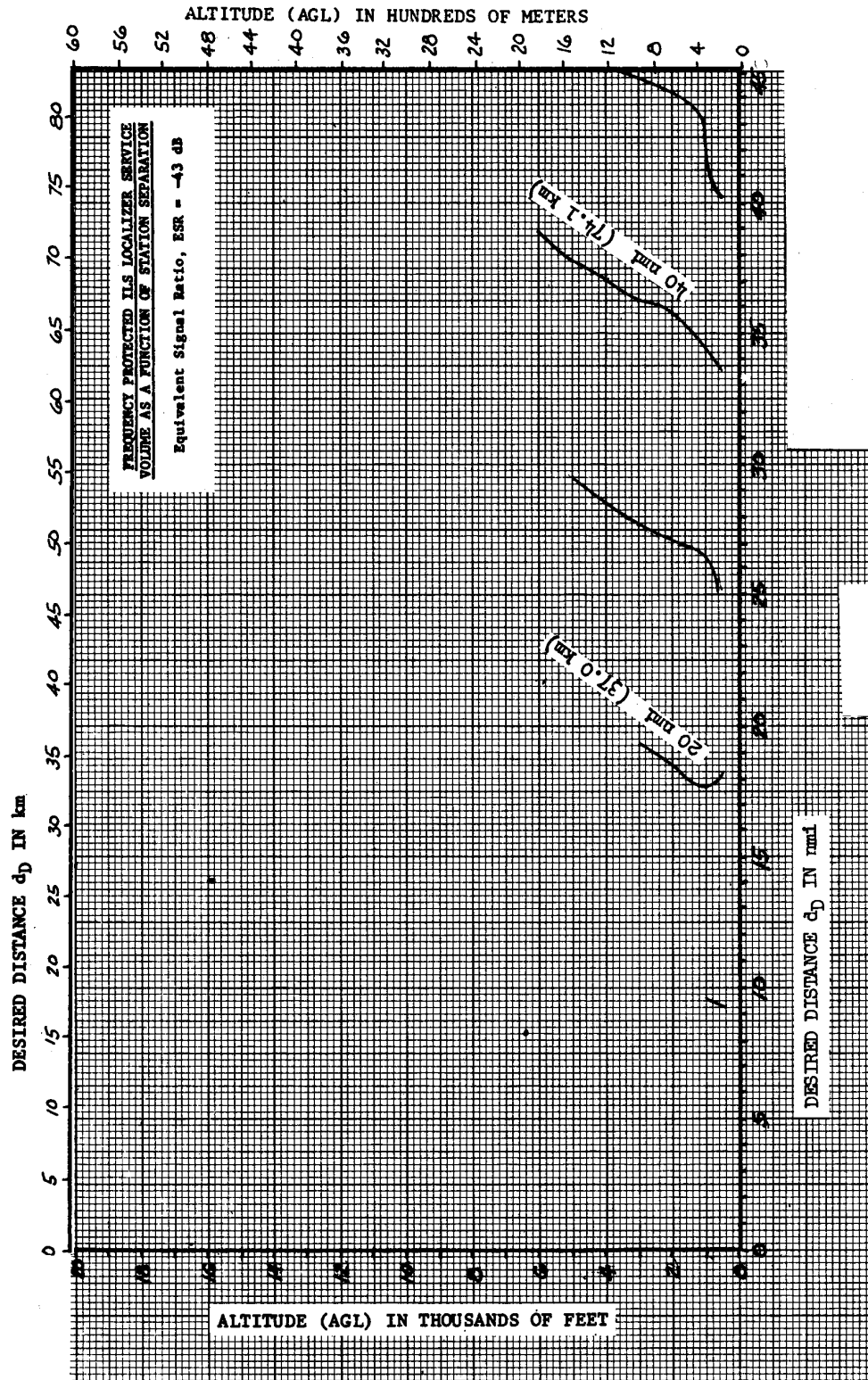


FIGURE 83. LOC FACILITY SEPARATION CURVES FOR ESR = -40 dB

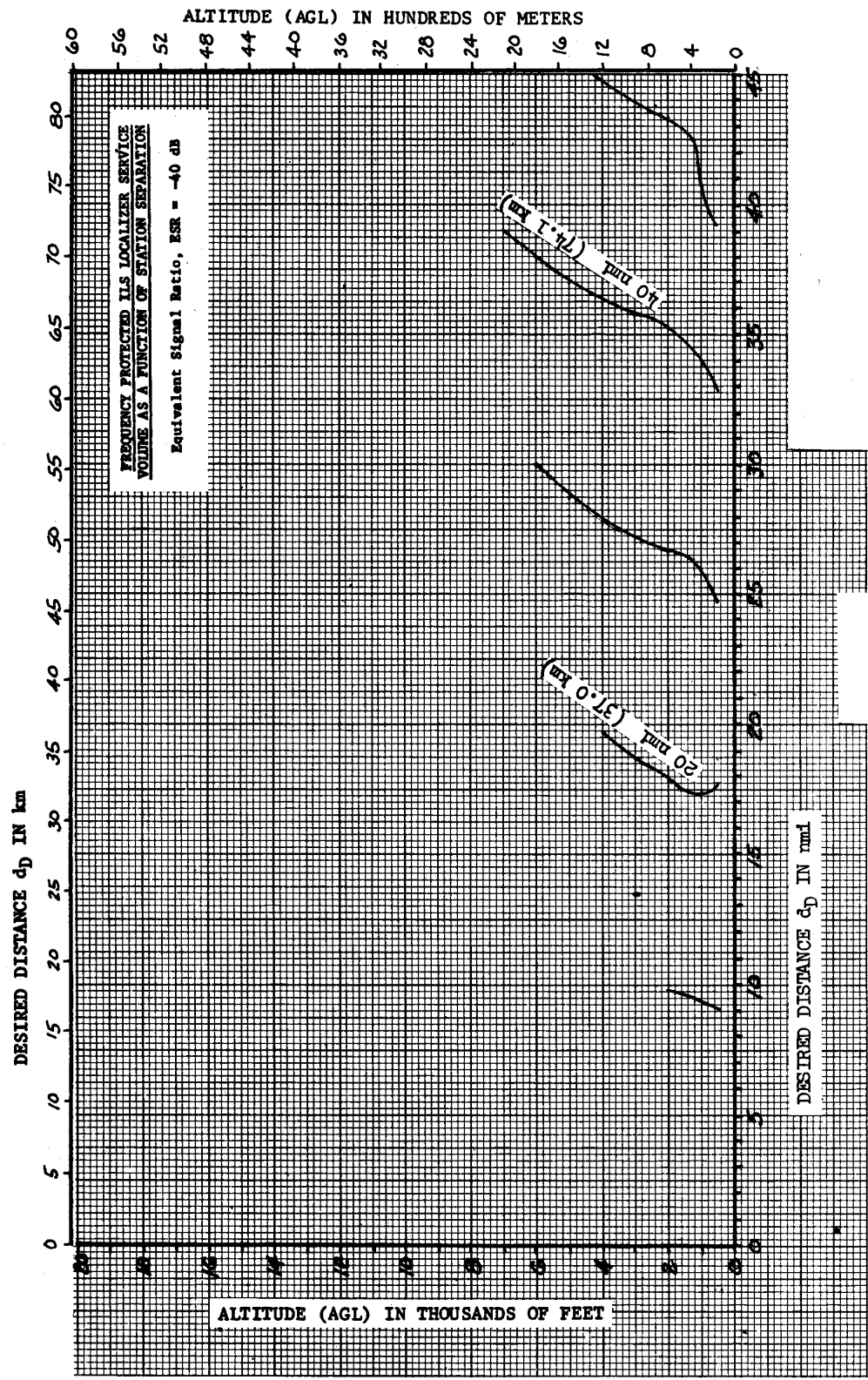


FIGURE 84. LOC FACILITY SEPARATION CURVES FOR ESR = -37 dB

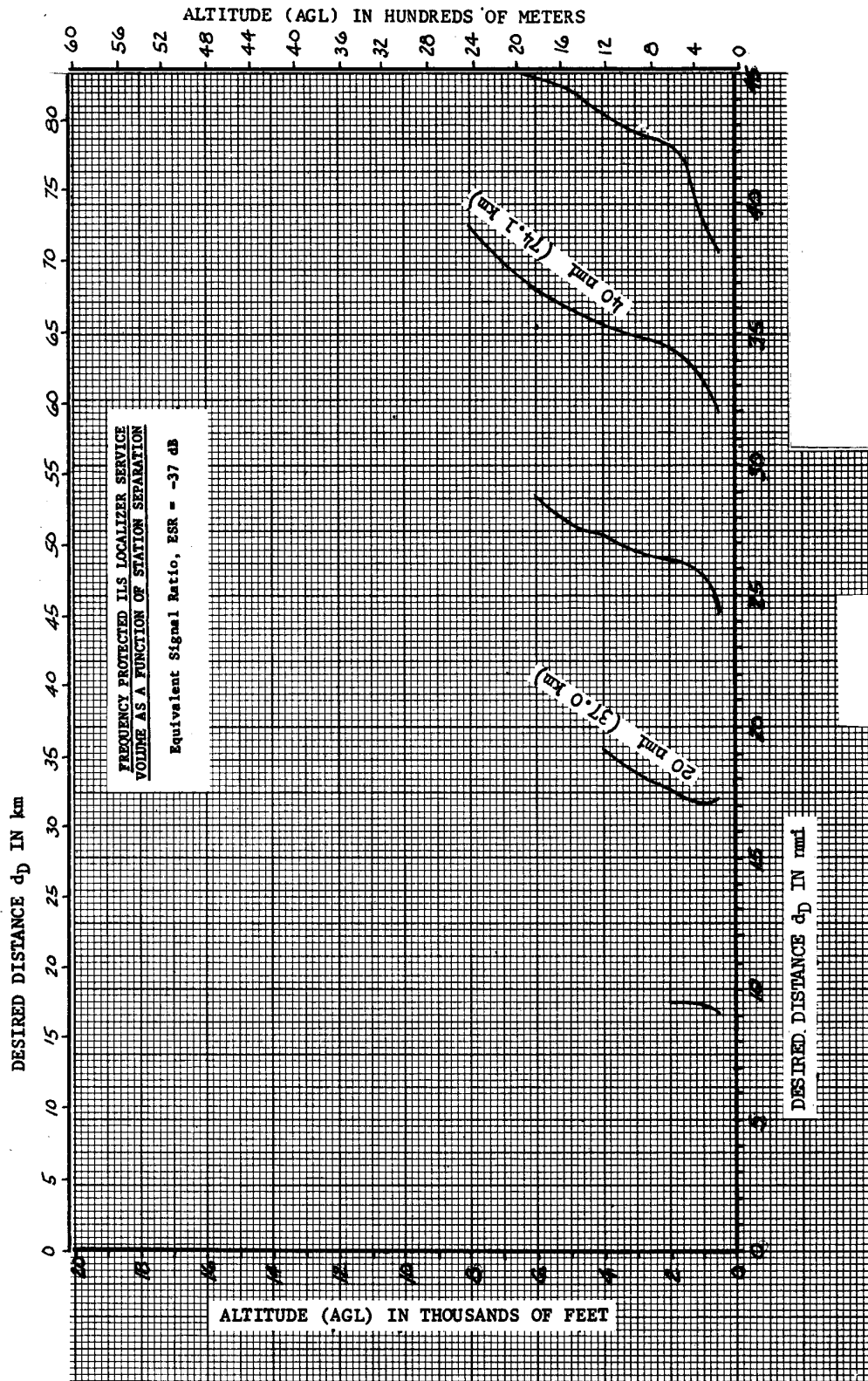


FIGURE 85. LOC FACILITY SEPARATION CURVES FOR ESR = -34 dB

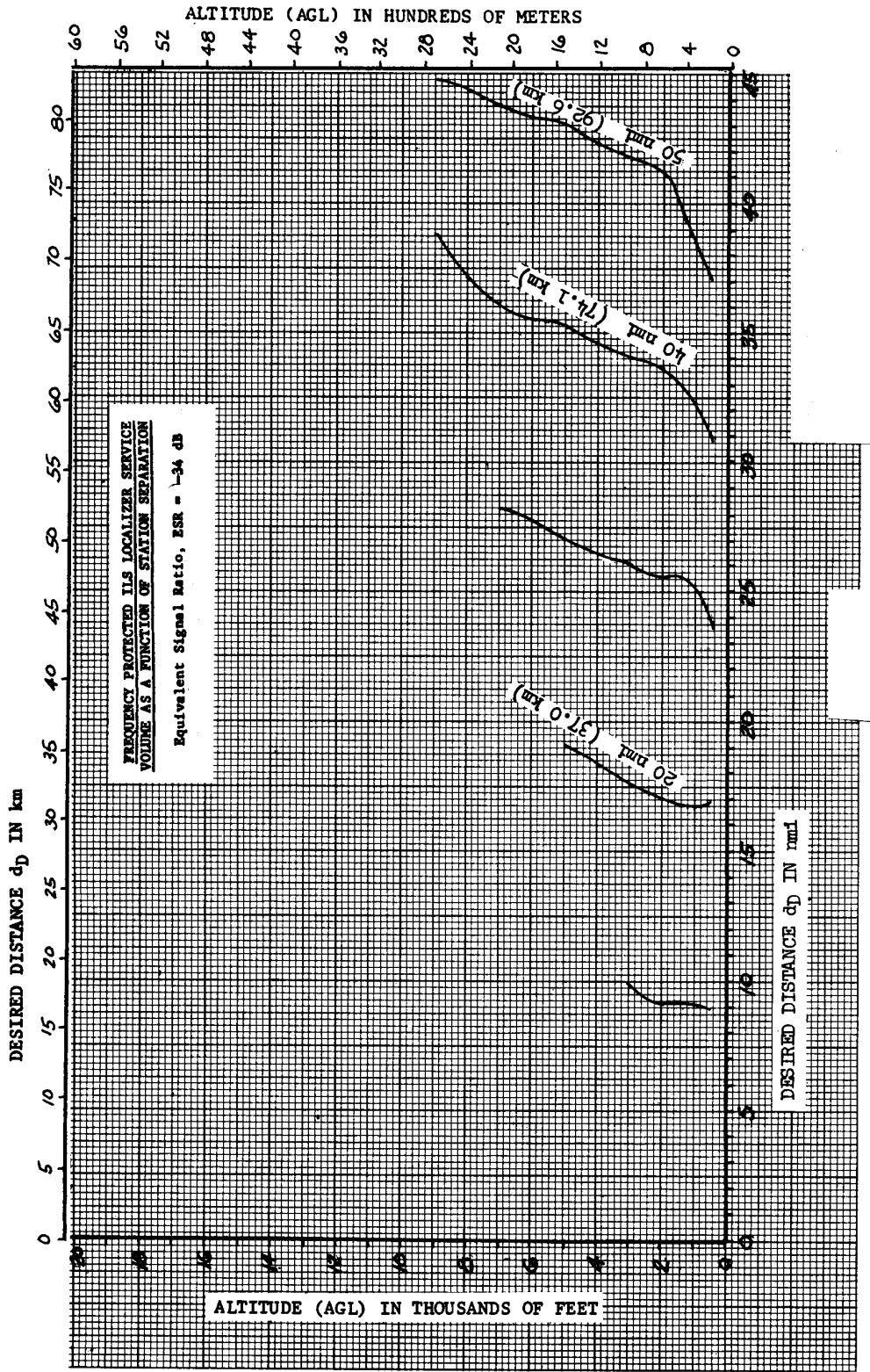




FIGURE 86. LOC FACILITY SEPARATION CURVES FOR ESR = -31 dB

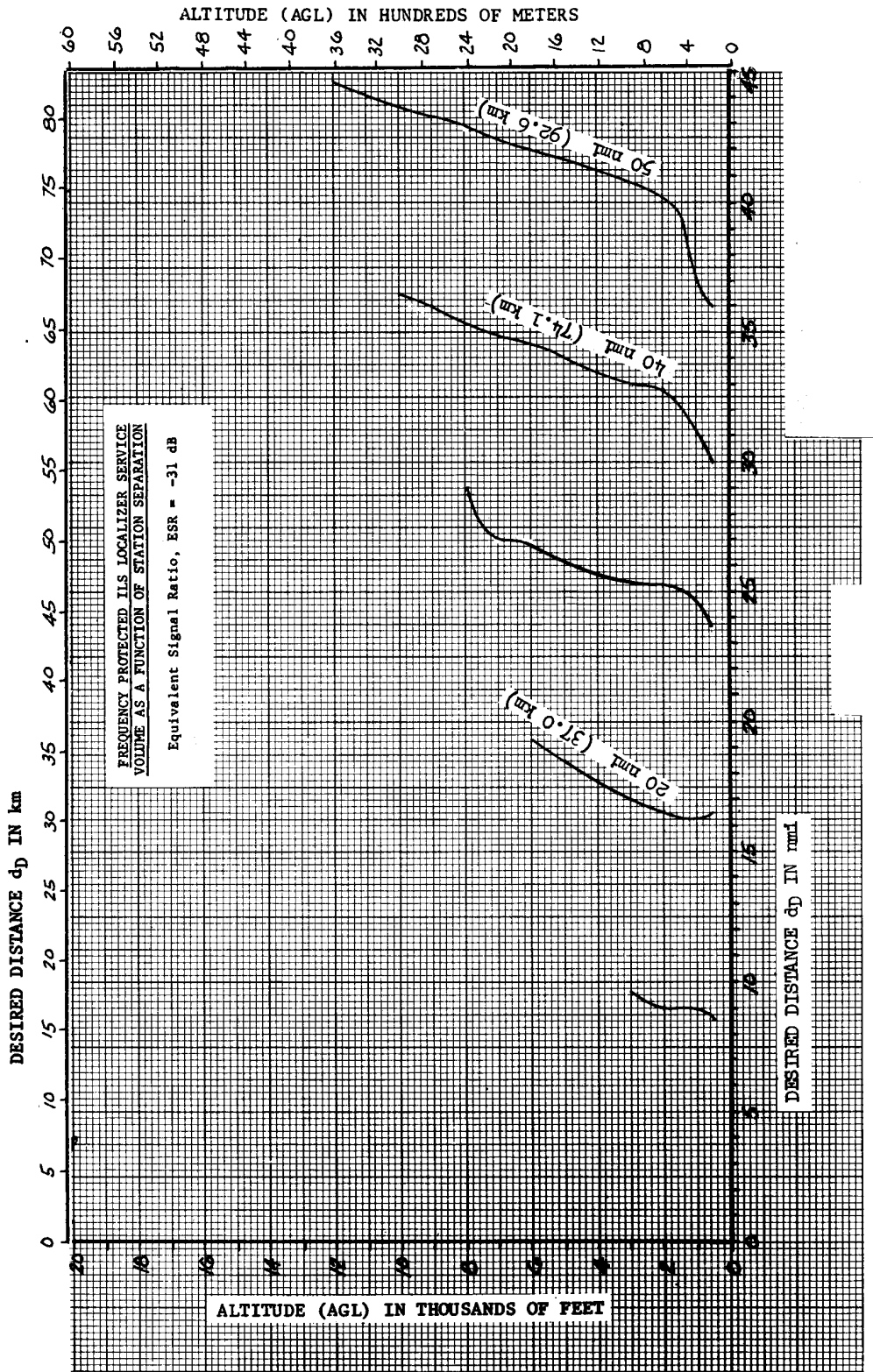


FIGURE 87. LOC FACILITY SEPARATION CURVES FOR ESR = -28 dB

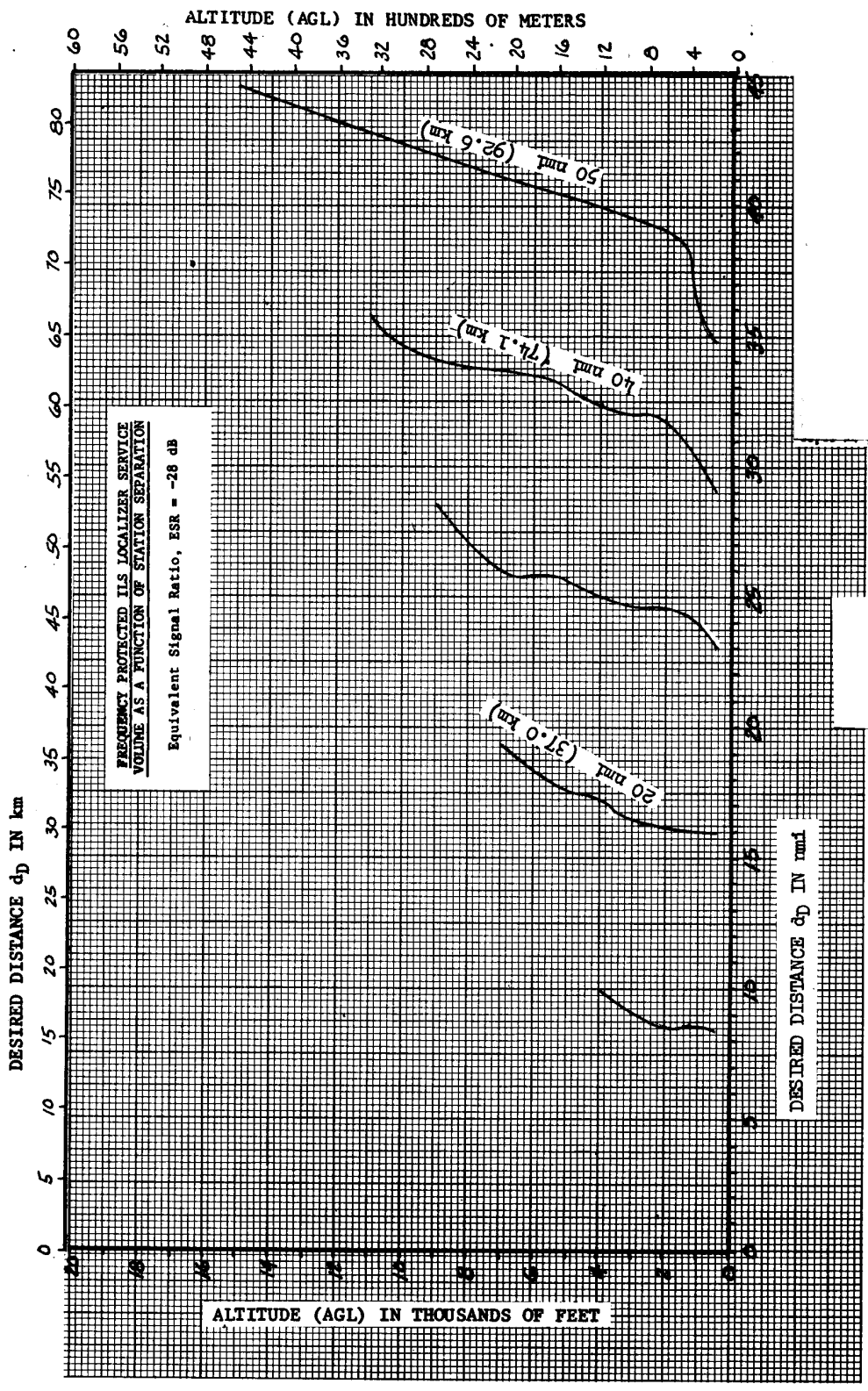


FIGURE 88. LOC FACILITY SEPARATION CURVES FOR ESR = -25 dB

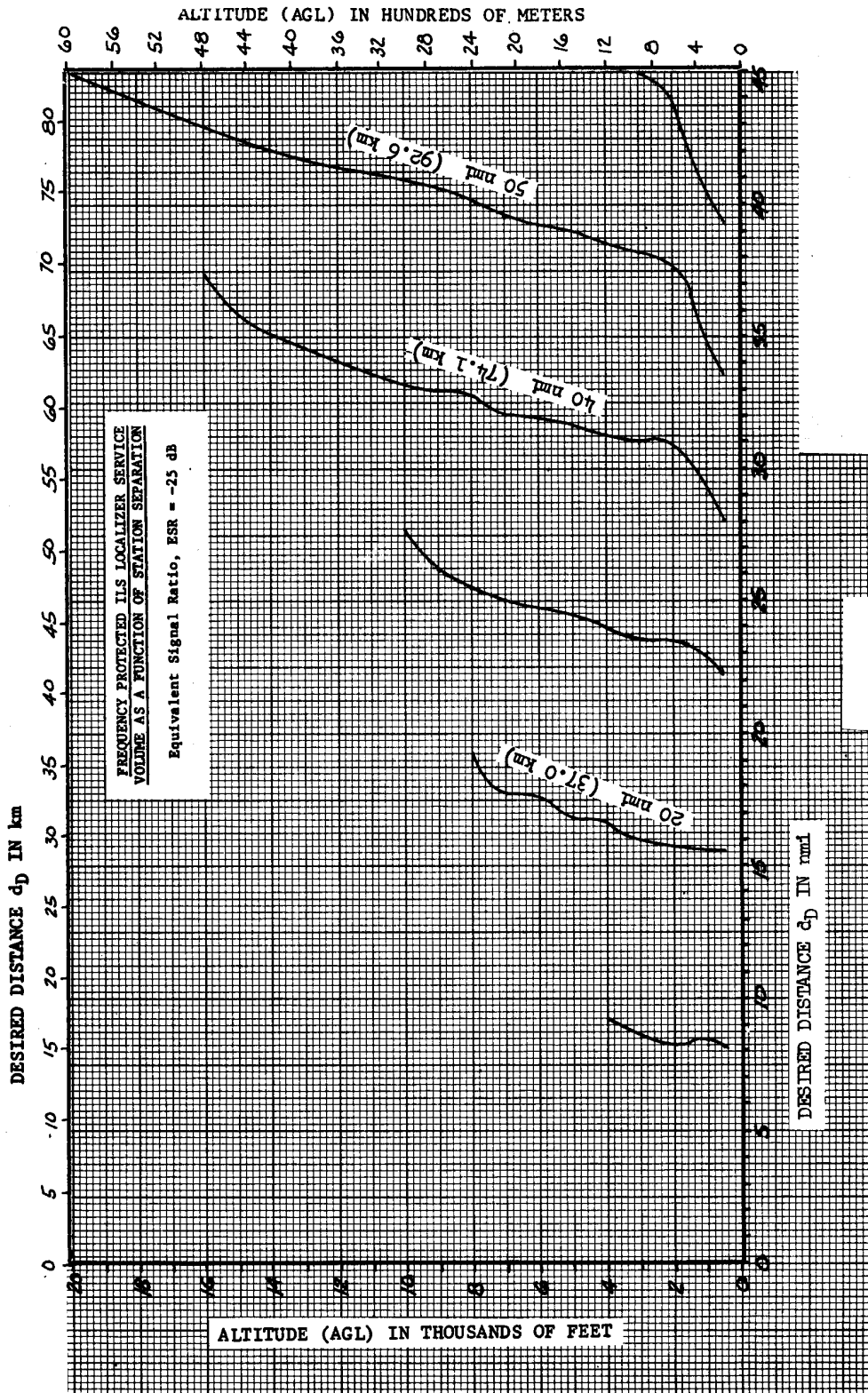


FIGURE 89. LOC FACILITY SEPARATION CURVES FOR ESR = -22 dB

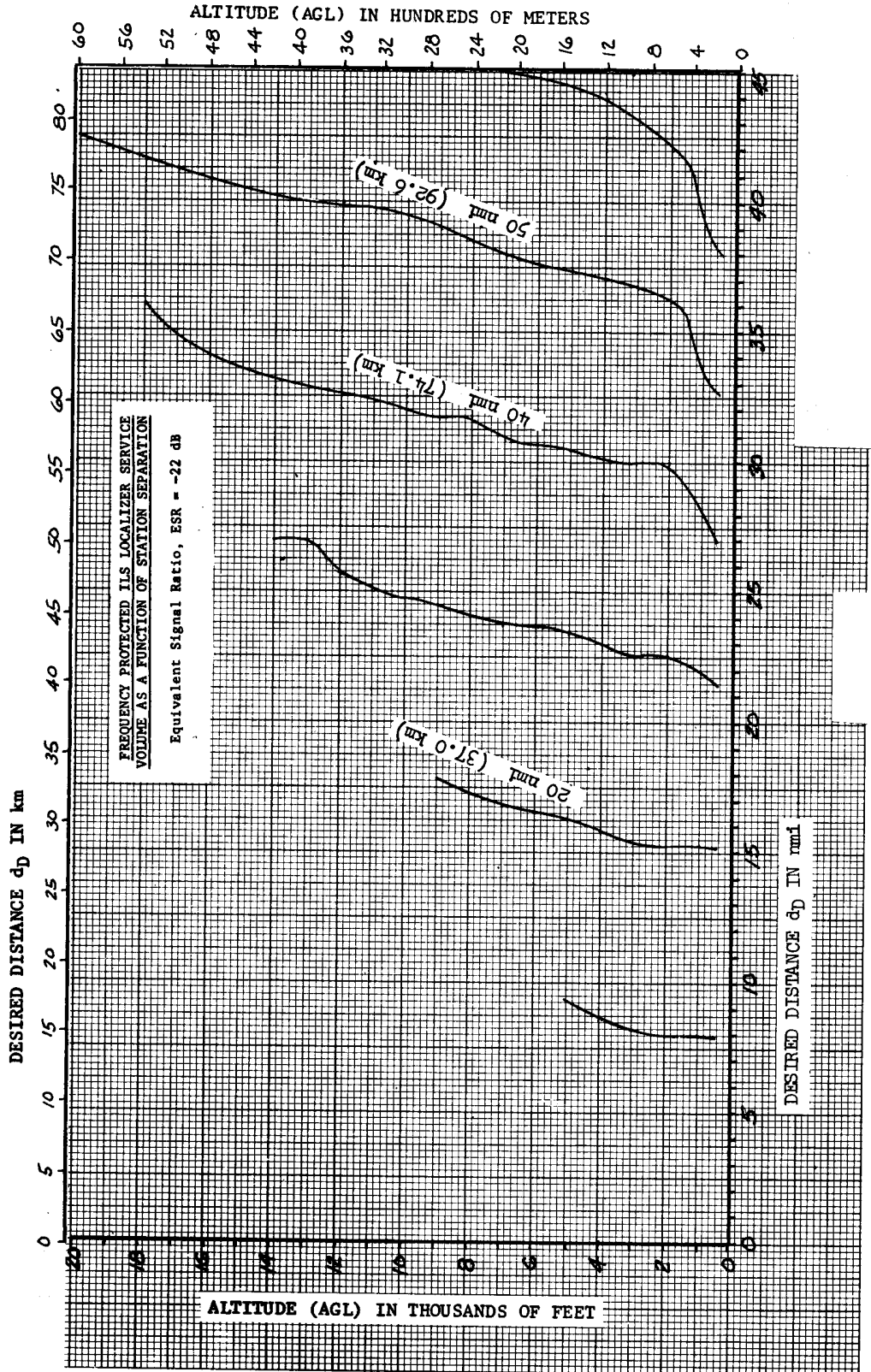


FIGURE 90. LOC FACILITY SEPARATION CURVES FOR ESR = -19 dB

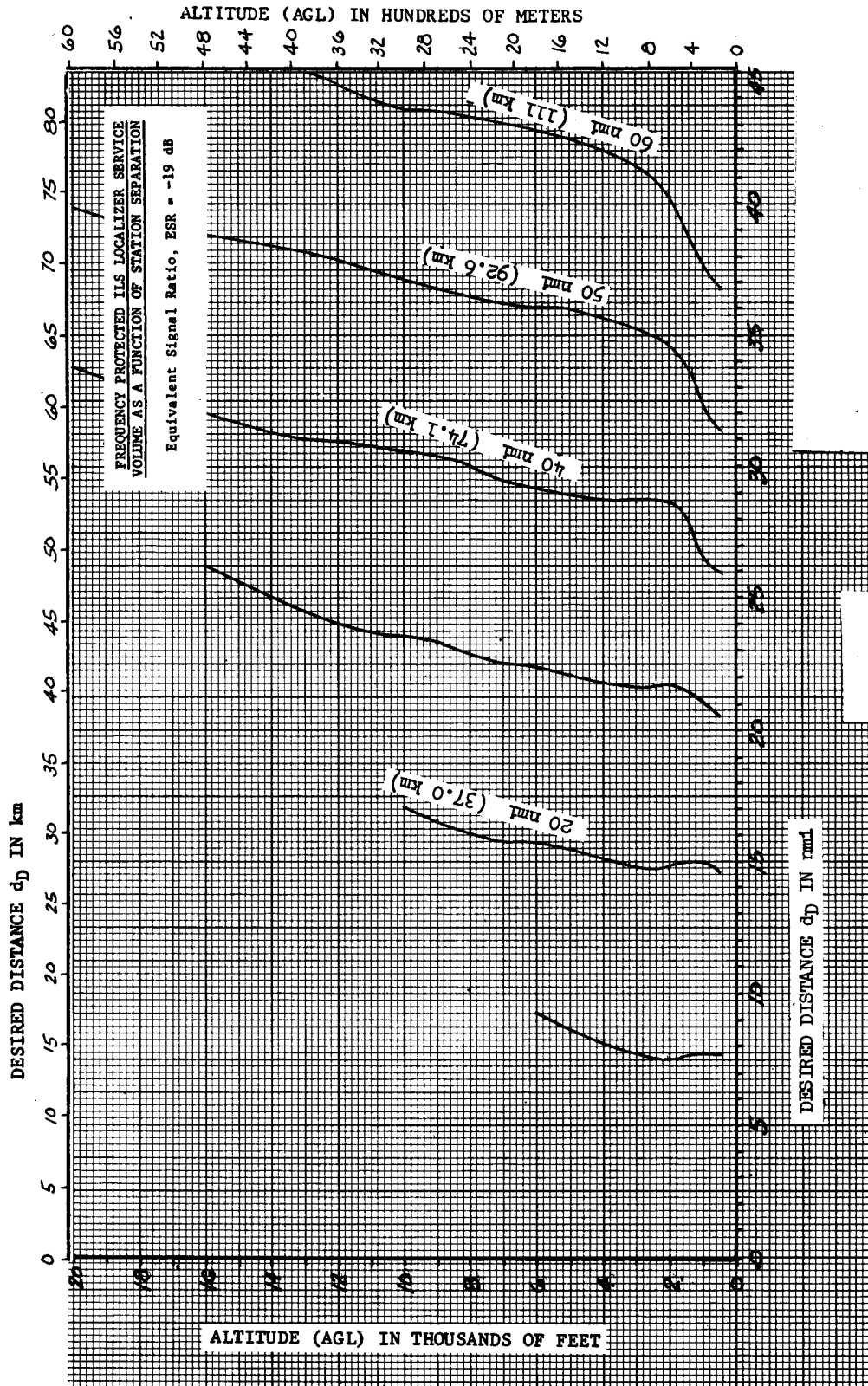


FIGURE 91. LOC FACILITY SEPARATION CURVES FOR ESR = -16 dB

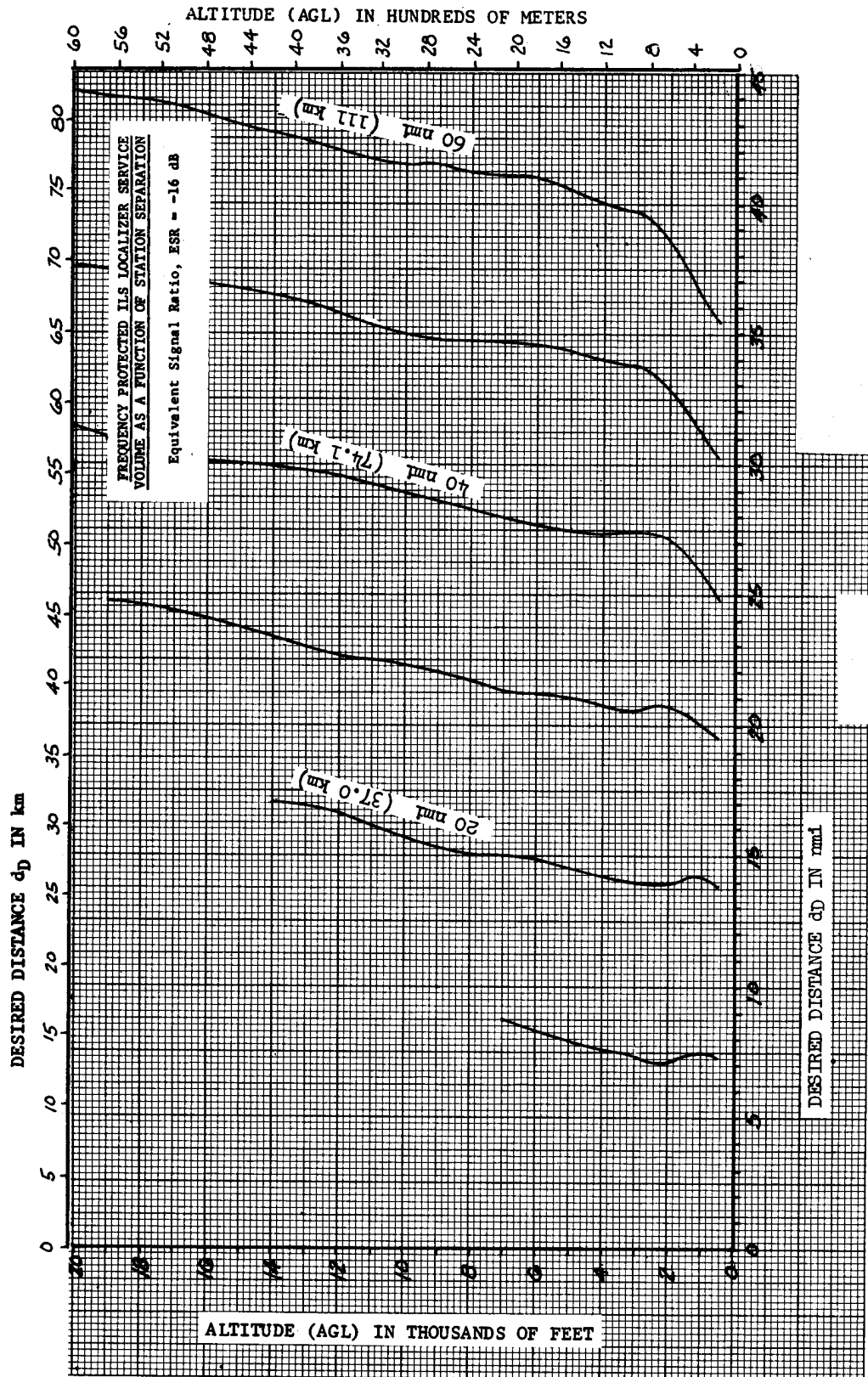


FIGURE 92. LOC FACILITY SEPARATION CURVES FOR ESR = -13 dB

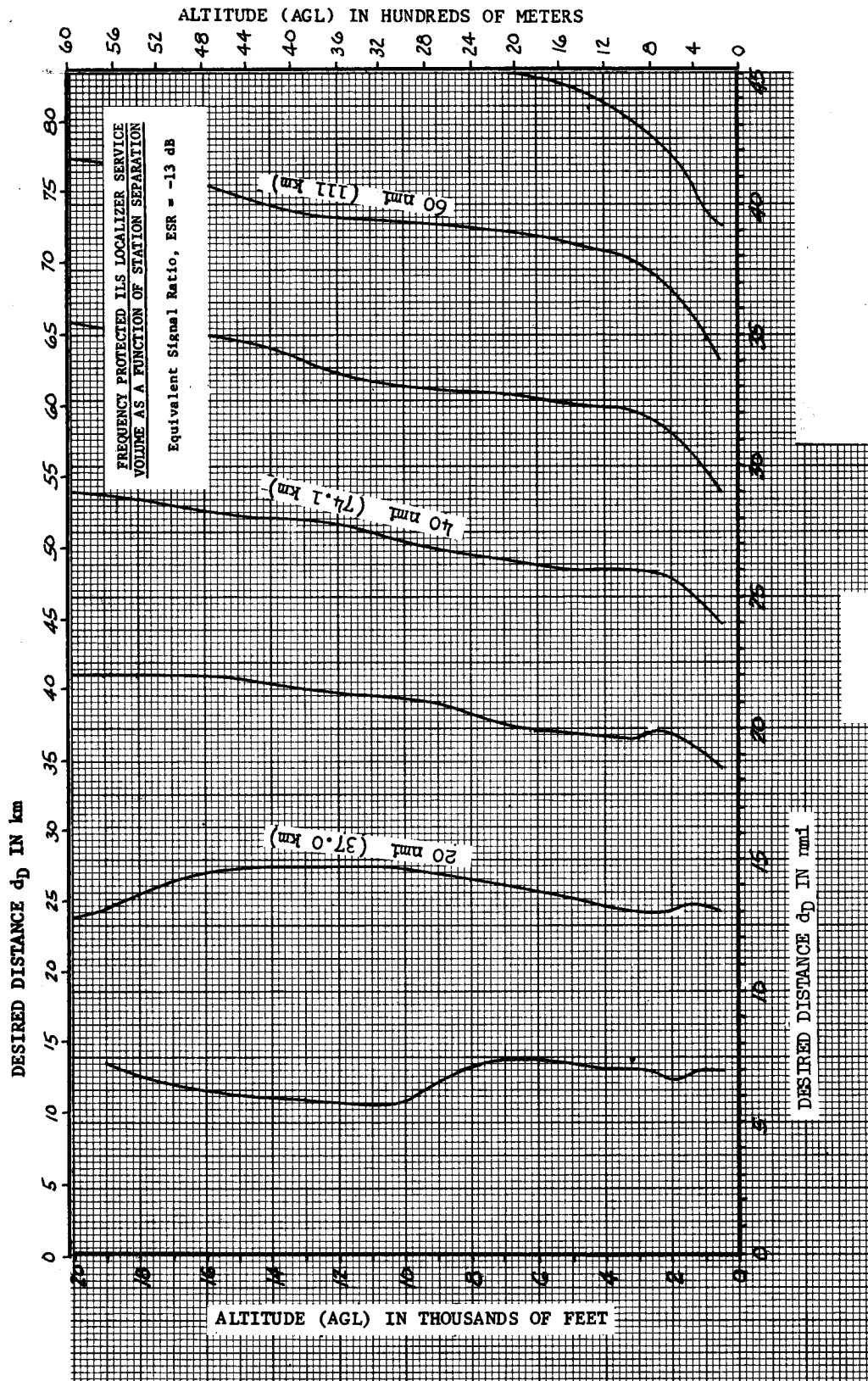


FIGURE 93. LOC FACILITY SEPARATION CURVES FOR ESR = -10 dB

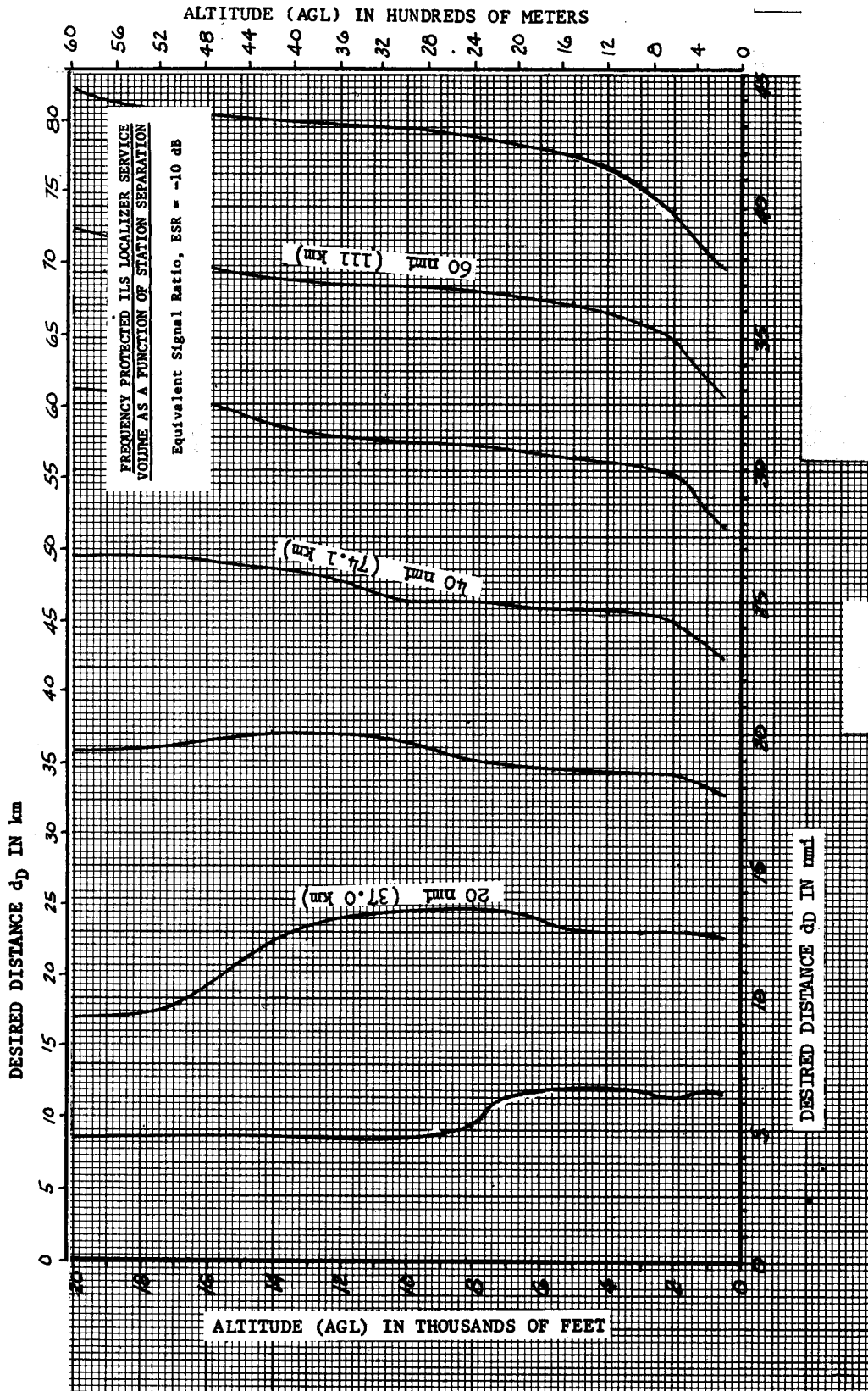




FIGURE 94. LOC FACILITY SEPARATION CURVES FOR ESR = -7 dB

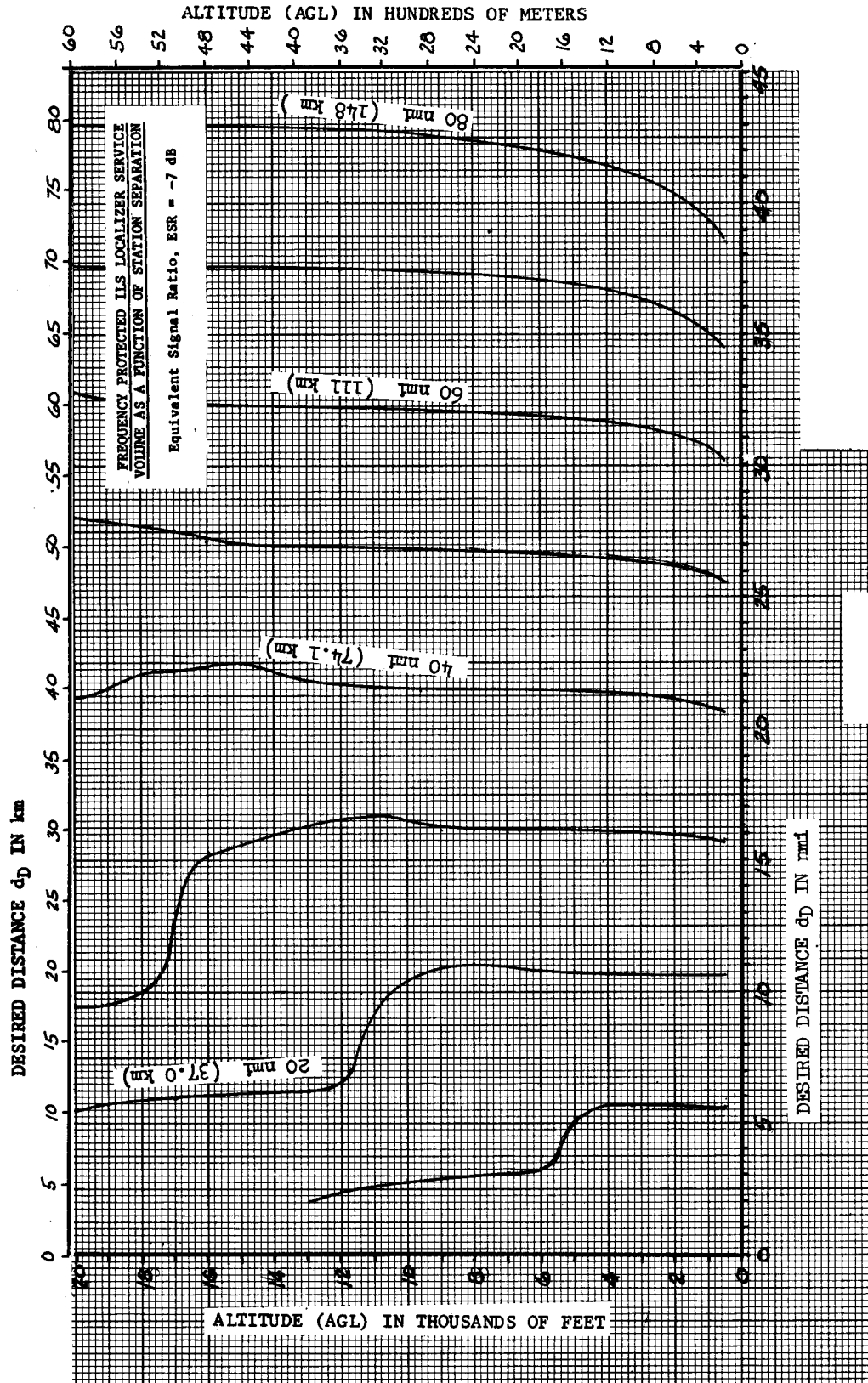


FIGURE 95. LOC FACILITY SEPARATION CURVES FOR ESR = -4 dB

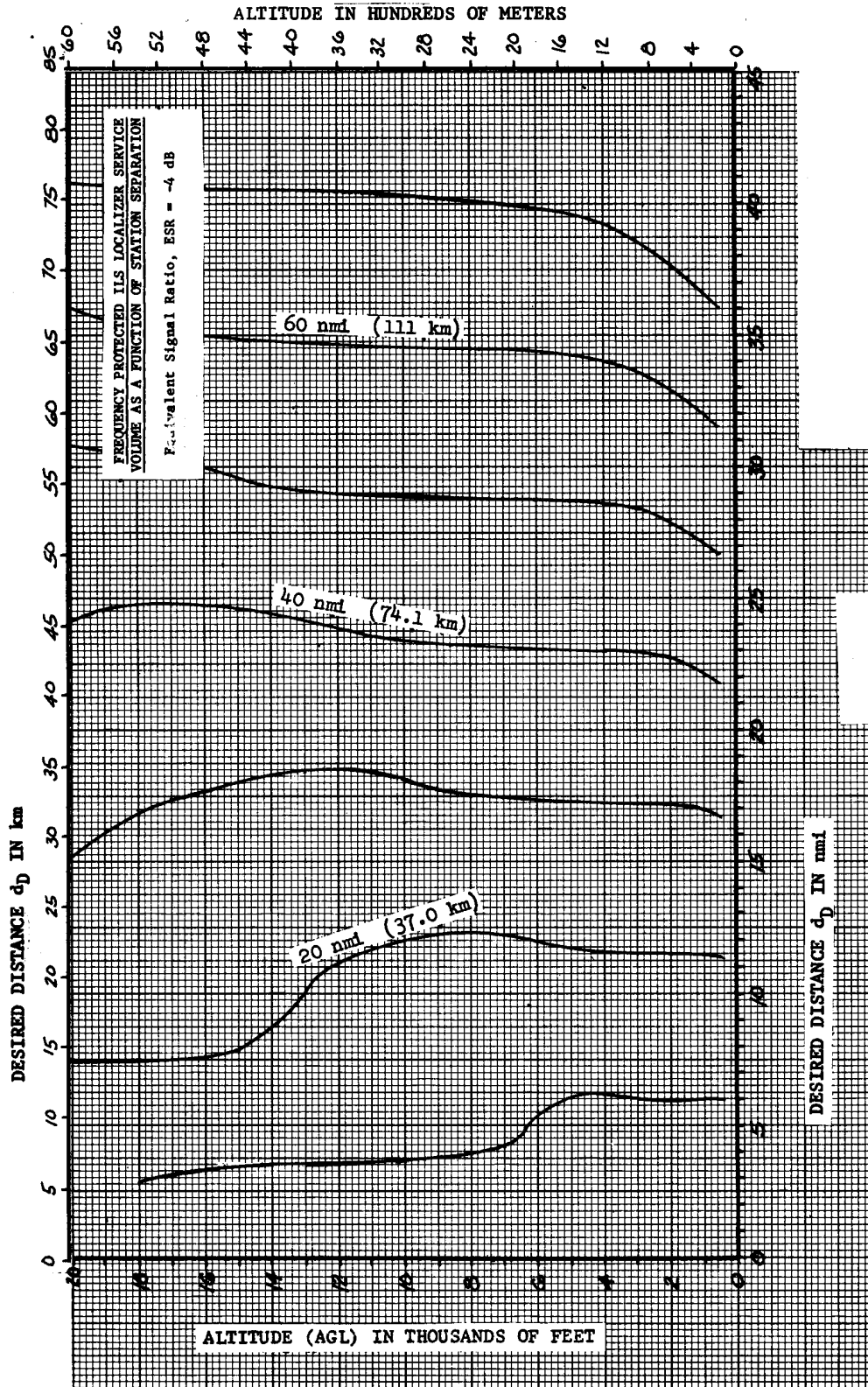


FIGURE 96. LOC FACILITY SEPARATION CURVES FOR ESR = -1 dB

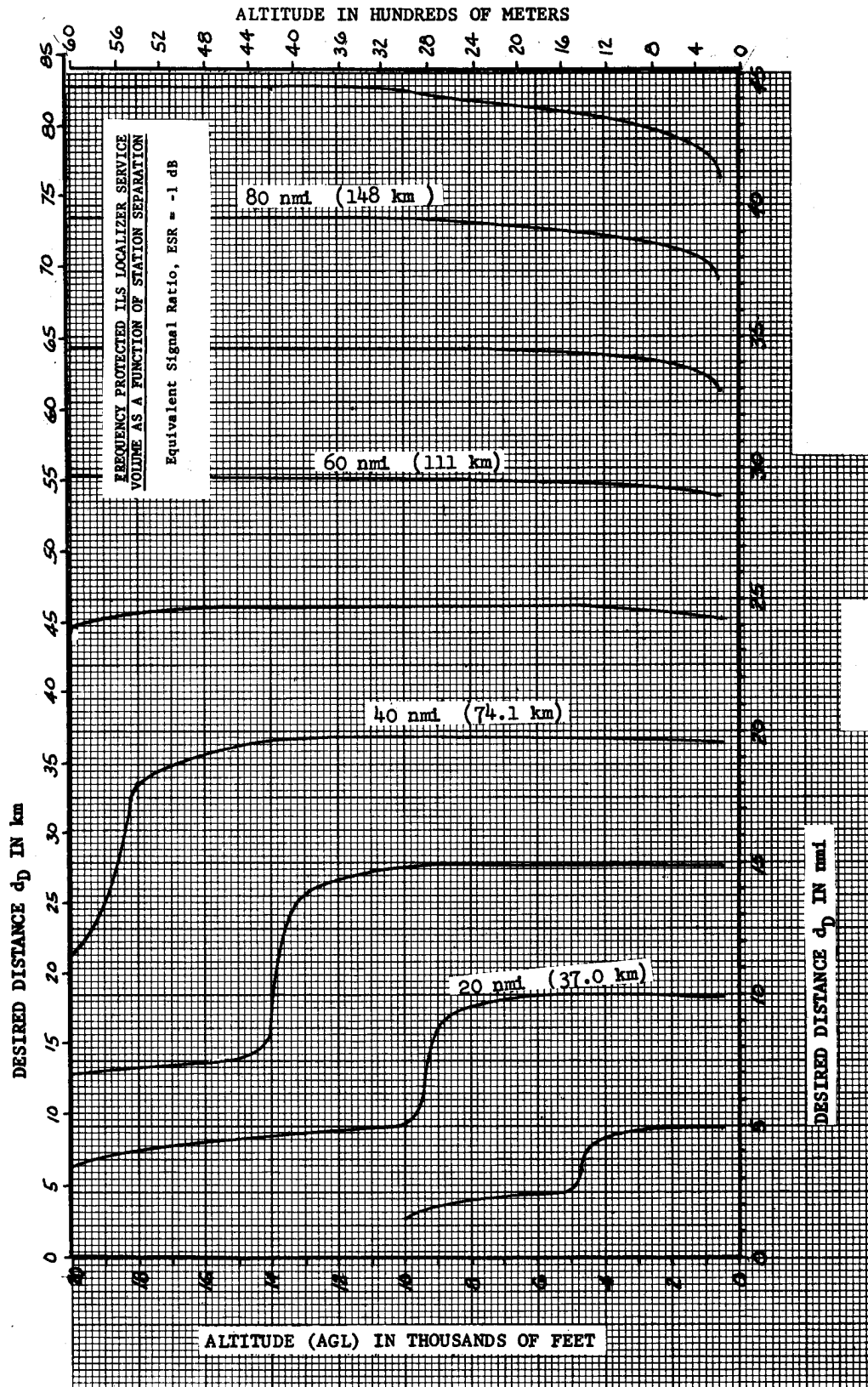


FIGURE 97. LOC FACILITY SEPARATION CURVES FOR ESR = +2 dB

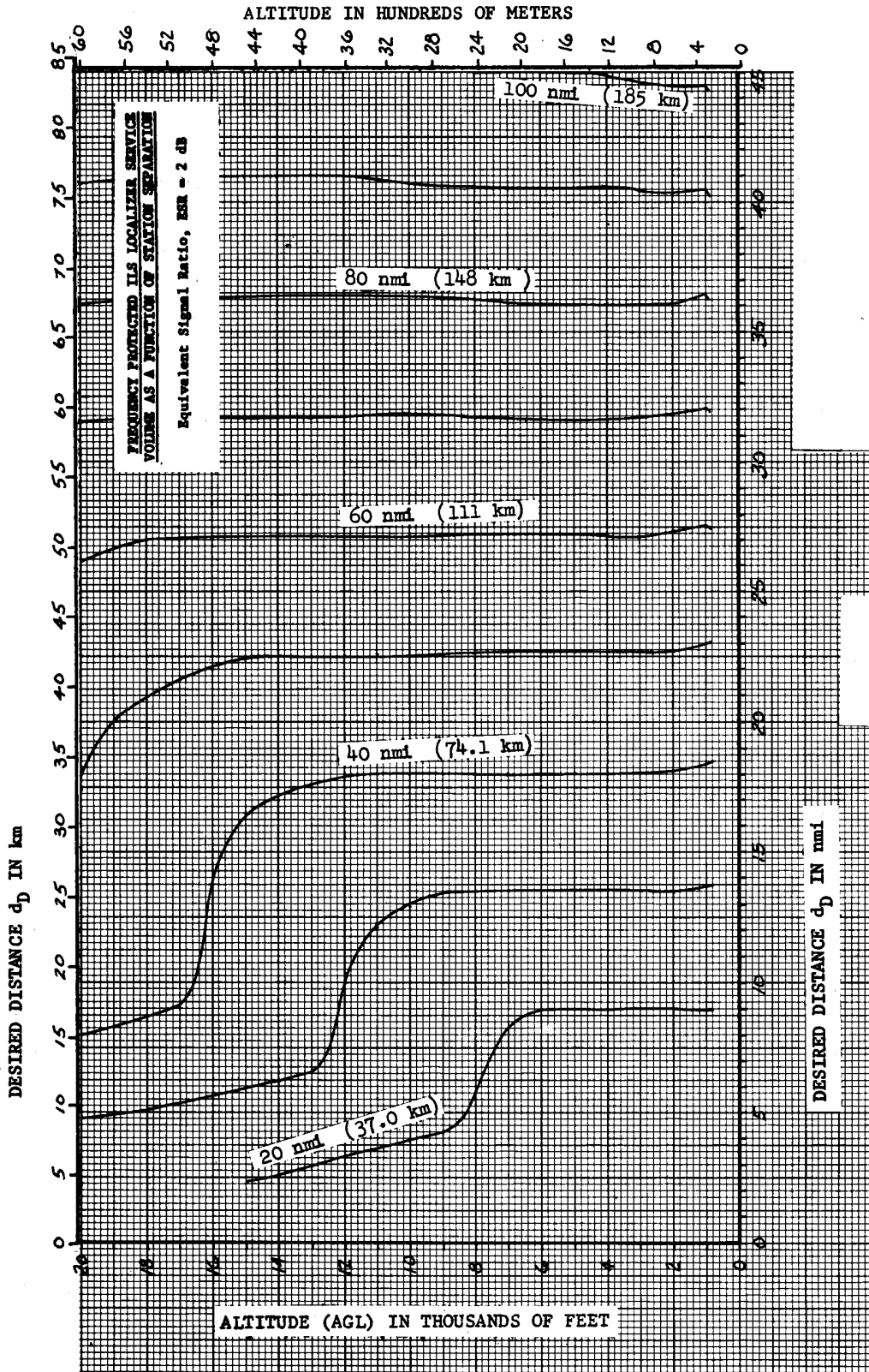


FIGURE 98. LOC FACILITY SEPARATION CURVES FOR ESR = +5 dB

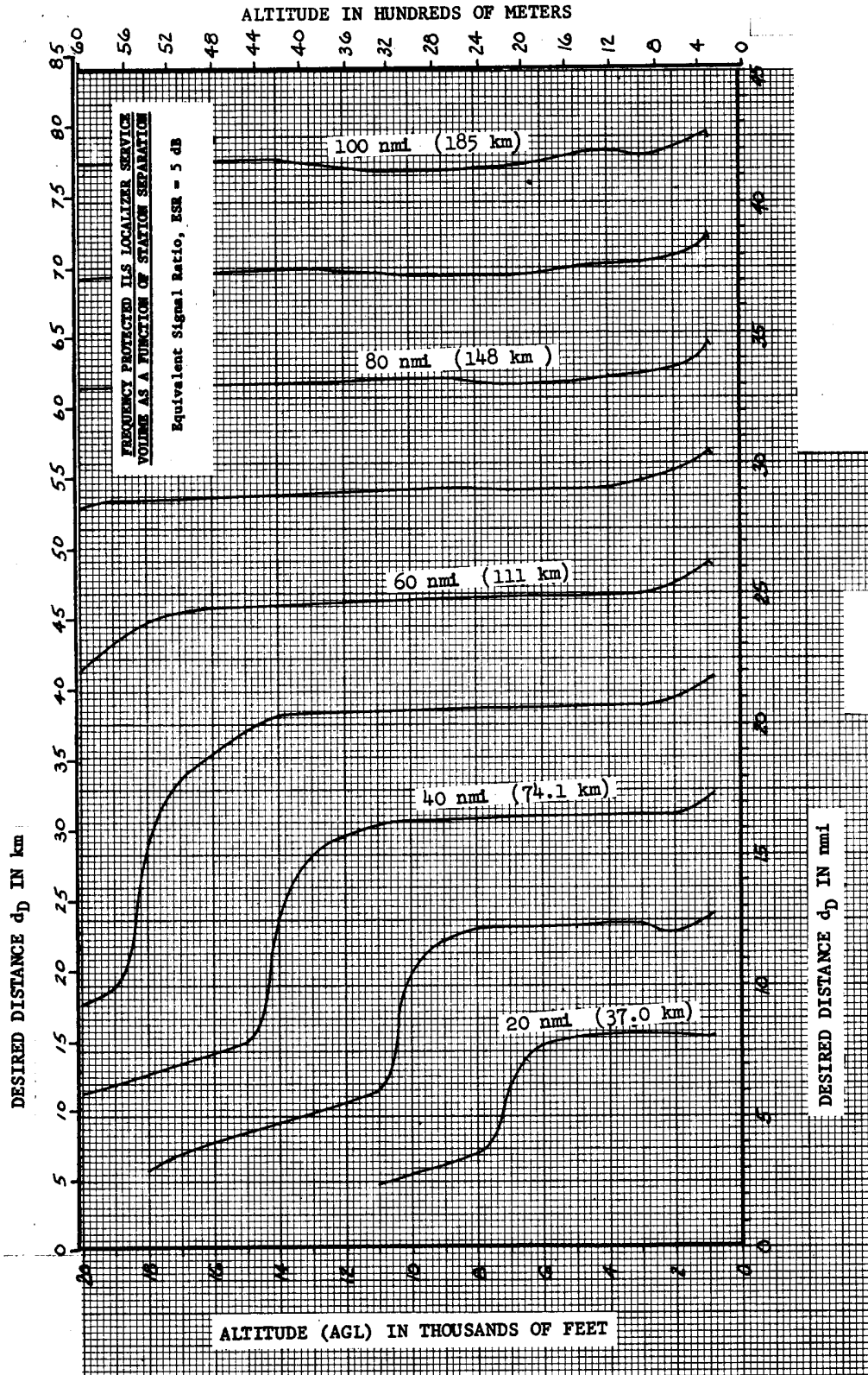


FIGURE 99. LOC FACILITY SEPARATION CURVES FOR ESR = +8 dB

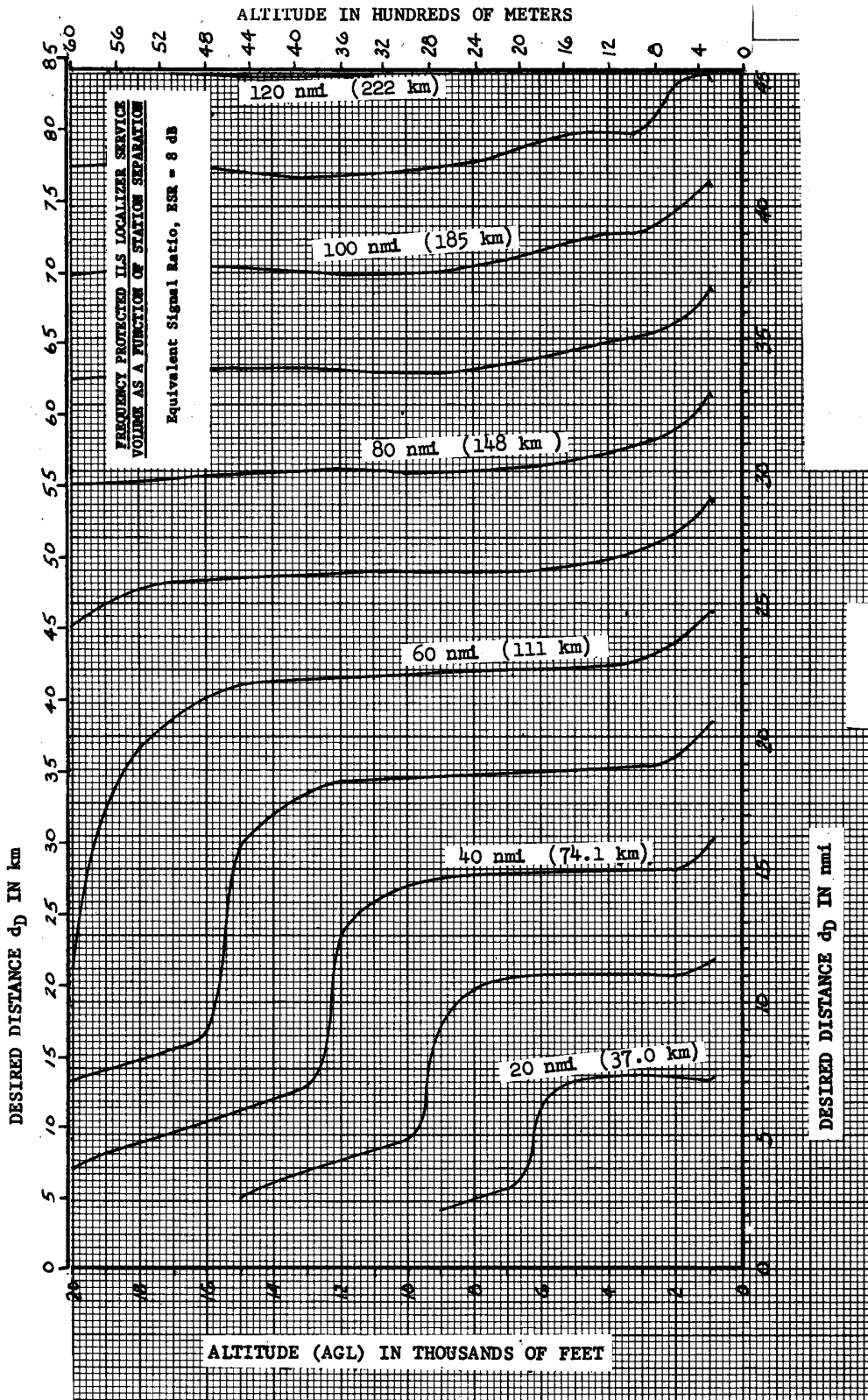


FIGURE 100. LOC FACILITY SEPARATION CURVES FOR ESR = +11 dB

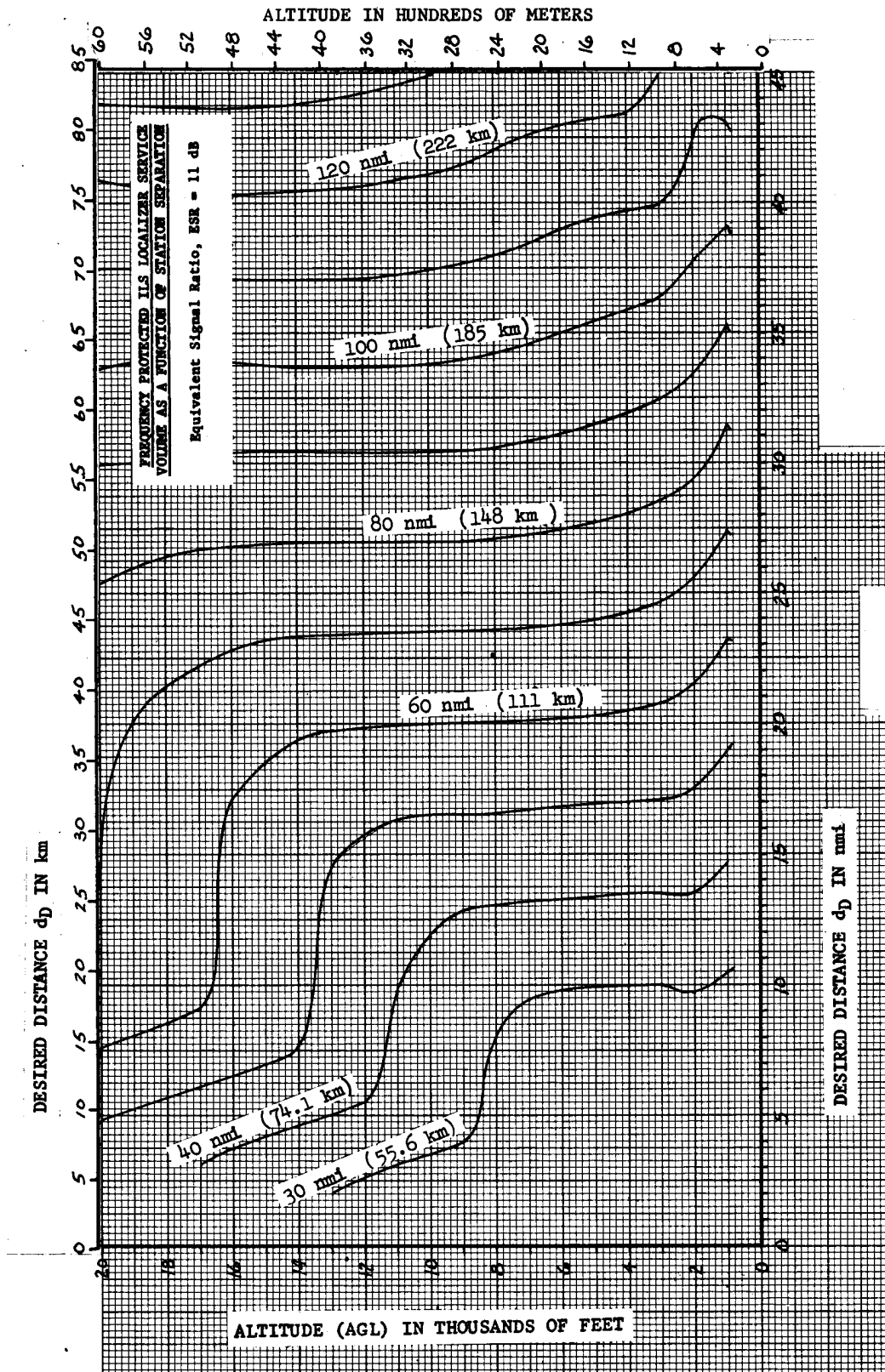


FIGURE 101. LOC FACILITY SEPARATION CURVES FOR ESR = +14 dB

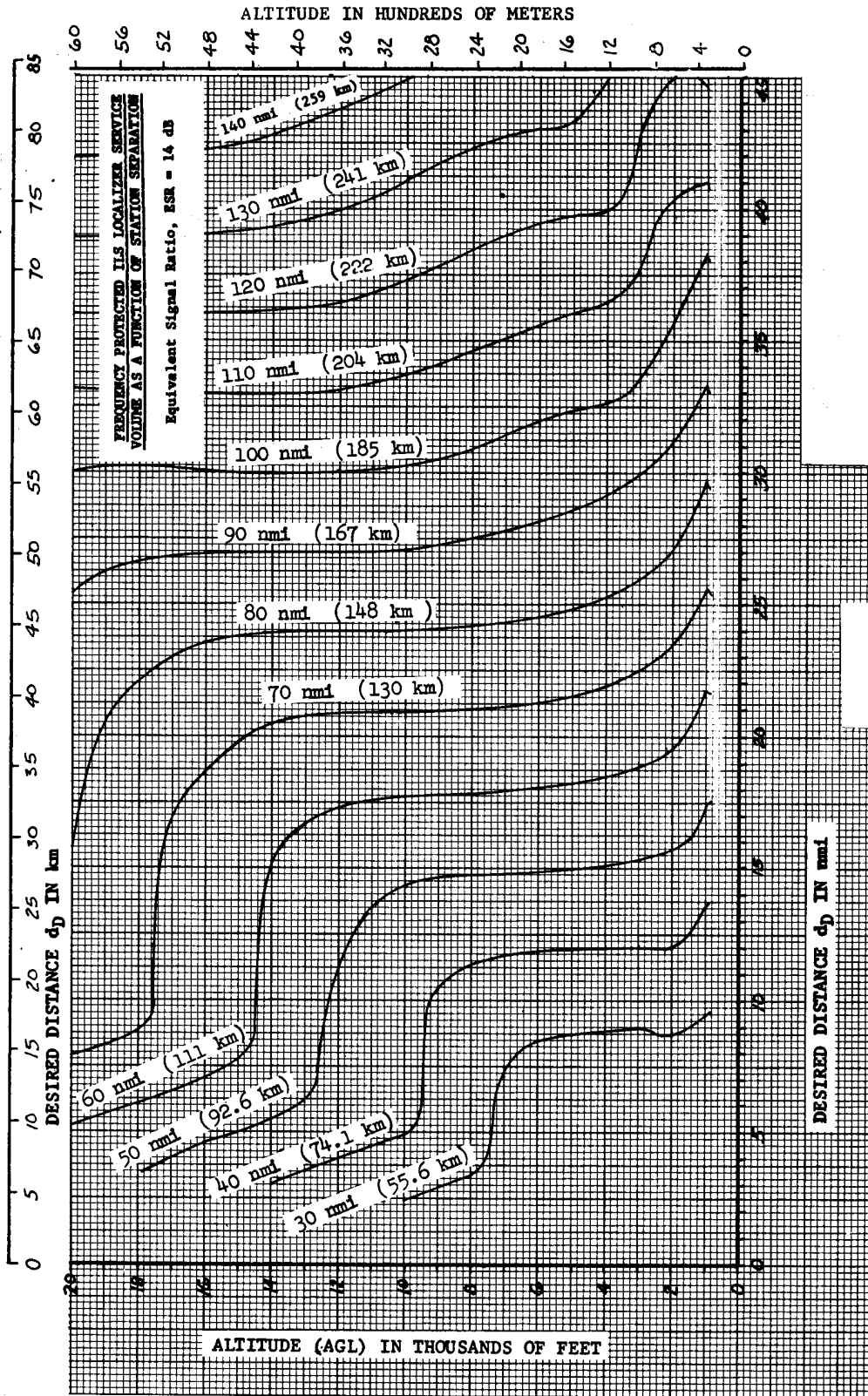




FIGURE 102. LOC FACILITY SEPARATION CURVES FOR ESR = +17 dB

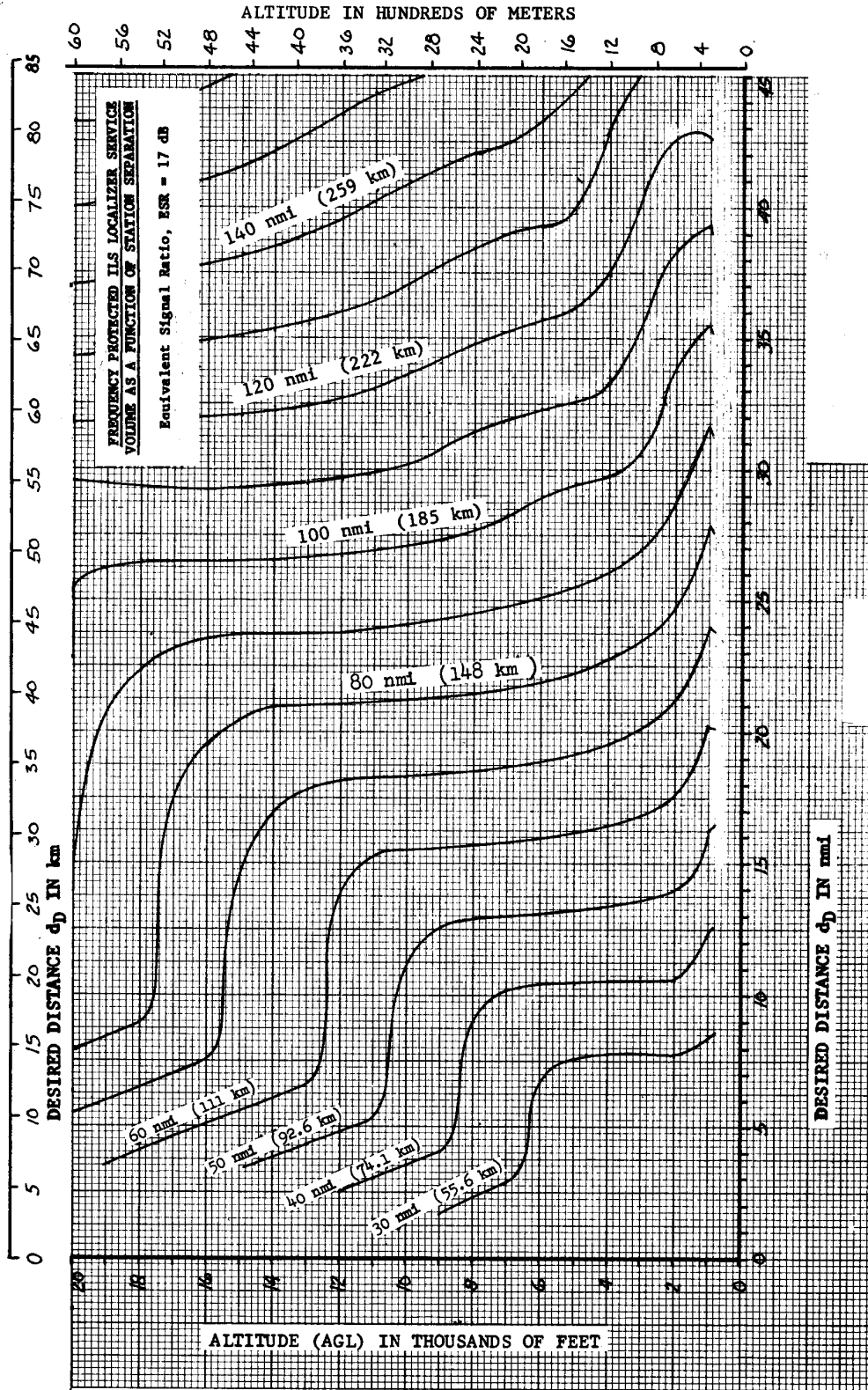


FIGURE 103. LOC FACILITY SEPARATION CURVES FOR ESR = +20 dB

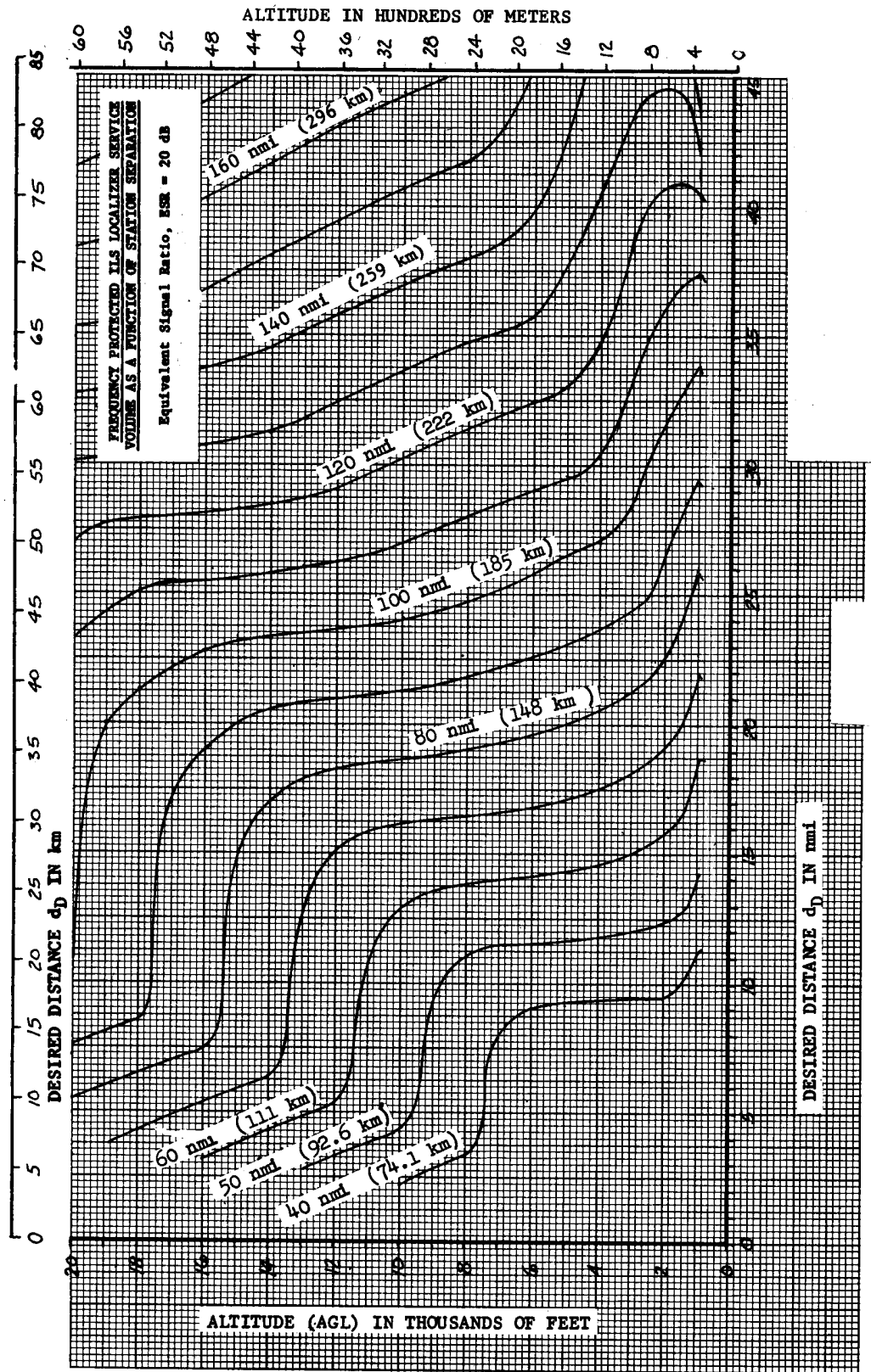


FIGURE 104. LOC FACILITY SEPARATION CURVES FOR ESR = +23 dB

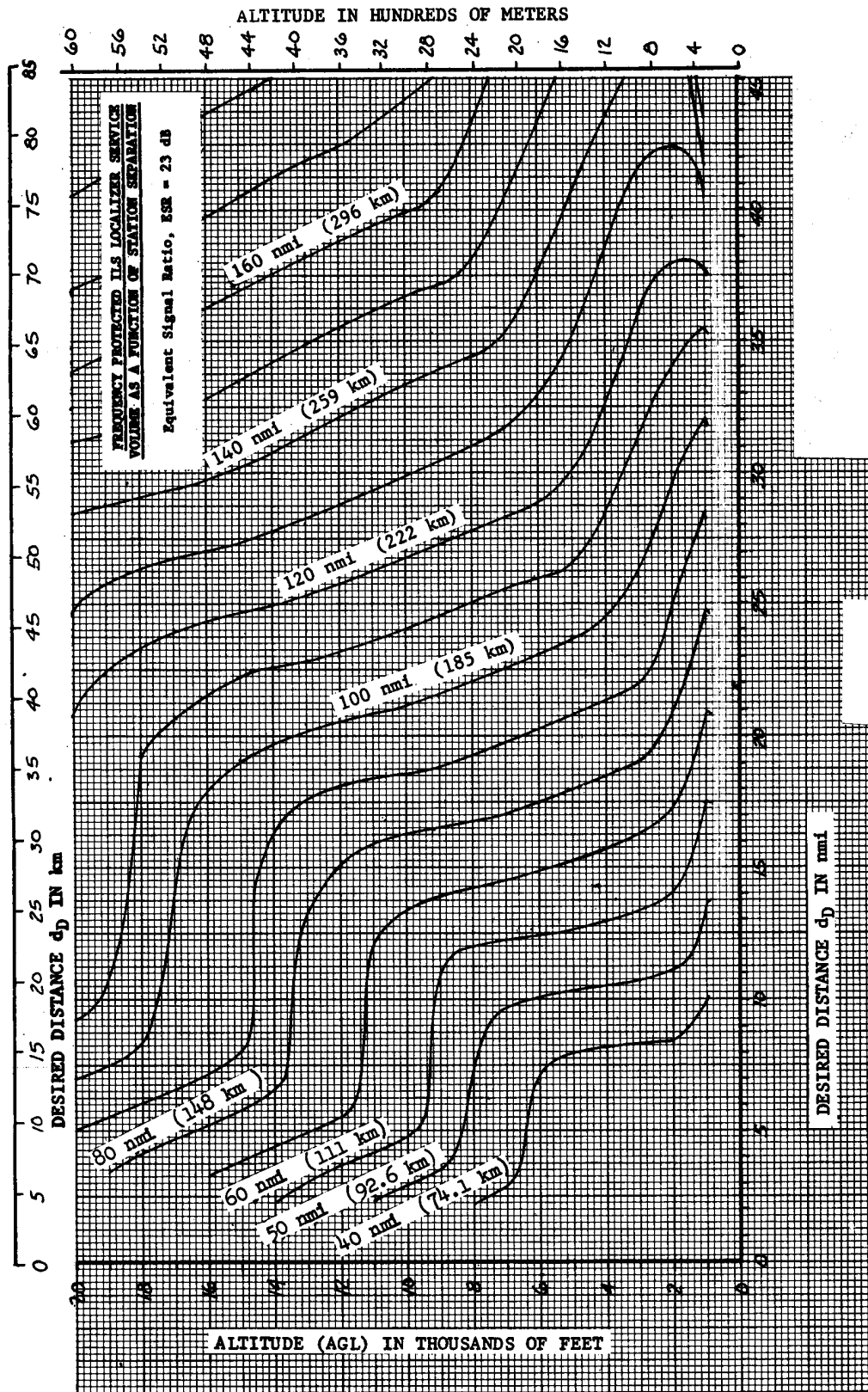


FIGURE 105. LOC FACILITY SEPARATION CURVES FOR ESR = +26 dB

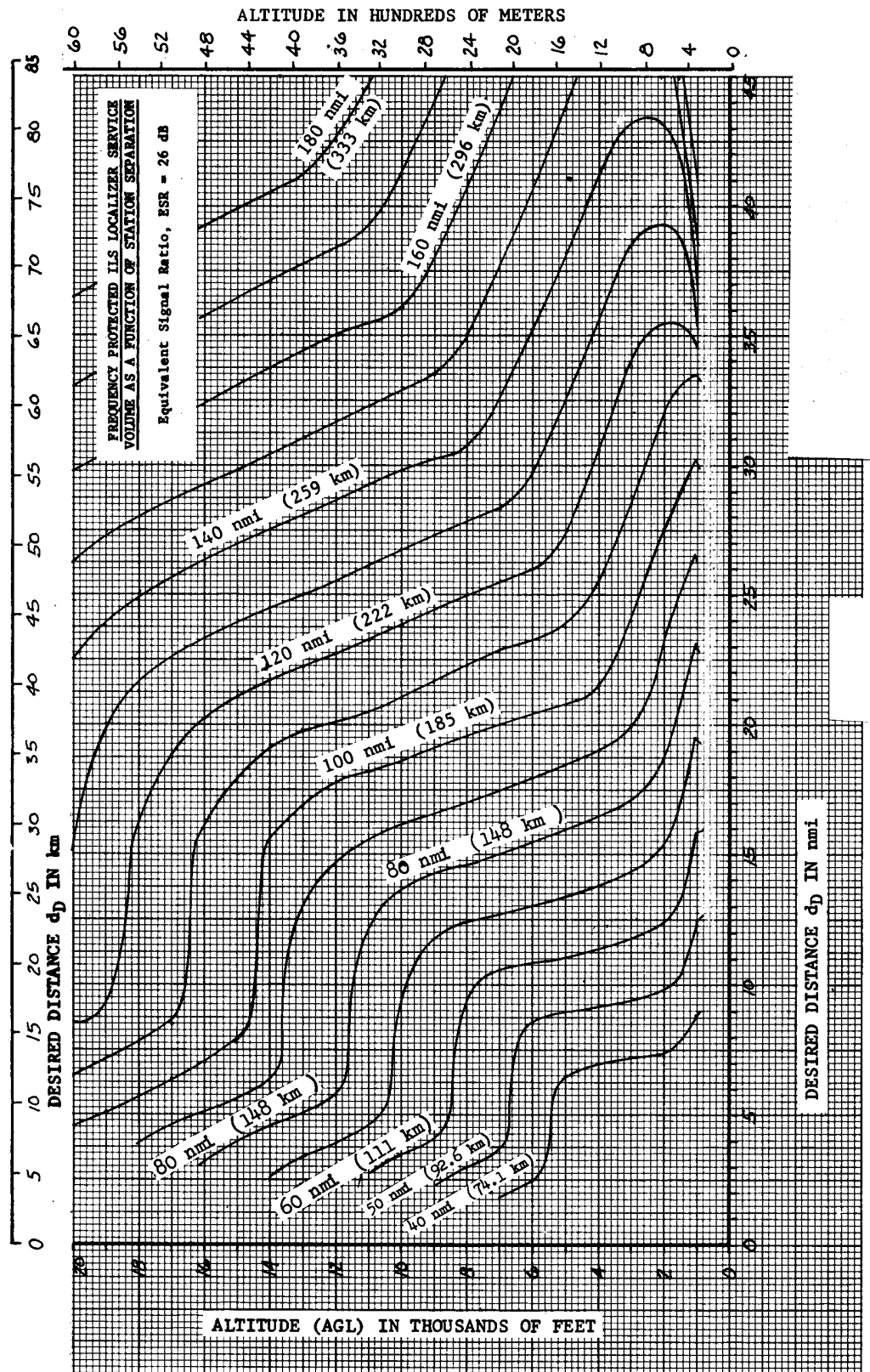


FIGURE 106. LOC FACILITY SEPARATION CURVES FOR ESR = +29 dB

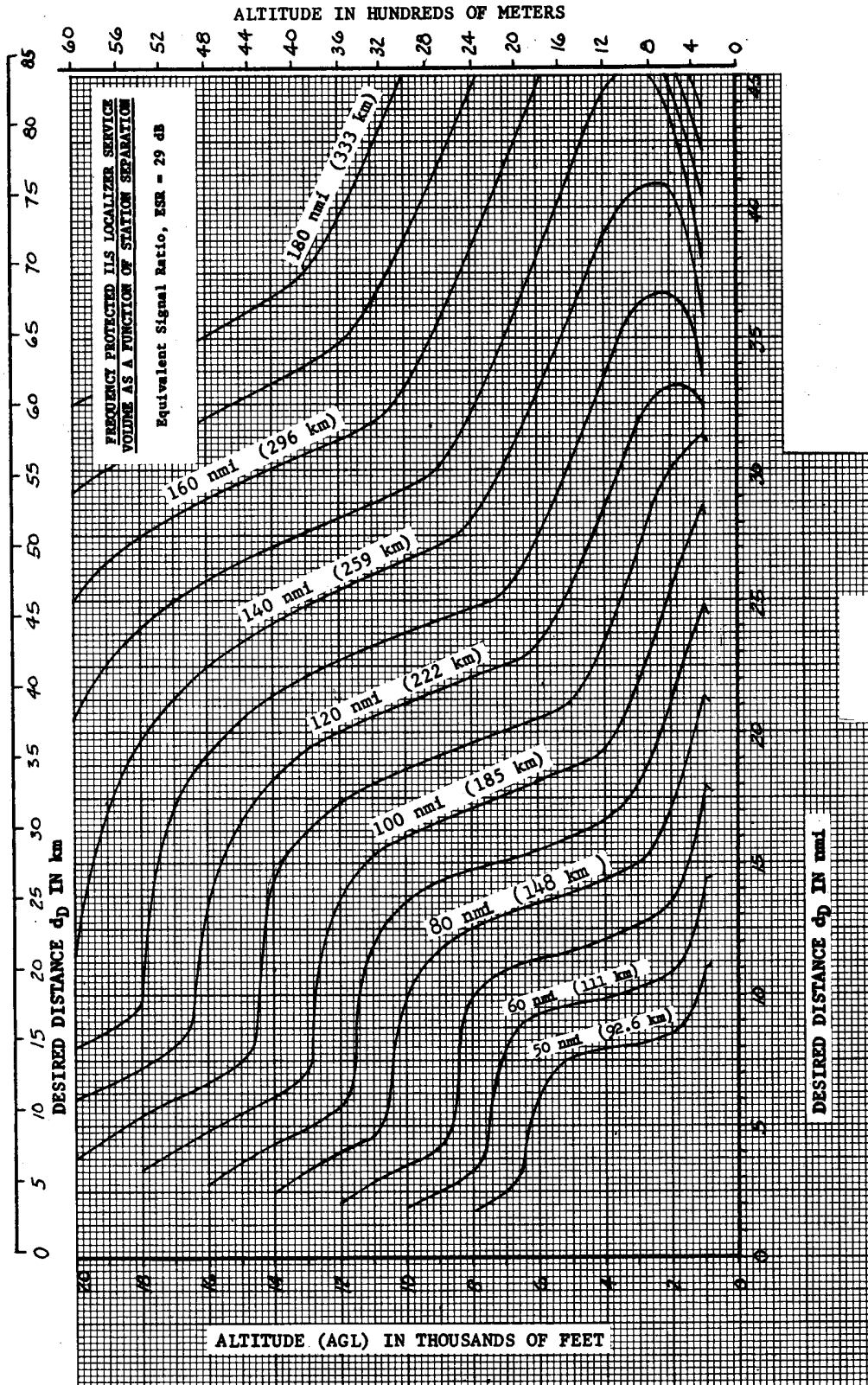


FIGURE 107. LOC FACILITY SEPARATION CURVES FOR ESR = +32 dB

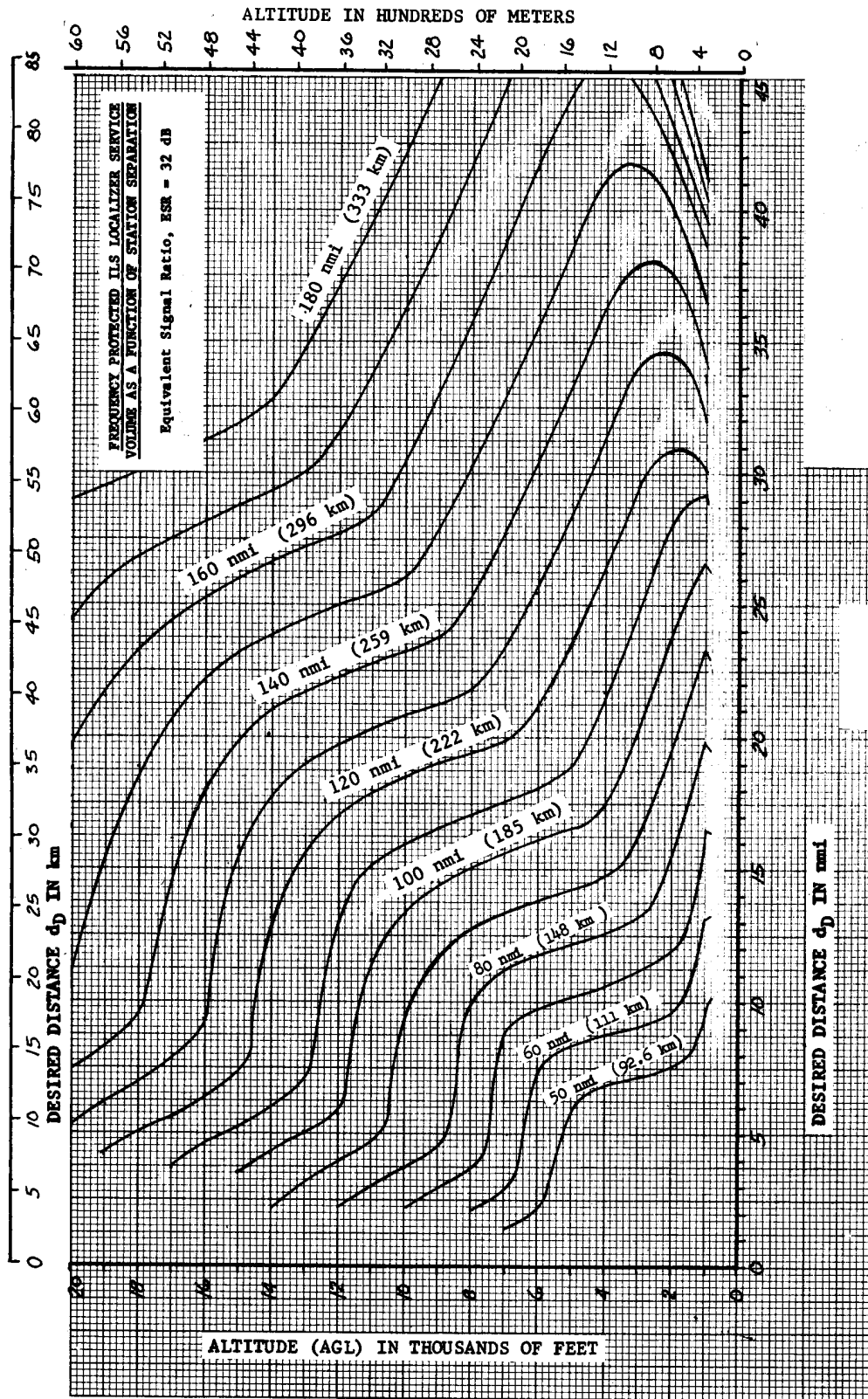


FIGURE 108. ESR RATIO – LOC/VOR. LOC IS DESIRED FACILITY @ 1,000'

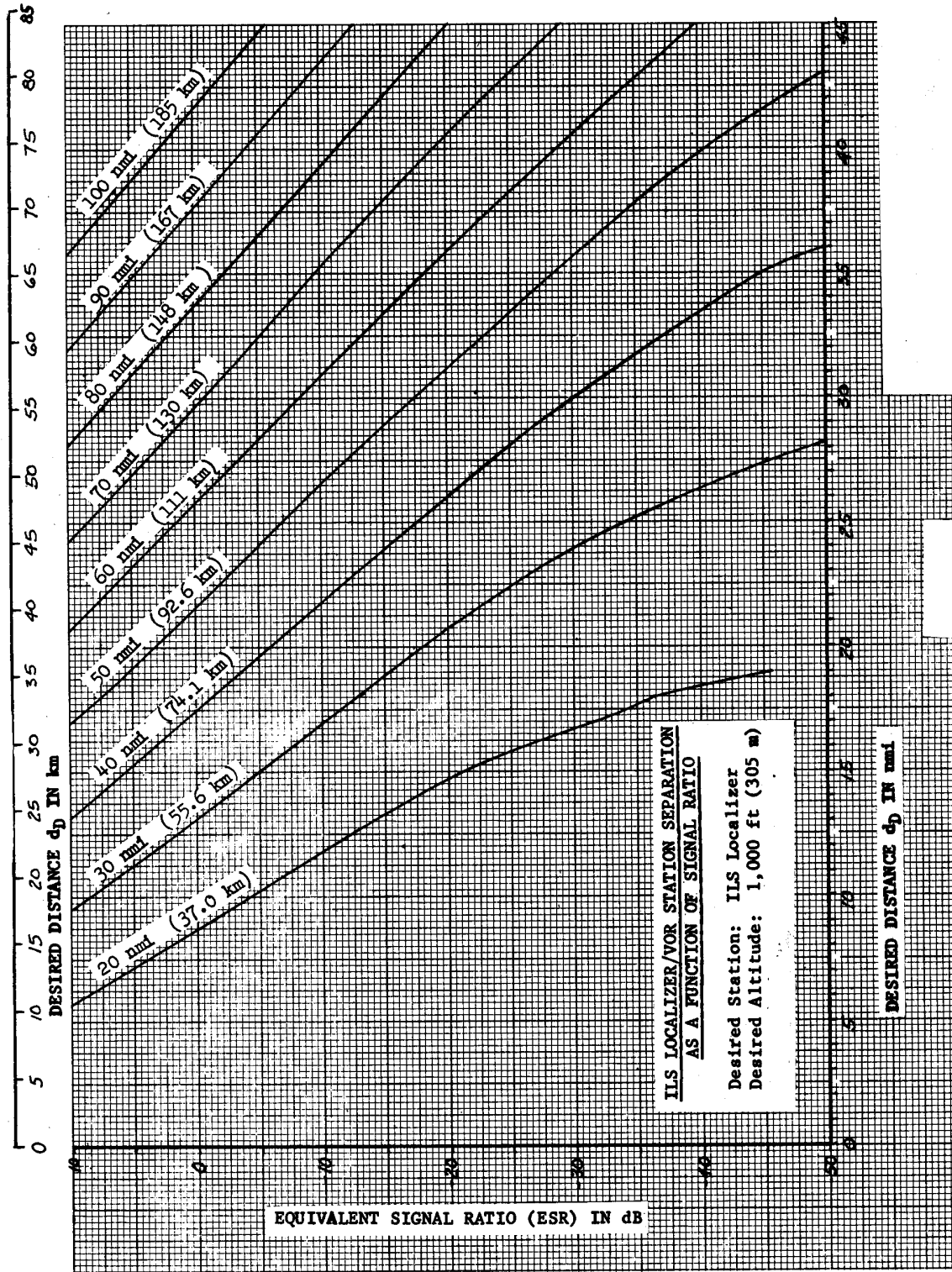


FIGURE 109. ESR RATIO - LOC/VOR. LOC IS DESIRED FACILITY @ 4,500'

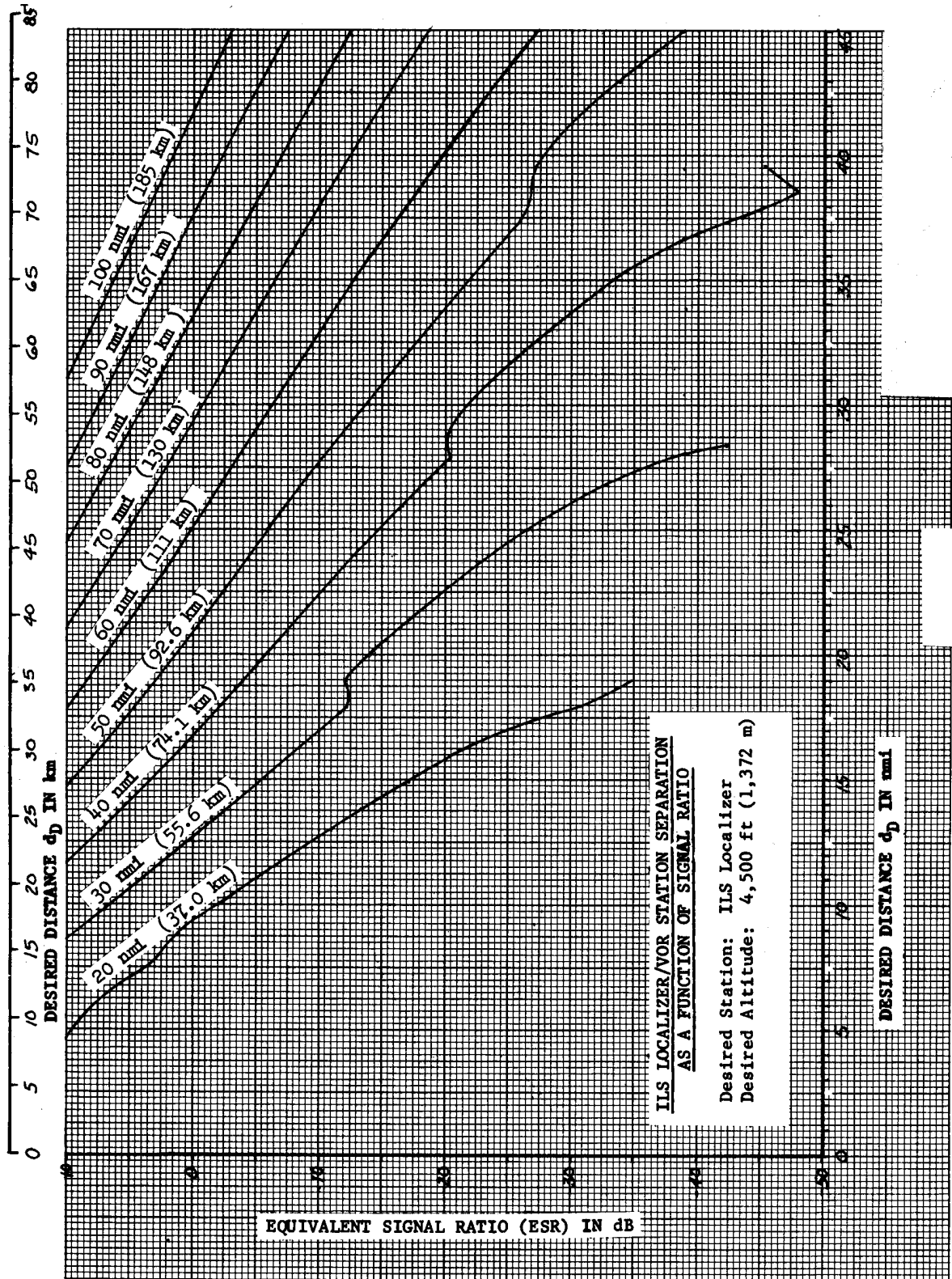
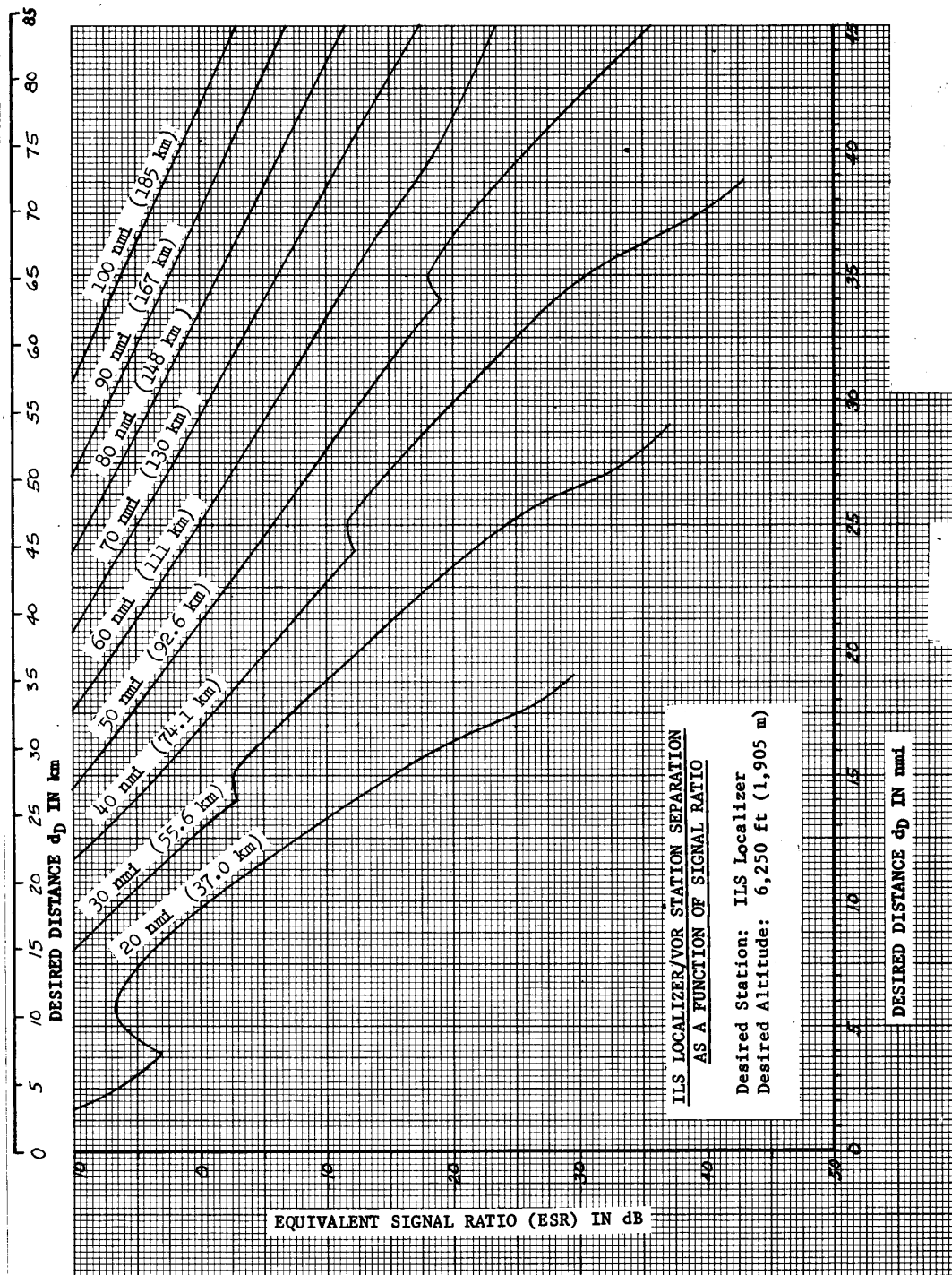
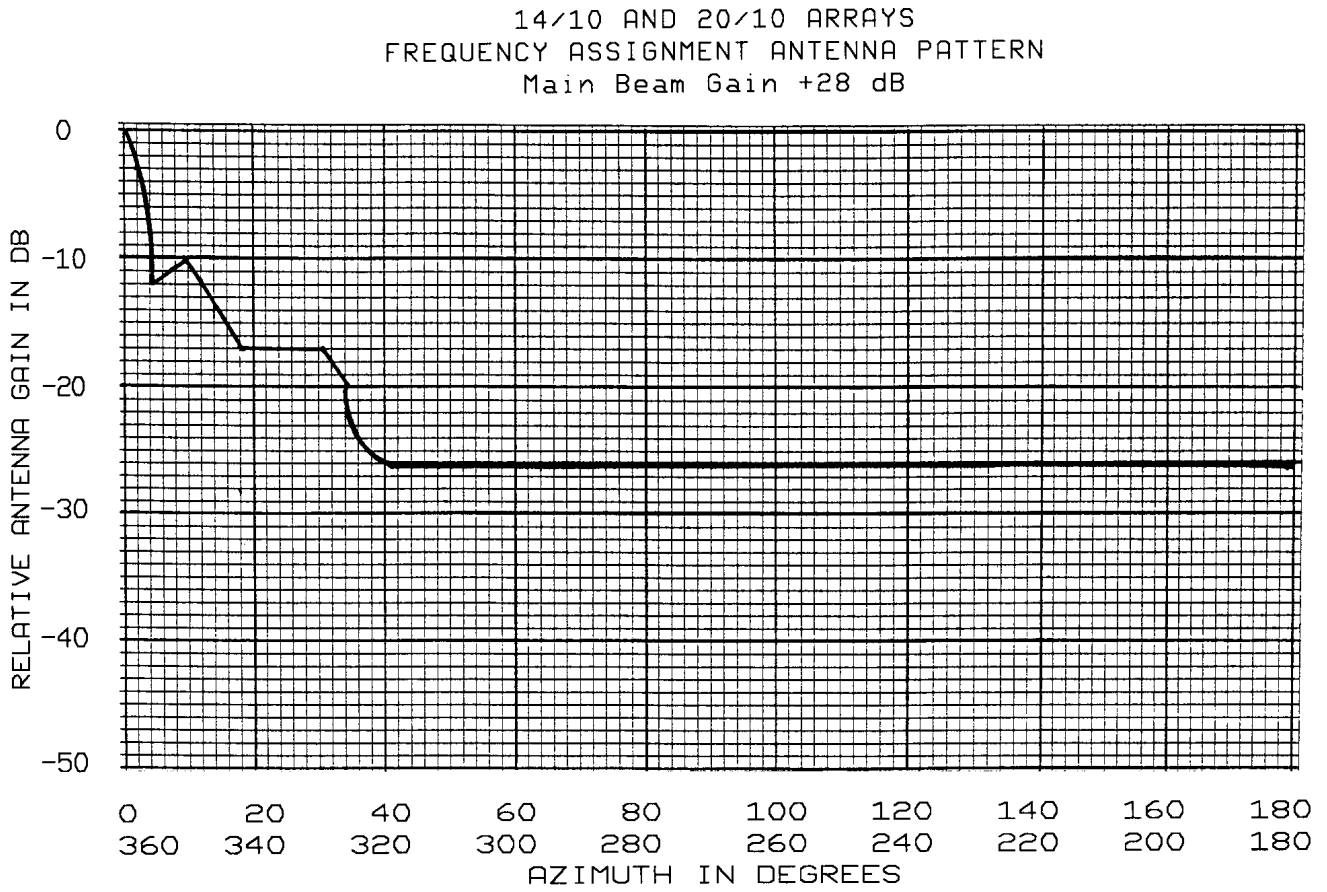




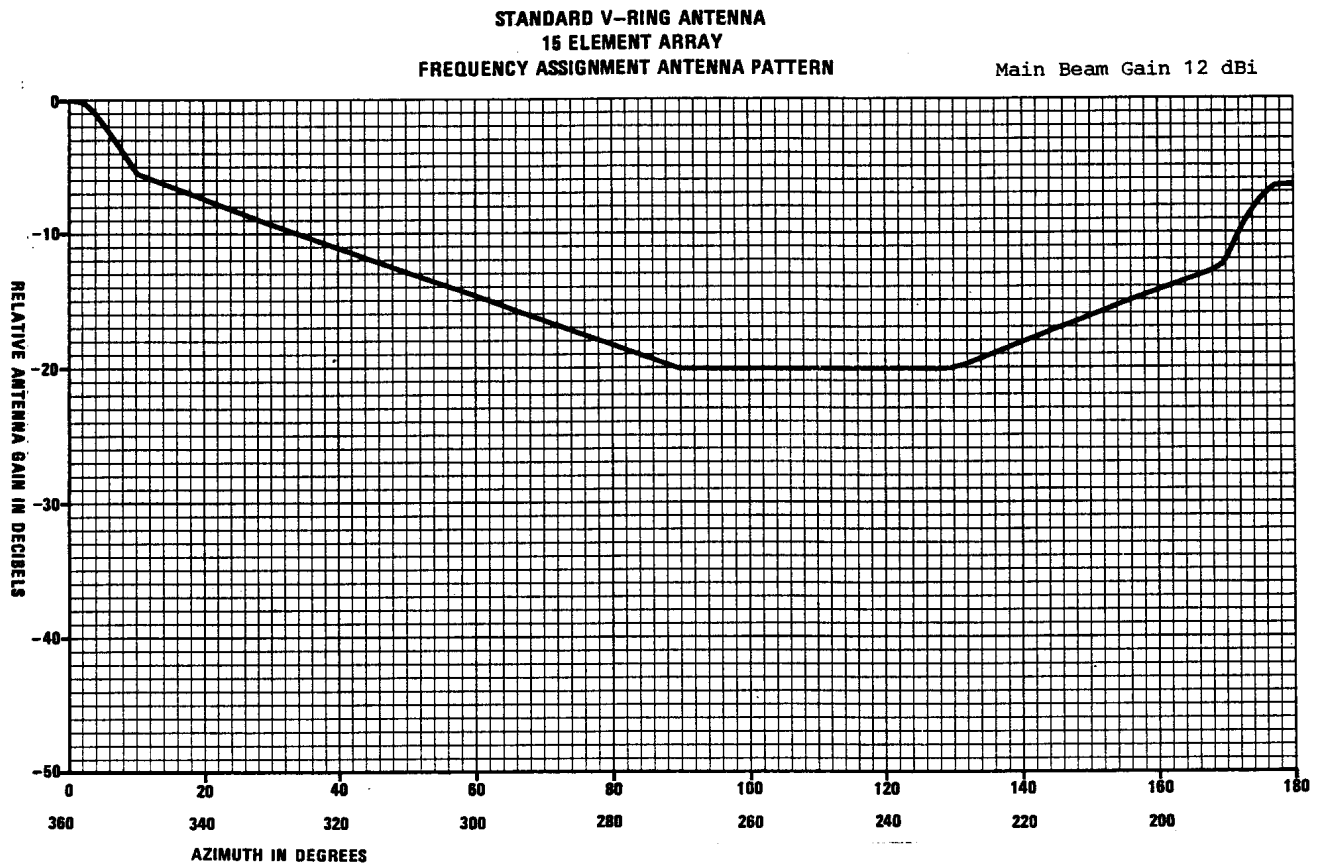
FIGURE 110. ESR RATIO – LOC/VOR. LOC IS DESIRED FACILITY @ 6,250'



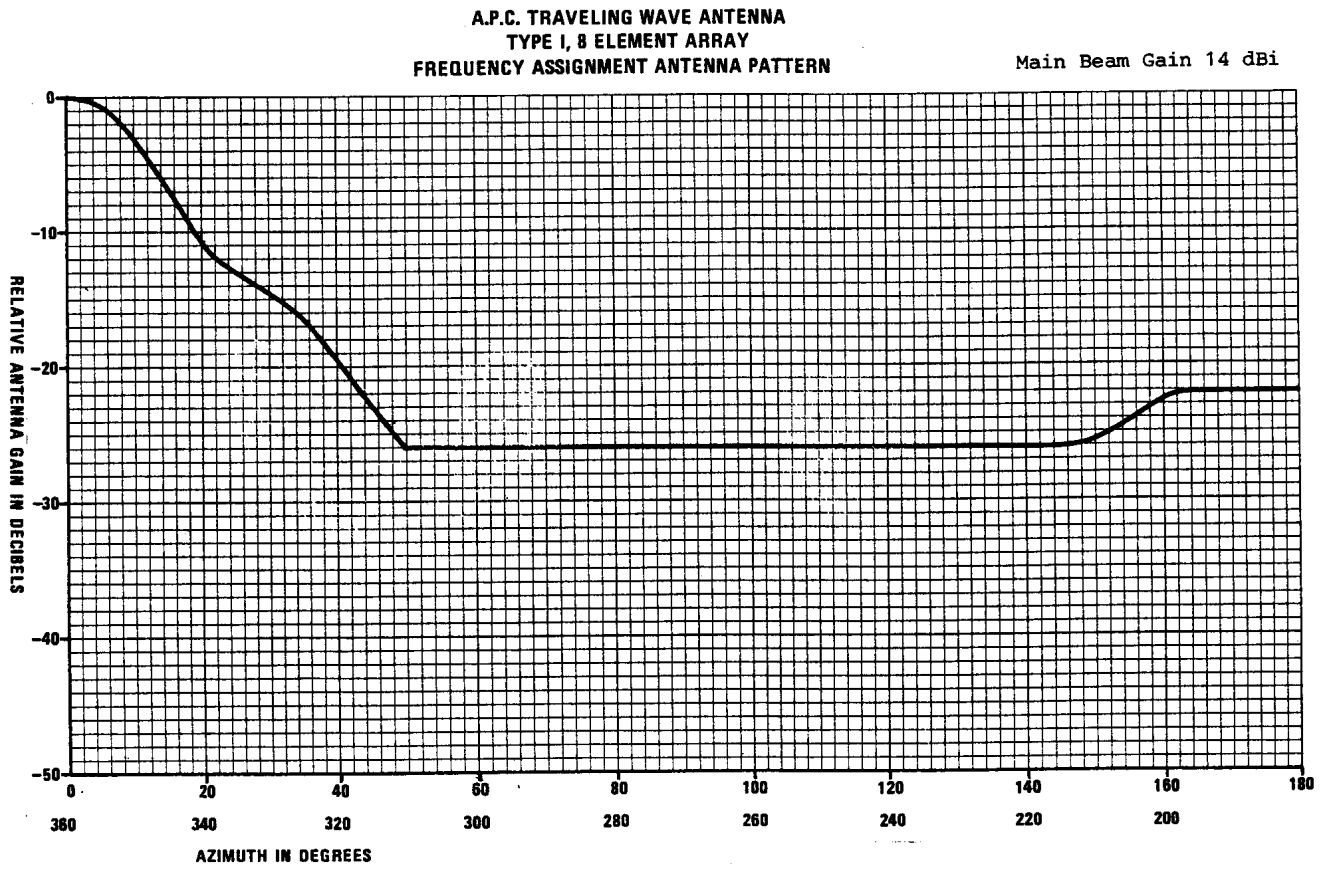
**FIGURE 111. LOC LPD (14-10) and (20-10) ANTENNA RADIATION PATTERNS**



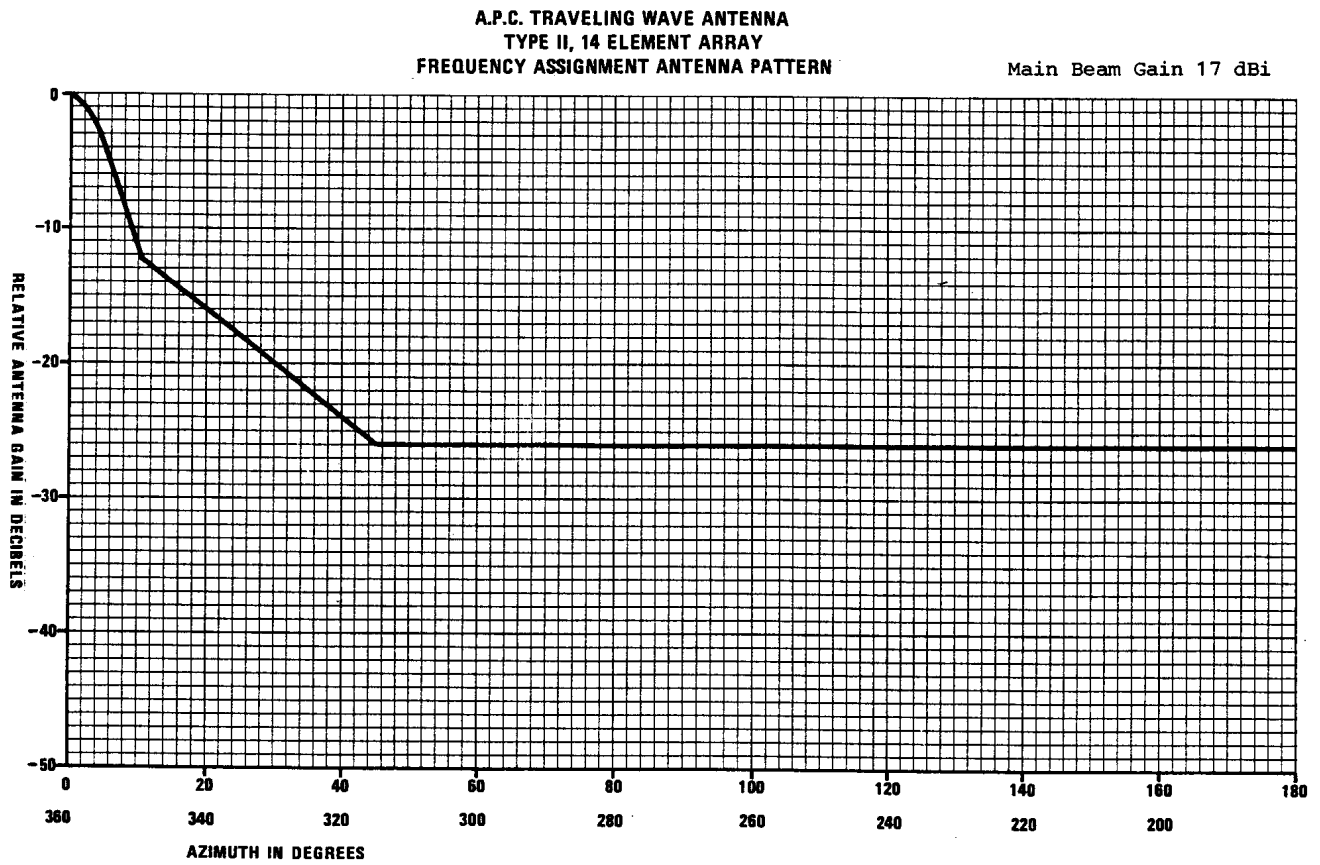
**FIGURE 112. LOC V RING ANTENNA RADIATION PATTERN**



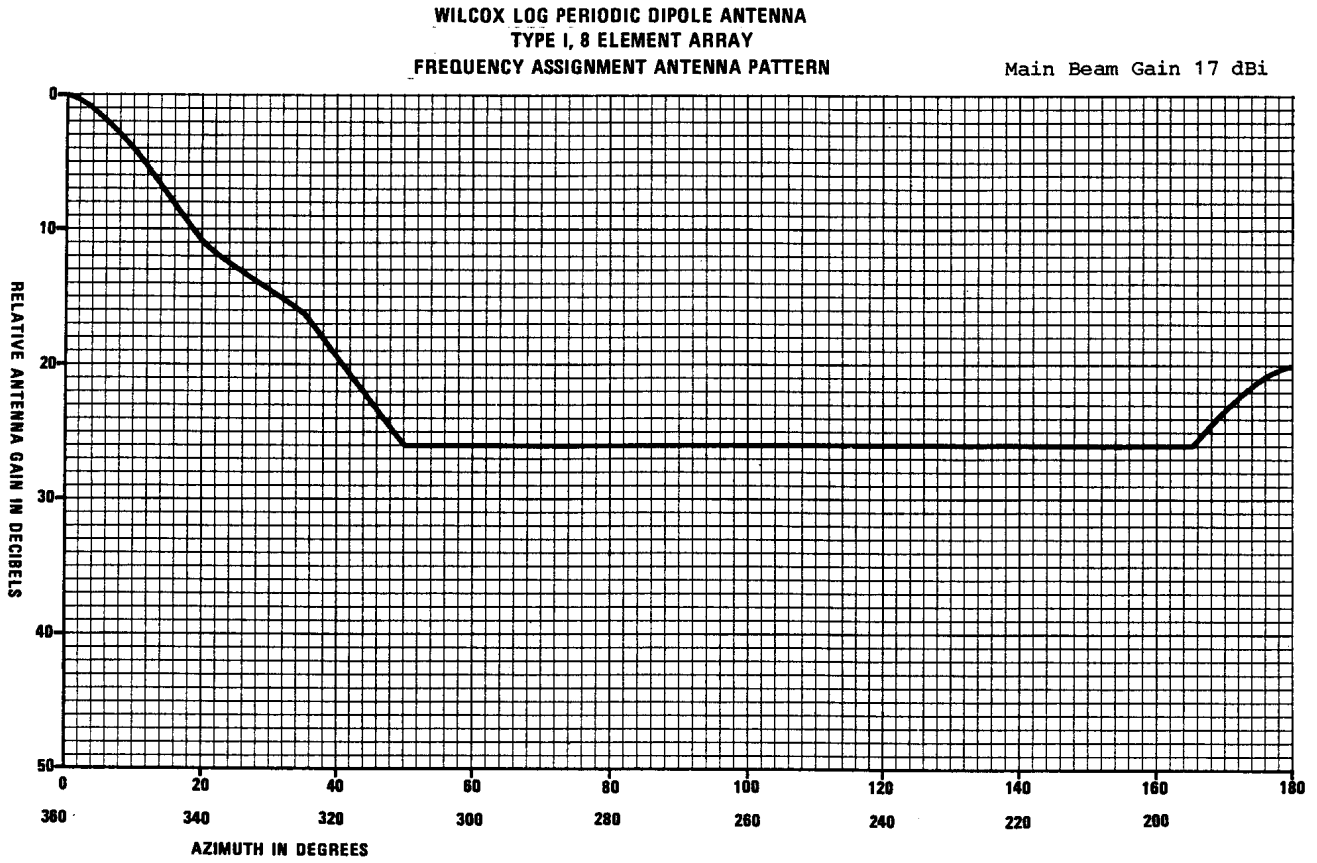
**FIGURE 113. LOC TRVLG WAVE 8 ELEMENT ANTENNA RADIATION PATTERN**



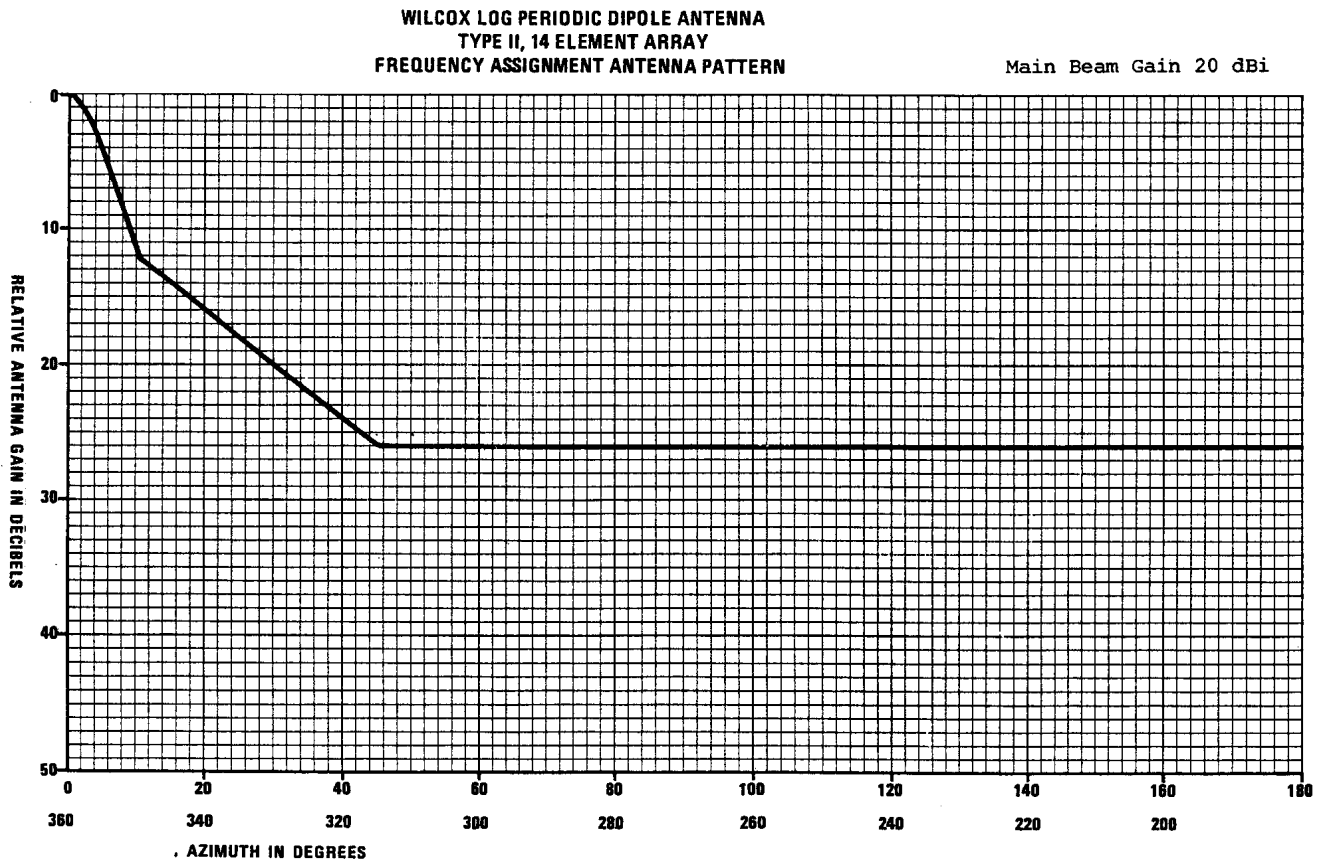
**FIGURE 114. LOC TRVLG WAVE 14 ELEMENT ANTENNA RADIATION PATTERN**



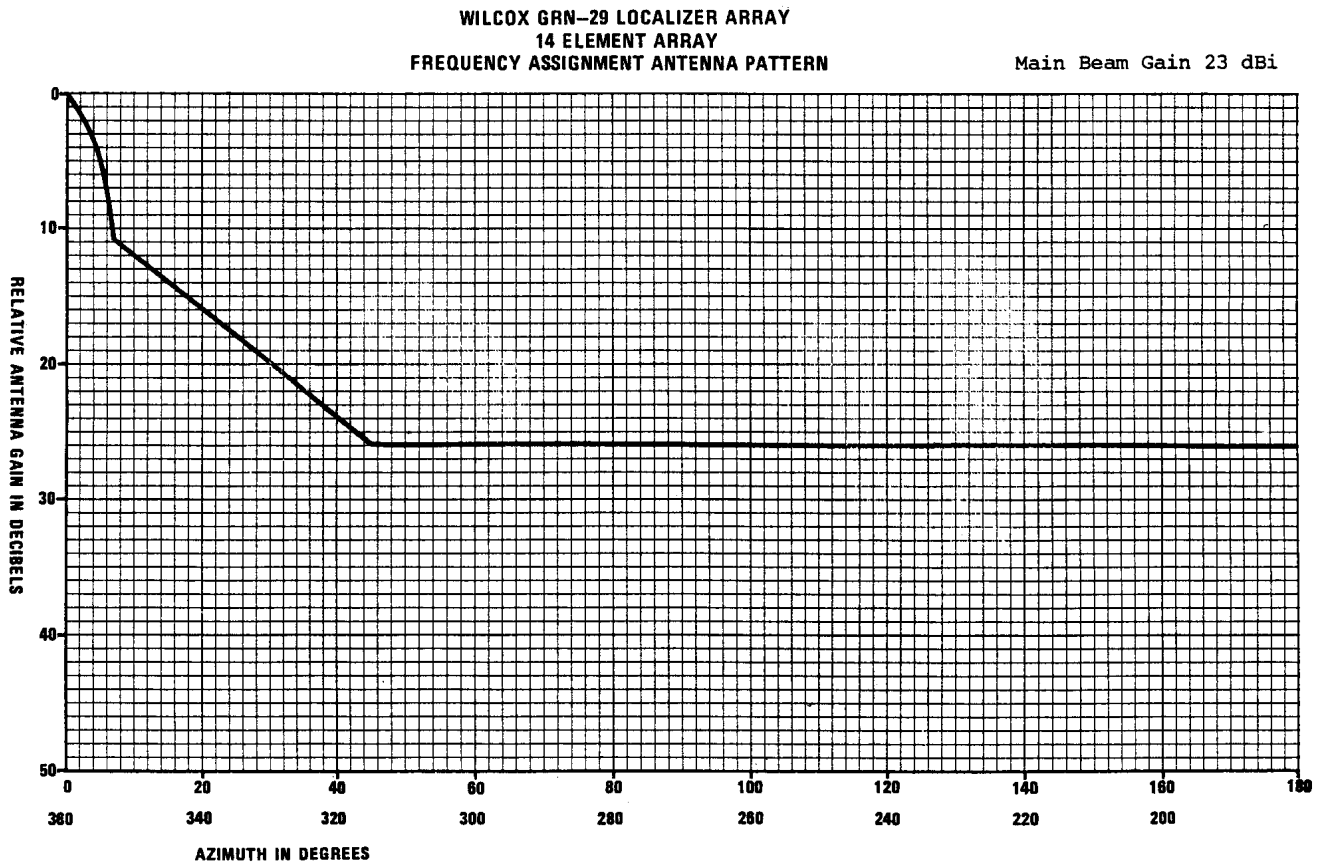
**FIGURE 115. LOC LPD 8 ELEMENT ANTENNA RADIATION PATTERN**



**FIGURE 116. LOC LPD 14 ELEMENT ANTENNA RADIATION PATTERN**

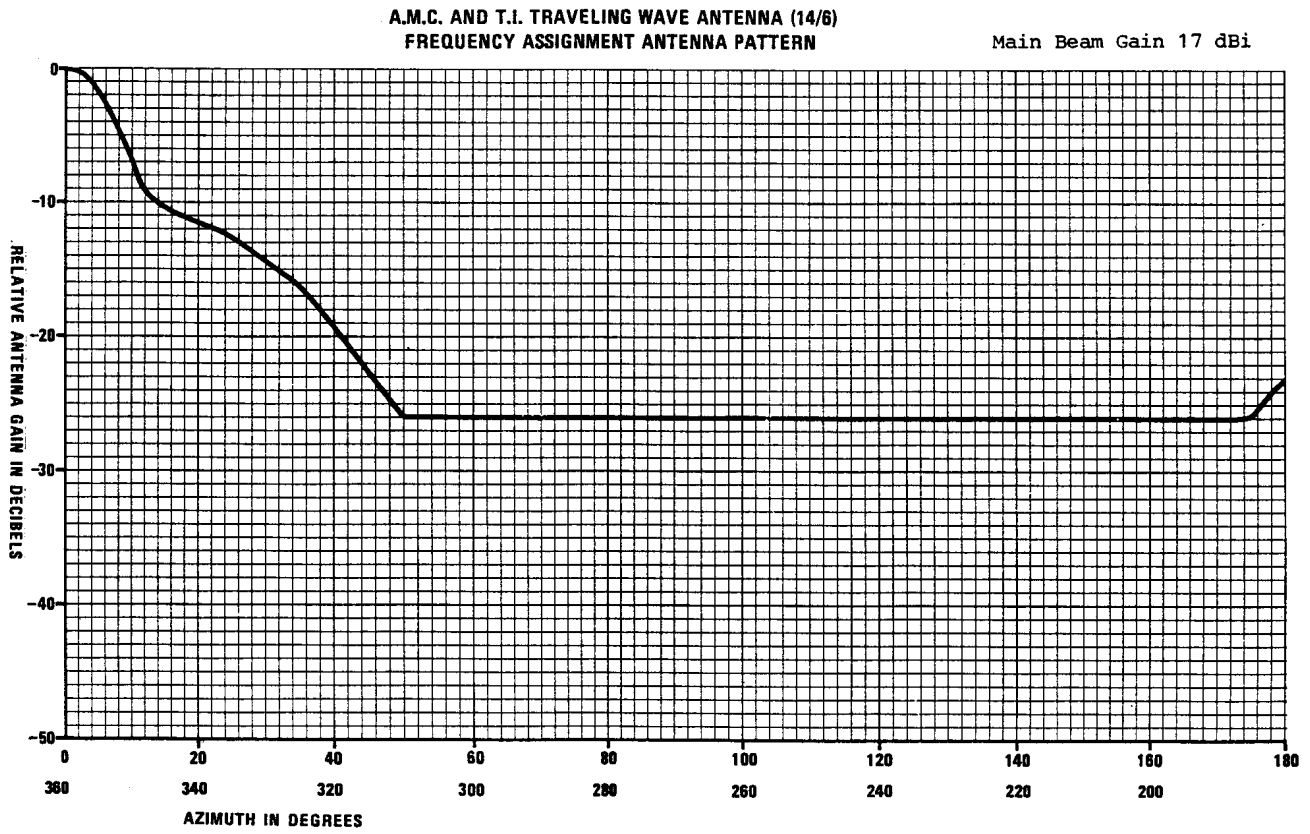


**FIGURE 117. LOC LPD GRN-29 ANTENNA RADIATION PATTERN**

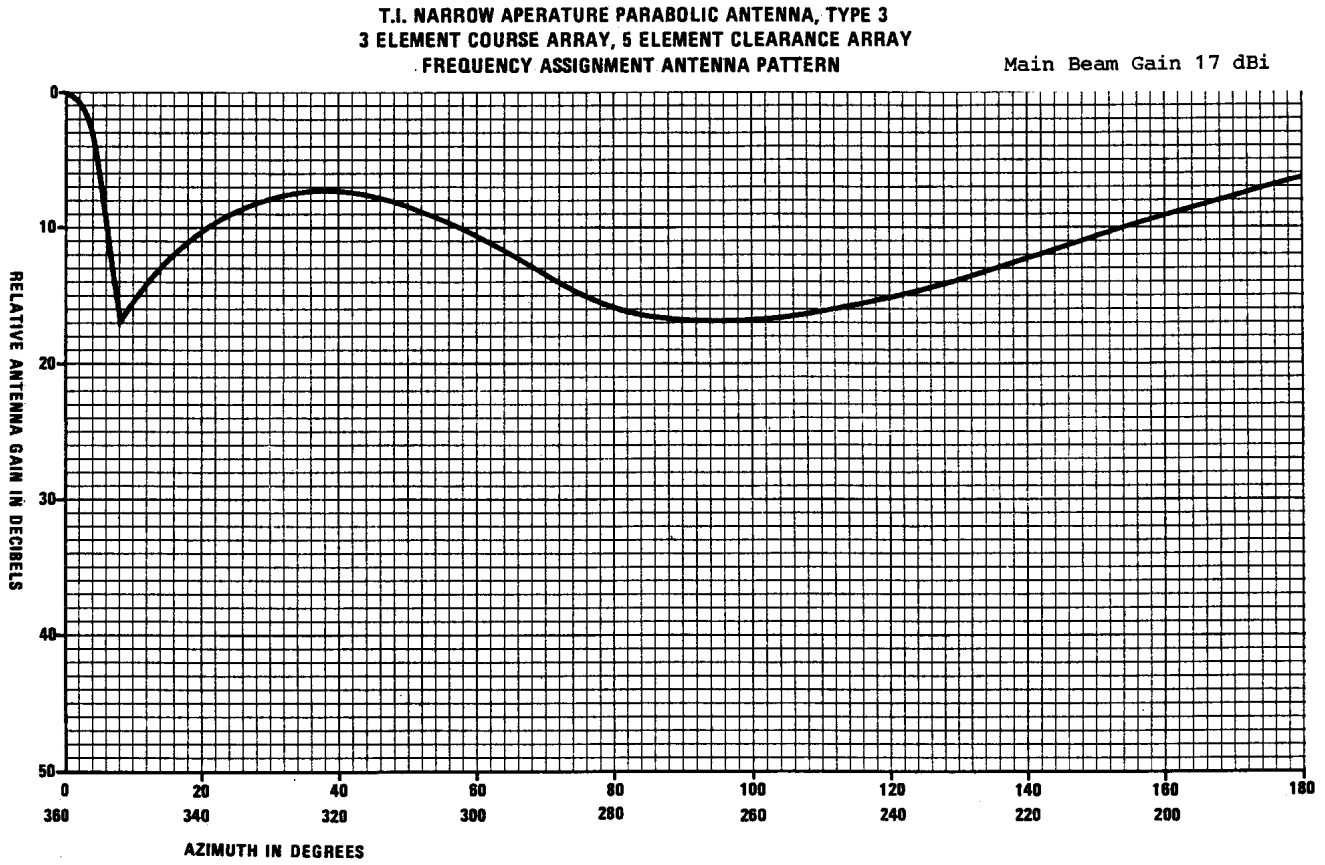




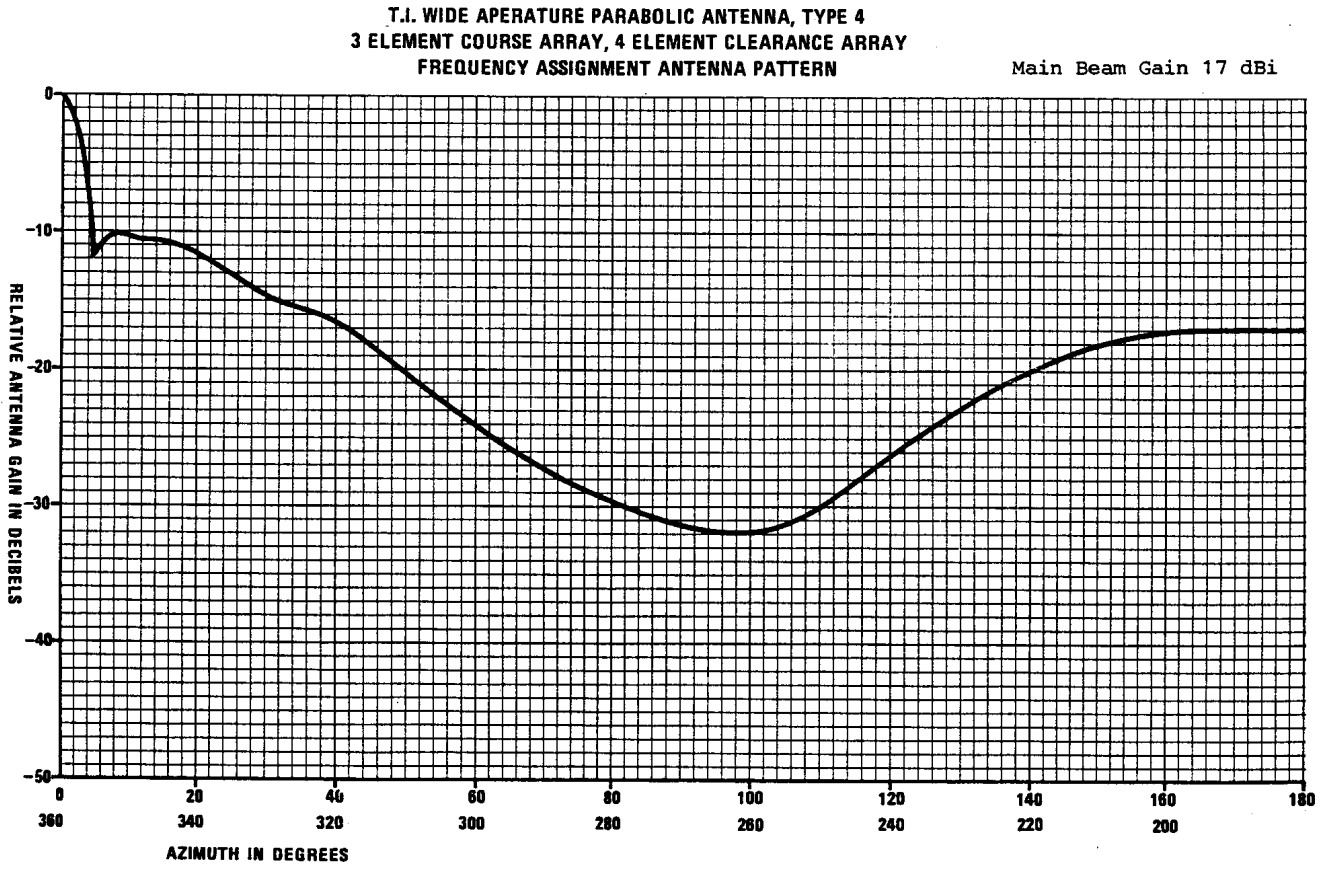
**FIGURE 118. LOC TRVLG WAVE 14/6 ANTENNA RADIATION PATTERN**



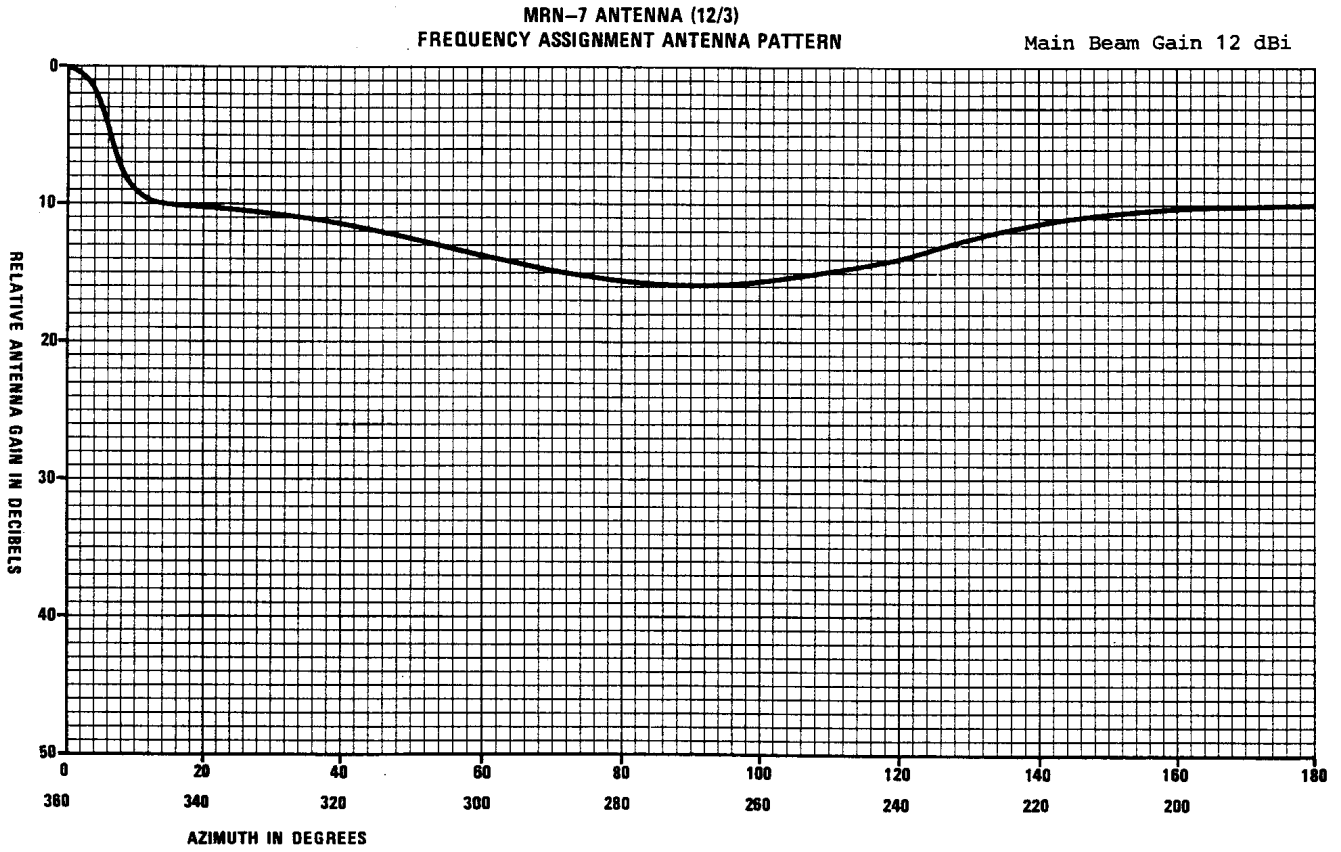
**FIGURE 119. LOC PARABOLIC NARROW ANTENNA RADIATION PATTERN**



**FIGURE 120. LOC PARABOLIC WIDE ANTENNA RADIATION PATTERN**



**FIGURE 121. LOC MRN-7 DIPOLE ANTENNA RADIATION PATTERN**



**FIGURE 122. LOC REDLICH LPD (14-10) ANTENNA RADIATION PATTERN**

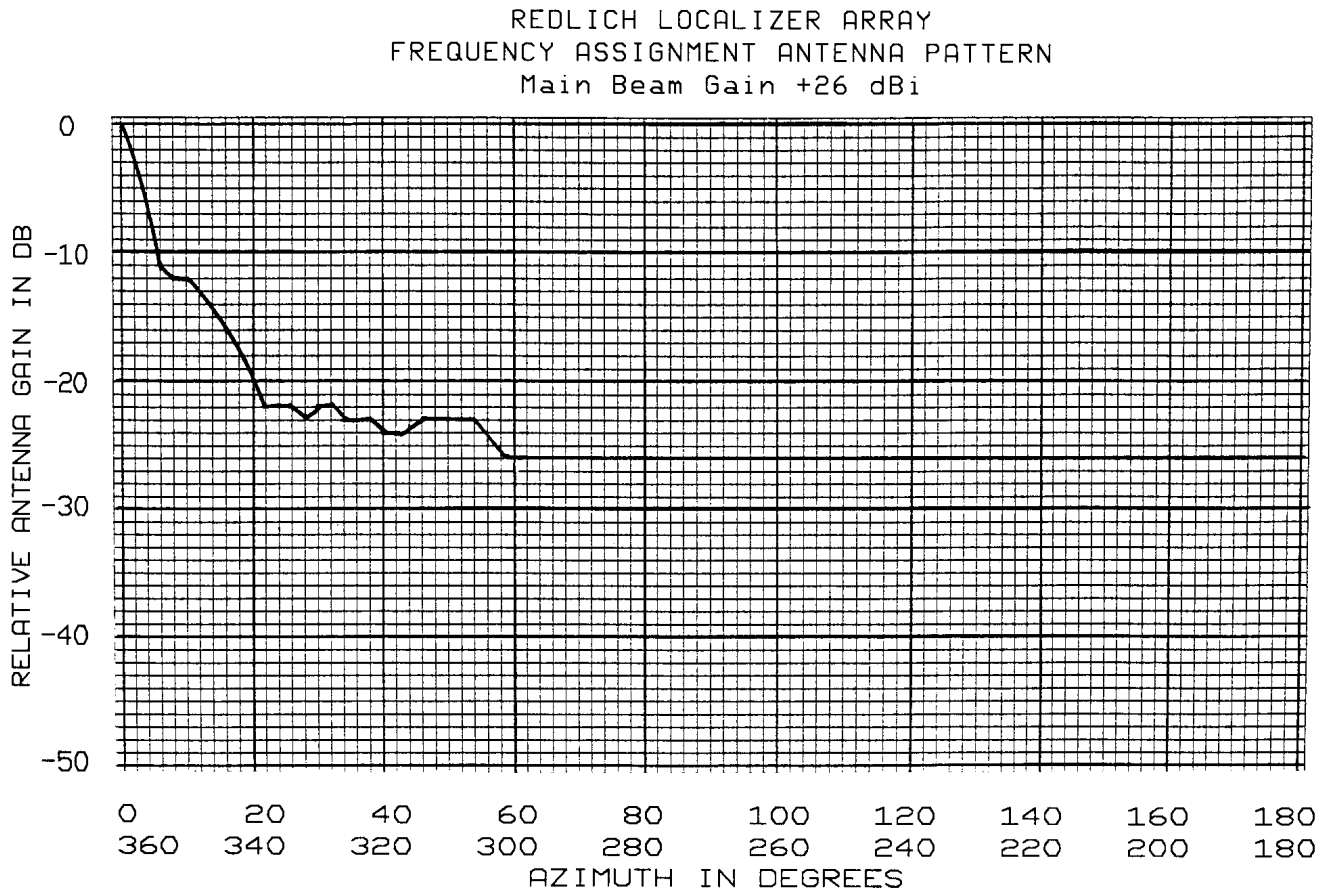


FIGURE 123. LOC MODIFIED V RING ANTENNA RADIATION PATTERN

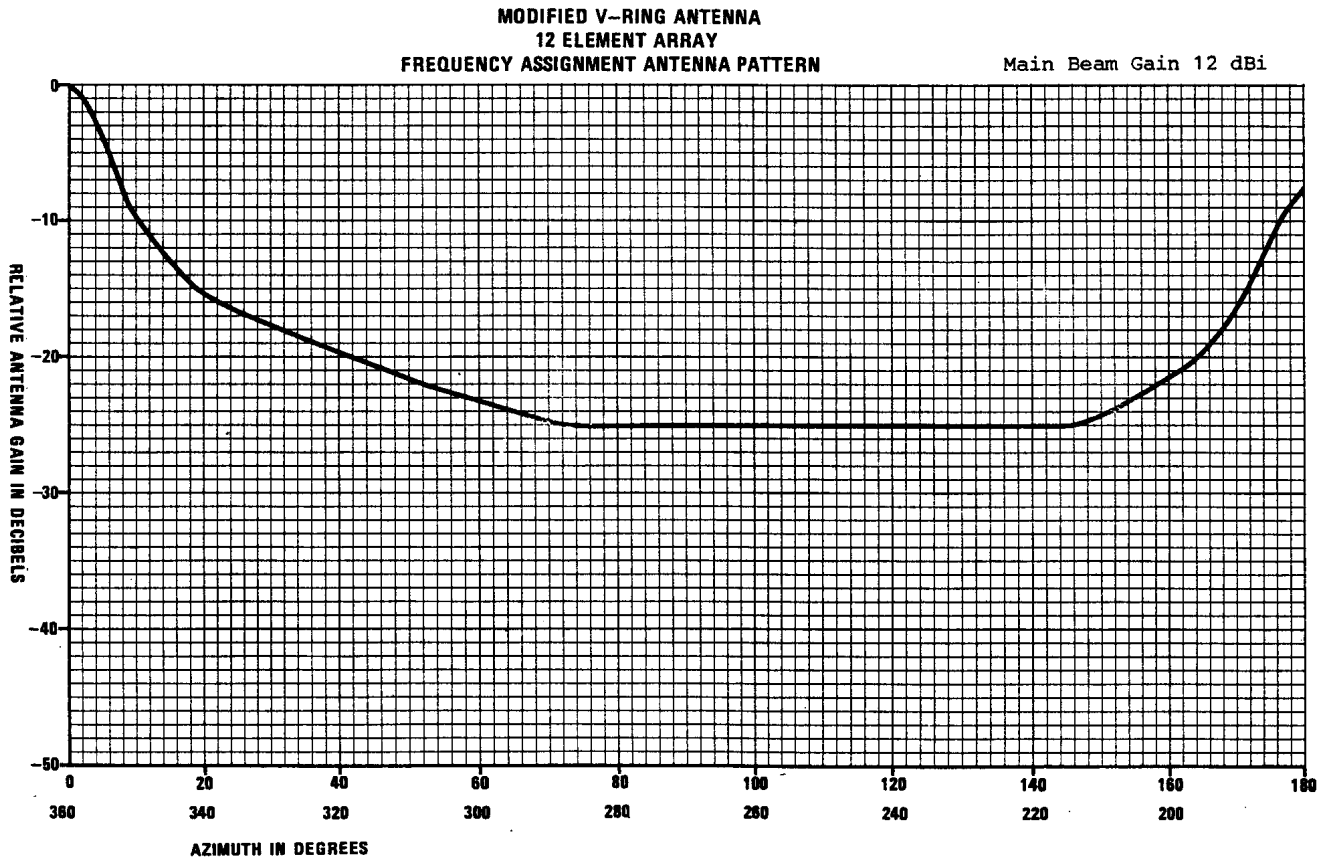
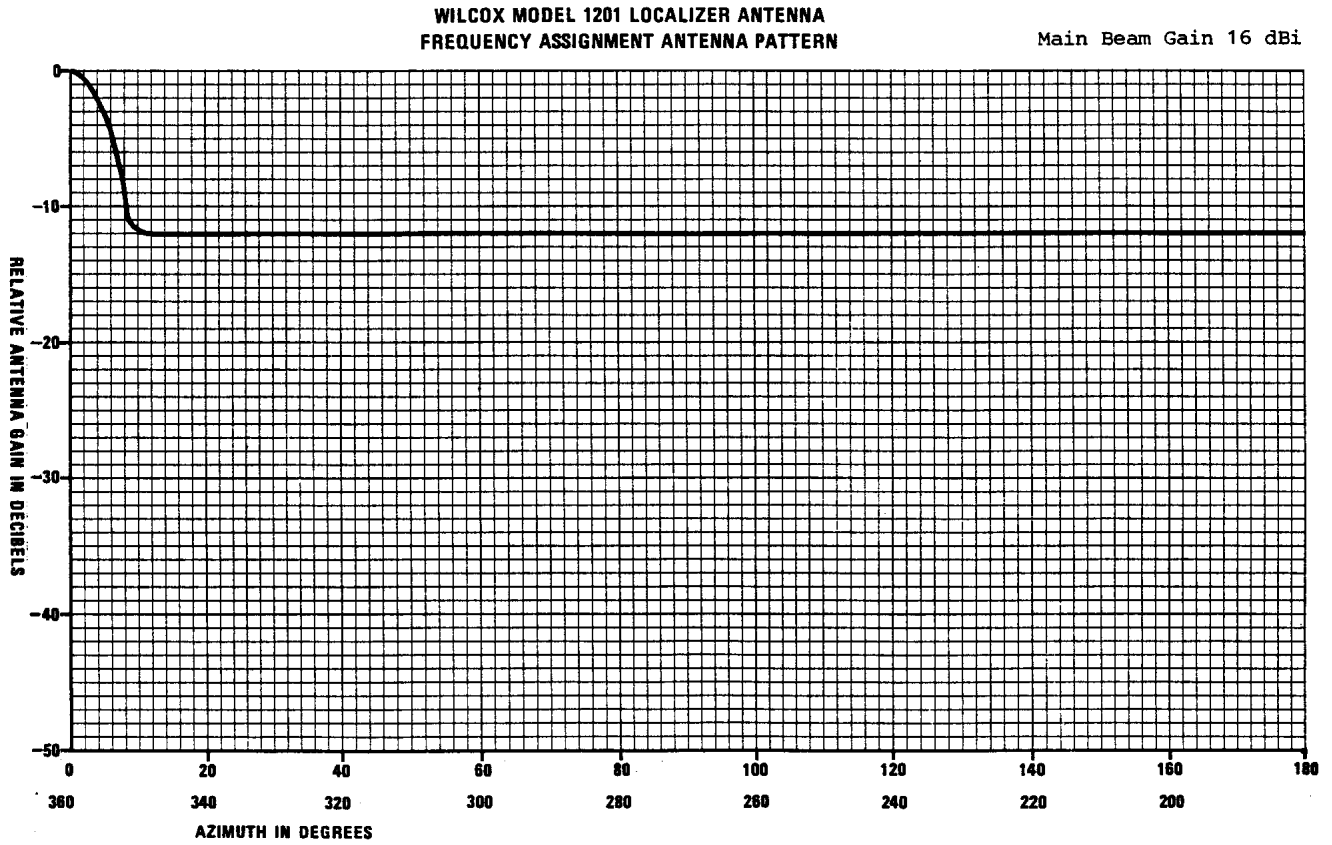
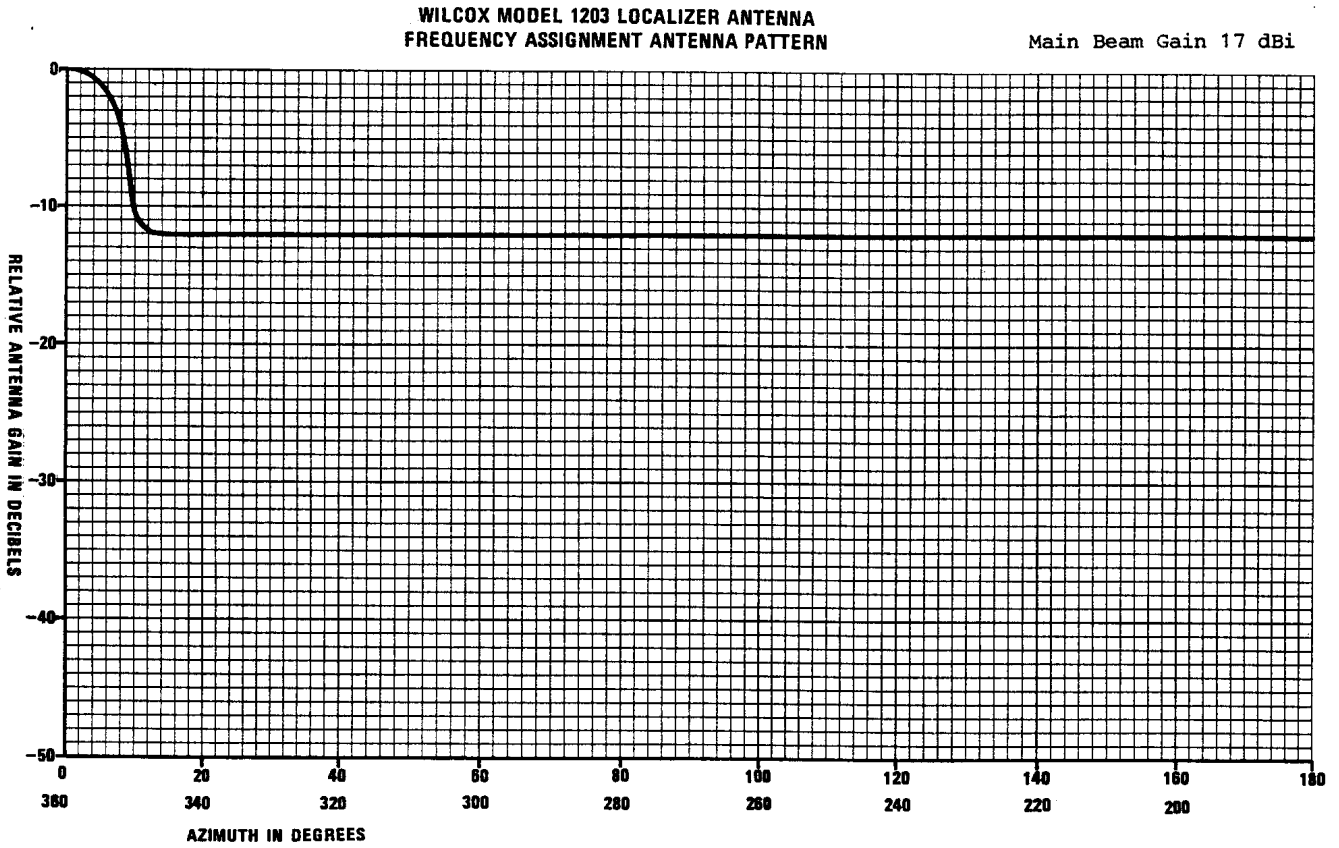


FIGURE 124. LOC 1201 DIPOLE ANTENNA RADIATION PATTERN



**FIGURE 125. LOC 1203 DIPOLE ANTENNA RADIATION PATTERN**





**FIGURE 126. LOC 1204 DIPOLE ANTENNA RADIATION PATTERN**

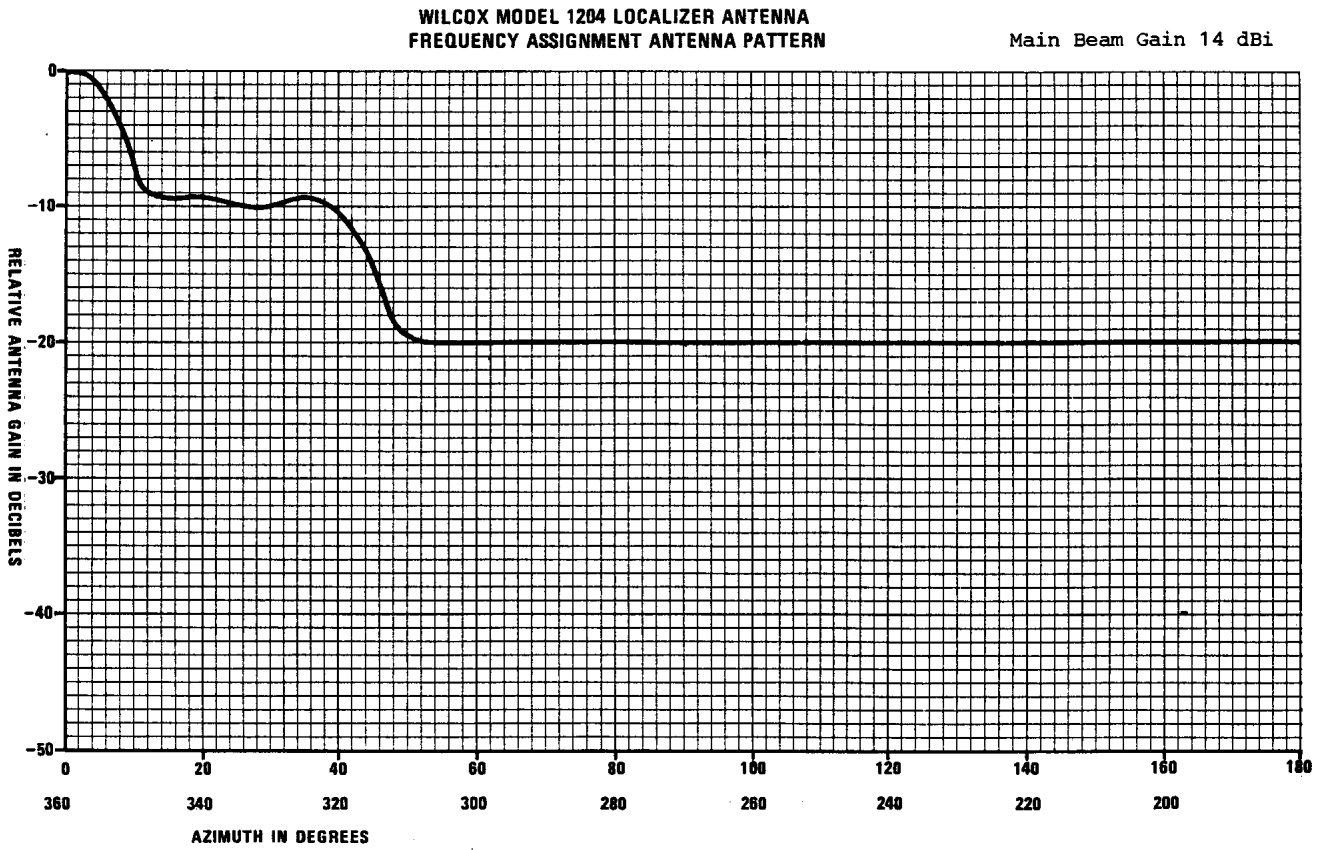
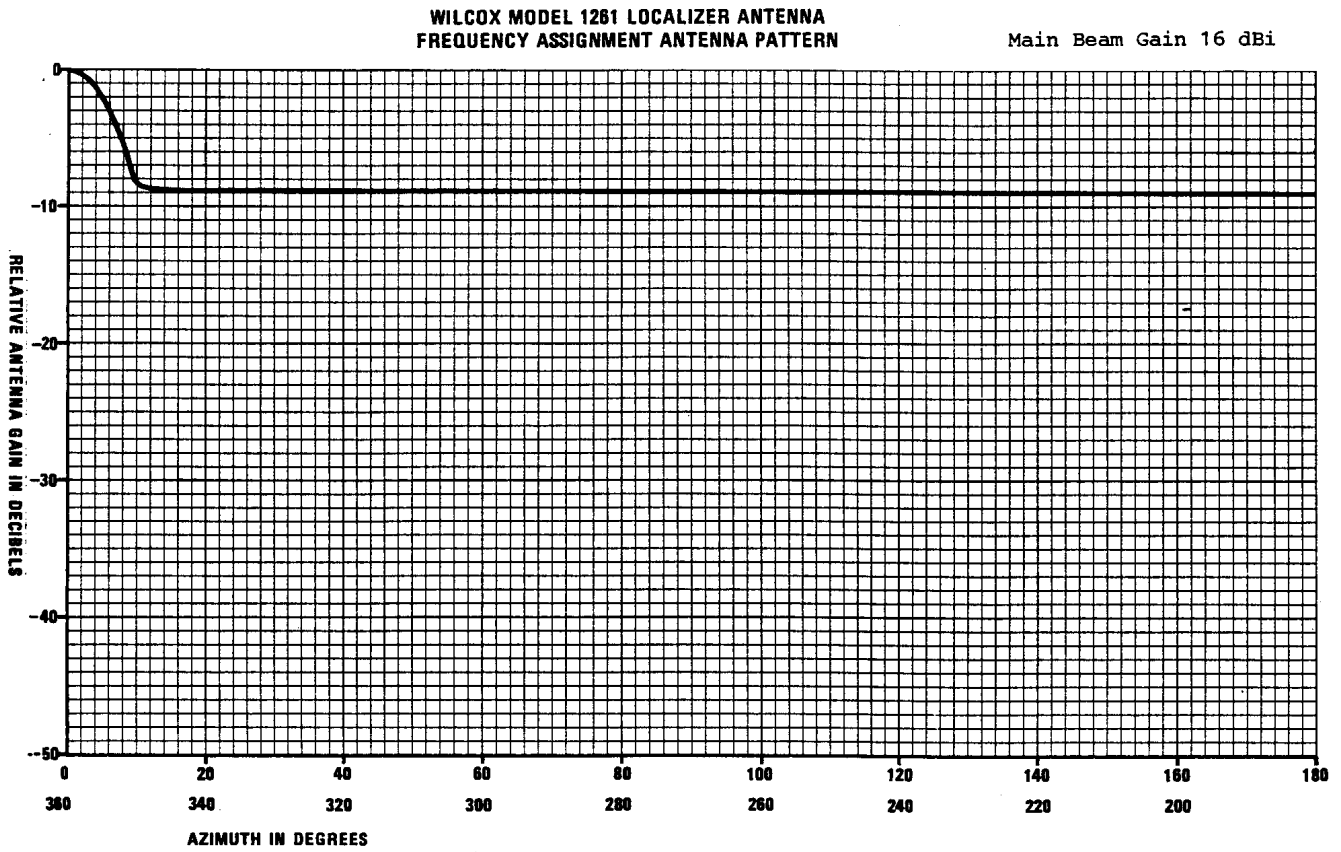
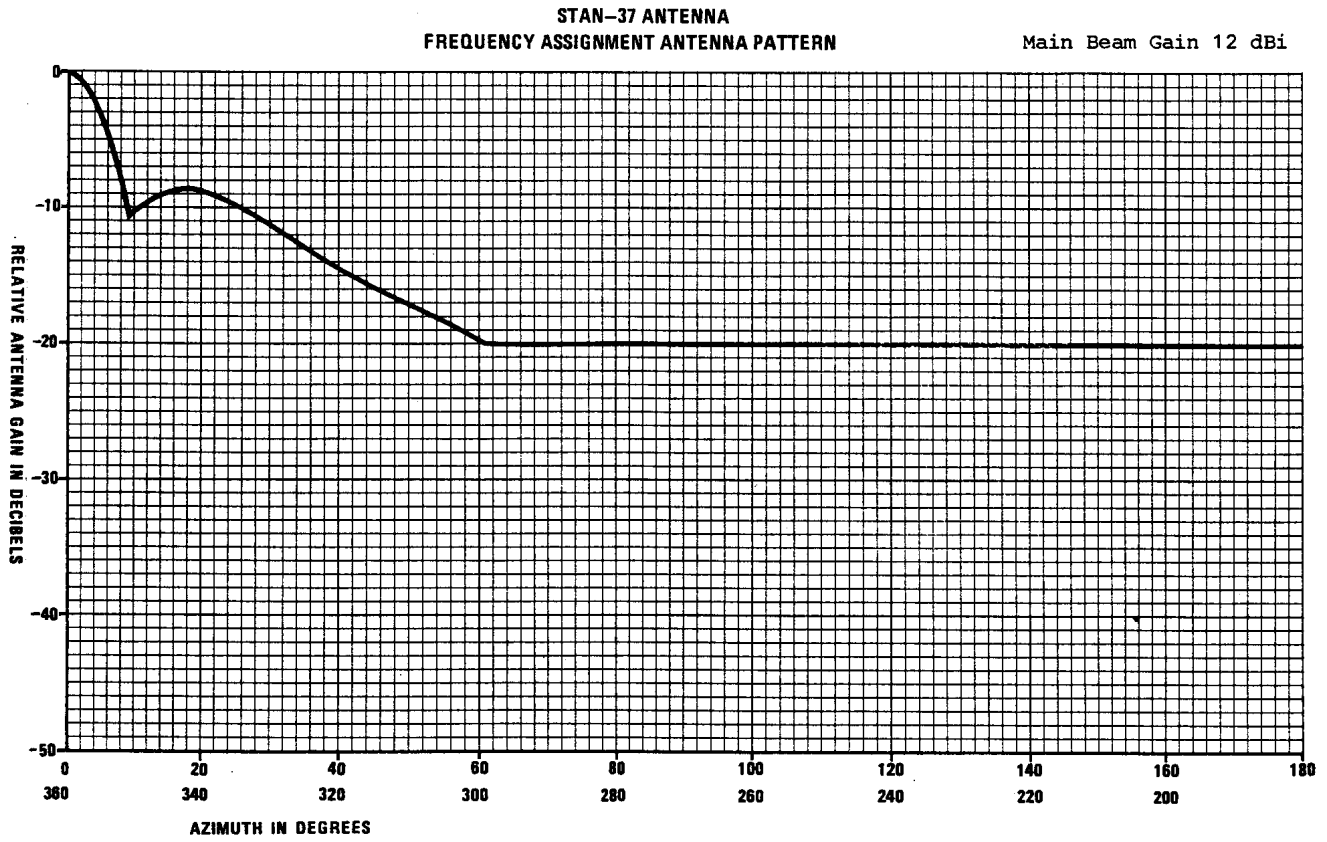


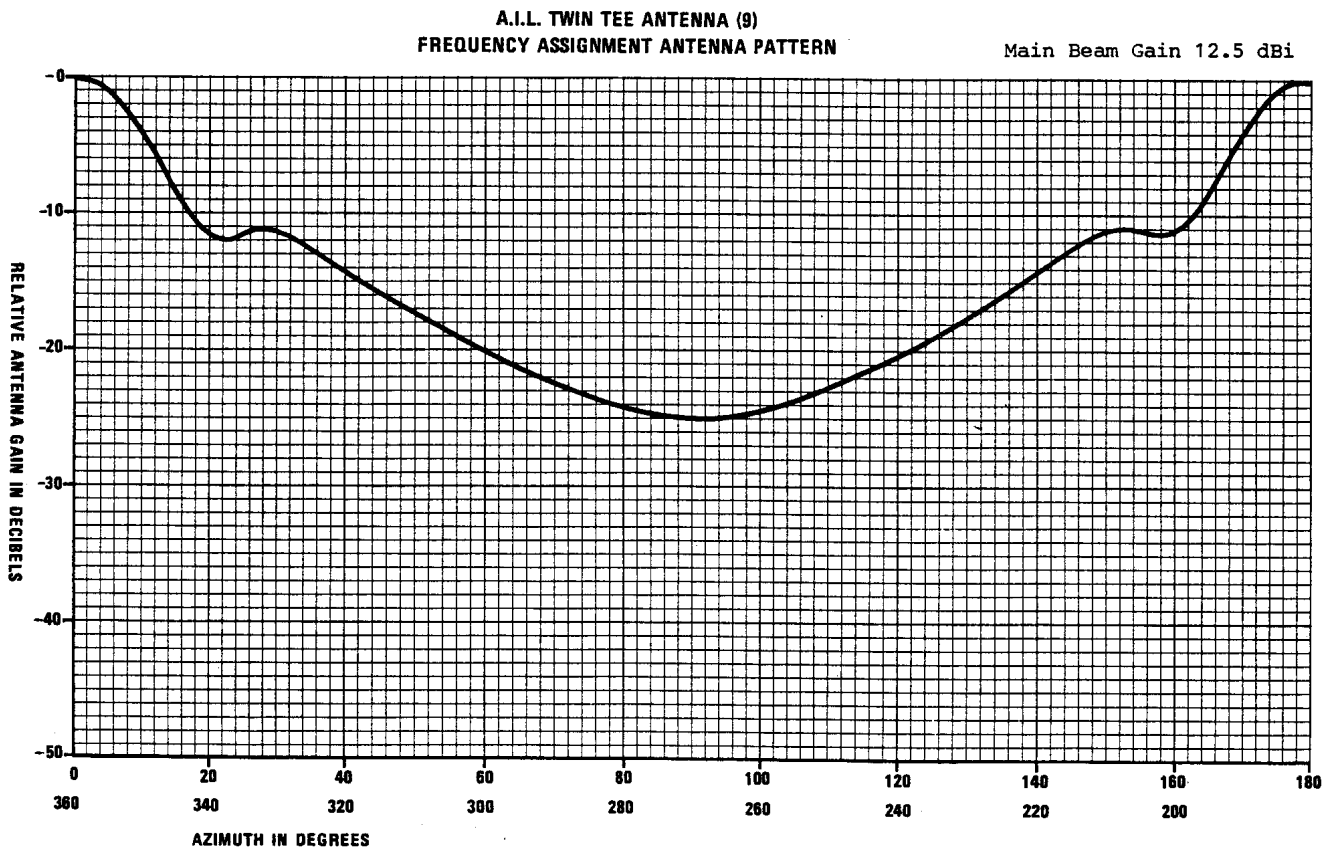
FIGURE 127. LOC 1261 DIPOLE ANTENNA RADIATION PATTERN



**FIGURE 128. LOC STAN 37 DIPOLE ANTENNA RADIATION PATTERN**

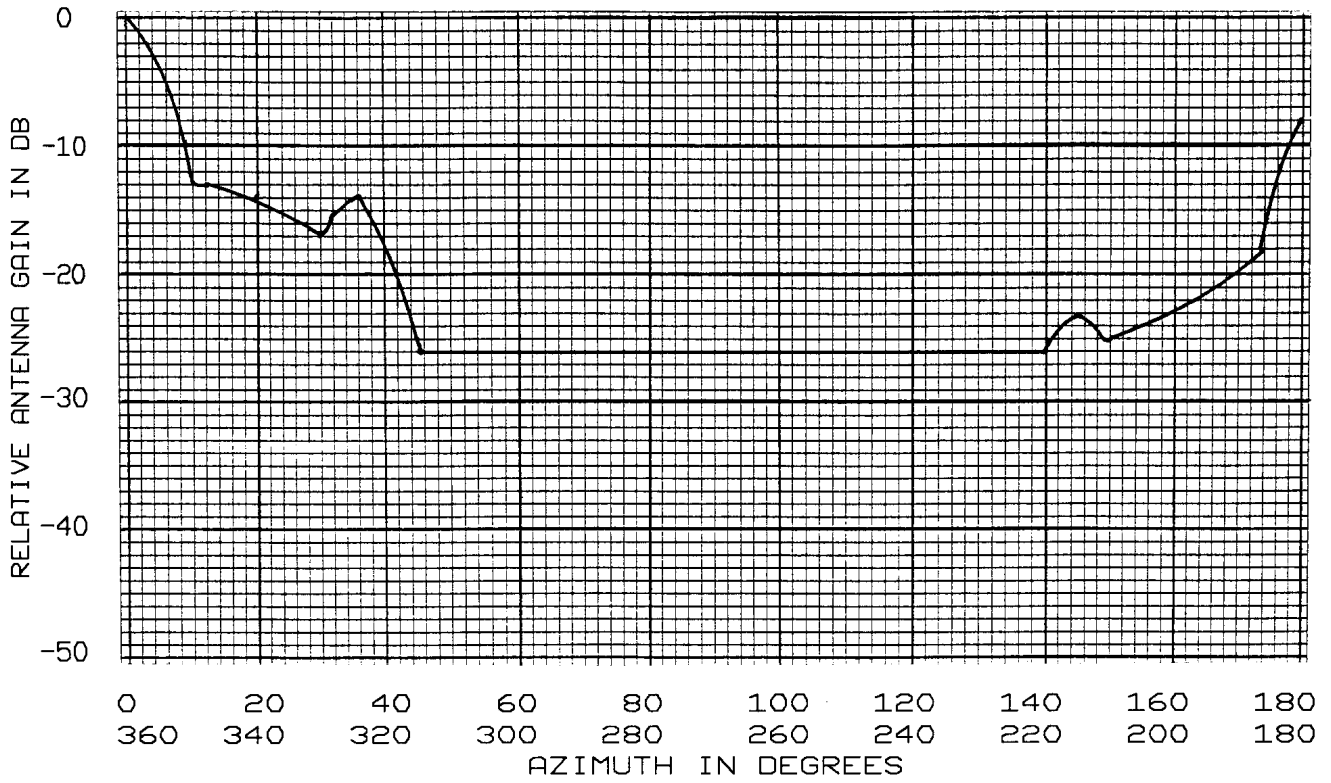


**FIGURE 129. LOC TWIN TEE ANTENNA RADIATION PATTERN**



**FIGURE 130. STANDARD 14 EL V-RING**

STANDARD 14-EL V-RING ARRAY  
FREQUENCY ASSIGNMENT ANTENNA PATTERN  
Main Beam Gain +14.6 dBi



**FIGURE 131. DME UNIDIRECTIONAL ANTENNA RADIATION PATTERN**

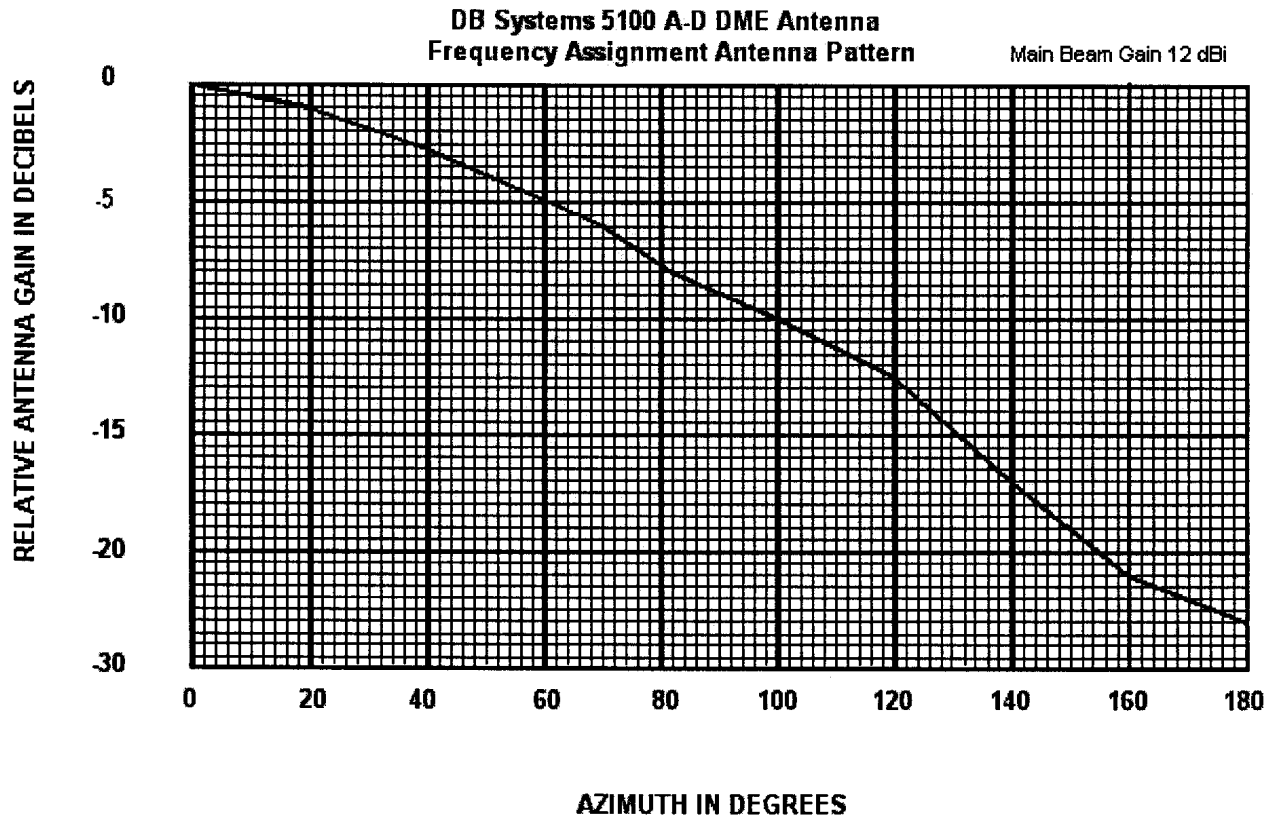
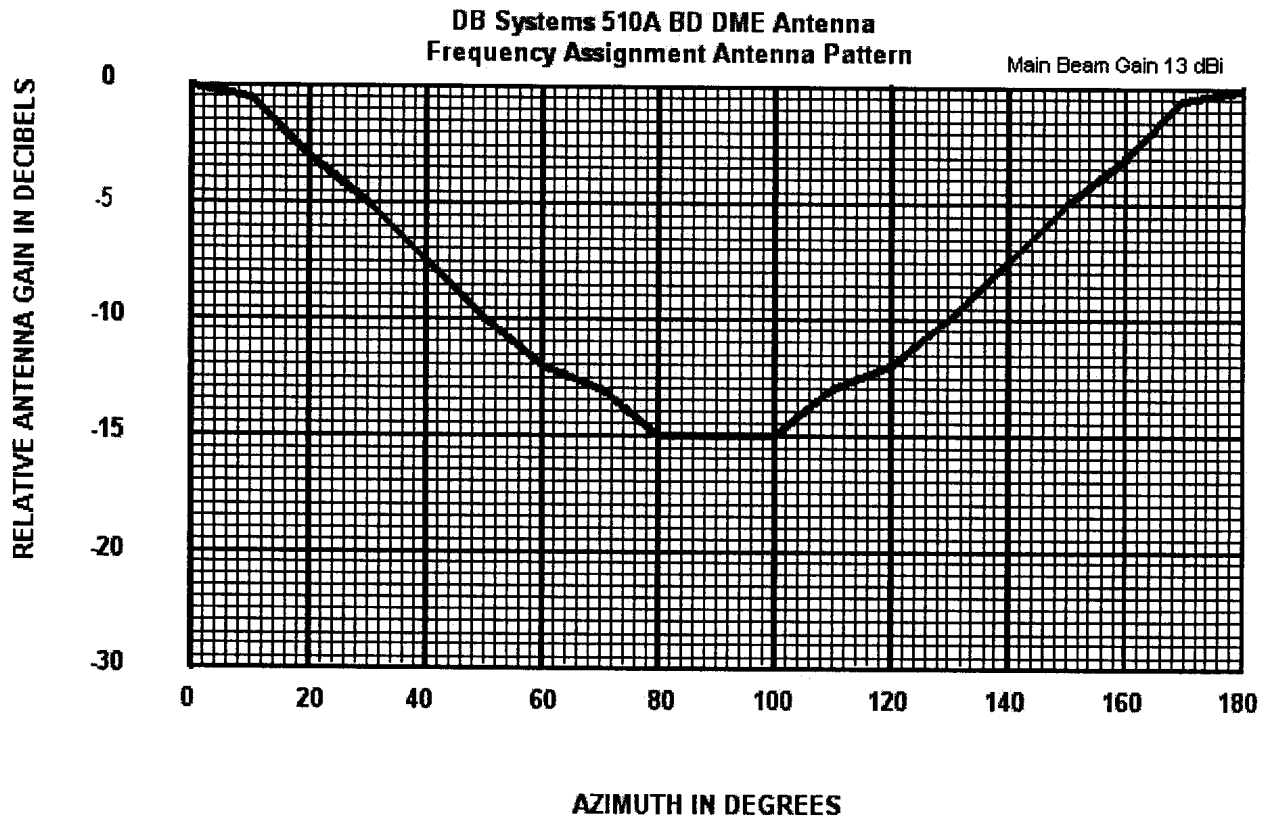


FIGURE 132. DME BIDIRECTIONAL ANTENNA RADIATION PATTERN



FIGURES 133. thru 140. RESERVED

## **SECTION 4. CHECKING AN FAA PROPOSED ILS FREQUENCY WITH THE AAM**

### **31. ILS FREQUENCY STUDY PROCEDURE.**

**a. The AAM must be used** to determine whether a proposed FAA ILS localizer frequency will be compatible with the existing FM broadcast environment. This is a case where the FAA must accept the status quo for any and all FM stations either operating or which have been approved within the OE case process.

**b. To start**, select an ILS channel for the proposed installation in accordance with Section 3 of this appendix, then proceed with the steps outline in paragraph 32, below.

### **32. STEP-BY-STEP STUDY PROCEDURE.**

**a. Select "NAVAID."**

**b. Select "Manual Entry."**

**c. On the next screen;**

**(1) Select "ILS" under "Navaid Type."**

**(2) Enter** the coordinates of the Localizer.

**(3) Enter** the Localizer Identifier.

**(4) Enter** the Localizer Frequency.

**(5) Enter** the Localizer fron course (under "Rwy Hdg").

**(6) Enter** the Localizaer Field Elevation.

**(7) Select "OK."**

**d. On the next screen**, select "Service Volume Type," and "OK."

**e. On the next screen**, select "Save" the indicated file name (in which the run data will be stored for future access).

**f. On the next screen**, select "Navaid Data."

**(1) Enter** the runway length.

**(2) Select** the antenna type from the options presented under "Array Type."

**g. Select "RF Sources"** at the top of the screen, followed by :

**(1) Select** proponent status ("PropStatus").



(2) **Enter** all the proponents by selecting "All Non-Proponent > Proponent."

(3) **For all hred highlighted FM stations** (indicating incomplete record data), enter a "click" in the far left hand column (resulting in an "x" being entered).

(4) **"Click"** on "Insert/Delete," and select "Delete Tagged Rows," followed by "OK."

(5) **Select** "File," followed by "Save, Run Simulation."

(6) **Select** "Display Results," followed by "Simulation Report" and "OK."

(7) **The Run file** will be displayed.

(8) **To Print** out the file, select "File" and then "Print."

**h. If the run is clear**, the frequency is OK.

**i. If there is a problem**, plots will be available for printout and analysis. Vertical plots are not needed, since any problem at any altitude within the FPSV will rule out selecting that frequency for an ILS.

**j. To obtain plots**, select "Files of Type," and "All plot files."

**k. Under "File Name,"** select (highlight) each file (only one file can be selected at a time) with an FM station call sign associated with it, click "OK," and the file will be displayed. To print out the report, select "File" and the "Print." Click "Exit" to return to the "File Name" screen and list to select any remaining files to print out.

### 33. STUDY RESULTS.

**a. If there are no IM points**, then the selected frequency is satisfactory, as far as the in-place FM broadcast environment is concerned. It has been run against all FM stations within the search range, each being used independently as a proponent.

**b. If there is any IM point**, then the FM stations making up the IM combination must be studied further to include the proper antenna type, duplicate applications, etc. If there are still IM points, the frequency is not usable since the FM stations are in place and FAA cannot ask an FM station to move to accommodate a new ILS frequency.

**c. Sample runs** have been made for the lowest and highest assignable ILS localizer frequencies of 108.3 and 110.3 MHz, as shown in figures 142a – 142f. On 108.3 MHz, there are no IM points, but for 110.3 MHz, there is a small number of IM points, as present in the plots. Note them at the very top corner of the "arrow."

### 34. thru 40. RESERVED.

**FIGURE 141a. AAM PRINTOUT PAGE 1**

Airspace Analysis Model, Version 5.0

Airspace Case: TEST  
 Site: 5903  
 Date: 07/28/03

Facility Identifier: ILS  
 Facility Frequency: 108.300 MHz

Facility Latitude: 37° 22' 51"  
 Facility Longitude: 120° 35' 03"

Runway Heading: 0.0 deg (true)  
 Runway Elevation: 188 ft MSL  
 Runway Length: 5903 ft

Prop ID	Call	Freq MHz	Latitude	Longitude	ERP kW	Height ft MSL	Range nmi	Radial true	Lic
*	1	KLVN	88.300	37 36 31 120 39 02	0.1533	305	14.03	166.98	LIC
*	2	KMPO	88.700	37 32 00 120 01 29	2.0500	4301	28.17	251.05	LIC
*	3	K208	89.500	37 01 09 121 05 07	0.0100	1729	32.32	47.82	LIC
*	4	KBES	89.500	37 35 21 120 57 23	0.1500	223	21.69	125.20	LIC
*	5	KEFR	89.900	37 32 01 120 01 50	1.8000	4364	27.92	250.83	LIC
*	6	K211	90.100	36 43 32 120 45 49	0.0100	2195	40.24	12.33	LIC
*	7	9811	90.500	36 43 32 120 45 49	9.1000	89	40.24	12.33	APP
*	8	9811	90.500	36 43 32 120 45 49	9.1000	2178	40.24	12.33	APP
*	9	9805	90.500	36 43 32 120 45 49	9.4000	2182	40.24	12.33	APP
*	10	9811	90.500	36 51 46 120 27 32	0.1000	758	31.66	349.09	APP
*	11	KADV	90.500	37 36 26 120 57 26	1.5000	207	22.36	127.41	LIC
*	12	KHRI	90.700	36 54 32 121 13 21	0.0400	3422	41.64	47.15	APP
*	13	KHRI	90.700	36 54 32 121 13 25	0.0400	3422	41.68	47.20	APP
*	14	KBDG	90.900	37 29 59 120 49 41	0.7800	190	13.63	121.55	LIC
*	15	None	91.100	37 18 02 120 29 23	0.0600	262	6.60	316.91	APP
*	16	K219	91.700	36 55 08 120 07 05	0.0100	410	35.57	321.19	CP
*	17	K220	91.900	36 59 32 120 54 17	0.0600	315	27.90	33.31	LIC
*	18	K220	91.900	36 59 32 120 54 17	0.0800	305	27.90	33.31	CP
*	19	KBRE	92.500	37 16 41 120 37 35	6.0000	456	6.49	18.09	LIC
*	20	KNTO	93.300	37 13 02 120 11 56	2.9500	682	20.85	298.09	LIC
*	21	KNTO	93.300	37 13 02 120 11 56	6.0000	673	20.85	298.09	CP
*	22	KEJC	93.900	37 39 00 121 01 21	4.0000	482	26.38	127.75	LIC
*	23	KBKY	94.100	37 27 59 120 14 09	6.0000	1207	17.37	252.81	LIC
*	24	KOKO	94.300	36 44 29 120 05 08	6.0000	528	45.19	328.11	LIC
*	25	KAJP	94.700	36 51 37 120 27 19	0.9000	230	31.84	348.83	CP
*	26	KHOP	95.100	37 47 34 120 31 08	29.5000	1421	24.91	187.16	LIC
*	27	KSKD	95.900	36 55 35 120 50 42	3.3000	951	29.98	24.58	CP
*	28	KSKD	95.900	37 18 57 120 43 20	3.0000	413	7.65	59.36	LIC
*	29	KUBB	96.300	37 32 01 120 01 46	1.9000	4360	27.97	250.87	LIC
*	30	KTSE	97.100	37 29 34 121 13 29	1.3500	1158	31.25	102.41	LIC
*	31	KABX	97.500	37 26 44 120 08 37	8.8000	2454	21.35	259.52	LIC
*	32	KWNN	98.300	37 34 46 120 50 48	2.0000	515	17.27	133.64	LIC
*	33	KLOQ	98.700	37 16 41 120 37 35	6.0000	427	6.49	18.09	LIC
*	34	K258	99.500	37 38 30 121 00 07	0.0800	249	25.30	128.21	LIC
*	35	KCIV	99.900	37 32 00 120 01 29	1.9000	4360	28.17	251.05	LIC
*	36	KCIV	99.900	37 32 00 120 01 29	1.9000	4386	28.17	251.05	CP
*	37	KMEN	100.500	36 38 50 120 21 02	6.0000	354	45.42	345.73	CP

FIGURE 141b. AAM PRINTOUT PAGE 2

*	38	9710	100.700	37 15 37	120 23 49	0.1400	387	11.49	309.00	APP
*	39	KAMB	101.500	37 32 01	120 01 46	1.8500	4390	27.97	250.87	LIC
*	40	KJSN	102.300	37 40 50	120 55 26	6.0000	397	24.18	138.05	LIC
*	41	KDJK	103.900	37 32 00	120 01 29	0.0700	4334	28.17	251.05	LIC
*	42	KHTN	104.700	37 11 29	120 32 03	50.0000	617	11.61	348.14	LIC
*	43	KIBG	106.300	37 25 35	120 26 25	2.9500	774	7.38	248.27	LIC
*	44	9708	106.700	37 32 01	120 01 46	0.0100	4350	27.97	250.87	APP
*	45	KQLB	106.900	36 55 35	120 50 42	6.0000	843	29.98	24.58	LIC

---

Interference thresholds are computed using the following:

Facility antenna type:       14 Element V-Ring 15 dBi Gain  
 Service volume type:         ILS, U.S. Standard

---

Evaluation of adjacent channel (A2) and overload (B2) interference

---

No A2/B2 interference found.

Evaluation of 2-signal intermodulation interference

---

No 2-signal intermodulation interference found.

Evaluation of 3-signal intermodulation interference

---

No 3-signal intermodulation interference found.

**FIGURE 142a. AAM PRINTOUT PAGE 1**

Airspace Analysis Model, Version 5.0

Airspace Case: ATLANTA, GA  
 Site: A10  
 Date: 07/28/03

Facility Identifier: A10  
 Facility Frequency: 110.300 MHz

Facility Latitude: 33° 37' 55"  
 Facility Longitude: 84° 24' 52"

Runway Heading: 90.0 deg (true)  
 Runway Elevation: 1011 ft MSL  
 Runway Length: 9000 ft

Prop ID	Call	Freq MHz	Latitude	Longitude	ERP kW	Height ft MSL	Range nmi	Radial true	Lic
* 1	WRAS	88.500	33 41 04	84 17 23	37.0000	1184	6.98	243.17	CP
* 2	WRAS	88.500	33 41 04	84 17 23	100.0000	1316	6.98	243.17	LIC
* 3	W204	88.700	33 34 50	85 04 12	0.0600	1165	32.90	84.62	CP
* 4	WRFG	89.300	33 44 56	84 24 26	100.0000	1184	7.03	182.94	LIC
* 5	WRFG	89.300	33 48 26	84 20 22	14.5000	1417	11.16	199.59	APP
* 6	WRFG	89.300	33 48 26	84 20 22	65.0000	1417	11.16	199.59	APP
* 7	WWBM	89.700	33 27 47	84 53 35	1.0000	1152	25.99	67.05	CP
* 8	None	89.700	33 48 27	84 20 26	0.0100	1621	11.16	199.29	APP
* 9	None	89.900	33 37 50	85 06 50	0.0100	1306	34.94	89.86	APP
* 10	None	89.900	33 37 50	85 06 50	0.0300	1293	34.94	89.86	APP
* 11	WABE	90.100	33 45 32	84 20 07	96.0000	1742	8.58	207.42	CP
* 12	WABE	90.100	33 48 18	84 08 40	96.0000	1890	17.01	232.38	LIC
* 13	W213	90.500	33 51 00	84 02 11	0.0100	1371	22.96	235.25	LIC
* 14	WMVV	90.700	33 22 12	84 08 00	18.0000	1250	21.09	318.17	LIC
* 15	WUWG	90.700	33 33 50	85 01 04	0.5000	1519	30.43	82.29	LIC
* 16	None	90.900	33 21 37	84 33 47	0.0100	994	17.92	24.52	APP
* 17	None	90.900	33 21 37	84 33 47	0.0100	1001	17.92	24.52	APP
* 18	None	90.900	34 11 49	84 46 18	0.0100	1506	38.28	152.31	APP
* 19	WREK	91.100	33 46 41	84 24 22	40.0000	1257	8.78	182.72	LIC
* 20	9704	91.700	33 16 03	84 33 20	10.0000	1142	22.98	17.90	APP
* 21	9704	91.700	33 16 04	84 33 20	1.5000	1142	22.96	17.92	APP
* 22	9611	91.700	33 16 04	84 33 20	10.0000	1142	22.96	17.92	APP
* 23	None	91.900	33 44 16	84 05 19	0.0100	1102	17.46	248.68	APP
* 24	WCLK	91.900	33 44 56	84 24 26	6.0000	1220	7.03	182.94	LIC
* 25	WBTR	92.100	33 33 54	85 01 02	0.5800	1634	30.39	82.41	LIC
* 26	W221	92.100	33 52 28	84 10 26	0.0300	1220	18.86	219.51	LIC
* 27	W222	92.300	33 58 41	84 33 25	0.0100	1421	21.95	161.11	LIC
* 28	WEKS	92.500	33 05 18	84 19 47	6.0000	1142	32.89	352.58	LIC
* 29	NEWx	92.500	33 49 07	84 14 40	0.0200	1230	14.05	217.14	APP
* 30	WZGC	92.900	33 45 33	84 20 05	39.0000	1949	8.61	207.53	APP
* 31	WZGC	92.900	33 45 34	84 23 19	99.0000	1821	7.76	189.57	LIC
* 32	WVFJ	93.300	33 05 10	84 46 10	27.0000	2434	37.27	28.51	LIC
* 33	9710	93.500	34 04 02	84 27 23	0.0100	1864	26.20	175.42	APP
* 34	NEWx	93.700	33 44 01	84 47 47	0.0100	1624	20.02	107.74	APP
* 35	NEWx	93.700	33 52 44	84 44 51	0.0200	1211	22.26	131.73	APP
* 36	WSTR	94.100	33 45 35	84 20 07	100.0000	1942	8.63	207.27	LIC
* 37	NEWx	94.500	33 29 29	84 35 00	0.0100	1306	11.93	45.04	APP

FIGURE 142b. AAM PRINTOUT PAGE 2

*	38	NEWx	94.500	33 30 11	84 09 58	0.0100	981	14.63	301.92	APP
*	39	NEWx	94.500	33 41 20	84 30 38	0.0100	1214	5.89	125.44	APP
*	40	NEWx	94.500	33 44 41	84 21 36	0.0100	2028	7.29	201.88	APP
*	41	NEWx	94.500	33 45 24	84 19 55	0.0100	1919	8.54	208.82	APP
*	42	NEWx	94.500	33 48 18	84 08 40	0.0100	1726	17.01	232.38	APP
*	43	NEWx	94.500	33 48 18	84 08 40	0.0100	1804	17.01	232.38	APP
*	44	NEWx	94.500	33 55 01	84 12 06	0.0100	1250	20.13	211.82	APP
*	45	NEWx	94.500	33 58 40	85 00 45	0.0100	1463	36.33	124.84	APP
*	46	NEWx	94.500	33 58 41	84 33 25	0.0100	1368	21.95	161.11	APP
*	47	NEWx	94.500	34 03 59	84 27 20	0.0100	1739	26.15	175.51	APP
*	48	WLTM	94.900	33 48 27	84 20 27	99.0000	1906	11.16	199.23	LIC
*	49	WKLS	96.100	33 48 27	84 20 26	99.0000	1906	11.16	199.29	LIC
*	50	NEWx	96.500	33 55 01	84 12 05	0.0100	1319	20.13	211.86	APP
*	51	WBZY	96.700	33 29 22	84 34 07	2.1500	1450	11.51	42.04	LIC
*	52	NEWx	96.900	33 33 54	85 01 03	0.0100	1490	30.40	82.41	APP
*	53	NEWx	97.100	33 40 54	84 48 57	0.0100	1565	20.27	98.47	APP
*	54	NEWx	97.300	33 57 50	84 53 28	0.0100	1496	31.01	129.96	APP
*	55	WPZE	97.500	33 29 29	84 35 00	7.9000	1470	11.93	45.04	LIC
*	56	NEWx	97.900	33 33 45	84 20 28	0.0100	1181	5.55	318.66	APP
*	57	NEWx	98.100	33 49 22	84 33 09	0.0100	1266	13.36	148.97	APP
*	58	WSB-	98.500	33 45 33	84 20 05	100.0000	1949	8.61	207.53	LIC
*	59	NEWx	98.900	33 26 09	84 33 16	0.0200	1148	13.69	30.76	APP
*	60	NEWx	98.900	33 57 24	84 53 06	0.0100	1896	30.50	129.71	APP
*	61	NEWx	98.900	33 59 12	84 03 25	0.0100	1332	27.76	219.94	APP
*	62	NEWx	98.900	33 59 48	84 36 41	0.0300	1165	23.98	155.84	APP
*	63	NEWx	98.900	34 02 44	84 36 11	0.0200	1240	26.54	159.25	APP
*	64	NEWx	98.900	34 07 35	84 15 29	0.0100	1381	30.67	194.71	APP
*	65	9610	99.100	33 46 15	84 23 10	0.0100	2047	8.45	189.63	APP
*	66	NEWx	99.300	33 57 24	84 53 06	0.0100	1896	30.50	129.71	APP
*	67	WNNX	99.700	33 46 57	84 23 20	100.0000	1949	9.12	188.04	LIC
*	68	WNNX	99.700	33 48 26	84 20 22	100.0000	2008	11.16	199.59	CP
*	69	NEWx	100.100	33 33 45	84 20 28	0.0100	1302	5.55	318.66	APP
*	70	NEWx	100.100	33 44 06	85 15 08	0.0100	1470	42.28	98.41	APP
*	71	NEWx	100.100	33 44 16	84 05 19	0.0100	1102	17.46	248.68	APP
*	72	WWWQ	100.500	33 41 20	84 30 38	27.0000	1365	5.89	125.44	APP
*	73	WWWQ	100.500	33 45 34	84 23 19	3.0000	1867	7.76	189.57	CP
*	74	WWWQ	100.500	33 46 57	84 23 19	0.4100	1660	9.13	188.12	APP
*	75	W263	100.500	33 48 20	84 08 40	0.0200	1781	17.03	232.29	LIC
*	76	WGHR	100.700	33 56 22	84 31 12	0.0200	1155	19.19	164.08	LIC
*	77	W265	100.900	34 04 02	84 27 23	0.0100	1873	26.20	175.42	LIC
*	78	NEWx	101.100	33 35 41	84 32 04	0.0100	1339	6.40	69.57	APP
*	79	9708	101.100	33 49 47	84 17 59	0.0100	1138	13.18	205.75	APP
*	80	WKHX	101.500	33 48 26	84 20 22	100.0000	2008	11.16	199.59	CP
*	81	WKHX	101.500	33 48 27	84 20 27	99.0000	1909	11.16	199.23	LIC
*	82	NEWx	101.900	33 23 46	84 47 08	0.0100	1299	23.34	52.69	APP
*	83	NEWx	101.900	33 30 16	85 09 58	0.0300	1181	38.35	78.49	APP
*	84	NEWx	101.900	33 45 24	84 19 55	0.0100	1919	8.54	208.82	APP
*	85	NEWx	101.900	33 45 47	85 16 04	0.0200	1325	43.32	100.46	APP
*	86	NEWx	101.900	33 48 26	84 20 22	0.0100	1919	11.16	199.59	APP
*	87	NEWx	101.900	33 50 42	84 38 38	0.0100	1306	17.16	138.15	APP
*	88	NEWx	101.900	33 58 01	84 22 10	0.0100	1368	20.23	186.37	APP
*	89	NEWx	101.900	33 58 40	85 00 45	0.0100	1463	36.33	124.84	APP
*	90	NEWx	101.900	34 03 54	84 37 39	0.0100	1302	28.07	157.77	APP
*	91	NEWx	102.100	33 15 19	84 17 18	0.0100	1132	23.47	344.39	APP
*	92	NEWx	102.100	33 23 39	84 35 41	0.0200	1076	16.88	32.30	APP
*	93	NEWx	102.100	33 33 45	84 20 28	0.0100	1309	5.55	318.66	APP
*	94	NEWx	102.100	33 40 35	84 48 25	0.0100	1404	19.78	97.75	APP
*	95	NEWx	102.100	34 04 00	84 27 09	0.0100	1473	26.15	175.84	APP

**FIGURE 142c. AAM PRINTOUT PAGE 3**

*	96	NEWx	102.300	33 07 24	84 57 44	0.2500	541	41.04	41.97	APP
*	97	NEWx	102.300	33 18 45	84 17 23	0.0400	984	20.16	341.96	APP
*	98	NEWx	102.300	33 29 01	84 12 54	0.0400	984	13.37	311.75	APP
*	99	NEWx	102.300	33 32 18	84 12 11	0.0600	928	11.97	297.99	APP
*	100	NEWx	102.300	33 52 54	84 13 07	0.0200	1207	17.89	213.10	APP
*	101	WAMJ	102.500	33 41 20	84 30 38	3.0000	1348	5.89	125.44	APP
*	102	WAMJ	102.500	33 41 20	84 30 38	3.0000	1365	5.89	125.44	LIC
*	103	WAMJ	102.500	33 47 58	84 33 46	3.0000	1234	12.48	143.62	CP
*	104	WCKS	102.700	33 37 24	85 20 14	1.6500	1670	46.10	89.36	LIC
*	105	NEWx	102.900	34 02 12	84 40 59	0.0200	1198	27.73	151.13	APP
*	106	WVEE	103.300	33 45 33	84 20 05	100.0000	1949	8.61	207.53	LIC
*	107	WVEE	103.300	33 45 34	84 23 19	8.8000	1867	7.76	189.57	CP
*	108	NEWx	103.700	33 35 41	84 32 04	0.0100	1345	6.40	69.57	APP
*	109	NEWx	103.700	33 45 24	84 19 55	0.0100	1919	8.54	208.82	APP
*	110	NEWx	103.700	33 58 19	84 30 12	0.0100	1539	20.88	167.74	APP
*	111	WALR	104.100	33 24 43	84 50 03	60.0000	2028	24.80	57.84	LIC
*	112	WALR	104.100	33 24 43	84 50 03	100.0000	2028	24.80	57.84	APP
*	113	WMAX	105.300	33 24 41	84 49 48	61.0000	2014	24.64	57.52	LIC
*	114	WMAX	105.300	33 24 41	84 49 48	70.0000	1818	24.64	57.52	CP
*	115	WLCL	105.700	34 03 55	84 27 14	16.5000	1834	26.07	175.68	LIC
*	116	WLCL	105.700	34 03 58	84 27 15	20.0000	1791	26.13	175.65	CP
*	117	W290	105.900	33 14 55	84 15 33	0.0300	1056	24.28	341.32	LIC
*	118	W290	105.900	33 45 00	84 23 30	0.0200	1240	7.17	189.12	LIC
*	119	NEWx	106.300	33 48 31	84 38 55	0.0100	1181	15.78	132.21	APP
*	120	NEWx	106.700	33 21 57	84 48 43	0.1500	997	25.50	51.24	APP
*	121	NEWx	107.100	33 29 58	84 20 34	0.0400	1027	8.72	335.74	APP
*	122	WTSH	107.100	33 57 50	84 53 28	37.0000	1539	31.01	129.96	APP
*	123	WJZZ	107.500	33 55 54	84 20 43	6.7000	1316	18.31	190.86	CP
*	124	WJZZ	107.500	33 55 54	84 20 43	21.5000	1339	18.31	190.86	CP
*	125	WJZZ	107.500	33 55 54	84 20 43	25.0000	1306	18.31	190.86	LIC
*	126	WHTA	107.900	33 29 22	84 34 07	41.0000	1391	11.51	42.04	LIC
*	127	WHTA	107.900	33 29 24	84 34 07	27.0000	1480	11.49	42.15	CP
*	128	W300	107.900	33 45 33	84 20 05	0.1000	1841	8.61	207.53	CP

Interference thresholds are computed using the following:

Facility antenna type: 14/10 Element (Mark 20) 26.2 dBi Gain  
 Service volume type: ILS, U.S. Standard

Evaluation of adjacent channel (A2) and overload (B2) interference

Freq MHz	ID	Call	Type	Offset MHz	#Pts
107.900	127	WHTA	A2/B2	2.400	2
107.900	126	WHTA	A2/B2	2.400	9

Evaluation of 2-signal intermodulation interference

No 2-signal intermodulation interference found.

**FIGURE 142d. AAM PRINTOUT PAGE 4**

Evaluation of 3-signal intermodulation interference

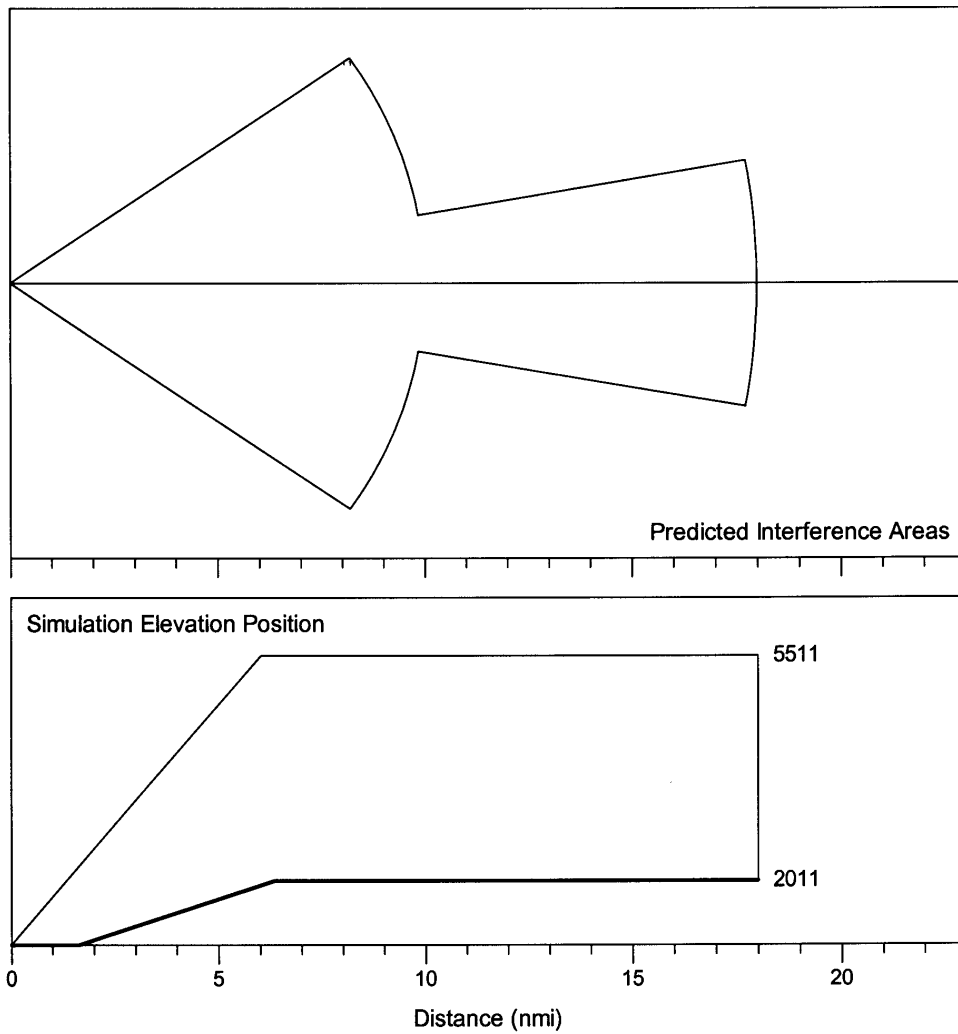
---

No 3-signal intermodulation interference found.

Note: Some 3-signal points masked by adjacent-channel / overload interference.

**FIGURE 142e. AAM PRINTOUT PAGE 5**

### Airspace Analysis Model Plot

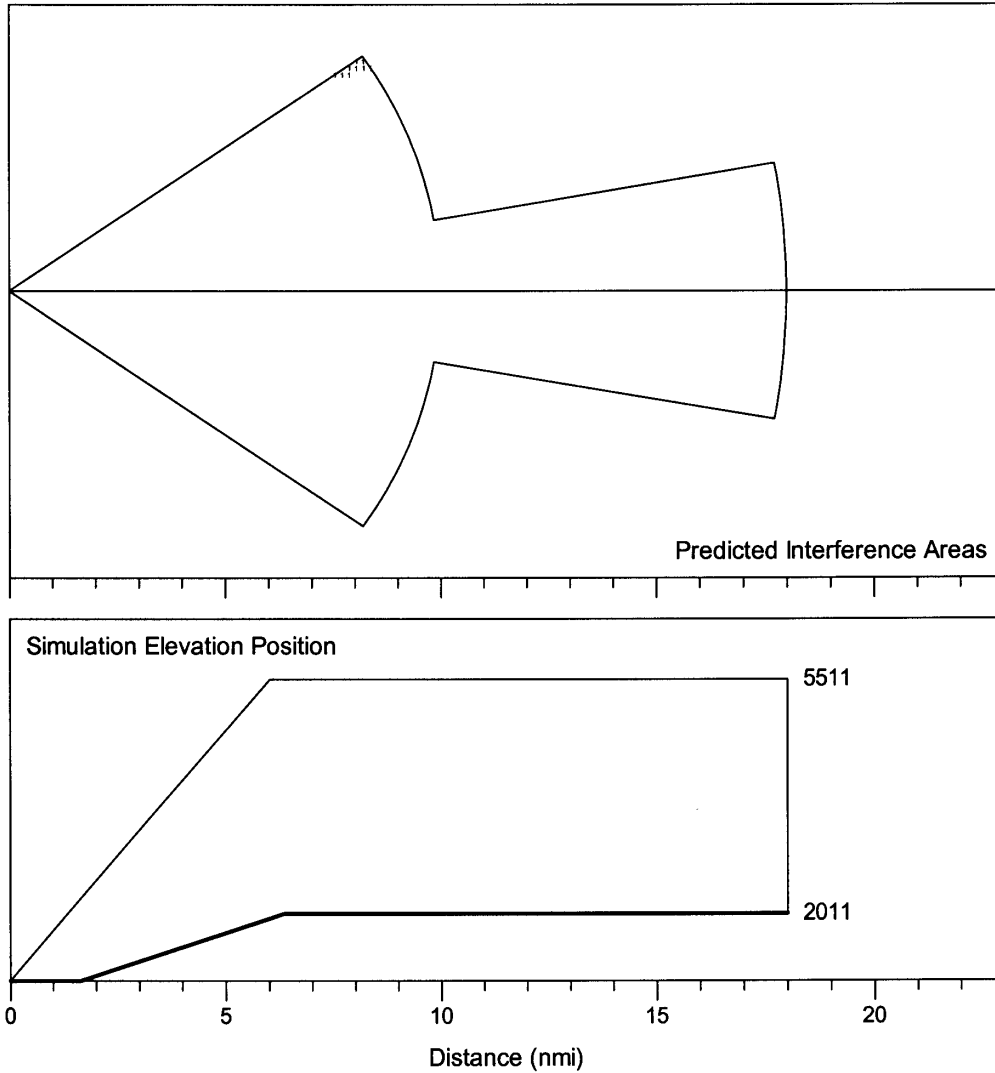


Airspace Case: ATLANTA, GA      Site: A10  
Date: 07/28/03    Plot File: 3J\_\_A2B2.plt  
Adjacent Channel (A2) plot: WHTA (127)  
Frequency: WHTA = 107.900 MHz  
Navaid: A10    Frequency: 110.3 MHz    Elevation: 1011 ft MSL  
Runway Heading: 90°  
Grid Orientation: Bottom of service volume



**FIGURE 142f. AAM PRINTOUT PAGE 6**

**Airspace Analysis Model Plot**



Airspace Case: ATLANTA, GA      Site: A10  
Date: 07/28/03      Plot File: 3I\_A2B2.plt  
Adjacent Channel (A2) plot: WHTA (126)  
Frequency: WHTA = 107.900 MHz  
Navaid: A10      Frequency: 110.3 MHz      Elevation: 1011 ft MSL  
Runway Heading: 90°  
Grid Orientation: Bottom of service volume

**FIGURES 143. thru 154. RESERVED**

## SECTION 5. NAVAID RECEIVER TEST FACILITIES FREQUENCY ENGINEERING

**41. FREQUENCY ENGINEERING FOR VOT TEST FACILITIES.** A VOT is provided to give the pilot an opportunity to check the aircraft's VOR avionics on the ground before a flight. Frequency protection for VOTs is not provided in the air.

**a. The frequencies used** are those found in figure 1, section 1.

**b. VOT FPSVs are not specifically described**, except for the Area VOT (AVOT), which is described in subparagraph d.

**c. The FPSV is set by flight check inspection** at the time of commissioning. The VOT check point is physically located on the field.

(1) **VOT power output** may not exceed 2 watts, and may be somewhat less, depending on flight inspection determination of necessary local airport coverage.

(2) **VOT cochannel separation** from another VOT is that distance required to assure they are beyond RLOS to each other.

**d. An AVOT** is a VOT whose power may exceed 2 watts, and is intended to be received in the air, or if installed at an elevated site, to cover several airports. Although it emits a special VOT signal which only tests VOR receivers, it can cause interference to other cochannel and adjacent channel operational facilities. Frequency engineering is done in the same manner as with any two VOR's and depends on the power and service volumes of the facilities involved.

**42. FREQUENCY ENGINEERING FOR SECONDARY RECEIVER TEST FACILITIES.** Other ground-based receiver test facilities also may radiate low power signals to test NAVAID (VOR, ILS, DME, DME/P, MLS) systems aboard an aircraft, including the antenna. They are commonly called "test generators" or "ramp testers" and are located in and operated by Fixed Base Operators or airlines facilities on an airport, and FAA Flight Inspection facilities. They are restricted as follows:

**a. If operated by a non-Federal entity**, they must be licensed by FCC.

**b. If operated by a Federal agency** (including military and FAA), they must be authorized by NTIA.

**c. They may operate** only on the following frequencies:

(1) **108.00/978, 108.05/1104 MHz** for VOR/DME test, 1 W maximum.

(2) **108.10/334.70/979 MHz**, for ILS/DME test, 1 W maximum.

(3) **108.15/334.55/1105 MHz**, for 50 kHz ILS channel, 100 mW maximum.

(4) **5031.0/979.0 MHz**, for MLS/DME/P, 1 W maximum.

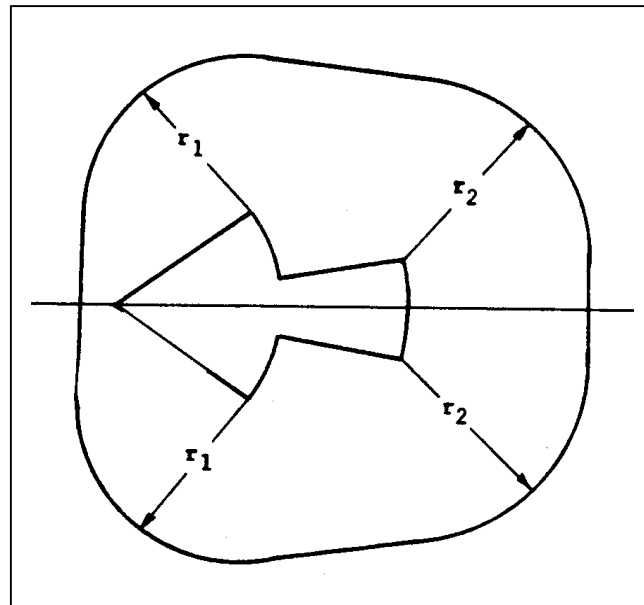
**d. If interference is received by aircraft** in the normal testing area from nearby or strong FM Broadcast stations, a frequency other than those listed in subparagraph c above may be assigned, upon coordination with Technical Operations ATC Spectrum Engineering Services.

**43. VOT FREQUENCY ENGINEERING BY THE TABLE METHOD.** The tables and diagram in figures 155-157 may be used for VOT frequency engineering. If the indicated cochannel mileages are not exceeded, and the adjacent channels are compliant with paragraph 7 of this appendix, the frequency request may be filed without further study. Note that the highest power in figures 155 and 157 is 20 dBW (100 W) EIRP. Since there usually is 1.5-2.0 dB loss in cable and connectors, this encompasses VOR's of 150/200 W normal operating power closely. Differences can be interpolated.

**FIGURE 155. COCHANNEL SEPARATION OF VOT AND OPERATING VORs**

VOR CLASS	-----VOR EIRP-----		
	20 dBW	17 dBW	14 dBW
SEPARATION FROM VOR'S (nmi)			
H	355	375	386
L	150	162	172
T	105	111	120

**FIGURE 156. LOC RADII DEFINED, COCHANNEL**



(See Figure 157)

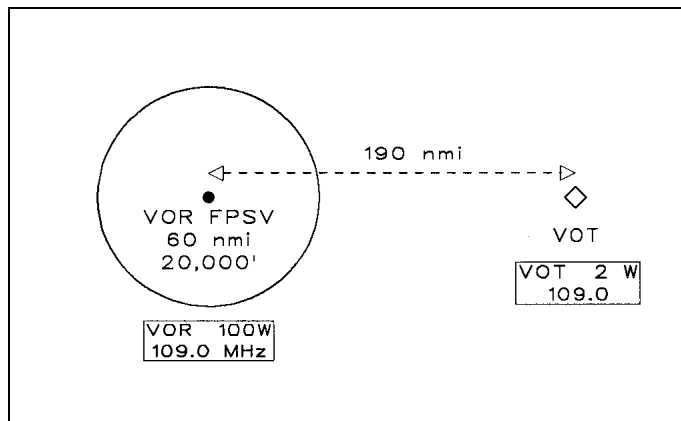
**FIGURE 157. COCHANNEL SEPARATION OF ILS AND ILS-TEST**

VOR CLASS	-----ILS EIRP-----					
	20 dBW		17 dBW (nmi)		14 dBW	
	r <sub>1</sub>	r <sub>2</sub>	r <sub>1</sub>	r <sub>2</sub>	r <sub>1</sub>	r <sub>2</sub>
STD & OPT B	11	32	13	35	16	38
OPTS A & C	19	43	22	49	24	54

(See Figure 156)

**44. VOT FREQUENCY ENGINEERING BY THE CALCULATION METHOD.** The required distance separation may also be determined by calculation. This is needed when there is a nonstandard FPSV or ESV on the cochannel operating facility. A graphical sample is shown in figure 158. A nonstandard VOR FPSV of 60 nmi radius @ 20,000' is assumed. Appropriate facility separation curves will be found in figures 159 through 161.

**FIGURE 158. VOR VERSUS COCHANNEL VOT BY CALCULATION**



a. Calculate the EIRP of the operating VOR as follows:

VOR output = 100 W	= +20.0 dBW
VOR antenna gain	= +2 dB
VOR cable and connector losses	= - 2.5 dB
VOR ERP	<hr/> = +19.5 dBW

b. Use figure 161, the closest separation curve on the high protection side for VOR/VOT.

c. Determine the required separation by interpolation. Since this is a cochannel problem, the highest altitude of the FPSV will be used. Locating the intersection of the 20,000' altitude line and the 60 NM line, interpolation will show the required separation to be 190 NM.

45. thru 50. RESERVED

FIGURE 159. VOR/VOT COCHANNEL FACILITY SEPARATION CURVES +14 dBW

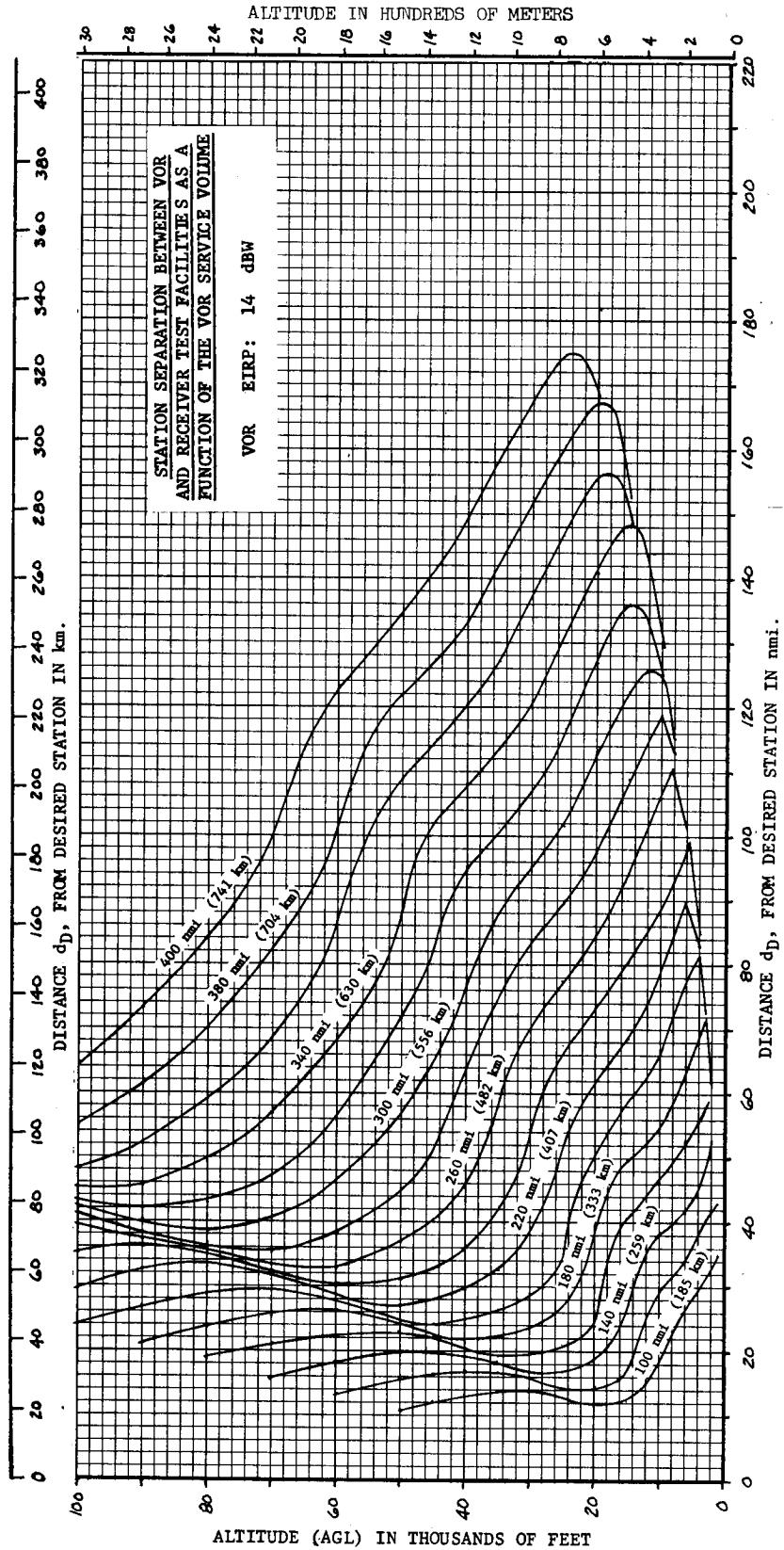


FIGURE 160. VOR/VOT COCHANNEL FACILITY SEPARATION CURVES +17 dBW

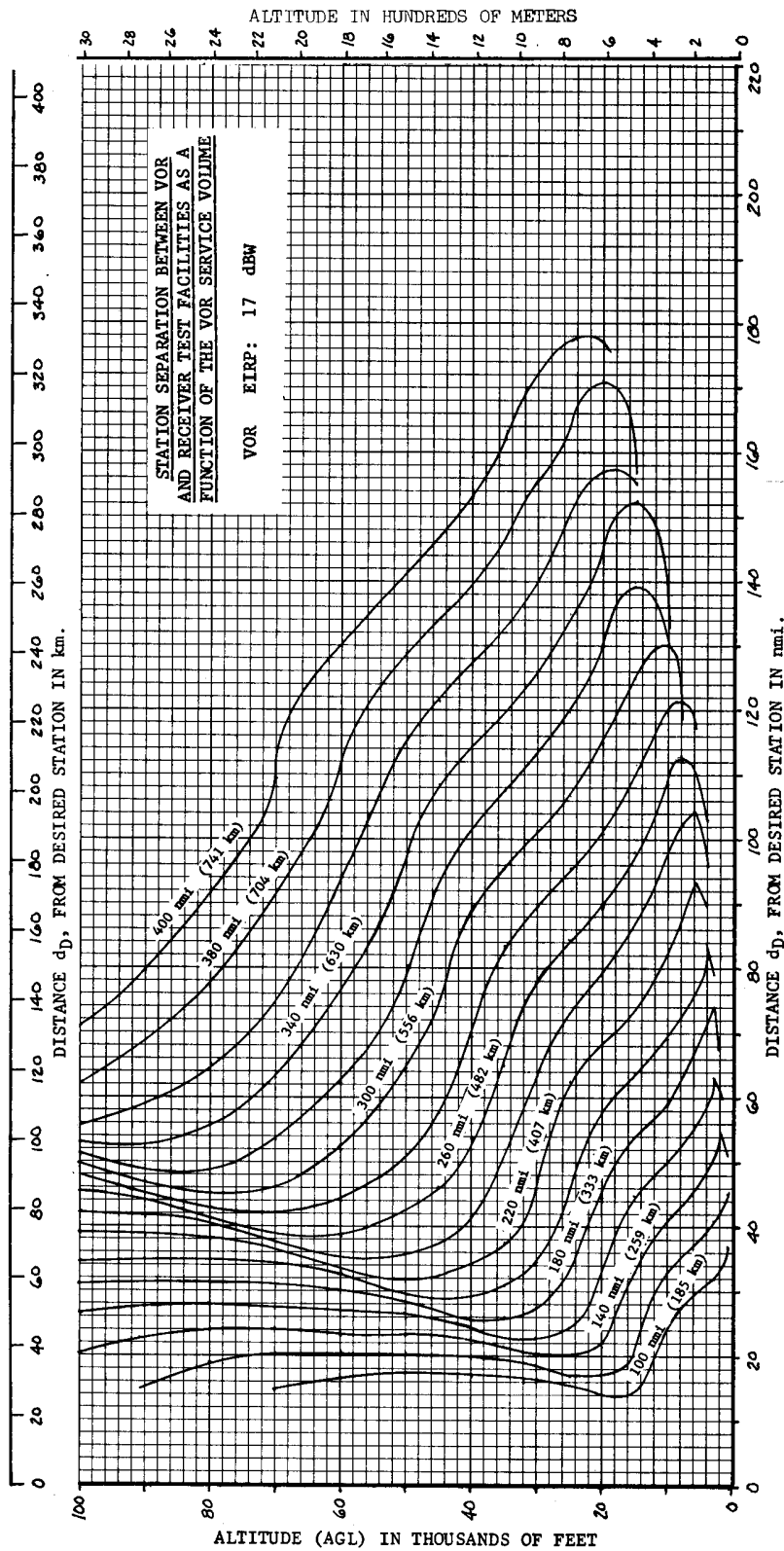
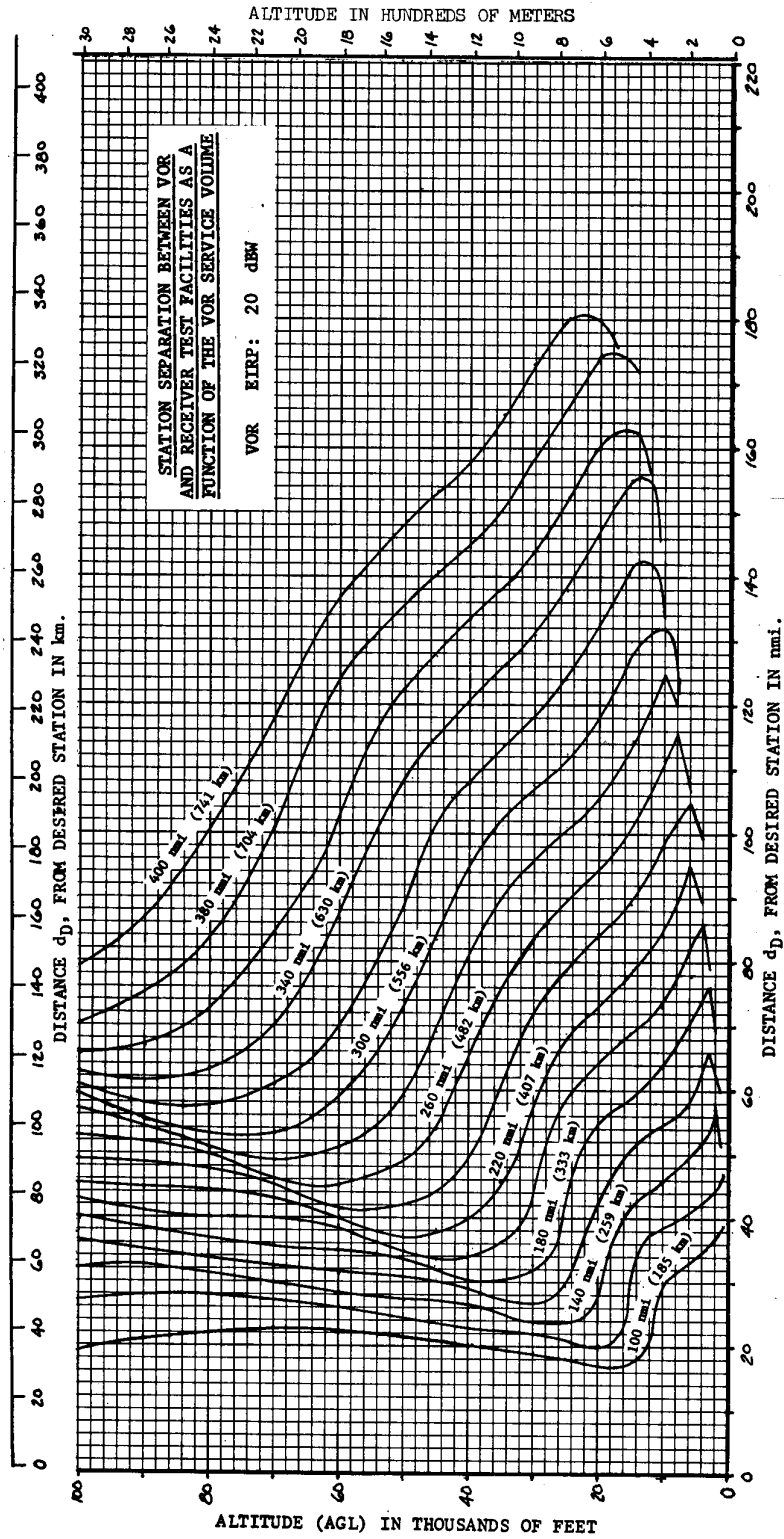


FIGURE 161. VOR/VOT COCHANNEL FACILITY SEPARATION CURVES +20 dBW



FIGURES 162. thru 164. RESERVED.



## SECTION 6. ESV FREQUENCY ENGINEERING

**51. FREQUENCY ENGINEERING FOR ESV.** An ESV is a volume of airspace in addition to the normal FPSV of a NAVAID, protected from interference from other NAVAID facilities.

**a. An ESV merely adds** to a standard FPSV. The ESV extends the standard FPSV in a particular direction, distance, altitude, and shape. Since power availability curves are in altitude AGL, the FMO will need to make an appropriate adjustment when analyzing ESV suitability because ESVs are designated in altitude MSL.

**b. An ESV can be placed** on any VOR, ILS-DME or TACAN. When a DME or TACAN and VOR are paired, BOTH shall have identical ESVs for safety reasons (except in those cases where the DME ESV supports DME/DME RNAV operations). ESVs may be added to any class of NAVAID facilities, including NDBs.

**c. An ESV is frequency engineered** just like the parent facility using the same facility separation and ESR curves.

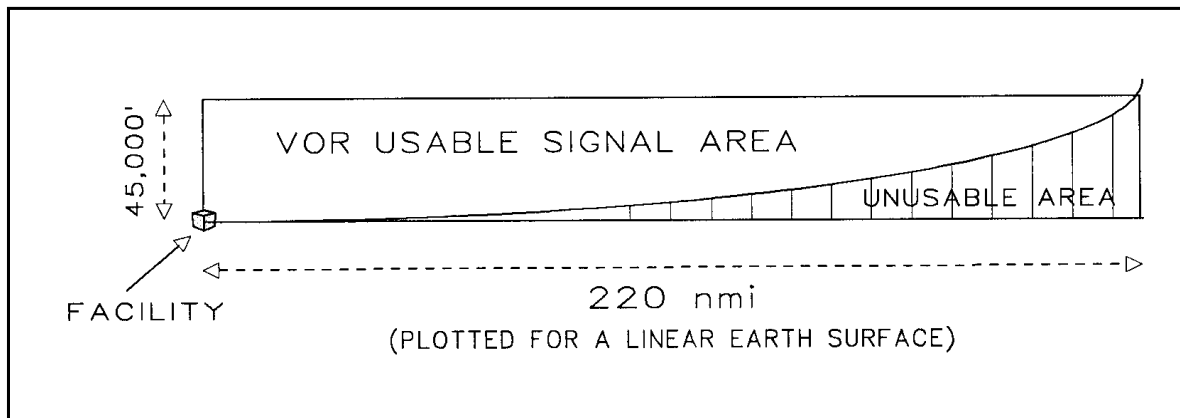
**d. The extension of the coverage** distance involves a new dimension, not covered in previous sections of this appendix. That is the power availability of the facility at the extremity of the ESV. In all standard FPSVs, the power availability of a standard NAVAID has been assured. However, extending the FPSV substantially can put the outer most critical point outside the acceptable signal level range. For example, an H-VOR has an FPSV of 130 nmi. If it were requested to protect an ESV at some azimuth out to 165 nmi, the FMO should first check signal availability before doing the whole study. Obviously, if the standard signal strength is not available at the critical point, the ESV cannot be used, regardless of the freedom from calculated interference for both cochannel and adjacent channel. The FMO should ask the proponent to adjust their requirements to meet the available signal level. If the signal level requirement is marginal, flight inspection can determine the minimum altitude.

**52. MINIMUM POWER AVAILABLE REQUIREMENTS.** To satisfy defined FAA national standards, the minimum powers listed in the table in figure 165 must be available at the aircraft antennas for the identified NAVAIDs. (Note: these minimum power values correspond to the powers which would be obtained from signals-in-space using isotropic (0 dB gain) receiving antennas.)

**FIGURE 165. POWER AVAILABLE REQUIREMENTS FOR NAVAID RECEIVERS**

FACILITY	MINIMUM POWER
VOR	-123.0 dBW @ 117.95 MHz
ILS LOCALIZER	-123.0 dBW @ 111.95 MHz
DME & TACAN	(> 18,000') -114.5 dBW @ 1213.0 MHz (< 18,000') -109.0 dBW @ 1213.0 MHz

**53. AN EXAMPLE OF POWER AVAILABILITY.** The typical geographic (distance vs. altitude) usable signal coverage for a VOR is shown in figure 166.

**FIGURE 166. POWER AVAILABLE - VOR**

a. **Figure 166** is a composite of VOR power available curves and is for illustrative purposes only.

b. **Suppose a proposed ESV** asks for 160 nmi @ 18,000' to 25,000'. (Note that this request will be for MSL altitude.) From figure 165, it will be seen that a -123 dBW level is required. Assume the site at 2,000' elevation.

c. **Refer to figure 171**, the power available curves for VOR. Trace the 160 nmi line from the bottom of the graph up to the -123 dBW curve. At that intersection, follow the horizontal line to the left to find that the minimum altitude to reach the needed power level is 26,000' AGL, or 28,000' MSL. On that basis, the ESV could not be used below 28,000' MSL, at 160 nmi. The requestor would have to be informed to revise the ESV request downward in mileage or upward in ESV floor before any further study could be done.

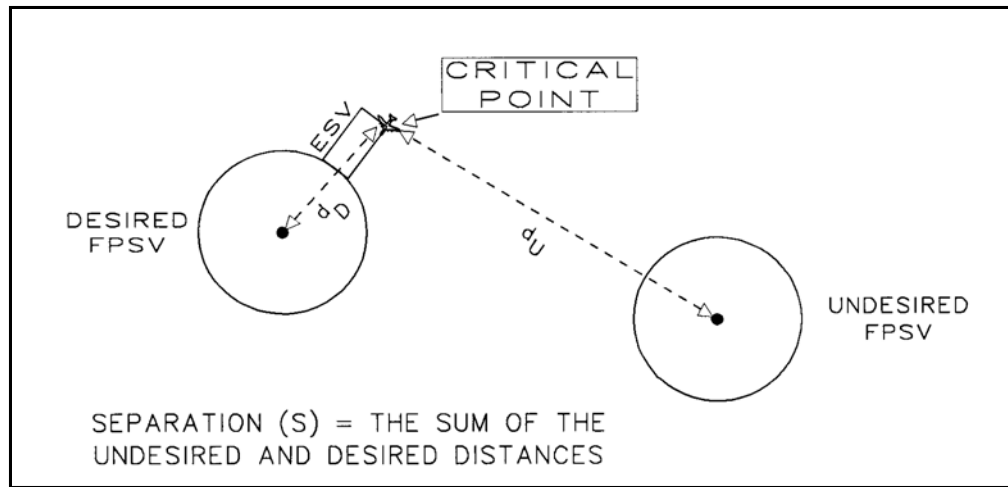
d. **Had the ESV been** for 160 nmi from 28,000' - 45,000' MSL, it would have met the needs of figure 171.

**54. THE INTERRELATIONSHIP OF THE VOR AND DME/TACAN ESV.** If a VOR exists and there is an associated DME/TACAN, they must have identical ESVs for safety reasons (except in those cases where the DME ESV supports DME/DME RNAV operations). Refer to figure 173. It will be noted that a TACAN cannot meet a 160 nmi requirement except above 32,000' AGL. Thus any ESV which will be certified as protected must have the power availability for both collocated facilities as well as frequency protection for both before it can be approved. In the example of paragraph 53, the lowest permissible VORTAC ESV for 160 nmi would be 32,000', or some lower minimum altitude at a lesser radial distance.

**55. VOR/DME/TACAN ESV DETERMINATION PROCEDURE.** Once the power available has been determined to be satisfactory, the actual calculation to determine protection can begin. The same curves used for standard FPSV protection are used for ESV determination, so they will not be repeated in this section. Whenever an ESV is to be calculated, use the ESR curves associated with the facility in Section 3.

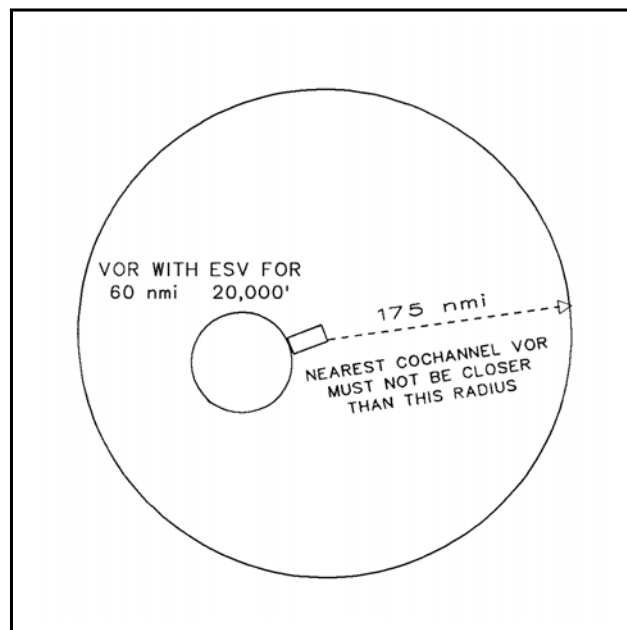
a. **When an ESV is designed**, it is necessary to make the determination at the critical point. That point is defined as that which is furthest from the desired facility and simultaneously closest to the undesired facility, as shown in figure 167.

**FIGURE 167. CRITICAL POINT MEASUREMENT OF AN ESV**



**b. Refer to figure 168** and figure 17 in Section 2, VOR separation curves for ESR = +23 dB. Following the 60 nmi base line of figure 17 upward to its intersection with the 20,000' line will produce the value of (S) = 235 nmi. With the 60 nmi ESV, that means any cochannel L-VOR or T-VOR must be at least 175 nmi from the desired critical point. Were the cochannel VOR an H-VOR, the ESV would be automatically protected in that direction, due to the H-VOR separation requirement of 395 nmi previously required for the two to be cochannel at standard FPSVs.

**FIGURE 168. EXAMPLE OF VOR ESV BY CALCULATION**



**c. If a DME or TACAN were collocated,** the DME/TACAN separation requirement would have to be determined in the same manner. Refer to figure 42, Section 2, DME/TACAN separation curves for ESR = +11 dB. Follow the same procedure as subparagraph a. By interpolation, (S) = 235 nmi.

**d. To meet the ESV protection** required in figure 168, it would be necessary that the nearest cochannel VOR/DME be at least 175 nmi away from the critical point. As in subparagraph a, if the nearest cochannel is an H-VOR/DME, the requirement of 395 nmi (S) would more than protect the example ESV.

**e. Adjacent channel determination** is made exactly the same way that a VOR/DME/TACAN FPSV is frequency engineered. Using the values of Section 2, paragraph 1e, the appropriate ESR curves are used to determine the required distance from the critical point on the ESV to the nearest adjacent channel, for both VOR and DME/TACAN.

**56. ILS-DME ESV DETERMINATION PROCEDURE.** An ESV on an ILS is handled the same way as the VOR in paragraph 55 using the appropriate ESR curves and the LOC antenna radiation patterns.

**As indicated in section 3,** the DME function nearly always requires a greater geographical separation than its associated ILS. Therefore, the FMO should check the DME requirements first. If the DME ESV fits, the ILS ESV will nearly always fit easily.

### **57. ESV SPECIAL CONSIDERATIONS.**

**a. ESV operational radials and areas** have a definite tolerance to maintain.

**(1) Radials**

**(a) VOR/DME/TACAN  $\pm 4.5^\circ$ .**

**(b) ILS  $\pm 10^\circ$ .**

**(c) NDB  $\pm 10^\circ$ .**

**(2) Wedge areas**

**(a) VOR/DME/TACAN — add  $4.5^\circ$  in both directions.**

**(b) NDB — add  $10^\circ$  in both directions.**

**(3) Holding patterns (HP)** are described by an arc enclosing two radials, e.g.,  $306^\circ$ - $322^\circ$ , 83 nmi, and shall enclose the HP.

**b. When the FMO receives a request** via the ESV Management System (ESVMS) to establish, revise or cancel an ESV, the FMO shall engineer each ESV and approve the proposed request, if appropriate, via the ESVMS. As a result of an approval, the Flight Inspection Office will conduct a flight check of the ESV. The results of this action will be communicated to Technical Operations ATC Spectrum Engineering Services (via the ESVMS) for final review and approval. Technical Operations ATC Spectrum Engineering Services will enter the approval into the ESVMS, which subsequently generates an input into the AFM national data base and a notification of the action taken back to the FMO.

**c. FMO's shall review** each ESV in their service areas on a yearly basis to confirm the accuracy of the national ESV data base.

**FIGURE 169. SAMPLE ESV RECORD FORMAT**

ESV Report  
Run Date: Mon Jun 03 11:15:21 1996  
One Site Only

File/SER	State/City	Frequency	Service	Type	Call	Sign	No	st	Rad1	& 2-Dist	Min	Max	Type	Orig.	Facil.	Requirements	Bear/Dist.	
GmFAA 672133	GA ALBANY	M116.100000	L	VOR	P2D		1		30	71	50	180	E				SUB RTE V35 MCH	
							2		160	71	49	180	E				SUB RTE-GEF	
							3		186	66	180	450	E				SUB J43	
							4		222	70	40	180	E				SUB INT-MAI	
							5		233	65	30	180	E				INT MALOW	
							6		259	45	20	180	E				NALER INT	
							7		264	55	25	180	E				INT-ABIDE	
							8		281	50	20	180	E				INT-BAIZE	
							9		309	58	20	180	E				95 RTEIZE	
							10		359	42	30	175	E				WILMS INT	
							11		359	59	30	175	E				PRATZ INT	
							12		359	70	30	175	E				GRANT INT	
							13		110	43	50	175	E				SUB ROUTE	
							14	A	82	42	020	175	E	ZJX ARTCC			ESTABLISH ROCKH INT.	

58. thru 62. RESERVED

FIGURE 170. POWER AVAILABLE CURVES - 100 W - VOR 0-50 NMI

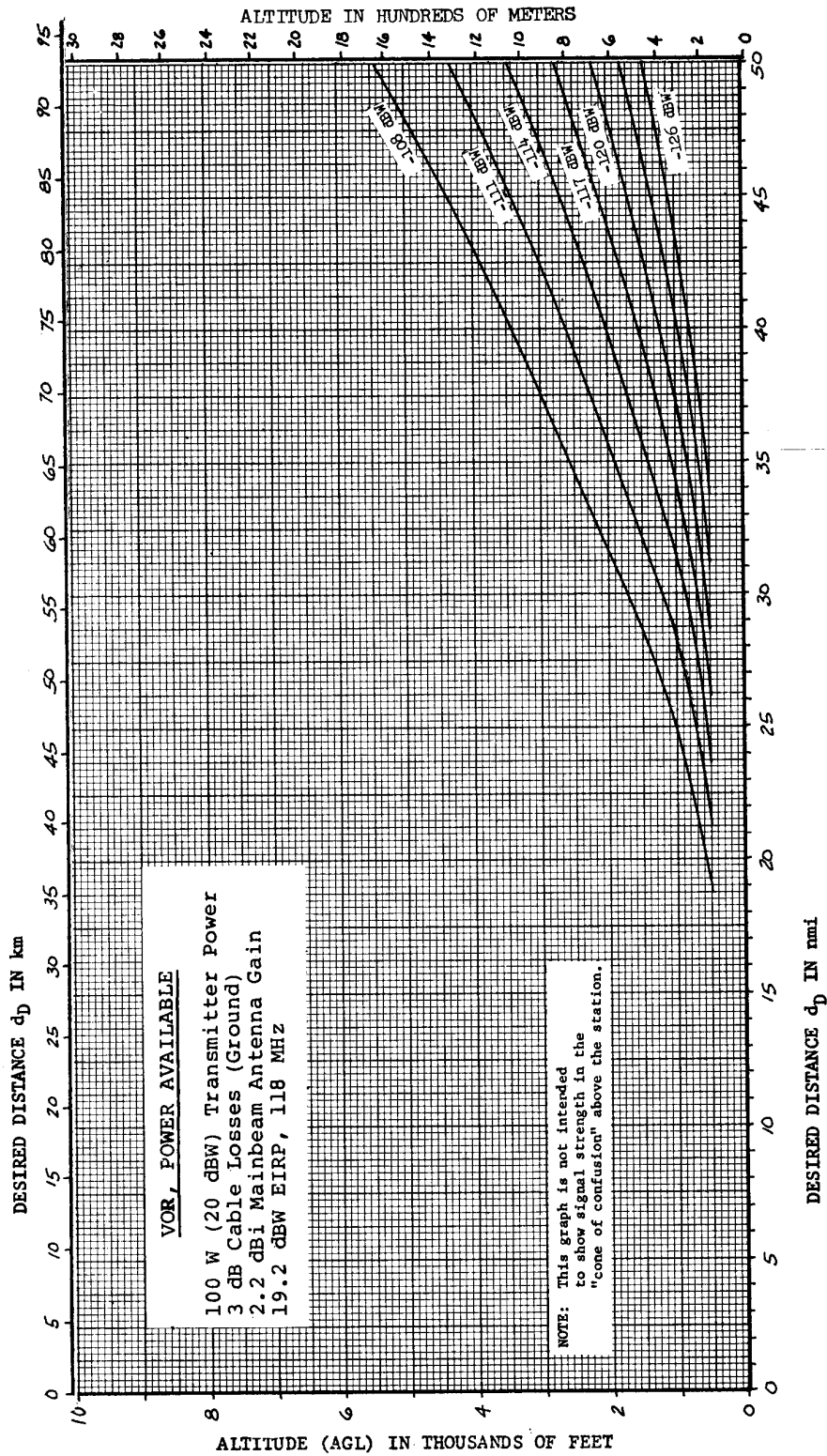


FIGURE 171. POWER AVAILABLE CURVES - 100 W - VOR 0-220 NMI

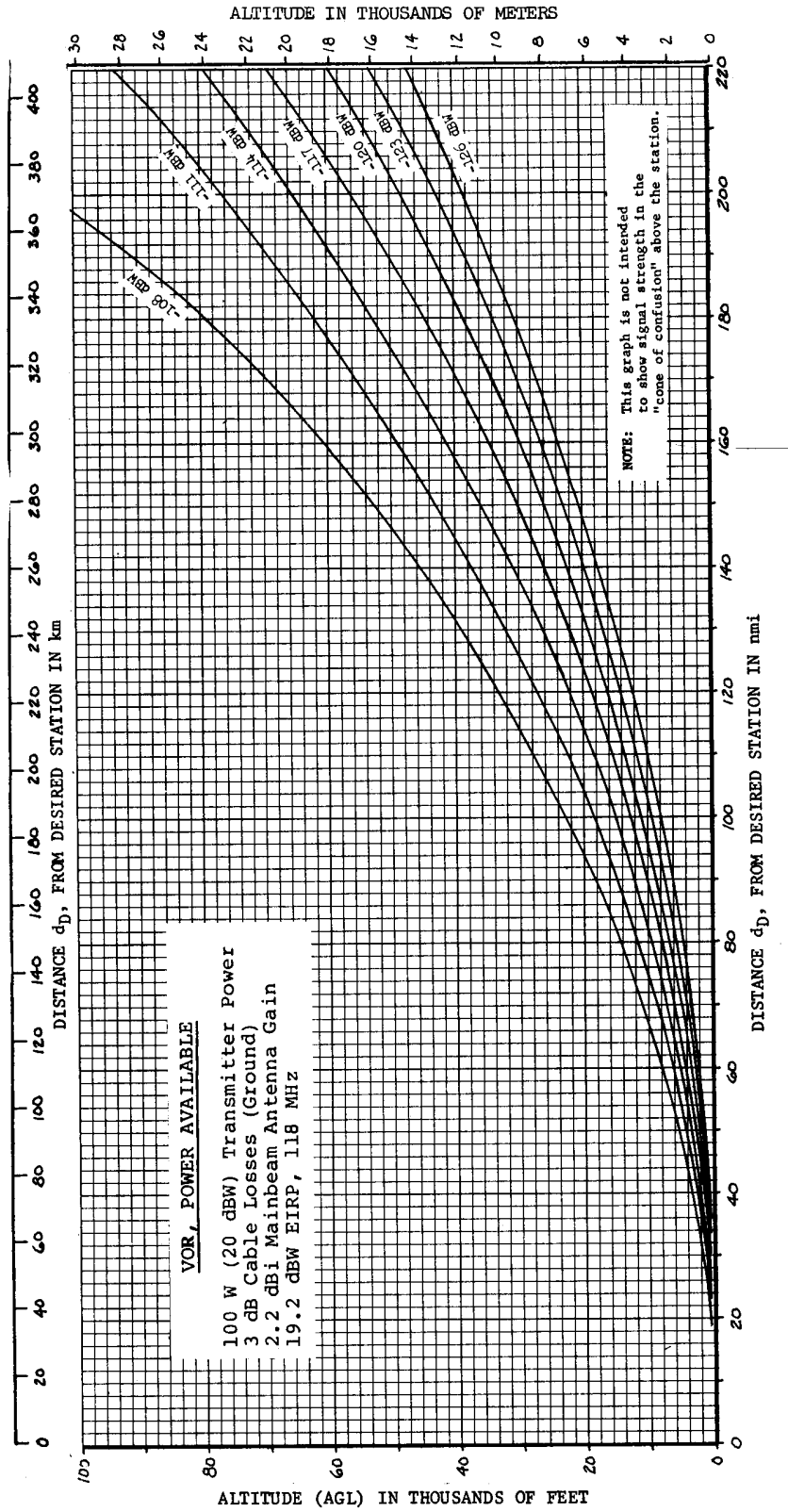


FIGURE 172. POWER AVAILABLE CURVES - 5 KW - TACAN 0-50 NMI

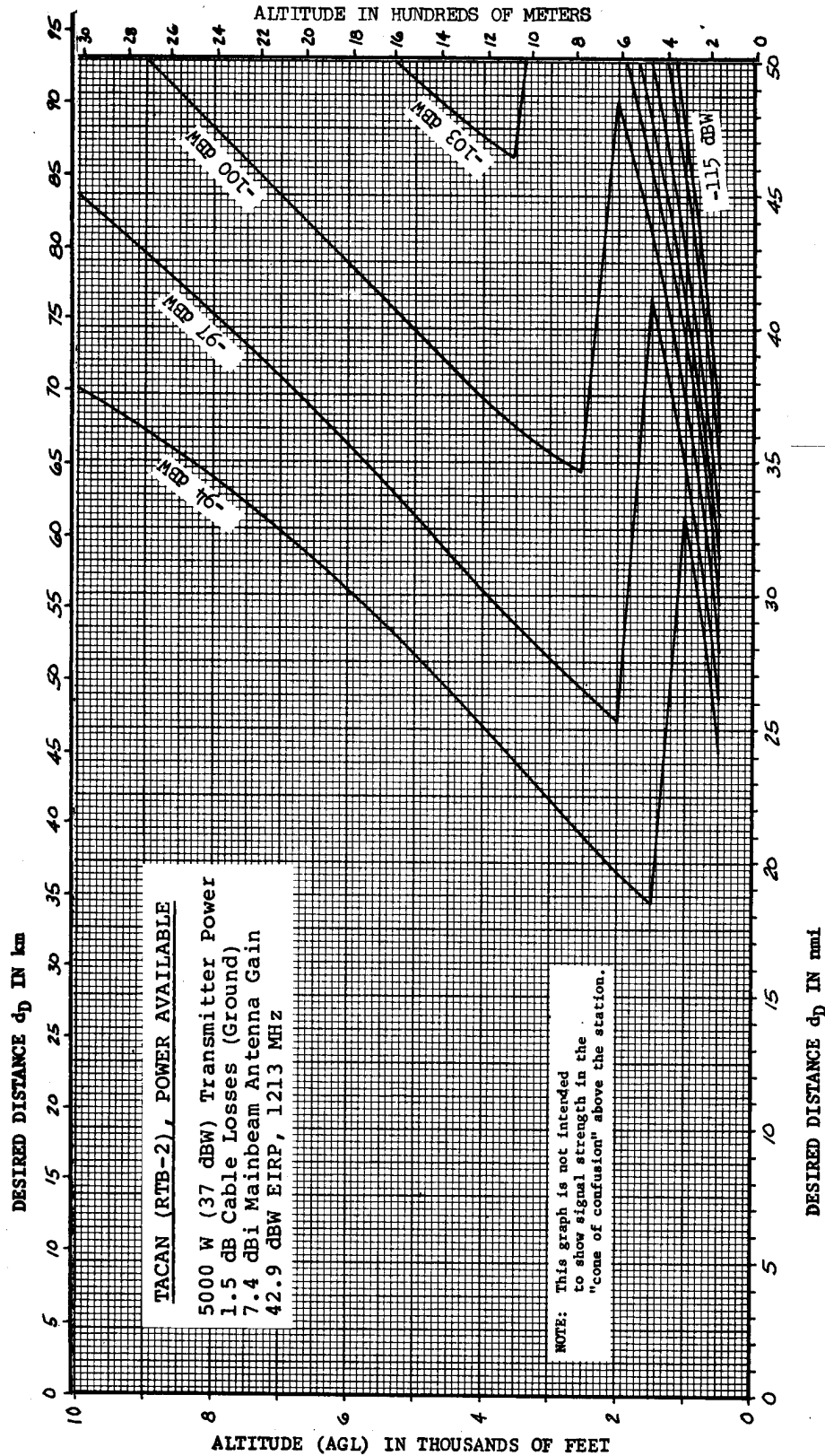




FIGURE 173. POWER AVAILABLE CURVES - 5 KW - TACAN 0-220 NMI

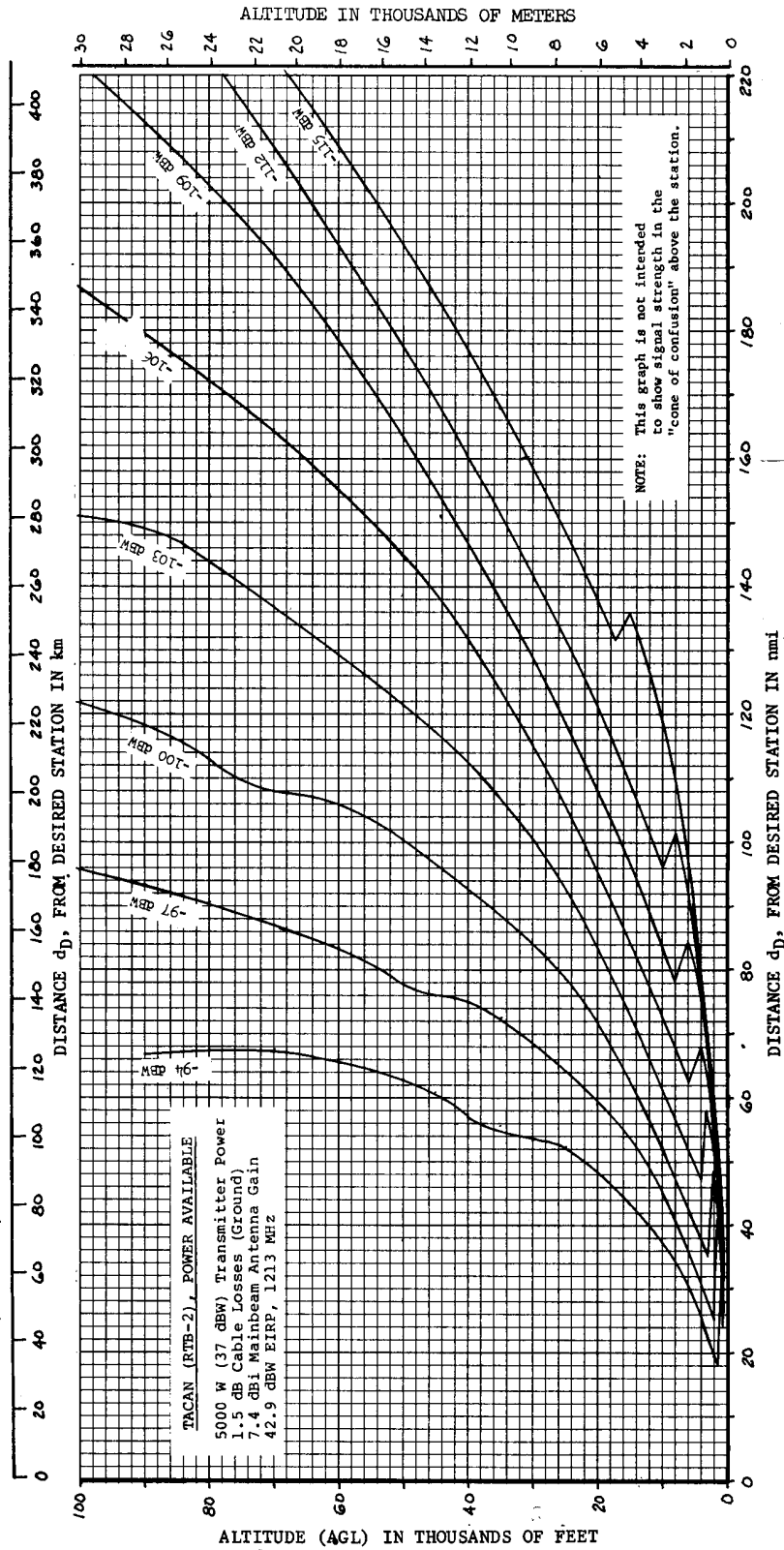


FIGURE 174. POWER AVAILABLE CURVES - 100 W -CARDION DME 0-50 NMI

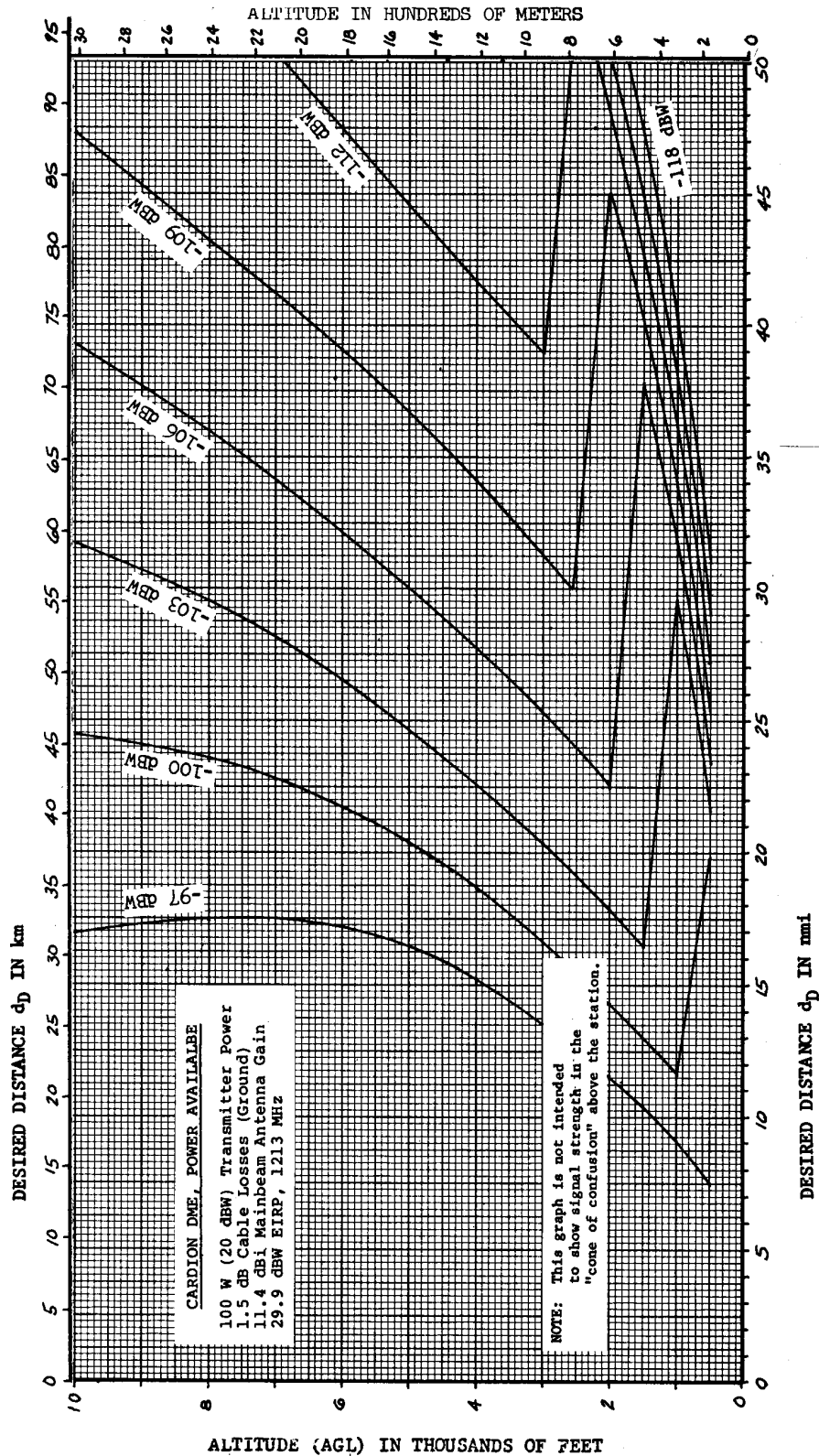


FIGURE 175. POWER AVAILABLE CURVES - 100 W - CARDION DME 0-220 NMI

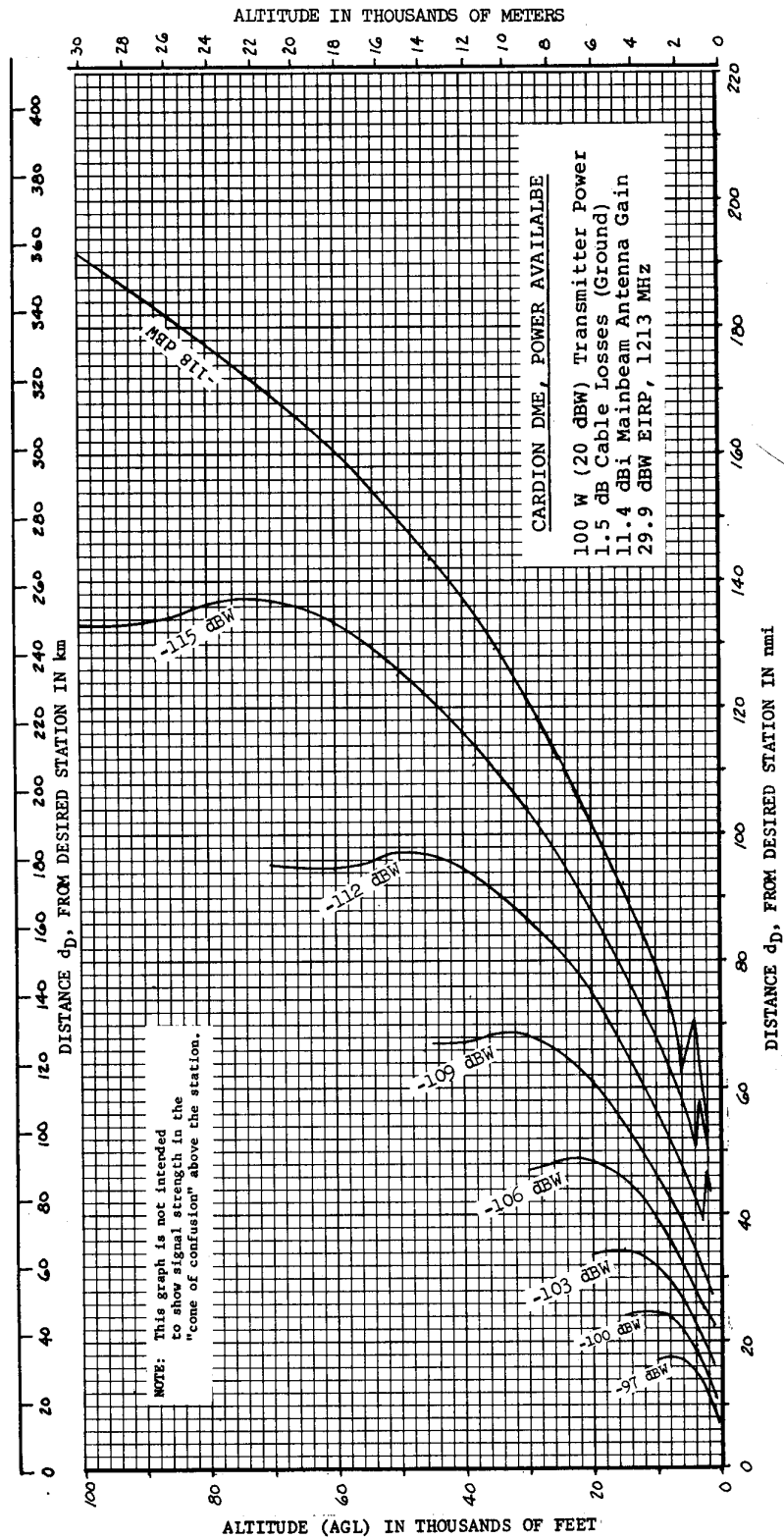


FIGURE 176. POWER AVAILABLE CURVES - 100 W - MONTEK DME 0-50 NMI

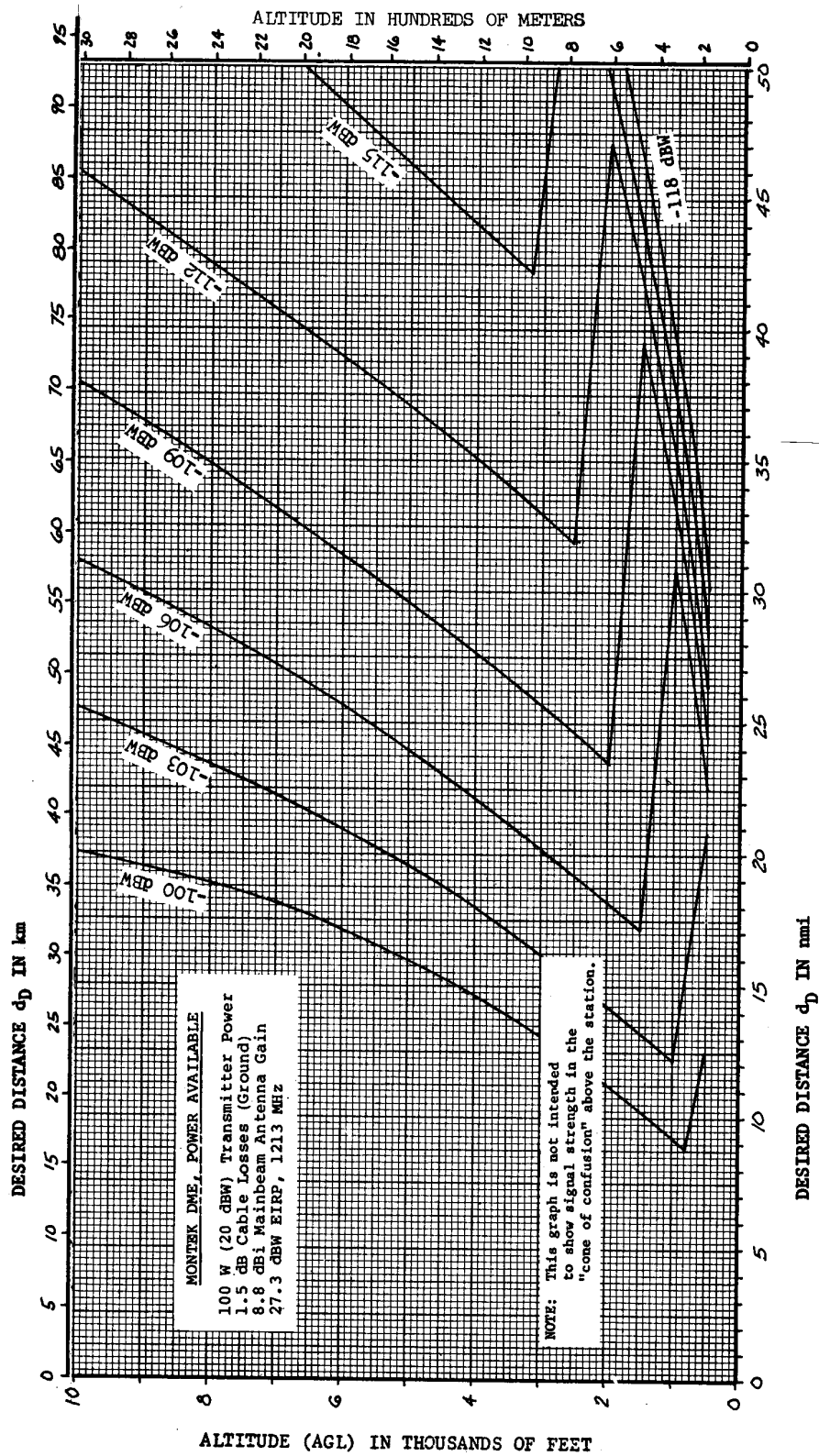


FIGURE 177. POWER AVAILABLE CURVES - 100W - MONTEK DME 0-220 NMI

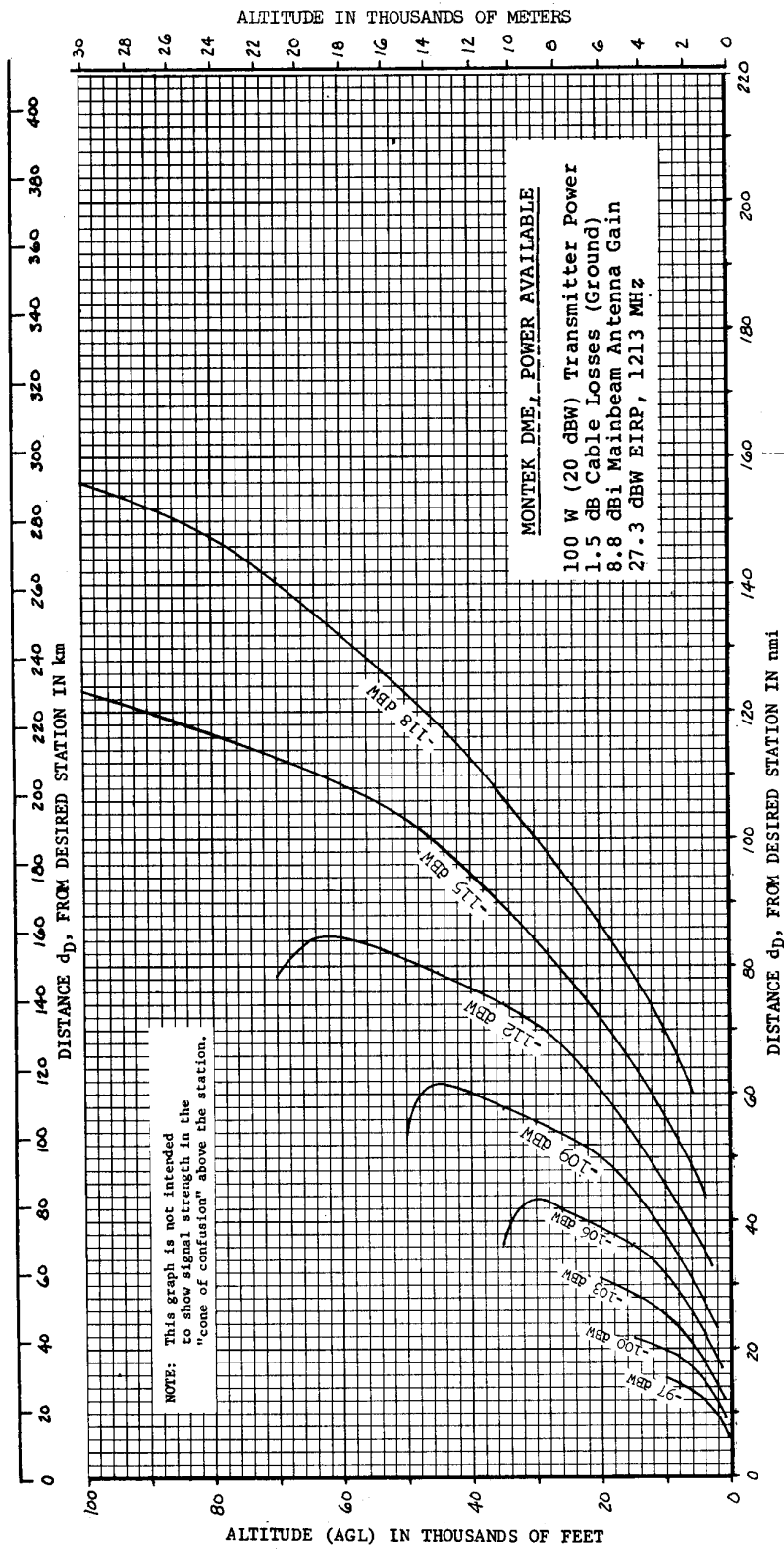


FIGURE 178. POWER AVAILABLE CURVES - 1 KW - CARDION DME 0-50 NMI

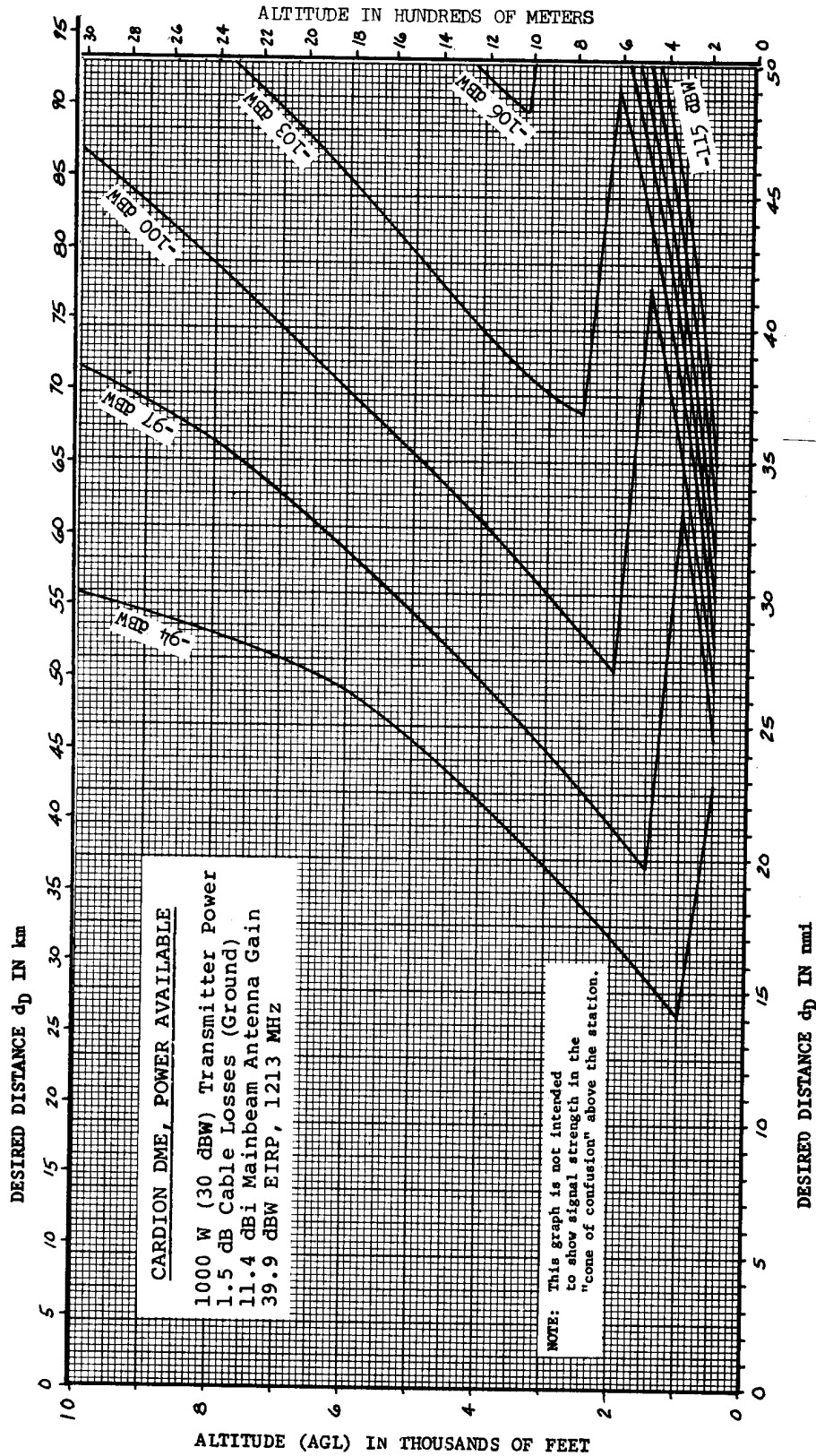


FIGURE 179. POWER AVAILABLE CURVES - 1 KW - CARDION DME 0-220 NMI

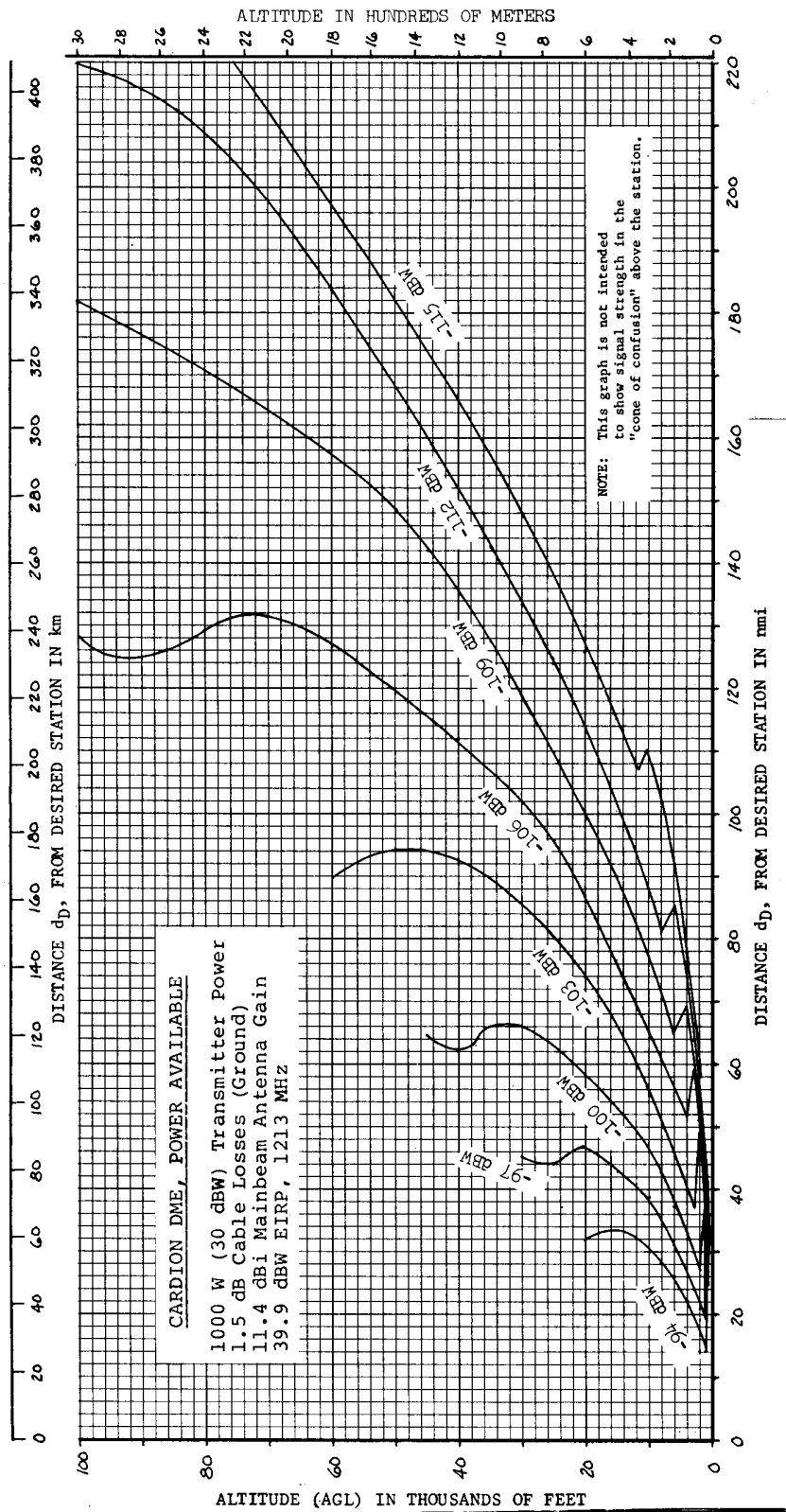


FIGURE 180. POWER AVAILABLE CURVES - 1 KW - MONTEK DME 0-50 NMI

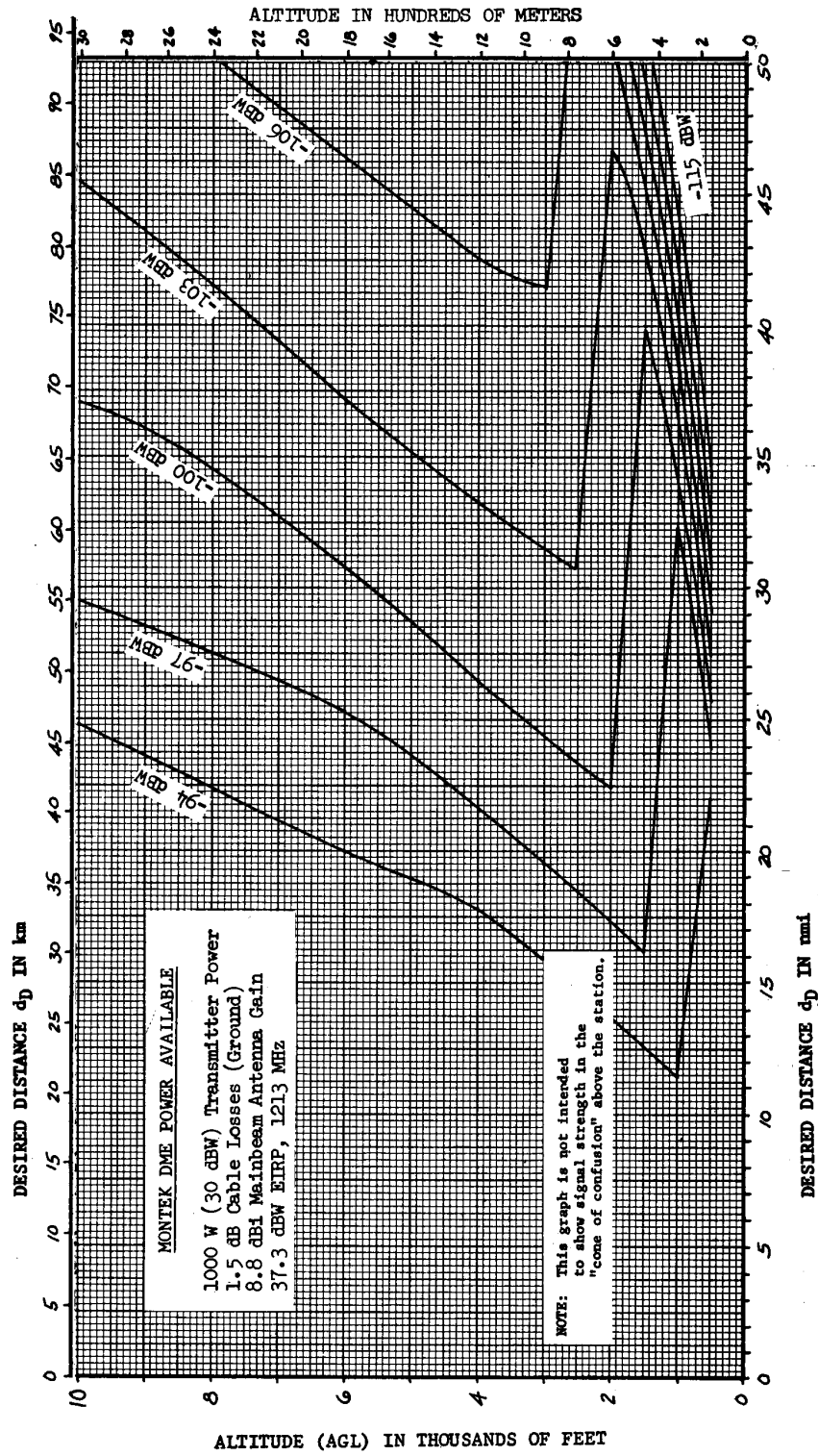




FIGURE 181. POWER AVAILABLE CURVES - 1 KW - MONTEK DME 0-220 NMI

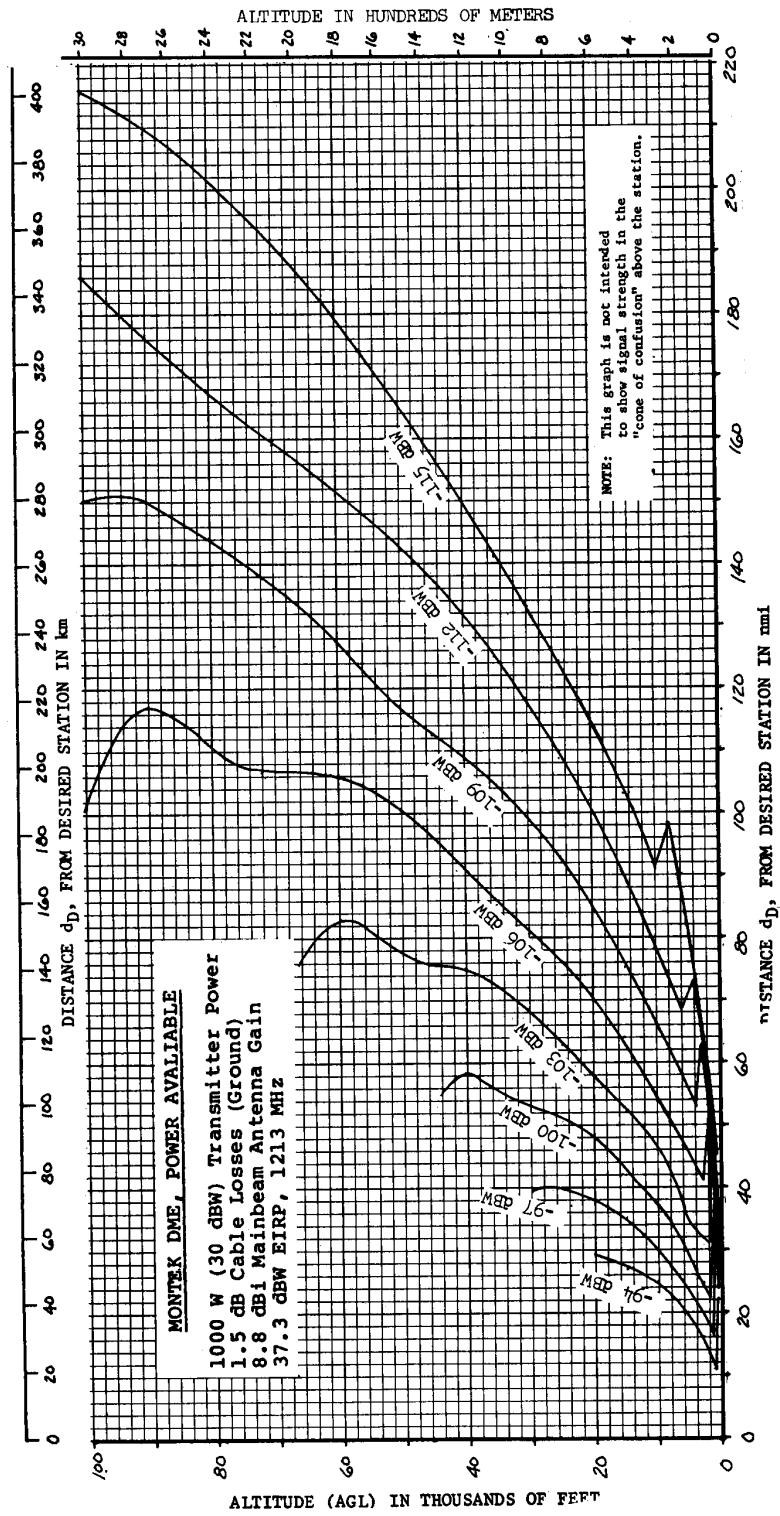


FIGURE 182. POWER AVAILABLE CURVES - 100W - FA10153 DME 0-50 NMI

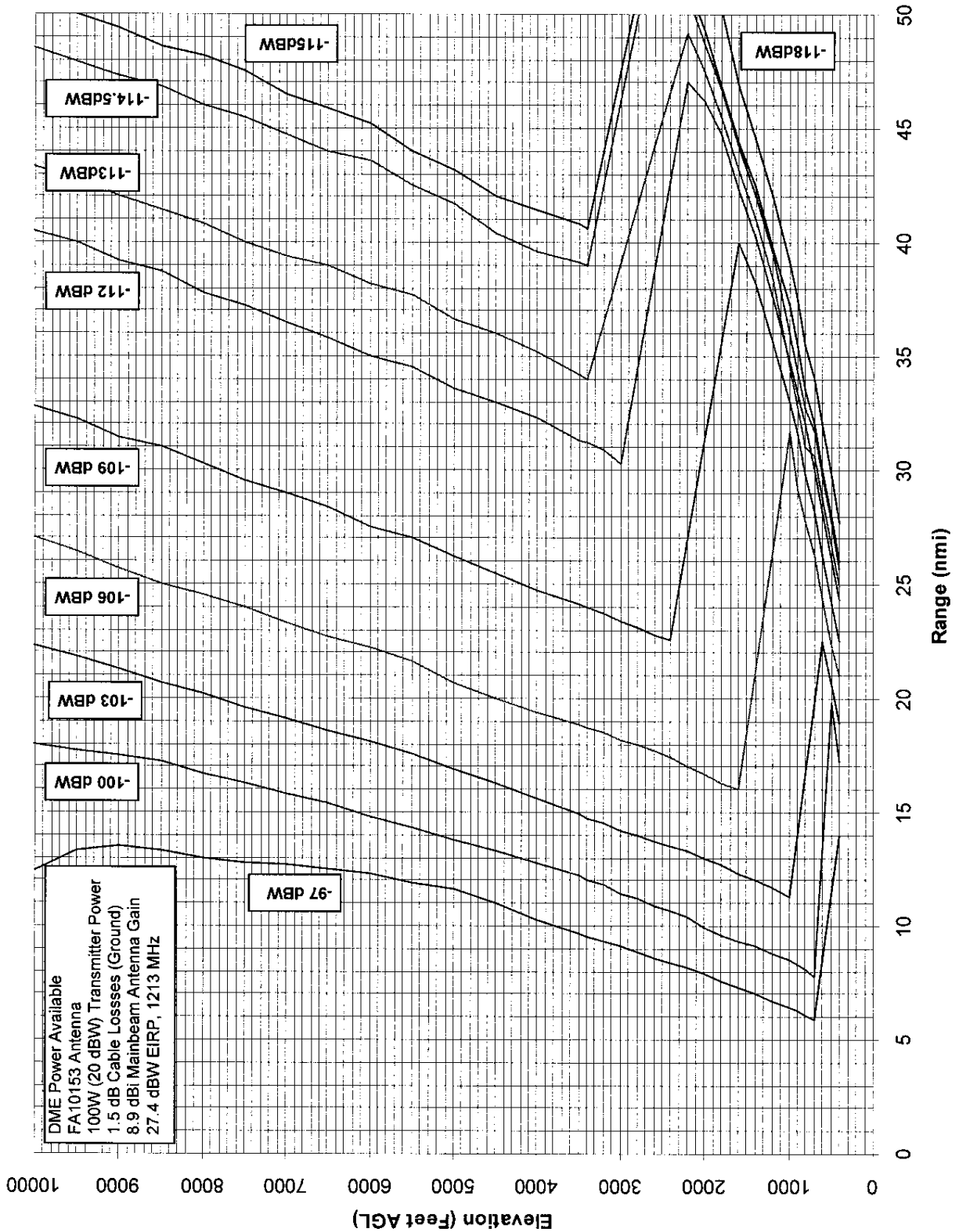


FIGURE 183. POWER AVAILABLE CURVES - 100W - FA10153 DME 0-220 NMI

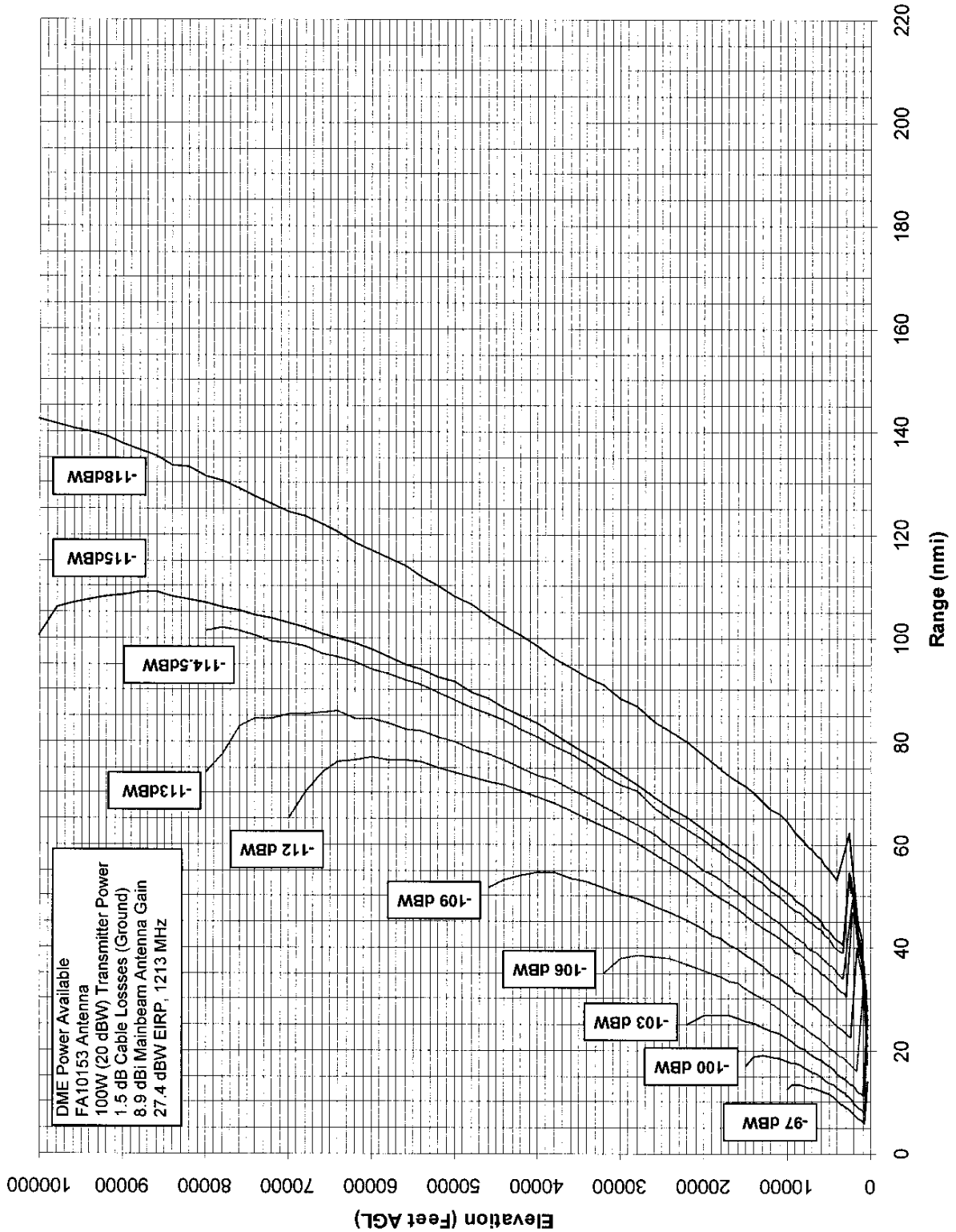


FIGURE 184. POWER AVAILABLE CURVES - 100W - dBS5100A DME 0-50 NMI

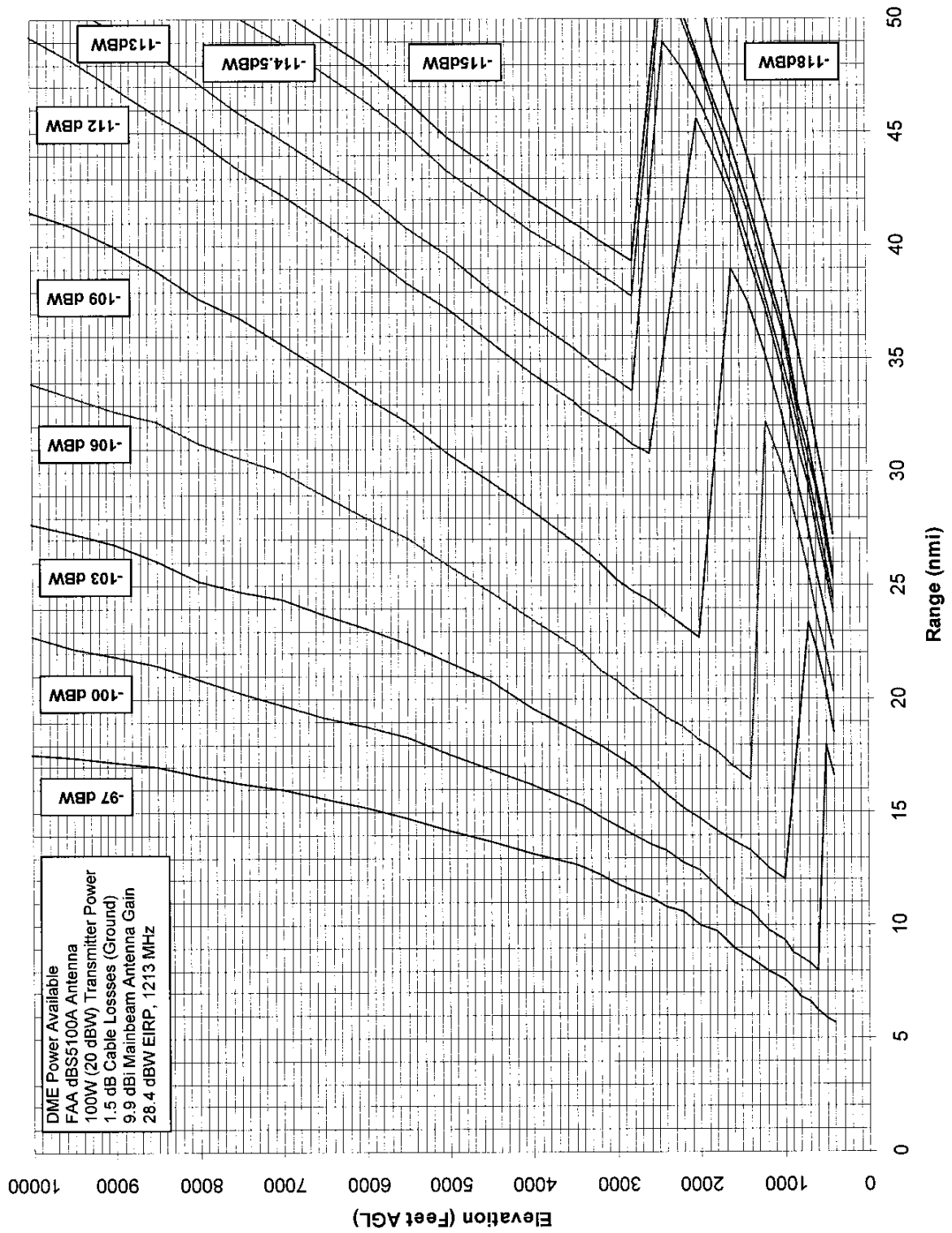


FIGURE 185. POWER AVAILABLE CURVES - 100W - dB5100A DME 0-220 NMI

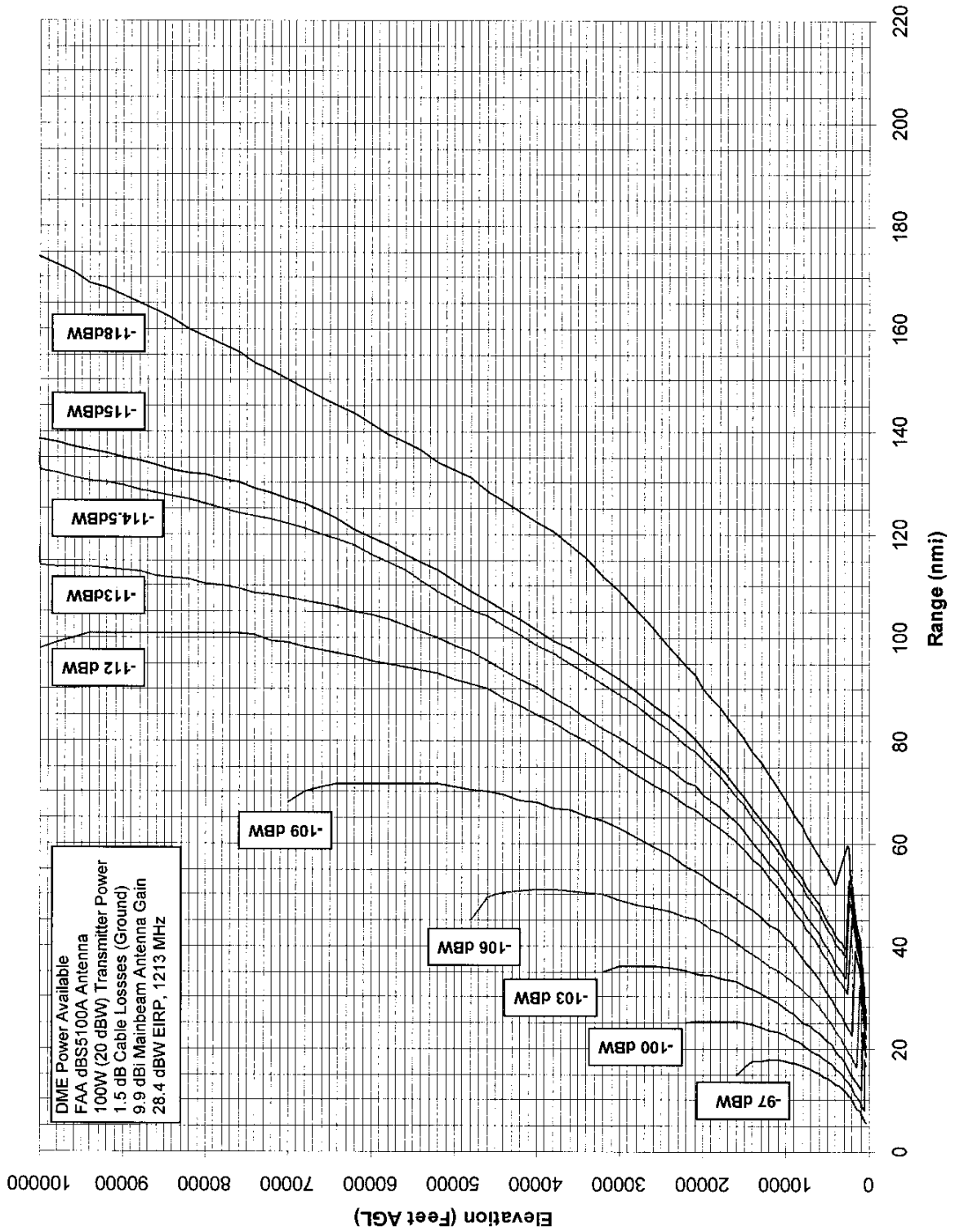


FIGURE 186 RESERVED

**SECTION 7. MLS AND DME/P FREQUENCY ENGINEERING**

**63. FREQUENCY ENGINEERING FOR MLS AND DME/P.**

a. **MLS and associated DME/P** frequencies are listed in Section 1, figure 1.

b. **Use of a paired channel** as listed in figure 1 requires that DME/Ps be collocated with the MLS antennas, which means within 100' of the antenna.

c. **FPSVs for MLS and DME/P** are as shown in figures 187-190.

**FIGURE 187. FPSV FOR MLS APPROACH AZIMUTH/DATA COVERAGE**

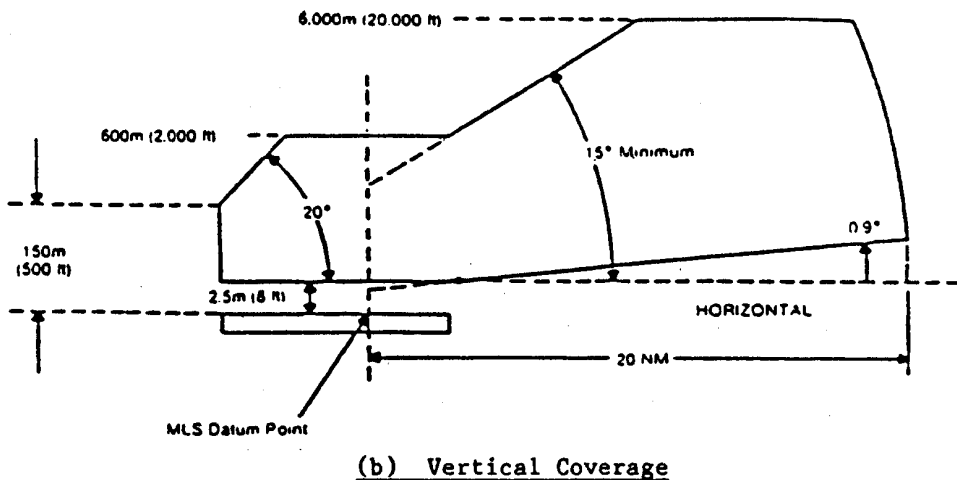
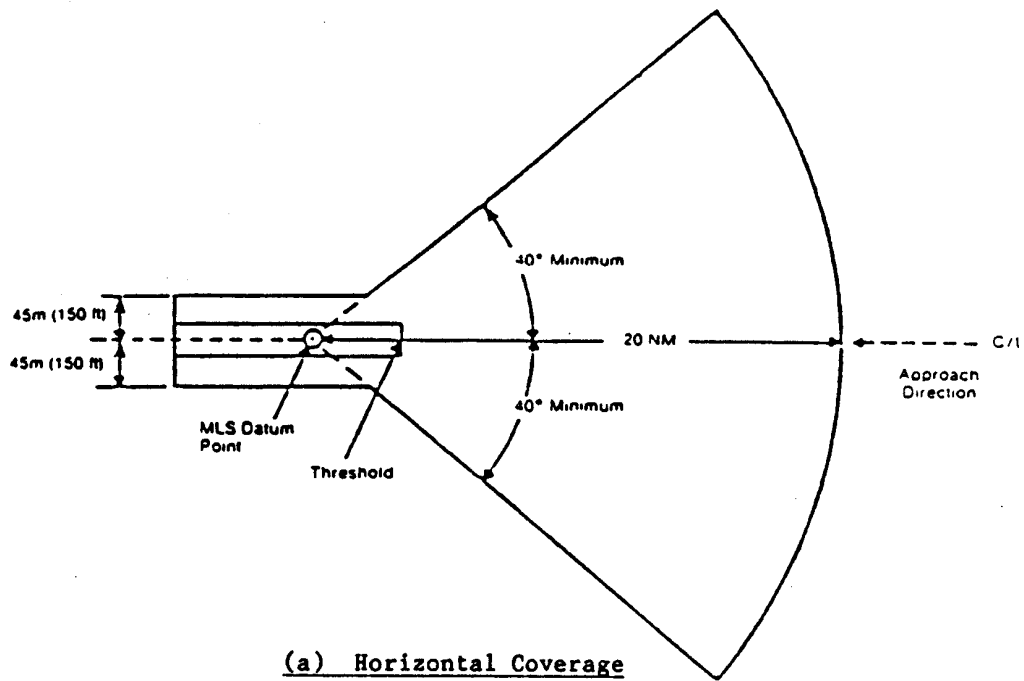
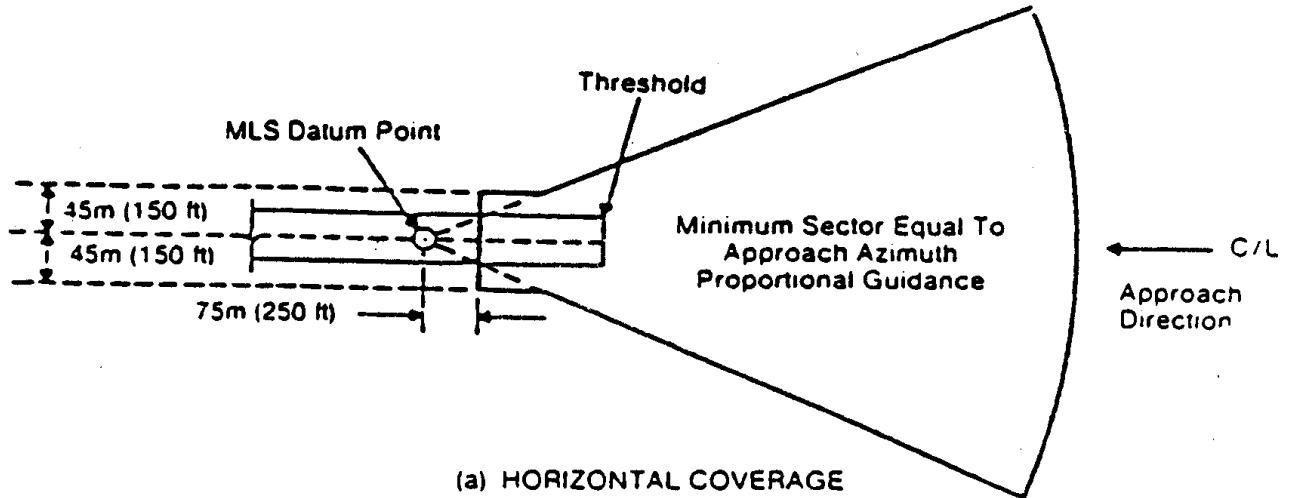
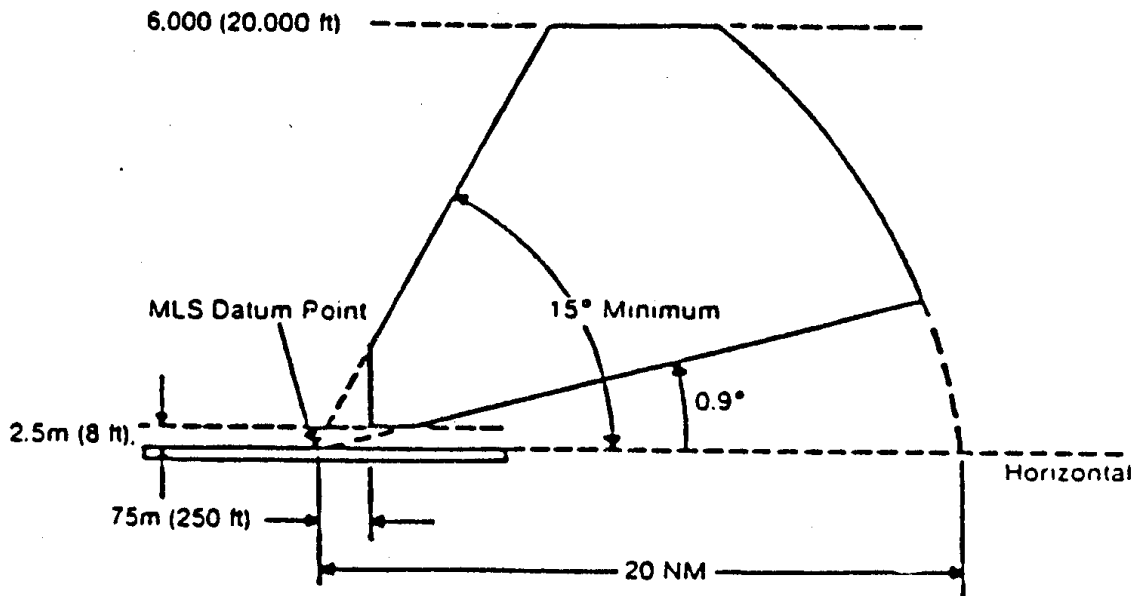


FIGURE 188. FPSV FOR MLS APPROACH ELEVATION COVERAGE



(a) Horizontal Coverage



(b) Vertical Coverage

FIGURE 189. FPSV FOR MLS BACK AZIMUTH/DATA COVERAGE

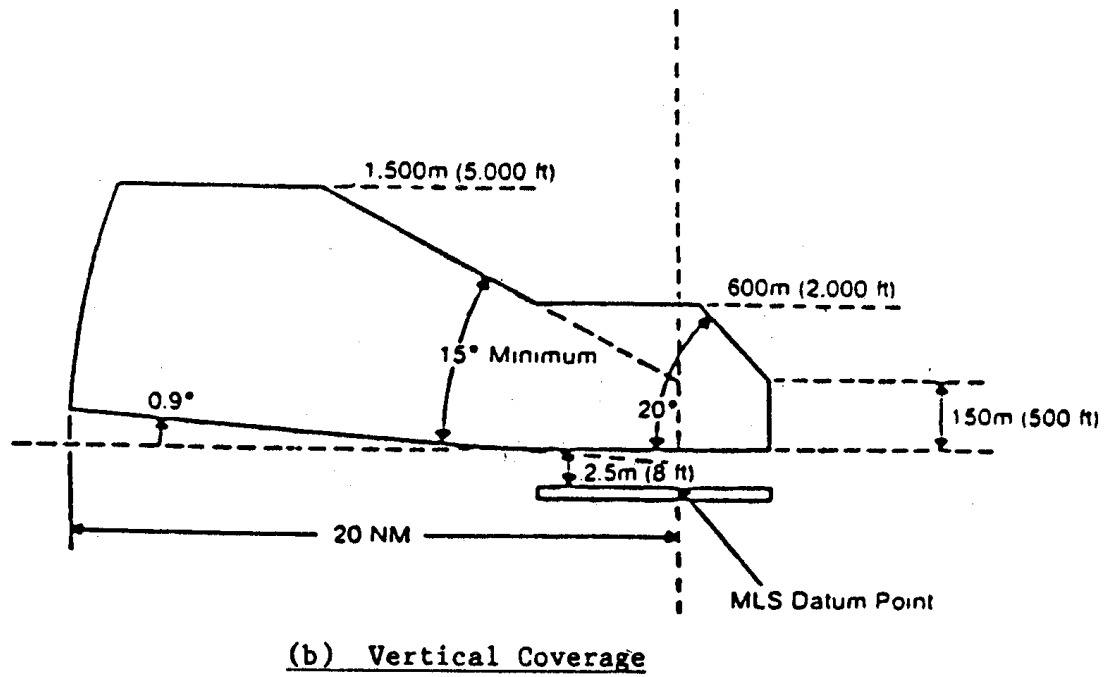
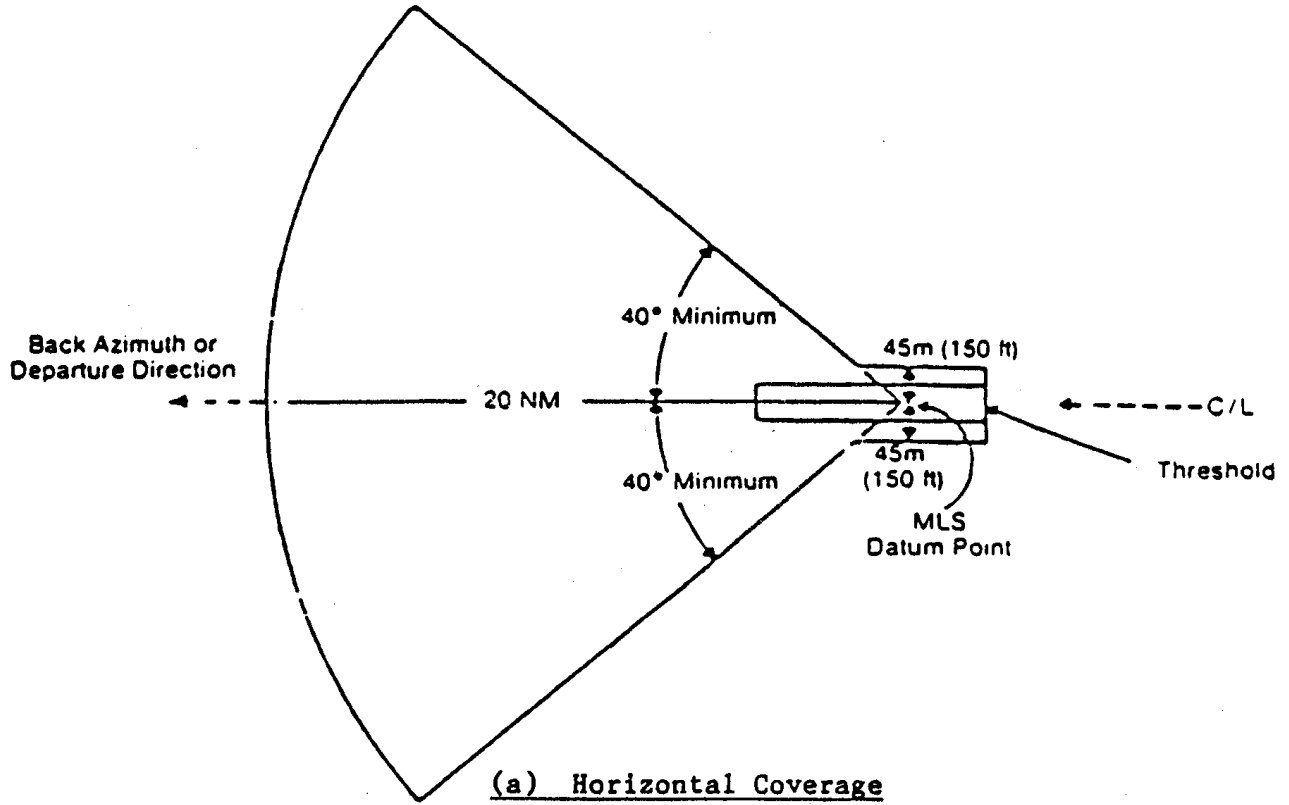
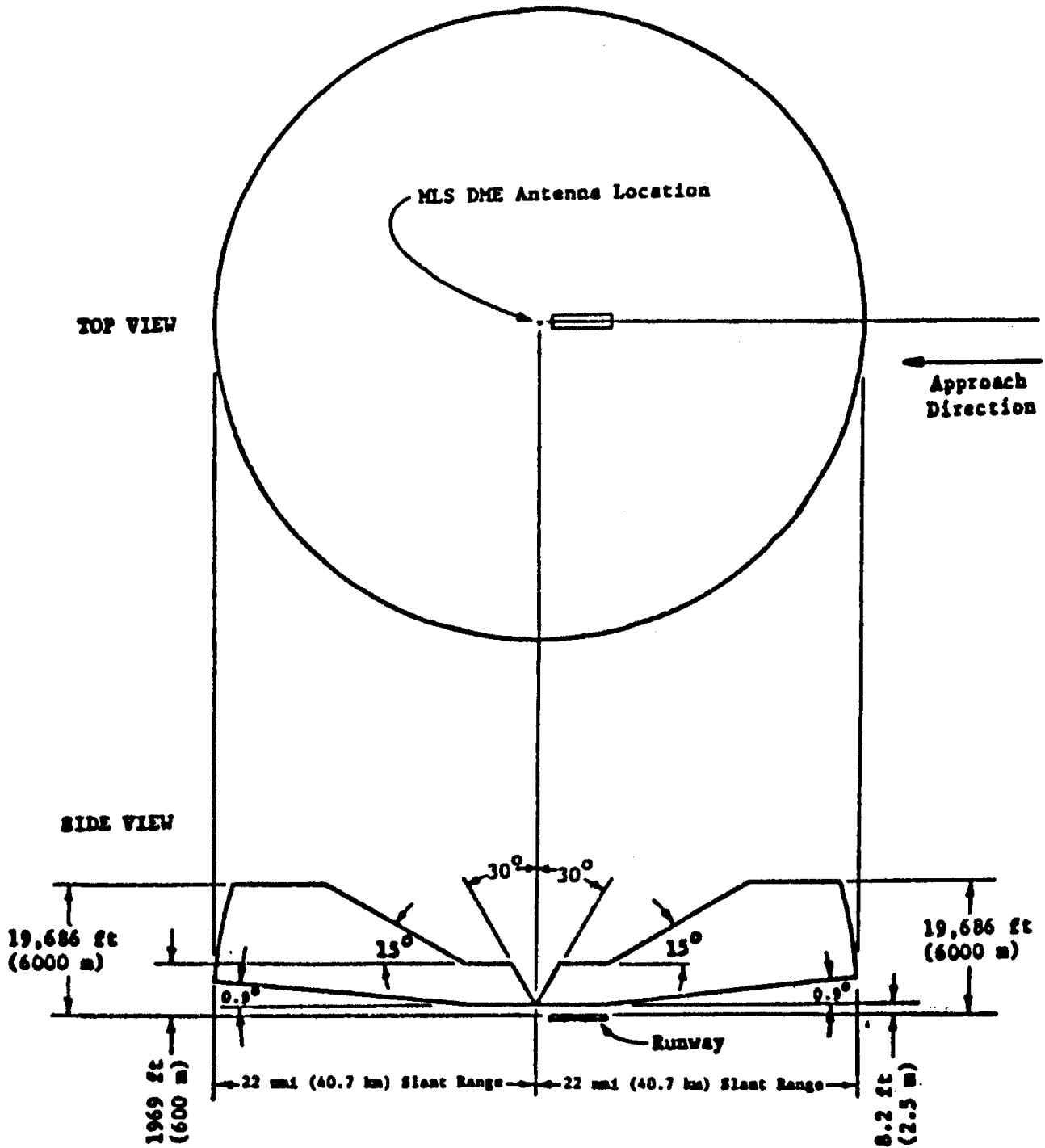




FIGURE 190. FPSV FOR MLS DME/P



d. **The MLS approach azimuth** and elevation horizontal service volumes are conical segments, 80' wide with a complex vertical service volume. Figure 191 shows the D/U values.

**FIGURE 191. INTERIM MLS COCHANNEL AND ADJ. CHANNEL SEPARATION D/U VALUES**

COCHANNEL	+26.5 dB D/U
1ST ADJ. CHANNEL	-19 dB D/U
2ND ADJ. CHANNEL	-23.5 dB D/U

e. **Harmful interference to DME/Ps** associated with MLS is prevented by geographically separating cochannel and adjacent-channel assignments. Within each FPSV, the DME/P D/U ratio shall be at least the values shown in figure 192, on a basis of 95 percent availability.

**FIGURE 192. DME/P COCHANNEL AND ADJACENT CHANNEL SEPARATION D/U VALUES**

Cochannel @ 22 nmi	
Same Pulse Code	+9.5 dB
Different Pulse Code	-40.5 dB
1 <sup>st</sup> Adjacent Channel @ 22 nmi	
Same Pulse Code	-40.5 dB
Different Pulse Code	-73.5 dB
2 <sup>nd</sup> Adjacent Channel @ 7 nmi	
Same Pulse Code	-73.5 dB
Different Pulse Code	-73.5 dB
NOTES:	
All D/U ratios include the +1.5 dB factor for transmitter power variation.	
Cochannel and 1st adj. channel D/U values are for the protection of a 22 nmi radius.	
2 <sup>nd</sup> adjacent channel D/U values are for the protection of a 7 nmi radius.	

**64. FREQUENCY ENGINEERING PROCEDURES.** To ensure that the proposed MLS-DME/P frequencies would provide interference-free operations within their FPSVs, the following analysis must be performed on the proposed frequencies. Intersite analysis is used to determine whether the proposed frequencies meet the assignment criteria as specified in paragraph 63 d. There are two analysis methods, table and calculation.

**65. MLS INTERSITE ANALYSIS BY TABLE METHOD.** Intersite analysis may be performed on a proposed MLS frequency through the use of the tables shown in figure 192, which shows conservative-worst-case separation distances. Figure 193 is for MLS/MLS cochannel and adjacent channel. Adjacent channel criteria require a minimum of 1.2 MHz separation for MLS sites at the same airport.

**FIGURE 193. INTERIM MLS COCHANNEL SEPARATION DISTANCE**

MLS DESIRED, MLS UNDESIRED. +26.5 dB PROTECTION	
FACILITY CLASS	SEPARATION (NMI)
MLS	205
1st Adjacent Channel	32
2nd Adjacent Channel	32

**66. DME/P INTERSITE ANALYSIS BY TABLE METHOD.** Intersite analysis may be performed on a proposed DME/P frequency through the use of the table shown in figure 194 which shows the conservative-worst-case separation distance.

**FIGURE 194. MLS DME/P ASSIGNMENT CRITERIA**

DME/P	VS.	DME/P (nmi)	T-DME (nmi)	L-DME (nmi)	H-DME (nmi)
COCHANNEL	SAME CODE	205*	205	205	400
	DIFFERENT CODE	50	50	170	170
1ST ADJ. CHNL	SAME CODE	25	30	45	145
	DIFFERENT CODE	25	30	45	145
2ND ADJ. CHNL	SAME CODE	8	9	12	14
	DIFFERENT CODE	8	9	12	14

\*RLOS to protect MLS angle receiver at 20,000N.

Pulse loading criteria: Maximum 3 DME, DME/P or TACAN sites within 50 nmi radius and within ±3 MHz.

Ground receiver protection: ±63 MHz minimum 15 nmi separation.

**67. thru 70. RESERVED**

**FIGURES 195 thru 200 RESERVED.**

**SECTION 8. LOCAL AREA AUGMENTATION SYSTEM FREQUENCY ENGINEERING**

**71. FREQUENCY ENGINEERING.**

**a. Frequencies.** The Local Area Augmentation System (LAAS) is planned to operate on center frequencies from 112.050 to 117.950 MHz. However, the last upper assignable LAAS channel will be center on 117.150 MHz to protect adjacent air/ground voice communications operations. The international ICAO standard Ground Based Augmentation System (GBAS) is planned to operate on center frequencies from 108.000 to 117.950 MHz.

**b. Channeling Plan.** While the LAAS equipment is capable of operating with 25 kHz frequency assignments, the LAAS channel plan will only use 50 kHz frequency assignments until otherwise changed. Thus, with the present channel plan, the first adjacent channel is at 50 kHz.

**(1) Time Slots.** The modulation format used by the LAAS is D8PSK. This has eight separate time slots. One transmitter will use two time slots allowing the additional time slots to be assigned on the same channel.

**(2) Coverage.** More than one LAAS transmitter may be required at a specific location to provide the required coverage.

**(3) A/G Communications.** The highest LAAS transmitter frequency to be assigned is 117.15 MHz. This limits the LAAS ground transmitter to 400 feet or greater to an A/G communications facility.

**(4) FM Broadcast Immunity.** The LAAS receivers conform to the ICAO Annex 10 1998 Immunity criteria.

**c. FPSVs.** The standard FPSV is a 23 NM cylinder up to 10,000 feet with the option for 20,000 feet coverage. [Note: These are referenced to site elevation (i.e., FPSV altitudes are in AGL). Adjustments must be made if MSL elevations are needed.]

**d. LAAS D/U criteria.** Harmful interference to LAAS facilities is avoided by geographically separating co-channel and adjacent channel VOR/LAAS/ILS assignments. Within each FPSV, the D/U ratio shall be at least the following, on a basis of 95 percent time signal availability.

**FIGURE 201. LAAS/LAAS/VOR SEPARATION CRITERIA**

<b>Co-Channel D/U</b>	
<b>LAAS/LAAS</b>	<b>+26 dB</b>
<b>LAAS/VOR</b>	<b>+26 dB</b>
<b>1<sup>st</sup> Adjacent (50 kHz)</b>	
<b>LAAS/LAAS</b>	<b>-46 dB</b>
<b>LAAS/VOR</b>	<b>-4 dB (Interim)</b>
	<b>-34 dB (Final)</b>

(1) **D/U ratio of –4 dB.** The –4 dB D/U ratio is referred to as the interim criterion and shall be used whenever possible to protect 100 kHz assignments (100 channel receivers).

(2) **D/U ratio of –34 dB.** The –34 dB is referred to as the final criterion and shall be used for 50 kHz assignments (200 channel receivers).

(3) **All the D/U ratio values.** The D/U value includes a +3 dB to take into account transmitter power degradation before system shutdown.

**72. FREQUENCY ENGINEERING PROCEDURES.** To ensure that the proposed LAAS frequencies would provide interference-free operations within their FPSVs, the following analyses must be performed on the proposed frequencies:

**a. Intersite analysis** is used to determine whether the proposed frequencies meet the assignment criteria as specified in subparagraph 71d. There are two analysis methods, table and calculation. The calculation method will be used in a manner similar to that used for VOR analysis.

**b. The LAAS antenna** polarization is elliptical. The total ERP is 70 W, with 50 W Horizontal and 20 W Vertical.

**73. INTERSITE ANALYSIS BY THE TABLE METHOD FOR LAAS.** Analysis for LAAS facilities may be performed on a proposed LAAS frequency through the use of the following tables that show separation distances required, with respect to LAAS/LAAS and LAAS/VOR:

**a. Figure 202** for LAAS/LAAS co-channel.

**b. Figure 203** for VOR/LAAS 2nd adjacent channel (interim).

**c. Figure 204** for VOR/LAAS 2nd adjacent channel (final).

**d. Geographical separations** are not required between LAAS facilities which differ in frequency by more than 25 kHz. LAAS/VOR separations that differ in frequency by 150 kHz or less should not have overlapping FPSVs.

**FIGURE 202. LAAS/LAAS CO-CHANNEL SEPARATIONS**

10,000 FT	159 NM
20,000 FT	206 NM

**FIGURE 203. LAAS/VOR INTERIM 1<sup>st</sup> ADJACENT CHANNEL 50 kHz SEPARATIONS**

VOR DESIRED, LAAS UNDESIRED -4 dB PROTECTION	
H-VOR	250 NM
L-VOR	75 NM
T-VOR	40 NM

**FIGURE 204. LAAS/VOR FINAL 1<sup>st</sup> ADJACENT CHANNEL 50 kHz SEPARATIONS**

VOR DESIRED, LAAS UNDESIRED -34 dB PROTECTION	
H-VOR	187 NM
L-VOR	56 NM
T-VOR	35 NM

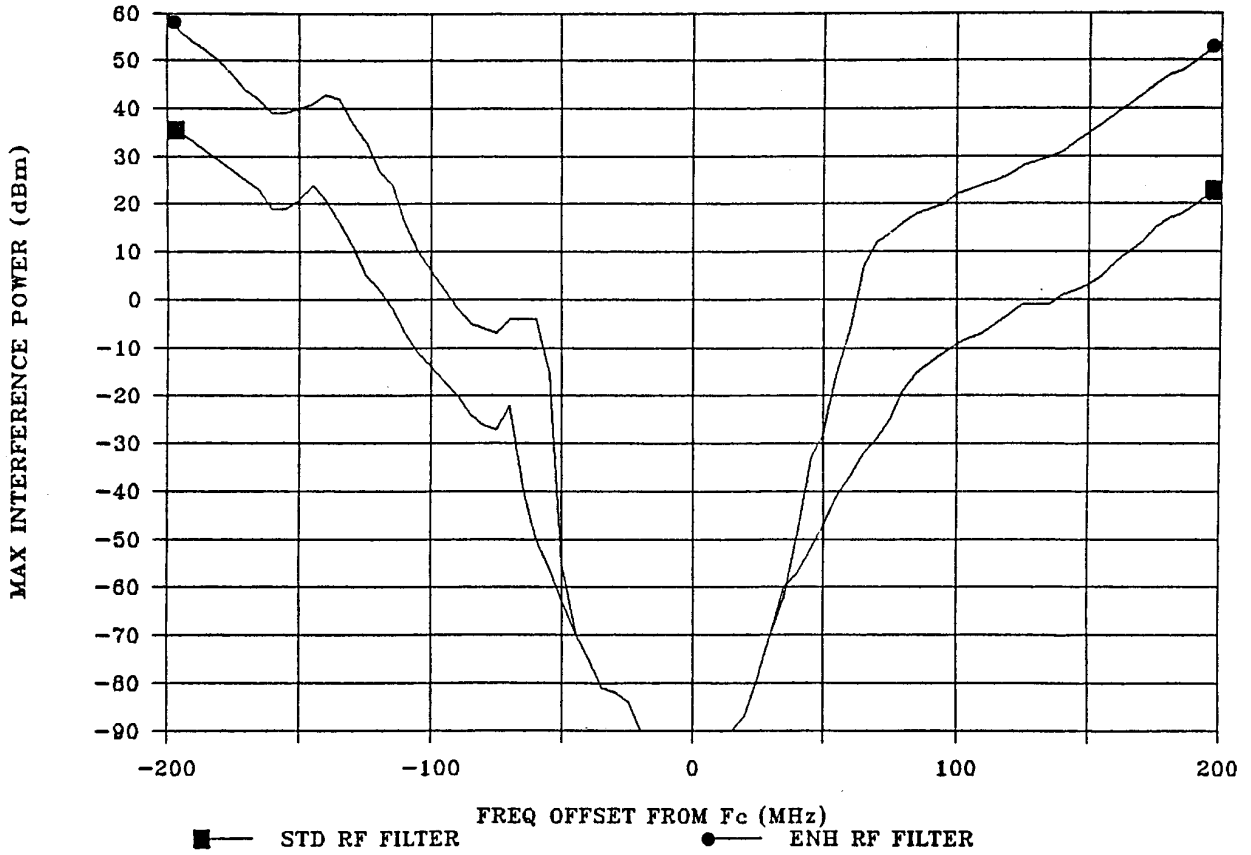
## APPENDIX 4. TECHNICAL DATA FOR VHF/UHF LINKS

FIGURE 1. TECHNICAL PARAMETERS, ATT FR8 RCL

Frequency range		7125-8400 MHz
RF output power	Low	0 dBw, 1 W, 30 dBm
	High	5 dBw, 3 W, 35 dBm
Emission		M20F9
Power Amplifier Output		1.6 W, 32 dBm 5.0 W, 37 dBm
Transmitter freq. stability		±0.0005 percent
Receiver RF bandpass		-3 dB @ 52 MHz -30 dB @ 86 MHz -60 dB @ 134 MHz
Receiver IF bandpass		-3 dB @ 44 MHz -20 dB @ 56 MHz
Receiver IF frequency		70 MHz
Receiver noise figure		< 6 dB
Receiver threshold		-77 dBm, -118 dBW
Image rejection		> 90 dB



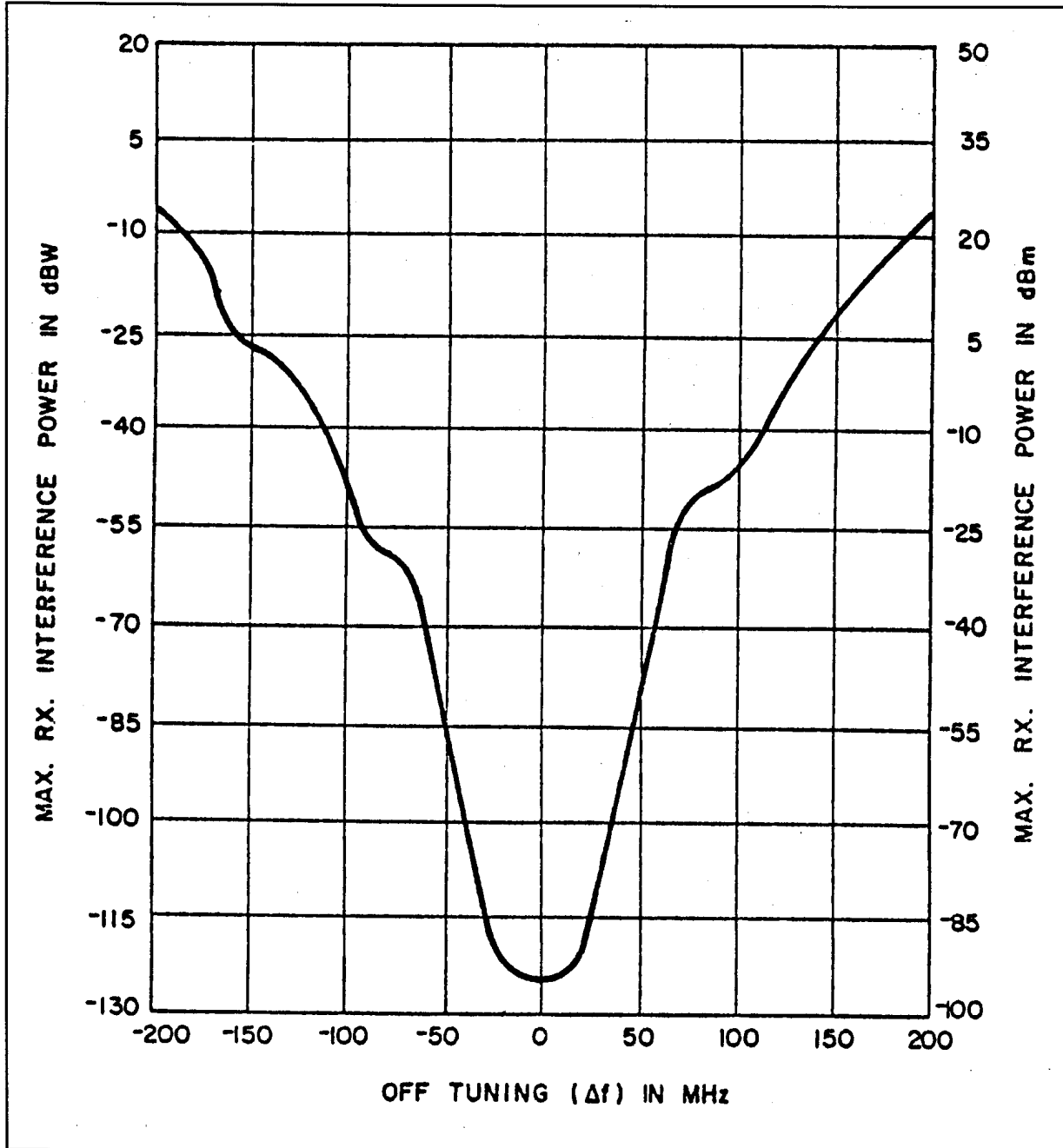
FIGURE 2. FR8 INTERFERENCE SUSCEPTIBILITY CURVES



**FIGURE 3. TECHNICAL PARAMETERS, TML**

Frequency range	14.40 - 15.25 GHz
RF output power	150 mW (-8.2 dBW)
Emission	27M0F9W
Spectral purity	3 dB @ 18 MHz 20 dB @ 40 MHz 0 dB @ 135 MHz
Transmitter freq. stab.	±0.005%
Receiver RF bandwidth	-3 dB @ 45 MHz -20 dB @ 80 MHz -60 dB @ 270 MHz
Receiver IF bandwidth	-3 dB @ 44 MHz -20 dB @ 60 MHz -60 dB @ 120 MHz
	Receiver IF frequency
	70 MHz
Receiver noise figure	10.5 dB
Receiver tangential sensitivity	-117 dB
Image rejection	60 dB
NOTE: RF and IF bandwidth may vary 20-55 MHz, depending on equipment used.	
<b>Associated antennas</b>	
Parabolic Reflector (Diameter in feet)	4'
-3 dB beamwidth	1.4E H x 1.4E V
Gain	42.5 dBi
Max. sidelobe gain	-15.0 dB
Polarization	H or V

FIGURE 4. TML INTERFERENCE SUSCEPTIBILITY CURVES



**FIGURE 5. FAA LOW DENSITY RCL PATH DESIGN CRITERIA**

RADIO TYPE	XMT POWER (dBm)	RCV THRESHOLD (dBm)	NOTES
9xx MHz UHF 12 CH UHF Hi-Pwr Option	+37 +45	-87	2
DIG 1.8 GHz 1-DS1	+30	-78.5	1,2
DIG 1.8 GHz 8-DS1	+30	-75.5	1,2
DIG 1.8 GHz Hi-Pwr	+35		
DIG 23 GHz 8-DS-1	+16.8	-74.5	1,2
DIG 23 GHz Hi-Pwr	+21.2		

Notes:  
1 - Receiver threshold at  $10^{-6}$  BER.  
2 - Receiver threshold includes 3:3 hot standby loss.  
DS1 - 1.544 Mbit/sec North American rate  
BER = Bit Error Rate

**FIGURE 6. MDR 6X08 SPECIFICATIONS**

TRANSMIT POWER AT ANTENNA PORT						
MDR 6X08	Standard Power		28 dBm			
MDR 6X08	Low Power		15 dBm			
Frequency Range		7125-8500 MHz				
-----						
INTERFERENCE SPECIFICATION IN dB						
		MDR-6508		MDR-6708		
Threshold/Interference, Cochannel		28		34		
Threshold/Interference, Adjacent Channel		-8		-8		
Carrier/Interference(C/I in dB), BER = 10 <sup>-3</sup>		17		23		
Carrier/Interference(C/I in dB), BER = 10 <sup>-6</sup>		20		26		
-----						
MINIMUM CHANNEL SEPARATION (MHz)						
Transmit-to-transmit	Transmitters on same antenna, same polarization					46 MHz
Transmit-to-transmit	Transmitter on different antennas					30 MHz
Transmit-to-receive	Transmitter and Receiver on same antenna, same polarization					115 MHz
Transmit-to-receive	Transmitter and Receiver on same antenna, different polarization					95 MHz
Transmit-to-receive	Transmitter and Receiver on different antennas					30 MHz
-----						
RADIO TYPE	CAPACITY	B/W	RX THRESHOLD		DISPERSIVE FADE	
	DS1	(MHz)	(dBm)		MARGIN (dB)	
			BER=10 <sup>-3</sup>	BER=10 <sup>-6</sup>	BER=10 <sup>-3</sup>	BER=10 <sup>-6</sup>
MDR-6508-2	2	1.25	-89	-87	80	78
MDR-6508-4	8	2.50	-86	-84	76	74
MDR-6508-8	8	3.75	-83	-81	67	65
MDR-6508-12	12	5.50	-81	-79	64	62
MDR-6508-16	16	7.50	-80	-78	62	60
MDR-6708-2	2	0.80	-85	-83	83	81
MDR-6708-4	4	1.25	-82	-80	79	77
MDR-6708-8	8	2.50	-79	-77	70	68
MDR-6708-12	12	3.75	-77	-75	67	65
MDR-6708-16	16	5.00	-76	-74	65	63

FIGURE 7. NOMOGRAPH FOR FREE SPACE PROPAGATION LOSS

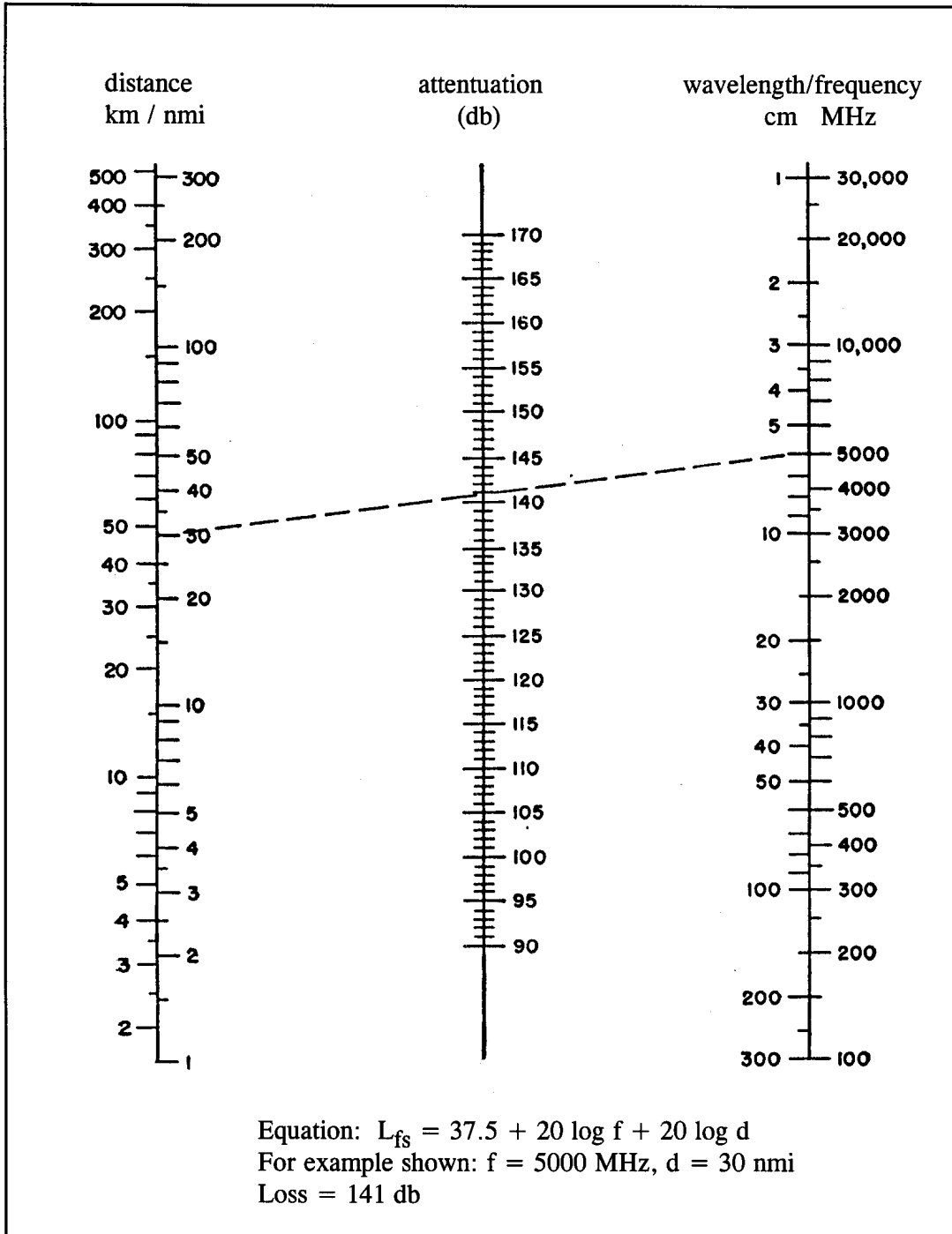
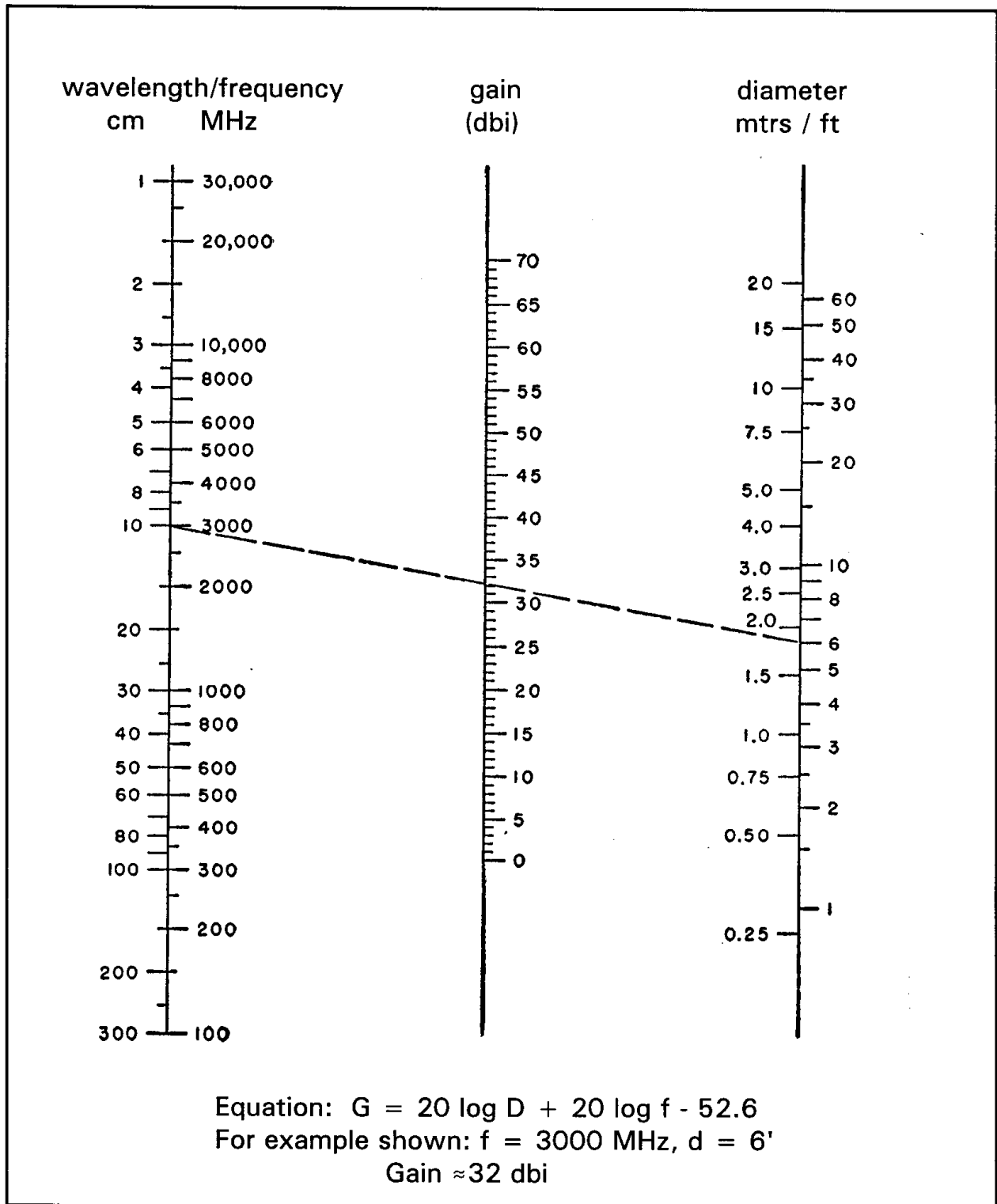


FIGURE 8. NOMOGRAPH FOR PARABOLIC ANTENNA GAIN



**FIGURE 9. AVAILABLE COMPUTER ANALYSIS MODELS****MSAM**

The Microcomputer Spectrum Analysis Models are a collection of engineering programs useful for spectrum management. These models were adapted to run on Windows computers by the NTIA. These programs have not been rigorously tested, but have been verified to be correct for many scenarios run over a number of years. Specific programs are listed below.

- a. **SHADO** – Calculates and plots the areas around a fixed point that are within RLOS.
- b. **HORIZON** – Calculates the RLOS for 360° around a specified site, using an on-line digitized terrain data base.
- c. **PROFILE** – Calculates elevation versus distance data path Profile between two specified sites using an on-line digitized data base.
- d. **SATAZ** – The Satellite Azimuth program computes the distance and various angles from an earth station a satellite (both geostationary and nongeostationary) and from a satellite to an earth station.
- e. **APD** – The Antenna Power Density program provides simplified procedures for estimating the near field power density of a number of common types of antennas and graphically checking the compliance of systems with different emission exposure standards or user-defined limits.
- f. **FDR** -- Computes Frequency Dependent Rejection and optionally, frequency-distance relationships between a transmitter and a receiver.
- g. **ITM** – Estimates radio propagation losses over irregular terrain for VHF, UHF and SHF frequencies as a function of distance and the variability of signal in time and space.
- h. **INTMOD** – Performs harmonic and intermodulation analysis of 2 and/or 3 signals of 3<sup>rd</sup>, 5<sup>th</sup> or 7<sup>th</sup> order mixing.
- i. **SEAM** – The Single Emitter Analysis Model estimate the signal level received at a specified propagation distance in terms of the field strength or emitter power of a single emitter.
- j. **ANNEX1** – The program is based on the procedures outline in Annex 1 of the NTIA Manual. It is for use as a frequency selection aid to evaluate proposals for a new station to be introduced into an existing environment of fixed and/or mobile station in the 30 – 960 MHz band.
- k. **LMS** – Terrestrial Land Mobile Services model is a package of empirical models. It uses Okumura-Hata ITU-R-529, Cost 231 and Okumura-Hata-Davidson models.
- l. **BDIST** -- Computes the true Bearings and great circle Distance given the coordinates of the two endpoints using the WGS84 ellipsoid.



## APPENDIX 5. GLOSSARY OF ACRONYMS

### A

AAG	Aeronautical Assignment Group
AAM	Airspace Analysis Model
AC	Alternating Current
AC	Approach Control
ACDO	Air Carrier District Office
ADS-B	Automatic Dependant Surveillance – Broadcast
AFC	Area Frequency Coordinator (military)
AFM	Automated Frequency Management system
A/G	Air-to-Ground (communications)
AGC	Automatic Gain Control
AGL	Above Ground Level
ALPA	Air Line Pilots Association
AM	Amplitude Modulation (Broadcast Station)
AMCP	Aeronautical Mobile Communications Panel
AMSL	Above Mean Sea Level (altitude)
ANC	Air Navigation Commission
AOPA	Aircraft Owners and Pilots Association
ARINC	Aeronautical Radio, Incorporated
ARP	Azimuth reference pulse
ARRAS	Automated Remote Radio Access System
ARSR	Air Route Surveillance Radar
ARTCC	Air Route Traffic Control Center
ASD	Aircraft Situation Display
ASDE	Airport Surface Detection Equipment
ASR	Airport Surveillance Radar
ASOS	Automated Surface Observation System
AS T	Air Show, Temporary
ATA	Air Transport Association of America
ATC	Air Traffic Control
ATCRBS	Air Traffic Control Radar Beacon System
ATCT	Air Traffic Control Tower
ATIS	Automatic Terminal Information Service
AVOT	Area VOT
AWOS	Automated Weather Observing System

### B

BC	Broadcast
BCM	Back Course Marker
BEACON	Old name for ATCRBS
BFTE	Beacon False Target Eliminator
BLM	Bureau of Land Management
BUEC	Backup Emergency Communication (system)

**C**

C3	Command and Control Communications
CAP	Civil Air Patrol
CB	Citizens Band
CCCC	Communications Crises Control Center
CCSA	Computer Controlled Spectrum Analyzer
CD	Clearance Delivery
CFR	Code of Federal Regulations
CIP	Capital Investment Plan
CNS	Communications, Navigation and Surveillance
COMM	Communications
COMLO	Compass Locator
CONUS	Conterminous (or Contiguous) United States (48)
COTS	Commercial off-the-shelf
CP	Construction Permit (Issued by FCC)
cps	Cycles per second
CSV	Cylindrical Service Volume
CW	Continuous Wave

**D**

D	Desired (facility)
dB	Decibel
dBd	Decibel gain over a dipole antenna
dBi	Decibel gain over an isotropic antenna
dBm	Decibels above 1 milliwatt
dB $\mu$ v	Decibels above 1 microvolt
dBuv/m	Decibels above 1 microvolt per meter
DBRITE	Digital Bright Radar Indicator Tower Equipment
dc	Direct Current
DC	Departure Control
d <sub>D</sub>	Distance from the desired facility to the edge of the desired service volume
DECCO	Defense Commercial Communications Office
DF	Direction-Finding, Direction-Finder
DGPS	Differential Global Positioning System
DME	Distance Measuring Equipment
DME/N	Distance Measuring Equipment - Normal
DME/P	Distance Measuring Equipment - Precision
DOC	Department of Commerce
DOD	Department of Defense
DOD AFC	Department of Defense Area Frequency Coordinator
dpi	Dots Per Inch
DR	Distance ratio
DTMF	Dual Tone Multiple Frequency
d <sub>U</sub>	Distance from the undesired facility service volume edge to the edge of the desired service volume
D/U	Ratio between the d <sub>D</sub> and d <sub>U</sub> facilities, in dB

**E**

EA	Electric Attack
ECM	Electronic Countermeasures (now known as EA)
ECP	Engineering Change Proposal
ECS	Emergency Communications System (also C3)
EFAS	En Route Flight Advisory Service
EHF	Extremely High Frequency
EIRP	Effective Radiated Power above an Isotropic antenna
ELT	Emergency Locator Transmitter
EMC	Electromagnetic Compatibility
EMI	Electromagnetic Interference (same as RFI)
EMS	Emission
EPS	Emergency Planning Subcommittee
ER	Emergency Readiness
ERP	Effective Radiated Power
ESR	Equivalent Signal Ratio
ESV	Expanded Service Volume
ESVMS	ESV Management System

**F**

FA	Final Approach (MLS)
FAA	Federal Aviation Administration
FAR	Federal Air Regulations
FAS	Frequency Assignment Subcommittee
FCC	Federal Communications Commission
FET	Fractional Exposure Time
FFT	Fire Fighting Temporary (prefix)
FICO	Flight Inspection Central Operations
FIS	Flight Information Service
FM	Frequency Modulation
FMF	Facility Master File
FMO	Frequency Management Office(r)
FOT	Frequency for Optimum Transmission
FPSV	Frequency Protected Service Volume
FRUIT	False Returns Unsynchronized In Time
FS	Flight Standards (Division or Service)
FSDO	Flight Standards District Office
FSFO	Flight Standards Field Office
FSL	Free Space Loss
FSS	Flight Service Station
FTA	Facility Transmitter Authorization

**G**

GADO	General Aviation District Office
GAMA	General Aviation Manufacturers Association
GBAS	Ground Based Augmentation System
GC	Ground Control

GENOT	General Notice
GHz	GigaHertz
GMF	Government Master File
GNSS	Global Navigation Satellite System
GNSSP	Global Navigation Satellite System Panel
GPS	Global Positioning System
GPS L1	GPS Civil Signal L1
GPS L5	GPS Civil Signal L5
GS	Glideslope

**H**

H	High Altitude (VOR/DME/TACAN)
H	High Power Non-directional Beacon
HE	High Altitude En Route (A/G)
HC	Helicopter Control
HF	High Frequency
HH	High power Non-directional Beacon
HIWAS	Hazardous Inflight Weather Advisory System
Homer	Nondirectional Radio Beacon
HP	Holding Pattern
Hz	Hertz

**I**

IA	Initial Approach (MLS)
ICAO	International Civil Aviation Organization
ID	Identification
IF	Intermediate Frequency
IFF	Identification, Friend or Foe
IFR	Instrument Flight Rules
ILS	Instrument Landing System
IM	Intermodulation Product (same as Intermod)
Intermod	Intermodulation Product (same as IM)
iOE/AAA	Internet Obstruction Evaluation/Airport Airpace Analysis
IRAC	Interdepartment Radio Advisory Committee
ISLS	Improved Side Lobe Suppression
ITS	Institute For Telecommunications Science
ITU	International Telecommunication Union

**J**

JTIDS	Joint Tactical Information Distribution System
-------	--

**K**

kHz	KiloHertz
kW	KiloWatt

**L**

L	Low Altitude (VOR/DME/TACAN)
LAAS	Local Area Augmentation System
LAD	Administrative Report
LAX	Los Angeles, CA ILS System Identifier
LE	Low Altitude En Route (A/G)
LC	Local Control
LDRCL	Low Density Radio Communications Link
LF	Low Frequency
LIR	Interrupt Report
LLF	Line/Frequency
LLWAS	Low Level Wind Shear Alert System
L/MF	Low and Medium Frequency bands combined
LO	Local Oscillator
LOA	Letter of Agreement
LOB	Line of Bearing
LOC	ILS Localizer
LMM	Compass Locator at a Middle Marker
LOM	Compass Locator at an Outer Marker
LPTV	Low Power TV
LSB	Lower Sideband
LUF	Lowest Usable Frequency (MF/HF)

**M**

MAG	Military Assignment Group
MALSR	Medium Intensity Approach Lighting System with Runway Alignment Indicator Lights
MCS	Management Control System (RFIM Van)
MF	Medium Frequency
MH	Medium Power Nondirectional Beacon
MHz	MegaHertz
MILDEP	Military Department
MLS	Microwave Landing System
MM	Middle Marker
mm/m	Millimhos Per Meter
mm/min	Millimeters Per Minute
MMS	Maintenance Management System
MOA	Military Operating Area
Mode S	Specialized ATCRBS with discrete address capability
MOPS	Minimum Operational Performance Standards
MPE	Maximum Personal Exposure
m/s	Meters Per Second
msec	Millisecond
MUF	Maximum Usable Frequency (MF/HF)
MULTICOM	Special Conditional Use Frequency (FCC)
mV	Millivolt
MWARA	Major World Air Route Areas
mW/cm <sup>2</sup>	Milliwatts Per Square Centimeter

**N**

NAFEC	National Airway Facilities Experimental Center (now, the FAA William J. Hughes Technical Center)
NADIF	NAFEC Dipole Feed
NAPRS	National Automated Performance Reporting System
NAS	National Airspace System
NASE/RFI	Navigational Aids Signal Evaluator/Radio Frequency Interference
NAVAID	Navigational Aid
NBAA	National Business Aircraft Association
NCP	NAS Change Proposal
NDB	Nondirectional Beacon
NDI	Non Development Item
NEXRAD	Next Generation Weather Radar
NIFC	National Interagency Fire Center
NIST	National Institute of Science and Technology
nm	Nautical Miles (used in computer printout copies)
nmi	Nautical Miles (used in text)
NOCC	National Operations Control Center
*NRM	Number of stations (NTIA Form 19-A)
NRCS	National Radio Communications System
NRQZ	National Radio Quiet Zone
NSEP	National Security Emergency Preparedness
NSF	National Science Foundation
NTIA	National Telecommunications and Information Administration
NTIA Manual	Manual of Regulation and Procedures For Federal Radio Frequency Management, published by NTIA
NWS	National Weather Service

**O**

OCC	Operational Control Center
OE	Obstruction Evaluation
OM	Outer Marker
OSHA	Occupational and Safety Hazards Administration
OTS	Out to Service

**P**

PAR	Precision Approach Radar
PEL	Permissible Exposure Limit
PL	Private Line (squellch tones)
pps	Pulses Per Second
PROP	Proponent
PRR	Pulse Repetition Rate (formerly PRF)
PRT	Pulse Repetition Time
PTP	Point-To-Point
PTT	Push-To-Talk
PTTA	Postal Telegraph and Telephone Authority
PWR	Power

**Q**

None

**R**

(R)	Route (used with "aeronautical Mobile")
RAD	Receive Antenna Dimensions (NTIA Form 19-A)
*RAD	Authorized Area of Operation (NTIA Form 19-A)
RADHAZ	Radiation Hazard
RAL	Receive Antenna Location (NTIA Form 19-A)
RAPM	Regional Associate Program Manager
RBPM	Radar Beacon Performance Monitor
RC	Resistor/Capacitor Combination
RCAG	Remote Control A/G facility
RCAMSL	Radiation Center Above Mean Sea Level
RCAS	Radio Coverage Analysis System
RCF	Remote Communications Facility
RCL	Radio Communications Link
RCOM	Recovery Communications (Previously NARACS)
RCS	Radio Conference Subcommittee
RDARA	Regional and Domestic Air Route Area
RF	Radio Frequency
RFI	Radio Frequency Interference (same as EMI)
RFI Van	Radio Frequency Interference Van
RFIM	Radio Frequency Interference Monitoring (Van or System)
RLA	Receive Antenna Latitude (NTIA Form 19-A)
RLG	Receive Antenna Longitude (NTIA Form 19-A)
RLOS	Radio Line Of Sight
r/min	Revolutions Per Minute
RML	Radar Microwave Link
RMM	Remote Maintenance Monitoring
ROSHM	Regional Occupational Safety and Health Manager
r/s	Revolutions Per Second
RSC	Receive State (NTIA Form 19-A)
RTCA	RTCA, Incorporated (formerly the Radio Technical Commission for Aeronautics)
RTDE	Research, Test, Development and Evaluation
RTR	Remote Transmitter/Receiver
RX or Rx	Receive, Receiver

**S**

(S)	Required facility geographical separation
SA	Spectrum Analyzer
SAR	Search And Rescue
SARP	Standards and Recommended Practices
SAWS	Stand Alone Weather System
SCAT-I	Special Category I (DGPS)
SE	Super High Altitude Enroute
SECRA	Secondary Radar (old name for ATCRBS)

SHF	Super High Frequency
SIF	Selective Identification Feature (modified IFF)
SLC	Space Loss Calculator
SLS	Side Lobe Suppression
SMDb	Spectrum Management Data Base
smi	Statute Miles
SMO	System Maintenance Office
SOC	System Operations Center
SPS	Spectrum Planning Subcommittee
SSL	Secure Socket Layer
SSS	Space Systems Subcommittee
STA	Special Temporary Authorization (FCC)
STALO	Stabilized Local Oscillator
STC	Station Class (NTIA Form 19-A)

**T**

T	Terminal (VOR/DME/TACAN)
TACAN	Tactical Air Navigation
TC	Time Constant
TDWR	Terminal Doppler Weather Radar
TFR	Temporary Flight Restrictions
TIMDS	Transportable Interference Monitoring Detection System
TIOA	Transmitter Identification and Operation Authorization
TIS	Travelers Information Service
Title 49 U.S.C.	Codified FAA Act of 1958, as amended
TLS	Transponder Landing System
TML	Television Microwave Link
T/R	Transmit and Receive
TRACON	Terminal Radar Approach Control
TSC	Technical Subcommittee
TSV	Tailored Service Volume
TV	Television
TWEB	Transcribed Weather Broadcast
TX	Transmit, Transmitter
TX LO	Transmitter Local Oscillator

**U**

U	Undesired (facility)
UAT	Universal Access Transceiver
ufd	Microfarad
UHF	Ultra High Frequency
UNICOM	Aeronautical Advisory Station (FCC)
USAF	United States Air Force
USB	Upper Sideband
usec	Microsecond
USER ID	User Identification
USFS	United States Forest Service



USN United States Navy  
uV/m Microvolts Per Meter

**V**

V Volt  
VFR Visual Flight Rules  
VHF Very High Frequency  
VIP Variable Interpulse Period  
VLF Very Low Frequency  
VOLMET Meteorological Area Weather Broadcasts  
VOR VHF Omnidirectional Radio Range  
VORTAC VOR with TACAN  
VOT VHF Omnidirectional Radio Range Test  
VPN Virtual Private Network

**W**

W Watt  
WAAS Wide Area Augmentation System  
WRC World Radiocommunication Conference  
WSR-88D Next Generation Weather Radar (NEXRAD)

**X**

XAD Transmit Antenna Dimensions (NTIA Form19-A)  
XAL Transmit Antenna Location (NTIA Form19-A)  
XAZ Transmit Azimuth (NTIA Form 19-A)  
XLA Transmit Antenna Latitude (NTIA Form19-A)  
XLG Transmit Antenna Longitude (NTIA Form 19-A)  
XSC/RSC Transmit State (NTIA Form 19-A)

**Y**

None

**Z**

None

**APPENDIX 6. EMISSION DESIGNATORS**

<u>FACILITY TYPE/FREQUENCY BAND</u>	<u>DESIGNATOR</u>	<u>STATION CLASS</u>
NDB (single carrier) (190-535 kHz)	2K04A2A	ALB
NDB (two carrier) (190-535 kHz)	1K12XXA	ALB
#	#	#
Marker Beacon [75 MHz (OM)]	800HA2A	ALA
Marker Beacon [75 MHz (MM)]	2K60A2A	ALA
Marker Beacon [75 MHz (IM/BCM)]	6K00A2A	ALA
#	#	#
Localizer capture effect (108.30-111.95 MHz)	8K00A9W	ALL
Localizer (108.30-111.95 MHz)	2K04A2A	ALL
LAAS (108.025-117.950 MHz)	14K0G7DET	DGP
Glide Slope (328.600-335.400 MHz)	300HA1N	ALG
Glide Slope capture effect (328.600-335.400 MHz)	8K30A1N	ALG
DME (960-1215 MHz)	650KM1A	AL
DME/P (960-1215 MHz)	750KM1A	AL
TACAN (960-1215 MHz)	650KV1A	AL
VOR with voice (108.2000-117.9875 MHz)	20K9A9W	ALO
VOR without voice (108.2000-117.9875 MHz)	20K9A2A	ALO
MLS (5000-5250 MHz)	150KM1D	ALL,ALG
#	#	#
Radar (ASDE-X) (9000-9200 MHz)	35M00P0N	LR
Radar (TDWR) (5600-5650 MHz)	4M00P0NAN	SMD
Radar (ASR-11) (2700-2900 MHz)	2M80Q3N/5M10P0N	ALS
Radar (ASR-9) (2700-2900 MHz)	5M00P0N	ALS
Radar (ASR-8) (2700-2900 MHz)	6M00P0N	ALS
Radar (ASR-7) (2700-2900 MHz)	8M00P0N	ALS
Radar (ARSR-4) (1215-1400 MHz)	5M00P0N	ALS
Radar (ARSR-3) (1215-1400 MHz)	6M00P0N	ALS
Radar (ARSR1/2) (1215-1400 MHz)	10M0P0N	ALS
Radar (ASDE-3) (15.7-16.2 GHz)	28M0P0N	LR
ATCRBS (transmit 1030 MHz - receive 1090 MHz)	6M00M1D	RN
ATCBI-6 (transmit 1030 MHz – receive 1090 MHz)	21M50V1D	RN
Mode S (transmit 1030 MHz – receive 1090 MHz)	21M50V1D	RN
MSSR (transmit 1030 MHz – receive 1090 MHz)	9M001D	RN
Multi-Lat (transmit 1030 MHz – 1090 MHz)	9M20M1D	RN
RPBM/CPME (transmit 1030 MHz–receive 1090 MHz)	14M00V1D	ALTO
#	#	#
Voice communications using double sideband (118.000-136.475 and 225.000-400.000 MHz)	6K00A3E	FA (enroute) FAC (lcl ctl, apch ctl, etc.) FAB (ATIS, AWOS, etc.) FLU (gnd ctl, clnc dlvy, etc.)
#	#	#
VDL-3 (TDMA) communications (118.000-136.475 MHz)	14K07WET	FA (enroute) FAC (lcl ctl, apch ctl, etc.) FAB (ATIS, AWOS, etc.) FLU (gnd ctl, clnc dlvy, etc.)

<u>FACILITY TYPE/FREQUENCY BAND</u>	<u>DESIGNATOR</u>	<u>STATION CLASS</u>
VDL-2 (FIS-only) data link communications (136.425-136.475 MHz)	14K0G1DE	FA (enroute) FAC (lcl ctl, apch ctl, etc.)
#	#	#
HF (3-30 MHz)	1K28F1B	FX, FA, MA, FB, ML
	3K00J3E	FX, FA, MA, FB, ML
	2K80J3E	FX, FA, MA, FB, ML
	6K00B9W	FX, FA, MA, FB, ML
#	#	#
RCL (ATT FR8) (7125-8500 MHz)	20M0F9W	FX
RCL (Alcatel MDR6508-4) (7125-8500 MHz)	2M50D7W	FX
RCL (Alcatel MDR6508-8) (7125-8500 MHz)	3M75D7W	FX
RCL (Alcatel MDR6508-16) (7125-8500 MHz)	7M50D7W	FX
TML (14.40-15.35 GHz)	27M0F9W	FX
#	#	#
Land Mobile (C3) (162-174 MHz)	8K10F1E	FXR, FB, ML
Fixed (406.100-420.000 MHz)	11K00F1D	FX

## APPENDIX 7. FORMULAS USED IN THIS ORDER

(S)	Required nmi separation distance between NAVAID's or COMM's	CH 11 Pg 106 APX 3 Pg 015 APX 3 Pg 073
$G_{dB}$	Gain of parabolic antenna	CH 12 Pg 113
$L_{fs}$	Free space loss in nmi	CH 12 Pg 115 APX 2 Pg 007
$L_i$	Free space loss in feet of interferer (sub item in LEVEL out-of-band)	APX 1 Pg 012
$f_i$	PRR "running rabbits" interferer's frequency	CH 14 Pg 182
$f_o$	Intermod products, any set of frequencies	APX 1 Pg 009
LEVEL	Maximum in-band level of power in dBm before RFI occurs	APX 1 Pg 010
LEVEL	Maximum out-of-band level of power in dBm before RFI occurs	APX 1 Pg 012
$D_a$	Slant range distance in any standard between two elevated antennas	APX 1 Pg 012
d	Venn diagram RFI radii, 10, 20 or 30 dBm distances in nmi	APX 1 Pg 014
RLOS	Radio line of sight between two points in nmi and smi	APX 2 Pg 006
ESR	Equivalent signal ratio, used in connection with VOR ESV's	APX 3 Pg 014
ESR	Equivalent signal ratio, used in connection with ILS's and ESV's	APX 3 Pg 071

## APPENDIX 8. SOME PROCEDURES FOR RADAR ANTENNA VERTICAL PATTERN MEASUREMENT BY SOLAR MEANS

**1. GENERAL.** FMOs ordinarily do not perform "solar" antenna measurements (see paragraph 1601 d. of this order). When such measurements are done, the procedures described below are suggested. There are several procedures, but all have the same purpose.

**a. The methods described** in this chapter use the sun's electromagnetic radiant "noise" as a signal source. Measurement is accomplished with a field strength meter or SA in either a manual or computer-controlled recording system and recorders of either pen type or floppy disc. This system also requires shutdown of the radar, since the radar antenna is connected to the measurement system. The antenna is left at its normal mechanical tilt and rotated at its normal speed, with the transmitter and receiver turned off. These "solar" procedures described below are examples of some of the available and effective procedures.

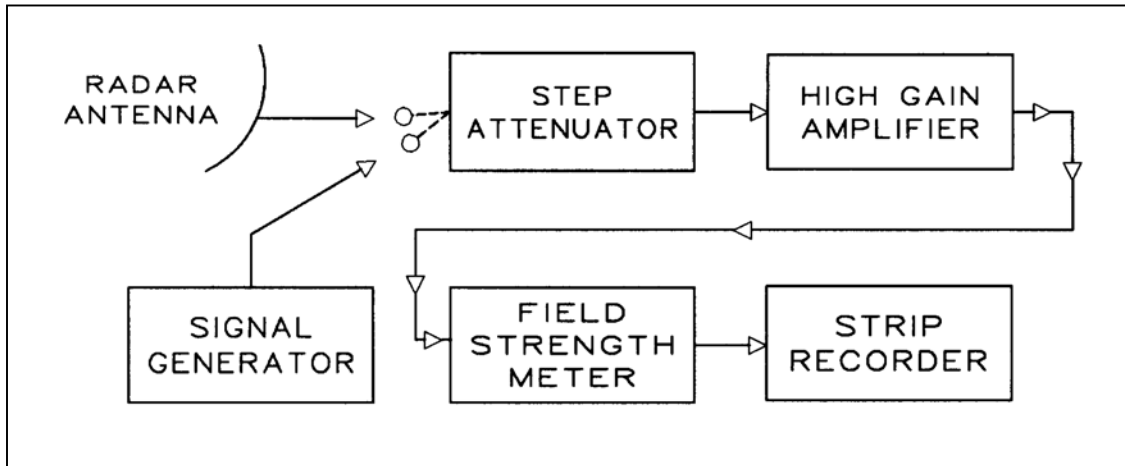
**b. As the earth rotates,** the sun "rises" above (or "sets" into) the horizon, and it effectively passes through the radar antenna's main beam. That relatively stable noise source is recorded at each revolution. Since the radar's rotation is very rapid with respect to the angular velocity of the sun, many antenna revolution sun passes are possible at approximately the same elevation, thus enabling the recording system to average out small differences and give a very high degree of resolution.

**c. The RFIM van is equipped** to make horizontal radar antenna pattern measurements. The van equipment may be used by the FMO for the vertical pattern measurements described in this appendix. Some additional equipment may be needed depending on which method of measurement is used.

**d. There is considerable equipment setup** and calibration required which, instead of being in the van, must be transported to the radar site, set up, taken down, then the results either manually plotted or fed into an automatic plotter back at the FMO's office.

**2. TWO METHODS OF SOLAR MEASUREMENTS.** Two methods of solar-based radar antenna pattern measurement are manual and automated. Each will produce quality results, but the automated method does away with any manual extrapolation, interpolation, and plotting. It produces a superior product at the expense of using a computer and considerable other equipment.

**3. MANUAL MEASUREMENT.** A vertical antenna pattern can be produced manually from just the NM-65T field strength meter, an attenuator, an amplifier, and a strip chart recorder. The recorded signal will be the signal received from the sun's noise radiation as the antenna sweeps past the sun's azimuth. A block diagram of the necessary equipment setup is found in figure 1, with a procedural description following.

**FIGURE 1. BLOCK DIAGRAM OF MANUAL MEASUREMENT**

**a. Equipment required** for a radar antenna measurement using the sun as a source is essentially the same as the setup in the RFIM van. However, the relatively weaker source (sun noise) requires extra amplification and a source of accurate time is needed.

(1) **Any good high-gain amplifier** with a low noise figure may be used. The AVENTEK AMG 2021 or 2022 for 1-2 GHz or the AMG 4031 for 2-4 GHz are examples.

(2) **An accurate field strength meter.** The Eaton NM-65T field strength meter supplied the FMOs is excellent. The later model NM-67T is also excellent for those who have it. The signal output of a quality spectrum analyzer could also be used in lieu of the field strength meter.

(3) **An in-line step attenuator**, with at least 30 dB total attenuation, in steps of 1 or 2 dB is required.

(4) **A strip chart recorder is needed.** This is a key element in the measuring package. It must have low ballistics so that it follows the detected noise signal accurately; e.g., 10 msec or less from zero to full scale. It also must be capable of quite slow paper travel to permit recording the passes in a reasonable length of paper. An HP 17401A recorder has been used satisfactorily, but this is a two channel device and requires considerable adjustment to get the crossover of the two channels to match. There are several strip chart recorders available which will do the job satisfactorily. The principal concern is that it have sufficient span to accurately record a 25-30 dB range of values and that it is capable of being set to a slow speed of around 5 millimeters per minute (mm/min).

(5) **A time source** accurate to a few seconds a day is required. Before using the time source, it should be coordinated with an accurate time source such as radio station WWV. If a time-tick device is available, that device can be used to put a marked tick on the recording automatically. If not, a manual mark each minute will be sufficient.

(6) **An accurate determination of the sun's position** is essential. The sun's position with respect to time, date, and geographical position of the radar must be accurately known, otherwise the whole measurement will be faulty. The radar's coordinates can be obtained from the IRAC authorization document, GMF files or GPS receiver. The sun's actual position minute-to-minute is determined from the Air Almanac or Nautical Almanac, published by the Naval Observatory, Washington, DC.

**b. Measurement procedure.**

(1) **Connect the system components** as shown in figure 1, with the calibrating signal generator connected to the input of the in-line step attenuator.

(2) **Set the in-line attenuator** to 0 dB.

(3) **Set and calibrate the NM-65T** to the frequency of the radar.

(4) **Set the NM-65T attenuator** to the 0 dB position.

(5) **Set the NM-65T function.**

(a) **The function setting** is critical to the calibration procedure, thus to the overall accuracy of the measurements. Some experimentation will be necessary and will depend on many factors. Whether field intensity, direct peak, or quasi-peak function is used will depend upon the systems setup, the ballistics of the strip recorder, the radar antenna azimuth rate and the antenna beam width ( $\pm 3$  dB). For instance, an ARSR with a rate of 4 revolutions per minute (r/min) and a beam width of  $2^\circ$  would mean an illumination of the antenna within its beam width for  $2/360 \times 15$  secs = 83.33 msec. That means the strip recorder has only 83 msec to reach its full swing position and come to rest before it starts down again. A  $2^\circ$  beam width of an ASR of 15 r/min would give illumination for only  $2/360 \times 4$  secs = 22.22 msec to accomplish the same swing. Depending on the ballistics of the recorder and the time constant of the field strength meter, this could be sufficient to give an accurate reading, or could lag behind the actual value due to the "drag" resulting in an inaccurate reading.

(b) **Testing of the setup** must be done before the first measurement is made. Once done, the parameters will be known and set for all subsequent measurements, using the same equipment and antenna rates. The manufacturer's instruction book should specify the slew rate of the pen. If it will make a full excursion in 20 msec or less, then both the examples in subparagraph b(5)(a) above would be operable in quasi-peak function. However, if as is often the case with recorders which have slow paper rates, the manufacturer specifies the slew rate as 500 msec or so, another function will be required, most likely peak with 0.5 sec hold time.

(c) **Peak function in the NM-65T** holds the meter reading (and thus the recorder output) for 0.5 or 5 sec, switchable. This is to permit easy reading of a very short pulse, even a  $\mu$ sec or less. Setting the time constant to 0.5 sec would match a 500 msec slew rate of a strip recorder. The NM-65T inserts a brief "dump" voltage (a reverse voltage) at the end of the selected hold time in direct peak function to restore the charging circuit to zero quickly to be ready for the next pulse to be measured. This is satisfactory if the strip recorder is partially damped or has a slow slew rate. Damping allows the pen to return to zero safely, without "ramming" it down and possibly damaging the recorder. The 5 sec peak time constant would be acceptable for an ARSR rate of 4r/min, but not an ASR of 15 r/min because the next illumination would come before the 5 sec "hold" time had expired.

(d) **Quasi-peak in the NM-65T** has a time constant of around 10 msec which is ideal for the Techni-rite 711 high-speed recorder used for antenna patterns described in chapter 13 of this order. The TR-711 would be excellent for this solar measurement, except the slowest normal speed would run out quite a bit of paper for the hour or more required for a complete sun "pass." If the TR-711 is reduced in tape speed to be usable for this function, then quasi-peak must be used, or the "dump" feature of direct peak will render the recording useless and could damage the recorder. The TR-711 has a slew rate of approximately 5 msec to full scale and no damping.

**(6) Calibrate the strip recorder** by injecting a known signal at a level about 150 to 250 milliVolts (mV) and adjusting the recorder scan to a desired scale reading, usually about 75 percent. Experience will soon teach what level is expected to be the peak noise recorded off each type of radar antenna and frequency. The NM-65T will handle a 60 dB dynamic range of level without distortion. Should the recorded level be above scale with the in-line attenuator set at 0, insert sufficient attenuation with this device to bring the pen to an on-scale reading for the whole recording session. DO NOT reduce signal level with the NM-65T internal attenuator. Doing so would activate AGC action within the NM-65T which occurs at other than 0 dB setting and would upset recording linearity. Set the recording paper speed at an appropriate rate, nominally around 5mm/min.

**(7) Insert steps of attenuation** with the signal generator untouched, (maximum of 2 dB/step) so that the individual levels of attenuation are shown on the recorder paper. After step intervals of 25 to 30 dB attenuation levels have been recorded and marked on the recording strip, return the attenuator to 0 dB.

**(8) Disconnect the generator** and connect the radar antenna to the input of the attenuator. With the radar turned off, start the antenna rotating.

**(9) Sunrise (or sunset) time** will have to have been previously determined for the particular day of the measurement. The actual recording should be started 2-3 min before sunrise. If the measurement is to be made at the sunset period, start the recording in sufficient time to assure a full range of vertical azimuth desired. Also start the time ticks and assure they are marked either manually or automatically on the recording for later data resolution.

**(10) Run the recording** for as long as needed to show the range of vertical pattern desired. For a NADIF, for instance, this is just over an hour. Once the peak has been reached and further sun azimuthal excursion drops the sun noise passes more than 20 to 25 dB from the peak, recording may be stopped.

**(11) Rerun the calibration** on the recording at this time, to assure that parameters have not drifted significantly. Should they somehow have done so, it will be necessary to check all equipment and the overall system to find the cause of the apparent drift before another recording is made.

**(12) Dismantle the setup and disconnect the equipment.** The recording is now ready to be analyzed to permit drawing the actual radiation pattern. Refer to figure 2.

**c. Data analysis.** With the recorded signal in hand, it is now possible to calculate the actual vertical beam pattern. The recorder sheet already has the calibration on it, so the only analysis required is to correlate the sun's azimuth with the time ticks on the recording.

**(1) Using the sun's position** determined from the Naval Observatory Almanac, mark each fractional degree of sun azimuth on the recording aside the time tick marks. These should be small increments of  $0.1^\circ$  or so.

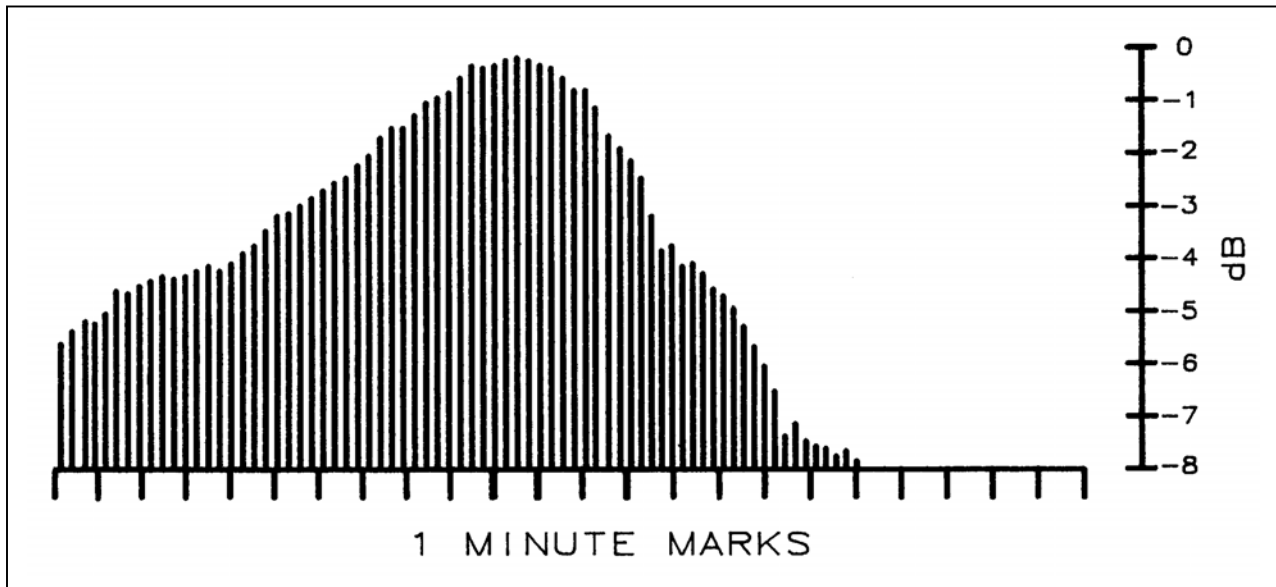
**(2) Using the previous calibration marks,** evaluate and mark each azimuth increment with a dB value. Generally, there will be a small variation of  $\pm 1$  dB or less between successive passes. If so, take a simple average of those passes nearest the marked increment.

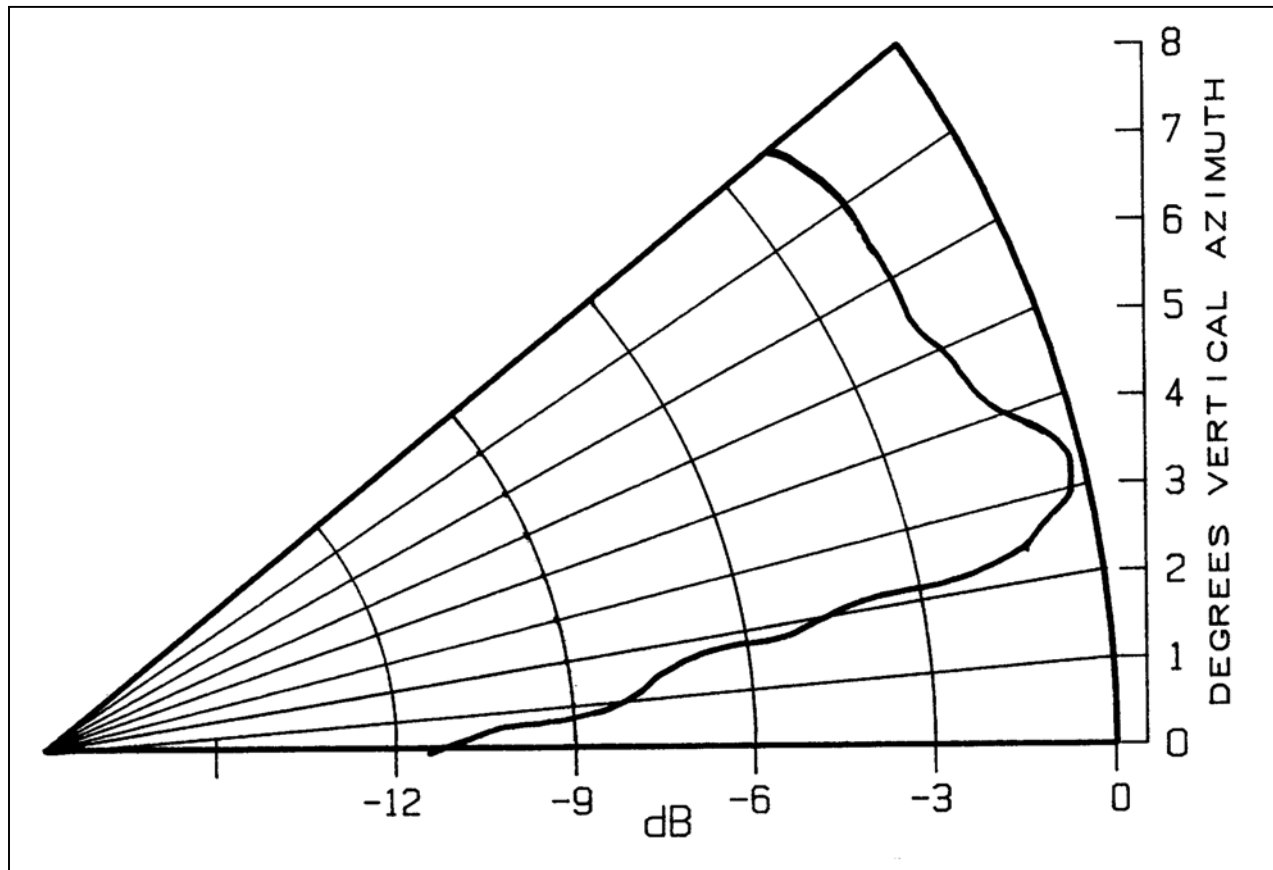
**(3) Analyzing the calibrated recording,** work up a chart of vertical azimuth in degrees versus amplitude in dB. Refer to figure 3.



(4) Using the data now available, plot the chart values onto a graph of expanded angular scale to produce a graphic view of the actual vertical beam antenna pattern of the radar measured. Be sure to subtract any mechanical tilt from the plot, or to specifically indicate that the plot is true vertical azimuth as installed, rather than the actual vertical radiation pattern of the antenna itself.

**FIGURE 2. SAMPLE RECORDING WITH CALIBRATION, TIME AND AMPLITUDE MARKINGS**



**FIGURE 3. SAMPLE PLOT OF ANALYZED RECORDING**

**4. AUTOMATED MEASUREMENT.** Automated systems of measurement have been developed by a few service areas to permit not only automated recording of the sun's azimuth passing through the antenna's beam, but then to produce automatically the graph of the beam resulting from the data collection. They use the equipment indicated previously in the manual method with the addition of a high-speed digital voltmeter, a real time clock, and a desktop computer. One service area used the HP 3437A voltmeter, the HP 98035A clock and the HP 9825A desktop computer. A block diagram of the setup is found in figure 4.

**a. Automated mode operation** is different from that of the manual mode described in paragraph 1702. The field strength meter output is fed to a digital voltmeter, then to a microcomputer which is time calibrated by a real time clock input. When the data collection is completed, the recorded information is taken back to the FMO's office and plotted by using the microcomputer and a suitable plotter. The final product is a vertical pattern plotted by the automated system.

**(1) Azimuth reference** is required for the system to identify the "window" to record. The purpose here is twofold. First, it greatly reduces extraneous signals from other radars from getting into the data base. Secondly, it reduces the need for memory and permits putting the whole recording on one tape. As the block diagram shows, the radar's Azimuth Reference Pulse (ARP) is used in conjunction with the clock to open the data window only for a few degrees before and then closing it a few degrees after the antenna scans the sun area.

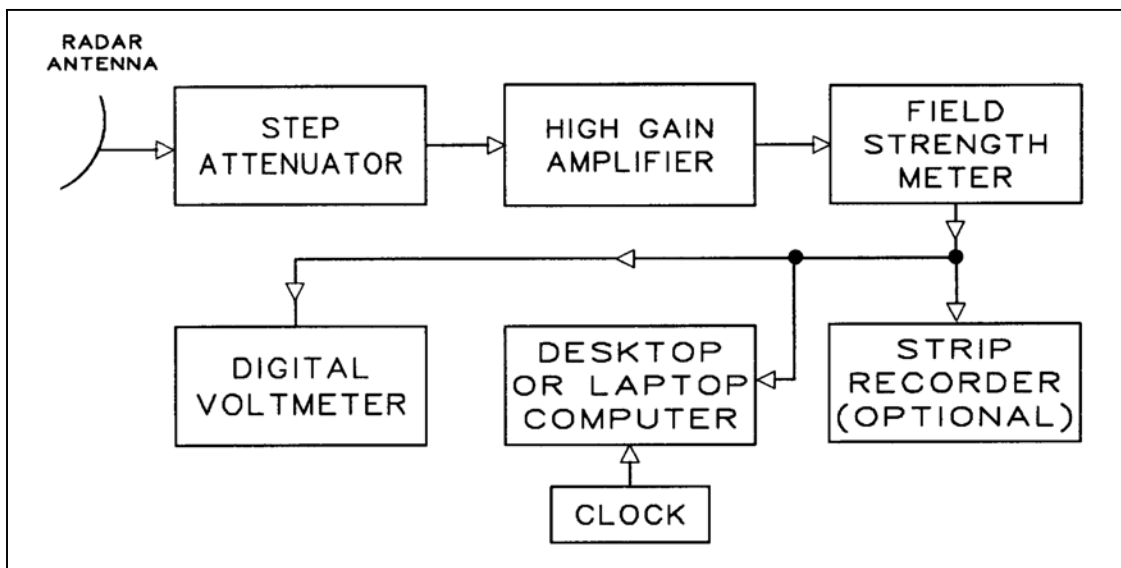
(2) **The digital voltmeter** is used to assure the overall signal applied to the computer does not exceed 1.5 V, the system maximum permissible value. It also serves to integrate the ARP into the system.

(3) **The microcomputer** is used primarily to program the measurement system, and once done, needs only "fill-ins" to run other radar measurements. It also serves to provide magnetic tape recording of the data as it is produced. After the recording is completed, it is used to playback the data and provide program information to the plotter for the final plotting.

(4) **The plotter** is used purely for graphics in plotting the final graph itself. Any good plotter compatible with the program language may be used.

(5) **Strip recording** can be done simultaneously to allow eye viewing of real time progress of the recording session. It is valuable as a monitoring tool to assure that all peripherals are operating in their proper mode. It allows the FMO to see the increasing, peaking and decreasing levels as the sun traverses the vertical beam path. For this reason, it is shown as optional in the block diagram of figure 4.

**FIGURE 4. AUTOMATED RADAR ANTENNA SOLAR MEASUREMENT BLOCK DIAGRAM**



**b. The service area automated program** upon which this description has been based is available as a 16-page, three-file program from Technical Operations ATC Spectrum Engineering Services. Other programs have been developed subsequently by other service areas and also are available through Technical Operations ATC Spectrum Engineering Services. At present, the decision as to whether the FMO should use an automated system or manual is dependent upon the FMO's choice and availability of equipment. The computer programs are not included in this manual. With the rapid growth in microcomputers, laptop computers, and engineers' knowledge of programming, any FMO who wishes to write a program is encouraged to do so. If a successful program for automated solar measurements is written, it is requested that the FMO forward it to Technical Operations ATC Spectrum Engineering Services for study and circulation to other service areas.

**c. A Headquarters automated system** has been devised by the Technical Operations Support National Airway Systems Engineering Office. It is designed to use with ASR, ARSR and ATCRBS antennas. It utilizes low-noise amplifiers, HP 8500 series spectrum analyzers and a microcomputer with HP-Basic language. The information entitled *Radar Antenna Solar Data Recording And Analysis* can be procured from Technical Operations ATC Spectrum Engineering Services.

**5. DOCUMENTATION.** As with other engineering data described in other chapters of this manual, any and all measurements and plots will be placed in the facility file as part of the permanent engineering record of the facility. Since spectrum management records are exempt from the destruction schedule, these records will serve as a permanent record of antenna capability and performance. They also can provide important clues to any suspected improper operation of the facility.