

# PUBLIC SUBMISSION

<b>As of:</b> 4/28/16 11:21 AM
<b>Received:</b> April 15, 2016
<b>Status:</b> Posted
<b>Posted:</b> April 22, 2016
<b>Tracking No.</b> 1k0-8p36-ulyi
<b>Comments Due:</b> May 02, 2016
<b>Submission Type:</b> Web

**Docket:** ATSDR-2016-0002

Collections Related to Synthetic Turf Fields with Crumb Rubber Infill 0923-16PJ

**Comment On:** ATSDR-2016-0002-0003

Collections Related to Synthetic Turf Fields with Crumb Rubber Infill ATSDR-2016-0002

**Document:** ATSDR-2016-0002-0023

Collections Related to Synthetic Turf Fields with Crumb Rubber Infill 0923-16PJ Comment on FR Doc # 2016-03305

---

## Submitter Information

**Name:** Vincent McDermott

**Address:** 06410

**Email:** vmcdermott@mminc.com

---

## General Comment

I participated in the 4/14/16 webinar and came away feeling hopeful since the design of the study will put many of the concerns to rest. As part of your literature search, I refer you to "Evaluation of the Environmental Effects of Synthetic Turf Fields", Milone & MacBroom, Inc. December 2008. This was an early study that our firm undertook at our own expense to better understand the issues. You may find it helpful to your research.

# PUBLIC SUBMISSION

<b>As of:</b> 4/28/16 11:39 AM
<b>Received:</b> April 27, 2016
<b>Status:</b> Posted
<b>Posted:</b> April 28, 2016
<b>Tracking No.</b> 1k0-8pbd-i7rh
<b>Comments Due:</b> May 02, 2016
<b>Submission Type:</b> Web

**Docket:** ATSDR-2016-0002

Collections Related to Synthetic Turf Fields with Crumb Rubber Infill 0923-16PJ

**Comment On:** ATSDR-2016-0002-0003

Collections Related to Synthetic Turf Fields with Crumb Rubber Infill ATSDR-2016-0002

**Document:** ATSDR-2016-0002-0041

Collections Related to Synthetic Turf Fields with Crumb Rubber Infill 0923-16PJ Comment on FR Doc # 2016-03305

---

## Submitter Information

**Name:** Aaron Crowell

---

## General Comment

Given the numerous chemicals that have been found in crumb rubber derived from scrap tires, the study should examine relevant knowledge gaps regarding the potential for synergistic effects in chemical mixtures, even in small doses. One reference that should be consulted is Goodson et al. (2015), "Assessing the carcinogenic potential of low-dose exposures to chemical mixtures in the environment: the challenge ahead", available at: [http://carcin.oxfordjournals.org/content/36/Suppl\\_1/S254.full?sid=db47f5ec-47a2-4879-bf30-6da9c076003d](http://carcin.oxfordjournals.org/content/36/Suppl_1/S254.full?sid=db47f5ec-47a2-4879-bf30-6da9c076003d)

# PUBLIC SUBMISSION

<b>As of:</b> 4/28/16 11:40 AM
<b>Received:</b> April 27, 2016
<b>Status:</b> Posted
<b>Posted:</b> April 28, 2016
<b>Tracking No.</b> 1k0-8pbf-ipjs
<b>Comments Due:</b> May 02, 2016
<b>Submission Type:</b> Web

**Docket:** ATSDR-2016-0002

Collections Related to Synthetic Turf Fields with Crumb Rubber Infill 0923-16PJ

**Comment On:** ATSDR-2016-0002-0003

Collections Related to Synthetic Turf Fields with Crumb Rubber Infill ATSDR-2016-0002

**Document:** ATSDR-2016-0002-0042

Collections Related to Synthetic Turf Fields with Crumb Rubber Infill 0923-16PJ Comment on FR Doc # 2016-03305

---

## Submitter Information

**Name:** Michael Dorsey

**Address:** 45255

**Email:** dorsey@wyomingcityschools.org

---

## General Comment

I am the corresponding author of the paper, Mutagenic Potential of Artificial Athletic Field Crumb Rubber at Increased Temperatures (Dorsey et. al. 2015. OHIO J. SCI. 115(2) 32-39. Available at: <https://library.osu.edu/ojs/index.php/OJS/article/view/4857>).

We were interested in identifying any realistic conditions that might lead to exposure of mutagenic compounds to athletes using crumb rubber fields. We heated crumb rubber from athletic fields to different temperatures for 30 minutes in water. These "leachates" were tested for the ability to cause mutations in bacteria using Ames fluctuation assays. Because substances that cause mutations are often, but not always, carcinogenic, the Ames assay is a classic first step in determining if a substance may be carcinogenic. We demonstrated that a compound, or compounds, with mutagenic potential is released from crumb rubber taken off of athletic fields when heated briefly in water to temperatures that these fields are known to reach, including 60 degrees C. In our study, crumb rubber heated in water to lower temperatures (40 degrees C.), did not result in the same effect. A separate 2015 paper has suggested that crumb rubber at 60 degrees C. releases significant amounts of PAHs including some known or suspected human carcinogens (Release of Polycyclic Aromatic Hydrocarbons and Heavy Metals from Rubber Crumb in Synthetic Turf Fields: Preliminary Hazard Assessment for Athletes. Marsili et al. 2015. J Environ Anal Toxicol 5: 265). Also, the results posted in these public comment pages by J. Klabin (ID: ATSDR-2016-0002-0017) concerning the analysis of painted playground

rubber heated in water at different temperatures (different compounds were identified at different temperatures) are consistent with our results on crumb rubber. We have since tested unpainted playground rubber with results similar to what we saw with crumb rubber (unpublished data).

It would be difficult to ignore mutagenicity data when evaluating a potential environmental cancer risk. Your study should explain why the results in our paper either are or are not relevant to your studies and conclusions. Otherwise, whether or not these fields pose a health risk will remain an open question. There could be legitimate reasons why the mutagenicity detected in our studies would not be of concern to human health, but those reasons will need to be articulated and justified.

I would point out that in our published study the crumb rubber was taken directly off of athletic fields, and therefore the possibility remains that it is something else environmental, and not the crumb rubber per se, that is the source of the mutagenicity we detect. To date, we have tested five different fields and one source of playground rubber, all showing a consistent pattern, but all five fields and the playground are within thirty miles of each other.

Next, the success of evaluating "potential cancer and non-cancer toxicity of key tire crumb constituents based on existing databases of information" (from Federal Research Action Plan on Recycled Tire Crumb Used on Playing Fields and Playgrounds) will hinge on certain assumptions:

1. That all of the "key" constituents are identified under all appropriate conditions (for example, water versus organic solvents, lower versus higher temperatures, and new versus old crumb rubber).
2. That the databases used are complete and accurate.
3. That there is no synergistic effect of individual components.

If after evaluating the crumb rubber toxicity no cancer causing agents can be found, the question will remain as to whether the results of our mutagenicity studies may be due to an unidentified constituent or to some other environmental source. For this reason I suggest, as part of your studies, starting with leachates similar to what we have made, testing whether they have biological activity (i.e., mutagenicity), and, if so, using those to identify the source of the activity.

The CalEPA/OEHHA has requested that the National Institute of Environmental Health Sciences and National Toxicology Program perform a short-term toxicology study. I feel that this type of study, in eukaryotic cells, is part of what must be done in order to address the particular concerns outlined above.

During your analysis of crumb rubber, you may identify compounds that are currently listed by the USGS as a concern for the environment. The finding of any such compounds should justify an environmental risk analysis.

I urge you to be completely transparent in releasing or publishing all results.

I hope athletic fields with crumb rubber infill are convincingly shown by the proposed study to be safe in all respects.



Thank you for addressing it.

Michael J. Dorsey, Ph.D.

# PUBLIC SUBMISSION

<b>As of:</b> 5/3/16 6:18 PM
<b>Received:</b> April 29, 2016
<b>Status:</b> Posted
<b>Posted:</b> April 29, 2016
<b>Tracking No.</b> 1k0-8pcg-82s1
<b>Comments Due:</b> May 02, 2016
<b>Submission Type:</b> Web

**Docket:** ATSDR-2016-0002

Collections Related to Synthetic Turf Fields with Crumb Rubber Infill 0923-16PJ

**Comment On:** ATSDR-2016-0002-0003

Collections Related to Synthetic Turf Fields with Crumb Rubber Infill ATSDR-2016-0002

**Document:** ATSDR-2016-0002-0045

Collections Related to Synthetic Turf Fields with Crumb Rubber Infill 0923-16PJ Comment on FR Doc # 2016-03305

---

## Submitter Information

**Name:** Maya van Rossum

**Address:** 19007

**Email:** [keepermaya@delawariverkeeper.org](mailto:keepermaya@delawariverkeeper.org)

---

## General Comment

The Delaware Riverkeeper Network submits the attached comment for your consideration.

In addition to the attached comment we would like to request that Maya van Rossum, the Delaware Riverkeeper, on behalf of the Delaware Riverkeeper Network, be identified as a stakeholder for participation in your process. Ms. van Rossum has engaged in a significant amount of research and community education and advocacy around the issue of synthetic turf fields, particularly those with crumb rubber infill, and would bring an important environmental and community perspective to your deliberations. Ms. van Rossum is the primary author on the documents we are submitting today.

Ms. van Rossum can be reached at:

[keepermaya@delawariverkeeper.org](mailto:keepermaya@delawariverkeeper.org)

or by phone at 215 369 1188 ext 102

Respectfully submitted and requested.

(p.s. the action alert document submitted previously was submitted in error and need not be entered for the record.)

---

## **Attachments**

Comment 4.29.16 ATSDR & EPA re Art Turf study



April 29, 2016

Leroy A. Richardson, Information Collection Review Office  
Centers for Disease Control and Prevention  
1600 Clifton Road NE., MS-D74  
Atlanta, Georgia 30329.

Federal eRulemaking Portal: [Regulation.gov](http://www.regulation.gov)

**Re: Docket No. ATSDR-2016-0002**

Dear Mr. Richardson,

Conducting additional research into the health and environmental impacts synthetic turf fields with crumb rubber infill is essential. Crumb Rubber turf fields are proliferating quickly through communities with schools and municipalities constructing crumb rubber fields to accommodate kids playing sports of all ages from elementary level on up. In every instance school district and town officials cite industry funded research as a primary demonstration of safety. Inadequate Government documents are of little help in countering such assertions or information the decisionmaking process as, to the degree they exist, they are very limited in scope, they often rely on industry-provided information, and they often rely on an absence of information as somehow supporting a demonstration of no harm. A thorough and independent investigation is essential if we are to protect children, adults and the environment from the harms of crumb rubber artificial turf.

The Delaware Riverkeeper Network would also like to suggest that research into the impacts of other artificial turf infill materials is important given that they too are the subject of a multitude of claims of safety backed by little but industry marketing materials and industry funded research.

I believe it will be important to include an organization like the Delaware Riverkeeper Network among your stakeholders. We have had to engage in significant research into, and advocacy about, artificial turf, its environmental and health impacts on a number of occasions over the past 8+ years. As a result we have a significant and healthy understanding of the science and the issues that have been and need to be evaluated.

I include with this comment a series of fact sheets and informational materials created by my organization to help inform local debates regarding the construction or expansion of artificial turf

DELAWARE RIVERKEEPER NETWORK  
925 Canal Street, Suite 3701  
Bristol, PA 19007  
Office: (215) 369-1188  
fax: (215) 369-1181  
dmn@delawareriverkeeper.org  
www.delawareriverkeeper.org

fields. In these materials we cite a number of scientific and government materials that assess the environmental and health impacts of crumb rubber artificial turf. We would like to submit them for the record and your consideration.

Synthetic turf is generally made with rubber from waste tires. Recycled rubber varies considerably in its chemical composition, even when from the same manufacturer.<sup>1</sup> Hazardous substances found in tires may persist in the environment including polycyclic aromatic hydrocarbons (PAHs), phthalates and certain metals. These substances may be bioaccumulative, carcinogenic, reprotoxic, mutagenic and/or endocrine disrupting.<sup>2</sup>

- Most PAHs are persistent, bioaccumulative and carcinogenic.<sup>3</sup>
- Phthalates are generally used as solvents and plasticisers in plastics. Phthalates are not chemically bound to the rubber and as a result can leach from the infill material.<sup>4</sup>
- Phenols likewise are not chemically bound to the rubber and so can leach. Phenols too are persistent and bioaccumulative and can have long-term effects on the environment.<sup>5</sup>
- Among the metals found in tires that may be of concern are zinc, lead, copper, chromium and cadmium. While zinc and copper are essential for living organisms, when absorbed at high levels they become harmful. Lead can affect reproduction, development of the nervous system leading to poor cognitive development, and is a particular threat to fetuses and young children. Chromium is carcinogenic and mutagenic. Cadmium is toxic to humans and if taken in can contribute to poor liver and kidney function, as well as osteoporosis.<sup>6</sup>

### **Playing on Artificial Turf brings threats of exposure to hazardous substances through a variety of pathways.**

Direct human exposure to the hazardous substances contained in the rubber in-fill of artificial turf is believed to occur via three pathways: inhalation, skin contact, and/or ingestion including by children who come into contact with the material.<sup>7</sup>

A 2012 study focused on the threat of lead ingestion from artificial turf noted that lead, in the “case of chronic exposure in early childhood, can induce cell necrosis, nerve behavioral abnormalities and developmental disability, and in the case of long-term exposure it can induce cell necrosis, blood pressure, cancer, and kidney tumor.”<sup>8</sup> In this study researchers considered the impacts for lead exposure from children who ingest rubber powder resulting from exposure to crumb rubber infill artificial turf. The research showed elementary school children had a hazard index that exceeded 0.1,

---

<sup>1</sup> T. Kallqvist, Norwegian Institute for Water Research (NIVA), Environmental Risk Assessment of Artificial Turf Systems, December 2005, p. 7.

<sup>2</sup> KEM, Swedish Chemicals Agency, [Facts: Synthetic Turf](#), April 2007.

<sup>3</sup> KEM, Swedish Chemicals Agency, [Facts: Synthetic Turf](#), April 2007.

<sup>4</sup> KEM, Swedish Chemicals Agency, [Facts: Synthetic Turf](#), April 2007.

<sup>5</sup> KEM, Swedish Chemicals Agency, [Facts: Synthetic Turf](#), April 2007.

<sup>6</sup> KEM, Swedish Chemicals Agency, [Facts: Synthetic Turf](#), April 2007.

<sup>7</sup> Environment & Human Health, Inc., [Artificial Turf, Exposures to Ground-Up Rubber Tires](#), 2007.

<sup>8</sup> Kim, S., Yang, J.-Y., Kim, H.-H., Yeo, I.-Y., Shin, D.-C., & Lim, Y.-W. (2012). Health Risk Assessment of Lead Ingestion Exposure by Particle Sizes in Crumb Rubber on Artificial Turf Considering Bioavailability. *Environmental Health and Toxicology*, 27, e2012005. <http://doi.org/10.5620/eht.2012.27.e2012005>.

a level that is considered a “potential for hazard”.<sup>9</sup> Middle and high school children were also found to have exposure levels.

In 2011, research conducted for the New Jersey Department of Environmental Protection began investigation into the potential for players on artificial turf fields to be exposed to lead, chromium, arsenic and cadmium as a respirable/inhalable aerosol.<sup>10</sup> In air samples collected from the turf during various levels of activity, researchers detected arsenic, cadmium, chromium and lead, all metals with known human toxicity.<sup>11</sup> “The findings of this study, although limited in scope, raise some concerns with regard to the potential hazards that may exist for individuals and in particular children who engage in sports activities on artificial turf fields.”<sup>12</sup> The research demonstrated that activity by players on the fields could suspend contaminated particulates into the air that could be inhaled. “The findings show that both inhalable PM [particulate matter], as well as inhalable lead (when present) are resuspended from even minor physical activity on an artificial surface. These data therefore indicates that human exposure from lead-containing artificial turf fields is not just limited to dermal, but also to inhalation route of exposure.”<sup>13</sup> The three potential avenues for lead from artificial turf are the blades of artificial grass, the pigment used for the field markings and lines, and the infill material. Even studies that have not found exposure levels to lead high enough to be of concern in the context of the study conducted are careful to point out: “some health scientists believe that *any* Pb [lead] is harmful to children’s neurocognitive development, and that *no* new Pb should be added to their surroundings”<sup>14</sup> and that “...physicians should be aware of synthetic turf as a potential source of exposure for young children. Health officials investigating elevated blood lead in children should also be aware of synthetic turf as a potential source of lead exposure.”<sup>15</sup>

Furthermore, a 2008 study that looked at a variety of contaminants associated with artificial turf did find that the lead present in the rubber granules, while at low levels, was “highly bioaccessible” to synthetic gastric fluid used in their research. This study also found a “slightly worrisome” level of chromium in an artificial turf fiber sample and “high bioaccessible fractions of lead in both synthetic gastric and intestinal fluids.”<sup>16</sup>

---

<sup>9</sup> Kim, S., Yang, J.-Y., Kim, H.-H., Yeo, I.-Y., Shin, D.-C., & Lim, Y.-W. (2012). Health Risk Assessment of Lead Ingestion Exposure by Particle Sizes in Crumb Rubber on Artificial Turf Considering Bioavailability. *Environmental Health and Toxicology*, 27, e2012005. <http://doi.org/10.5620/eht.2012.27.e2012005>.

<sup>10</sup> S.L. Shalat, Sc.D., “An Evaluation of Potential Exposures to Lead and Other Metals as the Result of Aerosolized Particulate Matter from Artificial Turf Playing Fields, Final Report”, submitted to NJ Department of Environmental Protection, July 14, 2011.

<sup>11</sup> S.L. Shalat, Sc.D., “An Evaluation of Potential Exposures to Lead and Other Metals as the Result of Aerosolized Particulate Matter from Artificial Turf Playing Fields, Final Report”, submitted to NJ Department of Environmental Protection, July 14, 2011.

<sup>12</sup> S.L. Shalat, Sc.D., “An Evaluation of Potential Exposures to Lead and Other Metals as the Result of Aerosolized Particulate Matter from Artificial Turf Playing Fields, Final Report”, submitted to NJ Department of Environmental Protection, July 14, 2011.

<sup>13</sup> S.L. Shalat, Sc.D., “An Evaluation of Potential Exposures to Lead and Other Metals as the Result of Aerosolized Particulate Matter from Artificial Turf Playing Fields, Final Report”, submitted to NJ Department of Environmental Protection, July 14, 2011.

<sup>14</sup> J. Zhang, I. Han, L. Zhang, W. Crain, “Hazardous Chemicals in synthetic turf materials and their bioaccessibility in digestive fluids,” *Journal of Exposure Science and Environmental Epidemiology* (2008)

<sup>15</sup> G. Van Ulirsch et. al, Evaluating and Regulating Lead in Synthetic Turf, Commentary, *Environmental Health Perspectives*, Vol 118, No. 10, Oct. 2010.

<sup>16</sup> J. Zhang, I. Han, L. Zhang, W. Crain, “Hazardous Chemicals in synthetic turf materials and their bioaccessibility in digestive fluids,” *Journal of Exposure Science and Environmental Epidemiology* (2008)

In October 2006 and January 2007, respectively, two sites in New York where synthetic turf has been used (a large, then 3 year old, Parade Ground in Brooklyn; a relatively small then 5 month old Sara D. Roosevelt Park in Manhattan) were analyzed. This testing found PAHs at hazardous levels (as per New York standards) at each of the sites. At both sites dibenzo (a,h)anthracene, a probable human carcinogen, was found at hazardous levels, with two other PAH forms, both possible human carcinogens, found at hazardous levels at the Parade Ground site. A 2008 study also found that the rubber granules found in artificial turf fields had PAH levels above health-based soil standards, that there was "low" but not "no" bioaccessibility, and that while levels appear to decline over time this can be altered by the fact that new rubber can be added periodically to compensate for the loss of infill material.<sup>17</sup> Additional research is needed into the pathways by which these substances may be absorbed into the bodies of children and athletes via skin contact, ingestion or other pathways<sup>18</sup> - but the need for additional research does not displace the concerns raised by these findings.

Analyses conducted at the Environmental and Occupational Health Sciences Institute of Rutgers University found the crumb rubber from artificial turf to contain high levels of PAHs, as well as zinc and arsenic.<sup>19</sup> PAHs found to be contained in the crumb rubber "were above the concentration levels that the New York State Department of Environmental Conservation (DEC) considers sufficiently hazardous to public health to require their removal from contaminated soil sites. It is highly likely that all six PAHs are carcinogenic to humans."<sup>20</sup> "The analyses also revealed levels of zinc in both samples that exceed the DEC's tolerable levels."<sup>21</sup> The researchers associated with these findings were careful to state "We want to emphasize that the findings are preliminary. PAHs in rubber might not act the same way as in soil, and we do not yet have information on the ease with which the PAHs in these rubber particles might be absorbed by children or adults -- by ingestion, inhalation, or absorption through the skin. However, the findings are worrisome. Until more is known, it wouldn't be prudent to install the synthetic turf in any more parks."<sup>22</sup>

---

<sup>17</sup> J. Zhang, I. Han, L. Zhang, W. Crain, "Hazardous Chemicals in synthetic turf materials and their bioaccessibility in digestive fluids," *Journal of Exposure Science and Environmental Epidemiology* (2008)

<sup>18</sup> Rachel's' Democracy & Health News #992, Hazardous Chemicals in Synthetic Turf, Follow-up Analyses, April 12, 2007.

<sup>19</sup> Junfeng Zhang, professor and acting chair, Department of Environmental and Occupational Health, the School of Public Health, the University of Medicine and Dentistry of New Jersey and Rutgers University & William Crain, professor of psychology at The City College of New York, president of Citizens for a Green Riverside Park, Hazardous Chemicals in Synthetic Turf, 2006, analyses conducted at the Environmental and Occupational Health Sciences Institute of Rutgers.

<sup>20</sup> Junfeng Zhang, professor and acting chair, Department of Environmental and Occupational Health, the School of Public Health, the University of Medicine and Dentistry of New Jersey and Rutgers University & William Crain, professor of psychology at The City College of New York, president of Citizens for a Green Riverside Park, Hazardous Chemicals in Synthetic Turf, 2006, analyses conducted at the Environmental and Occupational Health Sciences Institute of Rutgers.

<sup>21</sup> Junfeng Zhang, professor and acting chair, Department of Environmental and Occupational Health, the School of Public Health, the University of Medicine and Dentistry of New Jersey and Rutgers University & William Crain, professor of psychology at The City College of New York, president of Citizens for a Green Riverside Park, Hazardous Chemicals in Synthetic Turf, 2006, analyses conducted at the Environmental and Occupational Health Sciences Institute of Rutgers.

<sup>22</sup> Junfeng Zhang, professor and acting chair, Department of Environmental and Occupational Health, the School of Public Health, the University of Medicine and Dentistry of New Jersey and Rutgers University & William Crain, professor of psychology at The City College of New York, president of Citizens for a Green Riverside Park, Hazardous Chemicals in Synthetic Turf, 2006, analyses conducted at the Environmental and Occupational Health Sciences Institute of Rutgers.

A study by the California Office of Environmental Health Hazard Assessment (OEHHA) summarized 46 studies that identified 49 chemicals which are released from tire crumb. Of the 49, “seven of the chemicals leached from tire shreds were carcinogens. OEHHA calculated a cancer risk of 1.2 in 10 million based on a **one-time** ingestion of the tire crumb rubber over a lifetime.”<sup>23</sup> While there are limited studies which assert that recycled tire crumb are stable in the gastrointestinal tract and that therefore this is not a pathway for exposure, there are other studies which contradict these findings.<sup>24</sup>

Concerns have been raised about the potential implications of recycled tire in-fill for individuals with latex allergies and that inhalation could result in a systemic response, as opposed to a contact response.<sup>25</sup>

Asserted one analysis, while, “the status of the information about human exposures to recycled tire crumb rubber in-fill ... is not sufficient to determine the safety of the use of the product in situations that involve continuous episodes of human exposure;”<sup>26</sup> “the available information is sufficient and strong enough to raise plausible questions with respect to acute toxicity for susceptible persons, and for cancer risks.”<sup>27</sup>

Chrysene, a PAH and carcinogen, was found to be ingested as the result of hand-to-surface-to-mouth transfer from playground surfaces made with recycled tires. Assuming playground use for an 11 year period (from age 1 to 12) there was found to be an increased cancer risk of 2.9 in one million ( $2.9 \times 10^{-6}$ ). This risk is greater than the general cancer risk gauge of one in one million ( $1 \times 10^{-6}$ ).<sup>28</sup> This research would seem to suggest that repeat exposure over time to the chemicals released from artificial turf increases the associated increase in cancer risk.

The hot temperatures create additional concern for exposing players to dangerous toxins. As well explained by a well cited petition to the Consumer Product Safety Commission for rulemaking: “When tires are shredded and pulverized, their surface area increases exponentially, as does the particulate and gas yield from the tire material. Since tires are made of very harmful materials, including 24 gases found to be harmful to humans, carbon black, (a carcinogen which makes up 30% of tires), latex, benzothiazoles, phthalates, lead, mercury, cadmium, zinc and many other known toxins, when the fields heat up, they become increasingly dynamic. Of primary concern is the interaction of particles and gases, ‘because when particles adsorb onto the surface of gases, they become 10-20 times more toxic than the materials themselves.’ The fields yield continuously, but become more dynamic and more toxic as they heat up.”<sup>29</sup>

A Case Study conducted by a group of “physicians and public health professionals working with the U.S. Environmental Protection Agency’s Region Pediatric Environmental Health Specialty Unit” found

---

<sup>23</sup> Environment & Human Health, Inc., Artificial Turf, Exposures to Ground-Up Rubber Tires, 2007 citing California Office of Environmental Health Hazard Assessment (OEHHA), Evaluation of Health Effects of Recycled Waste Tires in Playground and Track Products, January, 2007.

<sup>24</sup> Environment & Human Health, Inc., Artificial Turf, Exposures to Ground-Up Rubber Tires, 2007.

<sup>25</sup> Environment & Human Health, Inc., Artificial Turf, Exposures to Ground-Up Rubber Tires, 2007.

<sup>26</sup> Environment & Human Health, Inc., Artificial Turf, Exposures to Ground-Up Rubber Tires, 2007.

<sup>27</sup> Environment & Human Health, Inc., Artificial Turf, Exposures to Ground-Up Rubber Tires, 2007.

<sup>28</sup> Office of Environmental Health Hazard Assessment, Evaluation of Health Effects of Recycled Waste Tires in Playground and Track Products, January 2007. Note -- the 1.2 in 10 million cancer risk found in the OEHHA study was considered by the authors to be an acceptable level of risk as it falls below the general cancer risk gauge of one in one million ( $1 \times 10^{-6}$ ).

<sup>29</sup> Petition for a Rulemaking on Surface Heat from Artificial Turf, Submitted by PEER to Consumer Product Safety Commission, Sept 6, 2012.



that they could not secure the research and information necessary to establish the safety in use with children of tire crumb used as playground surface.<sup>30</sup> “The use of recycled tire crumb products on playgrounds has had little health investigation. The major unresolved concern is the potential for latex allergy with short-term dermal exposure.”<sup>31</sup> “No published information is available specifically regarding exposure to crumb rubber constituents from use of the product on playgrounds.”<sup>32</sup>

### **Excessive heat is a major health threat for those that play on artificial turf.**

Extreme heat is a health concern – high surface temperatures found on artificial turf fields can contribute to physiological stress and cause “serious heat-related illnesses”.<sup>33</sup> Heat stress, heat stroke and burns are all of concern. In fact, the “New York City Department of Health and Mental Hygiene recognizes excessive surface temperatures as the most important health concern associated with infilled synthetic turf.”<sup>34</sup> Studies document that the surface temperature on artificial turf is dramatically increased as compared to surrounding land uses including asphalt – so much so that it is a genuine health threat for players.

Concerns regarding the excessive temperatures range from the implications for players who are already exerting themselves playing in such excessively high temperatures, to the implications for burns when players or pedestrians come into contact with the hot surfaces, to the implications for small children who may come into contact with the extremely hot surfaces during non-sporting events. Research has also concluded that the “heat transfer from the surface to the sole of the individual’s foot” could contribute to physiological stress of players.<sup>35</sup>

In a 2002 study it was found that “the surface temperature of the synthetic turf was 37° F higher than asphalt and 86.5° F hotter than natural turf.”<sup>36</sup> A study published in the Journal of Health and Physical Education and Recreation showed “surface temperatures as much as 95 to 140 degrees Fahrenheit higher on synthetic turf than natural turf grass when exposed to sunlight.”<sup>37</sup> Random sampling at Brigham Young University identified temperatures ranging from 117.38 to 157 degrees on artificial turf while neighboring natural grass areas were in the range of 78.19 to 88.5 degrees Fahrenheit. “Two inches below the synthetic turf surface was 28.5° F hotter than natural turf at the surface.”<sup>38</sup> Another study comparing temperatures on artificial turf temperatures with air temperature found that artificial turf ranged from 58 to 75 degrees hotter than measured air temperature.<sup>39</sup> And yet another study considering found ranges of 155.3 to 173.4 degrees on the turf

---

<sup>30</sup> M.E. Anderson et al, A Case Study of tire Crumb Use on Playgrounds: Risk Analysis and Communication When Major Clinical Knowledge Gaps Exist, Environmental Health Perspectives, Vol 114, No. 1, January 2006.

<sup>31</sup> M.E. Anderson et al, A Case Study of tire Crumb Use on Playgrounds: Risk Analysis and Communication When Major Clinical Knowledge Gaps Exist, Environmental Health Perspectives, Vol 114, No. 1, January 2006.

<sup>32</sup> M.E. Anderson et al, A Case Study of tire Crumb Use on Playgrounds: Risk Analysis and Communication When Major Clinical Knowledge Gaps Exist, Environmental Health Perspectives, Vol 114, No. 1, January 2006.

<sup>33</sup> T.J. Serensits, A.S. McNitt, D.M. Petrunak; Human health issues on synthetic turf in the USA, Dept of Crop and Soil Sciences, The Pennsylvania State University, IMechE Vol 225 Part P: J. Sports Engineering & Technology, Jan 6, 2011.

<sup>34</sup> T.J. Serensits, A.S. McNitt, D.M. Petrunak; Human health issues on synthetic turf in the USA, Dept of Crop and Soil Sciences, The Pennsylvania State University, IMechE Vol 225 Part P: J. Sports Engineering & Technology, Jan 6, 2011.

<sup>35</sup> T.J. Serensits, A.S. McNitt, D.M. Petrunak; Human health issues on synthetic turf in the USA, Dept of Crop and Soil Sciences, The Pennsylvania State University, IMechE Vol 225 Part P: J. Sports Engineering & Technology, Jan 6, 2011.

<sup>36</sup> Dr. C. Frank Williams and Dr. Gilbert E. Pulley, Synthetic Surface Heat Studies, Brigham Young University.

<sup>37</sup> SportsTurf Managers Association, A Guide to Synthetic and natural Turfgrass for Sports Fields, Selection, Construction and Maintenance Considerations.

<sup>38</sup> Dr. C. Frank Williams and Dr. Gilbert E. Pulley, Synthetic Surface Heat Studies, Brigham Young University.

<sup>39</sup> T. Sciacca, The Thermal Physics of Artificial Turf, January 2008.

fields when air temperatures were in the 76 degree range; and 104.2 to 159.3 degrees when air temperatures were in the 77 degree range.<sup>40</sup>

Research has not found good solutions for the excessive heat levels of turf. Irrigation of excessively hot artificial turf surfaces only provides cooling benefits for about 20 minutes.<sup>41</sup> While irrigation provides cooling for the synthetic turf, in one seminal study lowering the temperature from 174° F to 85° F, after only 5 minutes the temperature quickly rose again to 120°F; after 20 minutes it rose to 164°F.<sup>42</sup> In another important body of work by Penn State, it was found again that irrigation is only successful in reducing temperatures for about 20 minutes, with a rebound to within 10 degrees of the pre-irrigation temperature within 3 hours.<sup>43</sup> The use of white crumb rubber as the infill does not resolve the heat issue.<sup>44</sup> In fact, according to Penn State as part of a study which looked at various color options for infill and temperature, “[w]hile marketing materials may claim lower surface temperatures, no scientific reports exist that substantiate such claims.”<sup>45</sup>

Natural grass, by comparison, provides a natural cooling affect and helps to dissipate heat from neighboring developed areas.<sup>46</sup> “The temperature of natural grass rarely rises above 85 degrees Fahrenheit, regardless of air temperature.”<sup>47</sup>

The heat impacts of artificial turf need to be considered in the context of today’s changing climate. Global climate change is expected to dramatically increase the number of days over 100 degrees in many communities. Depending on how aggressively global warming gasses are reduced in coming years, communities nearby Philadelphia will begin to experience in the range of 10 days (in lower emission scenarios) to 30 days (if higher emission scenarios continue to prevail) over 100 degrees.<sup>48</sup> By later in this century seasonable temperatures are projected to rise 6°F to 14°F in summer (depending again on emission reductions achieved in the future).<sup>49</sup>

### **Concerns for increased head injuries and bacterial infections as the result of playing on turf are justified.**

There is great concern that the increased level of abrasions and burns which result from playing on an artificial turf field as compared to natural grass increases the pathways by which bacterial infections, such as MRSA (methicillin-resistant staphylococcus aureus), can enter the body. As explained in a 2011 Penn State study, “It is important to note that synthetic turf is more abrasive than natural turf grass and, as a result, breaks in the skin are more common, creating a pathway for infection when in

---

<sup>40</sup> Penn State’s Center for Sports Surface Research, Synthetic Turf Heat Evaluation – Progress Report, January 2012.

<sup>41</sup> T.J. Serensits, A.S. McNitt, D.M. Petrunak; Human health issues on synthetic turf in the USA, Dept of Crop and Soil Sciences, The Pennsylvania State University, IMechE Vol 225 Part P: J. Sports Engineering & Technology, Jan 6, 2011.

<sup>42</sup> Dr. C. Frank Williams and Dr. Gilbert E. Pulley, Synthetic Surface Heat Studies, Brigham Young University.

<sup>43</sup> T.J. Serensits, A.S. McNitt, D.M. Petrunak; Human health issues on synthetic turf in the USA, Dept of Crop and Soil Sciences, The Pennsylvania State University, IMechE Vol 225 Part P: J. Sports Engineering & Technology, Jan 6, 2011.

<sup>44</sup> T.J. Serensits, A.S. McNitt, D.M. Petrunak; Human health issues on synthetic turf in the USA, Dept of Crop and Soil Sciences, The Pennsylvania State University, IMechE Vol 225 Part P: J. Sports Engineering & Technology, Jan 6, 2011.

<sup>45</sup> Penn State’s Center for Sports Surface Research, Synthetic Turf Heat Evaluation – Progress Report, January 2012.

<sup>46</sup> James B. Beard & Robert L. Green, The Role of Turfgrasses in Environmental Protection and Their Benefits to Humans, J. Environ Qual. 23:452-460 (1994).

<sup>47</sup> SportsTurf Managers Association, A Guide to Synthetic and natural Turfgrass for Sports Fields, Selection, Construction and Maintenance Considerations.

<sup>48</sup> Union of Concerned Scientists, Confronting Climate Change in the U.S. Northeast ● New Jersey, 2007.

<sup>49</sup> Union of Concerned Scientists, Confronting Climate Change in the U.S. Northeast ● New Jersey, 2007.

contact with an infected surface.”<sup>50</sup> There are studies to indicate that turf burns may be facilitating infection by acting as a pathway for infection.<sup>51</sup> Study has found that turf burns increased the risk of infection regardless of the type and timing of care provided the burn.<sup>52</sup>

Older turf fields have been found to have higher microbial populations, as well as higher levels in the higher traffic areas such as the sidelines, thereby suggesting to researchers that microbial populations can accumulate in synthetic turf over time.<sup>53</sup>

Concussions (formally described as Mild Traumatic Brain Injury or MTBI) resulting from sports has, according to the US Centers for Disease Control, reached “epidemic proportions.”<sup>54</sup> “Mild’ head traumas, and especially a series of such minor concussions can have long term, negative effects on cognitive function.”<sup>55</sup> Study has documented that artificial turf increases the risk of MTBI over natural turf, approximately doubling that risk, as well as causing a greater degree of trauma.<sup>56</sup> According to study, artificial turf presents a 5 times greater risk of the more severe head injury than natural turf, although it is still unknown the particular characteristics of the two surfaces that cause the difference in head injury incidence.<sup>57</sup> Only 31% of the playground surfaces made of recycled tires tested in one research study passed the California State mandated Head Impact Criterion (HIC) of  $\leq 1,000$ . In this same study 100% of the playground surfaces made of wood chips passed the same standard.<sup>58</sup>

**Research shows there are adverse environmental impacts resulting from crumb rubber infill artificial turf; it is also clear that additional study for water and other natural resources is needed.**

While it seems well recognized that there is a limited level of assessment and investigation into the environmental impacts associated with artificial turf, a growing body of scientific analysis is

---

<sup>50</sup> T.J. Serensits, A.S. McNitt, D.M. Petrunak; Human health issues on synthetic turf in the USA, Dept of Crop and Soil Sciences, The Pennsylvania State University, IMechE Vol 225 Part P: J. Sports Engineering & Technology, Jan 6, 2011.

<sup>51</sup> A High Morbidity Outbreak of Methicillin-Resistant *Staphylococcus aureus* among Players on a College Football Team, Facilitated by Cosmetic Body Shaving and Turf Burns, study conducted 2004 for Connecticut Dept of Public Health, Student Health Services of Sacred Heart Univ, Centers for Disease Control and Prevention, Minnesota Dept of Public Health, Los Angeles County Dept of Health Svces; Dr. S.V. Kazakova et.al., A Clone of Methicillin-Resistant *Staphylococcus aureus* among Professional Football Players, The New England Journal of Medicine, Vol 352:468-475 No. 5, Feb. 3, 2005.

<sup>52</sup> A High Morbidity Outbreak of Methicillin-Resistant *Staphylococcus aureus* among Players on a College Football Team, Facilitated by Cosmetic Body Shaving and Turf Burns, study conducted 2004 for Connecticut Dept of Public Health, Student Health Services of Sacred Heart Univ, Centers for Disease Control and Prevention, Minnesota Dept of Public Health, Los Angeles County Dept of Health Svces.

<sup>53</sup> J.J. Bass, D.W. Hintze, (2013) “Determination of Microbial Populations in a Synthetic Turf System,” Skyline – The Big Sky Undergraduate Journal, Vol. 1, Iss. 1, Art. 1.

<sup>54</sup> Dr. M. Shorten, J.A. Himmelsbach, BioiMechanica, Sports Surfaces and the Risk of Traumatic Brain Injury citing the US Centers for Disease Control.

<sup>55</sup> Dr. M. Shorten, J.A. Himmelsbach, BioiMechanica, Sports Surfaces and the Risk of Traumatic Brain Injury.

<sup>56</sup> Dr. M. Shorten, J.A. Himmelsbach, BioiMechanica, Sports Surfaces and the Risk of Traumatic Brain Injury.

<sup>57</sup> Dr. M. Shorten, J.A. Himmelsbach, BioiMechanica, Sports Surfaces and the Risk of Traumatic Brain Injury. See also K.M. Guskiewica, N.L. Weaver, D.A. Padua, W.E. Garrett Jr., Epidemiology of Concussion in Collegiate and High School Football Players, Sep-Oct 2000 & Does the Use of Artificial Turf Contribute to Head Injuries, The Journal of Trauma-Injury, Infection and Critical Care, Oct 2002 for the finding that artificial turf increases the level of injury in comparison to natural grass fields.

<sup>58</sup> Office of Environmental Health Hazard Assessment, Evaluation of Health Effects of Recycled Waste Tires in Playground and Track Products, January 2007. Please note that in this study 32 recycled tire playground surfaces were tested as compared to only 5 wood chip playground surfaces.

documenting a concerning level of environmental threat and harm and is further demonstrating the need for more research regarding artificial turf and its ramifications for the environment.

The Connecticut Agricultural Experiment Station conclusively found four compounds which out-gassed and leached into water from synthetic turf rubber crumb under ambient temperatures:

- Benzothiazole (a skin and eye irritant),
- Butylated hydroxyanisole (a “recognized carcinogen, suspected endocrine toxicant, gastrointestinal toxicant, immune toxicant, neurotoxicant, skin and sense-organ toxicant”),
- n-hexadecane (a severe irritant) &
- 4-(t-octyl) phenol (“corrosive and destructive to mucous membranes”).<sup>59</sup>

As rubber degrades it can leach toxic substances which can contaminate soil, plants and aquatic ecosystems.<sup>60</sup> Study has concluded that the use of tires in artificial turf has the potential to pollute our environment with PAHs, phenols and zinc<sup>61</sup> and that runoff from an artificial turf field draining to a local creek can pose “a positive risk of toxic effects on biota in the water phase and in the sediment.”<sup>62</sup> Other metal contaminants found to leach from tire crumb rubber include zinc, selenium, lead and cadmium.<sup>63</sup> Zinc has also been shown to leach from the artificial turf fibers.<sup>64</sup> Extreme temperatures or solvents are not needed to release these metals, volatile organic compounds or semi-volatile organic compounds from the rubber in-fill of artificial turf into the air or water – release takes place in ambient air and water temperatures.<sup>65</sup>

“Runoff with high Zn [zinc] from synthetic turf fields may produce adverse effects to plants and aquatic life. This is of particular concern given that the leaching rate of Zn [zinc] from rubber granules can be up to 20 times greater than the leaching rate of Zn from agricultural applications of manure and pesticides.”<sup>66</sup> Leaching of substances as the result of surface water runoff from precipitation has, by some researchers, been predicted to be the greatest risk for the environment from artificial turf.<sup>67</sup> Study shows there is a risk of local effects for aquatic and sediment dwelling

---

<sup>59</sup> The Connecticut Agricultural Experiment Station, Examination of Crumb Rubber Produced from Recycled Tires, August 2007; Environment & Human Health, Inc., Artificial Turf, Exposures to Ground-Up Rubber Tires, 2007.

<sup>60</sup> Quoting Dr. Linda Chalker-Scott, Washington State University -- Turfgrass Resource Center, Facts About Artificial Turf and Natural Grass; T. Kallqvist, Norwegian Institute for Water Research(NIVA), Environmental Risk Assessment of Artificial Turf Systems, December 2005, p. 17.; Connecticut Agricultural Experiment Station, Examination of Crumb Rubber Produced from Recycled Tires.

<sup>61</sup> T. Kallqvist, Norwegian Institute for Water Research(NIVA), Environmental Risk Assessment of Artificial Turf Systems, December 2005, p. 5; T. Edeskar, Lulea University of Technology, Technical and Environmental Properties of Tyre Shreds Focusing on Ground Engineer Application, 2004 as cited in KEM, Swedish Chemicals Agency, Facts: Synthetic Turf, April 2007.

<sup>62</sup> T. Kallqvist, Norwegian Institute for Water Research (NIVA), Environmental Risk Assessment of Artificial Turf Systems, December 2005, p. 6.

<sup>63</sup>Environment & Human Health, Inc., Artificial Turf, Exposures to Ground-Up Rubber Tires, 2007.

<sup>64</sup> T. Kallqvist, Norwegian Institute for Water Research (NIVA), Environmental Risk Assessment of Artificial Turf Systems, December 2005, p. 17.

<sup>65</sup> Environment & Human Health, Inc., Artificial Turf, Exposures to Ground-Up Rubber Tires, 2007.

<sup>66</sup> J. Zhang, I. Han, L. Zhang, W. Crain, “Hazardous Chemicals in synthetic turf materials and their bioaccessibility in digestive fluids,” *Journal of Exposure Science and Environmental Epidemiology* (2008)

<sup>67</sup> T. Kallqvist, Norwegian Institute for Water Research (NIVA), Environmental Risk Assessment of Artificial Turf Systems, December 2005, p. 5; NIVA (The Norwegian Institute for Water Research), Evaluation of the Environmental Risks of Synthetic Turf, 2005; KEM, Swedish Chemicals Agency, Facts: Synthetic Turf, April 2007.

organisms in impacted water courses.<sup>68</sup> Recycled rubber, and associated leachate, has been found to contain a variety of metals (including lead, cadmium, copper, mercury and zinc), as well as organic pollutants such as PAHs, phthalates, 4-t-octylphenol and iso-nonyphenol.<sup>69</sup> The leaching of zinc has been determined to be of major environmental concern.<sup>70</sup> The leaching of zinc increases as the rubber infill weathers over time,<sup>71</sup> it is likely this is the same for other contaminants. While Zinc contributes the most risk, phenols (specifically octylphenol) and PAHs are also of concern.<sup>72</sup> Of the organic compounds at issue, Octylphenol represents the greatest risk, and possibly could occur at levels where hormone disrupting effects are a concern.<sup>73</sup> The varying content of tires makes this threat a moving target.

The Norwegian Institute for Water Research has determined that it is “appropriate to perform a risk assessment which covers water and sediments in watercourses which receive run-off from artificial turf pitches.”<sup>74</sup>

While recycled rubber is a greater source of pollution, newly manufactured rubber also contains levels of hazardous substances; in the case of zinc and chromium the levels of recycled and newly manufactured rubber are comparable.<sup>75</sup>

It is predicted that chemicals leaching from synthetic turf materials occurs slowly, and as a result the environmental harms may take place over many years.<sup>76</sup>

Leaching may not be the only source of water contamination from artificial turf. As the artificial turf is used there is a level of “erosion” that takes place and can result in fine particles that could be carried to local waterways. This source of contamination needs study.<sup>77</sup>

The synthetic grass fibers can also be a significant source of pollution, particularly zinc, albeit significantly lesser amounts leach from the synthetic grass than the rubber infill.<sup>78</sup>

---

<sup>68</sup> T. Kallqvist, Norwegian Institute for Water Research(NIVA), Environmental Risk Assessment of Artificial Turf Systems, December 2005, p. 5; NIVA (The Norwegian Institute for Water Research), Evaluation of the Environmental Risks of Synthetic Turf, 2005, as cited by KEM, Swedish Chemicals Agency, Facts: Synthetic Turf, April 2007; KEM, Swedish Chemicals Agency, Facts: Synthetic Turf, April 2007

<sup>69</sup> T. Kallqvist, Norwegian Institute for Water Research (NIVA), Environmental Risk Assessment of Artificial Turf Systems, December 2005, p. 7.

<sup>70</sup> INTRON, Environmental and Health Risks of Rubber Infill, rubber crumb from car tyres as infill on artificial turf, February 9, 2007.

<sup>71</sup> INTRON, Environmental and Health Risks of Rubber Infill, rubber crumb from car tyres as infill on artificial turf, February 9, 2007.

<sup>72</sup> NIVA (The Norwegian Institute for Water Research), Evaluation of the Environmental Risks of Synthetic Turf, 2005, as cited by KEM, Swedish Chemicals Agency, Facts: Synthetic Turf, April 2007.

<sup>73</sup> T. Kallqvist, Norwegian Institute for Water Research (NIVA), Environmental Risk Assessment of Artificial Turf Systems, December 2005, p. 17.

<sup>74</sup> T. Kallqvist, Norwegian Institute for Water Research (NIVA), Environmental Risk Assessment of Artificial Turf Systems, December 2005, p. 8.

<sup>75</sup> Byggforsk, SINTEF Building and Infrastructure, Potential Health and Environmental Effects Associated with Synthetic Turf Systems, 2004, as referenced in KEM, Swedish Chemicals Agency, Facts: Synthetic Turf, April 2007.

<sup>76</sup> T. Kallqvist, Norwegian Institute for Water Research(NIVA), Environmental Risk Assessment of Artificial Turf Systems, December 2005, p. 5; NIVA (The Norwegian Institute for Water Research), Evaluation of the Environmental Risks of Synthetic Turf, 2005, as cited by KEM, Swedish Chemicals Agency, Facts: Synthetic Turf, April 2007.

<sup>77</sup> T. Kallqvist, Norwegian Institute for Water Research (NIVA), Environmental Risk Assessment of Artificial Turf Systems, December 2005, p. 18.

When talking about the use of ground rubber as a supplement to planting soils the North Carolina Department of Agriculture and Consumer Services sent out a notice identifying the risk that zinc leaching from the rubber causes a decline in plant growth “directly attributable to zinc toxicity.”<sup>79</sup>

One Norwegian assessment/presentation reported that “recycled rubber was the major source of potentially hazardous substances. An exposure scenario where the runoff from a football field is drained to a small creek showed a positive risk of toxic effects on biota in the water phase and in the sediment. The risk was mainly attributed to zinc, but also for octylphenol the predicted environmental concentrations exceeded the no environmental effect concentration.”<sup>80</sup> The hazardous leaching could result in local environmental effect.<sup>81</sup>

## **Conclusion**

Given all of the science on the record that demonstrates artificial turf is a threat to health and the environment, the precautionary principle dictates that artificial turf with crumb rubber infill be recognized as a threat to public health and safety and the environment and that the ongoing expansion and construction of crumb rubber turf fields should be prohibited and those fields that have already been installed should be removed and properly disposed of.

When a community installs a crumb rubber artificial turf field it is forcing children who want to participate in sports to be forced to expose themselves to its hazards. It is simply neither right nor fair for communities, with the support or false sense of security given by an acquiescing government agency, to be making investments that take from parents and kids the ability to decide for themselves what health hazards they are willing to be exposed to if they want to participate in sports. Advancing in anyway the construction and expansion of crumb rubber artificial turf fields is forcing an unfair choice on kids and parents: play sports or protect your health, but you are not allowed to have both.

Respectfully,



Maya K. van Rossum  
the Delaware Riverkeeper

P.S. I note, that as a result of my work on this issue, as a parent I have had to pull my son from the township lacrosse team because they started playing on artificial turf this past year. The health impacts of artificial turf are too significant and concerning for me, as a parent, to allow my 10 year old son to play on crumb rubber artificial turf.

---

<sup>78</sup> Byggforsk, SINTEF Building and Infrastructure, Potential Health and Environmental Effects Associated with Synthetic Turf Systems, 2004, as referenced in KEM, Swedish Chemicals Agency, Facts: Synthetic Turf, April 2007.

<sup>79</sup> M. Ray Tucker, Agronomist, Ground Rubber: Potential Toxicity to Plants, Media Notes for North Carolina Growers, North Carolina Dept of Agriculture & Consumer Services, April 1997.

<sup>80</sup> Dr. Christine Borge, Norwegian Institute of Public Health, Artificial turf Pitches – an assessment of the health risks for football players and the environment, Presentation at the ISSS Technical meeting 2006, Dresden.

<sup>81</sup> Dr. Christine Borge, Norwegian Institute of Public Health, Artificial turf Pitches – an assessment of the health risks for football players and the environment, Presentation at the ISSS Technical meeting 2006, Dresden.

**Attachments:**

Submitted as part of this comment are fact sheets and an annotated bibliography that discuss the research detailed above as well as additional research speaking about the environmental and public health threats posed by crumb rubber infill artificial turf.



## Summary of Research

### Assessing the Impacts of Artificial Turf

Updated 4/29/2016

**Heat:** Research has documented that the surface temperature on artificial turf is dramatically higher than the surrounding land uses including asphalt. Concerns regarding the excessive temperatures range from the implications for players who are already exerting themselves to the implications for burns when players or pedestrians come into contact with the hot surfaces.

1. Petrass, L. A., et al. (2014). Comparison of surface temperatures of different synthetic turf systems and natural grass: Have advances in synthetic turf technology made a difference. *Proceedings of the Institution of Mechanical Engineers, Part P: Journal of Sports Engineering and Technology*.
  - a. A comparison of surface temperatures of third-generation synthetic turf with a cool climate product that claims to reduce surface temperatures to surface temperatures of natural grass.
  - b. Although surface temperatures were lower for the cool climate field compared to other synthetic turf, both types of artificial turf fields were considerably hotter than natural grass with temperatures that were between 12° C (53° F) and 22° C (72° F) hotter.
2. Reasor, E. H. (2014). Synthetic Turf Surface Temperature Reduction and Performance Characteristics as Affected by Calcined Clay Modified Infill. Master's Thesis, University of Tennessee. Available at: [http://trace.tennessee.edu/utk\\_gradthes/2750](http://trace.tennessee.edu/utk_gradthes/2750)
  - a. Surface temperatures of artificial turf were between 31° C (88° F) and 57° C (135° F).
  - b. Although irrigation reduced surface temperatures of artificial turf, increases of 74 to 102% of the pre-irrigation temperature were observed within 30 minutes after irrigation.
  - c. Surface temperatures returned to pre-irrigation temperature on all of the treatments between 60 and 120 minutes after irrigation. Therefore, the cooling effect of irrigation will not last the entire length of an athletic competition.
3. Thoms, A. W. et al. (2014). Models for Predicting Surface Temperatures on Synthetic Turf Playing Surfaces. *Procedia Engineering*, 72, 895-900. Available at: <http://www.sciencedirect.com/science/article/pii/S1877705814006699>
  - a. Artificial turf surface temperatures ranged from -9.8 to 86.4° C (14 to 188° F) to when ambient air temperatures ranged from -0.4 to 37.1° C (31 to 99° F).
  - b. Absorption of solar radiation results in increased temperatures on artificial turf surfaces, and high rates of solar radiation are absorbed with minimal light reflectance. Therefore, air temperature in conjunction with solar radiation explained most of the variation in artificial turf surface temperatures.
4. Penn State's Center for Sports Surface Research (2012). Synthetic Turf Heat Evaluation- Progress Report. January 2012. Available at: <http://plantscience.psu.edu/research/centers/ssrc/documents/heat-progress-report.pdf>



- a. This study measured surface temperatures of artificial turf fields between 140.2 and 173.4° F when air temperatures were between 73 and 79° F.
  - b. Looking at various color options for infill and temperature, no product significantly reduced surface temperatures. Small reductions in temperature are insignificant when surface temperatures still exceed 150° F. This study concluded that “[w]hile marketing materials may claim lower surface temperatures, no scientific reports exist that substantiate such claims.”
  - c. Research has not found a good solution for excessive heat levels of turf.
5. Serensits, T. J. et al. (2011). Human health issues on synthetic turf in the USA. *Proceedings of the Institution of Mechanical Engineers, Part P: Journal of Sports Engineering and Technology*, 225(3), 139-146.
    - a. High surface temperatures found on artificial turf fields can contribute to physiological stress and cause “serious heat-related illnesses” including heat stress, heat stroke, and burns.
    - b. The “New York City Department of Health and Mental Hygiene recognizes excessive surface temperatures as the most important health concern associated with infilled synthetic turf.”
    - c. Irrigation of excessively hot artificial turf surfaces only provides cooling benefits for about 20 minutes, with a rebound to within 10 degrees of the pre-irrigation temperature within 3 hours.
    - d. The use of white crumb rubber as the infill does not resolve the heat issue.
  6. Sciacca, T (2008). The Thermal Physics of Artificial Turf. SynTurf.org. Available at: <http://www.synturf.org/sciaccaheatstudy.html>
    - a. A study comparing temperatures on artificial turf temperatures with air temperature found that artificial turf ranged from 58 to 75° hotter than measured air temperature.
  7. SportsTurf Managers Association (STMA) (2008). A Guide to Synthetic and Natural Turfgrass for Sports Fields: Selection, Construction and Maintenance Considerations. 2<sup>nd</sup> edition. Available at: [http://www.stma.org/sites/stma/files/STMA\\_Synthetic\\_Guide\\_2nd\\_Edition.pdf](http://www.stma.org/sites/stma/files/STMA_Synthetic_Guide_2nd_Edition.pdf)
    - a. Artificial turf gets dramatically hotter than surrounding land uses including asphalt with surface temperatures as much as 95 to 140° F hotter than natural grass fields whereas the temperature of natural grass rarely rises above 85° F, regardless of air temperature
  8. Williams, C. F., & Pulley, G. E. (2002). Synthetic surface heat studies. *Brigham Young University*. Available at: [www.wellesley.ma.gov/pages/WellesleyMA\\_SpragueResources/Synthetic%20Surfaces%20Heat%20Study.doc](http://www.wellesley.ma.gov/pages/WellesleyMA_SpragueResources/Synthetic%20Surfaces%20Heat%20Study.doc)
    - a. Temperature measurements were taken at the surface, above the surface, and below the surface of artificial turf, natural turf, bare soil, asphalt, and concrete.
    - b. Surface temperatures of synthetic turf were 37° F higher than asphalt and 86.5° F hotter than natural turf.
    - c. Two inches below the surface, synthetic turf was 28.5° F hotter than natural turf.
    - d. Although irrigation of synthetic turf resulted in a reduction of close to 90°F, temperatures rose 35° within five minutes and returned to the starting temperature within 20 minutes.
    - e. “The hottest surface temperature recorded was 200° F on a 98° F day. Even in October the surface temperature reached 112.4° F.”
    - f. Brigham Young University has set a surface temperature guideline which restricts play on synthetic turf fields when surface temperatures are potentially hazardous to athletes. This reduces the playing season and eliminates any continuous play benefit that is typically mentioned in favor of artificial turf.
  9. Beard, J. B., & Green, R. L. (1994). The role of turf grasses in environmental protection and their benefits to humans. *Journal of Environmental Quality*, 23(3), 452-460. Available at: <https://www.landcarenetwork.org/legislative/TheRoleofTurfgrassesinEnvironmentalProtection.pdf>
    - a. Synthetic surfaces can be up to 39° C (102° F) hotter than natural turf. Natural turf grass provides a natural cooling affect and helps to dissipate heat from neighboring developed areas.

**Health:** The impacts of inhalation or ingestion of chemicals continues to be a concern for those playing on artificial turf. Direct human exposure to the hazardous substances contained in the rubber in-fill of artificial turf is believed to occur via inhalation, skin contact, and/or ingestion. Furthermore, there are concerns for increased injuries and bacterial infections when playing on artificial turf.

1. Kim, S., Yang, J.-Y., Kim, H.-H., Yeo, I.-Y., Shin, D.-C., & Lim, Y.-W. (2012). Health Risk Assessment of Lead Ingestion Exposure by Particle Sizes in Crumb Rubber on Artificial Turf Considering Bioavailability. *Environmental Health and Toxicology*, 27, e2012005. <http://doi.org/10.5620/eht.2012.27.e2012005>.
  - a. Researchers considered the risks for lead exposure from children ingesting rubber powder resulting from exposure to crumb rubber infill artificial turf and found that elementary school students had a hazard index that exceeded 0.1, a level that is considered a “potential for hazard”, with middle and high school students also suffering exposure levels.
2. Balazs, G. C., et al. (2014). Risk of Anterior Cruciate Ligament Injury in Athletes on Synthetic Playing Surfaces A Systematic Review. *The American journal of sports medicine*, 0363546514545864.
  - a. A systematic review of available literature on the risk of ACL rupture on natural grass versus artificial turf found that there is an increased rate of ACL injury on synthetic playing surfaces for football players.
3. Celeiro, M., Lamas, J. P., Garcia-Jares, C., Dagnac, T., Ramos, L., & Llompart, M. (2014). Investigation of PAH and other hazardous contaminant occurrence in recycled tyre rubber surfaces. Case-study: restaurant playground in an indoor shopping centre. *International Journal of Environmental Analytical Chemistry*, 94(12), 1264-1271.
  - a. The presence of a large number of hazardous substances were found in both the runoff and vapor phase of recycled tire playground surfaces.
  - b. Nine polycyclic aromatic hydrocarbons (PAHs) were detected in the runoff/ cleaning water with total PAH concentrations in the ppm (parts per million) range.
  - c. The most toxic PAH, benzo[a]pyrene was detected in extracts from playground surfaces.
  - d. “The presence and the high concentration of these chemical compounds in playground should be a matter of concern owing to their high toxicity.”
4. Laible, C., & Sherman, O. H. (2014). Risk Factors and Prevention Strategies of Non-Contact Anterior Cruciate Ligament Injuries. *Bulletin of the Hospital for Joint Diseases*, 72(1), 70-5. Available at: [http://www.nyuhjdbulletin.org/mod/bulletin/v72n1/docs/v72n1\\_7.pdf](http://www.nyuhjdbulletin.org/mod/bulletin/v72n1/docs/v72n1_7.pdf)
  - a. Since shoe-surface interaction is important for injury prevention, “the optimal surface to prevent injury is outdoors on natural grass.”
  - b. Artificial turf has a higher friction coefficient and greater ground reaction force, both conditions that increase the risk for injury.
  - c. Furthermore, as temperature increases the shoe-surface friction interaction increases and exposes athletes to greater risk of injury.
5. Bass, J. J., & Hintze, D. W. (2013). Determination of Microbial Populations in a Synthetic Turf System. *Skyline-The Big Sky Undergraduate Journal*, 1(1), 1. Available at: <http://skyline.bigskyconf.com/cgi/viewcontent.cgi?article=1000&context=journal>
  - a. Abrasions, even insignificant ones, from artificial turf can create an entry site for pathogens.
  - b. The higher abrasion rate for synthetic turf increases the risk of infection, and the microbial populations found within synthetic turf are a source of pathogens when abrasions occur.
  - c. Older turf fields have higher microbial populations, as well as higher levels in the higher traffic areas such as the sidelines. These results indicate that artificial turf poses a greater risk for the spread of pathogens and infections among student athletes.
6. Llompart, M., Sanchez-Prado, L., Lamas, J. P., Garcia-Jares, C., Roca, E., & Dagnac, T. (2013). Hazardous organic chemicals in rubber recycled tire playgrounds and pavers. *Chemosphere*, 90(2), 423-431. Available at: [http://www.elcorreodelsol.com/sites/default/files/chemosphere\\_maria\\_llompart.pdf](http://www.elcorreodelsol.com/sites/default/files/chemosphere_maria_llompart.pdf)

- a. An analysis of surfaces containing recycled rubber tires confirmed the presence of hazardous substances including PAHs, phthalates, antioxidants (e.g. BHT, phenols), benzothiazole, derivatives, and other chemicals.
  - b. The vapor phase above the samples confirmed volatilization of many organic compounds demonstrating that these chemicals can enter the human body through inhalation.
  - c. The use of recycled rubber tires for play areas, especially facilities for children, should be restricted or prohibited.
7. Serensits, T. J., McNitt, A. S., & Petrunak, D. M. (2011). Human health issues on synthetic turf in the USA. *Proceedings of the Institution of Mechanical Engineers, Part P: Journal of Sports Engineering and Technology*, 225(3), 139-146.
    - a. Synthetic turf is more abrasive than natural turf grass, therefore, "breaks in the skin are more common, creating a pathway for infection when in contact with an infected surface."
  8. Shalat, S.L. (2011). An Evaluation of Potential Exposures to Lead and Other Metals as the Result of Aerosolized Particulate Matter from Artificial Turf Playing Fields, Final Report. Submitted to NJ Department of Environmental Protection, July 14, 2011. Available at: <http://www.nj.gov/dep/dsr/publications/artificial-turf-report.pdf>
    - a. In air samples collected from artificial turf during various levels of activity, researchers detected arsenic, cadmium, chromium and lead, all metals with known human toxicity.
    - b. This research demonstrates that activity by players on the fields could suspend contaminated particulates into the air that could be inhaled and therefore, human exposure from artificial turf fields is not limited to dermal.
    - c. These results "raise some concerns with regard to the potential hazards that may exist for individuals and in particular children who engage in sports activities on artificial turf fields."
  9. Van Ulirsch, G. et al. (2010). Evaluating and regulating lead in synthetic turf. *Environmental health perspectives*, 118(10), 1345. Available at: <http://www.ncbi.nlm.nih.gov/pmc/articles/PMC2957910/pdf/ehp-118-1345.pdf>
    - a. Artificial turf can degrade to form lead containing dust at levels that pose a health risk to children.
    - b. Due to the lack of research, "...physicians should be aware of synthetic turf as one potential source of exposure for young children..." and "Health officials investigating elevated blood lead in children should also be aware of synthetic turf as a potential source of lead exposure."
  10. Center for Disease Control and Prevention. (2008). CDC Health Advisory. Potential exposures to lead inartificial turf: Public health issues, actions, and recommendations. June 18, 2008. Available at: [http://www.dhhr.wv.gov/oeps/disease/Documents/Advisory\\_00275.pdf](http://www.dhhr.wv.gov/oeps/disease/Documents/Advisory_00275.pdf)
    - a. Artificial turf made of nylon or nylon/ polyethylene blend fibers contain lead and pose a potential public health concern.
    - b. The risk for lead exposure is higher for artificial fields that are old, frequently used, exposed to the weather, or demonstrate signs of abraded, faded, or broken fibers. As turf ages, lead is released in dust that could then be ingested or inhaled.
    - c. CDC does not know how much lead the body will absorb. However, lead can cause neurological development symptoms and behavioral problems. Children less than 6 years old are more affected by lead than adults and absorb lead more easily.
    - d. CDC does not understand the potential risks associated with lead exposure from artificial turf but recommends precautions including aggressive hand and body washing after playing on fields, washing clothes immediately to avoid tracking contaminated dust to other places, and discouraging eating and drinking while on turf products.
  11. Han, I. K., Zhang, L., & Crain, W. (2008). Hazardous chemicals in synthetic turf materials and their bioaccessibility in digestive fluids. *Journal of Exposure Science and Environmental Epidemiology*, 18(6), 600-607. Available at: <http://www.nature.com/jes/journal/v18/n6/pdf/jes200855a.pdf>

- a. Samples from rubber granules and from artificial grass fibers were taken at fields of different ages and analyzed for polycyclic aromatic hydrocarbons (PAHs), zinc, chromium, arsenic, cadmium, and lead. These samples were then analyzed to determine their bioaccessibility in synthetic digestive fluids.
  - b. The rubber granules found in artificial turf fields had PAH levels above health-based soil standards. Although levels appear to decline over time, this trend can be altered by the fact that new rubber can be added periodically to compensate for the loss of infill material.
  - c. There was a “slightly worrisome” level of chromium found in artificial turf fiber samples.
  - d. Lead in artificial fields can come from the blades of artificial grass, the pigment used for the field markings and lines, and the infill material. Although there were relatively low concentrations of lead measured, the researchers were careful to point out: “some health scientists believe that any Pb [lead] is harmful to children’s neurocognitive development, and that no new Pb should be added to their surroundings.” Furthermore, the lead present in the rubber granules, while at low levels, was “highly bioaccessible” to synthetic gastric fluid.
12. Brown, D.R. (2007). Artificial Turf: Exposures to Ground-up Rubber Tires. Environment & Human Health, Inc. (EHHI). Available at: [http://www.ehhi.org/reports/turf/turf\\_report07.pdf](http://www.ehhi.org/reports/turf/turf_report07.pdf)
- a. Direct human exposure to the hazardous substances contained in artificial turf occurs via three pathways: inhalation as chemicals off gas from the turf, skin contact, or ingestion including by children or infants who come into contact with the material. In the case of allergies (i.e. latex allergies), inhalation could result in a systemic response, as opposed to a contact response.
  - b. Extreme temperatures or solvents are not needed to release metals (including zinc, selenium, lead and cadmium), volatile organic compounds, or semi-volatile organic compounds from the rubber infill of artificial turf into the air or water – release takes place in ambient air and water temperatures.
  - c. While, “the status of the information about human exposures to recycled tire crumb rubber infill ... is not sufficient to determine the safety of the use of the product in situations that involve continuous episodes of human exposure;” “the available information is sufficient and strong enough to raise plausible questions with respect to acute toxicity for susceptible persons, and for cancer risks.”
13. California Office of Environmental Health Hazard Assessment (OEHHA) (2007). Evaluation of Health Effects of Recycled Waste Tires in Playground and Track Products. Report prepared for the Integrated Waste Management Board. Available at: <http://www.calrecycle.ca.gov/publications/Documents/Tires%5C62206013.pdf>
- a. Based on a review of 46 studies, 49 chemicals that are released from tire crumb were identified.
  - b. Of the 49 chemicals identified, “seven of the chemicals leached from tire shreds were carcinogens.”
  - c. OEHHA calculated a cancer risk of 1.2 in 10 million based on a one-time ingestion of the tire crumb rubber over a lifetime.
  - d. Chrysene, a PAH and carcinogen, was found to be ingested as the result of hand-to-surface-to-mouth transfer from playground surfaces made with recycled tires. Assuming playground use for an 11 year period (from age 1 to 12) there was found to be an increased cancer risk of 2.9 in one million from the general cancer risk gauge of one in one million
  - e. Only 31% of the playground surfaces made of recycled tires tested passed the California State mandated Head Impact Criterion (HIC) of <1,000. In this same study 100% of the playground surfaces made of wood chips passed the same standard.
14. Crain, W. and Zhang, J. (2007). Rachel’s Democracy and Health News #992: Hazardous Chemicals in Synthetic Turf, Follow-up Analyses, April 12, 2007. Available at: [http://www.precaution.org/lib/07/prn\\_synthetic\\_turf.070405.htm](http://www.precaution.org/lib/07/prn_synthetic_turf.070405.htm)

- a. Testing on two sites in New York where synthetic turf has been used (the large, 3 year old, Parade Ground in Brooklyn; the relatively small 5 month old Sara D. Roosevelt Park in Manhattan) found PAHs at hazardous levels (as per New York standards). Dibenzo (a,h)anthracene, a probable human carcinogen, was also found at hazardous levels, with two other PAH forms, both possible human carcinogens, found at hazardous levels at the Parade Ground site.
  - b. Research into the pathways by which these substances may be absorbed into the bodies of children and athletes via skin contact, ingestion or other pathways, is very limited with additional research needed.
15. Epstein, V. (2007). Texas Football Succumbs to Virulent Staph Infection from Turf. Bloomberg Press, December 21, 2007. Available at:  
<http://www.bloomberg.com/apps/news?pid=newsarchive&sid=alxhRJdn.cdc>
- a. Artificial turf is linked with serious and potentially life threatening staph infections including MRSA (methicillin-resistant staphylococcus aureus). MRSA can exploit minor skin injuries such as turf burn, and therefore, MRSA infection rate among players is 16 times higher than the national average.
16. KEMI, Swedish Chemicals Agency (2007). Facts: Synthetic Turf. April 2007. Available:  
<http://www2.kemi.se/upload/trycksaker/pdf/faktablad/fbsyntheticiturf.pdf>.
- a. Tires contain up to 60 different substances which may be bioaccumulative, carcinogenic, reprotoxic, mutagenic and/or endocrine disrupting.
  - b. Most PAHs are persistent, bioaccumulative and carcinogenic.
  - c. Among the metals found in tires that may be of concern are zinc, lead, copper, chromium and cadmium. Zinc and copper are harmful when absorbed at high levels. Lead can affect reproduction and development of the nervous system leading to poor cognitive development. Chromium is carcinogenic and mutagenic. Cadmium is toxic to humans and can contribute to poor liver and kidney function, as well as osteoporosis.
17. Mattina, M. I., Isleyen, M., Berger, W., & Ozdemir, S. (2007). Examination of crumb rubber produced from recycled tires. *The Connecticut Agricultural Experiment Station, New Haven, CT*. Available at:  
[http://www.ct.gov/caes/lib/caes/documents/publications/fact\\_sheets/examinationofcrumbrubberac005.pdf](http://www.ct.gov/caes/lib/caes/documents/publications/fact_sheets/examinationofcrumbrubberac005.pdf)
- a. Multiple compounds out-gas and leached into water from synthetic turf rubber crumb under ambient temperatures including benzothiazole (a skin and eye irritant), butylated hydroxyanisole (a “recognized carcinogen, suspected endocrine toxicant, gastrointestinal toxicant, immune toxicant, neurotoxicant, skin and sense-organ toxicant”), n-hexadecane (a severe irritant), and 4-(t-octyl) phenol (“corrosive and destructive to mucous membranes”).
18. Anderson, M. E. et al. (2006). A case study of tire crumb use on playgrounds: risk analysis and communication when major clinical knowledge gaps exist. *Environmental health perspectives*, 114(1), 1. Available at: <http://www.ncbi.nlm.nih.gov/pmc/articles/PMC1332647/pdf/ehp0114-000001.pdf>
- a. A Case Study conducted by a group of physicians and public health professionals working with the U.S. Environmental Protection Agency’s Region Pediatric Environmental Health Specialty Unit found that the research and information necessary is not available to establish “the safety in use with children” of tire crumb used as playground surfaces.
  - b. “The use of recycled tire crumb products on playgrounds has had little health investigation. The major unresolved concern is the potential for latex allergy with short-term dermal exposure.”
19. Crain, W. and Zhang, J. (2006). Rachel’s Democracy and Health News #871: Hazard Chemicals in Synthetic Turf. September 7, 2006. Available at:  
[http://www.precaution.org/lib/06/prn\\_toxins\\_in\\_synthetic\\_turf.060831.htm](http://www.precaution.org/lib/06/prn_toxins_in_synthetic_turf.060831.htm)

- a. Analyses conducted at the Environmental and Occupational Health Sciences Institute of Rutgers University found the crumb rubber from artificial turf to contain high levels of PAHs, as well as zinc and arsenic.
  - b. PAHs found to be contained in the crumb rubber “were above the concentration levels that the New York State Department of Environmental Conservation (DEC) considers sufficiently hazardous to public health to require their removal from contaminated soil sites. It is highly likely that all six PAHs are carcinogenic to humans.”
  - c. “The analyses also revealed levels of zinc in both samples that exceed the DEC's tolerable levels.”
  - d. The researchers associated with these findings were careful to state “We want to emphasize that the findings are preliminary. PAHs in rubber might not act the same way as in soil, and we do not yet have information on the ease with which the PAHs in these rubber particles might be absorbed by children or adults -- by ingestion, inhalation, or absorption through the skin. However, the findings are worrisome. Until more is known, it wouldn't be prudent to install the synthetic turf in any more parks.”
20. Kazakova, S. V. et al. (2005). A clone of methicillin-resistant *Staphylococcus aureus* among professional football players. *New England Journal of Medicine*, 352(5), 468-475. Available at: <http://www.nejm.org/doi/pdf/10.1056/NEJMoa042859>
- a. In a study of professional football players from the St. Louis Rams team, all MRSA infections developed at sites of turf burns.
  - b. Players reported a higher frequency of abrasions when playing on artificial turf compared to natural grass.
21. Begier, E. M. et al. (2004). A high-morbidity outbreak of methicillin-resistant *Staphylococcus aureus* among players on a college football team, facilitated by cosmetic body shaving and turf burns. *Clinical infectious diseases*, 39(10), 1446-1453. (a study conducted for the Connecticut Department of Public Health, Student Health Services of Sacred Heart Univ, Centers for Disease Control and Prevention, Minnesota Department of Public Health, and the Los Angeles County Department of Health Services).
- a. In a study of MRSA outbreaks involving college football players, infection was associated with turf burns from artificial grass. Turf burns increased the risk of infection regardless of the type and timing of care provided the burn. Turf burns may be facilitating infection by acting as a pathway for infection.
22. Shorten, M. R., & Himmelsbach, J. A. (2003). Sports surfaces and the risk of traumatic brain injury. *Sports surfaces*. University of Calgary, Calgary, 49-69. Available at: <http://biomechanica.com/docs/publications/docs/Shorten%20-%20Head%20Injury%20Risk.pdf>
- a. There is double the risk of head traumas such as concussions associated with artificial turf compared to natural turf, and artificial turf presents a 5 times greater risk of more severe head injury.
  - b. Concussions (formally described as Mild Traumatic Brain Injury or MTBI) resulting from sports has, according to the US Centers for Disease Control, reached “epidemic proportions,” and these ‘mild’ head traumas, especially a series of concussions, can have long term, negative effects on cognitive function.
23. Naunheim, R., et al. (2002). Does the use of artificial turf contribute to head injuries?. *Journal of Trauma-Injury, Infection, and Critical Care*, 53(4), 691-694.
- a. The impact-attenuating properties of two artificial fields were compared to a grass outdoor practice field. Both artificial surfaces were harder compared to the outdoor grass field. It was concluded that the low impact attenuation of the artificial turf may be contributing to the high incidence of concussion.
24. Guskiewicz, K. M., et al. (2000). Epidemiology of concussion in collegiate and high school football players. *The American Journal of Sports Medicine*, 28(5), 643-650.



- a. In a survey of both high school and collegiate certified athletic trainers representing over 17,000 football players, contact with artificial turf was associated with more serious concussion than contact with natural grass.

**Environment:** The pollutant substances found in artificial turf contribute to contamination of soil, plants and aquatic ecosystems and pose a risk of toxic effects for aquatic and sediment dwelling organisms. The resulting environmental harm is on-going and long-term, happening over many years. The varying content of tires used for infill of turf systems makes this threat a moving target. A growing body of scientific analysis is documenting a concerning level of environmental threat and harm and is further demonstrating the need for more research regarding artificial turf and its ramifications for the environment.

1. Public Employees for Environmental Responsibility (PEER) (2012). Petition for a Rulemaking on Surface Heat from Artificial Turf, Submitted by PEER to Consumer Product Safety Commission, Sept 6, 2012. Available at: [http://www.peer.org/assets/docs/doc/9\\_6\\_12\\_PEER\\_Petition\\_heat\\_rulemaking.pdf](http://www.peer.org/assets/docs/doc/9_6_12_PEER_Petition_heat_rulemaking.pdf)
  - a. As well explained by an oft cited petition to the Consumer Product Safety Commission for rulemaking: "When tires are shredded and pulverized, their surface area increases exponentially, as does the particulate and gas yield from the tire material. Since tires are made of very harmful materials, including 24 gases found to be harmful to humans, carbon black, (a carcinogen which makes up 30% of tires), latex, benzothiazoles, phthalates, lead, mercury, cadmium, zinc and many other known toxins, when the fields heat up, they become increasingly dynamic. Of primary concern is the interaction of particles and gases, 'because when particles adsorb onto the surface of gases, they become 10-20 times more toxic than the materials themselves.'"
  - b. Furthermore, artificial turf becomes more toxic as it heats up.
2. Sadiktsis, I., et al. (2012). Automobile Tires A Potential Source of Highly Carcinogenic Dibenzopyrenes to the Environment. *Environmental science & technology*, 46(6), 3326-3334. Available at: <http://www.locchiadiromolo.it/blog/wp-content/uploads/2012/03/Sadiktsis-et-al-Automobile-Tires-Potential-Source-of-Highly-Carcinogenic-2012.pdf>
  - a. The variability in PAH concentrations between different tires is large.
  - b. Due to "leaching of PAHs from recycled tire rubber material, tires are a source of environmental pollution of PAHs through their entire lifecycle."
3. Connecticut Department of Environmental Protection (2010). Artificial Turf Study: Leachate and Stormwater Characteristics, Final Report. Available at: [http://www.ct.gov/deep/lib/deep/artificialturf/dep\\_artificial\\_turf\\_report.pdf](http://www.ct.gov/deep/lib/deep/artificialturf/dep_artificial_turf_report.pdf)
  - a. Stormwater runoff from artificial turf contained zinc, manganese, and chromium at levels toxic to aquatic organisms.
  - b. Therefore, there is a potential risk to surface waters from the installation of artificial turf. Zinc levels could cause exceedance of acute aquatic toxicity criteria. This risk is especially high for smaller watercourses.
  - c. Best management practices and treatment (i.e. wetlands, wet ponds, infiltration structures, compost filter, sand filters, or biofiltration structures) should be used for stormwater runoff from artificial turf fields that discharge to surface waters.
4. Yaghoobian, N., et al. (2010). Modeling the thermal effects of artificial turf on the urban environment. *Journal of Applied Meteorology and Climatology*, 49(3), 332-345.
  - a. An urban temperature model showed an increase in local atmospheric temperatures of up to 4° C (39° F) in areas where natural grass cover had been replaced with artificial turf.
5. Han, I. K., et al. (2008). Hazardous chemicals in synthetic turf materials and their bioaccessibility in digestive fluids. *Journal of Exposure Science and Environmental Epidemiology*, 18(6), 600-607. Available at: <http://www.nature.com/jes/journal/v18/n6/pdf/jes200855a.pdf>

- a. Zinc was found to exceed soil limits and the leaching rate from rubber granules was up to 20 times more than the leaching rate from agricultural applications of manure and pesticides. "Runoff with high Zn [zinc] from synthetic turf fields may produce adverse effects to plants and aquatic life."
6. KEMI, Swedish Chemicals Agency (2007). Facts: Synthetic Turf. April 2007. Available: <http://www2.kemi.se/upload/trycksaker/pdf/faktablad/fbsyntheticiturf.pdf>.
  - a. Hazardous substances found in tires may persist in the environment including polycyclic aromatic hydrocarbons (PAHs), phthalates, phenols, and certain metals.
  - b. Most PAHs are persistent, bioaccumulative and carcinogenic.
  - c. Phthalates and phenols are not chemically bound to the rubber and as a result can leach from the infill material. These chemicals are persistent and bioaccumulative and can have long-term effects on the environment.
7. Meil, J., & Bushi, L. (2006). Estimating the Required Global Warming Offsets to Achieve a Carbon Neutral Synthetic Field Turf System Installation. *Athena Institute. Ontario Canada*. Available at: <http://sfrecpark.org/wp-content/uploads/AthenalCarbonOffsets.pdf>
  - a. Artificial turf systems have a carbon footprint due to the greenhouse gases emitted during the life cycle of synthetic turf systems compared to natural grass surfaces.
  - b. To achieve a 10-year carbon neutral synthetic turf installation, 1861 trees would need to be planted to offset the field's carbon footprint.
8. Källqvist, T. (2005). Environmental risk assessment of artificial turf systems. *Norwegian Institute for Water Research*, 19.
  - a. Recycled rubber varies considerably in its chemical composition, even when from the same manufacturer.
  - b. Leaching of contaminants from artificial turf as the result of surface water runoff from precipitation is a great risk for the environment. It is predicted that chemicals leaching from synthetic turf materials occurs slowly, and as a result the environmental harms may take place over many years. There is also a level of "erosion" that takes place and can result in fine particles that could be carried to local waterways. Chemicals have even been shown to leach from the artificial turf fibers.
  - c. The leachate from artificial turf can contain a variety of metals (including lead, cadmium, copper, mercury and zinc) and organic pollutants (including PAHs, phthalates, 4-t-octylphenol and isononyphenol).
  - d. The runoff from an artificial turf field poses "a positive risk of toxic effects on biota in the water phase and in the sediment."
  - e. Of the organic compounds at issue, octylphenol represents the greatest risk, and possibly could occur at levels where hormone disrupting effects are a concern.
  - f. The Norwegian Institute for Water Research has determined that it is "appropriate to perform a risk assessment which covers water and sediments in watercourses which receive run-off from artificial turf pitches."
9. Thale, S.W. et al. (2004) Potential Health and Environmental Effects Associated with Synthetic Turf Systems-final report. Byggforsk, Norwegian Building Research Institute. Available at: [http://www.iss-sportsurfacescience.org/downloads/documents/vskyslv2qq\\_nbiengelsk.pdf](http://www.iss-sportsurfacescience.org/downloads/documents/vskyslv2qq_nbiengelsk.pdf)
  - a. While recycled rubber is a greater source of pollution, newly manufactured rubber also contains levels of hazardous substances; in the case of zinc and chromium the levels of recycled and newly manufactured rubber are comparable.
  - b. The synthetic grass fibers can also be a significant source of pollution, albeit significantly lesser amounts leach from the synthetic grass than the rubber infill



10. Tucker, M.R. (1997). Ground Rubber: Potential Toxicity to Plants. Media Notes for North Carolina Growers, North Carolina Dept. of Agriculture & Consumer Services, April 1997. Available at: <http://www.ncagr.gov/agronomi/pdffiles/rubber.pdf>
  - a. When talking about the use of ground rubber as a supplement to planting soils, the North Carolina Department of Agriculture and Consumer Services sent out a notice identifying the risk that zinc leaching from the rubber causes a decline in plant growth “directly attributable to zinc toxicity.”
11. Quoting Dr. Linda Chalker-Scott, Washington State University - Turfgrass Resource Center, Facts About Artificial Turf and Natural Grass. (n.d.) Available at: <http://plasticfieldsforever.org/ArtificialTurfBooklet.pdf>
  - a. “There is no question that toxic substances leach from rubber as it degrades, contaminating the soil, flora, and fauna and aquatic systems.”
12. Turfgrass Resource Center (n.d.) Facts About Artificial Turf and Natural Grass. Available at: <http://plasticfieldsforever.org/ArtificialTurfBooklet.pdf>
  - a. Part of artificial turf maintenance is the regular replenishment of the infill. Some of the infill is merely settling, but some of it is washing away or literally “walking away” with players after use. The effects of this “runaway” infill are unknown and more research is needed to draw conclusions—where is it going and what impacts is it having?
  - b. Maintenance of artificial turf can include application of algaecides or disinfectants to keep the surface clean and application of fabric softener to mask the odor of the artificial turf. What is the final destination of these chemicals and their implications for the environment and those coming into contact with them while playing on the fields?
  - c. There is no indication that artificial turf drains more effectively for purposes of a stormwater infiltration system than natural grass. In addition, infiltration systems are designed to work with whatever surface coating they receive from natural grass to porous paving. Although there is no assumed benefit from an infiltration perspective of natural turf or artificial turf, in many cases the complex systems designed for artificial turf fields have experience problems, work incorrectly, or inefficiently.



## *Fact Sheet* **Artificial/Synthetic Turf**

While professional sports are turning away from artificial turf, it is gaining ground and use at the local level at schools and community fields. Producers of artificial turf make claims of environment, health and safety benefits associated with artificial turf – when they make these blanket claims they are not giving the full picture.

**In terms of environment, health and safety, the jury is still very far out on artificial turf. There continues to be information documenting harm in each of these arenas. Most of all, there is a widespread demonstration and recognition that in terms of environmental, health and safety threats from artificial turf, much more study, analysis and consideration is needed.** And whatever the final outcome of the research, manufacturers neglect the reality that as much as they try to mimic natural grass, artificial turf is not grass, and cannot provide the same natural feel, natural look, natural smell and environmental benefits that natural grass provides.

Artificial Turf is generally comprised of plastic fibers (generally made of polyethylene, polypropylene or nylon) attached to a polypropylene or polyester plastic webbing. A combination of sand and rubber, or sometimes rubber alone, fills between the fibers. The source for the rubber infill is generally recycled tires. Sometimes newly manufactured rubber granulate is used but the cost is so much greater than the recycled tire form that it is generally not the substance used. New developments in artificial turf technology seem continually in the works.

### **Water Quality:**

Delaware Riverkeeper Network  
300 Pond Street, Second Floor  
Bristol, PA 19007  
tel: (215) 369-1188  
fax: (215) 369-1181  
drkn@delawareriverkeeper.org  
www.delawareriverkeeper.org

While it seems well recognized that there is a limited level of assessment and investigation into the environmental impacts associated with artificial turf, a growing body of scientific analysis is documenting a concerning level of environmental threat and harm and is further demonstrating the need for more research regarding artificial turf and its ramifications for the environment.

Synthetic turf is generally made with rubber from waste tires. Recycled rubber varies considerably in its chemical composition, even when from the same manufacturer.<sup>1</sup>

Hazardous substances found in tires may persist in the environment including polycyclic aromatic hydrocarbons (PAHs), phthalates and certain metals. These substances may be bioaccumulative, carcinogenic, reprotoxic, mutagenic and/or endocrine disrupting.<sup>2</sup> The chemicals in waste tires are of such concern that a report published by the Swedish Chemicals Inspectorate recommends: “waste tyres should not be used for synthetic turf surfaces.”<sup>3</sup>

- Most PAHs are persistent, bioaccumulative and carcinogenic.<sup>4</sup>
- Phthalates are generally used as solvents and plasticisers in plastics. Phthalates are not chemically bound to the rubber and as a result can leach from the infill material.<sup>5</sup>
- Phenols likewise are not chemically bound to the rubber and so can leach. Phenols too are persistent and bioaccumulative and can have long-term effects on the environment.<sup>6</sup>
- Among the metals found in tires that may be of concern are zinc, lead, copper, chromium and cadmium. While zinc and copper are essential for living organisms, when absorbed at high levels they become harmful. Lead can affect reproduction, development of the nervous system leading to poor cognitive development, and is a particular threat to fetuses and young children. Chromium is carcinogenic and mutagenic. Cadmium is toxic to humans and if taken in can contribute to poor liver and kidney function, as well as osteoporosis.<sup>7</sup>

The Connecticut Agricultural Experiment Station conclusively found four compounds which out-gassed and leached into water from synthetic turf rubber crumb under ambient temperatures:

- Benzothiazole (a skin and eye irritant),

---

<sup>1</sup> T. Kallqvist, Norwegian Institute for Water Research (NIVA), Environmental Risk Assessment of Artificial Turf Systems, December 2005, p. 7.

<sup>2</sup> KEM, Swedish Chemicals Agency, [Facts: Synthetic Turf](#), April 2007.

<sup>3</sup> KEM, Swedish Chemicals Agency, [Facts: Synthetic Turf](#), April 2007.

<sup>4</sup> KEM, Swedish Chemicals Agency, [Facts: Synthetic Turf](#), April 2007.

<sup>5</sup> KEM, Swedish Chemicals Agency, [Facts: Synthetic Turf](#), April 2007.

<sup>6</sup> KEM, Swedish Chemicals Agency, [Facts: Synthetic Turf](#), April 2007.

<sup>7</sup> KEM, Swedish Chemicals Agency, [Facts: Synthetic Turf](#), April 2007.

- Butylated hydroxyanisole (a “recognized carcinogen, suspected endocrine toxicant, gastrointestinal toxicant, immune toxicant, neurotoxicant, skin and sense-organ toxicant”),
- n-hexadecane (a severe irritant) &
- 4-(t-octyl) phenol (“corrosive and destructive to mucous membranes”).<sup>8</sup>

As rubber degrades it can leach toxic substances which can contaminate soil, plants and aquatic ecosystems.<sup>9</sup> Study has concluded that the use of tires in artificial turf has the potential to pollute our environment with PAHs, phenols and zinc<sup>10</sup> and that runoff from an artificial turf field draining to a local creek can pose “a positive risk of toxic effects on biota in the water phase and in the sediment.”<sup>11</sup> Other metal contaminants found to leach from tire crumb rubber include zinc, selenium, lead and cadmium.<sup>12</sup> Zinc has also been shown to leach from the artificial turf fibers.<sup>13</sup> Extreme temperatures or solvents are not needed to release these metals, volatile organic compounds or semi-volatile organic compounds from the rubber in-fill of artificial turf into the air or water – release takes place in ambient air and water temperatures.<sup>14</sup>

Leaching of substances as the result of surface water runoff from precipitation has, by some researchers, been predicted to be the greatest risk for the environment from artificial turf.<sup>15</sup> Study shows there is a risk of local effects for aquatic and sediment dwelling organisms in impacted water courses.<sup>16</sup> Recycled rubber, and associated

---

<sup>8</sup> The Connecticut Agricultural Experiment Station, Examination of Crumb Rubber Produced from Recycled Tires, August 2007; Environment & Human Health, Inc., Artificial Turf, Exposures to Ground-Up Rubber Tires, 2007.

<sup>9</sup> Quoting Dr. Linda Chalker-Scott, Washington State University -- Turfgrass Resource Center, Facts About Artificial Turf and Natural Grass; T. Kallqvist, Norwegian Institute for Water Research(NIVA), Environmental Risk Assessment of Artificial Turf Systems, December 2005, p. 17.; Connecticut Agricultural Experiment Station, Examination of Crumb Rubber Produced from Recycled Tires.

<sup>10</sup> T. Kallqvist, Norwegian Institute for Water Research(NIVA), Environmental Risk Assessment of Artificial Turf Systems, December 2005, p. 5; T. Edeskar, Lulea University of Technology, Technical and Environmental Properties of Tyre Shreds Focusing on Ground Engineer Application, 2004 as cited in KEM, Swedish Chemicals Agency, Facts: Synthetic Turf, April 2007.

<sup>11</sup> T. Kallqvist, Norwegian Institute for Water Research (NIVA), Environmental Risk Assessment of Artificial Turf Systems, December 2005, p. 6.

<sup>12</sup>Environment & Human Health, Inc., Artificial Turf, Exposures to Ground-Up Rubber Tires, 2007.

<sup>13</sup> T. Kallqvist, Norwegian Institute for Water Research (NIVA), Environmental Risk Assessment of Artificial Turf Systems, December 2005, p. 17.

<sup>14</sup> Environment & Human Health, Inc., Artificial Turf, Exposures to Ground-Up Rubber Tires, 2007.

<sup>15</sup> T. Kallqvist, Norwegian Institute for Water Research (NIVA), Environmental Risk Assessment of Artificial Turf Systems, December 2005, p. 5; NIVA (The Norwegian Institute for Water Research), Evaluation of the Environmental Risks of Synthetic Turf, 2005; KEM, Swedish Chemicals Agency, Facts: Synthetic Turf, April 2007.

<sup>16</sup> T. Kallqvist, Norwegian Institute for Water Research(NIVA), Environmental Risk Assessment of Artificial Turf Systems, December 2005, p. 5; NIVA (The Norwegian Institute for Water Research), Evaluation of the Environmental Risks of Synthetic Turf, 2005, as cited by KEM, Swedish Chemicals

leachate, has been found to contain a variety of metals (including lead, cadmium, copper, mercury and zinc), as well as organic pollutants such as PAHs, phthalates, 4-t-octylphenol and iso-nonyphenol.<sup>17</sup> The leaching of zinc has been determined to be of major environmental concern.<sup>18</sup> The leaching of zinc increases as the rubber infill weathers over time,<sup>19</sup> it is likely this is the same for other contaminants. While Zinc contributes the most risk, phenols (specifically octylphenol) and PAHs are also of concern.<sup>20</sup> Of the organic compounds at issue, Octylphenol represents the greatest risk, and possibly could occur at levels where hormone disrupting effects are a concern.<sup>21</sup> The varying content of tires makes this threat a moving target.

The Norwegian Institute for Water Research has determined that it is “appropriate to perform a risk assessment which covers water and sediments in watercourses which receive run-off from artificial turf pitches.”<sup>22</sup>

While recycled rubber is a greater source of pollution, newly manufactured rubber also contains level of hazardous substances; in the case of zinc and chromium the levels of recycled and newly manufactured rubber are comparable.<sup>23</sup>

It is predicted that chemicals leaching from synthetic turf materials occurs slowly, and as a result the environmental harms may take place over many years.<sup>24</sup>

Leaching may not be the only source of water contamination from artificial turf. As the artificial turf is used there is a level of “erosion” that takes place and can result in

---

Agency, Facts: Synthetic Turf, April 2007; KEM, Swedish Chemicals Agency, Facts: Synthetic Turf, April 2007

<sup>17</sup> T. Kallqvist, Norwegian Institute for Water Research (NIVA), Environmental Risk Assessment of Artificial Turf Systems, December 2005, p. 7.

<sup>18</sup> INTRON, Environmental and Health Risks of Rubber Infill, rubber crumb from car tyres as infill on artificial turf, February 9, 2007.

<sup>19</sup> INTRON, Environmental and Health Risks of Rubber Infill, rubber crumb from car tyres as infill on artificial turf, February 9, 2007.

<sup>20</sup> NIVA (The Norwegian Institute for Water Research), Evaluation of the Environmental Risks of Synthetic Turf, 2005, as cited by KEM, Swedish Chemicals Agency, Facts: Synthetic Turf, April 2007.

<sup>21</sup> T. Kallqvist, Norwegian Institute for Water Research (NIVA), Environmental Risk Assessment of Artificial Turf Systems, December 2005, p. 17.

<sup>22</sup> T. Kallqvist, Norwegian Institute for Water Research (NIVA), Environmental Risk Assessment of Artificial Turf Systems, December 2005, p. 8.

<sup>23</sup> Byggforsk, SINTEF Building and Infrastructure, Potential Health and Environmental Effects Associated with Synthetic Turf Systems, 2004, as referenced in KEM, Swedish Chemicals Agency, Facts: Synthetic Turf, April 2007.

<sup>24</sup> T. Kallqvist, Norwegian Institute for Water Research(NIVA), Environmental Risk Assessment of Artificial Turf Systems, December 2005, p. 5; NIVA (The Norwegian Institute for Water Research), Evaluation of the Environmental Risks of Synthetic Turf, 2005, as cited by KEM, Swedish Chemicals Agency, Facts: Synthetic Turf, April 2007.

fine particles that could be carried to local waterways. This source of contamination needs study.<sup>25</sup>

The synthetic grass fibers can also be a significant source of pollution, particularly zinc, albeit significantly lesser amounts leach from the synthetic grass than the rubber infill.<sup>26</sup>

Concerns about the environmental and health effects of synthetic turf in European countries is so great that standards and/or guidelines have been set or are under consideration. For example: Germany has set standards for the use of synthetic turf including a maximum allowable level of pollution or contamination of water and soil, with a requirement of regular sampling to ensure these standards are not exceeded. Allowable pollution levels include: lead 0.04 mg/l, cadmium 0.005 mg/l; chromium 0.05 mg/l, mercury 0.001 mg/l and zinc 3.0 mg/l or 0.5 mg/l depending on the testing method used.<sup>27</sup> Holland has also suggested appropriate language for a standard applicable to use of synthetic turf including a ban on the use of carcinogens, mutagenic, reprotoxic, persistent, bioaccumulative and toxic, or very persistent and very bioaccumulative substances in the surface layer of the turf and a limitation on the level of substances in the rubber infill that may cause cancer, may cause heritable genetic damage, may cause cancer by inhalation, are toxic or harmful to aquatic organisms or may cause long term affects on the aquatic environment, that may impair fertility or cause harm to unborn children. Sweden has set guidelines and limiting values for some of the substances that are present in synthetic turf, specifically as it relates to air pollution, soil contamination and water pollution.<sup>28</sup> And because vehicle tires contain levels of several substances of “very high concern”, the recycling and use of tires in synthetic turf is apparently in conflict with the Swedish environmental objective of A Non Toxic Environment.<sup>29</sup>

Part of artificial turf maintenance is the regular replenishment of the infill. There is a need for research into the loss of existing infill – where is it going and what impacts is it having?<sup>30</sup>

Maintenance of artificial turf can include application of algaecides or disinfectants to keep the surface clean.<sup>31</sup> Maintenance could also include application of fabric

---

<sup>25</sup> T. Kallqvist, Norwegian Institute for Water Research (NIVA), Environmental Risk Assessment of Artificial Turf Systems, December 2005, p. 18.

<sup>26</sup> Byggforsk, SINTEF Building and Infrastructure, Potential Health and Environmental Effects Associated with Synthetic Turf Systems, 2004, as referenced in KEM, Swedish Chemicals Agency, Facts: Synthetic Turf, April 2007.

<sup>27</sup> KEM, Swedish Chemicals Agency, Facts: Synthetic Turf, April 2007.

<sup>28</sup> KEM, Swedish Chemicals Agency, Facts: Synthetic Turf, April 2007.

<sup>29</sup> KEM, Swedish Chemicals Agency, Facts: Synthetic Turf, April 2007.

<sup>30</sup> Turfgrass Resource Center, Facts About Artificial Turf and Natural Grass.

softener to mask the odor of the artificial turf.<sup>32</sup> What is the final destination of these chemicals and their implications for the environment and those coming into contact with them while playing on the fields? More information is needed on this subject as well.

### **Stormwater:**

There is no indication that artificial turf drains more effectively for purposes of a stormwater infiltration system than natural grass. In addition, infiltration systems are designed to work with whatever surface coating they receive from natural grass to porous paving. It should be noted that while generally there can be no assumed benefit from an infiltration perspective of natural turf or artificial turf, there are instances where schools have experienced problems with the drainage of their artificial turf fields.<sup>33</sup>

Natural grass provides a level of evapotranspiration, pulling water out of the soil and subsurface and releasing it to the air, providing benefits in reducing the volume of runoff that results from a site and/or needs to be addressed by other stormwater management strategies. Artificial turf has no evapotranspiration capabilities.

Grass does provide a level of pollution filtering and therefore water quality protection for nearby waterways. While this filtering may be limited in the case of turf grass; such filtering is nonexistent with artificial turf.

### **Heat Island Effect – for Human Health and Surrounding communities:**

Extreme heat is a health concern. Studies document that the surface temperature on artificial turf is dramatically increased as compared to surrounding land uses including asphalt.

In a 2002 study it was found that “the surface temperature of the synthetic turf was 37° F higher than asphalt and 86.5° F hotter than natural turf.”<sup>34</sup> A study published in the Journal of Health and Physical Education and Recreation showed “surface temperatures as much as 95 to 140 degrees Fahrenheit higher on synthetic turf than natural turfgrass when exposed to sunlight.”<sup>35</sup> Random sampling at Brigham Young University identified temperatures ranging from 117.38 to 157 degrees on artificial turf while neighboring natural grass areas were in the range of 78.19 to 88.5 degrees Fahrenheit. “Two inches below the synthetic turf surface was 28.5° F hotter than

---

<sup>31</sup> Turfgrass Resource Center, Facts About Artificial Turf and Natural Grass.

<sup>32</sup> Turfgrass Resource Center, Facts About Artificial Turf and Natural Grass.

<sup>33</sup> Turfgrass Resource Center, Facts About Artificial Turf and Natural Grass.

<sup>34</sup> Dr. C. Frank Williams and Dr. Gilbert E. Pulley, Synthetic Surface Heat Studies, Brigham Young University.

<sup>35</sup> SportsTurf Managers Association, A Guide to Synthetic and natural Turfgrass for Sports Fields, Selection, Construction and Maintenance Considerations.

natural turf at the surface.”<sup>36</sup> And still another study comparing temperatures on artificial turf temperatures with air temperature found that artificial turf ranged from 58 to 75 degrees hotter than measured air temperature.<sup>37</sup> While irrigation provided significant cooling for the synthetic turf (lowering the temperature from 174° F to 85° F) after only 5 minutes the temperature quickly rose again to 120°F; after 20 minutes it rose to 164°F.<sup>38</sup>

Concerns regarding the excessive temperatures range from the implications for players who are already exerting themselves playing in such excessively high temperatures, to the implications for burns when players or pedestrians come into contact with the hot surfaces, to the implications for small children who may come into contact with the extremely hot surfaces during non-sporting events. Particularly when installed in already built up areas, what affect does the extreme heat associated with artificial turf have on the surrounding community in terms of temperature?

Natural grass, by comparison, provides a natural cooling affect and helps to dissipate heat from neighboring developed areas.<sup>39</sup> “The temperature of natural grass rarely rises above 85 degrees Fahrenheit, regardless of air temperature.”<sup>40</sup>

The heat impacts of artificial turf need to be considered in the context of today’s changing climate. Global climate change is expected to dramatically increase the number of days over 100 degrees communities in our region experience. Depending on how aggressively global warming gasses are reduced in coming years, communities nearby Philadelphia will begin to experience in the range of 10 days (in lower emission scenarios) to 30 days (if higher emission scenarios continue to prevail) over 100°. <sup>41</sup> By later in this century seasonable temperatures are projected to rise 6°F to 14°F in summer (depending again on emission reductions achieved in the future). <sup>42</sup> Educators and decisionmakers selecting artificial turf based on its long-term viability and community impacts should consider the affect of global climate change to magnify the heat impacts of artificial turf.

---

<sup>36</sup> Dr. C. Frank Williams and Dr. Gilbert E. Pulley, Synthetic Surface Heat Studies, Brigham Young University.

<sup>37</sup> T. Sciacca, The Thermal Physics of Artificial Turf, January 2008.

<sup>38</sup> Dr. C. Frank Williams and Dr. Gilbert E. Pulley, Synthetic Surface Heat Studies, Brigham Young University.

<sup>39</sup> James B. Beard & Robert L. Green, The Role of Turfgrasses in Environmental Protection and Their Benefits to Humans, J. Environ Qual. 23:452-460 (1994).

<sup>40</sup> SportsTurf Managers Association, A Guide to Synthetic and natural Turfgrass for Sports Fields, Selection, Construction and Maintenance Considerations.

<sup>41</sup> Union of Concerned Scientists, Confronting Climate Change in the U.S. Northeast ● New Jersey, 2007.

<sup>42</sup> Union of Concerned Scientists, Confronting Climate Change in the U.S. Northeast ● New Jersey, 2007.



## Health Issues:

Direct human exposure to the hazardous substances contained in the rubber in-fill of artificial turf is believed to occur via three pathways: inhalation, skin contact, or ingestion including by children or infants who come into contact with the material.<sup>43</sup>

In October 2006 and January 2007, respectively, two sites in New York where synthetic turf has been used (the large, 3 year old, Parade Ground in Brooklyn; the relatively small 5 month old Sara D. Roosevelt Park in Manhattan) were analyzed. This testing found PAHs at hazardous levels (as per New York standards) at each of the sites. At both sites dibenzo (a,h)anthracene, a probable human carcinogen, was found at hazardous levels, with two other PAH forms, both possible human carcinogens, found at hazardous levels at the Parade Ground site. Research into the pathways by which these substances may be absorbed into the bodies of children and athletes via skin contact, ingestion or other pathways, is very limited with additional research needed.<sup>44</sup>

A study by the California Office of Environmental Health Hazard Assessment (OEHHA) summarized 46 studies that identified 49 chemicals which are released from tire crumb. Of the 49, “seven of the chemicals leached from tire shreds were carcinogens. OEHHA calculated a cancer risk of 1.2 in 10 million based on a *one-time* ingestion of the tire crumb rubber over a lifetime.”<sup>45</sup> While there are limited studies which assert that recycled tire crumb are stable in the gastrointestinal tract and that therefore this is not a pathway for exposure, there are other studies which contradict these findings.<sup>46</sup>

Concerns have been raised about the potential implications of recycled tire in-fill for individuals with latex allergies and that inhalation could result in a systemic response, as opposed to a contact response.<sup>47</sup>

While, “the status of the information about human exposures to recycled tire crumb rubber in-fill ... is not sufficient to determine the safety of the use of the product in situations that involve continuous episodes of human exposure;”<sup>48</sup> “the available

---

<sup>43</sup> Environment & Human Health, Inc., Artificial Turf, Exposures to Ground-Up Rubber Tires, 2007.

<sup>44</sup> Rachel’s’ Democracy & Health News #992, Hazardous Chemicals in Synthetic Turf, Follow-up Analyses, April 12, 2007.

<sup>45</sup> Environment & Human Health, Inc., Artificial Turf, Exposures to Ground-Up Rubber Tires, 2007 citing California Office of Environmental Health Hazard Assessment (OEHHA), Evaluation of Health Effects of Recycled Waste Tires in Playground and Track Products, January, 2007.

<sup>46</sup> Environment & Human Health, Inc., Artificial Turf, Exposures to Ground-Up Rubber Tires, 2007.

<sup>47</sup> Environment & Human Health, Inc., Artificial Turf, Exposures to Ground-Up Rubber Tires, 2007.

<sup>48</sup> Environment & Human Health, Inc., Artificial Turf, Exposures to Ground-Up Rubber Tires, 2007.

information is sufficient and strong enough to raise plausible questions with respect to acute toxicity for susceptible persons, and for cancer risks.”<sup>49</sup>

There is great debate about whether artificial turf can increase exposure to, and infection from, MRSA (methicillin-resistant staphylococcus aureus). Reports including a December 21, 2007 article in the Bloomberg Press reporting the affliction of an 18 year old football player from MRSA as the result (according to the boy’s doctor) of an abrasion he received from playing on artificial turf, and citing other findings linking MRSA infections with artificial turf,<sup>50</sup> are a great concern for parents and sports players alike. Defenders of artificial turf often refer to studies like that of the Penn State Department of Crop and Soil Sciences which finds that *Staphylococcus aureus* is commonplace in the human environment, including on both artificial turf and natural grass fields.<sup>51</sup> But even this study acknowledges that there is no conclusive evidence currently available that the source of bacteria causing the infections of sports players is not artificial turf. In addition, the study does not consider the link between burns sustained while playing on artificial turf and available bacteria as a pathway for infection. New studies are emerging that demonstrate that turf burns may be facilitating infection by acting as a pathway for infection.<sup>52</sup> Study has found that turf burns increased the risk of infection regardless of the type and timing of care provided the burn.<sup>53</sup>

Concussions (formally described as Mild Traumatic Brain Injury or MTBI) resulting from sports has, according to the US Centers for Disease Control, reached “epidemic proportions.”<sup>54</sup> “Mild’ head traumas, and especially a series of such minor concussions can have long term, negative effects on cognitive function.”<sup>55</sup> Study has documented that artificial turf increases the risk of MTBI over natural turf,

---

<sup>49</sup> Environment & Human Health, Inc., Artificial Turf, Exposures to Ground-Up Rubber Tires, 2007.

<sup>50</sup> Texas Football Succumbs to Virulent Staph Infection from Turf, December 21, 2007, Bloomberg Press.

<sup>51</sup> Penn State Department of Crop and Soil Sciences, A Survey of Microbial Populations in Infilled Synthetic Turf Fields.

<sup>52</sup> A High Morbidity Outbreak of Methicillin-Resistant *Staphylococcus aureus* among Players on a College Football Team, Facilitated by Cosmetic Body Shaving and Turf Burns, study conducted 2004 for Connecticut Dept of Public Health, Student Health Services of Sacred Heart Univ, Centers for Disease Control and Prevention, Minnesota Dept of Public Health, Los Angeles County Dept of Health Svces; Dr. S.V. Kazakova et.al., A Clone of Methicillin-Resistant *Staphylococcus aureus* among Professional Football Players, The New England Journal of Medicine, Vol 352:468-475 No. 5, Feb. 3, 2005.

<sup>53</sup> A High Morbidity Outbreak of Methicillin-Resistant *Staphylococcus aureus* among Players on a College Football Team, Facilitated by Cosmetic Body Shaving and Turf Burns, study conducted 2004 for Connecticut Dept of Public Health, Student Health Services of Sacred Heart Univ, Centers for Disease Control and Prevention, Minnesota Dept of Public Health, Los Angeles County Dept of Health Svces.

<sup>54</sup> Dr. M. Shorten, J.A. Himmelsbach, BioiMechanica, Sports Surfaces and the Risk of Traumatic Brain Injury citing the US Centers for Disease Control.

<sup>55</sup> Dr. M. Shorten, J.A. Himmelsbach, BioiMechanica, Sports Surfaces and the Risk of Traumatic Brain Injury.

approximately doubling that risk, as well as causing a greater degree of trauma.<sup>56</sup> According to study, artificial turf presents a 5 times greater risk of the more severe head injury than natural turf, although it is still unknown the particular characteristics of the two surfaces that cause the difference in head injury incidence.<sup>57</sup>

**Costs:**

It is generally agreed that artificial turf costs more to install than natural grass, while natural grass costs more to maintain. Installation and maintenance costs for each must be assessed on a case by case basis depending on site specific conditions. But generally speaking, when the installation and maintenance costs of artificial turf are assessed for the life span of the turf, particularly when the cost of disposal is added, the cost of installing and maintaining natural grass is far less. The guaranteed life and/or lifespan of artificial turf is 8 to 10 years.<sup>58</sup> Some attempt to claim a longer life in order to assert a lower annual cost.<sup>59</sup> Comparative cost figures for artificial turf and natural grass include:

	Artificial Turf	Natural Grass
<i>Source: San Francisco Rec and Parks<sup>60</sup></i>		
Installation	\$800,000	\$260,000
Annual Maintenance	\$6,000	\$42,000
Cost of Disposal	Unknown but significant as a hazardous waste	\$0
Average annual cost for guaranteed life of 8 years.	\$106,000	\$74,500
Average annual cost for life of 10 years	\$86,000	\$68,000
Average annual cost for life of 15 years (maximum life span seen asserted in the	\$59,333	\$59,333

<sup>56</sup> Dr. M. Shorten, J.A. Himmelsbach, BioMechanica, Sports Surfaces and the Risk of Traumatic Brain Injury.

<sup>57</sup> Dr. M. Shorten, J.A. Himmelsbach, BioMechanica, Sports Surfaces and the Risk of Traumatic Brain Injury. See also K.M. Guskiewica, N.L. Weaver, D.A. Padua, W.E. Garrett Jr., Epidemiology of Concussion in Collegiate and High School Football Players, Sep-Oct 2000 & Does the Use of Artificial Turf Contribute to Head Injuries, The Journal of Trauma-Injury, Infection and Critical Care, Oct 2002 for the finding that artificial turf increases the level of injury in comparison to natural grass fields.

<sup>58</sup> Turfgrass Resource Center, Facts About Artificial Turf and Natural Grass.

<sup>59</sup> San Francisco Recreation & Parks, Natural and Synthetic Turf: A Comparative Analysis, December 20, 2005.

<sup>60</sup> San Francisco Recreation & Parks, Natural and Synthetic Turf: A Comparative Analysis, December 20, 2005.

literature)		
<b>Source: Facts About Artificial Turf and Natural Grass<sup>61</sup></b>		
Cost of construction and maintenance per sq. ft.	\$7.80 – \$10.75	With high quality soil amendments \$6.50 – \$7.95 With native soils \$2.50 – \$5.25
Cost of disposal per sq. ft.	\$1.75 - \$2.25	\$0
Springfield College case study installation and maintenance average annual cost during 8 year guaranteed life of artificial turf – no disposal costs included	\$105,000  (\$800,000 install & annual maintenance of \$5,000)  For a 10 year life the figure is \$85,000; for 15 years it is \$58,377	\$78,000  (\$400,000 install & \$28,000 annual maintenance)  For a 10 year life the figure is \$68,000; for 15 years it is \$54,666
<b>Source: A Guide to Synthetic and Natural Turfgrass for Sports Fields.<sup>62</sup></b>		
Cost of installation per square foot	\$7.80 to \$10.75	\$2.50 to \$5.25 if done with native soils \$3.50 to \$5.25 if done with combination of native soils and sand. \$6.50 to \$7.95 if done with sand and drainage
Annual Maintenance	\$5,000 to \$25,000	\$4,000 to \$11,000 as per the case studies provided
Disposal per square foot – note this cost does not include the cost of transportation or landfill	\$1.75 to \$2.25	\$0

<sup>61</sup> Turfgrass Resource Center, [Facts About Artificial Turf and Natural Grass](#).

<sup>62</sup> SportsTurf Managers Association, A Guide to Synthetic and natural Turfgrass for Sports Fields, Selection, Construction and Maintenance Considerations. While the cost figures in this document focus on the southeast, the figures provide a sound comparative for the relative cost figures provided.

surcharges for environmentally controlled products		
--	--	--

Artificial turf made from rubber contains a number of hazardous substances. As a result disposal is neither easy nor cheap. It is important to identify and consider the cost of disposal when considering an investment in artificial turf. The life expectancy of artificial turf generally ranges from 8 to 10 years<sup>63</sup> – therefore disposal of artificial turf should be amortized over this time frame.

**Miscellaneous:**

Artificial Turf is available for use immediately upon installation. Natural Turf generally requires 2 growing seasons before it should be heavily used.<sup>64</sup>

One of the biggest supporting assertions for artificial turf is the increased level of playing time it provides. While natural grass may not equal artificial turf in playing time, natural soil and grass science has progressed significantly, greatly increasing its durability for sports. Modern natural grass sports fields include sand in their soil profile to resist compaction and a combination of grass varieties. Natural grass is becoming the preferred surface for a number of professional sports teams.

Natural grass fields require regular maintenance including, mowing and watering, and may also result in the use of fertilizers and potentially herbicides. But there are less environmentally harmful alternatives available for maintenance including electric mowing equipment and environmentally sensitive lawn care strategies that do not rely on environmentally harmful chemicals. A number of schools, including Radnor Township, Delaware County, PA, have successful policies that prevent the use of dangerous chemicals on school grounds.

Artificial turf also requires regular maintenance. Artificial turf maintenance includes sweeping, dragging and watering to provide a clean and uniform appearance.<sup>65</sup> In addition, as the result of wear, the infill may need periodic replenishment.<sup>66</sup> Management of an artificial turf field requires special knowledge in seam repair and snow removal.<sup>67</sup> Special solvents and cleansers are needed to remove tough debris.<sup>68</sup>

---

<sup>63</sup> Turfgrass Resource Center, Facts About Artificial Turf and Natural Grass.

<sup>64</sup> Communication with Nancy Bosold, Extension Educator, Turfgrass Management, Penn Stat Cooperative Extension, Berks County, Aug 15, 2007.

<sup>65</sup> SportsTurf Managers Association, A Guide to Synthetic and natural Turfgrass for Sports Fields, Selection, Construction and Maintenance Considerations.

<sup>66</sup> SportsTurf Managers Association, A Guide to Synthetic and natural Turfgrass for Sports Fields, Selection, Construction and Maintenance Considerations.

<sup>67</sup> SportsTurf Managers Association, A Guide to Synthetic and natural Turfgrass for Sports Fields, Selection, Construction and Maintenance Considerations.

Artificial turf is at risk of damage from plastic bottles, cigarettes and/or gum as well as general trash thrown on the field. When damaged special repairs may be needed. Artificial turf also becomes a recipient of a variety of bodily fluids which cannot be cleansed by natural action as is the case with natural grass. Maintenance can include application of algaecides and fabric softener to mask the odor of the artificial turf.<sup>69</sup>

Artificial turf systems that claim chemical treatment is not required do not seem to provide a mechanism for handling the germs associated with the bodily fluids on the turf when there is an absence of rain or when it is captured and reused in newly emerging artificial turf cooling systems.

**It is important to note that the environmental, health and safety impacts of artificial turf are in need of further study by independent experts. Until such time as there are conclusive findings regarding the environmental, health and safety impacts of artificial turf the Precautionary Principle would direct decisionmakers away from artificial turf and towards the traditional use of natural grass for sports and public play fields.**

Updated: February 25, 2008

Dated: September 9, 2007

---

<sup>68</sup> SportsTurf Managers Association, A Guide to Synthetic and natural Turfgrass for Sports Fields, Selection, Construction and Maintenance Considerations.

<sup>69</sup> Turfgrass Resource Center, Facts About Artificial Turf and Natural Grass.



## Artificial Turf Fact Sheet Temporary Addendum.

Chrysene, a PAH and carcinogen, was found to be ingested as the result of hand-to-surface-to-mouth transfer from playground surfaces made with recycled tires. Assuming playground use for an 11 year period (from age 1 to 12) there was found to be an increased cancer risk of 2.9 in one million ( $2.9 \times 10^{-6}$ ). This risk is greater than the general cancer risk gauge of one in one million ( $1 \times 10^{-6}$ ).<sup>1</sup> This research would seem to suggest that repeat exposure over time to the chemicals released from artificial turf increases the associated increase in cancer risk.

Only 31% of the playground surfaces made of recycled tires tested in one research study passed the California State mandated Head Impact Criterion (HIC) of  $\leq 1,000$ . In this same study 100% of the playground surfaces made of wood chips passed the same standard.<sup>2</sup>

When talking about the use of ground rubber as a supplement to planting soils the North Carolina Department of Agriculture and Consumer Services sent out a notice identifying the risk that zinc leaching from the rubber causes a decline in plant growth "directly attributable to zinc toxicity."<sup>3</sup>

A Case Study conducted by a group of "physicians and public health professionals working with the U.S. Environmental Protection Agency's Region Pediatric Environmental Health Specialty Unit" found that they could not secure the research and information necessary to establish the safety in use with

---

<sup>1</sup> Office of Environmental Health Hazard Assessment, Evaluation of Health Effects of Recycled Waste Tires in Playground and Track Products, January 2007. Note -- the 1.2 in 10 million cancer risk found in the OEHHA study was considered by the authors to be an acceptable level of risk as it falls below the general cancer risk gauge of one in one million ( $1 \times 10^{-6}$ ).

<sup>2</sup> Office of Environmental Health Hazard Assessment, Evaluation of Health Effects of Recycled Waste Tires in Playground and Track Products, January 2007. Please note that in this study 32 recycled tire playground surfaces were tested as compared to only 5 wood chip playground surfaces.

<sup>3</sup> M. Ray Tucker, Agronomist, Ground Rubber: Potential Toxicity to Plants, Media Notes for North Carolina Growers, North Carolina Dept of Agriculture & Consumer Services, April 1997.

Delaware Riverkeeper Network

300 Pond Street, Second Floor  
Bristol, PA 19007

tel: (215) 369-1188

fax: (215) 369-1181

drkn@delawariverkeeper.org

www.delawariverkeeper.org

children of tire crumb used as playground surface.<sup>4</sup> “The use of recycled tire crumb products on playgrounds has had little health investigation. The major unresolved concern is the potential for latex allergy with short-term dermal exposure.”<sup>5</sup> “No published information is available specifically regarding exposure to crumb rubber constituents from use of the product on playgrounds.”<sup>6</sup>

Analyses conducted at the Environmental and Occupational Health Sciences Institute of Rutgers University found the crumb rubber from artificial turf to contain high levels of PAHs, as well as zinc and arsenic.<sup>7</sup> PAHs found to be contained in the crumb rubber “were above the concentration levels that the New York State Department of Environmental Conservation (DEC) considers sufficiently hazardous to public health to require their removal from contaminated soil sites. It is highly likely that all six PAHs are carcinogenic to humans.”<sup>8</sup> “The analyses also revealed levels of zinc in both samples that exceed the DEC's tolerable levels.”<sup>9</sup> The researchers associated with these findings were careful to state “We want to emphasize that the findings are preliminary. PAHs in rubber might not act the same way as in soil, and we do not yet have information on the ease with which the PAHs in these rubber particles might be absorbed by children or adults -- by ingestion, inhalation, or absorption through the skin. However, the findings are worrisome. Until more is known, it wouldn't be prudent to install the synthetic turf in any more parks.”<sup>10</sup>

---

<sup>4</sup> M.E. Anderson et al, A Case Study of tire Crumb Use on Playgrounds: Risk Analysis and Communication When Major Clinical Knowledge Gaps Exist, Environmental Health Perspectives, Vol 114, No. 1, January 2006.

<sup>5</sup> M.E. Anderson et al, A Case Study of tire Crumb Use on Playgrounds: Risk Analysis and Communication When Major Clinical Knowledge Gaps Exist, Environmental Health Perspectives, Vol 114, No. 1, January 2006.

<sup>6</sup> M.E. Anderson et al, A Case Study of tire Crumb Use on Playgrounds: Risk Analysis and Communication When Major Clinical Knowledge Gaps Exist, Environmental Health Perspectives, Vol 114, No. 1, January 2006.

<sup>7</sup> Junfeng Zhang, professor and acting chair, Department of Environmental and Occupational Health, the School of Public Health, the University of Medicine and Dentistry of New Jersey and Rutgers University & William Crain, professor of psychology at The City College of New York, president of Citizens for a Green Riverside Park, Hazardous Chemicals in Synthetic Turf, 2006, analyses conducted at the Environmental and Occupational Health Sciences Institute of Rutgers.

<sup>8</sup> Junfeng Zhang, professor and acting chair, Department of Environmental and Occupational Health, the School of Public Health, the University of Medicine and Dentistry of New Jersey and Rutgers University & William Crain, professor of psychology at The City College of New York, president of Citizens for a Green Riverside Park, Hazardous Chemicals in Synthetic Turf, 2006, analyses conducted at the Environmental and Occupational Health Sciences Institute of Rutgers.

<sup>9</sup> Junfeng Zhang, professor and acting chair, Department of Environmental and Occupational Health, the School of Public Health, the University of Medicine and Dentistry of New Jersey and Rutgers University & William Crain, professor of psychology at The City College of New York, president of Citizens for a Green Riverside Park, Hazardous Chemicals in Synthetic Turf, 2006, analyses conducted at the Environmental and Occupational Health Sciences Institute of Rutgers.

<sup>10</sup> Junfeng Zhang, professor and acting chair, Department of Environmental and Occupational Health, the School of Public Health, the University of Medicine and Dentistry of New Jersey and Rutgers University & William Crain, professor of psychology at The City College of New York, president of Citizens for a Green Riverside Park, Hazardous Chemicals in Synthetic Turf, 2006, analyses conducted at the Environmental and Occupational Health Sciences Institute of Rutgers.



Connecticut is currently considering legislation to provide \$250,000 of funding for a study into the toxicity of artificial turf athletic fields.<sup>11</sup>

One Norwegian assessment/presentation concluded that while indoor artificial turf fields were not generally an elevated health risk, studies to date could not eliminate the concerns associated with development of airway allergies and made a point of noting “a link between exposure to phthalates and the development of asthma/allergies”.<sup>12</sup> Phthalates is one of the contaminants of concern found in artificial turf crumb rubber.<sup>13</sup>

The Norwegian assessment/presentation also reported that “recycled rubber was the major source of potentially hazardous substances. An exposure scenario where the runoff from a football field is drained to a small creek showed a positive risk of toxic effects on biota in the water phase and in the sediment. The risk was mainly attributed to zinc, but also for octylphenol the predicted environmental concentrations exceeded the no environmental effect concentration.”<sup>14</sup> The hazardous leaching could result in local environmental effect.<sup>15</sup>

Of interest – William Carin, OpEd, NY Times, **Turf Wars**, September 16, 2007.

---

<sup>11</sup> *An Act Concerning a Study of the Toxicity of Artificial Turf Athletic Fields*, Raised Bill No. 361, February Session 2008.

<sup>12</sup> Dr. Christine Bjorge, Norwegian Institute of Public Health, Artificial turf Pitches – an assessment of the health risks for football players and the environment, Presentation at the ISSS Technical meeting 2006, Dresden.

<sup>13</sup> KEM, Swedish Chemicals Agency, Facts: Synthetic Turf, April 2007.

<sup>14</sup> Dr. Christine Bjorge, Norwegian Institute of Public Health, Artificial turf Pitches – an assessment of the health risks for football players and the environment, Presentation at the ISSS Technical meeting 2006, Dresden.

<sup>15</sup> Dr. Christine Bjorge, Norwegian Institute of Public Health, Artificial turf Pitches – an assessment of the health risks for football players and the environment, Presentation at the ISSS Technical meeting 2006, Dresden.

# PUBLIC SUBMISSION

<b>As of:</b> 5/3/16 6:20 PM
<b>Received:</b> May 02, 2016
<b>Status:</b> Posted
<b>Posted:</b> May 02, 2016
<b>Tracking No.</b> 1k0-8pe9-yfcg
<b>Comments Due:</b> May 02, 2016
<b>Submission Type:</b> Web

**Docket:** ATSDR-2016-0002

Collections Related to Synthetic Turf Fields with Crumb Rubber Infill 0923-16PJ

**Comment On:** ATSDR-2016-0002-0003

Collections Related to Synthetic Turf Fields with Crumb Rubber Infill ATSDR-2016-0002

**Document:** ATSDR-2016-0002-0047

Collections Related to Synthetic Turf Fields with Crumb Rubber Infill 0923-16PJ Comment on FR Doc # 2016-03305

---

## Submitter Information

**Name:** Nicholas Baker

**Address:** 91411

**Email:** nicholasbaker@alum.calarts.edu

---

## General Comment

Collections Related to Synthetic Turf Fields with Crumb Rubber Infill  
Docket # ATSDR-2016-0002

Thank you. I appreciate the ability to comment. For more than a decade our government has permitted tire waste, a material that is considered to be so toxic that it's not allowed in landfills, to be shredded and placed on athletic fields, kids play areas, gardens, driveways and other recreational areas.

We know from numerous credible studies, that tires contain carbon black, benzene, arsenic, mercury, hydrocarbons, and heavy metals, that have been linked to cancer. We know when people are playing sports on these fields, it's common for these materials to be swallowed, caught in ears, nose, clothing, hair, under skin, and in floor or seats of cars, showers, tubs, etc.

Tire crumb and it's by products are harmful to our environment, water, soil, and our eco-system. Anecdotal evidence of

hundreds of individuals who have played on fields using this material, who have died or become seriously ill should be enough to stop the use of these materials once and for all. If your studies will move this toxic material out of areas where harm can occur, then please let's move forward quickly. In the meantime, stopping any further fields from using this material should be mandated .

Sincerely,

Nicholas Baker

# PUBLIC SUBMISSION

<b>As of:</b> 5/3/16 6:28 PM
<b>Received:</b> May 02, 2016
<b>Status:</b> Posted
<b>Posted:</b> May 03, 2016
<b>Tracking No.</b> 1k0-8pef-4vnd
<b>Comments Due:</b> May 02, 2016
<b>Submission Type:</b> Web

**Docket:** ATSDR-2016-0002

Collections Related to Synthetic Turf Fields with Crumb Rubber Infill 0923-16PJ

**Comment On:** ATSDR-2016-0002-0003

Collections Related to Synthetic Turf Fields with Crumb Rubber Infill ATSDR-2016-0002

**Document:** ATSDR-2016-0002-0059

Collections Related to Synthetic Turf Fields with Crumb Rubber Infill 0923-16PJ Comment on FR Doc # 2016-03305

---

## Submitter Information

**Name:** Jeff Ruch

**Address:** 20910

**Email:** jruch@peer.org

**Organization:** PEER

---

## General Comment

See attached

---

## Attachments

5-2-16\_PEER Comments \_Federal Artificial Turf Research Action Plan



# Public Employees for Environmental Responsibility

962 Wayne Avenue, Suite 610 • Silver Spring, MD 20910

Phone: (202) 265-PEER • Fax: (202) 265-4192

Email: [info@peer.org](mailto:info@peer.org) • Web: <http://www.peer.org>

**Comments on  
Federal Research Action Plan on Recycled Tire Crumbs Used on  
Playing Fields and Playgrounds**

**Submitted by  
Public Employees for Environmental Responsibility (PEER)**

**May 2, 2016**

## **Introduction**

Many parents have remarked on their children looking like “coal-miners” after playing in tire crumb on playgrounds or fields, and that their white soccer balls quickly turn dark gray to black as they roll on these artificial surfaces, in contrast to the green chlorophyll stains from playing on grass.

Yet, there is poor official understanding of what exactly is in the tacky fine tire-derived material coming off the tire crumb playgrounds and fields sticking to objects and children alike and the possible short and long term impacts on human health.

There can be no disagreement, and indeed government and independent experts and the industry concede, that there are a litany of substances in tire crumb and plastics, many of which are known to be harmful to various body systems (e.g. as carcinogens, hormone disruptors, neurotoxins, inflammatory irritants etc) and most of the rest have not been tested. There remains an array of unknowns about the effects on children being in direct contact – some for hours a day and in a variety of conditions – with shredded tire pellets containing known toxic substances such as but not limited to lead, arsenic, cadmium, chromium, mercury, carbon black, benzothiazoles and a number of dangerous hydrocarbons.

Public Employees for Environmental Responsibility (PEER) is submitting the following comments on the proposed multi-agency federal study into the human health and eco-impacts of widespread use of shredded tires in playgrounds and sports fields:

## **I. Research Action Plan Is Poorly Designed and Will Raise More Questions than It Answers**

Announced in February to address to growing public concerns “about the safety of recycled tire crumb used in playing fields and playgrounds in the United States,” the Obama administration directed the U.S. Environmental Protection Agency (EPA), the Centers for Disease Control and

Prevention/Agency for Toxic Substances and Disease Registry, and the Consumer Product Safety Commission (CPSC) to undertake a “coordinated Federal Research Action Plan.” That plan, however, will not produce definitive guidance as it is geared to diagnose the array of “data and knowledge gaps” including what precise mix of chemicals is in “recycled tire crumb” and the potential pathways for human exposure.

The very preliminary nature of this initiative, however, may delay rather than hasten public health safeguards, especially for very young children spending hours a day on turf playgrounds and sports fields:

- There will be no moratorium on building new tire crumb fields while the research continues. Nor will parents be given warnings about the potential risks already identified;
- Even for the chemical exposures identified previously or through these studies, there are no longitudinal studies proposed to learn the effects of long-term exposure, especially to children. Instead, toxicity reviews will be confined to “existing databases” which are few and seriously incomplete at best. As a result, the key question of what level of childhood exposure should be of concern will be left largely unexamined; and
- Some of the plan’s elements are an utter waste of resources, such as CPSC being tasked with “exploring conducting a survey of parents to get first hand perspectives on potential exposures from playground surface materials.” The Consumer Product Safety Commission does not need a survey to know that children come into intimate contact with playground surfaces and play with any loose shredded or granular surface by building with it, pouring it over each other, burying each other in it and sometimes ingesting it in the process.

## **II. There Should Be a Focus on Lead**

The scattered design of this effort threatens to deflect attention away from several already identified toxic substances. One of the most obvious of immediate concern is lead – one of the most harmful neurotoxic substances for children often but irregularly and unpredictably found in both tire crumb and plastic components of synthetic turf systems.

As CDC’s National Center for Environmental Health warns:

“Reducing children’s exposure to lead is one of the greatest environmental health accomplishments in the past 20 years. However, there is no safe level of lead, and children are still being exposed to lead and other environmental hazards.”<sup>1</sup>

Moreover, there is no identified safe blood lead level in children. Lead exposure can affect nearly every system in the body. The effects are especially insidious because lead exposure often occurs with no obvious symptoms, it frequently goes unrecognized.<sup>2</sup>

---

<sup>1</sup> Healthy Homes/Lead Poisoning Prevention Program *CDC 24/7: Saving Lives. Protecting People from Health Threats* [http://www.cdc.gov/nceh/information/healthy\\_homes\\_lead.htm](http://www.cdc.gov/nceh/information/healthy_homes_lead.htm)

<sup>2</sup> <http://www.cdc.gov/nceh/lead/> and [http://www.cdc.gov/nceh/information/healthy\\_homes\\_lead.htm](http://www.cdc.gov/nceh/information/healthy_homes_lead.htm)

Lead has been identified in synthetic turf fields as early as 2008 but was not addressed in any systemic way due to lack of standards or required testing (although the CPSC could have required the testing mandated for children's products since 2008 under the Children's Product Safety Improvement Act (CPSIA).

In fact, the CPSC tested synthetic turf carpets and found lead at varying levels depending on sample age, but then, astoundingly, concluded the whole synthetic turf system was always and everywhere safe for children, based on inappropriate modelling rooted in two incorrect presuppositions: 1) that there is a safe level of blood lead for children; and 2) ingestion is the only mode of exposure, which it is not since inhalation and dermal exposure are obvious routes as well.<sup>3</sup>

To this day the synthetic turf industry cites the still CPSC-posted "OK to Install, OK to Play On" press release<sup>4</sup> which has been disavowed, in front of Congress, by CPSC Commissioner Kaye.<sup>5</sup>

A 2012 study on artificial turf done for the New Jersey Department of Environmental Protection found artificial fields made of tire crumb can contain highly elevated levels of lead much greater than the allowed levels for children, noting "concerns with regard to potential hazards that may exist for individuals and in particular children who engage in sports activities on artificial fields"; and that "Inhalable lead present in artificial turf fields can be resuspended by even minimal activity on the playing surface."<sup>6</sup>

Scientists from Rutgers recently participated in a study which found lead and other toxins in the both the plastic rug (supplied by the industry) and tire crumb infill. Lead was also found in simulated body fluids meaning there is little or no protection of any kind against the lead getting out of the material into the body:

"Since it is possible that children may be exposed to potentially high concentrations of lead while using artificial turf fields we recommend, at a minimum, all infill and fibers should be certified for low or no lead content prior to purchase and installation."<sup>7</sup>

The study also found lead and chromium in both the tire crumb and the plastic rug and simulated body fluids at sometimes extremely high levels even in new field carpets:

"Lead was detected in almost all field samples for digestive, sweat, and total extraction fluids with digestive fluid extract of one field sample as high as 260 mg/kg. Metal concentrations were not markedly different across the three different sample types (new infill, new turf fiber, tire crumb field sample). However, one of the 'new' turf fiber

---

<sup>3</sup> [http://www.peer.org/assets/docs/epa/3\\_21\\_13\\_CPSC\\_Complaint.pdf](http://www.peer.org/assets/docs/epa/3_21_13_CPSC_Complaint.pdf)

<sup>4</sup> <http://www.cpsc.gov/en/Newsroom/News-Releases/2008/CPSC-Staff-Finds-Synthetic-Turf-Fields-OK-to-Install-OK-to-Play-On>

<sup>5</sup> <https://www.youtube.com/watch?v=7crcxR8aYjo>

<sup>6</sup> <http://www.nj.gov/dep/dsr/publications/artificial-turf-report.pdf>

<sup>7</sup> "Bio-accessibility and Risk of Exposure to Metals and SVOCs in Artificial Turf Field Fill Materials and Fibers" 2014 Brian T. Pavilonis<sup>1</sup>, Clifford P. Weisel<sup>1</sup>, Brian Buckley<sup>1</sup>, and Paul J. Liroy  
<http://www.ncbi.nlm.nih.gov/pmc/articles/PMC4038666/pdf/nihms565643.pdf>

samples contained relatively large concentrations of chromium (820 mg/kg) and lead (4400 mg/kg) compared to the other samples tested... [The] variability of lead contained in the infill material is large and can span more than two orders of magnitude. One field [tire crumb] sample did contain a high lead level (260 mg/kg) which was on the same order of magnitude as the NJ DEP cleanup value (400 mg/kg).”

In evaluating and regulating lead in synthetic turf, the Division of Health Assessment and Consultation of the Agency for Toxic Substances and Disease Registry concluded that:

“Synthetic turf can deteriorate to form dust containing lead at levels that may pose a risk to children. Given elevated lead levels in turf and dust on recreational fields and in child care settings, it is imperative that a consistent, nationwide approach for sampling, assessment, and action be developed. In the absence of a standardized approach, we offer an interim approach to assess potential lead hazards when evaluating synthetic turf.”<sup>8</sup>

But no such approach has ever been instituted. Indeed, as reported in *USA Today* in 2015:

“The CDC in 2008 said communities should test recreational areas with turf fibers made from nylon, and they should bar children younger than 6 from the areas if the lead level exceeded the federal limit for lead in soil in children's play areas. But some communities have refused to test their fields, fearing that a high lead level would generate lawsuits or force them to replace and remove a field, which costs about \$1 million, according to a 2011 New Jersey state report. Forty-five of 50 New Jersey schools and towns contacted in 2009 by epidemiologist Stuart Shalat would not let him test their turf-and-rubber fields, Shalat's report states. The EPA also found, in 2009, that ‘it was difficult to obtain access and permission to sample at playgrounds and synthetic turf fields.’”<sup>9</sup>

Industry also admits that its products contain lead. In testimony before the Maryland State House, a representative of the company FieldTurf when asked point-blank by one delegate: “Is there lead in your products?” The company executive answered,

“There’s lead in a lot of things in this world... Yes, there’s lead in our products.”<sup>10</sup>

Both old and new fields keep showing up with lead in them when tested. But the distribution is not homogeneous and is unpredictable with demonstrated high level content hotspots which could evade representative sampling. Some tested fields have little or no lead, while some have high levels and some fields have both high and low levels within the same field (both carpet and tire crumb infill). There is no way of knowing if any of the components of a given field contain lead, and how much, without stringent and thorough testing of each field. Unfortunately for the children, fields with high lead remain in use. However, no one is monitoring, let alone regulating, artificial turf for lead or other toxins in either old or new fields.

---

<sup>8</sup> Van Ulirsch et al (Environmental Health Perspectives. 2010 Oct;118(10):1345-

<sup>9</sup> <http://www.ncbi.nlm.nih.gov/pubmed/20884393>

<sup>9</sup> <http://www.usatoday.com/story/news/2015/03/15/artificial-turf-health-safety-studies/24727111/>

<sup>10</sup> <http://wtop.com/montgomery-county/2016/03/md-lawmakers-seem-information-artificial-turf-schools/>



In short, the priority for any federal efforts should be to ensure that all playing surfaces for children are lead-free. The CDC has repeatedly stressed that every effort should be made to eliminate all unnecessary sources of lead in the environment, especially a child's environment. **Lead in artificial turf is not only totally unnecessary but dangerous to health at any level.**

### **III. Federal Action Plan Should Be Tied to Some Action**

No matter how hazardous, artificial turf is essentially unregulated. Under a revised rule of the Resource Conservation and Recovery Act (RCRA), recycling of hazardous waste may be considered “legitimate” and therefore exempt from RCRA requirements, even if the end product it creates is more toxic than other similar products on the market. This applies even where the end-product is used by children. According to EPA:

“If a hazardous secondary material has been reclaimed and made into a product that will be used by children, and that product contains hazardous constituents that are not in analogous products, that product will likely need to be closely scrutinized.”<sup>11</sup>

Therefore, the EPA does not prohibit the unnecessary incorporation of hazardous constituents into these products, or even guarantee close scrutiny of this recycling even when children are involved. Thus, manufacturers that use hazardous wastes to make products for children are no longer subject to RCRA safety requirements.

To fill this void in public health safeguards, PEER makes three recommendations:

**1. The three participating agencies should issue a joint public statement urging that tire-crumb not be installed as play surfaces for children under age 13 until a thorough risk assessment and analysis of toxic pathways has been completed.**

**2. The CPSC should declare playgrounds and sports fields in elementary schools to be a children’s product.**

Spurred by outrage over importation of toxic Chinese-made toys, in 2008 Congress mandated safeguards for children’s products by imposing a lead content limit of 100 parts per million and third-party testing to ensure compliance. Playgrounds made with shredded tires, however, generally exceed this lead limit. In fact, the only test the CPSC ever conducted found nearly half of the fields that it sampled contained lead in amounts more than three times this legal limit (and they did not test tire crumb infill but only carpets).

In 2012, the Commission declined to classify crumb rubber playgrounds and elementary school sports fields as a children’s product in response to a PEER request saying that it needed evidence of promotion and marketing directed at children. In 2013, PEER submitted evidence of companies like TotTurf and KidWise Outdoor Products marketing products under names such as PlaySafer and Play Tuff Tiles using sales slogans declaring “softer on little knees” and “keep kids safe.”<sup>12</sup>

---

<sup>11</sup> <http://www.epa.gov/oecaerth/cleanup/rcra/index.html>

<sup>12</sup> <http://www.peer.org/news/news-releases/move-to-make-synthetic-playgrounds-lead-free.html>

In response to this submission, on September 27, 2013 the CPSC informed PEER that it had tasked its Office of Compliance and Field Operations with a “review and determination of whether any enforcement action is appropriate.”<sup>13</sup> A year later PEER inquired and ultimately submitted a formal request under the Freedom of Information Act to find out the outcome of this review. The Commission declined to reply and PEER filed a lawsuit in federal district court to compel the answer.

That lawsuit ultimately produced documents that that the CPSC had decided not to enforce toxic lead limits required by law for children’s products in artificial turf playgrounds. On July 20, 2015, CPSC sent a letter to U.S. Senator Elizabeth Warren (D-MA) which contained the following statement:

“Upon further exploration, Compliance staff concluded, at that time, specific product enforcement was unlikely to be the best option, based upon the need for individual health assessments, among other factors. To my knowledge, this information has also been communicated to PEER.”<sup>14</sup>

This statement is curious in several respects, beyond that this decision was never shared with PEER:

- The children’s product enforcement route does not require a health assessment. It only requires a test for lead content – a test which is supposed to be done by the manufacturer;
- In response to the PEER Freedom of Information Act lawsuit and a subsequent FOIA about the basis for the letter to Senator Warren, the CPSC has not been able to locate any paper trail documenting this decision. A request for clarification received no written answer. Another email suggests the decision was never reduced to writing; and
- If enforcement was not “the best option,” CPSC cannot identify what other options it examined.

In short, this federal research action plan is proposed solely because the CPSC has abdicated its legal duty to protect children on playgrounds from chemical exposure.

### **3. Standardize and monitor ingredients used in artificial fields.**

There should be stringent testing of all the colors and of the backing of the carpet for total lead content (chromium and cadmium should also be tested for) as well as testing of many samples of the infill.

These products contain an ever-changing “witches brew” of chemicals with wide variations even in the same field.- so undetectable, low and very high levels can all be found in the same field. Since there is not standardization, monitoring or regulation of the source material, there is no way that any study or combination of studies, including the ones proposed, can identify with certainty just what people are being exposed to on these fields from one field to another or even

---

<sup>13</sup> [http://www.peer.org/assets/docs/cpsc/11\\_12\\_13\\_CPSC\\_child\\_product\\_referral.pdf](http://www.peer.org/assets/docs/cpsc/11_12_13_CPSC_child_product_referral.pdf)

<sup>14</sup> <http://www.peer.org/news/news-releases/cpsc-drops-artificial-turf-playground-safety-review.html>

within a given field. Certainly any assurance of health safety can never be made given the knowledge of definite toxins present and the sheer magnitude of the unknowns.

At the same time, there is a lack of Material Safety Data Sheets (MSDS) for the source material i.e., the tires themselves.

A single company MSDS is an anomaly and indeed its partial list of ingredients raises many red flags. Most tire companies have asserted they do not need to file MSDS, stating:

“Tires meet the definition of article as defined by the OSHA Hazard Communication Standard (29 CFR 190.1200) and are exempt from MSDS requirements.”

This ingredient labeling is even more important since pulverizing of the material makes all the ingredients exponentially more available to interact with and affect living things including people the smaller the pieces get.

In summary, the federal research action plan is inadequate and must be tied to some actions, including immediate actions available to CPSC, if it is to do any good.

###

# PUBLIC SUBMISSION

<b>As of:</b> 5/3/16 6:32 PM
<b>Received:</b> May 02, 2016
<b>Status:</b> Posted
<b>Posted:</b> May 03, 2016
<b>Tracking No.</b> 1k0-8pej-7832
<b>Comments Due:</b> May 02, 2016
<b>Submission Type:</b> Web

**Docket:** ATSDR-2016-0002

Collections Related to Synthetic Turf Fields with Crumb Rubber Infill 0923-16PJ

**Comment On:** ATSDR-2016-0002-0003

Collections Related to Synthetic Turf Fields with Crumb Rubber Infill ATSDR-2016-0002

**Document:** ATSDR-2016-0002-0064

Collections Related to Synthetic Turf Fields with Crumb Rubber Infill 0923-16PJ Comment on FR Doc # 2016-03305

---

## Submitter Information

**Name:** Elliot Belilos

**Organization:** SFA, RRC, ISRI and STC

---

## General Comment

Comments of (1) The Safe Fields Alliance, (2) The Recycled Rubber Council, (3) The Synthetic Turf Council, and  
(4) The Institute of Scrap Recycling Industries, Inc.

---

## Attachments

STC-SFA-RRC-ISRI Final Comments on FRAP 5-2-16



May 2, 2016

Mr. Leroy A. Richardson  
Information Collection Review Office  
Centers for Disease Control and Prevention  
1600 Clifton Road, N.E., MS-D74  
Atlanta, Georgia 30329

Re: Information Collection Related to Synthetic Turf Fields with Crumb Rubber Infill – Agency for Toxic Substances and Disease Registry – ATSDR-2016-0002

The undersigned organizations provide these comments in response to the notice requesting public comment on “Collections Related to Synthetic Turf Fields with Crumb Rubber Infill.” Specifically, the notice seeks input on proposed and/or continued information collections that will assist the Agency for Toxic Substances and Disease Registry (“ATSDR”) within the Centers for Disease Control and Prevention (“CDC”) and the Environmental Protection Agency (“EPA”) to “conduct two studies to investigate the chemical composition and use of crumb rubber infill in synthetic turf and the potential for exposure to environmental constituents that may result from contact with crumb rubber infill.” Although the information collection request does not specifically reference the *Federal Research Action Plan on Recycled Tire Crumb Used on Playing Fields* (“FRAP”), the notice does request information intended to implement the plan, specifically including comments on the necessity of the proposed collection and ways to enhance the quality, utility and clarity of the collected information. The FRAP provides an overview of the research to be conducted by ATSDR, the EPA and the U.S. Consumer Product Safety Commission (“CPSC”).

We support the research efforts to the extent they are based on sound science and produce meaningful results upon which users of playing fields and playgrounds with recycled rubber can properly assess the risks relative to natural grass fields. To that end, we urge that the FRAP (1) carefully consider current research related to the safety of crumb rubber (properly weighing the value of both peer-reviewed and non-peer-reviewed research); (2) account for ambient sources of any identified chemicals, by including control samples of air and natural grass/dirt fields near each synthetic turf field and playground sampled; (3) report any chemicals identified only in proper context with relation to health-based guidelines.

### **The Undersigned Commenters**

The Synthetic Turf Council (STC) is an industry association formed in 2003 and made up of 212 members that range from large textile manufacturers, to builders and installers, to independent professionals such as architects and engineers. The Safe Fields Alliance (SFA) is composed of three of the largest synthetic sports field businesses in America: FieldTurf, AstroTurf, and Sprinturf. The Recycled Rubber Council (RRC) is made up of companies directly involved in recycling rubber, including that used in making the infill for synthetic turf fields. The Institute of Scrap Recycling Industries, Inc. (ISRI) is a

trade association representing more than 1,600 companies operating at more than 3,500 facilities in the United States and 34 countries worldwide.

### **The FRAP Must Carefully Consider Available Research and Ongoing Research.**

There are more than 90 studies and reports over the past two decades conducted by independent bodies, including academic institutions and government agencies over multiple continents. These studies and reports cover more than 125 fields with different life spans. They investigate toxicity, bioavailability, and multiple exposure pathways, and include consideration of potential chronic health effects.

Many of these studies have been peer reviewed. All studies that used accepted methodologies to evaluate exposure or risk indicated no elevated risk of health effects compared with natural grass fields. While we are aware of one or two published studies (and a few unpublished reports sponsored by advocacy groups) that allege significant health risks associated with recycled rubber, those studies are generally chemical composition studies utilizing total extraction methods and provide no information related to actual chemical exposure or risk. The FRAP must not allow such reports to marginalize the significant body of published credible scientific data.

In addition to the existing published research, we urge the FRAP to consider ongoing independent research like that which is currently underway at Brown University. The *in-vitro* toxicology studies being conducted at Brown University are attempting to determine whether exposure to crumb rubber can transform human cells and thus be a precursor to cancer. In fact, this research specifically addresses the concerns that California OEHHA both has recognized and requested that the National Toxicology Program (“NTP”) consider conducting.<sup>1</sup>

### **The FRAP Must Include Adequate Scientific Controls in its Sampling Methodology.**

Any sampling of recycled rubber from playing fields and playgrounds must be accompanied with parallel sampling from nearby soil from grass fields as well to provide proper scientific controls. In addition, air sampling must be conducted with appropriate upwind and downwind controls. However, it is our understanding that appropriate natural soil control samples are not being contemplated by the FRAP. Sampling controls are important for three reasons.

First, sampling controls would allow the Agencies to identify potential outside sources of chemicals found in the test results. For example, if a chemical of concern were found in both the recycled rubber and the surrounding soil, it could potentially be from sources such as a nearby parking lot or other potential outside exposure points. Failure to utilize sampling controls will compromise the reliability and relevance of uncontrolled findings.

A second reason to apply scientific controls in the sampling is to provide a reference point. Users of synthetic turf sports fields and playgrounds need to be provided the information in context. For example, if a chemical of concern is one that is naturally occurring and is present in soil or grass fields at comparable or higher levels than is found in synthetic turf fields, consumers need to have that useful

---

<sup>1</sup> The letter can be found here: [http://oehha.ca.gov/risk/SyntheticTurfStudies/pdf/OEHHA\\_NTP110915.pdf](http://oehha.ca.gov/risk/SyntheticTurfStudies/pdf/OEHHA_NTP110915.pdf)

information. Failing to provide the information in proper context would be a disservice to the owners and users of the playing fields and playgrounds. While the stated mission of the FRAP is limited to identifying potential health risks associated with recycled rubber infill, that mission cannot be fulfilled in a meaningful way without providing the public information upon which they can determine the risks and the benefits of both natural fields and synthetic fields.

Finally, failing to utilize adequate sampling controls will call into question the validity of the results of the federal research. We note that California OEHHA staff had initially not included control soil sampling in its research, but is reconsidering that position based on comments at a recent Public Meeting of its Synthetic Turf Scientific Advisory Panel (Feb. 8, 2016). See <http://oehha.ca.gov/SyntheticTurf01122016.mp4>.

- 3:18:35. Comments of Nick Lapas, Californians Against Waste (asking the OEHHA panel to reconsider the initial decision not to use control samples – *i.e.*, natural turf and air – in their study)
- 3:28:00. Comments of Michael Peterson, Gradient Consulting, and a consultant to the RRC (Urging the panel to include natural turf samples as a control)
- 3:35:12. The Scientific Advisory Panel discussion after comments from the observers, with several panel members expressing the need for sampling controls.

Sampling controls are a critical component of any scientific sampling plan. If the FRAP fails to include such controls in the research – particularly if California OEHHA is including sampling controls – this will call into question the validity and relevance of the Federal research.

### **The Presence of Chemicals Must Be Reported Only in Context With Regard to Health-based Guidelines.**

Finally, the identification of chemical compounds in recycled rubber must include context, *i.e.*, a baseline below which the presence of those constituents has been determined to present no significant health hazards (*e.g.*, health-based standards for toys). Simply reporting the presence of chemical compounds without regard to whether the levels create any cause for concern, including the bioavailability of those chemicals, ignores sound science and would needlessly create fear and concern for the users of the facilities. Sound science recognizes that *both* natural and synthetic chemicals are harmful *only* if they are actually absorbed in actually harmful amounts. At the very least, if the presence of chemicals found at low levels is reported, the Agencies must provide context to that report by noting (if so) that the chemical compounds are present only at levels below which there is any significant risk. And, the Agencies should note whether such chemicals are also present in natural grass and dirt fields, especially those in urban and suburban settings, where contributions from pollutants deposited from vehicular exhaust, paint chips, and other dusts and debris are common.

Currently, the synthetic turf and crumb rubber industry uses the following strict, health-based guidelines:

1. For heavy metals, crumb rubber is benchmarked against the heavy metal standards used by the very stringent EN71-3 European Union toy standards. Crumb rubber is also certified to comply with the lead standard set by CPSC for children's toys and the lead standard set by the EPA for urban/rural soils.

2. Human health risk assessment models to estimate additional cancer risk from exposure to PAH's via the dermal and ingestion exposure pathways are benchmarked against exposure to background level of PAH's and arsenic in urban and rural soils. Additional, theoretical, lifetime cancer risk-estimates from exposure during recreational uses are found to be smaller than a *de minimis* risk level of one in one million (a standard well below EPA's level of risk)

Reporting on crumb rubber without comparing data to allowable levels in toys or urban/rural soils would provide inconclusive and potentially misleading results.

### **The FRAP Must Consider Benefits and Risks vis-à-vis Alternatives to Recycled Rubber.**

The 12,000 synthetic turf sports fields in use today have a significant positive health impact on communities. Availability during or after rain events increases field play time by a factor of five. Moreover, turf fields offer a lower maintenance and offer other positive environmental benefits, including reductions in water usage, pesticides, herbicides, and fertilizer.

In evaluating the relative risks and benefits of recycled rubber, the environmental benefits of recycled rubber should also be considered. A typical synthetic turf sports field uses recycled rubber from 25,000 tires which may otherwise end up in landfills.

### **Conclusion**

We urge that the Federal Research Action Plan apply sound science, including analyzing all available peer-reviewed research, applying sampling controls from nearby grass fields and air, and providing proper context to the low level presence of chemical compounds, if any, in recycled rubber. Finally, the environmental and health benefits of recycled rubber *vis-à-vis* alternatives must be considered. The undersigned organizations represent multiple industries in various parts of the supply chain: we have spent over a decade studying this issue and are able, willing, and ready to assist the Federal effort in any way possible. Only with sound scientific methodologies can the FRAP achieve results upon which users of recycled rubber surfaces can reasonably rely and make informed decisions as to the relative risks of those surfaces *vis-à-vis* alternatives.

Respectfully,

The Safe Fields Alliance

The Recycled Rubber Council

The Synthetic Turf Council

The Institute of Scrap Recycling Industries, Inc.



# PUBLIC SUBMISSION

<b>As of:</b> 5/3/16 6:33 PM
<b>Received:</b> May 02, 2016
<b>Status:</b> Posted
<b>Posted:</b> May 03, 2016
<b>Tracking No.</b> 1k0-8pek-unms
<b>Comments Due:</b> May 02, 2016
<b>Submission Type:</b> Web

**Docket:** ATSDR-2016-0002

Collections Related to Synthetic Turf Fields with Crumb Rubber Infill 0923-16PJ

**Comment On:** ATSDR-2016-0002-0003

Collections Related to Synthetic Turf Fields with Crumb Rubber Infill ATSDR-2016-0002

**Document:** ATSDR-2016-0002-0066

Comment on FR Doc # 2016-03305

---

## Submitter Information

**Name:** Rockwood Turf

**Email:** rockwoodturf@gmail.com

---

## General Comment

Studies with Conflicts of Interest and Other Recommendations for Studies and Data.

Attached please find comments regarding studies with conflicts of interest in addition to recommendations for other studies pertaining to crumb rubber used on playgrounds and synthetic turf fields, and synthetic turf fields in general.

Comments reference EPA's own "Tire Crumb and Synthetic Turf Field Literature and Report List as of Nov. 2015" located at <https://www.epa.gov/chemical-research/tire-crumb-and-synthetic-turf-field-literature-and-report-list-nov-2015> to be used as part of the new February 2016 federal study: Federal Research Action Plan on Recycled Tire Crumb Used on Playing Fields and Playgrounds.

Thank you for your consideration of this important matter. Our children thank you!

---

## Attachments

Conflicts-of-Interest-and-Recs-for-EPA-CR-Lit-Report-List-20160502

## Comments: “Tire Crumb and Synthetic Turf Field Literature and Report List as of Nov. 2015”

Please see table below referencing EPA’s “Tire Crumb and Synthetic Turf Field Literature and Report List as of Nov. 2015” posted at <https://www.epa.gov/chemical-research/tire-crumb-and-synthetic-turf-field-literature-and-report-list-nov-2015>. Conflicts of interest are identified in the studies conducted on shredded waste tires in crumb rubber infill and playground rubber mulch. Because conflicts of interest affect a study’s conclusions, determining them is important. EPA should be aware of studies funded or conducted by industry, if the group/company makes a profit from the product, or if the mission of the group interferes with safety, such as promoting use of recycled tires. This explains why time has been taken to study this issue. Provided comments are not a review of whether the studies have data gaps or are well done, although a few notes have been given in this regard.

Comments presented here include:

- Identification of conflicts of interest – EPA’s “Tire Crumb and Synthetic Turf Field Literature and Report List as of Nov. 2015” (pp. 1-28)
- Recommendations for studies to be added (pp. 29-43)
- Other data for consideration (pp. 44-56)

### Identification of Conflicts of Interest – EPA’s “Tire Crumb and Synthetic Turf Field Literature and Report List as of Nov. 2015”

	Study	Author(s)	Group(s)	Conflict of Interest?	Reason for Conflict of Interest	Notes
1.	<a href="#">Leaching of DOC, DN and Inorganic Constituents from Scrap Tires</a>	Selbes M., Yilmaz O., Khan A.A., Karanfil T. (2015). Chemosphere. 139:617-23. ( <a href="#">Selbes M</a> <sup>1</sup> , <a href="#">Yilmaz O</a> <sup>1</sup> , <a href="#">Khan AA</a> <sup>2</sup> , <a href="#">Karanfil T</a> <sup>3</sup> .)	<sup>1</sup> Department of Environmental Engineering and Earth Sciences, Clemson University, Anderson, South Carolina. <sup>2</sup> Department of Civil Engineering, Clemson University, Clemson, South Carolina. <sup>3</sup> Department of Environmental Engineering and Earth Sciences, Clemson University, Anderson, South Carolina. <a href="mailto:tkaranf@clemson.edu">tkaranf@clemson.edu</a>	N	N/A	

Identification of Conflicts of Interest – EPA’s “Tire Crumb and Synthetic Turf Field Literature and Report List as of Nov. 2015”

	Study	Author(s)	Group(s)	Conflict of Interest?	Reason for Conflict of Interest	Notes
2.	<a href="#">Environmental and Health Impacts of Artificial Turf: A Review</a>	Cheng H. <sup>1</sup> , Hu Y., Reinhard M. (2014). Environ Sci Technol. 48(4):2114-29.	<sup>1</sup> State Key Laboratory of Organic Geochemistry Guangzhou Institute of Geochemistry, Chinese Academy of Sciences Guangzhou 510640, China.	N	N/A	Not a study; a literature review only.
3.	<a href="#">Environmental Sanitary Risk Analysis Procedure Applied to Artificial Turf Sports Fields</a>	Ruffino et al. (2013). Environ Sci Pollut Res Int. (Ruffino B <sup>1</sup> , Flore S, Zanetti MC.)	<sup>1</sup> DIATI-Department of Environment, Land and Infrastructure Engineering, Politecnico di Torino, Corso Duca degli Abruzzi, 24 10129 Torino, Italy. <a href="mailto:barbara.ruffino@polito.it">barbara.ruffino@polito.it</a>	Y	Promotes recycling used tires (see notes).	<p>“Management of the huge quantity of end-of-life tires (ELTs) collected every year leads to several options among which the preferable ones seem to be recycling and reuse, that allow the high quality of component materials to be fully exploited...”</p> <p><a href="http://www.ucprc.ucdavis.edu/P-LCA2014/media/pdf/Papers/LCA14_Crumb%20Rubber%20Pavements.pdf">http://www.ucprc.ucdavis.edu/P-LCA2014/media/pdf/Papers/LCA14_Crumb%20Rubber%20Pavements.pdf</a></p> <p>“Management of end-of-life tyres (ELTs) has become a critical problem worldwide... Since landfill disposal has been banned in most Countries, alternative final destinations have been sought, with a major effort being placed in trying to exploit in the most efficient manner the high energy potential of ELTs. Nevertheless, due to the fact that rubber employed in tyre fabrication is the result of specialized materials’ selection, recycling and reuse seem to be preferable options for such a high-quality waste material (Santagata and Zanetti, 2012).”</p> <p><a href="http://opensample.info/order/ad6145a12f3aa43693b0e51dee50a107761f3af0">http://opensample.info/order/ad6145a12f3aa43693b0e51dee50a107761f3af0</a></p>

Identification of Conflicts of Interest – EPA’s “Tire Crumb and Synthetic Turf Field Literature and Report List as of Nov. 2015”

	Study	Author(s)	Group(s)	Conflict of Interest?	Reason for Conflict of Interest	Notes
4.	<a href="#">New Approach to the Ecotoxicological Risk Assessment of Artificial Outdoor Sporting Grounds</a>	Krüger O. <sup>1</sup> , Kalbe U., Richter E., Egeler P., Römbke J., Berger W. (2013). Environ Pollut. 175:69-74.	<sup>1</sup> BAM Federal Institute for Materials Research and Testing, Division 4.4 Thermochemical Residues Treatment and Resource Recovery, Unter den Eichen 87, 12205 Berlin, Germany. <a href="mailto:oliver.krueger@bam.de">oliver.krueger@bam.de</a>	N	N/A	
5.	<a href="#">Artificial Turf Football Fields: Environmental and Mutagenicity Assessment</a>	Schilirò T. <sup>1</sup> , Traversi D., Degan R., Pignata C., Alessandria L., Scozia D., Bono R., Gilli G. (2013). Arch Environ Contam Toxicol. 64(1):1-11.	<sup>1</sup> Department of Public Health and Microbiology, University of Torino, Via Santena, 5bis, 10126, Torino, Italy. <a href="mailto:tiziana.schiliro@unito.it">tiziana.schiliro@unito.it</a>	N	N/A	This study was financed by the Department of Sport and Recreation of the city of Torino, Italy.
6.	<a href="#">Bioaccessibility and Risk Exposure to Metals and SVOCs in Artificial Turf Field Fill Materials and Fibers</a>	Pavilonis B.T. <sup>1</sup> , Weisel C.P., Buckley B., Liyo P.J. (2013). Risk Anal.	Environmental and Occupational Health Sciences Institute, Robert Wood Johnson Medical School.	Y	Promotes recycling used tires (see note).	The study was supported by contract #SHW10-004 from the NJ Department of Environmental Protection, Recycling Program and Planning.  This study found lead and other toxins in both the plastic rug and tire crumb infill. Lead was also found in simulated body fluids meaning there is little or no protection of any kind against the lead getting out of the material into the body.  "Since it is possible that children may be exposed to potentially high concentrations of lead while using artificial turf fields we recommend, at a minimum, all infill and fibers should be certified for low or no lead content prior to purchase and installation."

Identification of Conflicts of Interest – EPA’s “Tire Crumb and Synthetic Turf Field Literature and Report List as of Nov. 2015”

	Study	Author(s)	Group(s)	Conflict of Interest?	Reason for Conflict of Interest	Notes
						<p>The main outcomes of concern:</p> <ul style="list-style-type: none"> <li>• The finding of lead and chromium in both the tire crumb and the plastic rug and body fluids at sometimes extremely high levels EVEN IN NEW FIELD CARPETS.</li> <li>• Benzothiazole derivatives and 4-(tert-octyl) phenol were also found. Both are probable carcinogens.</li> </ul> <p>“Lead was detected in almost all field samples for digestive, sweat, and total extraction fluids with digestive fluid extract of one field sample as high as 260 mg/kg. Metal concentrations were not markedly different across the three different sample types (new infill, new turf fiber, tire crumb field sample). However, one of the new turf fiber samples contained relatively large concentrations of chromium (820 mg/kg) and lead (4,400 mg/kg) compared to the other samples tested...the variability of lead contained in the infill material is large and can span more than two orders of magnitude. One field [tire crumb] sample did contain a high lead level (260 mg/kg) which was on the same order of magnitude as the NJ DEP cleanup value (400 mg/kg).”</p> <p>Lead-free is the only acceptable level for child products (and indeed for people in general.). There is NO safe level of lead for children. And yet many of our children are playing often, if not daily, on fields that may contain lead and certainly do contain many other toxic substances. Finding ANY lead in any play area for children of any age is unacceptable. Every effort should be made to eliminate ALL unnecessary sources of lead in the environment, especially a child's environment. Lead in artificial turf is not only totally unnecessary but dangerous to health.</p>

Identification of Conflicts of Interest – EPA’s “Tire Crumb and Synthetic Turf Field Literature and Report List as of Nov. 2015”

	Study	Author(s)	Group(s)	Conflict of Interest?	Reason for Conflict of Interest	Notes
						The levels of bioaccessibility would have been <b>greatly underestimated</b> ; this study did not use biologically relevant crumb rubber particle sizes or incubation times when determining the bioaccessibility of SVOCs and metals in simulated lung fluids. Tire crumbs do not float in the air. Athletes are inhaling particulate matter often only a few microns in diameter. Further, the particulate matter may stay lodged in the lungs for months, not 24 hours. Surface area is a key factor in determining bioavailability. The toxicants in dust are far more bioavailable than those in crumbs, which in turn are more bioavailable than those in whole tires.
7.	<a href="#">Review of the Human Health &amp; Ecological Safety of Exposure to Recycled Tire Rubber Found at Playgrounds and Synthetic Turf Fields</a>	Cardno Chem Risk. (2013).	Prepared for: Rubber Manufacturers Association, Washington, DC.	Y	Prepared for Rubber Manufacturers Association	
8.	<a href="#">Health Risk Assessment of Lead Ingestion Exposure by Particle Sizes in Crumb Rubber on Artificial Turf Considering Bioavailability</a>	Kim S. <sup>1</sup> , Yan J.Y., Kim H.H., Yeo I.Y., Shin D.C., Lim Y.W. (2012). Environ Health Toxicol. 27:e2012005.	<sup>1</sup> Institute for Environmental Research, Yonsei University, Seoul, Korea.	N	N/A	The authors have no conflict of interest to declare on this study.

Identification of Conflicts of Interest – EPA’s “Tire Crumb and Synthetic Turf Field Literature and Report List as of Nov. 2015”

	Study	Author(s)	Group(s)	Conflict of Interest?	Reason for Conflict of Interest	Notes
9.	<a href="#">Zinc Leaching from Tire Crumb Rubber</a>	Rhodes E.P. <sup>1</sup> , Ren Z., Mays D.C. (2012). Environ Sci Technol. 46(23):12856-63.	<sup>1</sup> Department of Civil Engineering, University of Colorado Denver, Campus Box 113, PO Box 173364, Denver, Colorado.	N	N/A	
10.	<a href="#">Comparison of Batch and Column Tests for the Elution of Artificial Turf System Components</a>	Krüger O. <sup>1</sup> , Kalbe U., Berger W., Nordhauß K., Christoph G., Walzel H.P. (2012). Environ Sci Technol. 46(24):13085-92	<sup>1</sup> BAM Federal Institute for Materials Research and Testing , Unter den Eichen 87, 12205 Berlin, Germany. <a href="mailto:oliver.krueger@bam.de">oliver.krueger@bam.de</a>	N	N/A	<b>Faulty testing method:</b> sand is routinely used to filter pollutants out of stormwater. Krueger’s method included filter sand at the top and bottom of the column to “disperse the flow.” The filter sand may also have reduced the levels of leachates that were measured. Addition of extraneous filtering media into a system does not yield a realistic model.
11.	<a href="#">Design of a New Test Chamber for Evaluation of the Toxicity of Rubber Infill</a>	Gomes JF <sup>1</sup> , Mota HI, Bordado JC, Baião M, Sarmiento GM, Fernandes J, Pampulim VM, Custódio ML, Veloso I. (2011). Toxicol Mech Methods. 21(8):622-7	<sup>1</sup> IBB/Centre for Chemical and Biological Engineering, Instituto Superior Técnico-UTL , Lisboa , Portugal. <a href="mailto:jgomes@deq.isel.ipl.pt">jgomes@deq.isel.ipl.pt</a>	N	N/A	
12.	<a href="#">An Evaluation of Potential Exposure to Lead and Other Metals as the Result of Aerosolized Particulate Matter from Artificial Turf Playing Fields</a>	Shalat, S.L. (2011).	Division of Environmental Health. Submitted to the New Jersey Department of Environmental Protection.	N	N/A	This study examined the levels of PM 100 and respirable lead dust measured by a stationary air monitor, a mobile air monitor on a robot remotely controlled by a computer, and by a personal breathing space air monitor on a child running soccer drills. Total inhalable particles and inhalable lead levels were lowest when measured by the stationary air monitor.  The study found lead in the field dust in the respirable air space of a robot and real player; highly variable but

Identification of Conflicts of Interest – EPA’s “Tire Crumb and Synthetic Turf Field Literature and Report List as of Nov. 2015”

	Study	Author(s)	Group(s)	Conflict of Interest?	Reason for Conflict of Interest	Notes
						<p>sometimes very high (note most facilities would NOT allow testing). The concerns about lead exposure have taken on a new urgency following the release in June 2012 of a study completed for the New Jersey DEP which found artificial fields made of tire crumb can contain highly elevated levels of lead much greater than the allowed levels for children:</p> <ul style="list-style-type: none"> <li>• It reports concerns with regard to potential hazards that may exist for individuals, and in particular, children, who engage in sports activities on artificial fields</li> <li>• Inhalable lead present in artificial turf fields can be resuspended by even minimal activity on the playing surface.</li> </ul>
13.	<a href="#">Artificial-Turf Playing Fields: Contents of Metals, PAHs, PCBs, PCDDs and PCDFs, Inhalation Exposure to PAHs and Related Preliminary Risk Assessment</a>	<p>Menichini et al. (2011). Sci Total Environ. 409(23):4950-7.                      (Edoardo Menichini<sup>a</sup>, Vittorio Abate<sup>a</sup>, Leonello Attias<sup>b</sup>, Silvia De Luca<sup>a</sup>, Alessandro di Domenico<sup>a</sup>, Igor Fochi<sup>a</sup>, Giovanni Forte<sup>a</sup>, Nicola Iacovella<sup>a</sup>, Anna Laura Iamiceli<sup>a</sup>, Paolo Izzo<sup>b</sup>, Franco Merli<sup>a</sup>, Beatrice Bocca<sup>a</sup>)</p>	<p><sup>a</sup>Department of Environment and Primary Prevention, Istituto Superiore di Sanità, Viale Regina Elena 299, 00161 Rome, Italy.  <sup>b</sup>National Centre for Chemical Substances, Istituto Superiore di Sanità, Viale Regina Elena 299, 00161 Rome, Italy.</p>	N	N/A	



Identification of Conflicts of Interest – EPA’s “Tire Crumb and Synthetic Turf Field Literature and Report List as of Nov. 2015”

	Study	Author(s)	Group(s)	Conflict of Interest?	Reason for Conflict of Interest	Notes
14.	<a href="#">Human Health Risk Assessment of Synthetic Turf Fields Based Upon Investigation of Five Fields in Connecticut</a>	Ginsberg <sup>1</sup> et al. (2011). J Toxicol Environ Health A. 74(17):1150-74.	<sup>1</sup> Connecticut Dept of Public Health, Hartford, Connecticut. <a href="mailto:gary.ginsberg@ct.gov">gary.ginsberg@ct.gov</a>	N	N/A	<p><b>Faulty testing method, faulty risk assessment method.</b> The authors excluded benzene from the risk assessment based on results from personal air monitor samples taken from a grass field approximately 15 months after the original sampling was taken. It is not plausible to suggest that air samples taken more than a year later, in a different season, can serve as an adequate background control. The authors failed to mention the second round of sampling in this report although it was discussed in a separate report generated by this research project. <b>The addition of implausible post hoc control data and the lack of transparency in this article violate good scientific practices.</b></p> <p><b>Thirteen compounds</b> were included in the cancer risk assessment. Cancer unit risks were obtained from standard toxicology databases for four of those, <b>two of those included human epidemiologic data.</b> Unit risk estimates for the other nine carcinogens were estimated, assumed or obtained from nonstandard sources.</p> <p>Of the dozens of chemicals known to be contained in crumb rubber, twenty-seven chemicals of potential concern were identified by the CT DPH for the risk assessment portion of the “Connecticut Study.” (A total of five documents comprise the Connecticut Study.) Thirteen chemicals were identified as carcinogens and included in the cancer risk assessment. The study authors were only able to identify unit risk estimates from standard governmental databases for four of the thirteen carcinogens in the cancer risk assessment. Unit risk estimates for the other nine carcinogens were assumed or obtained from nonstandard sources. This study demonstrates both the lack of necessary toxicity information to do a quantitative risk assessment and the inappropriate risk assessment methodology.</p>

Identification of Conflicts of Interest – EPA’s “Tire Crumb and Synthetic Turf Field Literature and Report List as of Nov. 2015”

	Study	Author(s)	Group(s)	Conflict of Interest?	Reason for Conflict of Interest	Notes
						<p>The Connecticut study used a component-based risk assessment method in which the risks posed by the individual chemicals were simply summed, ignoring any possible interaction effects. However, the Connecticut risk assessment relied on an inappropriate methodology and both approaches relied on extremely incomplete toxicity databases. There are too many possible synergistic or antagonistic interactions between combinations of chemicals to predict the overall toxicity of the mixture with any confidence.</p> <p>Other issues with study methods:</p> <ol style="list-style-type: none"> <li>1. The study inappropriately used component-based risk assessment methods.</li> <li>2. The study did not include a legitimate estimate of the risk from respirable rubber dust and carbon black. The 2010 study done by the University of Connecticut Health Center (UCHC) had used stationary air monitors to measure PM 10 levels on the turf fields near simulated games using 3-4 players and up wind of turf fields (Simcox, Bracker, &amp; John, 2010). However, as noted earlier, the Norwegian study found increased levels of PM 2.5, not PM 10. PM 2.5 is also considered to be more of a health threat than PM 10.</li> </ol> <p>Although personal air monitors were used in other parts of the study, they were not used to measure PM 10, PM 2.5 or carbon black. As indicated by the Shalat study, this may have led to a significant underestimation of the levels of respirable particles that players were exposed to. No good explanation exists for this oversight.</p>

Identification of Conflicts of Interest – EPA’s “Tire Crumb and Synthetic Turf Field Literature and Report List as of Nov. 2015”

	Study	Author(s)	Group(s)	Conflict of Interest?	Reason for Conflict of Interest	Notes
						<p>Since the UCHC study found no significant difference between the upwind and the on-field levels of PM 10, the DPH study authors concluded that particulate matter posed zero risk for the purposes of their health risk assessment.</p> <ol style="list-style-type: none"> <li>3. The study assumed that the levels of VOCs and SVOCs measured on sunny days when the temperatures were generally in the low 80’s would be a suitable average of levels of these chemicals for the four warmest months of the year, and that no VOCs or SVOCs would be emitted the other four months of the year when the fields were used. However, the rate at which VOCs and SVOCs off gas increases exponentially as temperatures increase. Exposures at a 100° F day and a 60° F do not equal the exposure from two 80 °F days. Further, it cannot be argued that these exposure levels could be applied to areas with higher temperatures, such as Texas, Southern California, or even Eastern Washington. Eastern Washington had far too many days last summer with the temperature in the 90’s for these exposure levels to be relevant.</li> <li>4. No model of inhalation by soccer goalies and younger people who spend much time on or close to the surface has been conducted.</li> <li>5. Three carcinogens that were identified as Contaminants of Possible Concern were excluded from the cancer health risk assessment without explanation.             <ol style="list-style-type: none"> <li>a. <b>Ethylbenzene:</b> It is unclear why this carcinogen was not included in the risk assessment. Ethylbenzene would have made a significant contribution to the overall risk.</li> </ol> </li> </ol>

Identification of Conflicts of Interest – EPA’s “Tire Crumb and Synthetic Turf Field Literature and Report List as of Nov. 2015”

	Study	Author(s)	Group(s)	Conflict of Interest?	Reason for Conflict of Interest	Notes
						<p>Ethylbenzene has been considered a carcinogen by California’s OEHHA since 2004. A cancer unit risk value was established by OEHHA in 2007.</p> <p><b>b. Methyl isobutyl ketone:</b> The risk assessment also did not include methyl isobutyl ketone. Methyl isobutyl ketone was declared to be a carcinogen by OEHHA in 2011, but no unit risk was established. Given the lengths the authors went to in order to obtain unit risk estimates for chemicals that are still not considered to be carcinogens, it is odd that this chemical was excluded from the risk analysis with no discussion or indication as to why.</p> <p><b>c. Styrene:</b> In the study, the authors state that the data on styrene is limited and conflicting but that styrene has positive mutagenicity data and that its main metabolite, styrene oxide, is a known carcinogen. Because they considered styrene a potential carcinogen, they added an additional uncertainty factor to styrene’s RFC when calculating its hazard index in a separate part of the study. Nonetheless, styrene was omitted from the cancer health risk assessment.</p> <p>California’s OEHHA declared styrene to be a carcinogen in 2010. An updated cancer risk assessment was published by the Connecticut Department of Public Health in 2011, after additional measurements were taken in October of 2010. This risk assessment also did not include styrene (Simcox N. J., et al., 2011).</p>

Identification of Conflicts of Interest – EPA’s “Tire Crumb and Synthetic Turf Field Literature and Report List as of Nov. 2015”

	Study	Author(s)	Group(s)	Conflict of Interest?	Reason for Conflict of Interest	Notes
						<p>OEHHA currently estimates the unit risk for styrene oxide to be <math>4.6 \times 10^{-5}</math>. Had styrene been included in the risk estimate with this as a conservative estimate of its unit risk, styrene would have been the largest contributor of risk.</p> <p>6. The limitations of the toxicity data were not fully discussed, thus giving readers an overly optimistic view of the accuracy and precision of the estimates. Although the authors noted how they obtained their cancer unit risk, reference concentration, and acute target level for each chemical in a table, the body of the report does not indicate that most of the table is filled in based on assumptions of toxic equivalency or estimated relative potencies. There was no discussion of the limitations of drawing conclusions about human health effects based on animal studies.</p> <p>A discussion of the chemicals involved in Connecticut’s study, and the nature of the toxicology data for each chemical is provided below. The Connecticut study drew data from the Environmental Protection Agency’s (EPA) Integrated Risk Information System (IRIS) database, California’s Office of Environment Health Hazard Assessment (OEHHA) Toxicity Criteria Database, as well as other standard government sources. The information below contains information from the above referenced sources as well as the International Agency for Research on Cancer (IARC), and the National Toxicology Program (NTP).</p> <p>The first four chemicals have sufficient data to have established cancer unit risks in one or more standard toxicology databases.</p> <p><b>Benzene</b> – Adequate animal studies and human epidemiological data are available. The OEHHA cancer unit risk estimate was at least 3.7 times greater than the EPA IRIS</p>

Identification of Conflicts of Interest – EPA’s “Tire Crumb and Synthetic Turf Field Literature and Report List as of Nov. 2015”

	Study	Author(s)	Group(s)	Conflict of Interest?	Reason for Conflict of Interest	Notes
						<p>unit risk estimate. The authors of the Connecticut study decided that neither either estimate was demonstrably more accurate, so the study authors averaged the two unit risk estimates to create a new unit risk estimate for use in their study (Ginsburg &amp; Toal, 2010).</p> <p><b>Methylene Chloride</b> – Adequate animal studies and human epidemiological data are available. The study used the EPA IRIS cancer unit risk.</p> <p><b>Naphthalene</b> – The unit risk was from OEHHA’s database and was based on studies conducted in rodents. There are a couple of cancer case series in humans, but the EPA and IARC consider these to be insufficient evidence of carcinogenicity in humans.</p> <p><b>Benzo(a)pyrene</b> – The unit risk was from OEHHA’s database and was derived from a few studies on hamsters. While OEHHA staff felt that the studies on benzo(a)pyrene were not ideal for calculating a cancer unit risk, the toxicology data on other PAHs were even less complete (Office of Environment Health Hazard Assessment, 2011).</p> <p><b>Benz(a)anthracene Benzo(b)fluoranthene Benzo(k)fluoranthene Chrysene</b></p> <p>The next four chemicals, benz(a)anthracene, benzo(b)fluoranthene, benzo(k)fluoranthene, and chrysene are all polycyclic aromatic hydrocarbons (PAHs).</p> <p>The U.S. EPA determined that these are probable carcinogens but lacked information sufficient to allow for direct estimation of cancer unit risks. However, the EPA did publish, “EPA Provisional Guidance for Quantitative Risk Assessment of Polycyclic Aromatic Hydrocarbons.” In this document, the relative potencies of seven PAHs were estimated based on the effects of dermal exposures to the</p>

Identification of Conflicts of Interest – EPA’s “Tire Crumb and Synthetic Turf Field Literature and Report List as of Nov. 2015”

	Study	Author(s)	Group(s)	Conflict of Interest?	Reason for Conflict of Interest	Notes
						<p>PAHs in mice. These potencies were rounded to a single order of magnitude. The authors of the Connecticut study assumed that the relative potencies of the PAHs derived from dermal exposures in mice were equivalent to the relative potencies for inhalation exposures in humans, thus allowing for the derivation of unit risks for these chemicals. There is uncertainty from using mice to model human toxicity. Uncertainty from using dermal studies to model inhalation risk. Uncertainty from computing relative potencies to estimate unit risks rather than computing unit risks directly from sufficient data. Rounding error. Uncertainty from using hamsters to model human toxicity. Uncertainty from exposing hamsters to inhalation of benzo(a)pyrene in a particle bound form or dissolved in a medium to estimate response to exposure to the gas. Uncertainty was multiplied by uncertainty which was multiplied by rounding error, and the result was represented as a scientifically supported risk calculation accurate to two significant digits.</p> <p><b>Chloromethane:</b> The study authors stated that the cancer unit risk for chloromethane (methyl chloride) was obtained from documentation for California’s Proposition 65. However, no citation was given and the source was unable to be identified. Chloromethane is not considered by California or the EPA to a carcinogen. There is some evidence from a mouse study that chloromethane may cause renal tumors, but the relevance of this study to humans is questionable due to differences in rodent and human physiology.</p> <p><b>1-Methylnaphthalene 2-Methylnaphthalene 2,6 Dimethylnaphthalene</b></p> <p>Three chemicals, 1-methylnaphthalene, 2-methylnaphthalene, and 2,6 dimethylnaphthalene are not</p>

Identification of Conflicts of Interest – EPA’s “Tire Crumb and Synthetic Turf Field Literature and Report List as of Nov. 2015”

	Study	Author(s)	Group(s)	Conflict of Interest?	Reason for Conflict of Interest	Notes
						<p>classified by the EPA or California as carcinogens. , 1-Methylnaphthalene and 2,6 dimethylnaphthalene do not even appear in the EPA’s IRIS or OEHHA’s toxicity criteria database. 2-Methylnaphthalene is listed in IRIS as unclassifiable as to carcinogenicity due to insufficient data. The limited animal studies thus far on the methylnaphthalenes have not yielded clear evidence of oncogenetic effects for these chemicals (Lin, Wheelock, Morin, Baldwin, &amp; al, 2009).</p> <p><b>Benzothiazole:</b> The risk estimate for benzothiazole must be considered speculative, at best. It is also not considered to be a carcinogen in the EPA IRIS or the OEHHA database. There was not enough information on benzothiazole to estimate a unit risk directly from studies on the chemical itself. Rather, a related chemical 2-MBT (2-mercaptobenzothiazole) was used. In a study for the National Toxicology Program, rats and mice were orally exposed to 2-MBT dissolved in corn oil and the animals displayed elevated rates of cancers at various sites. A researcher attempting to assess the risk of 2-MBT in water calculated cancer unit risks based on the study’s data. The author’s calculations underestimated the total cancer risk because the calculations only considered the risk for renal cancer, even though the rodents developed multiple types of cancer. The authors of the Connecticut study converted the unit risk for an oral dose of 2-MBT to a unit risk for inhalation. Thus, the study authors used an underestimate the unit risk of orally administered 2-MBT in rodents as an estimate of the unit risk for inhaled benzothiazole in humans.</p>



Identification of Conflicts of Interest – EPA’s “Tire Crumb and Synthetic Turf Field Literature and Report List as of Nov. 2015”

	Study	Author(s)	Group(s)	Conflict of Interest?	Reason for Conflict of Interest	Notes
15.	<a href="#">Synthetic Turf Field Investigation in Connecticut</a>	Simcox et al. (2011). J Toxicol Environ Health A. 74(17):1133-49.	<sup>1</sup> University of Connecticut Health Center, Farmington, Connecticut. <a href="mailto:simcox@uchc.edu">simcox@uchc.edu</a>	Y	Promotes recycling used tires (see note).	Funding for this project was provided by the Connecticut Department of Environmental Protection.  The addition of post hoc ‘control’ data from personal air monitor samples violates generally accepted rules of scientific methodology. Control and test groups should have been declared and created at the beginning of the study. Further, background air pollution levels vary from day to day and from season to season. Thus it is implausible to suggest that an air sample gathered over a year later, during a different season, could serve as a control.
16.	<a href="#">Benzothiazole Toxicity Assessment in Support of Synthetic Turf Field Human Health Risk Assessment</a>	Ginsberg et al. (2011). J Toxicol Environ Health A. 74(17):1175-83. ( <a href="#">Gary Ginsberg</a> <sup>a</sup> , <a href="#">Brian Toal</a> <sup>a</sup> & <a href="#">Tara Kurland</a> <sup>b</sup> )	<sup>a</sup> Connecticut Dept of Public Health , Hartford, Connecticut.  <sup>b</sup> Clark University , Worcester, Massachusetts.	N	N/A	<b>Not a study</b> ; it is a literature review only.  The Connecticut study used a component-based risk assessment method in which the risks posed by the individual chemicals were simply summed, ignoring any possible interaction effects. However, the Connecticut risk assessment relied on an inappropriate methodology and both approaches relied on extremely incomplete toxicity databases. There are too many possible synergistic or antagonistic interactions between combinations of chemicals to predict the overall toxicity of the mixture with any confidence.  This article gives the justification for the toxicity estimates for benzothiazole (BZT) used in the synthetic turf risk assessments performed by the Connecticut Department of Public Health (DPH). BZT was slightly more acutely toxic than 2-mercaptobenzothiazol (2-MBZT) in tests on laboratory animals, and showed genetic toxicity in one strain of salmonella while 2-MBZT did not show genetic toxicity in any strains. Given the chemical structure of BZT, and the positive

Identification of Conflicts of Interest – EPA’s “Tire Crumb and Synthetic Turf Field Literature and Report List as of Nov. 2015”

	Study	Author(s)	Group(s)	Conflict of Interest?	Reason for Conflict of Interest	Notes
						genetic toxicity test result, the authors chose to estimate the cancer risk from BZT based on the chemical 2-MBZT. While 2-MBZT did appear to be slightly less toxic than BZT in several tests, the authors’ approach seems reasonable, and is far preferable to leaving the risk from BZT out of the health risk assessment entirely.
17.	<a href="#">Hydroxypyrene in Urine of Football Players After Playing on Artificial Sports Fields with Tire Crumb Infill</a>	Van Rooij <sup>1</sup> and Jongeneelen. (2010). Int Arch Occup Environ Health. 83(1):105-10.	<sup>1</sup> IndusTox Consult, PO Box 31070, 6503 CB, Nijmegen, The Netherlands. <a href="mailto:joost.vanrooij@industox.nl">joost.vanrooij@industox.nl</a>	Y	Promotes recycling used tires (see note).	<p>This study is funded by the following organizations in the Netherlands: KNVB, NOC*NSF, WG Materialen, VACO, DSM, RecyBem and Ten Cate.</p> <p><b>“Old tires, great agreements</b></p> <p>RecyBEM B.V. and the Association Tire and Environment come together in the execution of the Decision Management Car Tires.</p> <p>As a member of the Association Tire and Environment, Yde van der Veen has been made responsible for processing used car tires in an environmentally-friendly way by virtue of the decree. The RecyBEM B.V. was founded as an execution organization for the Decision Management Car Tires to ensure that all used car tires on the Dutch market are collected structurally and are reprocessed in an environmentally-friendly way.</p> <p>RecyBEM B.V. exercises supervision on the collection companies contracted by RecyBEM B.V. You can also recognize BEM-certified collection companies, such as Yde van der Veen by the use of the uniform tire recycling receipt of RecyBEM B.V. and the Association Tire and Environment.”</p> <p><a href="http://www.ydevanderveen.nl/en/recybem-en">http://www.ydevanderveen.nl/en/recybem-en</a></p> <p>Exposure was only measured for one day, at 2.5 hrs. All players were age 20 or older; no children were included in study.</p>

Identification of Conflicts of Interest – EPA’s “Tire Crumb and Synthetic Turf Field Literature and Report List as of Nov. 2015”

	Study	Author(s)	Group(s)	Conflict of Interest?	Reason for Conflict of Interest	Notes
18.	<a href="#">Risk Assessment of Artificial Turf Fields</a>	Connecticut Department of Energy & Environmental Protection. (2010). Connecticut Departments of Public Health and Environmental Protection and the Connecticut Agricultural Research Station.	Connecticut Department of Energy & Environmental Protection. (2010). Connecticut Departments of Public Health and Environmental Protection and the Connecticut Agricultural Research Station.	Y	This study relies on data collected by Synthetic Turf Field Investigation in Connecticut by Simcox et al. (2011). J Toxicol Environ Health A. 74(17):1133-49, which also has a conflict of interest.	<p><b>Failure to disclose the use of a post hoc control group.</b> The Connecticut study used a component-based risk assessment method in which the risks posed by the individual chemicals were simply summed, ignoring any possible interaction effects. However, the Connecticut risk assessment relied on an inappropriate methodology and both approaches relied on extremely incomplete toxicity databases. There are too many possible synergistic or antagonistic interactions between combinations of chemicals to predict the overall toxicity of the mixture with any confidence.</p> <p>----</p> <p>“Their “headline” conclusion, however, reflects none of that concern: ‘Results indicate cancer risks slightly above de minimis levels for all scenarios evaluated ...’ The conclusion fails to indicate that such risks are highly improbable, reflecting a series of systematic overestimates of exposure and risk, and including a contaminant that is almost certainly not actually off-gassing from the crumb rubber. The CASE Peer Review Committee strongly urges DPH to revise its risk assessment and then present its findings with appropriate cautions. At the least, the various assumptions underlying the risk assessment should be compiled and presented in a manner so that they can be understood by non-scientists (e.g., parents and journalists) reading the report.”</p> <p><a href="http://www.ct.gov/deep/lib/deep/artificialturf/case_artificial_turf_review_report.pdf">http://www.ct.gov/deep/lib/deep/artificialturf/case_artificial_turf_review_report.pdf</a></p>

Identification of Conflicts of Interest – EPA’s “Tire Crumb and Synthetic Turf Field Literature and Report List as of Nov. 2015”

	Study	Author(s)	Group(s)	Conflict of Interest?	Reason for Conflict of Interest	Notes
19.	<a href="#">Toxicological Assessment of Coated Versus Uncoated Rubber Granulates Obtained from Used Tires for Use in Sport Facilities</a>	Gomes et al. (2010). J Air Waste Manag Assoc. 60(6):741-6. ( <a href="#">Gomes J</a> <sup>1</sup> , <a href="#">Mota H</a> , <a href="#">Bordado J</a> , <a href="#">Cadete M</a> , <a href="#">Sarmiento G</a> , <a href="#">Ribeiro A</a> , <a href="#">Baiao M</a> , <a href="#">Fernandes J</a> , <a href="#">Pampulim V</a> , <a href="#">Custódio M</a> , <a href="#">Veloso I</a> .)	<sup>1</sup> IBB/Center for Chemical and Biological Engineering, Instituto Superior Técnico, and Chemical Engineering Department, Instituto Superior de Engenharia de Lisboa, Lisboa, Portugal. <a href="mailto:jgomes@deq.isel.ipl.pt">jgomes@deq.isel.ipl.pt</a>	N	N/A	
20.	<a href="#">Characterization of Substances Released from Crumb Rubber Material Used on Artificial Turf Fields</a>	Li et al. (2010). Chemosphere. 80(3):279-85. ( <a href="#">Li X</a> <sup>1</sup> , <a href="#">Berger W</a> , <a href="#">Musante C</a> , <a href="#">Mattina MI</a> .)	The Connecticut Agricultural Experiment Station.	N	N/A	
21.	<a href="#">Evaluating and Regulating Lead in Synthetic Turf</a>	Gregory Van Ulirsch, Kevin Gleason, Shawn Gerstenberger, Daphne B. Moffett, Glenn Pulliam, Tariq Ahmed, Jerald Fagliano. (2010). Environ Health Perspect. 118(10): 1345–1349. (Gregory Van Ulirsch <sup>1</sup> , Kevin Gleason <sup>2</sup> , Shawn Gerstenberger <sup>3</sup> , Daphne B. Moffett <sup>1</sup> , Glenn Pulliam <sup>4</sup> , Tariq Ahmed <sup>4</sup> , Jerald Fagliano <sup>4</sup> )	<sup>1</sup> Agency for Toxic Substances and Disease Registry, Atlanta, Georgia. <sup>2</sup> New York State Department of Health, Troy, New York. <sup>3</sup> Department of Environmental and Occupational Health, University of Nevada Las Vegas, Las Vegas, Nevada. <sup>4</sup> New Jersey Department of Health and Senior Services, Trenton, New Jersey.	N	N/A	Not a study; literature review only.

**Identification of Conflicts of Interest – EPA’s “Tire Crumb and Synthetic Turf Field Literature and Report List as of Nov. 2015”**

	<b>Study</b>	<b>Author(s)</b>	<b>Group(s)</b>	<b>Conflict of Interest?</b>	<b>Reason for Conflict of Interest</b>	<b>Notes</b>
22.	<a href="#">Safety Study of Artificial Turf Containing Crumb Rubber Infill Made from Recycled Tires: Measurements of Chemicals and Particulates in the Air, Bacteria in the Turf, and Skin Abrasions Caused by Contact with the Surface</a>	California Office of Environmental Health Hazard Assessment. (2010). Prepared for the California Department of Resources Recycling and Recovery.	California Office of Environmental Health Hazard Assessment. (2010). Prepared for the California Department of Resources Recycling and Recovery.	Y	Prepared for the California Department of Resources Recycling and Recovery. CalRecycle, as part of OEHHA, promotes recycling used tires.	This study examined the temperature at four artificial turf fields. It measured the VOCs in the air above the air at the four fields. Air for the VOC samples was collected from stationary monitors placed beneath galvanized steel garbage cans for 45 minutes. PM 2.5 samples were also collected from three fields, however, the results from two fields were below the limit of detection. The results from the third field were inconsistent. The study also looked at MRSA risk. While artificial turf has not been shown to harbor or transmit the MRSA virus, its abrasiveness significantly increases the risk of epidermal injuries that could result in a MRSA infection.
23.	<a href="#">An Assessment of Chemical Leaching, Releases to Air and Temperature at Crumb-Rubber Infilled Synthetic Turf Fields</a>	Lim L., Walker R. (2009).	New York State Department of Environmental Conservation, New York State Department of Health.	Y	Promotes recycling used tires (New York State Department of Environmental Conservation).	This report only involved two artificial turf fields, both of which were located in downtown New York City, making it very difficult to separate out signal from noise when attempting to measure possible off-gassing from the fields. PM 10 and PM 2.5 were measured, but the measurements at Thomas Jefferson Field were deemed unreliable due to the implausible relationship between the PM 2.5 and PM 10 readings. The temperature readings on the fields clearly demonstrated that once the ambient temperature reached the 80’s, the fields could become hot enough to significantly increase the risk of heat-related illness.

Identification of Conflicts of Interest – EPA’s “Tire Crumb and Synthetic Turf Field Literature and Report List as of Nov. 2015”

	Study	Author(s)	Group(s)	Conflict of Interest?	Reason for Conflict of Interest	Notes
24.	<a href="#">A Scoping-Level Field Monitoring Study of Synthetic Turf Fields and Playgrounds</a>	Highsmith R., Thomas K.W., Williams R.W. (2009). EPA/600/R-09/135.	National Exposure Research Laboratory, U.S. Environmental Protection Agency.	N	N/A	<p>“This report was prepared for the U.S. Environmental Protection Agency (EPA) Tire Crumb Committee, a cross-Agency workgroup.”</p> <p>This study examined airborne PM 10 and VOCs at four outdoor fields and one outdoor playground. Additionally the extractable heavy metals from surface wipes, the crumb rubber and the turf blades from each location were also measured. Bioaccessibility of the lead in the crumb rubber was estimated using the protocols for assessing the bioaccessibility of lead in soil.</p>
25.	<a href="#">Air Quality Survey of Synthetic Turf Fields Containing Crumb Rubber Infill</a>	Vetrano, K.M., Ritter G. (2009).	Prepared by TRC for the New York City Department of Mental Health and Hygiene, New York, New York.	N	N/A	
26.	<a href="#">New Jersey Investigation of Artificial Turf and Human Health Concerns</a>	New Jersey Department of Health and Senior Services. (2008). Fact Sheet. Consumer and Environmental Health Services. Epidemiology, Environmental and Occupational Health. Trenton, New Jersey.	New Jersey Department of Health and Senior Services. (2008). Fact Sheet. Consumer and Environmental Health Services. Epidemiology, Environmental and Occupational Health. Trenton, New Jersey.	N	N/A	

Identification of Conflicts of Interest – EPA’s “Tire Crumb and Synthetic Turf Field Literature and Report List as of Nov. 2015”

	Study	Author(s)	Group(s)	Conflict of Interest?	Reason for Conflict of Interest	Notes
27.	<a href="#">A Review of the Potential Health and Safety Risks from Synthetic Turf Fields Containing Crumb Rubber Infill</a>	Denly E., Rutkowski K., Vetrano K.M. (2008).	Prepared by TRC for the New York City Department of Mental Health and Hygiene, New York, New York.	N	N/A	<p><b>Not a study</b>; it’s a literature review only. This report is a review of the literature on crumb rubber and artificial turf safety. It also provides information on the manufacture of tires and the chemicals contained in tires.</p> <p>"In a letter dated May 14 of that year [2008], Landrigan and two other doctors at the center advised the Health Department to not release the ‘deeply flawed’ report, calling it ‘superficial and one-sided.’ City Limits obtained the damning five-page letter through another Freedom of Information Law request.</p> <p>The literature review ‘does not present a fair and balanced assessment of the issues surrounding the potential health hazards of synthetic turf,’ the letter read. ‘It is not up to the high standard of work that we have come to expect from the New York City Department of Health and Mental Hygiene in this administration.’ The letter went on to identify four ‘proven and potential’ hazards of synthetic turf made from recycled tires. The first and ‘best established’ was exposure to ‘excessive heat,’ with such medical consequences as ‘foot burns, dehydration and heat exhaustion.’ The doctors warned that watering the fields to cool them down could actually do more harm than good: ‘That can set the stage for skin infections,’ because ‘residual water droplets may act as bacterial incubators.’</p> <p>This observation led to a more in-depth discussion of the second risk: MRSA, the antibiotic-resistant staph infection that can be acquired through turf burns. MRSA clusters from turf burns had been reported in The New England Journal of Medicine, the doctors noted, and in the CDC’s Morbidity and Mortality Weekly Report.</p>

Identification of Conflicts of Interest – EPA’s “Tire Crumb and Synthetic Turf Field Literature and Report List as of Nov. 2015”

	Study	Author(s)	Group(s)	Conflict of Interest?	Reason for Conflict of Interest	Notes
						<p>Lastly, the letter raised the risk of chemical exposures, acknowledging that the scientific literature was ‘much less well developed’ on these hazards than on the dangers from heat and MRSA. ‘Several credible studies’ had found the crumb rubber contained ‘known human carcinogens’ and ‘neurotoxic chemicals,’ as well as lead, chromium and arsenic. The city’s literature review relied on reports of human exposure to toxic chemicals from poured- or hard-rubber products, ‘very different from the particulate rubber infill found in synthetic turf fields’ and therefore ‘only remotely relevant’ to its topic.</p> <p>The letter was blunt in its criticism: ‘Overall the draft report from [TRC Companies] on the health hazards of synthetic turf is incomplete, it relies on irrelevant data sources, it uses a deeply flawed approach to risk assessment, it glosses over glaring gaps in the data, and it far too readily dismisses proven risks to human health. It does not take into account the unique exposures and the special vulnerabilities of young children. It concludes quite inappropriately that absence of evidence of risk is evidence of no risk.’”</p> <p><a href="http://citylimits.org/2010/08/24/it-wont-taste-great/">http://citylimits.org/2010/08/24/it-wont-taste-great/</a></p>
28.	<a href="#">Synthetic Turf: Health Debate Takes Root</a>	Claudio L. (2008). Environ Health Perspect 116(3): A116–A122.	Mount Sinai School of Medicine, New York, New York.	N	N/A	<b>Not a study</b> ; opinion piece only
29.	<a href="#">Artificial Turf: Safe or Out on Ball Fields Around the World</a>	Lioy P., Weisel C. (2008). Editorial. J of Expos Anal Environ Epidem. 18:533-534	Exposure Science Division, Environmental and Occupational Health Sciences Institute of Robert Wood Johnson Medical School.	N	N/A	<b>Not a study</b> ; it is an editorial providing an opinion only.



Identification of Conflicts of Interest – EPA’s “Tire Crumb and Synthetic Turf Field Literature and Report List as of Nov. 2015”

	Study	Author(s)	Group(s)	Conflict of Interest?	Reason for Conflict of Interest	Notes
30.	<a href="#">Hazardous Chemicals in Synthetic Turf Materials and their Bioaccessibility in Digestive Fluids</a>	Zhang et al. (2008). J Expo Sci Environ Epidemiol. 18(6):600-7. (Zhang JJ <sup>1</sup> , Han IK, Zhang L, Crain W.)	<sup>1</sup> School of Public Health, University of Medicine and Dentistry of New Jersey. <a href="mailto:jjzhang@eohsi.rutgers.edu">jjzhang@eohsi.rutgers.edu</a>	N	N/A	
31.	<a href="#">Mapping, Emissions and Environmental and Health Assessment of Chemical Substances in Artificial Turf</a>	Nilsson N.H., Malmgren-Hansen B., Thomsen U.S. (2008).	Danish Ministry of the Environment, Environmental Protection Agency.	Y	Promotes recycling used tires (see note).	<p>Study financed by Danish EPA.</p> <p><b>“3.2 Tyres (Waste strategy 2005-2008)</b></p> <p>Landfilling of used tyres has been banned as of 16 July 2001 according to the Statutory Order No 648 of 29 June 2001 on the revision of Statutory Order No 619 of 27 June 2000 on Waste. Collection and recovery of tyres is regulated by the Statutory Order on a Fee on Tyres and a Recovery Subsidy No 111 of 5 February 2000.</p> <p>...An intermediary goal was that at least 80% of all discarded tyres from private cars, vans, and motorbikes will be collected and recycled or incinerated before 1997. According to the agreement, 80% of all discarded tyres must be recycled or incinerated before 2000. Since 2001, the collection rate has been close to 100%. Goals for 2008:</p> <ul style="list-style-type: none"> <li>• 90% reuse or recycling of all discarded tyres</li> </ul> <p>On 20 February 1995, the Minister for Environment and Energy entered into an agreement with the tyre and motor trade associations, the Association of Danish Recycling Industries and municipal associations on a take-back scheme for discarded tyres. Through the agreement it is ensured that discarded tyres are collected and recycled or incinerated, thus avoiding landfilling and ensuring resource utilisation of waste tyres...”</p> <p><a href="http://scp.eionet.europa.eu/facts/factsheets_waste/2006_edition/Denmark">http://scp.eionet.europa.eu/facts/factsheets_waste/2006_edition/Denmark</a></p>

Identification of Conflicts of Interest – EPA’s “Tire Crumb and Synthetic Turf Field Literature and Report List as of Nov. 2015”

	Study	Author(s)	Group(s)	Conflict of Interest?	Reason for Conflict of Interest	Notes
32.	<a href="#">Evaluation of Health Effects of Recycled Waste Tires in Playgrounds and Track Products</a>	California Office of Environmental Health Hazard Assessment. (2007). Prepared for the California Integrated Waste Management Board.	California Office of Environmental Health Hazard Assessment. (2007). Prepared for the California Integrated Waste Management Board.	Y	CalRecycle, as part of COEHHA, promotes recycling used tires.	<b>Not a study</b> ; a literature review only. Reviews numerous related studies on shredded and poured in place recycled tire products. It also contains an original study of oral toxicity based on gastric digestion simulation of tire shreds.
33.	<a href="#">Examination of Crumb Rubber Produced from Recycled Tires</a>	Incorvia Mattina M.J., Isleyen M., Berger W., Ozdemir S. (2007). The Connecticut Agricultural Research Station, New Haven, CT.	The Connecticut Agricultural Research Station, New Haven, Connecticut.	N	N/A	
34.	<a href="#">Artificial Turf: Exposures to Ground-Up Rubber Tires - Athletic Fields - Playgrounds - Gardening Mulch</a>	Brown, D., Alderman, N., Addiss, S., Bradley, J.	Environment and Human Health, Inc. (2007).	N	N/A	Non-profit organization Study referenced in this source is <a href="#">Examination of Crumb Rubber Produced from Recycled Tires</a> , Incorporvia Mattina M.J., Isleyen M., Berger W., Ozdemir S. (2007). The Connecticut Agricultural Research Station, New Haven, CT.
35.	<a href="#">Environmental and Health Evaluation of the Use of Elastomer Granulates (Virgin and from Used Tyres) as Filling in Third-Generation Artificial Turf</a>	Moretto. (2007). France.	ALIAPUR in partnership with Fieldturf Tarkett and the ADEME (Environmental French Agency).	Y	ALIAPUR in partnership with Fieldturf Tarkett	

Identification of Conflicts of Interest – EPA’s “Tire Crumb and Synthetic Turf Field Literature and Report List as of Nov. 2015”

	Study	Author(s)	Group(s)	Conflict of Interest?	Reason for Conflict of Interest	Notes
36.	<a href="#">Preliminary Assessment of the Toxicity from Exposure to Crumb Rubber: Its Use in Playgrounds and Artificial Turf Playing Fields</a>	LeDoux T. (2007).	Division of Science, Research and Technology. New Jersey Department of Environmental Protection.	N	N/A	Not a study; literature review only.
37.	<a href="#">A Case Study of Tire Crumb Use on Playgrounds: Risk Analysis and Communication When Major Clinical Knowledge Gaps Exists</a>	Anderson et al. (2006). Environ Health Perspect.114(1):1-3. ( <a href="#">Mark E. Anderson</a> , <sup>1,2</sup> <a href="#">Katherine H. Kirkland</a> , <sup>3</sup> <a href="#">Tee L. Guidotti</a> , <sup>4</sup> and <a href="#">Cecile Rose</a> <sup>5</sup> )	<sup>1</sup> Department of Community Health Services, Denver Health, Denver, Colorado. <sup>2</sup> Department of Pediatrics, Univ. of Colorado Health Science Center, Denver, Colorado. <sup>3</sup> Association of Occupational and Environmental Clinics, Washington, DC. <sup>4</sup> Department of Environmental and Occupational Health, Mid-Atlantic Center for Child Health and the Environment, School of Public Health and Health Sciences, George Washington Univ. Medical Center, Washington, DC. <sup>5</sup> Departments of Medicine/ Preventive Medicine and Biometrics, National Jewish Medical and Research Center, Denver, Colorado.	N	N/A	Not a study; it’s a commentary only. The authors declare they have no competing financial interests.

Identification of Conflicts of Interest – EPA’s “Tire Crumb and Synthetic Turf Field Literature and Report List as of Nov. 2015”

	Study	Author(s)	Group(s)	Conflict of Interest?	Reason for Conflict of Interest	Notes
38.	<a href="#">A Survey of Microbial Populations in Infilled Synthetic Turf Fields</a>	McNitt A.S., Petrunak D., Serensits T. (2006).	Penn State University, College of Agricultural Sciences, Department of Plant Science.	Y	This study was funded by the Synthetic Turf Council. In addition, Penn State has a partnership with FieldTurf. <a href="http://www.syntheticurfCouncil.org/?page=Research">http://www.syntheticurfCouncil.org/?page=Research</a>	This study does not address tire crumb. It is a study about the possible risk of Staph and MRSA infections on ST. Compare with Weber State study <a href="#">Determination of Microbial Populations in a Synthetic Turf System</a> <b>Sample Size of Infill Material Being Tested</b> <ul style="list-style-type: none"> <li>•Penn State-.075 Grams</li> <li>•Weber State-10 Grams</li> </ul> <b>Collection Time Frame of Samples</b> <ul style="list-style-type: none"> <li>•Penn State-15 days, June only.</li> <li>•Weber State-Once a week for 14 weeks. Very controlled samples.</li> </ul> <b>Location of Samples</b> <ul style="list-style-type: none"> <li>•Penn State-“High Use” and “Low Use” areas.</li> <li>•Weber State-1) Sideline, 2) 50 Yard Line and 3) end of field. 3 locations and same locations on both new and old field being sampled.</li> </ul> <b>Time of Study</b> <ul style="list-style-type: none"> <li>•Penn State-Height of Summer when field temperatures were at the peak.</li> <li>•Weber State-Height of the Actual Football Season when the fields were in use.</li> </ul> <b>Technical Issues of reasons why the Penn St study did not find Pathogens (Staph)</b> <ul style="list-style-type: none"> <li>•Penn State-Shortened agitation times for the samples (shortened time means less chance for full discovery of Pathogens, technical please read study)</li> <li>•Penn State-Failed to Isolate S. Aureus (Staph) on samples</li> </ul>

Identification of Conflicts of Interest – EPA’s “Tire Crumb and Synthetic Turf Field Literature and Report List as of Nov. 2015”

	Study	Author(s)	Group(s)	Conflict of Interest?	Reason for Conflict of Interest	Notes
39.	<a href="#">Artificial Turf Pitches: An Assessment of Health Risks for Football Players and the Environment</a>	Norwegian Institute of Public Health and the Radium Hospital. (2006). Norwegian Institute of Public Health and the Radium Hospital, Oslo, Norway.	Norwegian Institute of Public Health and the Radium Hospital. (2006). Norwegian Institute of Public Health and the Radium Hospital, Oslo, Norway.	N	N/A	Demonstrated elevated Particulate Matter (PM) 2.5 and carbon black levels in indoor turf arenas that used crumb rubber infills.
40.	<a href="#">Measurement of Air Pollution in Indoor Artificial Turf Halls</a>	Dye C., Bjerke A, Schmidbauer N., Mano S. (2006).	Norwegian Pollution Control Authority/Norwegian Institute for Air Research, State Programme for Pollution Monitoring.	N	N/A	This study clearly demonstrated that crumb rubber infill in indoor turf halls generated significant amounts of fine respirable dust in the form of rubber particles and carbon black. (Crumb rubber in outdoor fields would obviously also generate significant amounts of fine respirable dust.) As the American Lung Association article explained, fine respirable dust in general, and carbon black in particular, are associated with numerous adverse health outcomes. There are no studies of fine respirable dust or carbon black exposure in the breathing space of field users during active field use conditions on indoor or outdoor fields. There are also no studies of the potential exposures to people living or attending class in buildings adjacent to artificial turf fields.
41.	<a href="#">Toxicological Evaluation for the Hazard Assessment of Tire Crumb for Use in Public Playgrounds</a>	Birkholz <sup>1</sup> et al. (2003). J Air Waste Manag, 53:903-07.	<sup>1</sup> Enviro-Test Laboratories, Edmonton, Alberta, Canada.	Y	Promotes recycling used tires (see note).	“The Tire Recycling Management Association of Alberta provided funding through the Alberta Centre for Injury Control and Prevention. Harold Hoffman reviewed the initial proposal and provided comments.” <a href="http://www.synturf.org/images/birkholz_crumb_safety_paper.pdf">http://www.synturf.org/images/birkholz_crumb_safety_paper.pdf</a>

## Recommendations for Studies to be Added

	Study	Author(s)	Group(s)	Conflict of Interest?	Reason for Conflict of Interest	Notes
<b>Crumb Rubber Components</b>						
42.	<a href="#">News Release: Many carcinogens found in Yale analysis of crumb rubber infill and playground mulch surfacing</a>	Benoit, G. (2015)	Yale University for Environment and Human Health, Inc.	N	N/A	EHHI is a non-profit organization. Yale researchers document that no toxicological information exists for approximately half of the 96 identified chemicals in crumb rubber; inadequate information is available on many other chemicals. <a href="http://seas.yale.edu/news-events/news/study-led-gaboury-benoit-looks-chemicals-synthetic-playing-surfaces-0">http://seas.yale.edu/news-events/news/study-led-gaboury-benoit-looks-chemicals-synthetic-playing-surfaces-0</a> <a href="http://www.ehhi.org/turf/findings0815.shtml">http://www.ehhi.org/turf/findings0815.shtml</a> <a href="http://www.ehhi.org/turf/metal_analysis2016.shtml">http://www.ehhi.org/turf/metal_analysis2016.shtml</a>
43.	Pilot study: characterizes chemical components of artificial turf, potential inhalation and dermal exposure to these chemicals	Harari, H. (Underway as of 2015)	Children's Environmental Health Center at Mount Sinai Hospital	N	N/A	<a href="http://www.slideshare.net/KatherineSouthwick1/cehc2015annualreport">http://www.slideshare.net/KatherineSouthwick1/cehc2015annualreport</a>
44.	<a href="#">Scrap Tire Mulch on Duluth Public Schools' Playgrounds</a>	North Shore Analytical for Duluth Parents for Healthy Playgrounds (2015).	North Shore Analytical for Duluth Parents for Healthy Playgrounds	N	N/A	Kirsling raised funds through a GoFundMe website

Recommendations for Studies to be Added

	Study	Author(s)	Group(s)	Conflict of Interest?	Reason for Conflict of Interest	Notes
45.	<a href="#">Identification of Benzothiazole Derivatives and Polycyclic Aromatic Hydrocarbons as Aryl Hydrocarbon Receptor Agonists Present in Tire Extracts</a>	<a href="#">He G<sup>1</sup></a> , <a href="#">Zhao B</a> , <a href="#">Denison MS</a> . Environ Toxicol Chem. 2011 August ; 30(8): 1915–1925. doi:10.1002/etc.581	<sup>1</sup> Department of Environmental Toxicology, University of California, Davis, California	N	N/A	“Leachate from rubber tire material contains a complex mixture of chemicals previously shown to produce toxic and biological effects in aquatic organisms. The ability of these leachates to induce Ah receptor (AhR)-dependent cytochrome P4501A1 expression in fish indicated the presence of AhR active chemicals, but the responsible chemicals and their direct interaction with the AhR signaling pathway were not examined. Using a combination of AhR-based bioassays, we have demonstrated the ability of tire extract to stimulate both AhR DNA binding and AhR-dependent gene expression and confirmed that the responsible chemicals were metabolically labile. The application of CALUX (chemical-activated luciferase gene expression) cell bioassay-driven toxicant identification evaluation not only revealed that tire extract contained a variety of known AhR-active polycyclic aromatic hydrocarbons but also identified 2-methylthiobenzothiazole and 2-mercaptobenzothiazole as AhR agonists. Analysis of a structurally diverse series of benzothiazoles identified many that could directly stimulate AhR DNA binding and transiently activate the AhR signaling pathway and identified benzothiazoles as a new class of AhR agonists. In addition to these compounds, the relatively high AhR agonist activity of a large number of fractions strongly suggests that tire extract contains a large number of physiochemically diverse AhR agonists whose identities and toxicological/biological significances are unknown.”

## Recommendations for Studies to be Added

	Study	Author(s)	Group(s)	Conflict of Interest?	Reason for Conflict of Interest	Notes
46.	<a href="#">Release of Polycyclic Aromatic Hydrocarbons and Heavy Metals from Rubber Crumb in Synthetic Turf Fields: Preliminary Hazard Assessment for Athletes</a>	Marsili L, Coppola D, Bianchi N, Maltese S, Bianchi M (2015) J Environ Anal Toxicol 5: 265. doi:10.4172/2161-0525.1000265	<sup>1</sup> Department of Physical Sciences, Earth and Environment, Siena University, Via Mattioli 4, 53100 Siena, Italy. <sup>2</sup> Department of Political Science and International, Siena University, Via Mattioli 10, 53100 Siena, Italy.	N	N/A	<p>“Synthetic turf, made with an infill of rubber crumb from used tyres or virgin rubber, is now common in many sporting facilities. It is known that it contains compounds such as polycyclic aromatic hydrocarbons (PAHs) and heavy metals. We evaluated in nine samples of rubber crumb the total content of some heavy metals (Zn, Cd, Pb, Cu, Cr, Ni, Fe) normally found in tyres by microwave mineralization and the levels of the 14 US EPA priority PAHs by Soxhlet extraction and HPLC analysis. The results showed high levels of PAHs and zinc in all rubber crumb samples compared to rubber granulate limits set by Italian National Amateur League (LND). Following the precautionary principle, a risk assessment at 25°C was done, using the Average Daily Dose (ADD) assumed by athletes, expressed in terms of mass of contaminant per unit of body weight per day (mg/kg day), and the Lifetime Average Daily Dose (LADD) and then evaluating the Hazard Index (HI) and the Cumulative Excess Cancer Risk (<math>\sum</math>ECR). In the different rubber granulates samples the HI ranges from a minimum of <math>8.94 \times 10^{-7}</math> to a maximum of <math>1.16 \times 10^{-6}</math>, while the <math>\sum</math>ECR ranges from a minimum of <math>4.91 \times 10^{-9}</math> to a maximum of <math>1.10 \times 10^{-8}</math>.</p> <p>Finally, the aim of this study was to estimate the “hazard” for athletes inhaling PAHs released at the high temperatures this synthetic turf may reach. Then a sequence of proofs was carried out at 60°C, a temperature that this rubber crumb can easily reach in sporting installations, to see whether PAH release occurs. The toxicity equivalent (TEQ) of evaporates from rubber crumb is not negligible and represents a major contribution to the total daily intake of PAHs by different routes.”</p>



## Recommendations for Studies to be Added

	Study	Author(s)	Group(s)	Conflict of Interest?	Reason for Conflict of Interest	Notes
47.	<a href="#">Hazardous organic chemicals in rubber recycled tire playgrounds and pavers</a>	Llompарт, M. <sup>a</sup> , Sanchez-Prado, L. <sup>a</sup> , Lamas, J. P. <sup>a</sup> , Garcia-Jares C. <sup>a</sup> , Roca, E. <sup>b</sup> , Dagnac, T. <sup>c</sup> (2013). Chemosphere, 423-431.	<p><sup>a</sup>Departamento de Quimica Analitica, Nutricion y Bromatologia, Facultad de Quimica, Universidad de Santiago de Compostela, Santiago de Compostela 15782, Spain.</p> <p><sup>b</sup>Departamento de Ingeniería Química, Escuela de Ingeniería, Universidad de Santiago de Compostela, Santiago de Compostela 15782, Spain.</p> <p><sup>c</sup>INGACAL (Galician Institute for Food Quality)–CIAM (Agrarian and Agronomic Research Centre), Laboratory of Food/Feed Safety and Organic Contaminants, Apartado 10, E-15080 A Coruña, Spain.</p> <p>*Corresponding author. Tel.: +34 881814225. E-mail address: <a href="mailto:maria.llompart@usc.es">maria.llompart@usc.es</a> (M. Llompарт)</p>	N	N/A	“In this study, the presence of hazardous organic chemicals in surfaces containing recycled rubber tires is investigated. Direct material analyses using solvent extraction, as well as SPME analysis of the vapour phase above the sample, were carried out. Twenty-one rubber mulch samples were collected from nine different playgrounds. In addition, seven commercial samples of recycled rubber pavers were acquired in a local store of a multinational company. All samples were extracted by ultrasound energy, followed by analysis of the extract by GC–MS. The analysis confirmed the presence of a large number of hazardous substances including PAHs, phthalates, antioxidants (e.g. BHT, phenols), benzothiazole and derivatives, among other chemicals. The study evidences the high content of toxic chemicals in these recycled materials. The concentration of PAHs in the commercial pavers was extremely high, reaching values up to 1%. In addition, SPME studies of the vapour phase above the samples confirm the volatilisation of many of those organic compounds. Uses of recycled rubber tires, especially those targeting play areas and other facilities for children, should be a matter of regulatory concern.”

Recommendations for Studies to be Added

	Study	Author(s)	Group(s)	Conflict of Interest?	Reason for Conflict of Interest	Notes
48.	<a href="#">Empire State Consumer Project 2015 Children's Products Safety Report</a>	Chittenden, C., Muir, E. (2015). (Artificial Turf pp. 18-20, Artificial Mulch pp.21-22, Attachments pp. 32-33.)	Empire State Consumer Project, Inc.	N	N/A	<p>Non-profit organization</p> <p>"The attached table (last page of attached) lists results obtained on materials used in rubber mulch. Rubber mulch is made of ground recycled tires like those used for making artificial turf fields. The mulch is advertised as a garden and playground mulch. Some products are marked "Playground safety tested." There are no government standards for testing the safety of rubber mulch for playground use or for garden use. The East Rochester, New York school district is using Nike Grind for the infill on its artificial turf field.</p> <p>Among other health effects caused by arsenic and cadmium, both are known to be human carcinogens (cancer classification NTP). Zinc is known to cause respiratory and digestive health effects, and pancreatic and kidney damage <a href="http://www.atsdr.cdc.gov/substances/index.asp">http://www.atsdr.cdc.gov/substances/index.asp</a>. Inhalation, ingestion, and dermal exposure to toxic chemicals are all concerns where children play. Where foods are grown for human consumption, toxic chemicals potentially leaching into plants is also a concern that warrants study.</p> <p><b>We have included only chemicals that show levels higher than current acceptable limits. The 'limits' are NYS DEC soil cleanup guidelines for brownfields. These are minimum requirements and do not imply safety. Limits must be adjusted downward when multiple chemicals are found together.</b> US EPA limits for groundwater and wildlife exposure have not been included.</p> <p>Although some chemicals show values below equipment detection limits, in some cases, detection limits may be higher than DEC limits; these chemicals warrant further analysis."</p>

## Recommendations for Studies to be Added

	Study	Author(s)	Group(s)	Conflict of Interest?	Reason for Conflict of Interest	Notes
<b>Particulate Matter (PM)</b>						
49.	<a href="#">American Lung Association, non-profit: State of the Air 2015: Particle Pollution</a>	American Lung Association. (2015).	American Lung Association (2015)	N	N/A	This article explains health risks associated with respirable dust, or the PM 10 and PM 2.5 and carbon black that you have been hearing about. (PM size 10 microns, or 2.5 microns and smaller, is abbreviated as PM 10 and PM 2.5.) Short-term exposure risks include increased severity of asthma attacks in children; increased hospitalizations for asthma in children; death from respiratory and cardiovascular disease, including stroke; and increased numbers of heart attacks.
<b>Toxicity</b>						
50.	<a href="#">Carbon nanotubes introduced into the abdominal cavity of mice show asbestos-like pathogenicity in a pilot study</a>	Poland Craig A, et al. Nature Nanotechnology 2008. 3: 423-428.		N	N/A	
51.	<a href="#">Supplementary Guidance for Conducting Health Risk Assessment of Chemical Mixtures</a>	EPA Risk Assessment Forum Technical Panel. (2000). Washington DC.	U.S. Environmental Protection Agency			<b>Thus far, risk assessments on crumb rubber, a complex chemical mixture, have not been conducted in a manner consistent with these guidelines.</b>  The guidelines define a complex mixture thus: "A mixture containing so many components that any estimation of its toxicity based on its components' toxicities contains too much uncertainty and error to be useful...Risk assessments of complex mixtures are preferably based on toxicity and exposure data on the complete mixture..." Appendix B p.2

## Recommendations for Studies to be Added

	Study	Author(s)	Group(s)	Conflict of Interest?	Reason for Conflict of Interest	Notes
52.	<a href="#">Assessing the carcinogenic potential of low-dose exposures to chemical mixtures in the environment: the challenge ahead</a>	Goodson, W. H., Lowe, L., & al, e. (2015). Carcinogenesis, S254-S296.	(Over 141 affiliations; see hyperlink.)	N	N/A	This paper reports that the World Health Organization and the International Agency for Research on Cancer (IARC) suggest that the fraction of cancers attributable to toxic environmental exposures is between 7% and 19% of all cancers; other sources suggest the proportion of cancers due to unknown causes may be much higher. Supported by over 500 references, this paper presents evidence of physiologic mechanisms that predict/explain how chemicals that are not carcinogens when acting alone (heavy metals, endocrine disruptors, and others) can collectively work through different pathways (such as immune suppression) at different points in time to ultimately induce cancer. Note: Other articles in the supplement would also prove relevant.
53.	<a href="#">Toxicity and metabolism of methylnaphthalenes: Comparison with naphthalene and 1-nitronaphthalene</a>	Lin, C. Y., Wheelock, A. M., Morin, D., Baldwin, R. M., & al, e. (2009). Toxicology, 16-27.		N	N/A	
54.	<a href="#">Automobile Tires a Potential Source of Highly Carcinogenic Dibenzopyrenes to the Environment</a>	Ioannis Sadiktsis, et al. Environ. Sci. Technol. Feb 21, 2012, 46, 3326–3334.		N	N/A	“...Through the release of PAHs from stockpiled scrap tires, PAH emissions from pyrolysis of scrap tires or leaching of PAHs from recycled tire rubber material, tires are a source of environmental pollution of PAHs throughout their entire lifecycle.”

Recommendations for Studies to be Added

	Study	Author(s)	Group(s)	Conflict of Interest?	Reason for Conflict of Interest	Notes
Health Effects						
55.	<a href="#">Determination of Microbial Populations in a Synthetic Turf System</a>	Bass, Jason J. and Hintze, David W. (2013)	Weber State University	N	N/A	<p><b>Sample Size of Infill Material Being Tested</b></p> <ul style="list-style-type: none"> <li>• Penn State-.075 Grams</li> <li>• Weber State-10 Grams</li> </ul> <p><b>Collection Time Frame of Samples</b></p> <ul style="list-style-type: none"> <li>• Penn State-15 days, June only.</li> <li>• Weber State-Once a week for 14 weeks. Very controlled samples.</li> </ul> <p><b>Location of Samples</b></p> <ul style="list-style-type: none"> <li>• Penn State-“High Use” and “Low Use” areas.</li> <li>• Weber State-1) Sideline, 2) 50 Yard Line and 3) end of field. 3 locations and same locations on both new and old field being sampled.</li> </ul> <p><b>Time of Study</b></p> <ul style="list-style-type: none"> <li>• Penn State-Height of Summer when field temperatures were at the peak.</li> <li>• Weber State-Height of the Actual Football Season when the fields were in use.</li> </ul> <p><b>Technical Issues of reasons why the Penn St study did not find Pathogens (Staph)</b></p> <ul style="list-style-type: none"> <li>• Penn State-Shortened agitation times for the samples (shortened time means less chance for full discovery of Pathogens, technical please read study)</li> <li>• Penn State-Failed to Isolate S. Aureus (Staph) on samples</li> </ul>

Recommendations for Studies to be Added

	Study	Author(s)	Group(s)	Conflict of Interest?	Reason for Conflict of Interest	Notes
56.	<a href="#">A High-Morbidity Outbreak of Methicillin-Resistant Staphylococcus aureus among Players on a College Football Team, Facilitated by Cosmetic Body Shaving and Turf Burns</a>	Elizabeth M. Begier <sup>1,4</sup> , Kasia Frenette <sup>1</sup> , Nancy L. Barrett <sup>1,2</sup> , Pat Mshar <sup>1</sup> , Susan Petit <sup>1,2</sup> , Dave J. Boxrud <sup>5</sup> , Kellie Watkins-Colwell <sup>3</sup> , Sheila Wheeler <sup>3</sup> , Elizabeth A. Cebelinski <sup>5</sup> , Anita Glennen <sup>5</sup> , Dao Nguyen <sup>4,6</sup> , James L. Hadler <sup>1</sup> , The Connecticut Bioterrorism Field Epidemiology Response Team <sup>a</sup>	<sup>1</sup> Infectious Diseases Division, Hartford <sup>2</sup> Connecticut Active Bacterial Core Surveillance Project, Connecticut Department of Public Health, Hartford <sup>3</sup> Student Health Services of Sacred Heart University, Fairfield, Connecticut <sup>4</sup> Epidemic Intelligence Service Program, Centers for Disease Control and Prevention, Atlanta, Georgia <sup>5</sup> Division of Public Health Laboratories, Minnesota Department of Public Health, Minneapolis, Minnesota <sup>6</sup> Los Angeles County Department of Health Services, Los Angeles, California	N	N/A	“Potential conflicts of interest. All authors: No conflict.” “Players who sustained turf burns had a risk of infection that was 7 times higher than that for players without turf burns... MRSA was likely spread predominantly during practice play, with skin breaks facilitating infection. Measures to minimize skin breaks among athletes should be considered, including prevention of turf burns and education regarding the risks of cosmetic body shaving. MRSA-contaminated pool water may have contributed to infections at covered sites, but small numbers limit the strength of this conclusion. Nevertheless, appropriate whirlpool disinfection methods should be promoted among athletic trainers.”
57.	<a href="#">Synthetic Turf Heat Evaluation – Progress Report</a>	Penn State’s Center for Sports Surface Research. (January 2012).	Penn State’s Center for Sports Research	Y	Penn State has a partnership with FieldTurf.	Lowest temp in a test of synthetic fields on an average 76 degree air temp day...154. See pp. 12-14 for outdoor testing."No product in this test substantially reduced surface temperature compared to the traditional system of green fibers filled with black rubber in both the indoor and outdoor test. Reductions of five or even ten degrees offer little advantage when temperatures still exceed 150 °F. Until temperatures can be reduced by at least twenty or thirty degrees for an extended period of time, surface temperature will remain a major issue on synthetic turf fields."

## Recommendations for Studies to be Added

	Study	Author(s)	Group(s)	Conflict of Interest?	Reason for Conflict of Interest	Notes
58.	<a href="#">Synthetic Surface Heat Studies</a>	Williams, C.F., and Pulley, G.E. (2002)	Brigham Young University	N	N/A	
59.	<a href="#">Associations between health effects and particulate matter and black carbon in subjects with respiratory disease</a>	Jansen Karen L., et al. Environ Health Perspect. 2005. 113:12: 1741–1746.		N	N/A	
60.	<a href="#">Acute respiratory inflammation in children and black carbon in ambient air before and during the 2008 Beijing Olympics</a>	Lin W., et al. Environ Health Perspect. 2011 Oct;119:10:1507-12.		N	N/A	
61.	<a href="#">Association of black carbon with cognition among children in a prospective British cohort study</a>	Sugilia S. Franco, et al. American Journal of Epidemiology 2007, 167:3:280-286.		N	N/A	
62.	<a href="#">Does traffic exhaust contribute to the development of asthma and allergic sensitization in children: findings from recent cohort studies</a>	Lennart, B. Bertil, F. Environmental Health 2009, 8:17.		N	N/A	

## Recommendations for Studies to be Added

	Study	Author(s)	Group(s)	Conflict of Interest?	Reason for Conflict of Interest	Notes
63.	<a href="#">Occupational Exposure in the Rubber Manufacturing Industry</a>	IARC Monographs Volume 100F, Supplementary Web Tables, Section 2, Cancer in Humans. IARC Monographs on the Evaluation of Carcinogenic Risks to Humans.	World Health Organization (WHO), International Agency for Research on Cancer (IARC)	N	N/A	These web tables formed part of the original submission and have been peer reviewed. They are posted as supplied by the Working Group. Readers are requested to report any errors to: <a href="mailto:edit-vol100F@iarc.fr">edit-vol100F@iarc.fr</a> .
64.	<a href="#">Tire-Derived Flooring Chemical Emissions Study and Indoor Reference Exposure Levels (iRELs)</a>	Office of Environment Health Hazard Assessment's (OEHHA), CalRecycle, California Department of Public Health's (CDPH). 2011.	Office of Environment Health Hazard Assessment's (OEHHA), CalRecycle, California Department of Public Health's (CDPH)	Y	CalRecycle, as part of OEHHA, promotes recycling used tires.	
65.	<a href="#">Dermal exposure to chemicals in the workplace: just how important is skin absorption?</a>	Semple, S. Department of Environmental & Occupational Medicine, University of Aberdeen, Foresterhill, Aberdeen AB25 2ZD, UK. Occup Environ Med 2004;61:376-382 doi:10.1136/oem.2003.010645.	Department of Environmental & Occupational Medicine, University of Aberdeen	N	N/A	



Recommendations for Studies to be Added

	Study	Author(s)	Group(s)	Conflict of Interest?	Reason for Conflict of Interest	Notes
66.	<a href="#">Nanotechnology: Toxicologic Pathology</a>	<p><a href="#">Ann F. Hubbs</a>,<sup>1</sup> <a href="#">Linda M. Sargent</a>,<sup>1</sup> <a href="#">Dale W. Porter</a>,<sup>1</sup> <a href="#">Tina M. Sager</a>,<sup>1</sup> <a href="#">Bean T. Chen</a>,<sup>1</sup> <a href="#">David G. Frazer</a>,<sup>1</sup> <a href="#">Vincent Castranova</a>,<sup>1</sup> <a href="#">Krishnan Sriram</a>,<sup>1</sup> <a href="#">Timothy R. Nurkiewicz</a>,<sup>2</sup> <a href="#">Steven H. Reynolds</a>,<sup>1</sup> <a href="#">Lori A. Battelli</a>,<sup>1</sup> <a href="#">Diane Schwegler-Berry</a>,<sup>1</sup> <a href="#">Walter McKinney</a>,<sup>1</sup> <a href="#">Kara L. Fluharty</a>,<sup>1</sup> and <a href="#">Robert R. Mercer</a><sup>1</sup></p> <p>Toxicol Pathol. Author manuscript; available in PMC 2015 Dec 1.</p> <p>Published in final edited form as:</p> <p><a href="#">Toxicol Pathol. 2013 Feb; 41(2): 395–409.</a></p> <p>Published online 2013 Feb 6. doi: <a href="#">10.1177/0192623312467403</a></p> <p>PMCID: PMC4665093 NIHMSID: NIHMS723787</p>	<p><sup>1</sup>Health Effects Laboratory Division, National Institute for Occupational Safety and Health, Morgantown, West Virginia</p> <p><sup>2</sup>Center for Cardiovascular and Respiratory Sciences, West Virginia University School of Medicine, Morgantown, West Virginia</p> <p>Address correspondence to: Ann F. Hubbs, Health Effects Laboratory Division, National Institute for Occupational Safety and Health, Centers for Disease Control and Prevention, 1095 Willowdale Rd, Morgantown, WV 26505; Email: <a href="mailto:vog.cdc@sbbuha">vog.cdc@sbbuha</a></p>	N	N/A	

## Recommendations for Studies to be Added

	Study	Author(s)	Group(s)	Conflict of Interest?	Reason for Conflict of Interest	Notes
67.	<a href="#">nanoCOLT - Long-term effect of modified carbon black nanoparticles on healthy and damaged lungs</a>	Prof. Dr. Bernd Müller, <a href="#">Philipps-University of Marburg</a> , Marburg (DE) <a href="#">Press Release (16.10.2014, in GERMAN only)</a> . <i>Biowissenschaftler erforschen Auswirkungen von Nanopartikeln - Marburger Lungenspezialist leitet bundesweiten Forschungsverbund</i> (uni-marburg.de)	FB 20 Medizin und Universitätsklinikum - <a href="#">Klinik für Innere Medizin - Pneumologie</a> , <a href="#">Philipps-University of Marburg</a> , Marburg (DE), <a href="#">Institut für Anatomie - AG Barriere-Organ</a> , <a href="#">University Lübeck</a> , Lübeck (DE), <a href="#">Fraunhofer Institute for Toxicology and Experimental Medicine</a> (ITEM), Hannover (DE), <a href="#">Engler-Bunte-Institute - Division of Combustion Technology</a> (EBI vbt), <a href="#">Karlsruhe Institute of Technology</a> (KIT), Karlsruhe (DE), <a href="#">Experimental Pneumology, Research Center Borstel</a> - Leibniz-Center for Medicine and Biosciences, Borstel (DE)	N	N/A	
68.	<a href="#">Toxicological Profile for Synthetic Vitreous Fibers</a>	Syracuse Research Corporation for U.S. Department of Health and Human Services, Public Health Service, Agency for Toxic Substances and Disease Registry. 2004.	Syracuse Research Corporation for U.S. Department of Health and Human Services, Public Health Service, Agency for Toxic Substances and Disease Registry.	N	N/A	

## Recommendations for Studies to be Added

	Study	Author(s)	Group(s)	Conflict of Interest?	Reason for Conflict of Interest	Notes
69.	<a href="#">International Agency for Research on Cancer (IARC) - Summaries &amp; Evaluations: The Rubber Industry (Group 1)</a>	International Agency for Research on Cancer (IARC).	International Agency for Research on Cancer (IARC).	N	N/A	
70.	<a href="#">Work Environments and Exposure to Hazardous Substances in Korean Tire Manufacturing</a>	<a href="#">Naroo Lee</a> <sup>1</sup> <a href="#">Byung-kyu Lee</a> , <sup>2</sup> <a href="#">Sijeong Jeong</a> , <sup>2</sup> <a href="#">Gwang Yong Yi</a> , <sup>1</sup> and <a href="#">Jungah Shin</a> <sup>1</sup> Saf Health Work. 2012 Jun; 3(2): 130–139. Published online 2012 Jun 8. doi: <a href="#">10.5491/SHAW.2012.3.2.130</a> PMCID: PMC3440462.	<sup>1</sup> Occupational Safety and Health Research Institute, Incheon, Korea. <sup>2</sup> Korea Occupational Safety and Health Agency, Incheon, Korea. Corresponding author. Correspondence to: Naroo LEE. Occupational Safety and Health Research Institute, Korea Occupational Safety and Health Agency, 478, Munemi-ro, Bupyeong-gu, Incheon 403-711, Korea. Tel: +82-32-510-0802, Fax: +82-32-518-0864, Email: <a href="mailto:ten.ahsok@eelooran">ten.ahsok@eelooran</a>	N	N/A	

## Recommendations for Studies to be Added

	Study	Author(s)	Group(s)	Conflict of Interest?	Reason for Conflict of Interest	Notes
71.	<a href="#">Urban Airborne Particulate Matter: Origin, Chemistry, Fate and Health Impacts</a>	Springer-Verlag Berlin Heidelberg. Edited by Fathi Zereini, Clare L. S. Wiseman. 2010.	Institute for Atmospheric and Environmental Sciences. Department of Environmental Analytical Chemistry, J.W. Goethe-University. Adaptation and Impacts Research Group. Institute for Environmental Studies. University of Toronto.	N	N/A	
72.	<a href="#">Effects of Chemical Co-exposures at Doses Relevant for Human Safety Assessments</a>	European Centre for Ecotoxicology and Toxicology of Chemical (ECETOC). Technical Report No. 115. ISSN-0773-8072-115 (print). ISSN -2079-1526-115 (online). Brussels, July 2012.	European Centre for Ecotoxicology and Toxicology of Chemical (ECETOC)	N	N/A	
73.	<a href="#">Leaching of Phenols from Tire Shreds in a Noise Barrier</a>	Håøya, A.O. <sup>1</sup> , Aabøe, R. <sup>2</sup> , Edeskär, T. <sup>3</sup> .	<sup>1</sup> RAMBØLL. <sup>2</sup> Norwegian Public Roads Authorities, (NPRA) Norway. <sup>3</sup> Luleå University of Technology, Sweden.	N	N/A	

Other Data for Consideration

	Title	Author(s)	Group(s)	Conflict of Interest?	Reason for Conflict of Interest	Notes
<b>News Reports/Video</b>						
74.	<a href="#">Field Turf admits lead is in their [artificial turf] product but opposes signs to inform the public</a>	YouTube posted (April 7, 2016).	SF Parks	N	N/A	Video “March 11, 2016 testimony by Field Turf Mid-Atlantic Sales representative to the Ways and Means Committee of the Maryland General Assembly in a hearing on HB883 seeking to require informational signs at the entrance to artificial turf fields regarding precautions recommended by the CDC to safeguard children from exposures to lead. When asked by Delegate Mary Washington (D43, Baltimore City) about the status of a law suit against Field Turf regarding lead content, and whether Field Turf's artificial turf products contain lead, the response was ‘Yes, there is lead in our product.’” Yet Field Turf opposes HB883.”
75.	<a href="#">NBC News - How Safe is the Artificial Turf on Your Child's Sports Field ? (cancer)</a>	Gosk, S.	NBC News	N	N/A	Video
76.	<a href="#">Is Rubber Mulch a Safe Surface for Your Child's Playground?</a>	Rappleeye, H., Gosk, S., Monahan, K., Alba, M.	NBC News	N	N/A	Video
77.	<a href="#">E:60 Sports Matter: Turf Wars: How Safe Are The Fields Where We Play?</a>	Foudy, J. (November 24, 2015).	ESPN	N	N/A	Video

Other Data for Consideration

	Title	Author(s)	Group(s)	Conflict of Interest?	Reason for Conflict of Interest	Notes
78.	<a href="#">Children and synthetic turf</a>	Forman, J., Landrigan, P., Brown, D., Michels, K., Alderman, N.	Mount Sinai School of Medicine, Children's Environmental Health Center at Mount Sinai Hospital, Environment and Human Health, Inc.	N	N/A	Video includes pediatricians, toxicologists and others discussing plastic turf in addition to other toxins.
79.	<a href="#">The Health Hazards of Artificial Turf Crumb Rubber Playing Fields</a>	Landrigan, P.	Children's Environmental Health Center at Mount Sinai Hospital	N	N/A	Video
80.	<a href="#">Are we treating women athletes like guinea pigs?</a>	International News Review	International News Review	N	N/A	Video
81.	<a href="#">Playground Hazards: Are Rubber Chips Toxic?</a>	Enninga, H.	WDIO-TV, LLC	N	N/A	<p>Video</p> <p>"'He would come home with a black dust on him,' Kirsling said. 'It would be all over his legs. I mean, his legs would be black if he wore shorts.'</p> <p>Then one day this May, Kirsling said he realized those playground drawbacks might be more serious.</p> <p>'(Jack) would come home and he would blow his nose, and it would be gray from the dust,' Kirsling said. He would say, 'I have a headache. I have a scratchy throat.'</p> <p>After Kirsling spoke to other parents who had also noticed similar symptoms, his initial endearment turned to alarm.</p> <p>'It seems very odd that more than one child is coming home and saying the same things,' Kirsling said. 'Something doesn't seem right here.'"</p> <p>See: <a href="#">Scrap Tire Mulch on Duluth Public Schools' Playgrounds</a></p>

Other Data for Consideration

	Title	Author(s)	Group(s)	Conflict of Interest?	Reason for Conflict of Interest	Notes
82.	<a href="#">Student suffers severe injuries during punishment</a>	Smith, M.	ABC 7 KVIA	N	N/A	<p>Video</p> <p>“It took less than 200 yards for Brandon Chacon, 15, to bruise and blister his hands beyond recognition Tuesday. Chacon, taking part in a football drill known as "bear crawls," is now unable to play football all because of a punishment administered by an assistant coach...</p> <p>On Tuesday the temperature was around 96 degrees... Studies done by Penn State University show that turf, like the kind on El Dorado's new football field, can see temperatures 35-55 degrees hotter than normal grass. Previous studies done by Texas A&amp;M show turf can reach temperature above 160 degrees in the state of Texas.”</p>
83.	<a href="#">Football player burns hand on hot turf after coach's practice punishment</a>	Newton, J.	News 8 WTNH	N	N/A	<p>Video</p> <p>“...players at Stratford High, forced to crawl on the artificial turf with their bare hands during the September heat wave. Pictures...showing one student-athlete's hand with a huge blister covering most of his palm. Apparently caused by the extreme temperature of the turf, against his bare skin.</p> <p>‘Ridiculous. That was insane. That can cause an infection,’ said Felicia Murray, who has a daughter at the school.</p> <p>Our own thermometer showed temperatures of the artificial grass hovering around 150 degrees.”</p>

## Other Data for Consideration

	Title	Author(s)	Group(s)	Conflict of Interest?	Reason for Conflict of Interest	Notes
<b>Other Testimonial</b>						
84.	<a href="#">Life After Crumb Rubber</a>	Lindstrum, A. Playground Underlayment Committee.	Playground Underlayment Committee	N	N/A	“The Crumb Rubber underlayment was unacceptable to many parents for a variety of reasons. It off-gassed heavily year-round, though it was much stronger in hot weather. The smell had a strong chemical quality to it, similar to industrial solvents and tires. A number of adults and children reacted strongly to the Crumb Rubber after being on the playground for only minutes. Some had allergic reactions and had to get medical attention. Others got headaches and nausea. Enough people reacted strongly enough that the school had an unusually difficult time scheduling volunteers for playground duty during recess...”
<b>Overviews</b>						
85.	<a href="#">Written Testimony before the Connecticut General Assembly on Children</a>	Wright, R., Evans, S. (2016).	Children's Environmental Health Center at Mount Sinai Hospital	N	N/A	Testimony in Support of Raised Bill 5139, An Act Concerning the Use of Recycled Tire Rubber at Municipal and Public School Playgrounds. “Given the hazards associated with recycled tire rubber, it is our recommendation that these products never be used as surfaces where children play.”
86.	<a href="#">Dr. Landrigan Answers Back-to-School Questions</a>	Landrigan, P.	Children's Environmental Health Center at Mount Sinai Hospital	N	N/A	
87.	Reducing Environmental Cancer Risk: What We Can Do Now	President’s Cancer Panel. (2010). Bethesda: U.S. Department of Health and Human Services.		N	N/A	



Other Data for Consideration

	Title	Author(s)	Group(s)	Conflict of Interest?	Reason for Conflict of Interest	Notes
88.	<a href="#">Substantial contribution of extrinsic risk factors to cancer development</a>	Wu, S., Powers, S., Wei, Z., & Hannun, Y. A. (2016). Nature, 43-47.		N	N/A	
89.	<a href="#">Artificial Turf: Exposures to Ground Up Rubber Tires on Athletic Fields and Playgrounds</a>	Environment and Human Health, Inc. (EHHI)	Environment and Human Health, Inc. (EHHI)	N	N/A	Non-profit organization
90.	<a href="#">Overview of the Risks of Synthetic Turf Fields</a>	Brown, D.	Environment and Human Health, Inc. (EHHI). (April 4, 2015).	N	N/A	Non-profit organization Dr. David Brown, among other qualifications, is a former Deputy Director of The Public Health Practice Group of ATSDR at the CDC. In this article, he details weaknesses in scientific studies and holes in the “collective database” to date. This overview outlines why children are specifically at higher risk to toxins, and why he and many other epidemiologists, toxicologists, and public health officials are concerned about crumb rubber. Instead of conducting research proactively, prior to health effects, Dr. Brown asserts that “a natural experiment is being conducted in which thousands of children are being exposed on playing fields to rubber 1) known to contain carcinogens and 2) documented to produce cancer in workers in the tire manufacturing plants.”
91.	<a href="#">Fact Sheet: CPSC, EPA &amp; CDC on Artificial Turf Safety &amp; Precautions</a>	Safe Healthy Playing Fields Coalition. (July, 2015).	Safe Healthy Playing Fields Coalition	N	N/A	Non-profit organization The Consumer Product Safety Commission (CPSC) and the Environmental Protection Agency (EPA) have retracted prior assurances regarding artificial turf, in acknowledgement of multiple concerns raised by the scientific community and the public. The Centers for Disease Control and Prevention (CDC) identifies artificial turf as one of seven sources of lead exposure for children.

## Other Data for Consideration

	Title	Author(s)	Group(s)	Conflict of Interest?	Reason for Conflict of Interest	Notes
92.	<a href="#">Crumb Rubber</a>	Gilbert, S.	Toxipedia	N	N/A	Provides thorough overview of crumb rubber.
93.	<a href="#">Tire Crumb Synthetic Turf Study Reference Materials</a>		QWERTY Media Resources	N	N/A	“This resource is being posted and maintained for educational, journalistic, and reference purposes. The content continues to be vetted and updated for factual accuracy.” Provides thorough overview of synthetic turf including history.
<b>News Articles</b>						
94.	<a href="#">Texas Football Succumbs to Virulent Staph Infection From Turf</a>	Epstein, V. Bloomberg. (December 21, 2007).	Bloomberg L.P.	N	N/A	Player suffers from MRSA recurrence via turf burn/Texas has 16x higher player MRSA infection rate than national avg. “Mom, I can't move my arms or legs.” Boone, 16, wide receiver, ‘was suffering from a recurrence of...MRSA, which his doctor said he got through an abrasion from playing on artificial turf,’ Baker said. Texas has artificial turf at 18 percent of its high school football stadiums, according to Web site Texasbob.com. It also has an MRSA infection rate among players that is 16 times higher than the estimated national average, according to three studies by the Texas Department of State Health Services.”
95.	<a href="#">DCR removes tire mulch from local playgrounds</a>	Oliveira, R. Jamaica Plain Gazette. (December 3, 2010).	Jamaica Plain Gazette	N	N/A	“The JP Moms group’s efforts to get rid of the rubber mulch were based on fears that regular exposure to volatile organic compounds in the tires might have long-term negative health impacts. Some also said that exposure to the tires caused them to have respiratory issues, and complained that the light-weight material is easily spread throughout the park and carried home in children’s’ clothes.”

Other Data for Consideration

	Title	Author(s)	Group(s)	Conflict of Interest?	Reason for Conflict of Interest	Notes
96.	<a href="#">Feds promote artificial turf as safe despite health concerns</a>	Frank, T. USA Today. (March 16, 2015).	USA Today.	N	N/A	The article describes how the Synthetic Turf Council has mischaracterized the results of some studies on artificial turf fields and has ignored scientists' warnings about children possibly ingesting lead in turf and tire crumbs. The article describes the differing opinions of different health departments, and how the EPA ignored internal warnings from its scientists. It also discusses how the CPSC pronounced artificial turf, 'safe to play on,' whereas the CDC listed artificial turf as one of the top sources of lead exposure, along with paint and costume jewelry, for children.
97.	<a href="#">Critics say EPA played dual role in recycled tire controversy</a>	Gutierrez, M. San Francisco Chronicle. (February 21, 2015).	San Francisco Chronicle.	N	N/A	This article discusses the EPA's role in promoting the use of crumb rubber and how it ignored its own scientist's concerns about the safety of using crumb rubber in children's play areas. It also discusses the apparent link between crumb rubber and increased lymphoma and leukemia incidence in soccer players.
98.	<a href="#">Combinations of 'safe' chemicals may increase cancer risk, study suggests</a>	Harris-Lovett, S. Los Angeles Times. (July 1, 2015).	Los Angeles Times	N	N/A	<p>"...it's plausible that consuming mixtures of these chemicals is riskier than consuming any one individually.</p> <p>'To me, it's not a surprise,' said Birnbaum (Director of the National Institute of Environmental Health Sciences, NIEHS, of the NIH). Scientists know that small effects from many chemicals can add up to cause other diseases, she said. For instance, chemicals known as endocrine disruptors can lead to neurological, immune system and reproductive problems, among others.</p> <p>Considering the safety of individual chemicals is a lot like looking at the trees, but missing the forest, Birnbaum said.</p>

Other Data for Consideration

	Title	Author(s)	Group(s)	Conflict of Interest?	Reason for Conflict of Interest	Notes
						<p>When doing research to determine chemical safety, 'we've got to start thinking more about what reality is,' she said.</p> <p>This could mean sweeping changes in rules about the levels of chemicals considered safe in drinking water, food, and air.</p> <p>'I'd like to see regulators and policy makers start looking at the totality of the exposure instead of one chemical at a time,'" she said.</p>
<b>Other Miscellaneous</b>						
99.	Bioavailability Study Models	N/A	N/A	N	N/A	<p>When reading the details of all the bioavailability studies, shreds and crumbs are used even when modeling bioavailability in simulated lung fluid. Athletes are not inhaling crumbs because the crumbs aren't floating in the air! They are inhaling PM 2.5 and PM 10 which remain in the lungs for days to months, not 24 hours. Similarly, ingestion is crumbs and dust via hand to mouth behavior. A half inch long shred is not a good model.</p>
100	<a href="#">Human Rights Tribunal of Ontario between Players on National Teams Participating in the FIFA Women's World Cup Canada and Canadian Soccer Association, Fédération Internationale de Football Association</a>	<p>Boies, Schiller &amp; Flexner LLP</p> <p>Ryder, Wright, Blair &amp; Holmes LLP</p> <p>Osler, Hoskin &amp; Harcourt LLP</p> <p>(September 23, 2014).</p>	<p>Boies, Schiller &amp; Flexner LLP</p> <p>Ryder, Wright, Blair &amp; Holmes LLP</p> <p>Osler, Hoskin &amp; Harcourt LLP</p>	N	N/A	<p>Synthetic turf named "inferior, dangerous and discriminatory."</p> <p>Suit filed against FIFA January 2015: discrimination for forcing to play on synthetic turf, World Cup 2015. The women dropped it, due to FIFA's lack of response, and some players said FIFA was going to retaliate against them personally. After what the women experienced this year, FIFA will NEVER again hold ANY World Cup on synthetic.</p> <p>"1) by forcing them to compete on a surface that fundamentally alters the way the game is played, (2) by</p>

Other Data for Consideration

	Title	Author(s)	Group(s)	Conflict of Interest?	Reason for Conflict of Interest	Notes
						<p>subjecting them to unique and serious risks of injury, and (3) by devaluing their dignity, state of mind and self-respect as a result of requiring them to play on a second-class surface before tens of thousands of stadium spectators and a global broadcast audience."</p> <p>"No soccer player prefers FieldTurf. It pales in comparison to a well-manicured grass pitch and takes some getting used to."</p> <p>"Turf exposes players to injuries that do not exist on natural grass, such as skin lesions, abrasions and lacerations."</p> <p>"In addition, artificial turf is uniquely vulnerable to degradation upon installation as a result of the effects of weathering, brushing and painting. CSA's site choice for the finals is particularly susceptible to such adverse effects as it is in use more than 200 days a year according to a report published in 2013. This type of use makes artificial turf an even more dangerous and difficult surface on which to play."</p> <p>"force the top female soccer players in the world to play their preeminent event under inferior, dangerous and discriminatory conditions."</p> <p>Also see p. 7 - turf burn, other dangers of synthetic turf.</p>
10:	<a href="#">Public Health Statement for Lead</a>	ATSDR. (August 2007). CAS# 7439-92-1	ATSDR	N	N/A	<p>Synthetic turf is known to give players horrible turf burns frequently. It opens them up to more infection and apparently, more lead exposure.</p> <p>"More lead can pass through skin that has been damaged (for example, by scrapes, scratches, and wounds)."</p>

Other Data for Consideration

	Title	Author(s)	Group(s)	Conflict of Interest?	Reason for Conflict of Interest	Notes																
10:	<a href="#">Surface Temperature of Synthetic Turf</a>	Penn State Center for Sports Surface Research. The Sportsturf Scoop: Surface Temperature of Synthetic Turf	Penn State Center for Sports Surface Research	Y	Penn State has a partnership with FieldTurf.	"Children less able to adapt to changes in temperature...How does high surface temperature affect field users?...Greater chance of heat-related issues. Discomfort, dehydration, heat stroke." Some believe that the crumb rubber infill is to blame for high temperatures. However, no matter what type of infill is used, "Fibers are a major contributor to high surface temperatures."																
10:	Miscellaneous Extreme Temperature Information	N/A	N/A	N	N/A	<table border="1"> <thead> <tr> <th colspan="2">Sample Temperatures 2015 WWC</th> </tr> <tr> <th>Air</th> <th>Synthetic Turf</th> </tr> </thead> <tbody> <tr> <td>82 °F</td> <td>150 °F</td> </tr> <tr> <td></td> <td>From 86 °F to over 122 °F within 5 minutes.</td> </tr> <tr> <td>77 °F</td> <td>131 °F</td> </tr> <tr> <td>64 °F</td> <td>129 °F</td> </tr> <tr> <td>77 °F</td> <td>109 °F</td> </tr> <tr> <td>78 °F</td> <td>120 °F</td> </tr> </tbody> </table> <p>Sources:  <a href="https://en.m.wikipedia.org/wiki/2015_FIFA_Women%27s_World_Cup">https://en.m.wikipedia.org/wiki/2015_FIFA_Women%27s_World_Cup</a>  <a href="http://news.nationalpost.com/sports/soccer/womens-world-cup-offence-is-hot-and-the-fields-are-hotter-renewing-complaints-over-artificial-turf">http://news.nationalpost.com/sports/soccer/womens-world-cup-offence-is-hot-and-the-fields-are-hotter-renewing-complaints-over-artificial-turf</a>  <a href="http://t.thestar.com/#/article/sports/soccer/2015/06/08/womens-world-cup-heats-up-as-pitch-level-mercury-soars.html">http://t.thestar.com/#/article/sports/soccer/2015/06/08/womens-world-cup-heats-up-as-pitch-level-mercury-soars.html</a></p>	Sample Temperatures 2015 WWC		Air	Synthetic Turf	82 °F	150 °F		From 86 °F to over 122 °F within 5 minutes.	77 °F	131 °F	64 °F	129 °F	77 °F	109 °F	78 °F	120 °F
Sample Temperatures 2015 WWC																						
Air	Synthetic Turf																					
82 °F	150 °F																					
	From 86 °F to over 122 °F within 5 minutes.																					
77 °F	131 °F																					
64 °F	129 °F																					
77 °F	109 °F																					
78 °F	120 °F																					

Other Data for Consideration

	Title	Author(s)	Group(s)	Conflict of Interest?	Reason for Conflict of Interest	Notes
						<ul style="list-style-type: none"> <li>• <b>Kansas City, Missouri, Stanley-Durwood Soccer Stadium</b> <ul style="list-style-type: none"> <li>○ 95 °F air, 159 °F synthetic turf  <a href="http://www.sportingnews.com/soccer/story/2014-08-23/alex-morgan-nwsl-portland-thorns-hot-turf-field-uswnt">http://www.sportingnews.com/soccer/story/2014-08-23/alex-morgan-nwsl-portland-thorns-hot-turf-field-uswnt</a></li> </ul> </li> <li>• <b>On a 98 °F (37 °C) day, MU’s Faurot Field had a surface temperature of 173 °F (78 °C).</b> The temperature of the nearby natural grass was only 105 °F (41 °C). Even at head-level, the temperature over the artificial turf was 138 °F (59 °C).<sup>13</sup> <ul style="list-style-type: none"> <li>○ Dr. Brad Fresenburg, turfgrass specialist from the University’s Division of Plant Sciences, explains the danger of artificial turf is that the rubber and plastic materials used absorb more of sunlight’s heat energy than natural grass, causing extraordinarily high temperatures.  <a href="http://plasticfieldsforever.org/ArtificialTurfBooklet.pdf">http://plasticfieldsforever.org/ArtificialTurfBooklet.pdf</a> "Synthetic Turf Playing Fields Present Unique Dangers," <i>Applied Turfgrass Science</i>, November 3, 2005.</li> </ul> </li> <li>• <b>Columbia, Missouri: Professor says “the fibers in a synthetic field control the heat.”</b>            According to a news report in the <i>Columbia Missourian</i> (6 September 2013), the Faurot Field at the University of Missouri’s Memorial Stadium registered a high of 151 degrees during the school’s football season opener on         </li> </ul>

Other Data for Consideration

	Title	Author(s)	Group(s)	Conflict of Interest?	Reason for Conflict of Interest	Notes
						<p>Saturday 31 August. “A team of turf experts used an infrared thermometer to measure the heat coming off of the field in Memorial Stadium.” “The National Weather Service in St. Louis [had] reported Saturday” high temperature in Columbia as 100 degrees, but that reading was on a natural grass surface about 6 feet above the ground.” The service’s hydrologist, Mark Fuchs, said “on an artificial-turf surface, the temperatures jump.” The Division of Plant Sciences professor Brad Fresenburg had this to say about the heating of the artificial turf fields: sunlight plays a vital role in turf temperature. “If we’ve got the sun in the air and there’s a clear blue sky, we’re easily going to be in the 150s. It could even be in the 160s.” “We know that the fibers in a synthetic field control the heat.” “Artificial fields are made of petroleum-based fibers that absorb heat as weather conditions change. Mid- to late afternoon, when direct sunlight has had its greatest effect on temperature, is usually when turf fields reach high temperatures. Much like vinyl in cars, the fibers capture and hold heat until the field has time to cool. Often, the fields get so hot that the heat can be felt through the soles of shoes.” “Temperature readings vary depending on the kind of surface, amount of cloud cover, humidity, wind speed and thermometer height during the time of the reading. A slight breeze, for instance, can change temperatures by 20 or 30 degrees.” “The clarity of the sky and the time of day — that makes a huge difference in what reflects off of that field as far as heat. The sky, if it’s more clear blue, that’s going to allow the field to absorb more heat.” <u>Source</u>: Beth Castle, “Artificial turf turns up the heat on Faurot Field,” in the <i>Columbia Missourian</i>, 5</p>



Other Data for Consideration

	Title	Author(s)	Group(s)	Conflict of Interest?	Reason for Conflict of Interest	Notes
						<p>September 2013, at <a href="http://www.columbiamissourian.com/a/165243/artificial-turf-turns-up-the-heat-on-faurot-field/">http://www.columbiamissourian.com/a/165243/artificial-turf-turns-up-the-heat-on-faurot-field/</a> . See pdf <a href="#">here</a>.</p> <ul style="list-style-type: none"> <li>• <b>Cooling the synthetic field only lasts 5 minutes</b></li> </ul> <p>Irrigation of the synthetic turf had a significant result cooling the surface from 174 °F to 85 °F but after five minutes the temperature rebounded to 120 °F. The temperature rebuilt to 164 °F after only twenty minutes.</p> <p><a href="http://plasticfieldsforever.org/ArtificialTurfBooklet.pdf">http://plasticfieldsforever.org/ArtificialTurfBooklet.pdf</a></p>

# PUBLIC SUBMISSION

<b>As of:</b> 5/3/16 6:35 PM
<b>Received:</b> May 02, 2016
<b>Status:</b> Posted
<b>Posted:</b> May 03, 2016
<b>Tracking No.</b> 1k0-8pem-rune
<b>Comments Due:</b> May 02, 2016
<b>Submission Type:</b> Web

**Docket:** ATSDR-2016-0002

Collections Related to Synthetic Turf Fields with Crumb Rubber Infill 0923-16PJ

**Comment On:** ATSDR-2016-0002-0003

Collections Related to Synthetic Turf Fields with Crumb Rubber Infill ATSDR-2016-0002

**Document:** ATSDR-2016-0002-0069

Collections Related to Synthetic Turf Fields with Crumb Rubber Infill 0923-16PJ Comment on FR Doc # 2016-03305

---

## Submitter Information

**Name:** Marc Elrich

**Address:** 20850

**Email:** councilmember.elrich@montgomerycountymd.gov

---

## General Comment

See attached file(s)

---

## Attachments

ME comment re federal review of AT



**MONTGOMERY COUNTY COUNCIL  
ROCKVILLE, MARYLAND**

**Comment on “Collections Related to Synthetic Turf Fields with Crumb Rubber Infill”**

From: Montgomery County, Maryland Councilmember Marc Elrich (At-large)

Date: May 2, 2016

As an elected official, I have been confronted with the issue of whether artificial turf playing fields are safe and whether public funds should be used to construct and maintain these fields. I represent the almost one million residents of Montgomery County, Maryland; our county is one of the wealthiest and best-educated counties in the country. My staff and I have grappled with questions surrounding artificial turf for years, and the more we have examined the issue, the more we realize how little is known and how few questions can be adequately answered.

I appreciate the attempt by the federal agencies to tackle this issue, and on behalf of many of my constituents and based on years of reviewing research and conversations with scientists, parks managers, school administrators, elected officials, residents and other concerned individuals, I make the following comments, observations and requests. I have five major points and then follow them with additional information to support those points.

1. Clarify that the questions and goals outlined in this study will not answer the question of the true safety/toxicity of AT with tire crumb infill. Characterizing chemical composition and “exposure potential” are insufficient tools. This study will not satisfactorily answer the question: are artificial turf fields safe for children to use over the long-term? An epidemiological study is necessary. Only a long-term controlled epidemiological study could provide meaningful answers about human safety. University of Washington soccer coach Amy Griffin continues to collect names of soccer players, other athletes and other frequent users of artificial turf fields (like marching band participants). This information raises serious concern, and the federal agencies need to consider how they can collect information that could analyze actual uses and outcomes.
2. Any and all toxicity studies must address and examine cumulative and combined effects of toxic chemicals. Artificial turf contains a variety of chemicals that interact with each other and in the body. Without studying their synergistic effects, the study will exclude some important considerations. (See below for scientific comment on this issue.)
3. All potential health impacts should be viewed specifically and separately for children. Studies should examine exposure for **children**. “Environmental exposure for children is quite different. They take in much more of everything than adults. Their brains and nervous systems are developing quite rapidly – referred to as “unique windows of vulnerability.” (Joel Forman, MD, Mt. Sinai Medical School, Program Director of the Pediatric Residency

Program, Children's Environmental Health Center) Towards that end, I urge you to consult extensively with Dr. Forman, Dr. Phillip Landrigan and other researchers associated with the Childrens Environmental Health Center at Mt. Sinai Medical School.

4. For a federal study to be useful to local jurisdictions and residents, it must acknowledge and address the myriad of issues and concerns that are inextricably intertwined. The chemical composition of crumb rubber infill is an important issue, but it is not the only issue. The blades, carpet, carpet backing and the color of the blades are all integral to any meaningful assessment. Other issues should be examined and acknowledged: the heat impact for the field users as well as serious environmental concerns, including the “heat island” effect and impacts on waterways, aquatic life and wildlife.
5. Every step of the way, the involved federal agencies must be mindful of their possible biases. I would refer you to the EPA website announcing this study: “Limited studies have not shown an elevated health risk from playing on fields with tire crumb, but the existing studies do not comprehensively evaluate the concerns about health risks from exposure to tire crumb.” (<https://www.epa.gov/chemical-research/federal-research-action-plan-recycled-tire-crumb-used-playing-fields>) Such a statement is misleading and should be deleted. Results from “limited studies” have been mixed. If “limited studies” refers to EPA’s prior studies, it should be noted that they were not simply limited but also quite possibly flawed, and therefore, not an appropriate basis for any general statements. (<http://www.peer.org/news/news-releases/epa-retracts-synthetic-turf-safety-assurances.html>)

#### **Additional information and commentary:**

*Regarding points 1 and 2 above:*

#### **How we think about levels of concern of chemicals is changing and evolving.**

A recently published scientific paper, “What Can Epidemiological Studies Tell Us about the Impact of Chemical Mixtures on Human Health?” explains:

“Although there is growing concern that exposure to chemical mixtures during critical periods of human development could increase the risk of adverse health effects including allergic diseases, cancer, neurodevelopmental disorders, reproductive disorders, and respiratory diseases, researchers primarily study chemicals as if exposure occurs individually. This one-chemical-at-a-time approach has left us with insufficient knowledge about the human health effects of exposure to chemical mixtures.” [Emphasis added.] <http://ehp.niehs.nih.gov/15-10569/>

Another study from 2015 suggests that the **combination** of “safe” chemicals may increase cancer risk:

“Our analysis suggests that the cumulative effects of individual (non-carcinogenic) chemicals acting on different pathways, and a variety of related systems, organs, tissues and cells could plausibly conspire to produce carcinogenic synergies.” [Emphasis added.] [http://carcin.oxfordjournals.org/content/36/Suppl\\_1/S254.full?sid=db47f5ec-47a2-4879-bf30-6da9c076003d#ref-8](http://carcin.oxfordjournals.org/content/36/Suppl_1/S254.full?sid=db47f5ec-47a2-4879-bf30-6da9c076003d#ref-8)

In commenting on the above study, the director of the National Institute of Environmental Health Sciences, Linda Birnbaum (who was not involved in the study), said

“...We live in a chemical soup,... Considering the safety of individual chemicals is a lot like looking at the trees, but missing the forest, Birnbaum said. When doing research to determine chemical safety, “we’ve got to start thinking more about what reality is,” she said. This could mean sweeping changes in rules about the levels of chemicals considered safe in drinking water, food, and air. **I’d like to see regulators and policy makers start looking at the totality of the exposure instead of one chemical at a time,” she said.** [Emphasis added.] (“Combinations of ‘safe’ chemicals may increase cancer risk, study suggests,” *Los Angeles Times*, by Sasha Harris-Lovett, 7/1/15 <http://www.latimes.com/science/sciencenow/la-sci-sn-chemical-combinations-safety-cancer-20150626-story.html>)

While the 2015 report is important and significant, this general idea and information is not new. As the President’s Cancer Panel pointed out in its 2008-2009 annual report, federal environmental laws not only leave many known carcinogens completely unregulated, they also “fail to address the potential hazards of being exposed to combinations of chemicals”. [Emphasis added] (Environmental Working Group, <http://www.ewg.org/research/rethinking-carcinogens/executive-summary>)

### **The true impact of chemical exposure could take decades to be measured.**

A telling example is a study of 9,300 daughters born to mothers who had been exposed to the pesticide DDT, which was banned in 1972 because of its effects on the environment, especially the eggs of the bald eagle. EPA labeled DDT as a probable carcinogen, and multiple studies linked DDT exposure to breast cancer, but then a 2014 meta-analysis found no significant association. But then this mother-daughter study showed that the prior studies were looking at the wrong generation – the daughters of women exposed to DDT - were associated with almost a fourfold increase in breast cancer, independent of the mother’s history of breast cancer. The study, which covered a span of 54 years, also determined that those with higher levels of exposure were diagnosed with more advanced breast cancer. The study results are dramatic, but they took **54 years**. (“Startling link between pregnant mother’s exposure to DDT and daughter’s risk of breast cancer,” by Ariana Eunjung Cha, *The Washington Post*, 6/17/15 <https://www.washingtonpost.com/news/to-your-health/wp/2015/06/16/ddts-breast-cancer-legacy-pregnant-mothers-exposure-linked-to-four-fold-increase-in-daughters-risk/> and <http://press.endocrine.org/doi/10.1210/jc.2015-1841>)

You will not have “safety” answers in 2016 or one or two years later. Please acknowledge this fact and address epidemiological questions.

### **Further points to consider:**

Federal agencies should not reference “prior studies” without including and acknowledging the following studies, which raise serious concern about artificial turf. One study raises the possibility of inhalable lead.

The study states “...if the lead is present to any appreciable extent in the wipes it will likely be present in the breathing zone of players who are active on these fields, and that furthermore, these levels potentially exceed ambient EPA standards. (“An Evaluation of

Potential Exposures to Lead and Other Metals as the Result of Aerosolized Particulate Matter from Artificial Turf Playing Fields Submitted to: Alan Stern, Dr.P.H. New Jersey Department of Environmental Protection Submitted by: Stuart L. Shalat, Sc.D. (July 14, 2011) <http://www.nj.gov/dep/dsr/publications/artificial-turf-report.pdf>) Note that many facilities would not allow testing.

**Other studies have raised serious concerns about tire crumb and lead exposure.**

A 2014 study found lead and other toxins in the both the plastic rug and tire crumb infill. Lead was also found in simulated body fluids meaning there is little or no protection of any kind against the lead getting out of the material into the body. "Since it is possible that children may be exposed to potentially high concentrations of lead while using artificial turf fields we recommend, at a minimum, all infill and fibers should be certified for low or no lead content prior to purchase and installation."

("Bio-accessibility and Risk of Exposure to Metals and SVOCs in Artificial Turf Field Fill Materials and Fibers" Brian T. Pavilonis, Clifford P. Weisel, Brian Buckley, and Paul J. Lioy <http://www.ncbi.nlm.nih.gov/pmc/articles/PMC4038666/pdf/nihms565643.pdf> 2014)

**No two fields are alike because each field contains 30,000 to 40,000 ground up tires, which come from a multitude of manufacturers.**

**"Every turf field has to be analyzed in detail to be sure it doesn't have a problem,"** said Paul Lioy, a professor of environmental and occupational medicine at the Robert Wood Johnson Medical School in New Jersey." [Emphasis added.] ("Feds promote artificial turf as safe despite health concerns," by Thomas Frank *USA Today*, 3/16/2015 <http://www.usatoday.com/story/news/2015/03/15/artificial-turf-health-safety-studies/24727111/>)

"Not surprisingly, the shredded tires contain a veritable witch's brew of toxic substances," Gaboury Benoit, Ph.D., Yale Professor of Environmental Chemistry and Engineering. ("Study: Artificial turf contains carcinogens," by Tony Spinelli, 7/3/15 <http://www.theridgefieldpress.com/48210/study-artificial-turf-contains-carcinogens/#ixzz47WNF1FSf>)

Additionally, the information required from field managers around the country is time-intensive as outlined in the Federal Register, and the attempt to reach a maximum of 40 fields nationally is insufficient. So the time required from the individuals is large and the amount of information collected will not be much more than anecdotal.

**The fields heat is a health hazard. It is hotter than asphalt and much hotter than grass.**

At the Women's World Cup in Edmonton, Canada, in June 2015, the air temperature was 75 degrees, and **"the heat from the carpet approaching 120 degrees at kickoff...** Research, partly funded by the city of Las Vegas, found artificial turf above 122 degrees is considered unsafe for sustained athletic use and that, **depending on the air temperature, turf can get as hot as 180 degrees**... This was a temperature where if you put your hand down on it, you could only hold it for five seconds or so before it would burn," Dale Devitt, director of the Center for Urban Water Conservation at the University of Nevada Las Vegas told the Vegas Sun. [Emphasis added.]

(“The artificial turf at the Women’s World Cup was reportedly 120 degrees at kick off,” by Marissa Payne, *The Washington Post*, 6/6/2015

<http://www.washingtonpost.com/news/early-lead/wp/2015/06/06/the-artificial-turf-at-the-womens-world-cup-was-reportedly-120-degrees-at-kick-off/>)

### **Environmental impacts of artificial turf should also be noted.**

#### Artificial turf fields create “heat islands” – an environmental hazard.

The extreme heat “is not only a hazard for users, but also can contribute to the ‘heat island effect,’ in which cities become hotter than surrounding areas because of heat absorbed by dark man-made surfaces such as roofs and asphalt.” (“Synthetic Turf: Health Debate Takes Root” by Luz Claudio, *Environmental Health Perspectives* 2008 March; 116(3): A116–A122. <http://www.ncbi.nlm.nih.gov/pmc/articles/PMC2265067/>)

“Columbia University climate researcher Stuart Gaffin analyzed thermal images generated from NASA satellite maps of New York City. He wanted to figure out how urban trees may help cool down neighborhoods. When **Gaffin noticed a bunch of hot spots on the maps, he assumed they were rooftops**...two turned out to be turf fields” says Gaffin. In retrospect, he says he should have realized that, because they’re a perfect sunlight-absorbing system.” (“High Temps On Turf Fields Spark Safety Concerns,” by Allison Aubrey, *National Public Radio*, 8/7/2008

<http://www.npr.org/templates/story/story.php?storyId=93364750>)

#### Artificial turf appears to contribute to elevated levels of zinc in the water.

“There is a potential risk to surface waters and aquatic organisms associated with whole effluent and zinc toxicity of stormwater runoff from AT fields.” (“Artificial Turf Study, Leachate and Stormwater Characteristics,” July 2010 Conn. Department of Environmental Protection

“Crumb rubber derived entirely from truck tires may have an impact on aquatic life due to the release of zinc. For the other three types of crumb rubber, aquatic toxicity was found to be unlikely.” Pg. 2

“Zinc concentrations are higher than the surface water standards.” Pg. 29

(“An Assessment of Chemical Leaching, Releases to Air and Temperature at Crumb-rubber Infilled Synthetic Turf Fields” May 2009 from staff at NY State Department of Environmental Conservation)

#### Plastic artificial turf blades will likely disintegrate and degrade with some ending up in bodies of water and in the food of wildlife either directly or via landfills; plastics of various sizes are already threatening aquatic life.

The impacts of larger sized plastics is more widely known, but now more is being discovered about the serious effects of microplastics. (“Ingested microscopic plastic translocates to the circulatory system of the mussel, *Mytilus edulis* (L).” by Browne MA1, Dissanayake A, Galloway TS, Lowe DM, Thompson RC, *Environmental Science & Technology*, 7/1/2008 <http://www.ncbi.nlm.nih.gov/pubmed/18678044>) “As plastic breaks into smaller pieces, it is more likely to infiltrate food webs. In laboratory and field studies, fish, invertebrates and microorganisms ingest micrometer-sized particles...” (“Classify plastic waste

as hazardous,” by Chelsea M. Rochman, Mark Anthony Browne, Eunha Hoh, Hrisi K. Karapanagioti, Lorena M. Rios- Mendoza, Hideshige Takada, Swee Teh, Richard C. Thompson. *Nature*, 2/14/13.)

**Confusion over focus of the undertaking:**

While the official federal register announcement does not mention playgrounds, the EPA’s website explaining this study refers to “this coordinated Federal Research Action Plan on Recycled Tire Crumb Used on Playing Fields and Playgrounds...”

(<https://www.epa.gov/chemical-research/federal-research-recycled-tire-crumbs-used-playing-fields>)

It would be better to included playgrounds, especially since children are particularly vulnerable to toxic chemicals, but at a minimum the information disseminated should be consistent between postings.

**Conclusion:**

As should be apparent from the above information and comments, my staff, constituents and I have spent numerous hours reviewing these issues. I am deeply concerned that the study as designed will offer the false hope of absolute answers. We may not know for many years the true and complete impacts of artificial turf fields. I have concluded that we should adhere to the precautionary principle and minimize use of artificial turf fields. Instead, we need to focus our research and energy on improving natural grass fields, which already can be designed to withstand heavy rains and avoid rain-outs. Increasing knowledge and experience is helping expand the usage of these fields. The public focus should be on the best practices that give the greatest use of natural grass fields with the least amount of fertilizers, pesticides and water.



# PUBLIC SUBMISSION

<b>As of:</b> 5/3/16 6:42 PM
<b>Received:</b> May 02, 2016
<b>Status:</b> Posted
<b>Posted:</b> May 03, 2016
<b>Tracking No.</b> 1k0-8per-nvit
<b>Comments Due:</b> May 02, 2016
<b>Submission Type:</b> Web

**Docket:** ATSDR-2016-0002

Collections Related to Synthetic Turf Fields with Crumb Rubber Infill 0923-16PJ

**Comment On:** ATSDR-2016-0002-0003

Collections Related to Synthetic Turf Fields with Crumb Rubber Infill ATSDR-2016-0002

**Document:** ATSDR-2016-0002-0077

Collections Related to Synthetic Turf Fields with Crumb Rubber Infill 0923-16PJ Comment on FR Doc # 2016-03305

---

## Submitter Information

**Name:** Christi Davis, Ph.D.

**Address:** 98036

**Email:** christidavis2002@hotmail.com

**Organization:** Washington Alliance for Non-toxic Play and Athletic Fields

---

## General Comment

See attached file(s)

---

## Attachments

Comments on ASTDR 2016-0002

## **Comments on ASTDR 2016-0002-0003**

### **Federal Research Action Plan on**

### **Recycled Tire Crumbs Used on Playing Fields and Playgrounds**

**Submitted to Federal Register May 2, 2016**

---

Washington Alliance for Non-Toxic Play and Athletic Fields

---

The overarching public health question surrounding crumb rubber is, “Is crumb rubber safe to use on play fields and playgrounds?” Not only has it been established that the carcinogens and other toxicants from crumb rubber off-gas into the air, but research has also proven that they leach into water and simulated body fluids as well (1) (2) (3) (4) (5) (6). Coach Amy Griffin has already compiled a self-reported list of hundreds of athletes whose cancers may be related to crumb rubber exposure (7), and millions of children and young adults are currently exposed to crumb rubber on a daily basis. Therefore, a timely, accurate, and reliable estimate of the risks associated with crumb rubber exposure is of utmost importance.

Given the current state of relevant toxicity data, the planned exposure study is insufficient to provide reliable, timely estimates of the health risks associated with the use of crumb rubber. In the April 14, 2016 webinar for this study, one of the presenters stated that study researchers intended to combine exposure data from the federal study with existing toxicology data to predict health risks and make recommendations. There are no toxicity studies on crumb rubber as a complete mixture. Further, even if EPA guidelines didn’t clearly state that component-based methods were useless for estimating the toxicity of complex mixtures, the toxicity information on the components of crumb rubber is too incomplete to be usable (8). For example, the recent EHHI/Yale study identified 96 chemicals in crumb rubber, almost half of which had not undergone any government toxicity testing (9). Until there is a reliable, scientifically defensible estimate of the carcinogenicity of crumb rubber, there can be no reliable health risk assessment.

It is not even clear that an estimate of the carcinogenicity of crumb rubber is technically feasible because crumb rubber is not a standardized product. It is a waste product. The chemical composition of the waste stream used to produce it is highly heterogeneous, may contain chemical hot spots, and may change at any time in significant and unpredictable ways with no notice, ever.

Predicting the health risks posed by crumb rubber is a formidable challenge. However, measuring any harm already caused should be relatively straightforward.

Prior formal studies on crumb rubber have provided the scientific basis to ascertain not only that crumb rubber may cause cancer, but also predict what types of cancer it would be likely to cause on the basis of its chemical components. However, it is the list of athletes who have contracted cancer compiled by Coach Amy Griffin that gives research on the safety of crumb rubber urgency. Crumb rubber has only

been commonly used in playgrounds and playfields for about 15 years, but there is already a self-reported list of hundreds of suspected cancer cases in young people. The list is remarkable not only for the age of the cancer patients, but also for how quickly cancers related to crumb rubber exposure seem to be appearing. Cancer is typically slow to develop, often only appearing decades after exposure. Further, parents have been repeatedly reassured that any carcinogens in crumb rubber are present at minute doses that pose virtually no risk. If cancers are appearing in unexpectedly large numbers now, then either exposures are much higher than believed or crumb rubber may be a potent carcinogen and the long-term cancer risk may be far greater than originally thought.

### **Amy Griffin’s List**

While the list of athletes diagnosed with cancer collected by Coach Amy Griffin does not constitute an epidemiologic study, what the list reveals is as instructive as it is frightening. The distribution of cancers by type on the list does not reflect the distribution in the general population for individuals aged 5-29. There is an excess rate of leukemia, lymphoma, and lung cancer relative to thyroid, brain, and testicular cancer on the list. Further, the risk may be concentrated in certain areas or with certain teams.

If a self-reported cancer list is just the product of public fears, then the reported cancers should display a distribution that reflects the distribution of cancer in the underlying population. A failure to display this pattern either reflects a significant reporting bias or an underlying difference in cancer rates in the reference population, or both. Standard population cancer incidence rates are easily available from the SEER dataset as shown in Table 1 below (10).

Table 1. Age-Specific SEER Incidence Rates By Cancer Site, All Ages, All Races, Both Sexes, 2004-2013

Cancer Site	Age at Diagnosis				
	5-9	10-14	15-19	20-24	25-29
Leukemia	4.18	3.22	3.08	2.66	2.74
Lymphoma	1.50	2.52	4.82	6.89	7.54
Thyroid	0.15	0.65	2.36	5.24	9.25
Brain and Other Nervous System	3.41	2.61	2.20	2.26	2.82
Lung and Bronchus	--	0.05	0.12	0.32	0.60
Testis*	0.04	0.11	1.88	5.13	7.20

Rates are per 100,000 persons. \*Rates for testicular cancer are for 100,000 persons assuming 50,000 males.

An age 5-29 age adjusted cancer rate for each of the cancers can be calculated using the standard 2000 US population distribution (not shown) from the SEER database. The age adjusted cancer rates are shown in Table 2.

At last report, the individuals on Amy’s list range in age from 5 to 29 years and were diagnosed at least as far back as 2007. The list contains data through March of 2016, so it covers at least 9.25 years (11). The numbers included in Table 2 only include individuals that self-reported as playing soccer. Sixteen cases of sarcomas and 9 cases of other rare cancers in soccer players are not included in Table 2. Sarcomas were not included in the list because the SEER database breaks down cancers by site, not

type. Fifty-four individuals that only reported playing sports other than soccer are on Amy’s list but are not included in Table 2.

While the numbers on Amy Griffin’s list do not represent the cases for a defined population, they could be assumed to do so for purposes of illustration. Assume the actual cancer cases in Table 2 represent cases from a defined population of unknown size x. If it is assumed that the rate of thyroid cancer in the theoretical population is the same as the rate in the U.S. population, then the size of the theoretical population can be calculated as  $12 \times 100,000 / (3.37 \times 9.25) = 38,548$  individuals. Given a population of 38,548 individuals at risk for 9.25 years, it is possible to calculate the expected number of cases for each of the other cancers on Amy’s list. Then the ratio of actual to expected cases can be calculated. As can be seen in Table 2, the number of leukemia, lymphoma and lung cancer cases are elevated relative to thyroid, brain and testicular cancer.

Table 2. Expected Number of Cancer Cases Versus Actual Number on Amy Griffin’s List

	Age-adjusted incidence in 5-29 year olds	Expected number of cases	Actual number of soccer players	Ratio Actual to Expected Cases
Leukemia	3.19	11.39	41	3.60
Lymphoma	4.55	16.21	64	3.95
Thyroid	3.37	12	12	1
Brain and Other Nervous System	2.66	9.49	11	1.16
Lung and Bronchus	0.21	0.74	4	5.41
Testis	2.73	9.73	9	0.92

The incidence of lymphoma cases in soccer goalkeepers in Washington State was investigated based on Amy Griffin’s list. Washington was selected because the author and Ms. Griffin live in Washington and a significant percentage of the names on the list are from Washington. Goalkeepers were examined because of their elevated exposure and high rates of appearance on the list. Lymphoma was examined because many of the carcinogens in crumb rubber are believed to cause blood cancers and because of the number of lymphoma cases on the list as a whole.

Based on private communications with Amy Griffin, her list includes 7 goalkeepers from Washington State, aged 12-24 who were diagnosed with lymphoma between 2008 and 2015. By estimating the number of goalkeepers in this age group, it is possible to estimate incidence.

There are approximately 1,552 boys and girls high school soccer teams in Washington State. Per Amy Griffin, approximately an additional 10% of high school age soccer players play on select teams instead of high school teams. This yields a total estimate of 1,707 teams of high school age players, and an estimated 3,414 14-17 year old goalkeepers. Assuming goalkeepers are spread equally over the age range, this yields 854 goalkeepers per age, or 4,268 goalkeepers per 5 year age spread. Although athletes may stop playing after graduation from high school, their exposure during their youth can never be erased. Thus, they remain in the risk pool. Additionally, goalkeeper is such a specialized position that it is highly unlikely that a player who was not a goalkeeper in high school would become one after

high school. Thus, once a cohort completes high school, the number of people in that cohort who are exposed to crumb rubber while playing goalkeeper should remain stable over time.

Estimating the number of goalkeepers in the 12-13 age range is difficult. There are likely more 12-13 year old children playing soccer, but 12-13 year olds are less likely to be set in the position they play at that age. Therefore, to provide a conservative estimate, it is assumed that there are twice as many goalkeepers per age for 12-13 year olds as there are for 14-24 year olds. The estimate of the at-risk population is a back of the envelope estimate, and there are additional unstated assumptions in play. However, it provides a useful, reasonably conservative, estimate of the at-risk population.

Based on the estimated numbers of goalkeepers and age-specific rates for lymphoma for individuals aged 10-14, 15-19, and 20-24 years, there should have been approximately 5.6 lymphomas in goalkeepers between the ages of 12 and 24 in Washington between 2007 and 2015. There are 8 on Amy's list, approximately 43% more than expected. It is a disturbing finding given that Amy's list is entirely self-reported and should only represent a fraction of the actual number of cases. This provides support to the theory that soccer players are at an elevated risk of leukemia, lymphoma, and lung cancer and the proportions of cancers on Amy's list are due to elevated risks of certain cancers in soccer players and not reporting bias.

Amy Griffin testified before the Washington State House Environment Committee on January 26, 2016 that her list contained five different groups of two or more players with cancer from the same team (7). Thus, at least 5% of the names on Amy Griffin's list come from mini clusters. Some clustering of cancer cases will occur by random chance, but the proportion of the cases on Amy's list that come from individual teams is clearly excessive. Either players from teams with multiple cases are more likely to self-report, or something is placing players on certain teams at elevated risk, or both. Given the concerns about crumb rubber, it is entirely possible that players on teams with high levels of exposure to crumb rubber, either due to extended seasons, or practicing on indoor fields, are at elevated risk. It is also possible that certain fields pose much higher risk than other fields.

The data on Amy's list raise grave concerns. Many of these concerns can be answered by a thorough epidemiologic study. Fortunately, the necessary data exist, and the CDC has epidemiologists that are fully capable of doing the type of research that is necessary to protect the health of our children.

## **Epidemiology**

It should be fairly straightforward to design an epidemiologic study that would at least be able to determine if soccer players, or goalkeepers in particular, are at an elevated risk of developing certain cancers such as Hodgkin's lymphoma or lung cancer.

For example, epidemiologists could model the incidence of selected specific cancers for all athletes who played NCAA soccer between 2000 and 2013.

Cancer registries are already in place. The NCAA should have a list of all college athletes complete with basic demographic data as well as information on sports and positions played. Hopefully, the NCAA will be willing to cooperate in the name of public health and athlete health. While there are always concerns about privacy, the NCAA would not necessarily need to reveal any information that isn't

already publicly available. Further, cooperation in a government study designed to protect athlete health could be portrayed as positive and proactive. Failure to cooperate could be publicly portrayed as a sign that the association has something to hide or that it does not put the well-being of its student athletes first.

If the NCAA is unwilling to cooperate, it is likely that the necessary information will be available from big data brokers. Failing that, there are always sites such as TopDrawerSoccer.com that display the name, college, home town, and position of 69,802 college soccer players in the US right now (12). Sites such as this likely have archives of data from previous years as well.

Without a measure of athlete exposure to crumb rubber, a comparison of cancer incidence rates in soccer players to rates in the general population can underestimate the risks associated with crumb rubber. When soccer players are mixed together in the same data set with nothing to indicate exposure level, the resulting risk estimate is a function of both the risk associated with exposure to crumb rubber and the average level of exposure. However, the average level of exposure remains unknown, and if it is assumed that all practices and games are spent on artificial turf, then the risk associated with crumb rubber will be greatly underestimated.

However, adding proxy measures of exposure could improve estimates of any increased cancer risk associated with exposure to crumb rubber and provide an estimate of any potential dose response. NCAA data should include both the location of the athletes' colleges and their home towns or high schools. The average high temperatures in the summer and fall months might be one proxy measure of exposure since the outgassing of toxic chemicals increases exponentially with temperature.

Adding annual US crumb rubber market penetration data to the model would increase the precision of the model. Obviously, if exposure to crumb rubber causes cancer, then cancer rates should increase as market penetration increases and as the number of years athletes are exposed to it increases. College athletes in 2005 were exposed to crumb rubber for a relatively short period of time and a much smaller percentage were exposed. College athletes in 2013 may have played on it for 13 years, and a relatively large percentage probably played on it since high school.

Adding annual market penetration to the model for each athlete's home town/ home state would increase the precision of the model. Adding in the type of field present at each athlete's college or annual market penetration of crumb rubber in each athlete's college town / state would also increase the precision of the model.

Although the EPA no longer participates in the Scrap Tire Workgroup, it may have historical market penetration data. Otherwise, the Synthetic Turf Council, or major turf retailers such as FieldTurf, may have the data. Since this study has explicitly stated that it will include representatives from the synthetic turf industry in this research, it is only reasonable to expect basic cooperation from the stakeholders. If the STC or major retailers choose not to cooperate with an investigation on the safety of crumb rubber, partial, if not complete, data may be available elsewhere. For example, states that have given subsidies for the construction of synthetic turf fields and may have market data for their state. (A failure of the synthetic turf industry to cooperate with the study could be interpreted as a tacit admission that the industry believes that there are significant health risks associated with crumb rubber use. This could provide further justification for an immediate moratorium on the use of crumb rubber.)

A multivariate regression model with proxy variables and other basic explanatory variables such as age, gender, and position, as well as all necessary interaction terms could be created. Determination of the exact type of statistical model to be used should obviously be left up to biostatisticians / epidemiologists who regularly model cancer epidemiological data. A list of the types of cancer to investigate can be compiled from the list of cancer cases maintained by Coach Amy Griffin, and by consultation with toxicologists on the cancers expected from the carcinogens in crumb rubber. In addition, the Washington State Department of Health is validating the Washington State cancer cases on Amy's list and expects to publish some descriptive statistics concerning the list in the summer of 2016 (13). The DOH plans to determine if the cases represented on Amy's list represent an excessive rate of cancer cases among soccer players / goalkeepers in Washington (14). However, there is no plan to independently identify other cases of cancer in soccer players in Washington.

The main weakness of an epidemiologic study is that it has no ability to predict long-term effects. Crumb rubber has been widely used for around 15 years. The full effects of a carcinogen on human health typically take 30-50 years to appear. If the epidemiologic studies do not reveal any current cancer excesses, animal experimentation could help rule out any long-term risks. However animal experimentation is expensive, time-consuming, and should be avoided whenever possible for ethical reasons. If there is a current excess of cancer cases, then crumb rubber is unsafe and should not be used. Animal studies would not be necessary to determine whether or not to ban it.

## **Specific Comments on Exposure Study Design**

### **Bioavailability**

Any bioavailability studies should mimic real world exposure scenarios, including using realistic particle sizes and exposure periods as much as possible. Thus, gastric studies should include crumb rubber dust as well as crumbs. While some children engage in pica, and soccer goalies get crumbs in their mouths when diving for balls, much of the oral exposure of children is via hand to mouth behavior. Thus, children are ingesting dust, not tire shreds or crumbs. Toxins on particles 10 to 250 micrometers in diameter are likely to be much more bioavailable than toxins encased in shreds half an inch in length. The Kim study examined the effects of particle size on the bioavailability of lead in EPDM based on acid extraction and simulated digestive fluid extraction (15). The study found that lead was more than five times more bioavailable in particles less than 250 microns in diameter than it was in larger particles.

The bioavailability of toxins in 1-2 mm diameter crumbs in simulated lung fluid is not biologically relevant because humans are breathing in airborne particles, not large crumbs (4). Further, the smaller particles, those just a few microns in diameter, can pass through the lung tissue, into the bloodstream, and from there into various organs and tissues. At that point, the bioavailability of the toxicants in blood or tissue becomes relevant. Similarly, the estimated bioavailability of PAHs on PM 2.5 that are estimated to stay in the lungs for 3 months is very different than the estimated bioavailability of PAHs on a 1 mm crumb that is estimated to stay in the lungs for 24 hours.

### **Collection Procedures**

Samples of crumb rubber should not be washed as washing removes the smaller dust particles.

Samples of new crumb rubber should be taken from the top, middle and the bottom of the bag because of granular convection, also known as the 'Brazil-nut effect.'" Different sized crumbs will have different surface areas relative to their mass. Hence the toxicants contained in them will have different levels of bioaccessibility. Different sizes of crumb rubber particles may also be chemically different. A tire is not composed of a uniform piece of rubber. Different portions of the tire have different formulations, some of which may be more likely to crumble than others. Different tire parts have been exposed to different microenvironments containing different contaminants. This affects how the rubber ages and breaks down. The outer layer of the tread that was most exposed to roadway contaminants could be the most brittle and likely to crumble into dust. Conversely, inner layers of rubber that were more protected from the elements and contaminants may remain as larger crumbs. Washing the dust off of the crumbs could mean washing away relevant contaminants from the sample.

Similarly, when collecting crumb rubber samples from fields and playgrounds, care must be taken to collect the dust and respirable particulate matter as well. Care must be taken not to re-suspend particulate matter that has settled from the air. Sweeping samples into a collector risks loss of dust and settled particulates. Vacuuming up the crumb may be the best way of capturing all of the crumb rubber in a given area. It is important to know all of what is actually on the fields, not just what is in the large crumbs on the fields.

Legislation or administrative action compelling institutions that receive federal funding, such as most public schools, to participate upon request should be considered. In 2011, Dr. Stuart Shalat noted that only 5 of the 50 schools and towns he contacted gave him permission to test their fields due to liability concerns (16). That was before Coach Amy Griffin's list of athletes who have developed cancer started raising public concern. Field owners might be much less cooperative today. Given previous difficulties in obtaining permissions to test fields, collecting 40 samples from fields, stratified by field type, age and census region may mean contacting hundreds of towns or schools. Alternatively, it might help to publicize the school districts and cities that refuse to allow their fields to be tested. At the same time, a policy of not releasing any individual results, unless hazardous levels of a toxicant are identified (such as lead > 400 ppm in crumbs), could shield participants from unintended negative consequences. Thus, those who refuse to help look like they have something to hide or like they aren't concerned about the health of their field users, while those that participate get to look like they are taking steps to protect public health.

All air monitoring should include personal air monitoring of VOCs, SVOCs, PM 2.5, and carbon black. Proper off-field, up wind controls should be taken concurrently. On-field sampling should be done during actual games, scrimmages or practices. Referees may wear the monitoring equipment if it is not feasible to have players wear monitors. Stationary monitors on the side of the field do little to reveal what players on the field are exposed to due to atmospheric mixing and the settling of dusts. Players actively churn the crumb re-suspending dust and PM 2.5, and opening up pockets of trapped gasses (16).

Measurements of PM 2.5 and carbon black from personal air monitors would be new information. Personal air monitors have been used for VOCs and SVOCs but not PM 2.5 (17). Even though carbon



black constitutes roughly 30% of crumb rubber, no measurements of ambient carbon black levels at synthetic turf fields in the U.S. using any type of monitor were located. The estimates of airborne carbon black from crumb rubber typically come from a study of indoor turf fields conducted in Norway (18).

Estimating exposures goal keepers receive, especially during practice diving drills may be difficult. It may not be safe for either the player or the equipment for goal keepers to dive into the turf while wearing the monitors. It may be more practical to have engineers study films of goalies diving after balls, and then design ways to mimic the spray of crumbs and dust particles they receive each time they dive into the turf.

It is encouraging that the CDC, CPSC and EPA are examining the toxic exposures that children and athletes receive when using playgrounds and athletic fields that use artificial turf. However, given the number of citizens that are exposed to crumb rubber on a daily basis, and the evidence that crumb rubber is already responsible for excess cancer cases in the country's youth, a more aggressive research program, including a large epidemiological study, is needed.

## References

1. *Characterization of Substances Released from Crumb Rubber Material Used on Artificial Turf Fields*. **Li, X, et al.** 2010, *Chemosphere*, pp. 279-285.
2. *Hazardous organic chemicals in rubber recycled tire playgrounds and pavers*. **Llompart, Maria, et al.** 2013, *Chemosphere*, pp. 423-431.
3. *Release of Polycyclic Aromatic Hydrocarbons and Heavy Metals from Rubber Crumb in Synthetic Turf Fields: Preliminary Hazard Assessment for Athletes*. **Marsili, L., Coppola, D., Bianchi, N., Maltese, S., Bianchi, M., & Fossi, M. C.** 2016, *Environmental & Analytical Toxicology*.
4. *Bioaccessibility and Risk Exposure to Metals and SVOCs in Artificial Turf Field Fill Materials and Fibers*. **Pavilonis, B.T., et al.** 2013, *Risk Analysis*.
5. **Simcox, Nancy, Bracker, Anne and John, Meyer.** *Artificial Turf Field Investigation in Connecticut*. Farmington : University of Connecticut, 2010.
6. *Mutagenic Potential of Artificial Athletic Field Crumb Rubber at Increased Temperatures*. **Dorsey, Michale J., et al.** 2, 2015, *The Ohio Journal of Science*, Vol. 115, pp. 32-39.
7. **TVW.** House Environment Committee. [Online] January 26, 2016. [Cited: May 2, 2016.] <http://www.tvw.org/watch/?eventID=2016010305>.
8. **EPA Risk Assessment Forum Technical Panel.** *Supplementary Guidance for Conducting Health Risk Assessment of Chemical Mixtures*. Washington DC : U.S. Environmental Protection Agency, 2000.
9. **EHHI.** New Study – Many carcinogens found in Yale analysis of crumb rubber infill and playground mulch surfacing. *Environment and Human Health, Inc.,* [Online] June 11, 2015. [http://www.ehhi.org/turf/new\\_study\\_jun2015.shtml](http://www.ehhi.org/turf/new_study_jun2015.shtml).
10. **Surveillance, Epidemiology, and End Results (SEER) Program: SEER\*Stat Database: Incidence - SEER 18. Age-Specific (Crude) SEER Incidence Rates By Cancer Site All Ages, All Races, Both Sexes 2004-2013.** s.l. : National Cancer Institute, DCCPS, Surveillance Research Program, Surveillance Systems Branch, 2016.
11. **Alderman, Nancy.** *personal email.* 2016.
12. **TopDrawerSoccer.com.** College Player Search. [Online] Advanced Sports Media Group. [Cited: May 2, 2016.] <http://www.topdrawersoccer.com/search/?query=&genderId=&classId=&divisionId=All&conferenceId=All&positionId=0&pageNo=0&area=collegeplayer>.
13. **Wasserman, Cathy.** *personal email.* 2016.
14. **Washington State Department of Health.** Synthetic Turf. [Online] [Cited: May 2, 2016.] <http://www.doh.wa.gov/CommunityandEnvironment/Schools/EnvironmentalHealth/syntheticTurf>.
15. **Kim, Sunduk, et al.** Health Risk Assessment of Lead Ingestion Exposure by Particle Sizes in Crumb Rubber on Artificial Turf Considering Bioavailability. [Online] February 2, 2012. [Cited: May 2, 2016.] <http://e-eh.org/journal/view.php?doi=10.5620/eh.2012.27.e2012005>.

16. **Shalat, Stuart L.** *An Evaluation of Potential Exposures to Lead and Other Metals as the Result of Aerosolized Particulate Matter from Artificial Turf Playing Fields.* s.l. : New Jersey Department of Environmental Protection, 2011.
17. **Ginsburg, Gary and Toal, Brian.** *Human Health Risk Assessment of Artificial Turf Fields Based Upon Results from Five Fields in Connecticut.* Hartford : Connecticut Department of Public Health, 2010.
18. **Norwegian Institute for Air Pollution.** *Measurement of Air Pollutions in Indoor Turf Halls.* s.l. : Norwegian Pollution Control Authority, 2005.
19. *Assessing the carcinogenic potential of low-dose exposures to chemical mixtures in the environment: the challenge ahead.* **Goodson, William H, Lowe, Leroy and al, et.** 2015, *Carcinogenesis*, pp. S254-S296.
20. *Substantial contribution of extrinsic risk factors to cancer development.* **Wu, Song, et al.** 2016, *Nature*, pp. 43-47.
21. *Artificial-Turf Playing Fields: Contents of Metals, PAHs, PCBs, PCDDs and PCDFs, Inhalation Exposure to PAHs and Related Preliminary Risk Assessment.* **Menichini, E, et al.** 2011, *The Science of the Total Environment*, pp. 4950-4957.
22. **Highsmith, R., Thomas, K.W. and Williams, R.W.** *A Scoping-Level Field Monitoring Study of Synthetic Turf Fields and Playgrounds.* s.l. : National Exposure Research Laboratory, U.S. Environmental Protection Agency, 2009.
23. *Synthetic Turf Field Investigation in Connecticut.* **Simcox, Nancy J., et al.** 2011, *Journal of Toxicology and Environmental Health: Part A Current Issues*, pp. 1133-1149.
24. **Office of Environment Health Hazard Assessment.** Appendix B. Chemical-specific summaries of the information used to derive unit risk and cancer potency values. updated 2011. *OEHHA Toxicity Criteria Database.* [Online] 2011. <http://www.oehha.ca.gov/tcdb/index.asp>.
25. *Toxicity and metabolism of methylnaphthalenes: Comparison with naphthalene and 1-nitronaphthalene.* **Lin, Ching Yu, et al.** 2009, *Toxicology*, pp. 16-27.
26. **President's Cancer Panel.** *Reducing Environmental Cancer Risk: What We Can Do Now.* Bethesda : U.S. Department Health and Human Services, 2010.



# PUBLIC SUBMISSION

<b>As of:</b> 5/3/16 6:43 PM
<b>Received:</b> May 02, 2016
<b>Status:</b> Posted
<b>Posted:</b> May 03, 2016
<b>Tracking No.</b> 1k0-8per-o6x7
<b>Comments Due:</b> May 02, 2016
<b>Submission Type:</b> Web

**Docket:** ATSDR-2016-0002

Collections Related to Synthetic Turf Fields with Crumb Rubber Infill 0923-16PJ

**Comment On:** ATSDR-2016-0002-0003

Collections Related to Synthetic Turf Fields with Crumb Rubber Infill ATSDR-2016-0002

**Document:** ATSDR-2016-0002-0079

Collections Related to Synthetic Turf Fields with Crumb Rubber Infill 0923-16PJ Comment on FR Doc # 2016-03305

---

## Submitter Information

**Name:** Jonathan Damm

**Address:** 20191

**Email:** jondamm@yahoo.com

---

## General Comment

Dear Federal Agencies:

I am a concerned parent with a background in environmental law and a lacrosse player and coach. Because of my education, I understand and appreciate the dangers inherent with repeated exposure to toxins. Since I am a coach and player, I have also spent many hours on tire crumb fields. I have witnessed how children are exposed to the fine particulate. After reading all the available literature, my wife and I concluded the risks far outweigh any benefits of using fields with tire crumb. Regardless of your final conclusions, it is clear that tire crumb is beyond our capacity to thoroughly investigate - as I will discuss below. So we will never let our three young children play on tire crumb. A generation of young Americans relies on you for similar protection.

Later this year, when the federal government issue its preliminary statement regarding the safety of tire crumb on synthetic turf fields, the most important messages to communicate to concerned parents are: 1) Tire Crumb is a "Moving Target" - tire manufacturers frequently change tire ingredients. So any formal study conclusion only speaks to existing fields. Any field installed after a study, or any field not studied, may contain chemicals that were not examined in past studies - including any federal study. So for all the millions of dollars of resources the federal government is about to spend on this study, any conclusions can only speak to actual

fields that were studied. A study can only be backwards looking by its very nature since there can be zero confidence that manufacturers will not change tire ingredients. This must be clearly communicated. 2) Compound based risk assessment can only be done on chemicals and compounds that have regulatory risk frameworks. Tire crumb contains numerous chemicals and compounds with no regulatory risk frameworks. Therefore, any formal study will necessarily contain significant data gaps. 3) Given that tire crumb contains multiple chemicals and compounds with no risk frameworks, epidemiological studies and animal studies are the only available methods of study to overcome this intrinsic problem. If there are no significant epidemiological studies undertaken or planned, this must be communicated. If there are no animal studies planned, this must be communicated.

If the three points of focus above were communicated clearly and prominently, it would help educated field users to truly understand that sometimes, a problem is beyond our ability and present capacity to accurately make predictions or draw conclusions regarding safety. If the federal government was realistic in this endeavor, it would recognize this from the very start. And given what we know about the multiple carcinogens, mutagens and reprotoxins in this material, the government should conclude from the start that tire crumb is simply too risky to use in such close proximity to children.

#### Sweden Concluded that Tires should Not be Used

Such a position would not be novel or unprecedented. The Swedish agency tasked with reviewing tire crumb on synthetic fields recommended that tires should not be used as material on synthetic turf fields for exactly these reasons. Sweden wisely concluded that given the complexity and the inherent unknowns regarding tire crumb use on turf fields, they simply should not be used.

"Tyres contain substances of very high concern

Tyres contain several substances that are substances of very high concern. These substances may persist in the environment, they may be bioaccumulative, carcinogenic, reprotoxic, or mutagenic. This is true of, for example, polycyclic aromatic hydrocarbons (PAHs), phthalates and certain metals. These substances should not be released into the environment and thus waste tyres should not be used for synthetic turf surfaces.

#### KemI's Recommendations:

Do not select synthetic turf that contains substances of very high concern when laying new surfaces

Material that contains substances of very high concern should not be used, as specified by the environmental objectives of the Swedish parliament. This means that granulate formed from recycled rubber should not be used when laying new surfaces of synthetic turf. The Norwegian authorities have issued a similar recommendation."

[http://www.wellesleyma.gov/pages/WellesleyMA\\_SpragueResources/Swedish%20Study.doc](http://www.wellesleyma.gov/pages/WellesleyMA_SpragueResources/Swedish%20Study.doc)

In addition to Sweden and Norway, whole countries that have recommended that tires not be used on turf fields, municipalities like as New York City have has banned tire crumb since 2009 for their schools and parks.

Similarly in 2009, the L.A. Unified School district has banned tire crumb. The list grows larger by the week. In early 2015, Montgomery County, Maryland's most populous, banned tire crumb by a unanimous vote of the council.

Please honor the precautionary principal and recommend a complete ban on the use of tire crumb on turf fields and playgrounds. See attached for full comments.

Regards,

Jonathan Damm

---

## **Attachments**

Comments on ASTDR 2016-0002 by Jonathan Damm

## Comments on ASTDR 2016-0002-0003

### Federal Research Action Plan on

### Recycled Tire Crumbs Used on Playing Fields and Playgrounds

Submitted to Federal Register May 2, 2016

By Jonathan R. Damm

Dear Federal Agencies:

I am a concerned parent with a background in environmental law and a lacrosse player and coach. Because of my education, I understand and appreciate the dangers inherent with repeated exposure to toxins. Since I am a coach and player, I have also spent many hours on tire crumb fields. I have witnessed how children are exposed to the fine particulate. After reading all the available literature, my wife and I concluded the risks far outweigh any benefits of using fields with tire crumb. Regardless of your final conclusions, it is clear that tire crumb is beyond our capacity to thoroughly investigate – as I will discuss below. So we will never let our three young children play on tire crumb. **A generation of young Americans relies on you for similar protection.**

Later this year, when the federal government issue its preliminary statement regarding the safety of tire crumb on synthetic turf fields, the most important messages to communicate to concerned parents are: 1) Tire Crumb is a **“Moving Target”** – tire manufacturers frequently change tire ingredients. So any formal study conclusion only speaks to existing fields. Any field installed after a study, or any field not studied, may contain chemicals that were not examined in past studies – including any federal study. So for all the millions of dollars of resources the federal government is about to spend on this study, any conclusions can only speak to actual fields that were studied. A study can only be backwards looking by its very nature since there can be zero confidence that manufacturers will not change tire ingredients. This must be clearly communicated. 2) **Compound based risk assessment can only be done on chemicals and compounds that have regulatory risk frameworks. Tire crumb contains numerous chemicals and compounds with no regulatory risk frameworks.** Therefore, any formal study will necessarily contain significant data gaps. 3) Given that tire crumb contains multiple chemicals and compounds with no risk frameworks, epidemiological studies and animal studies are the only available methods of study to overcome this intrinsic problem. **If there are no significant epidemiological studies undertaken or planned, this must be communicated. If there are no animal studies planned, this must be communicated.**

If the three points of focus above were communicated clearly and prominently, it would help educated field users to truly understand that sometimes, a problem is beyond our ability and present capacity to accurately make predictions or draw conclusions regarding safety. If the federal government was realistic in this endeavor, it would recognize this from the very start. And given what we know about the multiple carcinogens, mutagens and reprotoxins in this material, the government should



conclude from the start that tire crumb is simply too risky to use in such close proximity to children. The following links provide examples of chemicals of concern in tire crumb.

[http://www.albany.edu/ihe/Synthetic\\_Turf\\_Chemicals.php](http://www.albany.edu/ihe/Synthetic_Turf_Chemicals.php)

<http://www.ncbi.nlm.nih.gov/m/pubmed/22352997/>

[http://www.ehhi.org/turf/new\\_study\\_jun2015.shtml](http://www.ehhi.org/turf/new_study_jun2015.shtml) <http://southlakesturf.org/wp-content/uploads/2015/02/Pg-31.jpg>

<http://southlakesturf.org/wp-content/uploads/2015/02/Attachment-1-Crumb-Rubber-Chemicals.pdf>

### **Sweden Concluded that Tires should Not be Used**

Such a position would not be novel or unprecedented. The Swedish agency tasked with reviewing tire crumb on synthetic fields recommended that tires should not be used as material on synthetic turf fields for exactly these reasons. Sweden wisely concluded that given the complexity and the inherent unknowns regarding tire crumb use on turf fields, they simply should not be used.

#### ***Tyres contain substances of very high concern***

Tyres contain several substances that are substances of very high concern. These substances may persist in the environment, they may be **bioaccumulative, carcinogenic, reprotoxic, or mutagenic**. This is true of, for example, polycyclic aromatic hydrocarbons (PAHs), phthalates and certain metals. These substances should not be released into the environment and thus waste tyres should not be used for synthetic turf surfaces.

#### ***Kemi's Recommendations:***

#### ***Do not select synthetic turf that contains substances of very high concern when laying new surfaces***

Material that contains substances of very high concern should not be used, as specified by the environmental objectives of the Swedish parliament. This means that granulate formed from recycled rubber should not be used when laying new surfaces of synthetic turf. **The Norwegian authorities have issued a similar recommendation.**

[http://www.wellesleyma.gov/pages/WellesleyMA\\_SpragueResources/Swedish%20Study.doc](http://www.wellesleyma.gov/pages/WellesleyMA_SpragueResources/Swedish%20Study.doc)

In addition to Sweden and Norway, whole countries that have recommended that tires not be used on turf fields, municipalities like as New York City have has banned tire crumb since 2009 for their schools and parks. <http://www.nydailynews.com/new-york/city-yields-ground-crumb-rubber-turf-wars-article-1.389543>

Similarly in 2009, the L.A. Unified School district has banned tire crumb.

[http://usatoday30.usatoday.com/sports/2009-06-10-artificial-turf\\_N.htm](http://usatoday30.usatoday.com/sports/2009-06-10-artificial-turf_N.htm)

The list grows larger by the week. In early 2015, Montgomery County, Maryland's most populous, banned tire crumb by a unanimous vote of the council.

<http://www.mymcmedia.org/councilmember-berliner-applauds-council-turning-the-page->

[on-artificial-turf/](http://on-artificial-turf/) Recently, the city of Hartford, CT banned Tire Crumb as well. <http://ctmirror.org/2016/02/12/a-shifting-ground-for-artificial-turf-in-connecticut/>

There are many other communities taking similar action. A Google search will provide you with plenty of evidence. Industry lobbyists and representatives will likely tell you that these are just reactionary measures because of sensational headlines of anecdotal news about goalies with cancer. I will discuss the goalies with cancer below. First, Sweden and Norway took their precautionary measures in 2006, well before the news about goalies with cancer in 2014. It was enough for them to understand what is in tire crumb. They didn't need to conduct a generation long experiment to decide if it is safe. They erred on the side of caution, which is a reasonable measure given the multiple chemicals of concern, carcinogens, PAHs, VOCs, phthalates, heavy metals and endocrine disruptors. All these things are in tire crumb. There is no debate about that.

Over the last ten to twenty years, parents have been increasingly aware that they should take reasonable steps to protect their kids from having toxins bioaccumulate in their kids' bodies. So countries and municipalities that are avoiding tire crumb are not simply acting because they are scared, they are taking prudent and reasonable measures to minimize exposure to dangerous toxins. BPA and phthalates are good examples. These chemicals are not banned by EPA and really not heavily regulated as far as I understand.

### Exposure

But the science is pretty clear at this point that we should protect children from unnecessary exposure to endocrine disruptors. When developing kids are on a tire crumb field, they often ingest tire crumb. They either ingest actual particles or they ingest micro particles that get mixed into their sweat as it runs over their skin and into their mouth. The attached document from the safe healthy playing fields coalition illustrates how small particles actually are. The picture below is from the attachment. But look at how small the dust is. The larger black spot is a highly magnified piece of tire crumb. The specs are microscopic dust. The picture of the woman illustrates how easily the dust can be transferred from a field to a sweaty person and into their mouth.

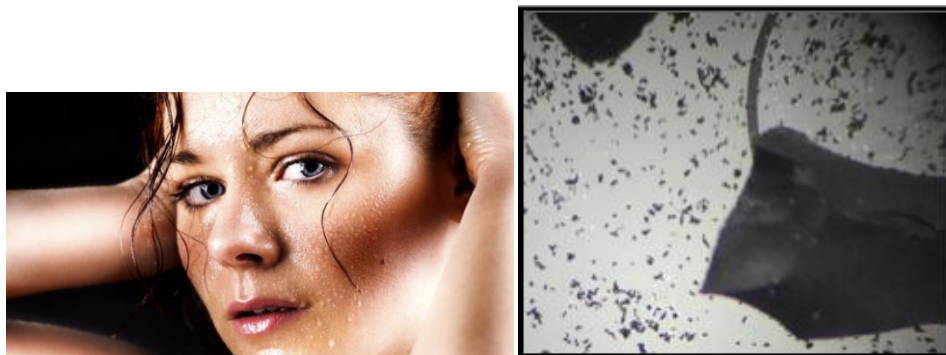

They inhale fine tire crumb dust. They inhale VOCs. They absorb chemicals and oils from tire plasticizers either directly through their skin or in open wounds. It gets in their noses. It gets in their eyes. There are multiple exposure routes.

### Bioavailability

Based on limited study, industry representatives like to assert that the chemicals in tire crumb are somehow not bioavailable. But there are studies that contradict that. For example, there is a study from South Korea that concludes that lead in EPDM rubber particulate is indeed bioavailable. It should not be any different for metals in particulate and dust like tire crumb. **“Conclusions - Results of this study confirm that the exposure of lead ingestion and risk level increases as the particle size of crumb rubber gets smaller.”** <http://www.ncbi.nlm.nih.gov/pmc/articles/PMC3278598/>

So it is reasonable for parents to take precautions in their daily lives to protect their children from toxins. People wash fruit, they off-gas products, they avoid flame retardants, and they avoid endocrine disruptors and PAHs in their children's products. The list goes on. So when municipalities ban tire crumb, they are simply acting in the same reasonable and cautious way that their populations act every day. **Why would parents want to take reasonable steps to protect their children from harmful toxins in their daily lives, then turn around and expose their kids to all the same chemicals of concern and even worse? It does not make sense to take one step forward and two steps back.**

Avoiding tire crumb is not a reactionary measure to sensational news; it is wisdom and common sense. Using tire crumb where kids play is reckless and out of step with a growing population of educated American's approach to toxins around children. It is truly mind boggling that there are individuals in the federal government that consider this even remotely as a good idea.

Every day, we learn how toxins bioaccumulate in the body. Folks take careful steps to protect their families. By even pretending that somehow a field full of all the same chemicals of concern could be tolerable under any circumstance is just plainly behind the times. The only reason there has not already been a mass revolt is that there has not been an opportunity to educate the millions of people that need the education. But if the same people who avoid BPA and phthalates in their children's products actually learned in detail just how full of toxins their kids' fields are, they would put it all together.

So please don't pretend that somehow different rules apply just because kids are running around and exercising. It is illogical to think that exercising somehow mitigates the harms and risks. If anything, it makes it worse.

## Goalies with Cancer – Only 5000 blood Cancers a Year

What about those soccer goalies with cancer? Anything short of a serious statistical analysis would be too bad. It appears that there are only around 5000 blood cancers a year under the age of 24. There are now over 100 goalies on Amy Griffin's list. Most have blood cancers. Given so few kids with blood cancers in a given year, it seems very unlikely that one person would be able to put together a list of so many people with two things in common 1) plays one particular position (goalie), and 2) plays mostly on one particular kind of field (tire crumb). And there are still not that many tire crumb fields nationally – around 12,000. So Amy Griffin's list should be taken very seriously.

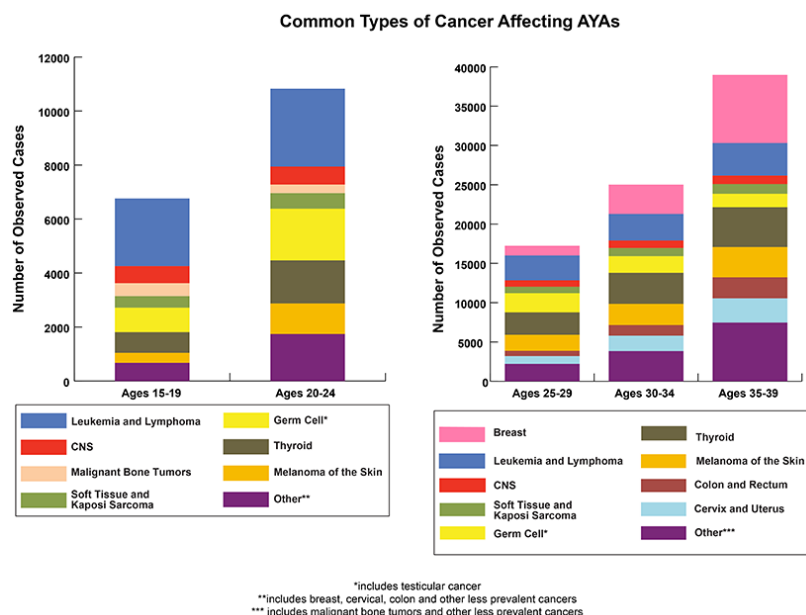

<http://www.cancer.gov/research/progress/snapshots/adolescent-young-adult>

## Carbon Black

Any investigation must also look closely at carbon black. Carbon black makes up about 1/3 of a tire. That means about 1/3 of a tire crumb field is also carbon black. Carbon black is a known animal carcinogen and a possible human carcinogen. Nanoparticles in carbon black have been theorized to present asbestos like concerns.

[http://www.turfandrec.com/index.php?option=com\\_content&task=view&id=2986](http://www.turfandrec.com/index.php?option=com_content&task=view&id=2986) If this is not looked at very closely, it would be a monumental oversight. Will the study look closely at carbon black exposure?

## Carbon Nanotubes

**“Inhaling carbon nanotubes could be as harmful as breathing in asbestos**, and its use should be regulated lest it lead to the same cancer and breathing problems that prompted a ban on the use of asbestos as insulation in buildings, according a new study

posted online . . . by *Nature Nanotechnology*.”  
<http://www.scientificamerican.com/article/carbon-nanotube-danger/>

"[Ti]res enhanced with CNT (carbon nanotubes) appear to have improved mechanical properties, such as tensile strength, tear strength and hardness of the composites, by almost 600%, 250% and 70% respectively, comparing with those of the pure SBR composites (styrene-butadiene rubber)." <http://www.iosrjournals.org/iosr-jmce/papers/vol11-issue4/Version-1/B011410711.pdf>

This concern with carbon nanotubes goes back to the “Moving Target” concern I discussed in the first page of this document. Tires are waste products that are not designed for use, ingestion, inhalation and absorption by children. Any slew of potentially carcinogenic material could make their way into the next generation of tires, and probably will. This should be unacceptable from the start.

Past studies have been negligent in how they collect data. They underestimate exposure. The 2008 EPA study set up a particle collector and had kids run by periodically. The particle collector was surrounded by a small 3 foot fence. That is not realistic exposure replication. In order to replicate a goalies exposure, you would literally have to kick the tire crumb fly-out into the collector again and again for hours and hours.

Past studies also use simulated body fluids that do not accurately extract all the chemicals in tire crumb. The Yale study found 12 carcinogens.  
<http://www.ehhi.org/turf/findings0815.shtml> Industry critics claim that Yale used to harsh an extraction method. But there is no debate that the carcinogens were present. One can make an argument that prior extraction methods based on simulated body fluids were not stringent enough.

I am attaching the written testimony of Dr. Wright from the Mount Sinai Children’s Environmental Health Center.

<https://dl.dropboxusercontent.com/u/101177270/CEHC%20RB%205139%20Testimony%20Feb%2016%202016.pdf>

It says it all. In short:

1. "Given the hazards associated with recycled tire rubber, it is our recommendation that these products never be used as surfaces where children play."
2. "[W]e found significant gaps in the evidence supporting the safety of recycled rubber turf products."
3. "Children are uniquely vulnerable to harmful exposures from recycled rubber surfaces."
4. "In the absence of convincing evidence of safety, we recommend that children not play on recycled rubber surfaces that contain known carcinogens and neurotoxins and support a ban on the use of these products."

I hope the federal government takes the same reasonable position. Even if you do not, a large portion of the population will continue to act prudently and will avoid using fields with tire crumb. You might as well act responsibly and protect those that do not have the fortune to be as educated on the dangers of bioaccumulated toxic exposure.

### Heat - 120 degrees

A few comments on heat - I read that the fields would be tested at two temperatures. One would be at room temperature or average outdoor temp. The other would be at a higher temperature to mimic a hot day. I hope you paid attention to the temperatures at the women's soccer world cup. The temperatures of the turf were not just hot, they were astonishingly hot. It was measured at 120 degrees! So please measure it at that temperature. Anything else would be a sham.

<https://www.washingtonpost.com/news/early-lead/wp/2015/06/06/the-artificial-turf-at-the-womens-world-cup-was-reportedly-120-degrees-at-kick-off/>

### Industry MSDS

The Synthetic Turf Council has a MSDS that makes clear there are certain precautions that their installer should take. They include washing frequently, wearing a respirator, and wearing eye protection to name a few (see next page). But importantly, this is the industries own material. How can they be asserting on the one hand that children are safe to play on tire crumb and then at the same time, warning their installers to take very deliberate and thorough measures to protect themselves from tire crumb as they install it?

It is very puzzling to try to understand how this material is safe for players who get the same if not more exposure than installers. Kids who roll in tire crumb, eat tire crumb, drink tire crumb in sweat, inhale tire crumb, absorb tire crumb, and grow up on tire crumb are getting absolutely no warnings like the installers. It is a terrible injustice and wildly hypocritical.



## Standard Format MSDS (continued)

<b>PRECAUTIONS FOR SAFE HANDLING AND USE</b>	
<b>STEPS TO BE TAKEN IN CASE MATERIAL IS RELEASED OR SPILLED</b>	Sweep up or vacuum into disposal containers
<b>WASTE DISPOSAL METHOD</b>	Product not defined as hazardous waste. Dispose of in accordance with federal, state, and local regulation.
<b>PRECAUTIONS TO BE TAKEN IN HANDLING AND STORAGE</b>	Do not store near flame or ignition source. Do not store hot material in tubs or containers where spontaneous ignition could occur.
<b>OTHER PRECAUTIONS</b>	If material burns, an oily residue will result. This residue must be disposed of in accordance with federal, state and local regulations.
<b>RESPIRATORY PROTECTION (Specify Type)</b>	Use any dust and mist respirator noted for up to 10 mg/m <sup>3</sup> .

<b>CONTROL MEASURES</b>	
<b>VENTILATION: Yes</b>	<b>LOCAL EXHAUST: Yes</b> , if dusty conditions occur.
<b>SPECIAL: None</b>	<b>MECHANICAL (General):</b> Dust collector and
<b>PROTECTIVE GLOVES: Recommended</b>	<b>EYE PROTECTION:</b> Use safety goggles to prevent dust entry.
<b>OTHER PROTECTIVE CLOTHING OR EQUIPMENT</b>	Enough fresh air should flow past the user to prevent exposure to airborne fibers and particles.
<b>WORK/HYGENE PRACTICES</b>	Good personal hygiene; frequent washing with soap and water of exposed areas; remove and clean solid clothing.

The information contained in this MSDS is consistent with the U.S. Department of Labor OSHA Form OMB 1218-0072. Consult OSHA Hazard Communication Standard 29 CFR 1910.1200 for additional information. To fully understand the use of any material, the user should avail themselves of reference material and expert consultation in the fields of fire prevention, ventilation and toxicology.



Why should kids not receive the same warnings when they get even more exposure than installers? When parents are educated on this seeming hypocrisy, they see right through industry assertions that the material is safe. If you conclude that tire crumb is safe as well, you will have to explain why installers receive special warnings about wearing respirators and washing.





There should be signs on every field that provide the same warnings to parents and players.

## **SAFE PRACTICES WHEN PLAYING ON SYNTHETIC TURF FIELDS**

- Watch for signs of **heat-related illness** and **dehydration**—fields can get excessively hot on warm, sunny days
- Wash crumb rubber dust off your hands and face before eating or drinking
- Wash hands, hair, and exposed skin parts thoroughly after playing on fields
- Turn clothes inside out as soon as possible to avoid transferring dust and fibers to other locations
- Keep water bottle nozzles, food containers, and other beverages closed and in bags/coolers when not drinking to minimize contamination from field dust and fibers

***Chemical contaminants in crumb rubber are known to be harmful to health***

These are just some thoughts that hopefully provide some insight as to why you should categorically conclude that tire crumb is too risky to use where children play. Please do the right thing and recommend that there be a moratorium on the use of tire crumb on synthetic turf fields and playgrounds.

Please consider attachments 1 and 2 as a fully incorporated part of this document and part of my formal comments as well.

Regards,

Jonathan R. Damm  
Reston, VA 20191  
[jondamm@yahoo.com](mailto:jondamm@yahoo.com)  
Vermont Law School, JD, MSEL '99

## Attachment 1



Children's Environmental Health Center  
Department of Preventive Medicine

Icahn School of Medicine at Mount Sinai  
One Gustave L. Levy Place, Box 1217  
New York, NY 10029-6574

Written Testimony before the Connecticut General Assembly Committee on Children  
February 16, 2016

Testimony in Support of:  
Raised Bill 5139, An Act Concerning the Use of Recycled Tire Rubber at Municipal and Public School Playgrounds.

To Senator Bartolomeo, Representative Urban, and honorable members of the Committee on Children:

We, the Children's Environmental Health Center of the Icahn School of Medicine at Mount Sinai, strongly support *Raised Bill 5139, An Act Concerning the Use of Recycled Tire Rubber at Municipal and Public School Playgrounds*. **Given the hazards associated with recycled tire rubber, it is our recommendation that these products never be used as surfaces where children play.**

As pediatricians, epidemiologists, and laboratory scientists at the Children's Environmental Health Center of the Icahn School of Medicine at Mount Sinai, which hosts one of 10 nationally funded Pediatric Environmental Health Specialty Units, we have received numerous phone calls from concerned parents and physicians regarding the wide scale use of recycled rubber surfaces on school grounds and in park properties. This led us to conduct a review of the risks and benefits of artificial playing surfaces, during which we found **significant gaps in the evidence supporting the safety of recycled rubber turf products**. Our findings are summarized below and discussed in detail in the attached documents: "Artificial Turf: A Health-Based Consumer Guide" and "Position Statement on the use of Recycled Tires in Artificial Turf Surfaces".

**Children are uniquely vulnerable to harmful exposures from recycled rubber surfaces.** Public playgrounds are typically utilized by children age 6 months to 12 years, a population exquisitely vulnerable to the health effects of toxic environmental exposures. This vulnerability is due to a number of factors including, but not limited to, their unique physiology and behaviors, rapidly developing organ systems, and immature detoxification mechanisms<sup>1</sup>. Additionally, because of their young age, children have more future years of life and therefore more time to develop chronic diseases.

---

<sup>1</sup> Bearer, CF. *Neurotoxicology* 21:925-934, 2000.



Children's Environmental Health Center  
Department of Preventive Medicine

Icahn School of Medicine at Mount Sinai  
One Gustave L. Levy Place, Box 1217  
New York, NY 10029-6574

We have identified several potential dangers that playing on recycled rubber playing surfaces pose to children. These include:

- 1. Extreme heat.** On hot summer days, temperatures of over 160 degrees Fahrenheit have been recorded on recycled rubber play surfaces<sup>2</sup>. Vigorous play in these conditions conveys a very real risk of burns, dehydration, heat stress, or heat stroke. Children are less able to regulate their body temperature than adults, making them particularly susceptible to conditions of extreme heat<sup>3</sup>. In addition, children have a higher surface area to body mass ratio, produce more body heat per unit mass, and sweat less than adults, all factors that increase susceptibility to heat injury<sup>4</sup>.
- 2. Inhalation and ingestion of toxic and carcinogenic chemicals.** Children are particularly vulnerable to chemical exposures from playground surfaces due to their developmentally appropriate hand to mouth behaviors. In addition, their close proximity to the ground and higher respiratory rates compared with adults increase the likelihood of inhalational exposures. Thus, there is a potential for toxins to be inhaled, absorbed through the skin and even swallowed by children who play on recycled rubber surfaces.

The major chemical components of recycled rubber are styrene and butadiene, the principal ingredients of the synthetic rubber used for tires in the United States<sup>5</sup>. Styrene is neurotoxic and reasonably anticipated to be a human carcinogen<sup>6</sup>. Butadiene is a proven human carcinogen that has been shown to

---

<sup>2</sup> Devitt, D.A., M.H. Young, M. Baghzouz, and B.M. Bird. 2007. Surface temperature, heat loading and spectral reflectance of artificial turfgrass. *Journal of Turfgrass and Sports Surface Science* 83:68-82

<sup>3</sup> <https://www.aap.org/en-us/advocacy-and-policy/aap-health-initiatives/Children-and-Disasters/Pages/Extreme-Temperatures-Heat-and-Cold.aspx>

<sup>4</sup> Falk B, Dotan R. *Appl Physiol Nutr Metab*. 2008 Apr;33(2):420-7. doi: 10.1139/H07-185.

<sup>5</sup> Denly *et al* A Review of the Potential Health and Safety Risks from Synthetic Turf Fields Containing Crumb Rubber Infill. May 2008. [http://www.nyc.gov/html/doh/downloads/pdf/eode/turf\\_report\\_05-08.pdf](http://www.nyc.gov/html/doh/downloads/pdf/eode/turf_report_05-08.pdf)

<sup>6</sup> ATSDR Toxicological Profile for Styrene, November 2010. <http://www.atsdr.cdc.gov/toxprofiles/tp53.pdf>.



Children's Environmental Health Center  
Department of Preventive Medicine

Icahn School of Medicine at Mount Sinai  
One Gustave L. Levy Place, Box 1217  
New York, NY 10029-6574

cause leukemia and lymphoma<sup>7</sup>. Shredded and crumb rubber also contain lead, cadmium, and other metals known to damage the developing nervous system<sup>8,9</sup>. Some of these metals are included in tires during manufacture, and others picked up by tires as they roll down the nation's streets and highways. Children may also inhale potentially harmful chemicals that have been detected in the air above rubber turf such as benzothiazole and polycyclic aromatic hydrocarbons (PAHs), both of which are linked to cancer<sup>10</sup>.

It is important to note that risk of harm due to exposures from recycled rubber turf has been assessed only for single chemicals, yet children are exposed to numerous harmful chemicals in aggregate during play on these surfaces. It is widely recognized that carcinogens and other environmental toxins act in an additive or multiplicative fashion, making risk assessment of the chemical mixtures present in recycled rubber critical for a comprehensive safety assessment<sup>11</sup>. Because tire rubber composition varies by manufacturer, it is impossible to know the full contents of chemicals contained within a recycled rubber playing surface. For a more comprehensive description of the harmful chemicals contained within recycled rubber products, please see the attached Consumer Guide.

- 4. Transportation home of rubber pellets.** Recycled rubber materials used in play surfaces break down into smaller pieces over time that may be picked up on children's shoes, clothing and skin. The rubber is then tracked into children's homes and cars, and carried into the places where children live, play, eat and sleep. Thus exposure can continue for many hours beyond the time that a child spends in the play area.

<sup>7</sup> International Agency for Research on Cancer, 2008.

<http://monographs.iarc.fr/ENG/Monographs/vol100F/mono100F-26.pdf>

<sup>8</sup> Timothy Ciesielski *et al.* Cadmium Exposure and Neurodevelopmental Outcomes in U.S. Children. *Environ Health Perspect.* 2012 May; 120(5): 758–763. 27. doi: 10.1289/ehp.1104152

<sup>9</sup> CDC (2012) Low Level Lead Exposure Harms Children: A Renewed Call for Primary Prevention.

[http://www.cdc.gov/nceh/lead/acclpp/final\\_document\\_010412.pdf](http://www.cdc.gov/nceh/lead/acclpp/final_document_010412.pdf)

<sup>10</sup> Connecticut Department of Public Health (2010) Human Health Risk Assessment of Artificial Turf Fields Based Upon Results from Five Fields in Connecticut.

[http://www.ct.gov/deep/lib/deep/artificialturf/dph\\_artificial\\_turf\\_report.pdf](http://www.ct.gov/deep/lib/deep/artificialturf/dph_artificial_turf_report.pdf)

<sup>11</sup> Goodson WH *et al* 2015. Assessing the carcinogenic potential of low-dose exposures to chemical mixtures in the environment: the challenge ahead. *Carcinogenesis* 36(Suppl 1):S254–S296.





Children's Environmental Health Center  
Department of Preventive Medicine

Icahn School of Medicine at Mount Sinai  
One Gustave L. Levy Place, Box 1217  
New York, NY 10029-6574

**5. Escape of chemical hazards from rubber surfaces to the environment.** A number of the toxic and chemical components of the recycled rubber that is installed on playgrounds are soluble in water. When rain and snow fall on synthetic fields, these materials can leach from the surface to contaminate ground water and soil<sup>12</sup>. In addition, chemicals in turf can be released into the air and inhaled, particularly on hot days.

**Disposal of recycled rubber surfaces.** A further unresolved issue is what to do with the toxic components of recycled rubber play surfaces 10 years from now when they reach the end of their usable life-span and need to be dismantled. The costly process of separating, reclaiming, reusing, recycling, or disposing of the various components of a turf field are often overlooked at the time of installation. What will disposal cost? Who will pay? Often, these questions have not been factored into the overall cost.

**Safe alternatives to recycled rubber playground surfaces exist.** Daily outdoor play and physical activity are essential components of a healthy childhood. Thus safe play areas are critical to any school environment. While it is important to minimize playground injuries, the Consumer Product Safety Commission Public Playground Safety Handbook<sup>13</sup> contains several additional safe and affordable alternatives such as wood mulch, which does not carry the same risks of chemical and heat exposure outlined above.

The potential long-term consequences of exposures to synthetic rubber play surfaces have not been carefully assessed by independent third parties prior to their installation throughout the country. For this reason, Senator Richard Blumenthal called upon the federal government to conduct comprehensive studies to verify the safety of recycled rubber for use in areas where children play – including playgrounds<sup>14</sup>. Subsequently, on February 12, 2016, the United States Environmental Protection Agency announced the launch of an investigation into the safety of crumb rubber in partnership with the Centers for Disease Control and Prevention and the Consumer Product Safety

---

<sup>12</sup> Connecticut Department of Environmental Protection (2010) Artificial Turf Study: Leachate and Stormwater Characteristics.

[http://www.ct.gov/deep/lib/deep/artificialturf/dep\\_artificial\\_turf\\_report.pdf](http://www.ct.gov/deep/lib/deep/artificialturf/dep_artificial_turf_report.pdf)

<sup>13</sup> US Consumer Product Safety Commission. *Public Playground Safety Handbook*. #365, November 2010. <https://www.cpsc.gov/PageFiles/122149/325.pdf>

<sup>14</sup> <http://www.nhregister.com/article/NH/20151106/NEWS/151109637>



Children's Environmental Health Center  
Department of Preventive Medicine

Icahn School of Medicine at Mount Sinai  
One Gustave L. Levy Place, Box 1217  
New York, NY 10029-6574

Commission, stating "existing studies do not comprehensively evaluate the concerns about health risks from exposure to tire crumb"<sup>15</sup>. **In the absence of convincing evidence of safety, we recommend that children not play on recycled rubber surfaces that contain known carcinogens and neurotoxins and support a ban on the use of these products.**

We urge your support of HB 5139 in order to protect the health of the children of Connecticut. Thank you for the opportunity to provide you with our professional opinion. We would be more than happy to answer any questions that you might have.

Kind Regards,

A handwritten signature in black ink, appearing to read "Robert Wright".

Robert Wright, MD, MPH  
Director, Mount Sinai Children's Environmental Health Center

A handwritten signature in black ink, appearing to read "Sarah Evans".

Sarah Evans, PhD, MPH  
Children's Environmental Health Center  
Icahn School of Medicine at Mount Sinai

---

<sup>15</sup> [http://www.epa.gov/sites/production/files/2016-02/documents/us\\_federal\\_research\\_action\\_plan\\_tirecrumb\\_final\\_0.pdf](http://www.epa.gov/sites/production/files/2016-02/documents/us_federal_research_action_plan_tirecrumb_final_0.pdf)

**Attachment 2**  
**Comments on ASTDR 2016-0002-0003**

**Federal Research Action Plan on**

**Recycled Tire Crumbs Used on Playing Fields and Playgrounds**

**Submitted to Federal Register May 2, 2016**

---

SAFE AND HEALTHY PLAYING FIELDS COALITION [www.safehealthyplayingfields.org](http://www.safehealthyplayingfields.org)

A grass roots coalition working for healthier alternatives for children and communities

---

**INTRODUCTION**

On behalf of the millions of children, parents and athletes who play field sports in the US at schools, parks, athletic facilities and playgrounds, thank you for agreeing to study the potential harm caused by playing on or being near athletic fields with surfaces made waste tires. There are more than 12,000 of these playfields in place (15,000 according to the website of a large company that installs them), and they are being installed at a rate we estimate to be about 3000 a year. By our calculations, 12,000 fields currently present 2,380,000 tons or 4,760,000,000 pounds of loose, unencapsulated tire crumb on their field surface. (See our Table of Runoff and Material Volumes attached.) Tens of thousands of students and young athletes play on those fields, many more thousands have direct or indirect contact with the material. It is a public health issue of substantial importance.

The following lists our comments on the proposed study. We argue that the fields present known carcinogenic, pathogenic, and mutagenic material in a high surface area, pulverized form that is more toxic than whole tires, and should never have been allowed near children, or adults, because of risk of ingestion and inhalation exposure to all the ingredients in tires. On warm, sunny days the surface temperature routinely reaches over 150F, which presents direct, well-known heat injury risks to children. The heat increases off-gassing of the tire components, increasing the likelihood of pulmonary

exposures, and creates a complex dynamic in the children's exposure zone immediately above a field that has not been correctly modeled or studied yet. The material lacks uniformity, or any regulatory or exposure controls. We assert that it is impossible to assure even a single tire crumb field is free of inhalation and ingestion risk of dangerous particulate and gases inherent in tires, tire crumb, and add-in composites; and that dangerous and unwanted exposures from lead, benzothiazoles, 12 carcinogens, phthalates, carbon black and other materials, can happen with every use. The data gaps are enormous, and we hope CDC/CPSC/EPA will recognize there is no way the tire crumb industry can protect any player, on any field, from the potential for dangerous exposures with normal use. We argue that not enough scrutiny was placed on this material.

NOTE: The Safe and Healthy Playing Fields Coalition is a grass roots group of scientists, public health professionals, toxicologists, neurobiologist, educators, plastics engineers, medical doctors, waste management and remediation professionals, coaches, researchers, and parents who donate their own time and skills towards helping communities and individuals assess risks to their communities from tire crumb field use. We do not have a lobbying firm, law firm, hired laboratory, consultant, or revenue-generating source (such as tire crumb), and rely solely on the skill of researchers who donate time to compile our comments. That said, we have found compelling data that refutes almost all claims of safety, and when we asked for additional time to compile the information, we were given two weeks, but denied additional time. Hence, we are working at a disadvantage, and hope that during this study year, we will have time and opportunity to substantiate our concerns, and share our research with the study officials. One of our comments below explains our requests for a conference or virtual meeting that allows more disclosure and discussion.

Our comments are listed in numerically and organized into: 1. General Comments, 2. Characterization and methodology comments; 3. Summary List of requests, and a number of supporting documents are also submitted as part of our comments.

#### **PART I: GENERAL COMMENTS:**



**1. CPSC/CDC/EPA should use their existing authority to immediately reclassify tire crumb athletic fields as a children’s product, since thousands of fields have been installed in schools that serve hundreds of thousands of children.**

2. We have grave concerns about their safety to human health and the environment, since **known carcinogenic and pathogenic components in the field material yield into both air and water pathways, and provide ample opportunity for both chronic low dose exposures with every use of the field to lead, chromium, mercury, zinc, PAH, VOC, carbon black, styrenes, benzothiazoles, and plastics; and more intermittent, but dangerous high dose exposures from “HOTSPOTS” of component material.** (See comments on Characterization). Each of the fields has material that is known to cause cancer, illnesses, and injury in humans; and leachate from runoff causes several negative impacts on the aquatic ecosystems. We believe that the potential for human illness (including several cancers) from both low dose and high dose exposures to the ingredients in tires is staggering. Basic logic favors our position. Based on the known potential for exposures to children, and the finding of a group of 200 soccer players with cancer (the group represents the reach of a single charismatic soccer coach), an immediate moratorium on new construction of the fields should be put in place with the existing authority of CDC/CPSC/EPA, until the tire crumb fields can be shown to be safe to inhale and ingest.

**3. The tire crumb recycling industry, which appears “green” in its efforts to sell millions of used tires in “repurposed” shredded form, in fact enables a direct transfer of the contamination burden of waste tires from landfills/collection sites (in the US and abroad) to the play surfaces of 12,000 schools and sports centers, where tens of thousands of children and adults have direct contact with the toxins in tire crumb materials on the field surface, and *these exposures could happen with every single contact.***

4. For the most part, the **schools and sports centers do not have resources to conduct toxicity due diligence;** meaning, they do not have access to a toxicologist who reads the industry studies with their health as the only priority. Purchasers rely on the tire crumb recycling industry statements, industry studies, and industry funded websites that claim toxicology assessment and public health guidance. The sales material can be striking, and the studies appear convincing on the surface, but our study groups have found significantly misleading information about the safety and actual risk of harm from the tire

crumb fields to all users, particularly children. They are likely unaware that claims that the fields are “SAFE TO INSTALL; SAFE TO PLAY” have been repealed.

5. **PEER Filings.** Public Employees for Environmental Responsibility have filed a number of complaints and documents that argue for a repeal of endorsements of tire crumb safety from EPA/CPSC, and those statements were in fact repealed; but most schools and potential purchasers are unaware of the removal of endorsements and claims of safety. The PEER filings are an excellent source for telling the toxicity story and regulatory story of this product. We respectfully request that the entire file of complaints and responses to the complaints, and other supporting material be entered into the record for ASTDR 2016-0002-0003.

**The full list of documents for the ASTDR 2016-002-0003 collection and record can be found here:**

**<http://www.peer.org/campaigns/public-health/artificial-turf/news-releases.html>. Please include all in that list, and all supporting materials.**

6. Formal legal requests have been made to classify the tire crumb fields as a children’s product since children use them, and sales and marketing material are very clear about tire crumb fields are for children. **CDC/CPSC/EPA should use their existing authority to explicitly label the fields as children’s products.** (Please refer to PEER filings for details and supporting arguments:

**<http://www.peer.org/campaigns/public-health/artificial-turf/news-releases.html>)**

## **7. CLASSIC CANCER CLUSTER APPEARANCE: SOCCER PLAYERS**

Parents and schools may have trusted the “Safe to Play” statements, **but the parents of the 200 young women and men, who played intense soccer and were stricken with cancer do not trust those claims anymore.**

The case of over 200 young soccer players who used tire crumb fields and contracted cancer, strongly indicates a classic cancer cluster, though the cases have not undergone the formal validation process, not yet. That is because a process for the collection of this information, does not exist yet for either cancer victims, or for other illnesses, head injuries, and heat injuries/illness from the fields.

**8. We respectfully request that an official study of the soccer player cancer cluster be initiated by CDC immediately.**

Through our activist network, we learned about these cases, which were reported to the NBC news link, or directly to a single, trusted concerned soccer coach. EHHI reported as follows:

---

“New Cancer Numbers Among Soccer Players on Synthetic Turf,

April 2016

It is important to remember that the only people counted in the numbers below are those who have known to call Amy Griffin. There is still no government agency tracking the cancers among the athletes who have played on synthetic turf. We know the actual numbers of athletes who have played on synthetic turf and contracted cancer have to be much greater than those who have known to report their illness to Amy Griffin.

In January of 2016, there were 159 cancers reported among soccer players; now (April 2016) there are 166. Ninety-seven of those in January were goalkeepers; now there are 102. Sixty-one percent of the soccer players with cancer are goalkeepers. As of this writing, 220 athletes of various sports who have played on synthetic turf have cancer; 166 soccer players who have played on synthetic turf also have cancer.

**166 Soccer Players who have played on synthetic turf and have cancer**

- 102 are goalkeepers (61% are goalkeepers)
- 64 soccer players with lymphomas, 39 are goalkeepers (61%—over half are goalkeepers)
- 10 soccer players with Non-Hodgkin lymphoma, 7 are goalkeepers (70%—over half)

- 54 soccer players with Hodgkin lymphoma, 32 are goalkeepers (60%—over half)
- 41 total leukemias, 24 are goalkeepers (59%—over half)
- 16 total sarcomas, 7 are goalkeepers (44%)
- 12 thyroid, 9 are goalkeepers (75%—over half)
- 11 brain—5 are goalkeepers (45%)
- 9 testicular—6 are goalkeepers (67%—over half)
- 4 lung—3 are goalkeepers (almost all are goalkeepers)

Remaining are OTHER rare cancers.”

Source: Various; Victim parent volunteers, EHHI primary collection; 4/2016 (ongoing)

---

All the victims were frequent users of turf fields, spending multiple hours a week in close contact with the material in the fields. All were in their mid-twenties or younger.

**9. The self-reporting to a trusted coach, is also an indication that the actual illness rates are not yet being properly assessed or managed by any hospital, medical system, or group; there is no “home” for this information, yet.** The 200+ cancer victim count is likely the reach of a single coach with the help of a link in broadcast media, and a fraction of the actual count of victims of cancer or other serious illnesses. Better investigation and creating a “safe” place to report serious and intermittent illness will uncover many more victims, and provide needed perspective on the accuracy of risk assessment for this product.

**10. The CDC and appropriate agencies should issue a directive asking for adequate screening for injury and disease.** That US hospital and medical systems are not yet set up to collect this data is a contributing factor; and concurrently, screening for synthetic field use should be part of a responsible screening protocol. To our utter dismay, we learned from pediatric oncologists in our group that at least some oncologist are prohibited from screening victims/patients for tire crumb field use; the screening must be part of the approved protocol, and tire crumb product is not yet included..

**11.** In fact, the number of **all injuries from tire crumb fields should be collected and analyzed to include, but not be limited to: head injury and concussion; joint injuries (multiple); heat injury; blood cancer; lymphomas; testicular cancer; pulmonary illness; neurological impairment; kidney disease; diabetes; brain disease and cancers.** These findings need to be documented, and the children who suffer from them should be screened for tire crumb field use and proximity. No doctor or oncologist should be prevented from asking questions, screening for, or questioning the safety of this product or contact with this product. We believe there are many more heat related illnesses, head injuries, and endocrine system disruptions directly resulting from exposure to the fields than what is being reported.

**12. REQUEST MORE INVESTIGATION INTO EXISTING AND POTENTIAL CANCER CLUSTER:** We ask that the multiagency group takes steps to expedite the process of collecting epidemiological data and verification of the current soccer player cluster, and other potential clusters, to include field maintenance workers who rake the fields, field installers who pour the millions of pounds of material onto field surfaces, school custodians, high contact users of any kind, and school children in buildings adjacent to the fields. Residences near the fields should be considered in the scope of the study or subsequent studies. **In our own informal assessment, and using SEER database and known levels of cancer victims, we found the potential for 7-11 cancer clusters.** We respectfully ask the CDC experts to look into this possibility and take the necessary steps to prevent additional injury and cancers.

**13. NEED FOR EXPLICIT PROTECTION FROM RETRIBUTION:** Sadly, the families, coaches, and school leaders who have reported illnesses do so with concern for **retribution from the tire crumb industry, school boards, university administrations, and even sports league administrators, and may need explicit protection and remedy against retribution.** Researchers who study the potential for harm tell us that they do not have protection from retribution from tire crumb field industry proponents. Even in our own group, public health and medical professionals must make statements of concern anonymously to protect themselves from retribution—professionally and personally from industry proponents. Adequate protections need to be established to protect the professionals and parents who speak out.

**14. PROTECTION FOR CHILDREN IS NOT A COST-BENEFIT ANALYSIS.** Children have a unique vulnerability to toxic exposures—both intermittent high exposures—and to low dose exposures, and if we are aware of a carcinogenic presence, then we are responsible for using a precautionary principle, and removing that exposure risk. With due respect, this is not a cost-benefit analysis that will show a

percentage of children will get sick (cost) vs. tournaments played or jobs created (benefit). It is a decision made by a civil society that upholds protection for children's health above all other industry priorities, and a recognition that tens of thousands of children, if not hundreds of thousands, are already being exposed to material with known carcinogenic, and harmful materials on school turf fields.

15. The CDC/CPSC/EPA should recognize that the fields serve children, acknowledge that there are zero safety controls on the material and the potential exposures, and immediately acknowledge tire crumb fields as children's products, and use your existing authority to regulate them as children's products.

**Therefore, we emphatically REQUEST THAT THE CPSC/EPA/CDC USE EXISTING AUTHORITY TO IMMEDIATELY CLASSIFY ARTIFICIAL TURF AS A CHILDREN'S PRODUCT, SINCE THOUSANDS OF CHILDREN ALREADY USE THE FIELDS, IN THOUSANDS OF SCHOOLS.**

Since children and adults are already being exposed on tire crumb fields to the materials in tires, we ask for an **immediate moratorium on further construction of tire crumb based or recycled rubber based artificial turf fields** until adequate assurances that tire crumb particulate, off-gassing, and combinations are safe for children to inhale and safe for children to ingest.

**Your three agencies do not need to conduct a study to know with absolute certainty that tires were not designed to be inhaled by children, and we should protect children, at any length, from chronic or lose dose carcinogenic exposures.**

Even if we cannot model or know (or will we ever know) the exposures to each child, each day (and we will never know), we do know with certainty that:

1. Carcinogens are in tires.
2. Shredded, pulverized tire crumb contains everything in tires, and more ingredients, including: carbon black, phthalates, VOCs, PAHs, benzothiazoles, lead, chromium, zinc, nanoparticle additives, proprietary additives, 12 known carcinogens, 90 materials known to be harmful to human and environmental health, (EHHI)
3. The material can be inhaled when playing and ingested with contact, or intermittent adjacent contact.

4. Every single direct or indirect use has the potential for exposure to hotspots and low dose chronic exposures to multiple scenarios of these materials.
5. The exposures could impact children, school buildings, and surrounding areas; contamination travels to cars, homes, and even children's bedrooms.
6. It is both within the authority and the responsibility of your three agencies to take immediate action to protect the public, especially children, from known carcinogenic, pathogenic exposures.

**Only a complete moratorium on their use will protect the millions of children, athletes and bystanders from inhalation and ingestion of the materials that yield from tire crumb synthetic turf fields.**

**16.** It is also evident that tire crumb will never be safe unless ALL tire ingredients, all "recipes", the manufacturing of tires, and then preparation of materials for fields are controlled from a toxicity perspective. This level of voluntary cooperation from the tire manufacturing industry will, of course, never happen.

**17. ONLY UNIFORM MATERIAL SAFE TO INHALE AND INGEST IS APPROPRIATE FOR SCHOOL FIELDS ; UNTIL THEN, A MORATORIUM.** When the play surface material is uniform, consistent, and controlled, when it is tested by an adequate study with pediatric toxicology assessments to be safe for ingestion and inhalation, and results are peer reviewed following IRB standards, then we may consider a synthetic turf field might be safe. Until then, tire crumb should be rejected from any casual or unnecessary contact with children or adults.

**18. RECONSIDERATION:** A reconsideration of the moratorium could occur when the industry can demonstrate a uniform, non-carcinogenic, non-inhalable, non-ingestible alternative that does not present PAH, VOCs, phthalates, lead, chromium, mercury, 1,3-benzothiazoles, butadiene, styrenes, carbon black (in particulate, gaseous form, or any form to children); and the product undergoes strict, peer-reviewed study by independent qualified toxicologists who have a mandate to protect children's health and the health of the environment above the interests of industry. The hypothetical product should be subject to regular reviews and quality control determinations to ensure safety over the life of the synthetic field. Safety Data Sheets should be provided and accessible for every user. If waste tires

are used, the controls requested above will never be possible, since the tire material, by definition, is a composite of many toxins in unknown quantities and with unknown impacts.

## **PART TWO: CHARACTERIZATION OF TIRE CRUMB COMMENTS**

**1. SCALE AND SCOPE:** Tire crumb potential to individuals, buildings, surrounding areas and stormwater for contamination is enormous.

### **2. PUBLIC HEALTH ISSUE: SCALE AND SCOPE CONCEPTS**

The potential for contamination from tire crumb is a growing public health issue, in terms of the relative size of the product and its mass; the total number of potential fields; and their basic contact with students, athletes, school personnel, buildings, communities, and streams/storm water.

To give an idea of the existing volumes of material, the field runoff and children affected or who may be affected, we have developed reference tables, and the summary is attached to this filing. These tables indicate the scope and scale, and demonstrate that these are not isolated fields, nor tiny exposure potentials. The quantities of material are enormous. The source and reasoning is explained, but the tables are designed for your model development and quick reference.

### **3. ENORMOUS QUANTITIES ON EACH FIELD SURFACE .**

To give an idea of the scale, a modest soccer field uses 30,000 waste tires. According to a randomly selected company selling packaged tire crumb infill for original or replacement treatments, 30,000 tires makes about 396,667 pounds of lbs of material. According to our calculations, the volume for 2" thick field is about 525 cubic yards. However, a large football field, three times the size of a small soccer field, could use 1,000,000 pounds of tire crumb material.

4. The tires are shredded, pulverized into crumb of various sizes, and the shredded material is poured on top of a plastic "grass" carpet. Importantly, the material is loose, unencapsulated and can loft into the air when struck by a ball or foot, or body. We estimate that, depending on the school, each field has



regular, daily contact with at least 1000 athletes and students. At sports events, busy tournaments, or with active use, a field can have contact with many, many more.

**5. No fields we found have mandated capture of the leachate or particulate at the field.**

**6. TOTAL FIELD VOLUMES POTENTIAL:** The universe of potential tire crumb playfields is approximately 200,000 - 220,000 schools and athletic facilities in the US, based on number of schools. The potential reach of exposure from use of these fields is in the millions of children, millions of adults, hundreds of thousands of exposed buildings and adjacent soils, and hundreds of thousands of public easements and storm water access points (we estimate 1:1 ratio for field to point source drainage).

**7. TABLE RUNOFF AND VOLUMES: SUMMARY OF KEY METRICS**

For reference, we analysed fields by sport type, by Metropolitan Service Area, and calculated the volumes for rainfall (by city), and for amount of tire crumb material on a field surface.

Key metrics are the following:

- Estimated tire crumb per 85,000 sq feet field and 2" deep tire crumb infill is 525 cubic yards, 396,667 pounds, or 198 tons per field.
- **The total amount of tire crumb material on surface of 12,000 fields is estimated to be 6,296,296 cubic yards, or 4,760,000,000 pounds or 2,380,000 tons** that are currently in sports centers and schools in April 2016..
- **Runoff is calculated by city and field size, but the total runoff for fields in the top 50 MSAs is 15,006,99,787 gallons.**

- **Total Runoff for** 12,000 fields based on number of fields per MSA, accounting for rainfall in that MSA, and added together for 2016 is: **23,370,639,827 gallons...** for a single year.

The calculations were made to illustrate the scale and scope of this product, and to characterize the reach of exposures from the field surface into the airway, and into the water pathway.

#### **8. INGREDIENTS IN TIRE CRUMB: Lack Of Uniformity, High Variation, Multiple Toxins**

Tire crumb appears to be a composite material, heterogenous with multiple known carcinogens, pathogens, and mutagens. The material is not uniform, comes from multiple sources and lots, and can be mixed with plastics and materials of unknown origin. The material can have anticlumping agents, flame retardant additives, paint, and strengthening or characteristic enhancing additives. Shredding of tires can cause small pieces of steel or metals to be included in the material from steel belted tires. Some tire crumb is from newer depositories from recalled tires, some from landfills, and some have been subjected to a variety of weather and conditions. Leachate and off gassing could be variable, with the expectation that newly installed/poured material off-gassing is higher than from an older field, but we expect those rates would vary with the age of the tires from which the tire crumb was made.

9. HETEROGENEOUS, MULTIPLE TOXINS, UNKNOWN ORIGIN: To say that tire crumb infill comes from multiple sources, is an understatement: dispensaries, landfills in the US, landfills abroad, collection centers, factory waste from China, factory waste from the US and abroad. Some of the newer marketed blends included multi colored sport shoe waste, shoe factory waste, and many unidentified synthetic materials. Just as tire companies may add anything to their “recipe” for a tire, an infill provider may offer materials that could have anything added into the blend. Tire plugs, tire polishes, tire coatings, and materials picked up on the roads should be considered. And even if it is known that there are only tires in the blend, there is a broad variation in the ingredients based on the use of the tire, and the manufacturer. Those tires may look the same, but from a toxicity standpoint their variation and the unknowns in the “recipe” create a margin of uncertainty that makes any claim of known safety for inhalation or ingestion impossible. If a vendor says he or she knows what is in a lot of tire crumb, and that is known to be safe, then they ignored the materials in the product. Since we never know what is

in any field for sure, and if we know that they have tire crumb, they cannot be demonstrated safe for children to inhale, ingest, nor play upon.

#### **10. What Is In Tires? SOME GROUPS WENT LOOKING**

Since it was difficult from MSDS or any other source to identify the components in tires or tire crumb, some groups studied them directly.

#### **11. Environment and Human Health Inc, and Yale University Study**

EHHI, Inc. in cooperation with Yale University studied samples of rubber mulch, and new tire crumb with the intent of characterizing their ingredients.

The summary text of their characterization study is found here:

[http://www.ehhi.org/turf/metal\\_analysis2016.shtml](http://www.ehhi.org/turf/metal_analysis2016.shtml)

<http://www.ehhi.org/turf/findings0815.shtml>

The EHHI/Yale Study list of components found is explained this way:

The shredded rubber tire playground mulch samples tested were provided by the manufacturer and were purchased in new bags of rubber mulch for use in gardens and playgrounds. The rubber tire infill for synthetic turf fields was obtained as new infill material from installers of synthetic turf fields. There were 5 samples of infill from 5 different installers of fields and 9 different samples of rubber mulch taken from 9 different unopened bags of playground mulch.

**RESULTS** There were 96 chemicals found in 14 samples analyzed. Half of those chemicals had no government testing on them - so we have no idea whether they are safe or harmful to health. Of

those chemicals found that have had some government testing done on them these are the findings with their health effects.

## **TWELVE (12) KNOWN CARCINOGENS**

2-Mercaptobenzothiazole/ **Carcinogen**, toxic to aquatic life

9,10-Dimethylanthracene/ **Carcinogen**, respiratory irritant and can cause asthma

Bis(2-ethylhexyl) phthalate/ **Carcinogen**, may cause damage to fetuses

Fluoranthene / **Carcinogen**, Fluoranthene is one of the US EPA's 16 priority pollutant, A PAH.

Heptadecane/ **Carcinogen**

2-mercaptobenzothiazole / **Carcinogen**

Phenol, 4-(1,1,3,3-tetramethylbutyl)/**Carcinogen**

Phenanthrene/ **Carcinogen** - A PAH

Phthalimide/ **Carcinogen**, skin, eye and lung irritant. A Fungicide

Pyrene, 1-methyl- /**Carcinogen**

Tetratriacontane /**Carcinogen**, eye and skin irritant. Can cause systemic damage to central nervous system.

Pyrene/ **Carcinogen**, toxic to liver and Kidneys, a PAH

Carbon Black/ **Carcinogen**

Carbon Black makes up to 20% to 30 % of every tire. It is used as a reinforcing filler. Carbon Black is listed as a carcinogen by the International Agency for Research on Cancer (IARC).

Carbon Black, as such, was not analyzed by the Yale Study because Carbon Black is made up of a

number of chemicals – some of which were found in the Yale study.

Carbon Black is not one chemical -- it is made up of many chemicals - often of petroleum products. Furthermore, carbon black has no fixed composition, even of the many compounds it contains. Carbon black from different sources will have differing compositions. In our method, carbon black will register as a series of substances extracted from it. There is no carbon black molecule, it is a mixture.

## **TWENTY (20) KNOWN IRRITANTS**

1,4-Benzenediamine, N-(1,3-dimethylbutyl)-N'-phenyl-

**Irritant** - causes skin and eye irritation, toxic to aquatic life

1,4-Benzenediamine, N-(1-methylethyl)-N'-phenyl-

**Irritant** - causes skin and eye irritation, toxic to aquatic life

2(3H)-Benzothiazolone

**Irritant** - causes skin and lung irritation

2-Dodecen-1-yl(-)succinic anhydride

**Irritant** - causes eyes, skin and lungs irritation

3,5-di-tert-Butyl-4-hydroxybenzaldehyde

**Irritant** - causes irritation to eyes, skin and lungs.

Anthracene

**Irritant** - causes skin, eye and respiratory irritation. Breathing it can irritate the nose, throat and lungs causing coughing and wheezing.

Benzenamine, 4-octyl-N-(4-octylphenyl)-

**Irritant** - causes eye and skin irritation

Benzenesulfonamide

Considered hazardous, very little testing has been done on it.

Benzothiazole, 2-(methylthio)-

**Irritant** - causes Skin and eye irritation.

Dehydroabietic acid

Toxic to aquatic organisms

Docosane

**Irritant** - causes Skin irritation

Hexadecanoic acid, butyl ester

**Irritant** - causes eye, skin and lung irritant. Can cause reproductive effects.

Methyl stearate

**Irritant** - causes eye, skin and lung irritation.

Octadecane

**Irritant** - causes skin, eye and respiratory irritation

Octadecanoic acid also known as Stearic acid

**Irritant** - causes skin, eye and respiratory irritation

Oleic Acid

**Irritant** - causes skin and eye irritation

Phenol, 2,2'-methylenebis[6-(1,1-dimethylethyl)-4-ethyl-

**Irritant** - causes skin, eye and respiratory irritation

Tetradecanoic acid

Toxic to aquatic organisms. Skin and eye irritant.

Anthracene, 2-methyl-

Acute aquatic toxicity, Not much data available - what there is shows it to be an eye, skin and lung irritant

Anthracene, 9-methyl-

Acute aquatic toxicity, serious eye irritant

### **13. Carbon Black**

Carbon black plays an extraordinary role in tires, and in their toxicity and potential for harm from exposures. Well known from decades of air pollution studies, urban epidemiological studies, carbon black causes lung cancer, brain cancer, kidney cancer, heart disease, neurological disorders, and cognitive degenerative disease.

A known carcinogen (WHO), we have found variations in percentages of the amount of carbon black in a tire, from 30%-68%. (EHHI/Yale Study; NY STUDY, .pdf, pp19-20.) Carbon black breaks down into many sized particles, including PM10/PM2.5. That size particle was shown to cause several types of cancer, including brain cancer, kidney cancer, kidney disease, bladder cancer, and neurological disease and cognitive impairment disorders. (CITE; Harvard Mexico Studies and Urban Cohort Studies) We know for sure that carbon black is in tires, in part from simple observation of color.

#### **14. THE NY STUDY CHARACTERIZES TIRE CRUMB THIS WAY:**

“The components of Firestone’s and Dow Chemical Company’s rubber are summarized in technical specification documents. Although they are only two of many different rubber manufacturers, a similarity between the two vendors is readily apparent, even between three different types of rubber, solution-SBR, cold polymerized emulsion SBR, and high cis-2-4 polybutadiene rubber. In general, the following similarities were observed between the two manufacturers for the compounds used to produce the rubber:

- The polymer used to produce solution-SBR contained approximately 18-40% bound styrene.
  
- The oil content in the polymer ranged from 27.3-32.5% in solution-SBR and cold polymerized emulsion SBR. Oils used include aromatic oil, high viscosity naphthenic oil, and treated distillate aromatic extract oil.
  
- Besides the polymer used, the other components of the rubber were similar between manufacturers and the relative proportions (parts by weight) of these other components ranged as follows:
  - o Carbon black: 50.00 – 68.75
  
  - o Zinc oxide: 3.00
  
  - o Stearic acid: 1.00 – 2.00
  
  - o Sulfur: 1.5 – 1.75
  
  - o N-tert-butyl benzothiazole sulfonamide (TBBS): 0.9 – 1.50
  
  - o Naphthenic or aromatic oil: 5.00 – 15.0



The components summarized above are the principal components of the major type of rubber (SBR) used for the manufacturing of crumb rubber and therefore have the potential to have a significant presence in crumb rubber. As discussed in subsequent sections of this report, some of these components have been found to be prevalent in crumb rubber, including zinc (from the zinc oxide), benzothiazole compounds (from TBBS), and PAHs (possibly from the oils used). These compounds may be attributed to the SBR used in the manufacturing of crumb rubber.”

**15. Phthalates are a regulated toxin, and PEER filings covered some of the toxicity and regulatory discussion. Please refer to <http://www.peer.org/campaigns/public-health/artificial-turf/news-releases.html>**

## **16. ZINC**

Coastal Marine Resource Center Study, found fatal levels of zinc in leachate from tire crumb fields. This amount would cause fatal impacts to aquatic ecosystem within 48 hours. This is a notable amount, and though was assessed in terms of environmental health, indicates presence.

Menichini and Abate Study: “Zn concentrations (1 to 19 g/kg) and BaP concentrations (0.02 to 11 mg/kg) in granulates largely exceeded the pertinent standards, up to two orders of magnitude”. “Zinc and BaP concentrations are high in rubber largely exceeding the Italian soil standards”.

## **17. METALS: MERCURY, CHROMIUM, ARSENIC**

The highest median values were found for Zn (10,229 mg/kg), Al (755 mg/kg), Mg (456 mg/kg), Fe (305 mg/kg), followed by Pb, Ba, Co, Cu and Sr. The other elements were present at few units of mg/kg. The highest leaching was observed for Zn (2300 µg/l) and Mg (2500 µg/l), followed by Fe, Sr, Al, Mn and

Ba, Little As, Cd, Co, Cr, Cu, Li, Mo, Ni, Pb, Rb, Sb and V leached, and Be, Hg, Se, Sn, Tl and W were below quantification limits. Data obtained were compared with the maximum tolerable amounts reported for similar materials, and only the concentration of Zn (total and leached) exceeded the expected values.

## 18. LEAD, POLITICS and CHILDREN

**The problem is synthetic turf is NOT REGULATED as a children's product by the CPSC thwarting the ability to apply lead regulations that CPSC could enforce.**

Lead was identified in synthetic turf fields as early as 2008 but was not addressed in any systemic way due to lack of standards or required testing (although the CPSC could have required the testing mandated for children's products since 2008). The CPSC has chosen not to mandate this children's product testing for synturf and in fact advised the industry about not having it designated as a children's product < <http://parentscoalitionmc.blogspot.com/2009/03/artificial-turf-tale-of-lead-levels.html>> .

This has led to a "buyer beware" situation especially after the CPSC tested synthetic turf carpets, found lead at varying levels depending on sample age, and astoundingly concluded the whole synthetic turf system was, always and everywhere, safe not just for adults but for children. The assumptions were based on inappropriate modelling for blood lead levels from a meager sampling and the troubling finding presupposes that there is, a safe level of blood lead, which most pediatricians and lead experts agree there is not safe level.

To this day the synthetic turf industry cites the still CPSC-posted "OK to Install, OK to Play on" press release which should never have been posted to begin with, has been disavowed, in front of US Congress, by CPSC commissioner Kaye and is an embarrassment to government science, policy and public health <<http://www.cpsc.gov/en/Newsroom/News-Releases/2008/CPSC-Staff-Finds-Synthetic-Turf-Fields-OK-to-Install-OK-to-Play-On/>>

19. By contrast, The Centers for Disease Control (CDC) in contrast warned and continues to warn the "there is no safe level of lead" to expose children.

<http://www.cdc.gov/nceh/lead/>>

[http://www.cdc.gov/nceh/information/healthy\\_homes\\_lead.htm](http://www.cdc.gov/nceh/information/healthy_homes_lead.htm).

**"No safe blood lead level in children has been identified.** Lead exposure can affect nearly every system in the body. Because lead exposure often occurs with no obvious symptoms, it frequently goes unrecognized"

In 2010 Van Ulirsch et al ( Environ Health Perspect. 2010 Oct;118(10):1345-9 <<http://www.ncbi.nlm.nih.gov/pubmed/20884393>

## **20. Evaluating and regulating lead in synthetic turf.**

Division of Health Assessment and Consultation, Agency for Toxic Substances and Disease Registry ([gulirsch@cdc.gov](mailto:gulirsch@cdc.gov)) concluded that: "Synthetic turf can deteriorate to form dust containing lead at levels that may pose a risk to children. Given elevated lead levels in turf and dust on recreational fields and in child care settings, it is **\*imperative that a consistent, nationwide approach for sampling, assessment, and action be developed\***. In the absence of a standardized approach, we offer an interim approach to assess potential lead hazards when evaluating synthetic turf."

**21. \*But no such approach has ever been instituted.** Indeed as reported in USA today this year: "The CDC in 2008 said communities should test recreational areas with turf fibers made from nylon, and they should bar children younger than 6 from the areas if the lead level exceeded the federal limit for lead in soil in children's play areas. But some communities have refused to test their fields, fearing that a high

lead level would generate lawsuits or force them to replace and remove a field, which costs about \$1million, according to a 2011 New Jersey state report . Forty-five of 50 New Jersey schools and towns contacted in 2009 by epidemiologist Stuart Shalat would not let him test their turf-and-rubber fields, Shalat's report states. The EPA also found, in 2009, that "it was difficult to obtain access and permission to sample at playgrounds and synthetic turf fields." <<http://www.usatoday.com/story/news/2015/03/15/artificial-turf-health-safety-studies/24727111/>>

22. And for the past 2 years the company FieldTurf has, with impunity, noted its synturf fields contain lead during testimony on various bills in the Maryland State House.

The latest admission documented on video: <<http://wtop.com/montgomery-county/2016/03/md-lawmakers-seem-information-artificial-turf-schools/>>

"....asked point-blank by one delegate, "Is there lead in your products? The executive answered, "There's lead in a lot of things in this world.".... **"Yes, there's lead in our products."** In spite of this admission and the fact that the legislation in question was meant to post the CDC prescribed warnings about minimizing lead and other toxin exposures from the synturf and tire waste products, and in spite of the fact that the legislation had strong and broad input and support, the legislation was not even allowed to come up for a vote in committee by the committee chair.

**23. Public Employees for Environmental Responsibility compiled the literature as of early 2012 on lead**

see: <<http://www.peer.org/campaigns/public-health/artificial-turf/news-releases.html>> and specifically: [2012-07-12 lead-limits-needed-on-tire-crumb-playgrounds](#) (NOTE if you go to [PEER.ORG](http://www.peer.org) news releases: click on public health and "artificial turf" to find the actual filings with many links)

Unfortunately for the children, fields with high lead remain. But those responsible for protecting children are kept in the dark. NO ONE IS MONITORING OR REGULATING ARTIFICIAL TURF FOR LEAD OR OTHER TOXINS in either old or new fields, including the Consumer Product Safety Commission (CPSC) (see <<http://www.peer.org/news/news-releases/cpsc-drops-artificial-turf-playground-safety-review.html>> Even though the Chairman of the CPSC, recently admitted to congress that its soothing conclusions of safety after finding lead in synthetic turf were NOT correct.

Tested fields keep showing up with lead in them both old AND NEW. Some tested fields have little or no lead , some high levels and some have both within the same field. There is no way of knowing if any of the components of a field contain lead, and how much without stringent and thorough testing of each field.

This problem highlights the need for application of the designation as a children's product for testing and regulation : 1) stringent testing of all the colors and of the backing of the carpet for total lead content (chromium and cadmium should also be tested for) AND 2) Testing many samples of the infill which is an ever-changing "witches brew" of chemicals- so undetectable, low and very high levels can all be found in the same field. In addition to having testimony both last year and this year in the MD state chambers from Field Turf that their product DOES indeed contain lead (as you heard in the recent committee testimony on MD house Bill 883 , and in addition to those referenced in the PEER review, other studies on lead also exist.

24. For a comprehensive media article on Lead in artificial turf which cites scientists and studies that the synturf industry avoids please go to: <<http://www.usatoday.com/story/news/2015/03/15/artificial-turf-health-safety-studies/24727111/>>

>

For example as reported in that article:

Dr. Shalat's New Jersey State Study (2012) on artificial turf found lead in the field dust in the respirable

air space of a robot and real player- highly variable but sometimes very high (note most facilities would NOT LET THEM TEST).

<http://www.nj.gov/dep/dsr/publications/artificial-turf-report.pdf>

25. PEER writes: The concerns about lead exposure have taken on a new urgency following the release in June of 2012 of a study done for the New Jersey Department of Environmental Protection which found artificial fields made of tire crumb can contain highly elevated levels of lead much greater than the allowed levels for children:

a)- It reports "concerns with regard to potential hazards that may exist for individuals and in particular children who engage in sports activities on artificial fields"; and

b) **\*"Inhalable lead present in artificial turf fields can be resuspended by even minimal activity on the playing surface."\***

26. Dr. Liroy of Rutgers who is quoted in the USA Today article recently participated as the senior author in a study which found lead and other toxins in the BOTH the plastic rug (supplied to them by the industry) and tire crumb infill. LEAD was also found in simulated body fluids meaning there is little or no protection of any kind against the lead getting out of the material into the body .

#### **27. Pavilonis Study found lead.**

<http://www.ncbi.nlm.nih.gov/pmc/articles/PMC4038666/pdf/nihms565643.pdf> > 2014

**" Bio-accessibility and Risk of Exposure to Metals and SVOCs in Artificial Turf Field Fill Materials and Fibers"** , Brian T. Pavilonis<sup>1</sup>, Clifford P. Weisel<sup>1</sup>, Brian Buckley<sup>1</sup>, and Paul J. Liroy<sup>1</sup>

QUOTE from Pavilonis et al.:**"Since it is possible that children may be exposed to potentially high concentrations of lead while using artificial turf fields we recommend, at a minimum, all infill and**

**fibers should be certified for low or no lead content prior to purchase and installation."**

\*The main out-comes of concern from Pavilonis et al:

a) the finding of **lead, and chromium** in **both the tire crumb and the plastic rug** and simulated **body fluids** at sometimes extremely high levels **\*EVEN IN NEW FIELD CARPETS.\***

b) **Benzothiazole** derivatives and **4-(tert-octyl) phenol** were also found in in the simulated body fluids. Both are probable carcinogens (the subject of another fact sheet).

QUOTE: "**Lead was detected in almost all field samples** for digestive, sweat, and total extraction fluids with digestive fluid extract of one field sample as high as 260 mg/kg. Metal concentrations were not markedly different across the three different sample types (new infill, new turf fiber, tire crumb field sample). However, one of the **\*new\*** turf fiber samples contained relatively large concentrations of **chromium (820 mg/kg) and lead (4400 mg/kg)** compared to the other samples tested...the variability of lead contained in the infill material is large and can span more than two orders of magnitude\* . One field [tire crumb] sample did contain a high lead level (260 mg/kg) which was on the **same order of magnitude as the NJ DEP cleanup value (400 mg/kg).**"

**In summary:** Lead-free is the only acceptable level for child products (and indeed for people in general). **There is NO safe level of lead for children.** And yet many of our children are playing often, if not daily, on fields that may contain lead and certainly do contain many other toxic substances. Finding ANY lead in any play area for children of any age is unacceptable. As the CDC notes: Every effort should be made to eliminate ALL unnecessary sources of lead in the environment, especially a child's environment. **\*Lead in artificial turf is not only totally unnecessary but dangerous to health AT ANY LEVEL\*.**

**28. Other sources of information on Lead in tire crumb fields:**

[www.ehhi.org/turf/](http://www.ehhi.org/turf/)<<http://www.ehhi.org/turf/>>

[www.safehealthyplayingfields.org](http://www.safehealthyplayingfields.org)<<http://www.safehealthyplayingfields.org>>

[www.synturf.org](http://www.synturf.org)<<http://www.synturf.org>>

[FOOTNOTE SYN TURF]Where on the Synturf page on lead you can find:

No. 36] Mayo Clinics tips to protect children from lead in artificial turf. April 2015.

No. 35] Durham, New Hampshire: Lead scare at UNH, s Memorial Field. November 2012.

No. 34] Beware of lead content in exotic color artificial turf fields! September 2012.

No. 33] Odessa, Texas: Eager fans will not be given pieces of the artificial turf field. September 2012.

No. 32] U.S. Federal panel increases child protection against lead. February 2012.

No. 31] UNLV researcher spreads word about the need to test artificial turf fields. December 2010.

No. 30] Environmental Health Sciences study (2010): Deteriorating synthetic turf dust containing lead may pose a risk to children. October 2010.

No. 29] Concord, Mass.: Town replaces fake grass fields, officials insist nothing is wrong with the lead levels! July 2012

**28. TWELVE (12) CARCINOGENS found and HOW DO THEY INTERACT:**

The Yale Study identified the presence of so many carcinogenic materials in a single material that it raises many more questions about interaction of PAHs with metals, and combination impacts. The



interaction of the PAHs and benzothiazoles with other materials in the fields needs to be characterized and addressed

### **29. Strengthening Additives: Nanoparticles**

We would also ask for information and clarity about tire strengthening additives of any kind that were built into the material anytime in the past 30 years, these would have been added to tires.

[<http://nice.asu.edu/nano/carbon-black-and-amorphous-silica-tires>]

Similarly, we request that the tire manufacturing industry explain their use of nanoparticle products, of any kind, including the type and size, source company and source country, and ask for an explanation about how:

- a. they can be quantified in the product, and
- b. how can they be cleaned up if they are released when the tire crumb and or plastic “grass” carpet degrades?
- c. We would also like to understand what material characterization of their behavior in tires performance,
- d. And or their behavior once they are released into the environment.
- e. We ask for any epidemiological due diligence that was conducted by any tire company on nanoparticle use prior to using them in a commercial product.
- f. Plans for continued use and safety precautions tire companies will impose upon themselves
- g. Epidemiological studies conducted on these particles in tires

### **30. Plastics, Microplastic Fibers, Microbeads, and Small Particulate Plastics**

Assessment of microfiber particulate and small particulate plastics needs to be assessed in characterization studies.

### **31. Flame Retardants**

Flame retardants can be added to a tire in production, or applied post production in a shipping setting or possibly as tire crumb. Since flame retardants are known carcinogens with health issues of concern, and will be on the surface of the waste tire crumb, tire infill providers need to know if they are present, and purchasers need to know that the material contains flame retardants prior to purchase.

### **32. Tires and Tire Crumb Additives**

Myriad products exist to clean, protect, condition, and color tires. We wonder if they are components of tire crumb?

### **33. Road Waste Picked Up By Tires**

Tires spend their lives on roadways, of course, and can pick up many materials in their travels. Debris, hydrocarbons, ....

**34 CARINOGENIC, PATHOGENIC, and MUTAGENIC ingredients in tires cannot be removed by shredding tires into tire crumb and must be assumed to be accessible.**

**35. Tire crumb and repurposed rubber appear to be the same thing, with interchangeable use... but are they the same? We would like clarification.**

We would like clarification about the distinction between the tire crumb, repurposed crumb rubber, and crumb rubber. Specifically if using the term “repurposed rubber crumb” implies uniformity of ingredients? Does that term imply tires are not used? If so, what are the ingredients in repurposed rubber crumb and how do they differ from tire crumb?

36. **We would also like access to all MSDS/SDS of tire crumb manufacturers and tire companies,** and the ability to ask questions about how and where they were made, variations on lots, source and composite addendums. It is difficult to locate them.

**37. EXEMPTION ON LISTING HAZARDOUS MATERIALS:** We would like to understand why tire companies have an exemption on their need to list ingredients under Section 2: Hazardous Materials of an MSDS/SDS. We were unable to find the source of that exemption, if it has a deadline, and whether your study group thinks it is an obstacle to understanding and characterizing risk of exposure from tires and tire crumb.

**38.** Of those MSDS that we located, several, like this Michelin North America Material Safety Data Sheet for Michelin, Uniroyal, BF Goodrich, says in **“Section 2 HAZARDOUS INGREDIENTS: Note: Tires meet the definition of article as defined by the OSHA Hazard Communication Standard (29 CFR 1910.1200) and are exempt from MSDS requirements.”**

There was clearly no mention of 1,3 butadiene, carbon black, POHs, VOCs, benzothiazoles, or any plasticizers, nor metals, styrene, sulphur, known irritants, or well... anything. Since that section also outlines corrosive, combustible and waste treatment, it is important for more than this issue. We explicitly ask CDC/CPSC/EPA if they can use their existing authority to require tire crumb companies and tire companies to provide ingredient information.

**39. SOURCE MATERIAL UNKNOWN: MSDS/SDS CANNOT REPRESENT WHOLE FIELD.** Tire crumb comes from many tires, and many sources. Since not a single tire crumb field can accurately list or track which tires were source materials, or what other mixed in components, and there is no accountability from tire crumb recycling industry for the shredded product, then MSDS/SDS cannot be accurate for a whole field due to variability. Therefore, the burden of “proof” of risk lays squarely on the ability of the purchaser (schools, sports directors, booster clubs) to assess risk... of a very very complex product. So,

if the exemption stays in place, we will know for sure that we cannot know what is in a tire crumb based field.

**40. TREATMENT TO SHOW NO PARTICULATE OR BREAKDOWN: SHOW US.**

As for studies that claim that their product has been treated (such as cryogenic treatment) to not break down into dangerous particulate, we are deeply skeptical, and would ask for proof. We also ask for assay testing over a period of at least several summer weeks. We ask for the researchers to simulate the pounding over 10 years and assess the particulate characteristics and particle size. That testing in fact is being done right now... in thousands of children across the country. Simple observation on a player body, on the sideline benches, or under a microscope shows consistent breakdown into particulate.

**41. SHREDDED, PULVERIZED, HIGH SURFACE AREA FORM OF TIRES and ADD INS is LIKELY MORE TOXIC THAN WHOLE TIRES.**

Unfortunately, because it is shredded, pulverized, and in loose and unencapsulated form, tire crumb has exponentially more surface area than whole tires (Thomas, Gupta study; ) and we are concerned the material is very likely more toxic—possibly many times more toxic—in the school field form than whole tire form, since the increased surface area provides more opportunity for molecules to escape. We know for sure that the increased amount of surface area in tire crumb makes the material in tire crumb more available to the breathing and exposure zones, and to runoff.

**42. CRUMB IS SURROUNDED BY DUST PARTICULATE:**

Accurate characterization technique must include a study of the particulate that surrounds tire crumbs, and steps must be taken to make sure that the sampling process does not inadvertently remove that dust and particles. We found several examples of the samples being washed, some in unbuffered water, prior to their analyses being done. Of course, that removes the particulate that concerns us the most. Distribution of the particulate size and type is important. Those particulate can become aerosolized by numerous gases and we ask that attempts are made to properly model this dynamic under high heat conditions, primarily.

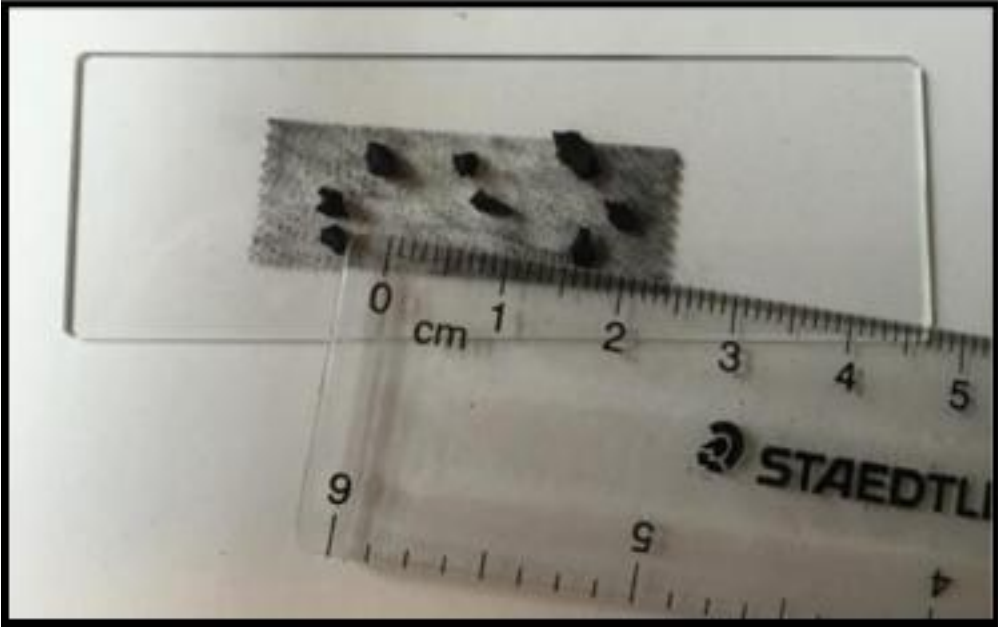

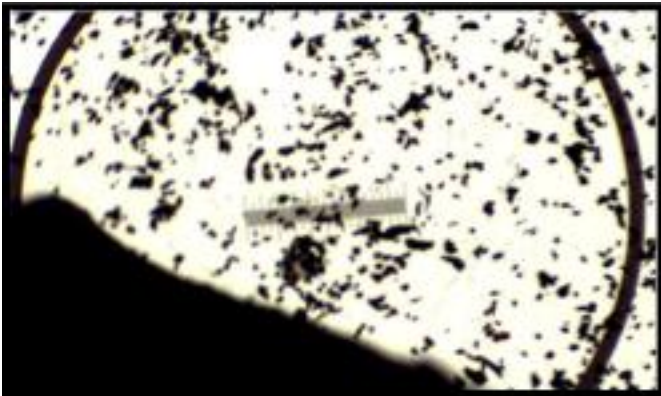
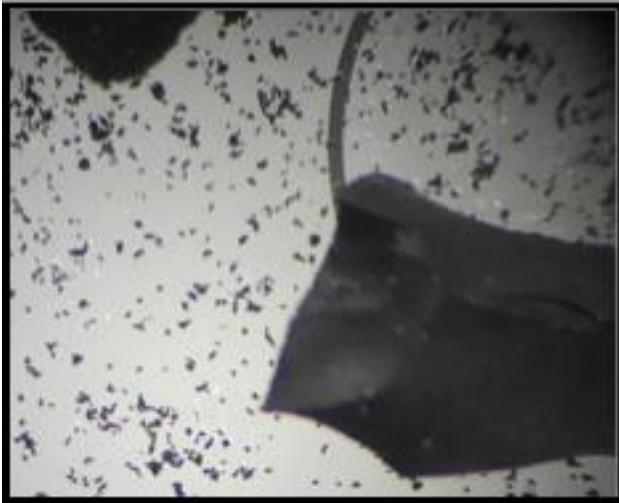

**43. VERY COMPLEX PICTURE From TOXICOLOGY PERSPECTIVE:** Tire crumb material is complex from a toxicology perspective, largely due to the chemical complexity presented by multiple known toxic components and variation. It has been described as a “toxic soup” of ingredients for which we have no consistent data on proportions or levels. Characterization of ingredients’ margin of error is unknown.. Testing must be done at the field levels using accepted sampling plans that have been statistically shown to be valid. Not fields have been tested in sufficient detail to determine or rule out any exposures or risks. A look at testing protocols for lead in urban soil sites illustrate the level of attention required and show the degree that current testing has fallen short of that needed for decision making for children’s health.

#### **44. CONTACT PATTERNS, FIELD USE and ADJACENT BUILDING CONTAMINATION**

Exposure is likely determined by ingredients in surface, activity, and number of children or users on field. Each school or community field has high use and high contact patterns, such as hosting contact sports, like football, lacrosse, soccer, and baseball, athletic camps, workshops and practices. In those sports, children dive into the field materials. As a child runs or skids or slide tackles, a column of material rises up, as does the dust and particulate that surround the tire crumbs themselves.

Testing for exposure need to list weather conditions including humidity, wind speed, and precipitation, temperature on field surface and ambient air temperature. Number of children on field, and activity level of that play needs to be recorded, video would be most interesting.

Children of all ages use the fields for multiple sports, recreation and school events. Artificial turf tire crumb fields abound in elementary schools and at indoor and outdoor sports centers where children of all ages and all stages of development play soccer, lacrosse, football, track, cheerleading, band, and use the field for general recreational school activities. In the fields with which we are familiar, families with members of all ages use the fields; and the community holds events, picnics, special fairs, and activities. Some fields are immediately adjacent to a school building.). That there are many uses, and probably many levels of contact and exposure is an important part of characterizing exposures, but both low dose exposures AND high contact exposure scenarios and use need to be examined, with appropriate epidemiological process.

**45.. SCHOOL BUILDINGS AND SURROUNDING AREAS ARE CONTAMINATED with a great deal of tire crumbs.** The fields appear to lose from 1-30 tons of material over their 8-10 year life, and some of it goes directly into buildings, cars, and then homes. This impact needs to be studied as an inadvertent consequence.

**46. CANNOT ARGUE NO INHALATION OR INGESTION RISK or SAFETY FOR EVEN A SINGLE FIELD.** We argue that given the unique characteristic of nonuniformity, known carcinogenic materials, breakdown into particulate/dust, no known source of origin, and no accurate studies on complex interactivity of those components in the children's exposure zone, in the tire crumb as it is installed today in 12, 000 fields, not a single field installer, nor material provider can demonstrate that the material is safe from inhalation and ingestion during normal use, active use, and on hot days.

**47. EVERY USE COULD POSE A TOXIC EXPOSURE** and it would be irrational to argue otherwise. We argue that due to the high variability of toxins in the tire crumb substrate (from tires, unknown additives, and factory waste add-ins), and lack of any control of the material, well-known sampling techniques will NOT accurately predict risks to human health.

**48. CHILDREN CANNOT AVOID THE EXPOSURES:** Since school children cannot self-advocate and take responsibility for staying off a field if directed to be there by coaches or school officials or parents, we must assume that children cannot avoid the exposures when they play on those fields.

**49. CANNOT CLAIM THAT EXPOSURES WILL NOT OCCUR.** Absolutely no way to responsibly claim that ingestion and inhalation of particulate from the material will NOT occur to those children.

**50. HOTSPOTS of intermittent dangerous exposures are possible, and should be expected and searched for in every field.**

We must assume that tires have different "recipes" based on their type of use. Therefore, knowing the type of tire used in tire crumb, and each tire "recipe" would be helpful in assessing characterization of



ingredients. However, there is no way to ever know what tires, or what material is in any field, and therefore, an MSDS/SDS cannot be representative of any field, or even any meaningful part of a field. Alarming, the high variability in the ingredients presents worrisome “hotspots” potential, where the hotspots might be missed in sampling but even a single exposure could have very serious impacts for a child who has the unfortunate luck to dive into that hotspot. PAH’s may be more prevalent, and present dangerous levels for installation period of the field, and for some unknown period of time afterwards, and considered a “hotspot”, then the consistent release of PAHs in the subsequent years could mean low dose, chronic exposures. Both need to be examined.

**51. Lead, chromium, mercury and arsenic could be hotspot sources, based on which tires were used, and how they were treated prior to being placed in the field.**

52. For example, when we asked about the source of lead in tire crumb fields, an infill vendor explained to us that a) lead could be in any field as an ingredient of the tires, of the treatment of tires, and b) once, they were aware of a shipment of tires that was treated with an anticlumping material that contained lead and the whole lot had lead, and c) that some lots had flame retardants added as well. They would never really know, but “most purchasers never ask”, according to the infill material vendor. If an MSDS was required, an additional charge was to be imposed, since MSDS were not available from the materials they acquired from China or other countries. We have collected many more examples of the worrisome unknown ingredients in our fields and can share with the study teams, if requested. While this information is anecdotal, that is the point: we have no idea what is in any field, for sure.

53. Another example, but this is not anecdotal: in a primary study field exposures in CT, a researcher found that the children’s monitors showed benzene. Since there is no safe level of exposure for benzene, and in fact, tires are not expected to have benzene, the field was sampled more closely, until that “hotspot” was located. The original source of that benzene was not determined, but it was next to a busy parking lot where cars’ exhaust may have been a source as they turned the corner, or possibly the tire crumb material had been previously stored in an area with benzene in surrounding environment, or perhaps it was picked up from contact on roads. We will never know. That finding suggests that the carbon black in the tires can adsorb additional toxins present near tires or tire crumb, and could release that material as the fields are pounded with running feet, or possibly on a hot day.

The proper characterization of this material needs to account for adsorption characteristics of carbon black, and other interactions

**54. The point is, that it is impossible to locate hotspots for all toxins in every field, and incorrect to extrapolate the risk for a whole field from a single sample or even multiple samples, since every sample is unique. So, while hotspots can easily be missed in a field, the unfortunate child that dives into that particular part of a field has an exposure that can actually be life threatening, but missed in its entirety in the sampling based risk assessment.**

**55. In fact, since the tire crumb creates multi sized “dust” particles, and off gases, it is impossible to prove that even a single field is safe from inhalation or ingestion exposures from tire dust particulate, off-gassing components, multiple toxins and combinations of toxins, and heat.**

**56. Importance of the Heat Factor: Source of direct injury and chemical catalyst**

#### **HOT HOT HOT HOT EXTREMELY HOT FIELDS**

Grass playfields remain close to the temperature of ambient air, and are often much cooler. Asphalt playgrounds used to have a use limit of 141F and many schools remove children from playgrounds when temperatures get hot. With tire crumb based turf fields, surface temperatures can soar on even mild sunny days.

Tire crumb fields “superheat” to levels that are routinely over 150F on a sunny spring day, and in a recent study conducted on a sunny day Utah, found to be close to boiling point, 190F, according to the Penn State Field Turf Heat Study. The study found that tire crumb field surfaces are hotter than ambient air, and increase in heat in a non-linear function with each additional degree Kelvin of heat, hence the designation “superheating”. To draw an example, on a Labor Day Weekend in DC area, with ambient temps of 82F, the field surface temperature hit 164F by noon on several fields used in a busy, tournament for about 1000 children, both boys and girls, ages 8-15. Those levels are known to melt plastic cleats, require tubs of water on the sidelines to cool down shoes, and create heat-related injury

including heat stroke, nausea, heat exhaustion, and dehydration in children and all users. It is not unusual for children players to vomit, faint, and suffer dehydration from hot conditions on the fields.

57. Marketing and sales for these fields tout their usability in all conditions as a benefit (more practice and play hours), but in fact, the heat build up on fields makes them very uncomfortable during many days and conditions. In DC, there are over 100 days of sunshine each year, and most are during the spring, summer and fall, making the fields uncomfortably hot and possibly dangerously hot for a third of a year. A calculus should be made on the percentage of safe days to play based on field yield risk, and heat.

58. Tire crumb fields do not have any protection from heat, and so they are irrigated to be cooled down, but the effect is temporary.

59. To our knowledge, there has been no well known place for doctors nor parents to report heat injury, though they are commonplace. (This author specifically remembers a hot, poor air quality day in August in 2014 in Washington DC when during a single practice, 4 soccer players vomited, another child was taken to the hospital after passing out, and another sidelined himself against the coach's wishes, due to extreme dizziness and nausea.)

60. **Reluctance to Report?** Yet, it is curiously uncommon for school teachers, coaches and parents to remove the children from the fields, due to temperature. We cannot explain that in rational terms.

We have also noted another curious effect: as football, soccer and lacrosse increase in popularity and competition in the US, competition for spots on high performance teams is fierce. There is a perception from strong sales and marketing of the fields, that the turf fields present a competitive edge for a school, a club or even a teenager trying to get into college, and are worth the high price paid. As psychologist Dr. Wendy Miller, explains, " it is a culture where high performance parents, players and schools might be willing to overlook these injuries, thinking that to complain would jeopardize their child's access to a competitive team. This thinking could easily lead to the silencing of reporting of injuries."

Heat injury reporting needs to be included in the survey questionnaires, and victims of heat injury and illnesses need to have a place to report, with impunity.

#### **61. HEAT MAKES THE CHEMICAL DYNAMICS ABOVE A FIELD VERY COMPLEX**

In addition to the serious issue of direct injury from hot playfields to young children, or anyone, the super hot fields present a very challenging chemical situation.

Dr. David Brown, ShD, toxicologist, professor and former Deputy Director of Public Health Practice Group at ATSDR/ CDC explains that, “the unintended, and largely unstudied chemical consequences of what comes off such an enormous quantity of high surface area material, in amounts and sequence that is scientifically accurate is very difficult to predict and model. Since the chemicals in the area above the field could change instantaneously, the conditions are critically important (number of players, temperature, time from last rainfall, etc.), as is the sampling methodology. But no one has been able to come close to modeling the actual yield, we only know the materials by characterization with samples, and that variation in samples is so broad as to almost be meaningless, since it could be easy to miss harmful exposures.”

62. Analyzing the field yield on a hot day is very complex, and challenging to even trained toxicologists. The superheating of the fields makes gases yield at faster rates as temperatures on the tire crumb surface increases. So, as a day heats up, it is very likely that the yield increases directly with temperature increase; a hot day creates more gases. Based on well understood scientific laws, we presume that the gas yield from the field at surface temperature of 50F (a cloudy day in January in DC) would be considerably less than a field surface temperature of 158F measured last week. If more gases are escaping the surface, then there are more “opportunities” for particulate to adsorb onto the surface of the gases, creating very dynamic series of compounds, none of which would be recommended to inhale.. The changes in the chemical composition over the fields as their temperatures rise is very difficult to test and model. These changes happen in an instant... as a threshold is reached... and the exposures can increase sharply. It is a very sophisticated and difficult challenge to model. But what is the most important is not only that the 24 gases that escape tire crumb (Norway Study) create dangerous mixtures but those gas/particulate mixtures, (and air) create a vector for deep lung exposures of all the

materials in the tire crumb field. So, on poor air quality days, when there are many children on the field and a lot of stirring up of the material, the fields could present enormous risk.

63. We are concerned about the range of yield levels, but, we are most concerned about the intermittent risk to children during those hot periods (a hot, poor air quality summer day during children's soccer camp week in Washington DC, for example) when the fields are likely yielding more gas, and therefore particulate has more "carriage" into lungs, respiration rates are higher, skin is exposed, and perspiration is highest. All these are likely factors in exposure. It is during those days when exposures are probably highest, and high enough overwhelm a developing immune system.

**64. Exposure Study Needs To Focus On Worst Case Conditions**

We acknowledge that the level of yield from the fields might vary widely with material variation, and will also vary with outdoor weather (temperature, wind, humidity and sun) conditions. Taking averages from fields across the country will be meaningless, and will only help the industry to expand its message of "found no harm". An analogy might be to determine the health of a forest taking 4 samples from 40 locations, evenly spaced, but the sampling might easily miss a blazing forest fire. That one day might destroy living material exponentially, but it could easily be missed. Dangerous exposures can be unpredictable in this material due to the scope and scale, the toxic character, and the superheating characteristic.

**65. A better approach is to carefully detect high yield days, and look THAT DAY for exposures in a child's body during those periods.** Since the exposures might attenuate, the work would have to be done expeditiously. The harmful exposures may or may not be detectable a day or a month later in a child. Monitor both genders, for patterns that might lead to that awful air quality soccer camp in the city on a tire crumb field, on days when vomiting and melting shoes are commonplace. A focus on the impacts from the high end of those yields we believe will present exposures that are clearly, and unequivocally harmful from both heat injury perspective and toxicity exposure potential. We do not know for sure if the carcinogenic exposures from low dose regular exposures or from high dose "events" are more dangerous, but both need to be studied as separate situations, not as an average.

**66. We urge your team to focus the study resources on primary measurements made in high use scenarios on hot days**, and refrain from the approach used in earlier studies that look at chemical compositions during winter or rain conditions on limited number of fields.

**67.** The only reliable way to assess the risk to children from a particular field, or groups of fields, is to look at their direct exposures, and importantly look at bloodlevels of the known substances. Cooperation from both high use athletes and those exposed to chronic levels of materials will be important.

**68. The Study Needs To Focus Also On Low Dose Exposure Risks**

**Trained immunotoxicologists look at the impacts of chronic low dose exposures to metals, PAHs, VOCs and many other materials in tire crumb. Their input is crucial to understanding risk of exposure in a developing child.**

**69. Characterization Mistakes**

Studies look convincing, but miss the forest for the trees.

Tire recycling and tire crumb industry reports are quick to point out that when they find harmful materials in their samples, they are under the known safety limits. There are two interesting fallacies in that reasoning.

First, since the samples in several studies are few and not uniform, they fail to acknowledge the statistical significance of finding known regulated toxic material in 2 million pounds of powdered tires... if one finds the needle, is it luck, or is it because needles are more prevalent than expected?

Proof of presence is meaningful! For example, in the NY Study, PAHs were found, as were metals, benzothiazoles, and many substances. Their presence indicates a risk.

In a child's product, since many materials are not known how they affect children, just knowing they are there is enough to use a precautionary principle and prevent the exposure. Arguing that the materials

appear under a limit (especially if that quantity is an average of multiple samples), or there is no established limit (because it has not been studied), are not as meaningful as the proof of their presence.

Second, though the conclusions of the industry reports may be of no harm found/safety, a close look at the data itself on PAHs, lead, cobalt, chromium, etc. is useful, since a) it proves presence, and b) at levels that suggest risk for **chronic exposure**. Chronic exposure risk is the subject of a great deal of new cancer research, and we care about all the materials, including those which are potentially toxic.

#### **70. ARGUMENT FOR MORATORIUM BASED ON KNOWN CHARACTERIZATION FOR TIRE CRUMB**

Because of the:

- a. known loss of 1-30 tons of material from the fields during the 8-10 year “life of the field” into air and water
- b. ingredients list: over 50% of its components are known carcinogens and pathogens, [cite Yale Study]
- c. massive scope and scale of this product, (the amount of material and surface area of these fields is enormous; scale/millions of pounds in each installation),
- d. inability to control the levels of toxic exposure to children, or even properly characterize them due to immense variation and chemical complexity of what happens on a hot day over a field, and around children. We cannot suggest mitigation strategies for the danger, because the material is inconsistent,
- e. Even if we did know for sure what was in each field, and suggest mitigation techniques and protections.... All the tire company has to do is change their recipe, or many recipes, as they do continually, and the study is worthless. Children are still being exposed to whatever is in the tire, the lot or that particular field..

#### **71. Moving Target Analogy**

Even if the study were completely successful, and the tire crumb material categorized properly, the trouble is, tire manufacturers could change the “recipe” for tires... and in fact they do this regularly... and the study results will be useless, or at best, diminish in usefulness.

Any attempt to study tire crumb safety on turf fields is analogous to trying to hit a moving target. Tire crumb is a waste product. Tires are not designed or intended to be used as infill for turf fields.

Ingestion, inhalation and absorption of fine particulate by children is not a consideration of tire manufacturers as they choose chemicals and compounds for their tires. Nor are they bound to maintain any safety considerations for such use by children.

So any study of present day tire crumb is a futile endeavor, because such study tells us nothing about a field that gets installed immediately after the study. Tire manufacturers often change the chemical composition of tires and will likely do so again.

Even if a field passed safety concerns in a present day study, a new field could easily fail a hypothetical study conducted the day after the present study. So unless every field was tested using the exact same methodology after every installation, there is absolutely no way to assure the user that their new field is safe. Those new fields could easily have an entirely different chemical composition simply because tire manufacturers changed their tire ingredients.

So the present Federal Study is only a backwards looking study, not forward looking. Any conclusion must be transparent and clear on that issue - upfront and center. Otherwise the public is being misled into a false sense of security.



## **72. Sampling: Not Appropriate For Tire Crumb**

The core pediatric toxicology problem in industry based safety studies, is that there appears to be an assumption that tire crumb is a uniform material, and behaves uniformly. It does not. There also appears to be an assumption that sampling will be an accurate method for studying tire crumb risk to children, and it is not. **Sampling will not be accurate to assess a nonuniform, heterogeneous material with multiple known toxic ingredients, high direct contact (dermal, hand to mouth, breathing zone) for pediatric use. Sampling cannot produce a single sample that is representative of the whole field, or even a part of the field, other than the sample itself.**

## **73. Methodology needs to study PERFECT STORM exposure conditions, and be able to calculate exposures during those relatively dangerous days.**

Nor can sampling in the way it is proposed (samples from 40 fields across the US), illustrate impacts from a perfect storm of exposure conditions on a particular field, say, during an intense soccer camp in in summer in Washington, DC with high ambient and field surface temperatures (ie 160F), bad air quality, no wind, when working athletes are breathing in particulate with high VOC, PAH, benzothiazoles, and carbon black... and many more compounds, on a particularly high yield day. Averages cannot be relied upon in sampling for this type of product, since they will further obscure the risk from exposures to hot spots of high risk material that are on fields. Averaging the results from a national distribution in various weather conditions simply obscures the acute risks further; it is useless for risk analysis. In layman's terms, it is like studying a forest using "x" number samples, but missing the forest fire that is blazing away at a nearby area of the park. For a child, it means that she plays on a field that was called "SAFE TO PLAY", after sampling, but in fact she might easily have been covered with multiple materials known to cause cancer, and in fact, that might be a regular event. The uncertainty of exposure frequency makes the risk higher, not less.

## **74. The core of the methodology used in the 50 studies asserted by the tire recycling industry were based on simple characterization of a single sample, but not on realistic, combined, nor worst case (the most important) use scenarios.**

**75. Multiple carcinogen and multiple pathogen combined effects need to be measured.** Single material measurements could be only a fraction of the exposures, since the material exposures are likely to be from combinations of materials.

#### **76. BIOMONITORING FRONT AND CENTER**

Because sampling presents inconclusive results, a methodology that relies on biomonitoring will be more meaningful. We suggest that more sophisticated approach be considered. Personal sampling monitors attached to children, dermal, urine, breathing analyses, and particularly, blood and tissue samples from frequent users, players on “Perfect Storm Days” and those expected to have chronic low dose exposures. We understand that biomonitoring raises more issues, but absent a good model, empirical data is the most reliable way to accumulate actual evidence of exposures and to be able to establish a reliable causal link to the cancers and diseases we predict from exposures.

**77. IMMUNOTOXICOLOGY SUPPORT: RECRUIT THE BEST PEDIATRIC IMMUNOTOXICOLOGISTS AND RESEARCHERS.** Some researchers and epidemiological professionals are already on the trail of better ways to identify actual exposures, and can create biomarker groups as indicators of presence of illness or exposures. These researchers have background in immunological toxicology, and can track subtle changes in an immune system that might be precursors to serious disease, like cancer, kidney disease, brain changes, and lung disease. It is possible to create biomarker group to prove tire crumb exposures in users and we believe that the preliminary proof of concept step could be accomplished in less than 6 months with cooperative athletes, and study volunteers, and modest budget. While we will not list them here, for protection of their privacy and frankly, for fear of industry retribution, we will nonetheless let you know that we have found multiple professionals who are capable and willing to work on this task, provided a protective forum and IRB standards are in place.

**78. Immunotoxicology support: look carefully at the ages those immune system markers in all children who are using these fields, understanding that some metabolic types, and ages may be more**

**vulnerable than others.** In fact, there are early indications that certain age groups, such as prepubescent females (age 8-11), may be more vulnerable to exposures to benzothiazoles, plastics, phthalates, and endocrine disruptors in general, and therefore might be at higher risk to contract cancer or disease from low dose particulate exposures from tirecrumb, and the plastic “grass” carpet particulate. We need to establish the datum from players to study this. We still do not know, but some indications exist. For that reason, we respectfully request that the study team include toxicologists and epidemiologists that are trained to keep these concepts front and center.

#### **79. LOW DOSE EXPOSURE CONCEPTS and CONCERNS**

Based on what we know now about low dose exposures to VOCs, PAHs, benzothiazoles, styrenes, carbon black, plastics, plasticizers, and metals, even at low, sub acute exposures, the fields could be very dangerous. That possibility was not considered in the CPSC study, EPA study, nor in multiple industry studies. These need to be assessed:

- Chronic exposure to metals, plastics and plasticizers
- Chronic exposure to carbon black mimics air pollution exposures
- Immune system reactions
- Endocrine disruption exposures from plasticizers and phthalates,
- Exposures from multiple low doses and chronic exposures

**80. The study should calculate yield of material that leaves the fields, and how it leaves the fields. How much in the air , water pathways, and with users (in shoes, cars, etc.) Interviews with schools and vendors need to establish the replacement quantities of these fields, and how often new material is put into place, since it would affect exposures, and give an indication of gross yields. We estimate that the fields lose from 1-30 tons (estimated) of material, so exposures and impacts need to be measured in adjacent buildings, soils, and stormwater systems. With 12,000 existing facilities, this may need to be the subject of additional studies conducted to also assess if the fields shall be regulated as point source contamination under Clean Water Act and Clean Air Act. It is a very important metric, and a perfect opportunity to include it, with little incremental cost, in your study.**

**81. INTEGRITY STANDARDS.** To track the history of the emergence of this product is to track effective lobbying for regulation changes that favored the tire industry, and the tire recycling industry. This industry took advantage of an enormous quantity of recalled and used tire stockpiles, and heavily sold and marketed the materials to schools, and sports centers where millions of children play. Central to the steps that catapulted this industry forward was the removal of the designation of artificial turf fields as children’s products, based on the rationale that adults played on them, too. Yet the fields continue to be sold to elementary schools and to sports centers brimming with elementary, middle and high school players. The sales oriented industry was willing to submit children, schools and communities to the materials in tires in enormous amounts, and call them safe. As this claim is deeply questioned now, we also urge you to NOT allow the sampling or data collection to be conducted by an interested party, including schools, sports centers, athletic group personnel or administrators, field installers or laboratories or consultants hired by those groups, and establish peer reviewed standards for testing.

**82. Any group or individual who does participate in the study, including regulatory staff, needs to sign an affidavit certifying that she or he, and her/his group has not received compensation or benefits in any form, including but not limited to sales commissions, direct payment, compensation, bonuses, grass to artificial turf grant, field financing, water savings rebates (State of California and possibly others), or physical benefits including but not limited to uniforms, facility enhancements (restrooms, concession stands, parking lots, storage facilities, etc.), stadium components, or field equipment of any sort, from the field installers or tire crumb field industry and its assigns, and has no financial conflict of interest. The document should be filed with an appropriate agency and made public.**

**83. We ask for full transparency on all parts of the study process for parents, interested parties, and schools.**

OUR REQUESTS TO ASTDR/CDC/CPSC/EPA	
Request	Background
I. Regulate tire crumb and rubber mulch as children’s product	PEER filed formal request; 12,000 fields x 30,000 tires is the amount of existing material in children’s use; see table A for details on volumes and surface area sizes, children/schools. Known carcinogenic material and known

	contact.
2. Remove “safe to play, safe to install” or any other references that imply safety from all EPA, CPSC and CDC websites and public information sources	PEER Formal Request; agencies must remove all endorsements of safety.
3. Place all PEER artificial turf filings in Federal Record	<a href="http://www.peer.org/campaigns/public-health/artificial-turf/news-releases.html">http://www.peer.org/campaigns/public-health/artificial-turf/news-releases.html</a>
4. Issue a directive to public health agencies to disseminate warnings regarding unknown risks from lead exposure from AT fields, as well as exposures to carbon black, known carcinogens, PAH, VOCs into air and water pathways; direct hospital systems and medical systems to screen for tire crumb field use, and report results	For parents, schools, athletic groups, and communities; conduct parent outreach webinars
5. Use only independent lab or consultants unassociated with tirecrumb industry, adhering to high ethics guidelines; transparent process for review; affidavit of no conflict of interest	
6. Commission a primary study, conducted by independent, peer reviewed group such as CDC to examine existing cancers AND illness in tire crumb field users and maintenance workers of tire crumb fields	
7. Mandate Cal Recycle Study corrections to methodology; mandate methodology peer review; and mandate to impose Prop 65 rule based on OEHHA’s own findings on carcinogenic exposure	
8. Convene a conference for presentation of risks and concerns from parent groups, cancer survivors to Federal Research Team	Needs participation from CDC/CPSC/EPA staff so parents and public can have direct contact
9. Convene series of webinars and open comment opportunities	
10. Allow public health and environmental advocacy groups in Federal Research Team with complete transparency	
11. Establish a collection point for recording experience of victims and those who may have suffered injury from use of the fields, including heat injury, concussion or head trauma, cognitive disorder, illness, and cancer for study and documentation; victim hotline; for both child and adult contact with fields	
12. Funding to identify potential biomarkers of exposure; conclusive marker study in users	
13. Conduct blood monitoring and studies on existing cancer survivors.	
14. Conduct cancer cluster study on soccer player cluster, and identify additional clusters such as maintenance workers and installers	
15. Provide full transparency with all interested parties	
16. Conduct full epidemiological study of tire crumb on playfields existing and predictive	
17. Study forms and questionnaires should include data collection on what is released from fields into air, adjacent areas, water pathways, and quantified. Replacement quantities for tire crumb fields should be quantified and examined as a metric that indicates yield.	
18. Based on release/yield figures, and other inputs, tire crumb fields should be evaluated for compliance with Clean Water Act and Clean Air Act, and regulated accordingly.	
19. We request that OEHHA study methodology be peer reviewed by your agencies before it begins, taking into account the comments received in this proceeding.	
20. OEHHA Study Process and Methodology Concerns: How will those be considered?	
21. Consider explicit protection from retribution steps be put in place to protect researchers, players, and concerned parents from retribution	

# PUBLIC SUBMISSION

<b>As of:</b> 5/3/16 6:48 PM
<b>Received:</b> May 02, 2016
<b>Status:</b> Posted
<b>Posted:</b> May 03, 2016
<b>Tracking No.</b> 1k0-8per-rnvv
<b>Comments Due:</b> May 02, 2016
<b>Submission Type:</b> Web

**Docket:** ATSDR-2016-0002

Collections Related to Synthetic Turf Fields with Crumb Rubber Infill 0923-16PJ

**Comment On:** ATSDR-2016-0002-0003

Collections Related to Synthetic Turf Fields with Crumb Rubber Infill ATSDR-2016-0002

**Document:** ATSDR-2016-0002-0085

Collections Related to Synthetic Turf Fields with Crumb Rubber Infill 0923-16PJ Comment on FR Doc # 2016-03305

---

## Submitter Information

**Name:** Tracy Stewart

**Address:** 02053

**Email:** tracystewart903@gmail.com

---

## General Comment

Synthetic Turf Fields with Crumb Rubber Infill ATSDR-2016-0002

Submitted by: Tracy Stewart

May 2, 2016

Please accept the following attached letter of inquiry and concern along with supporting documents as noted.

NOTE: I AM HAVING DIFFICULTY UPLOADING MY DOCUMENT TITLED "Heat" and "heat 2" and require assistance.

---

## Attachments

COVER LETTER\_STEWART\_Synthetic Turf Fields with Crumb Rubber Infill ATSDR

ATSDR-2016-0002\_STEWART\_Medway Athletic Fields Follow-Up

ATSDR-2016-0002\_STEWART\_Medway Turf Submittal 6-30-14-2

# Synthetic Turf Fields with Crumb Rubber Infill

## ATSDR-2016-0002

Submitted by: Tracy Stewart  
May 2, 2016

Please accept the following letter of inquiry and concern along with supporting documents as noted.

**Background:** I am a mother to a 10 yr old child who participates in sports throughout the year including soccer. In the town of Medway Massachusetts where we reside there are currently 3 synthetic turf fields constructed with the use of tire-crumb rubber infill. (voted in May 2014 and opened in April 2015) These fields are located on the grounds of our public High School and are used during the school day by the physical education classes and various outdoor groups. During the off hours when school is not in session, sports groups both independent and school-organized use the fields.

This spring my husband and I chose to defer our daughter's soccer practices which were held on the synthetic turf fields.

I have been an active and vocal resident regarding the concerns of tire-derived materials as outlined below.

While I oppose the use of any tire-derived material in spaces where athletes or children play; many "studies" and resources offer no definitive information. It is the desire of parents to obtain definitive answers through the launch of this investigation known as *Synthetic Turf Fields with Crumb Rubber Infill ATSDR-2016-0002*.

### Concerns that need to be proven:

- **HEAT:** The dangers of heat were documented in Medway MA in June of 2015 as found in attachment *ATSDR-2016-0002\_HEAT\_STEWART*

**The Thermal Physics of Artificial Turf By Tom Sciacca** found in: *ATSDR-2016-0002\_HEAT\_STEWART2*

- **OFF-GASSING,** see concerns addressed in attachment regarding off-gassing visible in sunny conditions.

### Regulatory issues need to be addressed and action taken:

- **Use as a Children's product:** It is commonly known that Children as young as age 4 are playing youth sports both indoors and outdoors on synthetic turf fields and playgrounds made with tire-derived crumb rubber and rubber mulch

**HEALTH:**

**Asthma: ?**

**Inhalation: ?**

**Cumulative exposure: ?**

I strongly believe that the industry has dominated the conversation for many years through paid consultants and hefty marketing budgets. Our government needs to listen to the parents and athletes while also gaining first-hand experience from our perspective. The health risk associated with tire-derived waste products used on sports field and playgrounds is extremely suspect. I hope the agencies will consider the exposures and causes that may be associated with various disease and illness from lung irritation through the more serious exposures leading to the possibility of cancer.

Thank you for your consideration,

Tracy Stewart



## **Board of Selectmen**

*Dennis P. Crowley, Chair*

*John A. Foresto, Vice-Chair*

*Richard A. D'Innocenzo, Clerk*

*Glenn D. Trindade*

*Maryjane White*

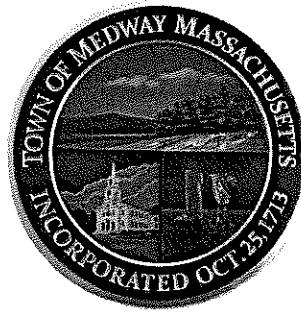

Medway Town Hall  
155 Village Street  
Medway, MA 02053  
Phone (508) 533-3264  
Fax (508) 321-4988

# **TOWN OF MEDWAY**

## **COMMONWEALTH OF MASSACHUSETTS**

**November 3, 2014**

**Dear Residents:**

During the last few weeks, the Board of Selectmen have received concerns from a group of residents regarding the safety of the materials being used as infill at the athletic complex at Medway High School. Specifically, these concerns have arisen again following a press story on NBC Nightly News earlier in October. That story, however, brought forward conjecture and speculation rather than scientific evidence that a real hazard or risk is present in these fields. With little in the way of new information, the story raised fears that were brought forth at the outset of our fields program, fears that were appropriately addressed and answered as recently as this spring. Now, with our project nearing completion, we again find ourselves as a community pausing to be certain that the path we have chosen for this project is indeed safe for all. As your Board of Selectmen, that is our responsibility and you can be certain that we take that responsibility very seriously.

Since the outset of this project, one point is very clear: everyone, from volunteer committee members, to our elected and appointed Boards, to staff alike, is in fact working toward a most common goal. That goal is the creation of a new modern field system that is not only multi-dimensional but most importantly, one that is safe for all those who may use it. This latter point is very clear upon a review of the project specifications, as well as a review of the certifications and attestations on our products used in and on the fields. In fact, our specifications directly require that the turf materials used are lead free, and that the infill substance is made with materials that meet or exceed safety standards. Further, the Town has also received a hold-harmless statement for any claims "related to hazardous materials (e.g. lead, zinc) or other environmental impacts." These are significant safety and legal protective measures that have been built into this project right from the beginning, measures that would not be possible if our product was anything but safe. And, since the NBC story aired, our volunteers and staff have again sought to confirm this data with our design professionals and the agents representing the manufactures of our products. To that end, this Board has again received assurances that the products designed and specified for the Town of Medway will result in a safe playing surface.

As noted from design through project construction, the Town has placed demands upon the design firm, Gale Associates, to produce documentation to verify that this product's history is well known from a safety and use perspective. To date, the information received has been quite positive. In fact, as presented by Gale,

“it should be noted that crumb rubber from recycled tires has been incorporated into recreational surfaces since the early 1970's where it can be found in playground and running surfaces. Such use has been a recycling alternative encouraged by the United States Environmental Protection Agency (USEPA). As a direct result, crumb rubber has been a highly tested and researched material. While there are alternative infill products available (EPDM, TPE, Cork, Coconut), they remain relatively untested in terms of their performance, long term stability, health, safety and environmental risks.”

Again, please be assured that your Board of Selectmen recognizes the concerns that some have raised relative to the NBC report. However, the suggested options of switching infill materials or simply halting the project may pose even greater health, environmental and financial risks to our Community, risks that are at best unnecessary and at worst irresponsible based upon the conjecture and innuendo that the aired story was based upon. Rather at this time, it is clear that the Town has indeed taken the appropriate steps to ensure safety for all, and will continue to do so as we move toward final completion of the fields complex. That said, please be reminded, as stated at the October 21 Board of Selectmen meeting, if any factual and scientific data is presented to the Town from State or Federal authorities that contradicts our current understanding, then we will respond to that accordingly as well.

What sets Medway apart from others is the commitment, the cooperation, and the caring of her residents. Those qualities are again most evident here, and those qualities will ensure that we as a Community and in particular this Board will make the best decision today and in the future regarding the safety of our fields and all public places.

Thank you!

Very truly yours,

Your Medway Board of Selectmen

Dennis P. Crowley, Chair  
John A. Foresto, Vice-Chair  
Richard A. D'Innocenzo, Clerk  
Glenn D. Trindade  
Maryjane White



Gale Associates, Inc.  
163 Libbey Parkway | P.O. Box 890189 | Weymouth, MA 02189-0004  
P 781.335.6465 F 781.335.6467  
www.galeassociates.com

November 3, 2014

Mr. Thomas Holder  
Department of Public Services  
Town of Medway  
155 Village Street  
Medway, MA 02053

Re: Athletic Facilities Improvements  
Medway High School  
Gale JN 715821

Dear Mr. Holder:

Gale Associates Inc. (Gale) is submitting this letter to provide a comparison of the rubber crumb infill specification compared to what was submitted and being installed.

- The specification requires a signed letter on turf manufacturer company letterhead holding the Owner, Designer and all other project consultants harmless for any violation of patent rights or infringements and claims related to hazardous materials (e.g. lead or zinc) or other environmental impacts.

This documentation was submitted on June 25, 2014 and meets or exceeds the requirements of the specification.

- The specification requires that the Synthetic Turf Supplier/Installer provide a written statement that their product is lead free prior to installation.

This documentation was provided on October 29, 2014 and meets or exceeds the requirements of the specification.

- The specification requires third party testing on the rubber crumb to be submitted for review.

This documentation was submitted November 3, 2014 showing the lead content is 38 ppm. This is less than the Federal requirement for lead in paint and similar surface coatings of a not to exceed limit 90 ppm, to be classified as "lead free".

- The specification requires a sieve analysis showing rubber crumb size distribution.

**CELEBRATING 50 YEARS**



This documentation was provided in June of 2014 and the product submitted substantially meets or exceeds the intent of the specification.

- The specification requires a mechanical analysis reflecting maximum percentage values for fiber, metal, and mineral content.

We have not received sufficient information on the product to compare to the specification.

Overall the product as submitted to date meets or exceeds the intent of the specification. We trust this information serves your needs at this time. Should you have any questions or require any additional information, please do not hesitate to contact the undersigned.

Very truly yours,

GALE ASSOCIATES, INC.

A handwritten signature in black ink, appearing to read "Sean T. Boyd". The signature is fluid and cursive, with a large initial "S" and "B".

Sean T. Boyd, E.I.T.  
Project Engineer

STB/lad

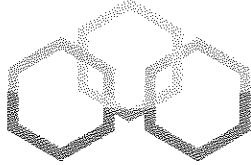

Advanced Polymer Technology  
*APT Worldwide - Always APT*

**APT AMERICAS**

Advanced Polymer Technology Corp | World Headquarters

Member of Advanced Polymer Technology Group

109 Conica Lane, PO Box 160 | Harmony, PA 16037 USA

Tel: (724) 452-1330  
Fax: (724) 452-1703

[info@advpolytech.com](mailto:info@advpolytech.com)

[www.advpolytech.com](http://www.advpolytech.com)

**Wednesday, October 29, 2014**

Town of Medway  
155 Village Street  
Medway MA 02503

**Re: APT Gridiron Turf Systems Lead Content Certificate**

To Whom It May Concern:

This letter serves as certification that all APT Gridiron turf systems are manufactured and installed without the use of any lead or other heavy metals. This includes all materials used for the turf fibers (in all colors) and backings.

In recent years, the CPSC released a standard for artificial turf stating that the total lead content measured shall be less than 100 mg/kg (ppm). The materials used in the production of APT turf systems contain no lead or heavy metals, and therefore our systems test in compliance with CPSC standard.

APT is proud to offer complete control over the production process of our turf, without the need to outsource any components. Each step, from extruding the yarn to tufting and coating with urethane produced by APT takes place in our U.S. manufacturing facility. With complete control of the materials going into the production of the turf, we are able to guarantee the quality and safety of your field.

Best regards

Dr. Axel Hinrichs  
[axelh@polytex-usa.com](mailto:axelh@polytex-usa.com)  
+1 706 229 4427



November 3, 2014

Rob Delmonico, CFB  
President  
RAD Sports  
171 VFW Drive  
Rockland, MA 02370

Dear Rob:

Per your request, I'd like to confirm that Liberty Tire Recycling supplies the only Crumb Rubber Infill that meets the industry's most stringent testing protocol, Underwriters Laboratories Environmental GREENGUARD™ Certification.

In addition, Liberty is a long-standing member of the Synthetic Turf Council and our product also meets the STC's guidelines for Crumb Rubber Infill.

For your reference, I've attached the GREENGUARD™ Certificate for both of our production sites that ship into the Northeast region, along with a copy of the STC's guidelines.

Please let me know if I can be of further service, and thanks as always for your continued business.

Best regards,



Kyle Eastman  
VP, Crumb Sales & Development

Enclosures (3)

Liberty Tire Recycling, LLC  
1251 Waterfront Place, 4th Floor, Pittsburgh, PA 15222-4261  
Phone: 412.562.1700 • Fax: 412.562.0248 • [www.libertytire.com](http://www.libertytire.com)

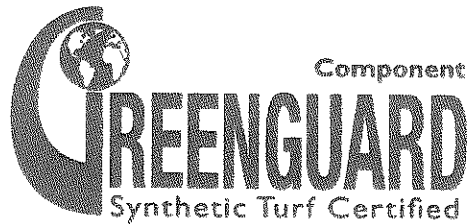

# Liberty Tire

Turf Infill—Brantford, ON, Canada

---

## Meets Criteria for:

Chemical Emissions  
Heavy Metals  
Lead

## Certification Details

Certificate Number: 902709  
Status: Certified  
Period: 5/2011 - 5/2015  
Restrictions: NONE

---

Reference Standard: GGPS.006 GREENGUARD Standard for Synthetic Turf Systems and Components  
Product Type: Component - infill

- Specified IVOCs must produce an air concentration level no greater than 1/100 the Threshold Limit Value (TLV) industrial workplace standard and no greater than 1/2 the CA Chronic Reference Exposure Level (CREL) following usage definition in GGPS.006 GREENGUARD Standard for Synthetic Turf Systems and Components.
- Total lead content meets the requirements of 90ppm in surface coatings (per Consumer Product Safety Improvement Act (CPSIA) of 2008).
- Heavy metal limits are based on ASTM F963-08 and the European Standard "Safety of toys," EN 71: Part 3: 1994, Amendments – AC: 2000 / AC: 2002.

GREENGUARD Certification affirms that products meet the criteria of the referenced standard and the requirements of the specific certification program.  
Certification testing is conducted according to a consistent, defined protocol.



**Synthetic Turf<sup>SM</sup>**  
C O U N C I L

# Guidelines for Crumb Rubber Infill Used in Synthetic Turf Fields

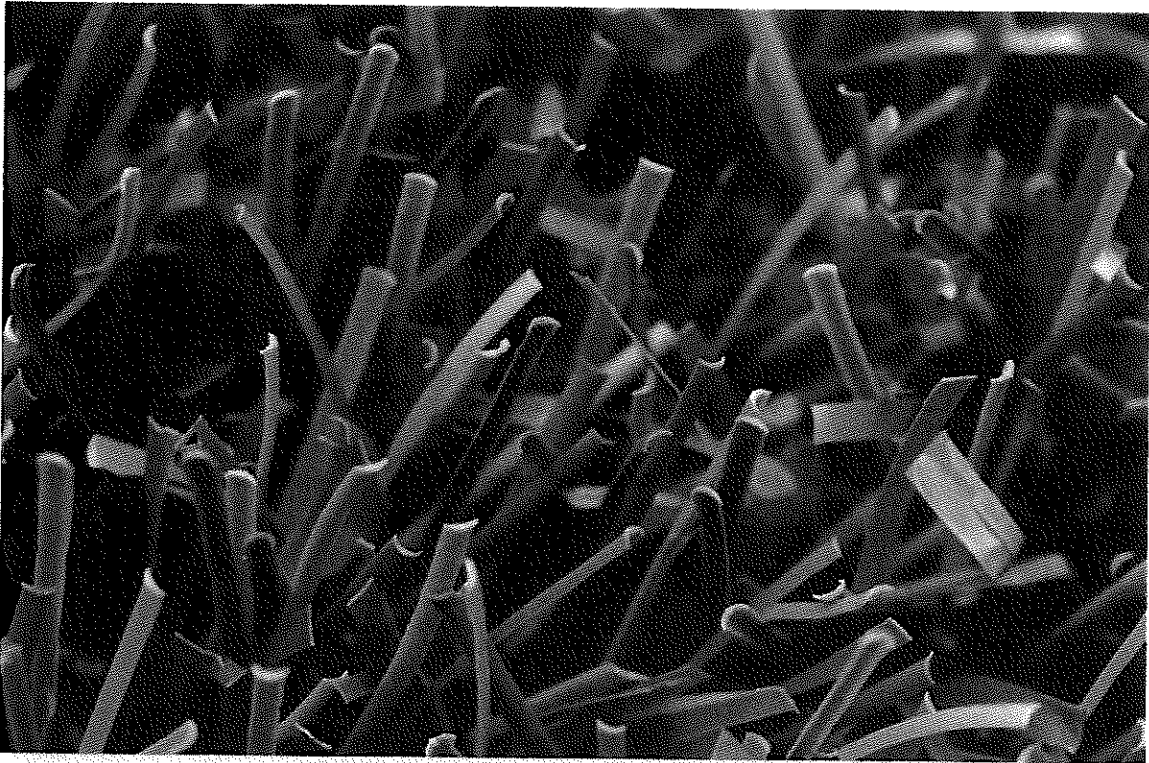



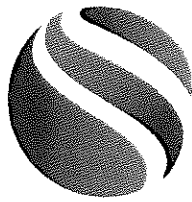

# Synthetic Turf<sup>SM</sup>

## C O U N C I L

### Guidelines for Crumb Rubber Infill Used in Synthetic Turf Fields

Printed October 2010

Revised October 23, 2014

Copyright © 2010 by the Synthetic Turf Council

400 Galleria Parkway, Suite 1500

Atlanta, GA 30339

No part of this document may be reproduced or transmitted in any form or by any means, electronic or mechanical, including photocopy, recording or any information storage or retrieval system now known or to be invented, without permission in writing from the Synthetic Turf Council, except by a reviewer who wishes to quote brief passages in a review written for inclusion in a magazine, newspaper or broadcast. The Synthetic Turf Council is a non-profit, educational organization and possesses all rights pertaining to this publication.

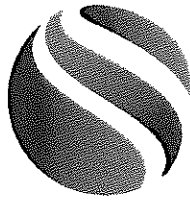

# Synthetic Turf<sup>SM</sup>

## C O U N C I L

### Table of Contents

- Purpose and Objectives..... 1
- General Characteristics ..... 2
- Processing Standards..... 3
- Certification Compliance..... 3
- Packaging and Pallets..... 4
- Field Quality Testing and Sampling..... 5
- Standard Format MSDS..... 7
- About the Synthetic Turf Council..... 11

# Introduction

## Purpose

To provide producers, customers and the public with an understanding of what CRI is and how the industry manages its safety, purity and quality.

## Objectives

- Clear standards on origin and composition of CRI
- Clear standards on cleanliness and purity of CRI
- Guidance on testing, sampling and packaging of CRI

## General Characteristics of Crumb Rubber Infill (CRI)

Effective January 1, 2011:

The CRI used in artificial turf fields shall be derived from used whole vulcanized automobile, SUV, and truck tires (DOT tires for over the road). Buffings, bladders and tubes shall not be used as feedstock for CRI.

The CRI shall have a specific gravity range from 1.1 minimum to 1.2 maximum grams per cubic centimeter as determined by ASTM D 297 (including any modifications made by ASTM in the future).

The CRI shall have an ash content of between 5 and 15% as determined by ASTM D 297 (including any modifications made by ASTM in the future).

CRI made after Jan 1, 2011 shall not contain more than .01% liberated fiber (mathematically expressed as 0.0001) (no more than 0.2 lbs. per ton, which is 3.2 ounces of fiber per 2,000 lb. supersack which is approximately 25 lbs. of fiber per average field) tested per ASTM D 5603. The liberated fiber remaining in the CRI shall be free flowing and not agglomerated into clumps of fiber as received at the job site. CRI made before Jan 1, 2011 shall contain no more than 0.05% liberated fiber. All CRI sold after 12/31/11 must meet the 0.01% standard.

The CRI shall be dry and free flowing.

Sieve/gradation specification shall be agreed upon between customer and producer.

## Processing Standards for CRI

- CRI shall be produced cryogenically, ambiently, or a combination.
- Scales used for bagging must be certified per local/state requirements.

## Certification Compliance

Suppliers shall certify that the CRI is derived from only used, whole, vulcanized automobile, SUV, or truck tires and produced in compliance with North American tire manufacturing specifications.

Providers of CRI shall provide in writing that they maintain an ongoing Quality Control program meeting all the standards of the STC Guidelines for CRI Used in Synthetic Turf Fields and capable of meeting all the specifications described herein.

Shipment and/or Order Certification shall include at least the following information:

- Type and origin of raw material (certify that it comes from tires)
- Production facility
- Production method (cryo or ambient)
- Fiber content (%)
- CRI sieve/gradation analysis

## Old Packaging (applicable before 12/31/2010)

Supersacks must meet the following specifications:

- Rated 2,200 (minimum) working load
- Rated 5:1 safety factor
- Minimum loop length of 8"
- UV treated with a 1,200 hour standard
- Minimum fabric weight of 5.5 ounce
- Side seams: at least 50% of the way down the bag
- At point of shipment bag should be clean and free of debris
- The supersack shall be secure and stable on the pallet
- Customers shall be billed for net weight of rubber shipped
- All supersacks must have traceability to date of production
- In the case of used/recycled supersacks:
  - Certified as 1x only prior use and indoor use only
  - Certified as cleaned of prior use materials

## New Packaging (applicable on and after 1/1/2011)

New supersacks must be used and must meet the following specifications. All material (regardless of date of manufacture) must be in new supersacks:

- Rated 2,200 (minimum) working load
- Rated 5:1 safety factor
- Minimum loop length of 8"
- UV treated with a 1,200 hour standard
- Minimum fabric weight of 5.5 ounce
- Side seams: at least 50% of the way down the bag
- At point of shipment bag should be clean and free of debris
- The supersack should be secure and stable on the pallet
- Customers should be billed for net weight of rubber shipped
- All supersacks should have traceability to date of production
- CRI producers may use used supersacks if a customer specifies them.

## Packaging

Pallets will meet the following specifications:

- 2 way or 4 way
- No broken or cracked boards
- No missing boards
- Fasteners all level with surface, none missing
- Construction:
  - ⇒ Top: 1 x 4's (measuring  $\frac{3}{4}$ " thick x 3.5" wide); gaps < 3"
  - ⇒ Structural: 2 x 4's (measuring 1.5" x 3.5"), minimum of 3
  - ⇒ Bottom: 1 x 4's (measuring  $\frac{3}{4}$ " thick x 3.5" wide), minimum of 3

## Field Quality Testing and Sampling

Equipment:

- Sampling stick
- Sample splitter
- Sample tray (width = 12", length = 12", Depth = 3")
- High precision scale (0.01 gram)
- Tweezers

Sampling:

- Randomly select 3 bags (super sacks) per load of infill material.
- Record the bag information such as bag number, lot number, date shipped, bill of lading number, etc.
- Place the sampling stick into the bag vertically 3 times in 3 different locations and collect 3 samples.
- Place the 3 samples into a plastic bag.
- Repeat above steps until at least 3000 grams of crumb rubber are obtained.
- Shake the collected sample well.

## Field Quality Testing and Sampling (*continued*)

### Measurements:

- Use the sample splitter to divide the crumb rubber sample evenly into 2 portions.
- Send 1 portion to the supplier with proper bag, lot, etc. identification as recorded above.
- Spread the second portion evenly on the sample tray and pick up all the free fabric with tweezers and place in the weighing tray of the scale.
- Weigh the collected fabric.
- Divide the weight of the fabric by the total weight of infill material in the tray and multiply the result by 100 to calculate percent fabric contamination.
- Repeat 3 times and average the result.
- Document the result with the proper bag, lot, etc. identification recorded above and report results to the supplier.



## Standard Format MSDS

To create and maintain a uniform understanding of CRI in the marketplace, all CRI suppliers should use an MSDS (Material Safety Data Sheet) with essentially the same elements and components.

The following format is the recommended MSDS format based on research that suggests more specificity is not required. Any producer who has received other counsel is free to use a more detailed MSDS.

Please note that this recommended format is intended to be fully consistent with OSHA and Canadian requirements and eliminates much of the chemical terminology that has historically been included because initial MSDS were derived from those used in the tire manufacturing industry.

<b>MATERIAL (CAS)</b>	<b>WT%</b>	<b>OSHA PEL</b>	<b>(ACGIHTLV)</b>
Vulcanized Rubber Compound	Approx. 99%	N/A	N/A
Talc (Hydrous Magnesium Silicate)	Less than 4%	2.0 mg/m <sup>3</sup>	2.0 mg/m <sup>3</sup>
FLASH POINT: Ignition temperature of dust cloud 320 degrees Centigrade (608 F) approximately		FLAMMABLE LIMITS	N/A

<b>HAZARDOUS INGREDIENTS</b>			
<b>PRODUCT IDENTIFICATION/CHEMICAL &amp; PHYSICAL CHARACTERISTICS</b>			
<b>PRODUCT NAME</b>	Crumb Rubber	<b>SOLUBILITY IN WATER</b>	Insoluble
<b>APPEARANCE</b>	Black granular powder	<b>ODOR</b>	Slight smell of
<b>SPECIFIC GRAVITY</b>	1.1—1.2 g/cm <sup>3</sup>	<b>MELTING POINT</b>	N/A
<b>VAPOR PRESSURE</b>	N/A	<b>VAPOR DENSITY</b>	N/A
<b>EVAPORATION RATE</b>	N/A	<b>BOILING POINT</b>	N/A

## Standard Format MSDS *(continued)*

### FIRE AND EXPLOSION HAZARD DATA

LEL—.025 OZ/CU.FT. \*

UEL: N/A

EXTINGUISHING MEDIA:

Water, foam, dry powder, encapsulating fire suppressant. (DO NOT USE HIGH PRESSURE WATER)

SPECIAL FIRE FIGHTING PROCEDURES:

Noxious gases may be formed under fire conditions. West NIOSH approved self contained apparatus.

UNUSUAL FIRE AND EXPLOSION HAZARDS:

Dust may be explosive if mixed with air in critical proportions and in the presence of an ignition source. The hazard is similar to that of many organic solids.

\* Estimates based on the NPFA Fire Protection Book

## Standard Format MSDS (*continued*)

<b>HAZARDOUS INGREDIENTS HEALTH HAZARD DATA</b>	
<b>STABLE:</b> Yes	<b>CONDITIONS TO AVOID:</b> Conditions that will cause burning
<b>INCOMPATIBILITY</b> (Materials to avoid)	Avoid strong oxidizing agents
<b>HAZARDOUS DECOMPOSITION OF BYPRODUCTS</b>	Thermal decomposition may produce carbon monoxide, carbon dioxide, zinc oxide fumes/dust, sulfur dioxide, liquid and gaseous hydrocarbons.
<b>HAZARDOUS POLYMERIZATION :</b> Will not occur	<b>CONDITIONS TO AVOID:</b> Do not store hot material in hoppers due to possibility of spontaneous combustion.
<b>ROUTES OF ENTRY</b>	Inhalation
<b>HEALTH HAZARDS</b> (Acute and Chronic)	This product can contain fine fibers that may cause itching. Otherwise, not known. This material is generally thought to be a nuisance dust.
<b>CARCINOGENICITY</b>	Rubber is not listed as a carcinogen.
<b>SIGNS AND SYMPTOMS OF EXPOSURE</b>	Itching of skin, irritation of mucous membranes, sneezing and coughing, irritation of eyes.
<b>MEDICAL CONDITIONS GENERALLY AGGRAVATED BY EXPOSURE</b>	Not known; however, could potentially aggravate allergies due to dust exposure/inhalation.
<b>EMERGENCY AND FIRST AID PROCEDURES</b>	Normal washing of skin with soap and water. Ordinary means of personal hygiene are adequate.

## Standard Format MSDS (*continued*)

<b>PRECAUTIONS FOR SAFE HANDLING AND USE</b>	
<b>STEPS TO BE TAKEN IN CASE MATERIAL IS RELEASED OR SPILLED</b>	Sweep up or vacuum into disposal containers
<b>WASTE DISPOSAL METHOD</b>	Product not defined as hazardous waste. Dispose of in accordance with federal, state, and local regulation.
<b>PRECAUTIONS TO BE TAKEN IN HANDLING AND STORAGE</b>	Do not store near flame or ignition source. Do not store hot material in tubs or containers where spontaneous ignition could occur.
<b>OTHER PRECAUTIONS</b>	If material burns, an oily residue will result. This residue must be disposed of in accordance with federal, state and local regulations.
<b>RESPIRATORY PROTECTION (Specify Type)</b>	Use any dust and mist respirator noted for up to 10 mg/m <sup>3</sup> .

<b>CONTROL MEASURES</b>	
<b>VENTILATION: Yes</b>	<b>LOCAL EXHAUST:</b> Yes, if dusty conditions occur.
<b>SPECIAL: None</b>	<b>MECHANICAL (General):</b> Dust collector and
<b>PROTECTIVE GLOVES: Recommended</b>	<b>EYE PROTECTION:</b> Use safety goggles to prevent dust entry.
<b>OTHER PROTECTIVE CLOTHING OR EQUIPMENT</b>	Enough fresh air should flow past the user to prevent exposure to airborne fibers and particles.
<b>WORK/HYGENE PRACTICES</b>	Good personal hygiene; frequent washing with soap and water of exposed areas; remove and clean solid clothing.

The information contained in this MSDS is consistent with the U.S. Department of Labor OSHA Form OMB 1218-0072. Consult OSHA Hazard Communication Standard 29 CFR 1910.1200 for additional information. To fully understand the use of any material, the user should avail themselves of reference material and expert consultation in the fields of fire prevention, ventilation and toxicology.

## About the Synthetic Turf Council

Based in Atlanta, the Synthetic Turf Council was founded in 2003 to promote the industry and to assist buyers and end users with the selection, use and maintenance of synthetic turf systems in sports field, golf, municipal parks, airports, landscape and residential applications. The organization is also a resource for current, credible, and independent research on the safety and environmental impact of synthetic turf. Membership includes builders, landscape architects, testing labs, maintenance providers, manufacturers, suppliers, installation contractors, infill material suppliers and other specialty service companies. For more information, visit the STC's Online Buyers' Guide and Member Directory at [www.syntheticurfCouncil.org](http://www.syntheticurfCouncil.org).



Synthetic Turf Council  
400 Galleria Parkway, Suite 1500  
Atlanta, GA 30339  
Phone: 678.385.6720 | Fax: 678.385.6501  
[www.syntheticurfCouncil.org](http://www.syntheticurfCouncil.org)

Online Buyer's Guide and Member Directory  
[www.stc.officialbuyersguide.net](http://www.stc.officialbuyersguide.net)



# Liberty Tire

## Turf Infill—Lockport, NY

**Meets Criteria for:**  
Chemical Emissions  
Heavy Metals  
Lead

**Certification Details**  
Certificate Number: 902708  
Status: Certified  
Period: 5/2011 - 5/2015  
Restrictions: NONE

Reference Standard: GGPS.006 GREENGUARD Standard for Synthetic Turf Systems and Components  
Product Type: Component - infill

- Specified IVOCs must produce an air concentration level no greater than 1/100 the Threshold Limit Value (TLV) industrial workplace standard and no greater than 1/2 the CA Chronic Reference Exposure Level (CREL) following usage definition in GGPS.006 GREENGUARD Standard for Synthetic Turf Systems and Components.
- Total lead content meets the requirements of 90ppm in surface coatings (per Consumer Product Safety Improvement Act (CPSIA) of 2008).
- Heavy metal limits are based on ASTM F963-08 and the European Standard "Safety of toys," EN 71: Part 3: 1994, Amendments – AC: 2000 /AC: 2002.

GREENGUARD Certification affirms that products meet the criteria of the referenced standard and the requirements of the specific certification program.  
Certification testing is conducted according to a consistent, defined protocol.



# Air Quality Sciences

January 15, 2013

Liberty Tire Recycling, LLC  
Mr. David Forrester  
14 North Pine Circle  
Belleair, FL 33756

Subject: AQS Project 90270, Profile Study Test Results

Dear David:

Thank you for choosing Air Quality Sciences, Inc. (AQS), an ISO 17025 accredited testing laboratory, for your analytical needs. Attached to this letter are profile study test results, including predicted room concentrations.

Sample Description	Predicted Levels Compared to GREENGUARD IAQ Criteria		
	TVOC	Formaldehyde	Total Aldehydes
10+20 BM Rubber Crumb, Brantford, ON	✓	✓	✓

✓ - meets criteria; ✓\* - meets within 25%; X - over by more than 25% of criteria

Sample Description	Predicted Levels Compared to GREENGUARD Children & Schools Criteria			
	TVOC	Formaldehyde	Total Aldehydes	CREL/TLV Issues
10+20 BM Rubber Crumb, Brantford, ON	✓	✓	✓	---

✓ - meets criteria; ✓\* - meets within 25%; X - over by more than 25% of criteria

AQS appreciates your business. Soon you will be contacted by your GREENGUARD Program Account Manager, John Testa (678) 444-4082.

Please keep in mind that all information obtained as part of the profile study testing is confidential as per the signed Testing Agreement. For more technical information about the GREENGUARD program, please visit, <http://greenguard.org/en/technicalCenter.aspx>.

Sincerely,

Allyson M. McFry  
Chemistry Laboratory Director

Attachment: AQS Report No. 90270-86





SYNTHETIC TURF PROFILE STUDY TEST REPORT
PRELIMINARY ASSESSMENT FOR GREENGUARD CERTIFICATION

Profile study data provides a preliminary estimate of the product's potential to qualify for GREENGUARD Certification

PREPARED FOR: LIBERTY TIRE RECYCLING, LLC
PRODUCT 90270-P0860AA; 10+20 BM RUBBER CRUMB, BRANTFORD, ON

Table with 4 columns: ANALYTE, GREENGUARD MAXIMUM ALLOWABLE LIMIT, 24 HR EMISSION FACTOR, 168 HR ESTIMATED CONCENTRATION. Rows include TVOC, Formaldehyde, and Individual VOCs.

BQL denotes below quantifiable level of 0.04 µg based on a standard 18 L air collection volume for TVOC and individual VOCs and 0.1 µg based on a standard 45 L air collection volume for formaldehyde and total aldehydes.

The predicted concentrations are based on a standard soccer field turf area usage (1,505 m²) in a stadium with ASHRAE 62.1-2010 ventilation conditions (94,423 m³ in volume and 0.73 ACH) and assumed decay parameters (kₜ = 0.005; kₓ = 0.005; kₐ = 0.005).

Analyses based on EPA Compendium Method TO-17 and ASTM D 6196 for VOCs by thermal desorption followed by gas chromatography/mass spectrometry (TD/GC/MS), and EPA Method TO-11A and ASTM D 5197 for selected aldehydes by high performance liquid chromatography (HPLC).

Table with 9 columns: Heavy Metals, Arsenic (As), Barium (Ba), Cadmium (Cd), Chromium (Cr), Mercury (Hg), Lead (Pb), Antimony (Sb), Selenium (Se). Rows include GREENGUARD MAXIMUM ALLOWABLE LIMIT and MEASURED VALUE.

(EN71-3: 1994 and Amendments -A1:2000/Ac:2002)

Test Method: Soluble heavy metals content analysis was determined by Inductively Coupled Plasma Spectrometry.

Table with 4 columns: CPSIA Lead Content, GREENGUARD MAXIMUM ALLOWABLE LIMIT, MEASURED VALUE, PRODUCT COMPLIANCE. Row shows RESULTS with values < 90, 38.0, and Yes.

Total Lead Content in Substrate. Consumer Product Safety Improvement Act (CPSIA) of 2008 reduced to EN requirements. Per ASTM F963-08, the CPSIA and the European Standard "Safety of toys", EN 71: Part 3: 1994 Consumer Product Safety Improvement Act (CPSIA) of 2008

Metal testing completed by a CPSC approved laboratory.

Volatile organic compound (VOC), including aldehyde, testing was completed by AQS, Inc.

This test data is provided for general informational purposes only. The data indicate the level of emissions from the designated product and how they compare to the emission criteria of the GREENGUARD IAQ standards. This data does not imply that the product has been qualified to meet the requirements of the GREENGUARD Certification Program nor does it imply that the product is or is not certified by the GREENGUARD Certification Program.

## **EMISSIONS TESTING PARAMETERS**

**Customer:** Liberty Tire Recycling, LLC

**AQS Sample Identification:** AQS 90270-P0860AA

**Product Description:** SYNTHETIC TURF; 10+20 BM Rubber Crumb, Brantford, ON  
(one-sided area = 0.0361 m<sup>2</sup>)

**Product Loading:** 0.42 m<sup>2</sup>/m<sup>3</sup>

**Test Conditions:** 1.0 ± 0.05 ACH  
50 % RH ± 5% RH  
23°C ± 1°C

**Test Period:** 12/05/12 - 12/06/12

**Test Description:** The product was received by AQS on 12/03/12 as packaged and shipped by the customer. The package was visually inspected and stored in a controlled environment immediately following sample check-in. Just prior to loading, the product was unpackaged, prepared for the required loading, and poured into a tray to expose the top surface only. The sample was placed inside the environmental chamber, and tested according to the specified protocol.

Environmental chamber test following ASTM D 5116 in a 0.09 ± 0.007 m<sup>3</sup> chamber.

**TABLE 1**

**EMISSION FACTORS OF IDENTIFIED INDIVIDUAL VOLATILE ORGANIC  
 COMPOUNDS AT 24 ELAPSED EXPOSURE HOURS**

**PREPARED FOR: LIBERTY TIRE RECYCLING, LLC**  
**PRODUCT 90270-P0860AA; 10+20 BM RUBBER CRUMB, BRANTFORD, ON**

CAS NUMBER	COMPOUND IDENTIFIED	EMISSION FACTOR ( $\mu\text{g}/\text{m}^3\cdot\text{hr}$ )
107-21-1	1,2-Ethanediol (Ethylene glycol) <sup>†</sup>	281
95-16-9	Benzothiazole <sup>†</sup>	226
108-94-1	Cyclohexanone	73.9
108-10-1	2-Pentanone, 4-methyl (Methyl isobutyl ketone, MIBK) <sup>†</sup>	61.1
1120-21-4	Undecane	60.7
7206-29-3	6-Dodecene, (Z)-*	56.1
124-18-5	Decane <sup>†</sup>	49.3
17302-32-8	Nonane, 3,7-dimethyl*	45.0
62-53-3	Aniline	37.1
91-57-6	Naphthalene, 2-methyl	35.9
62016-14-2	Octane, 2,5,6-trimethyl*	34.2
934-74-7	Benzene, 1-ethyl-3,5-dimethyl	33.7
98-55-5	3-Cyclohexene-1-methanol, $\alpha,\alpha,4$ -trimethyl	28.9
2425-74-3	Formamide, N-(1,1-dimethylethyl)-*	28.6
112-40-3	Dodecane	27.9
1758-88-9	Benzene, 2-ethyl-1,4-dimethyl*	26.5
17312-55-9	Decane, 3,8-dimethyl*	26.2
95-93-2	Benzene, 1,2,4,5-tetramethyl	26.0
91-17-8	Naphthalene, decahydro-*	25.0
17312-53-7	Decane, 3,6-dimethyl*	23.3
123-48-8	3-Heptene, 2,2,4,6,6-pentamethyl-*	21.2
1678-93-9	Cyclohexane, butyl	19.0
62016-33-5	Octane, 2,3,6-trimethyl*	17.8
629-50-5	Tridecane	16.8

**CONFIDENTIAL**  
 Test data and interpretation applicable to  
 GREENGUARD Certification Program only

CAS NUMBER	COMPOUND IDENTIFIED	EMISSION FACTOR (µg/m <sup>2</sup> •hr)
138-86-3	Limonene (Dipentene; 1-Methyl-4-(1-methylethyl)cyclohexene)	16.4
96-48-0	2(3H)-Furanone, dihydro (Butyrolactone)	16.1
25551-13-7	Trimethylbenzene (All Isomers) <sup>†</sup>	15.9
77376-84-2	Tert.-butylaminoacrylonitril*	15.4
17302-36-2	5-Ethyldecane*	14.9
91-20-3	Naphthalene <sup>†</sup>	14.9
106-42-3	Xylene (para and/or meta) <sup>†</sup>	14.7
874-35-1	1H-Indene, 2,3-dihydro-5-methyl*	14.4
17312-54-8	Decane, 3,7-dimethyl*	14.4
57-55-6	1,2-Propanediol (Propylene glycol)	14.2
68-12-2	Formamide, N,N-dimethyl <sup>†</sup>	13.7
17302-23-7	Nonane, 4,5-dimethyl*	13.7
108-95-2	Phenol <sup>†</sup>	13.2
2958-76-1	Naphthalene, decahydro-2-methyl*	13.0
764-96-5	5-Undecene, (Z)*	11.1
1680-51-9	Naphthalene, 1,2,3,4-tetrahydro-6-methyl*	11.1
4292-75-5	Cyclohexane, hexyl*	10.8
475-20-7	Longifolene	10.6
17301-94-9	Nonane, 4-methyl	9.9
147-47-7	Quinoline, 1,2-dihydro-2,2,4-trimethyl*	9.9
629-62-9	Pentadecane	9.6
109-02-4	Morpholine, 4-methyl*	8.9
17312-57-1	Dodecane, 3-methyl*	8.7
622-96-8	Benzene, 1-ethyl-4-methyl (4-Ethyltoluene)	8.4
119-64-2	Naphthalene, 1,2,3,4-tetrahydro	8.4
629-59-4	Tetradecane	8.4
90-12-0	Naphthalene, 1-methyl	7.9
871-83-0	Nonane, 2-methyl	7.7
489-40-7	1H-Cycloprop[e]azulene, 1a,2,3,4,4a,5,6,7b-octahydro-1,1,4,7-tetramethyl-, [1aR-(1aα,4α,4aβ,7bα)]*	7.5
99-87-6	Benzene, 1-methyl-4-(1-methylethyl) (p-Cymene; 4-Isopropyltoluene)	7.5
62016-30-2	Octane, 2,3,3-trimethyl*	7.2

**CONFIDENTIAL**  
 Test data and interpretation applicable to  
 GREENGUARD Certification Program only

CAS NUMBER	COMPOUND IDENTIFIED	EMISSION FACTOR (µg/m <sup>2</sup> •hr)
110-12-3	2-Hexanone, 5-methyl*	6.5
100-52-7	Benzaldehyde	6.5
18321-36-3	Benzene, (1,1-dimethyl-2-propenyl)-*	6.3
1678-92-8	Cyclohexane, propyl	6.3
4904-61-4	1,5,9-Cyclododecatriene*	6.0
41446-63-3	7-Tetradecene, (E)*	6.0
61141-72-8	Dodecane, 4,6-dimethyl*	6.0
53927-61-0	Benzenamine, N-(2,2-dimethylpropyl)-N-methyl-*	5.5
581-40-8	Naphthalene, 2,3-dimethyl*	5.5
2051-30-1	Octane, 2,6-dimethyl	5.3
79-09-4	Propanoic acid	5.3
762-84-5	N-tert-Butylacetamide*	4.8

Analysis based on EPA Compendium Method TO-17 and ASTM D 6196 for VOCs by thermal desorption followed by gas chromatography/mass spectrometry (TD/GC/MS).

Quantifiable level is 0.04 µg based on a standard 18 L air collection volume.

\*Indicates NIST/EPA/NIH best library match only based on retention time and mass spectral characteristics.

†Denotes quantified using multipoint authentic standard curve. Other VOCs quantified relative to toluene.

**TABLE 2**

**EMISSION FACTORS OF TARGET LIST ALDEHYDES  
 AT 24 ELAPSED EXPOSURE HOURS**

**PREPARED FOR: LIBERTY TIRE RECYCLING, LLC  
 PRODUCT 90270-P0860AA; 10+20 BM RUBBER CRUMB, BRANTFORD, ON**

CAS NUMBER	COMPOUND IDENTIFIED	EMISSION FACTOR (µg/m <sup>2</sup> ·hr)
4170-30-3	2-Butenal	BQL
75-07-0	Acetaldehyde	BQL
100-52-7	Benzaldehyde	4.8
5779-94-2	Benzaldehyde, 2,5-dimethyl	BQL
529-20-4	Benzaldehyde, 2-methyl	BQL
620-23-5 /104-87-0	Benzaldehyde, 3- and/or 4-methyl	BQL
123-72-8	Butanal	BQL
590-86-3	Butanal, 3-methyl	BQL
50-00-0	Formaldehyde	12.0
66-25-1	Hexanal	BQL
110-62-3	Pentanal	BQL
123-38-6	Propanal	BQL

Analysis based on EPA Method TO-11A and ASTM D 5197 for selected aldehydes by high performance liquid chromatography (HPLC).

BQL = Below quantifiable level of 0.1 µg based on a standard 45 L air collection volume.

**TABLE 3**  
**REGULATORY LIST**

**PREPARED FOR: LIBERTY TIRE RECYCLING, LLC**  
**PRODUCT 90270-P0860AA; 10+20 BM RUBBER CRUMB, BRANTFORD, ON**

CAS NUMBER	COMPOUND	✓() = FOUND IN LISTING (CLASS)					
		CAL PROP. 65	NTP	IARC	CAL AIR TOXICS	CREL	TLV
107-21-1	1,2-Ethanediol (Ethylene glycol) <sup>1</sup>				✓(IIA)	✓	✓
96-48-0	2(3H)-Furanone, dihydro (Butyrolactone)			✓(3)			
110-12-3	2-Hexanone, 5-methyl						✓
108-10-1	2-Pentanone, 4-methyl (Methyl isobutyl ketone, MIBK) <sup>1</sup>	✓(1)			✓(IVA)		✓
62-53-3	Aniline	✓(1)		✓(3)	✓(IIA)		✓
108-94-1	Cyclohexanone			✓(3)			✓
50-00-0	Formaldehyde	✓(1)	✓(2A)	✓(1)	✓(IIA)	✓	✓
68-12-2	Formamide, N,N-dimethyl <sup>1</sup>			✓(3)	✓(IIA)	✓	✓
91-20-3	Naphthalene <sup>1</sup>	✓(1)	✓(2B)	✓(2B)	✓(IIA)	✓	✓
90-12-0	Naphthalene, 1-methyl						✓
91-57-6	Naphthalene, 2-methyl						✓
108-95-2	Phenol <sup>1</sup>			✓(3)	✓(IIA)	✓	✓
79-09-4	Propanoic acid						✓
25551-13-7	Trimethylbenzene (All Isomers) <sup>1</sup>						✓
106-42-3	Xylene (para and/or meta) <sup>1</sup>			✓(3)	✓(IIA)	✓	✓

<sup>1</sup>Denotes quantified using multipoint authentic standard curve.

**CAL Prop. 65: California Health and Welfare Agency, Proposition 65 Chemicals**

1 = known to cause cancer

2 = known to cause reproductive toxicity

**IARC: International Agency on Research of Cancer**

1A = carcinogenic to humans

3 = unclassifiable as to carcinogenicity to humans

2A = probably carcinogenic to humans

4 = probably not carcinogenic to humans

2B = possibly carcinogenic to humans

**California Air Toxics**

**Category I** Substances identified as Toxic Air Contaminants, known to be emitted in California, with a full set of health values reviewed by the Scientific Review Panel. ☐

**Category IIA** Substances identified as Toxic Air Contaminants, known to be emitted in California, with one or more health values under development by the Office of Environmental Health Hazard Assessment for review by the Scientific Review Panel.

**Category IIB** Substances NOT identified as Toxic Air Contaminants, known to be emitted in California, with one or more health values under development by the Office of Environmental Health Hazard Assessment for review by the Scientific Review Panel. ☐

**Category III** Substances known to be emitted in California and are NOMINATED for development of health values or additional health values. ☐

**Category IVA** Substance identified as Toxic Air Contaminants, known to be emitted in California and are TO BE EVALUATED for entry into Category III. ☐

**Category IVBA** Substance NOT identified as Toxic Air Contaminants, known to be emitted in California and are TO BE EVALUATED for entry into Category III. ☐

**Category V** Substance identified as Toxic Air Contaminants, and NOT KNOWN TO BE EMITTED from stationary source facilities in California based on information from the AB 2588 Air Toxic "Hot Spots" Program and the California Toxic Release Inventory. ☐

**Category VI** Substances identified as Toxic Air Contaminants, NOT KNOWN TO BE EMITTED from stationary source facilities in California, and are active ingredients in pesticides in California. ☐

**CREL: California Office of Environmental Health Hazard Assessment (OEHHA), Chronic Reference Exposure Levels**

✓() = Found in Listing (Criterion)

**TLV: American Conference of Governmental Industrial Hygienists' Threshold Limit Values for Chemical Substances and Physical Agents.**

✓ = Found in Listing



Gale Associates, Inc.

163 Libbey Parkway | P.O. Box 890189 | Weymouth, MA 02189-0004  
P 781.335.6465 F 781.335.6467  
www.galeassociates.com

June 30, 2014

Mr. Thomas Holder  
Department of Public Services  
Town of Medway  
155 Village Street  
Medway, MA 02053

Re: Athletic Facilities Improvements  
Medway High School  
Gale JN 715821

Dear Mr. Holder:

Gale Associates Inc. (Gale) has received the turf submittal (Enclosure 1) for the Athletic Facilities Improvements Project at Medway High School from RAD Sports, Inc. on June 23, 2014 as well as a supplemental submission on June 27, 2014. Gale reviewed the turf submittal and completed a turf review comparison sheet (Enclosure 2).

Based on our review of the turf product submitted, it is our opinion the product meets the intent of the specification as an "or equal". Based on MA Public procurement regulations, it is our intent to approve this submittal pending further input from the Town. Please provide Gale with direction on how Medway would like to proceed.

Very truly yours,

GALE ASSOCIATES, INC.

Sean T. Boyd, E.I.T.  
Project Engineer

STB/lab

Enclosure 1 – Turf Submittal;  
Enclosure 2 – Medway High School Turf Review Comparison Sheet

G:\715821\Letters\715821 - Turf Submittal 6-30-14.doc

**CELEBRATING 50 YEARS**



ENCLOSURE 1

TURF SUBMITTAL

# R.A.D. Corp

171 VFW Drive  
Rockland, MA 02370  
Ph: 781-871-4400  
Fx: 781-878-1161

## Submittal

Submittal#: 14909-002

Submittal Date: 06/27/2014

To: Gale Associates, Inc.  
163 Libbey Pkwy  
Weymouth MA 02189

Project: 14909  
Medway High School  
88 Summer Street  
Medway MA 02053

---

Prepared By: James Doherty

---

Item	Description	Action Required	Date Required
1	Seaming Tape Sample	Review for approval	
2	Sample colored Turf fibers	Review for approval	
3	Sample blended Sand / rubber	Review for approval	
4	Memo Synthetic turf supplier	Review for approval	
5	Hold harmless for any patent Rights or infringements	Review for approval	
6	memo of synthetic turf review of drawings	Review for approval	
7	APT Completed References list	Review for approval	

### Notes

Ph #781-335-6465  
Fx #781-335-6467

Attn: Sean

Here are 99% of missing synthetic turf submittal items.

Please review and advise ASAP

Thank you

Please sign and date this form as proof that you are in receipt of the above listed items.  
Return form to R.A.D. Sports

Signed: 

Date: 6-27-14

Submittal

Submittal#: 14909-002

Continued...

Date: 06-27-2014

Item	Description	Action Required	Date Required
James P. Doherty			



**Advanced Polymer Technology**  
*APT Worldwide - Always APT*

## APT AMERICA'S

Advanced Polymer Technology Corp. | World Headquarters  
 Member of Advanced Polymer Technology Group  
 109 Conica Lane, PO Box 160 | Harmony, PA 16037 USA

Tel. (724) 452-1330  
 Fax (724) 452-1703  
[www.sportsbyapt.com](http://www.sportsbyapt.com)  
[info@advpolytech.com](mailto:info@advpolytech.com)

## COMPLETED REFERENCES

YEAR	DESCRIPTION	LOCATION	PRODUCT	
2014	Norwell High School	Norwell MA	Gridiron	Soccer
2014	Norwell High School	Norwell MA	Gridiron	Multisport
2014	Harvard University	Cambridge MA	Gridiron RS+52	Soccer
2014	North Greenville University	Tigerville SC	Gridiron RS+52	Multisport
2014	Bonham High School	Bonham TX	Gridiron RS+52	Football
2013	Hattiesburg High School	Hattiesburg MS	Gridiron	Multisport
2013	Total Sports Experience	East Rochester NY	Gridiron	Multisport
2013	SW Baptist University	Bolivar MO	LigaTurf	Soccer
2013	Rye Elementary School	Pueblo CO	Gridiron	Multisport
2013	Sweetwater High School	San Diego CA	LigaTurf	Multisport
2013	Philadelphia Eagles NFL Practice Field	Philadelphia PA	Gridiron	Football
2013	Jackson Prep High School	Jackson MS	LigaTurf	Multisport
2013	Tri City Sports Complex	Auburn MI	Gridiron	Multisport
2013	Pueblo Schools	Pueblo CO	Gridiron	Multisport
2013	Hartselle High School	Hartselle AL	Gridiron	Multisport
2013	Tucker Field	Cumberland, RI	Gridiron	Multisport
2013	Hooptown USA	Nashville TN	Gridiron	Multisport
2013	Camp Lejune Marine Base	Jacksonville NC	Gridiron	Multisport
2013	Denver Schools	Denver CO	Gridiron	Multisport
2013	Cedar Valley Sports Complex	Waterloo IA	Gridiron	Multisport
2013	Berry College	Rome GA	Gridiron	Baseball
2013	Endicott College	Boston MA	Gridiron	Soccer
2013	Maypearl High School	Maypearl, TX	Gridiron RS+ 52	Football
2013	Huffman High School	Birmingham, AL	Gridiron	Multisport
2010;2011	New London HS-Fields 1 & 2	New London, CT	LigaSport	Football
2012	Parker High School	Birmingham, AL	LigaSport RS+	Football
2012	Brown University	Providence, RI	Ligasport RS+ 45	Hockey
2012	Lawson Field	Birmingham, AL	Ligasport 40 oz	Football
2012	University of California - Davis	Sacramento, CA	Ligagrass 238 ACS 63n	Hockey
2011	Hurricane HS	Hurricane, UT	LigaSport	Football
2011	MIT	Cambridge, MA	LigaTurf 240 ACS 65	Soccer
2011	Saraland HS	Saraland, AL	LigaSport	Football
2011	Spring Arbor University	Spring Arbor, MI	LigaSport RS+	Soccer
2011	Boyle Stadium	Stamford, CT	LigaSport	Football
2011	University of Little Rock	Little Rock, AR	LigaSport RS+	Soccer
2010	Harvard	Boston, MA	LigaSport RS+	Soccer
2010	Highland Park Indoor	Dallas, TX	LigaTurf 240 ACS 65	Football
2010	Highland Park Softball	Dallas, TX	LigaGrass 250 ACS 75	Baseball

2010	Indiana University Field Hockey	Bloomington, IN	Megaturf CPF 13-2-38	Hockey
2010	Prince of Peace HS	Carrollton, TX	LigaTurf 240 ACS 65	Football
2010	University New England	Biddeford, ME	LigaGrass 238 ACS 63 - BLUE FIELD	Hockey
2010	University of Wisconsin Milwaukee	Milwaukee, WI	LigaTurf RS+ 240 ACS 70	Soccer
2010	Advanced Polymer Technology Vestavia	Vestavia, AL	LigaSport	Multisport
2010	Wills Point HS	Wills Point, TX	LigaTurf 240 ACS 65	Football
2009	Alabama Baseball	Tuscaloosa, AL	LigaTurf 255	Baseball
2009	Alabama State University	Montgomery, AL	LigaSport	Football
2009	Belton HS	Belton, MO	LigaTurf 260	Football
2009	Bessemer HS	Bessemer, AL	LigaSport	Football
2009	Booneville HS	Boonville, MO	LigaTurf 255	Football
2009	Eastern Connecticut State University	Willimantic, CT	LigaGrass 238 ACS 63	Hockey
2009	Hank Crisp Indoor - University of Alabama	Tuscaloosa, AL	Ligasport XP	Football
2009	Harper Creek HS Turf	Battle Creek, MI	LigaTurf 240 ACS 65	Football
2009	Little Elm HS	Little Elm, TX	LigaTurf 240 ACS 65	Football
2009	Waxahachie HS	Waxahachie, TX	LigaTurf 240 ACS 65	Football
2008	Boston College	Newton, MA	LigaTurf 240 ACS 65	Soccer
2007	Amherst HS	Amherst, MA	LigaGrass 238 ACS 63	Hockey
2007	Kingston HS	Kingston, WA	Monoslide PE 250 ACS 75	Football
2007	Mt.Holyoke HS	South Hadley, MA	LigaGrass 238 ACS 63	Hockey
2006	Brigham Young University	Rexburg, ID	LigaTurf 240 ACS 65	Football, Baseball, Soccer Fields
2006	John Burroughs School	St. Louis, MO	Monoslide PE 250 ACS 75	Soccer
2006	Wesleyan State University	Middletown, CT	LigaGrass 225 ACS 50	Soccer
2005	Chicago Bears - Walter Payton Center	Lake Forest, IL	LigaGrass 250 ACS 75	Football
2004	Austin Peay University	Clarksville, TN	LigaGrass 238 ACS 63	Football
2004	Paragould HS	Paragould, AR	Monoslide PE 250 ACS 75	Football
2002	College Misericordia	Dallas, PA	Monoslide PE 250 ACS 75	Football



**Advanced Polymer Technology**

*APT Worldwide - Always 'APT'*

## APT AMERICA'S

Advanced Polymer Technology Corp. | World Headquarters

Tel. (724) 452-1330

Fax. (724) 452-1703

Member of Advanced Polymer Technology Group

109 Conica Lane, PO Box 160 | Harmony, PA 16037 USA

[info@advpolytech.com](mailto:info@advpolytech.com)

[www.advpolytech.com](http://www.advpolytech.com)

[www.sportsbyapt.com](http://www.sportsbyapt.com)

June 25, 2014

Mr. Sean Boyd  
Gale Associates, Inc.  
163 Libbey Parkway  
Weymouth, MA 02189

Re: Medway Athletic Fields

Please be advised that the Drawings and Specifications have been reviewed by a qualified representative of Advanced Polymer Technologies and is in agreement that the materials and installation methods to be used for the infilled Synthetic Turf System are proper and adequate use as a multi-purpose athletic field in New England.

Thank you,

Gary

Gary Wilson  
Director of Sales Americas

404-791-2130

[wilson@advpolytech.com](mailto:wilson@advpolytech.com)





**Advanced Polymer Technology**

*APT Worldwide - Always 'APT'*

## APT AMERICA'S

Advanced Polymer Technology Corp. | World Headquarters

Tel. (724) 452-1330

Fax. (724) 452-1703

Member of Advanced Polymer Technology Group

109 Conica Lane, PO Box 160 | Harmony, PA 16037 USA

[info@advpolytech.com](mailto:info@advpolytech.com)

[www.advpolytech.com](http://www.advpolytech.com)

[www.sportsbyapt.com](http://www.sportsbyapt.com)

June 25, 2014

Mr. Sean Boyd  
Gale Associates, Inc.  
163 Libbey Parkway  
Weymouth, MA 02189

Re: Medway Athletic Fields

Please be advised that Advanced Polymer Technologies holds the Owner, Designer and all other project consultants harmless for any violation of patent rights or infringements and claims related to hazardous materials (e.g. lead or zinc) or other environmental impacts.

Thank you,

Gary

Gary Wilson  
Director of Sales Americas

404-791-2130

[wilson@advpolytech.com](mailto:wilson@advpolytech.com)



**Advanced Polymer Technology**

*APT Worldwide - Always APT*

## APT AMERICA'S

Advanced Polymer Technology Corp. | World Headquarters

Tel. (724) 452-1330

Fax. (724) 452-1703

Member of Advanced Polymer Technology Group

109 Conica Lane, PO Box 160 | Harmony, PA 16037 USA

[info@advpolytech.com](mailto:info@advpolytech.com)

[www.advpolytech.com](http://www.advpolytech.com)

[www.sportsbyapt.com](http://www.sportsbyapt.com)

June 25, 2014

Mr. Sean Boyd  
Gale Associates, Inc.  
163 Libbey Parkway  
Weymouth, MA 02189

Re: Medway Athletic Fields

Please be advised that the synthetic turf shall be manufactured and supplied by Advanced Polymer Technologies (APT) which has been in business continuously since 1969 under the same name and ownership. APT has 45 years experience in the manufacturing and supply of the type of materials specified herein on projects of comparable size to this project.

Thank you,

Gary

Gary Wilson  
Director of Sales Americas

404-791-2130

[wilson@advpolytech.com](mailto:wilson@advpolytech.com)



# R.A.D. Corp

171 VFW Drive  
Rockland, MA 02370  
Ph: 781-871-4400  
Fx: 781-878-1161

## Submittal

Submittal#: 14909-001

Submittal Date: 06/23/2014

To: Gale Associates, Inc.  
163 Libbey Pkwy  
Weymouth MA 02189

Project: 14909  
Medway High School  
88 Summer Street  
Medway MA 02053

---

Prepared By: James Doherty

---

Item	Description	Action Required	Date Required
1	Product Data Sheet	Review for approval	
2	Product Testing	Review for approval	
3	Sample Warranty	Review for approval	
4	Sample third party Warranty	Review for approval	
5	Certificate of Liability Insurance	Review for approval	
6	Sand Product spec & MSDS	Review for approval	
7	Rubber Product spec & MSDS	Review for approval	
8	Adhesive Product specs & MSDS	Review for approval	
9	Seaming Tape product	Review for approval	
10	Maintenance Equipment	Review for approval	
11	Resume installers and Ref-	Review for approval	
12	Layout Drawing Phase #1 field	Review for approval	
13	Sample Turf	Review for approval	
14	Sample Rubber	Review for approval	

Please sign and date this form as proof that you are in receipt of the above listed items.  
Return form to R.A.D. Sports

Signed: 

Date: 6-23-14

Submittal

Submittal#: 14909-001

Continued...

Date: 06-23-2014

Item	Description	Action Required	Date Required
15	Sample Sand	Review for approval	

**Notes**

Ph #781-335-6465  
Fx #781-335-6467

Attn: Sean

Attached is my submittal for the synthetic turf for the Medway High School project.

In this package is only the phase #1 layout drawings other tow fields drawing will be forwarded shortly.

We need to get this field released ASAP with the tight time frame of phase #1

Please advise by e-mail as soon as possible with approval or comments

Thank you

James P. Doherty



IT'S NOT JUST A FIELD.  
IT'S YOUR HOME TURF.

## GRIDIRON PRO ST

### Part 1 – General

#### Description

- A. Gridiron PRO ST is synthetic turf with sand-rubber infill; 100% PE monofilament yarn.

#### Quality Assurance

- A. Manufacturer: APT Group has over 40 years of manufacturing experience, with facilities around the world, having produced over 475 million square feet of surfacing products that meet or exceed all necessary industry standards.
- B. Face fibers shall be APT only; it shall be made of the highest quality LLDPE resins. Fibers shall be mixed and extruded with specialized equipment designed for the manufacturing of artificial turf yarns, and stretched and annealed to the desired strength and durability required.
- C. Urethane backing shall be a proprietary compound from APT, applied with state-of-the-art equipment and properly oven cured to achieve the best tuft bind strength in the industry.
- D. Turf manufacture shall be vertically integrated, supplying all fibers, tufting, and backing at one location in the USA, having the capacity of producing 75,000,000 square feet annually.
- E. Manufacturer shall provide current Lisport testing, documenting wear values of fibers and turf systems. Contact Gary Wilson @ 404-791-2130

### Part 2 – Products

#### A. YARN #1

Type:	APT MFPE350DM
Color:	Field Green (Other colors available)
Total Denier:	Approx. 10800
Description:	Proprietary PE formulation for good wear resistance
Thickness/Form:	Approx. 350 micron polyethylene diamond shape

Total Yarn Face Weight: 42 Oz. / SqYd

#### B. BACKING:

Primary Backing #1:	13 pic polybac
Primary Backing #2:	13 pic polybac
Primary Backing Weight:	6.0 Oz. / SqYd

Secondary Coating: 26 Oz. Urethane / SqYd  
Total Product Weight: 74.0 Oz. / SqYd (+/-2oz)

**C. TUFTING INFORMATION**

Pile Height: 2.5"  
Stitch Rate: AS REQUIRED  
Tufting Gauge: 1/2"  
Roll Widths: 15'  
Drainage Perforations: STANDARD  
Roll Length: Up to 240'

**D. INFILL**

Sand: 3 lbs. per square foot  
Particle size: passing 20 to 40 sieve  
Rubber Granules: 3.5 lbs. per square foot  
Granule size: 0.5-2 mm, 10/20 mesh

Complete Infill System  
Abrasive Index: app. 34, ASTM F 1015  
Flame Resistance: Pass ASTM D 2859-04  
Water Permeability: app. 24.5 inches/hour  
Initial Impact Attenuation: app. 140 Gmax, ASTM F 355-95

*Test data may vary due to manufacturing tolerances or consumer specifications.*



**APT**

109 Conica Lane  
P.O. Box 160  
Harmony, PA 16037 USA

Phone: 724.452.1300  
Fax: 724.452.1703

Web: [sportsbyapt.com](http://sportsbyapt.com)

## **E. LIMITED WARRANTY**

APT warrants against manufacturing and workmanship defects for a period of eight years. For comprehensive warranty information and terms, please refer to APT's turf warranty.

Rev 0 JMM 6/30/14



### **APT**

109 Conica Lane  
P.O. Box 160  
Harmony, PA 16037 USA

Phone: 724.452.1300  
Fax: 724.452.1703

Web: [sportsbyapt.com](http://sportsbyapt.com)





## TEST REPORT

DATE: 04-24-2014	TEST NUMBER: 0400442
CLIENT	Polytex USA
TEST CONDUCTED	ASTM D5034 Test Method for Breaking Strength and Elongation of Textile Fabrics (Grab Test)
	
PRODUCT NAME	Gridiron Pro St
DESCRIPTION OF PRODUCT TESTED	Turf 1404090166

### GENERAL PRINCIPLE

This test method is designed to measure the breaking load of woven and non-woven backing fabrics. It is a measure of the fabric's ability to withstand the forces applied during installation and the loads imposed by heavy traffic.

### TEST RESULTS

	WARP (LENGTH)	FILL (WIDTH)
	BREAKING LOAD lbs or newtons (circle)	BREAKING LOAD lbs or newtons circle)
SPECIMEN 1	337.0 Lbs.	332.3 Lbs.
SPECIMEN 2	341.2 Lbs.	340.2 Lbs.
SPECIMEN 3	351.2 Lbs.	345.1 Lbs.
SPECIMEN 4	330.9 Lbs.	339.8 Lbs.
SPECIMEN 5	346.2 Lbs.	329.2 Lbs.
AVERAGE	341.2 Lbs.	337.3 Lbs.

APPROVED BY:

This report is provided for the exclusive use of the client to whom it is addressed. It may be used in its entirety to gain product acceptance from duly constituted authorities. This report applies only to those samples tested and is not necessarily indicative of apparently identical or similar products. This report, or the name of Professional Testing Laboratory Inc. shall not be used under any circumstance in advertising to the general public.



## TEST REPORT

DATE: 04-24-2014

TEST NUMBER: 0400442

CLIENT

Polytex USA

TEST CONDUCTED

Surface Flammability of Carpets and Rugs (16 CFR Chapter II, Subchapter D, Part 1630 CPSC FF-170) also referenced as ASTM D2859



PRODUCT NAME

Gridiron Pro St

DESCRIPTION OF PRODUCT TESTED

Turf  
1404090166

### TEST CRITERION

The uncharred area of the test specimen must be greater than one inch in at least seven of the eight specimens tested in order to meet the acceptance criterion.

### TEST RESULTS

	SPECIMEN NUMBER							
	1	2	3	4	5	6	7	8
Uncharred Area (Inches)	3.3	3.2	3.4	3.2	3.2	3.3	3.4	3.3

*NOTE: This Sample was tested on the face side.*

*Sample was tested with infill per manufacturer's specifications.*

This sample **PASSES** the Federal Flammability Standard DOC FF 1-70

APPROVED BY:

This report is provided for the exclusive use of the client to whom it is addressed. It may be used in its entirety to gain product acceptance from duly constituted authorities. This report applies only to those samples tested and is not necessarily indicative of apparently identical or similar products. This report, or the name of Professional Testing Laboratory Inc. shall not be used under any circumstance in advertising to the general public.



TEST REPORT

DATE: 04-24-2014

TEST NUMBER: 0400442

CLIENT Polytex USA

TEST CONDUCTED ASTM D1335 Standard Test Method for Tuft Bind of Pile Yarn Floor Coverings



PRODUCT NAME Gridiron Pro St
DESCRIPTION OF PRODUCT TESTED Turf 1404090166

GENERAL PRINCIPLE

This test method is designed to measure the force required to pull a tuft completely out of a pile floor covering. It is applicable to both cut and looped pile construction.

TEST RESULTS

Table with 5 columns and 3 rows of test results: 10.3, 10.0, 10.2, 10.3, 10.7; 10.1, 10.5, 10.9, 10.6, 10.3; 10.4, 10.6, 10.7, 10.8, 10.8

AVERAGE TUFT BIND 10.5 Lbs.

APPROVED BY: [Signature]



This facility is accredited by the National Voluntary Laboratory Accreditation Program for the specific scope of accreditation under Lab Code 100297. This accreditation does not constitute an endorsement, certification, or approval by NIST or any agency of the United States Government for the product tested. This report is provided for the exclusive use of the client to whom it is addressed. It may be used in its entirety to gain product acceptance from duly constituted authorities. This report applies only to those samples tested and is not necessarily indicative of apparently identical or similar products. This report, or the name of Professional Testing Laboratory Inc. shall not be used under any circumstance in advertising to the general public.





### TEST REPORT

DATE: 04-24-2014

TEST NUMBER: 0400442

CLIENT: Polytex USA

TEST CONDUCTED: ASTM F1015 Relative Abrasiveness



PRODUCT NAME: Gridiron Pro St

DESCRIPTION OF PRODUCT TESTED: Turf  
1404090166

#### GENERAL PRINCIPLE

Friable foam blocks are attached to a weighted platform which is pulled over the playing surface in a prescribed manner. Five sets are conducted and averaged. The weight of foam abraded away determines the abrasive index of the surface.

#### SIGNIFICANCE AND USE

Data obtained from the procedure of this test method are indicative of the relative abrasiveness of synthetic playing surfaces.

#### TEST RESULTS

INFILL SYSTEM	Per Manufacturer's Specification
ABRASIVE INDEX	35.3 ± 2

APPROVED BY: *Larry Colburn*

This report is provided for the exclusive use of the client to whom it is addressed. It may be used in its entirety to gain product acceptance from duly constituted authorities. This report applies only to those samples tested and is not necessarily indicative of apparently identical or similar products. This report, or the name of Professional Testing Laboratory Inc. shall not be used under any circumstance in advertising to the general public.



## TEST REPORT

DATE: 04-24-2014

TEST NUMBER: 0400442

CLIENT

Polytex USA

TEST CONDUCTED

ASTM D5848 Mass Per Unit Area of Pile Yarn Floor Coverings



PRODUCT NAME

Gridiron Pro St

DESCRIPTION OF PRODUCT TESTED

Turf  
1404090166

### GENERAL PRINCIPLE

Representative test specimens are taken from the sample submitted and conditioned to equilibrium at  $70^{\circ} \pm 2^{\circ}$  F and  $65\% \pm 2\%$  relative humidity. The pile yarn mass is determined by separating and removing the pile yarn from the backing fabric and the back coating with the assistance of the appropriate solvents.

### TEST RESULTS

AVERAGE PILE YARN WEIGHT	ASTM D5848	39.5 Ounces/Square Yard
AVERAGE TOTAL WEIGHT	ASTM D5848	76.8 Ounces/Square Yard
PRIMARY BACKING WEIGHT	ASTM D5848	7.6 Ounces/Square Yard
SECONDARY BACKING WEIGHT	ASTM D5848	29.7 Ounces/Square Yard

APPROVED BY:

This report is provided for the exclusive use of the client to whom it is addressed. It may be used in its entirety to gain product acceptance from duly constituted authorities. This report applies only to those samples tested and is not necessarily indicative of apparently identical or similar products. This report, or the name of Professional Testing Laboratory Inc. shall not be used under any circumstance in advertising to the general public.



## TEST REPORT

DATE: 04-24-2014

TEST NUMBER: 0400442

CLIENT: Polytex USA

TEST CONDUCTED: ASTM F355 Test Method for Shock-Absorbing Properties of Playing Surface Systems and Materials



PRODUCT NAME: Gridiron Pro St  
DESCRIPTION OF PRODUCT TESTED: Turf  
1404090166

### GENERAL PRINCIPLE

A test specimen is impacted at a specified velocity with a missile of given mass and geometry. A transducer mounted in the missile monitors the acceleration-time history of the impact, which is recorded with the aid of an oscilloscope or other recording device. The 20 lb. missile with a 20 in<sup>2</sup> surface area was dropped at the appropriate height to ensure the appropriate missile speed as specified by the ASTM method. All samples were loose laid on a 4 inch thick concrete slab. The GMAX values, Severity Index, and Head Impact Criteria (HIC) are all recorded for three drops.

### TEST RESULTS

	DROP 2	DROP 3	AVERAGE OF DROP 2 & 3
G-MAX	120	122	121
HIC	400	406	403

### COMMENTS

The reference point used for GMAX is 200. This value is referenced and used to indicate the likelihood of a serious injury occurrence such as a skull fracture. The lower the value of GMAX the less the likelihood of a serious injury.

APPROVED BY:

This report is provided for the exclusive use of the client to whom it is addressed. It may be used in its entirety to gain product acceptance from duly constituted authorities. This report applies only to those samples tested and is not necessarily indicative of apparently identical or similar products. This report, or the name of Professional Testing Laboratory Inc. shall not be used under any circumstance in advertising to the general public.



**TOUGHNESS.  
RESILIENCY. LONGEVITY.  
A FORMAL WAY OF SAYING**

**BRING IT.**

IT'S NOT JUST A FIELD. IT'S YOUR HOME TURF.

**Turf Warranty  
Documentation**







## **8-Year Limited Warranty**

(READ THIS WARRANTY – it contains highly important information, including responsibilities of the Warranty Holder to maintain its validity.)

Your high-performance, engineered sports surface comes with an 8-year limited warranty (“Limited Warranty”), in which your APT sports surface provider (“Warrantor”) guarantees that under normal conditions your sports surface will be serviceable as a sports field/court for the particular sports activity specified at the time of purchase. The 8-year warranty period begins to run when installation of your surface is complete, or the date of first use (“Warranty Period”).

All rights to recovery and remedy under this Limited Warranty shall be limited to the repair or replacement of the sports surface with the costs not to exceed the original purchase price paid by the Warranty Holder (that’s you). The cost of repair or replacement shall include labor costs and any related product costs. No cash payment for repairs or replacement will be given under any circumstances.

### **“So what must I do in order to maintain MY right to recover under this Limited Warranty?”**

As the Warranty Holder you must do the following in order to keep your Limited Warranty Valid:

1. **Keep all documents related to the sale and warranty in a safe place** – In the event that you have to use your Limited Warranty, you will need to have the bill of sale (or other documentation that can show the price paid for the sports surface) and Certificate of Warranty. Keep these documents in a secure place.
2. **Pay for the sports surface in full** - This Limited Warranty is only valid, and entirely conditional, on the Warrantor receiving payment in full for all products and services which have been supplied and rendered and to which this Limited Warranty applies.
3. **Have an “APT-approved” Installer Install Your Sports Surface** - ALL SPORTS SURFACES MUST BE INSTALLED BY AN APT-APPROVED INSTALLER. The reason for this is that improper installation can lead to a lack of durability of the sports surface, as well as, decreased safety of the surface. APT-approved installers will have the specific knowledge on how to properly install your sports surface. Failure to have your APT sports surface installed by an APT-approved installer may result in your Limited Warranty being voided.
4. **Regularly Maintain Your Surface** - In order for the Limited Warranty to remain valid, regular maintenance (as laid out in the Maintenance Manual) must be performed on your sports surface. Regular maintenance will not only prolong the useful life of your sports surface, but will also help
5. **Keep a Maintenance Log** - A Maintenance Log (provided with the Maintenance Manual) must be maintained for the entire duration of the use of the sports surface for the Limited Warranty to remain valid. Because your Warrantor cannot be present to ensure that maintenance is being properly and regularly performed, if a complete Maintenance Log is not kept, the Warrantor is not responsible for any damage to the sports surface that could be attributable to the improper maintenance of the sports surface.
6. **Keep Your Filler at Proper Levels** (where applicable) - The SBR Rubber Granules in your sports surface (“Filler”) are very important to your surface. The Filler provides the field with its absorption qualities while also maintaining the look of the surface by holding the sports fibers in place. Too much or too little Filler can result in a variety of defects in the sports surface and can negatively impact the safety and longevity of your sports surface. Therefore, it is important that you maintain proper Filler levels as laid out in your Maintenance Manual. If proper levels are not maintained, then the Warrantor is not responsible for any damage to the sports surface, or any reduced safety, that could be attributable to the improper Filler levels.
7. **Use Only APT-Approved Paint When Marking Your Sports Surface** - Depending on the use, you may wish to add temporary or permanent markings to your sports surface. Using unauthorized paint or substances to mark the sports surface can result in permanent damage. Therefore, in order for this Limited Warranty to remain valid, for all temporary or permanent markings, you must use paint that is specifically approved by APT for APT sports surfaces. Use of any non-approved paint, or other non-approved marking substance, may result in this entire Limited Warranty to be voided.
8. **Use Only APT-Approved Service to Fix Your Sports Surface** – In the event you must repair your sports surface (and the repairs are not covered under this Limited Warranty) you must use an APT-approved service to fix your sports surface. Much like improper installation, improper repairs can lead to a lack of durability of the sports surface, as well as, decreased safety of the surface. Therefore, it is important to use a service that knows how to properly repair an ATP sports surface and failure to do so can lead to your Limited Warranty to be voided.
9. **Always Report Issues in a Timely Manner** – You have 30 days from the time you notice an issue, or should have noticed an issue, in order to report any issues to your Warrantor. The reason for this is that defects or problems that go unrepaired for extended periods of time can become much bigger problems. It is your responsibility to notify your Warrantor as soon as possible to keep mole hills from becoming mountains.



## **“So what is NOT covered under this Warranty?”**

The following things are specifically NOT covered under this Limited Warranty:

1. **Second-Hand or Irregular Products** – Your Warrantor can only ensure the quality of new, APT-approved sports surfaces. Therefore, this Limited Warranty only applies to sports surfaces sold as original, top-quality APT sports surfaces and is not applicable to any sports surfaces sold as used, irregular, or under any other designation other than “original, top quality.”
2. **Acts of God, Nature, People** – The Warrantor can only guarantee the quality of the products sold to you, and is not responsible for damage done to your sports surface by outside forces. Thus, this Limited Warranty does not cover damage done by outside forces, including, but not limited to: accident, vandalism, improper maintenance or lack of maintenance, animals, Act of God, flooding, burning, non-specified sports activity, excessive use or any non-specified activity by the Warranty Holder that was not disclosed at the time of sale.
3. **Failure in Your base work** - All sports surfaces require a proper base work on which to sit. The Warrantor has not provided the foundation, base or subsurface to this sports surface and this Limited Warranty does NOT in any way cover any claims of imperfections, dents, holes, or any other flaw in the sports surface caused by, or attributable to, a failure in the foundation, base or subsurface. This does not mean that you have no recourse if your foundation fails - you should check your warranty from your foundation provider.
4. **Pad Failure** (where applicable) - Some sports surfaces are installed with a shock-absorbing pad beneath the sports surface. The Warrantor is not the manufacturer or distributor of this padding and NOT responsible for any damage or change in appearance to the sports surface that is the result of any deterioration of the pad or defects in the pad. However, much like a failure in foundation, this does not mean that you have no recourse if your padding fails - you should check your warranty from your pad provider.
5. **Installation on an Uneven Surface** - APT sports surfaces are not meant to be installed on inclines. Therefore, if you requested your sports surface be installed on one, this Limited Warranty does not cover any damage or appearance changes in the sports surface that are directly attributable to its installation on an incline. Any potential issues regarding incline and potential hazards shall be disclosed by the Warrantor at the time of the sale.
6. **Changes in the Surface Due to Markings** – While you are required to use APT-approved paint on your sports surface, applying any paint, even APT-approved paint, may change the texture, safety and performance of the areas of the surface where the paint is applied. The Warrantor is not responsible for the performance of any painting or marking substance put onto the sports surface, nor responsible for any consequences that result from the paint or mark-

7. **Difference from Sales Samples** – If sales samples are used when you purchase your APT sports surface, any minor and ordinary differences, including color and texture, between the sports surface samples used at the time of sale and the actual installed surface are not covered by the Limited Warranty.

## **“I see an issue with my sports surface, but I’m not sure if it is covered by my warranty...”**

The following things are common issues with all artificial sports surfaces and are NOT covered by your Limited Warranty:

1. **Exfoliation of Fibers** – In the first year of use you may notice what appears to be a lot of exfoliation of sports fibers on your sports surface. This is completely normal. It will not affect the usefulness, durability or overall look of the sports surface. Regular maintenance should remove any exfoliated fibers
2. **Some Changes in Turf Color** - This Limited Warranty does not cover changes in the turf color that are due to improper maintenance, chemical spills, the application of any non-approved substance or residue from any objects placed on the sports surface. Further, a slight color variation from sunlight and weather should be expected.
3. **Visible Seams** - Seams are present in all APT sports surfaces. Some surfaces show the seams more than others.
4. **Indentations in the Surface** - Indentations will generally occur from heavy objects being placed on the surfaces, as well as from unauthorized vehicles being driven on the surface (or authorized vehicles with improper tires). Most indentations can be fixed by proper maintenance (as laid out in the Maintenance Manual).
5. **Matting of the Fibers** - Matting occurs when the sports fibers become entangled with each other and is generally caused by improper maintenance or low levels of “Filler” (where applicable). Further, matting can be caused by the application and removal of paint and markings on the sports surface, or by any other non-approved substance that is applied or comes into contact with the sports surface.
6. **Shifting of an Area of Fibers** - Shifting is a change in fiber direction in a certain area of the sports surface that appears as a color change. This is not in fact a color change and is not a manufacturing defect. The apparent change in color comes from the light catching the fibers at a different angle. Some shifting may be permanent and has no known cause. If shifting does occur it will not have any effect on the usefulness or durability of the sports surface.
7. **Areas of High Traffic** – As with all sports surfaces, synthetic or real, areas of high foot traffic and use are where the most changes will be visible. Regular maintenance will help prolong the look and usefulness of your sports surface, but cannot prevent areas of high use from changing appearance.





### **“So what do the lawyers have to say about this Limited Warranty?”**

1. This Limited Warranty is only valid in the United States and Canada.
2. This Limited Warranty, and all warranties herein, extend only to the original Warranty Holder and is not transferable to any successors not listed in the enclosed “Certificate of Warranty.”
3. Except as provided in this Limited Warranty, and to the extent permitted by law, the Warrantor is not responsible for any consequential, incidental, special or indirect damages that result from any breach of warranty or condition. This includes damages for loss of use, loss of revenue, loss of anticipated savings, loss of business, loss of goodwill, loss of reputation, loss of anticipated profits and any travel, transportation and accommodation costs.
4. To the extent permitted by law, this Limited Warranty is the exclusive warranty available to the Warranty Holder and in lieu of all other implied or statutory warranties, including without limitation, the warranties of: merchantability, fitness for a particular purpose, and warranties against hidden or latent defects. If the Warrantor cannot lawfully disclaim any of these warranties, then to the extent permitted by law, all such warranties shall be limited in duration to the Warranty Period of the Limited Warranty and to repair or replacement of your sports surface.
5. All APT sports surfaces are sport-specific and are not recommended for any other sport, activity or purpose than those specified at the time of sale. Any non-sport-specific activity performed on the sports surface may result in the voiding of the Limited Warranty.
6. This Limited Warranty is complete and contains all rights to repair and replace your sports surface. No third party is authorized to make any modification, extension or addition to this Limited Warranty on behalf of the Warrantor, and there are no warranties that extend beyond the face of this Limited Warranty.
7. All rights to recovery and remedy under this Limited Warranty shall be limited to the repair or replacement of the sports surface with the costs not to exceed the original purchase price paid by the Warranty Holder

### **“I have a problem, how do I report it under this Limited Warranty?”**

1. Immediately notify the Warrantor in writing, via email (Email address of warrantor: [info@advpolytech.com](mailto:info@advpolytech.com)) upon noticing a problem or defect in your sports surface. (Immediately in this paragraph shall mean within 30 days upon discovering the problem or defect, or within 30 days of when the problem or defect should have been discovered. Late notice may void this Limited Warranty.)
2. Provide detailed information of the problem in the email and include photographic evidence of the problem or defect as an attachment.

Upon making a valid claim the Warrantor will make a determination if the problem or defect can be repaired and perform said repairs. And remember, if the Warrantor determines that the affected areas cannot be repaired, the Warrantor will arrange for the replacement of said areas, SUBJECT TO THE COST OF SAID REPLACEMENT NOT EXCEEDING THE ORIGINAL PURCHASE PRICE PAID BY THE WARRANTY HOLDER FOR THE SPORTS SURFACE.



#### **APT**

109 Conica Lane  
P.O. Box 160  
Harmony, PA 16037 USA

Phone: 724.452.1330  
Fax: 724.452.1703

Web: [sportsbyapt.com](http://sportsbyapt.com)

## Warranty of Authority

Each of the signatories individually represents and warrants that he or she has the requisite power and authority to execute this Limited Warranty Certificate on behalf of the party for which he or she has signed, and that the party has the full power and authority to fully perform its obligations under this Limited Warranty Certificate.

<b>Policy Number</b>	
<b>Effective Date of Warranty</b>	<b>Expiration Date of Warranty</b>
<b>Warrantor</b>	<b>Warranty Holder</b>
<b>LOCATION of Installed Field</b>	<b>Installed Product</b>

APT sports

By: \_\_\_\_\_  
Signature of Authorized Officer/Manager

Its: \_\_\_\_\_  
Print Name of Authorized Officer/Manager

Date: \_\_\_\_\_

Name:

By: \_\_\_\_\_  
Signature of Authorized Officer/Manager

Its: \_\_\_\_\_  
Print Name of Authorized Officer/Manager

Date: \_\_\_\_\_







## SCOTT DANAHY NAYLON COMPANY, INC.

Date: 02/18/2014

Advanced Polymer Technology Corporation. "Insured" have secured a warranty insurance policy through our firm, Scott Danahy Naylon Company Inc. Outlined below are the key terms and conditions of the warranty policy(s).

**1. *Insuring Agreement:***

In consideration of the payment of the "Policy Premium" and subject to all of the terms and conditions of the policy, the "Company" will reimburse the insured for those costs paid or incurred by the insured that it was obligated to pay or incur to fulfill its "contractual Obligations" under an "Insured Warranty".

**2. *Insured Warranty:***

"Insured Warranty" means any standard warranty issued by the Insured and listed in Schedule A – Insured Warranty does not include that part of any warranty that extends beyond eight years after warranted installation is completed.

The Term of the warranty is to commence upon acceptance of the project by the Insured's client or at the time the turf field is used for its intended purpose whichever first occurs.

**3. *Claim Reporting Period:***

"Claim Reporting Period" means the period of time in which a claim for the costs that were paid or incurred must be made. The "Claims Reporting Period" is a period of eight (8) years from the date of each "Insured Warranty" listed in Schedule A.

**4. *Limit of Liability:***

\$10,000,000 each Insured warranty. \$15,000,000 aggregate for all fields installed during the 12 month period of 02/18/2014 – 02/18/2015.

**5. *Deductible:***

No deductible shall ever apply to the Warranty Holder.





## SCOTT DANAHY NAYLON COMPANY, INC.

6. *Policy Territory:*  
The policy contains no policy territory restrictions.
7. *Reporting:*  
The Insured shall report the enrollment of all designated contracts. Enrollment shall be sent to Colony within 60 days from the last day of each calendar quarter.
8. *Premium:*  
Premiums for all warranties accepted via the Schedule A are considered prepaid throughout the eight year claim reporting period.
9. *Bankruptcy or Insolvency:*  
Bankruptcy or Insolvency of the Insured or of the Insured's estate shall not relieve "The Company" of any of its obligations under this policy. Subject to all other terms and conditions of this policy, in the event bankruptcy or insolvency has caused the "Insured" to fail to fulfill its "Contractual Obligations" under its "Insured Warranties", the "Company" will reimburse the "Warranty Holder" for the expenses paid directly by the "Warranty Holder" to repair or replace a field, as required by "Insured Warranty" and as first approved by the "Company".
10. *Security:*  
Underwriter – Colony National Insurance Company is rated by AM Best "A" or Excellent – [www.Colonyins.com](http://www.Colonyins.com) a member of the Argonaut Insurance Group. Underwriter-Great American E&S Insurance Company is rated AM Best "A" or Excellent.

Notwithstanding any of the statements provided in this outline, all terms and conditions of Colony National Insurance Company policy #103GL000246400 and Great American E&S Insurance Company policy #XS1944556 the final measure of coverage to the Insured and the Insured's clients.





# CERTIFICATE OF LIABILITY INSURANCE

DATE (MM/DD/YYYY)

2/19/2014

**THIS CERTIFICATE IS ISSUED AS A MATTER OF INFORMATION ONLY AND CONFERS NO RIGHTS UPON THE CERTIFICATE HOLDER. THIS CERTIFICATE DOES NOT AFFIRMATIVELY OR NEGATIVELY AMEND, EXTEND OR ALTER THE COVERAGE AFFORDED BY THE POLICIES BELOW. THIS CERTIFICATE OF INSURANCE DOES NOT CONSTITUTE A CONTRACT BETWEEN THE ISSUING INSURER(S), AUTHORIZED REPRESENTATIVE OR PRODUCER, AND THE CERTIFICATE HOLDER.**

**IMPORTANT: If the certificate holder is an ADDITIONAL INSURED, the policy(ies) must be endorsed. If SUBROGATION IS WAIVED, subject to the terms and conditions of the policy, certain policies may require an endorsement. A statement on this certificate does not confer rights to the certificate holder in lieu of such endorsement(s).**

<b>PRODUCER</b> <b>Scott Danahy Naylor Co. Inc.</b> <b>300 Spindrift Drive</b> <b>Williamsville, NY 14221</b> <b>716 633-3400</b>	<b>CONTACT NAME:</b> <b>PHONE (A/C, No, Ext): 716 633-3400</b> <b>FAX (A/C, No): 716 633-4306</b> <b>E-MAIL ADDRESS:</b> <table border="1" style="width:100%"> <tr> <th colspan="2">INSURER(S) AFFORDING COVERAGE</th> <th>NAIC #</th> </tr> <tr> <td colspan="2">INSURER A : <b>Colony Insurance Company</b></td> <td></td> </tr> <tr> <td colspan="2">INSURER B : <b>Great American E&amp;S Ins Co</b></td> <td></td> </tr> <tr> <td colspan="2">INSURER C :</td> <td></td> </tr> <tr> <td colspan="2">INSURER D :</td> <td></td> </tr> <tr> <td colspan="2">INSURER E :</td> <td></td> </tr> <tr> <td colspan="2">INSURER F :</td> <td></td> </tr> </table>	INSURER(S) AFFORDING COVERAGE		NAIC #	INSURER A : <b>Colony Insurance Company</b>			INSURER B : <b>Great American E&amp;S Ins Co</b>			INSURER C :			INSURER D :			INSURER E :			INSURER F :		
INSURER(S) AFFORDING COVERAGE		NAIC #																				
INSURER A : <b>Colony Insurance Company</b>																						
INSURER B : <b>Great American E&amp;S Ins Co</b>																						
INSURER C :																						
INSURER D :																						
INSURER E :																						
INSURER F :																						
<b>INSURED</b> <b>Advanced Polymer Technology Corporation</b> <b>109 Conica Lane</b> <b>PO Box 160</b> <b>Harmony, PA 603716037</b>																						

<b>COVERAGES</b>	<b>CERTIFICATE NUMBER:</b>	<b>REVISION NUMBER:</b>
------------------	----------------------------	-------------------------

THIS IS TO CERTIFY THAT THE POLICIES OF INSURANCE LISTED BELOW HAVE BEEN ISSUED TO THE INSURED NAMED ABOVE FOR THE POLICY PERIOD INDICATED. NOTWITHSTANDING ANY REQUIREMENT, TERM OR CONDITION OF ANY CONTRACT OR OTHER DOCUMENT WITH RESPECT TO WHICH THIS CERTIFICATE MAY BE ISSUED OR MAY PERTAIN, THE INSURANCE AFFORDED BY THE POLICIES DESCRIBED HEREIN IS SUBJECT TO ALL THE TERMS, EXCLUSIONS AND CONDITIONS OF SUCH POLICIES. LIMITS SHOWN MAY HAVE BEEN REDUCED BY PAID CLAIMS.

INSR LTR	TYPE OF INSURANCE	ADDL INSR	SUBR WVD	POLICY NUMBER	POLICY EFF (MM/DD/YYYY)	POLICY EXP (MM/DD/YYYY)	LIMITS								
	<b>GENERAL LIABILITY</b> <input type="checkbox"/> COMMERCIAL GENERAL LIABILITY <input type="checkbox"/> CLAIMS-MADE <input type="checkbox"/> OCCUR  GEN'L AGGREGATE LIMIT APPLIES PER: <input type="checkbox"/> POLICY <input type="checkbox"/> PRO-JECT <input type="checkbox"/> LOC						EACH OCCURRENCE \$ DAMAGE TO RENTED PREMISES (Ea occurrence) \$ MED EXP (Any one person) \$ PERSONAL & ADV INJURY \$ GENERAL AGGREGATE \$ PRODUCTS - COMP/OP AGG \$ \$								
	<b>AUTOMOBILE LIABILITY</b> <input type="checkbox"/> ANY AUTO <input type="checkbox"/> ALL OWNED AUTOS <input type="checkbox"/> HIRED AUTOS  <input type="checkbox"/> SCHEDULED AUTOS <input type="checkbox"/> NON-OWNED AUTOS						COMBINED SINGLE LIMIT (Ea accident) \$ BODILY INJURY (Per person) \$ BODILY INJURY (Per accident) \$ PROPERTY DAMAGE (Per accident) \$ \$								
<b>B</b>	<input type="checkbox"/> UMBRELLA LIAB <input type="checkbox"/> OCCUR <input checked="" type="checkbox"/> EXCESS LIAB <input checked="" type="checkbox"/> CLAIMS-MADE DED      RETENTION \$			<b>XS1944556</b>	<b>02/18/2014</b>	<b>02/18/2015</b>	EACH OCCURRENCE <b>\$\$\$5,000,000</b> AGGREGATE <b>\$\$\$5,000,000</b> \$								
	<b>WORKERS COMPENSATION AND EMPLOYERS' LIABILITY</b> ANY PROPRIETOR/PARTNER/EXECUTIVE OFFICER/MEMBER EXCLUDED? <input type="checkbox"/> <b>Y/N</b> <b>(Mandatory In NH)</b> If yes, describe under DESCRIPTION OF OPERATIONS below			<b>N/A</b>			<table border="1" style="width:100%"> <tr> <td>WC STATU-TORY LIMITS</td> <td>OTH-ER</td> </tr> <tr> <td>E.L. EACH ACCIDENT</td> <td>\$</td> </tr> <tr> <td>E.L. DISEASE - EA EMPLOYEE</td> <td>\$</td> </tr> <tr> <td>E.L. DISEASE - POLICY LIMIT</td> <td>\$</td> </tr> </table>	WC STATU-TORY LIMITS	OTH-ER	E.L. EACH ACCIDENT	\$	E.L. DISEASE - EA EMPLOYEE	\$	E.L. DISEASE - POLICY LIMIT	\$
WC STATU-TORY LIMITS	OTH-ER														
E.L. EACH ACCIDENT	\$														
E.L. DISEASE - EA EMPLOYEE	\$														
E.L. DISEASE - POLICY LIMIT	\$														
<b>A</b>	<b>Warranty Coverage</b>			<b>103GL000246400</b>	<b>02/18/2014</b>	<b>02/18/2015</b>	<b>\$5,000,000 InsdWarranty</b> <b>\$10,000,000 Aggregate</b>								

DESCRIPTION OF OPERATIONS / LOCATIONS / VEHICLES (Attach ACORD 101, Additional Remarks Schedule, if more space is required)  
**\*Policy provides coverage for warranties issued during the policy period for eight years from completion date of the project.**

<b>CERTIFICATE HOLDER</b>  <b>SAMPLE CERTIFICATE</b>	<b>CANCELLATION</b>  SHOULD ANY OF THE ABOVE DESCRIBED POLICIES BE CANCELLED BEFORE THE EXPIRATION DATE THEREOF, NOTICE WILL BE DELIVERED IN ACCORDANCE WITH THE POLICY PROVISIONS.  AUTHORIZED REPRESENTATIVE <i>William Scott</i>
--	--



P.O. Box 1168, Slatersville, RI 02876  
Ph: 401-766-5010 | Fax: 401-762-4976 | www.hollistonsand.com

**SAMPLE PRODUCT DATA SHEET**

**PRODUCT NAME**

Screen Type	0S/00S Blend	
US Mesh	Percentage Retained	Percentage Passing
4.0	0.0	100.0
6.0	0.0	100.0
8.0	0.0	100.0
12.0	0.0	100.0
16.0	2.5	97.5
18.0	13.3	84.2
20.0	17.0	67.2
25.0	25.0	42.2
30.0	29.3	12.9
35.0	9.7	3.2
40.0	2.3	0.9
45.0	0.6	0.3
50.0	0.3	0.0
70.0	0.0	0.0
<b>Total</b>	<b>100.0</b>	

**DISCLAIMER:** The information set forth in this Sample Product Data Sheet represents typical properties of the sample product described; the information and the typical values are not specifications. Holliston Sand Company, Inc. makes no representation or warranty concerning the Products, expressed or implied, by this Product Data Sheet

**WARNING:** The product contains crystalline silica, which can cause silicosis (an occupational lung disease) and lung cancer. For detailed information on the potential health effect of crystalline silica, see the Holliston Sand Company, Inc. Material Safety Data Sheet (MSDS).



P.O. Box 1168, Slatersville, RI 02876  
 Ph: 401-766-5010 | Fax: 401-767-4976 | www.hollistonsand.com

*Holliston Sand Company, Inc.*

**SAMPLE PRODUCT DATA SHEET - PAGE 1**

**PRODUCT NAME**

MM	US Sieve Number	000s		00n		00s		0s		1s		2s		3s	
		Retained %	Passing	Retained %	Passing	Retained %	Passing	Retained %	Passing	Retained %	Passing	Retained %	Passing	Retained %	Passing
4.750	4														
4.000	5														100.00
3.350	6													2.10	97.90
2.800	7													8.00	89.90
2.360	8													23.20	66.70
2.000	10													100.00	0.90
1.700	12													99.10	23.20
1.400	14													32.30	34.40
1.180	16													19.90	14.50
1.000	18													12.30	2.20
0.850	20														
0.710	25														
0.600	30														
0.500	35														
0.425	40														
0.355	45														
0.300	50														
0.250	60														
0.212	70														
0.180	80														
0.150	100														
0.106	140														
Effective Size:		0.23		~ 0.40		~ 0.50		~ 0.60		~ 0.95		~ 1.20		~ 1.6	
Uniformity Coefficient:		~ 2.0		~ 1.50		~ 1.50		~ 1.50		~ 1.50		~ 1.50		~ 1.50	

**DISCLAIMER:** The information set forth in this Sample Product Data Sheet represents typical properties of the sample product described; the information and the typical values are not specifications. Holliston Sand Company, Inc. makes no representation or warranty concerning the Products, expressed or implied, by this Product Data Sheet

**WARNING:** The product contains crystalline silica, which can cause silicosis (an occupational lung disease) and lung cancer. For detailed information on the potential health effect of crystalline silica, see the Holliston Sand Company, Inc. Material Safety Data Sheet (MSDS).



# Technical Product Data Sheet



**Material:** Genan Rubber Granulate  
**Product Names:** Fine, Fine/Mix, Medium, Coarse  
  
**Producer:** Genan USA Inc.  
 18038 Beaumont Highway  
 Houston, TX 77049  
  
**Classification:** ASTM D 5603 - 01 / Grade 1 and 5  
**Source material:** Passenger / Truck tires  
**Revised:** June 2013

Properties		Test methods	Typical values, Genan granulate
Shape		EN 14955	Spherical, moderate angular
Specific gravity		./.	1.10 – 1.20 g/cm <sup>3</sup>
<b>FINE</b>	Bulk density	EN 1097-3	26.2 lb/ft <sup>3</sup> (+/-6%)
	Particle size range	EN 53477	0.7 – 2.0 mm @ D90
<b>FINE/MIX</b>	Bulk density	EN 1097-3	27.2 lb/ft <sup>3</sup> (+/-7%)
	Particle size range	EN 53477	0.7 – 3.0 mm @ D90
<b>MEDIUM</b>	Bulk density	EN 1097-3	27.2 lb/ft <sup>3</sup> (+/-8%)
	Particle size range	EN 53477	1.4 – 3.0 mm @ D90
<b>COARSE</b>	Bulk density	EN 1097-3	30.0 lb/ft <sup>3</sup> (+/-8%)
	Particle size range	EN 53477	2.0 – 4.0 mm @ D90
Particle sizes < 0.5mm		EN 53477	< 1% [w/w]
Ash content		ISO 9924	< 10%
Acetone extractable		ASTM D 297	< 16%
Moisture content (Loss 2h@105°C)		ASTM D 1509	≤ 1%
Free metal content		ASTM D 5603	≤ 0.01%
Free fibre content		ASTM D 5603	≤ 0.01%
Free mineral content		ASTM D 5603	≤ 0.01%

**SAMPLING:**

Sampling for performance control of deliveries: Samples are to be taken directly after delivery from the bags by using a minimum 200 gram sample. 3 samples of 200 grams each are to be taken from the top, middle and bottom of the bags. Samples are filled into a 1000 gram container and mixed 10 minutes by "bottom up and down" shaking.

**HEALTH & SAFETY:**

Not a dangerous substance when handled in accordance with good industrial hygiene and safety practices. See Material Safety Data Sheet.

These product specifications have been prepared to the best of our knowledge, and we shall not be liable for any insufficiency or inaccuracy in this information. Test results may vary depending on test protocol.

Product FINE

Company:	Genan
User:	
Result file:	K:\CAMDAT\Mesh_Granulat_fein\Fine_2012-04-20_16-23-59_2816.rdf
Task file:	C:\Program Files\CAMSIZER\CAMSYS\Mesh_fein.afg
Time:	20.04.2012 , 16:23 , duration 3 min 47 s at 1.0 % covered area, image rate 1:1 and 60 mm feeder
Particle model:	xc_min
No. of particles:	CCD-B = 104620 , CCD-Z = 6823
Fitting:	C:\Program Files\CAMSIZER\CAMSYS\Fein.ftc
Material:	FIN (F), FINE (F), FEIN (F)

ASTM(+)	No(-)	p3 [%]	Q3 [%]
PAN	#45	0.00	0.00
#45	#30	0.24	0.24
#30	#25	0.90	1.14
#25	#20	2.94	4.08
#20	#18	5.45	9.53
#18	#16	8.99	18.52
#16	#14	15.03	33.55
#14	#12	28.80	62.35
#12	#10	32.18	94.53
#10	#8	5.36	99.89
> #8		0.11	100.00

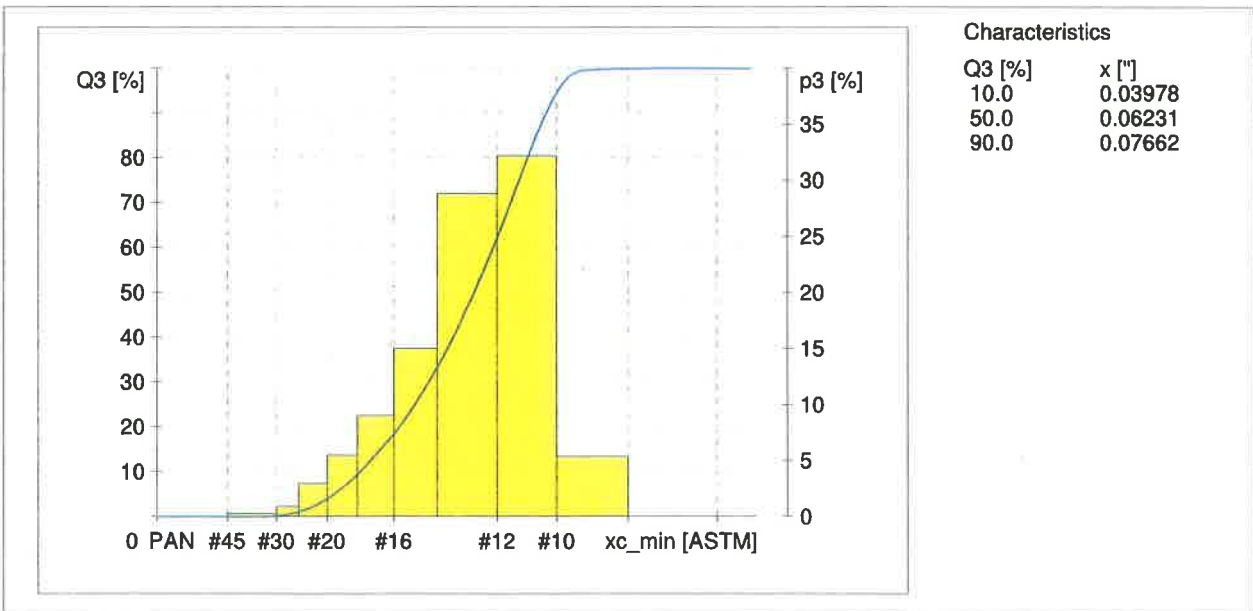

User



## TURF INFILL RUBBER

**Supplier** Liberty Tire Recycling, LLC  
1251 Waterfront Place, 4th Floor  
Pittsburgh, PA 15222-4261

Telephone: 412-562-1700  
Fax: 412-697-2411

### SIEVE SPECIFICATIONS (US Standard Screens)

<b>Mesh Size</b>	<b>Avg Weight Retained (g)</b>	<b>Range Specification</b>
8	0	0
10	3.2	0-15%
12	27.1	10-30%
14	33.6	20-40%
16	15.1	10-30%
20	17.4	15-30%
30	4.0	0-5%
Pan	3.8	0-5%

Product Test Sample Weight: 100g total sample weight + 5 grams talc for aid  
Length of test: 10 min in compliance with ASTM test standards

### PRODUCT DETAILS

**TYPE:** Ambiently-processed Styrene Butadiene Rubber (SBR)  
**ORIGIN:** Recycled passenger and/or truck tires collected only within North America  
**APPEARANCE:** Solid – small, irregularly shaped granules of rubber based material containing small portions of synthetic fibers  
**COLOR:** Black

**PACKAGING** Bulk bagged in one ton supersacks (2000 lbs min) on wooden pallets

**CERTIFICATION** 2014 GREENGUARD Synthetic Turf Certification Program

UL Environment's Synthetic Turf Certification Program identifies individual synthetic turf components and systems that have been tested to meet stringent, third-party requirements for lead content, heavy metal migration, and chemical emissions. Both certifications are based on the Consumer Product Safety Improvement Act (CPSIA), European toy safety standard criteria for heavy metals, and the California Office of Environmental Health Hazard Assessment (OEHHA)'s Chronic Reference Exposure Levels (CRELs) for volatile organic compounds. Individual components or entire systems may achieve certification. However, systems must use certified components to build a certified system. Both components and systems will undergo annual testing to remain certified. [www.greenguard.org](http://www.greenguard.org)



# MATERIAL SAFETY DATA SHEET

Manufacturer/ Supplier: Liberty Tire Recycling, LLC  
 1251 Waterfront Place, 4<sup>th</sup> Floor  
 Pittsburgh, PA  
 15222-4261

Emergency Telephone Number:  
 (412) 562-1700

## SECTION 1 – PRODUCT AND COMPANY IDENTIFICATION

<b>Product name</b>	Recycled Tire Rubber - White		
<b>Brand</b>	Liberty Tire Recycling		
<b>Product uses</b>	Various Uses		
<b>Supplier</b>	Liberty Tire Recycling, LLC 1251 Waterfront Place, 4 <sup>th</sup> Floor Pittsburgh, PA 15222-4261	<b>Manufacturer</b>	Liberty Tire Recycling, LLC 1251 Waterfront Place, 4 <sup>th</sup> Floor Pittsburgh, PA 15222-4261
<b>Telephone</b>	412-926-1746		
<b>Fax</b>	412-697-2411		
<b>Emergency phone #</b>	412-562-1700		

## SECTION 2 – HAZARDS IDENTIFICATION

<b>Emergency Overview</b>	
<b>WHMIS Classification</b>	Not a WHMIS controlled substance
<b>OSHA Hazards</b>	No known OSHA hazards
<b>GHS label elements, including precautionary statements</b>	
Signal Word	None
Hazard statement(s)	None
Precautionary statement(s)	P281: Use personal protective equipment as required
<b>HMIS Classification</b>	
Health hazard	1
Flammability	1
Physical hazards	1
<b>Potential health effects</b>	
Inhalation	Odor/vapors may be a nuisance in some individuals. In some individuals, short term exposure of material may produce mild and temporary discomfort to the respiratory tract resulting in wheezing, tightness in the chest, shortness of breath and coughing. Although they may be present in low amounts, dust and small pieces of material may aggravate bronchitis, asthma, and emphysema if inhaled.
Skin	Although fine material, particulate matter and dust may be present in low quantities, contact with such items may result in irritation (redness/itching) or other effects with some individuals.
Eyes	Material is abrasive if it enters the eye, which can cause irritation to severe damage if left untreated.
Ingestion	Irritation of mucus membranes of mouth, throat, esophagus and stomach along with nausea may occur. Abrasion to the mouth, esophagus, stomach and intestinal tract may occur.
Repeated exposure	Repeated exposure to material may result in sensitization in susceptible individuals.

## SECTION 3 – COMPOSITION/INFORMATION ON INGREDIENTS

Material	CAS-No.	EC-No.	Index-No.	Concentration (%wt)
Natural rubber	9006-04-6	232-689-0	N/AV	15 – 40
Synthetic rubber	9003-55-8	N/AV	N/AV	15 – 40
Carbon black	1333-86-4	215-609-9	N/AV	20 – 35
Zinc oxide	1314-13-2	215-222-5	030-013-00-7	0.1 – 1
Sulfur	7704-34-9	231-722-6	016-094-00-1	0.1 – 0.5
Synthetic fibers, fillers, accelerators, anti-ozonants	N/AP	N/AP	N/AP	5 – 10

\*Note: The amount of free synthetic fibers is below 1% by weight of the material.

# MATERIAL SAFETY DATA SHEET

Manufacturer/ Supplier: Liberty Tire Recycling, LLC  
1251 Waterfront Place, 4<sup>th</sup> Floor  
Pittsburgh, PA  
15222-4261

Emergency Telephone Number:  
(412) 562-1700

## SECTION 4 – FIRST AID MEASURES

### General advice

If negative symptoms develop while handling the product, move out of the area to prevent further exposure. Consult a physician as a precautionary measure if symptoms develop after being subjected to unprotected exposure of the material. Show this safety data sheet to the doctor in attendance.

### If inhaled

In emergency situations, use proper respiratory protection and immediately remove the affected person from exposure. Keep at rest. Administer artificial respiration if breathing has stopped. Seek medical attention.

### In case of skin contact

Wash exposed skin thoroughly with soap and water. If irritation develops and is prolonged and/or sore, consult a physician.

### In case of eye contact

Flush eyes with plenty of water for at least 15 minutes. Avoid rubbing the eye. If experiencing prolonged irritation or soreness, seek medical attention.

### If swallowed

Do not induce vomiting. Rinse mouth well with water. Never give anything by mouth to an unconscious person. Seek medical attention.

## SECTION 5 – FIREFIGHTING MEASURES

### Conditions of flammability

Non-flammable under standard use conditions. Material must be heated above 392°F (200°C) and an ignition source introduced before burning will occur.

### Suitable extinguishing media

Fire extinguishing substances: dirt, sand, dry chemical, CO<sub>2</sub>, alcohol-resistant foam, or F500 encapsulating agent.

If safe to do so, smothering the fire with large quantities of dirt or sand is usually the best option for extinguishing fires.

The material will be extremely hot if in liquid form. Be sure to keep distance between personnel and the fire.

If the fire is small and localized, CO<sub>2</sub> or foam are acceptable extinguishing substances. Due to the potential of pyrolytic oil being produced during uncontrolled burning, use of water may result in highly contaminated run-off that will require containment.

For large fires, trained firefighting personnel should be placed in charge of firefighting measures.

### Special protective equipment for firefighters

Respiratory and eye protection are required for firefighting personnel.

A self-contained breathing apparatus (SCBA) meeting NFPA standards should be used for any significant indoor or outdoor fires.

For small outdoor fires, which may easily be extinguished with a portable fire extinguisher, use of a SCBA may not be required.

Contact with the smoke and fumes should be avoided. With burning or high heating, the material may melt, resulting in a sticky, molten material.

### Hazardous combustion products

Thick, black, acrid smoke. Oxides of carbon, nitrogen and sulfur.

Uncontrolled burning may result in products of incomplete combustion including polynuclear aromatic hydrocarbons (naphthalene, anthracene, etc); aromatic hydrocarbons including benzene, toluene, xylene, styrene, etc; paraffinic oils; particulate and ash residues.

### Explosion data – sensitivity to mechanical

Not explosive on impact

### Explosion data – sensitivity to static discharge

Not explosive when subject to static discharge

## SECTION 6 – ACCIDENTAL RELEASE MEASURES

### Personal precautions

Ensure adequate ventilation to keep material component levels below workplace exposure limits. Avoid excessive dust formation and accumulation. Avoid prolonged exposure to vapors/odors and dusts created by material.

### Environmental precautions

Precautionary measures to prevent large quantities of the product from entering and/or accumulating in drains should be implemented. In case of emergency, prevent further leakage or spillage if safe to do so.

### Methods and material for containment and cleaning up

LAND SPILL : Sweep or vacuum material to prevent slip hazard. Try not to create dust. Collect for reuse if possible.

WATER SPILL : Material floats initially. Attempt to contain floating material and remove it from the surface by skimming first. Contain area and, if material sinks, try to recover material as best possible without disturbing surroundings.

# MATERIAL SAFETY DATA SHEET

Manufacturer/ Supplier: Liberty Tire Recycling, LLC  
1251 Waterfront Place, 4<sup>th</sup> Floor  
Pittsburgh, PA  
15222-4261

Emergency Telephone Number:  
(412) 562-1700

## SECTION 7 – HANDLING AND STORAGE

### Precautions for safe handling

For any application, use in a well-ventilated area or set engineering controls (ventilation) to keep airborne concentrations below the workplace exposure limits and prevent the build up of dust. Do not handle or store near an open flame or sources of heat.

### Conditions for safe storage

Keep material away from incompatible materials or conditions. Material can be safely stored outdoors in a contained or sectioned off area. If material is stored inside, it should be kept in a well-ventilated location to keep airborne concentrations below the workplace exposure limits.

## SECTION 8 – EXPOSURE CONTROLS/PERSONAL PROTECTION

Component	CAS #	Value	Control Parameters	Basis
Natural rubber	9006-04-6	TWA	0.0001 mg/m <sup>3</sup> 35 mg/m <sup>3</sup>	USA. ACGIH (inhalable proteins) USA. ACGIH Threshold Limit Values (TLV)
Synthetic rubber	9003-55-8	N/AV	N/AV	No occupational exposure limits set for material
Carbon black	1333-86-4	TWA	3.5 mg/m <sup>3</sup> 3.5 mg/m <sup>3</sup>	Canada. British Columbia OEL USA. ACGIH Threshold Limit Values (TLV)
Zinc oxide	1314-13-2	TWA	2 mg/m <sup>3</sup> 10 mg/m <sup>3</sup> 2 mg/m <sup>3</sup>	Canada. British Columbia OEL Canada. Alberta OEL USA. ACGIH Threshold Limit Values (TLV)
Sulfur	7704-34-9	TWA	10 mg/m <sup>3</sup>	Canada. Alberta OEL
Synthetic fibers, fillers, accelerators, anti-ozonants	N/AP	N/AP	N/AP	No occupational exposure limits set for material
Remarks:	If multiple exposure limits exist for a substance, the limits from the State(s), Province(s) or Territory with the highest and lowest values in the country are reported.			

### Personal Protection Equipment

#### Respiratory protection

Respiratory protection is typically not required. Where protection from nuisance levels of dust are desired, use of a dust mask is recommended. Typical certified dusts masks types are N95 (US) or P1 (EN 143).

#### Hand protection

Short term exposure does not require gloves. Gloves are recommended for continuous or prolonged exposure of material. Any type of protective gloves are recommended to avoid prolonged or repeated skin contact. If gloves are disposable, dispose of contaminated gloves after use in accordance with applicable laws and work place practices. If gloves are re-usable, wash periodically to avoid build up of material matter. Wash and dry hands.

#### Eye protection

Although they may be present in low concentration, if dust or fines are likely to become airborne, safety glasses with side shields or goggles should be worn. When using eye protection, equipment should be tested and approved under appropriate government standards such as NIOSH (US) or EN 166 (EU).

#### Skin and body protection

Long sleeved clothing and full length pants should be worn if repeated or prolonged direct contact is likely to occur.

#### Hygiene measures

Handle in accordance with good industrial and commercial hygiene and safety practices. Wash hands before breaks and at the end of the work day.

#### Specific engineering controls

Use in a well-ventilated area or set engineering controls to keep airborne concentrations below the exposure limits.

## SECTION 9 – PHYSICAL AND CHEMICAL PROPERTIES

### Appearance

Form: Solid - small (less than ~15 mm diameter) irregularly shaped granules of rubber based material containing small portions of synthetic fibers  
Color: Black with small white pieces of fiber material and uncolored rubber

### Safety data

pH: Not applicable  
Melting/freezing point: No data available  
Boiling point: No data available  
Flash point: > 212°F; > 100°C (ASTM D3828)  
Ignition temperature: No data available  
Autoignition temperature: No data available  
Lower explosion limit: No data available  
Upper explosion limit: No data available  
Vapor pressure: No data available

# MATERIAL SAFETY DATA SHEET

Manufacturer/ Supplier: Liberty Tire Recycling, LLC  
1251 Waterfront Place, 4<sup>th</sup> Floor  
Pittsburgh, PA  
15222-4261

Emergency Telephone Number:  
(412) 562-1700

Density	1.06 g/mL
Water solubility	Not soluble
Partition coefficient	Not applicable
Relative vapour density	No data available
Odor	Rubber or hydrocarbon-like odor
Odor threshold	No data available
Evaporation rate	Does not evaporate

## SECTION 10 – STABILITY AND REACTIVITY

### Chemical stability

Stable under recommended storage conditions.

### Possibility of hazardous reactions

No data available

### Conditions to avoid

Material may slowly degrade on storage, especially in the presence of iron particles and combined with heat or pressure, subsequently releasing carbon monoxide and carbon dioxide. Heat, ignition sources, and oxidizing agents should be avoided. Although typically present in small amounts, dust may be explosive under certain conditions (i.e. high airborne concentrations) in the presence of an ignition source.

### Materials to avoid

Acids, oxidizing agents, iron particles, excess moisture

### Hazardous decomposition products

Oxides of carbon, nitrogen and metals under fire or oxidative conditions

## SECTION 11 – TOXICOLOGICAL INFORMATION

### Acute toxicity

#### Oral LD50

No data available

#### Inhalation LC50

No data available

#### Dermal LD50

No data available

#### Other information on acute toxicity

No data available

### Skin corrosion/irritation

No data available

### Serious eye damage/eye irritation

No data available

### Respiratory or skin sensitization

No data available

### Germ cell mutagenicity

No data available

### Carcinogenicity

This product contains a component (when isolated) that has been reported to be possibly carcinogenic (specifically when inhaled) based on its IARC, ACGIH, NTP or EPA classification. Limited evidence to carcinogenicity in animal studies. IARC: 2B – Group 2B: Possibly carcinogenic to humans (Carbon black)

### Reproductive toxicity

No data available

### Specific target organ toxicity – single exposure (Globally Harmonized System)

No data available

### Specific target organ toxicity – repeated exposure (Globally Harmonized System)

No data available

### Aspiration hazard

No data available

# MATERIAL SAFETY DATA SHEET

Manufacturer/ Supplier: Liberty Tire Recycling, LLC  
1251 Waterfront Place, 4<sup>th</sup> Floor  
Pittsburgh, PA  
15222-4261

Emergency Telephone Number:  
(412) 562-1700

## Potential health effects

- Inhalation** Odor/vapors may be a nuisance in some individuals. In some individuals, short term exposure of material may produce mild and temporary discomfort to the respiratory tract resulting in wheezing, tightness in the chest, shortness of breath and coughing. Although they may be present in low amounts, dust and small pieces of material may aggravate bronchitis, asthma, and emphysema if inhaled. Small cuts to the airway may result if pieces of metal are inhaled.
- Skin** Although fine material, particulate matter and dust may be present in low quantities, contact with such items may result in irritation (redness/itching) or other effects with some individuals.
- Eyes** Material is abrasive if it enters the eye, which can cause irritation to sever damage if left untreated.
- Ingestion** Irritation of mucus membranes of mouth, throat, esophagus and stomach along with nausea may occur. Abrasion to the mouth, esophagus, stomach and intestinal tract may occur.

## Signs and Symptoms of Exposure

To the best of our knowledge, the chemical, physical and toxicological properties have not been thoroughly investigated.

## Synergistic effects

No data available

## Additional information

None

## SECTION 12 – ECOLOGICAL INFORMATION

### Toxicity

No data available

### Persistence and degradability

No data available

### Bioaccumulative potential

No data available

### Mobility in soil

No data available

### PBT and vPvB assessment

No data available

### Other adverse effects

Extensive ecological testing has not been performed on the product. Standard good environmental workplace practices should be implemented when handling material in a workplace or external setting.

## SECTION 13 – DISPOSAL CONSIDERATIONS

### Product

The product is not a characteristic nor is listed as hazardous waste. Product materials that are no longer usable or that may have become contaminated should be placed in disposable containers and such materials should be managed and disposed in compliance with applicable federal, state, provincial, and local regulations.

### Contaminated packaging

Packaging that is no longer usable or may have become contaminated should be placed in disposable containers and managed, recycled, or disposed of in compliance with applicable federal, state, provincial, and local regulations.

## SECTION 14 – TRANSPORT INFORMATION

### DOT (US)

Not dangerous goods

### IMDG

Not dangerous goods

### IATA

Not dangerous goods

## SECTION 15 – REGULATORY INFORMATION

### WHMIS Classification

Not WHMIS controlled

This product has been classified in accordance with the hazard criteria of the Controlled Products Regulations and the MSDS contains all the information required by the Controlled Products Regulations.

### OSHA Hazards

No known OSHA hazards



# MATERIAL SAFETY DATA SHEET

Manufacturer/ Supplier: Liberty Tire Recycling, LLC  
1251 Waterfront Place, 4<sup>th</sup> Floor  
Pittsburgh, PA  
15222-4261

Emergency Telephone Number:  
(412) 562-1700

## SECTION 16 – OTHER INFORMATION

### Further Information

Prepared August 30, 2013. The information, recommendations and suggestions in the Material Safety Data Sheet have been compiled from tests and data believed to be reliable. The above information is believed to be correct, but is not under guarantee or warranty to be all inclusive and shall be used only as a guide. The information contained herein is based on the present state of our knowledge and is only applicable to the product or material set forth in Section 1. The information provided may not be applicable or complete if such product or material is used in combination with any other product or material, or in any process. The information provided on the product or material is with regard to appropriate safety precautions and does not represent any guarantee of the properties of the product. It is the user's obligation to determine the safety, toxicity and suitability for their own use of the product described herein and to comply with all applicable laws and regulations. Liberty Tire, LLC and its affiliates shall not be held liable for any damage resulting from handling or from contact with the above product.

Rev.Date: 1/12/09

**Product#**

**6490**

**HOT MELT ADHESIVE**

**Chemistry:** Synthetic Resin

**Form:** Pillows

**Shelf Life:** One year from the date of shipment.

**Standard Disclaimer:**

The data presented is based on tests standard to the adhesive industry. Because we have no control over the application process or the substrates used by the customer, HMT can not certify the performance of the assembly the adhesive is used on. HMT will assume no responsibility for results obtained or for incidental or consequential damages arising from the use of this adhesive.

**Typical Physical Properties:**

- Typical Application Temperature Range: 330° - 375° F
- Viscosity: Approx. 1500 cps @ 350° F
- Softening Point: Approx. 160° F
- Color: Off-White

**General Uses and Product Characteristics:**

HMT-6490 is a versatile, general purpose adhesive. Excellent for bonding a variety of substrates. Sprayable.

**Storage and Handling Suggestions:**

Store in cool, dry place in the original shipping container only. Keep container closed and tightly sealed when not in use to avoid contamination.

**Clean-up and Safety Information:**

For surface cleaning of application equipment, use HMT's SS-900 Spray Cleaner. For purging, use HMT's Green-Kleen purge compound. To minimize the risk of burns, we recommend the use of eye protection and protective clothing when working near the hot melt applicator.

**Packaging Information:**

(Package changes can occur without notice)

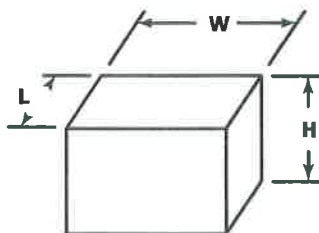

Container Type: Box  
 Container Dimensions: L=15", W=14", H=9"  
 Approx. Container Wt.: 25 lbs. Net

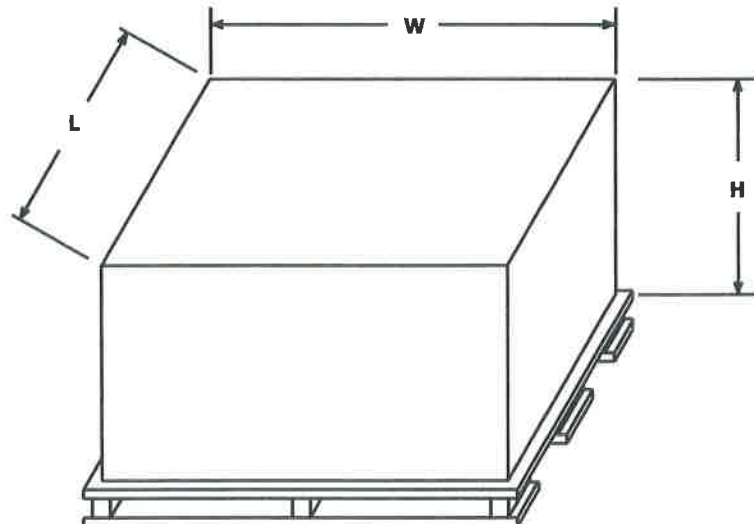

Approx. Pallet Dimensions: L=46", W=44", H=49"  
 Approx. Full Pallet weight: 1125 lbs. Net  
 Rows per Full Pallet: 5  
 Approx. Weight per Row: 225 lbs. Net (9 boxes)



# Hot Melt Technologies, Inc.

www.hotmelt-adhesive.com  
1723 W. Hamlin Rd. Rochester Hills, MI 48309  
Phone: (248) 853-2011 Fax: (248) 853-6650

# Material Safety Data Sheet

HMT PN#

6490

EMERGENCY CONTACT: (248) 853-2011

**SUBSTANCE IDENTIFICATION:**  
**Substance:** HOT MELT, 100% SOLID  
**Chemical Family:** HOT MELT  
**Molecular Formula:** MIXTURE

**COMPONENTS AND CONTAMINANTS:**  
**Hazardous Components:** NONE  
**Exposure Limits:** NONE

**FIRE AND EXPLOSION DATA**  
**Flash Point:** 450-500°F, Cleveland, Open Cup  
**Extinguishing Media:** Co<sub>2</sub>, Dry Chemical  
**Fire and Explosion Hazard:** N/A

**CONDITIONS TO AVOID**  
Store in a Cool, Dry Place  
**Precaution:** This Product should be heated only to the recommended temperatures.

**HEALTH EFFECT AND FIRST AID**

**Inhalation:** As supplied: Non-Hazardous  
As used: May cause isolated operator concern. Ventilate as required but not necessary.

**Skin Contact:** As supplied: Non-Hazardous  
As used: Severe Thermal Hazard.

**First Aid:** Flush with cold water. Treat as wax or resin burn. Do not attempt to remove. Get medical assistance.

**Eye Contact:** As supplied: Non-Hazardous  
As used: Severe Thermal Hazard.

**First Aid:** Flush with cold water. Treat as wax or resin burn. Do not attempt to remove. Get Medical assistance.

**Ingestion:** As supplied: Not significantly toxic, but should be avoided.

**SPILL AND LEAK PROCEDURES**

**Occupational Spill:**  
As Supplied: Sweep up  
As used: Allow to cool - sweep or scrape up. Dispose of in accordance with all federal, state and local regulations covering solid waste disposal.

**PROTECTIVE EQUIPMENT**

**Ventilation:** Local exhaust over melt chamber. General exhaust to avoid accumulation of vapors at ceilings.

**Respirator:** None required.

**Clothing:** To avoid burns, use long sleeved, long legged clothing.

**Gloves:** Thermal Resistant.

**Eye Protection:** Chemical Goggles.

HAZARD RATING



**REGULATORY INFORMATION**

**VOCs -** 0.0%  
**HAPs -** None  
**RoHS -** Compliant



## ProFlex G5, R-Series, Dual Melt Grid, 220 VAC

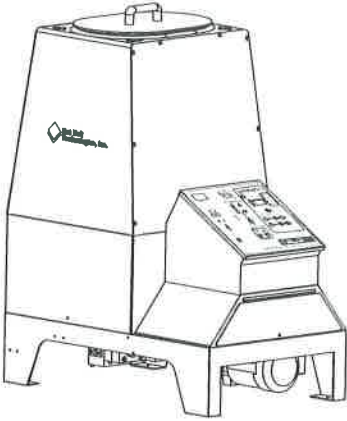

### ProFlex G5 Control Features

- 2 Hose/Gun Capability
- $\pm 1^\circ\text{F}$  Temp Control
- $^\circ\text{F}$  or  $^\circ\text{C}$  Temp Readout
- Manual Standby
- Auto-Standby Timer
- Auto-Off Timer
- Ready Delay Timer
- Set Point Limit
- Front Panel Diagnostics
- All Zone Ready
- Hose/Gun On/Off Control
- Audible Fault Alarm
- Service Clock
- Pump On/Off Control
- Precision Flow Control
- Optional OEM Interface Cable
- Optional Remote Motor Run Cable
- Optional Internal 24h/7d Timer
- Optional Key Lock

**G 5 X X X - R - 4 0 - X - X**

**Control Package**

G5: Proflex G5, 220 VAC

**Tank**

135: 135 lb.    200: 200 lb.

**Dual Grid Heater Harness**

R: 4800 W @ 220 VAC

**Pump**

40: PA-40 Steel Gear Pump

Motors	
AC Drive Motor	DC Drive Motor
L: 57 RPM, 1/6 hp	D: 62 RPM, 1/4 hp
M: 85 RPM, 1/6 hp	G: 125 RPM, 1/4 hp
F: 113 RPM, 1/3 hp	

Single Motor	Dual Motor
Leave Blank	2: 2 Motors & Pumps

- Additional Cost for "F" Motor
- Additional Cost for DC Motor Control

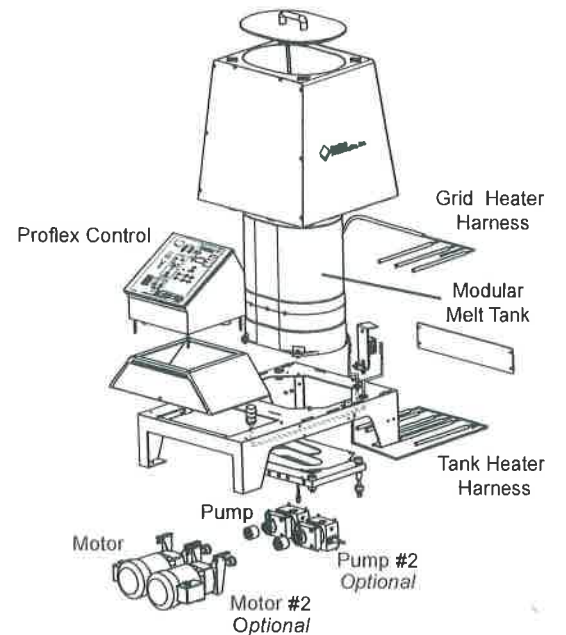
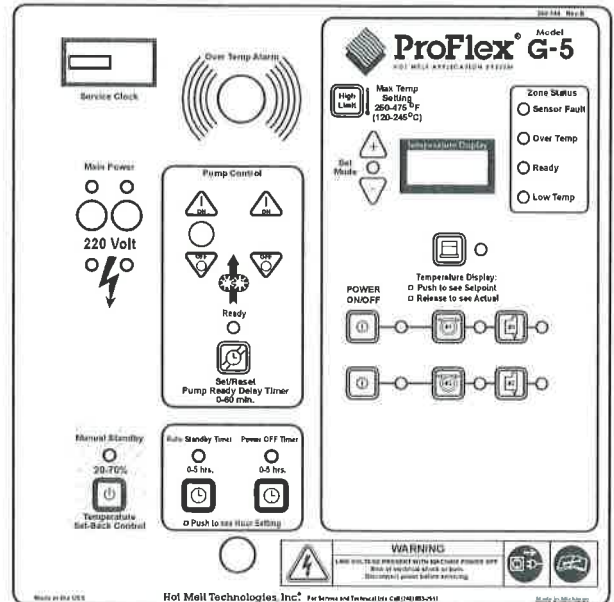



## STYLE SPECIFICATION SHEET

STYLE NAME:	<b>APT BOND-15 Seam tape</b>
PRIMARY BACKING	Woven primary with 1 oz. black cap.
PRIMARY BACKING TYPE	11152C00 – 11 Pic
PRIMARY PICS/INCH	11.0
PRIMARY FILL COLOR	Charcoal
PRIMARY BACKING WT.	2.65 oz. per sq.yd.
SECONDARY COATING:	15 Oz. Urethane / SqYd
TOTAL PRODUCT WT:	17.65 Oz. / SqYd
ROLL WIDTH	12' – 144"

These specifications are standard and may vary slightly due to manufacturing tolerances or consumer specifications.



Technical data  
**Dates Techniques**  
 Technische gegevens  
 Technische Daten

Seamingtape / Backingtape  
**Bande de jonction**  
 Lijmband / Nadenband  
 Nahtband

Article: **Seamingtape C145**  
 Artikel :  
 Artikel : **C145030SEAWI2**

Composition: Spunbonded Polyester 120 g/m<sup>2</sup> white coated with 25 g/m<sup>2</sup> PE  
 Samenstelling:  
 Zusammensetzung:

**NEN-EN 12228**

<b>Mass per unit area</b> <b>La masse par unité de superficie</b> Gewicht per oppervlakte-eenheid Masse je Flächeneinheit	g/m <sup>2</sup>	145 g/m <sup>2</sup>	
<b>Thickness</b> <b>Épaisseur</b> Dikte Dicke	mm	0.48	
<b>Tensile strength CD</b> <b>CD de résistance à la traction</b> Treksterkte dwarsrichting Höchstzugkraft quer * NEN-EN 12228	kN/m	> 10	12,44
<b>Peel strength CD</b> <b>Test de peler</b> Afpelwaarde dwarsrichting Schälwert quer * NEN-EN 12228	N/100mm	> 40	64

The data are average values and indicative.  
 De gegevens zijn gemiddelde waarden en indicatief.  
 Die angegebene Werte sind durchschnittlichen Mittelwerte und indikativ.

January 2008

=> **These peeling test meets the requirements of the new FIFA 2006 standard.**

**MATERIAL SAFETY DATA SHEET**

**Section I: General Information**

Trade Name: Bonded Polyester Thread	Manufacturer: Coats North America
	Address: 630 American Thread Rd Marion, NC 28752
Chemical Name/Synonyms: Polyethyleneterephthalate	Manufacturer's Phone Numbers: Information: (828) 756-4111
Chemical Family: Polyester	Emergency: (828) 756-4111
DOT Shipping Name: Polyester Fiber	DOT Hazard Class: N/A

**Section II: Hazardous Ingredients**

CAS #	Chemical Name	Wt. %	Threshold Limit Values
-------	---------------	-------	------------------------

N/A

**Section III: Physical Data**

Boiling Point (BF): N/A	Specific Gravity (H <sub>2</sub> O = 1): N/A
Vapor Pressure (mm Hg): N/A	Percent Volatile by Volume: N/A
Vapor Density: N/A	Evaporation Rate: N/A
Solubility in Water: Insoluble	pH: N/A
Appearance & Odor: Polyester thread on packages.	

**Section IV: Fire & Explosion Hazard Data**

Flash Point: N/A	Auto Ignition Temperature: N/A
Flammable Limits: N/A	LEL: N/A UEL: N/A

Extinguishing Media: Water, dry chemical, CO<sub>2</sub>

Special Fire Fighting Procedures: Fire fighters should wear self-contained breathing apparatus.

Unusual Fire & Explosion Hazards: N/A

**Section V: Reactivity Hazard Data**

Stability:  Stable  Unstable      Conditions to Avoid: N/A  
 Incompatibility (Materials to Avoid): N/A

Hazardous Decomposition Products: No unusual combustion gases have been observed; Combustion products are comparable to those of other similar organic materials.

Hazardous Polymerization: May Occur  Will Not Occur   
 Conditions to Avoid: N/A

**Section VI: Health Hazard Data**

Threshold Limit Value: N/A

OSHA Threshold Limit Value: N/A

ACGIH Threshold Limit Value: N/A

Carcinogen - NTP Program: N/A      Carcinogen - IARC Program: N/A

Symptoms of Exposure: None Known

Medical Conditions Aggravated By Exposure: None Known

Primary Route(s) of Entry: N/A

Emergency First Aid: N/A

---

Section VII: Environmental Protection Procedures

---

Spill Response: Sweep Up.

Waste Disposal: Dispose of in accordance with local, State and Federal regulations.

Precautions to be Taken in Handling & Storage: N/A

Other Precautions: N/A

---

Section VIII: Special Protection Information

---

Respiratory Protection: N/A

Eye Protection: N/A

Skin Protection: N/A

Ventilation: N/A

Other Protective: Normal uses of the thread should not require special protection.

---

Section IX: Special Precautions

---

Hygienic Practices In Handling & Storage: We are not aware of any special precautions required in the handling or storage of the thread.

Precautions For Repair & Maintenance of Contaminated Equipment:  
None Known

Other Precautions: None Known

Revised: 12/20/04

## *Material Safety Data Sheet*

### *Seam Tape C145*

**1. IDENTIFICATION OF THE COMPANY**

**Manufacturer:** KingSports BV, Holland

**2. COMPOSITION / INFORMATION ON INGREDIENTS**

The product is a polymer.

Contains no substance classified as hazardous, in concentrations which should be taken into account according to the EC directives.

**3. HAZARDS IDENTIFICATION**

The product is not classified as a dangerous preparation (EC).

Inhalation of dust may irritate the respiratory tract. Prolonged inhalation of high doses of decomposition products may give headache or irritation of the respiratory tract.

**4. FIRST AID MEASURES**

No specific instruction needed.

**5. FIRE FIGHTING MEASURES**

Extinguishing agents: water in spread jet, dry chemicals, foam or carbon dioxide should be used. The product burns, but is not classified as flammable. Principal toxicant in the smoke is carbon monoxide.

**6. HANDLING AND STORAGE**

During processing and thermal treatment of the product, small amounts of volatile hydrocarbons may be released. Provide adequate ventilation. Local exhaust ventilation may be necessary. Avoid inhalation of dust and decomposition fumes.

**7. EXPOSURE CONTROLS / PERSONAL PROTECTION**

Provide adequate ventilation. Local exhaust ventilation may be necessary.

**8. PHYSICAL AND CHEMICAL PROPERTIES**

**Appearance:** tape with coating

Melting point: 110 – 200 °C

Ignition temperature: > 300 °C



**9. STABILITY AND REACTIVITY**

The product is a stable thermoplastic, with no chemical reactivity.

**10. TOXICOLOGICAL INFORMATION**

The products is not dangerous.

**11. ECOLOGICAL INFORMATION**

The product is not considered dangerous for the environment.

**12. DISPOSAL CONSIDERATIONS**

Reuse or recycle if not contaminated. The product may be safely used as fuel or landfilled. Proper combustion does not require any special flue gas control. No leachate is generated in landfills. Check with local regulations.

**13. TRANSPORT INFORMATION**

The transport is not regulated by ADR/RID, IMDG or IATA

**14. REGULATORY INFORMATION**

**Label:** Product name: KingSports BV Seam Tape C145

**31.12.2007**

KingSports BV  
NL-8211 AJ Lelystad  
Tel: +31 (0) 320 23 24 22  
Fax: +31 (0) 320 22 06 30  
[Info@kingsports.nl](mailto:Info@kingsports.nl)  
[www.kingsports.nl](http://www.kingsports.nl)



# SPORTSFIELD SPECIALTIES

WWW.SPORTSFIELDSPECIALTIES.COM

"DESIGNED TO MEET THE DEMANDS OF MODERN SPORTS CONSTRUCTION"

41155 STATE HIGHWAY 10  
PO BOX 231  
DELHI, NY 13753  
TOLL FREE: 888-975-3343  
FAX: 607-746-8481

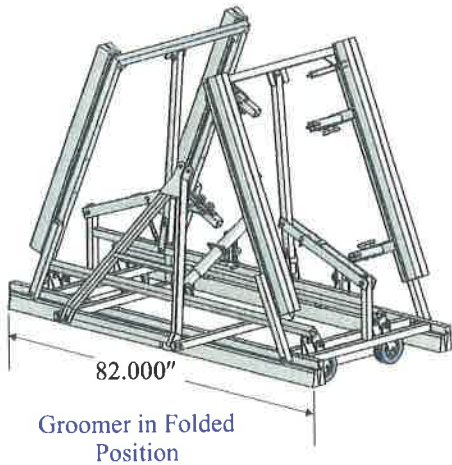
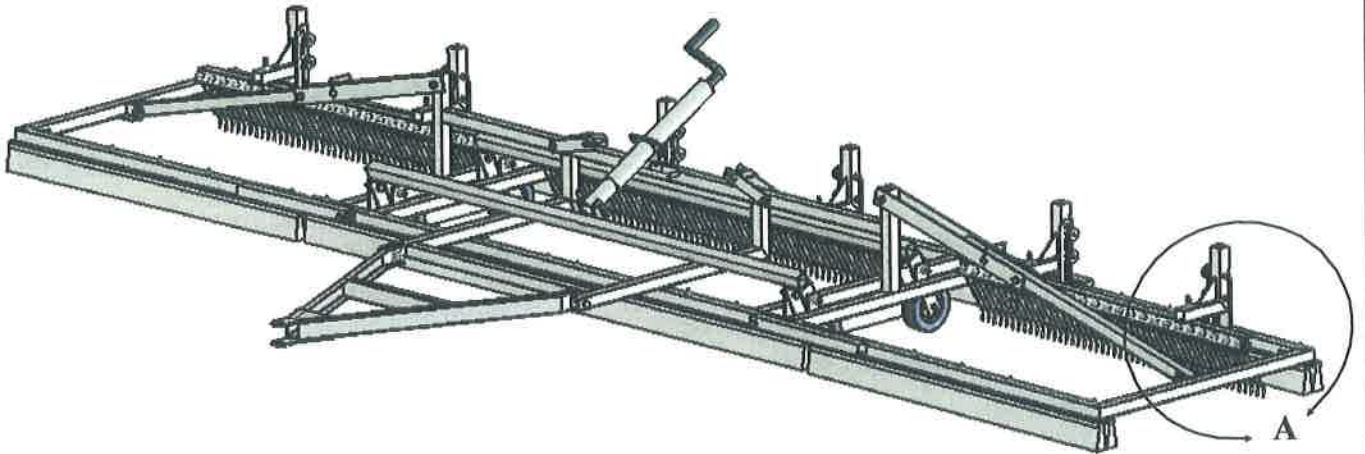

### Specifications:

- \* Powder Coated Steel Construction
- \* Towable with Small Tractor or Utility Vehicle
- \* Reversible & Replaceable Grooming Brushes
- \* Replaceable Dethatching Tines
- \* Simplified Height Adjustment
- \* Fold Up Wings for Easy Portability
- \* Approx. Unit Weight: 380 LBS

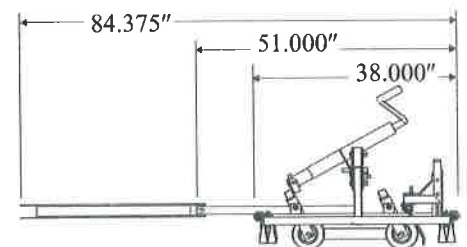
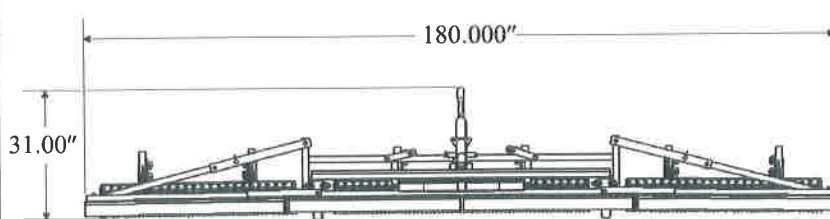
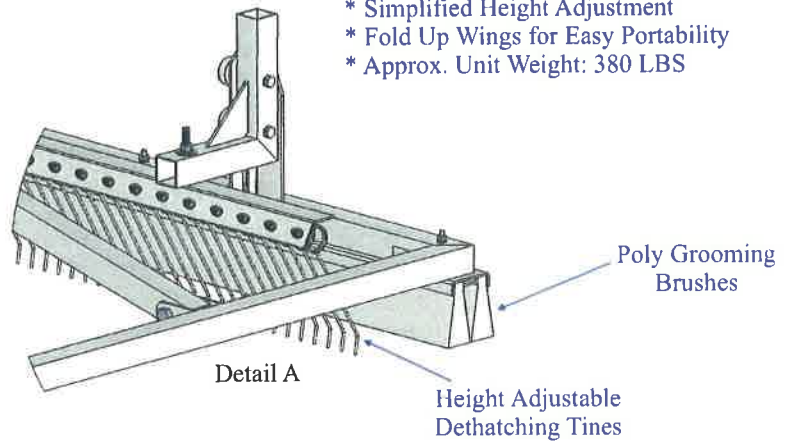

## FieldSpec® 15' Drag Brush

Not To Scale

Sportsfield Specialties Inc 11122007





*Specializing in the construction of high-quality sports surfaces*

**Richard Letourneau**  
**Director of Field Operations**

Veteran of the United States Army and Army National Guard  
Engineering graduate from Maine Maritime Academy -1997  
Project Manager for Cianbro Corporation (1997 – 2004)  
Senior Project Manager for Northeast Turf (2004 to 2013)

**FIELD INSTALLATIONS:**

Richard was involved in over 400 projects in New England, the Mid-Atlantic and Midwest, including numerous putting green and landscape projects. These projects included Gillette Stadium (2006 and 2010), Harvard Stadium, MIT, Dartmouth College, Xaverian Brothers High School, and Brown University.

**SYNTHETIC TURF EXPERTISE**

Field Installation  
Field Infilling  
Logo Fabrication / Installation  
Inlaid Numbers and Arrows Installation  
Inlaid Hash Mark Installation  
Inlaid End Zone Installation  
Inlaid Line Installation  
Hand Sewing  
Cart Sewing  
Gluing  
Field Repairs  
Field Maintenance  
Equipment Operation  
Machinery Repair  
Top Stone Acceptance  
Base Acceptance  
Field Closings (Walk Through / Sign Off)

**CERTIFICATIONS**

30 Hour OSHA Certified  
First Aid Certification  
CPR Certification  
DOT Drivers Health Card  
Forklift Certification  
Bobcat Certification  
Cushman Certification



*Specializing in the construction of high-quality sports surfaces*

**Josh Buczynski**  
**Site Manager-Field Resume**

**Field Installation**

- Involved in more than 200 fields to date with previous employer Northeast Turf, not including numerous putting green and landscape projects.

**Synthetic Turf Expertise**

- Field Installation
- Field Infilling
- Logo Fabrication/Installation
- Inlaid Numbers & Arrows Installation
- Inlaid Hash Mark Installation
- Inlaid End Zone Installation
- Inlaid Line Installation
- Hand Sewing
- Cart Sewing
- Gluing
- Field Repairs
- Field Maintenance
- Equipment Operator
- Machinery Repair
- Field Closings (Walk Through/Sign Off)

**Certifications**

- 30 Hour OSHA Certified
  - First Aid Certification
  - CPR Certification
  - DOT Drivers Health Card
  - Forklift Certification
  - Bobcat Certification
  - RI Hoisting License
  - MA Hoisting License
-



*Specializing in the construction of high-quality sports surfaces*

## **Erin Haakenstad**

Site Manager - Field Resume

Mr. Haakenstad has been involved in more than 150 fields to date with previous employer Northeast Turf, not including numerous putting green and landscape projects.

### **Synthetic Turf Expertise**

- Field Installation
- Field Infilling
- Logo Fabrication/Installation
- Inlaid Numbers & Arrows Installation
- Inlaid Hash Mark Installation
- Inlaid End Zone Installation
- Inlaid Line Installation
- Hand Sewing
- Cart Sewing
- Gluing
- Field Repairs
- Field Maintenance
- Equipment Operator
- Machinery Repair
- Field Closings (Walk Through/Sign Off)

### **Prior Work History**

Northeast Turf (2005-2013)

### **Certifications**

30 Hour OSHA Certified  
First Aid Certification  
CPR Certification  
DOT Drivers Health Card  
Forklift Certification  
Bobcat Certification  
Cushman Certification  
MA Hoisting License



*Specializing in the construction of high quality sports surfaces*

## Installations and References Massachusetts

Acton Boxborough High School (2005)  
36 Charter Rd.  
Acton, MA 01720  
JD Head (978) 375-0101

Amesbury Sports Park (2003)  
12 S. Hunt Rd. (3 Fields)  
Amesbury, MA 01913  
Ted Dipple (978) 388-5788

Anna Maria College (2009)  
50 Sunset Lane  
Paxton, MA 02115  
Dave Shea (508) 826-6918

Archbishop Williams (2007)  
80 Independence Ave.  
Braintree, MA 01284  
Joe Francis (781) 843-1237

Arlington High School (2005)  
869 Massachusetts Ave.  
Arlington, MA 02476  
Dave Johnson (781) 316-3551

Auburn High School - Eturf (2005)  
99 Auburn St.  
Auburn, MA 01501  
Bill Garneau (508) 832-7711

Auburn High School (2006)  
99 Auburn St.  
Auburn, MA 01501  
Bill Garneau (508) 832-7711

Barnstable High School (2010)  
744 West Main St.  
Hyannis, MA 02601  
Steve Francis (508) 862-4953

Becker College (2008)  
916 Main St.  
Leicester, MA 01609  
Frank Millerick (774) 354-0481

Belmont Hill School (2008)  
350 Prospect St. (2 Fields)  
Belmont, MA 02478  
Dan Krantz (508) 384-4330

Bentley College - Nylon (2004)  
175 Forest St.  
Waltham, MA 02452  
Bob DeFelice (781) 891-2256

Bentley College (2004)  
175 Forest St.  
Waltham, MA 02452  
Bob DeFelice (781) 891-2256

Berkshire School (2004)  
245 Undermountain Rd.  
Sheffield, MA 01257  
Dan Driscoll (413) 229-8511

Bishop Feehan High School (2012)  
70 Holcott Dr.  
Attleboro, MA 02703  
Paul O'Boy (508) 266-6223

Boston College - Nylon (2005)  
885 Centre St.  
Newton, MA 02459  
Scott McCoy (616) 552-1523

Boston College High School (2005)  
150 Morrissey Blvd.  
S. Boston, MA 02125  
Jeff Keith (617) 474-5091

Boston University (2001)  
Nickerson Field  
285 Babcock Street  
Boston, MA 02215  
Alan Weinberger (617) 353-4632

Boston University (2008)  
Nickerson Field (Replacement)  
285 Babcock St Boston, MA 02215  
Alan Weinberger (617) 353-4632



*Specializing in the construction of high quality sports surfaces*

## Installations and References Massachusetts

**Braintree High School – 2 Fields (2011)**  
128 Town St.  
Braintree, MA 02184  
Mike Denise (781) 848-4000

**Bridgewater State University (2010)**  
131 Summer St.  
Bridgewater, MA 02325  
Chuck Denune (508) 531-2704

**Brookline Landfill (2007)**  
815 Newton St.  
Chestnut Hill, MA 02467  
Jim Murray (978) 897-4353

**Brookline Soule Community Center (2011)**  
652 Hammond St.  
Brookline, MA 02467  
Dan Krantz (508) 384-4330

**Brookwood School (2012)**  
1 Brookwood Rd.  
Manchester, MA 01944  
Jane Pirie (978) 526-4500

**Buckingham Browne & Nichols School (2005)**  
80 Gerry's Landing Rd.  
Cambridge, MA 02138  
Rick Forestiere (617)-547-6100

**Burlington High School (2010)**  
123 Cambridge St.  
Burlington, MA 01803  
Edward Gillis (781) 270-1867

**Canton High School (2005)**  
900 Washington St.  
Canton, MA 02021  
John Kissida 617-452-6571

**Canton Sportsplex (2000)**  
5 Carver Circle (Indoor)  
Canton, MA 02021  
John Warren (781) 821-0304

**Catholic Memorial High School – Tear Out (2011)**  
235 Baker St.  
West Roxbury, MA 02135  
Alex Campea (617) 469-8000

**Ceylon Park (2008)**  
1 Ceylon Park  
Dorchester, MA 02125  
John Amato (508) 954-7503

**Charlestown High School (2007)**  
240 Medford St. (2 fields)  
Charlestown, MA 02129  
Mike Allen (617) 635-9914

**Chelsea High School (2003)**  
299 Everett Ave. Chelsea, MA 02150  
Dave Ferraro (617) 889-8409

**Chestnut Hill School (2003)**  
428 Hammond St.  
Chestnut Hill, MA 02467  
Clare McDermott (617) 566-4394

**City of Cambridge - Danehy Park (2001)**  
198 New St.  
Cambridge, MA 02138  
Paul Ryder (617) 349-6200

**Curry College (2004)**  
1071 Blue Hill Ave.  
Milton, MA 02186  
Vinnie Eruzione (617) 333-2202

**Dana Barrows Sports (2005)**  
31 Oxford Rd.  
Mansfield, MA 02048  
Brian Coffey (508) 406-2263

**Danehy Park – Tear Out (2011)**  
99 Sherman St.  
Cambridge, MA 02140  
Front Office (617) 349-4895



*Specializing in the construction of high-quality sports surfaces*

## Installations and References Massachusetts

DeFazio Park (2008)  
318 Dedham Ave. Rt. 135  
Needham, MA 02404  
Patricia Carey (781) 455-7521

Dexter School (2005)  
20 Newton St.  
Brookline, MA 02446  
Rick Saul (617) 522-5544

Dexter School (2006)  
20 Newton St.  
Brookline, MA 02446  
Rick Saul (617) 522-5544

Durfee High School (2006)  
360 Elsbree St.  
Fall River, MA 02720  
Jack Alston (508) 675-8189

East Longmeadow High School (2011)  
144 Maple St.  
East Longmeadow, MA 01028  
Matt Bean (413) 525-5460

Elms College (2007)  
291 Springfield St.  
Chicopee, MA 01013  
Louise McCleary (413) 265-2395

Emerson College (2004)  
389 Albany St.  
Boston, MA 02118  
Norm Sosin (617) 824-8691

Emmanuel College (2009)  
150 Park Dr.  
Boston, MA 02115  
Pam Roecker (617) 735-9715

Endicott College (2003)  
376 Hale St.  
Beverly, MA 01915  
Mark Kulakowski (978) 232-2337

Epiphany School (2007)  
154 Centre St.  
Dorchester, MA 02124  
Will Brown (617) 326-0427

Framingham State College (2003)  
100 State St.  
Framingham, MA 01701  
Warren Fairbanks (508) 626-4591

Hanscom Air Force Base (2000)  
81 Grenier St.  
Hanscom AFB, MA 01731  
Harlan Michaud (207) 767-4522

Harry Downes Field (2006)  
Pond Ave.  
Brookline, MA 02467  
Dan Krantz (508) 384-4330

Harvard University (2006) Soldiers Field Rd. (Indoor  
Tennis) Boston, MA 02215  
Jon Lister (617) 384-8426

Harvard University (2006)  
Soldiers Field Rd.  
Boston, MA 02215  
Jon Lister (617) 384-8426

Harvard University (2008)  
Soldiers Field Rd.  
Boston, MA 02215  
Jon Lister (617) 384-8426

Highland Park (2011)  
235 Marginal St.  
Chelsea, MA 02150  
Frank Depatto (617) 466-5000

Hormel Stadium (2012)  
Locust St.  
Medford, MA 02155  
Irene Flynn (781) 393-2417





*Specializing in the construction of high quality sports surfaces*

## Installations and References Massachusetts

Indoor Action Sports (1999)  
1385 Bernardston Rd. (Indoor/Outdoor)  
Greenfield, MA 01301  
Harlan Michaud (207) 767-4522

Joseph Hurley School (2007)  
70 Worcester St.  
Boston, MA 02118  
Peter Rait (671) 367-9679

King Middle School (2002)  
100 Putnam Ave.  
Cambridge, MA 02139  
Kelly Ryder (617) 349-4898

Larkum Lake Park (2011)  
600 Reservoir Rd.  
Otis, MA 01253  
Dan Zenkel (914) 400-8129

Lasell College (2005)  
1844 Commonwealth Ave.  
Newton, MA 02466  
Kristy Walter (617) 243-2147

Lawrence High School (2005)  
70 N. Parish Rd.  
Lawrence, MA 01843  
Pete Paladino (978) 682-0260

Lincoln Park - ETurf (2003)  
98 Lincoln St. (3 Fields)  
Lexington, MA 02421  
Dave Pinsonneault (781) 861-2757

Lincoln School – Faxon Farm (2008)  
Danforth St. & Rt. 44  
Rehobooth, MA 02906  
Ronnie McFarland (401) 331-9696

Lincoln-Sudbury Regional High School (2004)  
390 Lincoln Rd.  
Sudbury, Ma. 01770  
Kevin Rossley (978) 443-9961

Lincoln-Sudbury Regional High School (2007)  
390 Lincoln Rd.  
Sudbury, MA 01770  
Kevin Rossley (978) 443-9961

Lowell High School (2006)  
Cawley Stadium Douglas Rd.  
Lowell, MA 01852  
James Deprofio (978) 937-8900

Lunenburg High School - Eturf (2005)  
1079 Massachusetts Ave.  
Lunenburg, MA 01462  
Steve Marsden (978) 582-6898

Madison Park - Eturf (2005)  
Dewitt Dr.  
Roxbury, MA 02120  
Cathy Baker-Eclipse (617) 961-3058

Mahar Regional School (2006)  
507 S. Main St.  
Orange, MA 01364  
Tom Bates (978) 544-2542

Manchester Essex Middle School (2007)  
36 Lincoln St.  
Manchester, MA 01944  
Joe Lucido (978) 526-2055

Mass College of Liberal Arts (2007)  
345 Church St.  
North Adams, MA 01247  
Scott Nichols (413) 662-5412

Mass Youth Soccer (2006)  
512 Old Union Turnpike (5 Fields)  
Lancaster, MA 01523  
Skip Gorman (978) 466-8812

Max Lacrosse (2004)(Indoor)  
Cohasset, MA 02025  
Harlan Michaud (207) 767-4522



Specializing in the construction of high-quality sports surfaces

## Installations and References Massachusetts

Medford High School (2010)  
489 Winthrop St.  
Medford, MA 02155  
Bob Maloney (781) 393-2380

Medway High School (2004)  
45 Holliston St.  
Medway, MA 02053  
Jim MacClean (508) 533-3235

Melrose High School (2011)  
159 Termont St.  
Melrose, MA 02176  
Patricia Ruggiero (781) 979-2200

Memorial Park (2007)  
143 Porter St. (2 fields)  
Boston, MA 02128  
Ed Maiato (508) 823-6699

Memorial Park (2008)  
1174 Highland Ave.  
Needham, MA 02404  
Lance Remsen (781) 455-7548

Merrimack College (2005)  
Cullen Ave.  
N. Andover, MA 01845  
Robert Coppola (978) 837-5118

Milford Indoor Complex - E turf (2002)  
159 S. Main St (2 Fields Indoor)  
Milford, MA 01757  
John Smith (508) 634-8080

Milford High School (2011)  
31 West Fountain Ave.  
Milford, MA 01757  
Richard Piergustavo (508) 478-1110

Milton High School - E turf (2002)  
25 Gile Rd.  
Milton, MA 02186  
Bill Ritchie (617) 696-5045

Misserville Park (2007)  
Allen St.  
Lawrence, MA 01841  
Steve Cosmos (508) 628-3595

MIT (2008)  
77 Massachusetts Ave.  
Cambridge, MA 02139  
Dan Martin (617) 253-5003

Mt. Ida College (2012)  
777 Dedham St.  
Newton, MA 02459  
Rico Cabral (617) 928-4500

Natick High School (2011)  
15 West St.  
Natick, MA 01760  
Tim Collins (508) 647-6600

NB Regional Voc. Tech. High School (2004)  
1121 Ashley Blvd.  
New Bedford, MA 02745  
Jeff Liborio (508) 998-3321

New England Patriots (2002, 2012)  
Practice Facility #1 (Indoor)  
One Patriot Place  
Foxboro, MA 02035  
Dan Krantz (508) 384-4330

New England Patriots (2002)  
Practice Facility #2  
One Patriot Place  
Foxboro, MA 02035  
Dan Krantz (508) 384-4330

New England Patriots (2006)  
Gillette Stadium One Patriot Place  
Foxboro, MA 02035  
Dan Krantz (508) 384-4330





*Specializing in the construction of high quality sports surfaces*

## Installations and References Massachusetts

**New England Patriots (2010) Tear Out and Replacement  
Gillette Stadium  
One Patriot Place  
Foxboro, MA 02035  
Dan Krantz (508) 384-4330**

**Newton YMCA (2007)  
276 Church St.  
Newton, MA 02458  
Kurt Douty (617) 244-6050**

**Nichols College (2006)  
124 Center Rd.  
Dudley, MA 01571-6310  
Charlyn Robert (508) 213-2281**

**Normandin Middle School - ETurf (2003)  
81 Felton St.  
New Bedford, MA 02745  
Steve Leonardo (508) 985-4300**

**North Andover High School (2004)  
430 Osgood St.  
North Andover, MA 01845  
John Longley (978) 794-3144**

**North Andover High School (2004)  
430 Osgood St.  
North Andover, MA 01845  
John Longley (978) 794-3144**

**Northeastern University (2010)  
158 Kent St.  
Boston, MA 02115  
Peter Roby (617) 373-2672**

**North Reading High School (2009)  
180 Park St.  
No. Reading, MA 01864  
David Johnson (978) 664-7800**

**Northfield Mt. Hermon School (2008)  
1 Lamplighter Way  
Mt. Hermon, MA 01354  
Thomas Pratt (413) 498-300**

**Oakmont/Ashburnham (2007)  
10 Oakmont Dr.  
Ashburnham, MA 01430  
Dave Laroche (978) 827-5907**

**Oliver Ames High School (2009)  
100 Lothrop St.  
No. Easton, MA 02356  
James Von Euw (508) 230-3210**

**Pagel Park (2005)  
345 Hyde Park  
Hyde Park, MA 02131  
Cathy Baker-Eclipse (617) 961-3058**

**Peabody School (2000)  
70 Rindge Ave.  
Cambridge, MA 02140  
Kelly Ryder (617) 349-4898**

**Pembroke HS - ETurf (2005)  
80 learning Lane  
Pembroke, MA 02359  
Bill Fallon (781) 293-9281**

**Plymouth North High School (2012)  
41 Obery St.  
Plymouth, MA 02360  
Karl Braun (508) 830-4400**

**Reading High School (2005)  
62 Oakland Rd. (2 Fields)  
Reading, MA 01867  
Phil Vaccaro (781) 942-9122**

**Riverside Park (2005)  
144 Coffin Ave.  
New Bedford, MA 02746  
Kevin Amoral (508) 979-1520**

**Rocky Marciano Stadium – Replacement (2011)  
700 Belmont St.  
Brockton, MA 02301  
Tom Kenney (508) 580-7633**



*Specializing in the construction of high quality sports surfaces*

## Installations and References Massachusetts

Marshall Simonds Middle School - Burlington, MA  
(2013)  
114 Winn Street  
Burlington, MA 01803  
(781) 270-1781

Gloucester High School (2013)  
32 Leslie O Johnson Rd  
Gloucester, MA 01930  
Kim Patience - AD -(978) 281-9870

Plymouth South High School (2013)  
490 Long Pond Rd  
Plymouth, MA 02360  
Scott Fry - AD - (508) 224-7512

Milton High School (2013)  
25 Gile Rd, Milton  
MA 02186  
Lawrence Rooney - AD -(617) 696-4478

Roberts Playground - Boston, MA (2013)  
Dorchester, MA 02124  
Boston Parks and Recreation  
1010 Massachusetts Ave  
Boston, MA 02118  
(617) 635-2090

The English High School (2013) - 2 fields  
144 McBride St  
Boston, MA 02130  
(617) 635-8979

Xaverian Brothers High School (2013)  
800 Clapboardtree St.  
Westwood, MA 02090  
Charles Stevenson (781) 326-6392

Town of Lexington Parks and Recreation (2013) -  
Replacement  
1625 Massachusetts Ave  
Lexington, MA 02420  
Karen Simmons - Dir. of Recreation (781) 698-4800



*Specializing in the construction of high-quality sports surfaces*

**Russell Field (2005)**

Dudley St.

Cambridge, MA 02140

Sean Reardon (508) 903-2430

**Sprague Fields (2008) (2 Fields)**

Francis St.

Wellesley, MA 02482

Paul Tyrell (781) 337-7964

**Springfield College (2005)(2 Fields)**

Alden St.

Springfield, MA 01109

Cathie Schweitzer (413) 748-3333

**Springfield College (2007)**

263 Alden St.

Springfield, MA 01109

John Mailhot (413) 748-3145

**Southcoast Soccer Center (2006)**

424 Nash Rd. (Indoor)

New Bedford, MA 02746

(508) 999-1800

**St. Michael's School (2004)**

80 Maple Ave.

N. Andover, MA 01749

Don Marinelli (978) 686-4050

**St. Sebastian's (2007)**

1191 Greendale Ave.

Needham, MA 02492

Jack Doherty (781) 247-0111

**Tabor Academy (2011)**

260 Front St.

Marion, MA 02738

Dick Muther (508) 748-2000

**Taunton High School (2008)**

50 Williams St.

Taunton, MA 02780

Mark Ottavianelli (508) 821-1150

## Installations and References Massachusetts

**The Governor's Academy (2007)**

1 Elm St.

Byfield, MA 01922

Bert McLain (978) 499-3102

**UMass Dartmouth - ETurf (2003)**

285 Old Westport Rd.

North Dartmouth, MA 02747

Jim Filippo (508) 999-8732

**Umass Amherst (2006) McGuirk Stadium  
Stadium Dr.**

Amherst, MA 01003

Dan Markowski (413) 545-4085

**UMass Lowell (2000)**

1 University Ave.

Lowell, MA 01854

Jean Robinson (978) 934-4545

**UMass Lowell (2009)**

Replacement

1 University Ave.

Lowell, MA 01854

Jean Robinson (978) 934-4545

**Wachusett Regional High School (2007)**

1401 Main St.

Holden, MA 01520

Michael Dubzinski (508) 829-6771

**Walker Field – Ashland Middle School (2011)**

84 West Union St.

Ashland, MA 01721

Eric Scott (508) 881-0192

**Waltham High School (2004)**

Harding Field

617 Lexington St.

Waltham, MA 0245

Bill Foley (781) 314-5440

**Wayland High School (2007)**

264 Old Connecticut Path

Wayland, MA 01778 Nancy McShea (508) 358-3662



*Specializing in the construction of high quality sports surfaces*

## Installations and References Massachusetts

Wentworth Institute of Technology (2012)  
550 Huntington Ave.  
Boston, MA 02115  
Angel Ayres (617) 989-4159

Western New England College (2010)  
Tear Out & Replacement  
1215 Wilbraham Rd.  
Springfield, MA 01119  
Keith Emery (413) 796-2208

Westford Academy (2011)  
30 Patten Rd.  
Westford, MA 01886  
Dan Twomey (978) 692-5570

Westford Community Fields (2012)  
Nutting Rd.  
Westford, MA 01886  
Parks & Rec (978) 692-5532

Weymouth High School (2004)  
1 Wildcat Way  
S. Weymouth, MA 02190  
Tom Slattery (781) 589-8017

Whitman Hanson High School (2005)  
600 Franklin St.  
Whitman, MA 02382  
James Daley (781) 618-7443

Winchendon Indoor YMCA (2010)  
155 Central St.  
Winchendon, MA 01475  
Dave Bilodeau (978) 297-9622

Winchester High School (2009)  
100 Mystic Valley Parkway  
Winchester, MA 01890  
Brian Carroll (781) 721-7020

Winsor School (2008)  
103 Pilgrim Rd.  
Boston, MA 02215  
Karen Geromini (617) 912-1345

Woburn High School (2007)  
55 Locust St.  
Woburn, MA 01801  
Jim Duran (781) 937-8219

Worcester Foley Stadium (2007)  
305 Chandler St.  
Worcester, MA 10602  
David Brunelle (508) 799-2196

Worcester Poly Institute (2007)  
100 Institute Rd.  
Worcester, MA 10609  
Trey Sasser (617) 926-3300

Xaverian Brothers High School (2003)  
800 Clapboardtree St.  
Westwood, MA 02090  
Charles Stevenson (781) 326-6392

Xaverian Brothers High School (2005)  
800 Clapboardtree St.  
Westwood, MA 02090  
Charles Stevenson (781) 326-6392



*Specializing in the construction of high quality sports surfaces*

## Installations and References Connecticut

**Amistad Academy - Eturf (2002)**  
407 James St.  
New Haven, CT 06513  
Mario Calcagni Jr. (203) 287-9736

**Avon Old Farms (2011)**  
500 Old Farms Rd.  
Avon, CT 06001  
Brian Doyle (860) 404-4100

**Brien McMahon High School (2002)**  
300 Highland Ave.  
Norwalk, CT 06854  
Joe Madaffari (203) 854-9488

**Brunswick School (2004)**  
Edwards Campus Field  
100 Maher Ave.  
Greenwich, CT 06830  
Chuck Redahan (203) 223-2546

**Central Conn. State University Soccer (2010)**  
1615 Stanley St  
New Britain, CT 06053  
Joseph Connell (860) 832-3200

**Choate Rosemary Hall (2010)**  
35 North Elm St.  
Wallingford, CT 06492  
John Chiavaroli (203) 697-2000

**City of Danbury (2009)**  
Corner of Main St. & South St.  
Danbury, CT 06810  
Ted Cutsumpas (203) 797-4511  
Greenwich, CT 06831  
Tony Costa (203) 532-3511

**Danbury High School – Tear Out (2011)**  
43 Clapboard Ridge Rd.  
Danbury, CT 06811  
Dan Scavone (203) 797-4800

**Clem Lemire Rec Complex (2006)**  
New Britain Ave.  
Newington, CT 06111  
Parks & Rec (860) 665-8666

**Coginchaug Regional High School (2010)**  
135 Pickett Lane  
Durham, CT 06422  
Jeanne Boothroyd (860) 349-7215

**Connecticut Sports Complex (2002)**  
37 Lanesville Rd. (Indoor)  
New Milford, CT 06776  
Karl Noivadhama (860) 350-6655

**Daniel Hand High School - ETurf (2003)**  
286 Green Hill Rd.  
Madison, CT 06443

**Central Conn. State University (2009)**  
1615 Stanley St,  
New Britain, CT 06053  
Bill McMinn (203) 245-6470

**East Lyme High School (2012)**  
30 Chesterfield Rd.  
East Lyme, CT 06333  
Steve Hargus (860) 739-6946

**Darien High School (2004)**  
80 High St. (2 Fields)  
Darien, CT 06820  
Paul Engerman (203) 656-7418

**Enfield High School (2008)**  
27 Shaker Rd.  
Enfield, CT 06082  
Geoff McAlmond (860) 763-7094



*Specializing in the construction of high-quality sports surfaces*

## Installations and References Connecticut

**Oxford High School (2013)**  
61 Quaker Farms Rd.  
Oxford, CT 06478  
Teg Cosgriff - AD - (203) 888-2468; ext. 230

**Canterbury School (2013)**  
101 Aspetuck Ave  
New Milford, CT 06776  
860-210-3800

**Hopkins School (2013)**  
986 Forest Rd  
New Haven, CT 06515  
Thomas Parr - AD - (203) 397-1001



*Specializing in the construction of high-quality sports surfaces*

## Installations and References Connecticut

Ethel Walker School (2012)  
200 Bushy Hill Rd.  
Simsbury, CT 06070  
Dee Stephen (860) 658-4467

Farmington Sports Arena (2009, 2012)  
11 Executive Dr.  
Farmington, CT 06032  
(860) 677-2543

Greenwich Academy (2002)  
200 N. Maple Ave.  
Greenwich, CT 06830  
Ken Luhman (203) 625-8921

Greenwich Boys & Girls Club (2006)  
4 Horseneck Lane  
Greenwich, CT 06830  
Robert DeAngelo (203) 869-3224

Hamden High School (2002)  
2040 Dixwell Ave.  
Hamden, CT 06514  
Jeanne Cooper (203) 407-2040

Hotchkiss School (2009)  
Interlaken Rd.  
Lakeville, CT 06039  
Daniel Smith (860) 435-2591

Hyde School (2007)  
150 Rt. 169  
Woodstock, CT  
Hamden, CT 06518  
Gary Glambattista (860) 963-9096

Madison (2007)  
Green Hill Rd.  
Madison, CT 06443  
Stewart Macmillian (203) 245-5611

Newtown High School (2010)  
12 Berkshire Rd.  
Sandy Hook, CT 11373  
Gregg Simon (203) 426-7655

New Fairfield High School (2006) Tear Out (2011)  
54 Gillotti Rd.  
New Fairfield, CT 06812  
Jay Greenberg (203) 312-5800

New London High School (2009)  
490 Jefferson Ave.  
New London, CT 06320  
Bob Brackett (869) 437-6400

Norwalk High School (2000)  
23 Calvin Murphy Dr.  
Norwalk, CT 06851  
Wayne Mones (203) 838-4481

Oakwood Sports (2009)  
507 Glastonbury Turnpike  
Portland, CT 06480  
Dave Farrell (860) 633-3689

Quinnipiac College (2005)  
275 Mount Carmel Ave.  
Hamden, CT 06518  
Jack McDonald (203) 582-8621





*Specializing in the construction of high-quality sports surfaces*

## Installations and References Connecticut

Kingwood-Oxford (2007)

Forest St.

West Hartford, CT 06105

Garth Adams (860) 233-9631

KL-H&T (2007)

1450 Newfield Ave.

Stamford, CT 06905

Craig Flaherty (203) 327-0500

Korner Kick Sports (2000)

1791 Stratford Ave. (Indoor)

Stratford, CT 06615

Frank Vassina (203) 858-1531

Sage Park-Town of Berlin (2004)

Suranna Dr.

Kensington, CT 06037

Dave Paradise (860) 828-07027

Salisbury School (2007)

251 Canaan Rd.

Salisbury, CT 06068

Tim Sinclair (860) 435-5898

Sports Zone (2001) (Indoor)

29 Trefoil Dr.

Trumbull, CT 06611

Sacred Heart University (2001)

5151 Park Ave.

Fairfield, CT 06825

Floyd Young (203) 371-7871

Rocky Hill HS - Eturf (2004)

50 Chapin Ave.

Rocky Hill, CT 06067

Lisa Zerio (860) 258-2711

Rippowam Middle School (2005)

381 High Ridge Rd.

Stamford, CT 06905

Kevin Iassogna (203) 977-4525

Waterside School – rooftop (2011)

770 Pacific St.

Stamford, CT 06092

Front Office (203) 975-9655

Watertown High School (2009)

324 French Rd.

Watertown, CT 06779

June Legge (860) 945-4810

Westhill High School (2003)

125 Roxbury Rd.

Stamford, CT 06902

Mike King (203) 977-4696





*Specializing in the construction of high-quality sports surfaces*

## Installations and References Connecticut

**Stamford HS (2005)**  
55 Strawberry Hill Ave.  
Stamford, CT 06902  
Lou Casolo (203) 977-5796

**Taft School (2007)**  
110 Woodbury Rd.  
Watertown, CT 06795  
Jim Shepard (860) 974-7916

**Trinity College (2002)**  
300 Summit St.  
Hartford, CT 06067  
Bob Laptas (860) 297-2444

**UConn (2006)**  
Burton Complex  
2075 Hillside Rd.  
Storrs, CT 06269  
Jeffery Hathaway (806) 486-2725

**US Coast Guard Academy (2005)**  
31 Mohegan Ave.  
New London, CT 06320  
Dr. Raymond Cleplik (860) 444-8603

**Waterford Regional High School (2011)**  
20 Rope Ferry Rd.  
Waterford, CT 06385  
Dave Sousa (860) 442-0277

**Westminster School (2012)**  
995 Hopmeadow St.  
Simsbury, CT 06070  
Tim Joncas (860) 408 3066

**Weston High School (2003)**  
115 School Rd.  
Weston, CT 06883  
Mark Berkowitz (203) 291-1620

**Wethersfield High School (2004)**  
411 Wolcott Hill Rd.  
Wethersfield, CT 06109  
Mike Turner (860) 721-2853

**Wolcott High School (2006)**  
457 Bound Line Rd.  
Wolcott, CT 06716  
Fran Hubeny (203) 879-8150

**Woodstock Academy (2011)**  
57 Academy Rd.  
Woodstock, CT 06281  
Chris Coderre (860) 928-6575

**Yale Soccer – Tear Out (2011)**  
2 Whitney Rd.  
New Haven, CT 06510  
Thomas Beckett (203) 432-1414



Specializing in the construction of high quality sports surfaces

## Installations and References Maine

Bates College (2010)  
130 Central Ave.  
Lewiston, ME 04240  
Kevin McHugh (207) 786-6341

Cape Elizabeth School (2007)  
345 Ocean House Rd.  
Cape Elizabeth, ME 04107  
Mike Ott (207) 712-4298

Colby College - Nylon (2004)  
4000 Mayflower Hill  
Waterville, ME 04901  
Gordon Cheeseman (207) 872-3000

Colby College Football Stadium (2008)  
4000 Mayflower Hill  
Waterville, ME 04901  
Dale Deblois (207) 859-5022

Deering High School (2007)  
Ludlow St.  
Portland, ME 04101  
Ethan Owens (207) 756-8275

Falmouth Elementary School (2010)  
52 Woodville Rd.  
Falmouth, ME 04105  
Todd Livingston (207) 781-7429

Gould Academy (2008)  
Mill Hill Rd.  
Bethel, ME 04217  
Zack Leman (207) 824-7735

Hampden Academy (2003)  
1 Main Rd. N  
Hampden, ME 04444  
Dave Shapiro (207) 862-3791

Howard Sports Training Center (1999)  
400 North St. (2 Fields - Indoor)  
Saco, ME 04072  
Harlan Michaud (207) 767-4522

Howard Sports (2007)  
400 North St. (Indoor)  
Saco, ME 04072  
Harlan Michaud (207) 767-4522

Husson College (2002)  
John Winkin Baseball Complex  
One College Circle  
Bangor, ME 04401  
Gabby Price (207) 941-7025

Husson College (2007)  
One College Circle Dr.  
Bangor, ME 04401  
John Rubino (207) 941-7109

Kent's Hill School (2008)  
1614 Main St.  
Kent's Hill, ME 04349  
Harlan Michaud (207) 767-4522

Maine Elite Lacrosse (2011)  
173 Riverside St.  
Portland, ME 04103  
Deke Andrews (207) 841-2453

Mansfield Baseball Complex (2002)  
115 13th St.  
Bangor, ME 04401  
Greg Ganss (817) 473-6532

MBNA (2000)  
Atlantic Highway  
Camden, ME 04843  
Stephen Christie (207) 701-2225

North Yarmouth Academy (2006)  
148 Main St  
Yarmouth, ME 04096  
Harlan Michaud (207) 767-4522

Portland High School (2001)  
Fitzpatrick Stadium Portland Ave. & Deering St.  
Portland, ME 04101  
Ethan Owens (207) 756-8275



*Specializing in the construction of high quality sports surfaces*

## Installations and References Maine

Portland Sports Center (2003)  
512 Warren Ave. (Indoor)  
Portland, Maine 04103  
Kevin Barrett (207) 363-0084

Presque Isle Middle School (2007)  
569 Skyway St.  
Presque Isle, ME 04769  
Gehrig Johnson (207) 764-4101

Thornton Academy (2011)  
438 Main St.  
Saco, ME 04072  
Gary Stevens (207) 282-3361

University Of Maine Indoor Facility (2005)  
5747 Memorial Gym  
Orono, ME 04469  
Claude Junkins (207) 581-2683

University of Maine (2008)  
138 College Ave. (3 Fields)  
Orono, ME 04469  
Claude Junkins (207) 581-2683

University of Southern Maine (2011)  
University Way  
Gorham, ME 04308  
Al Bean (207) 780-5588

York Sports Center (2002)  
1050 U.S. Route 1 (Indoor)  
York, ME 03909  
Kirk Butterfield (207) 205-4007



Specializing in the construction of high quality sports surfaces

## Installations and References New Hampshire

All-Around Sports (2002)  
142 State Rt. 111 (Indoor)  
Hampstead, NH 03841  
Jim Dedeus (603) 329-4422

Bedford High School (2007)  
24 N. Amherst Rd.  
Bedford, NH 03110  
Mark Walsh (603) 623-1713

Clem Lemire Sports Complex (2004)  
1 Crusader Way  
Manchester, NH 06111  
Dave Gosslein (603) 624-6300

Dartmouth College (2006)  
Memorial Field  
Crosby St.  
Hanover, NH 03755  
Bob Thebobo (603) 646-3245

Dartmouth College (2007, 2008, 2012)  
Scully Fahey Field Summer Ct.  
Hanover, NH 03755  
Bob Thebobo (603) 646-3245

The Derryfield School (2008)  
2108 River Rd.  
Manchester, NH 03104  
Lenny McCaigue (603) 279-6162

Exeter High School (2005)  
1 Blue Hawk Dr.  
Exeter, NH 03833  
Dick Wendall (603) 774-6286

Fieldhouse Sports - Eturf (2002)  
12 Tallwood Dr. (2 Fields Indoor)  
Bow, NH 03304  
Craig Jensen (603) 226-4646

Fieldhouse Sports #2 - ETurf (2003)  
12 Tallwood Dr. (Indoor)  
Bow, NH 03304  
Craig Jensen (603) 226-4646

Hampshire Hills Sports & Fitness (2006)  
50 Emerson Rd.  
Milford, NH 03055  
Dan Wyborney (603) 673-7123 x218

Kimball Union Academy (2006)  
57 Main St.  
Meriden, NH 03770  
William Pottle (603) 469-2140

Nashua High School (2001)  
Stellos Stadium  
7 Riverside Dr.  
Nashua, NH 03062  
Peter Casey (603) 589-4311

New Hampton Prep (2007)  
70 Main St.  
New Hampton, NH 03256  
Jaime Arsenault (603) 677-3440

NH Phantoms Soccer Club (2004)  
142 State Rt. 111 (Indoor)  
Hampstead, NH  
Jim DeDeus (603) 329-4422

Phillips Exeter Academy (2006) - Phelps Stadium  
20 Main St.  
Exeter, NH 03833  
Joe Kovolyn (603) 777-4436

Portsmouth High School (2010)  
130 Andrew Jarvis Dr.  
Portsmouth, NH 03801  
Janet Lovering (603) 436-7100

Presentation of Mary Academy (2012)  
209 Lawrence St.  
Methuen, MA 01844  
Stephen Stankus (978) 682-9391

Proctor Academy (2012)  
204 Main St.  
Andover, NH 03216  
Gregor Makechnie (603) 735-6000



*Specializing in the construction of high quality sports surfaces*

## Installations and References New Hampshire

Rising Stars Sports Complex (2002)  
68 Technology Dr. (Indoor)  
Bedford, NH 03110  
Paul Parisi (603) 641-1313

Rising Stars Sports Complex (2003)  
68 Technology Dr. (Indoor)  
Bedford, NH 03110  
Paul Parisi (603) 641-1313

Rivier College (2009)  
20 Clement St.  
Nashua, NH 03060  
Joanne Merrill (603) 897-8257

Southern New Hampshire University (2003)  
2500 N. River Rd.  
Manchester, NH 03106  
Terry Prouty (603) 645-9641

Seacoast United Soccer Club (2006)  
3 Tilton Woods (4 Fields)  
Epping, NH 03042  
Paul Willis (603) 944-2569

St. Anselm College (2011)  
Eaton Rd.  
Manchester, NH 03105  
Jo-ann Nester (603) 641-7800

St. Paul's School (2004)  
325 Pleasant St.  
Concord, NH 03301  
Liesbeth Hirschfield (603) 229-4835

Stellos Stadium – Replacement (2011)  
7 Riverside St.  
Nashua, NH 03062  
Parks & Rec (603) 589-3370

Univeristy of New Hampshire (2007)  
Mooradian Field  
145 Main St.  
Durham, NH 03824  
Sean McDonnell (603) 862-1852

Windham Physical Education (2009)  
64 London Bridge Rd.  
Windham, NH 03087  
Bill Raycraft (603) 537-2403

Colby-Sawyer College (2013)  
541 Main St  
New London, NH 03257  
Bill Foti - AD - (603) 526-3610



*Specializing in the construction of high quality sports surfaces*

## Installations and References Rhode Island

Brown University (2004)  
164 Angell St.  
Providence, RI 02912  
Michael Goldberger 401-863-2972

Brown University (2007)  
164 Angell St. (2 Fields)  
Providence, RI 02912  
John Cooke (401) 863-7803

Cranston Stadium (2007)  
9 Flint Ave.  
Cranston, RI 02910  
Tony Liberatore (401) 461-1000

East Greenwich High School (2009)  
300 Avenger Dr.  
East Greenwich, RI 02818  
Vincent Varrecchione (401) 398-1660

La Salle Academy – 2 Fields (2011)  
612 Academy Ave.  
Providence, RI 02908  
Ted Quigley (401) 351-7750

Moses Brown High School (2007)  
250 Lloyd Ave.  
Providence, RI 02906  
Kevin Perry (401) 831-7350

North Smithfield Middle School (2008)  
412 Greenville Rd.  
North Smithfield, RI 02896  
Charlie Roberts (401) 632-7970

Providence Classical High School (2009)  
770 Westminster St.  
Providence, RI 02903  
Robert Palazzo (401) 456-9145

Roger Williams University (2011)  
One Old Ferry Rd.  
Bristol, RI 02809  
David Kemmy (401) 254-3428

Salve Regina – Gaudet MS (2009)  
122 Wyatt Rd.  
Middletown, RI 0842  
Collin Sullivan (401) 341-2268

South Side Soccer (2009)  
1000 Eddy St.  
Providence, RI 02905  
Robert McMahan (401) 785-9450

University of Rhode Island (2009)  
3 Keaney Rd  
Kingston, RI 02881  
Walter Boyle 401-874-7878



*Specializing in the construction of high-quality sports surfaces*

## Installations and References Vermont

**Burlington High School (2006)**  
52 Institute Rd.  
Burlington, VT 05401  
Bill Seymour (781) 337-7964

**Middlebury College (2006)**  
139 South St.  
Middlebury, VT 05753  
Dave Seward (802) 443-5255

**Middlebury College (2007)**  
139 South St.  
Middlebury, VT 05753  
Dave Seward (802) 443-5255

**Middlebury College (2008)**  
139 So. Main St.  
Middlebury, VT 05753  
Bob Ritter (802) 443-5601

**University of Vermont (2011)**  
293 Colchester Ave.  
Burlington, VT 05405  
Robert Corran (802) 656-3075



*Specializing in the construction of high-quality sports surfaces*

## Installations and References Michigan

**Detroit Country Day (2011)**  
22305 West 13th Mile Rd.  
Beverly Hills, MI 48025  
Dan MacLean (248) 646-7717

**Groves High School (2010)**  
20500 West Thirteen Mile Rd.  
Beverly Hills, MI 48025  
Brendan Flaherty (248) 203-3530

**Pinckney High School (2010)**  
2130 E. M-36  
Pinckney, MI 48169  
Cheryl Anderson (810) 225-5525

**University of Michigan (2010)**  
Michigan Stadium  
1000 S. State St.  
Ann Arbor, MI 48109  
Bill Martin (734) 764-9416





*Specializing in the construction of high-quality sports surfaces*

## **Installations and References Florida**

**NFL Experience (2010)**

**Dolphin Stadium**

**2269 Dan Marino Blvd.**

**Miami, FL 33101**

**Harlan Michaud (207) 767-4522**

**ENCLOSURE 2**

**MEDWAY HIGH SCHOOL  
TURF REVIEW COMPARISON SHEET**

Medway High School  
Turf Review Comparison Sheet

<b>Submittal Requirement / Product Data</b>	<b>Performance Specification</b>	<b>Revolution</b>	<b>Gridiron PRO ST</b>	<b>Meets Intent of Spec</b>
PILE WEIGHT	40-50 oz/sy	40 oz/sy	42 oz/sy	Yes
FACE YARN TYPE	Extruded monofilament custom blended polyethylene fiber	UV-resistant polyethylene monofilament	APT MFPE350DM Proprietary PE formulation for superior wear resistance	Yes
YARN SIZE – ASTM D1577	9,000 - 12,000 denier	10,800 denier	10,800 denier	Yes
YARN THICKNESS	230 Microns	235 microns	350 microns polyethylene diamond shape	Yes
PILE HEIGHT	2.5"	2.5"	2.5"	Yes
COLOR	Green	Green	Green	Yes
TUFTING GUAGE	3/8"-3/4"	3/4" centers	1/2"	Yes
PRIMARY BACKING	Double Layered polypropylene fabric treated with inhibitors	>7 oz/sy	6.0 oz/sy 13 pic polybac	Yes
SECONDARY BACKING	18-26 oz/sy urethane	16-18 oz/sy urethane	26 oz/sy urethane	Yes
TOTAL CARPET WEIGHT	63 oz/sy (min)	63 oz/sy	74 oz/sy	Yes
PERMEABILITY	Min. 10"-16"/hr (w/infill in place)	> 40 in/hr	24.5 in/hr	Yes
PERFORATIONS	3/16" holes on staggered 4"	Finger-Unit Drainage	Standard	Yes
TUFT BIND	Min. 9 lbs/force	9 lbs/force	10.5 lbs/force	Yes
SAND / RUBBER INFILL	Silica Sand and SBR Rubber (sand to be 45%-55% by weight) with 3/4" yarn reveal.	Cryogenic Rubber with Silica Sand 3 lbs/sf Rubber (32.6%) 6.2 lbs/sf Sand (67.4%) 9.2 lbs/sf Total Infill Weight	Ambient Rubber with Silica Sand 3.5 lbs/sf Rubber (53.8%) 3 lbs/sf Sand (46.2%) 6.5 lbs/sf Total Infill Weight	Yes
ROLL WIDTH	15'	15'	15'	Yes
ROLL LENGTH	Up to 240'	Up to 240'	Up to 240'	Yes
<b>Supplier/Installer Required Experience</b> (specification section 32 18 23)	The synthetic turf shall be manufactured and supplied by a company which has been in business continuously for a period of a minimum of five (5) years under the same name and ownership and with at least five (5) years' experience in the manufacture and supply and of the type of materials specified herein on projects of comparable size to this Project.	Historically Approved	Submitted	Yes
	The synthetic turf manufacturer must have completed a minimum of twenty-five (25) synthetic turf installations in the last 5 years, each in excess of 75,000 square feet.		Submitted	Yes
	Turf Installation Crew: Synthetic turf installation crew shall have installed a minimum of ten (10) outdoor athletic field systems of similar type measuring 75,000 square feet or greater. The Turf Installation Crew shall contain at least three (3) members who have installed at least five (5) similar outdoor turf installations each greater than 75,000 square feet. The designated crew foreman shall have installed at least ten (10) similar outdoor turf installations greater than 75,000 square feet, and shall be subject to the approval of the Engineer. The crew foreman shall be on site during all turf installation procedures, and shall not be replaced without Owner approval. Installation crew and foreman shall submit a list of previously installed projects, by type, size, and location for the Owner's representative inspection at the pre-construction conference and prior to start of Work.		Submitted	Yes

Medway High School  
Turf Review Comparison Sheet

Submittal Requirement / Product Data	Performance Specification	Revolution	Gridiron PRO ST	Meets Intent of Spec
	The General Contractor shall submit a list of previously installed projects, to include individual owner contact information, by the proposed Synthetic Turf Supplier/Installer, along with crew and foreman qualifications at the pre-construction conference that demonstrates compliance with the minimum requirements of this section, 1.02, Paragraphs 1-3.		Submitted	Yes
<b>Submittal Requirements</b> (specification section 32 18 23)	Submit a signed statement from the Infilled Synthetic Turf System Manufacturer that the Drawings and Specifications have been reviewed by a qualified representative of the Infilled Synthetic Turf System Manufacturer and major materials suppliers, and that they are in agreement that the materials and installation methods to be used for the Infilled Synthetic Turf System are proper and adequate for use as a multi-purpose athletic field in New England.	Historically Approved	Submitted	Yes
	Submit a recent reference list for the turf system manufacturer/installer of at least five (5) outdoor high school or college installations, each in excess of 80,000 S.F. <u>incorporating the monofilament synthetic turf system proposed for this project in compliance with this specification.</u> Minor variations in infill design in projects cited for experience are acceptable.		Submitted	Yes
	Submit a recent reference list for the turf system manufacturer/installer of at least fifteen (15) outdoor installations, each in excess of 80,000 S.F. <u>incorporating a tufted polyethylene infilled turf system.</u>		Submitted	Yes
	Job resumes of Infilled Synthetic Turf System Manufacturer's Installation Supervisor (showing supervision of at least ten (10) similar infilled turf installations) and Infilled Synthetic Turf System Installers.		Submitted	Yes
	Cut Sheets for all materials required under this Section (turf, fiber, sand, rubber, etc.) including third party ASTM certified lab gradation reports.		Submitted	Yes
	Provide a sample written 8-year labor and materials warranty from the Infilled Synthetic Turf System Manufacturer.		Submitted	Yes
	Provide a sample Written Third Party Insured Warranty.		Submitted	Yes
	A signed letter on turf manufacturer company letterhead holding the Owner, Designer and all other project consultants harmless for any violation of patent rights or infringements and claims related to hazardous materials (e.g. lead or zinc) or other environmental impacts.		Submitted	Yes

Medway High School  
Turf Review Comparison Sheet

Submittal Requirement / Product Data	Performance Specification	Revolution	Gridiron PRO ST	Meets Intent of Spec
	Provide a carpet seaming plan.		Submitted	Yes
	Supply shop drawings (including details) at an approved scale for location, installation, and erection of the synthetic turf anchoring system		Submitted	Yes
	Provide a striping and marking plan for all intended sports in compliance with NFHS, MIAA, and the Drawings for approval by the Owner and Designer.		Submitted	Yes
	Provide color samples of manufacturer's standard monofilament polyethylene fiber for approval.		Submitted	Yes
	Provide a minimum of 12" x 12" sample of monofilament polyethylene carpet. Provide additional carpet samples for other colors required under this Section.		Submitted	Yes
	Provide 12" long sample of seaming tape.		Submitted	Yes
	Provide certified sieve analysis of sand and rubber infill materials for approval.		Submitted	Yes
	Provide a 1-quart sample of the infill mix at the Designer's approved mix ratio.		Submitted	Yes
	Synthetic Turf Supplier/Installer shall provide a written statement that their product is lead free prior to installation.		Submitted	Yes

# PUBLIC SUBMISSION

<b>As of:</b> 5/3/16 6:49 PM
<b>Received:</b> May 02, 2016
<b>Status:</b> Posted
<b>Posted:</b> May 03, 2016
<b>Tracking No.</b> 1k0-8per-e8z3
<b>Comments Due:</b> May 02, 2016
<b>Submission Type:</b> Web

**Docket:** ATSDR-2016-0002

Collections Related to Synthetic Turf Fields with Crumb Rubber Infill 0923-16PJ

**Comment On:** ATSDR-2016-0002-0003

Collections Related to Synthetic Turf Fields with Crumb Rubber Infill ATSDR-2016-0002

**Document:** ATSDR-2016-0002-0086

Collections Related to Synthetic Turf Fields with Crumb Rubber Infill 0923-16PJ Comment on FR Doc # 2016-03305

---

## Submitter Information

**Name:** Andrew Markiel

---

## General Comment

Please immediately classify crumb rubber as a children's product. Please see attached document for justification.

See attached file(s)

---

## Attachments

2016HB-05139-R000216-Sarah Evans, Icahn School of Medicine at Mount Sinai-TMY



Children's Environmental Health Center  
Department of Preventive Medicine

Icahn School of Medicine at Mount Sinai  
One Gustave L. Levy Place, Box 1217  
New York, NY 10029-6574

Written Testimony before the Connecticut General Assembly Committee on Children  
February 16, 2016

Testimony in Support of:

Raised Bill 5139, An Act Concerning the Use of Recycled Tire Rubber at Municipal and Public School Playgrounds.

To Senator Bartolomeo, Representative Urban, and honorable members of the Committee on Children:

We, the Children's Environmental Health Center of the Icahn School of Medicine at Mount Sinai, strongly support *Raised Bill 5139, An Act Concerning the Use of Recycled Tire Rubber at Municipal and Public School Playgrounds*. **Given the hazards associated with recycled tire rubber, it is our recommendation that these products never be used as surfaces where children play.**

As pediatricians, epidemiologists, and laboratory scientists at the Children's Environmental Health Center of the Icahn School of Medicine at Mount Sinai, which hosts one of 10 nationally funded Pediatric Environmental Health Specialty Units, we have received numerous phone calls from concerned parents and physicians regarding the wide scale use of recycled rubber surfaces on school grounds and in park properties. This led us to conduct a review of the risks and benefits of artificial playing surfaces, during which we found **significant gaps in the evidence supporting the safety of recycled rubber turf products**. Our findings are summarized below and discussed in detail in the attached documents: "Artificial Turf: A Health-Based Consumer Guide" and "Position Statement on the use of Recycled Tires in Artificial Turf Surfaces".

**Children are uniquely vulnerable to harmful exposures from recycled rubber surfaces.** Public playgrounds are typically utilized by children age 6 months to 12 years, a population exquisitely vulnerable to the health effects of toxic environmental exposures. This vulnerability is due to a number of factors including, but not limited to, their unique physiology and behaviors, rapidly developing organ systems, and immature detoxification mechanisms<sup>1</sup>. Additionally, because of their young age, children have more future years of life and therefore more time to develop chronic diseases.

---

<sup>1</sup> Bearer, CF. *Neurotoxicology* 21:925-934, 2000.

We have identified several potential dangers that playing on recycled rubber playing surfaces pose to children. These include:

- 1. Extreme heat.** On hot summer days, temperatures of over 160 degrees Fahrenheit have been recorded on recycled rubber play surfaces<sup>2</sup>. Vigorous play in these conditions conveys a very real risk of burns, dehydration, heat stress, or heat stroke. Children are less able to regulate their body temperature than adults, making them particularly susceptible to conditions of extreme heat<sup>3</sup>. In addition, children have a higher surface area to body mass ratio, produce more body heat per unit mass, and sweat less than adults, all factors that increase susceptibility to heat injury<sup>4</sup>.
- 2. Inhalation and ingestion of toxic and carcinogenic chemicals.** Children are particularly vulnerable to chemical exposures from playground surfaces due to their developmentally appropriate hand to mouth behaviors. In addition, their close proximity to the ground and higher respiratory rates compared with adults increase the likelihood of inhalational exposures. Thus, there is a potential for toxins to be inhaled, absorbed through the skin and even swallowed by children who play on recycled rubber surfaces.

The major chemical components of recycled rubber are styrene and butadiene, the principal ingredients of the synthetic rubber used for tires in the United States<sup>5</sup>. Styrene is neurotoxic and reasonably anticipated to be a human carcinogen<sup>6</sup>. Butadiene is a proven human carcinogen that has been shown to

---

<sup>2</sup> Devitt, D.A., M.H. Young, M. Baghzouz, and B.M. Bird. 2007. Surface temperature, heat loading and spectral reflectance of artificial turfgrass. *Journal of Turfgrass and Sports Surface Science* 83:68-82

<sup>3</sup> <https://www.aap.org/en-us/advocacy-and-policy/aap-health-initiatives/Children-and-Disasters/Pages/Extreme-Temperatures-Heat-and-Cold.aspx>

<sup>4</sup> Falk B, Dotan R. *Appl Physiol Nutr Metab*. 2008 Apr;33(2):420-7. doi: 10.1139/H07-185.

<sup>5</sup> Denly *et al* A Review of the Potential Health and Safety Risks from Synthetic Turf Fields Containing Crumb Rubber Infill. May 2008. [http://www.nyc.gov/html/doh/downloads/pdf/eode/turf\\_report\\_05-08.pdf](http://www.nyc.gov/html/doh/downloads/pdf/eode/turf_report_05-08.pdf)

<sup>6</sup> ATSDR Toxicological Profile for Styrene, November 2010. <http://www.atsdr.cdc.gov/toxprofiles/tp53.pdf>.



cause leukemia and lymphoma<sup>7</sup>. Shredded and crumb rubber also contain lead, cadmium, and other metals known to damage the developing nervous system<sup>8,9</sup>. Some of these metals are included in tires during manufacture, and others picked up by tires as they roll down the nation's streets and highways. Children may also inhale potentially harmful chemicals that have been detected in the air above rubber turf such as benzothiazole and polycyclic aromatic hydrocarbons (PAHs), both of which are linked to cancer<sup>10</sup>.

It is important to note that risk of harm due to exposures from recycled rubber turf has been assessed only for single chemicals, yet children are exposed to numerous harmful chemicals in aggregate during play on these surfaces. It is widely recognized that carcinogens and other environmental toxins act in an additive or multiplicative fashion, making risk assessment of the chemical mixtures present in recycled rubber critical for a comprehensive safety assessment<sup>11</sup>. Because tire rubber composition varies by manufacturer, it is impossible to know the full contents of chemicals contained within a recycled rubber playing surface. For a more comprehensive description of the harmful chemicals contained within recycled rubber products, please see the attached Consumer Guide.

- 4. Transportation home of rubber pellets.** Recycled rubber materials used in play surfaces break down into smaller pieces over time that may be picked up on children's shoes, clothing and skin. The rubber is then tracked into children's homes and cars, and carried into the places where children live, play, eat and sleep. Thus exposure can continue for many hours beyond the time that a child spends in the play area.

---

<sup>7</sup> International Agency for Research on Cancer, 2008.

<http://monographs.iarc.fr/ENG/Monographs/vol100F/mono100F-26.pdf>

<sup>8</sup> Timothy Ciesielski *et al.* Cadmium Exposure and Neurodevelopmental Outcomes in U.S. Children. *Environ Health Perspect.* 2012 May; 120(5): 758–763. 27. doi: 10.1289/ehp.1104152

<sup>9</sup> CDC (2012) Low Level Lead Exposure Harms Children: A Renewed Call for Primary Prevention. [http://www.cdc.gov/nceh/lead/acclpp/final\\_document\\_010412.pdf](http://www.cdc.gov/nceh/lead/acclpp/final_document_010412.pdf)

<sup>10</sup> Connecticut Department of Public Health (2010) Human Health Risk Assessment of Artificial Turf Fields Based Upon Results from Five Fields in Connecticut. [http://www.ct.gov/deep/lib/deep/artificialturf/dph\\_artificial\\_turf\\_report.pdf](http://www.ct.gov/deep/lib/deep/artificialturf/dph_artificial_turf_report.pdf)

<sup>11</sup> Goodson WH *et al* 2015. Assessing the carcinogenic potential of low-dose exposures to chemical mixtures in the environment: the challenge ahead. *Carcinogenesis* 36(Suppl 1):S254–S296.

**5. Escape of chemical hazards from rubber surfaces to the environment.** A number of the toxic and chemical components of the recycled rubber that is installed on playgrounds are soluble in water. When rain and snow fall on synthetic fields, these materials can leach from the surface to contaminate ground water and soil<sup>12</sup>. In addition, chemicals in turf can be released into the air and inhaled, particularly on hot days.

**Disposal of recycled rubber surfaces.** A further unresolved issue is what to do with the toxic components of recycled rubber play surfaces 10 years from now when they reach the end of their usable life-span and need to be dismantled. The costly process of separating, reclaiming, reusing, recycling, or disposing of the various components of a turf field are often overlooked at the time of installation. What will disposal cost? Who will pay? Often, these questions have not been factored into the overall cost.

**Safe alternatives to recycled rubber playground surfaces exist.** Daily outdoor play and physical activity are essential components of a healthy childhood. Thus safe play areas are critical to any school environment. While it is important to minimize playground injuries, the Consumer Product Safety Commission Public Playground Safety Handbook<sup>13</sup> contains several additional safe and affordable alternatives such as wood mulch, which does not carry the same risks of chemical and heat exposure outlined above.

The potential long-term consequences of exposures to synthetic rubber play surfaces have not been carefully assessed by independent third parties prior to their installation throughout the country. For this reason, Senator Richard Blumenthal called upon the federal government to conduct comprehensive studies to verify the safety of recycled rubber for use in areas where children play – including playgrounds<sup>14</sup>. Subsequently, on February 12, 2016, the United States Environmental Protection Agency announced the launch of an investigation into the safety of crumb rubber in partnership with the Centers for Disease Control and Prevention and the Consumer Product Safety

---

<sup>12</sup> Connecticut Department of Environmental Protection (2010) Artificial Turf Study: Leachate and Stormwater Characteristics.

[http://www.ct.gov/deep/lib/deep/artificialturf/dep\\_artificial\\_turf\\_report.pdf](http://www.ct.gov/deep/lib/deep/artificialturf/dep_artificial_turf_report.pdf)

<sup>13</sup> US Consumer Product Safety Commission. *Public Playground Safety Handbook*. #365, November 2010.

<https://www.cpsc.gov//PageFiles/122149/325.pdf>

<sup>14</sup> <http://www.nhregister.com/article/NH/20151106/NEWS/151109637>



Icahn  
School of  
Medicine at  
Mount  
Sinai

Children's Environmental Health Center  
Department of Preventive Medicine

Icahn School of Medicine at Mount Sinai  
One Gustave L. Levy Place, Box 1217  
New York, NY 10029-6574

Commission, stating "existing studies do not comprehensively evaluate the concerns about health risks from exposure to tire crumb"<sup>15</sup>. **In the absence of convincing evidence of safety, we recommend that children not play on recycled rubber surfaces that contain known carcinogens and neurotoxins and support a ban on the use of these products.**

We urge your support of HB 5139 in order to protect the health of the children of Connecticut. Thank you for the opportunity to provide you with our professional opinion. We would be more than happy to answer any questions that you might have.

Kind Regards,

Robert Wright, MD, MPH  
Director, Mount Sinai Children's Environmental Health Center

Sarah Evans, PhD, MPH  
Children's Environmental Health Center  
Icahn School of Medicine at Mount Sinai

---

<sup>15</sup> [http://www.epa.gov/sites/production/files/2016-02/documents/us\\_federal\\_research\\_action\\_plan\\_tirecrumb\\_final\\_0.pdf](http://www.epa.gov/sites/production/files/2016-02/documents/us_federal_research_action_plan_tirecrumb_final_0.pdf)





**Mount Sinai** *Children's  
Environmental  
Health Center*

Position Statement on the use of Recycled Tires in Artificial Turf Surfaces

**Position:** Based upon the presence of known toxic substances in tire rubber and the lack of comprehensive safety studies, The Children's Environmental Health Center of the Icahn School of Medicine at Mount Sinai urges a moratorium on the use artificial turf generated from recycled rubber tires.

**Background:** Recycled rubber artificial turf products were introduced to athletic fields and playgrounds in the 1990s and have since been installed throughout the world with no prior safety testing. Tires are classified as "toxic waste" by federal law because they contain heavy metals, carcinogens, and other toxic substances. Grinding them into very small crumb rubber pellets, utilized on athletic fields, or mulch, utilized on playgrounds and gardens, furthers the risk of exposure by increasing the surface area and the likelihood of accidental ingestion. Children are exposed to harmful substances when pellets touch their skin or are swallowed, and possibly from breathing chemicals released into the air from the surface. In addition to crumb rubber infill, artificial athletic turf consists of synthetic grass blades and several layers of backing materials. To date, the safety of these materials has not been proven. While manufacturers claim that a number of scientific studies indicate low risk of harm from recycled tiring playing surfaces, these studies were not conducted in a rigorous manner comprehensive enough to prove safety.

**Recommendations:** Although we believe that the presence of cancer causing agents and other known toxins in recycled rubber playing surfaces is sufficient reason to mandate the use of safer alternatives, we recognize the need for further scientific study. Prior to the installation of artificial turf fields of any type, studies conducted by independent, academic, or federal research institutions must prove the safety of these products. To be informative, comprehensive studies should consider, at a minimum:

- Exposure assessment under realistic playing conditions.
- All possible routes of exposure: inhalation, ingestion and dermal absorption (through skin).
- Potential health effects not only of individual chemicals, but also of mixtures of chemicals to determine their additive and synergistic effects.

In addition to the above scientific requirements, it is the responsibility of municipalities and installers to assess the opinions and address all concerns of the communities that will be utilizing the fields.

Given mounting concerns about recycled rubber surfaces, several governmental agencies have recently modified their stance on the safety of crumb rubber. On February 12, 2016, the Environmental Protection Agency (EPA), Centers for Disease Control and Prevention/Agency for Toxic Substances and Disease Registry (CDC/ATSDR), and the Consumer Product Safety Commission (CPSC) unveiled the *Federal Research Action Plan on Recycled Tire Crumb Used on Playing Fields and Playgrounds* with the aim of addressing data gaps, characterizing crumb rubber constituents, and assessing exposure pathways. According to the EPA announcement of this collaborative effort, “existing studies do not comprehensively evaluate the concerns about health risks from exposure to tire crumb”. The same conclusion was reached by the California Office of Environmental Health Hazard Assessment in 2015, resulting in a commitment to conduct extensive studies that will include exposure assessment and biomonitoring. ***Based on these recent developments we recommend a moratorium on the installation of crumb rubber playing surfaces pending results of these studies.***



## **Artificial Turf: A Health-Based Consumer Guide**

If your school, community, or business is considering installing an artificial turf field, it's important to be an educated consumer. Many turf products are available and some are even advertised as "green" or "eco-friendly", but it can be difficult to assess their safety for use by children because adequate risk assessment studies that assess all potential routes of exposure during realistic play conditions have not been conducted. This guide will help you dig deeper than the label on the packaging to learn what chemicals these products contain, how children may be exposed to these chemicals, and understand what the potential health risks may be.

This Guide will:

- (1) describe turf infill options and chemicals of concern*
- (2) identify how children can be exposed to these chemicals*
- (3) explain potential health risks associated with certain artificial turf products*
- (4) suggest questions to ask manufacturers (and the answers you want to hear)*
- (5) provide tips for safer play on artificial turf*

### **TOP 7 TIPS TO BEING AN EDUCATED TURF CONSUMER**

1. Research the various infill options and turf companies.
2. Understand the long-term health concerns, both chemical and non-chemical, associated with artificial turf.
3. Ask the turf companies for detailed product information and environmental testing.
4. Request a product sample and the appropriate testing that ensures that the product does not contain dangerous chemicals.
5. Follow best practices for play on artificial turf if one is installed.
6. Consider all costs for the full life cycle of the product.
7. Determine whether natural grass is a feasible alternative.

## What is artificial turf?

Synthetic or artificial turf is a multi-layer product used as a surface on athletic playing fields, playgrounds, golf courses, and residential lawns. It typically consists of:

- a top layer of **fibers** usually made from usually nylon, polypropylene, polyethylene designed to mimic natural grass blades
- **infill** to provide cushioning and serve as a base for the blades
- a **backing layer** to which the blades are sewn
- a **drainage layer**
- additional **padding layers** in some applications

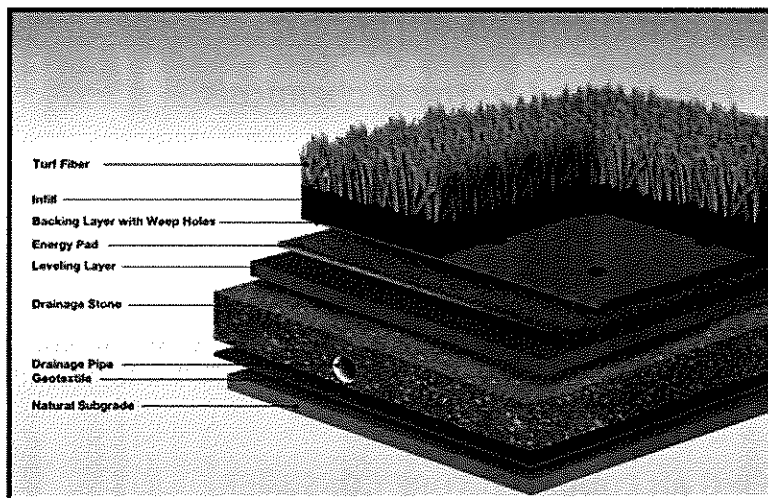

Figure 1. Anatomy of Artificial Turf  
Source: Synthetic Turf Council

## What health risks are associated with play on artificial turf?

### (1) Chemical Exposures

Chemicals that are known or suspected to be carcinogenic or toxic to the nervous or reproductive systems have been detected in turf infill and the surrounding air (Table 1). Exposures to chemicals from turf occurs through:

- **Inhalation** of Volatile Organic Compounds (VOCs) and small particulates
- **Dermal contact and absorption** through the skin or open wounds: Many of the components of turf may contain chemicals and even leach out of the product, increasing potential for dermal exposure upon contact.



- **Ingestion:** Turf infill particles are very small and can be ingested as can chemicals that leach from turf and accumulate on hands.
- Exposure levels are affected by weather conditions, temperature, and type of activity (i.e. physical impact on the turf itself and ventilation rate of the individual)
- **Tire rubber composition is highly variable** across manufacturers, and test results have identified numerous chemicals of concern in turf containing crumb rubber infill.

## **(2) Non-chemical Exposures**

---

- **Heat:** Because synthetic turf is typically dark and does not vaporize water, surface temperatures can get up to 60 degrees higher than natural grass and have been measured as high as 160 degrees on a summer day.
- **Latex allergy:** synthetic rubber contains latex in relatively low concentration; individuals with latex allergy should be warned about possible allergic reactions.
- **Contact injuries:**
  - Athletes playing on turf fields have been shown to have more abrasions or “turf burns,” which in turn can harbor infection.
  - Artificial turf may increase the rate of contact injuries such as knee injuries and concussions, however data is conflicting.

## **What Chemicals Should I Be Concerned About?**

---

Of all the turf components, the greatest concern for harmful exposures comes from the infill. There are currently several types of infill available, but to date we know the most about “crumb rubber” infill. Crumb rubber is made from recycled tires. The eco-friendly term sometimes used to advertise crumb rubber turf fields refers to the fact that by repurposing the tires into turf fields, hazardous tire waste is not going to landfills. However, because the lifespan of a turf field averages 10 years, the hazardous tire materials will eventually need to be safely disposed of.

Tire rubber composition is highly variable across manufacturers, making it difficult to know concentrations of individual chemicals. Below is a partial list of chemicals of concern known to present in artificial turf made from recycled rubber. Some of these chemicals may also present in artificial turf products that do not contain recycled crumb rubber, however manufacturers are not required by law to disclose the chemical content of their turf products, so this information is not publicly available. We will continue to update this guide as more information becomes available.

**Table 1. Partial list of chemicals of concern present in crumb rubber artificial turf infill\***

<b>Chemical</b>	<b>Potential Health Effect</b>
Benzene	Known human carcinogen
Arsenic	Known human carcinogen <sup>i</sup>
Styrene	Reasonably anticipated to be a human carcinogen
Polycyclic aromatic hydrocarbons (PAHs)	Reasonably anticipated to be a human carcinogen <sup>ii</sup>
Lead	Neurotoxicant
Zinc	Neurotoxicant
Cadmium	Known human carcinogen <sup>i</sup>
Chromium	Known human carcinogen <sup>i</sup> Respiratory irritant
VOCs and SVOCs (e.g. benzothiazole, hexane, toluene, formaldehyde)	Respiratory irritants or asthma triggers Neurotoxicants Some are known human carcinogens <sup>i</sup>
Phthalates	Reproductive toxicant
Crystalline Silica	Known human carcinogen <sup>i</sup> Respiratory irritant
Latex	Allergen
Particulate matter	Respiratory irritant or asthma trigger

\*For a complete list of chemicals of concern identified in turf see [http://www.nyc.gov/html/doh/downloads/pdf/eode/turf\\_report\\_05-08.pdf](http://www.nyc.gov/html/doh/downloads/pdf/eode/turf_report_05-08.pdf)

## Digging Deeper

As concerns about hazardous exposures from crumb rubber infill have mounted, several alternative fills have been developed. Below is a table of some of the options currently available. To date we know very little about the composition and consequences of playing on the newer generations of crumb rubber infill alternatives.

**Table 2. Available Infill Types**

<b>Type of Infill</b>	<b>Infill Details</b>	<b>Health Concerns</b>
<b>Crumb Rubber</b>	<ul style="list-style-type: none"> <li>• Most common type of infill, particularly on athletic fields</li> <li>• Made from shredded recycled tires (“Ambient” or Cryogenic” refers to the temperature at which the tires are shredded)</li> <li>• Crumbs are less than 3mm in diameter</li> <li>• 200,000lbs of crumbs per average playing field (2-3lb per square foot, 2-3 inches deep)</li> <li>• May be mixed with silica sand</li> </ul>	<ul style="list-style-type: none"> <li>• Extreme heat</li> <li>• Contact injuries</li> <li>• Chemical exposures to carcinogens and neurotoxins (See Table 1)</li> <li>• Exposure can occur by inhaling the off-gases, by absorbing chemicals through skin contact and, possibly, by ingesting particles that are airborne or transported into children’s mouths by hand contact.</li> </ul>
<b>Coated Crumb Rubber</b>	<ul style="list-style-type: none"> <li>• Crumb rubber may be coated with <b>colorants, sealers, or anti-microbial</b> substances for aesthetics, hygienic purposes, and to reduce dust generated during manufacturing</li> </ul>	<ul style="list-style-type: none"> <li>• Same as crumb rubber but possible reduction in heat and dust</li> <li>• Coating may contain additional chemicals of concern</li> </ul>
<b>Rubber or Foam Padding</b>	<ul style="list-style-type: none"> <li>• Made from recycled tires</li> <li>• Often used as an alternative to crumb rubber on playgrounds and residential lawns</li> </ul>	Similar to crumb rubber but possible reduction in exposure by ingestion in absence of tire crumbs
<b>Sand (Silica)</b>	<ul style="list-style-type: none"> <li>• One of the original infilling materials utilized in synthetic turf</li> <li>• Natural product</li> <li>• Often used in conjunction with other infills such as crumb rubber or coated with elastomer or acrylic</li> <li>• Acts as a shock absorber when coated</li> </ul>	Possible respiratory irritation if inhaled

<b>EPDM (Ethylene Propylene Diene Monomer)</b>	<ul style="list-style-type: none"> <li>• A synthetic vulcanized rubber polymer elastomer resistant to abrasion and wear</li> <li>• May be generated from recycled or new (“virgin”) material</li> <li>• Also contains UV stabilizers, anti-oxidants, chalk, pigments, flame retardants, and vulcanizing agents such as zinc oxide</li> <li>• Purportedly free of heavy metals</li> <li>• Few toxicological and risk assessment studies exist</li> </ul>	<p><b>Insufficient data</b> on chemical exposures due to limited studies that assess composition, off gassing, leaching, and associated potential health effects</p>
<b>TPE (Thermoplastic Elastomer)</b>	<ul style="list-style-type: none"> <li>• Polymer of rubber and plastic resistant to abrasion and wear</li> <li>• Composed of ethylene, butadiene and styrene copolymers or polyurethane elastomers generated utilizing isocyanides</li> <li>• May also contain UV stabilizers, anti-oxidants, chalk, pigments, and flame retardants</li> <li>• “Virgin” material, not made from recycled materials</li> <li>• Purportedly free of heavy metals</li> <li>• Can be reused or recycled</li> <li>• Few toxicological and risk assessment studies exist</li> </ul>	<ul style="list-style-type: none"> <li>• <b>Insufficient data</b> on chemical exposures due to limited studies that assess composition, off-gassing, leaching, and associated potential health effects</li> <li>• Styrene and butadiene are classified as carcinogens by the World Health Organization. The effects of human exposure to these substances from turf infill are not yet known as specific studies have not yet been conducted.</li> </ul>
<b>Nike Grind or Eco Grind</b>	<ul style="list-style-type: none"> <li>• Rubber infill generated from recycled athletic shoes and leftover materials from Nike manufacturing</li> <li>• May be mixed with sand</li> <li>• May contain heavy metals</li> </ul>	<p>Similar to crumb rubber from recycled tires:</p> <ul style="list-style-type: none"> <li>• Extreme heat exposure</li> <li>• Contact injuries</li> <li>• Chemical exposures to carcinogens and neurotoxins (See Table 1)</li> </ul>

- 
- |  |  |
|--|--|
| <p><b>“Organic” Infill</b></p> <ul style="list-style-type: none"><li>• Natural cork and/or ground fibers from the outside shell of the coconut (sometimes referred to as “corkonut,” or rice husks)</li><li>• Can be recycled directly into the environment</li><li>• Purported to absorb less heat and more humidity than crumb rubber infill</li></ul> | <ul style="list-style-type: none"><li>• Possible reduced heat exposure compared with rubber surfaces</li><li>• <b>Insufficient data</b> on chemical exposures due to limited studies that assess composition, off-gassing, leaching, and associated potential health effects</li></ul> |
|--|--|
- 

## **Be An Educated Artificial Turf Consumer**

- o Beware of **greenwashing**: the use of terms like “organic”, “green”, and “Eco” do not guarantee safety. In fact, those terms are not regulated for turf products, so their meaning in this context is at best ambiguous.
- o Choose companies that are transparent and disclose all materials<sup>1</sup>. Note that an MSDS sheet does NOT disclose all chemicals used in the product. To obtain complete disclosure, ask manufacturers to list all components in writing.
- o Contact the CEHC to discuss testing options and results.
- o Consider the possibility of maintaining a grass field with an underground drainage system
- o **ASK the turf company:**
  - **Are the infill materials new (“virgin”) or recycled?**  
*It’s possible to obtain a full ingredients list for new materials, versus recycled which vary from lot to lot.*

---

<sup>1</sup>Toxicological profiles of potential chemicals of concern can be found at: <http://www.atsdr.cdc.gov/substances/indexAZ.asp>: The Agency for Toxic Substances and Disease Registry, a federal public health agency of the U.S. Department of Health and Human Services, maintains a Toxic Substances Portal, a searchable database of chemicals that includes exposure risks and health effects.

<http://www.epa.gov/iris/> EPA’s Integrated Risk Information System (IRIS) is a human health assessment program that evaluates information on health effects that may result from exposure to environmental contaminants. The searchable IRIS database contains information on more than 550 chemicals.

- **What additives and coatings are used on the blades and infill such as colorants, sealants, antimicrobials, and flame retardants?**

*Many of these may be chemicals of concern and can leach from the product.*

- **What is the composition of each layer including fiber blades, infill, and backing?**

*Although much of the focus is on infill, all components of a turf field contain potential chemicals of concern.*

- **Are Safety Data Sheets (SDS or MSDS) available that discuss each component?**

*SDS or MSDS sheets are documents that contain information on potential hazards (health, fire, reactivity, and environmental) of a chemical product as well as safe handling procedures. Because manufacturers are not required to disclose all ingredients on an MSDS sheet, only those they deem to be potentially hazardous, these forms cannot be relied on as "ingredient lists." However any turf company that you choose should be able to provide a complete list of chemical components for their product.*

- **Has the turf been tested under realistic play conditions for heat generation, off-gassing, and particulate matter generation?**

*Ideally this testing has been conducted by a third party that is not a paid consultant to the turf company. At a minimum the company should be able to provide you with their own test results or those of a consultant they have hired.*

- **What products are required to sanitize (i.e. fungicides and antimicrobials) and clean the field and how often must they be applied?**

*These products not only increase the likelihood of chemical exposures, they may increase maintenance costs. It's important that manufacturers are upfront about all maintenance requirements. In addition, antimicrobials and fungicides may pose health risks for children chronically exposed to them.*

#### Other Considerations

- The lifespan of various turf options - how soon will it need to be replaced?
- Are there hidden costs such as those required for disposal of crumb rubber?
- Will the turf be indoors or outdoors? Inhalational exposures are likely to be higher indoors without proper ventilation.
- Ecotoxicity - Chemicals from artificial turf may be toxic to wildlife. Some studies have shown that new generations of turf such as EPDM are more toxic to aquatic life than crumb rubber
- Siting of the field - is it in close proximity to water sources that may be contaminated by runoff?

#### Tips for Safer Play on artificial turf surfaces

- If you select a turf field that does contain chemicals of concern, post a safety warning on your field to keep players and spectators safe
- Avoid use on very hot days
- Avoid use for passive activities (i.e. sitting, lounging, picnicking)
- Ensure good ventilation of indoor fields by opening doors and windows and utilizing fans
- Monitor young children to prevent accidental ingestion
- Always wear shoes on artificial turf
- Wash hands before eating, drinking, or adjusting mouth guard
- Clean cuts and abrasions immediately
- Brush hair thoroughly after play
- Remove and clean shoes and gear outside before getting in car
- At home, take off shoes and shake out your children's equipment and clothes outside or over the garbage
- Shower immediately after playing on artificial turf
- Vacuum any infill that comes into your home

## Additional Resources

[http://www.ct.gov/dph/lib/dph/environmental\\_health/eoha/pdf/artificial\\_turf\\_tech\\_fs\\_10-07.pdf](http://www.ct.gov/dph/lib/dph/environmental_health/eoha/pdf/artificial_turf_tech_fs_10-07.pdf)

[http://www.nyc.gov/html/doh/downloads/pdf/eode/turf\\_report\\_05-08.pdf](http://www.nyc.gov/html/doh/downloads/pdf/eode/turf_report_05-08.pdf)

<http://www.calrecycle.ca.gov/publications/Documents/Tires/2010009.pdf> 2010 CA report

<http://www.nbcnews.com/news/investigations/how-safe-artificial-turf-your-child-plays-n220166>

[http://www.ct.gov/deep/cwp/view.asp?a=2690&Q=463624&depNav\\_GID=1511](http://www.ct.gov/deep/cwp/view.asp?a=2690&Q=463624&depNav_GID=1511)

[http://www.ehhi.org/reports/turf/health\\_effects.shtml](http://www.ehhi.org/reports/turf/health_effects.shtml)

[http://www.wellesley.ma.gov/pages/WellesleyMA\\_SpragueResources/TPE%20vs%20EPDM%20vs%20SBR%20and%20quality.pdf](http://www.wellesley.ma.gov/pages/WellesleyMA_SpragueResources/TPE%20vs%20EPDM%20vs%20SBR%20and%20quality.pdf)

[https://www.health.ny.gov/environmental/outdoors/synthetic\\_turf/crumb-rubber\\_infilled/docs/fact\\_sheet.pdf](https://www.health.ny.gov/environmental/outdoors/synthetic_turf/crumb-rubber_infilled/docs/fact_sheet.pdf)

<http://www.zeofill.com/Prop-65.html>

<http://www.syntheticurfCouncil.org/?page=FAQs>

Ginsberg G, Toal B, Kurland T.m(2011) Benzothiazole toxicity assessment in support of synthetic turf field human health risk assessment. *J Toxicol Environ Health A*. 74(17):1175-83. doi: 10.1080/15287394.2011.586943.

**Cheng H, Hu Y, Reinhard M. (2014) Environmental and health impacts of artificial turf: a review.** *Environ Sci Technol*. Feb 18;48(4):2114-29. doi: 10.1021/es4044193.

<http://www.forbes.com/sites/mikeozanian/2014/09/28/how-taxpayers-get-fooled-on-the-cost-of-an-artificial-turf-field/>