

# NOMENCLATURE

## PLAYPENS

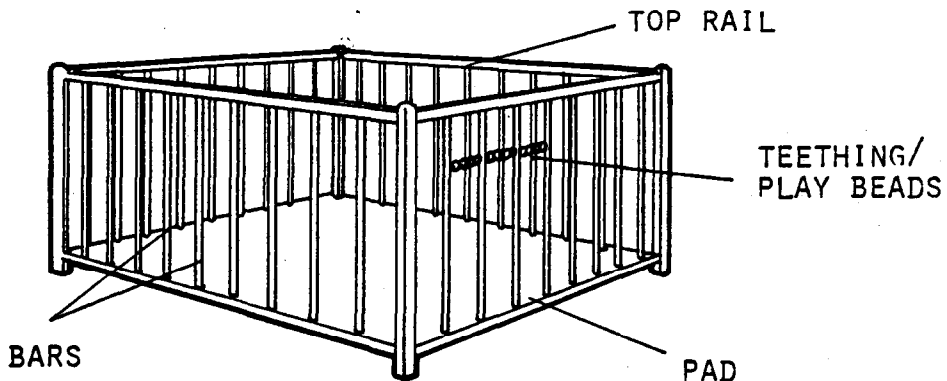

WOODEN TYPE

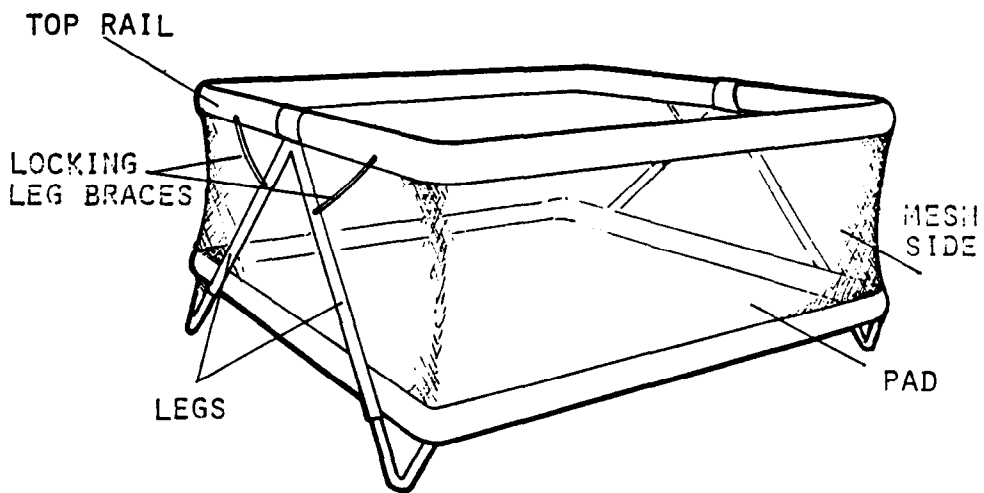

MESH TYPE

# HAZARD PATTERNS

## PLAYPENS

A

Chewing playpens: Child chews soft plastic edge or parts of playpen and chokes on piece removed.



B

Product failure: Part of playpen breaks, wears out or is constructed in such a way to cause hazard.



C

Cut on sharp edge: Child playing normally or trying to 'escape' cuts self on sharp edge.



D

Interference: Victim is pushed or pulled into playpen or person closing playpen is unaware that child will be trapped by closure.



THE VICTIM

Describe supervision/supervisor;  
in room at time of accident;  
attentive/distracted during  
accident; number and ages of  
children being watched

Any instructions/warnings with  
playpen received/understood; how  
and when received

Familiar with this playpen; how  
often/length of time used

Playpen was child's or other;  
length of use each time

Any teeth/how many; which ones  
(DIAGRAM)

A B C D

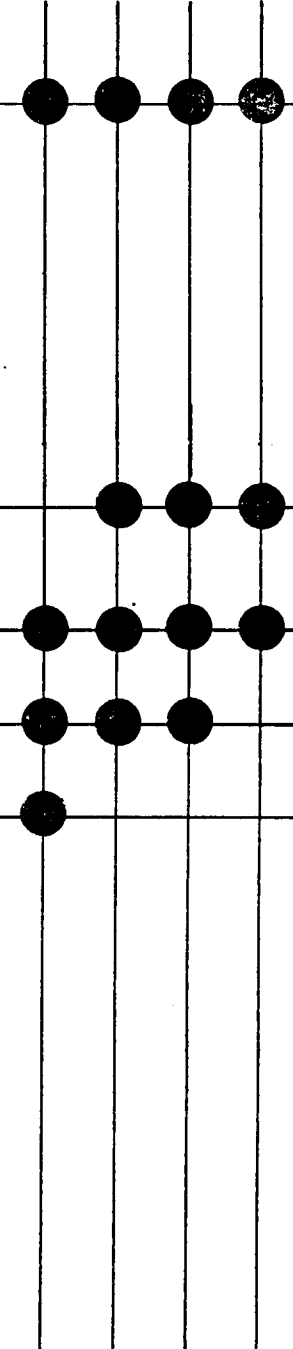

# GUIDELINES PLAYPENS

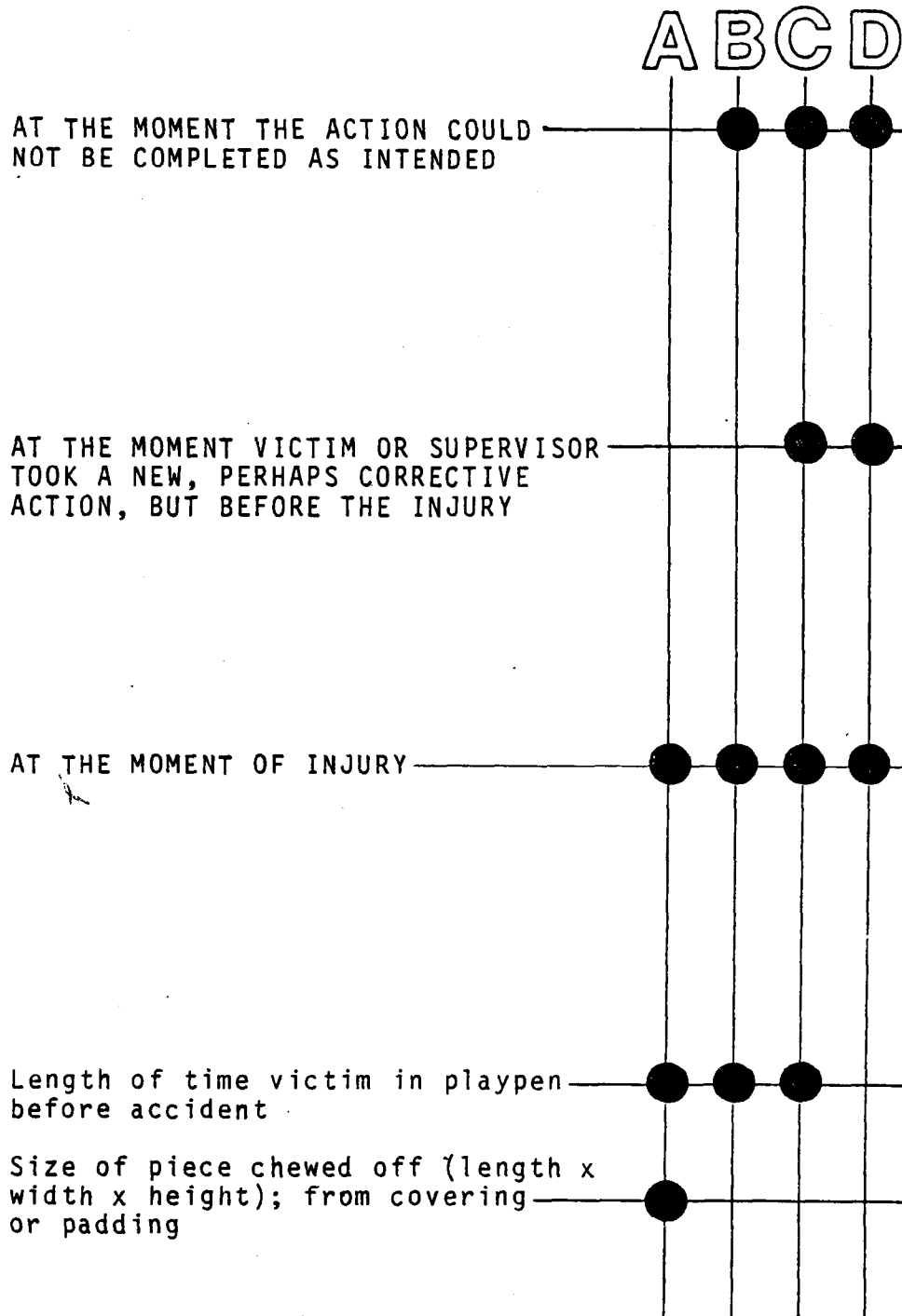

# GUIDELINES PLAYPENS

Appendix 84

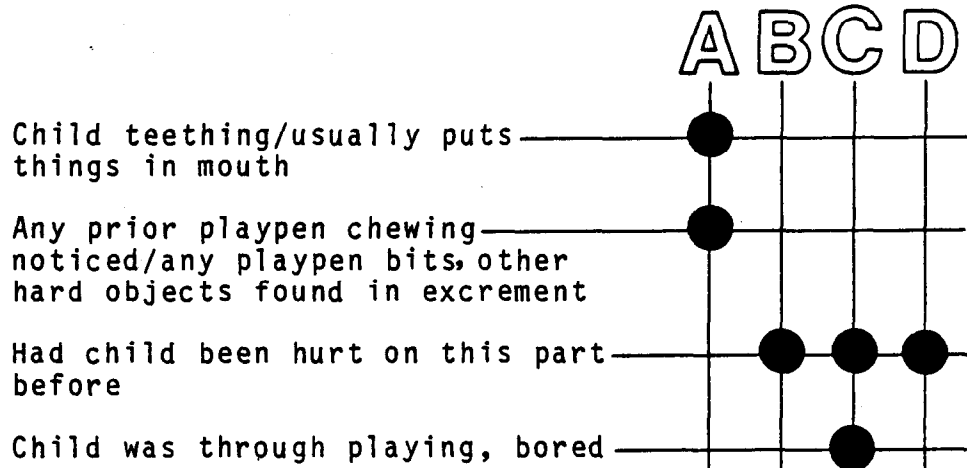

## THE TASK

*PHOTOGRAPH or DIAGRAM the following four-part sequence. In each part show the victim's and supervisor's body, limb and hand positions, playpen location and surroundings. With very young children entire sequence might not be known. Describe ACTIONS:*

INTENDED BY VICTIM OR SUPERVISOR IMMEDIATELY BEFORE THE ACCIDENT (what victim and supervisor were trying to do)	●	●	●	●
---	---	---	---	---

# GUIDELINES PLAYPENS

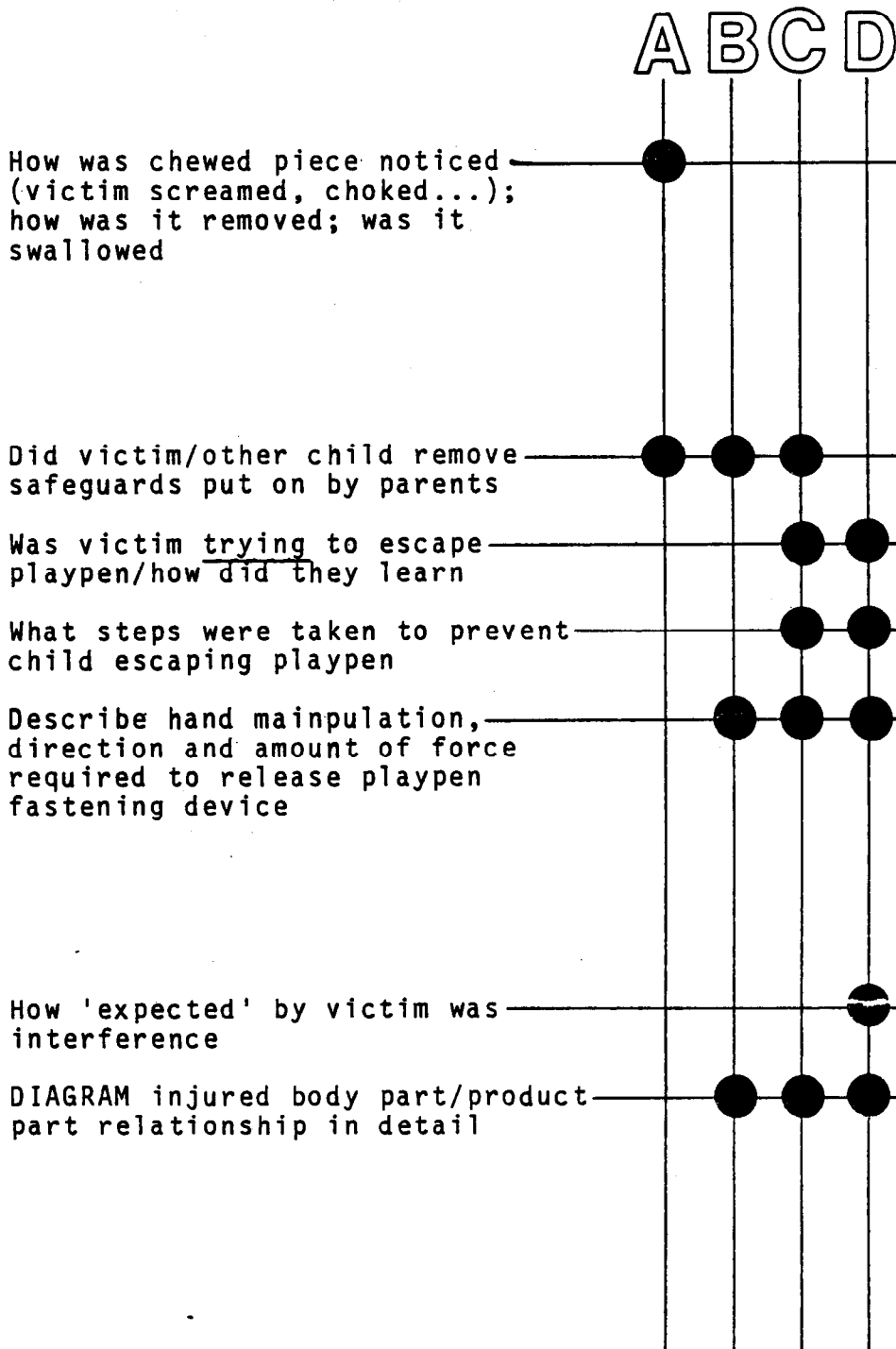

	A	B	C	D
<u>THE ENVIRONMENT</u>				
Any loud noises (lawnmower/TV/music...) masking sound of child's playing/crying...before accident	●	●	●	●
Victim at home/other's home/day-care...				●
If victim reaching for something (toy, bottle) possibly causing accident, describe object and where placed			●	
Lighting/could supervisor see victim				●
<u>THE PRODUCT</u>				
Covering, piping/padding material type, thickness and texture, measure if possible, and describe; any teething beads	●			
Playpen new/used; age	●	●	●	●

# GUIDELINES PLAYPENS

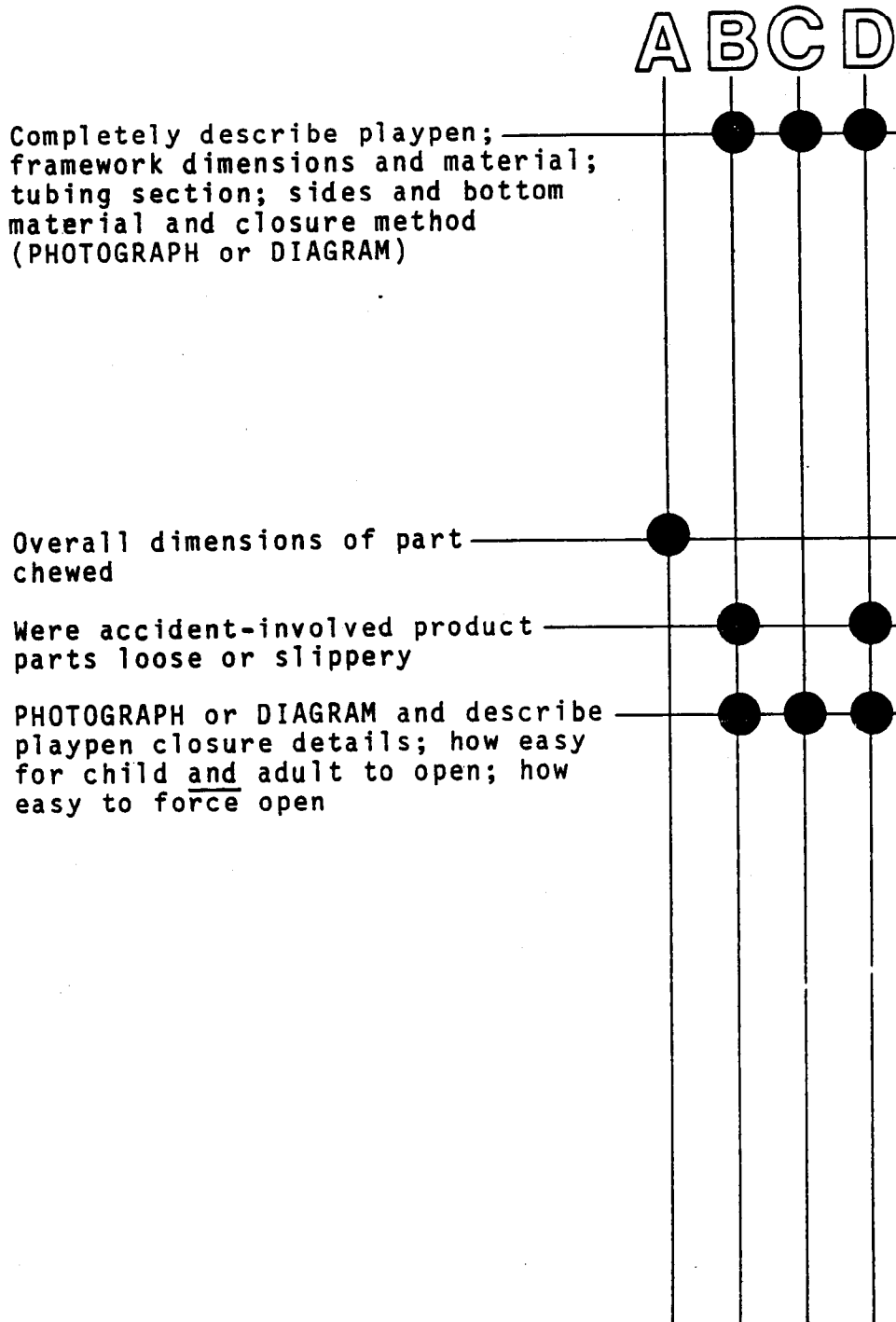



# GUIDELINES PLAYPENS

