

2017-18 Open Season Express

Call to OPM IVR (1-800-332-9798)

Welcome to Open Season Express, a service for federal retirees and survivor annuitants. In the event of your death your spouse may continue enrollment in the FEHB program as their survivor only if you are enrolled in Self Plus One or Self and Family at the time of death and you elected to provide a survivor benefit for their spouse. 100

If you are a current Federal Employee, please contact your Human Resources office for information regarding health benefits enrollment changes. If you pay your health benefit premiums directly to OPM and have questions, please contact the National Finance Center at 1-800-242-9630. For workers compensation questions please call the Department of Labor's toll free number 1-866-486-2365, Monday through Friday from 8am to 8pm eastern time. 154

If you are calling to enroll or change your dental or vision coverage, please call Benefeds at 1-877-888-3337. If you are interested in what a particular plan may offer, please contact the plan directly. To enroll or change your health benefits for Open Season Express, please remain on the line. Thank you. 121

The 2017 Federal Benefits Open Season will be held November 13th, 2017 through December 11th, 2017. 128

Check host hours

Our system is not available at this time. Please call later. 216

Exit

inside

We offer service in English and Spanish. 170

For English, press 1. 171

Para Espanol, oprima dos. 172

1 (or default)

2
SPANISH

INT

You can also complete transactions by logging onto retireefehb.opm.gov. 238

Share your email address with us so we can communicate with you electronically. To do this, log on to either of our websites: <https://retireefehb.opm.gov> or www.servicesonline.opm.gov. Please refer to the open season mailer you received in the mail to ensure you have the web site address spelled correct. 239

Before using the Health Benefits Open Season Express, please have available your CSA or CSF annuity claim number and your social security number. For enrollment changes into a Self Plus One or Self and Family plan, we will need your dependent's name, social security number, date of birth and any other private insurance they may have. Please have this information on hand when speaking to the customer service representative 101

After making your request, please wait to hear the message, "We have processed your transaction" before making another request or ending your call. 283

At the end of your call, you will be given the opportunity to complete a satisfaction survey. 164

A
To leave Open Season Express at anytime during this menu, press 9. (short pause)
To make a health benefit enrollment change, press 1.
To request health benefit plan brochures, press 2.
To request an Open Season Health Benefits Guide, press 3.
To request other Open Season information to be mailed to you, press 4.
To request a Change of Address, or if you need a password reset, press 0.
To hear the list of options again, press *.
102

options 1-4

Check to see if claim/ssn has been verified

Yes

FF

No

C

9

0

Exit

operOpt

Claim/SSN Verification

C

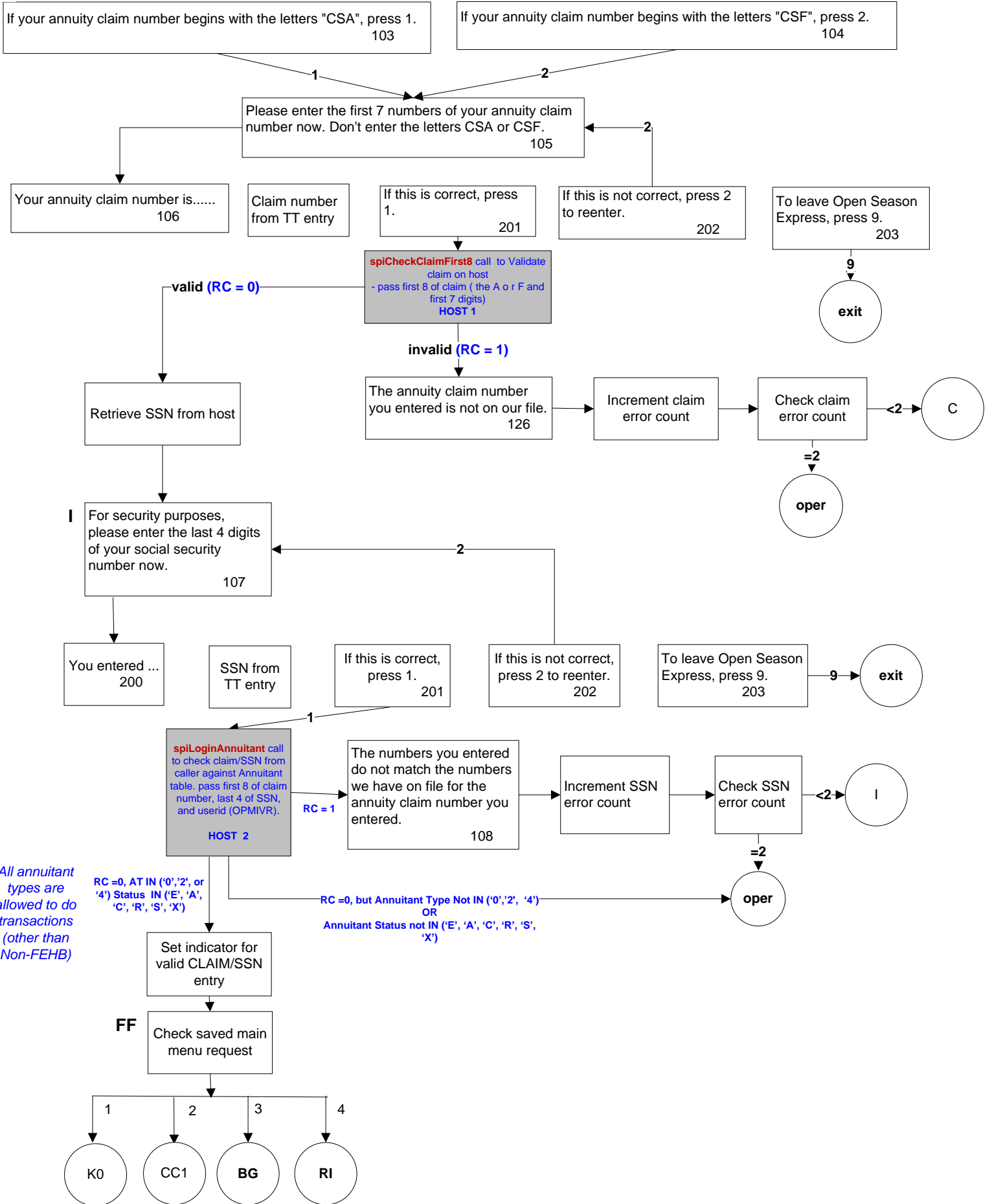

Request Information Sub-menu

RI

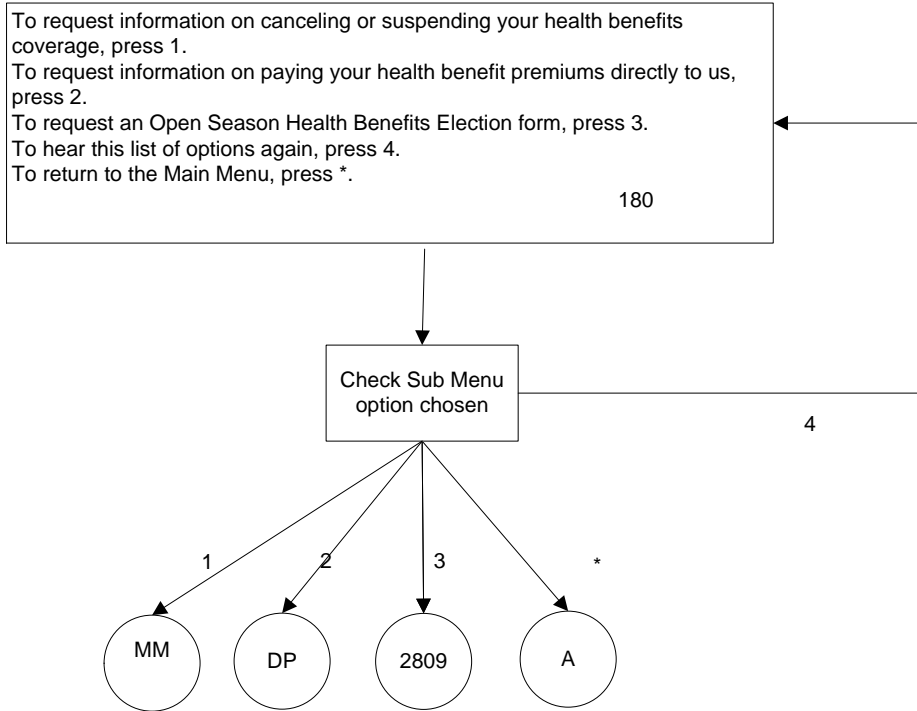

K0

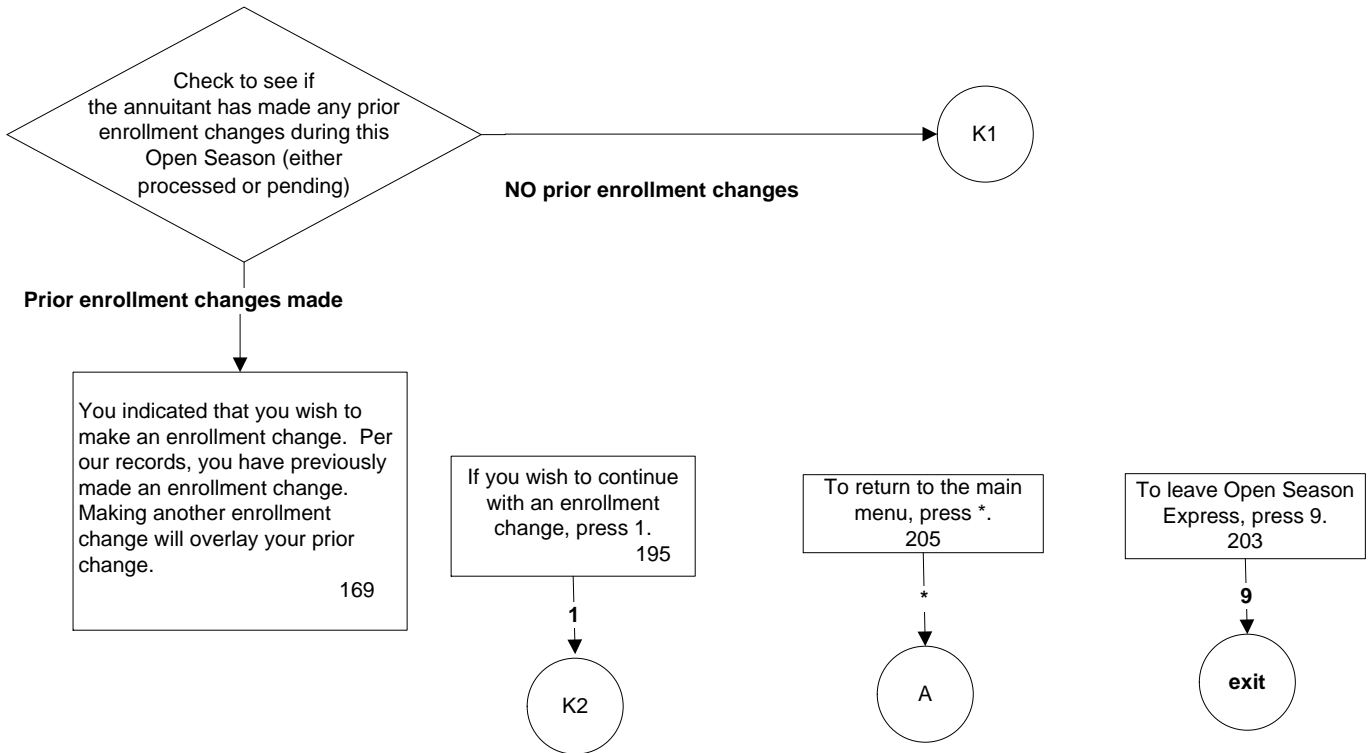

Enrollment Requests

K1

To make an enrollment change, you will need the first 2 characters for the health benefit plan you are selecting for 2018. You indicated that you wish to make an enrollment change. **166**

If this is correct, press 1. **201**

To return to the main menu, press *. **205**

To leave Open Season Express, press 9. **203**

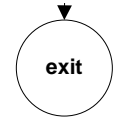
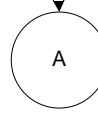

K2 If you want self only coverage, press 1. **115**

If you want self plus one coverage, press 2. **181**

If you want self and family coverage, press 3. **116**

1 - Self only

3 - Self and family
In order for your self and family enrollment to be processed, you must provide dependent information by speaking to a customer service representative. **177**

2 - Self plus one
In order for your self plus one enrollment to be processed, you must provide dependent information by speaking to a customer service representative. **182**

operOpt

Is annuitant's Date of Birth missing?

YES

NO

Is the annuitant's gender missing?

No

Yes

If you are male, press 1. If female, press 2. **262**

1

2

You selected male **173**

You selected Female **174**

If this is correct, press 1. **201**

If this is not correct, press 2 to re-enter. **202**

1

Reset Gender Missing flag to "N"

Please enter your 2 digit birth month, 2 digit day, and 4 digit birth year using your telephone keypad. **1204**

Edits for valid Date of Birth entry

You entered... **200**

Entry from caller

If this is correct, press 1. **201**

If this is not correct, press 2 to re-enter. **202**

Valid entry

Reset DOB missing flag to "N".

1

2

Please remember, your enrollment change will not be complete until you hear the message, "We have processed your transaction." **284**

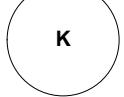

Enrollment Requests

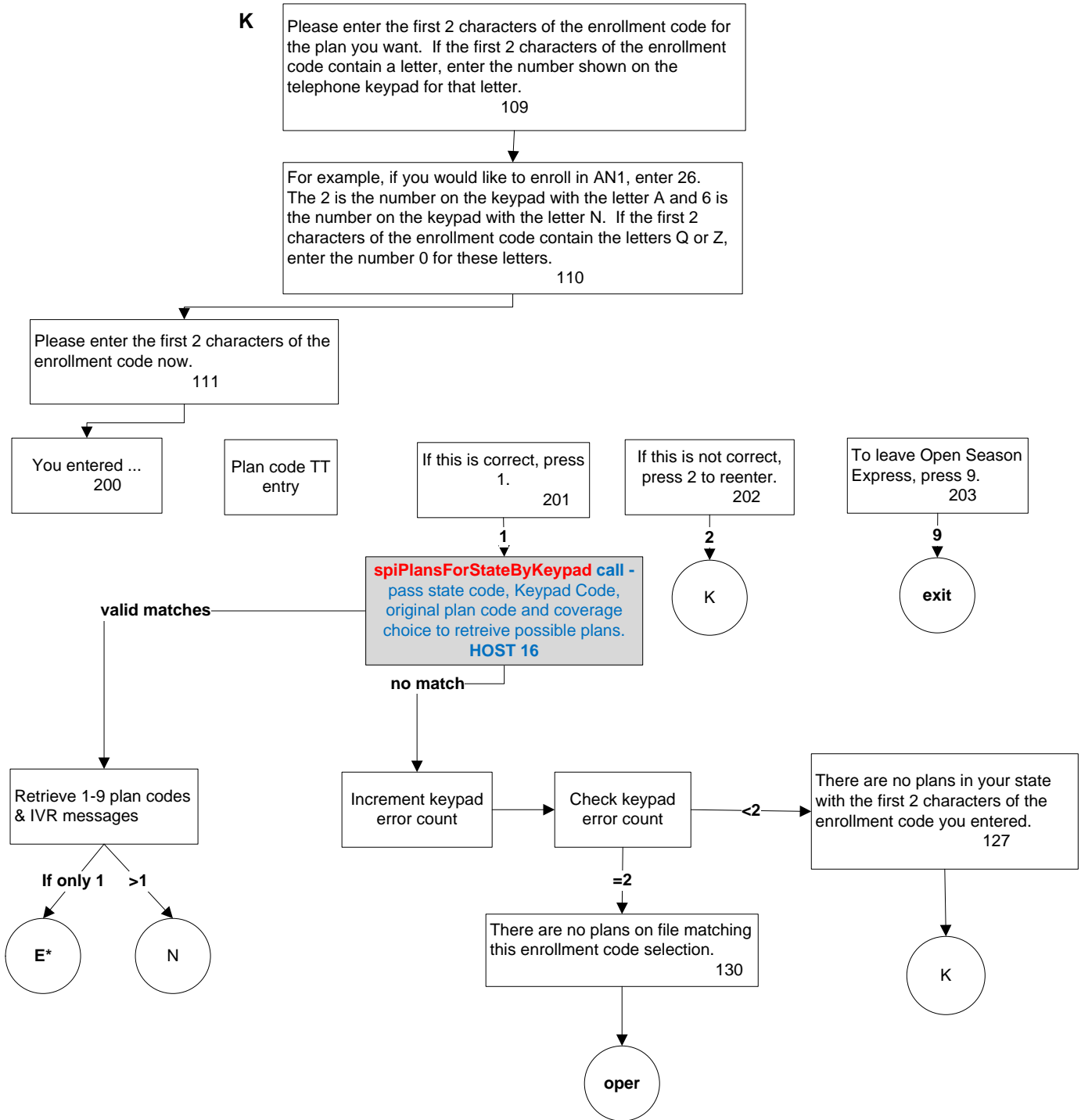

Enrollment Requests

N

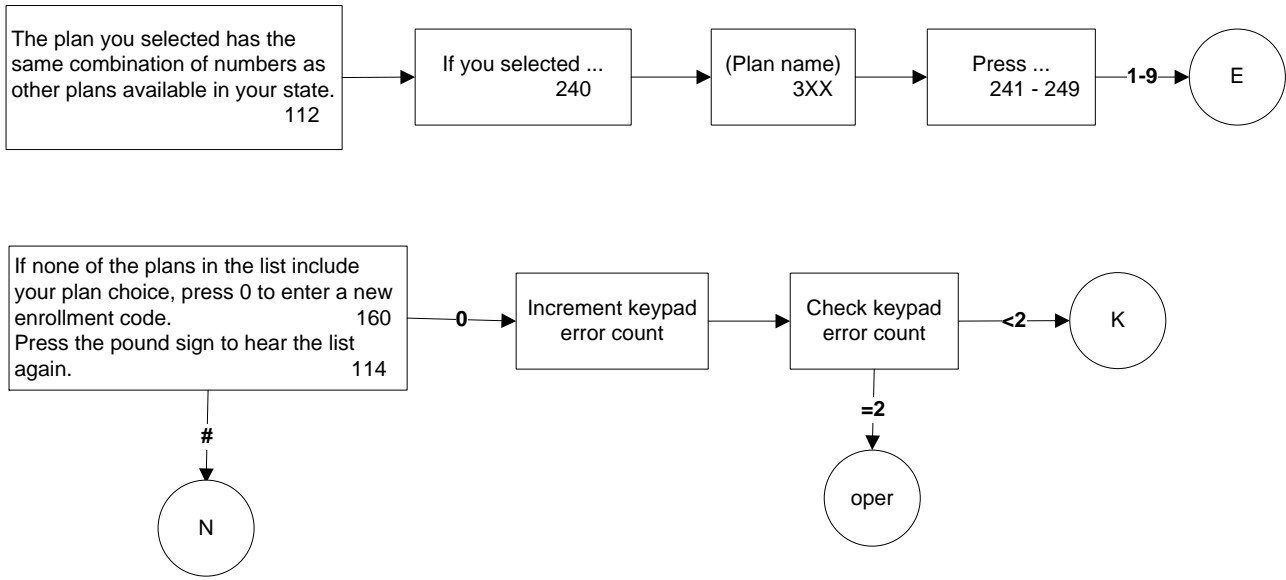

E

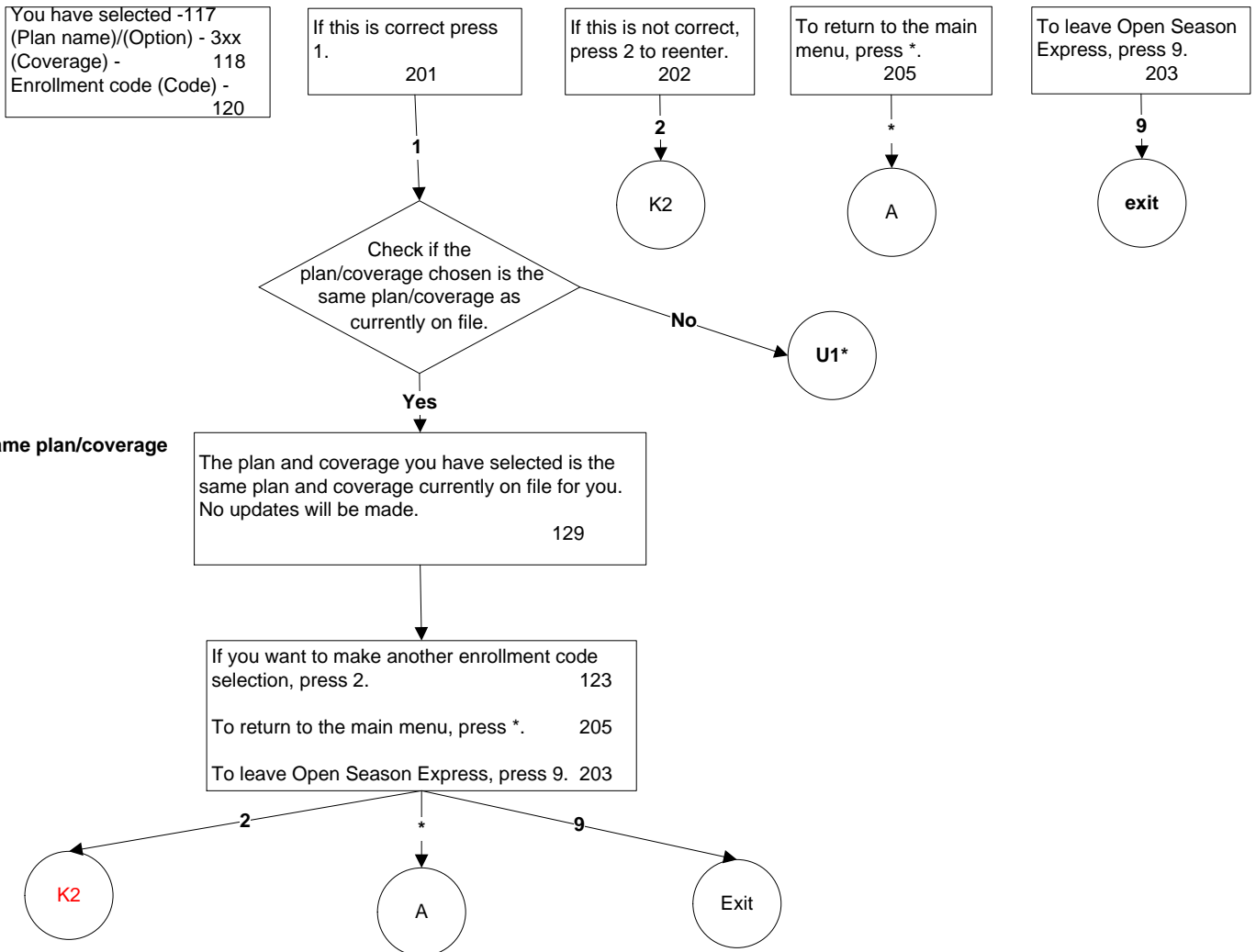

Enrollment Requests Self Only

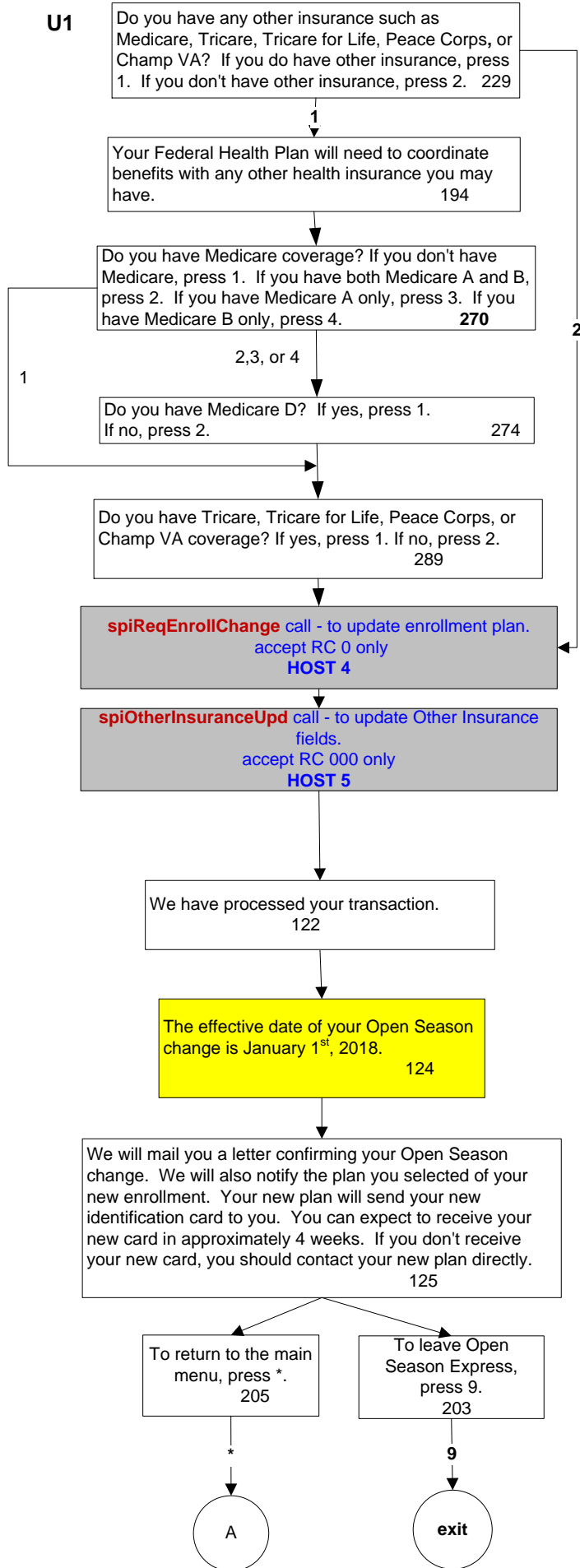

Brochure Requests

CC1

To request health benefit brochures, you will need the first 2 characters of the enrollment code for the brochure or brochures you are requesting.
You indicated that you wish to receive plan brochures.
165

If this is correct, press 1.
201

To return to the main menu, press *.
205

To leave Open Season Express, press 9.
203

spiChkNumBrochReqs call -
pass claim no. (Returns the number of brochures requested but not yet processed).
HOST 13

Is number of brochures > 9?

YES

You have reached the maximum number of plan brochure requests that we can process through our system **in one day**.
155

To return to the main menu, press *.
205

To leave Open Season Express, press 9.
203

Please remember, your brochure request will not be complete until you hear the message, "We have processed your transaction."
285

CC

Please enter the first 2 characters of the enrollment code for the brochure you want. If the first 2 characters of the enrollment code contain a letter, enter the number shown on the telephone keypad for that letter.
144
For example, if you would like to request brochure AN1, enter 26. The 2 is the number on the keypad with the letter A and 6 is the number on the keypad with the letter N. If the first 2 characters of the enrollment code contain the letters Q or Z, enter the number 0 for these letters.
151

Please enter the first 2 characters of the enrollment code now.
111

You entered ...
200

Plan code TT entry

If this is correct, press 1.
201

If this is not correct, press 2 to reenter.
202

To leave Open Season Express, press 9.
203

spiBrochsForStateByKeypad call
pass state code, Keypad Code, to retrieve possible plans.
HOST 17

valid matches

no match

Retrieve 1-9 plan codes & IVR messages

There are no plans in your state with the first 2 characters of the enrollment code you entered.
127

Increment keypad error count

Check keypad error count

If only 1
PP

>1
O

Requests < 1 and 2nd request invalid

There are no plans on file matching this enrollment code selection.
130

To re-enter the 2 digit brochure code, press 1.
163

To hear the list of plan brochures you have requested, press 2.
146

CC

EE

oper

Brochure Requests

PP

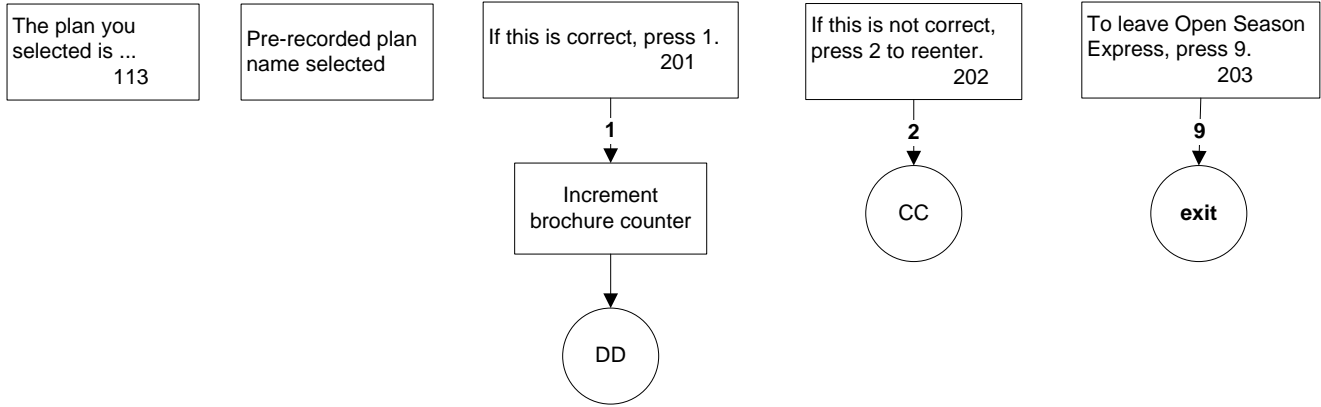

O

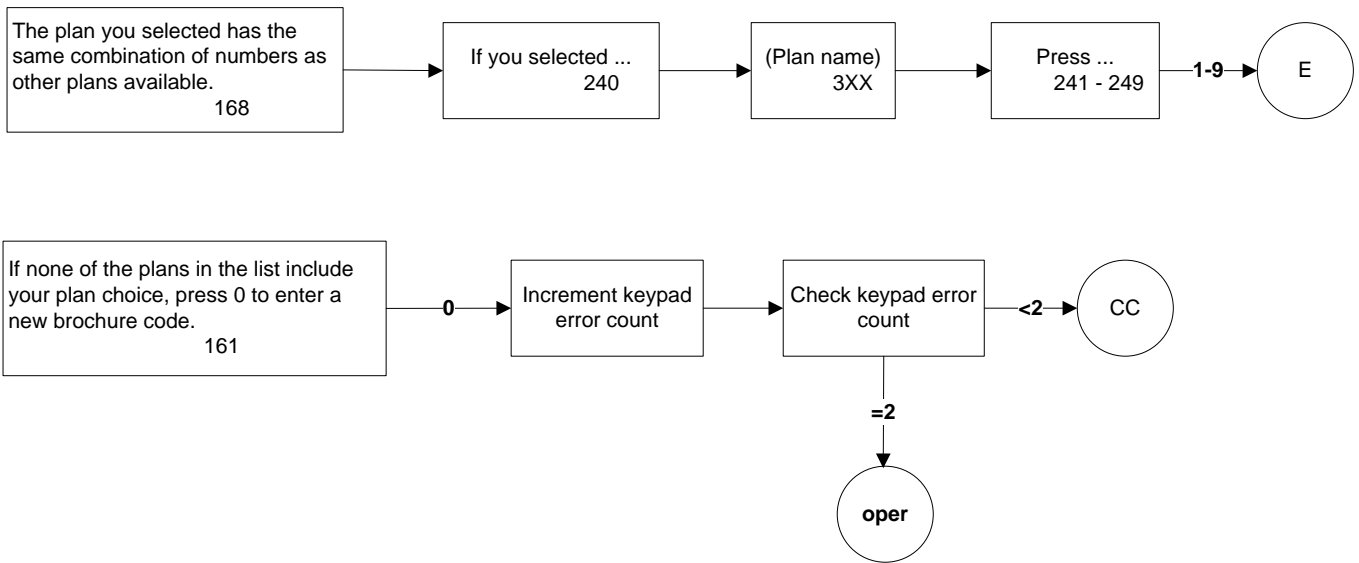

E

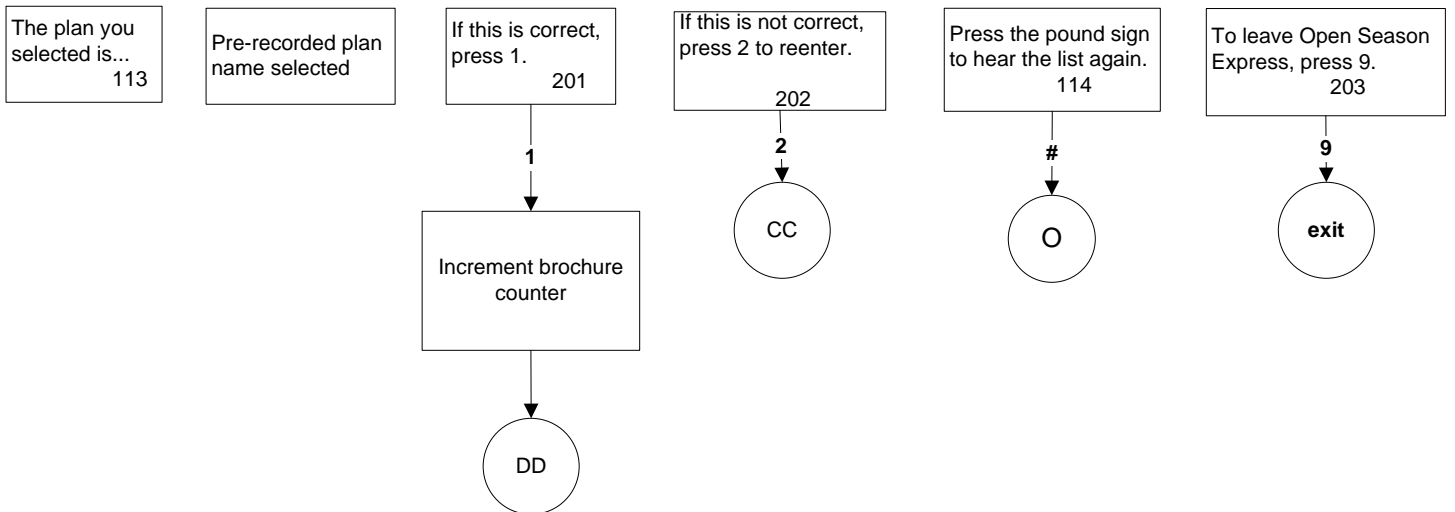

Brochure Requests

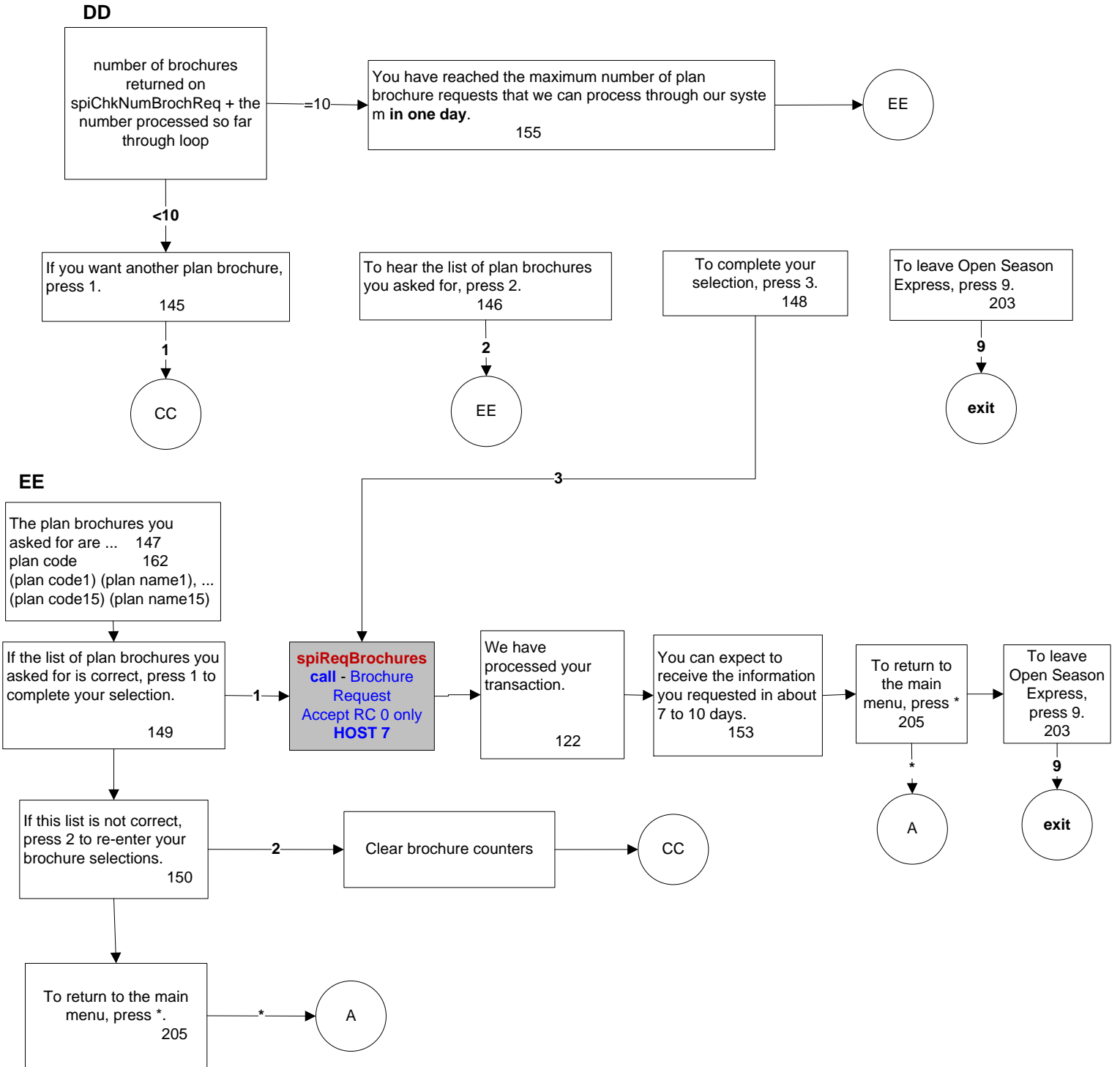

Suspend/Cancel

MM

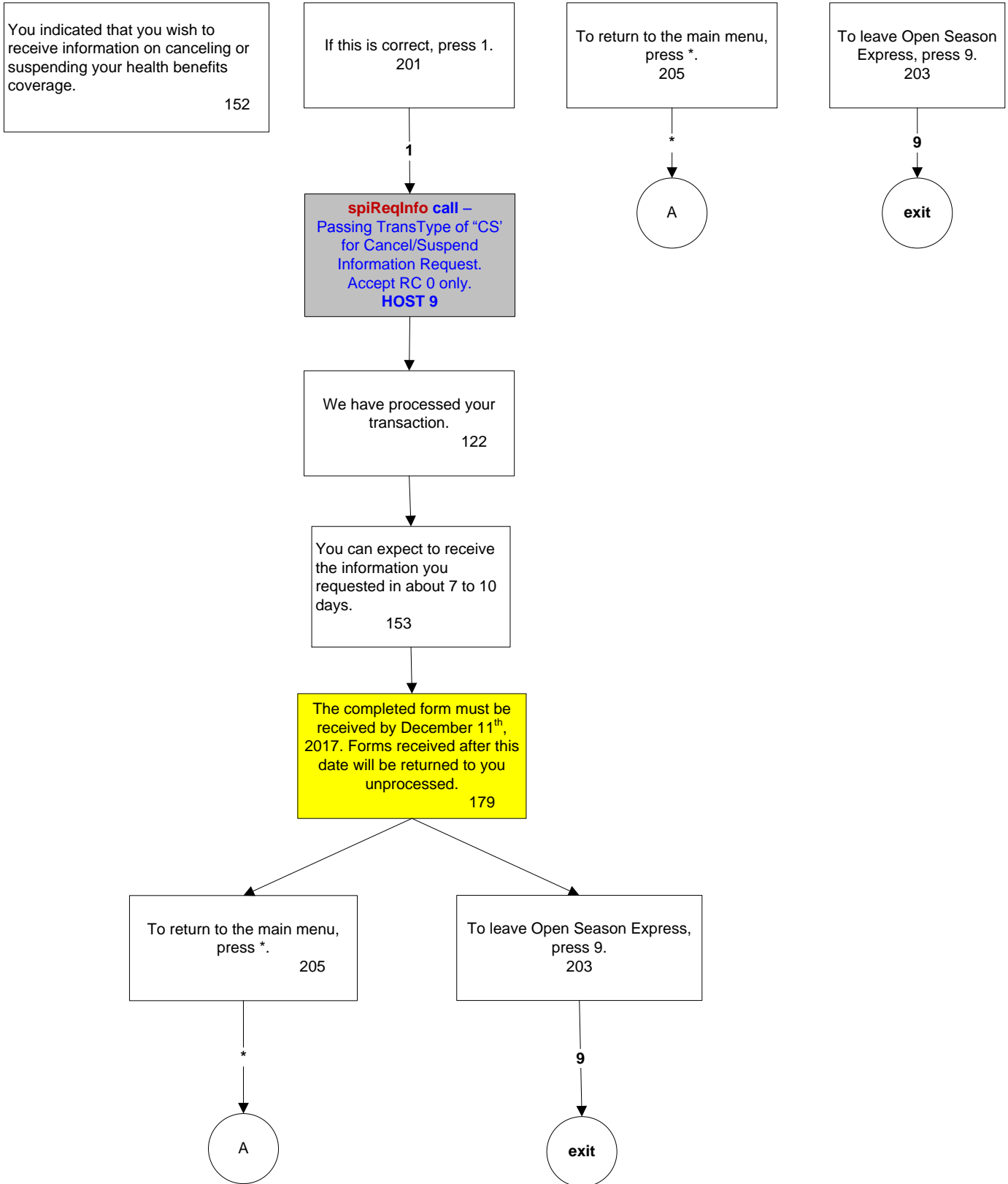

Premiums to OPM

DP

You indicated that you wish to receive information on how to pay your premiums directly to us. Please note this option is only available when your monthly annuity payment is not large enough to cover the cost of the monthly health benefits premium.
156

If this is correct, press 1.
201

To return to the main menu, press *.
205

To leave Open Season Express, press 9.
203

spiReqInfo call –
Passing TransType of “DP”
for Direct Pay Info Request.
Accept RC 0 only.
HOST 8

A

exit

We have processed your transaction.
122

You can expect to receive the information you requested in about 7 to 10 days.
153

The completed form must be received by December 11th, 2017. Forms received after this date will be returned to you unprocessed.
179

To return to the main menu, press *.
205

To leave Open Season Express, press 9.
203

A

exit

Open Season Health Benefits Election Form (SF-2809)

2809

You indicated that you wish to receive an Open Season Health Benefits Election Form.
158

If this is correct, press 1.
201

To return to the main menu, press *.
205

To leave Open Season Express, press 9.
203

spiReqInfo call –
Passing TransType of "RF"
for Open Season Health
Benefits Election Form
Request.
Accept RC 0 only.
HOST 18

We have processed your transaction.
122

You can expect to receive the information you requested in about 7 to 10 days.
153

The completed form must be received by December 11th, 2017. Forms received after this date will be returned to you unprocessed.
179

To return to the main menu, press *.
205

To leave Open Season Express, press 9.
203

A

exit

*

9

Open Season Health Benefits Guide

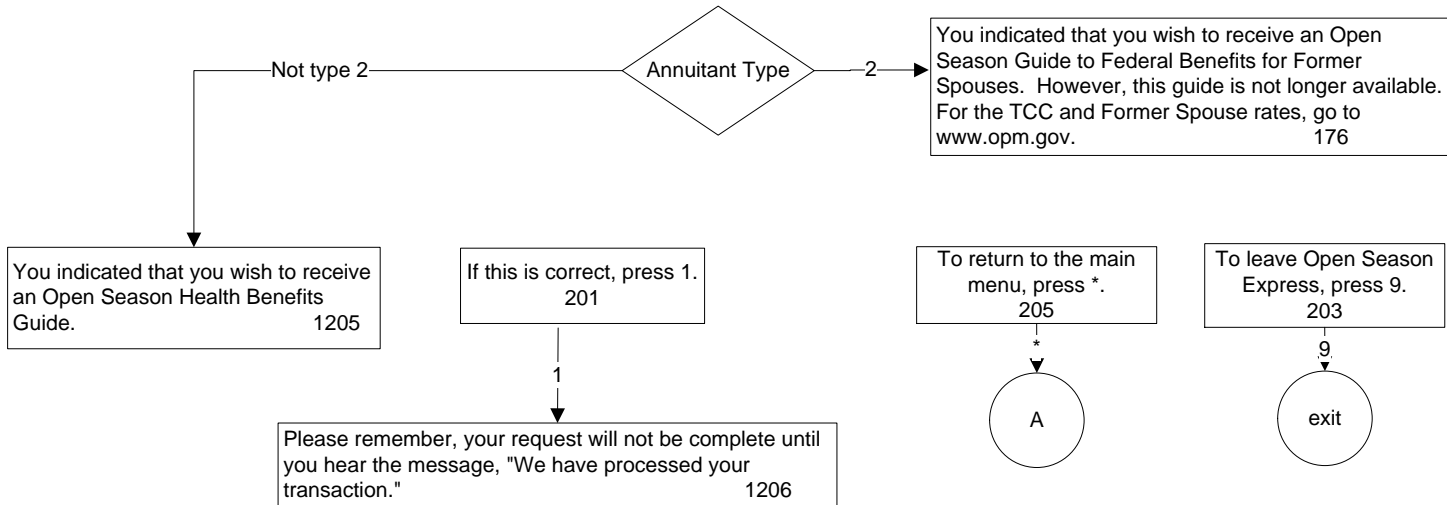

SG1

Please enter the two character state code for the guide you want. For example, if you are requesting a FEHB guide for Texas, state code TX, enter 8-9. The 8 is the number on the keypad with the letter T and 9 is the number on the keypad with the letter X. If the state code contains the letters Q or Z, enter the number 0 for these letters. For a foreign guide, enter 1-1. 1207

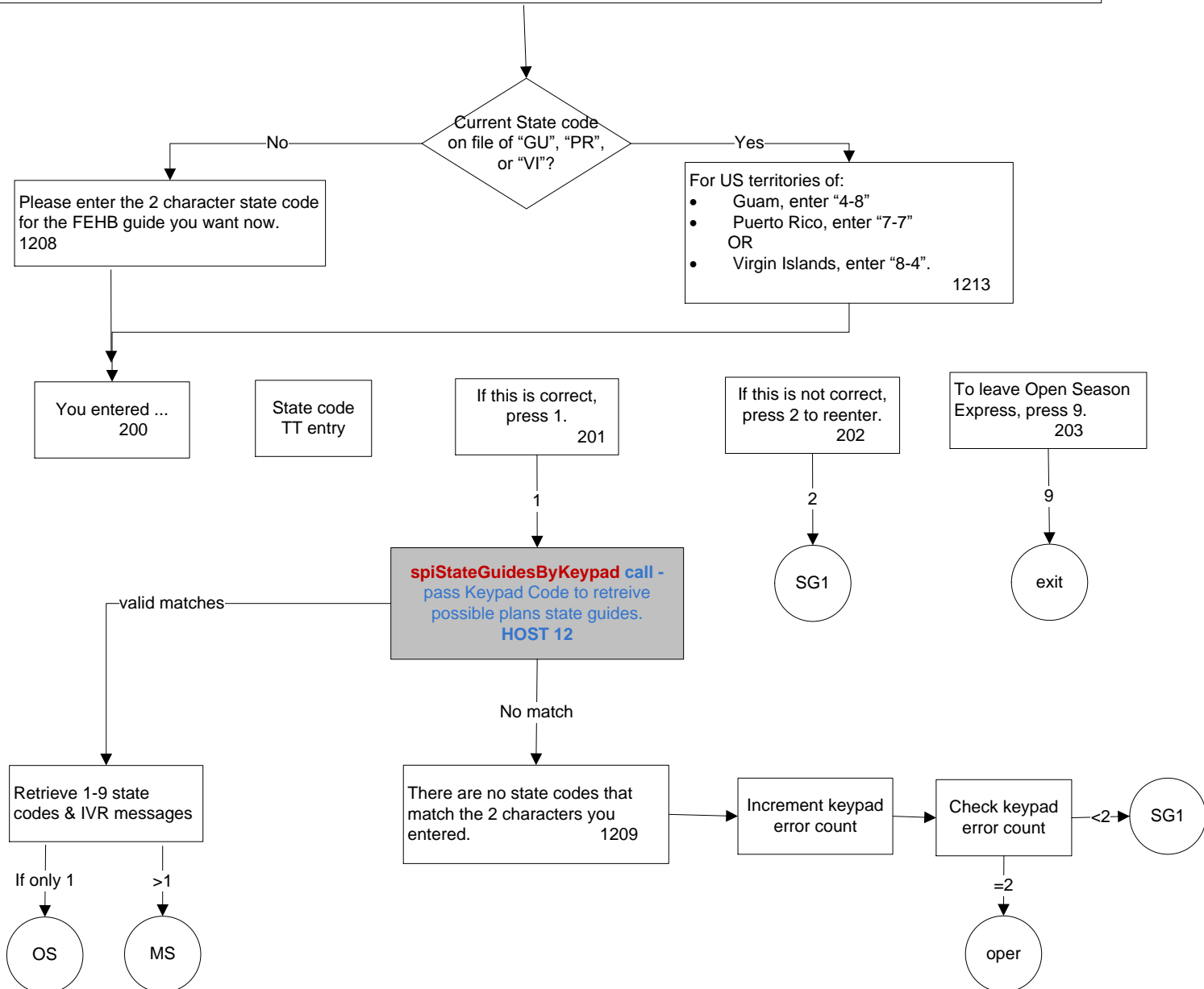

Open Season Health Benefits Guide - 2

OS

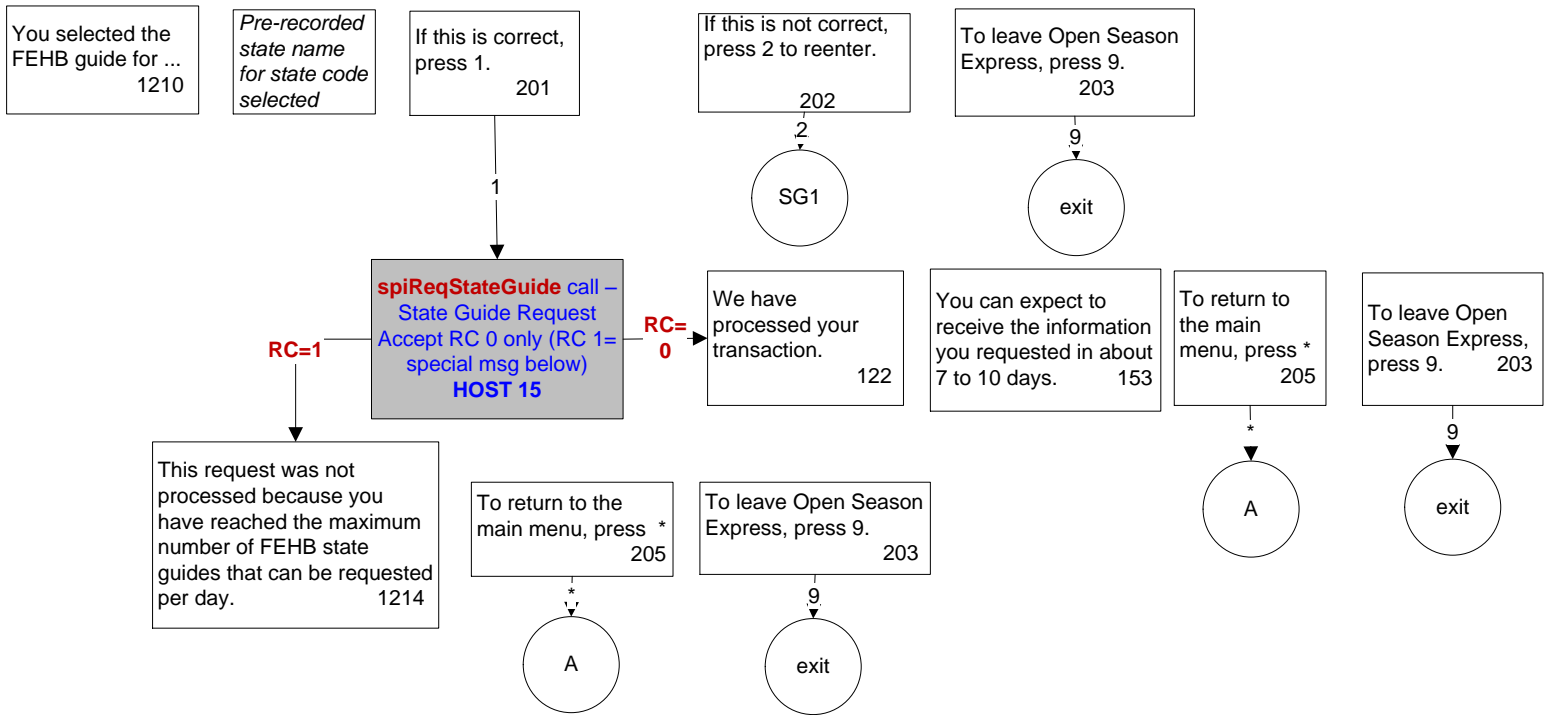

MS

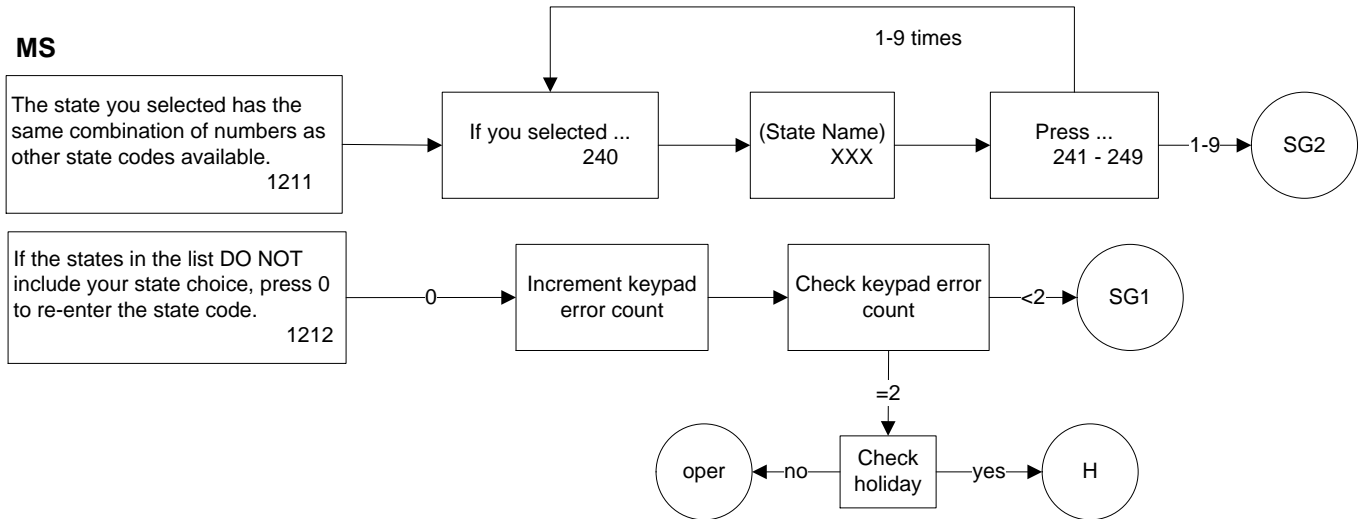

SG2

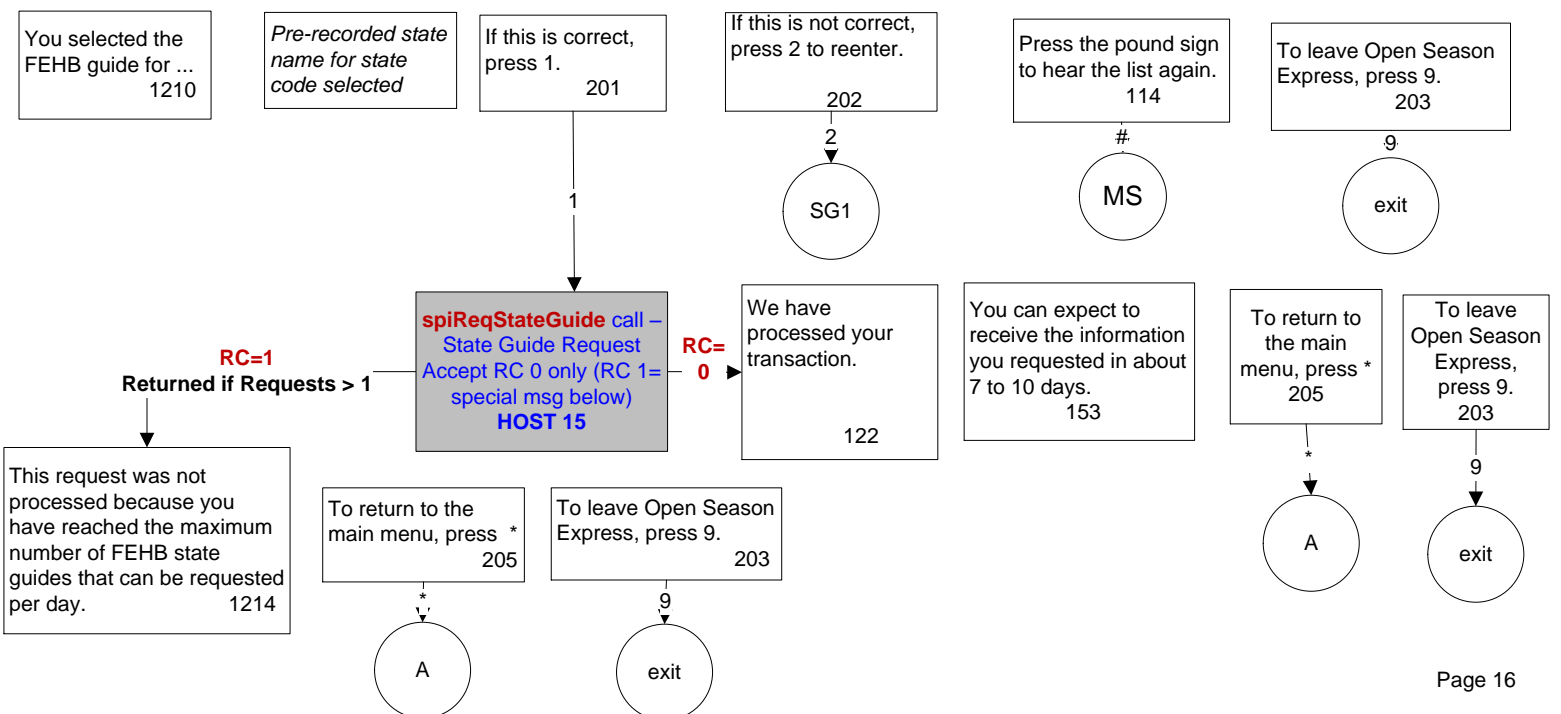

Transfer to Operator

with option to return to MM
if Outside of CSR hours

operOpt

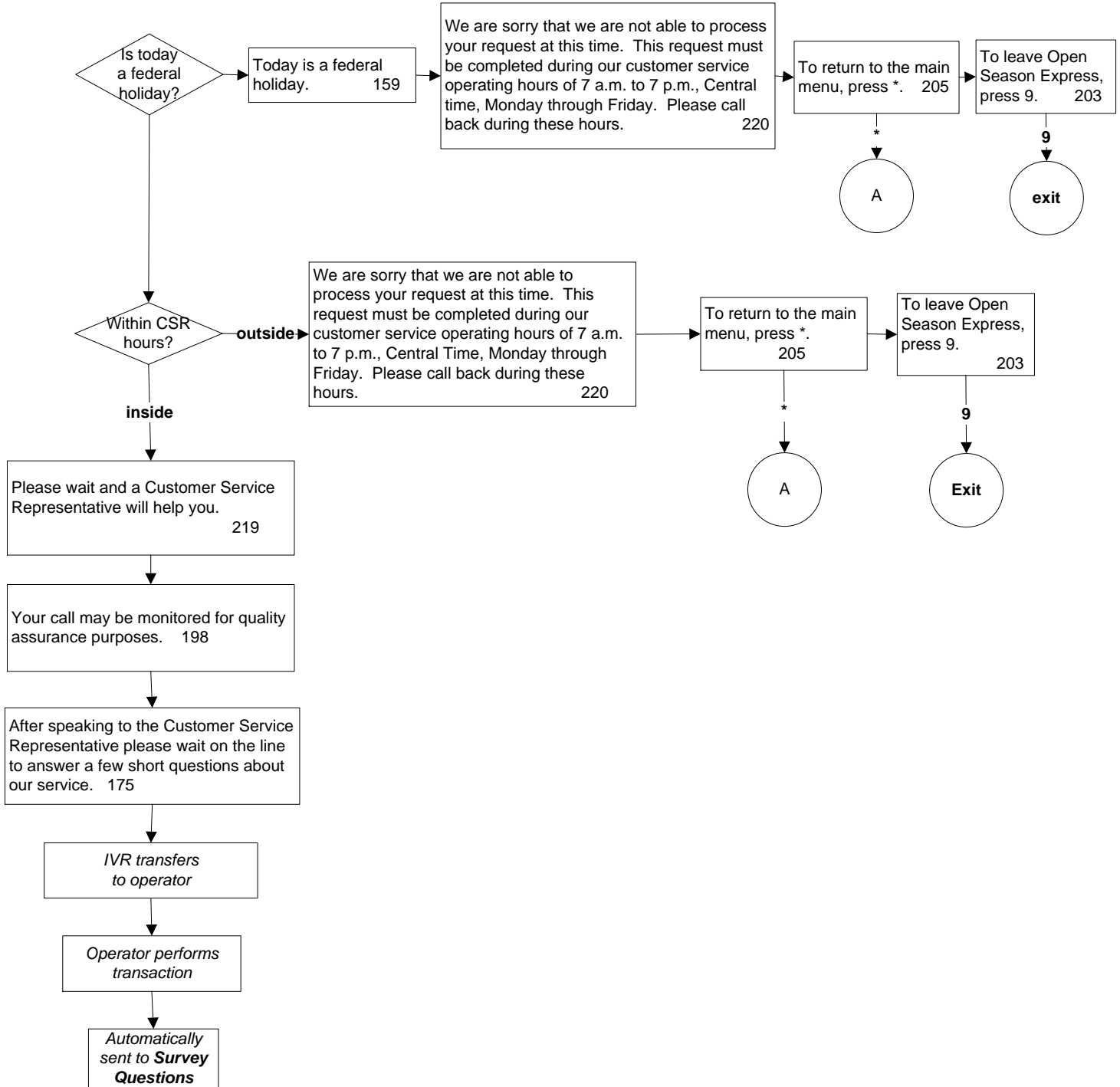

Transfer to operator

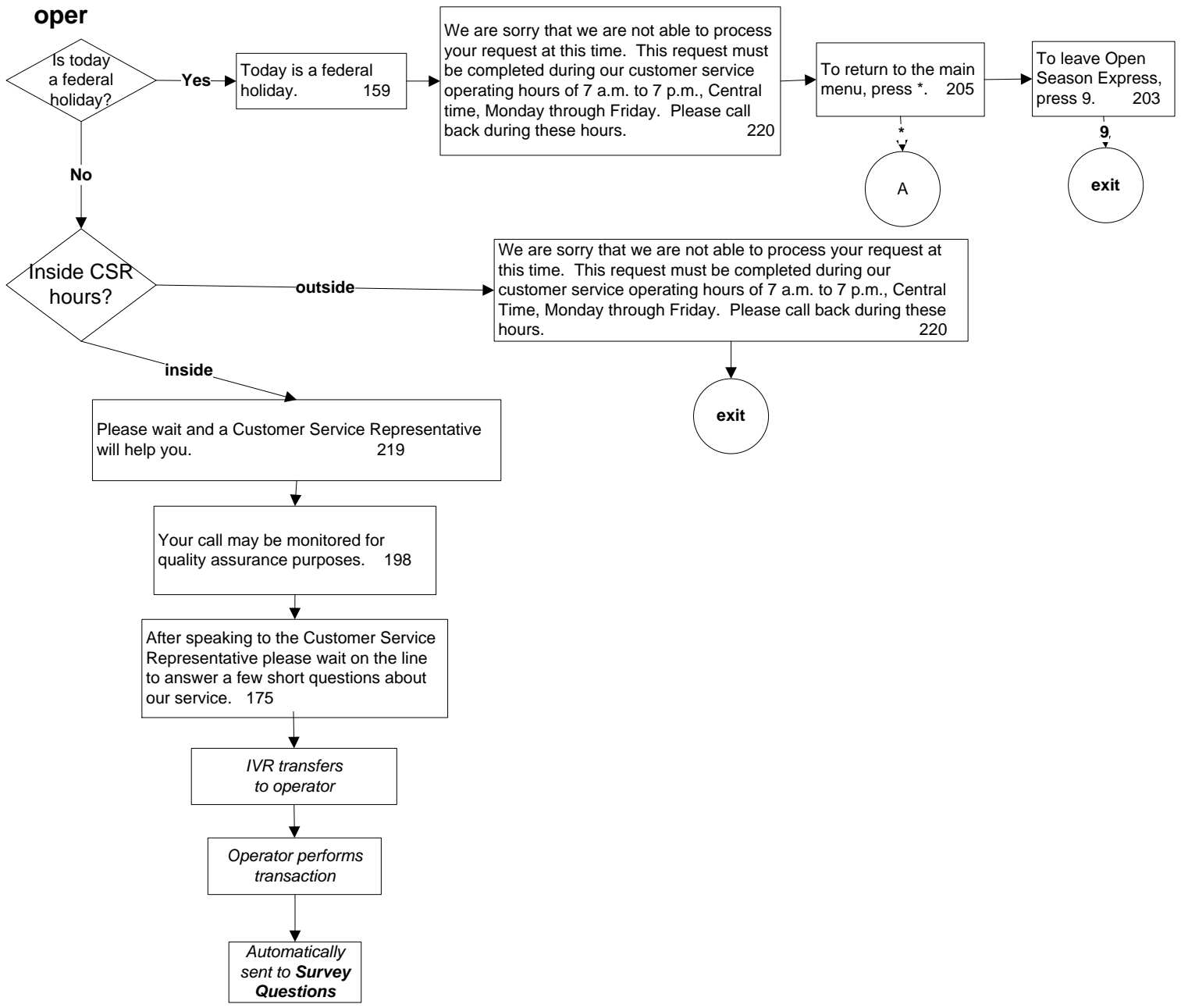

Exit Routine

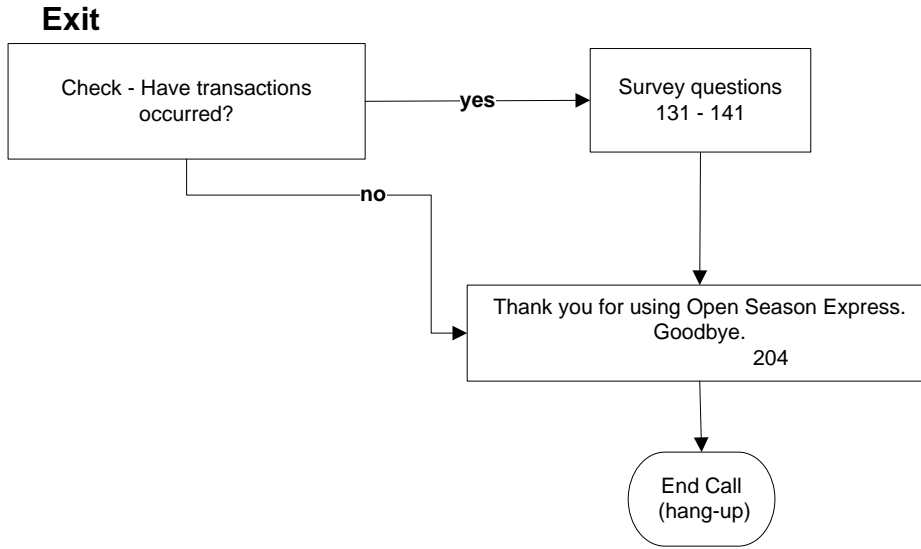

Survey Questions

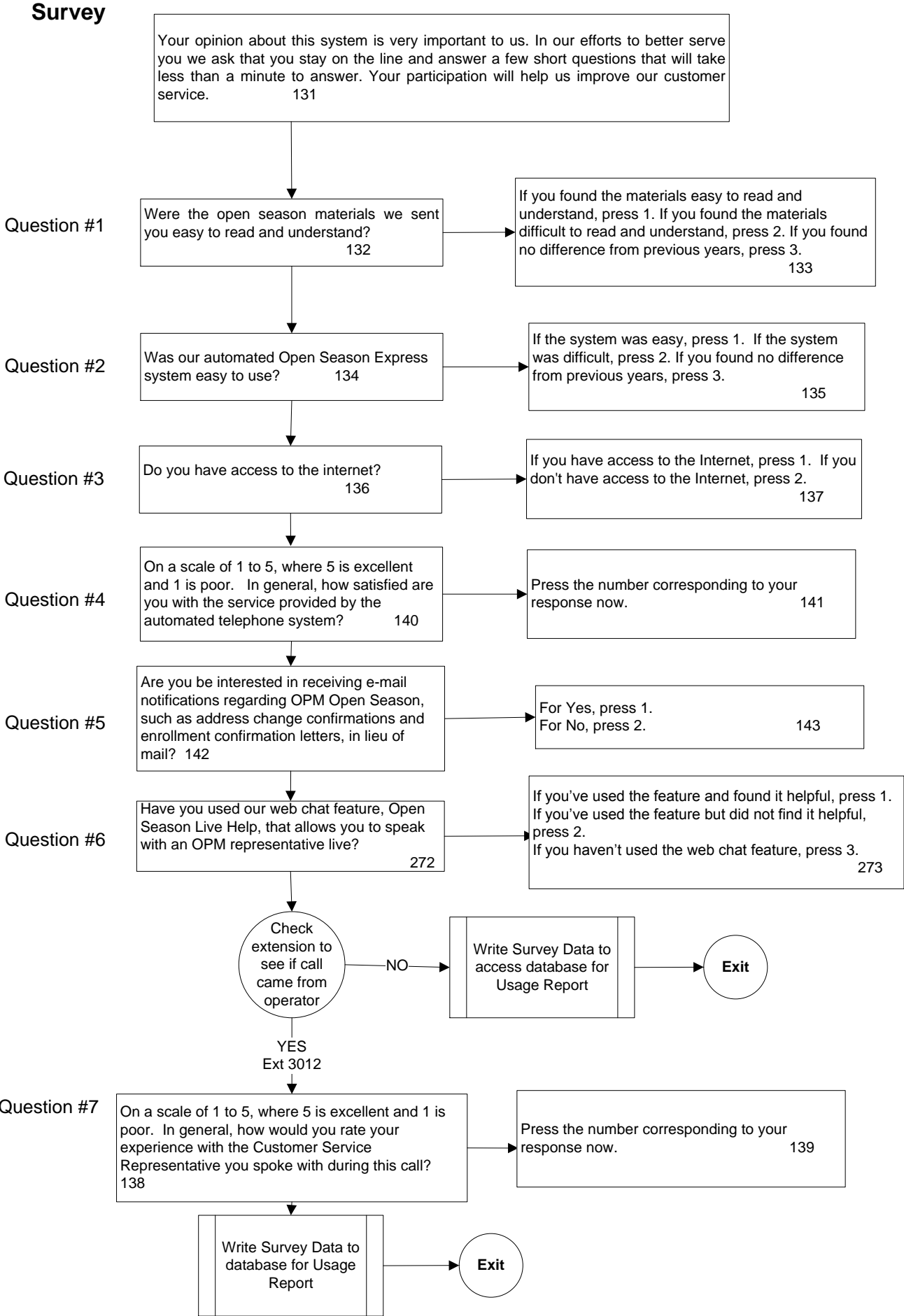

SPANISH

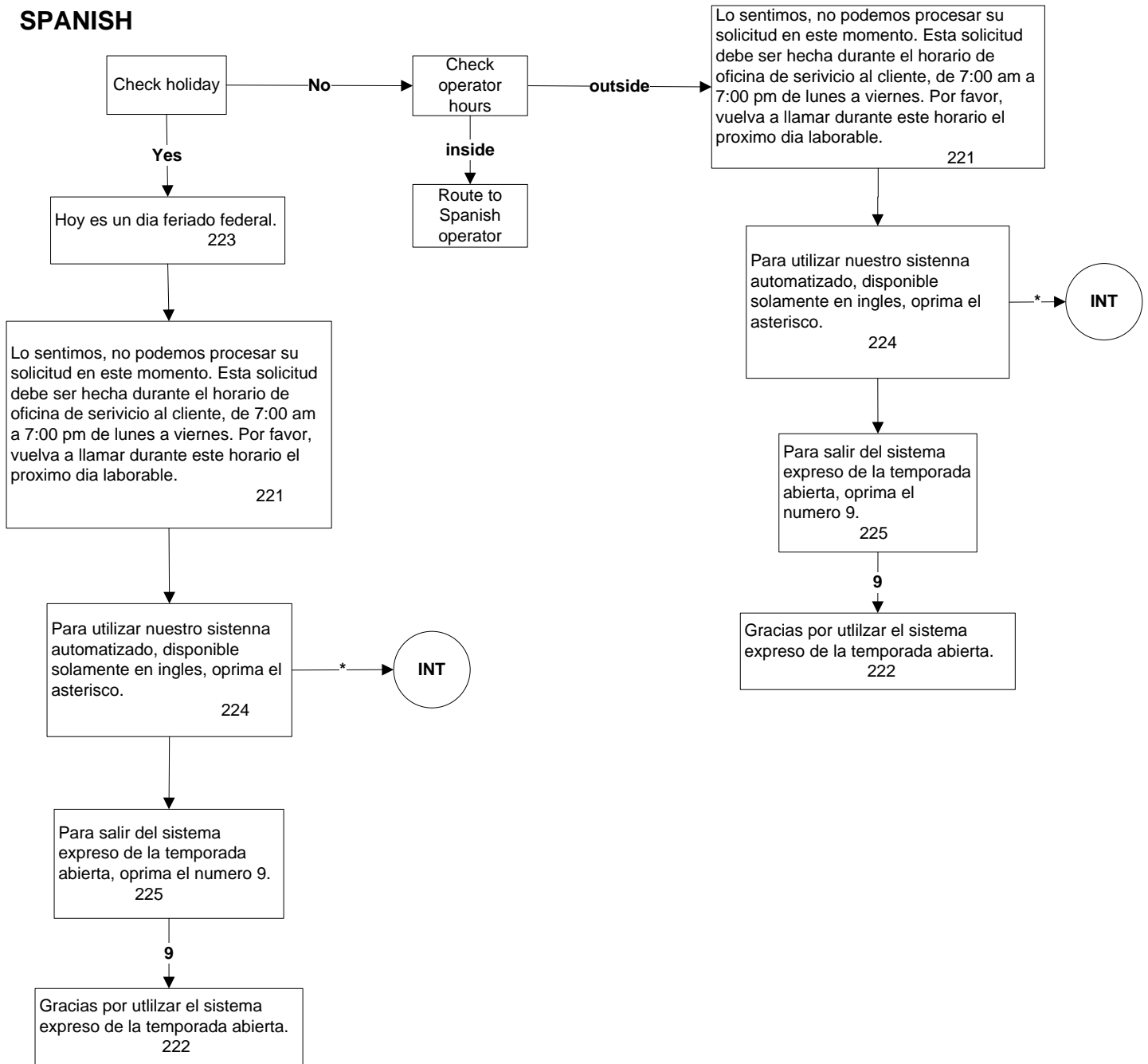

Call Flow Label Descriptors

A = Main Menu
C = Claim # Collection
CC = Collect 2 character plan code for Brochure request
CC1 = Initial Brochure request process (confirmation on Main Menu option 2)
DD = Check # of brochures requested
DP = Direct Pay (confirmation on **submenu option 2**)
E = One plan matching keypad plan code for Enrollment/coverage
Exit = Check if Survey should be offered, else end call w/ Thank you message
FF = Process Main Menu option chosen
I = Collect last 4 of SSN (security)
INT = Intro instructions for use
K = Collect 2 character plan code for Enrollment change
K0 = Check if enrollment change previously made (confirmation on Main Menu option 1)
K1 = Initial Enrollment Request process (confirmation on Main Menu option 1 when no prior changes)
K2 = Process enrollment change
MM = Suspend/Cancel (confirmation on **submenu option 1**)
MS = multiple keypad matches for state code request
N = Multiple plans matching keypad plan code for Enrollment
O = Multiple plans matching keypad plan code for Brochure req.
operOpt= transfer to operator with option to return to Main Menu if outside of hours
Oper = transfer to operator logic
OS = single match of keypad code for state code request
2809 = Open Season Health Benefits Election Form (confirmation on **submenu option 4**)

PP = single plan code match on keypad code for Brochure req.
RI = Request Information Sub-menu
RR = Address change (confirmation on Main Menu option 0)
Same plan/coverage = New edit check to not allow enrollment into current plan or pending plan
BG = Open Season Health Benefits Guide Request (*confirmation on Main Menu opt 3*) SG1 = Collect 2 character state code for State Guide Request
SG2 = Confirmation of state guide selection
Spanish= logic for transfer to Spanish CSR
Survey = Survey Questions asked of caller
U1 = Self Only Enrollment Change processing
U2 = Self/Family Enrollment Change processing