

**Exhibit A**

**Proposed Reliability Standard TPL-007-2 – Transmission System Planned Performance for  
Geomagnetic Disturbance Operations**

**Proposed Reliability Standard TPL-007-2 – Transmission System Planned Performance for  
Geomagnetic Disturbance Operations - Clean**

## A. Introduction

1. **Title:** Transmission System Planned Performance for Geomagnetic Disturbance Events
2. **Number:** TPL-007-2
3. **Purpose:** Establish requirements for Transmission system planned performance during geomagnetic disturbance (GMD) events.
4. **Applicability:**
  - 4.1. **Functional Entities:**
    - 4.1.1. Planning Coordinator with a planning area that includes a Facility or Facilities specified in 4.2;
    - 4.1.2. Transmission Planner with a planning area that includes a Facility or Facilities specified in 4.2;
    - 4.1.3. Transmission Owner who owns a Facility or Facilities specified in 4.2; and
    - 4.1.4. Generator Owner who owns a Facility or Facilities specified in 4.2.
  - 4.2. **Facilities:**
    - 4.2.1. Facilities that include power transformer(s) with a high side, wye-grounded winding with terminal voltage greater than 200 kV.
5. **Effective Date:** See Implementation Plan for TPL-007-2.
6. **Background:** During a GMD event, geomagnetically-induced currents (GIC) may cause transformer hot-spot heating or damage, loss of Reactive Power sources, increased Reactive Power demand, and Misoperation(s), the combination of which may result in voltage collapse and blackout

## B. Requirements and Measures

- R1. Each Planning Coordinator, in conjunction with its Transmission Planner(s), shall identify the individual and joint responsibilities of the Planning Coordinator and Transmission Planner(s) in the Planning Coordinator's planning area for maintaining models, performing the study or studies needed to complete benchmark and supplemental GMD Vulnerability Assessments, and implementing process(es) to obtain GMD measurement data as specified in this standard. [*Violation Risk Factor: Lower*] [*Time Horizon: Long-term Planning*]

- M1.** Each Planning Coordinator, in conjunction with its Transmission Planners, shall provide documentation on roles and responsibilities, such as meeting minutes, agreements, copies of procedures or protocols in effect between entities or between departments of a vertically integrated system, or email correspondence that identifies an agreement has been reached on individual and joint responsibilities for maintaining models, performing the study or studies needed to complete benchmark and supplemental GMD Vulnerability Assessments, and implementing process(es) to obtain GMD measurement data in accordance with Requirement R1.
- R2.** Each responsible entity, as determined in Requirement R1, shall maintain System models and GIC System models of the responsible entity’s planning area for performing the study or studies needed to complete benchmark and supplemental GMD Vulnerability Assessments. *[Violation Risk Factor: High] [Time Horizon: Long-term Planning]*
- M2.** Each responsible entity, as determined in Requirement R1, shall have evidence in either electronic or hard copy format that it is maintaining System models and GIC System models of the responsible entity’s planning area for performing the study or studies needed to complete benchmark and supplemental GMD Vulnerability Assessments.
- R3.** Each responsible entity, as determined in Requirement R1, shall have criteria for acceptable System steady state voltage performance for its System during the GMD events described in Attachment 1. *[Violation Risk Factor: Medium] [Time Horizon: Long-term Planning]*
- M3.** Each responsible entity, as determined in Requirement R1, shall have evidence, such as electronic or hard copies of the criteria for acceptable System steady state voltage performance for its System in accordance with Requirement R3.

**Benchmark GMD Vulnerability Assessment(s)**

- R4.** Each responsible entity, as determined in Requirement R1, shall complete a benchmark GMD Vulnerability Assessment of the Near-Term Transmission Planning Horizon at least once every 60 calendar months. This benchmark GMD Vulnerability Assessment shall use a study or studies based on models identified in Requirement R2, document assumptions, and document summarized results of the steady state analysis. *[Violation Risk Factor: High] [Time Horizon: Long-term Planning]*
  - 4.1.** The study or studies shall include the following conditions:
    - 4.1.1.** System On-Peak Load for at least one year within the Near-Term Transmission Planning Horizon; and
    - 4.1.2.** System Off-Peak Load for at least one year within the Near-Term Transmission Planning Horizon.

- 4.2.** The study or studies shall be conducted based on the benchmark GMD event described in Attachment 1 to determine whether the System meets the performance requirements for the steady state planning benchmark GMD event contained in Table 1.
- 4.3.** The benchmark GMD Vulnerability Assessment shall be provided: (i) to the responsible entity's Reliability Coordinator, adjacent Planning Coordinators, and adjacent Transmission Planners within 90 calendar days of completion, and (ii) to any functional entity that submits a written request and has a reliability-related need within 90 calendar days of receipt of such request or within 90 calendar days of completion of the benchmark GMD Vulnerability Assessment, whichever is later.
- 4.3.1.** If a recipient of the benchmark GMD Vulnerability Assessment provides documented comments on the results, the responsible entity shall provide a documented response to that recipient within 90 calendar days of receipt of those comments.
- M4.** Each responsible entity, as determined in Requirement R1, shall have dated evidence such as electronic or hard copies of its benchmark GMD Vulnerability Assessment meeting all of the requirements in Requirement R4. Each responsible entity, as determined in Requirement R1, shall also provide evidence, such as email records, web postings with an electronic notice of posting, or postal receipts showing recipient and date, that it has distributed its benchmark GMD Vulnerability Assessment: (i) to the responsible entity's Reliability Coordinator, adjacent Planning Coordinators, and adjacent Transmission Planners within 90 calendar days of completion, and (ii) to any functional entity that submits a written request and has a reliability-related need within 90 calendar days of receipt of such request or within 90 calendar days of completion of the benchmark GMD Vulnerability Assessment, whichever is later, as specified in Requirement R4. Each responsible entity, as determined in Requirement R1, shall also provide evidence, such as email notices or postal receipts showing recipient and date, that it has provided a documented response to comments received on its benchmark GMD Vulnerability Assessment within 90 calendar days of receipt of those comments in accordance with Requirement R4.
- R5.** Each responsible entity, as determined in Requirement R1, shall provide GIC flow information to be used for the benchmark thermal impact assessment of transformers specified in Requirement R6 to each Transmission Owner and Generator Owner that owns an applicable Bulk Electric System (BES) power transformer in the planning area. The GIC flow information shall include: *[Violation Risk Factor: Medium] [Time Horizon: Long-term Planning]*
- 5.1.** The maximum effective GIC value for the worst case geoelectric field orientation for the benchmark GMD event described in Attachment 1. This value shall be provided to the Transmission Owner or Generator Owner that owns each applicable BES power transformer in the planning area.

- 5.2.** The effective GIC time series, GIC(t), calculated using the benchmark GMD event described in Attachment 1 in response to a written request from the Transmission Owner or Generator Owner that owns an applicable BES power transformer in the planning area. GIC(t) shall be provided within 90 calendar days of receipt of the written request and after determination of the maximum effective GIC value in Part 5.1.
- M5.** Each responsible entity, as determined in Requirement R1, shall provide evidence, such as email records, web postings with an electronic notice of posting, or postal receipts showing recipient and date, that it has provided the maximum effective GIC values to the Transmission Owner and Generator Owner that owns each applicable BES power transformer in the planning area as specified in Requirement R5, Part 5.1. Each responsible entity, as determined in Requirement R1, shall also provide evidence, such as email records, web postings with an electronic notice of posting, or postal receipts showing recipient and date, that it has provided GIC(t) in response to a written request from the Transmission Owner or Generator Owner that owns an applicable BES power transformer in the planning area.
- R6.** Each Transmission Owner and Generator Owner shall conduct a benchmark thermal impact assessment for its solely and jointly owned applicable BES power transformers where the maximum effective GIC value provided in Requirement R5, Part 5.1, is 75 A per phase or greater. The benchmark thermal impact assessment shall: *[Violation Risk Factor: Medium] [Time Horizon: Long-term Planning]*
- 6.1.** Be based on the effective GIC flow information provided in Requirement R5;
- 6.2.** Document assumptions used in the analysis;
- 6.3.** Describe suggested actions and supporting analysis to mitigate the impact of GICs, if any; and
- 6.4.** Be performed and provided to the responsible entities, as determined in Requirement R1, within 24 calendar months of receiving GIC flow information specified in Requirement R5, Part 5.1.
- M6.** Each Transmission Owner and Generator Owner shall have evidence such as electronic or hard copies of its benchmark thermal impact assessment for all of its solely and jointly owned applicable BES power transformers where the maximum effective GIC value provided in Requirement R5, Part 5.1, is 75 A per phase or greater, and shall have evidence such as email records, web postings with an electronic notice of posting, or postal receipts showing recipient and date, that it has provided its thermal impact assessment to the responsible entities as specified in Requirement R6.

- R7.** Each responsible entity, as determined in Requirement R1, that concludes through the benchmark GMD Vulnerability Assessment conducted in Requirement R4 that their System does not meet the performance requirements for the steady state planning benchmark GMD event contained in Table 1, shall develop a Corrective Action Plan (CAP) addressing how the performance requirements will be met. The CAP shall:  
*[Violation Risk Factor: High] [Time Horizon: Long-term Planning]*
- 7.1.** List System deficiencies and the associated actions needed to achieve required System performance. Examples of such actions include:
- Installation, modification, retirement, or removal of Transmission and generation Facilities and any associated equipment.
  - Installation, modification, or removal of Protection Systems or Remedial Action Schemes.
  - Use of Operating Procedures, specifying how long they will be needed as part of the CAP.
  - Use of Demand-Side Management, new technologies, or other initiatives.
- 7.2.** Be developed within one year of completion of the benchmark GMD Vulnerability Assessment.
- 7.3.** Include a timetable, subject to revision by the responsible entity in Part 7.4, for implementing the selected actions from Part 7.1. The timetable shall:
- 7.3.1.** Specify implementation of non-hardware mitigation, if any, within two years of development of the CAP; and
- 7.3.2.** Specify implementation of hardware mitigation, if any, within four years of development of the CAP.
- 7.4.** Be revised if situations beyond the control of the responsible entity determined in Requirement R1 prevent implementation of the CAP within the timetable for implementation provided in Part 7.3. The revised CAP shall document the following, and be updated at least once every 12 calendar months until implemented:
- 7.4.1.** Circumstances causing the delay for fully or partially implementing the selected actions in Part 7.1;
- 7.4.2.** Description of the original CAP, and any previous changes to the CAP, with the associated timetable(s) for implementing the selected actions in Part 7.1; and
- 7.4.3.** Revisions to the selected actions in Part 7.1, if any, including utilization of Operating Procedures if applicable, and the updated timetable for implementing the selected actions.

- 7.5.** Be provided: (i) to the responsible entity’s Reliability Coordinator, adjacent Planning Coordinator(s), adjacent Transmission Planner(s), and functional entities referenced in the CAP within 90 calendar days of development or revision, and (ii) to any functional entity that submits a written request and has a reliability-related need within 90 calendar days of receipt of such request or within 90 calendar days of development or revision, whichever is later.
- 7.5.1.** If a recipient of the CAP provides documented comments on the results, the responsible entity shall provide a documented response to that recipient within 90 calendar days of receipt of those comments.
- M7.** Each responsible entity, as determined in Requirement R1, that concludes, through the benchmark GMD Vulnerability Assessment conducted in Requirement R4, that the responsible entity’s System does not meet the performance requirements for the steady state planning benchmark GMD event contained in Table 1 shall have evidence such as dated electronic or hard copies of its CAP including timetable for implementing selected actions, as specified in Requirement R7. Each responsible entity, as determined in Requirement R1, shall also provide evidence, such as email records or postal receipts showing recipient and date, that it has revised its CAP if situations beyond the responsible entity's control prevent implementation of the CAP within the timetable specified. Each responsible entity, as determined in Requirement R1, shall also provide evidence, such as email records, web postings with an electronic notice of posting, or postal receipts showing recipient and date, that it has distributed its CAP or relevant information, if any, (i) to the responsible entity’s Reliability Coordinator, adjacent Planning Coordinator(s), adjacent Transmission Planner(s), and functional entities referenced in the CAP within 90 calendar days of development or revision, and (ii) to any functional entity that submits a written request and has a reliability-related need within 90 calendar days of receipt of such request or within 90 calendar days of development or revision, whichever is later as specified in Requirement R7. Each responsible entity, as determined in Requirement R1, shall also provide evidence, such as email notices or postal receipts showing recipient and date, that it has provided a documented response to comments received on its CAP within 90 calendar days of receipt of those comments, in accordance with Requirement R7.

**Supplemental GMD Vulnerability Assessment(s)**

- R8.** Each responsible entity, as determined in Requirement R1, shall complete a supplemental GMD Vulnerability Assessment of the Near-Term Transmission Planning Horizon at least once every 60 calendar months. This supplemental GMD Vulnerability Assessment shall use a study or studies based on models identified in Requirement R2, document assumptions, and document summarized results of the steady state analysis. *[Violation Risk Factor: High] [Time Horizon: Long-term Planning]*
- 8.1.** The study or studies shall include the following conditions:
- 8.1.1.** System On-Peak Load for at least one year within the Near-Term Transmission Planning Horizon; and





- R9.** Each responsible entity, as determined in Requirement R1, shall provide GIC flow information to be used for the supplemental thermal impact assessment of transformers specified in Requirement R10 to each Transmission Owner and Generator Owner that owns an applicable Bulk Electric System (BES) power transformer in the planning area. The GIC flow information shall include: *[Violation Risk Factor: Medium] [Time Horizon: Long-term Planning]*
- 9.1.** The maximum effective GIC value for the worst case geoelectric field orientation for the supplemental GMD event described in Attachment 1. This value shall be provided to the Transmission Owner or Generator Owner that owns each applicable BES power transformer in the planning area.
- 9.2.** The effective GIC time series, GIC(t), calculated using the supplemental GMD event described in Attachment 1 in response to a written request from the Transmission Owner or Generator Owner that owns an applicable BES power transformer in the planning area. GIC(t) shall be provided within 90 calendar days of receipt of the written request and after determination of the maximum effective GIC value in Part 9.1.
- M9.** Each responsible entity, as determined in Requirement R1, shall provide evidence, such as email records, web postings with an electronic notice of posting, or postal receipts showing recipient and date, that it has provided the maximum effective GIC values to the Transmission Owner and Generator Owner that owns each applicable BES power transformer in the planning area as specified in Requirement R9, Part 9.1. Each responsible entity, as determined in Requirement R1, shall also provide evidence, such as email records, web postings with an electronic notice of posting, or postal receipts showing recipient and date, that it has provided GIC(t) in response to a written request from the Transmission Owner or Generator Owner that owns an applicable BES power transformer in the planning area.
- R10.** Each Transmission Owner and Generator Owner shall conduct a supplemental thermal impact assessment for its solely and jointly owned applicable BES power transformers where the maximum effective GIC value provided in Requirement R9, Part 9.1, is 85 A per phase or greater. The supplemental thermal impact assessment shall: *[Violation Risk Factor: Medium] [Time Horizon: Long-term Planning]*
- 10.1.** Be based on the effective GIC flow information provided in Requirement R9;
- 10.2.** Document assumptions used in the analysis;
- 10.3.** Describe suggested actions and supporting analysis to mitigate the impact of GICs, if any; and
- 10.4.** Be performed and provided to the responsible entities, as determined in Requirement R1, within 24 calendar months of receiving GIC flow information specified in Requirement R9, Part 9.1.

**M10.** Each Transmission Owner and Generator Owner shall have evidence such as electronic or hard copies of its supplemental thermal impact assessment for all of its solely and jointly owned applicable BES power transformers where the maximum effective GIC value provided in Requirement R9, Part 9.1, is 85 A per phase or greater, and shall have evidence such as email records, web postings with an electronic notice of posting, or postal receipts showing recipient and date, that it has provided its supplemental thermal impact assessment to the responsible entities as specified in Requirement R10.

### **GMD Measurement Data Processes**

**R11.** Each responsible entity, as determined in Requirement R1, shall implement a process to obtain GIC monitor data from at least one GIC monitor located in the Planning Coordinator's planning area or other part of the system included in the Planning Coordinator's GIC System model. *[Violation Risk Factor: Lower] [Time Horizon: Long-term Planning]*

**M11.** Each responsible entity, as determined in Requirement R1, shall have evidence such as electronic or hard copies of its GIC monitor location(s) and documentation of its process to obtain GIC monitor data in accordance with Requirement R11.

**R12.** Each responsible entity, as determined in Requirement R1, shall implement a process to obtain geomagnetic field data for its Planning Coordinator's planning area. *[Violation Risk Factor: Lower] [Time Horizon: Long-term Planning]*

**M12.** Each responsible entity, as determined in Requirement R1, shall have evidence such as electronic or hard copies of its process to obtain geomagnetic field data for its Planning Coordinator's planning area in accordance with Requirement R12.

## **C. Compliance**

### **1. Compliance Monitoring Process**

**1.1. Compliance Enforcement Authority:** "Compliance Enforcement Authority" means NERC or the Regional Entity, or any entity as otherwise designated by an Applicable Governmental Authority, in their respective roles of monitoring and/or enforcing compliance with mandatory and enforceable Reliability Standards in their respective jurisdictions.

**1.2. Evidence Retention:** The following evidence retention period(s) identify the period of time an entity is required to retain specific evidence to demonstrate compliance. For instances where the evidence retention period specified below is shorter than the time since the last audit, the Compliance Enforcement Authority may ask an entity to provide other evidence to show that it was compliant for the full-time period since the last audit.

The applicable entity shall keep data or evidence to show compliance as identified below unless directed by its Compliance Enforcement Authority to retain specific evidence for a longer period of time as part of an investigation.

- For Requirements R1, R2, R3, R5, R6, R9, and R10, each responsible entity shall retain documentation as evidence for five years.
- For Requirements R4 and R8, each responsible entity shall retain documentation of the current GMD Vulnerability Assessment and the preceding GMD Vulnerability Assessment.
- For Requirement R7, each responsible entity shall retain documentation as evidence for five years or until all actions in the Corrective Action Plan are completed, whichever is later.
- For Requirements R11 and R12, each responsible entity shall retain documentation as evidence for three years.

**1.3. Compliance Monitoring and Enforcement Program:** As defined in the NERC Rules of Procedure, “Compliance Monitoring and Enforcement Program” refers to the identification of the processes that will be used to evaluate data or information for the purpose of assessing performance or outcomes with the associated Reliability Standard.

**Table 1: Steady State Planning GMD Event**

**Steady State:**

- a. Voltage collapse, Cascading and uncontrolled islanding shall not occur.
- b. Generation loss is acceptable as a consequence of the steady state planning GMD events.
- c. Planned System adjustments such as Transmission configuration changes and re-dispatch of generation are allowed if such adjustments are executable within the time duration applicable to the Facility Ratings.

Category	Initial Condition	Event	Interruption of Firm Transmission Service Allowed	Load Loss Allowed
<b>Benchmark GMD Event - GMD Event with Outages</b>	1. System as may be postured in response to space weather information <sup>1</sup> , and then 2. GMD event <sup>2</sup>	Reactive Power compensation devices and other Transmission Facilities removed as a result of Protection System operation or Misoperation due to harmonics during the GMD event	Yes <sup>3</sup>	Yes <sup>3</sup>
<b>Supplemental GMD Event - GMD Event with Outages</b>	1. System as may be postured in response to space weather information <sup>1</sup> , and then 2. GMD event <sup>2</sup>	Reactive Power compensation devices and other Transmission Facilities removed as a result of Protection System operation or Misoperation due to harmonics during the GMD event	Yes	Yes

**Table 1: Steady State Performance Footnotes**

1. The System condition for GMD planning may include adjustments to posture the System that are executable in response to space weather information.
2. The GMD conditions for the benchmark and supplemental planning events are described in Attachment 1.
3. Load loss as a result of manual or automatic Load shedding (e.g., UVLS) and/or curtailment of Firm Transmission Service may be used to meet BES performance requirements during studied GMD conditions. The likelihood and magnitude of Load loss or curtailment of Firm Transmission Service should be minimized.

### Violation Severity Levels

R #	Violation Severity Levels			
	Lower VSL	Moderate VSL	High VSL	Severe VSL
R1.	N/A	N/A	N/A	The Planning Coordinator, in conjunction with its Transmission Planner(s), failed to determine and identify individual or joint responsibilities of the Planning Coordinator and Transmission Planner(s) in the Planning Coordinator’s planning area for maintaining models, performing the study or studies needed to complete benchmark and supplemental GMD Vulnerability Assessments, and implementing process(es) to obtain GMD measurement data as specified in this standard.
R2.	N/A	N/A	The responsible entity did not maintain either System models or GIC System models of the responsible entity’s planning area for performing the studies	The responsible entity did not maintain both System models and GIC System models of the responsible entity’s planning area for performing the studies

R #	Violation Severity Levels			
	Lower VSL	Moderate VSL	High VSL	Severe VSL
			needed to complete benchmark and supplemental GMD Vulnerability Assessments.	needed to complete benchmark and supplemental GMD Vulnerability Assessments.
<b>R3.</b>	N/A	N/A	N/A	The responsible entity did not have criteria for acceptable System steady state voltage performance for its System during the GMD events described in Attachment 1 as required.
<b>R4.</b>	The responsible entity completed a benchmark GMD Vulnerability Assessment, but it was more than 60 calendar months and less than or equal to 64 calendar months since the last benchmark GMD Vulnerability Assessment.	The responsible entity's completed benchmark GMD Vulnerability Assessment failed to satisfy one of the elements listed in Requirement R4, Parts 4.1 through 4.3; OR The responsible entity completed a benchmark GMD Vulnerability Assessment, but it was more than 64 calendar months and less than or equal to 68 calendar months since the	The responsible entity's completed benchmark GMD Vulnerability Assessment failed to satisfy two of the elements listed in Requirement R4, Parts 4.1 through 4.3; OR The responsible entity completed a benchmark GMD Vulnerability Assessment, but it was more than 68 calendar months and less than or equal to 72 calendar months since the	The responsible entity's completed benchmark GMD Vulnerability Assessment failed to satisfy three of the elements listed in Requirement R4, Parts 4.1 through 4.3; OR The responsible entity completed a benchmark GMD Vulnerability Assessment, but it was more than 72 calendar months since the last benchmark

R #	Violation Severity Levels			
	Lower VSL	Moderate VSL	High VSL	Severe VSL
		last benchmark GMD Vulnerability Assessment.	last benchmark GMD Vulnerability Assessment.	GMD Vulnerability Assessment; OR The responsible entity does not have a completed benchmark GMD Vulnerability Assessment.
R5.	The responsible entity provided the effective GIC time series, GIC(t), in response to written request, but did so more than 90 calendar days and less than or equal to 100 calendar days after receipt of a written request.	The responsible entity provided the effective GIC time series, GIC(t), in response to written request, but did so more than 100 calendar days and less than or equal to 110 calendar days after receipt of a written request.	The responsible entity provided the effective GIC time series, GIC(t), in response to written request, but did so more than 110 calendar days after receipt of a written request.	The responsible entity did not provide the maximum effective GIC value to the Transmission Owner and Generator Owner that owns each applicable BES power transformer in the planning area; OR The responsible entity did not provide the effective GIC time series, GIC(t), upon written request.
R6.	The responsible entity failed to conduct a benchmark thermal impact assessment for 5% or less or one of its solely owned and jointly owned applicable BES power	The responsible entity failed to conduct a benchmark thermal impact assessment for more than 5% up to (and including) 10% or two of its solely owned and jointly	The responsible entity failed to conduct a benchmark thermal impact assessment for more than 10% up to (and including) 15% or three of its solely owned and	The responsible entity failed to conduct a benchmark thermal impact assessment for more than 15% or more than three of its solely owned and jointly owned



R #	Violation Severity Levels			
	Lower VSL	Moderate VSL	High VSL	Severe VSL
	<p>transformers (whichever is greater) where the maximum effective GIC value provided in Requirement R5, Part 5.1, is 75 A or greater per phase; OR The responsible entity conducted a benchmark thermal impact assessment for its solely owned and jointly owned applicable BES power transformers where the maximum effective GIC value provided in Requirement R5, Part 5.1, is 75 A or greater per phase but did so more than 24 calendar months and less than or equal to 26 calendar months of receiving GIC flow information specified in Requirement R5, Part 5.1.</p>	<p>owned applicable BES power transformers (whichever is greater) where the maximum effective GIC value provided in Requirement R5, Part 5.1, is 75 A or greater per phase; OR The responsible entity conducted a benchmark thermal impact assessment for its solely owned and jointly owned applicable BES power transformers where the maximum effective GIC value provided in Requirement R5, Part 5.1, is 75 A or greater per phase but did so more than 26 calendar months and less than or equal to 28 calendar months of receiving GIC flow information specified in Requirement R5, Part 5.1; OR The responsible entity failed to include one of the</p>	<p>jointly owned applicable BES power transformers (whichever is greater) where the maximum effective GIC value provided in Requirement R5, Part 5.1, is 75 A or greater per phase; OR The responsible entity conducted a benchmark thermal impact assessment for its solely owned and jointly owned applicable BES power transformers where the maximum effective GIC value provided in Requirement R5, Part 5.1, is 75 A or greater per phase but did so more than 28 calendar months and less than or equal to 30 calendar months of receiving GIC flow information specified in Requirement R5, Part 5.1; OR The responsible entity failed to include two of the</p>	<p>applicable BES power transformers (whichever is greater) where the maximum effective GIC value provided in Requirement R5, Part 5.1, is 75 A or greater per phase; OR The responsible entity conducted a benchmark thermal impact assessment for its solely owned and jointly owned applicable BES power transformers where the maximum effective GIC value provided in Requirement R5, Part 5.1, is 75 A or greater per phase but did so more than 30 calendar months of receiving GIC flow information specified in Requirement R5, Part 5.1; OR The responsible entity failed to include three of the required elements as listed</p>

R #	Violation Severity Levels			
	Lower VSL	Moderate VSL	High VSL	Severe VSL
		required elements as listed in Requirement R6, Parts 6.1 through 6.3.	required elements as listed in Requirement R6, Parts 6.1 through 6.3.	in Requirement R6, Parts 6.1 through 6.3.
<b>R7.</b>	The responsible entity's Corrective Action Plan failed to comply with one of the elements in Requirement R7, Parts 7.1 through 7.5.	The responsible entity's Corrective Action Plan failed to comply with two of the elements in Requirement R7, Parts 7.1 through 7.5.	The responsible entity's Corrective Action Plan failed to comply with three of the elements in Requirement R7, Parts 7.1 through 7.5.	The responsible entity's Corrective Action Plan failed to comply with four or more of the elements in Requirement R7, Parts 7.1 through 7.5; OR The responsible entity did not have a Corrective Action Plan as required by Requirement R7.
<b>R8.</b>	The responsible entity's completed supplemental GMD Vulnerability Assessment failed to satisfy one of elements listed in Requirement R8, Parts 8.1 through 8.4; OR The responsible entity completed a supplemental GMD Vulnerability Assessment, but it was more	The responsible entity's completed supplemental GMD Vulnerability Assessment failed to satisfy two of elements listed in Requirement R8, Parts 8.1 through 8.4; OR The responsible entity completed a supplemental GMD Vulnerability Assessment, but it was more	The responsible entity's completed supplemental GMD Vulnerability Assessment failed to satisfy three of the elements listed in Requirement R8, Parts 8.1 through 8.4; OR The responsible entity completed a supplemental GMD Vulnerability Assessment, but it was more	The responsible entity's completed supplemental GMD Vulnerability Assessment failed to satisfy four of the elements listed in Requirement R8, Parts 8.1 through 8.4; OR The responsible entity completed a supplemental GMD Vulnerability Assessment, but it was more

R #	Violation Severity Levels			
	Lower VSL	Moderate VSL	High VSL	Severe VSL
	than 60 calendar months and less than or equal to 64 calendar months since the last supplemental GMD Vulnerability Assessment.	than 64 calendar months and less than or equal to 68 calendar months since the last supplemental GMD Vulnerability Assessment.	than 68 calendar months and less than or equal to 72 calendar months since the last supplemental GMD Vulnerability Assessment.	than 72 calendar months since the last supplemental GMD Vulnerability Assessment; OR The responsible entity does not have a completed supplemental GMD Vulnerability Assessment.
R9.	The responsible entity provided the effective GIC time series, GIC(t), in response to written request, but did so more than 90 calendar days and less than or equal to 100 calendar days after receipt of a written request.	The responsible entity provided the effective GIC time series, GIC(t), in response to written request, but did so more than 100 calendar days and less than or equal to 110 calendar days after receipt of a written request.	The responsible entity provided the effective GIC time series, GIC(t), in response to written request, but did so more than 110 calendar days after receipt of a written request.	The responsible entity did not provide the maximum effective GIC value to the Transmission Owner and Generator Owner that owns each applicable BES power transformer in the planning area; OR The responsible entity did not provide the effective GIC time series, GIC(t), upon written request.
R10.	The responsible entity failed to conduct a supplemental thermal impact assessment for 5% or less or one of its	The responsible entity failed to conduct a supplemental thermal impact assessment for more than 5% up to (and	The responsible entity failed to conduct a supplemental thermal impact assessment for more than 10% up to	The responsible entity failed to conduct a supplemental thermal impact assessment for more than 15% or more

R #	Violation Severity Levels			
	Lower VSL	Moderate VSL	High VSL	Severe VSL
	<p>solely owned and jointly owned applicable BES power transformers (whichever is greater) where the maximum effective GIC value provided in Requirement R9, Part 9.1, is 85 A or greater per phase;</p> <p>OR</p> <p>The responsible entity conducted a supplemental thermal impact assessment for its solely owned and jointly owned applicable BES power transformers where the maximum effective GIC value provided in Requirement R9, Part 9.1, is 85 A or greater per phase but did so more than 24 calendar months and less than or equal to 26 calendar months of receiving GIC flow information specified in Requirement R9, Part 9.1.</p>	<p>including) 10% or two of its solely owned and jointly owned applicable BES power transformers (whichever is greater) where the maximum effective GIC value provided in Requirement R9, Part 9.1, is 85 A or greater per phase;</p> <p>OR</p> <p>The responsible entity conducted a supplemental thermal impact assessment for its solely owned and jointly owned applicable BES power transformers where the maximum effective GIC value provided in Requirement R9, Part 9.1, is 85 A or greater per phase but did so more than 26 calendar months and less than or equal to 28 calendar months of receiving GIC flow information specified in Requirement R9, Part 9.1</p> <p>OR</p>	<p>(and including) 15% or three of its solely owned and jointly owned applicable BES power transformers (whichever is greater) where the maximum effective GIC value provided in Requirement R9, Part 9.1, is 85 A or greater per phase;</p> <p>OR</p> <p>The responsible entity conducted a supplemental thermal impact assessment for its solely owned and jointly owned applicable BES power transformers where the maximum effective GIC value provided in Requirement R9, Part 9.1, is 85 A or greater per phase but did so more than 28 calendar months and less than or equal to 30 calendar months of receiving GIC flow information specified in Requirement R9, Part 9.1;</p> <p>OR</p>	<p>than three of its solely owned and jointly owned applicable BES power transformers (whichever is greater) where the maximum effective GIC value provided in Requirement R9, Part 9.1, is 85 A or greater per phase;</p> <p>OR</p> <p>The responsible entity conducted a supplemental thermal impact assessment for its solely owned and jointly owned applicable BES power transformers where the maximum effective GIC value provided in Requirement R9, Part 9.1, is 85 A or greater per phase but did so more than 30 calendar months of receiving GIC flow information specified in Requirement R9, Part 9.1;</p> <p>OR</p>

R #	Violation Severity Levels			
	Lower VSL	Moderate VSL	High VSL	Severe VSL
		The responsible entity failed to include one of the required elements as listed in Requirement R10, Parts 10.1 through 10.3.	The responsible entity failed to include two of the required elements as listed in Requirement R10, Parts 10.1 through 10.3.	The responsible entity failed to include three of the required elements as listed in Requirement R10, Parts 10.1 through 10.3.
<b>R11.</b>	N/A	N/A	N/A	The responsible entity did not implement a process to obtain GIC monitor data from at least one GIC monitor located in the Planning Coordinator’s planning area or other part of the system included in the Planning Coordinator’s GIC System Model.
<b>R12.</b>	N/A	N/A	N/A	The responsible entity did not implement a process to obtain geomagnetic field data for its Planning Coordinator’s planning area.

**D. Regional Variances**

None.

**E. Associated Documents**

Attachment 1

## Version History

Version	Date	Action	Change Tracking
1	December 17, 2014	Adopted by the NERC Board of Trustees	New
2	November 9, 2017	Adopted by the NERC Board of Trustees	Revised to respond to directives in FERC Order No. 830.

## Attachment 1

### Calculating Geoelectric Fields for the Benchmark and Supplemental GMD Events

The benchmark GMD event<sup>1</sup> defines the geoelectric field values used to compute GIC flows that are needed to conduct a benchmark GMD Vulnerability Assessment. It is composed of the following elements: (1) a reference peak geoelectric field amplitude of 8 V/km derived from statistical analysis of historical magnetometer data; (2) scaling factors to account for local geomagnetic latitude; (3) scaling factors to account for local earth conductivity; and (4) a reference geomagnetic field time series or waveform to facilitate time-domain analysis of GMD impact on equipment.

The supplemental GMD event is composed of similar elements as described above, except (1) the reference peak geoelectric field amplitude is 12 V/km over a localized area; and (2) the geomagnetic field time series or waveform includes a local enhancement in the waveform.<sup>2</sup>

The regional geoelectric field peak amplitude used in GMD Vulnerability Assessment,  $E_{peak}$ , can be obtained from the reference geoelectric field value of 8 V/km for the benchmark GMD event (1) or 12 V/km for the supplemental GMD event (2) using the following relationships:

$$E_{peak} = 8 \times \alpha \times \beta_b \text{ (V/km)} \quad (1)$$

$$E_{peak} = 12 \times \alpha \times \beta_s \text{ (V/km)} \quad (2)$$

where,  $\alpha$  is the scaling factor to account for local geomagnetic latitude, and  $\beta$  is a scaling factor to account for the local earth conductivity structure. Subscripts  $b$  and  $s$  for the  $\beta$  scaling factor denote association with the benchmark or supplemental GMD events, respectively.

### Scaling the Geomagnetic Field

The benchmark and supplemental GMD events are defined for geomagnetic latitude of 60° and must be scaled to account for regional differences based on geomagnetic latitude. Table 2 provides a scaling factor correlating peak geoelectric field to geomagnetic latitude. Alternatively, the scaling factor  $\alpha$  is computed with the empirical expression:

$$\alpha = 0.001 \times e^{(0.115 \times L)} \quad (3)$$

where,  $L$  is the geomagnetic latitude in degrees and  $0.1 \leq \alpha \leq 1$ .

<sup>1</sup> The Benchmark Geomagnetic Disturbance Event Description, May 2016 is available on the Related Information webpage for TPL-007-1: [http://www.nerc.com/pa/Stand/TPL0071RD/Benchmark\\_clean\\_May12\\_complete.pdf](http://www.nerc.com/pa/Stand/TPL0071RD/Benchmark_clean_May12_complete.pdf).

<sup>2</sup> The extent of local enhancements is on the order of 100 km in North-South (latitude) direction but longer in East-West (longitude) direction. The local enhancement in the geomagnetic field occurs over the time period of 2-5 minutes. Additional information is available in the Supplemental Geomagnetic Disturbance Event Description, October 2017 white paper on the Project 2013-03 Geomagnetic Disturbance Mitigation project webpage: <http://www.nerc.com/pa/Stand/Pages/Project-2013-03-Geomagnetic-Disturbance-Mitigation.aspx>.

For large planning areas that cover more than one scaling factor from Table 2, the GMD Vulnerability Assessment should be based on a peak geoelectric field that is:

- calculated by using the most conservative (largest) value for  $\alpha$ ; or
- calculated assuming a non-uniform or piecewise uniform geomagnetic field.

<b>Table 2: Geomagnetic Field Scaling Factors for the Benchmark and Supplemental GMD Events</b>	
<b>Geomagnetic Latitude (Degrees)</b>	<b>Scaling Factor1 (<math>\alpha</math>)</b>
≤ 40	0.10
45	0.2
50	0.3
54	0.5
56	0.6
57	0.7
58	0.8
59	0.9
≥ 60	1.0

### Scaling the Geoelectric Field

The benchmark GMD event is defined for the reference Quebec earth model described in Table 4. The peak geoelectric field,  $E_{peak}$ , used in a GMD Vulnerability Assessment may be obtained by either:

- Calculating the geoelectric field for the ground conductivity in the planning area and the reference geomagnetic field time series scaled according to geomagnetic latitude, using a procedure such as the plane wave method described in the NERC GMD Task Force GIC Application Guide;<sup>3</sup> or
- Using the earth conductivity scaling factor  $\beta$  from Table 3 that correlates to the ground conductivity map in Figure 1 or Figure 2. Along with the scaling factor  $\alpha$  from equation (3) or Table 2,  $\beta$  is applied to the reference geoelectric field using equation (1 or 2, as applicable) to obtain the regional geoelectric field peak amplitude  $E_{peak}$  to be used in GMD Vulnerability Assessments. When a ground conductivity model is not available, the planning entity should use the largest  $\beta$  factor of adjacent physiographic regions or a technically justified value.

<sup>3</sup> Available at the NERC GMD Task Force project webpage: [http://www.nerc.com/comm/PC/Pages/Geomagnetic-Disturbance-Task-Force-\(GMDTF\)-2013.aspx](http://www.nerc.com/comm/PC/Pages/Geomagnetic-Disturbance-Task-Force-(GMDTF)-2013.aspx).



The earth models used to calculate Table 3 for the United States were obtained from publicly available information published on the U. S. Geological Survey website.<sup>4</sup> The models used to calculate Table 3 for Canada were obtained from Natural Resources Canada (NRCan) and reflect the average structure for large regions. A planner can also use specific earth model(s) with documented justification and the reference geomagnetic field time series to calculate the  $\beta$  factor(s) as follows:

$$\beta_b = E/8 \text{ for the benchmark GMD event} \quad (4)$$

$$\beta_s = E/12 \text{ for the supplemental GMD} \quad (5)$$

where,  $E$  is the absolute value of peak geoelectric in V/km obtained from the technically justified earth model and the reference geomagnetic field time series.

For large planning areas that span more than one  $\beta$  scaling factor, the most conservative (largest) value for  $\beta$  may be used in determining the peak geoelectric field to obtain conservative results. Alternatively, a planner could perform analysis using a non-uniform or piecewise uniform geoelectric field.

### **Applying the Localized Peak Geoelectric Field in the Supplemental GMD Event**

The peak geoelectric field of the supplemental GMD event occurs in a localized area.<sup>5</sup> Planners have flexibility to determine how to apply the localized peak geoelectric field over the planning area in performing GIC calculations. Examples of approaches are:

- Apply the peak geoelectric field (12 V/km scaled to the planning area) over the entire planning area;
- Apply a spatially limited (12 V/km scaled to the planning area) peak geoelectric field (e.g., 100 km in North-South latitude direction and 500 km in East-West longitude direction) over a portion(s) of the system, and apply the benchmark GMD event over the rest of the system; or
- Other methods to adjust the benchmark GMD event analysis to account for the localized geoelectric field enhancement of the supplemental GMD event.

---

<sup>4</sup> Available at <http://geomag.usgs.gov/conductivity/>.

<sup>5</sup> See the Supplemental Geomagnetic Disturbance Description white paper located on the Project 2013-03 Geomagnetic Disturbance Mitigation project webpage: <http://www.nerc.com/pa/Stand/Pages/Project-2013-03-Geomagnetic-Disturbance-Mitigation.aspx>.

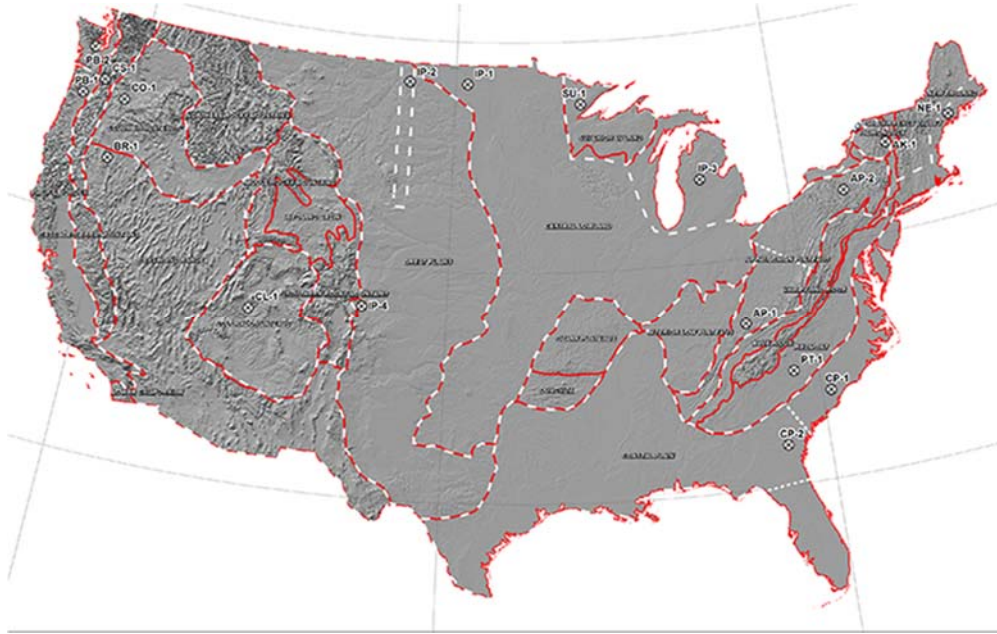

Figure 1: Physiographic Regions of the Continental United States<sup>6</sup>



Figure 2: Physiographic Regions of Canada

<sup>6</sup> Additional map detail is available at the U.S. Geological Survey: <http://geomag.usgs.gov/>.

<b>Table 3: Geoelectric Field Scaling Factors</b>		
<b>Earth model</b>	<b>Scaling Factor Benchmark Event (<math>\beta_b</math>)</b>	<b>Scaling Factor Supplemental Event (<math>\beta_s</math>)</b>
AK1A	0.56	0.51
AK1B	0.56	0.51
AP1	0.33	0.30
AP2	0.82	0.78
BR1	0.22	0.22
CL1	0.76	0.73
CO1	0.27	0.25
CP1	0.81	0.77
CP2	0.95	0.86
FL1	0.76	0.73
CS1	0.41	0.37
IP1	0.94	0.90
IP2	0.28	0.25
IP3	0.93	0.90
IP4	0.41	0.35
NE1	0.81	0.77
PB1	0.62	0.55
PB2	0.46	0.39
PT1	1.17	1.19
SL1	0.53	0.49
SU1	0.93	0.90
BOU	0.28	0.24
FBK	0.56	0.56
PRU	0.21	0.22
BC	0.67	0.62
PRAIRIES	0.96	0.88
SHIELD	1.0	1.0
ATLANTIC	0.79	0.76

**Rationale:** Scaling factors in Table 3 are dependent upon the frequency content of the reference storm. Consequently, the benchmark GMD event and the supplemental GMD event may produce different scaling factors for a given earth model.

The scaling factor associated with the benchmark GMD event for the Florida earth model (FL1) has been updated based on the earth model published on the USGS public website.

<b>Table 4: Reference Earth Model (Quebec)</b>	
<b>Layer Thickness (km)</b>	<b>Resistivity (<math>\Omega\text{-m}</math>)</b>
15	20,000
10	200
125	1,000
200	100
$\infty$	3

**Reference Geomagnetic Field Time Series or Waveform for the Benchmark GMD Event<sup>7</sup>**

The geomagnetic field measurement record of the March 13-14 1989 GMD event, measured at the NRCan Ottawa geomagnetic observatory, is the basis for the reference geomagnetic field waveform to be used to calculate the GIC time series, GIC(t), required for transformer thermal impact assessment.

The geomagnetic latitude of the Ottawa geomagnetic observatory is 55°; therefore, the amplitudes of the geomagnetic field measurement data were scaled up to the 60° reference geomagnetic latitude (see Figure 3) such that the resulting peak geoelectric field amplitude computed using the reference earth model was 8 V/km (see Figures 4 and 5). The sampling rate for the geomagnetic field waveform is 10 seconds.<sup>8</sup> To use this geoelectric field time series when a different earth model is applicable, it should be scaled with the appropriate benchmark conductivity scaling factor  $\beta_b$ .

<sup>7</sup> Refer to the Benchmark Geomagnetic Disturbance Event Description white paper for details on the determination of the reference geomagnetic field waveform: <http://www.nerc.com/pa/stand/Pages/TPL0071RI.aspx>.

<sup>8</sup> The data file of the benchmark geomagnetic field waveform is available on the Related Information webpage for TPL-007-1: <http://www.nerc.com/pa/stand/Pages/TPL0071RI.aspx>.

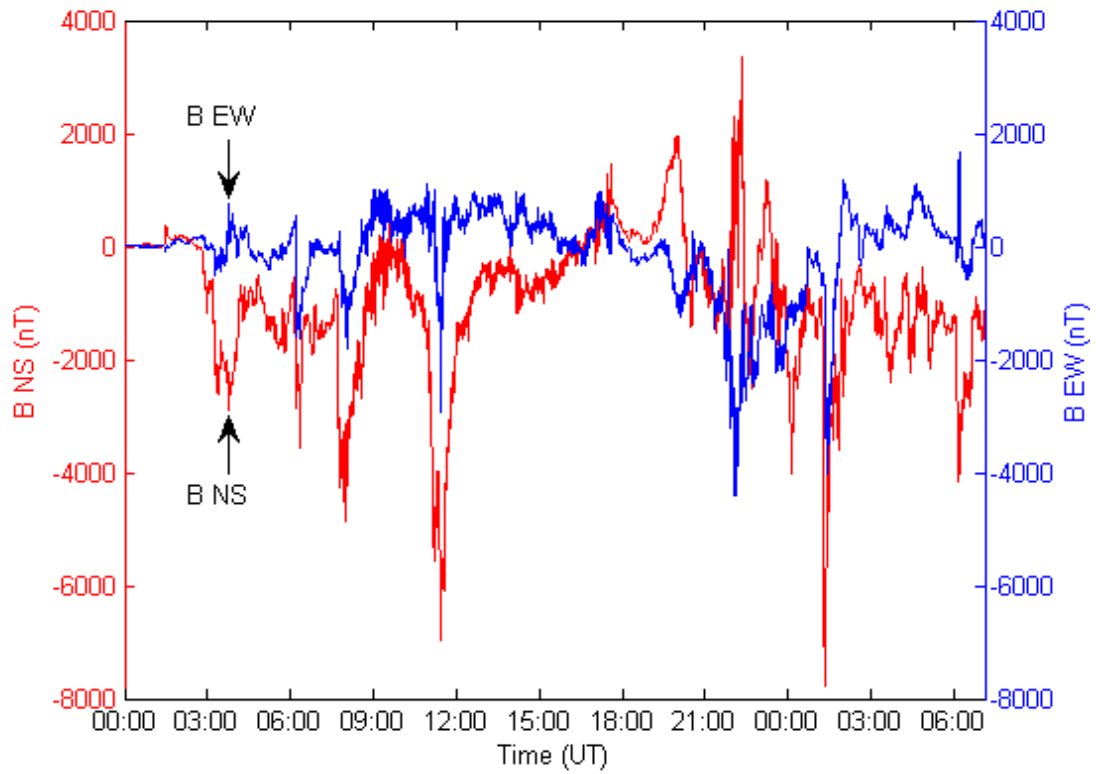

**Figure 3: Benchmark Geomagnetic Field Waveform**  
**Red  $B_n$  (Northward), Blue  $B_e$  (Eastward)**

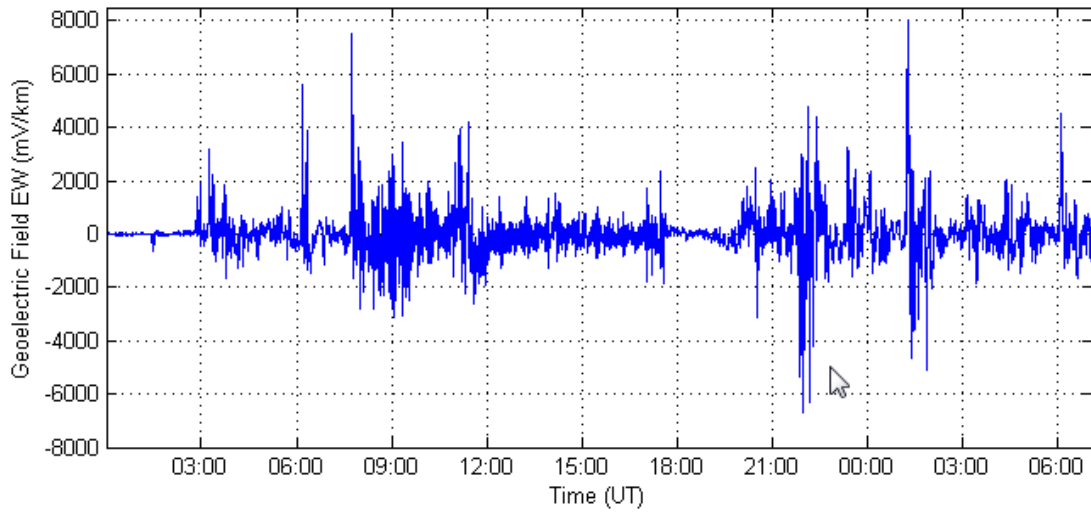

**Figure 4: Benchmark Goelectric Field Waveform**  
 **$E_E$  (Eastward)**

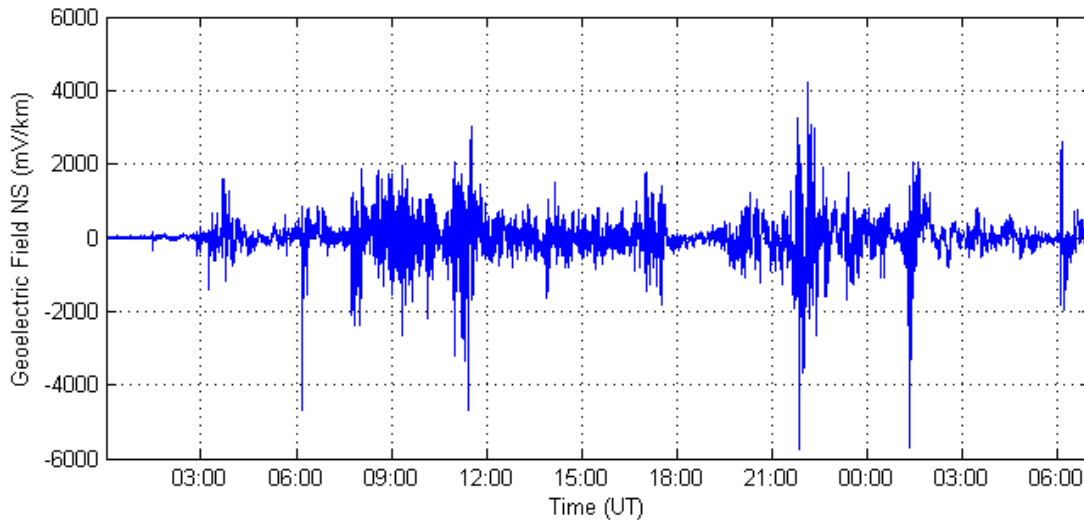

**Figure 5: Benchmark Geoelectric Field Waveform  
 $E_N$  (Northward)**

### Reference Geomagnetic Field Time Series or Waveform for the Supplemental GMD Event<sup>9</sup>

The geomagnetic field measurement record of the March 13-14, 1989 GMD event, measured at the NRCan Ottawa geomagnetic observatory, is the basis for the reference geomagnetic field waveform to be used to calculate the GIC time series,  $GIC(t)$ , required for transformer thermal impact assessment for the supplemental GMD event. The supplemental GMD event waveform differs from the benchmark GMD event waveform in that the supplemental GMD event waveform has a local enhancement.

The geomagnetic latitude of the Ottawa geomagnetic observatory is  $55^\circ$ ; therefore, the amplitudes of the geomagnetic field measurement data were scaled up to the  $60^\circ$  reference geomagnetic latitude (see Figure 6) such that the resulting peak geoelectric field amplitude computed using the reference earth model was 12 V/km (see Figure 7). The sampling rate for the geomagnetic field waveform is 10 seconds.<sup>10</sup> To use this geoelectric field time series when a different earth model is applicable, it should be scaled with the appropriate supplemental conductivity scaling factor  $\beta_s$ .

<sup>9</sup> Refer to the Supplemental Geomagnetic Disturbance Event Description white paper for details on the determination of the reference geomagnetic field waveform: <http://www.nerc.com/pa/Stand/Pages/Project-2013-03-Geomagnetic-Disturbance-Mitigation.aspx>.

<sup>10</sup> The data file of the benchmark geomagnetic field waveform is available on the NERC GMD Task Force project webpage: [http://www.nerc.com/comm/PC/Pages/Geomagnetic-Disturbance-Task-Force-\(GMDTF\)-2013.aspx](http://www.nerc.com/comm/PC/Pages/Geomagnetic-Disturbance-Task-Force-(GMDTF)-2013.aspx).

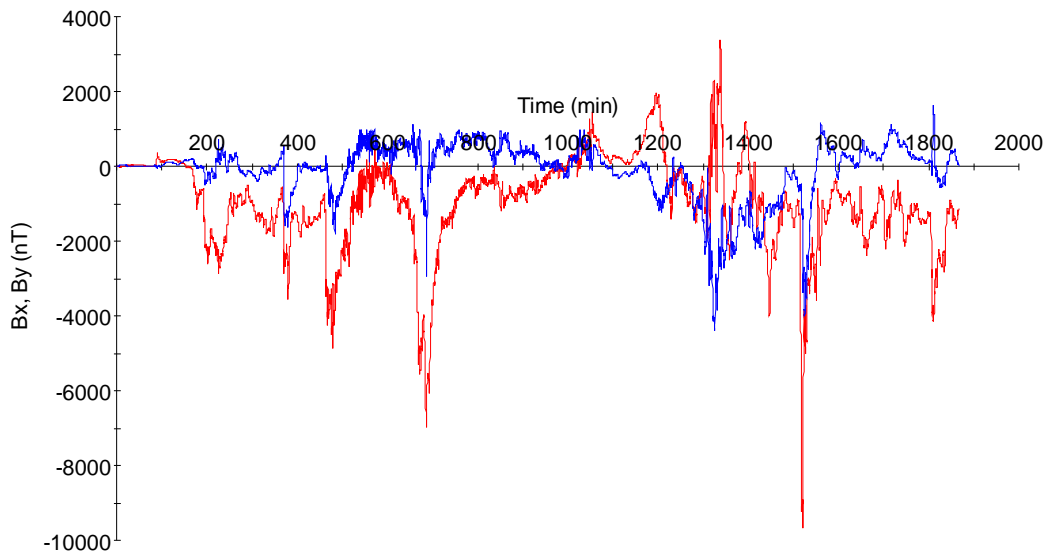

**Figure 6: Supplemental Geomagnetic Field Waveform  
Red  $B_N$  (Northward), Blue  $B_E$  (Eastward)**

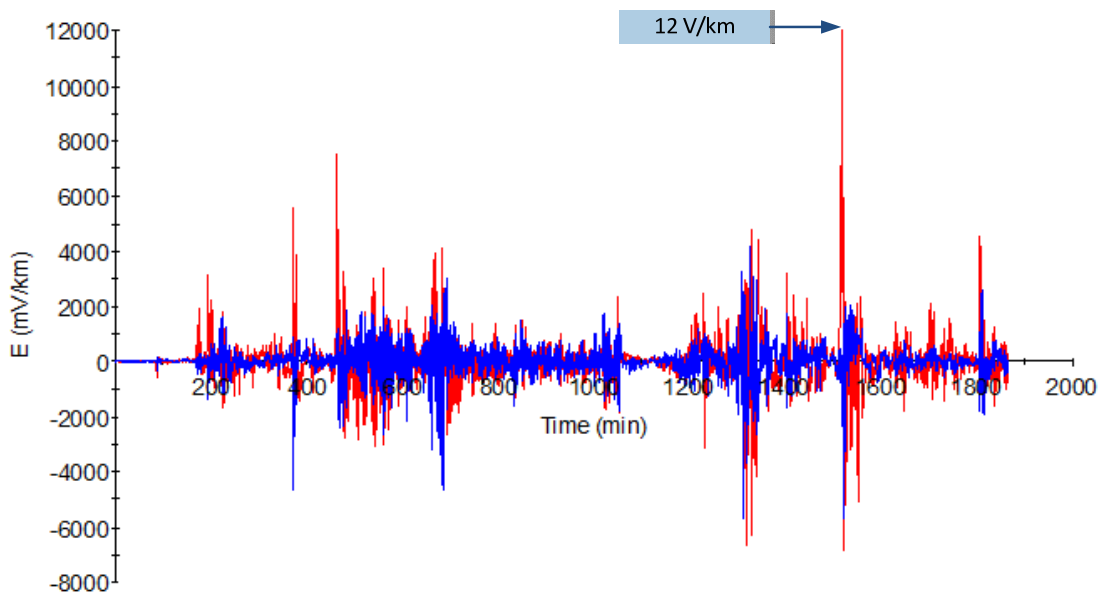

**Figure 7: Supplemental Goelectric Field Waveform  
Blue  $E_N$  (Northward), Red  $E_E$  (Eastward)**

## Guidelines and Technical Basis

The diagram below provides an overall view of the GMD Vulnerability Assessment process:

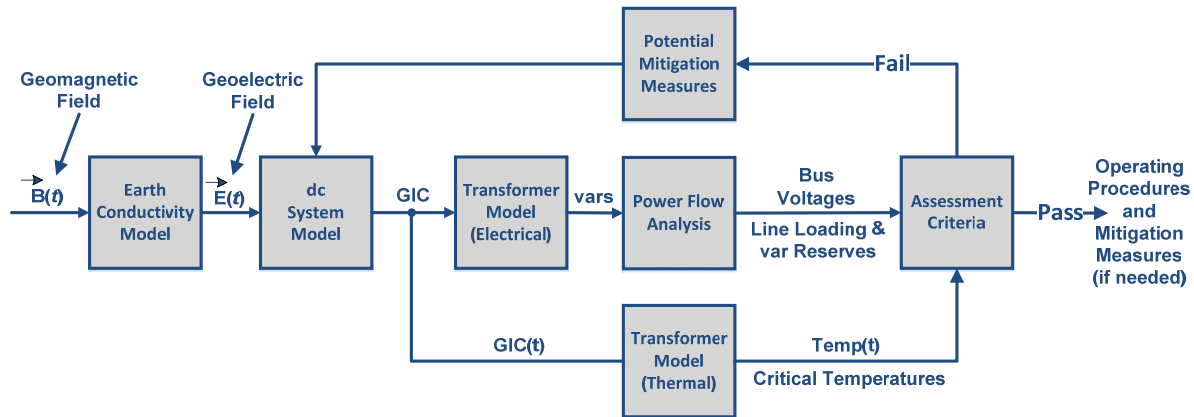

The requirements in this standard cover various aspects of the GMD Vulnerability Assessment process.

### Benchmark GMD Event (Attachment 1)

The benchmark GMD event defines the geoelectric field values used to compute GIC flows that are needed to conduct a benchmark GMD Vulnerability Assessment. The *Benchmark Geomagnetic Disturbance Event Description*, May 2016<sup>11</sup> white paper includes the event description, analysis, and example calculations.

### Supplemental GMD Event (Attachment 1)

The supplemental GMD event defines the geoelectric field values used to compute GIC flows that are needed to conduct a supplemental GMD Vulnerability Assessment. The *Supplemental Geomagnetic Disturbance Event Description*, October 2017<sup>12</sup> white paper includes the event description and analysis.

### Requirement R2

A GMD Vulnerability Assessment requires a GIC System model, which is a dc representation of the System, to calculate GIC flow. In a GMD Vulnerability Assessment, GIC simulations are used to determine transformer Reactive Power absorption and transformer thermal response. Details for developing the GIC System model are provided in the NERC GMD Task Force guide: *Application Guide for Computing Geomagnetically-Induced Current in the Bulk Power System*, December 2013.<sup>13</sup>

Underground pipe-type cables present a special modeling situation in that the steel pipe that encloses the power conductors significantly reduces the geoelectric field induced into the

<sup>11</sup> <http://www.nerc.com/pa/stand/Pages/TPL0071RI.aspx>.

<sup>12</sup> <http://www.nerc.com/pa/Stand/Pages/Project-2013-03-Geomagnetic-Disturbance-Mitigation.aspx>.

<sup>13</sup> [http://www.nerc.com/comm/PC/Geomagnetic%20Disturbance%20Task%20Force%20GMDTF%202013/GIC%20Application%20Guide%202013\\_approved.pdf](http://www.nerc.com/comm/PC/Geomagnetic%20Disturbance%20Task%20Force%20GMDTF%202013/GIC%20Application%20Guide%202013_approved.pdf).



conductors themselves, while they remain a path for GIC. Solid dielectric cables that are not enclosed by a steel pipe will not experience a reduction in the induced geoelectric field. A planning entity should account for special modeling situations in the GIC system model, if applicable.

#### **Requirement R4**

The *Geomagnetic Disturbance Planning Guide*,<sup>14</sup> December 2013 developed by the NERC GMD Task Force provides technical information on GMD-specific considerations for planning studies.

#### **Requirement R5**

The benchmark thermal impact assessment of transformers specified in Requirement R6 is based on GIC information for the benchmark GMD Event. This GIC information is determined by the planning entity through simulation of the GIC System model and must be provided to the entity responsible for conducting the thermal impact assessment. GIC information should be provided in accordance with Requirement R5 each time the GMD Vulnerability Assessment is performed since, by definition, the GMD Vulnerability Assessment includes a documented evaluation of susceptibility to localized equipment damage due to GMD.

The maximum effective GIC value provided in Part 5.1 is used for the benchmark thermal impact assessment. Only those transformers that experience an effective GIC value of 75 A or greater per phase require evaluation in Requirement R6.

GIC(t) provided in Part 5.2 is used to convert the steady state GIC flows to time-series GIC data for the benchmark thermal impact assessment of transformers. This information may be needed by one or more of the methods for performing a benchmark thermal impact assessment. Additional information is in the following section and the *Transformer Thermal Impact Assessment White Paper*,<sup>15</sup> October 2017.

The peak GIC value of 75 Amps per phase has been shown through thermal modeling to be a conservative threshold below which the risk of exceeding known temperature limits established by technical organizations is low.

#### **Requirement R6**

The benchmark thermal impact assessment of a power transformer may be based on manufacturer-provided GIC capability curves, thermal response simulation, thermal impact screening, or other technically justified means. Approaches for conducting the assessment are presented in the *Transformer Thermal Impact Assessment White Paper ERO Enterprise-Endorsed*

---

<sup>14</sup> [http://www.nerc.com/comm/PC/Geomagnetic%20Disturbance%20Task%20Force%20GMDTF%202013/GMD%20Planning%20Guide\\_approved.pdf](http://www.nerc.com/comm/PC/Geomagnetic%20Disturbance%20Task%20Force%20GMDTF%202013/GMD%20Planning%20Guide_approved.pdf).

<sup>15</sup> <http://www.nerc.com/pa/Stand/Pages/Project-2013-03-Geomagnetic-Disturbance-Mitigation.aspx>.

*Implementation Guidance*<sup>16</sup> for this requirement. This ERO-Endorsed document is posted on the NERC Compliance Guidance<sup>17</sup> webpage.

Transformers are exempt from the benchmark thermal impact assessment requirement if the effective GIC value for the transformer is less than 75 A per phase, as determined by a GIC analysis of the System. Justification for this criterion is provided in the *Screening Criterion for Transformer Thermal Impact Assessment White Paper*,<sup>18</sup> October 2017. A documented design specification exceeding this value is also a justifiable threshold criterion that exempts a transformer from Requirement R6.

The benchmark threshold criteria and its associated transformer thermal impact must be evaluated on the basis of effective GIC. Refer to the white papers for additional information.

### **Requirement R7**

Technical considerations for GMD mitigation planning, including operating and equipment strategies, are available in Chapter 5 of the *Geomagnetic Disturbance Planning Guide*,<sup>19</sup> December 2013. Additional information is available in the *2012 Special Reliability Assessment Interim Report: Effects of Geomagnetic Disturbances on the Bulk-Power System*,<sup>20</sup> February 2012.

### **Requirement R8**

The *Geomagnetic Disturbance Planning Guide*,<sup>21</sup> December 2013 developed by the NERC GMD Task Force provides technical information on GMD-specific considerations for planning studies.

The supplemental GMD Vulnerability Assessment process is similar to the benchmark GMD Vulnerability Assessment process described under Requirement R4.

### **Requirement R9**

The supplemental thermal impact assessment specified of transformers in Requirement R10 is based on GIC information for the supplemental GMD Event. This GIC information is determined by the planning entity through simulation of the GIC System model and must be provided to the entity responsible for conducting the thermal impact assessment. GIC information should be provided in accordance with Requirement R9 each time the GMD Vulnerability Assessment is performed since, by definition, the GMD Vulnerability Assessment includes a documented evaluation of susceptibility to localized equipment damage due to GMD.

---

<sup>16</sup> [http://www.nerc.com/pa/comp/guidance/EROEndorsedImplementationGuidance/TPL-007-1\\_Transformer\\_Thermal\\_Impact\\_Assessment\\_White\\_Paper.pdf](http://www.nerc.com/pa/comp/guidance/EROEndorsedImplementationGuidance/TPL-007-1_Transformer_Thermal_Impact_Assessment_White_Paper.pdf).

<sup>17</sup> <http://www.nerc.com/pa/comp/guidance/Pages/default.aspx>.

<sup>18</sup> <http://www.nerc.com/pa/Stand/Pages/Project-2013-03-Geomagnetic-Disturbance-Mitigation.aspx>.

<sup>19</sup> [http://www.nerc.com/comm/PC/Geomagnetic%20Disturbance%20Task%20Force%20GMDTF%202013/GMD%20Planning%20Guide\\_approved.pdf](http://www.nerc.com/comm/PC/Geomagnetic%20Disturbance%20Task%20Force%20GMDTF%202013/GMD%20Planning%20Guide_approved.pdf).

<sup>20</sup> <http://www.nerc.com/pa/RAPA/ra/Reliability%20Assessments%20DL/2012GMD.pdf>.

<sup>21</sup> [http://www.nerc.com/comm/PC/Geomagnetic%20Disturbance%20Task%20Force%20GMDTF%202013/GMD%20Planning%20Guide\\_approved.pdf](http://www.nerc.com/comm/PC/Geomagnetic%20Disturbance%20Task%20Force%20GMDTF%202013/GMD%20Planning%20Guide_approved.pdf).

The maximum effective GIC value provided in Part 9.1 is used for the supplemental thermal impact assessment. Only those transformers that experience an effective GIC value of 85 A or greater per phase require evaluation in Requirement R10.

GIC(t) provided in Part 9.2 is used to convert the steady state GIC flows to time-series GIC data for the supplemental thermal impact assessment of transformers. This information may be needed by one or more of the methods for performing a supplemental thermal impact assessment. Additional information is in the following section.

The peak GIC value of 85 Amps per phase has been shown through thermal modeling to be a conservative threshold below which the risk of exceeding known temperature limits established by technical organizations is low.

### **Requirement R10**

The supplemental thermal impact assessment of a power transformer may be based on manufacturer-provided GIC capability curves, thermal response simulation, thermal impact screening, or other technically justified means. Approaches for conducting the assessment are presented in the *Transformer Thermal Impact Assessment White Paper ERO Enterprise-Endorsed Implementation Guidance*<sup>22</sup> discussed in the Requirement R6 section above. A later version of the *Transformer Thermal Impact Assessment White Paper*,<sup>23</sup> October 2017, has been developed to include updated information pertinent to the supplemental GMD event and supplemental thermal impact assessment.

Transformers are exempt from the supplemental thermal impact assessment requirement if the effective GIC value for the transformer is less than 85 A per phase, as determined by a GIC analysis of the System. Justification for this criterion is provided in the revised *Screening Criterion for Transformer Thermal Impact Assessment White Paper*,<sup>24</sup> October 2017. A documented design specification exceeding this value is also a justifiable threshold criterion that exempts a transformer from Requirement R10.

The supplemental threshold criteria and its associated transformer thermal impact must be evaluated on the basis of effective GIC. Refer to the white papers for additional information.

### **Requirement R11**

Technical considerations for GIC monitoring are contained in Chapter 6 of the *2012 Special Reliability Assessment Interim Report: Effects of Geomagnetic Disturbances on the Bulk-Power System*,<sup>25</sup> February 2012. GIC monitoring is generally performed by Hall effect transducers that are attached to the neutral of the wye-grounded transformer. Data from GIC monitors is useful for model validation and situational awareness.

---

<sup>22</sup> [http://www.nerc.com/pa/comp/guidance/EROEndorsedImplementationGuidance/TPL-007-1\\_Transformer\\_Thermal\\_Impact\\_Assessment\\_White\\_Paper.pdf](http://www.nerc.com/pa/comp/guidance/EROEndorsedImplementationGuidance/TPL-007-1_Transformer_Thermal_Impact_Assessment_White_Paper.pdf).

<sup>23</sup> <http://www.nerc.com/pa/Stand/Pages/Project-2013-03-Geomagnetic-Disturbance-Mitigation.aspx>.

<sup>24</sup> <http://www.nerc.com/pa/Stand/Pages/Project-2013-03-Geomagnetic-Disturbance-Mitigation.aspx>.

<sup>25</sup> <http://www.nerc.com/pa/RAPA/ra/Reliability%20Assessments%20DL/2012GMD.pdf>.

Responsible entities consider the following in developing a process for obtaining GIC monitor data:

- **Monitor locations.** An entity's operating process may be constrained by location of existing GIC monitors. However, when planning for additional GIC monitoring installations consider that data from monitors located in areas found to have high GIC based on system studies may provide more useful information for validation and situational awareness purposes. Conversely, data from GIC monitors that are located in the vicinity of transportation systems using direct current (e.g., subways or light rail) may be unreliable.
- **Monitor specifications.** Capabilities of Hall effect transducers, existing and planned, should be considered in the operating process. When planning new GIC monitor installations, consider monitor data range (e.g., -500 A through + 500 A) and ambient temperature ratings consistent with temperatures in the region in which the monitor will be installed.
- **Sampling Interval.** An entity's operating process may be constrained by capabilities of existing GIC monitors. However, when possible specify data sampling during periods of interest at a rate of 10 seconds or faster.
- **Collection Periods.** The process should specify when the entity expects GIC data to be collected. For example, collection could be required during periods where the Kp index is above a threshold, or when GIC values are above a threshold. Determining when to discontinue collecting GIC data should also be specified to maintain consistency in data collection.
- **Data format.** Specify time and value formats. For example, Greenwich Mean Time (GMT) (MM/DD/YYYY HH:MM:SS) and GIC Value (Ampere). Positive (+) and negative (-) signs indicate direction of GIC flow. Positive reference is flow from ground into transformer neutral. Time fields should indicate the sampled time rather than system or SCADA time if supported by the GIC monitor system.
- **Data retention.** The entity's process should specify data retention periods, for example 1 year. Data retention periods should be adequately long to support availability for the entity's model validation process and external reporting requirements, if any.
- **Additional information.** The entity's process should specify collection of other information necessary for making the data useful, for example monitor location and type of neutral connection (e.g., three-phase or single-phase).

### **Requirement R12**

Magnetometers measure changes in the earth's magnetic field. Entities should obtain data from the nearest accessible magnetometer. Sources of magnetometer data include:

- Observatories such as those operated by U.S. Geological Survey and Natural Resources Canada, see figure below for locations:<sup>26</sup>

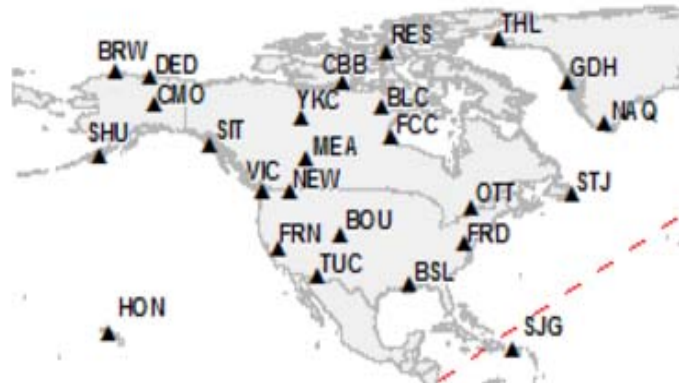

- Research institutions and academic universities;
- Entities with installed magnetometers.

Entities that choose to install magnetometers should consider equipment specifications and data format protocols contained in the latest version of the *INTERMAGNET Technical Reference Manual*, Version 4.6, 2012.<sup>27</sup>

---

<sup>26</sup> <http://www.intermagnet.org/index-eng.php>.

<sup>27</sup> [http://www.intermagnet.org/publications/intermag\\_4-6.pdf](http://www.intermagnet.org/publications/intermag_4-6.pdf).

## Rationale

During development of TPL-007-1, text boxes were embedded within the standard to explain the rationale for various parts of the standard. The text from the rationale text boxes was moved to this section upon approval of TPL-007-1 by the NERC Board of Trustees. In developing TPL-007-2, the SDT has made changes to the sections below only when necessary for clarity. Changes are marked with brackets [ ].

### **Rationale for Applicability:**

Instrumentation transformers and station service transformers do not have significant impact on geomagnetically-induced current (GIC) flows; therefore, these transformers are not included in the applicability for this standard.

Terminal voltage describes line-to-line voltage.

### **Rationale for R1:**

In some areas, planning entities may determine that the most effective approach to conduct a GMD Vulnerability Assessment is through a regional planning organization. No requirement in the standard is intended to prohibit a collaborative approach where roles and responsibilities are determined by a planning organization made up of one or more Planning Coordinator(s).

### **Rationale for R2:**

A GMD Vulnerability Assessment requires a GIC System model to calculate GIC flow which is used to determine transformer Reactive Power absorption and transformer thermal response. Guidance for developing the GIC System model is provided in the *Application Guide Computing Geomagnetically-Induced Current in the Bulk-Power System*,<sup>28</sup> December 2013, developed by the NERC GMD Task Force.

The System model specified in Requirement R2 is used in conducting steady state power flow analysis that accounts for the Reactive Power absorption of power transformer(s) due to GIC in the System.

The GIC System model includes all power transformer(s) with a high side, wye-grounded winding with terminal voltage greater than 200 kV. The model is used to calculate GIC flow in the network.

The projected System condition for GMD planning may include adjustments to the System that are executable in response to space weather information. These adjustments could include, for example, recalling or postponing maintenance outages.

The Violation Risk Factor (VRF) for Requirement R2 is changed from Medium to High. This change is for consistency with the VRF for approved standard TPL-001-4 Requirement R1, which is proposed for revision in the NERC filing dated August 29, 2014 (Docket No. RM12-1-000). NERC guidelines require consistency among Reliability Standards.

---

<sup>28</sup> [http://www.nerc.com/comm/PC/Geomagnetic%20Disturbance%20Task%20Force%20GMDTF%202013/GIC%20Application%20Guide%202013\\_approved.pdf](http://www.nerc.com/comm/PC/Geomagnetic%20Disturbance%20Task%20Force%20GMDTF%202013/GIC%20Application%20Guide%202013_approved.pdf).

**Rationale for R3:**

Requirement R3 allows a responsible entity the flexibility to determine the System steady state voltage criteria for System steady state performance in Table 1. Steady state voltage limits are an example of System steady state performance criteria.

**Rationale for R4:**

The GMD Vulnerability Assessment includes steady state power flow analysis and the supporting study or studies using the models specified in Requirement R2 that account for the effects of GIC. Performance criteria are specified in Table 1.

At least one System On-Peak Load and at least one System Off-Peak Load must be examined in the analysis.

Distribution of GMD Vulnerability Assessment results provides a means for sharing relevant information with other entities responsible for planning reliability. Results of GIC studies may affect neighboring systems and should be taken into account by planners.

The *Geomagnetic Disturbance Planning Guide*,<sup>29</sup> December 2013 developed by the NERC GMD Task Force provides technical information on GMD-specific considerations for planning studies. The provision of information in Requirement R4, Part 4.3, shall be subject to the legal and regulatory obligations for the disclosure of confidential and/or sensitive information.

**Rationale for R5:**

This GIC information is necessary for determining the thermal impact of GIC on transformers in the planning area and must be provided to entities responsible for performing the thermal impact assessment so that they can accurately perform the assessment. GIC information should be provided in accordance with Requirement R5 as part of the GMD Vulnerability Assessment process since, by definition, the GMD Vulnerability Assessment includes documented evaluation of susceptibility to localized equipment damage due to GMD.

The maximum effective GIC value provided in Part 5.1 is used for transformer thermal impact assessment.

GIC(t) provided in Part 5.2 can alternatively be used to convert the steady state GIC flows to time-series GIC data for transformer thermal impact assessment. This information may be needed by one or more of the methods for performing a thermal impact assessment. Additional guidance is available in the *Transformer Thermal Impact Assessment White Paper*,<sup>30</sup> October 2017.

A Transmission Owner or Generator Owner that desires GIC(t) may request it from the planning entity. The planning entity shall provide GIC(t) upon request once GIC has been calculated, but

---

<sup>29</sup> [http://www.nerc.com/comm/PC/Geomagnetic%20Disturbance%20Task%20Force%20GMDTF%202013/GMD%20Planning%20Guide\\_approved.pdf](http://www.nerc.com/comm/PC/Geomagnetic%20Disturbance%20Task%20Force%20GMDTF%202013/GMD%20Planning%20Guide_approved.pdf).

<sup>30</sup> <http://www.nerc.com/pa/Stand/Pages/Project-2013-03-Geomagnetic-Disturbance-Mitigation.aspx>.

no later than 90 calendar days after receipt of a request from the owner and after completion of Requirement R5, Part 5.1.

The provision of information in Requirement R5 shall be subject to the legal and regulatory obligations for the disclosure of confidential and/or sensitive information.

**Rationale for R6:**

The transformer thermal impact screening criterion has been revised from 15 A per phase to 75 A per phase [for the benchmark GMD event]. Only those transformers that experience an effective GIC value of 75 A per phase or greater require evaluation in Requirement R6. The justification is provided in the *Screening Criterion for Transformer Thermal Impact Assessment White Paper*,<sup>31</sup> October 2017.

The thermal impact assessment may be based on manufacturer-provided GIC capability curves, thermal response simulation, thermal impact screening, or other technically justified means. The transformer thermal assessment will be repeated or reviewed using previous assessment results each time the planning entity performs a GMD Vulnerability Assessment and provides GIC information as specified in Requirement R5. Approaches for conducting the assessment are presented in the *Transformer Thermal Impact Assessment White Paper*,<sup>32</sup> October 2017.

Thermal impact assessments are provided to the planning entity, as determined in Requirement R1, so that identified issues can be included in the GMD Vulnerability Assessment (R4), and the Corrective Action Plan (R7) as necessary.

Thermal impact assessments of non-BES transformers are not required because those transformers do not have a wide-area effect on the reliability of the interconnected Transmission system.

The provision of information in Requirement R6, Part 6.4, shall be subject to the legal and regulatory obligations for the disclosure of confidential and/or sensitive information.

**Rationale for R7:**

The proposed requirement addresses directives in Order No. 830 for establishing Corrective Action Plan (CAP) deadlines associated with GMD Vulnerability Assessments. In Order No. 830, FERC directed revisions to TPL-007 such that CAPs are developed within one year from the completion of GMD Vulnerability Assessments (P 101). Furthermore, FERC directed establishment of implementation deadlines after the completion of the CAP as follows (P 102):

- Two years for non-hardware mitigation; and
- Four years for hardware mitigation.

The objective of Part 7.4 is to provide awareness to potentially impacted entities when implementation of planned mitigation is not achievable within the deadlines established in Part

---

<sup>31</sup> <http://www.nerc.com/pa/Stand/Pages/Project-2013-03-Geomagnetic-Disturbance-Mitigation.aspx>.

<sup>32</sup> <http://www.nerc.com/pa/Stand/Pages/Project-2013-03-Geomagnetic-Disturbance-Mitigation.aspx>.



7.3. Examples of situations beyond the control of the of the responsible entity (see Section 7.4) include, but are not limited to:

- Delays resulting from regulatory/legal processes, such as permitting;
- Delays resulting from stakeholder processes required by tariff;
- Delays resulting from equipment lead times; or

Delays resulting from the inability to acquire necessary Right-of-Way.

**Rationale for Table 3:**

Table 3 has been revised to use the same ground model designation, FL1, as is being used by USGS. The calculated scaling factor for FL1 is 0.74. [The scaling factor associated with the benchmark GMD event for the Florida earth model (FL1) has been updated to 0.76 in TPL-007-2 based on the earth model published on the USGS public website.]

**Rationale for R8 – R10:**

The proposed requirements address directives in Order No. 830 for revising the benchmark GMD event used in GMD Vulnerability Assessments (P 44, P 47-49). The requirements add a supplemental GMD Vulnerability Assessment based on the supplemental GMD event that accounts for localized peak geoelectric fields.

**Rationale for R11 – R12:**

The proposed requirements address directives in Order No. 830 for requiring responsible entities to collect GIC monitoring and magnetometer data as necessary to enable model validation and situational awareness (P 88; P. 90-92). GMD measurement data refers to GIC monitor data and geomagnetic field data in Requirements R11 and R12, respectively. See the Guidelines and Technical Basis section of this standard for technical information.

The objective of Requirement R11 is for entities to obtain GIC data for the Planning Coordinator's planning area or other part of the system included in the Planning Coordinator's GIC System model to inform GMD Vulnerability Assessments. Technical considerations for GIC monitoring are contained in Chapter 9 of the *2012 Special Reliability Assessment Interim Report: Effects of Geomagnetic Disturbances on the Bulk-Power System* (NERC 2012 GMD Report). GIC monitoring is generally performed by Hall effect transducers that are attached to the neutral of the transformer and measure dc current flowing through the neutral.

The objective of Requirement R12 is for entities to obtain geomagnetic field data for the Planning Coordinator's planning area to inform GMD Vulnerability Assessments. Magnetometers provide geomagnetic field data by measuring changes in the earth's magnetic field. Sources of geomagnetic field data include:

- Observatories such as those operated by U.S. Geological Survey, Natural Resources Canada, research organizations, or university research facilities;
- Installed magnetometers; and
- Commercial or third-party sources of geomagnetic field data.

Geomagnetic field data for a Planning Coordinator’s planning area is obtained from one or more of the above data sources located in the Planning Coordinator’s planning area, or by obtaining a geomagnetic field data product for the Planning Coordinator’s planning area from a government or research organization. The geomagnetic field data product does not need to be derived from a magnetometer or observatory within the Planning Coordinator’s planning area.

**Proposed Reliability Standard TPL-007-2 – Transmission System Planned Performance for  
Geomagnetic Disturbance Operations - Redline**

## Standard Development Timeline

This section is maintained by the drafting team during the development of the standard and will be removed when the standard is adopted by the NERC Board of Trustees (Board).

### Description of Current Draft

<u>Completed Actions</u>	<u>Date</u>
<u>Standards Committee approved Standard Authorization Request (SAR) for posting</u>	<u>December 14, 2016</u>
<u>SAR posted for comment</u>	<u>December 16, 2016 – January 20, 2017</u>
<u>45-day formal comment period with initial ballot</u>	<u>June 28 – August 11, 2017</u>

<u>Anticipated Actions</u>	<u>Date</u>
<u>10-day final ballot</u>	<u>October 2017</u>
<u>Board adoption</u>	<u>November 2017</u>

### **New or Modified Term(s) Used in NERC Reliability Standards**

This section includes all new or modified terms used in the proposed standard that will be included in the *Glossary of Terms Used in NERC Reliability Standards* upon applicable regulatory approval. Terms used in the proposed standard that are already defined and are not being modified can be found in the *Glossary of Terms Used in NERC Reliability Standards*. The new or revised terms listed below will be presented for approval with the proposed standard. Upon Board adoption, this section will be removed.

**Term(s):**

None

Upon Board adoption, the rationale boxes will be moved to the Supplemental Material Section.

## A. Introduction

1. **Title:** Transmission System Planned Performance for Geomagnetic Disturbance Events
2. **Number:** TPL-007-~~1~~2
3. **Purpose:** Establish requirements for Transmission system planned performance during geomagnetic disturbance (GMD) events.
4. **Applicability:**
  - 4.1. **Functional Entities:**
    - 4.1.1. Planning Coordinator with a planning area that includes a Facility or Facilities specified in 4.2;
    - 4.1.2. Transmission Planner with a planning area that includes a Facility or Facilities specified in 4.2;
    - 4.1.3. Transmission Owner who owns a Facility or Facilities specified in 4.2; and
    - 4.1.4. Generator Owner who owns a Facility or Facilities specified in 4.2.
  - 4.2. **Facilities:**
    - 4.2.1. Facilities that include power transformer(s) with a high side, wye-grounded winding with terminal voltage greater than 200 kV.
5. **Effective Date:** See Implementation Plan for TPL-007-~~1~~2.
6. **Background:** During a GMD event, geomagnetically-induced currents (GIC) may cause transformer hot-spot heating or damage, loss of Reactive Power sources, increased Reactive Power demand, and Misoperation(s), the combination of which may result in voltage collapse and blackout.

## B. Requirements and Measures

- R1.** Each Planning Coordinator, in conjunction with its Transmission Planner(s), shall identify the individual and joint responsibilities of the Planning Coordinator and Transmission Planner(s) in the Planning Coordinator’s planning area for maintaining models, ~~and~~ performing the study or studies needed to complete benchmark and supplemental GMD Vulnerability Assessment(s), and implementing process(es) to obtain GMD measurement data as specified in this standard. [Violation Risk Factor: Lower] [Time Horizon: Long-term Planning]
- M1.** Each Planning Coordinator, in conjunction with its Transmission Planners, shall provide documentation on roles and responsibilities, such as meeting minutes, agreements, copies of procedures or protocols in effect between entities or between departments of a vertically integrated system, or email correspondence that identifies an agreement has been reached on individual and joint responsibilities for maintaining models, ~~and~~ performing the study or studies needed to complete benchmark and supplemental GMD Vulnerability Assessment(s), and implementing process(es) to obtain GMD measurement data in accordance with Requirement R1.
- R2.** Each responsible entity, as determined in Requirement R1, shall maintain System models and GIC System models of the responsible entity’s planning area for performing the study or studies needed to complete benchmark and supplemental GMD Vulnerability Assessment(s). [Violation Risk Factor: High] [Time Horizon: Long-term Planning]
- M2.** Each responsible entity, as determined in Requirement R1, shall have evidence in either electronic or hard copy format that it is maintaining System models and GIC System models of the responsible entity’s planning area for performing the study or studies needed to complete benchmark and supplemental GMD Vulnerability Assessment(s).
- R3.** Each responsible entity, as determined in Requirement R1, shall have criteria for acceptable System steady state voltage performance for its System during the ~~benchmark~~ GMD events described in Attachment 1. [Violation Risk Factor: Medium] [Time Horizon: Long-term Planning]
- M3.** Each responsible entity, as determined in Requirement R1, shall have evidence, such as electronic or hard copies of the criteria for acceptable System steady state voltage performance for its System in accordance with Requirement R3.

### Benchmark GMD Vulnerability Assessment(s)

- R4.** Each responsible entity, as determined in Requirement R1, shall complete a benchmark GMD Vulnerability Assessment of the Near-Term Transmission Planning Horizon at least once every 60 calendar months. This benchmark GMD Vulnerability Assessment shall use a study or studies based on models identified in Requirement R2, document assumptions, and document summarized results of the steady state analysis. [*Violation Risk Factor: High*] [*Time Horizon: Long-term Planning*]
- 4.1.** The study or studies shall include the following conditions:
- 4.1.1.** System On-Peak Load for at least one year within the Near-Term Transmission Planning Horizon; and
- 4.1.2.** System Off-Peak Load for at least one year within the Near-Term Transmission Planning Horizon.
- 4.2.** The study or studies shall be conducted based on the benchmark GMD event described in Attachment 1 to determine whether the System meets the performance requirements for the steady state planning benchmark GMD event contained in Table 1.
- 4.3.** The benchmark GMD Vulnerability Assessment shall be provided ~~within 90 calendar days of completion: (i)~~ to the responsible entity's Reliability Coordinator, adjacent Planning Coordinators, and adjacent Transmission Planners, ~~and~~ within 90 calendar days of completion, and (ii) to any functional entity that submits a written request and has a reliability-related need within 90 calendar days of receipt of such request or within 90 calendar days of completion of the benchmark GMD Vulnerability Assessment, whichever is later.
- 4.3.1.** If a recipient of the benchmark GMD Vulnerability Assessment provides documented comments on the results, the responsible entity shall provide a documented response to that recipient within 90 calendar days of receipt of those comments.



- M4.** Each responsible entity, as determined in Requirement R1, shall have dated evidence such as electronic or hard copies of its benchmark GMD Vulnerability Assessment meeting all of the requirements in Requirement R4. Each responsible entity, as determined in Requirement R1, shall also provide evidence, such as email records, web postings with an electronic notice of posting, or postal receipts showing recipient and date, that it has distributed its benchmark GMD Vulnerability Assessment ~~within 90 calendar days of completion:~~ (i) to its the responsible entity's Reliability Coordinator, adjacent Planning Coordinator(s), and adjacent Transmission Planner(s) within 90 calendar days of completion, and (ii) to any functional entity who has submitted that submits a written request and has a reliability-related need within 90 calendar days of receipt of such request or within 90 calendar days of completion of the benchmark GMD Vulnerability Assessment, whichever is later, as specified in Requirement R4. Each responsible entity, as determined in Requirement R1, shall also provide evidence, such as email notices or postal receipts showing recipient and date, that it has provided a documented response to comments received on its benchmark GMD Vulnerability Assessment within 90 calendar days of receipt of those comments in accordance with Requirement R4.
- R5.** Each responsible entity, as determined in Requirement R1, shall provide GIC flow information to be used for the benchmark transformer thermal impact assessment of transformers specified in Requirement R6 to each Transmission Owner and Generator Owner that owns an applicable Bulk Electric System (BES) power transformer in the planning area. The GIC flow information shall include: *[Violation Risk Factor: Medium] [Time Horizon: Long-term Planning]*
- 5.1.** The maximum effective GIC value for the worst case geoelectric field orientation for the benchmark GMD event described in Attachment 1. This value shall be provided to the Transmission Owner or Generator Owner that owns each applicable BES power transformer in the planning area.
- 5.2.** The effective GIC time series, GIC(t), calculated using the benchmark GMD event described in Attachment 1 in response to a written request from the Transmission Owner or Generator Owner that owns an applicable BES power transformer in the planning area. GIC(t) shall be provided within 90 calendar days of receipt of the written request and after determination of the maximum effective GIC value in Part 5.1.
- M5.** Each responsible entity, as determined in Requirement R1, shall provide evidence, such as email records, web postings with an electronic notice of posting, or postal receipts showing recipient and date, that it has provided the maximum effective GIC values to the Transmission Owner and Generator Owner that owns each applicable BES power transformer in the planning area as specified in Requirement R5, Part 5.1. Each responsible entity, as determined in Requirement R1, shall also provide evidence, such as email records, web postings with an electronic notice of posting, or postal receipts showing recipient and date, that it has provided GIC(t) in response to a written request from the Transmission Owner or Generator Owner that owns an applicable BES power transformer in the planning area.

- R6.** Each Transmission Owner and Generator Owner shall conduct a benchmark thermal impact assessment for its solely and jointly owned applicable BES power transformers where the maximum effective GIC value provided in Requirement R5, Part 5.1, is 75 A per phase or greater. The benchmark thermal impact assessment shall: *[Violation Risk Factor: Medium]*  
*[Time Horizon: Long-term Planning]*
- 6.1.** Be based on the effective GIC flow information provided in Requirement R5;
  - 6.2.** Document assumptions used in the analysis;
  - 6.3.** Describe suggested actions and supporting analysis to mitigate the impact of GICs, if any; and
  - 6.4.** Be performed and provided to the responsible entities, as determined in Requirement R1, within 24 calendar months of receiving GIC flow information specified in Requirement R5, Part 5.1.
- M6.** Each Transmission Owner and Generator Owner shall have evidence such as electronic or hard copies of its benchmark thermal impact assessment for all of its solely and jointly owned applicable BES power transformers where the maximum effective GIC value provided in Requirement R5, Part 5.1, is 75 A per phase or greater, and shall have evidence such as email records, web postings with an electronic notice of posting, or postal receipts showing recipient and date, that it has provided its thermal impact assessment to the responsible entities as specified in Requirement R6.

**Rationale for Requirement R7:** The proposed requirement addresses directives in Order No. 830 for establishing Corrective Action Plan (CAP) deadlines associated with GMD Vulnerability Assessments. In Order No. 830, FERC directed revisions to TPL-007 such that CAPs are developed within one year from the completion of GMD Vulnerability Assessments (P 101). Furthermore, FERC directed establishment of implementation deadlines after the completion of the CAP as follows (P 102):

- Two years for non-hardware mitigation; and
- Four years for hardware mitigation.

The objective of Part 7.4 is to provide awareness to potentially impacted entities when implementation of planned mitigation is not achievable within the deadlines established in Part 7.3. Examples of situations beyond the control of the of the responsible entity (see Section 7.4) include, but are not limited to:

- Delays resulting from regulatory/legal processes, such as permitting;
- Delays resulting from stakeholder processes required by tariff;
- Delays resulting from equipment lead times; or
- Delays resulting from the inability to acquire necessary Right-of-Way.

R7. Each responsible entity, as determined in Requirement R1, that concludes, through the benchmark GMD Vulnerability Assessment conducted in Requirement R4, that their System does not meet the performance requirements for the steady state planning benchmark GMD event contained in ~~of~~ Table 1, shall develop a Corrective Action Plan (CAP) addressing how the performance requirements will be met. The ~~Corrective Action Plan~~ CAP shall: [Violation Risk Factor: High] [Time Horizon: Long-term Planning]

7.1. List System deficiencies and the associated actions needed to achieve required System performance. Examples of such actions include:

- Installation, modification, retirement, or removal of Transmission and generation Facilities and any associated equipment.
- Installation, modification, or removal of Protection Systems or Remedial Action Schemes~~Special Protection Systems.~~
- Use of Operating Procedures, specifying how long they will be needed as part of the ~~Corrective Action Plan~~ CAP.
- Use of Demand-Side Management, new technologies, or other initiatives.

7.2. Be developed within one year of completion of the benchmark ~~reviewed in subsequent~~ GMD Vulnerability Assessments ~~until it is determined that the System meets the performance requirements contained in Table 1.~~

7.3. ~~Be provided within 90 calendar days of completion to the responsible entity's Reliability Coordinator, adjacent Planning Coordinator(s), adjacent Transmission Planner(s), functional entities referenced in the Corrective Action Plan, and any functional entity that submits a written request and has a reliability related need.~~ Include a timetable, subject to revision by the responsible entity in Part 7.4, for implementing the selected actions from Part 7.1. The timetable shall:

~~7.3.1. If a recipient of the Corrective Action Plan provides documented comments on the results, the responsible entity shall provide a documented response to that recipient within 90 calendar days of receipt of those comments. Specify implementation of non-hardware mitigation, if any, within two years of development of the CAP; and~~

~~7.3.1.7.3.2. Specify implementation of hardware mitigation, if any, within four years of development of the CAP.~~

~~7.4. Be revised if situations beyond the control of the responsible entity determined in Requirement R1 prevent implementation of the CAP within the timetable for implementation provided in Part 7.3. The revised CAP shall document the following, and be updated at least once every 12 calendar months until implemented:~~

~~7.4.1. Circumstances causing the delay for fully or partially implementing the selected actions in Part 7.1;~~

~~7.4.2. Description of the original CAP, and any previous changes to the CAP, with the associated timetable(s) for implementing the selected actions in Part 7.1; and~~

~~7.4.3. Revisions to the selected actions in Part 7.1, if any, including utilization of Operating Procedures if applicable, and the updated timetable for implementing the selected actions.~~

~~7.4.7.5. Be provided within 90 calendar days of completion: (i) to the responsible entity's Reliability Coordinator, adjacent Planning Coordinator(s), adjacent Transmission Planner(s), and functional entities referenced in the Corrective Action Plan, and CAP within 90 calendar days of development or revision, and (ii) to any functional entity that submits a written request and has a reliability-related need within 90 calendar days of receipt of such request or within 90 calendar days of development or revision, whichever is later.~~

~~7.4.1.7.5.1. If a recipient of the Corrective Action Plan CAP provides documented comments on the results, the responsible entity shall provide a documented response to that recipient within 90 calendar days of receipt of those comments.~~

**M7.** Each responsible entity, as determined in Requirement R1, that concludes, through the benchmark GMD Vulnerability Assessment conducted in Requirement R4, that the responsible entity's System does not meet the performance requirements for the steady state planning benchmark GMD event contained in ~~of~~ Table 1 shall have evidence such as dated electronic or hard copies of its CAP Corrective Action Plan including timetable for implementing selected actions, as specified in Requirement R7. Each responsible entity, as determined in Requirement R1, shall also provide evidence, such as email records or postal receipts showing recipient and date, that it has revised its CAP if situations beyond the responsible entity's control prevent implementation of the CAP within the timetable specified. Each responsible entity, as

determined in Requirement R1, shall also provide evidence, such as email records, web postings with an electronic notice of posting, or postal receipts showing recipient and date, that it has distributed its ~~CAP Corrective Action Plan~~ or relevant information, if any, (i) to the responsible entity's Reliability Coordinator, adjacent Planning Coordinator(s), adjacent Transmission Planner(s), and functional entities referenced in the ~~Corrective Action Plan~~ CAP within 90 calendar days of development or revision, and (ii) to any functional entity that submits a written request and has a reliability-related need, within 90 calendar days of receipt of such request or within 90 calendar days of development or revision, whichever is later as specified in Requirement R7. Each responsible entity, as determined in Requirement R1, shall also provide evidence, such as email notices or postal receipts showing recipient and date, that it has provided a documented response to comments received on its ~~CAP Corrective Action Plan~~ within 90 calendar days of receipt of those comments, in accordance with Requirement R7.

### Supplemental GMD Vulnerability Assessment(s)

Rationale for Requirements R8 – R10: The proposed requirements address directives in Order No. 830 for revising the benchmark GMD event used in GMD Vulnerability Assessments (P 44, P 47-49). The requirements add a supplemental GMD Vulnerability Assessment based on the supplemental GMD event that accounts for localized peak geoelectric fields.

- R8.** Each responsible entity, as determined in Requirement R1, shall complete a supplemental GMD Vulnerability Assessment of the Near-Term Transmission Planning Horizon at least once every 60 calendar months. This supplemental GMD Vulnerability Assessment shall use a study or studies based on models identified in Requirement R2, document assumptions, and document summarized results of the steady state analysis. [Violation Risk Factor: High] [Time Horizon: Long-term Planning]
- 8.1.** The study or studies shall include the following conditions:
- 8.1.1.** System On-Peak Load for at least one year within the Near-Term Transmission Planning Horizon; and
  - 8.1.2.** System Off-Peak Load for at least one year within the Near-Term Transmission Planning Horizon.
- 8.2.** The study or studies shall be conducted based on the supplemental GMD event described in Attachment 1 to determine whether the System meets the performance requirements for the steady state planning supplemental GMD event contained in Table 1.

8.3. If the analysis concludes there is Cascading caused by the supplemental GMD event described in Attachment 1, an evaluation of possible actions designed to reduce the likelihood or mitigate the consequences and adverse impacts of the event(s) shall be conducted.

8.4. The supplemental GMD Vulnerability Assessment shall be provided: (i) to the responsible entity's Reliability Coordinator, adjacent Planning Coordinators, adjacent Transmission Planners within 90 calendar days of completion, and (ii) to any functional entity that submits a written request and has a reliability-related need within 90 calendar days of receipt of such request or within 90 calendar days of completion of the supplemental GMD Vulnerability Assessment, whichever is later.

8.4.1. If a recipient of the supplemental GMD Vulnerability Assessment provides documented comments on the results, the responsible entity shall provide a documented response to that recipient within 90 calendar days of receipt of those comments.

M8. Each responsible entity, as determined in Requirement R1, shall have dated evidence such as electronic or hard copies of its supplemental GMD Vulnerability Assessment meeting all of the requirements in Requirement R8. Each responsible entity, as determined in Requirement R1, shall also provide evidence, such as email records, web postings with an electronic notice of posting, or postal receipts showing recipient and date, that it has distributed its supplemental GMD Vulnerability: (i) to the responsible entity's Reliability Coordinator, adjacent Planning Coordinators, adjacent Transmission Planners within 90 calendar days of completion, and (ii) to any functional entity that submits a written request and has a reliability-related need within 90 calendar days of receipt of such request or within 90 calendar days of completion of the supplemental GMD Vulnerability Assessment, whichever is later, as specified in Requirement R8. Each responsible entity, as determined in Requirement R1, shall also provide evidence, such as email notices or postal receipts showing recipient and date, that it has provided a documented response to comments received on its supplemental GMD Vulnerability Assessment within 90 calendar days of receipt of those comments in accordance with Requirement R8.

R9. Each responsible entity, as determined in Requirement R1, shall provide GIC flow information to be used for the supplemental thermal impact assessment of transformers specified in Requirement R10 to each Transmission Owner and Generator Owner that owns an applicable Bulk Electric System (BES) power transformer in the planning area. The GIC flow information shall include: *[Violation Risk Factor: Medium] [Time Horizon: Long-term Planning]*

9.1. The maximum effective GIC value for the worst case geoelectric field orientation for the supplemental GMD event described in Attachment 1. This value shall be provided to the Transmission Owner or Generator Owner that owns each applicable BES power transformer in the planning area.

9.2. The effective GIC time series, GIC(t), calculated using the supplemental GMD event described in Attachment 1 in response to a written request from the Transmission Owner or Generator Owner that owns an applicable BES power transformer in the planning area. GIC(t) shall be provided within 90 calendar days of receipt of the written request and after determination of the maximum effective GIC value in Part 9.1.

M9. Each responsible entity, as determined in Requirement R1, shall provide evidence, such as email records, web postings with an electronic notice of posting, or postal receipts showing recipient and date, that it has provided the maximum effective GIC values to the Transmission Owner and Generator Owner that owns each applicable BES power transformer in the planning area as specified in Requirement R9, Part 9.1. Each responsible entity, as determined in Requirement R1, shall also provide evidence, such as email records, web postings with an electronic notice of posting, or postal receipts showing recipient and date, that it has provided GIC(t) in response to a written request from the Transmission Owner or Generator Owner that owns an applicable BES power transformer in the planning area.

R10. Each Transmission Owner and Generator Owner shall conduct a supplemental thermal impact assessment for its solely and jointly owned applicable BES power transformers where the maximum effective GIC value provided in Requirement R9, Part 9.1, is 85 A per phase or greater. The supplemental thermal impact assessment shall: *[Violation Risk Factor: Medium]* *[Time Horizon: Long-term Planning]*

10.1. Be based on the effective GIC flow information provided in Requirement R9;

10.2. Document assumptions used in the analysis;

10.3. Describe suggested actions and supporting analysis to mitigate the impact of GICs, if any; and

10.4. Be performed and provided to the responsible entities, as determined in Requirement R1, within 24 calendar months of receiving GIC flow information specified in Requirement R9, Part 9.1.

M10. Each Transmission Owner and Generator Owner shall have evidence such as electronic or hard copies of its supplemental thermal impact assessment for all of its solely and jointly owned applicable BES power transformers where the maximum effective GIC value provided in Requirement R9, Part 9.1, is 85 A per phase or greater, and shall have evidence such as email records, web postings with an electronic notice of posting, or postal receipts showing recipient and date, that it has provided its supplemental thermal impact assessment to the responsible entities as specified in Requirement R10.

### GMD Measurement Data Processes

Rationale for Requirements R11 and R12: The proposed requirements address directives in Order No. 830 for requiring responsible entities to collect GIC monitoring and magnetometer data as necessary to enable model validation and situational awareness (P 88; P. 90-92). GMD measurement data refers to GIC monitor data and geomagnetic field data in Requirements R11 and R12, respectively. See the Guidelines and Technical Basis section of this standard for technical information.

The objective of Requirement R11 is for entities to obtain GIC data for the Planning Coordinator's planning area or other part of the system included in the Planning Coordinator's GIC System model to inform GMD Vulnerability Assessments. Technical considerations for GIC monitoring are contained in Chapter 9 of the 2012 *Special Reliability Assessment Interim Report: Effects of Geomagnetic Disturbances on the Bulk-Power System* (NERC 2012 GMD Report). GIC monitoring is generally performed by Hall effect transducers that are attached to the neutral of the transformer and measure dc current flowing through the neutral.

The objective of Requirement R12 is for entities to obtain geomagnetic field data for the Planning Coordinator's planning area to inform GMD Vulnerability Assessments. Magnetometers provide geomagnetic field data by measuring changes in the earth's magnetic field. Sources of geomagnetic field data include:

- Observatories such as those operated by U.S. Geological Survey, Natural Resources Canada, research organizations, or university research facilities;
- Installed magnetometers; and
- Commercial or third-party sources of geomagnetic field data.



Geomagnetic field data for a Planning Coordinator’s planning area is obtained from one or more of the above data sources located in the Planning Coordinator’s planning area, or by obtaining a geomagnetic field data product for the Planning Coordinator’s planning area from a government or research organization. The geomagnetic field data product does not need to be derived from a magnetometer or observatory within the Planning Coordinator’s planning area.

- R11. Each responsible entity, as determined in Requirement R1, shall implement a process to obtain GIC monitor data from at least one GIC monitor located in the Planning Coordinator's planning area or other part of the system included in the Planning Coordinator's GIC System model. [Violation Risk Factor: Lower] [Time Horizon: Long-term Planning]
- M11. Each responsible entity, as determined in Requirement R1, shall have evidence such as electronic or hard copies of its GIC monitor location(s) and documentation of its process to obtain GIC monitor data in accordance with Requirement R11.
- R12. Each responsible entity, as determined in Requirement R1, shall implement a process to obtain geomagnetic field data for its Planning Coordinator’s planning area. [Violation Risk Factor: Lower] [Time Horizon: Long-term Planning]
- M8-M12. Each responsible entity, as determined in Requirement R1, shall have evidence such as electronic or hard copies of its process to obtain geomagnetic field data for its Planning Coordinator’s planning area in accordance with Requirement R12.

## C. Compliance

### 1. Compliance Monitoring Process

- 1.1. Compliance Enforcement Authority:** ~~“As defined in the NERC Rules of Procedure;~~ “Compliance Enforcement Authority” means NERC or the Regional Entity, or any entity as otherwise designated by an Applicable Governmental Authority, in their respective roles of monitoring and /or enforcing compliance with the NERC mandatory and enforceable Reliability Standards in their respective jurisdictions.
- 1.2. Evidence Retention:** The following evidence retention ~~periods~~period(s) identify the period of time an entity is required to retain specific evidence to demonstrate compliance. For instances where the evidence retention period specified below is shorter than the time since the last audit, the CEA Compliance Enforcement Authority may ask an entity to provide other evidence to show that it was compliant for the full-time period since the last audit.

~~The Planning Coordinator, Transmission Planner, Transmission Owner, and Generator Owner~~The applicable entity shall keep data or evidence to show compliance as identified below unless directed by its Compliance Enforcement Authority to retain specific evidence for a longer period of time as part of an investigation:

- For Requirements R1, R2, R3, R5, R6, R9, and ~~R6~~R10, each responsible entity shall retain documentation as evidence for five years.
- For Requirements R4 and R8, each responsible entity shall retain documentation of the current GMD Vulnerability Assessment and the preceding GMD Vulnerability Assessment.
- For Requirement R7, each responsible entity shall retain documentation as evidence for five years or until all actions in the Corrective Action Plan are completed, whichever is later.
- For Requirements R11 and R12, each responsible entity shall retain documentation as evidence for three years.

**1.3.** Compliance Monitoring and Enforcement Program: As defined in the NERC Rules of Procedure, “Compliance Monitoring and Enforcement Program” refers to the identification of the processes that will be used to evaluate data or information for the purpose of assessing performance or outcomes with the associated Reliability Standard.

~~Compliance Audits~~

~~Self-Certifications~~

~~Spot Checking~~

~~Compliance Investigations~~

~~Self-Reporting~~

~~Complaints~~

**~~1.4. Additional Compliance Information~~**

~~None~~

**Table 1 – Steady State Planning ~~Events~~ GMD Event**

**Steady State:**

- Voltage collapse, Cascading and uncontrolled islanding shall not occur.
- Generation loss is acceptable as a consequence of the steady state planning ~~event~~ GMD events.
- Planned System adjustments such as Transmission configuration changes and re-dispatch of generation are allowed if such adjustments are executable within the time duration applicable to the Facility Ratings.

Category	Initial Condition	Event	Interruption of Firm Transmission Service Allowed	Load Loss Allowed
<b>Benchmark GMD Event - GMD Event with Outages</b>	1. System as may be postured in response to space weather information <sup>1</sup> , and then 2. GMD event <sup>2</sup>	Reactive Power compensation devices and other Transmission Facilities removed as a result of Protection System operation or Misoperation due to harmonics during the GMD event	Yes <sup>3</sup>	Yes <sup>3</sup>
<b><u>Supplemental GMD Event - GMD Event with Outages</u></b>	<u>1. System as may be postured in response to space weather information<sup>1</sup>, and then</u> <u>2. GMD event<sup>2</sup></u>	<u>Reactive Power compensation devices and other Transmission Facilities removed as a result of Protection System operation or Misoperation due to harmonics during the GMD event</u>	<u>Yes</u>	<u>Yes</u>

**Table 1 – Steady State Performance Footnotes**

- The System condition for GMD planning may include adjustments to posture the System that are executable in response to space weather information.
- The GMD conditions for the benchmark and supplemental planning ~~event~~ events are described in Attachment 1 ~~(Benchmark GMD Event)~~.
- Load loss as a result of manual or automatic Load shedding (e.g., UVLS) and/or curtailment of Firm Transmission Service may be used to meet BES performance requirements during studied GMD conditions. The likelihood and magnitude of Load loss or curtailment of Firm Transmission Service should be minimized.

### Violation Severity Levels

R #	Time Horizon	VRF	Violation Severity Levels			
			Lower VSL	Moderate VSL	High VSL	Severe VSL
R1.	Long-term Planning	Lower	N/A	N/A	N/A	The Planning Coordinator, in conjunction with its Transmission Planner(s), failed to determine and identify individual or joint responsibilities of the Planning Coordinator and Transmission Planner(s) in the Planning Coordinator’s planning area for maintaining models, <del>and</del> performing the study or studies needed to complete <u>benchmark and supplemental</u> GMD Vulnerability Assessment(s), <u>and implementing process(es) to obtain GMD measurement data as specified in this standard.</u>

R #	Time Horizon	VRF	Violation Severity Levels			
			Lower VSL	Moderate VSL	High VSL	Severe VSL
R2.	Long-term Planning	High	N/A	N/A	The responsible entity did not maintain either System models or GIC System models of the responsible entity's planning area for performing the <del>study or</del> studies needed to complete <u>benchmark and supplemental</u> GMD Vulnerability Assessment(s).	The responsible entity did not maintain both System models and GIC System models of the responsible entity's planning area for performing the <del>study or</del> studies needed to complete <u>benchmark and supplemental</u> GMD Vulnerability Assessment(s).
R3.	Long-term Planning	Medium	N/A	N/A	N/A	The responsible entity did not have criteria for acceptable System steady state voltage performance for its System during the <del>benchmark</del> GMD events described in Attachment 1 as required.

R #	Time Horizon	VRF	Violation Severity Levels			
			Lower VSL	Moderate VSL	High VSL	Severe VSL
R4.	Long-term Planning	High	The responsible entity completed a <u>benchmark</u> GMD Vulnerability Assessment, but it was more than 60 calendar months and less than or equal to 64 calendar months since the last <u>benchmark</u> GMD Vulnerability Assessment.	The responsible entity's completed <u>benchmark</u> GMD Vulnerability Assessment failed to satisfy one of <u>the</u> elements listed in Requirement R4, Parts 4.1 through 4.3; OR The responsible entity completed a <u>benchmark</u> GMD Vulnerability Assessment, but it was more than 64 calendar months and less than or equal to 68 calendar months since the last benchmark GMD Vulnerability Assessment.	The responsible entity's completed <u>benchmark</u> GMD Vulnerability Assessment failed to satisfy two of the elements listed in Requirement R4, Parts 4.1 through 4.3; OR The responsible entity completed a <u>benchmark</u> GMD Vulnerability Assessment, but it was more than 68 calendar months and less than or equal to 72 calendar months since the last <u>benchmark</u> GMD Vulnerability Assessment.	The responsible entity's completed <u>benchmark</u> GMD Vulnerability Assessment failed to satisfy three of the elements listed in Requirement R4, Parts 4.1 through 4.3; OR The responsible entity completed a <u>benchmark</u> GMD Vulnerability Assessment, but it was more than 72 calendar months since the last <u>benchmark</u> GMD Vulnerability Assessment; OR The responsible entity does not have a completed <u>benchmark</u> GMD Vulnerability Assessment.

R #	Time Horizon	VRF	Violation Severity Levels			
			Lower VSL	Moderate VSL	High VSL	Severe VSL
R5.	Long-term Planning	Medium	The responsible entity provided the effective GIC time series, GIC(t), in response to written request, but did so more than 90 calendar days and less than or equal to 100 calendar days after receipt of a written request.	The responsible entity provided the effective GIC time series, GIC(t), in response to written request, but did so more than 100 calendar days and less than or equal to 110 calendar days after receipt of a written request.	The responsible entity provided the effective GIC time series, GIC(t), in response to written request, but did so more than 110 calendar days after receipt of a written request.	The responsible entity did not provide the maximum effective GIC value to the Transmission Owner and Generator Owner that owns each applicable BES power transformer in the planning area; OR The responsible entity did not provide the effective GIC time series, GIC(t), upon written request.

R6.	Long-term Planning	Medium	<p>The responsible entity failed to conduct a <u>benchmark</u> thermal impact assessment for 5% or less or one of its solely owned and jointly owned applicable BES power transformers (whichever is greater) where the maximum effective GIC value provided in Requirement R5, Part 5.1, is 75 A or greater per phase;</p> <p>OR</p> <p>The responsible entity conducted a <u>benchmark</u> thermal impact assessment for its solely owned and jointly owned applicable BES power transformers where the maximum effective GIC value provided in Requirement R5, Part</p>	<p>The responsible entity failed to conduct a <u>benchmark</u> thermal impact assessment for more than 5% up to (and including) 10% or two of its solely owned and jointly owned applicable BES power transformers (whichever is greater) where the maximum effective GIC value provided in Requirement R5, Part 5.1, is 75 A or greater per phase;</p> <p>OR</p> <p>The responsible entity conducted a <u>benchmark</u> thermal impact assessment for its solely owned and jointly owned applicable BES power transformers where the maximum effective GIC value provided in Requirement R5, Part 5.1, is 75 A or greater</p>	<p>The responsible entity failed to conduct a <u>benchmark</u> thermal impact assessment for more than 10% up to (and including) 15% or three of its solely owned and jointly owned applicable BES power transformers (whichever is greater) where the maximum effective GIC value provided in Requirement R5, Part 5.1, is 75 A or greater per phase;</p> <p>OR</p> <p>The responsible entity conducted a <u>benchmark</u> thermal impact assessment for its solely owned and jointly owned applicable BES power transformers where the maximum effective GIC value provided in Requirement R5, Part 5.1, is 75 A or greater</p>	<p>The responsible entity failed to conduct a <u>benchmark</u> thermal impact assessment for more than 15% or more than three of its solely owned and jointly owned applicable BES power transformers (whichever is greater) where the maximum effective GIC value provided in Requirement R5, Part 5.1, is 75 A or greater per phase;</p> <p>OR</p> <p>The responsible entity conducted a <u>benchmark</u> thermal impact assessment for its solely owned and jointly owned applicable BES power transformers where the maximum effective GIC value provided in Requirement R5, Part 5.1, is 75 A or greater per phase but did so</p>
-----	--------------------	--------	--	--	---	--



R #	Time Horizon	VRF	Violation Severity Levels			
			Lower VSL	Moderate VSL	High VSL	Severe VSL
			5.1, is 75 A or greater per phase but did so more than 24 calendar months and less than or equal to 26 calendar months of receiving GIC flow information specified in Requirement R5, Part 5.1.	per phase but did so more than 26 calendar months and less than or equal to 28 calendar months of receiving GIC flow information specified in Requirement R5, Part 5.1; OR The responsible entity failed to include one of the required elements as listed in Requirement R6, Parts 6.1 through 6.3.	per phase but did so more than 28 calendar months and less than or equal to 30 calendar months of receiving GIC flow information specified in Requirement R5, Part 5.1; OR The responsible entity failed to include two of the required elements as listed in Requirement R6, Parts 6.1 through 6.3.	more than 30 calendar months of receiving GIC flow information specified in Requirement R5, Part 5.1; OR The responsible entity failed to include three of the required elements as listed in Requirement R6, Parts 6.1 through 6.3.

R #	Time Horizon	VRF	Violation Severity Levels			
			Lower VSL	Moderate VSL	High VSL	Severe VSL
R7.	Long-term Planning	High	<del>N/A</del> <u>The responsible entity's Corrective Action Plan failed to comply with one of the elements in Requirement R7, Parts 7.1 through 7.5.</u>	The responsible entity's Corrective Action Plan failed to comply with <del>one</del> <u>two</u> of the elements in Requirement R7, Parts 7.1 through 7. <del>3</del> <u>5</u> .	The responsible entity's Corrective Action Plan failed to comply with <del>two</del> <u>three</u> of the elements in Requirement R7, Parts 7.1 through 7. <del>3</del> <u>5</u> .	The responsible entity's Corrective Action Plan failed to comply with <u>four or more</u> <del>all three</del> of the elements in Requirement R7, Parts 7.1 through 7. <del>3</del> <u>5</u> ; OR The responsible entity did not have a Corrective Action Plan as required by Requirement R7.

R #	Time Horizon	VRF	Violation Severity Levels			
			Lower VSL	Moderate VSL	High VSL	Severe VSL
R8.			<p><u>The responsible entity completed a supplemental GMD Vulnerability Assessment, but it was more than 60 calendar months and less than or equal to 64 calendar months since the last supplemental GMD Vulnerability Assessment.</u></p> <p><u>OR</u></p> <p><u>The responsible entity's completed supplemental GMD Vulnerability Assessment failed to satisfy one of elements listed in Requirement R8, Parts 8.1 through 8.4;</u></p>	<p><u>The responsible entity's completed supplemental GMD Vulnerability Assessment failed to satisfy two of elements listed in Requirement R8, Parts 8.1 through 8.4;</u></p> <p><u>OR</u></p> <p><u>The responsible entity completed a supplemental GMD Vulnerability Assessment, but it was more than 64 calendar months and less than or equal to 68 calendar months since the last supplemental GMD Vulnerability Assessment.</u></p>	<p><u>The responsible entity's completed supplemental GMD Vulnerability Assessment failed to satisfy three of the elements listed in Requirement R8, Parts 8.1 through 8.4;</u></p> <p><u>OR</u></p> <p><u>The responsible entity completed a supplemental GMD Vulnerability Assessment, but it was more than 68 calendar months and less than or equal to 72 calendar months since the last supplemental GMD Vulnerability Assessment.</u></p>	<p><u>The responsible entity's completed supplemental GMD Vulnerability Assessment failed to satisfy four of the elements listed in Requirement R8, Parts 8.1 through 8.4;</u></p> <p><u>OR</u></p> <p><u>The responsible entity completed a supplemental GMD Vulnerability Assessment, but it was more than 72 calendar months since the last supplemental GMD Vulnerability Assessment;</u></p> <p><u>OR</u></p> <p><u>The responsible entity does not have a completed supplemental GMD Vulnerability Assessment.</u></p>

R #	Time Horizon	VRF	Violation Severity Levels			
			Lower VSL	Moderate VSL	High VSL	Severe VSL
R9.			<p><u>The responsible entity provided the effective GIC time series, GIC(t), in response to written request, but did so more than 90 calendar days and less than or equal to 100 calendar days after receipt of a written request.</u></p>	<p><u>The responsible entity provided the effective GIC time series, GIC(t), in response to written request, but did so more than 100 calendar days and less than or equal to 110 calendar days after receipt of a written request.</u></p>	<p><u>The responsible entity provided the effective GIC time series, GIC(t), in response to written request, but did so more than 110 calendar days after receipt of a written request.</u></p>	<p><u>The responsible entity did not provide the maximum effective GIC value to the Transmission Owner and Generator Owner that owns each applicable BES power transformer in the planning area;</u>  <u>OR</u>  <u>The responsible entity did not provide the effective GIC time series, GIC(t), upon written request.</u></p>

<p><b>R10.</b></p>			<p><u>The responsible entity failed to conduct a supplemental thermal impact assessment for 5% or less or one of its solely owned and jointly owned applicable BES power transformers (whichever is greater) where the maximum effective GIC value provided in Requirement R9, Part 9.1, is 85 A or greater per phase;</u>  <u>OR</u>  <u>The responsible entity conducted a supplemental thermal impact assessment for its solely owned and jointly owned applicable BES power transformers where the maximum effective GIC value</u></p>	<p><u>The responsible entity failed to conduct a supplemental thermal impact assessment for more than 5% up to (and including) 10% or two of its solely owned and jointly owned applicable BES power transformers (whichever is greater) where the maximum effective GIC value provided in Requirement R9, Part 9.1, is 85 A or greater per phase;</u>  <u>OR</u>  <u>The responsible entity conducted a supplemental thermal impact assessment for its solely owned and jointly owned applicable BES power transformers where the maximum effective GIC value provided in Requirement R9, Part 9.1, is 85 A or greater</u></p>	<p><u>The responsible entity failed to conduct a supplemental thermal impact assessment for more than 10% up to (and including) 15% or three of its solely owned and jointly owned applicable BES power transformers (whichever is greater) where the maximum effective GIC value provided in Requirement R9, Part 9.1, is 85 A or greater per phase;</u>  <u>OR</u>  <u>The responsible entity conducted a supplemental thermal impact assessment for its solely owned and jointly owned applicable BES power transformers where the maximum effective GIC value provided in Requirement R9, Part 9.1, is 85 A or greater</u></p>	<p><u>The responsible entity failed to conduct a supplemental thermal impact assessment for more than 15% or more than three of its solely owned and jointly owned applicable BES power transformers (whichever is greater) where the maximum effective GIC value provided in Requirement R9, Part 9.1, is 85 A or greater per phase;</u>  <u>OR</u>  <u>The responsible entity conducted a supplemental thermal impact assessment for its solely owned and jointly owned applicable BES power transformers where the maximum effective GIC value provided in Requirement R9, Part 9.1, is 85 A or greater per phase but did so</u></p>
--------------------	--	--	--	---	--	---

R #	Time Horizon	VRF	Violation Severity Levels			
			Lower VSL	Moderate VSL	High VSL	Severe VSL
			<p><u>provided in Requirement R9, Part 9.1, is 85 A or greater per phase but did so more than 24 calendar months and less than or equal to 26 calendar months of receiving GIC flow information specified in Requirement R9, Part 9.1.</u></p>	<p><u>per phase but did so more than 26 calendar months and less than or equal to 28 calendar months of receiving GIC flow information specified in Requirement R9, Part 9.1</u>                      OR  <u>The responsible entity failed to include one of the required elements as listed in Requirement R10, Parts 10.1 through 10.3.</u></p>	<p><u>per phase but did so more than 28 calendar months and less than or equal to 30 calendar months of receiving GIC flow information specified in Requirement R9, Part 9.1;</u>                      OR  <u>The responsible entity failed to include two of the required elements as listed in Requirement R10, Parts 10.1 through 10.3.</u></p>	<p><u>more than 30 calendar months of receiving GIC flow information specified in Requirement R9, Part 9.1;</u>                      OR  <u>The responsible entity failed to include three of the required elements as listed in Requirement R10, Parts 10.1 through 10.3.</u></p>

R #	Time Horizon	VRF	Violation Severity Levels			
			Lower VSL	Moderate VSL	High VSL	Severe VSL
<u>R11.</u>			<u>N/A</u>	<u>N/A</u>	<u>N/A</u>	<u>The responsible entity did not implement a process to obtain GIC monitor data from at least one GIC monitor located in the Planning Coordinator’s planning area or other part of the system included in the Planning Coordinator’s GIC System Model.</u>
<u>R12.</u>			<u>N/A</u>	<u>N/A</u>	<u>N/A</u>	<u>The responsible entity did not implement a process to obtain geomagnetic field data for its Planning Coordinator’s planning area.</u>

**C. Regional Variances**

None.

**D. Associated Documents**

Attachment 1

## Version History

Version	Date	Action	Change Tracking
1	December 17, 2014	Adopted by the NERC Board of Trustees	New
<u>2</u>	<u>TBD</u>	<u>Revised to respond to directives in FERC Order No. 830.</u>	<u>Revised</u>



## Attachment 1

### Calculating Geoelectric Fields for the Benchmark and Supplemental GMD Events

The benchmark GMD event<sup>1</sup> defines the geoelectric field values used to compute GIC flows that are needed to conduct a benchmark GMD Vulnerability Assessment. It is composed of the following elements: (1) a reference peak geoelectric field amplitude of 8 V/km derived from statistical analysis of historical magnetometer data; (2) scaling factors to account for local geomagnetic latitude; (3) scaling factors to account for local earth conductivity; and (4) a reference geomagnetic field time series or waveshape-waveform to facilitate time-domain analysis of GMD impact on equipment.

The supplemental GMD event is composed of similar elements as described above, except (1) the reference peak geoelectric field amplitude is 12 V/km over a localized area; and (2) the geomagnetic field time series or waveform includes a local enhancement in the waveform.<sup>2</sup>

The regional geoelectric field peak amplitude used in GMD Vulnerability Assessment,  $E_{peak}$ , can be obtained from the reference geoelectric field value of 8 V/km for the benchmark GMD event (1) or 12 V/km for the supplemental GMD event (2) using the following relationships:

$$E_{peak} = 8 \times \alpha \times \beta_b \text{ (V/km)} \quad (1)$$

$$E_{peak} = 12 \times \alpha \times \beta_s \text{ (V/km)} \quad (2)$$

where,  $\alpha$  is the scaling factor to account for local geomagnetic latitude, and  $\beta$  is a scaling factor to account for the local earth conductivity structure. Subscripts  $b$  and  $s$  for the  $\beta$  scaling factor denote association with the benchmark or supplemental GMD events, respectively.

### Scaling the Geomagnetic Field

The benchmark and supplemental GMD events is-are defined for geomagnetic latitude of 60° and ~~it~~ must be scaled to account for regional differences based on geomagnetic latitude. Table 2 provides a scaling factor correlating peak geoelectric field to geomagnetic latitude. Alternatively, the scaling factor  $\alpha$  is computed with the empirical expression:

$$\alpha = 0.001 \times e^{(0.115 \times L)} \quad (23)$$

where,  $L$  is the geomagnetic latitude in degrees and  $0.1 \leq \alpha \leq 1$ .

<sup>1</sup> The ~~benchmark~~ Benchmark GMD-Geomagnetic Disturbance event-Event description-Description, May 2016 is available on the Related Information webProject 2013-03-Geomagnetic Disturbance Mitigation project page for TPL-007-1: [http://www.nerc.com/pa/Stand/TPL0071RD/Benchmark\\_clean\\_May12\\_complete.pdf](http://www.nerc.com/pa/Stand/TPL0071RD/Benchmark_clean_May12_complete.pdf).

<sup>2</sup> The extent of local enhancements is on the order of 100 km in North-South (latitude) direction but longer in East-West (longitude) direction. The local enhancement in the geomagnetic field occurs over the time period of 2-5 minutes. Additional information is available in the Supplemental Geomagnetic Disturbance Event Description, October 2017 white paper on the Project 2013-03 Geomagnetic Disturbance Mitigation project webpage: <http://www.nerc.com/pa/Stand/Pages/Project-2013-03-Geomagnetic-Disturbance-Mitigation.aspx>.

For large planning areas that cover more than one scaling factor from Table 2, the GMD Vulnerability Assessment should be based on a peak geoelectric field that is:

- calculated by using the most conservative (largest) value for  $\alpha$ ; or
- calculated assuming a non-uniform or piecewise uniform geomagnetic field.

Table 2: — <u>Geomagnetic Field Scaling Factors for the Benchmark and Supplemental GMD Events</u>	
Geomagnetic Latitude (Degrees)	Scaling Factor1 ( $\alpha$ )
≤ 40	0.10
45	0.2
50	0.3
54	0.5
56	0.6
57	0.7
58	0.8
59	0.9
≥ 60	1.0

### Scaling the Geoelectric Field

The benchmark GMD event is defined for the reference Quebec earth model described in Table 4. The peak geoelectric field,  $E_{peak}$ , used in a GMD Vulnerability Assessment may be obtained by either:

- Calculating the geoelectric field for the ground conductivity in the planning area and the reference geomagnetic field time series scaled according to geomagnetic latitude, using a procedure such as the plane wave method described in the NERC GMD Task Force GIC Application Guide;<sup>3</sup> or
- Using the earth conductivity scaling factor  $\beta$  from Table 3 that correlates to the ground conductivity map in Figure 1 or Figure 2. Along with the scaling factor  $\alpha$  from equation (23) or Table 2,  $\beta$  is applied to the reference geoelectric field using equation (1 or 2, as applicable) to obtain the regional geoelectric field peak amplitude  $E_{peak}$  to be used in GMD Vulnerability Assessments. When a ground conductivity model is not available, the planning entity should use the largest  $\beta$  factor of adjacent physiographic regions or a technically justified value.

<sup>3</sup> Available at the NERC GMD Task Force project webpage: [http://www.nerc.com/comm/PC/Pages/Geomagnetic-Disturbance-Task-Force-\(GMDTF\)-2013.aspx](http://www.nerc.com/comm/PC/Pages/Geomagnetic-Disturbance-Task-Force-(GMDTF)-2013.aspx)

The earth models used to calculate Table 3 for the United States were obtained from publicly available information published on the U. S. Geological Survey website.<sup>4</sup> The models used to calculate Table 3 for Canada were obtained from Natural Resources Canada (NRCan) and reflect the average structure for large regions. A planner can also use specific earth model(s) with documented justification and the reference geomagnetic field time series to calculate the  $\beta$  factor(s) as follows:

$$\beta_b = E/8 \text{ for the benchmark GMD event} \quad (34)$$

$$\beta_s = E/12 \text{ for the supplemental GMD} \quad (5)$$

where,  $E$  is the absolute value of peak geoelectric in V/km obtained from the technically justified earth model and the reference geomagnetic field time series.

For large planning areas that span more than one  $\beta$  scaling factor, the most conservative (largest) value for  $\beta$  may be used in determining the peak geoelectric field to obtain conservative results. Alternatively, a planner could perform analysis using a non-uniform or piecewise uniform geoelectric field.

#### Applying the Localized Peak Geoelectric Field in the Supplemental GMD Event

The peak geoelectric field of the supplemental GMD event occurs in a localized area.<sup>5</sup> Planners have flexibility to determine how to apply the localized peak geoelectric field over the planning area in performing GIC calculations. Examples of approaches are:

- Apply the peak geoelectric field (12 V/km scaled to the planning area) over the entire planning area;
- Apply a spatially limited (12 V/km scaled to the planning area) peak geoelectric field (e.g., 100 km in North-South latitude direction and 500 km in East-West longitude direction) over a portion(s) of the system, and apply the benchmark GMD event over the rest of the system; or
- Other methods to adjust the benchmark GMD event analysis to account for the localized geoelectric field enhancement of the supplemental GMD event.

---

<sup>4</sup> Available at <http://geomag.usgs.gov/conductivity/>.

<sup>5</sup> See the Supplemental Geomagnetic Disturbance Description white paper located on the Project 2013-03 Geomagnetic Disturbance Mitigation project webpage: <http://www.nerc.com/pa/Stand/Pages/Project-2013-03-Geomagnetic-Disturbance-Mitigation.aspx>.

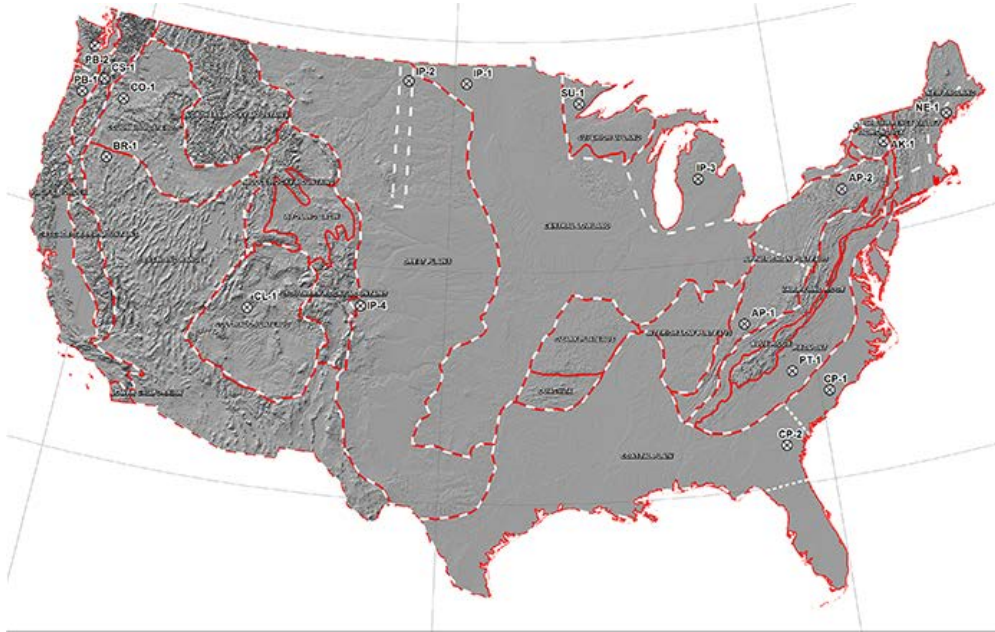

Figure 1: Physiographic Regions of the Continental United States<sup>6</sup>



Figure 2: Physiographic Regions of Canada

<sup>6</sup> Additional map detail is available at the U.S. Geological Survey: <http://geomag.usgs.gov/>.

<b>Table 3: Geoelectric Field Scaling Factors</b>		
<b>USGS Earth model</b>	<b>Scaling Factor Benchmark Event <math>(\beta_b)</math></b>	<b>Scaling Factor Supplemental Event <math>(\beta_s)</math></b>
AK1A	0.56	<u>0.51</u>
AK1B	0.56	<u>0.51</u>
AP1	0.33	<u>0.30</u>
AP2	0.82	<u>0.78</u>
BR1	0.22	<u>0.22</u>
CL1	0.76	<u>0.73</u>
CO1	0.27	<u>0.25</u>
CP1	0.81	<u>0.77</u>
CP2	0.95	<u>0.86</u>
FL1	0. <del>74</del> <u>76</u>	<u>0.73</u>
CS1	0.41	<u>0.37</u>
IP1	0.94	<u>0.90</u>
IP2	0.28	<u>0.25</u>
IP3	0.93	<u>0.90</u>
IP4	0.41	<u>0.35</u>
NE1	0.81	<u>0.77</u>
PB1	0.62	<u>0.55</u>
PB2	0.46	<u>0.39</u>
PT1	1.17	<u>1.19</u>
SL1	0.53	<u>0.49</u>
SU1	0.93	<u>0.90</u>
BOU	0.28	<u>0.24</u>
FBK	0.56	<u>0.56</u>
PRU	0.21	<u>0.22</u>
BC	0.67	<u>0.62</u>
PRAIRIES	0.96	<u>0.88</u>
SHIELD	1.0	<u>1.0</u>
ATLANTIC	0.79	<u>0.76</u>

**Rationale:** Scaling factors in Table 3 are dependent upon the frequency content of the reference storm. Consequently, the benchmark GMD event and the supplemental GMD event may produce different scaling factors for a given earth model.

The scaling factor associated with the benchmark GMD event for the Florida earth model (FL1) has been updated based on the earth model published on the USGS public website.

Layer Thickness (km)	Resistivity ( $\Omega$ -m)
15	20,000
10	200
125	1,000
200	100
$\infty$	3

**Reference Geomagnetic Field Time Series or Waveform for the Benchmark GMD Event**  
~~**Waveform for the Benchmark GMD Event**~~<sup>7</sup>

The geomagnetic field measurement record of the March 13-14 1989 GMD event, measured at ~~the NRC~~<sup>NARCA's</sup> Ottawa geomagnetic observatory, is the basis for the reference geomagnetic field waveform to be used to calculate the GIC time series, GIC(t), required for transformer thermal impact assessment.

The geomagnetic latitude of the Ottawa geomagnetic observatory is 55°; therefore, the amplitudes<sub>s</sub> of the geomagnetic field measurement data were scaled up to the 60° reference geomagnetic latitude (see Figure 3) such that the resulting peak geoelectric field amplitude computed using the reference earth model was 8 V/km (see Figures 4 and 5). ~~The S~~<sub>s</sub> sampling rate for the geomagnetic field ~~waveform~~<sub>waveshape</sub> is 10 seconds.<sup>8</sup> To use this geoelectric field time series when a different earth model is applicable, it should be scaled with the appropriate benchmark conductivity scaling factor  $\beta_b$ .

<sup>7</sup> Refer to the Benchmark Geomagnetic Disturbance GMD-Event Description white paper for details on the determination of the reference geomagnetic field ~~waveform~~<sub>waveshape</sub>: <http://www.nerc.com/pa/stand/Pages/TPL0071RI.aspx>.

<sup>8</sup> The data file of the benchmark geomagnetic field ~~waveshape~~<sub>waveform</sub> is available on the Related Information webpage for TPL-007-1/NERC GMD Task Force project page: <http://www.nerc.com/pa/stand/Pages/TPL0071RI.aspx>.

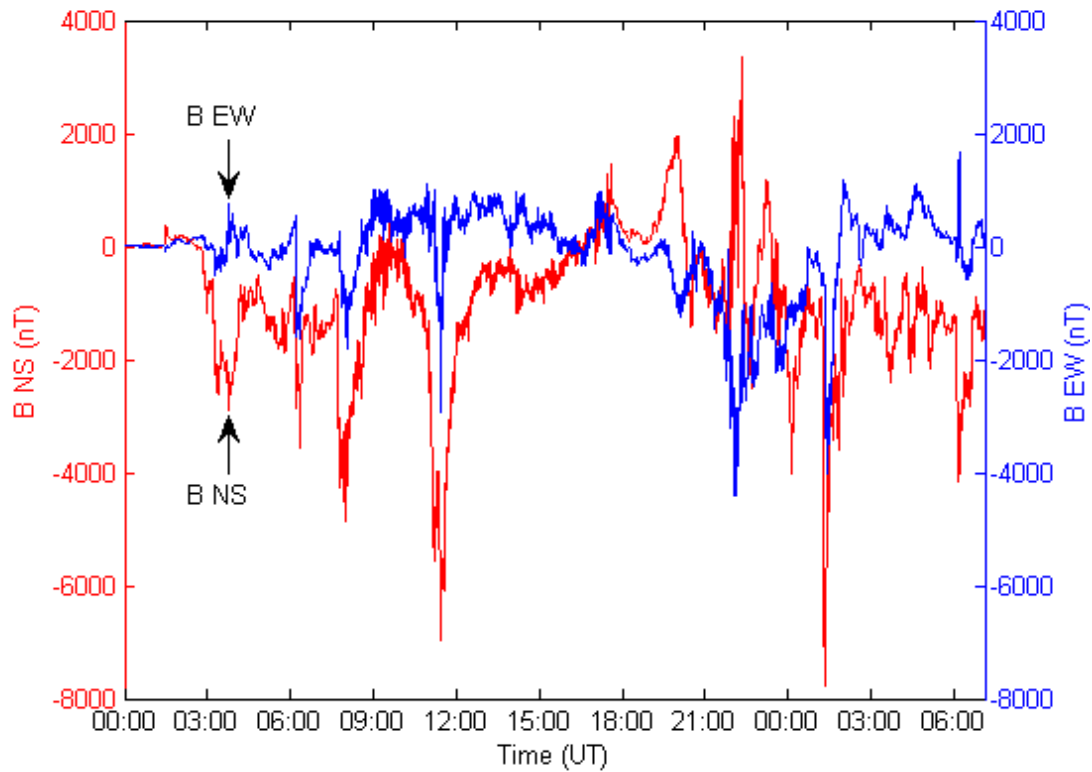

Figure 3: Benchmark Geomagnetic Field Waveform Waveshape  
Red  $B_n$  (Northward), Blue  $B_e$  (Eastward)

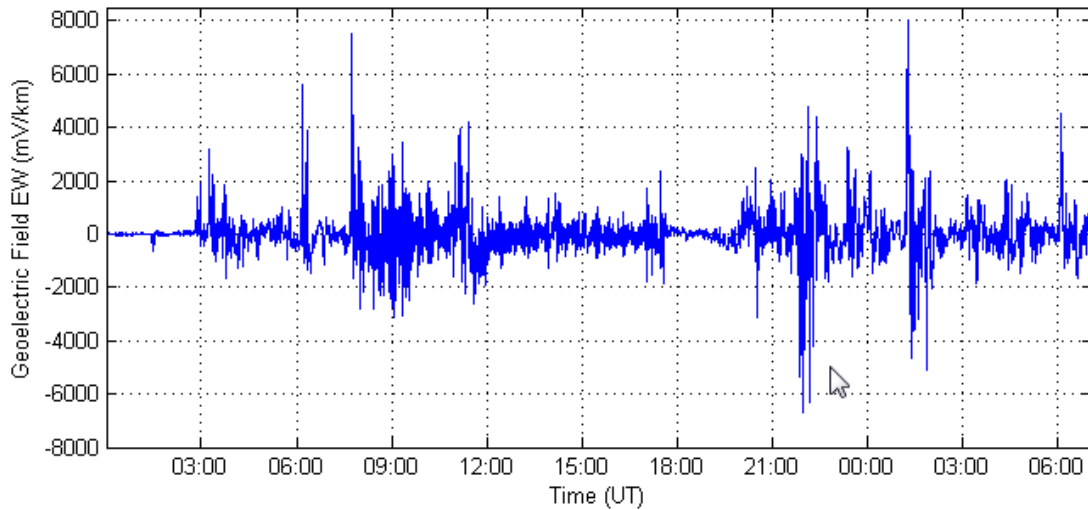

Figure 4: Benchmark Geoelectric Field Waveform Waveshape  
 $E_E$  (Eastward)

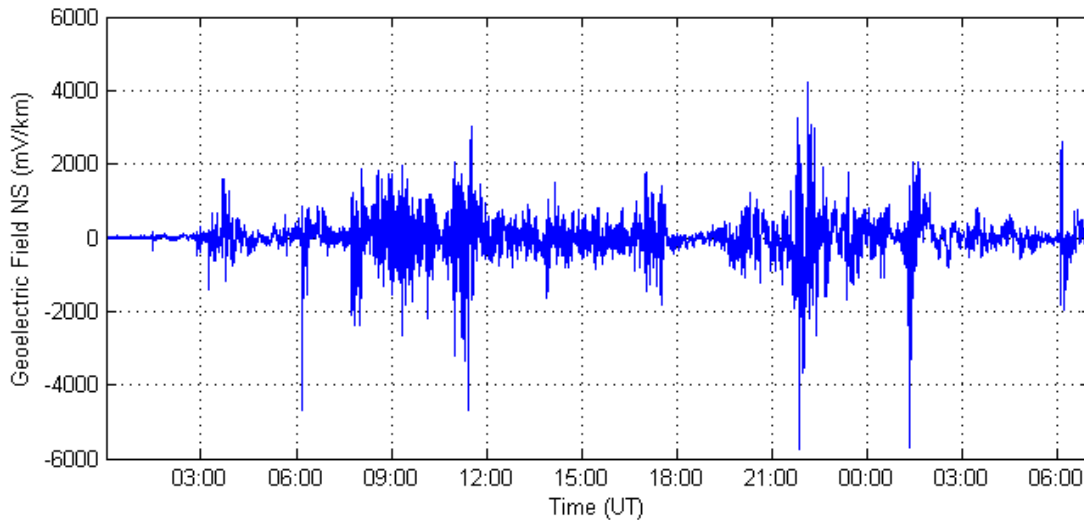

Figure 5: Benchmark Geoelectric Field ~~Waveform~~ **Waveshape**  
 $E_N$  (Northward)

**1.5.1.4.**

**Reference Geomagnetic Field Time Series or Waveform for the Supplemental GMD Event<sup>9</sup>**

The geomagnetic field measurement record of the March 13-14, 1989 GMD event, measured at the NRCan Ottawa geomagnetic observatory, is the basis for the reference geomagnetic field waveform to be used to calculate the GIC time series,  $GIC(t)$ , required for transformer thermal impact assessment for the supplemental GMD event. The supplemental GMD event waveform differs from the benchmark GMD event waveform in that the supplemental GMD event waveform has a local enhancement.

The geomagnetic latitude of the Ottawa geomagnetic observatory is  $55^\circ$ ; therefore, the amplitudes of the geomagnetic field measurement data were scaled up to the  $60^\circ$  reference geomagnetic latitude (see Figure 6) such that the resulting peak geoelectric field amplitude computed using the reference earth model was 12 V/km (see Figure 7). The sampling rate for the geomagnetic field waveform is 10 seconds.<sup>10</sup> To use this geoelectric field time series when a different earth model is applicable, it should be scaled with the appropriate supplemental conductivity scaling factor  $\beta_s$ .

<sup>9</sup> Refer to the Supplemental Geomagnetic Disturbance Event Description white paper for details on the determination of the reference geomagnetic field waveform: <http://www.nerc.com/pa/Stand/Pages/Project-2013-03-Geomagnetic-Disturbance-Mitigation.aspx>.

<sup>10</sup> The data file of the benchmark geomagnetic field waveform is available on the NERC GMD Task Force project webpage: [http://www.nerc.com/comm/PC/Pages/Geomagnetic-Disturbance-Task-Force-\(GMDTF\)-2013.aspx](http://www.nerc.com/comm/PC/Pages/Geomagnetic-Disturbance-Task-Force-(GMDTF)-2013.aspx).



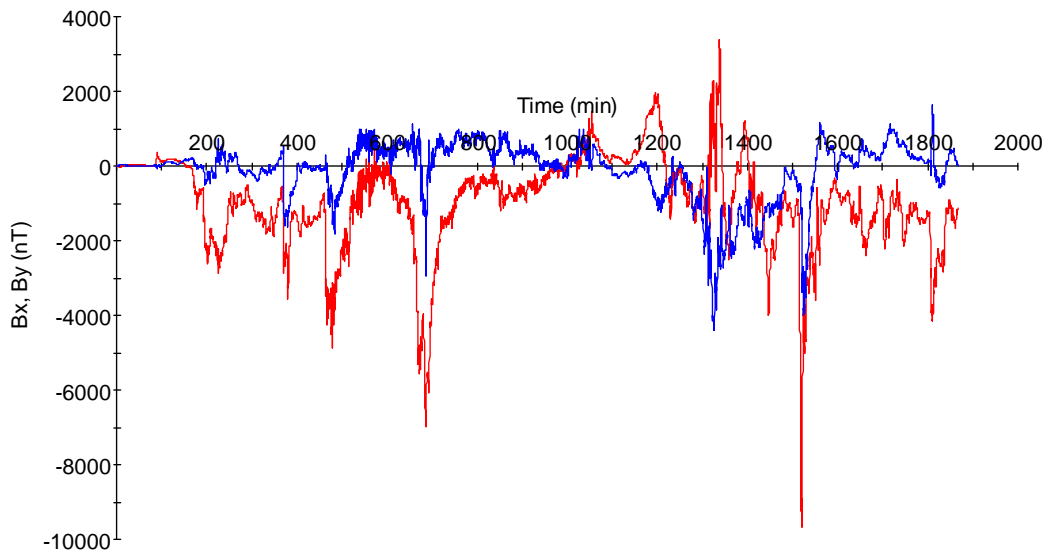

**Figure 6: Supplemental Geomagnetic Field Waveform**  
**Red  $B_N$  (Northward), Blue  $B_E$  (Eastward)**

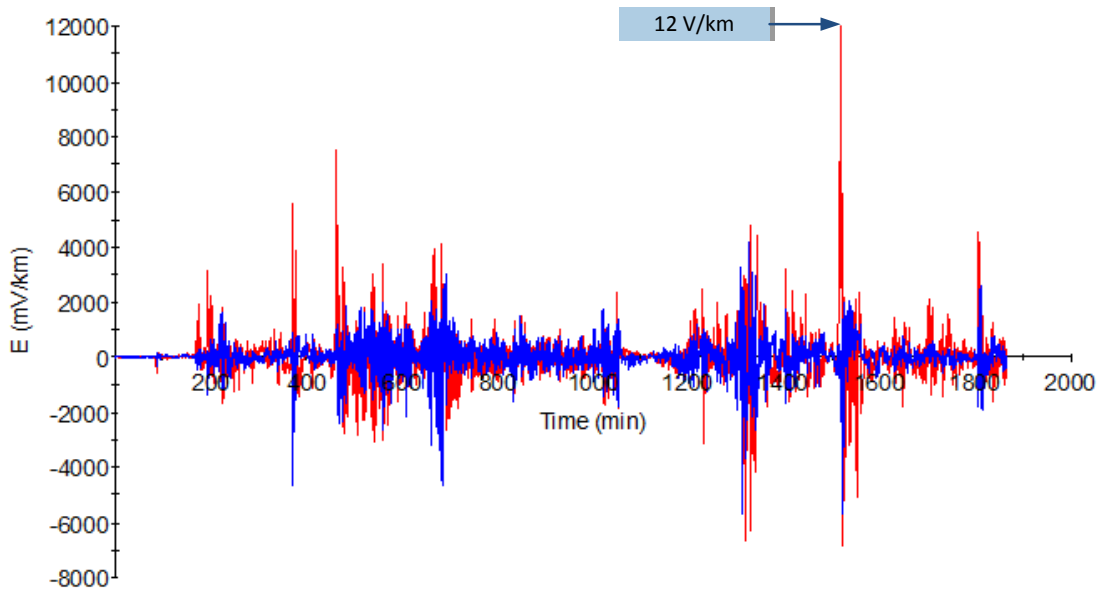

**Figure 7: Supplemental Geoelectric Field Waveform**  
**Blue  $E_N$  (Northward), Red  $E_E$  (Eastward)**

## Guidelines and Technical Basis

The diagram below provides an overall view of the GMD Vulnerability Assessment process:

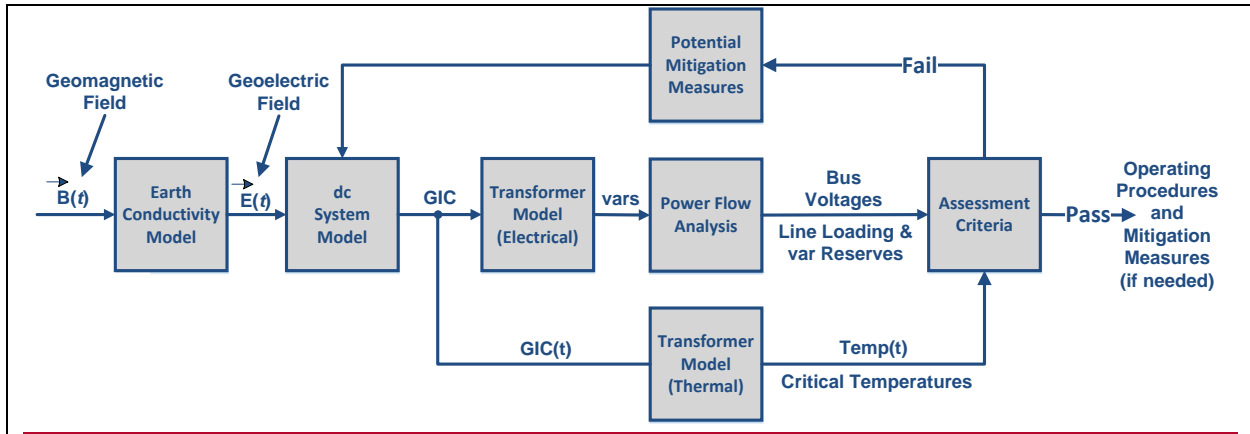

The requirements in this standard cover various aspects of the GMD Vulnerability Assessment process.

### Benchmark GMD Event (Attachment 1)

The benchmark GMD event defines the goelectric field values used to compute GIC flows that are needed to conduct a benchmark GMD Vulnerability Assessment. The *Benchmark Geomagnetic Disturbance Event Description, May 2016*<sup>11</sup> A white paper ~~that~~ includes the event description, analysis, and example calculations ~~is available on the Project 2013-03 Geomagnetic Disturbance Mitigation project page.~~

### Supplemental GMD Event (Attachment 1)

The supplemental GMD event defines the goelectric field values used to compute GIC flows that are needed to conduct a supplemental GMD Vulnerability Assessment. The *Supplemental Geomagnetic Disturbance Event Description, October 2017*<sup>12</sup> white paper includes the event description and analysis.

### Requirement R2

A GMD Vulnerability Assessment requires a GIC System model, which is a dc representation of the System, to calculate GIC flow. In a GMD Vulnerability Assessment, GIC simulations are used to determine transformer Reactive Power absorption and transformer thermal response. Details for developing the GIC System model are provided in the NERC GMD Task Force guide:

<sup>11</sup> <http://www.nerc.com/pa/stand/Pages/TPL0071RI.aspx>.

<sup>12</sup> <http://www.nerc.com/pa/Stand/Pages/Project-2013-03-Geomagnetic-Disturbance-Mitigation.aspx>.

*Application Guide for Computing Geomagnetically-Induced Current in the Bulk Power System, December 2013.*<sup>13</sup>

Underground pipe-type cables present a special modeling situation in that the steel pipe that encloses the power conductors significantly reduces the geoelectric field induced into the conductors themselves, while they remain a path for GIC. Solid dielectric cables that are not enclosed by a steel pipe will not experience a reduction in the induced geoelectric field. A planning entity should account for special modeling situations in the GIC system model, if applicable.

**Requirement R4**

The ~~Geomagnetic Disturbance GMD~~ *Planning Guide*,<sup>14</sup> December 2013 developed by the NERC GMD Task Force provides technical information on GMD-specific considerations for planning studies. ~~It is available at:~~

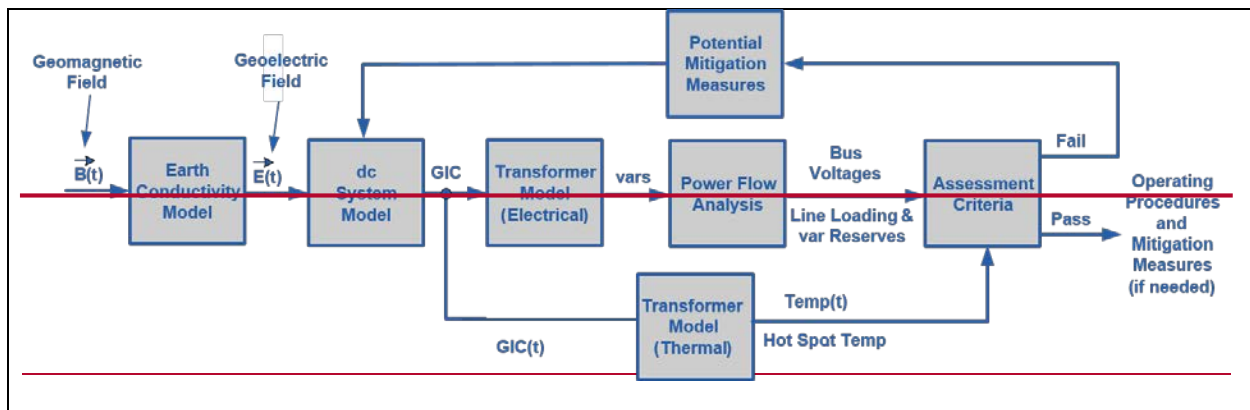

**Requirement R5**

The ~~benchmark transformer~~ thermal impact assessment of transformers specified in Requirement R6 is based on GIC information for the ~~Benchmark~~ GMD Event. This GIC information is determined by the planning entity through simulation of the GIC System model and must be provided to the entity responsible for conducting the thermal impact assessment. GIC information should be provided in accordance with Requirement R5 each time the GMD Vulnerability Assessment is performed since, by definition, the GMD Vulnerability Assessment includes a documented evaluation of susceptibility to localized equipment damage due to GMD.

The maximum effective GIC value provided in Part 5.1 is used for ~~the benchmark transformer~~ thermal impact assessment. Only those transformers that experience an effective GIC value of 75 A or greater per phase require evaluation in Requirement R6.

<sup>13</sup> [http://www.nerc.com/comm/PC/Geomagnetic%20Disturbance%20Task%20Force%20GMDTF%202013/GIC%20Application%20Guide%202013\\_approved.pdf](http://www.nerc.com/comm/PC/Geomagnetic%20Disturbance%20Task%20Force%20GMDTF%202013/GIC%20Application%20Guide%202013_approved.pdf).

<sup>14</sup> [http://www.nerc.com/comm/PC/Geomagnetic%20Disturbance%20Task%20Force%20GMDTF%202013/GMD%20Planning%20Guide\\_approved.pdf](http://www.nerc.com/comm/PC/Geomagnetic%20Disturbance%20Task%20Force%20GMDTF%202013/GMD%20Planning%20Guide_approved.pdf).

GIC(t) provided in Part 5.2 is used to convert the steady state GIC flows to time-series GIC data for the benchmark transformer thermal impact assessment of transformers. This information may be needed by one or more of the methods for performing a benchmark thermal impact assessment. Additional information is in the following section and the Transformer Thermal Impact Assessment White Paper, 15 October 2017~~thermal assessment whitepaper~~.

The peak GIC value of 75 Amps per phase has been shown through thermal modeling to be a conservative threshold below which the risk of exceeding known temperature limits established by technical organizations is low.

### **Requirement R6**

The benchmark thermal impact assessment of a power transformer may be based on manufacturer-provided GIC capability curves, thermal response simulation, thermal impact screening, or other technically justified means. Approaches for conducting the assessment are presented in the *Transformer Thermal Impact Assessment* ~~White Paper posted on the project page~~ ERO Enterprise-Endorsed Implementation Guidance<sup>16</sup> for this requirement. This ERO-Endorsed document is posted on the NERC Compliance Guidance<sup>17</sup> webpage.

Transformers are exempt from the benchmark thermal impact assessment requirement if the effective GIC value for the transformer is less than 75 A per phase, as determined by a GIC analysis of the System. Justification for this criterion is provided in the *Screening Criterion for Transformer Thermal Impact Assessment* ~~White Paper posted on the project page~~,<sup>18</sup> October 2017. A documented design specification exceeding this value is also a justifiable threshold criterion that exempts a transformer from Requirement R6.

The benchmark threshold criteria and its associated transformer thermal impact must be evaluated on the basis of effective GIC. Refer to the white papers for additional information.

### **Requirement R7**

Technical considerations for GMD mitigation planning, including operating and equipment strategies, are available in Chapter 5 of the Geomagnetic Disturbance GMD-Planning Guide,<sup>19</sup> December 2013. Additional information is available in the *2012 Special Reliability Assessment Interim Report: Effects of Geomagnetic Disturbances on the Bulk-Power System*,<sup>20</sup> February 2012.

---

<sup>15</sup> <http://www.nerc.com/pa/Stand/Pages/Project-2013-03-Geomagnetic-Disturbance-Mitigation.aspx>.

<sup>16</sup> [http://www.nerc.com/pa/comp/guidance/EROEndorsedImplementationGuidance/TPL-007-1\\_Transformer\\_Thermal\\_Impact\\_Assessment\\_White\\_Paper.pdf](http://www.nerc.com/pa/comp/guidance/EROEndorsedImplementationGuidance/TPL-007-1_Transformer_Thermal_Impact_Assessment_White_Paper.pdf).

<sup>17</sup> <http://www.nerc.com/pa/comp/guidance/Pages/default.aspx>.

<sup>18</sup> <http://www.nerc.com/pa/Stand/Pages/Project-2013-03-Geomagnetic-Disturbance-Mitigation.aspx>.

<sup>19</sup> [http://www.nerc.com/comm/PC/Geomagnetic%20Disturbance%20Task%20Force%20GMDTF%202013/GMD%20Planning%20Guide\\_approved.pdf](http://www.nerc.com/comm/PC/Geomagnetic%20Disturbance%20Task%20Force%20GMDTF%202013/GMD%20Planning%20Guide_approved.pdf).

<sup>20</sup> <http://www.nerc.com/pa/RAPA/ra/Reliability%20Assessments%20DL/2012GMD.pdf>.

**Requirement R8**

The *Geomagnetic Disturbance Planning Guide*,<sup>21</sup> December 2013 developed by the NERC GMD Task Force provides technical information on GMD-specific considerations for planning studies.

The supplemental GMD Vulnerability Assessment process is similar to the benchmark GMD Vulnerability Assessment process described under Requirement R4.

**Requirement R9**

The supplemental thermal impact assessment specified of transformers in Requirement R10 is based on GIC information for the supplemental GMD Event. This GIC information is determined by the planning entity through simulation of the GIC System model and must be provided to the entity responsible for conducting the thermal impact assessment. GIC information should be provided in accordance with Requirement R9 each time the GMD Vulnerability Assessment is performed since, by definition, the GMD Vulnerability Assessment includes a documented evaluation of susceptibility to localized equipment damage due to GMD.

The maximum effective GIC value provided in Part 9.1 is used for the supplemental thermal impact assessment. Only those transformers that experience an effective GIC value of 85 A or greater per phase require evaluation in Requirement R10.

GIC(t) provided in Part 9.2 is used to convert the steady state GIC flows to time-series GIC data for the supplemental thermal impact assessment of transformers. This information may be needed by one or more of the methods for performing a supplemental thermal impact assessment. Additional information is in the following section.

The peak GIC value of 85 Amps per phase has been shown through thermal modeling to be a conservative threshold below which the risk of exceeding known temperature limits established by technical organizations is low.

**Requirement R10**

The supplemental thermal impact assessment of a power transformer may be based on manufacturer-provided GIC capability curves, thermal response simulation, thermal impact screening, or other technically justified means. Approaches for conducting the assessment are presented in the *Transformer Thermal Impact Assessment White Paper ERO Enterprise-Endorsed Implementation Guidance*<sup>22</sup> discussed in the Requirement R6 section above. A later version of the *Transformer Thermal Impact Assessment White Paper*,<sup>23</sup> October 2017, has been developed to

---

<sup>21</sup> [http://www.nerc.com/comm/PC/Geomagnetic%20Disturbance%20Task%20Force%20GMDTF%202013/GMD%20Planning%20Guide\\_approved.pdf](http://www.nerc.com/comm/PC/Geomagnetic%20Disturbance%20Task%20Force%20GMDTF%202013/GMD%20Planning%20Guide_approved.pdf).

<sup>22</sup> [http://www.nerc.com/pa/comp/guidance/EROEndorsedImplementationGuidance/TPL-007-1\\_Transformer\\_Thermal\\_Impact\\_Assessment\\_White\\_Paper.pdf](http://www.nerc.com/pa/comp/guidance/EROEndorsedImplementationGuidance/TPL-007-1_Transformer_Thermal_Impact_Assessment_White_Paper.pdf).

<sup>23</sup> <http://www.nerc.com/pa/Stand/Pages/Project-2013-03-Geomagnetic-Disturbance-Mitigation.aspx>.

include updated information pertinent to the supplemental GMD event and supplemental thermal impact assessment.

Transformers are exempt from the supplemental thermal impact assessment requirement if the effective GIC value for the transformer is less than 85 A per phase, as determined by a GIC analysis of the System. Justification for this criterion is provided in the revised *Screening Criterion for Transformer Thermal Impact Assessment White Paper*,<sup>24</sup> October 2017. A documented design specification exceeding this value is also a justifiable threshold criterion that exempts a transformer from Requirement R10.

The supplemental threshold criteria and its associated transformer thermal impact must be evaluated on the basis of effective GIC. Refer to the white papers for additional information.

### **Requirement R11**

Technical considerations for GIC monitoring are contained in Chapter 6 of the *2012 Special Reliability Assessment Interim Report: Effects of Geomagnetic Disturbances on the Bulk-Power System*,<sup>25</sup> February 2012. GIC monitoring is generally performed by Hall effect transducers that are attached to the neutral of the wye-grounded transformer. Data from GIC monitors is useful for model validation and situational awareness.

Responsible entities consider the following in developing a process for obtaining GIC monitor data:

- **Monitor locations.** An entity's operating process may be constrained by location of existing GIC monitors. However, when planning for additional GIC monitoring installations consider that data from monitors located in areas found to have high GIC based on system studies may provide more useful information for validation and situational awareness purposes. Conversely, data from GIC monitors that are located in the vicinity of transportation systems using direct current (e.g., subways or light rail) may be unreliable.
- **Monitor specifications.** Capabilities of Hall effect transducers, existing and planned, should be considered in the operating process. When planning new GIC monitor installations, consider monitor data range (e.g., -500 A through + 500 A) and ambient temperature ratings consistent with temperatures in the region in which the monitor will be installed.
- **Sampling Interval.** An entity's operating process may be constrained by capabilities of existing GIC monitors. However, when possible specify data sampling during periods of interest at a rate of 10 seconds or faster.
- **Collection Periods.** The process should specify when the entity expects GIC data to be collected. For example, collection could be required during periods where the Kp index is

---

<sup>24</sup> <http://www.nerc.com/pa/Stand/Pages/Project-2013-03-Geomagnetic-Disturbance-Mitigation.aspx>.

<sup>25</sup> <http://www.nerc.com/pa/RAPA/ra/Reliability%20Assessments%20DL/2012GMD.pdf>.

above a threshold, or when GIC values are above a threshold. Determining when to discontinue collecting GIC data should also be specified to maintain consistency in data collection.

- **Data format.** Specify time and value formats. For example, Greenwich Mean Time (GMT) (MM/DD/YYYY HH:MM:SS) and GIC Value (Ampere). Positive (+) and negative (-) signs indicate direction of GIC flow. Positive reference is flow from ground into transformer neutral. Time fields should indicate the sampled time rather than system or SCADA time if supported by the GIC monitor system.
- **Data retention.** The entity's process should specify data retention periods, for example 1 year. Data retention periods should be adequately long to support availability for the entity's model validation process and external reporting requirements, if any.
- **Additional information.** The entity's process should specify collection of other information necessary for making the data useful, for example monitor location and type of neutral connection (e.g., three-phase or single-phase).

### **Requirement R12**

Magnetometers measure changes in the earth's magnetic field. Entities should obtain data from the nearest accessible magnetometer. Sources of magnetometer data include:

- Observatories such as those operated by U.S. Geological Survey and Natural Resources Canada, see figure below for locations:<sup>26</sup>

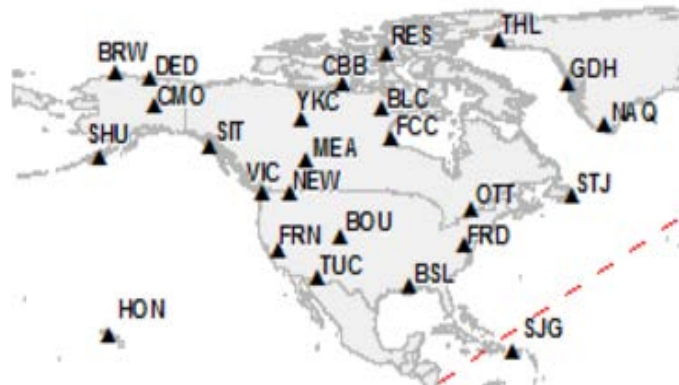

- Research institutions and academic universities;
- Entities with installed magnetometers.

---

<sup>26</sup> <http://www.intermagnet.org/index-eng.php>.

Entities that choose to install magnetometers should consider equipment specifications and data format protocols contained in the latest version of the *INTERMAGNET Technical Reference Manual, Version 4.6, 2012.*<sup>27</sup>

## **Rationale**

During development of ~~TPL-007-1 this standard~~, text boxes were embedded within the standard to explain the rationale for various parts of the standard. ~~Upon DOT approval, t~~The text from the rationale text boxes was moved to this section upon approval of TPL-007-1 by the NERC Board of Trustees. In developing TPL-007-2, the SDT has made changes to the sections below only when necessary for clarity. Changes are marked with brackets [ ].

### **Rationale for Applicability:**

Instrumentation transformers and station service transformers do not have significant impact on geomagnetically-induced current (GIC) flows; therefore, these transformers are not included in the applicability for this standard.

Terminal voltage describes line-to-line voltage.

### **Rationale for R1:**

In some areas, planning entities may determine that the most effective approach to conduct a GMD Vulnerability Assessment is through a regional planning organization. No requirement in the standard is intended to prohibit a collaborative approach where roles and responsibilities are determined by a planning organization made up of one or more Planning Coordinator(s).

### **Rationale for R2:**

A GMD Vulnerability Assessment requires a GIC System model to calculate GIC flow which is used to determine transformer Reactive Power absorption and transformer thermal response. Guidance for developing the GIC System model is provided in the ~~GIC Application Guide~~ *Computing Geomagnetically-Induced Current in the Bulk-Power System*,<sup>28</sup> December 2013, developed by the NERC GMD Task Force ~~and available at:~~

The System model specified in Requirement R2 is used in conducting steady state power flow analysis that accounts for the Reactive Power absorption of power transformer(s) due to GIC in the System.

The GIC System model includes all power transformer(s) with a high side, wye-grounded winding with terminal voltage greater than 200 kV. The model is used to calculate GIC flow in the network.

---

<sup>27</sup> [http://www.intermagnet.org/publications/intermag\\_4-6.pdf](http://www.intermagnet.org/publications/intermag_4-6.pdf).

<sup>28</sup> [http://www.nerc.com/comm/PC/Geomagnetic%20Disturbance%20Task%20Force%20GMDTF%202013/GIC%20Application%20Guide%202013\\_approved.pdf](http://www.nerc.com/comm/PC/Geomagnetic%20Disturbance%20Task%20Force%20GMDTF%202013/GIC%20Application%20Guide%202013_approved.pdf).



The projected System condition for GMD planning may include adjustments to the System that are executable in response to space weather information. These adjustments could include, for example, recalling or postponing maintenance outages.

The Violation Risk Factor (VRF) for Requirement R2 is changed from Medium to High. This change is for consistency with the VRF for approved standard TPL-001-4 Requirement R1, which is proposed for revision in the NERC filing dated August 29, 2014 ([Docket No. RM12-1-000](#)). NERC guidelines require consistency among Reliability Standards.

**Rationale for R3:**

Requirement R3 allows a responsible entity the flexibility to determine the System steady state voltage criteria for System steady state performance in Table 1. Steady state voltage limits are an example of System steady state performance criteria.

**Rationale for R4:**

The GMD Vulnerability Assessment includes steady state power flow analysis and the supporting study or studies using the models specified in Requirement R2 that account for the effects of GIC. Performance criteria are specified in Table 1.

At least one System On-Peak Load and at least one System Off-Peak Load must be examined in the analysis.

Distribution of GMD Vulnerability Assessment results provides a means for sharing relevant information with other entities responsible for planning reliability. Results of GIC studies may affect neighboring systems and should be taken into account by planners.

The [Geomagnetic Disturbance GMD-Planning Guide](#),<sup>29</sup> [December 2013](#) developed by the NERC GMD Task Force provides technical information on GMD-specific considerations for planning studies. ~~It is available at:~~ The provision of information in Requirement R4, Part 4.3, shall be subject to the legal and regulatory obligations for the disclosure of confidential and/or sensitive information.

**Rationale for R5:**

This GIC information is necessary for determining the thermal impact of GIC on transformers in the planning area and must be provided to entities responsible for performing the thermal impact assessment so that they can accurately perform the assessment. GIC information should be provided in accordance with Requirement R5 as part of the GMD Vulnerability Assessment process since, by definition, the GMD Vulnerability Assessment includes documented evaluation of susceptibility to localized equipment damage due to GMD.

The maximum effective GIC value provided in Part 5.1 is used for transformer thermal impact assessment.

---

<sup>29</sup> [http://www.nerc.com/comm/PC/Geomagnetic%20Disturbance%20Task%20Force%20GMDTF%202013/GMD%20Planning%20Guide\\_approved.pdf](http://www.nerc.com/comm/PC/Geomagnetic%20Disturbance%20Task%20Force%20GMDTF%202013/GMD%20Planning%20Guide_approved.pdf).

GIC(t) provided in Part 5.2 can alternatively be used to convert the steady state GIC flows to time-series GIC data for transformer thermal impact assessment. This information may be needed by one or more of the methods for performing a thermal impact assessment. Additional guidance is available in the *Transformer Thermal Impact Assessment White Paper*,<sup>30</sup> October 2017.

A Transmission Owner or Generator Owner that desires GIC(t) may request it from the planning entity. The planning entity shall provide GIC(t) upon request once GIC has been calculated, but no later than 90 calendar days after receipt of a request from the owner and after completion of Requirement R5, Part 5.1.

The provision of information in Requirement R5 shall be subject to the legal and regulatory obligations for the disclosure of confidential and/or sensitive information.

**Rationale for R6:**

The transformer thermal impact screening criterion has been revised from 15 A per phase to 75 A per phase [for the benchmark GMD event]. Only those transformers that experience an effective GIC value of 75 A per phase or greater require evaluation in Requirement R6. The justification is provided in the *Screening Criterion for Transformer Thermal Impact Assessment White Paper*,<sup>31</sup> October 2017~~white paper~~.

The thermal impact assessment may be based on manufacturer-provided GIC capability curves, thermal response simulation, thermal impact screening, or other technically justified means. The transformer thermal assessment will be repeated or reviewed using previous assessment results each time the planning entity performs a GMD Vulnerability Assessment and provides GIC information as specified in Requirement R5. Approaches for conducting the assessment are presented in the *Transformer Thermal Impact Assessment White Paper*,<sup>32</sup> October 2017.

Thermal impact assessments are provided to the planning entity, as determined in Requirement R1, so that identified issues can be included in the GMD Vulnerability Assessment (R4), and the Corrective Action Plan (R7) as necessary.

Thermal impact assessments of non-BES transformers are not required because those transformers do not have a wide-area effect on the reliability of the interconnected Transmission system.

The provision of information in Requirement R6, Part 6.4, shall be subject to the legal and regulatory obligations for the disclosure of confidential and/or sensitive information.

---

<sup>30</sup> <http://www.nerc.com/pa/Stand/Pages/Project-2013-03-Geomagnetic-Disturbance-Mitigation.aspx>.

<sup>31</sup> <http://www.nerc.com/pa/Stand/Pages/Project-2013-03-Geomagnetic-Disturbance-Mitigation.aspx>.

<sup>32</sup> <http://www.nerc.com/pa/Stand/Pages/Project-2013-03-Geomagnetic-Disturbance-Mitigation.aspx>.

**Rationale for R7:**

Corrective Action Plans are defined in the NERC Glossary of Terms:

*A list of actions and an associated timetable for implementation to remedy a specific problem.*

Corrective Action Plans must, subject to the vulnerabilities identified in the assessments, contain strategies for protecting against the potential impact of the Benchmark GMD event, based on factors such as the age, condition, technical specifications, system configuration, or location of specific equipment. Chapter 5 of the NERC GMD Task Force *Geomagnetic Disturbance GMD Planning Guide*,<sup>33</sup> December 2013 provides a list of mitigating measures that may be appropriate to address an identified performance issue.

The provision of information in Requirement R7, Part 7.3 [Part 7.5 in TPL-007-2], shall be subject to the legal and regulatory obligations for the disclosure of confidential and/or sensitive information.

**Rationale for Table 3:**

Table 3 has been revised to use the same ground model designation, FL1, as is being used by USGS. The calculated scaling factor for FL1 is 0.74. [The scaling factor associated with the benchmark GMD event for the Florida earth model (FL1) has been updated to 0.76 in TPL-007-2 based on the earth model published on the USGS public website.]

---

<sup>33</sup> [http://www.nerc.com/comm/PC/Geomagnetic%20Disturbance%20Task%20Force%20GMDTF%202013/GMD%20Planning%20Guide\\_approved.pdf](http://www.nerc.com/comm/PC/Geomagnetic%20Disturbance%20Task%20Force%20GMDTF%202013/GMD%20Planning%20Guide_approved.pdf).