

DEPARTMENT OF TRANSPORTATION**National Highway Traffic Safety Administration****49 CFR Parts 523, 531, 533, 536, and 537****ENVIRONMENTAL PROTECTION AGENCY****40 CFR Parts 85 and 86****[NHTSA–2018–0067; EPA–HQ–OAR–2018–0283; FRL–9981–74–OAR]****RIN 2127–AL76; RIN 2060–AU09****The Safer Affordable Fuel-Efficient (SAFE) Vehicles Rule for Model Years 2021–2026 Passenger Cars and Light Trucks****AGENCY:** Environmental Protection Agency and National Highway Traffic Safety Administration.**ACTION:** Notice of proposed rulemaking.

SUMMARY: The National Highway Traffic Safety Administration (NHTSA) and the Environmental Protection Agency (EPA) are proposing the “Safer Affordable Fuel-Efficient (SAFE) Vehicles Rule for Model Years 2021–2026 Passenger Cars and Light Trucks” (SAFE Vehicles Rule). The SAFE Vehicles Rule, if finalized, would amend certain existing Corporate Average Fuel Economy (CAFE) and tailpipe carbon dioxide emissions standards for passenger cars and light trucks and establish new standards, all covering model years 2021 through 2026. More specifically, NHTSA is proposing new CAFE standards for model years 2022 through 2026 and amending its 2021 model year CAFE standards because they are no longer maximum feasible standards, and EPA is proposing to amend its carbon dioxide emissions standards for model years 2021 through 2025 because they are no longer appropriate and reasonable in addition to establishing new standards for model year 2026. The preferred alternative is to retain the model year 2020 standards (specifically, the footprint target curves for passenger cars and light trucks) for both programs through model year 2026, but comment is sought on a range of alternatives discussed throughout this document. Compared to maintaining the post-2020 standards set forth in 2012, current estimates indicate that the proposed SAFE Vehicles Rule would save over 500 billion dollars in societal costs and reduce highway fatalities by 12,700 lives (over the lifetimes of vehicles through MY 2029). U.S. fuel consumption would increase by about

half a million barrels per day (2–3 percent of total daily consumption, according to the Energy Information Administration) and would impact the global climate by 3/1000th of one degree Celsius by 2100, also when compared to the standards set forth in 2012.

DATES: *Comments:* Comments are requested on or before October 23, 2018. Under the Paperwork Reduction Act, comments on the information collection provisions must be received by the Office of Management and Budget (OMB) on or before October 23, 2018. See the **SUPPLEMENTARY INFORMATION** section on “Public Participation,” below, for more information about written comments.

Public Hearings: NHTSA and EPA will jointly hold three public hearings in Washington, DC; the Detroit, MI area; and in the Los Angeles, CA area. The agencies will announce the specific dates and addresses for each hearing location in a supplemental **Federal Register** notice. The agencies will accept oral and written comments to the rulemaking documents, and NHTSA will also accept comments to the Draft Environmental Impact Statement (DEIS) at these hearings. The hearings will start at 10 a.m. local time and continue until everyone has had a chance to speak. See the **SUPPLEMENTARY INFORMATION** section on “Public Participation,” below, for more information about the public hearings.

ADDRESSES: You may send comments, identified by Docket No. EPA–HQ–OAR–2018–0283 and/or NHTSA–2018–0067, by any of the following methods:

- *Federal eRulemaking Portal:* <http://www.regulations.gov>. Follow the instructions for sending comments.

- *Fax:* EPA: (202) 566–9744; NHTSA: (202) 493–2251.

- *Mail:*

- EPA: Environmental Protection Agency, EPA Docket Center (EPA/DC), Air and Radiation Docket, Mail Code 28221T, 1200 Pennsylvania Avenue NW, Washington, DC 20460, Attention Docket ID No. EPA–HQ–OAR–2018–0283. In addition, please mail a copy of your comments on the information collection provisions for the EPA proposal to the Office of Information and Regulatory Affairs, Office of Management and Budget (OMB), Attn: Desk Officer for EPA, 725 17th St. NW, Washington, DC 20503.

- NHTSA: Docket Management Facility, M–30, U.S. Department of Transportation, West Building, Ground Floor, Rm. W12–140, 1200 New Jersey Avenue SE, Washington, DC 20590.

- *Hand Delivery:*

- EPA: Docket Center (EPA/DC), EPA West, Room B102, 1301 Constitution Avenue NW, Washington, DC, Attention Docket ID No. EPA–HQ–OAR–2018–0283. Such deliveries are only accepted during the Docket’s normal hours of operation, and special arrangements should be made for deliveries of boxed information.

- NHTSA: West Building, Ground Floor, Rm. W12–140, 1200 New Jersey Avenue SE, Washington, DC 20590, between 9 a.m. and 4 p.m. Eastern Time, Monday through Friday, except Federal holidays.

Instructions: All submissions received must include the agency name and docket number or Regulatory Information Number (RIN) for this rulemaking. All comments received will be posted without change to <http://www.regulations.gov>, including any personal information provided. For detailed instructions on sending comments and additional information on the rulemaking process, see the “Public Participation” heading of the **SUPPLEMENTARY INFORMATION** section of this document.

Docket: For access to the dockets to read background documents or comments received, go to <http://www.regulations.gov>, and/or:

- *For EPA:* EPA Docket Center (EPA/DC), EPA West, Room 3334, 1301 Constitution Avenue NW, Washington, DC 20460. The Public Reading Room is open from 8:30 a.m. to 4:30 p.m., Monday through Friday, excluding legal holidays. The telephone number for the Public Reading Room is (202) 566–1744.

- *For NHTSA:* Docket Management Facility, M–30, U.S. Department of Transportation, West Building, Ground Floor, Rm. W12–140, 1200 New Jersey Avenue SE, Washington, DC 20590. The Docket Management Facility is open between 9 a.m. and 4 p.m. Eastern Time, Monday through Friday, except Federal holidays.

FOR FURTHER INFORMATION CONTACT:

EPA: Christopher Lieske, Office of Transportation and Air Quality, Assessment and Standards Division, Environmental Protection Agency, 2000 Traverwood Drive, Ann Arbor, MI 48105; telephone number: (734) 214–4584; fax number: (734) 214–4816; email address: lieske.christopher@epa.gov, or contact the Assessment and Standards Division, email address: otaqpublicweb@epa.gov. NHTSA: James Tamm, Office of Rulemaking, Fuel Economy Division, National Highway Traffic Safety Administration, 1200 New Jersey Avenue SE, Washington, DC 20590; telephone number: (202) 493–0515.

SUPPLEMENTARY INFORMATION:

- I. Overview of Joint NHTSA/EPA Proposal
- II. Technical Foundation for NPRM Analysis
- III. Proposed CAFE and CO₂ Standards for MYs 2021–2026
- IV. Alternative CAFE and GHG Standards Considered for MYs 2021/22–2026
- V. Proposed Standards, the Agencies' Statutory Obligations, and Why the Agencies Propose To Choose Them Over the Alternatives
- VI. Preemption of State and Local Laws
- VII. Impacts of the Proposed CAFE and CO₂ Standards
- VIII. Impacts of Alternative CAFE and CO₂ Standards Considered for MYs 2021/22–2026
- IX. Vehicle Classification
- X. Compliance and Enforcement
- XI. Public Participation
- XII. Regulatory Notices and Analyses

I. Overview of Joint NHTSA/EPA Proposal**A. Executive Summary**

In this notice, the National Highway Traffic Safety Administration (NHTSA) and the Environmental Protection Agency (EPA) (collectively, “the agencies”) are proposing the “Safer Affordable Fuel-Efficient (SAFE) Vehicles Rule for Model Years 2021–2026 Passenger Cars and Light Trucks” (SAFE Vehicles Rule). The proposed SAFE Vehicles Rule would set Corporate Average Fuel Economy (CAFE) and carbon dioxide (CO₂) emissions standards, respectively, for passenger cars and light trucks manufactured for sale in the United States in model years (MYs) 2021 through 2026.¹ CAFE and CO₂ standards have the power to transform the vehicle fleet and affect Americans' lives in significant, if not always immediately obvious, ways. The proposed SAFE Vehicles Rule seeks to ensure that government action on these standards is appropriate, reasonable, consistent with law, consistent with current and foreseeable future economic realities, and supported by a transparent assessment of current facts and data.

The agencies must act to propose and finalize these standards and do not have discretion to decline to regulate. Congress requires NHTSA to set CAFE standards for each model year.² Congress also requires EPA to set emissions standards for light-duty vehicles if EPA has made an “endangerment finding” that the pollutant in question—in this case,

CO₂—“cause[s] or contribute[s] to air pollution which may reasonably be anticipated to endanger public health or welfare.”³ NHTSA and EPA are proposing these standards concurrently because tailpipe CO₂ emissions standards are directly and inherently related to fuel economy standards,⁴ and if finalized, these rules would apply concurrently to the same fleet of vehicles. By working together to develop these proposals, the agencies reduce regulatory burden on industry and improve administrative efficiency.

Consistent with both agencies' statutes, this proposal is entirely *de novo*, based on an entirely new analysis reflecting the best and most up-to-date information available to the agencies at the time of this rulemaking. The agencies worked together in 2012 to develop CAFE and CO₂ standards for MYs 2017 and beyond; in that rulemaking action, EPA set CO₂ standards for MYs 2017–2025, while NHTSA set final CAFE standards for MYs 2017–2021 and also put forth “augural” CAFE standards for MYs 2022–2025, consistent with EPA's CO₂ standards for those model years. EPA's CO₂ standards for MYs 2022–2025 were subject to a “mid-term evaluation,” by which EPA bound itself through regulation to re-evaluate the CO₂ standards for those model years and to undertake to develop new CO₂ standards through a regulatory process if it concluded that the previously finalized standards were no longer appropriate. EPA regulations on the mid-term evaluation process required EPA to issue a Final Determination no later than April 1, 2018 on whether the GHG standards for MY 2022–2025 light-duty vehicles remain appropriate under

section 202(a) of the Clean Air Act.⁵ The regulations also required the issuance of a draft Technical Assessment Report (TAR) by November 15, 2017, an opportunity for public comment on the draft TAR, and, before making a Final Determination, an opportunity for public comment on whether the GHG standards for MY 2022–2025 remain appropriate. In July 2016, the draft TAR was issued for public comment jointly by the EPA, NHTSA, and the California Air Resources Board (CARB).⁶ Following the draft TAR, EPA published a Proposed Determination for public comment on December 6, 2016 and provided less than 30 days for public comments over major holidays.⁷ EPA published the January 2017 Determination on EPA's website and *regulations.gov* finding that the MY 2022–2025 standards remained appropriate.⁸

On March 15, 2017, President Trump announced a restoration of the original mid-term review timeline. The President made clear in his remarks, “[i]f the standards threatened auto jobs, then commonsense changes” would be made in order to protect the economic viability of the U.S. automotive industry.⁹ In response to the President's direction, EPA announced in a March 22, 2017, **Federal Register** notice, its intention to reconsider the Final Determination of the mid-term evaluation of GHGs emissions standards for MY 2022–2025 light-duty vehicles.¹⁰ The Administrator stated that EPA would coordinate its reconsideration with the rulemaking process to be undertaken by NHTSA regarding CAFE standards for cars and light trucks for the same model years.

On August 21, 2017, EPA published a notice in the **Federal Register** announcing the opening of a 45-day public comment period and inviting stakeholders to submit any additional comments, data, and information they believed were relevant to the Administrator's reconsideration of the

³ 42 U.S.C. 7521, *see also* 74 FR 66495 (Dec. 15, 2009) (“Endangerment and Cause or Contribute Findings for Greenhouse Gases under Section 202(a) of the Clean Air Act”).

⁴ *See, e.g.*, 75 FR 25324, at 25327 (May 7, 2010) (“The National Program is both needed and possible because the relationship between improving fuel economy and reducing tailpipe CO₂ emissions is a very direct and close one. The amount of those CO₂ emissions is essentially constant per gallon combusted of a given type of fuel. Thus, the more fuel efficient a vehicle is, the less fuel it burns to travel a given distance. The less fuel it burns, the less CO₂ it emits in traveling that distance. [citation omitted] While there are emission control technologies that reduce the pollutants (*e.g.*, carbon monoxide) produced by imperfect combustion of fuel by capturing or converting them to other compounds, there is no such technology for CO₂. Further, while some of those pollutants can also be reduced by achieving a more complete combustion of fuel, doing so only increases the tailpipe emissions of CO₂. Thus, there is a single pool of technologies for addressing these twin problems, *i.e.*, those that reduce fuel consumption and thereby reduce CO₂ emissions as well.”)

⁵ 40 CFR 86.1818–12(h)(1); *see also* 77 FR 62624 (Oct. 15, 2012).

⁶ 81 FR 49217 (Jul. 27, 2016).

⁷ 81 FR 87927 (Dec. 6, 2016).

⁸ Docket item EPA–HQ–OAR–2015–0827–6270 (EPA–420–R–17–001). This conclusion generated a significant amount of public concern. *See, e.g.*, Letter from Auto Alliance to Scott Pruitt, Administrator, Environmental Protection Agency (Feb. 21, 2017); Letter from Global Automakers to Scott Pruitt, Administrator, Environmental Protection Agency (Feb. 21, 2017).

⁹ *See* <https://www.whitehouse.gov/briefings-statements/remarks-president-trump-american-center-mobility-detroit-mi/>.

¹⁰ 82 FR 14671 (Mar. 22, 2017).

¹ NHTSA sets CAFE standards under the Energy Policy and Conservation Act of 1975 (EPCA), as amended by the Energy Independence and Security Act of 2007 (EISA). EPA sets CO₂ standards under the Clean Air Act (CAA).

² 49 U.S.C. 32902.

January 2017 Determination.¹¹ EPA held a public hearing in Washington DC on September 6, 2017.¹² EPA received more than 290,000 comments in response to the August 21, 2017 notice.¹³

EPA has since concluded, based on more recent information, that those standards are no longer appropriate.¹⁴ NHTSA's "augural" CAFE standards for MYs 2022–2025 were not final in 2012 because Congress prohibits NHTSA from finalizing new CAFE standards for more than five model years in a single rulemaking.¹⁵ NHTSA was therefore obligated from the beginning to update and undertake a new rulemaking to set CAFE standards for MYs 2022–2025.

The proposed SAFE Vehicles Rule begins the rulemaking process for both agencies to establish new standards for MYs 2022–2025 passenger cars and light trucks. Standards are concurrently being proposed for MY 2026 in order to provide regulatory stability for as many years as is legally permissible for both agencies together.

Separately, the proposed SAFE Vehicles Rule includes revised standards for MY 2021 passenger cars and light trucks. The information now available and the current analysis

suggest that the CAFE standards previously set for MY 2021 are no longer maximum feasible, and the CO₂ standards previously set for MY 2021 are no longer appropriate. Agencies always have authority under the Administrative Procedure Act to revisit previous decisions in light of new facts, as long as they provide notice and an opportunity for comment, and it is plainly the best practice to do so when changed circumstances so warrant.¹⁶

Thus, the proposed SAFE Vehicles Rule would maintain the CAFE and CO₂ standards applicable in MY 2020 for MYs 2021–2026, while taking comment on a wide range of alternatives, including different stringencies and retaining existing CO₂ standards and the augural CAFE standards.¹⁷ Table I–4

¹⁶ See *FCC v. Fox Television*, 556 U.S. 502 (2009).

¹⁷ Note: This does not mean that the miles per gallon and grams per mile levels that were estimated for the MY 2020 fleet in 2012 would be the "standards" going forward into MYs 2021–2026. Both NHTSA and EPA set CAFE and CO₂ standards, respectively, as mathematical functions based on vehicle footprint. These mathematical functions that are the actual standards are defined as "curves" that are separate for passenger cars and light trucks, under which each vehicle manufacturer's compliance obligation varies depending on the footprints of the cars and trucks that it ultimately produces for sale in a given model year. It is the MY 2020 CAFE and CO₂ curves which we propose would continue to apply to the passenger car and light truck fleets for MYs 2021–2026. The mpg and g/mi values which those curves would eventually require of the fleets in those model years would be known for certain only at the ends of each of those model years. While it is convenient to discuss CAFE and CO₂ standards as a set "mpg," "g/mi," or "mpg-e" number, attempting to define those values today will end up being inaccurate.

below presents those alternatives. We note further that prior to MY 2021, CO₂ targets include adjustments reflecting the use of automotive refrigerants with reduced global warming potential (GWP) and/or the use of technologies that reduce the refrigerant leaks, and optionally offsets for nitrous oxide and methane emissions. In the interests of harmonizing with the CAFE program, EPA is proposing to exclude air conditioning refrigerants and leakage, and nitrous oxide and methane emissions for compliance with CO₂ standards after model year 2020 but seeks comment on whether to retain these element, and reinsert A/C leakage offsets, and remain disharmonized with the CAFE program. EPA also seeks comment on whether to change existing methane and nitrous oxide standards that were finalized in the 2012 rule. Specifically, EPA seeks information from the public on whether those existing standards are appropriate, or whether they should be revised to be less stringent or more stringent based on any updated data.

While actual requirements will ultimately vary for automakers depending upon their individual fleet mix of vehicles, many stakeholders will likely be interested in the current estimate of what the MY 2020 CAFE and CO₂ curves would translate to, in terms of miles per gallon (mpg) and grams per mile (g/mi), in MYs 2021–2026. These estimates are shown in the following tables.

BILLING CODE 4910–59–P

¹¹ 82 FR 39551 (Aug. 21, 2017).

¹² 82 FR 39976 (Aug. 23, 2017).

¹³ The public comments, public hearing transcript, and other information relevant to the Mid-term Evaluation are available in docket EPA–HQ–OAR–2015–0827.

¹⁴ 83 FR 16077 (Apr. 2, 2018).

¹⁵ 49 U.S.C. 32902.

Table I-1 - Average of OEMs' CAFE and CO₂ Estimated Requirements for Passenger Cars

Model Year	Avg. of OEMs' Est. Requirements	
	CAFE (mpg)	CO ₂ (g/mi)
2017	39.1	220
2018	40.5	210
2019	42.0	201
2020	43.7	191
2021	43.7	204
2022	43.7	204
2023	43.7	204
2024	43.7	204
2025	43.7	204
2026	43.7	204

Table I-2 - Average of OEMs' CAFE and CO₂ Estimated Requirements for Light Trucks

Model Year	Avg. of OEMs' Est. Requirements	
	CAFE (mpg)	CO ₂ (g/mi)
2017	29.5	294
2018	30.1	284
2019	30.6	277
2020	31.3	269
2021	31.3	284
2022	31.3	284
2023	31.3	284
2024	31.3	284
2025	31.3	284
2026	31.3	284

Table I-3 - Average of OEMs' Estimated CAFE and CO₂ Requirements (Passenger Cars and Light Trucks)

Model Year	Avg. of OEMs' Est. Requirements	
	CAFE (mpg)	CO ₂ (g/mi)
2017	34.0	254
2018	34.9	244
2019	35.8	236
2020	36.9	227
2021	36.9	241
2022	36.9	241
2023	36.9	241
2024	37.0	241
2025	37.0	240
2026	37.0	240

BILLING CODE 4910-59-C

In the tables above, estimated required CO₂ increases between MY 2020 and MY 2021 because, again, EPA is proposing to exclude CO₂-equivalent emission improvements associated with

air conditioning refrigerants and leakage (and, optionally, offsets for nitrous oxide and methane emissions) after model year 2020.

As explained above, the agencies are taking comment on a wide range of

alternatives and have specifically modeled eight alternatives (including the proposed alternative) and the current requirements (*i.e.*, baseline/no-action). The modeled alternatives are provided below:

Table I-4 - Regulatory Alternatives Currently under Consideration

Alternative	Change in stringency	A/C efficiency and off-cycle provisions	CO ₂ Equivalent AC Refrigerant Leakage, Nitrous Oxide and Methane Emissions Included for Compliance?
Baseline/ No-Action	MY 2021 standards remain in place; MYs 2022-2025 augural CAFE standards are finalized and GHG standards remain unchanged; MY 2026 standards are set at MY 2025 levels	No change	Yes, for all MYs ¹⁸
1 (Proposed)	Existing standards through MY 2020, then 0%/year increases for both passenger cars and light trucks, for MYs 2021-2026	No change	No, beginning in MY 2021 ¹⁹
2	Existing standards through MY 2020, then 0.5%/year increases for both passenger cars and light trucks, for MYs 2021-2026	No change	No, beginning in MY 2021
3	Existing standards through MY 2020, then 0.5%/year increases for both passenger cars and light trucks, for MYs 2021-2026	Phase out these adjustments over MYs 2022-2026	No, beginning in MY 2021
4	Existing standards through MY 2020, then 1%/year increases for passenger cars and 2%/year increases for light trucks, for MYs 2021-2026	No change	No, beginning in MY 2021
5	Existing standards through MY 2021, then 1%/year increases for passenger cars and 2%/year increases for light trucks, for MYs 2022-2026	No change	No, beginning in MY 2022
6	Existing standards through MY 2020, then 2%/year increases for passenger cars and 3%/year increases for light trucks, for MYs 2021-2026	No change	No, beginning in MY 2021
7	Existing standards through MY 2020, then 2%/year increases for passenger cars and 3%/year increases for light trucks, for MYs 2021-2026	Phase out these adjustments over MYs 2022-2026	No, beginning in MY 2021
8	Existing standards through MY 2021, then 2%/year increases for passenger cars and 3%/year increases for light trucks, for MYs 2022-2026	No change	No, beginning in MY 2022

Summary of Rationale

Since finalizing the agencies' previous joint rulemaking in 2012 titled "Final Rule for Model Year 2017 and Later

Light-Duty Vehicle Greenhouse Gas Emission and Corporate Average Fuel Economy Standards," and even since EPA's 2016 and early 2017 "mid-term

evaluation" process, the agencies have gathered new information, and have performed new analysis. That new information and analysis has led the

¹⁸ Carbon dioxide equivalent of air conditioning refrigerant leakage, nitrous oxide and methane emissions are included for compliance with the EPA standards for all MYs under the baseline/no action alternative. Carbon dioxide equivalent is

calculated using the Global Warming Potential (GWP) of each of the emissions.

¹⁹ Beginning in MY 2021, the proposal provides that the GWP equivalents of air conditioning

refrigerant leakage, nitrous oxide and methane emissions would no longer be able to be included with the tailpipe CO₂ for compliance with tailpipe CO₂ standards.

agencies to the tentative conclusion that holding standards constant at MY 2020 levels through MY 2026 is maximum feasible, for CAFE purposes, and appropriate, for CO₂ purposes.

Technologies have played out differently in the fleet from what the agencies assumed in 2012.

The technology to improve fuel economy and reduce CO₂ emissions has not changed dramatically since prior analyses were conducted: A wide variety of technologies are still available to accomplish the goals of the programs, and a wide variety of technologies would likely be used by industry to accomplish these goals. There remains no single technology that the majority of vehicles made by the majority of manufacturers can implement at low cost without affecting other vehicle attributes that consumers value more than fuel economy and CO₂ emissions. Even when used in combination, technologies that can improve fuel economy and reduce CO₂ emissions still need to (1) actually work together and (2) be acceptable to consumers and avoid sacrificing other vehicle attributes while also avoiding undue increases in vehicle cost. Optimism about the costs and effectiveness of many individual technologies, as compared to recent prior rounds of rulemaking, is somewhat tempered; a clearer understanding of what technologies are already on vehicles in the fleet and how they are being used, again as compared to recent prior rounds of rulemaking, means that technologies that previously appeared to offer significant “bang for the buck” may no longer do so. Additionally, in light of the reality that vehicle manufacturers may choose the relatively cost-effective technology option of vehicle lightweighting for a wide array of vehicles and not just the largest and heaviest, it is now recognized that as the stringency of standards increases, so does the likelihood that higher stringency will increase on-road fatalities. As it turns out, there is no such thing as a free lunch.²⁰

Technology that can improve both fuel economy and/or performance may not be dedicated solely to fuel economy.

As fleet-wide fuel efficiency has improved over time, additional improvements have become both more complicated and more costly. There are two primary reasons for this

phenomenon. First, as discussed, there is a known pool of technologies for improving fuel economy and reducing CO₂ emissions. Many of these technologies, when actually implemented on vehicles, can be used to improve other vehicle attributes such as “zero to 60” performance, towing, and hauling, etc., either instead of or in addition to improving fuel economy and reducing CO₂ emissions. As one example, a V6 engine can be turbocharged and downsized so that it consumes only as much fuel as an inline 4-cylinder engine, or it can be turbocharged and downsized so that it consumes less fuel than it would originally have consumed (but more than the inline 4-cylinder would) while also providing more low-end torque. As another example, a vehicle can be lightweighted so that it consumes less fuel than it would originally have consumed, or so that it consumes the same amount of fuel it would originally have consumed but can carry more content, like additional safety or infotainment equipment. Manufacturers employing “fuel-saving/emissions-reducing” technologies in the real world make decisions regarding how to employ that technology such that fewer than 100% of the possible fuel-saving/emissions-reducing benefits result. They do this because this is what consumers want, and more so than exclusively fuel economy improvements.

This makes actual fuel economy gains more expensive.

Thus, even though the technologies may be largely the same, previous assumptions about how much fuel can be saved or how much emissions can be reduced by employing various technologies may not have played out as prior analyses suggested, meaning that previous assumptions about how much it would cost to save that much fuel or reduce that much in emissions fall correspondingly short. For example, the agencies assumed in the 2010 final rule that dual clutch transmissions would be widely used to improve fuel economy due to expectations of strong effectiveness and very low cost: In practice, dual clutch transmissions had significant customer acceptance issues, and few manufacturers employ them in the U.S. market today.²¹ The agencies included some “technologies” in the 2012 final rule analysis that were defined ambiguously and/or in ways

that precluded observation in the known (MYs 2008 and 2010) fleets, likely leading to double counting in cases where the known vehicles already reflected the assumed efficiency improvement. For example, the agencies assumed that transmission “shift optimizers” would be available and fairly widely used in MYs 2017–2025, but involving software controls, a “technology” not defined in a way that would be observed in the fleet (unlike, for example, a dual clutch transmission).

To be clear, this is no one’s “fault”—the CAFE and CO₂ standards do not require manufacturers to use particular technologies in particular ways, and both agencies’ past analyses generally sought to illustrate technology paths to compliance that were assumed to be as cost-effective as possible. If manufacturers choose different paths for reasons not accounted for in regulatory analysis, or choose to use technologies differently from what the agencies previously assumed, it does not necessarily mean that the analyses were unreasonable when performed. It *does* mean, however, that the fleet ought to be reflected as it stands today, with the technology it has and as that technology has been used, and consider what technology remains on the table at this point, whether and when it can realistically be available for widespread use in production, and how much it would cost to implement.

Incremental additional fuel economy benefits are subject to diminishing returns.

As fleet-wide fuel efficiency improves and CO₂ emissions are reduced, the incremental benefit of continuing to improve/reduce inevitably decreases. This is because, as the base level of fuel economy improves, fewer gallons are saved from subsequent incremental improvements. Put simply, a one mpg increase for vehicles with low fuel economy will result in far greater savings than an identical 1 mpg increase for vehicles with higher fuel economy, and the cost for achieving a one-mpg increase for low fuel economy vehicles is far less than for higher fuel economy vehicles. This means that improving fuel economy is subject to diminishing returns. Annual fuel consumption can be calculated as follows:

²⁰ Mankiw, N. Gregory, *Principles of Macroeconomics*, Sixth Edition, 2012, at 4.

²¹ In fact, one manufacturer saw enough customer pushback that it launched a buyback program. See,

e.g., Steve Lehto, “What you need to know about the settlement for Ford Powershift owners,” *Road and Track*, Oct. 19, 2017. Available at <https://www.roadandtrack.com/car-culture/a10316276/>

what-you-need-to-know-about-the-proposed-settlement-for-ford-powershift-owners/ (last accessed Jul. 2, 2018).

$$\text{Fuel Consumption (gallons)} = \frac{\text{Distance Traveled (miles)}}{\text{Fuel Economy (mpg)}}$$

For purposes of illustration, assume a vehicle owner who drives a light vehicle 15,000 miles per year (a typical assumption for analytical purposes).²² If that owner trades in a vehicle with fuel economy of 15 mpg for one with fuel economy of 20 mpg, the owner's annual fuel consumption would drop from 1,000 gallons to 750 gallons—saving 250 gallons annually. If, however, that owner were to trade in a vehicle with fuel economy of 30 mpg for one with fuel economy of 40 mpg, the owner's annual gasoline consumption would drop from 500 gallons/year to 375 gallons/year—only 125 gallons even though the mpg improvement is twice

as large. Going from 40 to 50 mpg would save only 75 gallons/year. Yet, each additional fuel economy improvement becomes much more expensive as the low-hanging fruit of low-cost technological improvement options are picked.²³ Automakers, who must nonetheless continue adding technology to improve fuel economy and reduce CO₂ emissions, will either sacrifice other performance attributes or raise the price of vehicles—neither of which is attractive to most consumers.

If fuel prices are high, the value of those gallons may be enough to offset the cost of further fuel economy improvements, but (1) the most recent

reference case projections in the Energy Information Administration's (EIA's) Annual Energy Outlook (AEO 2017 and AEO 2018) do not indicate particularly high fuel prices in the foreseeable future, given underlying assumptions,²⁴ and (2) as the baseline level of fuel economy continues to increase, the marginal cost of the next gallon saved similarly increases with the cost of the technologies required to meet the savings. The following figure illustrates the fact that fuel savings and corresponding avoided costs diminish with increasing fuel economy, showing the same basic pattern as a 2014 illustration developed by EIA.²⁵

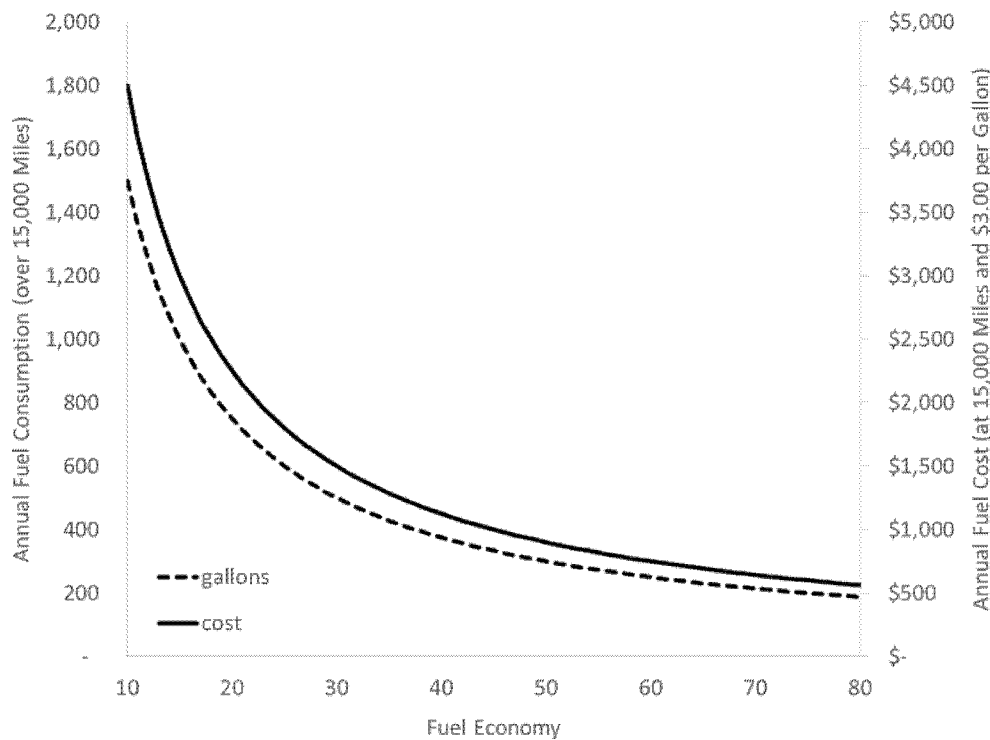

Figure I-1 - Annual Fuel Use and Costs vs. Fuel Economy (at 15,000 Miles and \$3.00 per Gal.)

²² A different vehicle-miles-traveled (VMT) assumption would change the absolute numbers in the example, but would not change the mathematical principles. Today's analysis uses mileage accumulation schedules that average about 15,000 miles annually over the first six years of vehicle operation.

²³ The examples in the text above are presented in mpg because that is a metric which should be readily understandable to most readers, but the example would hold true for grams of CO₂ per mile as well. If a vehicle emits 300 g/mi CO₂, a 20

percent improvement is 60 g/mi, so that the vehicle would emit 240 g/mi. At 180 g/mi, a 20% improvement is 36 g/mi, so the vehicle would get 144 g/mi. In order to continue achieving similarly large (on an absolute basis) emissions reductions, mathematics require the percentage reduction to continue increasing.

²⁴ The U.S. Energy Information Administration (EIA) is the statistical and analytical agency within the U.S. Department of Energy (DOE). EIA is the nation's premiere source of energy information, and every fuel economy rulemaking since 2002 (and

every joint CAFE and CO₂ rulemaking since 2009) has applied fuel price projections from EIA's Annual Energy Outlook (AEO). AEO projections, documentation, and underlying data and estimates are available at <https://www.eia.gov/outlooks/aeo/>.

²⁵ *Today in Energy: Fuel economy improvements show diminishing returns in fuel savings*, U.S. Energy Information Administration (Jul. 11, 2014), <https://www.eia.gov/todayinenergy/detail.php?id=17071>.

This effect is mathematical in nature and long-established, but when combined with relatively low fuel prices potentially through 2050, and the likelihood that a large majority of American consumers could consequently continue to place a higher value on vehicle attributes other than fuel economy, it makes manufacturers' ability to sell light vehicles with ever-higher fuel economy and ever-lower carbon dioxide emissions increasingly difficult. Put more simply, if gas is cheap and each additional improvement saves less gas anyway, most consumers would rather spend their money on attributes other than fuel economy when they are considering a new vehicle purchase, whether that is more safety technology, a better infotainment package, a more powerful powertrain, or other features (or, indeed, they may prefer to spend the savings on something other than automobiles). Manufacturers trying to sell consumers more fuel economy in such circumstances may convince consumers who place weight on efficiency and reduced carbon emissions, but consumers decide for themselves what attributes are worth to them. And while some contend that consumers do not sufficiently consider or value future fuel savings when making vehicle purchasing decisions,²⁶ information regarding the benefits of higher fuel economy has never been made more readily available than today, with a host of online tools and mandatory prominent disclosures on new vehicles on the Monroney label showing fuel savings compared to average vehicles. This is not a question of "if you build it, they will come." Despite the widespread availability of fuel economy information, and despite manufacturers building and marketing vehicles with higher fuel economy and increasing their offerings of hybrid and electric vehicles, in the past several years as gas prices have remained low, consumer preferences have shifted markedly away from higher-fuel-economy smaller and midsize passenger vehicles toward crossovers and truck-based utility vehicles.²⁷ Some consumers plainly

value fuel economy and low CO₂ emissions above other attributes, and thanks in part to CAFE and CO₂ standards, they have a plentiful selection of high-fuel economy and low CO₂-emitting vehicles to choose from, but those consumers represent a relatively small percentage of buyers.

Changed petroleum market has supported a shift in consumer preferences.

In 2012, the agencies projected fuel prices would rise significantly, and the United States would continue to rely heavily upon imports of oil, subjecting the country to heightened risk of price shocks.²⁸ Things have changed significantly since 2012, with fuel prices projected to remain low through 2050. Furthermore, the global petroleum market has shifted dramatically with the United States taking advantage of its own oil supplies through technological advances that allow for cost-effective extraction of shale oil. The U.S. is now the world's largest oil producer and expected to become a net petroleum exporter in the next decade.²⁹

At least partially in response to lower fuel prices, consumers have moved more heavily into crossovers, sport utility vehicles and pickup trucks, than anticipated at the time of the last rulemaking. Because standards are based on footprint and specified separately for passenger cars and light trucks, these shifts do not necessarily pose compliance challenges by themselves, but they tend to reduce the overall average fuel economy rates and

increasing vehicle footprint size in order to get "easier" CAFE and CO₂ standards. This misunderstands, somewhat, how the footprint-based standards work. While it is correct that larger-footprint vehicles have less stringent "targets," the difficulty of compliance rests in how far above or below those vehicles are *as compared to* their targets, and more specifically, whether the manufacturer is selling so many vehicles that are far short of their targets that they cannot average out to compliant levels through other vehicles sold that beat their targets. For example, under the CAFE program, a manufacturer building a fleet of larger-footprint vehicles may have an objectively lower mpg-value compliance obligation than a manufacturer building a more mixed fleet, but it may still be more challenging for the first manufacturer to reach its compliance obligation if it is selling only very-low-mpg variants at any given footprint. There is only so much that increasing footprint makes it "easier" for a manufacturer to reach compliance.

²⁶ The 2012 final rule analysis relied on the Energy Information Administration's Annual Energy Outlook 2012 Early Release, which assumed significantly higher fuel prices than the AEO 2017 (or AEO 2018) currently available. See 77 FR 62624, 62715 (Oct. 15, 2012) for the 2012 final rule's description of the fuel price estimates used.

²⁹ Annual Energy Outlook 2018, U.S. Energy Information Administration, at 53 (Feb. 6, 2018), <https://www.eia.gov/outlooks/aeo/pdf/AEO2018.pdf>.

increase the overall average CO₂ emission rates of the new vehicle fleet. Consumers are also demonstrating a preference for more powerful engines and vehicles with higher seating positions and ride height (and accompanying mass increase relative to footprint)³⁰—all of which present challenges for achieving increased fuel economy levels and lower CO₂ emission rates.

The Consequence of Unreasonable Fuel Economy and CO₂ Standards: Increased vehicle prices keep consumers in older, dirtier, and less safe vehicles.

Consumers tend to avoid purchasing things that they neither want or need. The analysis in today's proposal moves closer to being able to represent this fact through an improved model for vehicle scrappage rates. While neither this nor a sales response model, also included in today's analysis, nor the combination of the two, are consumer choice models, today's analysis illustrates market-wide impacts on the sale of new vehicles and the retention of used vehicles. Higher vehicle prices, which result from more-stringent fuel economy standards, have an effect on consumer purchasing decisions. As prices increase, the market-wide incentive to extract additional travel from used vehicles increases. The average age of the in-service fleet has been increasing, and when fleet turnover slows, not only does it take longer for fleet-wide fuel economy and CO₂ emissions to improve, but also safety improvements, criteria pollutant emissions improvements, many other vehicle attributes that also provide societal benefits take longer to be reflected in the overall U.S. fleet as well because of reduced turnover. Raising vehicle prices too far, too fast, such as through very stringent fuel economy and CO₂ emissions standards (especially considering that, on a fleet-wide basis, new vehicle sales and turnover do not appear strongly responsive to fuel economy), has effects beyond simply a slowdown in sales. Improvements over time have better longer-term effects simply by not alienating consumers, as compared to great leaps forward that drive people out of the new car market or into vehicles that do not meet their needs. The industry has achieved tremendous gains in fuel economy over the past decade, and these increases will continue at least through 2020.

Along with these gains, there have also been tremendous increases in vehicle prices, as new vehicles become increasingly unaffordable—with the average new vehicle transaction price

²⁶ In docket numbers EPA-HQ-OAR-2015-0827 and NHTSA-2016-0068, see comments submitted by, e.g., Consumer Federation of America (NHTSA-2016-0068-0054, at p. 57, *et seq.*) and the Environmental Defense Fund (EPA-HQ-OAR-2015-0827-4086, at p. 18, *et seq.*)

²⁷ Carey, N. *Lured by rising SUV sales, automakers flood market with models*, Reuters (Mar. 29, 2018), available at <https://www.reuters.com/article/us-autoshow-new-york-suvs/lured-by-rising-suv-sales-automakers-flood-market-with-models-idUSKBN1H50KI> (last accessed Jun. 13, 2018). Many commentators have recently argued that manufacturers are deliberately

³⁰ See *id.*

recently exceeding \$36,000—up by more than \$3,000 since 2014 alone.³¹ In fact, a recent independent study indicated that the average new car price is unaffordable to median-income families in every metropolitan region in the United States except one: Washington, DC.³² That analysis used the historically accepted approach that consumers should make a down-payment of at least 20% of a vehicle's purchase price, finance for no longer than four years, and make payments of 10% or less of the consumer's annual income to car payments and insurance. But the market looks nothing like that these days, with average financing terms of 68 months, and an increasing proportion exceeding 72 or even 84 months.³³ Longer financing terms may

³¹ See, e.g., *Average New-Car Prices Rise Nearly 4 Percent for January 2018 On Shifting Sales Mix, According To Kelley Blue Book*, Kelley Blue Book, <https://mediaroom.kbb.com/2018-02-01-Average-New-Car-Prices-Rise-Nearly-4-Percent-For-January-2018-On-Shifting-Sales-Mix-According-To-Kelley-Blue-Book> (last accessed Jun. 15, 2018).

³² Bell, C. *What's an 'affordable' car where you live? The answer may surprise you*, Bankrate.com (Jun. 28, 2017), available at <https://www.bankrate.com/auto/new-car-affordability-survey/> (last accessed Jun. 15, 2018).

³³ *Average Auto Loan Interest Rates: 2018 Facts and Figures*, ValuePenguin, available at <https://>

allow a consumer to keep their monthly payment affordable but can have serious potential financial consequences. Longer-term financing leads (generally) to higher interest rates, larger finance charges and total consumer costs, and a longer period of time with negative equity. In 2012, the agencies expected prices to increase under the standards announced at that time. The agencies estimated that, compared to a continuation of the model year 2016 standards, the standards issued through model year 2025 would eventually increase average prices by about \$1,500–\$1,800.^{34 35 36} Circumstances have

www.valuepenguin.com/auto-loans/average-auto-loan-interest-rates (last accessed Jun. 15, 2018).

³⁴ 77 FR 62624, 62666 (Oct. 15, 2012).

³⁵ The \$1,500 figure reported in 2012 by NHTSA reflected application of carried-forward credits in model year 2025, rather than an achieved CAFE level that could be sustainably compliant beyond 2025 (with standards remaining at 2025 levels). As for the 2016 draft TAR, NHTSA has since updated its modeling approach to extend far enough into the future that any unsustainable credit deficits are eliminated. Like analyses published by EPA in 2016, 2017, and early 2018, the \$1,800 figure reported in 2012 by EPA did not reflect either simulation of manufacturers' multiyear plans to progress from the initial MY 2008 fleet to the MY 2025 fleet or any accounting for manufacturers' potential application of banked credits. Today's analysis of both CAFE and CO₂ standards accounts

changed, the analytical methods and inputs have been updated (including updates to address issues still present in analyses published in 2016, 2017, and early 2018), and today, the analysis suggests that, compared to the proposed standards today, the previously-issued standards would increase average vehicle prices by about \$2,100. While today's estimate is similar in magnitude to the 2012 estimate, it is relative to a baseline that includes increases in stringency between MY 2016 and MY 2020. Compared to leaving vehicle technology at MY 2016 levels, today's analysis shows the previously-issued standards through model year 2025 could eventually increase average vehicle prices by approximately \$2,700. A pause in continued increases in fuel economy standards, and cost increases attributable thereto, is appropriate.

explicitly for multiyear planning and credit banking.

³⁶ While EPA did not refer to the reported \$1,800 as an estimate of the increase in average prices, because EPA did not assume that manufacturers would reduce profit margins, the \$1,800 estimate is appropriately interpreted as an estimate of the average increase in vehicle prices.

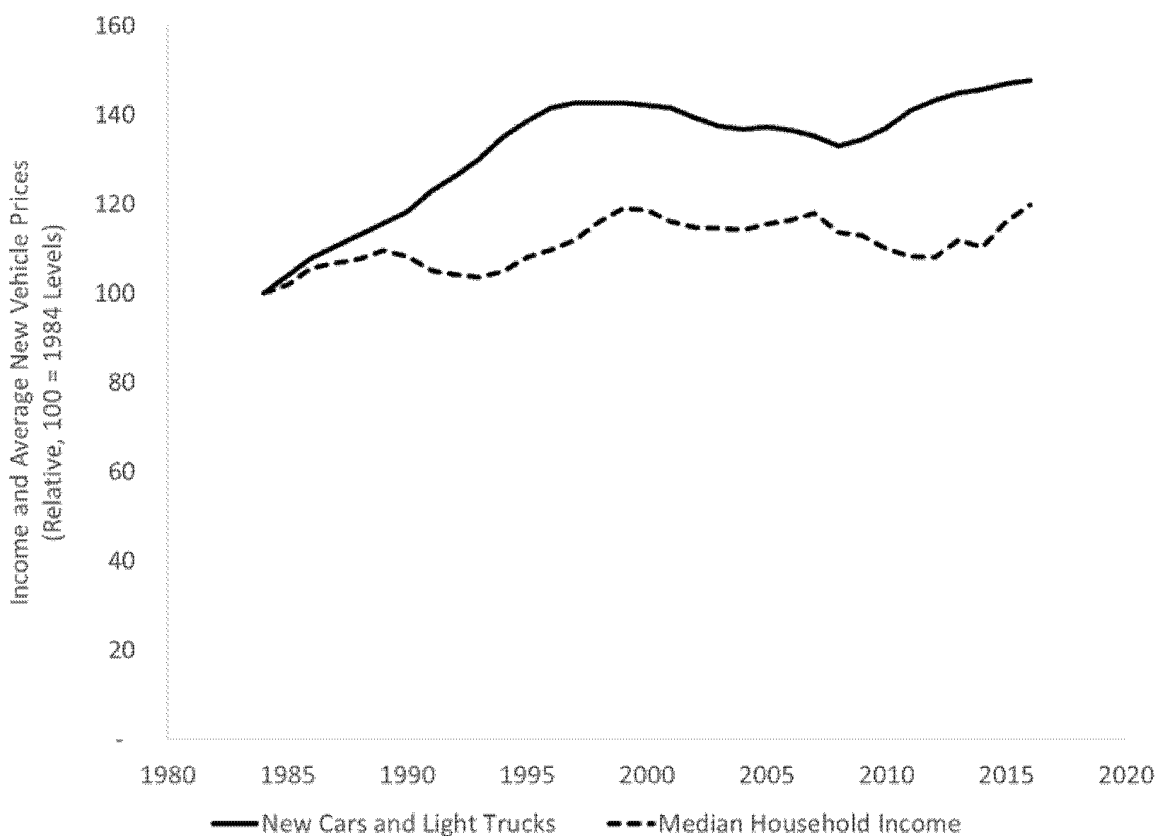

Figure I-2 - New Vehicle Prices and Median Household Income (Indexed, 1984 Levels = 100)³⁷

Preferred Alternative

For all of these reasons, the agencies are proposing to maintain the MY 2020 fuel economy and CO₂ emissions standards for MYs 2021–2026. Our goal is to establish standards that promote both energy conservation and safety, in light of what is technologically feasible and economically practicable, as directed by Congress.

Energy Conservation

EPCA requires that NHTSA, when determining the maximum feasible levels of CAFE standards, consider the need of the Nation to conserve energy. However, EPCA also requires that NHTSA consider other factors, such as

technological feasibility and economic practicability. The analysis suggests that, compared to the standards issued previously for MYs 2021–2025, today's proposed rule will eventually (by the early 2030s) increase U.S. petroleum consumption by about 0.5 million barrels per day—about two to three percent of projected total U.S. consumption. While significant, this additional petroleum consumption is, from an economic perspective, dwarfed by the cost savings also projected to result from today's proposal, as indicated by the consideration of net benefits appearing below.

Safety Benefits From Preferred Alternative

Today's proposed rule is anticipated to prevent more than 12,700 on-road fatalities³⁸ and significantly more injuries as compared to the standards set forth in the 2012 final rule over the lifetimes of vehicles as more new, safer vehicles are purchased than the current (and aural) standards. A large portion of these safety benefits will come from

improved fleet turnover as more consumers will be able to afford newer and safer vehicles.

Recent NHTSA analysis shows that the proportion of passengers killed in a vehicle 18 or more model years old is nearly double that of a vehicle three model years old or newer.³⁹ As the average car on the road is approaching 12 years old, apparently the oldest in our history,⁴⁰ major safety benefits will occur by reducing fleet age. Other safety benefits will occur from other areas such as avoiding the increased driving

³⁹ Passenger Vehicle Occupant Injury Severity by Vehicle Age and Model Year in Fatal Crashes, Traffic Safety Facts Research Note, DOT HS 812 528. Washington, DC: National Highway Traffic Safety Administration. April 2018.

⁴⁰ See, e.g., IHS Markit, *Vehicles Getting Older: Average Age of Light Cars and Trucks in U.S. Rises Again in 2016 to 11.5 years*, IHS Markit Says, IHS Markit (Nov. 22, 2016), <http://news.ihsmarkit.com/press-release/automotive/vehicles-getting-older-average-age-light-cars-and-trucks-us-rises-again-2016> (“... consumers are continuing the trend of holding onto their vehicles longer than ever. As of the end of 2015, the average length of ownership measured a record 79.3 months, more than 1.5 months longer than reported in the previous year. For used vehicles, it is nearly 66 months. Both are significantly longer lengths of ownership since the same measure a decade ago.”).

³⁷ Data on new vehicle prices are from U.S. Bureau of Economic Analysis, National Income and Product Accounts, Supplemental Table 7.2.5S, Auto and Truck Unit Sales, Production, Inventories, Expenditures, and Price (<https://www.bea.gov/iTable/iTable.cfm?reqid=19&step=2#reqid=19&step=3&isuri=1&1921=underlying&1903=2055>, last accessed Jul. 20, 2018). Median Household Income data are from U.S. Census Bureau, Table A-1, Households by Total Money Income, Race, and Hispanic Origin of Householder: 1967 to 2016 (<https://www.census.gov/data/tables/2017/demo/income-poverty/p60-259.html>, last accessed Jul. 20, 2018).

³⁸ Over the lifetime of vehicles through MY 2029.

that would otherwise result from higher fuel efficiency (known as the rebound effect) and avoiding the mass reductions in passenger cars that might otherwise be required to meet the standards established in 2012.⁴¹ Together these and other factors lead to estimated annual fatalities under the proposed standards that are significantly reduced⁴² relative to those that would occur under current (and augural) standards.

The Preferred Alternative Would Have Negligible Environmental Impacts on Air Quality

Improving fleet turnover will result in consumers getting into newer and cleaner vehicles, accelerating the rate at which older, more-polluting vehicles are removed from the roadways. Also, reducing fuel economy (relative to levels that would occur under previously-issued standards) would increase the marginal cost of driving newer vehicles, reducing mileage accumulated by those vehicles, and

reducing corresponding emissions. On the other hand, increasing fuel consumption would increase emissions resulting from petroleum refining and related “upstream” processes. Our analysis shows that none of the regulatory alternatives considered in this proposal would noticeably impact net emissions of smog-forming or other “criteria” or toxic air pollutants, as illustrated by the following graph. That said, the resultant tailpipe emissions reductions should be especially beneficial to highly trafficked corridors.

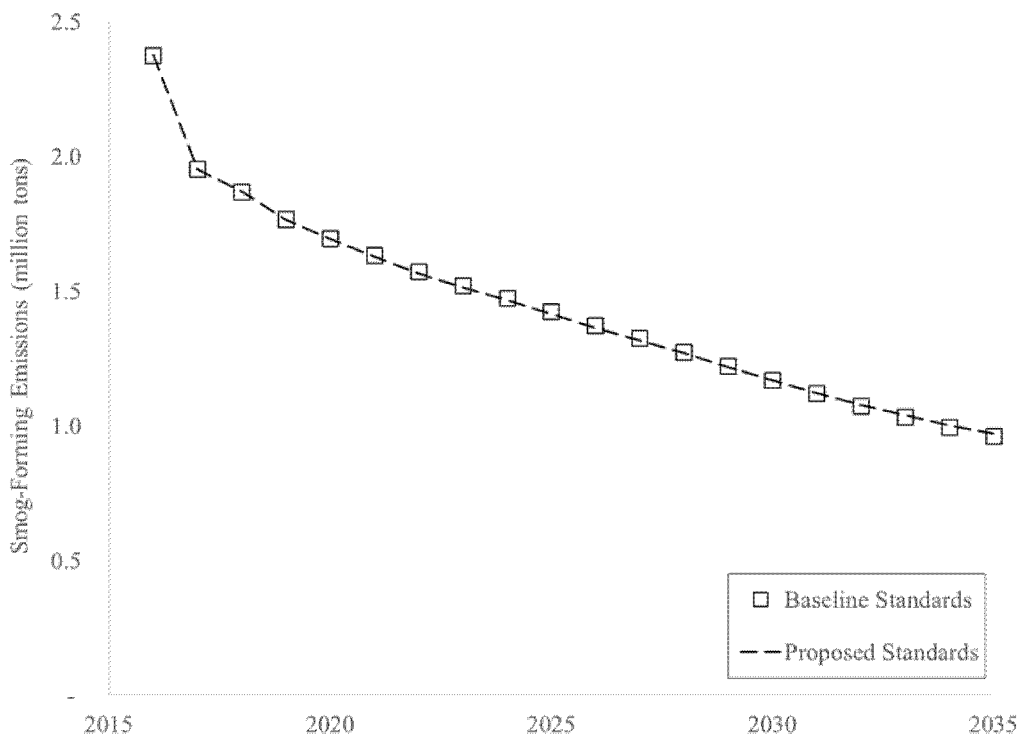

Figure I-3 - Annual Smog-Forming Emissions under Baseline and Proposed Standards

Climate Change Impacts From Preferred Alternative

The estimated effects of this proposal in terms of fuel savings and CO₂ emissions, again perhaps somewhat counter-intuitively, is relatively small as compared to the 2012 final rule.⁴³

NHTSA’s Environmental Impact Statement performed for this rulemaking shows that the preferred alternative would result in 3/1,000ths of a degree Celsius increase in global average temperatures by 2100, relative to the standards finalized in 2012. On a net CO₂ basis, the results are similarly

minimal. The following graph compares the estimated atmospheric CO₂ concentration (789.76 ppm) in 2100 under the proposed standards to the estimated level (789.11 ppm) under the standards set forth in 2012—or an 8/100ths of a percentage increase:

⁴¹The agencies are specifically requesting comment on the appropriateness and level of the effects of the rebound effect. The agencies also seek comment on changes as compared to the 2012 modeling relating to mass reduction assumptions. During that rulemaking, the analysis limited the amount of mass reduction assumed for certain vehicles, which impacted the results regarding potential for adverse safety effects, even while acknowledging that manufacturers would not

necessarily choose to avoid mass reductions in the ways that the agencies assumed. See, 77 FR 623624, 62763 (Oct. 15, 2012). By choosing where and how to limit assumed mass reduction, the 2012 rule’s safety analysis reduced the projected apparent risk to safety associated with aggressive fuel economy and CO₂ targets. That specific assumption has been removed for today’s analysis.

⁴²The reduction in annual fatalities varies each calendar year, averaging 894 fewer fatalities

annually for the CAFE program and 1,150 fewer fatalities for the CO₂ program over calendar years 2036–2045.

⁴³Counter-intuitiveness is relative, however. The estimated effects of the 2012 final rule on climate were similarly small in magnitude, as shown in the Final EIS accompanying that rule and available on NHTSA’s website.

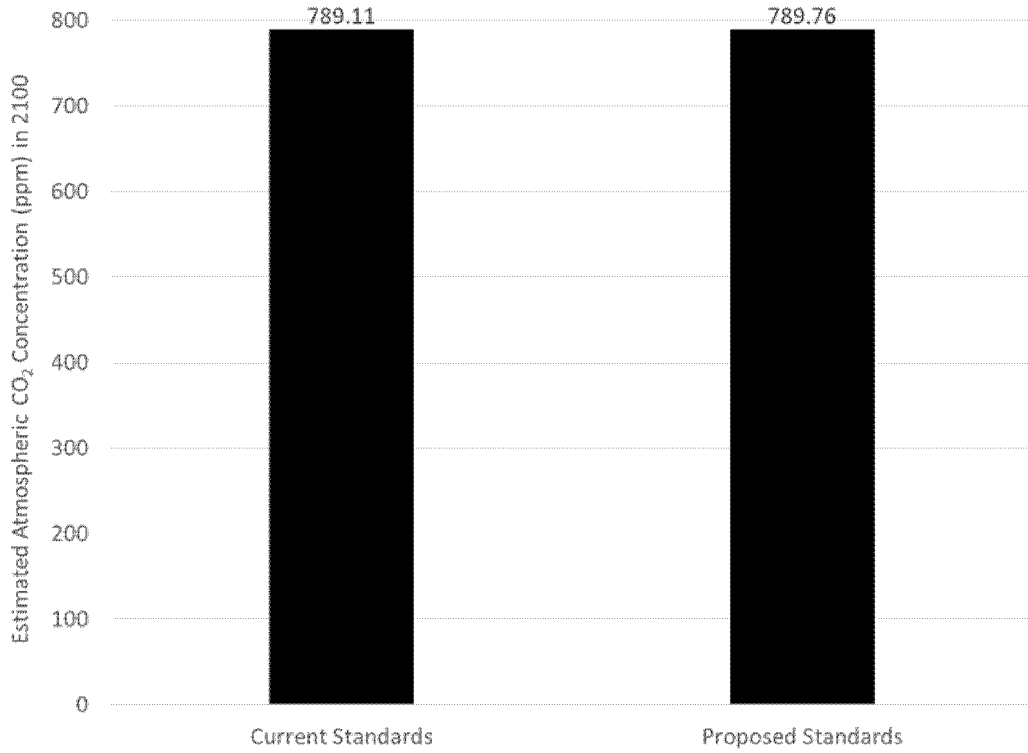

Figure I-4 - Estimated Atmospheric CO₂ Concentration in 2100

Net Benefits From Preferred Alternative

Maintaining the MY 2020 curves for MYs 2021–2026 will save American consumers, the auto industry, and the public a considerable amount of money

as compared to if EPA retained the previously-set CO₂ standards and NHTSA finalized the augural standards. This was identified as the preferred alternative, in part, because it maximizes net benefits compared to the

other alternatives analyzed, recognizing the statutory considerations for both agencies. Comment is sought on whether this is an appropriate basis for selection.

Table I-4 - Estimated 1977-2029 Model Year Costs, Benefits, and Net Benefits under the Preferred Alternative (Billions of 2016\$)

Cumulative Across MYs 1977-2029				
	Totals		Annualized	
	3%	7%	3%	7%
	Discount	Discount	Discount	Discount
	Rate	Rate	Rate	Rate
<i>CAFE Standards:</i>				
Costs	-502.1	-335.3	-19.2	-24.2
Benefits	-325.8	-203.8	-12.4	-14.7
Net Benefits	176.3	131.5	6.7	9.5
<i>CO₂ Standards:</i>				
Costs	-563.3	-367.1	-21.5	-26.5
Benefits	-362.6	-226.5	-13.9	-16.3
Net Benefits	200.7	140.6	7.7	10.1

These estimates, reported as changes relative to impacts under the standards issued in 2012, account for impacts on vehicles produced during model years 2016–2029, as well as (through changes in utilization) vehicles produced in earlier model years, throughout those vehicles' useful lives. Reported values are in 2016 dollars, and reflect three-percent and seven-percent discount rates. Under CAFE standards, costs are estimated to decrease by \$502 billion overall at a three-percent discount rate (\$335 billion at a seven-percent discount rate); benefits are estimated to decrease by \$326 billion at a three-percent discount rate (\$204 billion at a seven-percent discount rate). Thus, net benefits are estimated to increase by \$176 billion at a three-percent discount rate and \$132 billion at a seven-percent discount rate. The estimated impacts under CO₂ standards are similar, with net benefits estimated to increase by \$201 billion at a three-percent discount rate and \$141 billion at a seven-percent discount rate.

Compliance Flexibilities

This proposal also seeks comment on a variety of changes to NHTSA's and EPA's compliance programs for CAFE and CO₂ as well as related programs. Compliance flexibilities can generally be grouped into two categories. The first category are those compliance flexibilities that reduce unnecessary compliance costs and provide for a more efficient program. The second category of compliance flexibilities are those that distort the market—such as by incentivizing the implementation of one type of technology by providing credit for compliance in excess of real-world fuel savings.

Both programs provide for the generation of credits based upon fleet-wide over-compliance, provide for adjustments to the test measured value of each individual vehicle based upon the implementation of certain fuel saving technologies, and provide additional incentives for the implementation of certain preferred technologies (regardless of actual fuel savings). Auto manufacturers and others have petitioned for a host of additional

adjustment- and incentive-type flexibilities, where there is not always consumer interest in the technologies to be incentivized nor is there necessarily clear fuel-saving and emissions-reducing benefit to be derived from that incentivization. The agencies seek comment on all of those requests as part of this proposal.

Over-compliance credits, which can be built up in part through use of the above-described per-vehicle adjustments and incentives, can be saved and either applied retroactively to accounts for previous non-compliance, or carried forward to mitigate future non-compliance. Such credits can also be traded to other automakers for cash or for other credits for different fleets. But such trading is not pursued openly. Under the CAFE program, the public is not made aware of inter-automaker trades, nor are shareholders. And even the agencies are not informed of the price of credits. With the exception of statutorily-mandated credits, the agencies seek comment on all aspects of the current system. The agencies are particularly interested in comments on flexibilities that may distort the market.

The agencies seek comment as to whether some adjustments and non-statutory incentives and other provisions should be eliminated and stringency levels adjusted accordingly. In general, well-functioning banking and trading provisions increase market efficiency and reduce the overall costs of compliance with regulatory objectives. The agencies request comment on whether the current system as implemented might need improvements to achieve greater efficiencies. We seek comment on specific programmatic changes that could improve compliance with current standards in the most efficient way, ranging from requiring public disclosure of some or all aspects of credit trades, to potentially eliminating credit trading in the CAFE program. We request commenters to provide any data, evidence, or existing literature to help agency decision-making.

One National Standard

Setting appropriate and maximum feasible fuel economy and tailpipe CO₂ emissions standards requires regulatory efficiency. This proposal addresses a fundamental and unnecessary complication in the currently-existing regulatory framework, which is the regulation of GHG emissions from passenger cars and light trucks by the State of California through its GHG standards and Zero Emission Vehicle (ZEV) mandate and subsequent adoption of these standards by other States. Both EPCA and the CAA preempt State regulation of motor vehicle emissions (in EPCA's case, standards that are related to fuel economy standards). The CAA gives EPA the authority to waive preemption for California under certain circumstances. EPCA does not provide for a waiver of preemption under any circumstances. In short, the agencies propose to maintain one national standard—a standard that is set exclusively by the Federal government.

Proposed Withdrawal of California's Clean Air Act Preemption Waiver

EPA granted a waiver of preemption to California in 2013 for its "Advanced Clean Car" regulations, composed of its GHG standards, its "Low Emission Vehicle (LEV)" program and the ZEV program,⁴⁴ and, as allowed under the CAA, a number of other States adopted California's standards.⁴⁵ The CAA states that EPA shall not grant a waiver of preemption if EPA finds that California's determination that its

standards are, in the aggregate, at least as protective of public health and welfare as applicable Federal standards, is arbitrary and capricious; that California does not need its own standards to meet compelling or extraordinary conditions; or that such California standards and accompanying enforcement procedures are not consistent with Section 202(a) of the CAA. In this proposal, EPA is proposing to withdraw the waiver granted to California in 2013 for the GHG and ZEV requirements of its Advanced Clean Cars program, in light of all of these factors.

Attempting to solve climate change, even in part, through the Section 209 waiver provision is fundamentally different from that section's original purpose of addressing smog-related air quality problems. When California was merely trying to solve its air quality issues, there was a relatively-straightforward technology solution to the problems, implementation of which did not affect how consumers lived and drove. Section 209 allowed California to pursue additional reductions to address its notorious smog problems by requiring more stringent standards, and allowed California and other States that failed to comply with Federal air quality standards to make progress toward compliance. Trying to reduce carbon emissions from motor vehicles in any significant way involves changes to the entire vehicle, not simply the addition of a single or a handful of control technologies. The greater the emissions reductions are sought, the greater the likelihood that the characteristics and capabilities of the vehicle currently sought by most American consumers will have to change significantly. Yet, even decades later, California continues to be in widespread non-attainment with Federal air quality standards.⁴⁶ In the past decade, California has disproportionately focused on GHG emissions. Parts of California have a real and significant local air pollution problem, but CO₂ is not part of that local problem.

California's Tailpipe CO₂ Emissions Standards and ZEV Mandate Conflict With EPCA

Moreover, California regulation of tailpipe CO₂ emissions, both through its GHG standards and ZEV program, conflicts directly and indirectly with EPCA and the CAFE program. EPCA expressly preempts State standards

related to fuel economy. Tailpipe CO₂ standards, whether in the form of fleet-wide CO₂ limits or in the form of requirements that manufacturers selling vehicles in California sell a certain number of low- and no-tailpipe-CO₂ emissions vehicles as part of their overall sales, are unquestionably related to fuel economy standards. Standards that control tailpipe CO₂ emissions are *de facto* fuel economy standards because CO₂ is a direct and inevitable byproduct of the combustion of carbon-based fuels to make energy, and the vast majority of the energy that powers passenger cars and light trucks comes from carbon-based fuels.

Improving fuel economy means getting the vehicle to go farther on a gallon of gas; a vehicle that goes farther on a gallon of gas produces less CO₂ per unit of distance; therefore, improving fuel economy necessarily reduces tailpipe CO₂ emissions, and reducing CO₂ emissions necessarily improves fuel economy. EPCA therefore necessarily preempts California's Advanced Clean Cars program to the extent that it regulates or prohibits tailpipe CO₂ emissions. Section VI of this proposal, below, discusses the CAA waiver and EPCA preemption in more detail.

Eliminating California's regulation of fuel economy pursuant to Congressional direction will provide benefits to the American public. The automotive industry will, appropriately, deal with fuel economy standards on a national basis—eliminating duplicative regulatory requirements. Further, elimination of California's ZEV program will allow automakers to develop such vehicles in response to consumer demand instead of regulatory mandate. This regulatory mandate has required automakers to spend tens of billions of dollars to develop products that a significant majority of consumers have not adopted, and consequently to sell such products at a loss. All of this is paid for through cross subsidization by increasing prices of other vehicles not just in California and other States that have adopted California's ZEV mandate, but throughout the country.

Request for Comment

The agencies look forward to all comments on this proposal, and wish to emphasize that obtaining public input is extremely important to us in selecting from among the alternatives in a final rule. While the agencies and the Administration met with a variety of stakeholders prior to issuance of this proposal, those meetings have not resulted in a predetermined final rule outcome. The Administrative Procedure Act requires that agencies provide the

⁴⁴ 78 FR 2112 (Jan. 9, 2013).

⁴⁵ CAA Section 177, 42 U.S.C. 7507.

⁴⁶ See California Nonattainment/Maintenance Status for Each County by Year for All Criteria Pollutants, current as of May 31, 2018, at https://www3.epa.gov/airquality/greenbook/anayo_ca.html (last accessed June 15, 2018).

public with adequate notice of a proposed rule followed by a meaningful opportunity to comment on the rule's content. The agencies are committed to following that directive.

II. Technical Foundation for NPRM Analysis

A. Basics of CAFE and CO₂ Standards Analysis

The agencies' analysis of CAFE and CO₂ standards involves two basic elements: first, estimating ways each manufacturer could potentially respond to a given set of standards in a manner that considers potential consumer response; and second, estimating various impacts of those responses. Estimating manufacturers' potential responses involves simulating manufacturers' decision-making processes regarding the year-by-year application of fuel-saving technologies to specific vehicles. Estimating impacts involves calculating resultant changes in new vehicle costs, estimating a variety of costs (e.g., for fuel) and effects (e.g., CO₂ emissions from fuel combustion) occurring as vehicles are driven over their lifetimes before eventually being scrapped, and estimating the monetary value of these effects. Estimating impacts also involves consideration of the response of consumers—e.g., whether consumers will purchase the vehicles and in what quantities. Both of these basic analytical elements involve the application of many analytical inputs.

The agencies' analysis uses the CAFE model to estimate manufacturers' potential responses to new CAFE and CO₂ standards and to estimate various impacts of those responses. The model makes use of many inputs, values of which are developed *outside* of the model and not *by* the model. For example, the model applies fuel prices; it does not estimate fuel prices. The model does not determine the form or stringency of the standards; instead, the model applies inputs specifying the form and stringency of standards to be analyzed and produces outputs showing effects of manufacturers working to meet those standards, which become the basis for comparing between different potential stringencies.

DOT's Volpe National Transportation Systems Center (often simply referred to as the "Volpe Center") develops, maintains, and applies the model for NHTSA. NHTSA has used the CAFE model to perform analyses supporting every CAFE rulemaking since 2001, and the 2016 rulemaking regarding heavy-duty pickup and van fuel consumption

and GHG emissions also used the CAFE model for analysis.⁴⁷

DOT recently arranged for a formal peer review of the model. In general, reviewers' comments strongly supported the model's conceptual basis and implementation, and commenters provided several specific recommendations. DOT staff agreed with many of these recommendations and have worked to implement them wherever practicable. Implementing some of them would require considerable further research, development, and testing, and will be considered going forward. For a handful of other recommendations, DOT staff disagreed, often finding the recommendations involved considerations (e.g., other policies, such as those involving fuel taxation) beyond the model itself or were based on concerns with inputs rather than how the model itself functioned. A report available in the docket for this rulemaking presents peer reviewers' detailed comments and recommendations, and provides DOT's detailed responses.⁴⁸

The agencies also use four DOE and DOE-sponsored models to develop inputs to the CAFE model, including three developed and maintained by DOE's Argonne National Laboratory. The agencies use the DOE Energy Information Administration's (EIA's) National Energy Modeling System (NEMS) to estimate fuel prices,⁴⁹ and used Argonne's Greenhouse gases, Regulated Emissions, and Energy use in Transportation (GREET) model to estimate emissions rates from fuel production and distribution processes.⁵⁰ DOT also sponsored DOE/Argonne to use their Autonomie full-vehicle simulation system to estimate the fuel economy impacts for roughly a million combinations of technologies and vehicle types.^{51 52}

⁴⁷ While this rulemaking employed the CAFE model for analysis, EPA and DOT used different versions of the CAFE model for establishing their respective standards, and EPA also used the EPA MOVES model. See 81 FR 73478, 73743 (Oct. 25, 2016).

⁴⁸ Docket No. NHTSA–2018–0067.

⁴⁹ See https://www.eia.gov/outlooks/aeo/info/nems_archive.php. Today's notice uses fuel prices estimated using the Annual Energy Outlook (AEO) 2017 version of NEMS (see <https://www.eia.gov/outlooks/archive/aeo17/> and <https://www.eia.gov/outlooks/aeo/data/browser/#/?id=3-AEO2017&cases=ref2017&sourcekey=0>).

⁵⁰ Information regarding GREET is available at <https://greet.es.anl.gov/index.php>. Availability of NEMS is discussed at https://www.eia.gov/outlooks/aeo/info/nems_archive.php. Today's notice uses fuel prices estimated using the AEO 2017 version of NEMS.

⁵¹ As part of the Argonne simulation effort, individual technology combinations simulated in Autonomie were paired with Argonne's BatPAC

EPA developed two models after 2009, referred to as the "ALPHA" and "OMEGA" models, which provide some of the same capabilities as the Autonomie and CAFE models. EPA applied the OMEGA model to conduct analysis of GHG standards promulgated in 2010 and 2012, and the ALPHA and OMEGA models to conduct analysis discussed in the above-mentioned 2016 Draft TAR and Proposed and Final Determinations regarding standards beyond 2021. In an August 2017 notice, the agencies requested comments on, among other things, whether EPA should use alternative methodologies and modeling, including DOE/Argonne's Autonomie full-vehicle simulation tool and DOT's CAFE model.⁵³

Having reviewed comments on the subject and having considered the matter fully, the agencies have determined it is reasonable and appropriate to use DOE/Argonne's model for full-vehicle simulation, and to use DOT's CAFE model for analysis of regulatory alternatives. EPA interprets Section 202(a) of the CAA as giving the agency broad discretion in how it develops and sets GHG standards for light-duty vehicles. Nothing in Section 202(a) mandates that EPA use any specific model or set of models for analysis of potential CO₂ standards for light-duty vehicles. EPA weighs many factors when determining appropriate levels for CO₂ standards, including the cost of compliance (see Section 202(a)(2)), lead time necessary for compliance (also Section 202(a)(2)), safety (see *NRDC v. EPA*, 655 F.2d 318, 336 n. 31 (D.C. Cir. 1981) and other impacts on consumers,⁵⁴ and energy impacts associated with use of the technology.⁵⁵ Using the CAFE model

model to estimate the battery cost associated with each technology combination based on characteristics of the simulated vehicle and its level of electrification. Information regarding Argonne's BatPAC model is available at <http://www.cse.anl.gov/batpac/>.

⁵² Additionally, the impact of engine technologies on fuel consumption, torque, and other metrics was characterized using GT POWER simulation modeling in combination with other engine modeling that was conducted by IAV Automotive Engineering, Inc. (IAV). The engine characterization "maps" resulting from this analysis were used as inputs for the Autonomie full-vehicle simulation modeling. Information regarding GT Power is available at <https://www.gtisoft.com/gt-suite-applications/propulsion-systems/gt-power-engine-simulation-software>.

⁵³ 82 FR 39533 (Aug. 21, 2017).

⁵⁴ Since its earliest Title II regulations, EPA has considered the safety of pollution control technologies. See 45 FR 14496, 14503 (1980).

⁵⁵ See *George E. Warren Corp. v. EPA*, 159 F.3d 616, 623–624 (D.C. Cir. 1998) (ordinarily permissible for EPA to consider factors not specifically enumerated in the Act).

allows consideration of the following factors: the CAFE model explicitly evaluates the cost of compliance for each manufacturer, each fleet, and each model year; it accounts for lead time necessary for compliance by directly incorporating estimated manufacturer production cycles for every vehicle in the fleet, ensuring that the analysis does not assume vehicles can be redesigned to incorporate more technology without regard to lead time considerations; it provides information on safety effects associated with different levels of standards and information about many other impacts on consumers, and it calculates energy impacts (*i.e.*, fuel saved or consumed) as a primary function, besides being capable of providing information about many other factors within EPA's broad CAA discretion to consider.

Because the CAFE model simulates a wide range of actual constraints and practices related to automotive engineering, planning, and production, such as common vehicle platforms, sharing of engines among different vehicle models, and timing of major vehicle redesigns, the analysis produced by the CAFE model provides a transparent and realistic basis to show pathways manufacturers could follow over time in applying new technologies, which helps better assess impacts of potential future standards. Furthermore, because the CAFE model also accounts fully for regulatory compliance provisions (now including CO₂ compliance provisions), such as adjustments for reduced refrigerant leakage, production "multipliers" for some specific types of vehicles (*e.g.*, PHEVs), and carried-forward (*i.e.*, banked) credits, the CAFE model provides a transparent and realistic basis to estimate how such technologies might be applied over time in response to CAFE or CO₂ standards.

There are sound reasons for the agencies to use the CAFE model going forward in this rulemaking. First, the CAFE and CO₂ fact analyses are inextricably linked. Furthermore, the analysis produced by the CAFE model and DOE/Argonne's Autonomie addresses several analytical needs. The CAFE model provides an explicit year-by-year simulation of manufacturers' application of technology to their products in response to a year-by-year progression of CAFE standards and accounts for sharing of technologies and the implications for timing, scope, and limits on the potential to optimize powertrains for fuel economy. In the real world, standards actually are specified on a year-by-year basis, not simply some single year well into the

future, and manufacturers' year-by-year plans involve some vehicles "carrying forward" technology from prior model years and some other vehicles possibly applying "extra" technology in anticipation of standards in ensuing model years, and manufacturers' planning also involves applying credits carried forward between model years. Furthermore, manufacturers cannot optimize the powertrain for fuel economy on every vehicle model configuration—for example, a given engine shared among multiple vehicle models cannot practicably be split into different versions for each configuration of each model, each with a slightly different displacement. The CAFE model is designed to account for these real-world factors.

Considering the technological heterogeneity of manufacturers' current product offerings, and the wide range of ways in which the many fuel economy-improving/CO₂ emissions-reducing technologies included in the analysis can be combined, the CAFE model has been designed to use inputs that provide an estimate of the fuel economy achieved for many tens of thousands of different potential combinations of fuel-saving technologies. Across the range of technology classes encompassed by the analysis fleet, today's analysis involves more than a million such estimates. While the CAFE model requires no specific approach to developing these inputs, the National Academy of Sciences (NAS) has recommended, and stakeholders have commented, that full-vehicle simulation provides the best balance between realism and practicality. DOE/Argonne has spent several years developing, applying, and expanding means to use distributed computing to exercise its Autonomie full-vehicle simulation tool over the scale necessary for realistic analysis of CAFE or average CO₂ standards. This scalability and related flexibility (in terms of expanding the set of technologies to be simulated) makes Autonomie well-suited for developing inputs to the CAFE model.

Additionally, DOE/Argonne's Autonomie also has a long history of development and widespread application by a much wider range of users in government, academia, and industry. Many of these users apply Autonomie to inform funding and design decisions. These real-world exercises have contributed significantly to aspects of Autonomie important to producing realistic estimates of fuel economy levels and CO₂ emission rates, such as estimation and consideration of performance, utility, and driveability metrics (*e.g.*, towing capability, shift

business, frequency of engine on/off transitions). This steadily increasing realism has, in turn, steadily increased confidence in the appropriateness of using Autonomie to make significant investment decisions. Notably, DOE uses Autonomie for analysis supporting budget priorities and plans for programs managed by its Vehicle Technologies Office (VTO). Considering the advantages of DOE/Argonne's Autonomie model, it is reasonable and appropriate to use Autonomie to estimate fuel economy levels and CO₂ emission rates for different combinations of technologies as applied to different types of vehicles.

Commenters have also suggested that the CAFE model's graphical user interface (GUI) facilitates others' ability to use the model quickly—and without specialized knowledge or training—and to comment accordingly.⁵⁶ For today's proposal, DOT has significantly expanded and refined this GUI, providing the ability to observe the model's real-time progress much more closely as it simulates year-by-year compliance with either CAFE or CO₂ standards.⁵⁷ Although the model's ability to produce realistic results is independent of the model's GUI, it is anticipated the CAFE model's GUI will facilitate stakeholders' meaningful review and comment during the comment period.

Beyond these general considerations, several specific related technical comments and considerations underlie the agencies' decision in this area, as discussed, where applicable, in the remainder of this Section.

Other commenters expressed a number of concerns with whether DOT's CAFE model could be used for CAA analysis. Many of these concerns focused on inputs used by the CAFE model for prior rulemaking analyses.^{58 59 60} Because inputs are

⁵⁶ From Docket Number EPA-HQ-OAR-2015-0827, see Comment by Global Automakers, Docket ID EPA-HQ-OAR-2015-0827-9728, at 34.

⁵⁷ The updated GUI provides a range of graphs updated in real time as the model operates. These graphs can be used to monitor fuel economy or CO₂ ratings of vehicles in manufacturers' fleets and to monitor year-by-year CAFE (or average CO₂ ratings), costs, avoided fuel outlays, and avoided CO₂-related damages for specific manufacturers and/or specific fleets (*e.g.*, domestic passenger car, light truck). Because these graphs update as the model progresses, they should greatly increase users' understanding of the model's approach to considerations such as multiyear planning, payment of civil penalties, and credit use.

⁵⁸ For example, EDF's recent comments (EDF at 12, Docket ID. EPA-HQ-OAR-2015-0827-9203) stated "the data that NHTSA needs to input into its model is sensitive confidential business information that is not transparent and cannot be independently verified . . ." and claimed "the

exogenous to any model, they do not determine whether it would be reasonable and appropriate for EPA to use DOT's model for analysis. Other concerns focused on characteristics of the CAFE model that were developed to better align the model with EPCA and EISA; the model has been revised to accommodate both EPCA/EISA and CAA analysis, as explained further below. Some commenters also argued that use of any models other than ALPHA and OMEGA for CAA analysis would constitute an arbitrary and capricious delegation of EPA's decision-making authority to DOT, if DOT models are used for analysis instead. These comments were made prior to the development of the CAA analysis function in the CAFE model, and, moreover, appear to conflate the analytical tool used to inform decision-making with the action of making the decision. As explained elsewhere in this document and as made repeatedly clear over the past several rulemakings, the CAFE model neither sets standards nor dictates where and how to set standards; it simply informs as to the effects of setting different levels of standards. In this rulemaking, EPA will be making its own decisions regarding what CO₂ standards would be appropriate under the CAA. The CAA does not require EPA to create a specific model or use a specific model of its own creation in setting GHG standards. The fact EPA's

OMEGA model's focus on direct technological inputs and costs—as opposed to industry self-reported data—ensures the model more accurately characterizes the true feasibility and cost effectiveness of deploying greenhouse gas reducing technologies.” Neither statement is correct, as nothing about either the CAFE or OMEGA model either obviates or necessitates the use of CBI to develop inputs.

⁵⁹ In recent comments (CARB at 28, Docket ID. EPA-HQ-OAR-2015-0827-9197), CARB stated “another promising technology entering the market was not even included in the NHTSA compliance modeling” and that EPA assumes a five-year redesign cycle, whereas NHTSA assumes a six to seven-year cycle.” Though presented as criticisms of the models, these comments—at least with respect to the CAFE model—actually concern model *inputs*. NHTSA did not agree with CARB about the commercialization potential of the engine technology in question (“Atkinson 2”) and applied model *inputs* accordingly. Also, rather than applying a one-size-fits-all assumption regarding redesign cadence, NHTSA developed estimates specific to each vehicle model and applied these as model *inputs*.

⁶⁰ NRDC's recent comments (NRDC at 37, Docket ID. EPA-HQ-OAR-2015-0827-9826) state EPA should not use the CAFE model because it “allows manufacturers to pay civil penalties in lieu of meeting the standards, an alternative compliance pathway currently allowed under EISA and EPCA.” While the CAFE model can simulate civil penalty payment, NRDC's comment appears to overlook the fact that this result depends on model *inputs*; the inputs can easily be specified such that the CAFE model will set aside civil penalty payment as an alternative to compliance.

decision may be informed by non-EPA-created models does not, in any way, constitute a delegation of its statutory power to set standards or decision-making authority.⁶¹ Arguing to the contrary would suggest, for example, that EPA's decision would be invalid because it relied on EIA's Annual Energy Outlook for fuel prices rather than developing its own model for estimating future trends in fuel prices. Yet, all Federal agencies that have occasion to use forecasts of future fuel prices regularly (and appropriately) defer to EIA's expertise in this area and rely on EIA's NEMS-based analysis in the AEO, even when those same agencies are using EIA's forecasts to inform their own decision-making.

Moreover, DOT's CAFE model with inputs from DOE/Argonne's Autonomie model has produced analysis supporting rulemaking under the CAA. In 2015, EPA proposed new GHG standards for MY 2021–2027 heavy-duty pickups and vans, finalizing standards in 2016. Supporting the NPRM and final rule, EPA relied on analysis implemented by DOT using DOT's CAFE model, and DOT used inputs developed by DOE/Argonne using DOE/Argonne's Autonomie model.

The following sections provide a brief technical overview of the CAFE model, including changes NHTSA made to the model since 2012, before discussing inputs to the model and then diving more deeply into how the model works. For more information on the latter topic, see the CAFE model documentation July 2018 draft, available in the docket for this rulemaking and on NHTSA's website.

1. Brief Technical Overview of the Model

The CAFE model is designed to simulate compliance with a given set of CAFE or CO₂ standards for each manufacturer selling vehicles in the United States. The model begins with a representation of the current (for today's analysis, model year 2016) vehicle model offerings for each manufacturer

⁶¹ “[A] federal agency may turn to an outside entity for advice and policy recommendations, provided the agency makes the final decisions itself.” *U.S. Telecom. Ass'n v. FCC*, 359 F.3d 554, 565–66 (D.C. Cir. 2004). To the extent commenters meant to suggest outside parties have a reliance interest in EPA using ALPHA and OMEGA to set standards, EPA does not agree a reliance interest is properly placed on an analytical methodology (as opposed to on the standards themselves). Even if it were, all parties that closely examined ALPHA and OMEGA-based analyses in the past either also simultaneously closely examined CAFE and Autonomie-based analyses in the past, or were fully capable of doing so, and thus, should face no additional difficulty now they have only one set of models and inputs/outputs to examine.

that includes the specific engines and transmissions on each model variant, observed sales volumes, and all fuel economy improvement technology that is already present on those vehicles. From there it adds technology, in response to the standards being considered, in a way that minimizes the cost of compliance and reflects many real-world constraints faced by automobile manufacturers. After simulating compliance, the model calculates impacts of the simulated standard: technology costs, fuel savings (both in gallons and dollars), CO₂ reductions, social costs and benefits, and safety impacts.

Today's analysis reflects several changes made to the CAFE model since 2012, when NHTSA used the model to estimate the effects, costs, and benefits of final CAFE standards for light-duty vehicles produced during MYs 2017–2021 and augural standards for MYs 2022–2025. Key changes relevant to this analysis include the following:

- Expansion of model inputs, procedures, and outputs to accommodate technologies not included in prior analyses,
- Updated approach to estimating the combined effect of fuel-saving technologies using large scale simulation modeling,
- Modules that dynamically estimate new vehicle sales and existing vehicle scrappage in response to changes to new vehicle prices that result from manufacturers' compliance actions,
- A safety module that estimates the changes in light-duty traffic fatalities resulting from changes to vehicle exposure, vehicle retirement rates, and reductions in vehicle mass to improve fuel economy,
- Disaggregation of each manufacturer's fleet into separate “domestic” passenger car and “import” passenger car fleets to better represent the statutory requirements of the CAFE program,
- Changes to the algorithm used to apply technologies, enabling more explicit accounting of shared vehicle components (engines, transmissions, platforms) and “inheritance” of major technology within or across powertrains and/or platforms over time,
- An industry labor quantity module, which estimates net changes in the amount of U.S. automobile labor for dealerships, Tier 1 and 2 supplier companies, and original equipment manufacturers (OEMs),
- Cost estimation of batteries for electrification technologies incorporates an updated version of Argonne National Laboratory's BatPAC (battery) model for hybrid electric vehicles (HEVs), plug-in

hybrid electric vehicles (PHEVs), and battery electric vehicles (BEVs), consistent with how we estimate effectiveness for those values,

- Expanded accounting for CAFE credits carried over from years prior to those included in the analysis (a.k.a. “banked” credits) and application to future CAFE deficits to better evaluate anticipated manufacturer responses to proposed standards.⁶²
- The ability to represent a manufacturer’s preference for fine payment (rather than achieving full compliance exclusively through fuel economy improvements) on a year-by-year basis,
- Year-by-year simulation of how manufacturers could comply with EPA’s CO₂ standards, including
 - Calculation of vehicle models’ CO₂ emission rates before and after application of fuel-saving (and, therefore, CO₂-reducing) technologies,
 - Calculation of manufacturers’ fleet average CO₂ emission rates,
 - Calculation of manufacturers’ fleet average CO₂ emission rates under attribute-based CO₂ standards,
 - Accounting for adjustments to average CO₂ emission rates reflecting reduction of air conditioner refrigerant leakage,
 - Accounting for the treatment of alternative fuel vehicles for CO₂ compliance,
 - Accounting for production “multipliers” for PHEVs, BEVs, compressed natural gas (CNG) vehicles, and fuel cell vehicles (FCVs),
 - Accounting for transfer of CO₂ credits between regulated fleets,
 - Accounting for carried-forward (a.k.a. “banked”) CO₂ credits, including credits from model years earlier than modeled explicitly.

2. Sensitivity Cases and Why We Examine Them

Today’s notice presents estimated impacts of the proposed CAFE and CO₂ standards defining the proposals, relative to a baseline “no action” regulatory alternative under which the standards announced in 2012 remain in place through MY 2025 and continue unchanged thereafter. Relative to this same baseline, today’s notice also presents analysis estimating impacts under a range of other regulatory

alternatives the agencies are considering. All but one involve different standards, and three involve a gradual discontinuation of CAFE and GHG adjustments reflecting the application of technologies that improve air conditioner efficiency or, in other ways, improve fuel economy under conditions not represented by long-standing fuel economy test procedures. Like the baseline no action alternative, all of these alternatives are more stringent than the preferred alternative. Section III and Section IV describe the preferred and other regulatory alternatives, respectively.

These alternatives were examined because they will be considered as options for the final rule. The agencies seek comment on these alternatives, seek any relevant data and information, and will review responses. That review could lead to the selection of one of the other regulatory alternatives for the final rule or some combination of the other regulatory alternatives (*e.g.*, combining passenger cars standards from one alternative with light truck standards from a different alternative).

Because outputs depend on inputs (*e.g.*, the results of the analysis in terms of quantities and kinds of technologies required to meet different levels of standards, and the societal and private benefits associated with manufacturers meeting different levels of standards depend on input data, estimates, and assumptions), the analysis also explores the sensitivity of results to many of these inputs. For example, the net benefits of any regulatory alternative will depend strongly on fuel prices well beyond 2025. Fuel prices a decade and more from now are not knowable with certainty. The sensitivity analysis involves repeating the “central” or “reference case” analysis under alternative inputs (*e.g.*, higher fuel prices in one case, lower fuel prices in another case), and exploring changes in analytical results, which is discussed further in the agencies’ Preliminary Regulatory Impact Analysis (PRIA) accompanying today’s notice.

B. Developing the Analysis Fleet for Assessing Costs, Benefits, and Effects of Alternative CAFE Standards

The following sections describe what the analysis fleet is and why it is used, how it was developed for this NPRM, and the analysis-fleet-related topics on which comment is sought.

1. Purpose of Developing and Using an Analysis Fleet

The starting point for the evaluation of the potential feasibility of different stringency levels for future CAFE and

CO₂ standards is the analysis fleet, which is a snapshot of the recent vehicle market. The analysis fleet provides a snapshot to project what vehicles will exist in future model years covered by the standards and what technologies they will have, and then evaluate what additional technologies can feasibly be applied to those vehicles in a cost-effective way to raise their fuel economy and lower their CO₂ emission levels.⁶³

Part of reflecting what vehicles will exist in future model years is knowing which vehicles are produced by which manufacturers, how many of each are sold, and whether they are passenger cars or light trucks. This is important because it improves our understanding of the overall impacts of different levels of CAFE and CO₂ standards; overall impacts result from industry’s response to standards, and industry’s response is made up of individual manufacturer responses to the standards in light of the overall market and their individual assessment of consumer acceptance. Having an accurate picture of manufacturers’ existing fleets (and the vehicle models in them) that will be subject to future standards helps us better understand individual manufacturer responses to those future standards in addition to potential changes in those standards.

Another part of reflecting what vehicles will exist in future model years is knowing what technologies are already on those vehicles. Accounting for technologies already being on vehicles helps avoid “double-counting” the value of those technologies, by assuming they are still available to be applied to improve fuel economy and reduce CO₂ emissions. It also promotes more realistic determinations of what additional technologies can feasibly be applied to those vehicles: if a manufacturer has already started down a technological path to fuel economy or performance improvements, we do not assume it will completely abandon that path because that would be unrealistic and would not accurately represent manufacturer responses to standards. Each vehicle model (and configurations of each model) in the analysis fleet, therefore, has a comprehensive list of its technologies, which is important because different configurations may have different technologies applied to

⁶² While EPCA/EISA precludes NHTSA from considering manufacturers’ potential use of credits in model years for which the agency is establishing new standards, NHTSA considers credit use in earlier model years. Also, as allowed by NEPA, NHTSA’s EISs present results of analysis that considers manufacturers’ potential use of credits in all model years, including those for which the agency is establishing new standards.

⁶³ The CAFE model does not generate compliance paths a manufacturer should, must, or will deploy. It is intended as a tool to demonstrate a compliance pathway a manufacturer *could* choose. It is almost certain all manufacturers will make compliance choices differing from those projected in the CAFE model.

them.⁶⁴ Additionally, the analysis accounts for platforms within manufacturers' fleets, recognizing platforms will share technologies, and the vehicles that make up that platform should receive (or not receive) additional technological improvements together. The specific engineering characteristics of each model/configuration are available in the aforementioned input file.⁶⁵ For the regulatory alternatives considered in today's proposal, estimates of rates at which various technologies might be expected to penetrate manufacturers' fleets (and the overall market) are summarized below in Sections VI and VII, and in Chapter 6 of the accompanying PRIA and in detailed model output files available at NHTSA's website. A solid characterization of a recent model year as an analytical starting point helps to realistically estimate ways manufacturers could potentially respond to different levels of standards, and the modeling strives to realistically simulate how manufacturers could progress from that starting point. Nevertheless, manufacturers can respond in many ways beyond those represented in the analysis (*e.g.*, applying other technologies, shifting production volumes, changing vehicle footprint), such that it is impossible to predict with any certainty exactly how each manufacturer *will* respond. Therefore, recent trends in manufacturer performance and technology application, although of interest in terms of understanding manufacturers' current compliance positions, are not in themselves innately indicative of future potential.

Yet, another part of reflecting what vehicles will exist in future model years is having reasonable real-world assumptions about when certain technologies can be applied to vehicles. Each vehicle model/configuration in the analysis fleet also has information about its redesign schedule, *i.e.*, the last year it was redesigned and when the agencies expect it to be redesigned again. Redesign schedules are a key part of manufacturers' business plans, as each new product can cost more than \$1.0B and involve a significant portion of a manufacturer's scarce research,

⁶⁴ Considering each vehicle model/configuration also improves the ability to consider the differential impacts of different levels of potential standards on different manufacturers, since all vehicle model/configurations "start" at different places, in terms of the technologies they already have and how those technologies are used.

⁶⁵ Available with the model and other input files supporting today's announcement at <https://www.nhtsa.gov/corporate-average-fuel-economy/compliance-and-effects-modeling-system>.

development, and manufacturing and equipment budgets and resources.⁶⁶ Manufacturers have repeatedly told the agencies that sustainable business plans require careful management of resources and capital spending, and that the length of time each product remains in production is crucial to recouping the upfront product development and plant/equipment costs, as well as the capital needed to fund the development and manufacturing equipment needed for future products. Because the production volume of any given vehicle model varies within a manufacturer's product line and also varies among different manufacturers, redesign schedules typically vary for each model and manufacturer. Some (relatively few) technological improvements are small enough they can be applied in any model year; others are major enough they can only be cost-effectively applied at a vehicle redesign, when many other things about the vehicle are already changing. Ensuring the CAFE model makes technological improvements to vehicles only when it is feasible to do so also helps the analysis better represent manufacturer responses to different levels of standards.

A final important aspect of reflecting what vehicles will exist in future model years and potential manufacturer responses to standards is estimating how future sales might change in response to different potential standards. If potential future standards appear likely to have major effects in terms of shifting production from cars to trucks (or vice versa), or in terms of shifting sales between manufacturers or groups of manufacturers, that is important for the agencies to consider. For previous analyses, the CAFE model used a static forecast contained in the analysis fleet input file, which specified changes in production volumes over time for each vehicle model/configuration. This approach yielded results that, in terms of production volumes, did not change between scenarios or with changes in important model inputs. For example, very stringent standards with very high technology costs would result in the same estimated production volumes as less stringent standards with very low technology costs.

New for today's proposal, the CAFE model begins with the first-year production volumes (*i.e.*, MY 2016 for today's analysis) and adjusts ensuing sales mix year by year (between cars and

⁶⁶ Shea, T. *Why Does It Cost So Much For Automakers To Develop New Models?*, Autblog (Jul. 27, 2010), <https://www.autblog.com/2010/07/27/why-does-it-cost-so-much-for-automakers-to-develop-new-models/>.

trucks, and between manufacturers) endogenously as part of the analysis, rather than using external forecasts of future car/truck split and future manufacturer sales volumes. This leads the model to produce different estimates of future production volumes under different standards and in response to different inputs, reflecting the expectation that regulatory standards and other external factors will, in fact, impact the market.

The input file for the CAFE model characterizing the analysis fleet⁶⁷ includes a large amount of data about vehicle models/configurations, their technological characteristics, the manufacturers and fleets to which they belong, and initial prices and production volumes which provide the starting points for projection (by the sales model) to ensuing model years. The following sections discuss aspects of how the analysis fleet was built for this proposal and seek comment on those topics.

2. Source Data for Building the Analysis Fleet

The source data for the vehicle models/configurations in the analysis fleet and their technologies is a central input for the analysis. The sections below discuss pros and cons of different potential sources and what was used for this proposal.

(a) Use of Confidential Business Information Versus Publicly-Releasable Sources

Since 2001, CAFE analysis has used either confidential, forward-estimating product plans from manufacturers, or publicly available data on vehicles already sold, as a starting point for determining what technologies can be applied to what vehicles in response to potential different levels of standards. These two sources present a tradeoff. Confidential product plans comprehensively represent what vehicles a manufacturer expects to produce in coming years, accounting for plans to introduce new vehicles and fuel-saving technologies and, for example, plans to discontinue other vehicles and even brands. This information can be very thorough and can improve the accuracy of the analysis, but for competitive reasons, most of this information must be redacted prior to publication with rulemaking documentation. This makes it difficult for public commenters to reproduce the analysis for themselves as

⁶⁷ Available with the model and other input files supporting today's announcement at <https://www.nhtsa.gov/corporate-average-fuel-economy/compliance-and-effects-modeling-system>.

they develop their comments. Some non-industry commenters have also expressed concern manufacturers would have an incentive in the submitted plans to (deliberately or not) underestimate their future fuel economy capabilities and overstate their expectations about, for example, the levels of performance of future vehicle models in order to affect the analysis. Since 2010, EPA and NHTSA have based analysis fleets almost exclusively on information from commercial and public sources, starting with CAFE compliance data and adding information from other sources.

An analysis fleet based primarily on public sources can be released to the public, solving the issue of commenters being unable to reproduce the overall analysis when they want to. However, industry commenters have argued such an analysis fleet cannot accurately reflect manufacturers actual plans to apply fuel-saving technologies (e.g., manufacturers may apply turbocharging to improve not just fuel economy, but also to improve vehicle performance) or manufacturers' plans to change product offerings by introducing some vehicles and brands and discontinuing other vehicles and brands, precisely because that information is typically confidential business information (CBI). A fully-publicly-releasable analysis fleet holds vehicle characteristics unchanged over time and arguably lacks some level of accuracy when projected into the future. For example, over time, manufacturers introduce new products and even entire brands. On the other hand, plans announced in press releases do not always ultimately bear out, nor do commercially-available third-party forecasts. Assumptions could be made about these issues to improve the accuracy of a publicly-releasable analysis fleet, but concerns include that this information would either be largely incorrect, or information would be released that manufacturers would consider CBI. We seek comment on how to address this issue going forward, recognizing the competing interests involved and also recognizing typical timeframes for CAFE and CO₂ standards rulemakings.

(b) Use of MY 2016 CAFE Compliance Data Versus Other Starting Points

Based on the assumption that a publicly-available analysis fleet continues to be desirable, for this NPRM, an analysis fleet was constructed starting with CAFE compliance

information from manufacturers.⁶⁸ Information from MY 2016 was chosen as the foundation for today's analysis fleet because, at the time the rulemaking analysis was initiated, the 2016 fleet represented the most up-to-date information available in terms of individual vehicle models and configurations, production technology levels, and production volumes. If MY 2017 data had been used while this analysis was being developed, the agencies would have needed to use product planning information that could not be made available to the public until a later date.

The analysis fleet was initially developed with 2016 mid-model year compliance data because final compliance data was not available at that time, and the timing provided manufacturers the opportunity to review and comment on the characterization of their vehicles in the fleet. With a view toward developing an accurate characterization of the 2016 fleet to serve as an analytical starting point, corrections and updates to mid-year data (e.g., to production estimates) were sought, in addition to corroboration or correction of technical information obtained from commercial and other sources (to the extent that information was not included in compliance data), although future product planning information from manufacturers (e.g., future product offerings, products to be discontinued) was not requested, as most manufacturers view such information as CBI. Manufacturers offered a range of corrections to indicate engineering characteristics (e.g., footprint, curb weight, transmission type) of specific vehicle model/configurations, as well as updates to fuel economy and production volume estimates in mid-year reporting. After following up on a case-by-case basis to investigate significant differences, the analysis fleet was updated.

Sales, footprint, and fuel economy values with final compliance data were also updated if that data was available. In a few cases, final production and fuel economy values may be slightly different for specific model year 2016 vehicle models and configurations than are indicated in today's analysis; however, other vehicle characteristics (e.g., footprint, curb weight, technology content) important to the analysis should be accurate. While some commenters have, in the past, raised concerns that non-final CAFE compliance data is subject to change,

the potential for change is likely not significant enough to merit using final data from an earlier model year reflecting a more outdated fleet. Moreover, even ostensibly final CAFE compliance data can sometimes be subject to later revision (e.g., if errors in fuel economy tests are discovered), and the purpose of today's analysis is not to support enforcement actions but rather to provide a realistic assessment of manufacturers' potential responses to future standards.

Manufacturers integrated a significant amount of new technology in the MY 2016 fleet, and this was especially true for newly-designed vehicles launched in MY 2016. While subsequent fleets will involve even further application of technology, using available data for MY 2016 provides the most realistic detailed foundation for analysis that can be made available publicly in full detail, allowing stakeholders to independently reproduce the analysis presented in this proposal. Insofar as future product offerings are likely to be more similar to vehicles produced in 2016 than to vehicles produced in earlier model years, using available data regarding the 2016 model year provides the most realistic, publicly releasable foundation for constructing a forecast of the future vehicle market for this proposal.

A number of comments to the Draft TAR, EPA's Proposed Determination, and EPA's 2017 Request for Comment⁶⁹ stated that the most up-to-date analysis fleet possible should be used, because a more up-to-date analysis fleet will better capture how manufacturers apply technology and will account better for vehicle model/configuration introductions and deletions.⁷⁰ On the other hand, some commenters suggested that because manufacturers continue improving vehicle performance and utility over time, an older analysis fleet should be used to estimate how the fleet could have evolved had manufacturers applied all technological potential to

⁶⁹ 82 FR 39551 (Aug. 21, 2017).

⁷⁰ For example, in 2016 comments to dockets EPA-HQ-OAR-2015-0827 and NHTSA-2016-0068, the Alliance of Automobile Manufacturers commented that "the Alliance supports the use of the most recent data available in establishing the baseline fleet, and therefore believes that NHTSA's selection [of, at the time, model year 2015] was more appropriate for the Draft TAR." (Alliance at 82, Docket ID. EPA-HQ-OAR-2015-0827-4089) Global Automakers commented that "a one-year difference constitutes a technology change-over for up to 20% of a manufacturer's fleet. It was also generally understood by industry and the agencies that several new, and potentially significant, technologies would be implemented in MY 2015. The use of an older, outdated baseline can have significant impacts on the modeling of subsequent Reference Case and Control Case technologies." (Global Automakers at A-10, Docket ID. EPA-HQ-OAR-2015-0827-4009).

⁶⁸ CO₂ emissions rates are directly related to fuel economy levels, and the CAFE model uses the latter to calculate the former.

fuel economy rather than continuing to improve vehicle performance and utility.⁷¹ Because manufacturers change and improve product offerings over time, conducting analysis with an older analysis fleet (or with a fleet using fuel economy levels and CO₂ emissions rates that have been adjusted to reflect an assumed return to levels of performance and utility typical of some past model year) would miss this real-world trend. While such an analysis could demonstrate what industry *could* do if, for example, manufacturers devoted all technological improvements toward raising fuel economy and reducing CO₂ emissions (and if consumers decided to purchase these vehicles), we do not believe it would be consistent with a transparent examination of what effects different levels of standards would have on individual manufacturers and the fleet as a whole.

Generally, all else being equal, using a newer analysis fleet will produce more realistic estimates of impacts of potential new standards than using an outdated analysis fleet. However, among relatively current options, a balance must be struck between, on one hand, inputs' freshness, and on the other, inputs' completeness and accuracy.⁷² During assembly of the inputs for today's analysis, final compliance data was available for the MY 2015 model year but not in a few cases for MY 2016. However, between mid-year compliance information and manufacturers' specific updates discussed above, a robust and detailed characterization of the MY 2016 fleet was developed. However, while information continued to develop regarding the MY 2017 and, to a lesser extent MY 2018 and even MY 2019 fleets, this information was—even in mid-2017—too incomplete and inconsistent to be assembled with

⁷¹ For example, in 2016 comments to dockets EPA-HQ-OAR-2015-0827 and NHTSA-2016-0068, UCS stated “in modeling technology effectiveness and use, the agencies should use 2010 levels of performance as the baseline.” (UCS at 4, Docket ID. EPA-HQ-OAR-2015-0827-4016).

⁷² Comments provided through a recent peer review of the CAFE model recognize the need for this balance. For example, referring to NHTSA's 2016 analysis documented in the draft TAR, one of the peer reviewers commented as follows: “The NHTSA decision to use MY 2015 data is wise. In the TAR they point out that a MY 2016 foundation would require the use of confidential data, which is less desirable. Clearly they would also have a qualitative vision of the MY 2016 landscape while employing MY 2015 as a foundation. Although MY 2015 data may still be subject to minor revision, this is unlikely to impact the predictive ability of the model A more complex alternative approach might be to employ some 2016 changes in technology, and attempt a blend of MY 2015 and MY 2016, while relying of estimation gained from only MY 2015 for sales. This approach may add some relevancy in terms of technology, but might introduce substantial error in terms of sales.”

confidence into an analysis fleet for modeling supporting deliberations regarding today's proposal.

In short, the 2016 fleet was, in fact, the most up-to-date fleet that could be produced for this NPRM. Moreover, during late 2016 and early 2017, nearly all manufacturers provided comments on the characterization of their vehicles in the analysis fleet, and many provided specific feedback about their vehicles, including aerodynamic drag coefficients, tire rolling resistance values, transmission efficiencies, and other information used in the analysis. NHTSA worked with manufacturers to clarify and correct some information and integrated the information into a single input file for use in the CAFE model. Accordingly, the current analysis fleet is reasonable to use for purposes of the NPRM analysis.

As always, however, ways to improve the analysis fleet used for subsequent modeling to evaluate potential new CAFE and CO₂ standards will undergo continuous consideration. As described above, the compliance data is only the starting point for developing the analysis fleet; much additional information comes directly from manufacturers (such as details about technologies, platforms, engines, transmissions, and other vehicle information, that may not be present in compliance data), and other information must come from commercial and public sources (for example, fleet-wide information like market share, because individual manufacturers do not provide this kind of information). If newer compliance data (*i.e.*, MY 2017) becomes available and can be analyzed during the pendency of this rulemaking, and if all of the other necessary steps can be performed, the analysis fleet will be updated, as feasible, and made publicly available. The agencies seek comment on the option used today and any other options, as well as on the tradeoffs between, on one hand, fidelity with manufacturers' actual plans and, on the other, the ability to make detailed analysis inputs and outputs publicly available.

(c) Observed Technology Content of 2016 Fleet

As explained above, the analysis fleet is defined not only by the vehicle models/configurations it contains but also by the technologies on those vehicles. Each vehicle model/configuration in the analysis fleet has an associated list of observed technologies and equipment that can improve fuel

economy and reduce CO₂ emissions.⁷³ With a portfolio of descriptive technologies arranged by manufacturer and model, the analysis fleet can be summarized and project how vehicles in that fleet may improve over time via the application of additional technology.

In many cases, vehicle technology is clearly observable from the 2016 compliance data (*e.g.*, compliance data indicates clearly which vehicles have turbochargers and which have continuously variable transmissions), but in some cases technology levels are less observable. For the latter, like levels of mass reduction, the analysis categorized levels of technology already used in a given vehicle. Similarly, engineering judgment was used to determine if higher mass reduction levels may be used practicably and safely in a given vehicle.

Either in mid-year compliance data for MY 2016 or, separately and at the agencies' invitation (as discussed above), most manufacturers identified most of the technology already present in each of their MY 2016 vehicle model/configurations. This information was not as complete for all manufacturers' products as needed for today's analysis, so in some cases, information was supplemented with publicly available data, typically from manufacturer media sites. In limited cases, manufacturers did not supply information, and information from commercial and publicly available sources was used.

(d) Mapping Technology Content of 2016 Fleet to Argonne Technology Effectiveness Simulation Work

While each vehicle model/configuration in the analysis fleet has its list of observed technologies and equipment, the ways in which manufacturers apply technologies and equipment do not always coincide perfectly with how the analysis characterizes the various technologies that improve fuel economy and reduce CO₂ emissions. To improve how the observed vehicle fleet “fits into” the analysis, each vehicle model/configuration is “mapped” to the full-

⁷³ These technologies are generally grouped into the following categories: Vehicle technologies include mass reduction, aerodynamic drag reduction, low rolling resistance tires, and others. Engine technologies include engine attributes describing fuel type, engine aspiration, valvetrain configuration, compression ratio, number of cylinders, size of displacement, and others. Transmission technologies include different transmission arrangements like manual, 6-speed automatic, 8-speed automatic, continuously variable transmission, and dual-clutch transmissions. Hybrid and electric powertrains may complement traditional engine and transmission designs or replace them entirely.

vehicle simulation modeling⁷⁴ by Argonne National Laboratory that is used to estimate the effectiveness of the fuel economy-improving/CO₂ emissions-reducing technologies considered. Argonne produces full-vehicle simulation modeling for many combinations of technologies, on many types of vehicles, but it did not simulate literally every single vehicle model/configuration in the analysis fleet because it would be impractical to assemble the requisite detailed information—much of which would likely only be provided on a confidential basis—specific to each vehicle model/configuration and because the scale of the simulation effort would correspondingly increase by at least two orders of magnitude.

⁷⁴ Full-vehicle simulation modeling uses software and physics models to compute and estimate energy use of a vehicle during explicit driving conditions. Section II.D below contains more information on the Argonne work for this analysis.

Instead, Argonne simulated 10 different vehicle types, corresponding to the “technology classes” generally used in CAFE analysis over the past several rulemakings (e.g., small car, small performance car, pickup truck, etc.). Each of those 10 different vehicle types was assigned a set of “baseline characteristics,” to which Argonne added combinations of fuel-saving technologies and then ran simulations to determine the fuel economy achieved when applying each combination of technologies to that vehicle type given its baseline characteristics. These inputs, discussed at greater length in Sections II.D and II.G, provide the basis for the CAFE model’s estimation of fuel economy levels and CO₂ emission rates.

In the analysis fleet, inputs assign each specific vehicle model/configuration to a technology class, and once there, map to the simulation within that technology class most closely matching the combination of

observed technologies and equipment on that vehicle.⁷⁵ This mapping to a specific simulation result most closely representing a given vehicle model/configuration’s initial technology “state” enables the CAFE model to estimate the same vehicle model/configuration’s fuel economy after application of some other combination of technologies, leading to an alternative technology state.

BILLING CODE 4910-59-P

⁷⁵ Mapping vehicle model/configurations in the analysis fleet to Argonne simulations was generally straightforward, but occasionally the mapping was complicated by factors like a vehicle model/configuration being a great match for simulations within more than one technology class (in which case, the model/configuration was assigned to the technology class that it best matched), or when technologies on the model/configuration were difficult to observe directly (like friction reduction or parasitic loss characteristics of a transmission, in which case the agencies relied on manufacturer-reported data or CBI to help map the vehicle to a simulation).

Table II-1 - List of Technologies with Data Sources for Technology Assignments

Technology Name	Abbreviation	Data Source for Mapping	Tech Group
Single Overhead Cam	SOHC	Public Specifications	Basic Engines
Dual Overhead Cam	DOHC	Public Specifications	Basic Engines
Overhead Valve	OHV	Public Specifications	Basic Engines
Variable Valve Timing	VVT	Public Specifications	Basic Engines
Variable Valve Lift	VVL	Public Specifications	Basic Engines
Stoichiometric Gasoline Direct Injection	SGDI	Public Specifications	Basic Engines
Cylinder Deactivation	DEAC	Public Specifications	Basic Engines
Turbocharged Engine	TURBO1	Public Specifications	Advanced Engines
Advanced Turbocharged Engine	TURBO2	Manufacturer CBI	Advanced Engines
Turbocharged Engine with Cooled Exhaust Gas Recirculation	CEGR1	Manufacturer CBI	Advanced Engines
High Compression Ratio Engine	HCR1	Public Specifications	Advanced Engines
EPA High Compression Ratio Engine, with Cylinder Deactivation	HCR2	Not commercialized in MY 2016	Advanced Engines
Variable Compression Ratio Engine	VCR	Not commercialized in MY 2016	Advanced Engines
Advanced Cylinder Deactivation (Skip Fire)	ADEAC	Not commercialized in MY 2016	Advanced Engines
Advanced Diesel Engine	ADSL	Public Specifications	Advanced Engines
Advanced Diesel Engine Improvements	DSLII	Not commercialized in MY 2016	Advanced Engines
Compressed Natural Gas	CNG	Public Specifications	Advanced Engines
Manual Transmission - 5 Speed	MT5	Public Specifications	Transmissions
Manual Transmission - 6 Speed	MT6	Public Specifications	Transmissions
Manual Transmission - 7 Speed	MT7	Public Specifications	Transmissions
Automatic Transmission - 5 Speed	AT5	Public Specifications	Transmissions
Automatic Transmission - 6 Speed	AT6	Public Specifications	Transmissions
Automatic Transmission - 6 Speed with Efficiency Improvements	AT6L2	Manufacturer CBI	Transmissions
Automatic Transmission - 7 Speed	AT7	Public Specifications	Transmissions
Automatic Transmission - 8 Speed	AT8	Public Specifications	Transmissions

Automatic Transmission - 8 Speed with Efficiency Improvements	AT8L2	Manufacturer CBI	Transmissions
Automatic Transmission - 8 Speed with Maximum Efficiency Improvements	AT8L3	Not commercialized in MY 2016	Transmissions
Automatic Transmission - 9 Speed	AT9	Public Specifications	Transmissions
Automatic Transmission - 10 Speed	AT10	Public Specifications	Transmissions
Automatic Transmission - 10 Speed with Maximum Efficiency Improvements	AT10L2	Not commercialized in MY 2016	Transmissions
Dual Clutch Transmission - 6 Speed	DCT6	Public Specifications	Transmissions
Dual Clutch Transmission - 8 Speed	DCT8	Public Specifications	Transmissions
Continuously Variable Transmission	CVT	Public Specifications	Transmissions
Continuously Variable Transmission with Efficiency Improvements	CVTL2A / CVT2B	Manufacturer CBI	Transmissions
No Electrification Technologies (Baseline)	CONV	Public Specifications	Electrification
12V Start-Stop	SS12V	Public Specifications	Electrification
Belt Integrated Starter Generator	BISG	Public Specifications	Electrification
Crank Integrated Starter Generator	CISG	Public Specifications	Electrification
Strong Hybrid Electric Vehicle, Parallel	SHEVP2	Public Specifications	Electrification
Strong Hybrid Electric Vehicle, Power Split	SHEVPS	Public Specifications	Electrification
Plug-in Hybrid Vehicle with 30 miles of range	PHEV30	Public Specifications	Electrification
Plug-in Hybrid Vehicle with 50 miles of range	PHEV50	Public Specifications	Electrification
Battery Electric Vehicle with 200 miles of range	BEV200	Public Specifications	Electrification
Fuel Cell Vehicle	FCV	Public Specifications	Electrification
Baseline Tire Rolling Resistance	ROLL0	Manufacturer CBI	Rolling Resistance
Tire Rolling Resistance, 10% Improvement	ROLL10	Manufacturer CBI	Rolling Resistance
Tire Rolling Resistance, 20% Improvement	ROLL20	Manufacturer CBI	Rolling Resistance
Baseline Mass Reduction Technology	MR0	Public Specifications & Manufacturer CBI	Mass Reduction
Mass Reduction - 5% of Glider	MR1	Public Specifications & Manufacturer CBI	Mass Reduction

Mass Reduction - 7.5% of Glider	MR2	Public Specifications & Manufacturer CBI	Mass Reduction
Mass Reduction - 10% of Glider	MR3	Public Specifications & Manufacturer CBI	Mass Reduction
Mass Reduction - 15% of Glider	MR4	Public Specifications & Manufacturer CBI	Mass Reduction
Mass Reduction - 20% of Glider	MR5	Public Specifications & Manufacturer CBI	Mass Reduction
Baseline Aerodynamic Drag Technology	AERO0	Manufacturer CBI	Aerodynamic Drag
Aerodynamic Drag, 5% Drag Coefficient Reduction	AERO5	Manufacturer CBI	Aerodynamic Drag
Aerodynamic Drag, 10% Drag Coefficient Reduction	AERO10	Manufacturer CBI	Aerodynamic Drag
Aerodynamic Drag, 15% Drag Coefficient Reduction	AERO15	Manufacturer CBI	Aerodynamic Drag
Aerodynamic Drag, 20% Drag Coefficient Reduction	AERO20	Manufacturer CBI	Aerodynamic Drag
Electric Power Steering	EPS	Public Specifications	Additional Technologies
Improved Accessories	IACC	Manufacturer CBI	Additional Technologies
Low Drag Brakes	LDB	Manufacturer CBI	Additional Technologies
Secondary Axle Disconnect	SAX	Manufacturer CBI	Additional Technologies

BILLING CODE 4910-59-C

(e) Shared Vehicle Platforms, Engines, and Transmissions

Another aspect of characterizing vehicle model/configurations in the analysis fleet is based on whether they share a “platform” with other vehicle model/configurations. A “platform” refers to engineered underpinnings shared on several differentiated products. Manufacturers share and standardize components, systems, tooling, and assembly processes within their products (and occasionally with the products of another manufacturer) to cost-effectively maintain vibrant portfolios.⁷⁶

Vehicle model/configurations derived from the same platform are so identified in the analysis fleet. Many manufacturers’ use of vehicle platforms is well documented in the public record and widely recognized among the vehicle engineering community. Engineering knowledge, information from trade publications, and feedback from manufacturers and suppliers was also used to assign vehicle platforms in the analysis fleet.

When the CAFE model is deciding where and how to add technology to vehicles, if one vehicle on the platform receives new technology, other vehicles on the platform also receive the technology as part of their next major redesign or refresh.⁷⁷ Similar to vehicle platforms, manufacturers create engines that share parts.⁷⁸ One engine family

⁷⁶The concept of platform sharing has evolved with time. Years ago, manufacturers rebadged vehicles and offered luxury options only on premium nameplates (and manufacturers shared some vehicle platforms in limited cases). Today, manufacturers share parts across highly differentiated vehicles with different body styles, sizes, and capabilities that may share the same platform. For instance, the Honda Civic and Honda CR-V share many parts and are built on the same platform. Engineers design chassis platforms with the ability to vary wheelbase, ride height, and even driveline configuration. Assembly lines can produce hatchbacks and sedans to cost-effectively utilize manufacturing capacity and respond to shifts in market demand. Engines made on the same line may power small cars or mid-size sport utility vehicles. Additionally, although the agencies’ analysis, like past CAFE analyses, considers vehicles produced for sale in the U.S., the agency notes these platforms are not constrained to vehicle models built for sale in the United States; many manufacturers have developed, and use, global platforms, and the total number of platforms is decreasing across the industry. Several automakers (for example, General Motors and Ford) either plan to, or already have, reduced their number of platforms to less than 10 and account for the overwhelming majority of their production volumes on that small number of platforms.

⁷⁷The CAFE model assigns mass reduction technology at a platform level, but many other technologies may be assigned and shared at a vehicle nameplate or vehicle model level.

⁷⁸For instance, manufacturers may use different piston strokes on a common engine block or bore

may appear on many vehicles on a platform, and changes to that engine may or may not carry through to all the vehicles. Some engines are shared across a range of different vehicle platforms. Vehicle model/configurations in the analysis fleet that share engines belonging to the same platform are also identified as such.

It is important to note that manufacturers define common engines differently. Some manufacturers consider engines as “common” if the engines shared an architecture, components, or manufacturing processes. Other manufacturers take a narrower definition, and only assume “common” engines if the parts in the engine assembly are the same. In some cases, manufacturers designate each engine in each application as a unique powertrain.⁷⁹ Engine families for each manufacturer were tabulated and assigned⁸⁰ based on data-driven criteria. If engines shared a common cylinder count and configuration, displacement, valvetrain, and fuel type, those engines may have been considered together. Additionally, if the compression ratio, horsepower, and displacement of engines were only slightly different, those engines were considered to be the same for the purposes of redesign and sharing. Vehicles in the analysis fleet with the same engine family will therefore adopt engine technology in a coordinated fashion.⁸¹ By grouping engines together, the CAFE model controls future engine

out common engine block castings with different diameters to create engines with an array of displacements. Head assemblies for different displacement engines may share many components and manufacturing processes across the engine family. Manufacturers may finish crankshafts with the same tools, to similar tolerances. Engines on the same architecture may share pistons, connecting rods, and the same engine architecture may include both six and eight cylinder engines.

⁷⁹For instance, a manufacturer may have listed two engines for a pair that share designs for the engine block, the crank shaft, and the head because the accessory drive components, oil pans, and engine calibrations differ between the two. In practice, many engines share parts, tooling, and assembly resources, and manufacturers often coordinate design updates between two similar engines.

⁸⁰Engine family is referred to in the analysis as an “engine code.”

⁸¹Specifically, if such vehicles have different design schedules (*i.e.*, refresh and redesign schedules), and a subset of vehicles using a given engine add engine technologies in the course of a redesign or refresh that occurs in an early model year (*e.g.*, 2018), other vehicles using the same engine “inherit” these technologies at the soonest ensuing refresh or redesign. This is consistent with a view that, over time, most manufacturers are likely to find it more practicable to shift production to a new version of an engine than to indefinitely continue production of both the new engine and a “legacy” engine.

families to retain reasonable powertrain complexity.⁸²

Like with engines, manufacturers often use transmissions that are the same or similar on multiple vehicles.⁸³ To reflect this reality, shared transmissions were considered for manufacturers as appropriate. To define common transmissions, the agencies considered transmission type (manual, automatic, dual-clutch, continuously variable), number of gears, and vehicle architecture (front-wheel-drive, rear-wheel-drive, all-wheel-drive based on a front-wheel-drive platform, or all-wheel-drive based on a rear-wheel-drive platform). If vehicles shared these attributes, these transmissions were grouped for the analysis. Vehicles in the analysis fleet with the same transmission configuration⁸⁴ will adopt transmission technology together, as described above.⁸⁵

Having all vehicles that share a platform (or engines that are part of a family) adopt fuel economy-improving/CO₂ emissions-reducing technologies together, subject to refresh/redesign constraints, reflects the real-world considerations described above but also overlooks some decisions manufacturers might make in the real world in response to market pull, meaning that even though the analysis fleet is incredibly complex, it is also oversimplified in some respects compared to the real world. For example, the CAFE model does not currently attempt to simulate the potential for a manufacturer to shift the application of technologies to improve performance rather than fuel economy. Therefore, the model’s representation of the “inheritance” of technology can lead to estimates a manufacturer might eventually exceed fuel economy

⁸²This does mean, however, that for manufacturers that submitted highly atomized engine and transmission portfolios, there is a practical cap on powertrain complexity and the ability of the manufacturer to optimize the displacement of (*a.k.a.* “right size”) engines perfectly for each vehicle configuration.

⁸³Manufacturers may produce transmissions that have nominally different machining to castings, or manufacturers may produce transmissions that are internally identical, except for final output gear ratio. In some cases, manufacturers sub-contract with suppliers that deliver whole transmissions. In other cases, manufacturers form joint-ventures to develop shared transmissions, and these transmission platforms may be offered in many vehicles across manufacturers. Manufacturers use supplier and joint-venture transmissions to a greater extent than engines.

⁸⁴Transmission configurations are referred to in the analysis as “transmission codes.”

⁸⁵Similar to the inheritance approach outlined for engines, if one vehicle application of a shared transmission family upgraded the transmission, other vehicle applications also upgraded the transmission at the next refresh or redesign year.

standards as technology continues to propagate across shared platforms and engines. In the past, there were some examples of extended periods during which some manufacturers exceeded one or both of the CAFE and/or GHG standards, but in plenty of other examples, manufacturers chose to introduce (or even reintroduce) technological complexity into their vehicle lineups in response to buyer preferences. Going forward, and recognizing the recent trend for consolidating platforms, it seems likely manufacturers will be more likely to choose efficiency over complexity in this regard; therefore, the potential should be lower than today's analysis turns out to be over-simplified compared to the real world.

Options will be considered to further refine the representation of sharing and inheritance of technology, possibly including model revisions to account for tradeoffs between fuel economy and performance when applying technology. Please provide comments on the sharing and inheritance-related aspects of the analysis fleet and the CAFE model along with information that would support refinement of the current approach or development and implementation of alternative approaches.

(f) Estimated Product Design Cycles

Another aspect of characterizing vehicle model/configurations in the analysis fleet is based on when they can next be refreshed or redesigned. Redesign schedules play an important role in determining when new technologies may be applied. Many technologies that improve fuel economy and reduce CO₂ emissions may be difficult to incorporate without a major product redesign. Therefore, each vehicle model in the analysis fleet has an associated redesign schedule, and the CAFE model uses that schedule to restrict significant advances in some technologies (like major mass reduction) to redesign years, while allowing manufacturers to include minor advances (such as improved tire rolling resistance) during a vehicle "refresh," or a smaller update made to a vehicle, which can happen between redesigns.

In addition to refresh and redesign schedules associated with vehicle model/configurations, vehicles that share a platform subsequently have platform-wide refresh and redesign schedules for mass reduction technologies.

To develop the refresh/redesign cycles used for the MY 2016 vehicles in the analysis fleet, information from commercially available sources was used to project redesign cycles through MY 2022, as for NHTSA's analysis for the Draft TAR published in 2016.⁸⁶ Commercially available sources' estimates through MY 2022 are generally supported by detailed consideration of public announcements plus related intelligence from suppliers and other sources, and recognize that uncertainty increases considerably as the forecasting horizon is extended. For MYs 2023–2035, in recognition of that uncertainty, redesign schedules were extended considering past pacing for each product, estimated schedules through MY 2022, and schedules for other products in the same technology classes. As mentioned above, potentially confidential forward-looking information was not requested from manufacturers; nevertheless, all manufacturers had an opportunity to review the estimates of product-specific redesign schedules, a few manufacturers provided related forecasts and, for the most part, that information corroborated the estimates.

Some commenters suggested supplanting these estimated redesign schedules with estimates applying faster

⁸⁶ In some cases, data from commercially available sources was found to be incomplete or inconsistent with other available information. For instance, commercially available sources identified some newly imported vehicles as new platforms, but the international platform was midway through the product lifecycle. While new to the U.S. market, treating these vehicles as new entrants would have resulted in artificially short redesign cycles if carried forward, in some cases. Similarly, commercially available sources labeled some product refreshes as redesigns, and vice versa. In these limited cases, the data was revised to be consistent with other available information or typical redesign and refresh schedules, for the purpose of the CAFE modeling. In these limited cases, the forecast time between redesigns and refreshes was updated to match the observed past product timing.

cycles (e.g., four to five years), and this approach was considered for the analysis.⁸⁷ Some manufacturers tend to operate with faster redesign cycles and may continue to do so, and manufacturers tend to redesign some products more frequently than others. However, especially considering that information presented by manufacturers largely supports estimates discussed above, applying a "one size fits all" acceleration of redesign cycles would likely not improve the analysis; instead, doing so would likely reduce consistency with the real world, especially for light trucks. Moreover, if some manufacturers accelerate redesigns in response to new standards, doing so would likely involve costs (greater levels of stranded capital, reduced opportunity to benefit from "learning"-related cost reductions) greater than reflected in other inputs to the analysis. However, a wider range of technologies can practicably be applied during mid-cycle "freshenings" than has been represented by past analyses, and this part of the analysis has been expanded, as discussed below in Section II.D.⁸⁸ Also, in the sensitivity analysis supporting today's proposal and presented in Chapter 13 of the PRIA, one case involving faster redesign schedules and one involving slower redesign schedules has been analyzed.

Manufacturers use diverse strategies with respect to when, and how often they update vehicle designs. While most vehicles have been redesigned sometime in the last five years, many vehicles have not. In particular, vehicles with lower annual sales volumes tend to be redesigned less frequently, perhaps giving manufacturers more time to amortize the investment needed to bring the product to market. In some cases, manufacturers continue to produce and sell vehicles designed more than a decade ago.

⁸⁷ In response to the EPA's August 21, 2017, Request for Comments (docket numbers EPA-HQ-OAR-2015-0827 and NHTSA-2016-0068), see, e.g., CARB at 28 (Docket ID. EPA-HQ-OAR-2015-0827-9197), EDF at 12 (Docket ID. EPA-HQ-OAR-2015-0827-9203), and NRDC, et. al. at 29–33 (Docket ID. EPA-HQ-OAR-2015-0827-9826).

⁸⁸ NRDC, et al., at 32.

Table II-2 - Sales Distribution by Age of Vehicle Engineering Design

Most Recent Engineering Redesign Model Year of the Observed MY 2016 Vehicle	% of MY 2016 Fleet (Unit Sales) by Engineering Design Age	Portion of Analysis Fleet Observations in MY 2016 Fleet by Engineering Design Age	Age of Vehicle Engineering Design	Portion of total New Vehicle Sales with Engineering Designs As New or Newer than "Age of Vehicle Engineering Design"
2006	2.1%	1.7%	10	99.97%
2007	1.3%	2.0%	9	97.9%
2008	3.2%	2.3%	8	96.6%
2009	4.3%	9.8%	7	93.4%
2010	5.0%	7.2%	6	89.1%
2011	9.6%	7.9%	5	84.1%
2012	10.5%	13.0%	4	74.6%
2013	18.1%	10.6%	3	64.0%
2014	20.5%	21.8%	2	46.0%
2015	12.6%	14.1%	1	25.4%
2016	12.9%	9.2%	New (0)	12.9%

BILLING CODE 4910-59-P

Each manufacturer may use different strategies throughout their product portfolio, and a component of each strategy may include the timing of

refresh and redesign cycles. Table II-3 below summarizes the average time between redesigns, by manufacturer, by vehicle technology class.⁸⁹ Dashes mean the manufacturer has no volume in that

vehicle technology class in the MY 2016 analysis fleet. Across the industry, manufacturers average 6.5 years between product redesigns.

⁸⁹ Technology class, or tech class, refers to a group of fuel-economy simulations of similar

vehicles. As explained, each vehicle is assigned to

a representative simulation to estimate technology effectiveness for purposes of the analysis.

Table II-3 - Summary of Sales Weighted Average Time between Engineering Redesigns, by Manufacturer, by Vehicle Technology Class

Manufacturer	SmallCar	SmallCarPerf	MedCar	MedCarPerf	SmallSUV	SmallSUVPerf	MedSUV	MedSUVPerf	Pickup	PickupHT	ALL CLASSES
BMW	6.0	6.1	6.7	6.5	5.5	6.4	6.3	6.1	-	-	6.3
Daimler	7.0	5.5	7.0	6.6	5.6	7.0	10.0	7.3	-	-	6.7
FCA	6.2	6.1	6.0	8.2	9.0	7.4	8.3	8.7	10.0	10.0	8.6
Ford	8.3	8.5	6.3	6.9	7.7	7.6	7.4	7.9	5.8	5.8	7.1
General Motors	5.7	5.2	5.0	6.2	5.7	7.3	7.4	6.1	6.5	7.9	6.3
Honda	4.4	4.8	4.8	4.9	5.5	5.8	-	6.0	-	-	5.3
Hyundai Kia-H	5.0	4.8	5.3	6.0	5.3	5.3	5.3	5.3	-	-	5.2
Hyundai Kia-K	5.7	6.0	5.5	5.0	4.7	5.5	5.5	7.1	-	-	5.4
JLR	-	-	-	7.5	-	6.3	-	6.4	-	-	6.5
Mazda	-	6.4	4.2	7.7	5.1	7.0	-	7.0	-	-	5.4
Nissan Mitsubishi	5.1	5.7	5.5	6.0	6.9	6.6	-	6.5	8.0	-	6.1
SUBARU	4.8	7.8	5.4	4.7	5.4	5.5	-	-	-	-	5.4
Tesla	-	-	-	10.0	-	-	-	10.0	-	-	10.0
TOYOTA	5.5	9.6	6.3	6.0	5.3	5.7	5.3	7.2	10.5	10.1	6.6
Volvo	-	8.3	-	8.6	-	8.0	-	7.2	-	-	7.8
VWA	-	5.9	7.3	6.0	7.7	7.1	-	7.6	-	-	6.6
TOTAL	5.5	6.0	5.6	6.7	6.2	6.6	7.2	7.1	8.1	7.8	6.5

There are a few notable observations from this table. Pick-up trucks have much longer redesign schedules (7.8 years on average) than small cars (5.5 years on average). Some manufacturers redesign vehicles often (every 5.2 years in the case of Hyundai), while other manufacturers redesign vehicles less often (FCA waits on average 8.6 years between vehicle redesigns). Across the

industry, light-duty vehicle designs last for about 6.5 years.

Even if two manufacturers have similar redesign cadence, the model years in which the redesigns occur may still be different and dependent on where each of the manufacturer's products are in their life cycle.

Table II-4 summarizes the average age of manufacturers' offering by vehicle

technology class. A value of "0.0" means that every vehicle for a manufacturer in that vehicle technology class, represented in the MY 2016 analysis fleet was new in MY 2016. Across the industry, manufacturers redesigned MY 2016 vehicles an average of 3.2 years earlier.

Table II-4 - Summary of Sales Weighted Average Age of Engineering Design in MY 2016 by Manufacturer, by Vehicle Technology Class

Manufacturer	SmallCar	SmallCarPerf	MedCar	MedCarPerf	SmallSUV	SmallSUVPerf	MedSUV	MedSUVPerf	Pickup	PickupHT	ALL CLASSES
BMW	2.0	2.4	4.0	3.1	3.3	2.8	5.0	2.1	-	-	2.9
Daimler	2.0	2.3	6.0	2.8	0.5	0.0	4.0	3.7	-	-	2.8
FCA	4.3	4.8	5.0	5.5	4.1	5.0	4.8	7.8	7.0	7.0	6.0
Ford	4.9	4.0	3.0	2.7	3.0	1.5	2.6	3.2	1.0	1.0	2.5
General Motors	3.9	4.8	1.6	3.2	4.3	4.2	6.0	3.9	3.4	2.0	3.5
Honda	1.1	0.3	2.9	2.5	3.5	1.5	-	2.7	-	-	2.3
Hyundai Kia-H	4.0	4.0	0.9	2.6	0.6	3.0	3.0	3.0	-	-	2.5
Hyundai Kia-K	2.7	2.0	0.0	0.6	2.1	0.2	0.0	0.6	-	-	1.4
JLR	-	-	-	2.8	-	1.7	-	2.6	-	-	2.4
Mazda	-	1.7	2.0	2.0	2.7	0.0	-	0.0	-	-	2.2
Nissan Mitsubishi	2.5	0.3	3.0	1.7	2.7	0.9	-	2.6	2.0	-	2.6
SUBARU	4.0	3.3	2.9	0.3	1.9	1.3	-	-	-	-	2.0
Tesla	-	-	-	4.0	-	-	-	4.0	-	-	4.0
TOYOTA	1.6	2.8	4.9	2.9	3.0	1.2	3.1	4.2	0.0	8.0	3.2
Volvo	-	6.0	-	6.4	-	6.8	-	1.0	-	-	4.0
VWA	-	2.6	4.6	3.7	6.1	6.3	-	5.4	-	-	4.0
TOTAL	2.7	2.3	2.9	3.2	3.0	2.5	4.4	4.1	1.9	3.5	3.2

BILLING CODE 4910-59-C

Based on historical observations and refresh/redesign schedule forecasts, careful consideration to redesign cycles for each manufacturer and each vehicle is important. Simply assuming every vehicle is redesigned by 2021 and by 2025 is not appropriate, as this would misrepresent both the likely timing of redesigns and the likely time between redesigns in most cases.

C. Development of Footprint-Based Curve Shapes

As in the past four CAFE rulemakings, the most recent two of which included related standards for CO₂ emissions, NHTSA and EPA are proposing to set attribute-based CAFE standards that are defined by a mathematical function of vehicle footprint, which has observable correlation with fuel economy and

vehicle emissions. EPCA, as amended by EISA, expressly requires that CAFE standards for passenger cars and light trucks be based on one or more vehicle attributes related to fuel economy and be expressed in the form of a mathematical function.⁹⁰ While the CAA includes no specific requirements regarding GHG regulation, EPA has chosen to adopt standards consistent with the EPCA/EISA requirements in the interest of simplifying compliance for the industry since 2010.⁹¹ Section II.C.1 describes the advantages of attribute standards, generally. Section II.C.2 explains the agencies' specific decision to use vehicle footprint as the attribute over which to vary stringency for past and current rules. Section II.C.3 discusses the policy considerations in selecting the specific mathematical function. Section II.C.4 discusses the

methodologies used to develop current attribute-based standards, and the agencies' current proposal to continue to do so for MYs 2022-2026. Section II.C.5 discusses the methodologies used to reconsider the mathematical function for the proposed standards.

1. Why attribute-based standards, and what are the benefits?

Under attribute-based standards, every vehicle model has fuel economy and CO₂ targets, the levels of which depend on the level of that vehicle's determining attribute (for this proposed rule, footprint is the determining attribute, as discussed below). The manufacturer's fleet average performance is calculated by the harmonic production-weighted average of those targets, as defined below:

⁹⁰ 49 U.S.C. 32902(a)(3)(A).

⁹¹ Such an approach is permissible under section 202(a) of the CAA, and EPA has used the attribute-

based approach in issuing standards under analogous provisions of the CAA.

$$\text{Required CAFE} = \frac{\sum_{i \in \text{OEM Fleet}} \text{Production}_i}{\sum_{i \in \text{OEM Fleet}} \frac{\text{Production}_i}{\text{Target}_i}}$$

Here, i represents a given model⁹² in a manufacturer's fleet, Production_i represents the U.S. production of that model, and Target_i represents the target as defined by the attribute-based standards. This means no vehicle is required to meet its target; instead, manufacturers are free to balance improvements however they deem best within (and, given credit transfers, at least partially across) their fleets.

The idea is to select the shape of the mathematical function relating the standard to the fuel economy-related attribute to reflect the trade-offs manufacturers face in producing more of that attribute over fuel efficiency (due to technological limits of production and relative demand of each attribute). If the shape captures these trade-offs, every manufacturer is more likely to continue adding fuel efficient technology across the distribution of the attribute within their fleet, instead of potentially changing the attribute—and other correlated attributes, including fuel economy—as a part of their compliance strategy. Attribute-based standards that achieve this have several advantages.

First, assuming the attribute is a measurement of vehicle size, attribute-based standards reduce the incentive for manufacturers to respond to CAFE standards by reducing vehicle size in ways harmful to safety.⁹³ Larger vehicles, in terms of mass and/or crush space, generally consume more fuel, but are also generally better able to protect occupants in a crash.⁹⁴ Because each

vehicle model has its own target (determined by a size-related attribute), properly fitted attribute-based standards provide little, if any, incentive to build smaller vehicles simply to meet a fleet-wide average, because smaller vehicles are subject to more stringent compliance targets.

Second, attribute-based standards, if properly fitted, better respect heterogeneous consumer preferences than do single-valued standards. As discussed above, a single-valued standard encourages a fleet mix with a larger share of smaller vehicles by creating incentives for manufacturers to use downsizing the average vehicle in their fleet (possibly through fleet mixing) as a compliance strategy, which may result in manufacturers building vehicles for compliance reasons that consumers do not want. Under a size-related, attribute-based standard, reducing the size of the vehicle is a less viable compliance strategy because smaller vehicles have more stringent regulatory targets. As a result, the fleet mix under such standards is more likely to reflect aggregate consumer demand for the size-related attribute used to determine vehicle targets.

Third, attribute-based standards provide a more equitable regulatory framework across heterogeneous manufacturers who may each produce different shares of vehicles along attributes correlated with fuel economy.⁹⁵ A single, industry-wide CAFE standard imposes disproportionate cost burden and compliance challenges on manufacturers who produce more vehicles with attributes inherently correlated with lower fuel economy—*i.e.* manufacturers who produce, on average, larger vehicles. As discussed above, retaining the ability for manufacturers to produce vehicles which respect heterogeneous market preferences is an important consideration. Since manufacturers may target different markets as a part of their business strategy, ensuring that these manufacturers do not incur a disproportionate share of the regulatory cost burden is an important part of conserving consumer choices within the market.

2. Why footprint as the attribute?

It is important that the CAFE and CO₂ standards be set in a way that does not encourage manufacturers to respond by selling vehicles that are less safe. Vehicle size is highly correlated with vehicle safety—for this reason, it is important to choose an attribute correlated with vehicle size (mass or some dimensional measure). Given this consideration, there are several policy and technical reasons why footprint is considered to be the most appropriate attribute upon which to base the standards, even though other vehicle size attributes (notably, curb weight) are more strongly correlated with fuel economy and emissions.

First, mass is strongly correlated with fuel economy; it takes a certain amount of energy to move a certain amount of mass. Footprint has some positive correlation with frontal surface area, likely a negative correlation with aerodynamics, and therefore fuel economy, but the relationship is less deterministic. Mass and crush space (correlated with footprint) are both important safety considerations. As discussed below and in the accompanying PRIA, NHTSA's research of historical crash data indicates that holding footprint constant, and decreasing the mass of the largest vehicles, will have a net positive safety impact to drivers overall, while holding footprint constant and decreasing the mass of the smallest vehicles will have a net decrease in fleetwide safety. Properly fitted footprint-based standards provide little, if any, incentive to build smaller vehicles to meet CAFE and CO₂ standards, and therefore help minimize the impact of standards on overall fleet safety.

Second, it is important that the attribute not be easily manipulated in a manner that does not achieve the goals of EPCA or other goals, such as safety. Although weight is more strongly correlated with fuel economy than footprint, there is less risk of manipulation (changing the attribute(s) to achieve a more favorable target) by increasing footprint under footprint-based standards than there would be by increasing vehicle mass under weight-based standards. It is relatively easy for a manufacturer to add enough weight to a vehicle to decrease its applicable fuel economy target a significant amount, as compared to increasing vehicle

⁹² If a model has more than one footprint variant, here each of those variants is treated as a unique model, i , since each footprint variant will have a unique target.

⁹³ The 2002 NAS Report described at length and quantified the potential safety problem with average fuel economy standards that specify a single numerical requirement for the entire industry. See Transportation Research Board and National Research Council. 2002. *Effectiveness and Impact of Corporate Average Fuel Economy (CAFE) Standards*. Washington, DC: The National Academies Press ("2002 NAS Report") at 5, finding 12, available at <https://www.nap.edu/catalog/10172/effectiveness-and-impact-of-corporate-average-fuel-economy-cafe-standards> (last accessed June 15, 2018). Ensuing analyses, including by NHTSA, support the fundamental conclusion that standards structured to minimize incentives to downsize all but the largest vehicles will tend to produce better safety outcomes than flat standards.

⁹⁴ Bento, A., Gillingham, K., & Roth, K. (2017). *The Effect of Fuel Economy Standards on Vehicle Weight Dispersion and Accident Fatalities*. NBER Working Paper No. 23340. Available at <http://www.nber.org/papers/w23340> (last accessed June 15, 2018).

⁹⁵ 2002 NAS Report at 4–5, finding 10.

footprint, which is a much more complicated change that typically takes place only with a vehicle redesign.

Further, some commenters on the MY 2011 CAFE rulemaking were concerned that there would be greater potential for gaming under multi-attribute standards, such as those that also depend on weight, torque, power, towing capability, and/or off-road capability. As discussed in NHTSA's MY 2011 CAFE final rule,⁹⁶ it is anticipated that the possibility of gaming is lowest with footprint-based standards, as opposed to weight-based or multi-attribute-based standards. Specifically, standards that incorporate weight, torque, power, towing capability, and/or off-road capability in addition to footprint would not only be more complex, but by providing degrees of freedom with respect to more easily-adjusted attributes, they could make it less certain that the future fleet would actually achieve the projected average fuel economy and CO₂ levels. This is not to say that a footprint-based system will eliminate gaming, or that a footprint-based system will eliminate the possibility that manufacturers will change vehicles in ways that compromise occupant protection, but footprint-based standards achieve the best balance among affected considerations. Please provide comments on whether vehicular footprint is the most suitable attribute upon which to base standards.

3. What mathematical function should be used to specify footprint-based standards?

In requiring NHTSA to “prescribe by regulation separate average fuel economy standards for passenger and non-passenger automobiles based on 1 or more vehicle attributes related to fuel economy and express each standard in the form of a mathematical function”, EPCA/EISA provides ample discretion regarding not only the selection of the attribute(s), but also regarding the

nature of the function. The CAA provides no specific direction regarding CO₂ regulation, and EPA has continued to harmonize this aspect of its CO₂ regulations with NHTSA's CAFE regulations. The relationship between fuel economy (and GHG emissions) and footprint, though directionally clear (*i.e.*, fuel economy tends to decrease and CO₂ emissions tend to increase with increasing footprint), is theoretically vague, and quantitatively uncertain; in other words, not so precise as to *a priori* yield only a single possible curve.

The decision of how to specify this mathematical function therefore reflects some amount of judgment. The function can be specified with a view toward achieving different environmental and petroleum reduction goals, encouraging different levels of application of fuel-saving technologies, avoiding any adverse effects on overall highway safety, reducing disparities of manufacturers' compliance burdens, and preserving consumer choice, among other aims. The following are among the specific technical concerns and resultant policy tradeoffs the agencies have considered in selecting the details of specific past and future curve shapes:

- Flatter standards (*i.e.*, curves) increase the risk that both the size of vehicles will be reduced, potentially compromising highway safety, and reducing any utility consumers would have gained from a larger vehicle.
- Steeper footprint-based standards may create incentives to upsize vehicles, potentially oversupplying vehicles of certain footprints beyond what consumers would naturally demand, and thus increasing the possibility that fuel savings and CO₂ reduction benefits will be forfeited artificially.
- Given the same industry-wide average required fuel economy or CO₂ standard, flatter standards tend to place greater compliance burdens on full-line manufacturers.

- Given the same industry-wide average required fuel economy or CO₂ standard, dramatically steeper standards tend to place greater compliance burdens on limited-line manufacturers (depending of course, on which vehicles are being produced).

- If cutpoints are adopted, given the same industry-wide average required fuel economy, moving small-vehicle cutpoints to the left (*i.e.*, up in terms of fuel economy, down in terms of CO₂ emissions) discourages the introduction of small vehicles, and reduces the incentive to downsize small vehicles in ways that could compromise overall highway safety.

- If cutpoints are adopted, given the same industry-wide average required fuel economy, moving large-vehicle cutpoints to the right (*i.e.*, down in terms of fuel economy, up in terms of CO₂ emissions) better accommodates the design requirements of larger vehicles — especially large pickups — and extends the size range over which downsizing is discouraged.

4. What mathematical functions have been used previously, and why?

Notwithstanding the aforementioned discretion under EPCA/EISA, data should inform consideration of potential mathematical functions, but how relevant data is defined and interpreted, and the choice of methodology for fitting a curve to that data, can and should include some consideration of specific policy goals. This section summarizes the methodologies and policy concerns that were considered in developing previous target curves (for a complete discussion see the 2012 FRIA).

As discussed below, the MY 2011 final curves followed a constrained logistic function defined specifically in the final rule.⁹⁷ The MYs 2012–2021 final standards and the MYs 2022–2025 augural standards are defined by constrained linear target functions of footprint, as shown below:⁹⁸

$$Target = \frac{1}{\min\left(\max\left(c * Footprint + d, \frac{1}{a}\right), \frac{1}{b}\right)}$$

Here, *Target* is the fuel economy target applicable to vehicles of a given footprint in square feet (*Footprint*). The

upper asymptote, *a*, and the lower asymptote, *b*, are specified in mpg; the reciprocal of these values represent the

lower and upper asymptotes, respectively, when the curve is instead specified in gallons per mile (gpm). The

⁹⁶ See 74 FR at 14359 (Mar. 30, 2009).

⁹⁷ See 74 FR 14196, 14363–14370 (Mar. 30, 2009) for NHTSA discussion of curve fitting in the MY 2011 CAFE final rule.

⁹⁸ The right cutpoint for the light truck curve was moved further to the right for MYs 2017–2021, so that more possible footprints would fall on the sloped part of the curve. In order to ensure that, for all possible footprints, future standards would be at least as high as MY 2016 levels, the final standards

for light trucks for MYs 2017–2021 is the maximum of the MY 2016 target curves and the target curves for the give MY standard. This is defined further in the 2012 final rule. See 77 FR 62624, at 62699–700 (Oct. 15, 2012).

slope, c , and the intercept, d , of the linear portion of the curve are specified as gpm per change in square feet, and gpm, respectively.

The min and max functions will take the minimum and maximum values within their associated parentheses. Thus, the max function will first find the maximum of the fitted line at a given footprint value and the lower asymptote from the perspective of gpm. If the fitted line is below the lower asymptote it is replaced with the floor, which is also the minimum of the floor and the ceiling by definition, so that the target in mpg space will be the reciprocal of the floor in mpg space, or simply, a . If, however, the fitted line is not below the lower asymptote, the fitted value is returned from the max function and the min function takes the minimum value of the upper asymptote (in gpm space) and the fitted line. If the fitted value is below the upper asymptote, it is between the two asymptotes and the fitted value is appropriately returned from the min function, making the overall target in mpg the reciprocal of the fitted line in gpm. If the fitted value is above the upper asymptote, the upper asymptote is returned from the min function, and the overall target in mpg is the reciprocal of the upper asymptote in gpm space, or b .

In this way curves specified as constrained linear functions are specified by the following parameters:

- a = upper limit (mpg)
- b = lower limit (mpg)
- c = slope (gpm per sq. ft.)
- d = intercept (gpm)

The slope and intercept are specified as gpm per sq. ft. and gpm instead of mpg per sq. ft. and mpg because fuel consumption and emissions appear roughly linearly related to gallons per mile (the reciprocal of the miles per gallon).

(a) NHTSA in MY 2008 and MY 2011 CAFE (Constrained Logistic)

For the MY 2011 CAFE rule, NHTSA estimated fuel economy levels by footprint from the MY 2008 fleet after normalization for differences in technology,⁹⁹ but did not make adjustments to reflect other vehicle attributes (e.g., power-to-weight ratios). Starting with the technology-adjusted passenger car and light truck fleets, NHTSA used minimum absolute deviation (MAD) regression without sales weighting to fit a logistic form as a starting point to develop mathematical

⁹⁹ See 74 FR 14196, 14363–14370 (Mar. 30, 2009) for NHTSA discussion of curve fitting in the MY 2011 CAFE final rule.

functions defining the standards. NHTSA then identified footprints at which to apply minimum and maximum values (rather than letting the standards extend without limit) and transposed these functions vertically (i.e., on a gallons-per-mile basis, uniformly downward) to produce the promulgated standards. In the preceding rule, for MYs 2008–2011 light truck standards, NHTSA examined a range of potential functional forms, and concluded that, compared to other considered forms, the constrained logistic form provided the expected and appropriate trend (decreasing fuel economy as footprint increases), but avoided creating “kinks” the agency was concerned would provide distortionary incentives for vehicles with neighboring footprints.¹⁰⁰

(b) MYs 2012–2016 Standards (Constrained Linear)

For the MYs 2012–2016 rule, potential methods for specifying mathematical functions to define fuel economy and CO₂ standards were reevaluated. These methods were fit to the same MY 2008 data as the MY 2011 standard. Considering these further specifications, the constrained logistic form, if applied to post-MY 2011 standards, would likely contain a steep mid-section that would provide undue incentive to increase the footprint of midsize passenger cars.¹⁰¹ A range of methods to fit the curves would have been reasonable, and a minimum absolute deviation (MAD) regression without sales weighting on a technology-adjusted car and light truck fleet was used to fit a linear equation. This equation was used as a starting point to develop mathematical functions defining the standards. Footprints were then identified at which to apply minimum and maximum values (rather than letting the standards extend without limit). Finally, these constrained/piecewise linear functions were transposed vertically (i.e., on a gpm or CO₂ basis, uniformly downward) by multiplying the initial curve by a single factor for each MY standard to produce the final attribute-based targets for passenger cars and light trucks described in the final rule.¹⁰² These transformations are typically presented

¹⁰⁰ See 71 FR 17556, 17609–17613 (Apr. 6, 2006) for NHTSA discussion of “kinks” in the MYs 2008–2011 light truck CAFE final rule (there described as “edge effects”). A “kink,” as used here, is a portion of the curve where a small change in footprint results in a disproportionately large change in stringency.

¹⁰¹ 75 FR at 25362.

¹⁰² See generally 74 FR at 49491–96; 75 FR at 25357–62.

as percentage improvements over a previous MY target curve.

(c) MYs 2017 and Beyond Standards (Constrained Linear)

The mathematical functions finalized in 2012 for MYs 2017 and beyond changed somewhat from the functions for the MYs 2012–2016 standards. These changes were made to both address comments from stakeholders, and to further consider some of the technical concerns and policy goals judged more preeminent under the increased uncertainty of the impacts of finalizing and proposing standards for model years further into the future.¹⁰³ Recognizing the concerns raised by full-line OEMs, it was concluded that continuing increases in the stringency of the light truck standards would be more feasible if the light truck curve for MYs 2017 and beyond was made steeper than the MY 2016 truck curve and the right (large footprint) cut-point was extended only gradually to larger footprints. To accommodate these considerations, the 2012 final rule finalized the slope fit to the MY 2008 fleet using a sales-weighted, ordinary least-squares regression, using a fleet that had technology applied to make the technology application across the fleet more uniform, and after adjusting the data for the effects of weight-to-footprint. Information from an updated MY 2010 fleet was also considered to support this decision. As the curve was vertically shifted (with fuel economy specified as mpg instead of gpm or CO₂ emissions) upwards, the right cutpoint was progressively moved for the light truck curves with successive model years, reaching the final endpoint for MY 2021; this is further discussed and shown in Chapter 4.3 of the PRIA.

5. Reconsidering the Mathematical Functions for This Proposal

(a) Why is it important to reconsider the mathematical functions?

By shifting the developed curves by a single factor, it is assumed that the underlying relationship of fuel consumption (in gallons per mile) to vehicle footprint does not change significantly from the model year data used to fit the curves to the range of model years for which the shifted curve shape is applied to develop the standards. However, it must be recognized that the relationship

¹⁰³ The MYs 2012–2016 final standards were signed April 1st, 2010—putting 6.5 years between its signing and the last affected model year, while the MYs 2017–2021 final standards were signed August 28th, 2012—giving just more than nine years between signing and the last affected final standards.

between vehicle footprint and fuel economy is not necessarily constant over time; newly developed technologies, changes in consumer demand, and even the curves themselves could, if unduly susceptible to gaming, influence the observed relationships between the two vehicle characteristics. For example, if certain technologies are more effective or more marketable for certain types of vehicles, their application may not be uniform over the range of vehicle footprints. Further, if market demand has shifted between vehicle types, so that certain vehicles make up a larger share of the fleet, any underlying technological or market restrictions which inform the average shape of the curves could change. That is, changes in the technology or market restrictions themselves, or a mere re-weighting of different vehicle types, could reshape the fit curves.

For the above reasons, the curve shapes were reconsidered using the newest available data, from MY 2016. With a view toward corroboration through different techniques, a range of descriptive statistical analyses were

conducted that do not require underlying engineering models of how fuel economy and footprint might be expected to be related, and a separate analysis that uses vehicle simulation results as the basis to estimate the relationship from a perspective more explicitly informed by engineering theory was conducted as well. Despite changes in the new vehicle fleet both in terms of technologies applied and in market demand, the underlying statistical relationship between footprint and fuel economy has not changed significantly since the MY 2008 fleet used for the 2012 final rule; therefore, it is proposed to continue to use the curve shapes fit in 2012. The analysis and reasoning supporting this decision follows.

(b) What statistical analyses did NHTSA consider?

In considering how to address the various policy concerns discussed above, data from the MY 2016 fleet was considered, and a number of descriptive statistical analyses (*i.e.*, involving observed fuel economy levels and footprints) using various statistical methods, weighting schemes, and

adjustments to the data to make the fleets less technologically heterogeneous were performed. There were several adjustments to the data that were common to all of the statistical analyses considered.

With a view toward isolating the relationship between fuel economy and footprint, the few diesels in the fleet were excluded, as well as the limited number of vehicles with partial or full electric propulsion; when the fleet is normalized so that technology is more homogenous, application of these technologies is not allowed. This is consistent with the methodology used in the 2012 final rule.

The above adjustments were applied to all statistical analyses considered, regardless of the specifics of each of the methods, weights, and technology level of the data, used to view the relationship of vehicle footprint and fuel economy. Table II-5, below, summarizes the different assumptions considered and the key attributes of each. The analysis was performed considering all possible combinations of these assumptions, producing a total of eight footprint curves.

Table II-5 - Summary of Assumptions Considered in the Statistical Analysis of the Current Footprint-FE Relationship

Varying Assumptions	Regression Type		Regression Weights		Technology Level	
	<i>OLS</i>	<i>MAD</i>	<i>Production-weighted</i>	<i>Model-weighted</i>	<i>Current Technology</i>	<i>Max. Technology</i>
Alternatives Considered	<i>OLS</i>	<i>MAD</i>	<i>Production-weighted</i>	<i>Model-weighted</i>	<i>Current Technology</i>	<i>Max. Technology</i>
Details	Ordinary Least Squares Regression	Minimum Absolute Deviation Regression	Points weighted by production volumes of each model.	Equal weight for each model; collapses points with similar footprint, FE, and curb weight.	Current MY 2016 tech., excluding: HEV, PHEV, BEV, and FCV.	Maximum tech. applied, excluding: HEV, PHEV, BEV, and FCV.
Key Attributes	Describes the average relationship between footprint and fuel economy; outliers can skew results.	Describes the median relationship between footprint and fuel economy; does not give outliers as much weight.	Tends towards higher-volume models; may systematically disadvantage manufacturers who produce fewer vehicles.	Tends towards the space of the joint distribution of footprint and FE with the most models; gives low-volume models equal weight.	Describes current market, including demand factors; may miss changes in curve shape due to advanced technology application.	Captures relationship with homogenous technology application; may miss varying demand considerations for different segments.

(1) Current Technology Level Curves

The “current technology” level curves exclude diesels and vehicles with electric propulsion, as discussed above, but make no other changes to each model year fleet. Comparing the MY 2016 curves to ones built under the same methodology from previous model year fleets shows whether the observed curve shape has changed significantly over time as standards have become more stringent. Importantly, these curves will include any market forces which make technology application variable over the distribution of footprint. These market forces will not be present in the “maximum technology” level curves: By making technology levels homogenous, this variation is removed. The current technology level curves built using both regression types and both regression weight methodologies from the MY 2008, MY 2010, and MY 2016 fleets, shown in more detail in Chapter 4.4.2.1 of the PRIA, support the curve slopes finalized in the 2012 final rule. The curves built from most methodologies using each fleet generally shift, but remain very similar in slope. This suggests that the relationship of footprint to fuel economy, including both technology and market limits, has not significantly changed.

(2) Maximum Technology Level Curves

As in prior rulemakings, technology differences between vehicle models were considered to be a significant factor producing uncertainty regarding the relationship between fuel consumption and footprint. Noting that attribute-based standards are intended to encourage the application of additional technology to improve fuel efficiency and reduce CO₂ emissions across the distribution of footprint in the fleet, approaches were considered in which technology application is simulated for purposes of the curve fitting analysis in order to produce fleets that are less varied in technology content. This approach helps reduce “noise” (*i.e.*, dispersion) in the plot of vehicle footprints and fuel consumption levels and identify a more technology-neutral relationship between footprint

and fuel consumption. The results of updated analysis for maximum technology level curves are also shown in Chapter 4.4.2.2 of the PRIA. Especially if vehicles progress over time toward more similar size-specific efficiency, further removing variation in technology application both better isolates the relationship between fuel consumption and footprint and further supports the curve slopes finalized in the 2012 final rule.

(c) What other methodologies were considered?

The methods discussed above are descriptive in nature, using statistical analysis to relate observed fuel economy levels to observed footprints for known vehicles. As such, these methods are clearly based on actual data, answering the question “how does fuel economy appear to be related to footprint?” However, being independent of explicit engineering theory, they do not answer the question “how might one expect fuel economy to be related to footprint?” Therefore, as an alternative to the above methods, an alternative methodology was also developed and applied that, using full-vehicle simulation, comes closer to answer the second question, providing a basis to either corroborate answers to the first, or suggest that further investigation could be important.

As discussed in the 2012 final rule, several manufacturers have confidentially shared with the agencies what they described as “physics-based” curves, with each OEM showing significantly different shapes for the footprint-fuel economy relationships. This variation suggests that manufacturers face different curves given the other attributes of the vehicles in their fleets (*i.e.*, performance characteristics) and/or that their curves reflected different levels of technology application. In reconsidering the shapes of the proposed MYs 2021–2026 standards, a similar estimation of physics-based curves leveraging third-party simulation work from Argonne National Laboratories (ANL) was developed. Estimating physics-based curves better ensures that technology and performance are held constant for

all footprints; augmenting a largely statistical analysis with an analysis that more explicitly incorporates engineering theory helps to corroborate that the relationship between fuel economy and footprint is in fact being characterized.

Tractive energy is the amount of energy it will take to move a vehicle.¹⁰⁴ Here, tractive energy effectiveness is defined as the share of the energy content of fuel consumed which is converted into mechanical energy and used to move a vehicle—for internal combustion engine (ICE) vehicles, this will vary with the relative efficiency of specific engines. Data from ANL simulations suggest that the limits of tractive energy effectiveness are approximately 25% for vehicles with internal combustion engines which do not possess ISG, other hybrid, plug-in, pure electric, or fuel cell technology.

A tractive energy prediction model was also developed to support today’s proposal. Given a vehicle’s mass, frontal area, aerodynamic drag coefficient, and rolling resistance as inputs, the model will predict the amount of tractive energy required for the vehicle to complete the Federal test cycle. This model was used to predict the tractive energy required for the average vehicle of a given footprint¹⁰⁵ and “body technology package” to complete the cycle. The body technology packages considered are defined in Table II–6, below. Using the absolute tractive energy predicted and tractive energy effectiveness values spanning possible ICE engines, fuel economy values were then estimated for different body technology packages and engine tractive energy effectiveness values.

¹⁰⁴ Thomas, J. “Drive Cycle Powertrain Efficiencies and Trends Derived from EPA Vehicle Dynamometer Results.” *SAE Int. J. Passeng. Cars—Mech. Syst.* 7(4):2014, doi:10.4271/2014-01-2562. Available at <https://www.sae.org/publications/technical-papers/content/2014-01-2562/> (last accessed June 15, 2018).

¹⁰⁵ The mass reduction curves used elsewhere in this analysis were used to predict the mass of a vehicle with a given footprint, body style box, and mass reduction level. The ‘Body style Box’ is 1 for hatchbacks and minivans, 2 for pickups, and 3 for sedans, and is an important predictor of aerodynamic drag. Mass is an essential input in the tractive energy calculation.

Table II-6 - Summary of Body Technology Packages Considered for Tractive Energy Analysis

Body Tech. Package	Mass Reduction Level	Aerodynamics Level	Roll Resistance Level
1	0%	0%	0%
2	0%	10%	10%
3	10%	10%	10%
4	10%	15%	20%
5	15%	20%	20%

Chapter 6 of the PRIA shows the resultant CAFE levels estimated for the vehicle classes ANL simulated for this analysis, at different footprint values and by vehicle “box.” Pickups are considered 1-box, hatchbacks and minivans are 2-box, and sedans are 3-box. These estimates are compared with the MY 2021 standards finalized in 2012. The general trend of the simulated data points follows the pattern of the previous MY 2021 standards for all technology packages and tractive energy effectiveness values presented in the PRIA. The tractive energy curves are intended to validate the curve shapes against a physics-based alternative, and the analysis suggests that the curve shapes track the physical relationship between fuel economy and tractive energy for different footprint values.

Physical limitations are not the only forces manufacturers face; they must also produce vehicles that consumers will purchase. For this reason, in setting future standards, the analysis will continue to consider information from statistical analyses that do not homogenize technology applications in addition to statistical analyses which do, as well as a tractive energy analysis similar to the one presented above.

The relationship between fuel economy and footprint remains directionally discernable but quantitatively uncertain. Nevertheless, each standard must commit to only one function. Approaching the question “how is fuel economy related to footprint” from different directions and applying different approaches will provide the greatest confidence that the single function defining any given standard appropriately and reasonably reflects the relationship between fuel economy and footprint. Please provide comments on this tentative conclusion and the above discussion.

D. Characterization of Current and Anticipated Fuel-Saving Technologies

The analysis evaluates a wide array of technologies manufacturers could use to

improve the fuel economy of new vehicles, in both the near future and the timeframe of this proposed rulemaking, to meet the fuel economy and CO₂ standards proposed in this rulemaking. The analysis evaluated costs for these technologies, and looked at how these costs may change over time. The analysis also considered how fuel-saving technologies may be used on many types of vehicles (ranging from small cars to trucks) and how the technologies may perform in improving fuel economy and CO₂ emissions in combination with other technologies. With cost and effectiveness estimates for technologies, the analysis can forecast how manufacturers may respond to potential standards and can estimate the associated costs and benefits related to technology and equipment changes. This assists the assessment of technological feasibility and is a building block for the consideration of economic practicability of potential standards.

NHTSA, EPA, and CARB issued the Draft Technical Assessment Report (Draft TAR)¹⁰⁶ as the first step in the EPA MTE process. The Draft TAR provided an opportunity for the agencies to share with the public updated technical analysis relevant to development of future standards. For this NPRM, the analysis relies on portions of the analysis presented in the Draft TAR, along with new information that has been gathered and developed since conducting that analysis, and the significant, substantive input that was received during the public comment period.

The Draft TAR considered many technologies previously assessed in the 2012 final rule.¹⁰⁷ In some cases, manufacturers have nearly universally adopted a technology in today’s new vehicle fleet (for example, electric power steering). In other cases,

manufacturers occasionally use a technology in today’s new vehicle fleet (like turbocharged engines). For a few technologies considered in the 2012 rulemaking, manufacturers began implementing the technologies but have since largely pivoted to other technologies due to consumer acceptance issues (for instance, in some cases drivability and performance feel issues associated with dual clutch transmissions without a torque converter) or limited commercial success. The analysis utilizes new information as manufacturers’ use of technologies evolves.

Some of the emerging technologies described in the Draft TAR were not included in this analysis, but this includes some additional technologies not previously considered. As industry invents and develops new fuel-savings technologies, and as suppliers and manufacturers produce and apply the technologies, and as consumers react to the new technologies, efforts are continued to learn more about the capabilities and limitations of new technologies. While a technology is in early development, theoretical constructs, limited access to test data, and CBI is relied on to assess the technology. After manufacturers commercialize the technology and bring products to market, the technology may be studied in more detail, which generally leads to the most reliable information about the technology. In addition, once in production, the technology is represented in the fuel economy and CO₂ status of the baseline fleet. The technology analysis is kept as current as possible in light of the ongoing technology development and implementation in the automotive industry.

Some technology assumptions have been updated since the MYs 2017–2025 final rule and, in many cases, since the 2016 Draft TAR. In some cases, EPA and NHTSA presented different analytical approaches in the Draft TAR; the analysis is now presented using the

¹⁰⁶ Available at <https://www.nhtsa.gov/staticfiles/rulemaking/pdf/cape/Draft-TAR-Final.pdf> (last accessed June 15, 2018).

¹⁰⁷ 77 FR 62624 (Oct. 15, 2012).

same direct manufacturing costs, retail costs, and learning rates. In addition, the effectiveness of fuel-economy technologies is now assessed based on the same assumptions, and with the same tools. Finally, manufacturers' response to stringency alternatives is forecast with the same simulation model.

Since the 2017 and later final rule, many cost assessments, including tear down studies, were funded and completed, and presented as part of the Draft TAR analysis. These studies evaluated transmissions, engines, hybrid technologies, and mass reduction.¹⁰⁸ As a result, the analysis uses updated cost estimates for many technologies, some of which have been updated since the Draft TAR. In addition to those studies, the analysis also leveraged research reports from other organizations to assess costs.¹⁰⁹ Today's analysis also updates the costs to 2016 dollars, as in many cases technology costs were estimated several years ago.

The analysis uses an updated, peer-reviewed model developed by ANL for the Department of Energy to provide a more rigorous estimate for battery costs. The new battery model provides an estimate future for battery costs for hybrids, plug-in hybrids, and electric vehicles, taking into account the different battery design characteristics and taking into account the size of the battery for different applications.¹¹⁰

In the Draft TAR, two possible methodologies to estimate indirect costs from direct manufacturing costs, described as "indirect cost multipliers" and "retail price equivalent" were presented. Both of these methodologies attempted to relate the price of parts for

¹⁰⁸ FEV prepared several cost analysis studies for EPA on subjects ranging from advanced 8-speed transmissions to belt alternator starter, or Start/Stop systems. NHTSA also contracted with Electricore, EDAG, and Southwest Research on teardown studies evaluating mass reduction and transmissions. The 2015 NAS report on fuel economy technologies for light-duty vehicles also evaluated the agencies' technology costs developed based on these teardown studies, and the technology costs used in this proposal were updated accordingly. These studies are discussed in detail in Chapter 6 of the PRIA accompanying this proposal.

¹⁰⁹ For example, the agencies relied on reports from the Department of Energy's Office of Energy Efficiency & Renewable Energy's Vehicle Technologies Office. More information on that office is available at <https://www.energy.gov/eere/vehicles/vehicle-technologies-office>. Other agency reports that were relied on for technology or other information are referenced throughout this proposal and accompanying PRIA.

¹¹⁰ For instance, battery electric vehicles with high levels of mass reduction may use a smaller battery than a comparable vehicle with less mass reduction technology and still deliver the same range on a charge.

fuel-saving technologies to a retail price. Today's analysis utilizes the direct manufacturing costs (DMC) and the retail price equivalent (RPE) methodology published in the Draft TAR.

Two tools to estimate effectiveness of fuel-saving technologies were used in the Draft TAR, and for today's analysis, only one tool was used (Autonomie).¹¹¹ Previously, EPA developed "ALPHA", an in-house model that estimated fuel-savings for technologies, which provided a foundation for EPA's analysis. EPA's "ALPHA" results were used to calibrate a much simpler "Lumped Parameter Model" that was developed by EPA to estimate technology effectiveness for many technologies. The Lumped Parameter Model (LPM) approximated simulation modeling results instead of directly using the results and lead to less accurate estimates of technology effectiveness. Many stakeholders questioned the efficacy of the Lumped Parameter Model and ALPHA assumptions and outputs in combination,¹¹² especially as the tool was used to evaluate increasingly heterogeneous combinations of technologies in the baseline fleet.¹¹³ For today's analysis, EPA and NHTSA used an updated version of the Autonomie model—an improved version of what NHTSA presented in the 2016 Draft TAR—to assess technology effectiveness of technologies and combinations of technologies. The Department of Energy's ANL developed Autonomie and the underpinning model assumptions leveraged research from the DOE's Vehicle Technologies Office and feedback from the public. Autonomie is commercially available and widely used; third parties such as suppliers, automakers, and academic researchers (who publish findings in peer reviewed academic journals) commonly use the Autonomie simulation software.

Similarly for today's analysis, only one tool is used. Previously, EPA developed "OMEGA," a tool that looked at costs of technologies and effectiveness of technologies (as estimated by EPA's Lumped Parameter

Model or ALPHA), and applied cost effective technologies to manufacturers' fleets in response to potential standards. Many stakeholders commented that the OMEGA model oversimplified fleet-wide analysis, resulting in significant shortcomings.¹¹⁴ For instance, OMEGA assumed manufacturers would redesign all vehicles in the fleet by 2021, and then again by 2025; stakeholders purported that these assumptions did not reflect practical constraints in many manufacturers' business models.¹¹⁵ Additionally, stakeholders commented that OMEGA did not adequately take into consideration common parts like shared engines, shared transmissions, and engineering platforms. The CAFE model does consider refresh and redesign cycles and parts sharing. The CAFE model can evaluate responses to any policy alternative on a year-by-year basis, as required by EPCA/EISA¹¹⁶ and as allowed by the CAA, and can also account for manufacturers' year-by-year plans that involve "carrying forward" technology from prior model years, and some other vehicles possibly applying "extra" technology in anticipation of standards in ensuing model years. For today's analysis, an updated version of the CAFE model is used—an improved version of what NHTSA presented in the 2016 Draft TAR—to assess manufacturers' response to policy alternatives. See Section II.A.1 above for further discussion of the decision to use the CAFE model for the NPRM analysis.

Each aforementioned change is discussed briefly in the remainder of this section and in much greater detail in Chapter 6 of the PRIA. A brief summary of the technologies considered in this proposal is discussed below. Please provide comments on all aspects of the analysis as discussed here and as detailed in the PRIA.

¹¹⁴ The Alliance of Automobile Manufacturers commented that "the OMEGA model is over-optimized and unrealistic. . . many of these issues either are not present or are accounted for in DOT's Volpe model. The Alliance therefore recommends that EPA focus on ensuring needs specific to its regulatory analysis are appropriately addressed in the Volpe model." Alliance at 48 (Docket ID. EPA-HQ-OAR-2015-0827-9194).

¹¹⁵ For example, FCA provided the following comments: "EPA's expectation of 10–20% mass reduction rates across 70% of FCA's fleet, which includes a 70% truck mix, is simply unreasonable as the magnitude of change would require complete product redesigns in less than eight years shortening existing production needed to amortize the large capital cost involved." FCA at 19 (Docket ID. EPA-HQ-OAR-2015-0827-6160).

¹¹⁶ 49 U.S.C. 32902(b)(2)(B).

¹¹¹ ANL's Full-Vehicle Simulation Autonomie Model is discussed in Chapter 6 of the PRIA and in the ANL Model Documentation available at Docket No. NHTSA-2018-0067.

¹¹² At NHTSA-2016-0068-0082, p. 49, FCA provided the following comments, "FCA believes EPA is overestimating the benefits of technology. As the LPM is calibrated to those projections, so too is the LPM too optimistic." FCA also shared the chart, "LPM vs. Actual for 8 Speed Transmissions."

¹¹³ See e.g., Automotive News "CAFE math gets trickier as industry innovates" (Kulisich), March 26, 2018.

1. Data Sources and Processes for Developing Individual Technology Assumptions

Technology assumptions were developed that provide a foundation for conducting a fleet-wide compliance analysis. As part of this effort, the analysis estimated technology costs, projected technology effectiveness values, and identified possible limitations for some fuel-saving technologies. There is a preference to use values developed from careful review of commercialized technologies; however, in some cases for technologies that are new, and are not yet for sale in any vehicle, the analysis relied on information from other sources, including CBI and third-party research reports and publications. Many emerging technologies are still being evaluated for the analysis supporting the final rule, including those that are currently emerging.

For today's analysis, one set of cost assumptions, one set of effectiveness values (developed with one tool), and one set of assumptions about the limitations of some technologies are presented. Many sources of data were evaluated, in addition to many stakeholder comments received on the Draft TAR. Throughout the process of developing the assumptions for today's analysis, the preferred approach was to harmonize on sources and methodologies that were data-driven and reproducible in independent verification, produced using tools utilized by OEMs, suppliers, and academic institutions, and using tools that could support both CAFE and CO₂ analysis. A single set of assumptions also facilitates and focuses public comment by reducing burden on stakeholders who seek to review all of the supporting documentation for this proposal.

(a) Technology Costs

The analysis estimated present and future costs for fuel-saving technologies, taking into consideration the type of vehicle, or type of engine if technology costs vary by application. Cost estimates were developed based on three main inputs. First, direct manufacturing costs (DMC), or the component costs of the physical parts and systems, were considered, with estimated costs assuming high volume production. DMCs generally do not include the indirect costs of tools, capital equipment, and financing costs, nor do they cover indirect costs like engineering, sales, and administrative support. Second, indirect costs via a scalar markup of direct manufacturing

costs (the retail price equivalent, or RPE) was taken into account. Finally, costs for technologies may change over time as industry streamlines design and manufacturing processes. Potential cost improvements with learning effects (LE) were also considered. The retail cost of equipment in any future year is estimated to be equal to the product of the DMC, RPE, and LE. Considering the retail cost of equipment, instead of merely direct manufacturing costs, is important to account for the real-world price effects of a technology, as well as market realities. Absent government mandate, a manufacturer will not undertake expensive development and support costs to implement technologies without realistic prospects of consumer willingness to pay enough for such technology to allow for the manufacturer to recover its investment.

(1) Direct Manufacturing Costs

In many instances, the analysis used agency-sponsored tear-down studies of vehicles and parts to estimate the direct manufacturing costs of individual technologies. In the simplest cases, the studies produced results that confirmed third-party industry estimates, and aligned with confidential information provided by manufacturers and suppliers. In cases with a large difference between the tear-down study results and credible independent sources, study assumptions were scrutinized, and sometimes the analysis was revised or updated accordingly.¹¹⁷ Studies were conducted on vehicles and technologies that would cover a breadth of fuel-savings technologies, but because tear-down studies can be time-intensive and expensive, the agencies did not sponsor tear-down studies for every technology. For some technologies, independent tear-down studies were also utilized, in addition to other publications and confidential business information.¹¹⁸ Due to the variety of technologies and their applications, a detailed tear-down study could not be conducted for every technology, including pre-production technologies.

Many fuel-saving technologies were considered that are pre-production, or sold in very small pilot volumes. For emerging technologies that could be applied in the rulemaking timeframe, a tear-down study cannot be conducted to

¹¹⁷ For instance, in previous analysis, EPA referenced an old study that purported the first 7–10% of mass reduction to be “free” or at a significant “cost savings” to for many vehicles and many manufacturers.

¹¹⁸ The analysis referenced studies from private businesses and business analysts for emerging technologies and for off-the-shelf technologies that were commercially mature.

assess costs because the product is not yet in the marketplace for evaluation. In these cases, third-party estimates and confidential information from suppliers and manufacturers are relied upon; however, there are some common pitfalls with relying on confidential business information to estimate costs. The agencies and the source may have had incongruent or incompatible definitions of “baseline.”¹¹⁹ The source may have provided direct manufacturer costs at a date many years in the future, and assumed very high production volumes, important caveats to consider for agency analysis. In addition, a source, under no contractual obligation to the agencies, may provide incomplete and/or misleading information. In other cases, intellectual property considerations and strategic business partnerships may have contributed to a manufacturer's cost information and could be difficult to account for in the model as not all manufacturer's may have access to proprietary technologies at stated costs. New information is carefully evaluated in light of these common pitfalls, especially regarding emerging technologies. The analysis used third-party, forward looking information for advanced cylinder deactivation and variable compression ratio engines, and while these cost estimates may be cursory (as is the case with many emerging technologies prior to commercialization), the agencies took care to use early information provided fairly and reasonably. While costs for fuel-saving technologies reflect the best estimates available today, technology cost estimates will likely change in the future as technologies are deployed and as production is expanded. For emerging technologies, the best information available at the time of the analysis was utilized, and cost assumptions will continue to be updated.

(2) Indirect Costs

As explained above, in addition to direct manufacturing costs, the analysis estimates and considers indirect manufacturing costs. To estimate indirect costs, direct manufacturing costs are multiplied by a factor to represent the average price for fuel-saving technologies at retail. This factor, referred to as the retail price equivalence (RPE), accounts for indirect costs like engineering, sales, and administrative support, as well as other overhead costs, business expenses, warranty costs, and return on capital

¹¹⁹ “Baseline” here refers to a reference part, piece of equipment, or engineering system that efficiency improvements and costs are relative to.

considerations. This approach to the RPE remains unchanged from the RPE approach NHTSA presented in the Draft TAR.

The RPE was chosen for this analysis instead of indirect cost multipliers (ICM) because it provides the best estimate of indirect costs. For a more detailed discussion of the approach to indirect costs, see PRIA Chapter 9.

(3) Stranded Capital Costs

Past analyses accounted for costs associated with stranded capital when fuel economy standards caused a technology to be replaced before its costs were fully amortized. The idea behind stranded capital is that manufacturers amortize research, development, and tooling expenses over many years, especially for engines and transmissions. The traditional production life-cycles for transmissions and engines have been a decade or longer. If a manufacturer launches or updates a product with fuel-saving technology, and then later replaces that technology with an unrelated or different fuel-saving technology before the equipment and research and development investments have been fully paid off, there will be unrecovered, or stranded, capital costs. Quantifying stranded capital costs attempted to account for such lost investments. In the Draft TAR analysis, there were only a few technologies for a few manufacturers that were projected to have stranded capital costs.

As more technologies are included in this analysis, and as the CAFE model has been expanded to account for platform and engine sharing and updated with redesign and refresh cycles, accounting for stranded capital has become increasingly complex. Separately, the fact that manufacturers may be shifting their investment strategies in ways that may affect stranded capital calculations was considered. For instance, Ford and General Motors agreed to jointly develop next generation transmission technologies,¹²⁰ and some suppliers sell similar transmissions to multiple manufacturers. These arrangements allow manufacturers to share in capital expenditures, or amortize expenses more quickly. Manufacturers increasingly share parts on vehicles around the globe, achieving greater scale and greatly affecting tooling strategies and costs. Given these trends in the

industry and their uncertain effect on capital amortization, and given the difficulty of handling this uncertainty in the CAFE model, this analysis does not account for stranded capital. However, these trends will be monitored to assess the role of stranded capital moving forward.

The analysis continues to rely on projected refresh and redesign cycles in the CAFE model to moderate the cadence for technology adoption and limit the occurrence of stranded capital and the need to account for it. Stranded capital is an important consideration to appropriately account for costs if there is too rapid of a turnover for certain technologies.

(4) Cost Learning

Manufacturers make improvements to production processes over time, often resulting in lower costs. Today's analysis estimates cost learning by considering Wright's learning theory, which states that as every time cumulative volume for a product doubles, the cost lowers by a scalar factor. The analysis accounts for learning effects with model year-based cost learning forecasts for each technology that reduce direct manufacturing costs over time. Historical use of technologies were evaluated, and industry forecasts were reviewed to estimate future volumes for the purpose of developing the model year-based technology cost learning curves. The CAFE model does not dynamically update learning curves, based on compliance pathways chosen in simulation.

As discussed above, cost inputs to the CAFE model incorporate estimates of volume-based learning. As an alternative approach, Volpe Center staff have considered modifications such that the CAFE model would calculate degrees of volume-based learning dynamically, responding to the model's application of affected technologies. While it is intuitive that the degree of cost reduction achieved through experience producing a given technology should depend on the actual accumulated experience (*i.e.*, volume) producing that technology, staff have thus far found such dynamic implementation in the CAFE model infeasible. Insufficient data has been available regarding manufacturers' historical application of specific technology. Also, insofar as underlying direct manufacturing costs already make some assumptions about volume and scale, insufficient information is currently available to determine how to dynamically adjust these underlying costs. It should be noted that if learning

responds dynamically to volume, and volume responds dynamically to learning, an internally consistent model solution would likely require iteration of the CAFE model to seek a stable solution within the model's representation multiyear planning. Thus far, these challenges suggest it would be infeasible to calculate degrees of volume-based learning in a manner that responds dynamically to modeled technology application. Nevertheless, the agencies invite comment on the issue, and seek data and methods that would provide the basis for a practicable approach to doing so.

Today's analysis also updates the way learning effects apply to costs. In the Draft TAR analysis, NHTSA applied learning curves only to the incremental direct manufacturing costs or costs over the previous technology on the tech tree. In practice, two things were observed: (1) If the incremental direct manufacturing costs were positive, technologies could not become less expensive than their predecessors on the tech tree, and (2) absolute costs over baseline technology depended on the learning curves of root technologies on the tech tree. Today's analysis applies learning effects to the incremental cost over the null technology state on the tech tree. After this step, the analysis calculates year-by-year incremental costs over preceding technologies on the tech tree to create the CAFE model inputs.

Direct manufacturing costs and learning effects for many technologies were reviewed by evaluating historical use of technologies and industry forecasts to estimate future volumes. This approach produced reasonable estimates for technologies already in production. For technologies not yet in production in MY 2016, the cumulative volume in MY 2016 is zero, because manufacturers have not yet produced the technologies. For pre-production cost estimates, the analysis often relies on confidential business information sources to predict future costs. Many sources for pre-production cost estimates include significant learning effects, often providing cost estimates assuming high volume production, and often for a timeframe late in the first production generation or early in the second generation of the technology. Rapid doubling and re-doubling of a low cumulative volume base with Wright's learning curves can provide unrealistic cost estimates. In addition, direct manufacturing cost projections can vary depending on the initial production volume assumed. Direct costs with learning were carefully examined, and adjustments were made to the starting

¹²⁰ See, e.g., Nick Bunkley, *Ford to invest \$1.4 billion to build 10-speed transmissions for 2017 F-150*, Automotive News (Apr. 26, 2016), [http://www.autonews.com/article/20160426/OEM01/160429878/ford-to-invest-\\$1.4-billion-to-build-10-speed-transmissions-for-2017](http://www.autonews.com/article/20160426/OEM01/160429878/ford-to-invest-$1.4-billion-to-build-10-speed-transmissions-for-2017).

point for those technologies on the learning curve to better align with the assumptions used for the initial direct cost estimate. See PRIA Chapter 9 for more detailed information on cost learning.

(b) Technology Effectiveness

(1) Technology Effectiveness Simulation Modeling

Full-vehicle simulation modeling was used to estimate the fuel economy improvements manufacturers could make to their fleet by adding new technologies, taking into account MY 2016 vehicle specifications, as well as how combinations of technologies interact. Full-vehicle simulation modeling uses computer software and physics-based models to predict how combinations of technologies perform together.

The simulation and modeling requires detailed specifications for each technology that describes its efficiency and performance-related characteristics. Those specifications generally come from design specifications, laboratory measurements, simulation or modeling, and may involve additional analysis. For example, the analysis used engine maps showing fuel use vs. engine torque vs. engine speed, and transmission maps taking into account gear efficiency for a range of loads and speeds. With physics-based technology specifications, full-vehicle simulation modeling can be used to estimate technology effectiveness for various combinations and permutations of technologies for many vehicle classes. To develop the specifications used for the simulation and modeling, laboratory test data was evaluated for production and pre-production technologies, technical publications, manufacturer and supplier CBI, and simulation modeling of specific technologies. Evaluating recently introduced production products to inform the technology effectiveness models of emerging technologies is preferred because doing so allows for a more reliable analysis of incremental improvements over previous technologies; however, some technologies were considered that are not yet in production. As technologies evolve and new applications emerge, this work will be continued and may include additional technologies and/or updated modeling for the final rule. The details of new and emerging technologies are discussed in PRIA Chapter 6.

Using full-vehicle simulation modeling has two primary advantages over using single or limited point estimates for fuel efficiency

improvements of technologies. First, technology effectiveness often differs significantly depending on the type of vehicle and the other technologies that are on the vehicle, and this is shown in full-vehicle simulations. Different technologies may provide different fuel economy improvements depending on whether they are implemented alone or in tandem with other technologies. Single point estimates often oversimplify these important, complex relationships and lead to less accurate effectiveness estimates. Also, because manufacturers often implement a number of fuel-saving technologies simultaneously at vehicle redesigns, it is generally difficult to isolate the effect of individual technologies using laboratory measurement of production vehicles alone. Simulation modeling offers the opportunity to isolate the effects of individual technologies by using a single or small number of baseline configurations and incrementally adding technologies to those baseline configurations. This provides a consistent reference point for the incremental effectiveness estimates for each technology and for combinations of technologies for each vehicle type and reduces potential double counting or undercounting technology effectiveness. Note: It is most important that the incremental effectiveness of each technology and combinations be accurate and relative to a consistent baseline, because it is the incremental effectiveness that is applied to each vehicle model/configuration in the MY 2016 baseline fleet (and to each vehicle model/configuration's absolute fuel economy value) to determine the absolute fuel economy of the model/configuration with the additional technology. The absolute fuel economy values of the simulation modeling runs by themselves are used only to determine the incremental effectiveness and are never used directly to assign an absolute fuel economy value to any vehicle model/configuration for the rulemaking analysis. Therefore, commenters on technology effectiveness should be specific about the incremental effectiveness of technologies relative to other specifically defined technologies. The fuel economy of a specific vehicle or simulation modeling run in isolation may be less useful.

Second, full-vehicle simulation modeling requires explicit specifications and assumptions for each technology; therefore, these assumptions can be presented for public review and comment. For instance, transmission gear efficiencies, shift logic, and gear ratios are explicitly

stated as model inputs and are available for review and comment. For today's analysis, every effort was made to make the input specifications and modeling assumptions available for review and comment. PRIA Chapter 6 and referenced documents provide more detailed information.

Technology development and application will be monitored to acquire more information for the final rule. The agencies may update the analysis for the final rule based on comments and/or new information that becomes available.

Today's analysis utilizes effectiveness estimates for technologies developed using Autonomie software,¹²¹ a physics-based full-vehicle simulation tool developed and maintained by the Department of Energy's ANL. Autonomie has a long history of development and widespread application by users in industry, academia, research institutions and government.¹²² Real-world use has contributed significantly to aspects of Autonomie important to producing realistic estimates of fuel economy and CO₂ emission rates, such as estimation and consideration of performance, utility, and driveability metrics (*e.g.*, towing capability, shift business, frequency of engine on/off transitions). This steadily increasing realism has, in turn, steadily increased confidence in the appropriateness of using Autonomie to make significant investment decisions. Notably, DOE uses Autonomie for analysis supporting budget priorities and plans for programs managed by its Vehicle Technologies Office (VTO) and to decide among competing vehicle technology R&D projects.

In the 2015 National Academies of Science (NAS) study of fuel economy improving technologies, the Committee recommended that the agencies use full-vehicle simulation to improve the analysis method of estimating technology effectiveness.¹²³ The committee acknowledged that developing and executing tens or hundreds of thousands of constantly changing vehicle packages models in

¹²¹ More information about Autonomie is available at <https://www.anl.gov/technology/project/autonomie-automotive-system-design> (last accessed June 21, 2018).

¹²² ANL Model Documentation, "A Detailed Vehicle Simulation Process To Support CAFE Standards" ANL/ESD-18/6.

¹²³ National Research Council. 2015. *Cost, Effectiveness, and Deployment of Fuel Economy Technologies for Light-Duty Vehicles*. Washington, DC: The National Academies Press [hereinafter "2015 NAS Report"] at pg. 263, available at <https://www.nap.edu/catalog/21744/cost-effectiveness-and-deployment-of-fuel-economy-technologies-for-light-duty-vehicles> (last accessed June 21, 2018).

real-time is extremely challenging. While initially this approach was not considered practical to implement, a process developed by Argonne in collaboration with NHTSA and the DOT Volpe Center has succeeded in enabling large scale simulation modeling. For more details about the Autonomie simulation model and its submodels and inputs, see PRIA Chapter 6.2.

Today's analysis modeled more than 50 fuel economy-improving technologies, and combinations thereof, on 10 vehicle types (an increase from five vehicle types in NHTSA's Draft TAR analysis). While 10 vehicle types may seem like a small number, a large portion of the production volume in the MY 2016 fleet have specifications that are very similar, especially in highly competitive segments (for instance, many mid-sized sedans, many small SUVs, and many large SUVs coalesce around similar specifications, respectively), and baseline simulations have been aligned around these modal specifications. The sequential addition of these technologies generated more than 100,000 unique technology combinations per vehicle class. The analysis included 10 technology classes, so more than one million full-vehicle

simulations were run. In addition, simulation modeling was conducted to determine the appropriate amount of engine downsizing needed to maintain baseline performance across all modeled vehicle performance metrics when advanced mass reduction technology or advanced engine technology was applied, so these simulations take into account performance neutrality, given logical engine down-sizing opportunities associated with specific technologies.

Some baseline vehicle assumptions used in the simulation modeling were updated based on public comment and the assessment of the MY 2016 production fleet. The analysis included updated assumptions about curb weight, component inertia, as well as technology properties like baseline rolling resistance, aerodynamic drag coefficients, and frontal areas. Many of the assumptions are aligned with published research from the Department of Energy's Vehicle Technologies Office and other independent sources.¹²⁴

¹²⁴ Pannone, G. "Technical Analysis of Vehicle Load Reduction Potential for Advanced Clear Cars," April 29, 2015. Available at <https://www.arb.ca.gov/research/apr/past/13-313.pdf> (last accessed June 21, 2018).

Additional transmission technologies and more levels of aerodynamic technologies than NHTSA presented in the Draft TAR analysis were also added for today's analysis. Having additional technologies allowed the agencies to assign baselines and estimate fuel-savings opportunities with more precision.

The 10 vehicle types (referred to as "technology classes" in the modeling documentation) are shown in Table II-7. Each vehicle type (technology class) represented a large segment of vehicles, such as medium cars, small SUVs, and medium performance SUVs.¹²⁵ Baseline parameters were defined with ANL for each technology class, including baseline curb weight, time required to accelerate from stop to 60 miles per hour, time required to accelerate from 50 miles per hour to 80 miles per hour, ability of the vehicle to maintain constant 65 miles per hour speed on a six percent upgrade, and (for some classes) assumptions about towing capability.

¹²⁵ Separate technology classes were created for high performance and low performance vehicles to better account for performance diversity across the fleet.

Table II-7 - Summary of Vehicle Type (“Technology Class”) Assumptions for the NPRM and NHTSA Draft TAR Analysis

Technology Class	NHTSA Draft TAR Baseline			NPRM Baseline		
	Curb Weight (lbs.)	0-60 Time (s)	Percent of Sales, 2015MY	Curb Weight (lbs.)	0-60 Time (s)	Percent of Sales, 2016MY
Small Car	2,705	9.1	20.7%	2,950	10.6	10.3%
Small Car Performance	-	-	-	3,214	8.2	7.5%
Medium Car	3,199	9.0	25.6%	3,549	9.4	13.0%
Medium Car Performance	-	-	-	3,832	6.0	10.2%
Small SUV		9.0	18.3%	3,633	9.2	19.8%
Small SUV Performance	-	-	-	3,959	6.9	5.9%
Medium SUV	4,063	9.0	18.6%	3,777	10.3	2.5%
Medium SUV Performance	-	-	-	4,429	7.0	19.9%
Pickup	4,791	8.2	16.8%	4,350	7.0	3.0%
Pickup High Towing	-	-	-	5,055	7.0	7.9%

From these baseline specifications, incremental combinations of fuel saving technologies were applied. As the combinations of technologies change, so too may predicted performance.

The analysis attempts to maintain performance by resizing engines at a few specific incremental technology steps. Steps from one technology to another typically associated with a major vehicle redesign, or engine redesign, were identified, and engine resizing was restricted only to these steps. The analysis allowed engine resizing when mass reduction of 10% or greater was applied to the vehicle glider mass,¹²⁶ and when one powertrain architecture was replaced with another architecture.¹²⁷ The analysis resized

engines to the extent that performance was maintained for the least capable performance criteria to maintain vehicle utility for that criteria; therefore, sometimes other performance attributes may improve. For instance, the amount of engine resizing may be determined based on its high speed acceleration time if it is the least capable criteria, but that resizing may also improve the low speed acceleration time.¹²⁸ The analysis did not re-size the engine in response to adding technologies that have small effects on vehicle performance. For instance, if a vehicle’s weight is reduced by a small amount causing the 0–60 mile per hour time to improve slightly, the analysis would not resize the

belt-integrated starter generators, and other basic technologies. However, switching from a naturally aspirated engine to a turbo-downsized engine is an engine architecture change typically associated with a major redesign and radical change in engine displacement.

¹²⁸The simulation database, or summary of simulation outputs, includes all of the estimated performance metrics for each combination of technology as modeled.

engine. Manufacturers have repeatedly told the agencies that the high costs for redesign and the increased manufacturing complexity that would result from resizing engines for such small changes in the vehicle preclude doing so. The analysis should not, in fact, include engine resizing with the application of every technology or for combinations of technologies that drive small performance changes so that the analysis better reflects what is feasible for manufacturers to do.¹²⁹

2. CAFE model

The CAFE model is designed to simulate compliance with a given set of CAFE or CO₂ standards for each manufacturer that sells vehicles in the United States. The model begins with a

¹²⁹For instance, a vehicle would not get a modestly bigger engine if the vehicle comes with floor mats, nor would the vehicle get a modestly smaller engine without floor mats. This example demonstrates small levels of mass reduction. If manufacturers resized engines for small changes, manufacturers would have dramatically more part complexity, potentially losing economies of scale.

¹²⁶ The vehicle glider is defined here as the vehicle without the engine, transmission, and driveline. See PRIA Chapter 6.3 for further information.

¹²⁷ Some engine and accessory technologies may be added to an engine without an engine architecture change. For instance, manufacturers may adapt, but not replace engine architectures to include cylinder deactivation, variable valve lift,

representation of the MY 2016 vehicle model offerings for each manufacturer that includes the specific engines and transmissions on each model variant, observed sales volumes, and all fuel economy improving technology that is already present on those vehicles. From there the model adds technology, in response to the standards being considered, in a way that minimizes the cost of compliance and reflects many real-world constraints faced by automobile manufacturers. The model addresses fleet year-by-year compliance, taking into consideration vehicle refresh and redesign schedules and shared platforms, engines, and transmissions among vehicles.

As a result of simulating compliance, the CAFE model provides the technology pathways that manufacturers could use to comply with regulations, including how technologies could be applied to each of their vehicle model/configurations in response to a given set of standards. The model calculates the impacts of the simulated standard: Technology costs, fuel savings (both in gallons and dollars), CO₂ reductions, social costs and benefits, and safety impacts.

The current analysis reflects several changes made to the CAFE model since 2012, when NHTSA used the model to estimate the effects, costs, and benefits of final CAFE standards for light-duty vehicles produced during MYs 2017–2021 and augural standards for MYs 2022–2025. The changes are discussed in Section II.A.1, above, and PRIA Chapter 6.

3. Assumptions About Individual Technology Cost and Effectiveness Values

Cost and effectiveness values were estimated for each technology included in the analysis, with a summary list of all technologies provided in Table II–1 (List of Technologies with Data Sources for Technology Assignments) of Preamble Chapter II.B, above. In all, more than 50 technologies were considered in today's analysis, and the analysis evaluated many combinations of these technologies on many applications. Potential issues in assessing technology effectiveness and cost were identified, including:

- *Baseline (MY 2016) vehicle technology level assessed as too low, or too high.* Compliance information was extensively reviewed and supplemented with available literature on many MY 2016 vehicle models. Manufacturers could also review the baseline technology assignments for their vehicles, and the analysis incorporates feedback received from manufacturers.

- *Technology costs too low or too high.* Tear down cost studies, CBI, literature, and the 2015 NAS study information were referenced to estimate technology costs. In cases that one technology appeared exemplary on cost and effectiveness relative to all other technologies, information was acquired from additional sources to confirm or reject assumptions. Cost assumptions for emerging technologies are continuously being evaluated.

- *Technology effectiveness too high or too low in combination with other vehicle technologies.* Technology effectiveness was evaluated using the Autonomie full-vehicle simulation modeling, taking into account the impact of other technologies on the vehicle and the vehicle type. Inputs and modeling for the analysis took into account laboratory test data for production and some pre-production technologies, technical publications, manufacturer and supplier CBI, and simulation modeling of specific technologies. Evaluating recently introduced production products to inform the technology effectiveness models of emerging technologies was preferred; however, some technologies that are not yet in production were considered, via CBI. Simulation modeling used carefully chosen baseline configurations to provide a consistent, reasonable reference point for the incremental effectiveness estimates.

- *Vehicle performance not considered or applied in an infeasible manner.* Performance criteria, including low speed acceleration (0–60 mph time), high speed acceleration (50–80 mph time), towing, and gradeability (six percent grade at 65 mph) were also considered. In the simulation modeling, resizing was applied to achieve the same performance level as the baseline for the least capable performance criteria but only with significant design changes. The analysis struck a balance by employing a frequency of engine downsizing that took product complexity and economies of scale into account.

- *Availability of technologies for production application too soon or too late.* A number of technologies were evaluated that are not yet in production. CBI was gathered on the maturity and timing of these technologies and the likely cadence at which manufacturers might adopt these technologies.

- *Product complexity and design cadence constraints too low or too high.* Product platforms, refresh and redesign cycles, shared engines, and shared transmissions were also considered in the analysis. Product complexity and the cadence of product launches were

matched to historical values for each manufacturer.

- *Customer acceptance under estimated or over estimated.* Resale prices for hybrid vehicles, electric vehicles, and internal combustion engine vehicles were evaluated to assess consumer willingness to pay for those technologies. The analysis accounts for the differential in the cost for those technologies and the amount consumers have actually paid for those technologies. Separately, new dual-clutch transmissions and manual transmissions were applied to vehicles already equipped with these transmission architectures.

Please provide comments on all assumptions for fuel economy and CO₂ technology costs, effectiveness, availability, and applicability to vehicles in the fleet.

The technology effectiveness modeling results show effectiveness of a technology often varies with the type of vehicle and the other technologies that are on the vehicle. Figure II–1 and Figure II–2 show the range of effectiveness for each technology for the range of vehicle types and technology combinations included in this NPRM analysis. The data reflect the change in effectiveness for applying each technology by itself while all other technologies are held unchanged. The data show the improvement in fuel consumption (in gallons per mile) and tailpipe CO₂ over the combined 2-cycle test procedures. For many technologies, effectiveness values ranged widely; only a few technologies for which effectiveness may be reasonably represented as a fixed offset were identified.

For engine technologies, the effectiveness improvement range is relative to a comparably equipped vehicle with only variable valve timing (VVT) on the engine. For automatic transmission technologies, the effectiveness improvement range is over a 5-speed automatic transmission. For manual transmission technologies, the effectiveness improvement range is over a 5-speed manual transmission. For road load technologies like aerodynamics, rolling resistance, and mass reduction, the effectiveness improvement ranges are relative to the least advanced technology state, respectively. For hybrid and electric drive systems that wholly replace an engine and transmission, the effectiveness improvement ranges are relative to a comparably equipped vehicle with a basic engine with VVT only and a 5-speed automatic transmission. For hybrid or electrification technologies that complement other advanced engine

and transmission technologies, the effectiveness improvement ranges are relative to a comparably equipped vehicle without the hybrid or electrification technologies (for

instance, parallel strong hybrids and belt integrated starter generators retain engine technologies, such as a turbo charged engine or an Atkinson cycle engine). Many technologies have a wide

range of estimated effectiveness values. Figure II-3 below shows a hierarchy of technologies discussed.

BILLING CODE 4910-59-P

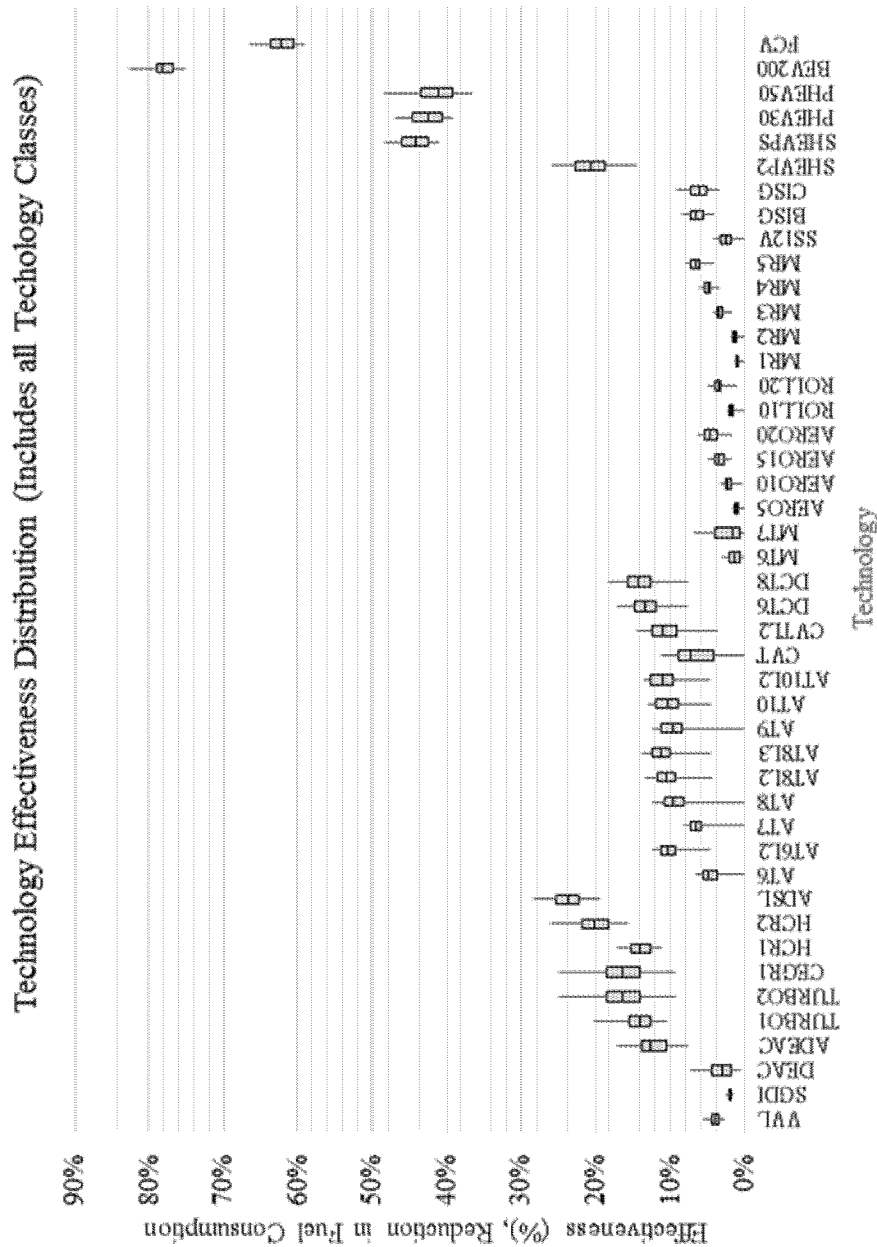

Figure II-1 - Simulated Technology Effectiveness Values

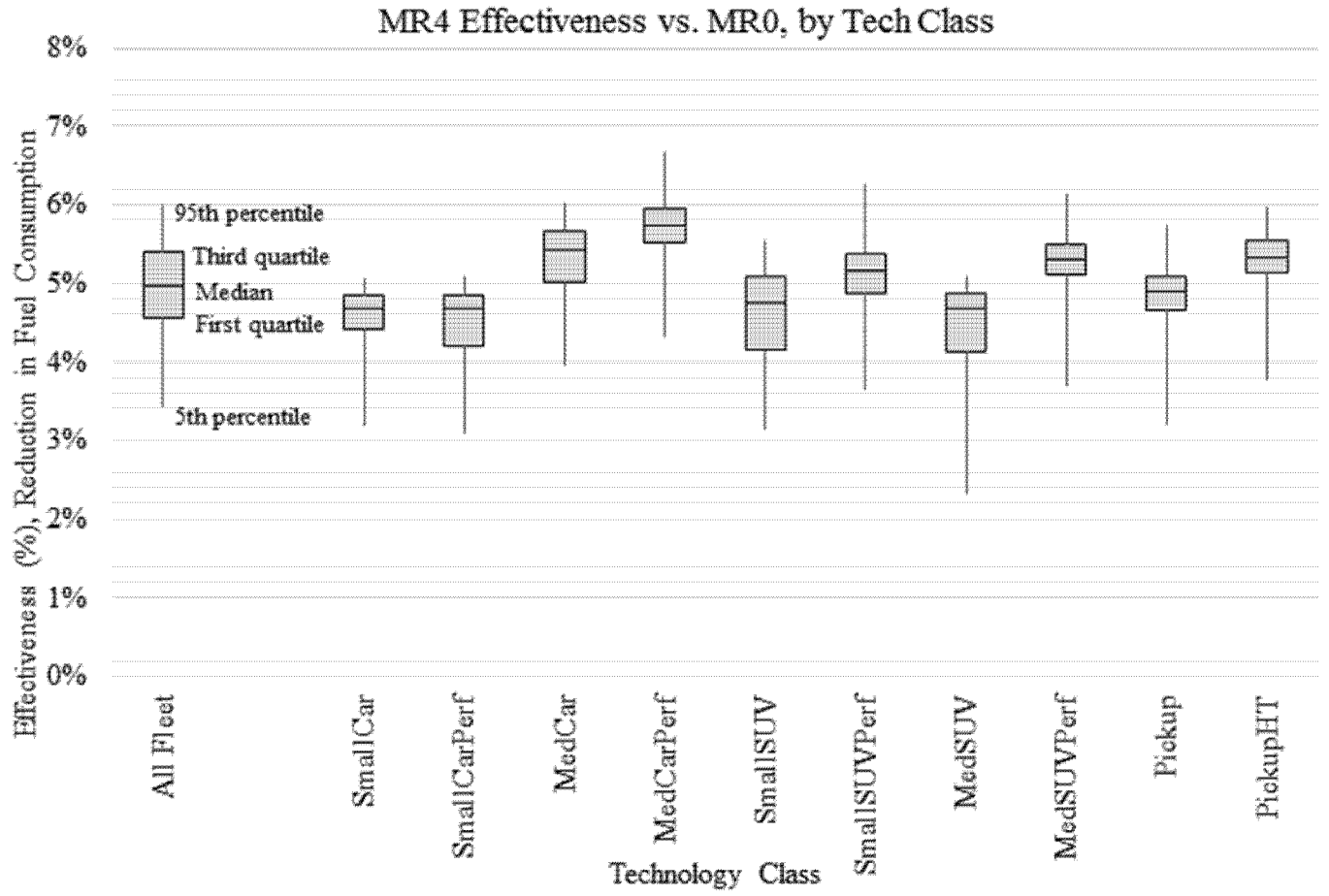

Figure II-2 - Example of Technology Effectiveness Variation by Application

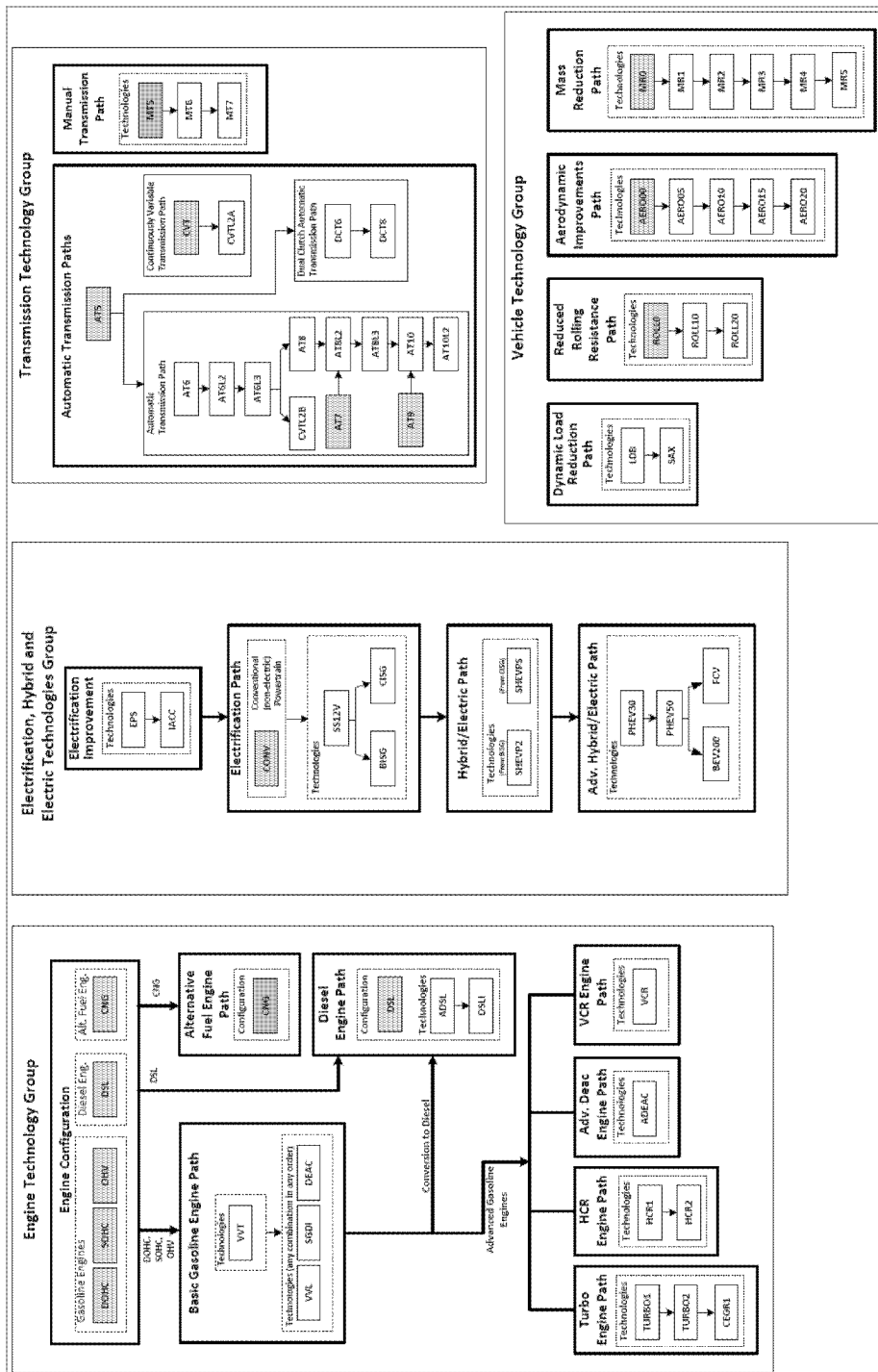

Figure II-3 - CAFE Model Technologies

4. Engine Technologies

There are a number of engine technologies that manufacturers can use to improve fuel economy and CO₂. Some engine technologies can be incorporated into existing engines with minor or moderate changes to the engines, but many engine technologies require an entirely new engine architecture.

In this section and for this analysis, the terms “basic engine technologies”

and “advanced engine technologies” are used only to define how the CAFE model applies a specific engine technology and handles incremental costs and effectiveness improvements. “Basic engine technologies” refer to technologies that, in many cases, can be adapted to an existing engine with minor or moderate changes to the engine. “Advanced engine technologies” refer to technologies that generally require significant changes or

an entirely new engine architecture. In the CAFE model, basic engine technologies may be applied in combination with other basic engine technologies; advanced engine technologies (defined by an engine map) stand alone as an exclusive engine technology. The words “basic” and “advanced” are not meant to confer any information about the level of sophistication of the technology. Also, many advanced engine technology

definitions include some basic engine technologies, but these basic technologies are already accounted for in the costs and effectiveness values of the advance engine. The “basic engine technologies” need not be (and are not) applied in addition to the “advanced engine technologies” in the CAFE model.

Engines come in a wide variety of shapes, sizes, and configurations, and

the incremental engine costs and effectiveness values often depend on engine architecture. The agencies modeled single overhead cam (SOHC), dual overhead cam (DOHC), and overhead valve (OHV) engines separately to account for differences in engine architecture. The agencies adjusted costs for some engine technologies based on the number of cylinders and number of banks in the

engine, and the agencies evaluated many production engines to better understand how costs and capabilities may vary with engine configuration. Table II–8, Table II–9, Table II–10 below shows the summary of absolute costs¹³⁰ for different technologies.

¹³⁰ “Absolute” being in reference to cost above the lowest level of technology considered in simulations. For instance, an engine of the same architecture with no VVT, VVL, SGDI, or DEAC.

Table II-8 - Summary of Absolute Engine Technology Cost vs. 14 Basic Engine, including Learning Effects and Retail Price Equivalent

Name	Technology Pathway	C-2017	C-2021	C-2025	C-2029
VVT	Basic Engine	\$ 111.97	\$ 108.79	\$ 106.24	\$ 104.13
VVL	Basic Engine	\$ 417.59	\$ 405.74	\$ 396.22	\$ 388.34
SGDI	Basic Engine	\$ 450.04	\$ 437.26	\$ 427.00	\$ 418.51
DEAC	Basic Engine	\$ 153.95	\$ 149.58	\$ 146.07	\$ 143.17
TURBO1	Turbocharged Engine	\$ 1,147.98	\$ 1,078.90	\$ 1,044.43	\$ 1,022.34
TURBO2	Turbocharged Engine	\$ 1,722.96	\$ 1,612.78	\$ 1,490.01	\$ 1,403.80
CEGR1	Turbocharged Engine	\$ 2,138.49	\$ 2,001.73	\$ 1,849.36	\$ 1,742.36
HCR1	HCR Engine	\$ 735.65	\$ 692.23	\$ 683.64	\$ 681.67
HCR2	HCR Engine	\$ 980.78	\$ 980.78	\$ 980.78	\$ 980.78
VCR	VCR Engine	not estimated	not estimated	not estimated	not estimated
ADEAC	Adv. DEAC Engine	\$ 1,370.86	\$ 1,237.93	\$ 1,156.83	\$ 1,108.63
ADSL	Diesel Engine	\$ 5,110.08	\$ 5,110.08	\$ 5,110.08	\$ 5,110.08
DSLI	Diesel Engine	\$ 5,661.68	\$ 5,661.68	\$ 5,661.68	\$ 5,661.68
CNG	Alt. Fuel Engine	\$ 159.54	\$ 156.22	\$ 153.41	\$ 150.72

Table II-9 - Summary of Absolute Engine Technology Cost vs. V6 Basic Engine, including Learning Effects and Retail Price Equivalent

Name	Technology Pathway	C-2017	C-2021	C-2025	C-2029
VVT	Basic Engine	\$ 223.94	\$ 217.58	\$ 212.48	\$ 208.25
VVL	Basic Engine	\$ 682.38	\$ 663.00	\$ 647.45	\$ 634.57
SGDI	Basic Engine	\$ 731.05	\$ 710.29	\$ 693.63	\$ 679.83
DEAC	Basic Engine	\$ 265.92	\$ 258.37	\$ 252.31	\$ 247.29
TURBO1	Turbocharged Engine	\$ 1,253.70	\$ 1,178.26	\$ 1,140.61	\$ 1,116.49
TURBO2	Turbocharged Engine	\$ 1,849.68	\$ 1,731.39	\$ 1,599.60	\$ 1,507.05
CEGR1	Turbocharged Engine	\$ 2,265.21	\$ 2,120.35	\$ 1,958.95	\$ 1,845.60
HCR1	HCR Engine	\$ 1,133.23	\$ 1,066.34	\$ 1,053.11	\$ 1,050.09
HCR2	HCR Engine	\$ 1,490.32	\$ 1,490.32	\$ 1,490.32	\$ 1,490.32
VCR	VCR Engine	not estimated	not estimated	not estimated	not estimated
ADEAC	Adv. DEAC Engine	\$ 2,115.07	\$ 1,909.98	\$ 1,784.85	\$ 1,710.48
ADSL	Diesel Engine	\$ 6,122.76	\$ 6,122.76	\$ 6,122.76	\$ 6,122.76
DSLI	Diesel Engine	\$ 6,841.17	\$ 6,841.17	\$ 6,841.17	\$ 6,841.17
CNG	Alt. Fuel Engine	\$ 159.54	\$ 156.22	\$ 153.41	\$ 150.72

Table II-10 - Summary of Absolute Engine Technology Cost vs. V8 Basic Engine, including Learning Effects and Retail Price Equivalent

Name	Technology Pathway	C-2017	C-2021	C-2025	C-2029
VVT	Basic Engine	\$ 223.94	\$ 217.58	\$ 212.48	\$ 208.25
VVL	Basic Engine	\$ 835.19	\$ 811.47	\$ 792.44	\$ 776.68
SGDI	Basic Engine	\$ 900.08	\$ 874.52	\$ 854.01	\$ 837.03
DEAC	Basic Engine	\$ 265.92	\$ 258.37	\$ 252.31	\$ 247.29
TURBO1	Turbocharged Engine	\$ 1,929.02	\$ 1,812.94	\$ 1,755.01	\$ 1,717.90
TURBO2	Turbocharged Engine	\$ 2,897.03	\$ 2,711.76	\$ 2,505.34	\$ 2,360.38
CEGR1	Turbocharged Engine	\$ 3,312.55	\$ 3,100.71	\$ 2,864.69	\$ 2,698.94
HCR1	HCR Engine	\$ 1,480.31	\$ 1,392.94	\$ 1,375.66	\$ 1,371.71
HCR2	HCR Engine	\$ 1,935.14	\$ 1,935.14	\$ 1,935.14	\$ 1,935.14
VCR	VCR Engine	not estimated	not estimated	not estimated	not estimated
ADEAC	Adv. DEAC Engine	\$ 2,741.71	\$ 2,475.87	\$ 2,313.66	\$ 2,217.26
ADSL	Diesel Engine	\$ 6,502.61	\$ 6,502.61	\$ 6,502.61	\$ 6,502.61
DSLI	Diesel Engine	\$ 7,221.02	\$ 7,221.02	\$ 7,221.02	\$ 7,221.02
CNG	Alt. Fuel Engine	\$ 159.54	\$ 156.22	\$ 153.41	\$ 150.72

Many types of production powertrains analysis, and engine maps were reviewed and tested for this developed for each combination of

engine technologies. For a given engine configuration, some production engines may be less efficient than the engine maps presented in the analysis, and some may be more efficient. Developing engine maps that reasonably represented most vehicles equipped with the engine technology, and that are in production today, was the preferred approach for this analysis. Additionally, some advanced engines were included in the simulation that are not yet in production. The engine maps for these engines were either based on CBI or were theoretical. The most recently released production engines are still being reviewed, and the analysis may include updated engine maps in the future or add entirely new engine maps to the analysis if either action could improve the quality of the fleet-wide analysis.

Stakeholders provided many comments on the engine maps that were presented in the Draft TAR. These comments were considered, and today's analysis utilizes several engine maps that were updated since the Draft TAR. Most notably, for turbocharged and downsized engines, the engine maps were adjusted in high torque, low speed operating conditions to address engine knock with regular octane fuel to align with the fuel octane that manufacturers recommend be used for the majority of vehicles. In the Draft TAR, NHTSA assumed high octane fuel to develop engine maps. See the discussion below and in PRIA Chapter 6.3 for more details. Please provide comment on the appropriateness of assuming the use of lower octane fuels.

(a) "Basic" Engine Technologies

The four "basic" engine technologies in today's model are Variable Valve Timing (VVT), Variable Valve Lift (VVL), Stoichiometric Gasoline Direct Injection (SGDI), and basic Cylinder Deactivation (DEAC). Over the last decade, manufacturers upgraded many engines with these engine technologies. Implementing these technologies involves changes to the cylinder head of the engine, but the engine block, crankshaft, pistons, and connecting rods require few, if any, changes. In today's analysis, manufacturers may apply the four basic engine technologies in various combinations, just as manufacturers have done recently.

(1) Variable Valve Timing (VVT)

Variable Valve Timing (VVT) is a family of valve-train designs that dynamically adjusts the timing of the intake valves, exhaust valves, or both, in relation to piston position. This family of technologies reduces pumping losses.

VVT is nearly universally used in the MY 2016 fleet.

(2) Variable Valve Lift (VVL)

Variable Valve Lift (VVL) dynamically adjusts the travel of the valves to optimize airflow over a broad range of engine operating conditions. The technology increases effectiveness by reducing pumping losses and may improve efficiency by affecting in-cylinder charge (fuel and air mixture), motion, and combustion.

(3) Stoichiometric Gasoline Direct Injection (SGDI)

Stoichiometric Gasoline Direct Injection (SGDI) sprays fuel at high pressure directly into the combustion chamber, which provides cooling of the in-cylinder charge via in-cylinder fuel vaporization to improve spark knock tolerance and enable an increase in compression ratio and/or more optimal spark timing for improved efficiency. SGDI appears in about half of basic engines produced in MY 2016, and the technology is used in many advanced engines as well.

(4) Basic Cylinder Deactivation (DEAC)

Basic Cylinder Deactivation (DEAC) disables intake and exhaust valves and prevents fuel injection into some cylinders during light-load operation. The engine runs temporarily as though it were a smaller engine, which reduces pumping losses and improves efficiency. Manufacturers typically disable one-cylinder bank with basic cylinder deactivation. In the MY 2016 fleet, manufacturers used DEAC on V6, V8, V10, and V12 engines on OHV, SOHC, and DOHC engine configurations. With some engine configurations in some operating conditions, DEAC creates noise-vibration-and-harshness (NVH) challenges. NVH challenges are significant for V6 and I4 DEAC configurations. For I4 engine configurations, manufacturers can operate the DEAC function of an engine in very few operating conditions, with limited potential to save fuel. No manufacturers sold I4 DEAC engines in the MY 2016 fleet. Typically, the smaller the engine displacement, the less opportunity DEAC provides to improve fuel consumption.

Manufacturers and suppliers continue to evaluate more improved versions of cylinder deactivation, including advanced cylinder deactivation and pairing basic cylinder deactivation with turbo charged engines. No manufacturers produced such technologies in the MY 2016 fleet. Advanced cylinder deactivation and

turbo technologies were modeled and considered separately in today's analysis.

(b) "Advanced" Engine Technologies

The analysis included "advanced" engine technologies that can deliver high levels of effectiveness but often require a significant engine design change or a new engine architecture. In the CAFE model, "basic" engine technologies may be considered in combination and applied before advanced engine technologies. "Advanced" engine technologies generally include one or more basic engine technologies in the simulation, without the need to layer on "basic" engine technologies on top of "advanced" engines. Once an advanced engine technology is applied, the model does not reconsider the basic engine technologies. The characterization of each advanced engine technology takes into account the prerequisite technologies.

Many of the newest advanced engine technologies improve effectiveness over their predecessors, but the engines may also include sophisticated materials or manufacturing processes that contribute to efficiency improvements. For instance, one recently introduced turbo charged engine uses sodium filled valve stems.¹³¹ Another recently introduced high compression ratio engine uses a sophisticated laser cladding process to manufacture valve seats and improve airflow.¹³² To fully consider these advancements (and their potential benefits), the incremental costs of these technologies, as well as the effectiveness improvements, must be accounted for.

(1) Turbocharged Engines

Turbo engines recover energy from hot exhaust gas and compress intake air, thereby increasing available airflow and increasing specific power level. Due to specific power improvements on turbo engines, engine displacement can be downsized. The downsizing reduces pumping losses and improves fuel economy at lower loads. For the NPRM analysis, a level of downsizing is assumed to be applied that achieves performance similar to the baseline naturally-aspirated engine. This assumes manufacturers would apply the benefits toward improved fuel economy

¹³¹ See Honda, "2018 Honda Accord Press Kit—Powertrain," Oct. 2, 2017. Available at <http://news.honda.com/newsandviews/article.aspx?g=honda-automobiles&id=9932-en>. (last accessed June 21, 2018).

¹³² Hakariya *et al.*, "The New Toyota Inline 4-Cylinder 2.5L Gasoline Engine," SAE Technical Paper 2017-01-1021 (Mar. 28, 2017), available at <https://www.sae.org/publications/technical-papers/content/2017-01-1021/>.

and not trade off fuel economy improvements to increase overall vehicle performance. In practice, manufacturers have often also improved some vehicle performance attributes at the expense of not maximizing potential fuel economy improvements.

Manufacturers may develop engines to operate on varying levels of boost,¹³³ with higher levels of boost achieving higher engine specific power and enabling greater levels of engine downsizing and corresponding reductions in pumping losses for improved efficiency. However, engines operating at higher boost levels are generally more susceptible to engine knock,¹³⁴ especially at higher torques and low engine speeds. Additionally, engines with higher boost levels typically require larger induction and exhaust system components, dissipate greater amounts of heat, and with greater levels of engine downsizing have increased challenges with turbo lag.¹³⁵ For these reasons, three levels of turbo downsizing technologies are separately modeled in this analysis.

The analysis also modeled turbocharged engines with parallel hybrid technology. In simulations with high stringencies, many manufacturers produced turbo-hybrid electric vehicles. In the MY 2016 fleet, of the vehicles that use parallel hybrid technology, many use turbocharged engines.

Since the Draft TAR, the turbo family engine maps were updated to reflect operation on 87 AKI regular octane fuel.¹³⁶ In the Draft TAR, turbo engine maps were developed assuming premium fuel. For this rulemaking analyses, pathways to improving fuel economy and CO₂ are analyzed, while also maintaining vehicle performance, capability, and other attributes. This includes assuming there is no change in the fuel octane required to operate the vehicle. Using 87 AKI regular octane fuel is consistent with the fuel octane that manufacturers specify for the majority of vehicles, and enables the modeling to account for important design and calibration issues associated

¹³³ Boost refers to the degree to which the turbocharger compresses the intake air for the engine, which may affect the specific power of the engine.

¹³⁴ Knock refers to rapid uncontrolled combustion in the cylinder part way through the combustion process, which can create an audible sound and can damage the engine.

¹³⁵ Turbo lag refers to the delay time between power demanded and power delivered; it is typically associated with rapid accelerations from a stopped vehicle at idle.

¹³⁶ Specifically, 87 Anti-Knock Index (AKI) Tier 3 certification fuel. 87 AKI is also known as 87 (R+M)/2 or 87 (Research Octane + Motor Octane)/2.

with regular octane fuel. Using the updated criteria assures the NPRM analysis reflects real-world constraints faced by manufacturers to assure engine durability, and acceptable drivability, noise and harshness, and addresses the over-estimation of potential fuel economy improvements related to the fuel octane assumptions, which did not fully account for these constraints, in the Draft TAR. Compared with the NHTSA analysis in the Draft TAR, these engine maps adjust the fuel use at high torque and low speed operation and at high speed operation to fully account for knock limitations with regular octane fuel.

The analysis assumes engine downsizing with the addition of turbo technology. For instance, in the simulations, manufacturers may have replaced a naturally-aspirated V8 engine with a turbo V6 engine, and manufacturers may have replaced a naturally-aspirated V6 engine with a turbo I4 engine. When manufacturers reduced the number of banks or cylinders of an engine, some cost savings is projected due to fewer cylinders and fewer valves. Such cost savings is projected to help offset the additional costs of turbo charger specific hardware, making turbo downsizing a very attractive technology progression for some engines.¹³⁷

(a) TURBO1

Level 1 Turbo Charging (TURBO1) adds a turbo charger to a DOHC engine with SGDI, VVT, and continuously VVL. The engine operates at up to 18 bar brake mean effective pressure (BMEP).

Manufacturers used Turbo1 technology in a little less than a quarter of the MY 2016 fleet with particularly high concentrations in premium vehicles.

(b) TURBO2

Level 2 Turbo Charging (TURBO2) operates at up to 24 bar BMEP. The step from Turbo1 to Turbo2 is accompanied with additional displacement downsizing for reduced pumping losses. Very few manufacturers have Turbo2 technology in the MY 2016 fleet.

(c) CEGR1

Turbo Charging with Cooled Exhaust Gas Recirculation (CEGR1) improves the knock resistance of Turbo2 engines by mixing cooled inert exhaust gases into the engine's air intake. That allows greater boost levels, more optimal spark timing for improved fuel economy, and

¹³⁷ In particular, the step from a naturally-aspirated V6 to a turbo I4 was particularly cost effective in agency simulations.

performance and greater engine downsizing for lower pumping losses. CEGR1 technology is used in only a few vehicles in the MY 2016 fleet, and many of these vehicles include high-performance utility either for towing or acceleration.

(a) Turbocharged Engine Technologies Not Considered

Previous analyses considered turbo charged engines with even higher BMEP than today's Turbo2 and CEGR1 technologies, but today's analysis does not present 27 bar BMEP turbo engines. Turbo engines with very high BMEP have demonstrated limited potential to improve fuel economy due to practical limitations on engine downsizing and tradeoffs with launch performance and drivability. Based on the analysis, and based on CBI, CEGR2 turbo engine technology was not included in this NPRM analysis.

(2) High Compression Ratio Engines (Atkinson Cycle Engines)

Atkinson cycle gasoline engines use changes in valve timing (e.g., late-intake-valve-closing or LIVC) to reduce the effective compression ratio while maintaining the expansion ratio. This approach allows a reduction in top-dead-center (TDC) clearance ratio (e.g., increase in "mechanical" or "physical" compression ratio) to increase the effective expansion ratio without increasing the effective compression ratio to a point that knock-limited operation is encountered. Increasing the expansion ratio in this manner improves thermal efficiency but also lowers peak BMEP, particularly at lower engine speeds.

Often knock concerns for these engines limit applications in high load, low RPM conditions. Some manufacturers have mitigated knock concerns by lowering back pressure with long, intricate exhaust systems, but these systems must balance knock performance with emissions tradeoffs, and the increased size of the exhaust manifold can pose packaging concerns, particularly on V-engine configurations.¹³⁸

Only a few manufacturers produced internal combustion engine vehicles with Atkinson cycle engines in MY

¹³⁸ Some HCR1 4-cylinder (I-4) engines use an intricate 4-2-1 exhaust manifold to lower backpressure and to improve engine efficiency. Manufacturers sometimes fitted such an exhaust system into a front-wheel-drive vehicle with an I-4 engine by using a high underbody tunnel or rearward dashpanel (trading off some interior space), but packaging such systems on rear-wheel-drive vehicles may pose challenges, especially if the engine has two banks and would therefore require room for two such exhaust manifolds.

2016; however, these engines are commonly paired with hybrid electric vehicle technologies due to the synergy of peak efficiency of Atkinson cycle engines and immediate torque from electric motors in strong hybrids. Atkinson cycle engines are very common on power split hybrids and are sometimes observed as part of a parallel hybrid system or plug-in hybrid system.

Atkinson cycle engines played a prominent role in EPA's January 2017 final determination, which has since been withdrawn. Today's analysis recognizes that the technology is not suitable for many vehicles due to performance, emissions and packaging issues, and/or the extensive capital and resources that would be required for manufacturers to shift from other powertrain technology pathways (such as turbocharging and downsizing) to standalone Atkinson cycle engine technology.

(a) HCR1

A number of Asian manufacturers have launched Atkinson cycle engines in smaller vehicles that do not use hybrid technologies. These production engines have been benchmarked to characterize HCR1 technology for today's analysis.

Today's analysis restricted the application of stand-alone Atkinson cycle engines in the CAFE model in some cases. The engines benchmarked for today's analysis were not suitable for MY 2016 baseline vehicle models that have 8-cylinder engines and in many cases 6-cylinder engines.

(b) HCR2

EPA conceptualized a "future" Atkinson cycle engine and published the theoretical engine map in an SAE paper.^{139 140} For this engine, EPA staff began with a best-in-class 2.0L Atkinson cycle engine and then increased the efficiency of the engine map further, through the theoretical application of additional technologies in combination, like cylinder deactivation, engine friction reduction, and cooled exhaust gas recirculation. This engine remains entirely speculative, as no production

¹³⁹ Ellies, B., Schenk, C., and Dekraker, P., "Benchmarking and Hardware-in-the-Loop Operation of a 2014 MAZDA SkyActiv 2.0L 13:1 Compression Ratio Engine," SAE Technical Paper 2016-01-1007, 2016. Available at <https://www.sae.org/publications/technical-papers/content/2016-01-1007/>.

¹⁴⁰ Lee, S., Schenk, C., and McDonald, J., "Air Flow Optimization and Calibration in High-Compression-Ratio Naturally Aspirated SI Engines with Cooled-EGR," SAE Technical Paper 2016-01-0565, 2016. Available at <https://www.sae.org/publications/technical-papers/content/2016-01-0565/>.

engine as outlined in the EPA SAE paper has ever been commercially produced or even produced as a prototype in a lab setting. Furthermore, the engine map has not been validated with hardware and bench data, even on a prototype level (as no such engine exists to test to validate the engine map).

Previously, EPA relied heavily on the HCR2 (or sometimes referred to as ATK2 in previous EPA analysis) engine as a cost effective pathway to compliance for stringent alternatives, but many engine experts questioned its technical feasibility and near term commercial practicability. Stakeholders asked for the engine to be removed from compliance simulations until the performance could be validated with engine hardware.^{141 142} While for the Draft TAR, the agencies ran full-vehicle simulations with the theoretical engine map and made these available in the CAFE model, HCR2 technology as described in EPA's SAE paper was not included in today's analysis because there has been no observable physical demonstration of the speculative technology, and many questions remain about its practicability as specified, especially in high load, low engine speed operating conditions. Simulations with EPA's HCR2 engine map produce results that approach (and sometimes exceed) diesel powertrain efficiency.¹⁴³ Given the prominence of this unproven technology in previous rule-makings, the CAFE model may be configured to consider the application of HCR2 technology for reference only.

As new engines emerge that achieve high thermal efficiency, questions may be raised as to whether the HCR2 engine is a simulation proxy for the new engine technology. It is important to conduct a thorough evaluation of the actual new production engines to measure the brake specific fuel consumption and to characterize the improvements

¹⁴¹ At NHTSA-2016-0068-0082, FCA recommended, "Remove ATK2 from OMEGA model until the performance is validated," p. viii. And FCA stated, "ATK2—High Compression engines coupled with Cylinder Deactivation and Cooled EGR are unlikely to deliver modeled results, meet customer needs, or be ready for commercial application," p. 6-9.

¹⁴² At Docket ID No EPA-HQ-OAR-2015-0827-6156, The Alliance of Automobile Manufacturers commented, "[There] is no current example of combined Atkinson, plus cooled EGR, plus cylinder deactivation technology in the present fleet to verify EPA's modeled benefits and . . . EPA could not provide physical test results replicating its modeled benefits of these combined technologies," p. 40.

¹⁴³ Thomas, J. "Drive Cycle Powertrain Efficiencies and Trends Derived from EPA Vehicle Dynamometer Results," SAE Int. J. Passeng. Cars—Mech. Syst. 7(4):2014. Available at <https://www.sae.org/publications/technical-papers/content/2014-01-2562/>.

attributable to friction and thermal efficiency before drawing conclusions. Using vehicle level data may misrepresent or conflate complex interactions between a high thermal efficiency engine, engine friction reduction, accessory load improvements, transmission technologies, mass reduction, aerodynamics, rolling resistance, and other vehicle technologies. For instance, some of the newest high compression ratio engines show improved thermal efficiency, in large part due to improved accessory loads or reduced parasitic losses from accessory systems.¹⁴⁴ The CAFE model allows for incremental improvement over existing HCR1 technologies with the addition of improved accessory devices (IACC), a technology that is available to be applied on many baseline MY 2016 vehicles with HCR1 engines and may be applied as part of a pathway of compliance to further improve the effectiveness of existing HCR1 engines.

(c) Emerging Gasoline Engine Technologies

Manufacturers and suppliers continue to invest in many emerging engine technologies, and some of these technologies are on the cusp of commercialization. Often, manufacturers submit information about new engine technologies that they may soon bring into production. When this happens, a collaborative effort is undertaken with suppliers and manufacturers to learn as much as possible and sometimes begin simulation modeling efforts. Bench data, or performance data for preproduction vehicles and engines, is usually closely held confidential business information. To properly characterize the technologies, it is often necessary to wait until the engine technologies are in production to study them.

(1) Advanced Cylinder Deactivation (ADEAC)

Advanced cylinder deactivation systems (or rolling or dynamic cylinder deactivation systems) allows a further degree of cylinder deactivation than DEAC. The technology allows the engine to vary the percentage of cylinders deactivated and the sequence in which cylinders are deactivated, essentially providing "displacement on demand" for low load operations, so long as the calibration avoids certain frequencies.

¹⁴⁴ For instance, the MY 2018 2.5L Camry engine that uses HCR technology also reduces parasitic losses with a variable capacity oil pump.

ADEAC systems may be integrated into the valvetrains with moderate modifications on OHV engines. However, while the ADEAC operating concept remains the same on DOHC engines, the valvetrain hardware configuration is very different, and application on DOHC engines is projected to be more costly per cylinder due to the valvetrain differences.

Some preproduction 8-cylinder OHV prototype vehicles were briefly evaluated for this analysis, but no production versions of the technology have been studied.

Today's analysis relied on CBI to estimate costs and effectiveness values of ADEAC. Since no engine map was available at the time of the NPRM analysis, ADEAC was estimated to improve a basic engine with VVL, VVT, SGDI, and DEAC by three percent (for 4 cylinder engines) six percent (for engines with more than 4 cylinders).

ADEAC systems will continue to be studied as production begins.

(2) Variable Compression Ratio Engines (VCR)

Engines using variable compression ratio (VCR) technology appear to be at a production-intent stage of development but also appear to be targeted primarily towards limited production, high performance and very high BMEP (27–30 bar) applications. Variable compression ratio engines work by changing the length of the piston stroke of the engine to operate at a more optimal compression ratio and improve thermal efficiency over the full range of engine operating conditions.

A number of manufacturers and suppliers provided information about VCR technologies, and several design concepts were reviewed that could achieve a similar functional outcome. In addition to design concept differences, intellectual property ownership complicates the ability of the agencies to define a VCR hardware system that could be widely adopted across the industry.

For today's analysis, VCR engines have a spot on the technology simulation tree, but VCR is not actively used in the NPRM simulation. Reasonable representations of costs and technology characterizations remain open questions for VCR engine technology and the analysis.

NHTSA is sponsoring work to develop engine maps for additional combinations of technologies. Some of these technologies being researched presently, including VCR, may be used in the analysis supporting the final rule. Please provide comment on variable compression ratio engine technology.

Should VCR technology be employed in the timeframe of this proposed rulemaking? Why or why not? Do commenters believe VCR technology will see widespread adoption in the US vehicle fleet? Why or why not? What vehicle segments may it best be suited for, and which segments would it not be best suited for? Why or why not? What cost and effectiveness values should be used if VCR is modeled for analysis? Please provide supporting data. Additionally, please provide any comments on the sponsored work related to VCR, described further in PRIA Chapter 6.3.

(3) Compression Ignition Gasoline Engines (SpCCI, HCCI)

For many years, engine developers, researchers, manufacturers have explored ways to achieve the inherent efficiency of a diesel engine while maintaining the operating characteristics of a gasoline engine. A potential pathway for striking this balance is utilizing compression ignition for gasoline fueled engines, more commonly referred to as Homogeneous Charge Compression Ignition (HCCI).

Ongoing, periodic discussions with manufacturers on future fuel saving technologies and powertrain plans have, generally, included HCCI as a long-term strategy. The technology appears to always be a strong consideration as, in theory, it provides the “best of both worlds,” meaning a way to provide diesel engine efficiency with gasoline engine performance and emissions levels.

Developments in both the research and the potential production implementation of HCCI for the US market is continually assessed. In 2017, a significant, potentially production breakthrough was announced by Mazda regarding a gasoline-fueled engine employing Spark Controlled Compression Ignition (SpCCI), where HCCI is employed for a portion of its normal operation and spark ignition is used at other times.¹⁴⁵ Soon after, Mazda publicly stated they plan to introduce this engine as part of the Skyactiv family of engines in 2019.¹⁴⁶

However, HCCI was not included in the simulation and vehicle fleet

¹⁴⁵ Mazda Next-Generation Technology—Press Information, Mazda USA (Oct. 24, 2017), <https://insidemazda.mazdausa.com/press-release/mazda-next-generation-technology-press-information/> (last visited Apr. 13, 2018).

¹⁴⁶ Mazda introduces updated 2019 CX-3 at 2018 New York International Auto Show, Mazda USA (Mar. 28, 2018), <https://insidemazda.mazdausa.com/press-release/mazda-introduces-2019-cx-3-2018-new-york-auto-show/> (last visited Apr. 13, 2018).

modeling for past rulemakings, and is not included in this NPRM analysis, primarily because effectiveness, cost, and mass market implementation readiness data are not available.

Please comment on the potential use of HCCI technology in the timeframe covered by this rule. More specifically, should HCCI be included in the final rulemaking analysis for this proposed rulemaking? Why or why not? Please provide supporting data, including effectiveness values, costs in relation varying engine types and applications, and production timing that supports the timeframe of this rulemaking.

(d) Diesel Engines

Diesel engines have several characteristics that give superior fuel efficiency, including reduced pumping losses due to lack of (or greatly reduced) throttling, high pressure direct injection of fuel, a combustion cycle that operates at a higher compression ratio, and a very lean air/fuel mixture relative to an equivalent-performance gasoline engine. This technology requires additional enablers, such as a NO_x adsorption catalyst system or a urea/ammonia selective catalytic reduction system for control of NO_x emissions during lean (excess air) operation.

(e) Alternative Fuel Engines

(1) Compressed Natural Gas (CNG)

Compressed Natural Gas (CNG) engines use compressed natural gas as a fuel source. The fuel storage and supply systems for these engines differ tremendously from gasoline, diesel, and flex fuel vehicles.

(2) Flex Fuel Engines

Flex fuel engines can run on regular gasoline and fuel blended with ethanol. These vehicles may require additional equipment in the fuel system to effectively supply different blends of fuel to the engine.

(f) Lubrication and Friction Reduction

Low-friction lubricants including low viscosity and advanced low friction lubricant oils are now available (and widely used). If manufacturers choose to make use of these lubricants, they may need to make engine changes and conduct durability testing to accommodate the lubricants. The level of low friction lubricants exceeded 85% penetration in the MY 2016 fleet.

Reduction of engine friction can be achieved through low-tension piston rings, roller cam followers, improved material coatings, more optimal thermal management, piston surface treatments, and other improvements in the design of

engine components and subsystems that improve efficient engine operation.

Manufacturers have already widely adopted both lubrication and friction reduction technologies. This analysis includes advanced engine maps that already assume application of low-friction lubricants and engine friction reduction technologies. Therefore, additional friction reduction is not considered in today's analysis.

The use and commercial development of improved lubricants and friction reduction components will continue to be monitored, including conical boring and oblong cylinders, and future analyses may be updated if new information becomes available.

5. Fuel Octane

(a) What is fuel octane level?

Gasoline octane levels are an integral part of potential engine performance. According to the United States Energy Information Administration (EIA), octane ratings are measures of fuel stability. These ratings are based on the pressure at which a fuel will spontaneously combust (auto-ignite) in a testing engine.¹⁴⁷ Spontaneous combustion is an undesired condition that will lead to serious engine damage and costly repairs for consumers if not properly managed. The higher an octane number, the more stable the fuel, mitigating the potential for spontaneous combustion, also commonly known as "knock." Modern engine control systems are sophisticated and allow manufacturers to detect when "knock" occurs during engine operation. These control systems are designed to adjust operating parameters to reduce or eliminate "knock" once detected.

In the United States, consumers are typically able to select from three distinct grades of fuel, each of which provides a different octane rating. The octane levels can vary from region to region, but on the majority, the octane levels offered are regular (the lowest octane fuel—generally 87 Anti-Knock Index (AKI) also expressed as (the average of Research Octane + Motor Octane), midgrade (the middle range octane fuel—generally 89–90 AKI), and premium (the highest octane fuel—generally 91–94 AKI).¹⁴⁸ At higher elevations, the lowest octane rating available can drop to 85 AKI.¹⁴⁹

¹⁴⁷ U.S. Energy Information Administration, *What is Octane?*, https://www.eia.gov/energyexplained/index.cfm?page=gasoline_home#tab2 (last visited Mar. 19, 2018).

¹⁴⁸ *Id.*

¹⁴⁹ See e.g., U.S. Department of Energy and U.S. Environmental Protection Agency, *What is 85 octane, and is it safe to use in my vehicle?*, <https://www.fueleconomy.gov/feg/octane.shtml#85> (last

Currently, throughout the United States, pump fuel is a blend of 90% gasoline and 10% ethanol. It is standard practice for refiners to manufacture gasoline and ship it, usually via pipelines, to bulk fuel terminals across the country. In many cases, refiners supply lower octane fuels than the minimum 87-octane required by law to these terminals. The terminals then perform blending operations to bring the fuel octane level up to the minimum required by law, and higher. In some cases, typically to lowest fuel grade, the "base fuel" is blended with ethanol, which has a typical octane rating of approximately 113. For example, in 2013, the State of Nebraska Ethanol Board defined requirements for refiners to 84-octane gas for blending to achieve 87-octane prior to final dispensing to consumers.¹⁵⁰

(b) Fuel Octane Level and Engine Performance

A typical, overarching goal of optimal spark-ignited engine design and operation is to maximize the greatest amount of energy from the fuel available, without manifesting detrimental impacts to the engine over its expected operating conditions. Design factors, such as compression ratio, intake and exhaust valve control specifications, combustion chamber and piston characteristics, among others, are all impacted by octane (stability) of the fuel consumers are anticipated to use.¹⁵¹

Vehicle manufacturers typically develop their engines and engine control system calibrations based on the fuel available to consumers. In many cases, manufacturers may recommend a fuel grade for best performance and to prevent potential damage. In some cases, manufacturers may *require* a specific fuel grade for both best performance and/or to prevent potential engine damage.

Consumers, though, may or may not choose to follow the recommendation or requirement for a specific fuel grade. Additionally, regional fuel availability

visited Mar. 19, 2018). 85 octane fuel is available in high-elevation regions where the barometric pressure is lower causing naturally-aspirated engines to operate with less air and, therefore, at lower torque and power. This creates less benefit and need for higher octane fuels as compared to at lower elevations where engine airflow, torque, and power levels are higher.

¹⁵⁰ Nebraska Ethanol Board, *Oil Refiners Change Nebraska Fuel Components*, Nebraska.gov, <http://ethanol.nebraska.gov/wordpress/oil-refiners-change-nebraska-fuel-components/> (last visited Mar. 19, 2018).

¹⁵¹ Additionally, PRIA Chapter 6 contains a brief discussion of fuel properties, octane levels used for engine simulation and in real-world testing, and how octane levels can impact performance under these test conditions.

could also limit consumer choice, or, in the case of higher elevation regions, present an opportunity for consumers to use a fuel grade that is below the minimum recommended. As such, vehicle manufacturers employ strategies for scenarios where a lower than recommended, or required, fuel grade is used, mitigating engine damage over the life of a vehicle.

When knock (also referred to as detonation) is encountered during engine operation, at the most basic level, non-turbo charged engines can reduce or eliminate knock by adjusting the timing of the spark that ignites the fuel, as well as the amounts of fuel injected at each intake stroke ("fueling"). In turbo-charged applications, boost levels are typically reduced along with spark timing and fueling adjustments. Past rulemakings have also discussed other techniques that may be employed to allow higher compression ratios, more optimal spark timing to be used without knock, such as the addition of cooled exhaust gas recirculation (EGR). Regardless of the type of spark-ignition engine or technology employed, reducing or preventing knock results in the loss of potential power output, creating a "knock-limited" constraint on performance and efficiency.

Despite limits imposed by available fuel grades, manufacturers continue to make progress in extracting more power and efficiency from spark-ignited engines. Production engines are safely operating with regular 87 AKI fuel with compression ratios and boost levels once viewed as only possible with premium fuel. According to the Department of Energy, the average gasoline octane level has remained fundamentally flat starting in the early 1980's and decreased slightly starting in the early 2000s. During this time, however, the average compression ratio for the U.S. fleet has increased from 8.4 to 10.52, a more than 20% increase, yielding the statement that, "There is some concern that in the future, auto manufacturers will reach the limit of technological increases in compression ratios without further increases in the octane of the fuel."¹⁵²

As such, manufacturers are still limited by the available fuel grades to consumers and the need to safeguard the durability of their products for all of the available fuels; thus, the potential

¹⁵² Fact of the Week, *Fact #940: August 29, 2016 Diverging Trends of Engine Compression Ratio and Gasoline Octane Rating*, U.S. Department of Energy, <https://www.energy.gov/eere/vehicles/fact-940-august-29-2016-diverging-trends-engine-compression-ratio-and-gasoline-octane> (last visited Mar. 21, 2018).

improvement in the design of spark-ignition engines continues to be overshadowed by the fuel grades available to consumers.

(c) Potential of Higher Octane Fuels

Automakers and advocacy groups have expressed support for increases to fuel octane levels for the U.S. market and are actively participating in Department of Energy research programs on the potential of higher octane fuel usage.¹⁵³ ¹⁵⁴ Some positions for potential future octane levels include advocacy for today's premium grade becoming the base grade of fuel available, which could enable low cost design changes that would improve fuel economy and CO₂. Challenges associated with this approach include the increased fuel cost to consumers who drive vehicles designed for current regular octane grade fuel that would not benefit from the use of the higher cost higher octane fuel. The net costs for a shift to higher octane fuel would persist well into the future. Net benefits for the transition would not be achieved until current regular octane fuel is not available in the North American market, causing manufacturers to redesign all engines to operate the higher octane fuel, and then after those vehicles have been in production a sufficient number of model years to largely replace the current on-road vehicle fleet. The transition to net positive benefits could take many years.

In anticipation of this proposed rulemaking, organizations such as the High Octane Low Carbon Alliance (HOLC) and the Fuel Freedom Foundation (FFA), have shared their positions on the potential for making higher octane fuels available for the U.S. market. Other stakeholders also commented to past NHTSA rulemakings

¹⁵³ Mark Phelan, *High octane gas coming—but you'll pay more for it*, Detroit Free Press (Apr. 25, 2017), <https://www.freep.com/story/money/cars/mark-phelan/2017/04/25/new-gasoline-promises-lower-emissions-higher-mpg-and-cost-octane-society-of-automotive-engineers/100716174/>.

¹⁵⁴ *The octane game: Auto industry lobbies for 95 as new regular*, Automotive News (April 17, 2018), <http://www.autonews.com/article/20180417/BLOG06/180419780/the-octane-game-auto-industry-lobbies-for-95-as-new-regular>.

and/or the Draft TAR regarding the potential for increasing octane levels for the U.S. market.

In the meetings with HOLC and the FFA, the groups advocated for the potential benefits high octane fuels could provide via the blending of non-petroleum feedstocks to increase octane levels available at the pump. The groups' positions on benefits took both a technical approach by suggesting an octane level of 100 is desired for the marketplace, as well as, the benefits from potential increased national energy security by reduced dependencies on foreign petroleum.

(d) Fuel Octane—Request for Comments

Please comment on the potential benefits, or dis-benefits, of considering the impacts of increased fuel octane levels available to consumers for purposes of the model. More specifically, please comment on how increasing fuel octane levels would play a role in product offerings and engine technologies. Are there potential improvements to fuel economy and CO₂ reductions from higher octane fuels? Why or why not? What is an ideal octane level for mass-market consumption balanced against cost and potential benefits? What are the negatives associated with increasing the available octane levels and, potentially, eliminating today's lower octane fuel blends? Please provide supporting data for your position(s).

6. Transmission Technologies

Transmissions transmit torque from the engine to the wheels. Transmissions may improve fuel efficiency primarily through two mechanisms: (1) Transmissions with more gears allow the engine to operate more regularly at the most efficient speed-load points, and (2) transmissions may have improvements in friction (gears, bearings, seals, and so on), or improvements in shift efficiency that help the transmission transfer torque more efficiently, lowering parasitic losses. These mechanisms are very different, so full-vehicle simulation is helpful to understand how a

transmission may work with complementary equipment to improve fuel economy.

Today's analysis significantly increased the number of transmissions modeled in full-vehicle simulations, attempting to more closely align the Department of Energy full-vehicle simulations with existing vehicles. Previously, EPA included just five transmissions¹⁵⁵ by vehicle class in their analysis, and often EPA represented upgrades among manual, automatic, continuously variable, and dual clutch transmissions with the same effectiveness¹⁵⁶ and cost values¹⁵⁷ within a vehicle class. Today's analysis simulated nearly 20 transmissions, with explicit assumptions about gear ratios, gear efficiencies, gear spans, shift logic, and transmission architecture.¹⁵⁸ ¹⁵⁹ This analysis improves transparency by making clear the assumptions underlying the transmissions in the full-vehicle simulations and by increasing the number of transmissions simulated since the Draft TAR. Methods will be continuously evaluated to improve transmission models in full-vehicle simulations. For the box plots of effectiveness values, as shown in the PRIA Chapter 6, all automatic transmissions are relative to a 5-speed automatic, and all manual transmissions are relative to a 5-speed manual. Table II–11 below shows the absolute costs of transmission used for this analysis including learning and retail price equivalent.

¹⁵⁵ Null, TRX11, TRX12, TRX21, TRX22.

¹⁵⁶ Draft TAR, p. 5–297 through 5–298 summarizes effectiveness values previously assumed for stepping between transmission technologies (Null, TRX11, TRX12, TRX21, TRX22).

¹⁵⁷ Draft TAR, p. 5–299. “For future vehicles, it was assumed that the costs for transitioning from one technology level (TRX11–TRX22) to another level is the same for each transmission type (AT, AMT, DCT, and CVT).”

¹⁵⁸ See PRIA Chapter 6.3.

¹⁵⁹ Ehsan, I.S., Moawad, A., Kim, N., & Rousseau, A. “A Detailed Vehicle Simulation Process To Support CAFE Standards.” ANL/ESD–18/6. Energy Systems Division, Argonne National Laboratory. 2018.

Table II-11 - Summary of Absolute Transmission Technology Cost vs. Basic Transmission, including Learning Effects and Retail Price Equivalent

Name	Technology Pathway	C-2017	C-2021	C-2025	C-2029
MT5	Manual Transmission	\$ -	\$ -	\$ -	\$ -
MT6	Manual Transmission	\$ 359.92	\$ 346.99	\$ 338.66	\$ 333.62
MT7	Manual Transmission	\$ 760.72	\$ 596.88	\$ 514.71	\$ 460.49
AT5	Automatic Transmission	\$ -	\$ -	\$ -	\$ -
AT6	Automatic Transmission	\$ (21.20)	\$ (21.17)	\$ (21.15)	\$ (21.15)
AT6L2	Automatic Transmission	\$ 496.02	\$ 385.75	\$ 356.82	\$ 343.77
AT6L3	Automatic Transmission	\$ 496.02	\$ 385.75	\$ 356.82	\$ 343.77
AT7	Automatic Transmission	\$ 66.67	\$ 51.85	\$ 47.96	\$ 46.21
AT8	Automatic Transmission	\$ 105.71	\$ 105.56	\$ 105.44	\$ 105.42
AT8L2	Automatic Transmission	\$ 426.75	\$ 331.88	\$ 306.99	\$ 295.76
AT8L3	Automatic Transmission	\$ 673.95	\$ 524.13	\$ 484.83	\$ 467.09
AT9	Automatic Transmission	\$ 230.63	\$ 179.36	\$ 165.91	\$ 159.84
AT10	Automatic Transmission	\$ 230.63	\$ 179.36	\$ 165.91	\$ 159.84
AT10L2	Automatic Transmission	\$ 477.83	\$ 371.60	\$ 343.74	\$ 331.17
CVTL2B	Automatic Transmission	\$ 430.97	\$ 411.83	\$ 398.64	\$ 388.43
DCT6	Sequential Transmission	\$ 29.37	\$ 29.33	\$ 29.30	\$ 29.29
DCT8	Sequential Transmission	\$ 693.34	\$ 692.36	\$ 691.62	\$ 691.47
CVT	CVT	\$ 246.08	\$ 235.16	\$ 227.62	\$ 221.79
CVTL2A	CVT	\$ 430.97	\$ 411.83	\$ 398.64	\$ 388.43

(a) Automatic Transmissions

Five-, six-, seven-, eight-, nine- and ten-speed automatic transmissions are optimized by changing the gear ratios to enable the engine to operate in a more efficient operating range over a broader range of vehicle operating conditions. While a six speed transmission application was most prevalent for the MYs 2012–2016 final rule, eight and

higher speed transmissions were more prevalent in the MY 2016 fleet.

“L2” and “L3” transmissions designate improved gear efficiency and reduced parasitic losses. Few transmissions in the MY 2016 fleet have achieved “L2” efficiency, and the highest level of transmission efficiencies modeled are assumed to be available in MY 2022.

(1) Continuously Variable Transmissions

Continuously variable transmission (CVT) commonly uses V-shaped pulleys connected by a metal belt rather than gears to provide ratios for operation. Unlike manual and automatic transmissions with fixed transmission ratios, continuously variable transmissions can provide fully variable and an infinite number of transmission

ratios that enable the engine to operate in a more efficient operating range over a broader range of vehicle operating conditions. In this NPRM, two levels of CVTs are considered for future vehicles. The second level CVT would have a wider transmission ratio, increased torque capacity, improvements in oil pump efficiency, lubrication improvements, and friction reduction. While CVTs work well with light loads, the technology as modeled is not suitable for larger vehicles such as trucks and large SUVs.

(2) Dual Clutch Transmissions

Dual clutch or automated shift manual transmissions (DCT) are similar to manual transmissions except for the vehicle controls shifting and launch functions. A dual-clutch automated shift manual transmission uses separate clutches for even-numbered and odd-numbered gears, so the next expected

gear is pre-selected, which allows for faster and smoother shifting. The 2012–2016 final rule limited DCT applications to a maximum of 6-speeds. Both 6-speed and 8-speed DCT transmissions are considered in today's proposal.

Dual clutch transmissions are very effective transmission technologies, and previous rule-making projected rapid, and wide adoption into the fleet. However, early DCT product launches in the U.S. market experienced shift harshness and poor launch performance, resulting in customer satisfaction issues—some so extreme as to prompt vehicle buyback campaigns.¹⁶⁰ Most manufacturers are not using DCTs in the U.S. market due to the customer satisfaction issues. Manufacturers used DCTs in about three percent of the MY 2016 fleet. Today's

¹⁶⁰ *Ford Powershift Transmission Settlement*, <http://fordtransmissionsettlement.com/> (last visited June 21, 2018).

analysis limits the application of improved DCTs to vehicles that already use DCTs. Many of these vehicles are imported performance products.

(b) Manual Transmissions

Manual 6- and 7-speed transmissions offer an additional gear ratio, sometimes with a higher overdrive gear ratio, over a 5-speed manual transmission. Similar to automatic transmissions, more gears often means the engine may operate in the efficient zone more frequently.

7. Vehicle Technologies

As discussed earlier in Section II.D.1.b)(1), several technologies were considered for this analysis, and Table II–12, Table II–13, and Table II–14 below shows the full list of vehicle technologies analyzed and the associated absolute cost.¹⁶¹

¹⁶¹ Mass reduction costs are in \$/lb.

**Table II-12 - Summary of Absolute Vehicle Technology Cost vs. Baseline for Cars,
Including Learning Effects and Retail Price Equivalent**

Name	Technology Pathway	C-2017	C-2021	C-2025	C-2029
LDB	DLR	\$ 88.32	\$ 81.14	\$ 75.14	\$ 70.94
SAX	DLR	\$ 93.43	\$ 83.15	\$ 77.05	\$ 72.87
ROLL0	ROLL	\$ -	\$ -	\$ -	\$ -
ROLL10	ROLL	\$ 7.47	\$ 6.69	\$ 6.25	\$ 5.96
ROLL20	ROLL	\$ 58.32	\$ 47.14	\$ 42.24	\$ 39.54
MR0	MR	\$ -	\$ -	\$ -	\$ -
MR1	MR	\$ 0.42	\$ 0.37	\$ 0.34	\$ 0.32
MR2	MR	\$ 0.51	\$ 0.45	\$ 0.42	\$ 0.39
MR3	MR	\$ 0.78	\$ 0.71	\$ 0.66	\$ 0.62
MR4	MR	\$ 1.44	\$ 1.17	\$ 1.04	\$ 0.95
MR5	MR	\$ 2.62	\$ 2.11	\$ 1.87	\$ 1.70
AERO0	AERO	\$ -	\$ -	\$ -	\$ -
AERO5	AERO	\$ 56.65	\$ 50.44	\$ 46.71	\$ 44.33
AERO10	AERO	\$ 115.82	\$ 103.13	\$ 95.49	\$ 90.62
AERO15	AERO	\$ 163.66	\$ 145.72	\$ 134.93	\$ 128.05
AERO20	AERO	\$ 289.56	\$ 257.82	\$ 238.72	\$ 226.56

**Table II-13 - Summary of Absolute Vehicle Technology Cost vs. Baseline for SUVs,
Including Learning Effects and Retail Price Equivalent**

Name	Technology Pathway	C-2017	C-2021	C-2025	C-2029
LDB	DLR	\$ 88.32	\$ 81.14	\$ 75.14	\$ 70.94
SAX	DLR	\$ 93.43	\$ 83.15	\$ 77.05	\$ 72.87
ROLL0	ROLL	\$ -	\$ -	\$ -	\$ -
ROLL10	ROLL	\$ 7.47	\$ 6.69	\$ 6.25	\$ 5.96
ROLL20	ROLL	\$ 58.32	\$ 47.14	\$ 42.24	\$ 39.54
MR0	MR	\$ -	\$ -	\$ -	\$ -
MR1	MR	\$ 0.25	\$ 0.22	\$ 0.20	\$ 0.19
MR2	MR	\$ 0.34	\$ 0.30	\$ 0.28	\$ 0.27
MR3	MR	\$ 0.59	\$ 0.54	\$ 0.50	\$ 0.47
MR4	MR	\$ 1.37	\$ 1.11	\$ 0.99	\$ 0.90
MR5	MR	\$ 2.44	\$ 1.96	\$ 1.74	\$ 1.58
AERO0	AERO	\$ -	\$ -	\$ -	\$ -
AERO5	AERO	\$ 56.65	\$ 50.44	\$ 46.71	\$ 44.33
AERO10	AERO	\$ 115.82	\$ 103.13	\$ 95.49	\$ 90.62
AERO15	AERO	\$ 163.66	\$ 145.72	\$ 134.93	\$ 128.05
AERO20	AERO	\$ 289.56	\$ 257.82	\$ 238.72	\$ 226.56

**Table II-14 - Summary of Absolute Vehicle Technology Cost vs. Baseline for Pickups,
Including Learning Effects and Retail Price Equivalent**

Name	Technology Pathway	C-2017	C-2021	C-2025	C-2029
LDB	DLR	\$ 88.32	\$ 81.14	\$ 75.14	\$ 70.94
SAX	DLR	\$ 93.43	\$ 83.15	\$ 77.05	\$ 72.87
ROLL0	ROLL	\$ -	\$ -	\$ -	\$ -
ROLL10	ROLL	\$ 7.47	\$ 6.69	\$ 6.25	\$ 5.96
ROLL20	ROLL	\$ 58.32	\$ 47.14	\$ 42.24	\$ 39.54
MR0	MR	\$ -	\$ -	\$ -	\$ -
MR1	MR	\$ 0.25	\$ 0.22	\$ 0.20	\$ 0.19
MR2	MR	\$ 0.34	\$ 0.30	\$ 0.28	\$ 0.27
MR3	MR	\$ 0.59	\$ 0.54	\$ 0.50	\$ 0.47
MR4	MR	\$ 1.37	\$ 1.11	\$ 0.99	\$ 0.90
MR5	MR	\$ 2.44	\$ 1.96	\$ 1.74	\$ 1.58
AERO0	AERO	\$ -	\$ -	\$ -	\$ -
AERO5	AERO	\$ 56.65	\$ 50.44	\$ 46.71	\$ 44.33
AERO10	AERO	\$ 115.82	\$ 103.13	\$ 95.49	\$ 90.62
AERO15	AERO	\$ 289.56	\$ 257.82	\$ 238.72	\$ 226.05
AERO20	AERO	\$ 755.38	\$ 672.57	\$ 622.75	\$ 591.01

(a) Reduced Rolling Resistance

Lower-rolling-resistance tires have characteristics that reduce frictional losses associated with the energy dissipated mainly in the deformation of the tires under load, thereby improving fuel economy and reducing CO₂ emissions. New for this proposal, and also marking an advance over low rolling resistance tires considered during the heavy duty greenhouse gas rulemaking,¹⁶² is a second level of lower rolling resistance tires that reduce frictional losses even further. The first level of low rolling resistance tires will have 10% rolling resistance reduction while the second level would have 20%

rolling resistance reduction. In this NPRM, baseline vehicle reference rolling resistance values were determined based on the MY 2016 vehicles rather than the MY 2008 vehicles used in the 2012 final rule. Rolling resistance values were assigned based on CBI shared by manufacturers.

In some cases, low rolling resistance tires can affect traction, which may be untenable for some high performance vehicles. For cars and SUVs with more than 405 horsepower, the analysis restricted the application of the highest levels of rolling resistance. For cars and SUVs with more than 500 horsepower, the analysis restricted the application of any additional rolling resistance technology.

(b) Reduced Aerodynamic Drag Coefficient

Aerodynamic drag reduction can be achieved via two approaches, either by reducing the drag coefficients or reducing vehicle frontal area. To reduce the drag coefficient, skirts, air dams, underbody covers, and more aerodynamic side view mirrors can be applied. In the MY 2017–2025 final rule and the 2016 Draft TAR, the analysis included two levels of aerodynamic technologies. The second level included active grille shutters, rear visors, and larger under body panels. This NPRM expanded the aerodynamic drag improvements from two levels to four to provide more discrete levels. The NPRM levels are 5%, 10%, 15%, and 20%

¹⁶² See 76 FR 57106, at 57207, 57229 (Sep. 15, 2011).

improvement relative to baseline reference vehicles. The agencies relied on the wind tunnel testing performed by National Research Council (NRC), Canada, Transport Canada (TC), and Environment and Climate Change, Canada (ECCC) to quantify the aerodynamic drag impacts of various OEM aerodynamic technologies and to explore the improvement potential of these technologies by expanding the capability and/or improving the design of MY 2016 state-of-the-art aerodynamic treatments. The agencies estimated the level of aerodynamic drag in each vehicle model in the MY 2016 baseline fleet and gathered CBI on aerodynamic drag coefficients, so each vehicle has an appropriate initial value for further improvements.

Notably, today's analysis assumes aerodynamic drag reduction can only come from reduction in the aerodynamic drag coefficient and not from reduction of frontal area.¹⁶³ For some bodystyles, the agencies have no evidence that manufacturers may be able to achieve 15% or 20% aerodynamic drag coefficient reduction relative to baseline for some bodystyles (for instance, with pickup trucks) due to form drag limitations. Previously, EPA analysis assumed some vehicles from all bodystyles could (and would) reduce aerodynamic forces by 20%, which in some cases led to future pickup trucks having aerodynamic drag coefficients better than some of today's typical cars, if frontal area were held constant. While ANL created full-vehicle simulations for trucks with 20% drag reduction, those simulations were not used in the CAFE

¹⁶³ EPA previously assumed that manufacturers could reduce frontal area as well as aerodynamic drag coefficient to achieve 20% aerodynamic force reduction relative to "Null" or initial aerodynamic technology level; however, reducing frontal area would likely degrade other utility features like interior volume, or ingress/egress.

modeling. That level of drag reduction is likely not technologically feasible with today's technology, and the analysis accordingly restricted the application of advanced levels of aerodynamics in some instances, such as in this case, due to bodystyle form drag limitations. Separate from form drag limitations, some high performance vehicles already use advanced aerodynamics technologies to generate down force, and sometimes these applications must trade-off between aerodynamic drag coefficient reduction and down force. Today's analysis does not apply 15% or 20% aerodynamic drag coefficient reduction to cars and SUVs with more than 405 horsepower.

(c) Mass Reduction

Mass Reduction can be achieved in many ways, such as material substitution, design optimization, part consolidation, improving manufacturing process, etc. The analysis utilizes mass reduction levels of 5, 10, 15, and 20% relative to a reference glider vehicle for each vehicle subsegment. For HEV, PHEV, and BEV vehicles, net mass reduction was considered, including the mass reduction applied to the glider and the added mass of electrification components. An extensive discussion of mass reduction technologies as well as the cost of mass reduction is located in Chapter 6.3 of the PRIA. The analysis included an estimated level of mass reduction technology in each vehicle model in the MY 2016 baseline fleet so that each vehicle model has an appropriate initial value for further improvements.

(d) Low Drag Brakes (LDB)

Low-drag brakes reduce the sliding friction of disc brake pads on rotors when the brakes are not engaged because the brake pads are pulled away from the rotors.

(e) Secondary Axle Disconnect (SAX)

Front or secondary axle disconnect for all-wheel drive systems provides a torque distribution disconnect between front and rear axles when torque is not required for the non-driving axle. This results in the reduction of associated parasitic energy losses.

8. Electrification Technologies

For this NPRM, the analysis of electrification technologies relies primarily on research published by the Department of Energy, ANL.¹⁶⁴ ANL's assumptions regarding all hybrid systems, including belt-integrated starter generators, strong parallel and series hybrids, plug-in hybrids,¹⁶⁵ and battery electric vehicles, and most projected technology costs were adopted for this analysis. In addition, the most recent ANL BatPaC model is used to estimate battery costs. Table II-15 and Table II-16 below show the absolute costs of all electrification technologies estimated for this NPRM analysis relative to a basic internal combustion engine vehicle with a 5-speed automatic transmission.¹⁶⁶

¹⁶⁴ Moawad et al., *Assessment of vehicle sizing, energy consumption, and cost through large-scale simulation of advanced engine technologies*, Argonne National Laboratory (March 2016), available at <https://www.autonomie.net/pdfs/Report%20ANL%20ESD-1528%20-%20Assessment%20of%20Vehicle%20Sizing,%20Energy%20Consumption%20and%20Cost%20through%20Large%20Scale%20Simulation%20of%20Advanced%20Vehicle%20Technologies%20-%201603.pdf>.

¹⁶⁵ Notably all power split hybrids, and all plug-in hybrid vehicles were assumed to be paired with a high compression ratio internal combustion engine for this analysis.

¹⁶⁶ **Note:** These costs do not include value loss for HEVs, PHEVs, and BEVs. Powertrain hardware between cars and small SUV's is often similar, especially if technology is used vehicles on the same platform; however, battery pack sizes may vary meaningfully to deliver similar range in different applications.

Table II-15 - Summary of Car and Small SUV Absolute Electrification Technology Cost Without Batteries vs. Baseline Internal Combustion Engine, Including Learning Effects and Retail Price Equivalent

Name	Technology Pathway	C-2017	C-2021	C-2025	C-2029
CONV	Electrification	\$ -	\$ -	\$ -	\$ -
SS12V	Electrification	\$ 657.92	\$ 568.03	\$ 508.83	\$ 473.05
BISG	Electrification	\$ 1,137.19	\$ 829.75	\$ 714.98	\$ 655.86
CISG	Electrification	\$ 893.28	\$ 781.09	\$ 691.89	\$ 651.54
SHEVP2	Hybrid/Electric	\$ 2,206.07	\$ 1,942.13	\$ 1,732.29	\$ 1,637.38
SHEVPS	Hybrid/Electric	\$ 6,477.91	\$ 5,664.33	\$ 5,017.49	\$ 4,724.85
PHEV30	Advanced Hybrid/Electric	\$ 8,180.35	\$ 6,956.06	\$ 6,008.25	\$ 5,587.55
PHEV50	Advanced Hybrid/Electric	\$ 8,338.69	\$ 7,011.23	\$ 5,994.55	\$ 5,546.75
BEV200	Advanced Hybrid/Electric	\$ 2,976.02	\$ 2,324.66	\$ 1,859.67	\$ 1,664.95
FCV	Advanced Hybrid/Electric	\$19,673.32	\$17,607.59	\$16,485.05	\$15,702.81

Table II-16 - Summary of Truck and Medium SUV Absolute Electrification Technology Cost Without Batteries vs. Baseline Internal Combustion Engine, Including Learning Effects and Retail Price Equivalent

Name	Technology Pathway	C-2017	C-2021	C-2025	C-2029
CONV	Electrification	\$ -	\$ -	\$ -	\$ -
SS12V	Electrification	\$ 735.31	\$ 634.85	\$ 568.69	\$ 528.70
BISG	Electrification	\$ 524.86	\$ 382.96	\$ 329.99	\$ 302.70
CISG	Electrification	\$ 1,786.54	\$ 1,562.17	\$ 1,383.78	\$ 1,303.07
SHEVP2	Hybrid/Electric	\$ 1,924.68	\$ 1,696.08	\$ 1,514.34	\$ 1,432.14
SHEVPS	Hybrid/Electric	\$ 8,038.86	\$ 7,029.24	\$ 6,226.53	\$ 5,863.38
PHEV30	Advanced Hybrid/Electric	\$10,395.42	\$ 8,839.62	\$ 7,635.17	\$ 7,100.55
PHEV50	Advanced Hybrid/Electric	\$10,683.13	\$ 8,982.46	\$ 7,679.93	\$ 7,106.23
BEV200	Advanced Hybrid/Electric	\$ 4,351.27	\$ 3,398.92	\$ 2,719.04	\$ 2,434.34
FCV	Advanced Hybrid/Electric	\$25,969.16	\$23,242.36	\$21,760.59	\$20,728.01

(a) Hybrid Technologies

(1) 12-Volt Stop-Start

12-volt Stop-Start, sometimes referred to as idle-stop or 12-volt micro hybrid, is the most basic hybrid system that facilitates idle-stop capability. These systems typically incorporate an enhanced performance battery and other features such as electric transmission pump and cooling pump to maintain vehicle systems during idle-stop.

(2) Higher Voltage Stop-Start/Belt Integrated Starter Generator

Higher Voltage Stop-Start/Belt Integrated Starter Generator (BISG), sometimes referred to as a mild hybrid system, provides idle-stop capability and uses a higher voltage battery with increased energy capacity over typical automotive batteries. The higher system voltage allows the use of a smaller, more powerful electric motor. This system replaces a standard alternator with an enhanced power, higher voltage, higher efficiency starter-alternator, that is belt driven and that can recover braking energy while the vehicle slows down (regenerative braking). Today's analysis assumes 48V systems on cars and small SUVs and high voltage systems for large SUVs and trucks. Future analysis may reference the application and operation of 48V systems on large SUVs and trucks, if applicable.

(3) Integrated Motor Assist (IMA)/Crank Integrated Starter Generator

Integrated Motor Assist (IMA)/Crank integrated starter generator (CISG) provides idle-stop capability and uses a high voltage battery with increased energy capacity over typical automotive batteries. The higher system voltage allows the use of a smaller, more powerful electric motor and reduces the weight of the wiring harness. This system replaces a standard alternator with an enhanced power, higher voltage, higher efficiency starter alternator that is crankshaft-mounted and can recover braking energy while the vehicle slows down (regenerative braking).

(4) P2 Hybrid

P2 Hybrid (SHEVP2) is a newly emerging hybrid technology that uses a transmission-integrated electric motor placed between the engine and a gearbox or CVT, much like the IMA system described above except with a wet or dry separation clutch that is used to decouple the motor/transmission from the engine. In addition, a P2 hybrid would typically be equipped with a larger electric machine. Disengaging the clutch allows all-

electric operation and more efficient brake-energy recovery. Engaging the clutch allows efficient coupling of the engine and electric motor and, when combined with a DCT transmission, reduces gear-train losses relative to power-split or 2-mode hybrid systems. Battery costs are now considered separately from other HEV hardware.

P2 Hybrid systems typically rely on the internal combustion engine to deliver high, sustained power levels. While many vehicles may use HCR1 engines as part of a hybrid powertrain, HCR1 engines may not be suitable for all vehicles, especially high performance vehicles, or vehicles designed to carry or tow large loads. Many manufacturers may prefer turbo engines (with high specific power output) for P2 Hybrid systems.

(5) Power-Split Hybrid

Power-split Hybrid (SHEVPS) is a hybrid electric drive system that replaces the traditional transmission with a single planetary gearset and a motor/generator. This motor/generator uses the engine to either charge the battery or supply additional power to the drive motor. A second, more powerful motor/generator is permanently connected to the vehicle's final drive and always turns with the wheels. The planetary gear splits engine power between the first motor/generator and the drive motor to either charge the battery or supply power to the wheels. The power-split hybrid technology is included in this analysis as an enabling technology supporting this proposal, (the agencies evaluate the P2 hybrid technology discussed above where power-split hybrids might otherwise have been appropriate). As stated above, battery costs are now considered separately from other HEV hardware. Power-split hybrid technology as modeled in this analysis is not suitable for large vehicles that must handle high loads.

The ANL Autonomie simulations assumed all power-split hybrids use a high compression ratio engine. Therefore, all vehicles equipped with SHEVPS technology in the CAFE model inputs and simulations are assumed to have high compression ratio engines.

(6) Plug-in Hybrid Electric

Plug-in hybrid electric vehicles (PHEV) are hybrid electric vehicles with the means to charge their battery packs from an outside source of electricity (usually the electric grid). These vehicles have larger battery packs with more energy storage and a greater capability to be discharged than other hybrid electric vehicles. They also use

a control system that allows the battery pack to be substantially depleted under electric-only or blended mechanical/electric operation and batteries that can be cycled in charge sustaining operation at a lower state of charge than is typical of other hybrid electric vehicles. These vehicles are sometimes referred to as Range Extended Electric Vehicles (REEV). In this NPRM analysis, PHEVs with two all-electric ranges—both a 30 mile and a 50 mile all-electric range—have been included as potential technologies. Again, battery costs are now considered separately from other PHEV hardware.

The ANL Autonomie simulations assumed all PHEVs use a high compression ratio engine. Therefore, all vehicles equipped with PHEV technology in the CAFE model inputs and simulations are assumed to have high compression ratio engines. In practice, many PHEVs recently introduced in the marketplace use turbo-charged engines in the PHEV system, and this is particularly true for PHEVs produced by European manufacturers and for other PHEV performance vehicle applications.

Please provide comment on the modeling of PHEV systems. Should turbo PHEVs be considered instead, or in addition to high compression ratio PHEVs? Why or why not? What vehicle segments may turbo PHEVs best be suited for, and which segments would it not be best suited for? What vehicle segments may high compression ratio PHEVs best be suited for, and which segments would it not be best suited for? Similarly, the analysis currently considers PHEVs with 30-mile and 50-mile all-electric range, and should other ranges be considered? For instance, a 20-mile all-electric range may decrease the battery pack size, and hence the battery pack cost relative to a 30-mile all-electric range system, while still providing electric-vehicle functionality in many applications. Do commenters believe PHEV technology will see widespread adoption in the US vehicle fleet? Why or why not? Please provide supporting data.

(b) Full Electrification and Fuel Cell Vehicles

(1) Battery Electric

Electric vehicles (EV) are equipped with all-electric drive and with systems powered by energy-optimized batteries charged primarily from grid electricity. EVs with range of 200 miles have been included as a potential technology in this NPRM. Battery costs are now considered separately from other EV hardware.

(2) Fuel Cell Electric

Fuel cell electric vehicles (FCEVs) utilize a full electric drive platform but consume electricity generated by an onboard fuel cell and hydrogen fuel. Fuel cells are electrochemical devices that directly convert reactants (hydrogen and oxygen via air) into electricity, with the potential of achieving more than twice the efficiency of conventional internal combustion engines. High pressure gaseous hydrogen storage tanks are used by most automakers for FCEVs. The high pressure tanks are similar to those used for compressed gas storage in more than 10 million CNG vehicles worldwide, except that they are designed to operate at a higher pressure (350 bar or 700 bar vs. 250 bar for CNG). FCEVs are currently produced in limited numbers and are available in limited geographic areas.

(c) Electric Vehicle Infrastructure

BEVs and PHEVs may be charged at home or elsewhere. Home chargers may access electricity from a regular wall outlet, or they may require special equipment to be installed at the home. Commercial chargers may sometimes be found at businesses or other travel locations. These chargers often may supply power to the vehicle at a faster rate of charge but often require significant capital investment to install. Time to charge, and availability and convenience of charging are significant factors for plug-in vehicle operators. For many consumers, accessible charging stations present inconveniences that may deter the adoption of battery electric and plug-in hybrid vehicles. More detail about charging and charging infrastructure, including a discussion of potential electric vehicle impacts on the electric grid, is available in the PRIA, Chapter 6. For today’s analysis, costs for installing chargers

and charge convenience is not taken into account in the CAFE model. Also, today’s analysis assumes HEVs, PHEVs, and BEVs have the same survival rates and mileage accumulation schedules as vehicles with conventional powertrains, and that HEVs, PHEVs, and BEVs never receive replacement batteries before being scrapped. The agencies invite comment on these assumptions and on data and practicable methods to implement any alternatives.

9. Accessory Technologies

Two accessory technologies, electric power steering (EPS) and improved accessories (IACC) (accessory technologies categorized for the 2012 rule) were considered in this analysis, and are described below.¹⁶⁷ Table II-17 and Table II-18 below shows the estimated absolute costs including learning effects and retail price equivalent utilized in today’s analysis.

Table II-17 - Summary of Car and Small SUV Absolute Accessory Technology Cost vs. Baseline Vehicle, Including Learning Effects and Retail Price Equivalent

Name	Technology Pathway	C-2017	C-2021	C-2025	C-2029
EPS	Electric Improvements	\$ 127.78	\$ 119.33	\$ 112.48	\$ 107.39
IACC	Electric Improvements	\$ 188.36	\$ 156.72	\$ 140.67	\$ 131.35

Table II-18 - Summary of Truck and Medium SUV Absolute Accessory Technology Cost vs. Baseline Vehicle, Including Learning Effects and Retail Price Equivalent

Name	Technology Pathway	C-2017	C-2021	C-2025	C-2029
EPS	Electric Improvements	\$ 127.78	\$ 119.33	\$ 112.48	\$ 107.39
IACC	Electric Improvements	\$ 188.36	\$ 156.72	\$ 140.67	\$ 131.35

(a) Electric Power Steering (EPS)

Electric power steering (EPS)/ Electrohydraulic power steering (EHPS) is an electrically-assisted steering system that has advantages over traditional hydraulic power steering

because it replaces a continuously operated hydraulic pump, thereby reducing parasitic losses from the accessory drive. Manufacturers have informed the agencies that full EPS systems are being developed for all

types of light-duty vehicles, including large trucks. However, this analysis applies the EHPS technology to large trucks and the EPS technology to all other light-duty vehicles.

¹⁶⁷ For further discussion of accessory technologies, see Chapter 6 of the PRIA accompanying this NPRM.

(b) Improved Accessories (IACC)

Improved accessories (IACC) may include high efficiency alternators, electrically driven (*i.e.*, on-demand) water pumps, variable geometry oil pumps, cooling fans, a mild regeneration strategy, and high efficiency alternators. It excludes other electrical accessories such as electric oil pumps and electrically driven air conditioner compressors. In the MY 2017–2025 final rule, two levels of IACC were offered as a technology path (a low improvement level and a high improvement level). Since much of the market has incorporated some of these technologies in the MY 2016 fleet, the analysis assumes all vehicles have incorporated what was previously the low level, so only the high level remains as an option for some vehicles.

10. Other Technologies Considered but Not Included in This Analysis

Manufacturers, suppliers, and researchers continue to create a diverse set of fuel economy technologies. Many high potential technologies that are still in the early stages of the development and commercialization process are still being evaluated for any final analysis. Due to uncertainties in the cost and capabilities of emerging technologies, some new and pre-production technologies are not yet a part of the CAFE model simulation. Evaluating and benchmarking promising fuel economy technologies continues to be a priority as commercial development matures.

(a) Engine Technologies

- Variable compression ratio (VCR)—varies the compression ratio and swept volume by changing the piston stroke on all cylinders. Manufacturers accomplish this by changing the effective length of the piston connecting rod, with some prototypes having a range of 8:1 to 14:1 compression ratio. In turbocharged form, early publications suggest VCR may be possible to deliver up to 35% improved efficiency over the existing equivalent-output naturally-aspirated engine.¹⁶⁸

- Opposed-piston engine—sometimes known as opposed-piston opposed-cylinder (OPOC), operates with two pistons per cylinder working in opposite reciprocal motion and running on a two-stroke combustion cycle. It has no cylinder head or valvetrain but requires a turbocharger and

supercharger for engine breathing. The efficiency may be significantly higher than MY 2016 turbocharged gasoline engines with competitive costs. This engine architecture could run on many fuels, including gasoline and diesel. Packaging constraints, emissions compliance, and performance across a wide range of operating conditions remain as open considerations. No production vehicles have been publicly announced, and multiple manufacturers continue to evaluate the technology.^{169 170}

- Dual-fuel—engine concepts such as reactivity controlled compression ignition (RCCI) combine multiple fuels (*e.g.* gasoline and diesel) in cylinder to improve brake thermal efficiency while reducing NO_x and particulate emissions. This technology is still in the research phase.¹⁷¹

- Smart accessory technologies—can improve fuel efficiency through smarter controls of existing systems given imminent or expected controls inputs in real world driving conditions. For instance, a vehicle could adjust the use of accessory systems to conserve energy and fuel as a vehicle approaches a red light. Vehicle connectivity and sensors can further refine the operation for more benefit and smoother operation.¹⁷²

- High Compression Miller Cycle Engine with Variable Geometry Turbocharger or Electric Supercharger—Atkinson cycle gasoline engines with sophisticated forced induction system that requires advanced controls. The benefits of these technologies provide better control of EGR rates and boost which is achieved with electronically controlled turbocharger or supercharger. The electric version of this technology which incorporates 48V is called E-boost.^{173 174}

¹⁶⁹ Murphy, T. *Achates: Opposed-Piston Engine makers tooling up*, Wards Auto (Jan. 23, 2017), <http://wardsauto.com/engines/achates-opposed-piston-engine-makers-tooling>.

¹⁷⁰ Our Formula, Achates Power, <http://achatespower.com/our-formula/opposed-piston/> (last visited June 21, 2018).

¹⁷¹ Robert Wagner, *Enabling the Next Generation of High Efficiency Engines*, Oak Ridge National Laboratory, U.S. Department of Energy (2012), available at https://www.energy.gov/sites/prod/files/2014/03/f8/deer12_wagner_0.pdf.

¹⁷² EfficientDynamics—The intelligent route to lower emissions, BMW Group (2007), https://www.bmwgroup.com/content/dam/bmw-group-websites/bmwgroup.com/responsibility/downloads/en/2007/Alex_ED_englische_Version.pdf.

¹⁷³ Volkswagen at the 37th Vienna Motor Symposium, Volkswagen (Apr. 28, 2016), https://www.volkswagen-media-services.com/en/detailpage/-/detail/Volkswagen-at-the-37th-Vienna-Motor-Symposium/view/3451577/5f5a4dccc90111ee56bcca439f2dcc518?p_auth=M2yfp3Ze.

¹⁷⁴ These engines may be considered in the analysis supporting the final rule, but these engine

(b) Electrified Vehicle Powertrain

- Advanced battery chemistries—many emerging battery technologies promise to eventually improve the cost, safety, charging time, and durability in comparison to the MY 2016 automotive lithium-ion batteries. For instance, many view solid state batteries as a promising medium-term automotive technology. Solid state batteries replace the battery's liquid electrolyte with a solid electrolyte to potentially improve safety, power and energy density, durability, and cost. Some variations use ceramic, polymer, or sulfide-based solid electrolytes. Multiple automakers and suppliers are exploring the technology and possible commercialization that may occur in the early 2020s.^{175 176 177}

- Supercapacitors/Ultracapacitors—An electrical energy storage device with higher power density but lower energy density than batteries. Advanced capacitors may reduce battery degradation associated with charge and discharge cycles, with some tradeoffs to cost and engineering complexity. Supercapacitors/Ultracapacitors are currently not used in parallel or as a standalone traction motor energy storage device.¹⁷⁸

- Motor/Drivetrain:
 - Lower-cost magnets for Brushless Direct Current (BLDC) motors—BLDC motor technology, common in hybrid and battery electric vehicles, uses rare earth magnets. By substituting and eliminating rare earths from the magnets, motor cost can be significantly reduced. This technology is announced, but not yet in production. The capability and material configuration of these systems remains a closely guarded trade secret.¹⁷⁹

maps were not available in time for the NPRM analysis. Please see Chapter 6.3 of the PRIA accompanying this proposal for more information.

¹⁷⁵ Schmitt, B. *Ultrafast-Charging Solid-State EV Batteries Around The Corner, Toyota Confirms*, Forbes (Jul. 25, 2017), <https://www.forbes.com/sites/bertelschmitt/2017/07/25/ultrafast-charging-solid-state-ev-batteries-around-the-corner-toyota-confirms/#5736630244bb>.

¹⁷⁶ *Moving toward clean mobility*, Robert Bosch GmbH, <https://www.bosch.com/explore-and-experience/moving-toward-clean-mobility/> (last visited June 21, 2018).

¹⁷⁷ Reuters Staff, *Honda considers developing all solid-state EV batteries*, Reuters (Dec. 21, 2017), <https://www.reuters.com/article/us-honda-nissan/honda-considers-developing-all-solid-state-ev-batteries-idUSKBN1EF0FM>.

¹⁷⁸ Burke, A. & Zhao, H. *Applications of Supercapacitors in Electric and Hybrid Vehicles*, Institute of Transportation Studies University of California, Davis (Apr. 2015), available at <https://steps.ucdavis.edu/wp-content/uploads/2017/05/2015-UCD-ITS-RR-15-09-1.pdf>.

¹⁷⁹ Buckland, K. & Sano, N. *Toyota Readies Cheaper Electric Motor by Halving Rare Earth Use*, Continued

¹⁶⁸ See *e.g.*, VC—Turbo—The world's first production-ready variable compression ratio engine, Nissan Motor Corporation (Dec. 13, 2017), <https://newsroom.nissan-global.com/releases/release-917079cb4af478a2d26bf8e5ac00ae49-vc-turbo-the-worlds-first-production-ready-variable-compression-ratio-engine>.

○ Integrated multi-phase integrated electric vehicle drivetrains. Research has been conducted on 6-phase and 9-phase integrated systems to potentially reduce cost and improve power density. Manufacturers may improve system power density through integration of the motor, inverter, control, and gearing. These systems are in the research phase.^{180 181}

(c) Transmission Technologies

- Beltless CVT—Most MY 2016, commercially available CVTs rely on belt technology. A new architecture of CVT replaces belts or pulleys with a continuously variable variator, which is a special type of planetary set with balls and rings instead of gears. The technology promises to improve efficiency, handle higher torques, and change modes more quickly. This technology may be commercially available as early as 2020.¹⁸²

- Multi-speed electric motor transmission—MY 2016 battery electric vehicle transmissions are single-speed. Multiple gears can allow for more torque multiplication at lower speeds or a downsized electric machine, increased efficiency, and higher top speed. Two-speed transmission designs are available but not currently in production.¹⁸³

(d) Energy-Harvesting Technology

- Vehicle waste heat recovery systems—Internal combustion engines convert the majority of the fuel's energy to heat. Thermoelectric generators and heat pipes can convert this heat to electricity.¹⁸⁴ Thermoelectric generators, often made of semiconductors, have been tested by automakers but have traditionally not been implemented due to low efficiency

Bloomberg (Feb. 20, 2018), <https://www.bloomberg.com/news/articles/2018-02-20/toyota-readies-cheaper-electric-motor-by-halving-rare-earth-use>.

¹⁸⁰ Burkhardt, Y., Spagnolo, A., Lucas, P., Zavesky, M., & Brockerhoff, P. "Design and analysis of a highly integrated 9-phase drivetrain for EV applications" 20 November 2014. DOI: 10.1109/ICELMACH.2014.6960219. IEEE xplora.

¹⁸¹ Patel, V., Wang, J., Nugraha, D., Vuletic, R., & Touseen, J. "Enhanced Availability of Drivetrain Through Novel Multi-Phase Permanent Magnet Machine Drive" 2016. IEEE Transactions on Industrial Electronics Pages. 469–480.

¹⁸² Murphy, T. Planets Aligning for Dana's VariGlide Beltless CVT, Wards Auto (Aug. 22, 2017), <http://wardsauto.com/technology/planets-aligning-dana-s-variglide-beltless-cvt>.

¹⁸³ Faid, S. A Highly Efficient Two Speed Transmission for Electric Vehicles (May 2015), available at http://www.evs28.org/event_file/event_file/1/pfile/EV28_Saphir_Faid.pdf.

¹⁸⁴ Orr et al., A review of car waste heat recovery systems utilising thermoelectric generators and heat pipes, 101 Applied Thermal Engineering 490–495 (May 25, 2016).

and high cost.¹⁸⁵ These systems are not yet in production.

- Suspension energy recovery—Multiple electromechanical and electrohydraulic suspension technologies exist that can convert motion from uneven roads into electricity.^{186 187} These technologies are limited to luxury vehicles with limited production volumes. This technology is not produced in 2016 but planned for production as early as 2018.¹⁸⁸

11. Air Conditioning Efficiency and Off-Cycle Technologies

(a) Air Conditioning Efficiency Technologies

Air conditioning (A/C) is a virtually standard automotive accessory, with more than 95% of new cars and light trucks sold in the United States equipped with mobile air conditioning (MAC) systems. Most of the additional air conditioning related load on an engine is due to the compressor, which pumps the refrigerant around the system loop. The less the compressor operates or the more efficiently it operates, the less load the compressor places on the engine, and the better fuel consumption will be. This high penetration means A/C systems can significantly impact energy consumed by the light duty vehicle fleet.

Vehicle manufacturers can generate credits for improved A/C systems under EPA's GHG program and receive a fuel consumption improvement value (FCIV) equal to the value of the benefit not captured on the 2-cycle test under NHTSA's CAFE program.¹⁸⁹ Table II–19 provides a "menu" of qualifying A/C technologies, with the magnitude of each improvement value or credit estimated based on the expected reduction in CO₂ emissions from the technology.¹⁹⁰ NHTSA converts the improvement in grams per mile to a FCIV for each vehicle for purposes of measuring CAFE compliance. As part of a manufacturer's compliance data, manufacturers will provide information

¹⁸⁵ Patel, P. *Powering Your Car with Waste Heat*, MIT Technology Review (May 25, 2011), <https://www.technologyreview.com/s/424092/powering-your-car-with-waste-heat/>.

¹⁸⁶ Baeuml, B. et al., *The Chassis of the Future*, Schaeffler, https://www.schaeffler.com/remotemedien/media/shared_media/08_media_library/01_publications/schaeffler_2/symposia_1/downloads_11/Schaeffler_Kolloquium_2014_27_en.pdf (last visited June 21, 2018).

¹⁸⁷ *Advanced Suspension*, Tenneco, http://www.tenneco.com/overview/rc_advanced_suspension/ (last visited June 21, 2018).

¹⁸⁸ *Audi A8 Active Chassis*, Audi, https://www.audi.com/en/innovation/design/more_personal_comfort_a8_active_chassis.html (last visited June 21, 2018).

¹⁸⁹ 77 FR 62624, 62720 (Oct. 15, 2012).

¹⁹⁰ 40 CFR 86.1868–12 (2016).

about which off-cycle technologies are present on which vehicles (see Section X for further discussion of reporting off-cycle technology information).

The 2012 final rule for MYs 2017 and later outlined two test procedures to determine credit or FCIV eligibility for A/C efficiency menu credits, the idle test, and the AC17 test. The idle test, performed while the vehicle is at idle, determined the additional CO₂ generated at idle when the A/C system is operated.¹⁹¹ The AC17 test is a four-part performance test that combines the existing SC03 driving cycle, the fuel economy highway test cycle, and a pre-conditioning cycle, and solar soak period.¹⁹² Manufacturers could use the idle test or AC17 test to determine improvement values for MYs 2014–2016, while for MYs 2017 and later, the AC17 test is the exclusive test that manufacturers can use to demonstrate eligibility for menu A/C improvement values.

In MYs 2020 and later, manufacturers will use the AC17 test to demonstrate eligibility for A/C credits and to partially quantify the amount of the credit earned. AC17 test results equal to or greater than the menu value will allow manufacturers to claim the full menu value for the credit. A test result less than the menu value will limit the amount of credit to that demonstrated on the AC17 test. In addition, for MYs 2017 and beyond, A/C fuel consumption improvement values will be available for CAFE calculations, whereas efficiency credits were previously only available for GHG compliance. The agencies proposed these changes in the 2012 final rule for MYs 2017 and later largely as a result of new data collected, as well as the extensive technical comments submitted on the proposal.¹⁹³

The pre-defined technology menu and associated car and light truck credit value is shown in Table II–19 below. The regulations include a definition of each technology that must be met to be eligible for the menu credit.¹⁹⁴ Manufacturers are not required to submit any other emissions data or information beyond meeting the definition and useful life requirements¹⁹⁵ to use the pre-defined

¹⁹¹ 75 FR 25324, 25431 (May 7, 2010). The A/C CO₂ Idle Test is run with and without the A/C system cooling the interior cabin while the vehicle's engine is operating at idle and with the system under complete control of the engine and climate control system.

¹⁹² 77 FR 62624, 62723 (Oct. 15, 2012).

¹⁹³ *Id.*

¹⁹⁴ *Id.* at 62725.

¹⁹⁵ Lifetime vehicle miles travelled (VMT) for MY 2017–2025 are 195,264 miles and 225,865 miles for passenger cars and light trucks, respectively. The manufacturer must also demonstrate that the off-

credit value. Manufacturers' use of menu-based credits for A/C efficiency is subject to a regulatory cap: 5.7 g/mi for cars and trucks through MY 2016 and separate caps of 5.0 g/mi for cars and 7.2g/mi for trucks for later MYs.¹⁹⁶

In the 2012 final rule for MYs 2017 and later, the agencies estimated that manufacturers would employ significant advanced A/C technologies throughout their fleets to improve fuel economy, and this was reflected in the stringency

cycle technology is effective for the full useful life of the vehicle. Unless the manufacturer demonstrates that the technology is not subject to in-use deterioration, the manufacturer must account for the deterioration in their analysis.

¹⁹⁶ 40 CFR 86.1868–12(b)(2) (2016).

of the standards.¹⁹⁷ Many manufacturers have since incorporated A/C technology throughout their fleets, and the utilization of advanced A/C technologies has become a significant contributor to industry compliance plans. As summarized in the EPA Manufacturer Performance Report for the 2016 model year,¹⁹⁸ 15 auto manufacturers included A/C efficiency credits as part of their compliance demonstration in the 2016 MY. These

¹⁹⁷ See e.g., 77 FR 62623, 62803–62806 (Oct. 15, 2012).

¹⁹⁸ See *Greenhouse Gas Emission Standards for Light-Duty Vehicles: Manufacturer Performance Report for the 2016 Model Year (EPA Report 420–R18–002)*, U.S. EPA (Jan. 2018), available at <https://nepis.epa.gov/Exe/ZyPDF.cgi?Dockey=P100TGLA.pdf>.

amounted to more than 12 million Mg of fuel consumption improvement values of the total net fuel consumption improvement values reported. This is equivalent to approximately four grams per mile across the 2016 fleet. Accordingly, a significant amount of new information about A/C technology and the efficacy of test procedures has become available since the 2012 final rule.

The sections below provide a brief history of the AC17 test procedure for evaluating A/C efficiency improving technology and discuss stakeholder comments on the AC17 test procedure approach and discuss A/C efficiency technology valuation through the off-cycle program.

Table II-19 - A/C Efficiency Credits and Fuel Consumption Improvement Values

Technology Description	Estimated reduction in A/C CO ₂ emissions and fuel consumption (percent)	Car A/C efficiency credit (g/mi CO ₂)	Truck A/C efficiency credit (g/mi CO ₂)	Car A/C efficiency fuel consumption improvement (gallon/mi)	Truck A/C efficiency fuel consumption improvement (gallon/mi)
Reduced reheat, with externally-controlled, variable-displacement compressor	30	1.5	2.2	0.000169	0.000248
Reduced reheat, with externally-controlled, fixed-displacement or pneumatic variable displacement compressor	20	1	1.4	0.000113	0.000158
Default to recirculated air with closed-loop control of the air supply (sensor feedback to control interior air quality) whenever the outside ambient temperature is 75 °F or higher (although deviations from this temperature are allowed based on additional analysis)	30	1.5	2.2	0.000169	0.000248
Default to recirculated air with open-loop control of the air supply (no sensor feedback) whenever the outside ambient temperature is 75 °F or higher (although deviations from this temperature are allowed if accompanied by an engineering analysis)	20	1	1.4	0.000113	0.000158
Blower motor controls that limit wasted electrical energy (e.g. pulse width modulated power controller)	15	0.8	1.1	0.00009	0.000124
Internal heat exchanger (or suction line heat exchanger)	20	1	1.4	0.000113	0.000158
Internal heat exchanger (or suction line heat exchanger)	20	1	1.4	0.000113	0.000158
Oil Separator (internal or external to compressor)	10	0.5	0.7	0.000056	0.000079

(1) Evaluation of the AC17 Test Procedure Since the Draft TAR

In developing the AC17 test procedure, the agencies sought to develop a test procedure that could more reliably generate an appropriate fuel consumption improvement value based on an “A” to “B” comparison, that is, a comparison of substantially similar vehicles in which one has the

technology and the other does not.¹⁹⁹ The agencies believe that the AC17 test procedure is more capable of detecting the effect of more efficient A/C components and controls strategies during a transient drive cycle rather

¹⁹⁹ For an explanation of how the agencies, in collaboration with stakeholders, developed the AC17 test procedure, see the 2017 and later final rule at 77 FR 62624, 62723 (Oct. 15, 2012).

than during just idle (as measured in the old idle test procedure). As described above and in the 2012 final rule,²⁰⁰ the AC17 test is a four-part performance test that combines the existing SC03 driving

²⁰⁰ See 77 FR 62624, 62723 (Oct. 15, 2012); *Joint Technical Support Document: Final Rulemaking for 2017–2025 Light-Duty Vehicle Greenhouse Gas Emission and Corporate Average Fuel Economy Standards*, U.S. EPA, National Highway Traffic Safety Administration at 5–40 (August 2012).

cycle, the fuel economy highway cycle, as well as a pre-conditioning cycle, and a solar soak period.

The agencies received several comments on the Draft TAR evaluation of the AC17 test procedure. FCA commented generally that A/C efficiency technologies “are not showing their full effect on this AC17 test as most technologies provide benefit at different temperatures and humidity conditions in comparison to a standard test conditions. All of these technologies are effective at different levels at different conditions. So there is not one size fits all in this very complex testing approach. Selecting one test that captures benefits of all of these conditions has not been possible.”²⁰¹

The agencies acknowledge that any single test procedure is unlikely to equally capture the real-world effect of every potential technology in every potential use case. Both the agencies and stakeholders understood this difficulty when developing the AC17 test procedure. While no test is perfect, the AC17 test procedure represents an industry best effort at identifying a test that would greatly improve upon the idle test by capturing a greater range of operating conditions. General industry evaluation of the AC17 test procedure is in agreement that the test achieves this objective.

FCA also noted that “[i]t is a major problem to find a baseline vehicle that is identical to the new vehicle but without the new A/C technology. This alone makes the test unworkable.”²⁰²

The agencies disagree this makes the test unworkable. The regulation describes the baseline vehicle as a “similar” vehicle, selected with good engineering judgment (such that the test comparison is not unduly affected by other differences). Also, OEMs expressed confidence in using A-to-B testing to qualify for fuel consumption improvement values for software-based A/C efficiency technologies. While hardware technologies may pose a greater challenge in locating a sufficiently similar “A” baseline vehicle, the engineering analysis provision under 40 CFR 86.1868–12(g)(2) provides an alternative to locating and performing an AC17 test on such a vehicle. Further, as the USCAR program in general and the GM Denso SAS compressor application specifically have shown, the test is able to resolve small differences in CO₂ effectiveness (1.3 grams in the latter case) when carefully conducted.

Commenters on the Draft TAR also expressed a desire for improvements in the process by which manufacturers without an “A” vehicle (for the A-to-B comparison) could apply under the engineering analysis provision, such as development of standardized engineering analysis and bench testing procedures that could support such applications. For example, Toyota requested that “EPA consider an optional method for validation via an engineering analysis, as is currently being developed by industry.”²⁰³

Similarly, the Alliance commented that, “[t]he future success of the MAC credit program in generating emissions reductions will depend to a large extent on the manner in which it is administered by EPA, especially with respect to making the AC17 A-to-B provisions function smoothly, without becoming a prohibitive obstacle to fully achieving the MAC indirect credits.”²⁰⁴

As described in the Draft TAR, in 2016, USCAR members initiated a Cooperative Research Program (CRP) through the Society of Automotive Engineers (SAE) to develop bench testing standards for the four hardware technologies in the fuel consumption improvement value menu (blower motor control, internal heat exchanger, improved evaporators and condensers, and oil separator). The intent of the program is to streamline the process of conducting bench testing and engineering analysis in support of an application for A/C credits under 40 CFR part 86.1868–12(g)(2), by creating uniform standards for bench testing and for establishing the expected GHG effect of the technology in a vehicle application.

An update to the list of SAE standards under development originally presented in the Draft TAR is listed in Table II–20. Since completion of the Draft TAR, work has continued on these standards, which appear to be nearing completion. The agencies seek comment with the latest completion of these SAE standards.

Table II-20 - Hardware Bench Testing Standards under Development by SAE Cooperative Research Program

Number	Title	Status
J2765	Procedure for Measuring System COP of a Mobile Air Conditioning System on a Test Bench	Published
J3094	Internal Heat Exchanger (IHX) Measurement Standard	Work In Progress
J3109	HVAC PWM Blower Controller Efficiency Measurement	Published
J3112	A/C Compressor Oil Separator Effectiveness Test Standard	Published

(2) A/C Efficiency Technology Valuation Through the Off-Cycle Program

The A/C technology menu, discussed at length above, includes several A/C efficiency-improving technologies that were well defined and had been quantified for effectiveness at the time of the 2012 final rule for MYs 2017 and beyond. Manufacturers claimed the vast majority of A/C efficiency credits to date

by utilizing technologies on the menu; however, the agencies recognize that manufacturers will develop additional technologies that are not currently listed on the menu. These additional A/C efficiency-improving technologies are eligible for fuel consumption improvement values on a case-by-case basis under the off-cycle program. Approval under the off-cycle program

also requires “A-to-B” comparison testing under the AC17 test, that is, testing substantially similar vehicles in which one has the technology and the other does not.

To date, the agencies have received one type off-cycle application for an A/C efficiency technology. In December 2014, General Motors submitted an off-cycle application for the Denso SAS A/

²⁰¹ See Comment by FCA US LLC, Docket ID NHTSA 2016–0068–0082, at 123–124.

²⁰² *Id.* at 124.

²⁰³ See Comment by Toyota (revised), Docket ID NHTSA–2016–0068–0088, at 23.

²⁰⁴ See Comment by Alliance of Automobile Manufacturers, Docket ID EPA–HQ–OAR–2015–0827–4089 and NHTSA–2016–0068–0072, at 160.

C compressor with variable crankcase suction valve technology, requesting an off-cycle GHG credit of 1.1 grams CO₂ per mile. In December 2017, BMW of North America, Ford Motor Company, Hyundai Motor Company, and Toyota petitioned and received approval to receive the off-cycle improvement value for the same A/C efficiency technology.²⁰⁵ EPA, in consultation with NHTSA, evaluated the applications and found methodologies described therein were sound and appropriate.²⁰⁷ Accordingly, the agencies approved the fuel economy improvement value applications.

The agencies received additional stakeholder comments on the off-cycle approval process as an alternate route to receiving A/C technology credit values. The Alliance requested that EPA “simplify and standardize the procedures for claiming off-cycle credits for the new MAC technologies that have been developed since the creation of the MAC indirect credit menu.”²⁰⁸ Other commenters noted the importance of continuing to incentivize further innovation in A/C efficiency technologies as new technologies emerge that are not listed on the menu or when manufacturers begin to reach regulatory caps. The commenters suggested that EPA should consider adding new A/C efficiency technologies to the menu and/or update the fuel consumption improvement values for technology already listed on the menu, particularly in cases where manufacturers can show through an off-cycle application that the technology actually deserves more credit than that listed on the menu. For example, Toyota commented that “the incentive values for A/C efficiency should be updated along with including new technologies being deployed.”²⁰⁹

The agencies note that some of these comments are directed towards the off-cycle technology approval process generally, which is described in more detail in Section X of this preamble. Regarding the A/C technology menu specifically, the agencies do anticipate

that new A/C technologies not currently on the menu will emerge over the time frame of the MY 2021–2026 standards. This proposal requests comment on adding one additional A/C technology to the menu—the A/C compressor with variable crankcase suction valve technology, discussed below (and also one off-cycle technology, discussed below). The agencies also request comment on whether to change any fuel economy improvement values currently assigned to technologies on the menu.

Next, as mentioned above, the menu-based improvement values for A/C efficiency established in the 2012 final rule for MYs 2017 and by end are subject to a regulatory cap. The rule set a cap of 5.7 g/mi for cars and trucks through MY 2016 and separate caps of 5.0 g/mi for cars and 7.2 g/mi for trucks for later MYs.²¹⁰ Several commenters asked EPA to reconsider the applicability of the cap to non-menu A/C efficiency technologies claimed through the off-cycle process and questioned the applicability of this cap on several different grounds. These comments appear to be in response to a Draft TAR passage that stated:

“Applications for A/C efficiency credits made under the off-cycle credit program rather than the A/C credit program will continue to be subject to the A/C efficiency credit cap” (Draft TAR, p. 5–210). The agencies considered these comments and present clarification below. As additional context, the 2012 TSD states:

“. . . air conditioner efficiency is an off-cycle technology. It is thus appropriate [. . .] to employ the standard off-cycle credit approval process [to pursue a larger credit than the menu value]. Utilization of bench tests in combination with dynamometer tests and simulations [. . .] would be an appropriate alternate method of demonstrating and quantifying technology credits (*up to the maximum level of credits allowed for A/C efficiency*) [emphasis added]. A manufacturer can choose this method even for technologies that are not currently included in the menu.”²¹¹

This suggests the concept of placing a limit on total A/C fuel consumption improvement values, even when some are granted under the off-cycle program, is not entirely new and that EPA considered the menu cap as being appropriate at the time.

A/C regulatory caps specified under 40 CFR 86.1868–12(b)(2) apply to A/C efficiency menu-based improvement

values and are not part of the off-cycle regulation (40 CFR 86.1869–12). However, it should be noted that off-cycle applications submitted via the public process pathway are decided individually on merits through a process involving public notice and opportunity for comment. In deciding whether to approve or deny a request, the agencies may take into account any factors deemed relevant, including such issues as the realization of claimed fuel consumption improvement value in real-world use. Such considerations could include synergies or interactions among applied technologies, which could potentially be addressed by application of some form of cap or other applicable limit, if warranted. Therefore, applying for A/C efficiency fuel consumption improvement values through the off-cycle provisions in 40 CFR 86.1869–12 should not be seen as a route to unlimited A/C fuel consumption improvement values. The agencies discuss air conditioning efficiency improvement values further in Section X of this NPRM.

(b) Off-Cycle Technologies

“Off-cycle” emission reductions and fuel consumption improvements can be achieved by employing off-cycle technologies resulting in real-world benefits but where that benefit is not adequately captured on the test procedures used to demonstrate compliance with fuel economy emission standards. EPA initially included off-cycle technology credits in the MY 2012–2016 rule and revised the program in the MY 2017–2025 rule.²¹² NHTSA adopted equivalent off-cycle fuel consumption improvement values for MYs 2017 and later in the MY 2017–2025 rule.²¹³

Manufacturers can demonstrate the value of off-cycle technologies in three ways: First, they may select fuel economy improvement values and CO₂ credit values from a pre-defined “menu” for off-cycle technologies that meet certain regulatory specifications. As part of a manufacturer’s compliance data, manufacturers will provide information about which off-cycle technologies are present on which vehicles.

The pre-defined list of technologies and associated off-cycle light-duty vehicle fuel economy improvement values and GHG credits is shown in Table II–21 and Table II–22 below.²¹⁴ A

²⁰⁵ EPA Decision Document: Off-Cycle Credits for BMW Group, Ford Motor Company, and Hyundai Motor Company, U.S. EPA (Dec. 2017), available at <https://nepis.epa.gov/Exe/ZyPDF.cgi?Dockey=P100TF06.pdf>.

²⁰⁶ Alternative Method for Calculating Off-cycle Credits under the Light-Duty Vehicle Greenhouse Gas Emissions Program: Applications from General Motors and Toyota Motor North America, 83 FR 8262 (Feb. 26, 2018).

²⁰⁷ *Id.*

²⁰⁸ Comment by Alliance of Automobile Manufacturers, Docket ID EPA–HQ–OAR–2015–0827–4089 and NHTSA–2016–0068–0072, at 152.

²⁰⁹ Comment by Toyota (revised), Docket ID NHTSA–2016–0068–0088, at 23.

²¹⁰ 40 C.F.R. § 86.1868–12(b)(2) (2016).

²¹¹ Joint Technical Support Document: Final Rulemaking for 2017–2025 Light-Duty Vehicle Greenhouse Gas Emission and Corporate Average Fuel Economy Standards, U.S. EPA, National Highway Traffic Safety Administration at 5–58 (August 2012).

²¹² 77 FR 62624, 62832 (Oct. 15, 2012).

²¹³ *Id.* at 62839.

²¹⁴ For a description of each technology and the derivation of the pre-defined credit levels, see Chapter 5 of the Joint Technical Support Document:

definition of each technology equipment must meet to be eligible for the menu credit is included at 40 CFR 86.1869–12(b)(4). Manufacturers are not required

to submit any other emissions data or information beyond meeting the definition and useful life requirements to use the pre-defined credit value.

Credits based on the pre-defined list are subject to an annual manufacturer fleet-wide cap of 10 g/mile.

Table II-21 - Off-Cycle Fuel Consumption Improvement Value Menu Technologies for Light Duty Vehicles

Technology	CAFE Value for Cars	CAFE Value for Light Trucks
	g/mi (gallons/mi)	g/mi (gallons/mi)
High Efficiency Exterior Lighting (at 100W)	1.0 (0.000113)	1.0 (0.000113)
Waste Heat Recovery (at 100W; scalable)	0.7 (0.000079)	0.7 (0.000079)
Solar Roof Panels (for 75 W, battery charging only)	3.3 (0.000372)	3.3 (0.000372)
Solar Roof Panels (for 75 W, active cabin ventilation plus battery charging)	2.5 (0.000282)	2.5 (0.000282)
Active Aerodynamic Improvements (scalable)	0.6 (0.000068)	1.0 (0.000113)
Engine Idle Start-Stop w/ heater circulation system	2.5 (0.000282)	4.4 (0.000496)
Engine Idle Start-Stop without/ heater circulation system	1.5 (0.000169)	2.9 (0.000327)
Active Transmission Warm-Up	1.5 (0.000169)	3.2 (0.000361)
Active Engine Warm-Up	1.5 (0.000169)	3.2 (0.000361)
Solar/Thermal Control	Up to 3.0 (0.000338)	Up to 4.3 (0.000484)

Table II-22 - Off-Cycle Fuel Consumption Improvement Value Menu Technologies for Solar/Thermal Control Technologies for light Duty Vehicles

Thermal Control Technology	CAFE Value (CO ₂ g/mi)	
	Car	Truck
Glass or Glazing	Up to 2.9 (0.000326)	Up to 3.9 (0.000439)
Active Seat Ventilation	1.0 (0.000113)	1.3 (0.000146)
Solar Reflective Paint	0.4 (0.00005)	0.5 (0.00006)
Passive Cabin Ventilation	1.7 (0.000191)	2.3 (0.000259)
Active Cabin Ventilation	2.1 (0.000236)	2.8 (0.000315)

Manufacturers can also perform their own 5-cycle testing and submit test results to the agencies with a request explaining the off-cycle technology. The additional three test cycles have different operating conditions including high speeds, rapid accelerations, high temperature with A/C operation and

cold temperature, enabling improvements to be measured for technologies that do not impact operation on the 2-cycle tests. Credits determined according to this methodology do not undergo public review.

The third pathway allows manufacturers to seek EPA approval to

use an alternative methodology for determining the value of an off-cycle technology. This option is only available if the benefit of the technology cannot be adequately demonstrated using the 5-cycle methodology. Manufacturers may also use this option to demonstrate reductions that exceed

those available via use of the predetermined menu list. The manufacturer must also demonstrate that the off-cycle technology is effective for the full useful life of the vehicle. Unless the manufacturer demonstrates that the technology is not subject to in-use deterioration, the manufacturer must account for the deterioration in their analysis.

Manufacturers must develop a methodology for demonstrating the benefit of the off-cycle technology, and EPA makes the methodology available for public comment prior to an EPA determination, in consultation with NHTSA, on whether to allow the use of the methodology to measure improvements. The data needed for this demonstration may be extensive.

Several manufacturers have requested and been granted use of alternative test methodologies for measuring improvements. In 2013, Mercedes requested off-cycle credits for the following off-cycle technologies in use or planned for implementation in the 2012–2016 model years: Stop-start systems, high-efficiency lighting, infrared glass glazing, and active seat ventilation. EPA approved methodologies for Mercedes to

determine these off-cycle credits in September 2014.²¹⁵ Subsequently, FCA, Ford, and GM requested off-cycle credits using this same methodology. FCA and Ford submitted applications for off-cycle credits from high efficiency exterior lighting, solar reflective glass/glazing, solar reflective paint, and active seat ventilation. Ford's application also demonstrated off-cycle benefits from active aerodynamic improvements (grille shutters), active transmission warm-up, active engine warm-up technologies, and engine idle stop-start. GM's application described real-world benefits of an air conditioning compressor with variable crankcase suction valve technology. EPA approved the credits for FCA, Ford, and GM in September 2015.²¹⁶ Note, however, that although EPA granted the use of alternative methodologies to determine

²¹⁵ EPA Decision Document: Mercedes-Benz Off-cycle Credits for MYs 2012–2016, U.S. EPA (Sept. 2014), available at <https://nepis.epa.gov/Exe/ZyPDF.cgi/P100KB8U.PDF?Dockey=P100KB8U.PDF>.

²¹⁶ EPA Decision Document: Off-cycle Credits for Fiat Chrysler Automobiles, Ford Motor Company, and General Motors Corporation, U.S. EPA (Sept. 2015), available at <https://nepis.epa.gov/Exe/ZyPDF.cgi/P100N19E.PDF?Dockey=P100N19E.PDF>.

credit values, manufacturers have yet to report credits to EPA based on those alternative methodologies.

As discussed below, all three methods have been used by manufacturers to generate off-cycle improvement values and credits.

(1) Use of Off-Cycle Technologies to Date

Manufacturers used a wide array of off-cycle technologies in MY 2016 to generate off-cycle GHG credits using the pre-defined menu. Table II–23 below shows the percent of each manufacturer's production volume using each menu technology reported to EPA for MY 2016 by manufacturer. Table II–24 shows the g/mile benefit each manufacturer reported across its fleet from each off-cycle technology. Like Table II–23, Table II–24 provides the mix of technologies used in MY 2016 by manufacturer and the extent to which each technology benefits each manufacturer's fleet. Fuel consumption improvement values for off-cycle technologies were not available in the CAFE program until MY 2017; therefore, only GHG off-cycle credits have been generated by manufacturers thus far.

Table II-23 - Percent of 2016 Model Year Vehicle Production Volume with Credits from the Menu, by Manufacturer & Technology (%)

Manufacturer	Active Aerodynamics		Thermal Control Technologies					Engine & Transmission Warmup		Other		
	Grille shutters	Ride height adjustment	Passive cabin ventilation	Active cabin ventilation	Active seat ventilation	Glass or glazing	Solar reflective surface coating	Active engine warmup	Active transmission warmup	Engine idle stop-start	High efficiency exterior lights	Solar panel(s)
BMW	2.9	0.0	0.0	93.9	8.3	0.3	0.0	70.8	0.0	2.8	97.3	0.0
Ford	73.7	0.0	0.0	0.0	0.0	0.0	0.0	30.4	20.7	11.0	58.8	0.0
GM	14.6	0.0	0.0	0.0	9.3	62.5	21.1	25.6	0.0	15.0	67.3	0.0
Honda	0.0	0.0	0.0	0.0	2.6	0.0	0.0	0.0	78.8	3.4	82.8	0.0
Hyundai	4.1	0.0	0.0	0.0	11.5	69.4	0.0	0.0	37.2	3.0	50.1	0.0
Jaguar Land Rover	38.4	0.0	0.0	0.0	57.9	100.0	0.0	0.0	0.0	100.0	100.0	0.0
Kia	0.8	0.0	0.0	0.0	10.6	99.1	0.0	0.0	37.1	1.0	50.3	0.0
Mercedes	0.0	0.0	0.0	0.0	17.2	4.6	0.0	0.0	0.0	81.1	81.5	0.0
Nissan	26.9	0.0	0.0	0.0	5.3	0.0	16.9	16.5	70.9	0.6	65.7	0.2
Subaru	33.6	0.0	0.0	0.0	0.0	0.0	0.0	0.0	0.0	0.0	48.1	0.0
Toyota	3.6	0.2	0.0	0.0	0.0	0.0	0.0	19.7	0.0	9.2	59.0	0.0
FCA	27.7	2.4	91.8	0.0	10.8	98.6	3.1	51.5	22.7	11.9	69.0	0.0
Fleet Total	14.6	0.4	23.5	2.3	12.2	51.9	13.2	20.7	28.2	5.8	49.1	0.0

Table II-24 - Model Year 2016 Off-Cycle Technology Fuel Consumption Improvement Value from the Menu, by Manufacturer and Technology (g/mile)

Manufacturer	Active Aerodynamics			Thermal Control Technologies				Engine & Transmission Warmup	Other				Total
	Grille shutters	Ride height adjustment	Passive cabin ventilation	Active cabin ventilation	Active seat ventilation	Glass or glazing	Solar reflective surface coating	Active engine warmup	Active transmission warmup	Engine idle stop-start	High efficiency exterior lights	Solar panel(s)	
BMW	0.0	-	-	2.0	0.1	0.0	-	1.4	-	0.1	0.7	-	6.4
Ford	1.1	-	-	-	-	-	-	0.8	0.6	0.5	0.2	-	3.2
GM	0.1	-	-	-	0.1	0.6	0.1	0.4	-	0.3	0.3	-	3.9
Honda	-	-	-	-	0.0	-	-	-	1.8	0.1	0.3	-	2.3
Hyundai	0.0	-	-	-	0.1	0.4	-	-	0.7	0.0	0.1	-	2.0
Jaguar Land Rover	0.4	-	-	-	1.2	2.8	-	-	-	6.0	1.2	-	15.7
Kia	0.0	-	-	-	0.1	0.9	-	-	0.9	0.0	0.1	-	3.0
Mercedes	-	-	-	-	0.2	0.1	-	-	-	2.2	0.8	-	3.5
Nissan	0.1	-	-	-	0.0	-	0.1	0.2	1.2	0.0	0.1	0.0	1.8
Subaru	0.1	-	-	-	-	-	-	-	-	-	0.1	-	0.2
Toyota	0.0	0.0	-	-	-	-	-	0.4	-	0.2	0.2	-	2.0
FCA	0.2	0.0	1.8	-	0.1	1.4	0.0	1.4	0.7	0.5	0.1	-	9.4
Fleet Total	0.2	0.0	0.2	0.1	0.1	0.4	0.0	0.5	0.5	0.3	0.2	0.0	2.5

Note: "0.0" indicates the manufacturer implemented that technology, but the overall penetration rate was not high enough to round to 0.1 g/mi whereas a dash indicates no use of a given technology by a manufacturer.

In 2016, manufacturers generated the vast majority of credits using the pre-defined menu.²¹⁷ Although MY 2014

²¹⁷ Thus far, the agencies have only granted one manufacturer (GM) off-cycle credits for technology based on 5-cycle testing. These credits are for an off-cycle technology used on certain GM gasoline-electric hybrid vehicles, an auxiliary electric pump, which keeps engine coolant circulating in cold

was the first year that manufacturers could generate credits using pre-defined menu values, manufacturers have acted quickly to generate substantial off-cycle improvements. FCA and Jaguar Land

weather while the vehicle is stopped and the engine is off, thus allowing the engine stop-start system to be active more frequently in cold weather.

Rover generated the most off-cycle credits on a fleet-wide basis, reporting credits equivalent to approximately 6 g/mile and 5 g/mile, respectively. Several other manufacturers report fleet-wide credits in the range of approximately 1 to 4 g/mile. In MY 2016, the fleet total across manufacturers equaled approximately 2.5 g/mile. The agencies

expect that as manufacturers continue expanding their use of off-cycle technologies, the fleet-wide effects will continue to grow with some manufacturers potentially approaching the 10 g/mile fleet-wide cap.

E. Development of Economic Assumptions and Information Used as Inputs to the Analysis

1. Purpose of Developing Economic Assumptions for Use in Modeling Analysis

(a) Overall Framework of Costs and Benefits

It is important to report the benefits and costs of this proposed action in a format that conveys useful information about how those impacts are generated and that also distinguishes the impacts of those economic consequences for private businesses and households from the effects on the remainder of the U.S. economy. A reporting format will accomplish the first objective to the

extent that it clarifies the benefits and costs of the proposed action's impacts on car and light truck producers, illustrates how these are transmitted to buyers of new vehicles, shows the action's collateral economic effects on owners of used cars and light trucks, and identifies how these impacts create costs and benefits for the remainder of the U.S. economy. It will achieve the second objective by showing clearly how the economy-wide or "social" benefits and costs of the proposed action are composed of its direct effects on vehicle producers, buyers, and users, plus the indirect or "external" benefits and costs it creates for the general public.

Table II-25 through Table II-28 present the economic benefits and costs of the proposed action to reduce CAFE and CO₂ emissions standards for model years 2021-26 at three percent and seven percent discount rates in a format that is intended to meet these objectives.

Note: They include costs which are transfers between different economic actors—these will appear as both a cost and a benefit in equal amounts (to separate affected parties). Societal cost and benefit values shown elsewhere in this document do not show costs which are transfers for the sake of simplicity but report the same net societal costs and benefits. As it indicates, the proposed action first reduces costs to manufacturers for adding technology necessary to enable new cars and light trucks to comply with fuel economy and emission regulations (line 1). It may also reduce fine payments by manufacturers who would have failed to comply with the more demanding baseline standards. Manufacturers are assumed to transfer these cost savings on to buyers by charging lower prices (line 5); although this reduces their revenues (line 3), on balance, the reduction in compliance costs and lower sales revenue leaves them financially unaffected (line 4).

**Table II-25 - Benefits and Costs Resulting from the Proposed CAFE Standards
(present values discounted at 3%)**

Line	Affected Party	Source	Private Benefits and (Costs)	Amount
1	Vehicle Manufacturers	CAFE model	Savings in technology costs to increase fuel economy	\$252.6
2			Reduced fine payments for non-compliance	\$3.0
3		assumed = -(1+2)	Net loss in revenue from lower vehicle prices	(\$255.6)
4		net = 1+2+3	Net benefits to manufacturers	\$0.0
5	New Vehicle Buyers	assumed = 3	Lower purchase prices for new vehicles	\$255.6
6		CAFE model	Reduced injuries and fatalities from higher vehicle weight	\$2.4
7			Higher fuel costs from lower fuel economy (at retail prices)*	(\$152.6)
8			Inconvenience from more frequent refueling	(\$8.5)
9			Lost mobility benefits from reduced driving	(\$61.0)
10		net = 5+6+7+8+9	Net benefits to new vehicle buyers	\$35.9
11	Used Vehicle Owners	CAFE model	Reduced costs for injuries and property damage costs from driving in used vehicles	\$88.3
12	All Private Parties	net = 4+10+11	Net private benefits	\$124.2
Line	Affected Party	Source	External Benefits and (Costs)	Amount
13	Rest of U.S. Economy	CAFE Model	Increase in climate damages from added GHG Emissions**	(\$4.3)
14			Increase in health damages from added emissions of air pollutants**	(\$1.2)
15			Increase in economic externalities from added petroleum use**	(\$10.9)
16			Reduction in civil penalty revenue	(\$3.0)
17			Reduction in external costs from lower vehicle use***	\$51.9

Line	Affected Party	Source	Private Benefits and (Costs)	Amount
18			Increase in Fuel Tax Revenues	\$19.7
19		net = 13+14+15+16+17+18	Net external benefits	\$52.1
Line	Affected Party	Source	Economy-Wide Benefits and (Costs)	Amount
20	Entire U.S. Economy	total = 1+2+5+6+11+17+18	Total benefits	\$673.5
21		total = 3+7+8+9+13+14+15+16	Total costs	(\$497.2)
22		net = 20+21 (also =12+19)	Net Benefits	\$176.3

*Value represents lost fuel savings from lowered fuel economy of MY's 2017-2029 and gained fuel savings from more quickly replacing MY's 1977 to 2029 with newer vehicles.

**Value represents lost external benefits from lowered fuel economy of MY's 2017-2029 and lowered external costs from more quickly replacing MY's 1977 to 2029 with newer vehicles.

*** Value includes lower external costs from reducing rebound effect and any change in overall fleet usage from more quickly replacing MY's 1977 to 2029 with newer vehicles.

**Table II-26 - Benefits and Costs Resulting from the Proposed CAFE Standards
(present values discounted at 7%)**

Line	Affected Party	Source	Private Benefits and (Costs)	Amount
1	Vehicle Manufacturers	CAFE model	Savings in technology costs to increase fuel economy	\$192.2
2			Reduced fine payments for non-compliance	\$2.1
3		assumed = -(1+2)	Net loss in revenue from lower vehicle prices	(\$194.3)
4		net = 1+2+3	Net benefits to manufacturers	\$0.0
5	New Vehicle Buyers	assumed = 3	Lower purchase prices for new vehicles	\$194.3
6		CAFE model	Reduced injuries and fatalities from higher vehicle weight	\$1.3
7			Higher fuel costs from lower fuel economy (at retail prices)*	(\$96.9)
8			Inconvenience from more frequent refueling	(\$5.4)
9			Lost mobility benefits from reduced driving	(\$37.1)
10	net = 5+6+7+8+9	Net benefits to new vehicle buyers	\$56.2	
11	Used Vehicle Owners	CAFE model	Reduced costs for injuries and property damage costs from driving in used vehicles	\$45.9
12	All Private Parties	net = 4+10+11	Net private benefits	\$102.1
Line	Affected Party	Source	External Benefits and (Costs)	Amount
13	Rest of U.S. Economy	CAFE Model	Increase in climate damages from added GHG Emissions**	(\$2.7)
14			Increase in health damages from added emissions of air pollutants**	(\$1.1)
15			Increase in economic externalities from added petroleum use**	(\$6.9)
16			Reduction in civil penalty revenue	(\$2.1)
17			Reduction in external costs from lower vehicle use***	\$29.6
18			Increase in Fuel Tax Revenues	\$12.7
19		net = 13+14+15+16+17+18	Net external benefits	\$29.4
Line	Affected Party	Source	Economy-Wide Benefits and (Costs)	Amount
20	Entire U.S. Economy	total = 1+2+5+6+11+17+18	Total benefits	\$478.1
21		total = 3+7+8+9+13+14+15+16	Total costs	(\$346.6)
22		net = 20+21 (also =12+19)	Net Benefits	\$131.5

*Value represents lost fuel savings from lowered fuel economy of MY's 2017-2029 and gained fuel savings from more quickly replacing MY's 1977 to 2029 with newer vehicles.

**Value represents lost external benefits from lowered fuel economy of MY's 2017-2029 and lowered external costs from more quickly replacing MY's 1977 to 2029 with newer vehicles.

*** Value includes lower external costs from reducing rebound effect and any change in overall fleet usage from more quickly replacing MY's 1977 to 2029 with newer vehicles.

**Table II-27 - Benefits and Costs Resulting from the Proposed GHG Standards
(present values discounted at 3%)**

Line	Affected Party	Source	Private Benefits and (Costs)	Amount	
1	Vehicle Manufacturers	CAFE model	Savings in technology costs to increase fuel economy	\$259.8	
2			Reduced fine payments for non-compliance	\$0.0	
3			assumed = -(1+2)	Net loss in revenue from lower vehicle prices	(\$259.8)
4			net = 1+2+3	Net benefits to manufacturers	\$0.0
5	New Vehicle Buyers	CAFE model	assumed = 3	Lower purchase prices for new vehicles	\$259.8
6			Reduced injuries and fatalities from higher vehicle weight	\$7.5	
7			Higher fuel costs from lower fuel economy (at retail prices)*	(\$165.2)	
8			Inconvenience from more frequent refueling	(\$9.4)	
9			Lost mobility benefits from reduced driving	(\$69.5)	
10			net = 5+6+7+8+9	Net benefits to new vehicle buyers	\$23.2
11	Used Vehicle Owners	CAFE model	Reduced costs for injuries and property damage costs from driving in used vehicles	\$111.0	
12	All Private Parties	net = 4+10+11	Net private benefits	\$134.2	
Line	Affected Party	Source	External Benefits and (Costs)	Amount	
13	Rest of U.S. Economy	CAFE Model	Increase in climate damages from added GHG Emissions**	(\$4.7)	
14			Increase in health damages from added emissions of air pollutants**	(\$0.8)	
15			Increase in economic externalities from added petroleum use**	(\$11.9)	
16			Reduction in civil penalty revenue	\$0.0	
17			Reduction in external costs from lower vehicle use***	\$62.4	
18			Increase in Fuel Tax Revenues	\$21.5	
19			net = 13+14+15+16+17+18	Net external benefits	\$66.5
Line	Affected Party	Source	Economy-Wide Benefits and (Costs)	Amount	
20	Entire U.S. Economy	total = 1+2+5+6+11+17+18	Total benefits	\$722.0	
21		total = 3+7+8+9+13+14+15+16	Total costs	(\$521.3)	
22		net = 20+21 (also =12+19)	Net Benefits	\$200.7	

*Value represents lost fuel savings from lowered fuel economy of MY's 2017-2029 and gained fuel savings from more quickly replacing MY's 1977 to 2029 with newer vehicles.

**Value represents lost external benefits from lowered fuel economy of MY's 2017-2029 and lowered external costs from more quickly replacing MY's 1977 to 2029 with newer vehicles.

*** Value includes lower external costs from reducing rebound effect and any change in overall fleet usage from more quickly replacing MY's 1977 to 2029 with newer vehicles.

**Table II-28 - Benefits and Costs Resulting from the Proposed GHG Standards
(present values discounted at 7%)**

Line	Affected Party	Source	Private Benefits and (Costs)	Amount
1	Vehicle Manufacturers	CAFE model	Savings in technology costs to increase fuel economy	\$195.6
2			Reduced fine payments for non-compliance	\$0.0
3		assumed = -(1+2)	Net loss in revenue from lower vehicle prices	(\$195.6)
4		net = 1+2+3	Net benefits to manufacturers	\$0.0
5	New Vehicle Buyers	assumed = 3	Lower purchase prices for new vehicles	\$195.6
6		CAFE model	Reduced injuries and fatalities from higher vehicle weight	\$4.4
7			Higher fuel costs from lower fuel economy (at retail prices)*	(\$105.3)
8			Inconvenience from more frequent refueling	(\$6.0)
9			Lost mobility benefits from reduced driving	(\$42.0)
10		net = 5+6+7+8+9	Net benefits to new vehicle buyers	\$46.7
11	Used Vehicle Owners	CAFE model	Reduced costs for injuries and property damage costs from driving in used vehicles	\$56.7
12	All Private Parties	net = 4+10+11	Net private benefits	\$103.4
Line	Affected Party	Source	External Benefits and (Costs)	Amount
13	Rest of U.S. Economy	CAFE Model	Increase in climate damages from added GHG Emissions**	(\$3.0)
14			Increase in health damages from added emissions of air pollutants**	(\$1.0)
15			Increase in economic externalities from added petroleum use**	(\$7.6)
16			Reduction in civil penalty revenue	\$0.0
17			Reduction in external costs from lower vehicle use***	\$35.0
18			Increase in Fuel Tax Revenues	\$13.8
19		net = 13+14+15+16+17+18	Net external benefits	\$37.2
Line	Affected Party	Source	Economy-Wide Benefits and (Costs)	Amount
20	Entire U.S. Economy	total = 1+2+5+6+11+17+18	Total benefits	\$501.1
21		total = 3+7+8+9+13+14+15+16	Total costs	(\$360.5)
22		net = 20+21 (also =12+19)	Net Benefits	\$140.6

*Value represents lost fuel savings from lowered fuel economy of MY's 2017-2029 and gained fuel savings from more quickly replacing MY's 1977 to 2029 with newer vehicles.

**Value represents lost external benefits from lowered fuel economy of MY's 2017-2029 and lowered external costs from more quickly replacing MY's 1977 to 2029 with newer vehicles.

*** Value includes lower external costs from reducing rebound effect and any change in overall fleet usage from more quickly replacing MY's 1977 to 2029 with newer vehicles.

As the tables show, most impacts of the proposed action will fall on the businesses and individuals who design, manufacture, and sell (at retail and wholesale) cars and light trucks, the

consumers who purchase, drive, and subsequently sell or trade-in new models (and ultimately bear the cost of fuel economy technology), and owners of used cars and light trucks produced

during model years prior to those covered by this action. Compared to the baseline standards, if the preferred alternative is finalized, buyers of new cars and light trucks will benefit from

their lower purchase prices and financing costs (line 5). They will also avoid the increased risks of being injured in crashes that would have resulted from manufacturers' efforts to reduce the weight of new models to comply with the baseline standards, which represents another benefit from reducing stringency vis-à-vis the baseline (line 6).

At the same time, new cars and light trucks will offer lower fuel economy with more lenient standards in place, and this imposes various costs on their buyers and users. Drivers will experience higher costs as a consequence of new vehicles' increased fuel consumption (line 7), and from the added inconvenience of more frequent refueling stops required by their reduced driving range (line 8). They will also forego some mobility benefits as they use newly-purchased cars and light trucks less in response to their higher fueling costs, although this loss will be almost fully offset by the fuel and other costs they save by driving less (line 9). On balance, consumers of new cars and light trucks produced during the model years subject to this proposed action will experience significant economic benefits (line 10).

By lowering prices for new cars and light trucks, this proposed action will cause some owners of used vehicles to retire them from service earlier than they would otherwise have done, and replace them with new models. In effect, it will transfer some driving that would have been done in used cars and light trucks under the baseline scenario to newer and safer models, thus reducing costs for injuries (both fatal and less severe) and property damages sustained in motor vehicle crashes. This improvement in safety results from the fact that cars and light trucks have become progressively more protective in crashes over time (and also slightly less prone to certain types of crashes, such as rollovers). Thus, shifting some travel from older to newer models reduces injuries and damages sustained by drivers and passengers because they are traveling in inherently safer vehicles and not because it changes the risk profiles of drivers themselves. This reduction in injury risks and other damage costs produces benefits to owners and drivers of older cars and light trucks. This also results in benefits in terms of improved fuel economy and significant reductions of emissions from newer vehicles (line 11).

Table II–27 through Table II–28 also show that the changes in fuel consumption and vehicle use resulting from this proposed action will in turn generate both benefits and costs to the

remainder of the U.S. economy. These impacts are “external,” in the sense that they are by-products of decisions by private firms and individuals that alter vehicle use and fuel consumption but are experienced broadly throughout the U.S. economy rather than by the firms and individuals who indirectly cause them. Increased refining and consumption of petroleum-based fuel will increase emissions of carbon dioxide and other greenhouse gases that theoretically contribute to climate change, and some of the resulting (albeit uncertain) increase in economic damages from future changes in the global climate will be borne throughout the U.S. economy (line 13). Similarly, added fuel production and use will increase emissions of more localized air pollutants (or their chemical precursors), and the resulting increase in the U.S. population's exposure to harmful levels of these pollutants will lead to somewhat higher costs from its adverse effects on health (line 14). On the other hand, it is expected that the proposed standards, by reducing new vehicle prices relative to the baseline, will accelerate fleet turnover to cleaner, safer, more efficient vehicles (as compared to used vehicles that might otherwise continue to be driven or purchased).

As discussed in PRIA Section 9.8, increased consumption and imports of crude petroleum for refining higher volumes of gasoline and diesel will also impose some external costs throughout the U.S. economy, in the form of potential losses in production and costs for businesses and households to adjust rapidly to sudden changes in energy prices (line 15 of the table), although these costs should be tempered by increasing U.S. oil production.²¹⁸ Reductions in driving by buyers of new cars and light trucks in response to their higher operating costs will also reduce the external costs associated with their contributions to traffic delays and noise levels in urban areas, and these

²¹⁸ **Note:** This output was based upon the EIA Annual Energy Outlook from 2017. The 2018 Annual Energy Outlook projects the U.S. will be a net exporter by around 2029, with net exports peaking at around 0.5 mbd circa 2040. See Annual Energy Outlook 2018, U.S. Energy Information Administration, at 53 (Feb. 6, 2018), <https://www.eia.gov/outlooks/aeo/pdf/AEO2018.pdf>. Furthermore, pursuant to Executive Order 13783 (Promoting Energy Independence and Economy Growth), agencies are expected to review and revise or rescind policies that unduly burden the development of domestic energy resources beyond what is necessary to protect the public interest or otherwise comply with the law. Therefore, it is reasonable to anticipate further increases in domestic production of petroleum. The agencies may update the analysis and table to account for this revised information.

additional benefits will be experienced throughout much of the U.S. economy (line 17). Finally, some of the higher fuel costs to buyers of new cars and light trucks will consist of increased fuel taxes; this increase in revenue will enable Federal and State government agencies to provide higher levels of road capacity or maintenance, producing benefits for all road and transit users (line 18).

On balance, Table II–27 through Table II–28 show that the U.S. economy as a whole will experience large net economic benefits from the proposed action (line 22). While the proposal to establish less stringent CAFE and GHG emission standards will produce net external economic costs, as the increase in environmental and energy security externalities outweighs external benefits from reduced driving and higher fuel tax revenue (line 19), the table also shows that combined benefits to vehicle manufacturers, buyers, and users of cars and light trucks, and the general public (line 20), including the value of the lives saved and injuries avoided, will greatly outweigh the combined economic costs they experience as a consequence of this proposed action (line 21).

The finding that this action to reduce the stringency of previously-established CAFE and GHG standards will create significant net economic benefits—when it was initially claimed that establishing those standards would also generate large economic benefits to vehicle buyers and others throughout the economy—is notable. This contrast with the earlier finding is explained by the availability of updated information on the costs and effectiveness of technologies that will remain available to improve fuel economy in model years 2021 and beyond, the fleet-wide consequences for vehicle use, fuel consumption, and safety from requiring higher fuel economy (that is, considering these consequences for used cars and light trucks as well as new ones), and new estimates of some external costs of fuel in petroleum use.

2. Macroeconomic Assumptions That Affect the Benefit Cost Analysis

Unlike previous CAFE and GHG rulemaking analyses, the economic context in which the alternatives are simulated is more explicit. While both this analysis and previous analyses contained fuel price projections from the Annual Energy Outlook, which has embedded assumptions about future macroeconomic conditions, this analysis requires explicit assumptions about future GDP growth, labor force participation, and interest rates in order to evaluate the alternatives.

Table-II-29 - Macroeconomic Projections through CY 2050

Calendar Year	Real Interest Rate	Real GDP Growth Rate	Labor Force Participation (thousands)
2015	2.70	2.60	122,700
2016	1.00	1.60	124,248
2017	-0.30	2.90	125,739
2018	-0.30	3.00	127,625
2019	1.10	3.00	129,284
2020	1.70	2.90	130,577
2021	2.00	2.70	131,752
2022	2.20	2.40	132,674
2023	2.40	2.20	133,471
2024	2.40	2.20	134,271
2025	2.60	2.20	135,077
2026	2.70	2.10	135,887
2027	2.70	2.20	136,703
2028	2.70	2.20	137,386
2029	2.70	2.20	138,073
2030	2.70	2.10	138,764
2031	2.70	2.10	139,457
2032	2.70	2.10	140,155
2033	2.70	2.10	140,855
2034	2.70	2.10	141,560
2035	2.70	2.10	142,268
2036	2.70	2.10	142,979
2037	2.70	2.10	143,694
2038	2.70	2.20	144,556
2039	2.70	2.20	145,423
2040	2.70	2.20	146,296
2041	2.70	2.20	147,174
2042	2.70	2.20	148,057
2043	2.70	2.20	148,945
2044	2.70	2.20	149,839
2045	2.70	2.20	150,738
2046	2.70	2.20	151,642
2047	2.70	2.20	152,552
2048	2.70	2.20	153,467
2049	2.70	2.20	154,388
2050	2.70	2.20	155,314

The analysis simulates compliance through MY 2032 explicitly and must consider the full useful lives of those vehicles, approximately 40 years, in

order to estimate their lifetime mileage accumulation and fuel consumption. This means that any macroeconomic forecast influencing those factors must

cover a similar span of years. Due to the long time horizon, a source that regularly produces such lengthy forecasts of these factors was selected:

the 2017 OASDI Trustees Report from the U.S. Social Security Administration. While Table–II–29 only displays assumptions through CY 2050, the remaining years merely continue the trends present in the table.

The analysis once again uses fuel price projections from the 2017 Annual Energy Outlook.²¹⁹ The projections by

²¹⁹ The central analysis supporting today's proposal uses reference case estimates of fuel prices reported in the Energy Information Administration's (EIA's) Annual Energy Outlook 2017 (AEO 2017). Today's proposal also examines the sensitivity of this analysis to changes in key inputs, including fuel prices, and includes cases that apply fuel prices from the AEO 2017 low oil price and high oil price cases. The reference case prices are considerably lower than AEO 2011-based reference cases prices applied in the 2012

rulemaking, and this is one of several important changes in circumstances supporting revision of previously-issued standards.

After significant portions of today's analysis had already been completed, EIA released AEO 2018, which reports reference case fuel prices about 10% higher than reported in AEO 2017, though still well below the above-mentioned prices from AEO 2011. The sensitivity analysis therefore includes a case that applies fuel prices from the AEO 2018 reference case. The AEO 2018 low oil price case reports fuel prices somewhat higher than the AEO 2017 low oil price case, and the AEO 2018 high oil price case reports fuel prices very similar to the AEO 2017 high oil price case. Adding the AEO 2018 low and high oil price cases to the sensitivity analysis would thus have provided little, if any, additional insight into the sensitivity of the analysis to fuel prices. As shown in the summary of the sensitivity analysis, results obtained applying AEO 2018-based fuel prices are similar to those obtained applying AEO 2017-based fuel prices. For example,

fuel calendar year and fuel type are presented in Table–II–30, in real 2016 dollars. Fuel prices in this analysis affect not only the value of each gallon of fuel consumed but relative valuation of fuel-saving technologies demanded by the market as a result of their associated fuel savings.

net benefits between the two are about five percent different, especially considering that decisions regarding future standards are not single-factor decisions, but rather reflect a balancing of factors, applying AEO 2018-based fuel prices would not materially change the extent to which today's analysis supports the selection of the preferred alternative.

Like other inputs to the analysis, fuel prices will be updated for the analysis supporting the final rule after consideration of related new information and public comment.

Table-II-30 - Fuel Price Projections through CY 2050

Calendar Year	Gasoline (\$/gallon)	Diesel (\$/gallon)	Electricity (\$/kwh)
2015	2.55	2.76	0.11
2016	2.21	2.31	0.10
2017	2.30	2.63	0.10
2018	2.28	2.90	0.10
2019	2.48	3.08	0.11
2020	2.59	3.19	0.11
2021	2.71	3.27	0.11
2022	2.83	3.35	0.11
2023	2.86	3.41	0.11
2024	2.88	3.45	0.11
2025	2.93	3.51	0.11
2026	2.98	3.57	0.11
2027	2.99	3.59	0.11
2028	2.98	3.60	0.11
2029	3.01	3.64	0.11
2030	3.06	3.71	0.11
2031	3.10	3.76	0.11
2032	3.14	3.82	0.11
2033	3.13	3.82	0.11
2034	3.17	3.86	0.11
2035	3.19	3.88	0.11
2036	3.25	3.95	0.11
2037	3.26	3.97	0.11
2038	3.27	3.97	0.11
2039	3.32	4.02	0.11
2040	3.35	4.05	0.11
2041	3.37	4.07	0.11
2042	3.37	4.07	0.11
2043	3.36	4.07	0.11
2044	3.37	4.09	0.11
2045	3.38	4.10	0.11
2046	3.39	4.13	0.11
2047	3.41	4.17	0.11
2048	3.41	4.16	0.11
2049	3.42	4.18	0.12
2050	3.46	4.24	0.12

3. New Vehicle Sales and Employment Assumptions

In all previous CAFE and GHG rulemaking analyses, static fleet forecasts that were based on a

combination of manufacturer compliance data, public data sources, and proprietary forecasts were used. When simulating compliance with regulatory alternatives, the analysis projected identical sales across the

alternatives, for each manufacturer down to the make/model level where the exact same number of each model variant was simulated to be sold in a given model year under both the least stringent alternative (typically the

baseline) and the most stringent alternative considered. To the extent that an alternative matched the assumptions made in the production of the proprietary forecast, using a static fleet based upon those assumptions may have been warranted. However, it seems intuitive that any sufficiently large span of regulatory alternatives would contain alternatives for which that static forecast was unrepresentative. A number of commenters have encouraged consideration of the potential impact of CAFE/GHG standards on new vehicle prices and sales, and the changes to compliance strategies that those shifts could necessitate.²²⁰ In particular, the continued growth of the utility vehicle segment creates compliance challenges within some manufacturers' fleets as sales volumes shift from one region of the footprint curve to another.

Any model of sales response must satisfy two requirements: It must be appropriate for use in the CAFE model, and it must be econometrically reasonable. The first of these requirements implies that any variable used in the estimation of the econometric model, must also be available as a forecast throughout the duration of the years covered by the simulations (this analysis explicitly simulates compliance through MY 2032). Some values the model calculates endogenously, making them available in future years for sales estimation, but others must be known in advance of the simulation. As the CAFE model simulates compliance, it accumulates technology costs across the industry and over time. By starting with the last known transaction price and adding the accumulated technology cost to that value, the model is able to represent the average selling price in each future model year assuming that manufacturers are able to pass all of their compliance costs on to buyers of new vehicles. Other variables used in the estimation must enter the model as inputs prior to the start of the compliance simulation.

(a) How do car and light truck buyers value improved fuel economy?

How potential buyers value improvements in the fuel economy of new cars and light trucks is an important issue in assessing the benefits and costs of government regulation. If buyers fully value the savings in fuel costs that result from higher fuel economy, manufacturers will presumably supply any improvements that buyers demand, and vehicle prices

will fully reflect future fuel cost savings consumers would realize from owning—and potentially re-selling—more fuel-efficient models. In this case, more stringent fuel economy standards will impose net costs on vehicle owners and can only result in social benefits by correcting externalities, since consumers would already fully incorporate private savings into their purchase decisions. If instead consumers systematically undervalue the cost savings generated by improvements in fuel economy when choosing among competing models, more stringent fuel economy standards will also lead manufacturers to adopt improvements in fuel economy that buyers might not choose despite the cost savings they offer.

The potential for car buyers to forego improvements in fuel economy that offer savings exceeding their initial costs is one example of what is often termed the “energy-efficiency gap.” This appearance of such a gap, between the level of energy efficiency that would minimize consumers' overall expenses and what they actually purchase, is typically based on engineering calculations that compare the initial cost for providing higher energy efficiency to the discounted present value of the resulting savings in future energy costs.

There has long been an active debate about why such a gap might arise and whether it actually exists. Economic theory predicts that individuals will purchase more energy-efficient products only if the savings in future energy costs they offer promise to offset their higher initial costs. However, the additional cost of a more energy-efficient product includes more than just the cost of the technology necessary to improve its efficiency; it also includes the opportunity cost of any other desirable features that consumers give up when they choose the more efficient alternative. In the context of vehicles, whether the expected fuel savings outweigh the opportunity cost of purchasing a model offering higher fuel economy will depend on how much its buyer expects to drive, his or her expectations about future fuel prices, the discount rate he or she uses to value future expenses, the expected effect on resale value, and whether more efficient models offer equivalent attributes such as performance, carrying capacity, reliability, quality, or other characteristics.

Published literature has offered little consensus about consumers' willingness-to-pay for greater fuel economy, and whether it implies over-, under- or full-valuation of the expected

fuel savings from purchasing a model with higher fuel economy. Most studies have relied on car buyers' purchasing behavior to estimate their willingness-to-pay for future fuel savings; a typical approach has been to use “discrete choice” models that relate individual buyers' choices among competing vehicles to their purchase prices, fuel economy, and other attributes (such as performance, carrying capacity, and reliability), and to infer buyers' valuation of higher fuel economy from the relative importance of purchase prices and fuel economy.²²¹ Empirical estimates using this approach span a wide range, extending from substantial undervaluation of fuel savings to significant overvaluation, thus making it difficult to draw solid conclusions about the influence of fuel economy on vehicle buyers' choices (see Helfand & Wolverton, 2011; Green (2010) for detailed reviews of these cross-sectional studies). Because a vehicle's price is often correlated with its other attributes (both measured and unobserved), analysts have often used instrumental variables or other approaches to address endogeneity and other resulting concerns (e.g., Barry, *et al.* 1995).

Despite these efforts, more recent research has criticized these cross-sectional studies; some have questioned the effectiveness of the instruments they use (Allcott & Greenstone, 2012), while others have observed that coefficients estimated using non-linear statistical methods can be sensitive to the optimization algorithm and starting values (Knittel & Metaxoglou, 2014). Collinearity (*i.e.*, high correlations) among vehicle attributes—most notably among fuel economy, performance or power, and vehicle size—and between vehicles' measured and unobserved features also raises questions about the reliability and interpretation of coefficients that may conflate the value of fuel economy with other attributes (Sallee, *et al.*, 2016; Busse, *et al.*, 2013; Allcott & Wozny, 2014; Allcott & Greenstone, 2012; Helfand & Wolverton, 2011).

In an effort to overcome shortcomings of past analyses, three recently published studies rely on panel data from sales of individual vehicle models to improve their reliability in identifying the association between vehicles' prices and their fuel economy (Sallee, *et al.* 2016; Allcott & Wozny, 2014; Busse, *et al.*, 2013). Although they differ in certain details, each of these

²²¹ In a typical vehicle choice model, the ratio of estimated coefficients on fuel economy—or more commonly, fuel cost per mile driven—and purchase price is used to infer the dollar value buyers attach to slightly higher fuel economy.

²²⁰ See e.g., Comment by Alliance of Automobile Manufacturers, Docket ID EPA-HQ-OAR-2015-0827-4089 and NHTSA-2016-0068-0072.

analyses relates changes over time in individual models' selling prices to fluctuations in fuel prices, differences in their fuel economy, and increases in their age and accumulated use, which affects their expected remaining life, and thus their market value. Because a vehicle's future fuel costs are a function of both its fuel economy and expected gasoline prices, changes in fuel prices have different effects on the market values of vehicles with different fuel economy; comparing these effects over time and among vehicle models reveals the fraction of changes in fuel costs that is reflected in changes in their selling prices (Allcott & Wozny, 2014). Using very large samples of sales enables these studies to define vehicle models at an extremely disaggregated level, which enables their authors to isolate differences in their fuel economy from the many other attributes, including those that are difficult to observe or measure, that affect their sale prices.²²²

These studies point to a somewhat narrower range of estimates than suggested by previous cross-sectional studies; more importantly, they consistently suggest that buyers value a

large proportion—and perhaps even all—of the future savings that models with higher fuel economy offer.²²³ Because they rely on estimates of fuel costs over vehicles' expected remaining lifetimes, these studies' estimates of how buyers value fuel economy are sensitive to the strategies they use to isolate differences among individual models' fuel economy, as well as to their assumptions about buyers' discount rates and gasoline price expectations, among others. Since Anderson *et al.* (2013) find evidence that consumers expect future gasoline prices to resemble current prices, we use this assumption to compare the findings of the three studies and examine how their findings vary with the discount rates buyers apply to future fuel savings.²²⁴

²²³ Killian & Sims (2006) and Sawhill (2008) rely on similar longitudinal approaches to examine consumer valuation of fuel economy except that they use average values or list prices instead of actual transaction prices. Since these studies remain unpublished, their empirical results are subject to change, and they are excluded from this discussion.

²²⁴ Each of the studies makes slightly different assumptions about appropriate discount rates. Sallee *et al.* (2016) use five percent in their base specification, while Allcott & Wozny (2014) rely on six percent. As some authors note, a five to six percent discount rate is consistent with current interest rates on car loans, but they also acknowledge that borrowing rates could be higher in some cases, which could be justify higher discount rates. Rather than assuming a specific discount rate, Busse *et al.* (2013) directly estimate implicit discount rates at which future fuel costs would be fully internalized; they find discount rates of six to 21% for used cars and one to 13% for new cars at assumed demand elasticities ranging from -2 to -3 . Their estimates can be translated into the percent of fuel costs internalized by consumers, assuming a particular discount rate. To make these results more directly comparable to the other two studies, we assume a range of discount rates and uses the authors' spreadsheet tool to translate their results into the percent of fuel costs internalized into the purchase price at each rate. Because Busse *et al.* (2013) estimate the effects of future fuel costs on vehicle prices separately by fuel economy

As Table 1 indicates, Allcott & Wozny (2014) find that consumers incorporate 55% of future fuel costs into vehicle purchase decisions at a six percent discount rate, when their expectations for future gasoline prices are assumed to reflect prevailing prices at the time of their purchases. With the same expectation about future fuel prices, the authors report that consumers would fully value fuel costs only if they apply discount rates of 24% or higher. However, these authors' estimates are closer to full valuation when using gasoline price forecasts that mirror oil futures markets because the petroleum market expected prices to fall during this period (this outlook reduces the discounted value of a vehicle's expected remaining lifetime fuel costs). With this expectation, Allcott & Wozny (2014) find that buyers value 76% of future cost savings (discounted at six percent) from choosing a model that offers higher fuel economy, and that a discount rate of 15% would imply that they fully value future cost savings. Sallee *et al.* (2016) begin with the perspective that buyers fully internalize future fuel costs into vehicles' purchase prices and cannot reliably reject that hypothesis; their base specification suggests that changes in vehicle prices incorporate slightly more than 100% of changes in future fuel costs. For discount rates of five to six percent, the Busse *et al.* (2013) results imply that vehicle prices reflect 60 to 100% of future fuel costs. As Table II–31 suggests, higher private discount rates move all of the estimates closer to full valuation or to over-valuation, while lower discount rates imply less complete valuation in all three studies.

quartile, these results depend on which quartiles of the fuel economy distribution are compared; our summary shows results using the full range of quartile comparisons.

²²² These studies rely on individual vehicle transaction data from dealer sales and wholesale auctions, which includes actual sale prices and allows their authors to define vehicle models at a highly disaggregated level. For instance, Allcott & Wozny (2014) differentiate vehicles by manufacturer, model or nameplate, trim level, body type, fuel economy, engine displacement, number of cylinders, and "generation" (a group of successive model years during which a model's design remains largely unchanged). All three studies include transactions only through mid-2008 to limit the effect of the recession on vehicle prices. To ensure that the vehicle choice set consists of true substitutes, Allcott & Wozny (2014) define the choice set as all gasoline-fueled light-duty cars, trucks, SUVs, and minivans that are less than 25 years old (*i.e.*, they exclude vehicles where the substitution elasticity is expected to be small). Sallee *et al.* (2016) exclude diesels, hybrids, and used vehicles with less than 10,000 or more than 100,000 miles.

Table II-31 - Percent of Future Fuels Costs Internalized in Used Vehicle Purchase Price using Current Gasoline Prices to Reflect Expectations (for Base Case Assumptions)

Authors (Pub. Date)	Discount rate			
	3%	5%	6%	10%
Busse, et al. (2013)*	54%-87%	60%-96%	62%-100%	73%-117%
Allcott & Wozny (2014)	48%		55%	65%
Sallee, et al. (2016)		101%		142%

***Note:** The ranges in the Busse et al. estimates depend on which quartiles of the fuel economy distribution are compared. With no prior on which quartile comparison to use, this analysis presents the full quartile comparison range.

The studies also explore the sensitivity of the results to other parameters that could influence their results. Busse *et al.* (2013) and Allcott & Wozny (2014) find that relying on data that suggest lower annual vehicle use or survival probabilities, which imply that vehicles will not last as long, moves their estimates closer to full valuation, an unsurprising result because both reduce the changes in expected future fuel costs caused by fuel price fluctuations. Allcott & Wozny's (2014) base results rely on an instrumental variables estimator that groups miles-per-gallon (MPG) into two quantiles to mitigate potential attenuation bias due to measurement error in fuel economy, but they find that greater disaggregation of the MPG groups implies greater undervaluation (for example, it reduces the 55% estimated reported in Table 1 to 49%). Busse *et al.* (2013) allow gasoline prices to vary across local markets in their main specification; using national average gasoline prices, an approach more directly comparable to the other studies, results in estimates that are closer to or above full valuation. Sallee *et al.* (2016) find modest undervaluation by vehicle fleet operators or manufacturers making large-scale purchases, compared to retail dealer sales (*i.e.*, 70 to 86%).

Since they rely predominantly on changes in vehicles' prices between

repeat sales, most of the valuation estimates reported in these studies apply most directly to buyers of used vehicles. Only Busse *et al.* (2013) examine new vehicle sales; they find that consumers value between 75 to 133% of future fuel costs for new vehicles, a higher range than they estimate for used vehicles. Allcott & Wozny (2014) examine how their estimates vary by vehicle age and find that fluctuations in purchase prices of younger vehicles imply that buyers whose fuel price expectations mirror the petroleum futures market value a higher fraction of future fuel costs: 93% for one- to three-year-old vehicles, compared to their estimate of 76% for all used vehicles assuming the same price expectation.²²⁵

Accounting for differences in their data and estimation procedures, the three studies described here suggest that car buyers who use discount rates of five to six percent value at least half—and perhaps all—of the savings in future fuel costs they expect from choosing models that offer higher fuel economy.

²²⁵ Allcott & Wozny (2014) and Sallee, *et al.* (2016) also find that future fuel costs for older vehicles are substantially undervalued (26–30%). The pattern of Allcott and Wozny's results for different vehicle ages is similar when they use retail transaction prices (adjusted for customer cash rebates and trade-in values) instead of wholesale auction prices, although the degree of valuation falls substantially in all age cohorts with the smaller, retail price based sample.

Perhaps more important in assessing the case for regulating fuel economy, one study suggests that buyers of *new* cars and light trucks value three-quarters or more of the savings in future fuel costs they anticipate from purchasing higher-mpg models, although this result is based on more limited information.

In contrast, previous regulatory analyses of fuel economy standards implicitly assumed that buyers undervalue even more of the benefits they would experience from purchasing models with higher fuel economy so that without increases in fuel economy standards little improvement would occur, and the entire value of fuel savings from raising CAFE standards represented private benefits to car and light truck buyers themselves. For instance, in the EPA analysis of the 2017–2025 model year greenhouse gas emission standards, fuel savings alone added up to \$475 billion (at three percent discount rate) over the lifetime of the vehicles, far outweighing the compliance costs: \$150 billion). The assertion that buyers were unwilling to take voluntary advantage of this opportunity implies that collectively, they must have valued less than a third (\$150 billion/\$475 billion = 32%) of the fuel savings that would have resulted from those standards.²²⁶ The evidence

²²⁶ In fact, those earlier analyses assumed that new car and light truck buyers attach relatively

reviewed here makes that perspective extremely difficult to justify and would call into question any analysis that claims to show large private net benefits for vehicle buyers.

What analysts assume about consumers' vehicle purchasing behavior, particularly about potential buyers' perspectives on the value of increased fuel economy, clearly matters a great deal in the context of benefit-cost analysis for fuel economy regulation. In light of recent evidence on this question, a more nuanced approach than assuming that buyers drastically undervalue benefits from higher fuel economy, and that as a consequence, these benefits are unlikely to be realized without stringent fuel economy standards, seems warranted. One possible approach would be to use a baseline scenario where fuel economy levels of new cars and light trucks reflected full (or nearly so) valuation of fuel savings by potential buyers in order to reveal whether setting fuel economy standards above market-determined levels could produce net social benefits. Another might be to assume that, unlike in the agencies' previous analyses, where buyers were assumed to greatly undervalue higher fuel economy under the baseline but to value it fully under the proposed standards, buyers value improved fuel economy identically under both the baseline scenario and with stricter CAFE standards in place. The agencies ask for comment on these and any alternative approaches they should consider for valuing fuel savings, new peer-reviewed evidence on vehicle buyers' behavior that casts light on how they value improved fuel economy, the appropriate private discount rate to apply to future fuel savings, and thus the degree to which private fuel savings should be considered as private benefits of increasing fuel economy standards.

(b) Sales Data and Relevant Macroeconomic Factors

Developing a procedure to predict the effects of changes in prices and attributes of new vehicles is complicated by the fact that their sales are highly pro-cyclical—that is, they are very sensitive to changes in macroeconomic conditions—and also statistically “noisy,” because they reflect the transient effects of other factors such as consumers' confidence in the future, which can be difficult to observe and measure accurately. At the same time, their average sales price

little value to higher fuel economy, since their baseline scenarios assumed that fuel economy levels would not increase in the absence of progressively tighter standards.

tends to move in parallel with changes in economic growth; that is, average new vehicle prices tend to be higher when the total number of new vehicles sold is increasing and lower when the total number of new sales decreases (typically during periods of low economic growth or recessions). Finally, counts of the total number of new cars and light trucks that are sold do not capture shifts in demand among vehicle size classes or body styles (“market segments”); nor do they measure changes in the durability, safety, fuel economy, carrying capacity, comfort, or other aspects of vehicles' quality.

The historical series of new light-duty vehicle sales exhibits cyclic behavior over time that is most responsive to larger cycles in the macro economy—but has not increased over time in the same way the population, for example, has. While U.S. population has grown over 35 percent since 1980, the registered vehicle population has grown at an even faster pace—nearly doubling between 1980 and 2015.²²⁷ But annual vehicle sales did not grow at a similar pace—even accounting for the cyclical nature of the industry. Total new light-duty sales prior to the 2008 recession climbed as high as 16 million, though similarly high sales years occurred in the 1980's and 1990's as well. In fact, when considering a 10-year moving average to smooth out the effect of cycles, most 10-year averages between 1992 and 2015 are within a few percent of the 10-year average in 1992. And although average transaction prices for new vehicles have been rising steadily since the recession ended, prices are not yet at historical highs when adjusted for inflation. The period of highest inflation-adjusted transaction prices occurred from 1996–2006, when the average transaction price for a new light-duty vehicle was consistently higher than the price in 2015.

In an attempt to overcome these analytical challenges, various approaches were experimented with to predict the response of new vehicle sales to the changes in prices, fuel economy, and other features. These included treating new vehicle demand as a product of changes in total demand for vehicle ownership and demand necessary to replace used vehicles that are retired, analyzing total expenditures

²²⁷ There are two measurements of the size of the registered vehicle population that are considered to be authoritative. One is produced by the Federal Highway Administration, and the other by R.L. Polk (now part of IHS). The Polk measurement shows fleet growth between 1980 and 2015 of about 85%, while the FHWA measurement shows a slower growth rate over that period; only about 60%. Both are still considerably larger than the growth in new vehicle sales over the same period.

to purchase new cars and light trucks in conjunction with the total number sold, and other approaches. However, none of these methods offered a significant improvement over estimating the total number of vehicles sold directly from its historical relationship to directly measurable factors such as their average sales price, macroeconomic variables such as GDP or Personal Disposable Income, U.S. labor force participation, and regularly published surveys of consumer sentiment or confidence.

Quarterly, rather than annual data on total sales of new cars and light trucks, their average selling price, and macroeconomic variables was used to develop an econometric model of sales, in order to increase the number of observations and more accurately capture the causal effects of individual explanatory variables. Applying conventional data diagnostics for time-series economic data revealed that most variables were non-stationary (*i.e.*, they reflected strong underlying time trends) and displayed unit roots, and statistical tests revealed co-integration between the total vehicle sales—the model's dependent variable—and most candidate explanatory variables.

(c) Current Estimation of Sales Impacts

To address the complications of the time series data, the analysis estimated an autoregressive distributed-lag (ARDL) model that employs a combination of lagged values of its dependent variable—in this case, last year's and the prior year's vehicle sales—and the change in average vehicle price, quarterly changes in the U.S. GDP growth rate, as well as current and lagged values of quarterly estimates of U.S. labor force participation. The number of lagged values of each explanatory variable to include was determined empirically (using the Bayesian information criterion), by examining the effects of including different combinations of their lagged values on how well the model “explained” historical variation in car and light truck sales.

The results of this approach were encouraging: The model's predictions fit the historical data on sales well, each of its explanatory variables displayed the expected effect on sales, and analysis of its unexplained residual terms revealed little evidence of autocorrelation or other indications of statistical problems. The model coefficients suggest that positive GDP growth rates and increases in labor force participation are both indicators of increases in new vehicle sales, while positive changes in average new vehicle price reduce new sales. However, the magnitude of the

coefficient on change in average price is not as determinative of total sales as the other variables.

Based on the model, a \$1,000 increase in the average new vehicle price causes approximately 170,000 lost units in the first year, followed by a reduction of another 600,000 units over the next ten years as the initial sales decrease propagates over time through the lagged variables and their coefficients. The price elasticity of new car and light truck sales implied by alternative estimates of the model's coefficients ranged from -0.2 to -0.3 —meaning that changes in their prices have moderate effects on total sales—which contrasts with estimates of higher sensitivity to prices implied by some models.²²⁸ The analysis was unable to incorporate any measure of new car and light truck fuel economy in the model that added to its ability to explain historical variation in sales, even after experimenting with alternative measures of such as the unweighted and sales-weighted averages fuel economy of models sold in each quarter, the level of fuel economy they were required to achieve, and the change in their fuel economy from previous periods.

Despite the evidence in the literature, summarized above, that consumers value most, if not all, of the fuel economy improvements when purchasing new vehicles, the model described here operates at too high a level of aggregation to capture these preferences. By modeling the total number of new vehicles sold in a given year, it is necessary to quantify important measures, like sales price or fuel economy, by averages. Our model operates at a high level of aggregation, where the average fuel economy represents an average across many vehicle types, usage profiles, and fuel economy levels. In this context, the average fuel economy was not a meaningful value with respect to its influence on the total number of new vehicles sold. A number of recent studies have indeed shown that consumers value fuel savings (almost) fully. Those studies are frequently based on large datasets that are able to control for all other vehicle attributes through a variety of econometric techniques. They represent micro-level decisions, where a

buyer is (at least theoretically) choosing between a more or less efficient version of a pickup truck (for example) that is otherwise identical. In an aggregate sense, the average is not comparable to the decision an individual consumer faces.

Estimating the sales response at the level of total new vehicle sales likely fails to address valid concerns about changes to the quality or attributes of new vehicles sold—both over time and in response to price increases resulting from CAFE standards. However, attempts to address such concerns would require significant additional data, new statistical approaches, and structural changes to the CAFE model over several years. It is also the case that using absolute changes in the average price may be more limited than another characterization of price that relies on distributions of household income over time or percentage change in the new vehicle price. The former would require forecasting a deeply uncertain quantity many years into the future, and the latter only become relevant once the simulation moves beyond the magnitude of observed price changes in the historical series. Future versions of this model may use a different characterization of cost that accounts for some of these factors if their inclusion improves the model estimation and corresponding forecast projections are available.

The changes in selling prices, fuel economy, and other features of cars and light trucks produced during future model years that result from manufacturers' responses to lower CAFE and GHG emission standards are likely to affect both sales of individual models and the total number of new vehicles sold. Because the values of changes in fuel economy and other features to potential buyers are not completely understood; however, the magnitude, and possibly even the direction, of their effect on sales of new vehicles is difficult to anticipate. On balance, it is reasonable to assume that the changes in prices, fuel economy, and other attributes expected to result from their proposed action to amend and establish fuel economy and GHG emission standards are likely to increase total sales of new cars and light trucks during future model years. Please provide comment on the relationship between

price increases, fuel economy, and new vehicle sales, as well as methods to appropriately account for these relationships.

(d) Projecting New Vehicle Sales and Comparisons to Other Forecasts

The purpose of the sales response model is to allow the CAFE model to simulate new vehicle sales in a given future model year, accounting for the impact of a regulatory alternative's stringency on new vehicle prices (in a macro-economic context that is identical across alternatives). In order to accomplish this, it is important that the model of sales response be dynamically stable, meaning that it responds to shocks not by "exploding," increasing or decreasing in a way that is unbounded, but rather returns to a stable path, allowing the shock to dissipate. The CAFE model uses the sales model described above to dynamically project future sales; after the first year of the simulation, lagged values of new vehicle sales are those that were produced by the model itself rather than observed. The sales response model constructed here uses two lagged dependent variables and simple econometric conditions determine if the model is dynamically stable. The coefficients of the one-year lag and the two-year lag, β_1 and β_2 , respectively must satisfy three conditions. Their sum must be less than one, $\beta_2 - \beta_1 < 1$, and the absolute value of β_2 must be less than one. The coefficients of this model satisfy all three conditions.

Using the Augural CAFE standards as the baseline, it is possible to produce a series of future total sales as shown in Table-II-32. For comparison, the table includes the calculated total light-duty sales of a proprietary forecast purchased to support the 2016 Draft TAR analysis, the total new light-duty sales in EIA's 2017 Annual Energy Outlook, and a (short) forecast published in the Center for Automotive Research's Q4 2017 Automotive Outlook. All of the forecasts in Table-II-32 assume the Augural Standards are in place through MY 2025, though assumptions about the costs required to comply with them likely differ. As the table shows, despite differences among them, the dynamically produced sales projection from the CAFE model is not qualitatively different from the others.

²²⁸ Effects on the used car market are accounted for separately.

Table-II-32 - Comparison of Forecasts, 2016-2029

Year	CAFE model ²²⁹	IHS/Polk	AEO 2017	CAR Outlook	Actual Sales ²³⁰
2016	16.34	17.78	16.43	17.5	17.55
2017	16.83	18.20	17.05	17.5	17.25
2018	17.19	18.08	16.91	17.4	
2019	17.48	17.68	16.32	17.3	
2020	17.66	17.23	16.27	17	
2021	17.75	17.12	16.54	17.5	
2022	17.76	17.02	16.40	17.6	
2023	17.74	17.08	16.28		
2024	17.73	17.16	16.71		
2025	17.71	17.30	16.70		
2026	17.70	17.33	16.45		
2027	17.74	17.41	16.57		
2028	17.81	17.21	16.58		
2029	17.87	17.08	16.88		

While this forecast projects a relatively high, but flat, level of new vehicle sales into the future, it is worth noting that it continues another trend observed in the historical data. The time series of annual new vehicle sales is volatile from year to year, but multi-year averages are less so being sufficient to wash out the variation associated with them peaks and valleys of the series. Despite the fact that the moving average annual new vehicle sales has been growing over the last four decades, it has not kept pace with U.S. population growth. Data from the Federal Reserve Bank of St. Louis shows that the per-capita sales of new vehicles peaked in 1986 and has declined more than 25% from this peak to today's level.²³¹ While the sales projection in Table-II-32 would represent a historically high average of new vehicle sales over the analysis period, it would not be sufficient to reverse the trend of declining per-capita sales of new

vehicles during the analysis period, though it would continue the trend at a slower rate.

In addition to the statistical model that estimates the response of total new vehicle sales to changes in the average new vehicle price, the CAFE model incorporates a dynamic fleet share model that modifies the light truck (and, symmetrically, passenger car) share of the new vehicle market. A version of this model first appeared in the 2012 final rule, when this fleet share component was introduced to ensure greater internal consistency within inputs in the uncertainty analysis. For today's analysis, this dynamic fleet share is enabled throughout the analysis of alternatives.

The dynamic fleet share model is a series of difference equations that determine the relative share of light trucks and passenger cars based on the average fuel economy of each, the fuel price, and average vehicle attributes like horsepower and vehicle mass (the latter of which explicitly evolves as a result of the compliance simulation). While this model was taken from EIA's National Energy Modeling System (NEMS), it is applied at a different level. Rather than apply the shares based on the regulatory class distinction, the CAFE model applies the shares to body-style. This is done to account for the large-scale shift in recent years to crossover utility vehicles that have model variants in both the passenger car and light truck regulatory fleets. The agencies have always modified their static forecasts of new vehicle sales to reflect the PC/LT split present in the Annual Energy

Outlook; this integration continues that approach in a way that ensures greater internal consistency when simulating multiple regulatory alternatives (and conducting sensitivity analysis on any of the factors that influence fleet share).

(e) Vehicle Choice Models as an Alternative Method To Estimate New Vehicle Sales

Another potential option to estimate future new vehicle sales would be to use a full consumer choice model. The agencies simulate compliance with CAFE and CO₂ standards for each manufacturer using a disaggregated representation of its regulated vehicle fleets. This means that each manufacturer may have hundreds of vehicle model variants (e.g., the Honda Civic with the 6-cylinder engine, and the Honda Civic with the 4-cylinder engine would each be treated as different, in some ways, during the compliance simulation).²³² While the analysis accounts for a wide variety of attributes across these vehicles, only a few of them change during the compliance simulation. However, all of those attributes are relevant in the context of consumer choice models.

Aside from the computational intensity of simulating new vehicle sales at the level of individual models—for all manufacturers, under each regulatory alternative, over the next decade or more—it would be necessary to include additional relationships

²²⁹ Out of necessity, the analysis in today's rule conflates production year (or "model year") and calendar year. The volumes cited in the CAFE model forecast represent forecasted production volumes for those model years, while the other represent calendar year sales (rather than production)—during which two, or possibly three, different model year vehicles are sold. In the long run, the difference is not important. In the early years, there are likely to be discrepancies.

²³⁰ U.S. Total Sales by Make, Automotive News, <http://www.autonews.com/section/datalist18> (last visited June 22, 2018).

²³¹ Mislinski, J. *Light Vehicle Sales Per Capita: Our Latest Look at the Long-Term Trend*, Advisor Perspectives (June 1, 2018), <https://www.advisorperspectives.com/dshort/updates/2018/05/01/light-vehicle-sales-per-capita-our-latest-look-at-the-long-term-trend>.

²³² For more detail about the compliance simulation and manufacturer fleet representation, see Section II.G.

about how consumers trade off among vehicle attributes, which types of consumers prefer which types of attributes (and how much), and how manufacturers might strategically price these modified vehicles. This requires a strategic pricing model, which each manufacturer has and would likely be unwilling to share. Some of this strategic pricing behavior occurs on small time-scale through the use of dealer incentives, rebates on specific models, and creative financing offers. When simulating compliance at the annual scale, it is effectively impossible to account for these types of strategic decisions.

It is also true consumers have heterogeneous preferences that change over time and determine willingness-to-pay for a variety of vehicle attributes. These preferences change in response to marketing, distribution, pricing, and product strategies that manufacturers may change over time. With enough data, a consumer choice model could stratify new vehicle buyers into types and attempt to measure the strength of each type's preference for fuel economy, acceleration, safety rating, perceived

quality and reliability, interior volume, or comfort. However, other factors also influence customers' purchase decision, and some of these can be challenging to model. Consumer proximity to dealerships, quality of service and customer experience at dealerships, availability and terms of financing, and basic product awareness may significantly factor into sales success.

Manufacturers' marketing choices may significantly and unpredictably affect sales. Ad campaigns may increase awareness in the market, and campaigns may reposition consumers' perception of the brands and products. For example, in 2011 the Volkswagen Passat featured an ad with a child in a Darth Vader costume (and showcased remote start technology on the Passat). In MY 2012, Kia established the Kia Soul with party rocking, hip-hop hamster commercials showcasing push-button ignition, a roomy interior, and design features in the brake lights. Both commercials raised awareness and highlighted basic product features. Each commercial also impressed demographic groups with pop culture references, product placement, and co-

branding. While the marketing budget of individual manufacturers may help a consumer choice model estimate market share for a given brand, estimating the impact of a given campaign on new sales is more challenging as consumers make purchasing decisions based upon their own needs and desires.

Modelers must understand how consumers and commercial buyers select vehicles in order to effectively develop and implement a consumer choice model in a compliance simulation. Consumers purchase vehicles for a variety of reasons such as family need, need for more space, new technology, changes to income and affordability of a new vehicle, improved fuel economy, operating costs of current vehicles, and others. Once committed to buying a vehicle, consumers use different processes to narrow down their shopping list. Consumer choice decision attributes include factors both related and not related to the vehicle design. The vehicle's utility for those attributes is researched across many different information sources as listed in the table below.

Table-II-33 - Information Sourced Utilized during Vehicle Purchase Research

Word of mouth	Dealer salespeople
Independent car websites	Video sites and TV
Manufacturer websites	Social networking sites
Magazines/Newspapers	Auto shows
Blogs and Forums	Other

An objective, attribute-based consumer choice model could lead to projected swings in manufacturer market shares and individual model volumes. The current approach simulates compliance for each manufacturer assuming that it produces the same set of vehicles that it produced in the initial year of the simulation (MY 2016 in today's analysis). If a consumer choice model were to drive projected sales of a given vehicle model below some threshold, as consumers have done in the real market, the simulation currently has no way to generate a new vehicle model to take its place. As demand changes across specific market segments and models, manufacturers adapt by supplying new vehicle nameplates and models (e.g., the proliferation of crossover utility vehicles in recent years). Absent that flexibility in the compliance simulation, even the more accurate consumer choice model may produce unrealistic

projections of future sales volumes at the model, segment, or manufacturer level.

Comment is sought on the development and use of potential consumer choice model in compliance simulations. Comment is also sought on the appropriate breadth, depth, and complexity of considerations in a consumer choice model.

(f) Industry Employment Baseline (Including Multiplier Effect) and Data Description

In the first two joint CAFE/CO₂ rulemakings, the agencies considered an analysis of industry employment impacts in some form in setting both CAFE and emissions standards; NHTSA conducted an industry employment analysis in part to determine whether the standards the agency set were economically practicable, that is, whether the standards were "within the financial capability of the industry, but

not so stringent as to" lead to "adverse economic consequences, such as a significant loss of jobs or unreasonable elimination of consumer choice."²³³ EPA similarly conducted an industry employment analysis under the broad authority granted to the agency under the Clean Air Act.²³⁴ Both agencies recognized the uncertainties inherent in estimating industry employment impacts; in fact, both agencies dedicated a substantial amount of discussion to uncertainty in industry employment analyses in the 2012 final rule for MYs 2017 and beyond.²³⁵ Notwithstanding these uncertainties, CAFE and CO₂ standards do impact industry labor hours, and providing the best analysis practicable better informs stakeholders

²³³ 67 FR 77015, 77021 (Dec. 16, 2002).

²³⁴ See *George E. Warren Corp. v. EPA*, 159 F.3d 616, 623–624 (D.C. Cir. 1998) (ordinarily permissible for EPA to consider factors not specifically enumerated in the Act).

²³⁵ See 77 FR 62624, 62952, 63102 (Oct. 15, 2012).

and the public about the standards' impact than would omitting any estimates of potential labor impacts.

Today many of the effects that were previously qualitatively identified, but not considered, are quantified. For instance, in the PRIA for the 2017–2025 rule EPA identified “demand effects,” “cost effects,” and “factor shift effects” as important considerations for industry labor, but the analysis did not attempt to quantify either the demand effect or the factor shift effect.²³⁶ Today's industry labor analysis quantifies direct labor changes that were qualitatively discussed previously.

Previous analyses and new methodologies to consider direct labor effects on the automotive sector in the United States were improved upon and developed. Potential changes that were evaluated include (1) dealership labor related to new light duty vehicle unit sales; (2) changes in assembly labor for vehicles, for engines and for transmissions related to new vehicle unit sales; and (3) changes in industry labor related to additional fuel savings technologies, accounting for new vehicle unit sales. All automotive labor effects were estimated and reported at a national level,²³⁷ in job-years, assuming 2,000 hours of labor per job-year.

The analysis estimated labor effects from the forecasted CAFE model technology costs and from review of automotive labor for the MY 2016 fleet. For each vehicle in the CAFE model analysis, the locations for vehicle assembly, engine assembly, and transmission assembly and estimated labor in MY 2016 were recorded. The percent U.S. content for each vehicle was also recorded. Not all parts are made in the United States, so the analysis also took into account the percent U.S. content for each vehicle as manufacturers add fuel-savings technologies. As manufacturers added fuel-economy technologies in the CAFE model simulations, the analysis assumed percent U.S. content would remain constant in the future, and that the U.S. labor added would be proportional to U.S. content. From this foundation, the analysis forecasted automotive labor effects as the CAFE model added fuel economy technology and adjusted future sales for each vehicle.

²³⁶ *Regulatory Impact Analysis: Final Rulemaking for 2017–2025 Light-Duty Vehicle Greenhouse Gas Emission Standards and Corporate Average Fuel Economy Standards*, U.S. EPA at 8–24 to 8–32 (Aug. 2012).

²³⁷ The agencies recognize a few local production facilities may contribute meaningfully to local economies, but the analysis reported only on national effects.

The analysis also accounts for sales projections in response to the different regulatory alternatives; the labor analysis considers changes in new vehicle prices and new vehicle sales (for further discussion of the sales model, see Section 2.E). As vehicle prices rise, the analysis expected consumers to purchase fewer vehicles than they would have at lower prices. As manufacturers sell fewer vehicles, the manufacturers may need less labor to produce the vehicles and less labor to sell the vehicles. However, as manufacturers add equipment to each new vehicle, the manufacturers will require human resources to develop, sell, and produce additional fuel-saving technologies. The analysis also accounts for the potential that new standards could shift the relative shares of passenger cars and light trucks in the overall fleet (see Section 2.E); insofar as different vehicles involved different amounts of labor, this shifting impacts the quantity of estimated labor. The CAFE model automotive labor analysis takes into account reduction in vehicle sales, shifts in the mix of passenger cars and light trucks, and addition of fuel-savings technologies.

For today's analysis, it was assumed that some observations about the production of MY 2016 vehicles would carry forward, unchanged into the future. For instance, assembly plants would remain the same as MY 2016 for all products now, and in the future. The analysis assumed percent U.S. content would remain constant, even as manufacturers updated vehicles and introduced new fuel-saving technologies. It was assumed that assembly labor hours per unit would remain at estimated MY 2016 levels for vehicles, engines, and transmissions, and the factor between direct assembly labor and parts production jobs would remain the same. When considering shifts from one technology to another, the analysis assumed revenue per employee at suppliers and original equipment manufacturers would remain in line with MY 2016 levels, even as manufacturers added fuel-saving technologies and realized cost reductions from learning.

The analysis focused on automotive labor because adjacent employment factors and consumer spending factors for other goods and services are uncertain and difficult to predict. The analysis did not consider how direct labor changes may affect the macro economy and possibly change employment in adjacent industries. For instance, the analysis did not consider possible labor changes in vehicle maintenance and repair, nor did it

consider changes in labor at retail gas stations. The analysis did not consider possible labor changes due to raw material production, such as production of aluminum, steel, copper and lithium, nor did the agencies consider possible labor impacts due to changes in production of oil and gas, ethanol, and electricity. The analysis did not analyze effects of how consumers could spend money saved due to improved fuel economy, nor did the analysis assess the effects of how consumers would pay for more expensive fuel savings technologies at the time of purchase; either could affect consumption of other goods and services, and hence affect labor in other industries. The effects of increased usage of car-sharing, ride-sharing, and automated vehicles were not analyzed. The analysis did not estimate how changes in labor from any industry could affect gross domestic product and possibly affect other industries as a result.

Finally, no assumptions were made about full-employment or not full-employment and the availability of human resources to fill positions. When the economy is at full employment, a fuel economy regulation is unlikely to have much impact on net overall U.S. employment; instead, labor would primarily be shifted from one sector to another. These shifts in employment impose an opportunity cost on society, approximated by the wages of the employees, as regulation diverts workers from other activities in the economy. In this situation, any effects on net employment are likely to be transitory as workers change jobs (*e.g.*, some workers may need to be retrained or require time to search for new jobs, while shortages in some sectors or regions could bid up wages to attract workers). On the other hand, if a regulation comes into effect during a period of high unemployment, a change in labor demand due to regulation may affect net overall U.S. employment because the labor market is not in equilibrium. Schmalensee and Stavins point out that net positive employment effects are possible in the near term when the economy is at less than full employment due to the potential hiring of idle labor resources by the regulated sector to meet new requirements (*e.g.*, to install new equipment) and new economic activity in sectors related to the regulated sector longer run, the net effect on employment is more difficult to predict and will depend on the way in which the related industries respond to the regulatory requirements. For that reason, this analysis does not include multiplier effects but instead focuses on

labor impacts in the most directly affected industries. Those sectors are likely to face the most concentrated labor impacts.

Comment is sought on these assumptions and approaches in the labor analysis.

4. Estimating Labor for Fuel Economy Technologies, Vehicle Components, Final Assembly, and Retailers

The following sections discuss the approaches to estimating factors related to dealership labor, final assembly labor and parts production, and fuel economy technology labor.

(a) Dealership Labor

The analysis evaluated dealership labor related to new light-duty vehicle sales, and estimated the labor hours per new vehicle sold at dealerships, including labor from sales, finance, insurance, and management. The effect of new car sales on the maintenance, repair, and parts department labor is expected to be limited, as this need is based on the vehicle miles traveled of the total fleet. To estimate the labor hours at dealerships per new vehicle sold, the National Automobile Dealers Association 2016 Annual Report, which provides franchise dealer employment by department and function, was referenced.²³⁸ The analysis estimated that slightly less than 20% of dealership employees' work relates to new car sales (versus approximately 80% in service, parts, and used car sales), and that on average dealership employees working on new vehicle sales labor for 27.8 hours per new vehicle sold.

(b) Final Assembly Labor and Parts Production

How the quantity of assembly labor and parts production labor for MY 2016 vehicles would increase or decrease in the future as new vehicle unit sales increased or decreased was estimated.

Specific assembly locations for final vehicle assembly, engine assembly, and transmission assembly for each MY 2016 vehicle were identified. In some cases, manufacturers assembled products in more than one location, and the analysis identified such products and considered parallel production in the labor analysis.

The analysis estimated industry average direct assembly labor per vehicle (30 hours), per engine (four hours), and per transmission (five hours) based on a sample of U.S.

²³⁸ NADA Data 2016: Annual Financial Profile of America's Franchised New-Car Dealerships, National Automobile Dealers Association, <https://www.nada.org/2016NADAdata/> (last visited June 22, 2018).

assembly plant employment and production statistics and other publicly available information. The analysis recognizes that some plants may use less labor than the analysis estimates to produce the vehicle, the engine, or the transmission, and other plants may have used more labor. The analysis used the assembly locations and industry averages for labor per unit to estimate U.S. assembly labor hours for each vehicle. U.S. assembly labor hours per vehicle ranged from as high as 39 hours if the manufacturer assembled the vehicle, engine, and transmission at U.S. plants, to as low as zero hours if the manufacturer imported the vehicle, engine, and transmission.

The analysis also considered labor for part production in addition to labor for final assembly. Motor vehicle and equipment manufacturing labor statistics from the U.S. Census Bureau, the Bureau of Labor Statistics,²³⁹ and other publicly available sources were surveyed. Based on these sources, the analysis noted that the historical average ratio of vehicle assembly manufacturing employment to employment for total motor vehicle and equipment manufacturing for new vehicles remained roughly constant over the period from 2001 through 2013, at a ratio of 5.26. Observations from 2001–2013 spanned many years, many combinations of technologies and technology trends, and many economic conditions, yet the ratio remained about the same. Accordingly, the analysis scaled up estimated U.S. assembly labor hours by a factor of 5.26 to consider U.S. parts production labor in addition to assembly labor for each vehicle.

The industry estimates for vehicle assembly labor and parts production labor for each vehicle scaled up or down as unit sales scaled up or down over time in the CAFE model.

(c) Fuel Economy Technology Labor

As manufacturers spend additional dollars on fuel-saving technologies, parts suppliers and manufacturers require human resources to bring those technologies to market. Manufacturers may add, shift, or replace employees in ways that are difficult for the agencies to predict in response to adding fuel-savings technologies; however, it is expected that the revenue per labor hour at original equipment manufacturers (OEMs) and suppliers will remain about the same as in MY 2016 even as industry includes additional fuel-saving technology.

To estimate the average revenue per labor hour at OEMs and suppliers, the

²³⁹ NAICS Code 3361, 3363.

analysis looked at financial reports from publicly traded automotive businesses.²⁴⁰ Based on recent figures, it was estimated that OEMs would add one labor year per \$633,066 revenue²⁴¹ and that suppliers would add one labor year per \$247,648 in revenue.²⁴² These global estimates are applied to all revenues, and U.S. content is applied as a later adjustment. In today's analysis, it was assumed these ratios would remain constant for all technologies rather than that the increased labor costs would be shifted toward foreign countries. Comment is sought on the realism of this assumption.

(d) Labor Calculations

The analysis estimated the total labor as the sum of three components: Dealership hours, final assembly and parts production, and labor for fuel-economy technologies (at OEM's and suppliers). The CAFE model calculated additional labor hours for each vehicle, based on current vehicle manufacturing locations and simulation outputs for additional technologies, and sales changes. The analysis applied some constants to all vehicles,²⁴³ but other constants were vehicle specific,²⁴⁴ or year specific for a vehicle.²⁴⁵

While a multiplier effect of all U.S. automotive related jobs on non-auto related U.S. jobs was not considered for today's analysis, the analysis did program a "global multiplier" that can be used to scale up or scale down the total labor hours. This multiplier exists in the parameters file, and for today's analysis the analysis set the value at 1.00.

5. Additional Costs and Benefits Incurred by New Vehicle Buyers

Some costs of purchasing and owning a new or used vehicle scale with the

²⁴⁰ The analysis considered suppliers that won the Automotive News "PACE Award" from 2013–2017, covering more than 40 suppliers, more than 30 of which are publicly traded companies. Automotive News gives "PACE Awards" to innovative manufacturers, with most recent winners earning awards for new fuel-savings technologies.

²⁴¹ The analysis assumed incremental OEM revenue as the retail price equivalent for technologies, adjusting for changes in sales volume.

²⁴² The analysis assumed incremental supplier revenue as the technology cost for technologies before retail price equivalent mark-up, adjusting for changes in sales volume.

²⁴³ The analysis applied the same assumptions to all manufacturers for annual labor hours per employee, dealership hours per unit sold, OEM revenue per employee, supplier revenue per employee, and factor for the jobs multiplier.

²⁴⁴ The analysis made vehicle specific assumptions about percent U.S. content and U.S. assembly employment hours.

²⁴⁵ The analysis estimated technology cost for each vehicle, for each year based on the technology content applied in the CAFE model, year-by-year.

value of the vehicle. Where fuel economy standards increase the transaction price of vehicles, they will affect both the absolute amount paid in sales tax and the average amount of financing required to purchase the vehicle. Further, where they increase the MSRP, they increase the appraised value upon which both value-related registration fees and a portion of insurance premiums are based. The analysis assumes that the transaction price is a set share of the MSRP, which allows calculation of these factors as shares of MSRP. Below the assumptions made about how each of these additional costs of vehicle purchase and ownership scale with the MSRP and how the analysis arrived at these assumptions are discussed.

(a) Sales Taxes

The analysis took auto sales taxes by state²⁴⁶ and weighted them by population by state to determine a national weighted-average sales tax of 5.46%. The analysis sought to weight sales taxes by new vehicle sales by state; however, such data were unavailable. It is recognized that for this purpose, new vehicle sales by state is a superior weighting mechanism to Census population; in effort to approximate new vehicle sales by state, a study of the change in new vehicle registrations (using R.L. Polk data) by state across recent years was conducted, resulting in a corresponding set of weights. Use of the weights derived from the study of vehicle registration data resulted in a

national weighted-average sales tax rate almost identical to that resulting from the use of Census population estimates as weights, just slightly above 5.5%. The analysis opted to utilize Census population rather than the registration-based proxy of new vehicle sales as the basis for computing this weighted average, as the end results were negligibly different and the analytical approach involving new vehicle registrations had not been as thoroughly reviewed. *Note:* Sales taxes and registration fees are transfer payments between consumers and the Federal government and are therefore not considered a cost in the societal perspective. However, these costs are considered as additional costs in the private consumer perspective.

(b) Financing Costs

The analysis assumes 85% of automobiles are financed based on Experian’s quarter 4, 2016 “State of the Automotive Finance Market,” which notes that 85.2% of 2016 new vehicles were financed, as were 85.9% of 2015 new vehicle purchases.²⁴⁷ The analysis used data from Wards Automotive and JD Power on the average transaction price of new vehicle purchases, average financed new auto beginning principal, and the average incentive as a percent of MSRP to compute the ratio of the average financed new auto principal to the average new vehicle MSRP for calendar years 2011–2016. Table–II–34 shows that the average financed auto principal is between 82 and 84% of the

average new vehicle MSRP. Using the assumption that 85% of new vehicle purchases involve some financing, the average share of the MSRP financed for all vehicles purchased, including non-financed transactions, rather than only those that are financed, was computed. Table–II–34 shows that this share ranges between 70 and 72%. From this, the analysis assumed that on an aggregate level, including all new vehicle purchases, 70% of the value of all vehicles’ MSRP is financed. It is likely that the share financed is correlated with the MSRP of the new vehicle purchased, but for simplification purposes, it is assumed that 70% of all vehicle costs are financed, regardless of the MSRP of the vehicle. In measurements of the impacts on the average consumer, this assumption will not affect the outcome of our calculation, though this assumption will matter for any discussions about how many, or which, consumers bear the brunt of the additional cost of owning more expensive new vehicles. For sake of simplicity, the model also assumes that increasing the cost of new vehicles will not change the share of new vehicle MSRP that is financed; the relatively constant share from 2011–2016 when the average MSRP of a vehicle increased 10% supports this assumption. It is recognized that this is not indicative of average individual consumer transactions but provides a useful tool to analyze the aggregate marketplace.

Table-II-34 - Share of Average MSRP Financed

Year	Financed New Vehicles	All New Vehicles
2016	0.84	0.71
2015	0.84	0.71
2014	0.82	0.70
2013	0.82	0.70
2012	0.84	0.72
2011	0.84	0.72

From Wards Auto data, the average 48- and 60-month new auto interest rates were 4.25% in 2016, and the

average finance term length for new autos was 68 months. It is recognized that longer financing terms generally

include higher interest rates. The share financed, interest rate, and finance term length are added as inputs in the

²⁴⁶ See Car Tax by State, *FactoryWarrantyList.com*, <http://www.factorywarrantylist.com/car-tax-by-state.html> (last visited June 22, 2018). *Note:* County, city, and other municipality-specific taxes were excluded from weighted averages, as the variation in locality taxes within states, lack of accessible documentation of

locality rates, and lack of availability of weights to apply to locality taxes complicate the ability to reliably analyze the subject at this level of detail. Localities with relatively high automobile sales taxes may have relatively fewer auto dealerships, as consumers would endeavor to purchase vehicles in areas with lower locality taxes, therefore reducing

the effect of the exclusion of municipality-specific taxes from this analysis.

²⁴⁷ Zabritski, M. *State of the Automotive Finance Market: A look at loans and leases in Q4 2016*, Experian, <https://www.experian.com/assets/automotive/quarterly-webinars/2016-Q4-SAFM-revised.pdf> (last visited June 22, 2018).

parameters file so that they are easier to update in the future. Using these inputs the model computes the stream of

financing payments paid for the average financed purchases as the following:

$$\text{Annual interest} = \frac{\text{interest} * \text{MSRP} * (\text{share financed})}{1 - (1 + (\text{interest}/12))^{-\text{term}}} - \frac{\text{MSRP} * (\text{share financed})}{(\text{term}/12)}$$

Note: The above assumes the interest is distributed evenly over the period, when in reality more of the interest is paid during the beginning of the term. However, the incremental amount calculated as attributable to the standard will represent the difference in the annual payments at the time that they are paid, assuming that a consumer does not repay early. This will represent the expected change in the stream of financing payments at the time of financing.

The above stream does not equate to the average amount paid to finance the purchase of a new vehicle. In order to compute this amount, the share of financed transactions at each interest rate and term combination would have to be known. Without having projections of the full distribution of the auto finance market into the future, the above methodology reasonably accounts for the increased amount of financing costs due to the purchase of a more expensive vehicle, on an average basis taking into account non-financed transactions. Financing payments are also assumed to be an intertemporal transfer of wealth for a consumer; for

this reason, it is not included in the societal cost and benefit analysis. However, because it is an additional cost paid by the consumer, it is calculated as a part of the private consumer welfare analysis.

It is recognized that increased finance terms, combined with rising interest rates, lead to a longer period of time before a consumer will have positive equity in the vehicle to trade in toward the purchase of a newer vehicle. This has impacts in terms of consumers either trading vehicles with negative equity (thereby increasing the amount financed and potentially subjecting the consumer to higher interest rates and/or rendering the consumer unable to obtaining financing) or delaying the replacement of the vehicle until they achieve suitably positive equity to allow for a trade. Comment is sought on the effect these developments will have on the new vehicle market, both in general, and in light of increased stringency of fuel economy and GHG emission standards. Comment is also sought on whether and how the model should account for consumer decisions to purchase a used vehicle instead of a

new vehicle based upon increased new vehicle prices in response to increased CAFE standard stringency.

(c) Insurance Costs

More expensive vehicles will require more expensive collision and comprehensive (*e.g.*, fire and theft) car insurance. Actuarially fair insurance premiums for these components of value-based insurance will be the amount an insurance company will pay out in the case of an incident type weighted by the risk of that type of incident occurring. It is expected that the same driver in the same vehicle type will have the same risk of occurrence for the entirety of a vehicle's life so that the share of the value of a vehicle paid out should be constant over the life of a vehicle. However, the value of vehicles will decline at some depreciation rate so that the absolute amount paid in value-related insurance will decline as the vehicle depreciates. This is represented in the model as the following stream of expected collision and comprehensive insurance payments:

$$(\text{Comprehensive \& Collision})_{\text{age}} = \frac{\text{MSRP} * (\text{share MSRP})}{(1 + \text{depreciation})^{\text{age}}}$$

To utilize the above framework, estimates of the share of MSRP paid on collision and comprehensive insurance and of annual vehicle depreciations are needed to implement the above equation. Wards has data on the average annual amount paid by model year for new light trucks and passenger cars on collision, comprehensive and damage and liability insurance for model years 1992–2003; for model years 2004–2016, they only offer the total amount paid for insurance premiums. The share of total insurance premiums paid for collision

and comprehensive coverage was computed for 1979–2003. For cars the share ranges from 49 to 55%, with the share tending to be largest towards the end of the series. For trucks the share ranges from 43 to 61%, again, with the share increasing towards the end of the series. It is assumed that for model years 2004–2016, 60% of insurance premiums for trucks, and 55% for cars, is paid for collision and comprehensive. Using these shares the absolute amount paid for collision and comprehensive coverage for cars and trucks is

computed. Then each regulatory class in the fleet is weighted by share to estimate the overall average amount paid for collision and comprehensive insurance by model year as shown in Table–II–35. The average share of the initial MSRP paid in collision and comprehensive insurance by model year is then computed. The average share paid for model years 2010–2016 is 1.83% of the initial MSRP. This is used as the share of the value of a new vehicle paid for collision and comprehensive in the future.

Table-II-35 - Average Share of MSRP Paid for Collision and Comprehensive Insurance

Model Year	Collision and Comprehensive	Average MSRP	Percent MSRP
2016	\$681	\$33,590	2.03%
2015	\$601	\$32,750	1.84%
2014	\$567	\$31,882	1.78%
2013	\$548	\$31,056	1.76%
2012	\$530	\$30,062	1.76%
2011	\$517	\$29,751	1.74%
2010	\$548	\$29,076	1.88%

2017 data from Fitch Black Book was used as a source for vehicle depreciation rates; two- to six-year-old vehicles in 2016 had an average annual depreciation rate of 17.3%.²⁴⁸ It is assumed that future depreciation rates will be like recent depreciation, and the analysis used the same assumed depreciation. Table-II-36 shows the

cumulative share of the initial MSRP of a vehicle assumed to be paid in collision and comprehensive insurance in five-year age increments under this depreciation assumption, conditional on a vehicle surviving to that age—that is, the expected insurance payments at the time of purchase will be weighted by the probability of surviving to that age.

If a vehicle lives to 10 years, 9.9% of the initial MSRP is expected to be paid in collision and comprehensive payments; by 20 years 11.9% of the initial MSRP; finally, if a vehicle lives to age 40, 12.4% of the initial MSRP. As can be seen, the majority of collision and comprehensive payments are paid by the time the vehicle is 10 years old.

Table-II-36 - Cumulative MSRP Share of Collision/Comprehensive by Age

Age	Share of Value Remaining	Cumulative Share MSRP
5	0.590	0.068
10	0.266	0.099
15	0.120	0.113
20	0.054	0.119
25	0.024	0.122
30	0.011	0.123
35	0.005	0.124
40	0.002	0.124

The increase in insurance premiums resulting from an increase in the average value of a vehicle is a result of an increase in the expected amount insurance companies will have to pay out in the case of damage occurring to the driver’s vehicle. In this way, it is a cost to the private consumer, attributable to the CAFE standard that caused the price increase.

(d) Consumer Acceptance of Specific Technologies

In previous rulemaking analyses, NHTSA imposed an economic cost of lost welfare to buyers of advanced electric vehicles. NHTSA chose to

model a 75-mile EV for early adopters, who we assume would not be concerned with the lower range, and a 150-mile EV for the broader market. The initial five percent of EV sales were assumed to go to early adopters, with the remainder being 150-mile EVs. The broader market was assumed to have some lower utility for the 150-mile EV, due to the lower driving range between refueling events relative to a conventional vehicle. Thus, an additional social cost of about \$3,500 per vehicle was assigned to the EV150 to capture the lost utility to consumers.²⁴⁹ Additionally, NHTSA imposed a “relative value loss” of 1.94% of the vehicle’s MSRP to reflect

the economic value of the difference between the useful life of a conventional ICE and the 150-mile EV when it reaches a 55% battery capacity (as a result of battery deterioration).²⁵⁰ In subsequent analyses (the 2016 Draft TAR analysis and today’s analysis), NHTSA removed the low-range EVs from its technology set due to both weak consumer demand for low-range EVs in the marketplace and subsequent technology advances that make 200-mile EVs a more practical option for new EVs produced in future model years. The exclusion of low-range EVs in the technology set reduced the need to account for consumer welfare losses

²⁴⁸ Fitch Ratings Vehicle Depreciation Report February 2017, Black Book, <http://www.blackbook.com/wp-content/uploads/2017/02/Final-February-Fitch-Report.pdf> (last visited June 22, 2018).

²⁴⁹ Based on Michael K. Hidrue, George R. Parsons, Willett Kempton, Meryl P. Gardner, Willingness to pay for electric vehicles and their attributes, Resource and Energy Economics, Volume 33, Issue 3, 2011, Pages 686–705.

²⁵⁰ The vehicle was assumed to be retired once the capacity reached 55 percent of its initial capacity, and the residual lifetime miles from that point forward were valued, discounted, and expressed as a fraction of initial MSRP.

attributable to reduced driving range. While the sensitivity analysis explores some potential for continuing consumer value loss, even in the improved electrified powertrain vehicles, the central analysis assumes that no value loss exists for electrified powertrains. However, ongoing low sales volumes and a growing body of literature suggest that consumer welfare losses may still exist if manufacturers are forced to produce electric vehicles in place of vehicles with internal combustion engines (forcing sacrifices to cargo capacity or driving range) in order to comply with standards. This topic will receive ongoing investigation and revision before the publication of the final rule. Please provide comments and any relevant data that would help to inform the estimation of implementation of any value loss related to sacrificed attributes in electric vehicles.

One reason it was necessary to account for welfare losses from reduced driving range in this way is that, in previous rulemakings, the agencies implicitly assumed that every vehicle in the forecast would be produced and purchased and that manufacturers would pass on the entire incremental cost of fuel-saving technologies to new car (and truck) buyers. However, many stakeholders commented that consumers are not willing to pay the full incremental costs for hybrids, plug-in hybrids, and battery electric vehicles.²⁵¹ For this analysis, consumer willingness to pay for HEVs, PHEVs, BEVs relative to comparable ICE vehicles was investigated. The analysis compared the estimated price premium the electrified vehicles command in the used car market and estimated the willingness to pay premium for new vehicles with electrification technologies at age zero relative to their internal combustion engine counterparts. For the analysis, the willingness to pay was compared with the expected incremental cost to produce electrification technologies. Manufacturers also contributed

confidential business information about the costs, revenues, and profitability of their electrified vehicle lines. The CBI provided a valuable check on the empirical work described below. As a result of this examination, we no longer assume manufacturers can pass on the entire incremental cost of hybrid, plug-in hybrid, and battery electric vehicles to buyers of those vehicles. The difference between the buyer's willingness-to-pay for those technologies, and the cost to produce them, must be recovered from buyers of other vehicles in a manufacturer's product portfolio or sacrificed from its profits, or sacrificed from dealership profits, or supplemented with State or Federal incentives (or, some combination of the four).

Using data from the used vehicle market, statistical models were fit to estimate consumer willingness to pay for new vehicles with varying levels of electrification relative to comparable internal combustion engine vehicles was evaluated in four steps. The analysis (1) gathered used car fair market value for select vehicles; (2) developed regression models to estimate the portion of vehicle depreciation rate attributable to the vehicle nameplate and the portion attributable to the vehicle's technology content at each age (using fixed effects for nameplates and specific electrification technologies); (3) estimated the value of vehicles at age zero (*i.e.*, when the vehicles were new); and (4) compared new vehicle values for comparable vehicles across different electrification levels (*i.e.*, internal combustion, HEV, PHEV, and BEV) to estimate willingness-to-pay for the electric technology relative to an ICE.

The dataset used for estimation consisted of vehicle attribute data from Edmunds and transaction data from Kelley Blue Book published online in June and July of 2017 for select vehicles of interest.^{252 253} The dataset was constructed to contain pairs of vehicles that were nearly the same, except for type of powertrain (internal combustion

versus some amount of electrification). For instance, the dataset contained used vehicle prices for the Honda Accord and Honda Accord Hybrid, Toyota Camry and Toyota Camry Hybrid, Ford Fusion and Ford Fusion Hybrid, Kia Soul and Kia Soul EV, and so on for several model years. In some cases, the manufacturer produced no identically equivalent internal combustion engine vehicle, so a similar internal combustion vehicle produced by the same manufacturer was used as the point of comparison. For example, the Nissan Leaf was paired with the Nissan Versa, as well as the Toyota Prius and Toyota Corolla. Only vehicles available for private sale, and in good vehicle condition were included in the analysis.²⁵⁴ The dataset contains fewer observations for PHEVs and BEVs because manufacturers have produced fewer examples of vehicles with these technologies, compared to HEV and ICE vehicles. In all of these cases, trim level and options packages were matched between ICE and electric powertrains to minimize the degree of non-powertrain difference between vehicle pairs. The resale price data spanned many model years, but most observations in the dataset represent MY 2013 through MY 2016.

The regression models used to estimate the transaction price (or "Value") as a function of age, control for the type of powertrain (ICE, HEV, PHEV, and BEV) and nameplate to account for their impact on the value of the vehicle as it ages.²⁵⁵ The regression takes the following form, with ICE, HEV, PHEV, and BEV binary variables (0, or 1), and age defined as 2017 minus the model year was used:

$$\ln(\text{Value}) = \beta_1(\text{ICE} * \text{Age}) + \beta_2(\text{HEV} * \text{Age}) + \beta_3(\text{PHEV} * \text{Age}) + \beta_4(\text{BEV} * \text{Age}) + \beta_5(\text{HEV}) + \beta_6(\text{PHEV}) + \beta_7(\text{BEV}) + FE_{\text{Nameplate}}$$

For each observation in the dataset, the "Value" at age zero is determined by setting the age variable to zero and solving.

$$\text{Value}_{\text{Age}=0} = e^{\beta_5(\text{HEV}) + \beta_6(\text{PHEV}) + \beta_7(\text{BEV}) + FE_{\text{Nameplate}}}$$

²⁵¹ See *e.g.*, Comment by Alliance of Automobile Manufacturers, Docket ID EPA-HQ-OAR-2015-0827-4089 and NHTSA-2016-0068-0072.

²⁵² See Edmunds, <https://www.edmunds.com/> (last visited June 22, 2018). Edmunds publishes automotive data, reviews, and advice.

²⁵³ See Kelley Blue Book, <https://www.kbb.com/> (last visited June 22, 2018). Kelley Blue Book, part of Cox Automotive's Autotrader brand, provides automotive research, reviews, and advice, including estimated market values of new and used vehicles.

²⁵⁴ It is possible "good" vehicles for all ages may have inadvertently introduced a small bias in the sample, as a "good" conditioning rating on a vehicle just a year or two old may not be in average condition relative to other vehicles of the vintage, but a "good" rating for a much older car may reflect an impeccably maintained vehicle.

²⁵⁵ In the case of electrified vehicles with no internal combustion engine equivalent, the analysis grouped like vehicle pairs together under the same nameplate fixed effects (or $FE_{\text{Nameplate}}$). Tesla vehicles have no internal combustion engine

equivalent, and the used vehicle market for Tesla has not cleared in the same way because of a variety of unique business factors (previously, Tesla guaranteed resale value prices for their products, which was a factory incentive program that only recently ended, no longer applying to vehicles sold after July 1, 2016). These two factors impaired the quality of used Tesla data for the purposes of the analysis, so the agencies excluded Tesla vehicles from today's analysis on customer willingness-to-pay for electrified vehicles.

The estimated willingness-to-pay for electrified powertrain packages over an internal combustion engine in an otherwise similar vehicle is computed as the difference between their estimated initial values, using the functions above. These pair-wise differences are averaged to estimate a

price premium for new vehicles with HEV, PHEV, and BEV technologies. This analysis suggests that consumers are willing to pay more for new electrified vehicles than their new internal engine combustion counterparts, but only a little more, and not necessarily enough to cover the relatively large projected

incremental cost to produce these vehicles. Specifically, the analysis estimated consumers are willing to pay between \$2,000 and \$3,000 more for the electrified powertrains considered here than their internal combustion engine counterparts.

Table-II-37 - Estimated Willingness-to-Pay and Value Loss at Age Zero for Electrification Technologies

Technology	Median Predicted Price Premium at Age 0	Average Predicted Price Premium at Age 0	Estimated Price Premium After CBI Considerations
HEV	\$ 1,871	\$ 2,511	\$ 2,275
PHEV30	\$ 2,755	\$ 5,310	\$ 2,489
PHEV50	\$ 2,755	\$ 5,310	\$ 2,489
BEV	\$ 2,239	\$ 2,396	\$ 2,965

Table-II-37 illustrates the variation in willingness-to-pay by electrification level (although the statistical model did not distinguish between PHEV30 and PHEV50 due to the small number of available operations for plug-in hybrids). As the table demonstrates, the difference between the median and mean predicted price premium for PHEVs is significant. The limited number of PHEV observations were not uniformly distributed among the nameplates present, and some of the

luxury vehicles in the set retained value in a way that skewed the average. The CBI acquired from manufacturers was more consistent with the mean than median value (except for the PHEVs).

Additionally, the Kelley Blue Book data suggest that the used electrified vehicles were often worth less than their used internal combustion engine counterpart vehicles after a few years of use.²⁵⁶ As Table-II-38 illustrates, the value of the price premium shrinks as the vehicles age and depreciate. Using

the statistical model, we estimate that strong hybrids hold less than \$100 of the initial price premium by age eight (on average). While the battery electric vehicles appear to be worth less than their ICE counterparts by age eight, there is limited data about this emerging segment of the new vehicle market. These independently-produced results using publicly available data were in line with manufacturers' reported confidential business information.

Table-II-38 - Estimated Willingness-to-Pay at Age Eight for Electrification Technologies

Technology	Median Predicted Price Premium at Age 8	Average Predicted Price Premium at Age 8
HEV	\$ 65	\$ 87
PHEV30	\$ 2,500	\$ 4,820
PHEV50	\$ 2,500	\$ 4,820
BEV	(\$ 1,051)	(\$ 1,125)

The "technology cost burden" numbers used in today's analysis represent the amount of a given technology's incremental cost that manufacturers are unable to pass along to the buyer of a given vehicle at the time of purchase. The burden is defined as the difference between estimated willingness-to-pay, itself a combination of the estimated values and confidential

business information received from manufacturers any tax credits that can be passed through in the price, and the cost of the technology. In general, the incremental willingness-to-pay falls well short of the costs currently projected for HEVs, PHEVs, and BEVs; for example, BEV technology can add roughly \$18,000 in equipment costs to the vehicle after standard retail price

equivalent markups (with a large portion of those costs being batteries), but the estimated willingness-to-pay is only about \$3,000. While tax credits offset some, if not most of that difference for PHEVs and BEVs, there is some residual amount that buyers of new electrified vehicles are currently unwilling to cover, and that must either come from forgone profits or be passed

²⁵⁶ The analysis did not identify an underlying reason for this observation, but the agencies posit for discussion purposes there could be some

interaction between maintenance costs and batteries or maintenance costs and low volume vehicles. Alternatively, new electrified vehicles may be

superior to previous generation vehicles, and new electrified vehicles may be offered at lower prices still because of a variety of market conditions.

along to buyers of other vehicles in a manufacturer's portfolio.

Manufacturers may be able to recover some or all of these costs by charging higher prices for their other models, in which case it will represent a welfare loss to buyers of other vehicles (even if not to buyers of HEVs, PHEVs, or BEVs themselves). To the extent that they are unable to do so and must absorb part or all of these costs, their profits will decline, and in effect this cost will be borne by their investors. In practice, the analysis estimates benefits and costs to car and light truck manufacturers and buyers under the assumption that each manufacturer recovers all technology costs and civil penalties it incurs from buyers via higher average prices for the models it produces and sells, although sufficient information to support specific assumptions about price increases for individual models is not present. In effect, this means that any part of a manufacturer's costs to convert specific models to electric drive technologies that it cannot recover by charging higher prices to their buyers will be borne collectively by buyers of the other models they produce. Each of those buyers is in effect assumed to pay a slight premium (or "markup") over the manufacturer's cost to produce the models they purchase (including the cost of any technology used to improve its fuel economy), this premium on average is modeled to recover the full cost of technology applied to all vehicles to improve the fuel economy of the fleet. So, even though electrified vehicles are modeled as if their buyers are unwilling to pay the full cost of the technology associated with their fuel economy improvement, the price borne by the average new vehicle buyer represents the average incremental technology cost for all applied technology, the sum of all technology costs divided by the number of units sold, across all classes, for each manufacturer.

The willingness-to-pay analysis described above relies on used vehicle data that is widely available to the public. Market tracking services update used vehicle price estimates regularly as fuel prices and other market conditions change, making the data easy to update in the future as market conditions change. The used vehicle data also account for consumer willingness-to-pay absent State and Federal rebates at the time of sale, which are reflected in

both the initial purchase price of the vehicle and its later value in the used vehicle market. As such, the analysis would continue to be relevant even if incentive programs for vehicle electrification change or phase out in the future. By considering a variety of nameplates and body styles produced by several manufacturers, this analysis produces average willingness-to-pay estimates that can be applied to the whole industry. By evaluating matched pairs of vehicles from the same manufacturer, the analysis accounts for many additional factors that may be tied to the brand, rather than the technology, and influence the fair market price of vehicles. In particular, the data inherently include customer valuations for fuel-savings and vehicle maintenance schedules, as well as other factors like noise-vibration-and-harshness, interior space,²⁵⁷ and fueling convenience in the context of the vehicles considered.

There are some limitations to this approach. There are currently few observations of PHEV and BEV technologies in the data, and most of the observations for BEVs are sedans and small cars, the values for which are extrapolated to other market segments. Additionally, the used vehicle data supporting these estimates inherently includes both older and newer generations of technology, so the historical regression may be slow to react to rapid changes in the new vehicle marketplace. As new vehicle nameplates emerge, and existing nameplates improve their implementation of electrification technologies, this model will require re-estimation to determine how these new entrants impact the estimated industry average willingness-to-pay.

Additionally, the willingness-to-pay analysis does not consider electric vehicles with no direct ICE counterpart. For example, today's evaluation does not consider Tesla because the Tesla brand has no ICE equivalent, and because the free-market prices for used Tesla vehicles have been difficult (if not impossible) to obtain, primarily due to factory guaranteed resale values (which is a program that still affects the used market for many Tesla vehicles). Still, Tesla vehicles have a large share of the BEV market by both unit sales and dollar sales, it may be possible to include Tesla data in a future update to this analysis. Similarly, the analysis did

not include ICE vehicles with no similar HEV, PHEV, or BEV nameplate or counterpart, so the analysis presented here looks at a small portion of all transactions and is more likely to include fuel efficient models where market demand for hybrid (or higher) versions may exist. One possible alternative is to rely on new vehicle transaction prices to estimate consumer willingness-to-pay for new vehicles with certain attributes. However, new vehicle transaction data is highly proprietary and difficult to obtain in a form that may be disclosed to the public.

While estimating willingness-to-pay for electrification technologies from depreciation and MSRP data is appealing, many manufacturers handle MSRP and pricing strategies differently, with some preferring to deviate only a little from sticker price and others preferring to offer high discounts. There is evidence of large differences between MSRP and effective market prices to consumers for many vehicles, especially BEVs.

Please provide comments on methods and data used to evaluate consumer willingness-to-pay for electrification technologies.

(e) Refueling Surplus

Direct estimates of the value of extended vehicle range are not available in the literature, so the reduction in the required annual number of refueling cycles due to improved fuel economy was calculated and the economic value of the resulting benefits assessed. Chief among these benefits is the time that owners save by spending less time both in search of fueling stations and in the act of pumping and paying for fuel.

The economic value of refueling time savings was calculated by applying DOT-recommended valuations for travel time savings to estimates of how much time is saved.²⁵⁸ The value of travel time depends on average hourly valuations of personal and business time, which are functions of total hourly compensation costs to employers. The total hourly compensation cost to employers, inclusive of benefits, in 2010\$ is \$29.68.²⁵⁹ Table-II-39 below demonstrates the approach to estimating the value of travel time (\$/hour) for both urban and rural (intercity) driving. This approach relies on the use of DOT-recommended weights that assign a lesser valuation to personal travel time than to business travel time, as well as

²⁵⁷ Often HEVs and PHEVs place batteries in functional storage space, such as the trunk or floor storage bins, thereby forcing consumers to trade-off fuel-savings with other functional vehicle attributes.

²⁵⁸ See <https://www.transportation.gov/sites/dot.gov/files/docs/ValueofTravelTimeMemorandum.pdf> (last accessed July 3, 2018).

²⁵⁹ Total hourly employer compensation costs for 2010 (average of quarterly observations across all occupations for all civilians). See <https://www.bls.gov/ncs/ect/tables.htm> (last accessed July 3, 2018).

weights that adjust for the distribution between personal and business travel.

Table-II-39 - NHTSA Estimates of the Value of Travel Time for Urban and Rural (Intercity) Travel (\$/hour)²⁶⁰

Urban Travel			
	Personal travel	Business Travel	Total
Wage Rate (\$/hour)	\$29.68	\$29.68	--
DOT-Recommended Value of Travel Time Savings, as % of Wage Rate	50%	100%	--
Hourly Valuation (=Wage Rate * DOT-Recommended Value)	\$14.84	\$29.68	--
% of Total Urban Travel	94.4%	5.6%	100%
Hourly Valuation (Adjusted for % of Total Urban Travel)	\$14.01	\$1.66	\$15.67
Rural (Intercity) Travel			
	Personal travel	Business Travel	Total
Wage Rate (\$/hour)	\$29.68	\$29.68	--
DOT-Recommended Value of Travel Time Savings, as % of Wage Rate	70%	100%	--
Hourly Valuation (=Wage Rate * DOT-Recommended Value)	\$20.77	\$3.86	--
% of Total Rural Travel	87.0%	13.0%	100%
Hourly Valuation (Adjusted for % of Total Rural Travel)	\$18.07	\$3.86	\$21.93

The estimates of the hourly value of urban and rural travel time (\$15.67 and \$21.93, respectively) shown in Table-II-39 above must be adjusted to account for the nationwide ratio of urban to rural driving. By applying this adjustment (as shown in Table-II-40 below), an overall estimate of the hourly value of travel

time—independent of urban or rural status—may be produced.

Note: The calculations above assume only one adult occupant per vehicle. To fully estimate the average value of vehicle travel time, the presence of additional adult passengers during refueling trips must be accounted for. The analysis applies such an adjustment as shown in Table-II-40; this

adjustment is performed separately for passenger cars and for light trucks, yielding occupancy-adjusted valuations of vehicle travel time during refueling trips for each fleet.

Note: Children (persons under age 16) are excluded from average vehicle occupancy counts, as it is assumed that the opportunity cost of children’s time is zero.

²⁶⁰ Time spent on personal travel during rural (intercity) travel is valued at a greater rate than that of urban travel. There are several reasons behind

the divergence in these values: (1) Time is scarcer on a long trip; (2) a long trip involves complementary expenditures on travel, lodging,

food, and entertainment because time at the destination is worth such high costs.

Table-II-40 - NHTSA Estimates of the Value of Travel Time for Light-Duty Vehicles (\$/hour)

	Unweighted Value of Travel Time (\$/hour)	Weight (% of Total Miles Driven) ²⁶¹	Weighted Value of Travel Time (\$/hour)
Urban Travel	\$15.67	67.1%	\$10.51
Rural Travel	\$21.93	32.9%	\$7.22
Total	--	100.0%	\$17.73
	Passenger Cars	Light Trucks	
Average Vehicle Occupancy During Refueling Trips (persons) ²⁶²	1.21	1.23	
Weighted Value of Travel Time (\$/hour)	\$17.73	\$17.73	
Occupancy-Adjusted Value of Vehicle Travel Time During Refueling Trips (\$/hour)	\$21.45	\$21.81	

The analysis estimated the amount of refueling time saved using (preliminary) survey data gathered as part of our 2010–2011 National Automotive Sampling System’s Tire Pressure Monitoring System (TPMS) study.²⁶³ The study was conducted at fueling stations nationwide, and researchers made observations regarding a variety of characteristics of thousands of individual fueling station visits from August 2010 through April 2011.²⁶⁴

Among these characteristics of fueling station visits is the total amount of time spent pumping and paying for fuel. From a separate sample (also part of the TPMS study), researchers conducted interviews at the pump to gauge the distances that drivers travel in transit to and from fueling stations, how long that transit takes, and how many gallons of fuel are being purchased.

This analysis of refueling benefits considers only those refueling trips

which interview respondents indicated the primary reason was due to a low reading on the gas gauge.²⁶⁵ This restriction was imposed so as to exclude drivers who refuel on a fixed (*e.g.*, weekly) schedule and may be unlikely to alter refueling patterns as a result of increased driving range. The relevant TPMS survey data on average refueling trip characteristics are presented below in Table-II-41.

Table-II-41 - NHTSA Average Refueling Trip Characteristics for Passenger Cars and Light Trucks

	Gallons of Fuel Purchased	Round-Trip Distance to/from Fueling Station (miles)	Round-Trip Time to/from Fueling Station (minutes)	Time to Fill and Pay (minutes)	Total Time (minutes)
Passenger Cars	9.8	0.97	2.28	4.10	6.38
Light Trucks	13.0	1.08	2.53	4.30	6.83

As an illustration of how the value of extended refueling range was estimated, assume a small light truck model has an average fuel tank size of approximately 20 gallons and a baseline actual on-road fuel economy of 24 mpg (its assumed

level in the absence of a higher CAFE standard for the given model year). TPMS survey data indicate that drivers who indicated the primary reason for their refueling trips was a low reading on the gas gauge typically refuel when

their tanks are 35% full (*i.e.* as shown in Table-II-41, with 7.0 gallons in reserve, and the consumer purchases 13 gallons). By this measure, a typical driver would have an effective driving range of 312 miles (= 13.0 gallons × 24

²⁶¹ See *Travel Monitoring, Traffic Volume Trends*, U.S. Department of Transportation Federal Highway Administration, https://www.fhwa.dot.gov/policy_information/travel_monitoring/tvt.cfm (last visited June 22, 2018). Weights used for urban versus rural travel are computed using cumulative 2011 estimates of urban versus rural miles driven provided by the Federal Highway Administration.

²⁶² Source: National Automotive Sampling System 2010–2011 Tire Pressure Monitoring System (TPMS) study. See next page for further background

on the TPMS study. TPMS data are preliminary at this time, and rates are subject to change pending availability of finalized TPMS data. Average occupancy rates shown here are specific to refueling trips and do not include children under 16 years of age.

²⁶³ TPMS data are preliminary and not yet published. Estimates derived from TPMS data are therefore preliminary and subject to change. Observational and interview data are from distinct subsamples, each consisting of approximately 7,000

vehicles. For more information on the National Automotive Sampling System and to access TPMS data when they are made available, see <http://www.nhtsa.gov/NASS>.

²⁶⁴ The data collection period for the TPMS study ranged from October 10, 2010, through April 15, 2011.

²⁶⁵ Approximately 60% of respondents indicated “gas tank low” as the primary reason for the refueling trip in question.

mpg) before he or she is likely to refuel. Increasing this model's actual on-road fuel economy from 24 to 25 mpg would therefore extend its effective driving range to 325 miles (= 13.0 gallons \times 25 mpg). Assuming that the truck is driven 12,000 miles/year,²⁶⁶ this one mpg improvement in actual on-road fuel economy reduces the expected number of refueling trips per year from 38.5 (= 12,000 miles per year/312 miles per refueling) to 36.9 (= 12,000 miles per year/325 miles per refueling), or by 1.6 refuelings per year. If a typical fueling cycle for a light truck requires a total of 6.83 minutes, then the annual value of time saved due to that one mpg improvement would amount to \$3.97 (= (6.83/60) \times \$21.81 \times 1.6).

In the central analysis, this calculation was repeated for each future calendar year that light-duty vehicles of each model year affected by the standards considered in this rule would remain in service. The resulting cumulative lifetime valuations of time savings account for both the reduction over time in the number of vehicles of a given model year that remain in service and the reduction in the number of miles (VMT) driven by those that stay in service. The analysis also adjusts the value of time savings that will occur in future years both to account for expected annual growth in real wages²⁶⁷ and to apply a discount rate to determine the net present value of time saved.²⁶⁸ A further adjustment is made to account for evidence from the interview-based portion of the TPMS study which suggests that 40% of refueling trips are for reasons other than a low reading on the gas gauge. It is therefore assumed that only 60% of the theoretical refueling time savings will be realized, as it was assumed that owners who refuel on a fixed schedule

will continue to do. Based on peer reviewer comments to NHTSA's initial implementation of refueling time savings (subsequent to the CAFE NPRM issued in 2011), the analysis of refueling time savings was updated for the final rule to reflect peer reviewer suggestions.²⁶⁹ Beyond updating time values to current dollars, that analysis has been used, unchanged, in today's analysis as well.

Because a reduction in the expected number of annual refueling trips leads to a decrease in miles driven to and from fueling stations, the value of consumers' fuel savings associated with this decrease can also be calculated. As shown in Table II-41, the typical incremental round-trip mileage per refueling cycle is 1.08 miles for light trucks and 0.97 miles for passenger cars. Going back to the earlier example of a light truck model, a decrease of 1.6 in the number of refuelings per year leads to a reduction of 1.73 miles driven per year (= 1.6 refuelings \times 1.08 miles driven per refueling). Again, if this model's actual on-road fuel economy was 24 mpg, the reduction in miles driven yields an annual savings of approximately 0.07 gallons of fuel (= 1.73 miles/24 mpg), which at \$3.25/gallon²⁷⁰ results in a savings of \$0.23 per year to the owner.

Note: This example is illustrative only of the approach used to quantify this benefit. In practice, the societal value of this benefit excludes fuel taxes (as they are transfer payments) from the calculation and is modeled using fuel price forecasts specific to each year the given fleet will remain in service.

The annual savings to each consumer shown in the above example may seem like a small amount, but the reader should recognize that the valuation of the cumulative lifetime benefit of this savings to owners is determined separately for passenger car and light truck fleets and then aggregated to show the net benefit across all light-duty vehicles, which is much more significant at the macro level. Calculations of benefits realized in future years are adjusted for expected real growth in the price of gasoline, for the decline in the number of vehicles of a given model year that remain in service as they age, for the decrease in

the number of miles (VMT) driven by those that stay in service, and for the percentage of refueling trips that occur for reasons other than a low reading on the gas gauge; a discount rate is also applied in the valuation of future benefits. Using this direct estimation approach to quantify the value of this benefit by model year was considered; however, it was concluded that the value of this benefit is implicitly captured in the separate measure of overall valuation of fuel savings. Therefore, direct estimates of this benefit are not added to net benefits calculations. It is noted that there are other benefits resulting from the reduction in miles driven to and from fueling stations, such as a reduction in greenhouse gas emissions—CO₂ in particular—which, as per the case of fuel savings discussed in the preceding paragraph, are implicitly accounted for elsewhere.

Special mention must be made with regard to the value of refueling time savings benefits to owners of electric and plug-in electric (both referred to here as EV) vehicles. EV owners who routinely drive daily distances that do not require recharging on-the-go may eliminate the need for trips to fueling or charging stations. It is likely that early adopters of EVs will factor this benefit into their purchasing decisions and maintain driving patterns that require once-daily at-home recharging (a process which generally takes five to eleven hours for a full charge)²⁷¹ for those EV owners who have purchased and installed a Level Two charging station to a high-voltage outlet at their home or parking place. However, EV owners who regularly or periodically need to drive distances further than the fully-charged EV range may need to recharge at fixed locations. A distributed network of charging stations (e.g., in parking lots, at parking meters) may allow some EV owners to recharge their vehicles while at work or while shopping, yet the lengthy charging cycles of current charging technology may pose a cost to owners due to the value of time spent waiting for EVs to charge and potential EV shoppers who do not have access to charging at home (e.g., because they live in an apartment without a vehicle charging station, only

²⁶⁶ 2009 National Household Travel Survey (NHTS), U.S. Department of Transportation Federal Highway Administration at 48 (June 2011), available at <http://nhts.ornl.gov/2009/pub/stt.pdf>. 12,000 miles/year is an approximation of a light duty vehicle's annual mileage during its initial decade of use (the period in which the bulk of benefits are realized). The CAFE model estimates VMT by model year and vehicle age, taking into account the rebound effect, secular growth rates in VMT, and fleet survivability; these complexities are omitted in the above example for simplicity.

²⁶⁷ See *The Economics Daily, The compensation-productivity gap*, U.S. Department of Labor Bureau of Labor Statistics (Feb. 24, 2011), http://www.bls.gov/opub/td/2011/td_20110224.htm. A 1.1% annual rate of growth in real wages is used to adjust the value of travel time per vehicle (\$/hour) for future years for which a given model is expected to remain in service. This rate is supported by a BLS analysis of growth in real wages from 2000–2009.

²⁶⁸ Note: Here, as elsewhere in the analysis, discounting is applied on an annual basis from CY 2017.

²⁶⁹ Peer review materials, peer reviewer backgrounds, comments, and NHTSA responses for this prior assessment are available at Docket NHTSA–2012–0001.

²⁷⁰ Estimate of \$3.25/gallon is the forecasted cost per gallon (including taxes, as individual consumers consider reduced tax expenditures to be savings) for motor gasoline in 2025. Source of price projections: U.S. Energy Information Administration, Annual Energy Outlook Early 2018.

²⁷¹ See generally *All-New Nissan Leaf Range & Charging*, Nissan USA, <https://www.nissanusa.com/vehicles/electric-cars/leaf/range-charging.html> (last visited June 22, 2018); *Home Charging Calculator*, Tesla, <https://www.tesla.com/support/home-charging-calculator> (last visited June 22, 2018); *2018 Chevrolet Bolt EV*, GM, https://media.gm.com/content/media/us/en/chevrolet/vehicles/bolt-ev/2018/jcr_content/iconrow/textfile/file.res/2018-Chevrolet-Bolt-EV-Product-Guide.pdf (last visited June 22, 2018).

have street parking, or have garages with insufficient voltage). Moreover, EV owners who primarily recharge their vehicles at home will still experience some level of inconvenience due to their vehicle being either unavailable for unplanned use or to its range being limited during this time should they interrupt the charging process. Therefore, at present EVs hold potential in offering significant time savings but only to owners with driving patterns optimally suited for EV characteristics. If fast-charging technologies emerge and a widespread network of fast-charging stations is established, it is expected that a larger segment of EV vehicle owners will fully realize the potential refueling time savings benefits that EVs offer. This is an area of significant uncertainty.

6. Vehicle Use and Survival

To properly account for the average value of consumer and societal costs and benefits associated with vehicle usage under various CAFE and GHG alternatives, it is necessary to estimate the portion of these costs and benefits that will occur at each age (or calendar year) for each model year cohort. Doing so requires some estimate of how many miles the average vehicle of a given type²⁷² is expected to drive at each age and what share of the initial model year cohort is expected to remain at each age. The first estimates are referred to as the vehicle miles travelled (VMT) schedules and the second as the survival rate schedules. In this section the data sources and general methodologies used to develop these two essential inputs are briefly discussed. More complete discussions of the development of both the VMT schedules and the survival rate schedules are present in the PRIA Chapter 8.

(a) Updates to Vehicle Miles Traveled Schedules Since 2012 FR

The MY 2017–2021 FRM built estimates of average lifetime mileage accumulation by body style and age using the 2009 National Household Travel Survey (NHTS), which surveys odometer readings of the vehicles present from the approximately 113,000 households sampled. Approximately 210,000 vehicles were in the sample of self-reported odometer readings collected between April 2008 and April 2009. This represents a sample size of less than one percent of the more than 250 million light-duty vehicles registered in 2008 and 2009. The NHTS sample is now 10 years old and taken

during the Great Recession. The 2017 NHTS was not available at the time of this rulemaking. Because of the age of the last available NHTS and the unusual economic conditions under which it was collected, NHTSA built the new schedule using a similar method from a proprietary dataset collected in the fall of 2015. This new data source has the advantages of both being newer, a larger sample, and collected by a third party.

(1) Data Sources and Estimation (Polk Odometer Data)

To develop new mileage accumulation schedules for vehicles regulated under the CAFE program (classes 1–3), NHTSA purchased a data set of vehicle odometer readings from IHS/Polk (Polk). Polk collects odometer readings from registered vehicles when they encounter maintenance facilities, state inspection programs, or interactions with dealerships and OEMs—these readings are more likely to be precise than the self-reported odometer readings collected in the NHTS. The average odometer readings in the data set NHTSA purchased are based on more than 74 million unique odometer readings across 16 model years (2000–2015) and vehicle classes present in the data purchase (all registered vehicles less than 14,000 lbs. GVW). This sample represents approximately 28% of the light-duty vehicles registered in 2015, and thus has the benefit of not only being a newer, but also, a larger, sample.

Comparably to the NHTS, the Polk data provide a measure of the cumulative lifetime vehicle miles traveled (VMT) for vehicles, at the time of measurement, aggregated by the following parameters: Make, model, model year, fuel type, drive type, door count, and ownership type (commercial or personal). Within each of these subcategories they provide the average odometer reading, the number of odometer readings in the sample from which Polk calculated the averages, and the total number of that subcategory of vehicles in operation.

In estimating the VMT models, each data point was weighted (make/model classification) by the share of each make/model in the total population of the corresponding vehicle body style. This weighting ensures that the predicted odometer readings, by body style and model year, represent each vehicle classification among observed vehicles (*i.e.*, the vehicles for which Polk has odometer readings), based on each vehicles' representation in the registered vehicle population of its body style. Implicit in this weighting scheme is the assumption that the samples used

to calculate each average odometer reading by make, model, and model year are representative of the total population of vehicles of that type. Several indicators suggest that this is a reasonable assumption.

First, the majority of vehicle make/models is well-represented in the sample. For more than 85% of make/model combinations, the average odometer readings are collected for 20% or more of the total population. Most make/model observations have sufficient sample sizes, relative to their representation in the vehicle population, to produce meaningful average odometer totals at that level. Second, we considered whether the representativeness of the odometer sample varies by vehicle age because VMT schedules in the CAFE model are specific to each age. It is possible that, for some of those models, an insufficient number of odometer readings is recorded to create an average that is likely to be representative of all of those models in operation for a given year. For all model years other than 2015, approximately 95% or more of vehicles types are represented by at least five percent of their population. For this reason, observations from all model years, other than 2015, were included in the estimation of the new VMT schedules.

Because model years are sold in in the Fall of the previous calendar year, throughout the same calendar year, and even into the following calendar year—not all registered vehicles of a make/model/model year will have been registered for at least a year (or more) until age three. The result is that some MY 2014 vehicles may have been driven for longer than one year, and some less, at the time the odometer was observed. In order to consider this in the definition of age, an age of a vehicle is assigned to be the difference between the average reading date of a make/model and the average first registration date of that make/model. The result is that the continuous age variable reflects the amount of time that a car has been registered at the time of odometer reading and presumably the time span that the car has accumulated the miles.

After creating the “age” variable, the analysis fits the make/model lifetime VMT data points to a weighted quartic polynomial regression of the age of the vehicle (stratified by vehicle body styles). The predicted values of the quartic regressions are used to calculate the marginal annual VMT by age for each body style by calculating differences in estimated lifetime mileage accumulation by age. However, the Polk data acquired by NHTSA only contains

²⁷² Type here refers to the following body styles: Pickups, vans/SUVs, and other cars.

observations for vehicles newer than 16 years of age. In order to estimate the schedule for vehicles older than the age 15 vehicles in the Polk data, information about that portion of the schedule from the VMT schedules used in both the 2017–2021 Final Light Duty Rule and 2019–2025 Medium-Duty NPRM was combined. The light-duty schedules were derived from the survey data contained in the 2009 National Household Travel Survey (NHTS).

From the old schedules, the annual VMT is expected to be decreasing for all ages. Towards the end of the sample, the predictions for annual VMT increase. In order to force the expected monotonicity, a triangular smoothing algorithm is performed until the schedule is monotonic. This performs a weighted average which weights the observations close to the observation more than those farther from it. The result is a monotonic function, that predicts similar lifetime VMT for the sample span as the original function. Because the analysis does not have data beyond 15 years of age, it is not able to correctly capture that part of the annual VMT curve using only the new dataset. For this reason, trends in the old data to extrapolate the new schedule for ages beyond the sample range are used.

To use the VMT information from the newer data source for ages outside of the sample, final in-sample age (15 years) are used as a seed and then applied to the proportional trend from the old schedules to extrapolate the new schedules out to age 40. To do this, the annual percentage difference in VMT of the old schedule for ages 15–40 is calculated. The same annual percentage difference in VMT is applied to the new schedule to extend beyond the final in-sample value. This assumes that the overall proportional trend in the outer years is correctly modeled in the old VMT schedule and imposes this same trend for the outer years of the new schedule. The extrapolated schedules are the final input for the VMT schedules in the CAFE model. PRIA Chapter 8 contains a lengthier discussion of both the data source and the methodology used to create the new schedules.

(2) Using New Schedules in the CAFE Model/Analysis

While the Polk registration data set contains odometer readings for individual vehicles, the CAFE model tabulates “mileage accumulation” schedules, which relate average annual miles driven to vehicle age, based on vehicles’ body style. For the purposes of VMT accounting, the CAFE model classifies vehicles in the analysis fleet as being one of the following: Passenger car, SUV, pickup truck, passenger van, or medium-duty pickup/van.²⁷³ In order to use the Polk data to develop VMT schedules for each of these vehicle classes in the CAFE model, a mapping between the classification of each model in the Polk data and the classes in the CAFE model was first constructed. This mapping enabled separate tabulations of average annual miles driven at each age for each of the vehicle classes included in the CAFE model.

The only revision made to the mappings used to construct the new VMT schedules was to merge the SUV and passenger van body styles into a single class. These body styles were merged because there were very few examples of vans—only 38 models were in use during 2014, where every other body style had at least three times as many models. Further, as shown in the PRIA Chapter 8, there was not a significant difference between the 2009 NHTS van and SUV mileage schedules, nor was there a significant difference between the schedules built with the two body styles merged or kept separate using the 2015 Polk data. Merging these body styles does not change the workings of the CAFE model in any way, and the merged schedule is simply entered as an input for both vans and SUVs.

Although there is a single VMT by age schedule used as an input for each body style, the assumptions about the rebound effect require that this schedule be scaled for future analysis years to reflect changes in the cost of travel from the time the Polk sample was originally collected. These changes result from both changes in fuel prices between the time the sample was collected and any future analysis year and differences in fuel economy between the vehicles included in the sample used to build the mileage schedules and the future-year

vehicles analyzed within the CAFE Model simulation.

As discussed in Section 0, recent literature supports a 20% “rebound effect” for light-duty vehicle use, which represents an elasticity of annual use with respect to fuel cost per mile of -0.2 . Because fuel cost per mile is calculated as fuel price per gallon divided by fuel economy (in miles per gallon), this same elasticity applies to changes in fuel cost per mile that result from variation in fuel prices or differences in fuel economy. It suggests that a five percent reduction in the cost per mile of travel for vehicles of a certain body style will result in a one percent increase in the average number of miles they are driven annually.

The average cost per mile (CPM) of a vehicle of a given age and vehicle style in CY 2016 (the first analysis year of the simulation) was used as the reference point to calculate the rebound effect within the CAFE model. However, this does not perfectly align with the time of the collection of the Polk dataset. The Polk data were collected in 2015 (so that 2014 fuel prices were the last to influence sampled vehicles’ odometer readings), and represents the average odometer reading at a single point in time for age (model year) included in the cross-section. We use the difference in the average odometer reading for each vintage during 2014 to calculate the number of miles vehicles are driven at each age (see PRIA Chapter 8 for specific details on the analysis). For example, we interpret the difference in the average odometer reading between the five- and six-year-old vehicles of a given body style as the average number of miles they are driven during the year when they were five years old. However, vehicles produced during different model years do not have the same average fuel economy, so it is important to consider the average fuel economy of each vintage (or model year) used to measure mileage accumulation at a given age when scaling VMT for the rebound calculation.

The first step in doing so is to adjust for any change in average annual use that would have been caused by differences in fuel prices between CYs 2014 and 2016. This is done by scaling the original schedules of annual VMT by age tabulated from the Polk sample using the following equation:

²⁷³ Though not included in today’s analysis, corresponding schedules for heavy-duty pickups

and vans were developed using the same methodology.

$$VMT_{style,CY2016,age} = VMT_{style,CY2014,age} \left(1 - .2 * \left(\frac{CPM_{style,CY2016,age} - CPM_{style,CY2014,age}}{CPM_{style,CY2014,age}} \right) \right)$$

Where:

$$CPM_{style,CY=2016,age} = \frac{Fuel\ Price_{CY=2016}}{Fuel\ Economy_{style,CY=2016,age}}$$

Here, the average fuel economy for vehicles of a given body style and age refers to a different MY in 2016 than it did in 2014; for example, a MY 2014 vehicle had reached age two vehicle during CY 2016, whereas a 2012 model year vehicle was age two during CY 2014.

To estimate the average annual use of vehicles of a specified body type and age during future calendar years under a specific regulatory alternative, the CAFE model adjusts the resulting estimates of vehicle use by age for that body type during CY 2016 to reflect (1) the projected change in fuel prices from 2016 to each future calendar year; and

(2) the difference between the average fuel economy for vehicles of that body type and age during a future calendar year and the average fuel economy for vehicles of that same body type and age during 2016. These two factors combine to determine the average fuel cost per mile for vehicles of that body type and age during each future calendar year and the average fuel cost per mile for vehicles of that same body type and age during 2016.

The elasticity of annual vehicle use with respect to fuel cost per mile is applied to the difference between these two values because vehicle use is assumed to respond identically to

differences in fuel cost per mile that result from changes in fuel prices or from differences in fuel economy. The model then repeats this calculation for each calendar year during the lifetimes of vehicles of other body types, and subsequently repeats this entire set of calculations for each regulatory alternative under consideration. The resulting differences in average annual use of vehicles of each body type at each age interact with the number estimated to remain in use at that age to determine total annual VMT by vehicles of each body type.

This adjustment is defined by the equation below:

$$VMT_{style,CY,age} = VMT_{style,CY=2016,age} \left(1 - .2 * \left(\frac{CPM_{style,CY,age} - CPM_{style,CY=2016,age}}{CPM_{style,CY=2016,age}} \right) \right)$$

Where:

$$CPM_{style,CY,age} = \frac{Fuel\ Price_{CY}}{Fuel\ Economy_{style,age}}$$

This equation uses the observed cost per mile of a vehicle of each age and style in CY 2016 as the reference point for all future calendar years. That is, the reference fuel price is fixed at 2016 levels, and the reference fuel economy of vehicles of each age is fixed to the average fuel economy of the vintage that had reached that age in 2016. For example, the reference CPM for a one-year-old SUV is always the CPM of the average MY 2015 SUV in CY 2016, and the CPM for a two-year-old SUV is always the CPM of the average MYv2014 SUV in CY 2016.

This referencing ensures that the model's estimates of annual mileage accumulation for future calendar years reflect differences in the CPM of

vehicles of each given type and age relative to CPM resulting from the average fuel economy of vehicles of that type and age and observed fuel prices during the year when the mileage accumulation schedules were originally measured. This is consistent with a definition of the rebound effect as the elasticity of annual vehicle use with respect to changes in the fuel cost per mile of travel, regardless of the source of changes in fuel cost per mile.

Alternative forms of referencing are possible, but none can guarantee that projected future vehicle use will respond to *both* projected changes in fuel prices and differences in individual models' fuel economy among regulatory alternatives.

The mileage estimates described above are a crucial input in the CAFE model's calculation of fuel consumption and savings, energy security benefits, consumer surplus from cheaper travel, recovered refueling time, tailpipe emissions, and changes in crashes, fatalities, noise and congestion.

(3) Comparison to other VMT projections (2012 FR, AEO average lifetime miles, totals?)

Across all body styles and ages, the previous VMT schedules estimate higher average annual VMT than the updated schedules. Table-II-42 compares the lifetime VMT under the 2009 NHTS and the 2015 Polk dataset. The 40-year lifetime VMT gives the

expected lifetime VMT of a vehicle conditional on surviving to age 40. The new schedules predict between 24 and 31% fewer miles for a 40-year old vehicle depending on the body style. The new schedules predict that the average 40-year old vehicle will drive between approximately 260k and 280k miles depending on the body style versus between approximately 350k and 380k for the previous schedules.

The static survival-weighted lifetime VMT represents the expected number of miles the average vehicle of each body style will drive, weighting by the likelihood it survives to each age using the previous static scrappage schedules.

The dynamic survival-weighted lifetime VMT represents the expected number of miles driven by each body style, weighting by the dynamic survival schedules under baseline assumptions.²⁷⁴ There is a similar proportional reduction in expected lifetime VMT under both survival assumptions, with the dynamic scrappage model predicting lifetime mileage accumulation within 10,000 miles of the previous static model under both VMT schedules. The expected lifetime mileage accumulation reduces between 13 and 15% under the current VMT schedules when compared to the previous schedules—a smaller

proportional reduction than the unweighted lifetime assumptions. Using the updated schedules, the expected lifetime mileage accumulation is between approximately 150k and 170k miles depending on the body style, rather than the approximately 180k to 210k miles under the previous schedules. For more detail on when the mileage and survival rates occur, chapter 8 of the PRIA gives the full VMT schedules by age. The section below gives further estimates of how lifetime VMT estimates vary under different assumptions within the dynamic scrappage model.

Table-II-42 - Summary Comparison of Lifetime VMT of the New and Old Schedules

Body Style	40-year Lifetime VMT			Static Survival-Weighted Lifetime VMT			Dynamic Survival-Weighted Lifetime VMT ²⁷⁴		
	Polk, 2015	NHTS, 2009	% change	Polk, 2015	NHTS, 2009	% change	Polk, 2015	NHTS, 2009	% change
Car	257,244	370,731	-30.6%	153,121	179,399	-14.6%	152,538	175,617	-13.1%
Van	266,282	382,667	-30.4%	167,223	196,725	-15.0%	176,318	206,164	-14.5%
SUV	266,282	349,922	-23.9%	167,223	193,115	-13.4%	176,318	202,657	-13.0%
Pickup	282,371	384,012	-26.5%	159,826	188,634	-15.3%	166,414	196,111	-15.1%

We have several reasons for preferring the new VMT schedules over the prior iterations. Before discussing these reasons, it is important to note that NHTSA uses the same general methodology in developing both schedules. We consider data on average odometer readings by age and body style collected once during a given window of time; we then estimate a weighted polynomial function between vehicle age and lifetime accumulation for a given vehicle style. As with the previous schedules, we use the inter-annual differences as the estimate of annual miles traveled for a given age.

The primary advantage of the current schedules is the data source. The previous schedules are based on data that is outdated and self-reported, while the observations from Polk are between five and seven years newer than those in the NHTS and represent valid odometer readings (rather than self-

reported information). Further, the 2009 NHTS represents approximately one percent of the sample of vehicles registered in 2008/2009, while the 2015 Polk dataset represents approximately 30% of all registered light-duty vehicles; it is a much larger dataset, and less likely to oversample certain vehicles. Additionally, while the NHTS may be a representative sample of households, it is less likely to be a representative sample of vehicles. However, by properly accounting for vehicle population weights in the new averages and models, we corrected for this issue in the derivation of the new schedules.

Importantly, this methodology treats the cross-section of ages in a single calendar year as a panel of the same model year vehicle, when in reality each age represents a single model year, and not a true panel. We have some concern that where the most heavily driven vehicles drop out of the sample that the lifetime odometer readings will be lower than they would be if the scrapped vehicles had been left in the dataset without additional mileage accumulation. This would bias our estimates of inter-annual mileage accumulation downward and may result in an undervaluation of costs and benefits associated with additional travel for vehicles of older ages. For the

next VMT schedule iteration, NHTSA intends to use panel data to test the magnitude of any attrition effect that may exist. While this caveat is important, all previous iterations were also built from a single calendar year cross-section and contain the same inherent bias.

(b) How does CAFE affect vehicle retirement rates?

Lightly used vehicles are a close substitute for new vehicles; thus, there is relationship between the two markets. As the price for new vehicles increases, there is an upward shift in the demand for used vehicles. As a result of the upward shift in the demand curve, the equilibrium price and quantity of used vehicles both increase; the value of used vehicles increases as a result. The decision to scrap or maintain a used vehicle is closely linked with the value of the vehicle; when the value is lesser than the cost to maintain the vehicle, it will be scrapped. In general, as a result of new vehicle price increases, the scrappage rate, or the proportion of vehicles remaining on the road unregistered in a given year, of used vehicles will decline. Because older vehicles are on average less efficient and less safe, this will have important implications for the evaluations of costs

²⁷⁴ In estimating the dynamic survival rate to weight the annual VMT schedules, we make the following input assumptions: The reference vehicle is MY 2016, GDP growth rates and fuel prices are our central estimates, and the future average new vehicle fuel economies by body style and overall average new vehicle prices are those simulated by the CAFE model when CAFE standards are omitted (by setting standards at 1 mpg), such that only technologies that pay back within 30 months are applied.

and benefits of fuel economy standards, which increase the cost of new vehicles and reduce the average cost per mile of fuel costs.

Fuel economy standards result in the application of more fuel saving technologies for at least some models, which result in a higher cost for manufacturers to produce otherwise identical vehicles. This increase in production cost amounts to an upward shift in the supply curve for new vehicles. This increases the equilibrium price and reduces the quantity of vehicles demanded. While the cost of new vehicles increases under increased fuel economy standards, the fuel cost per mile of travel declines. Consumers will place some value on the fuel savings associated with the additional technology, to the extent that they value reduced operating expenses against the increased price of a new vehicle, increased financing costs (and impediments to obtaining financing), and increased insurance costs.

There is a trade-off between fuel economy and other attributes that consumers value such as: Vehicle performance, interior volume, etc. Where the additional value of fuel savings associated with a technology is greater than any loss of value from trade-offs with other attributes, the demand for new vehicles will also shift upwards. Where the additional evaluation of fuel savings is lesser than any loss of value from changes to other attributes, the demand will shift downwards. Thus, the direction of the demand shift is unknown. However, if we assume that manufacturers pass all costs associated with a model off to the consumer of that vehicle, then the per vehicle profit remains constant. If we also assume that manufacturers are good predictors of the valuation and elasticity of certain vehicle attributes, then we can assume that even if there is some positive demand shift, it is not enough to increase demand above the original equilibrium levels, or manufacturers would apply those technologies even in the absence of regulation.

As noted above, the increase in the price of new vehicles will result in increased demand for used vehicles as substitutes, extending the expected age and lifetime vehicle miles travelled of less efficient, and generally, less safe vehicles. The additional usage of older vehicles will result in fewer gallons saved and more total on-road fatalities under more stringent CAFE alternatives. For more on the topic of safety, the relative safety of specific model year vehicles is discussed in Section 0 of the preamble and PRIA Chapter 11. Both the erosion of fuel savings and the increase

in incremental fatalities will decrease the societal net benefits of increasing new vehicle fuel economy standards.

Our previous estimates of vehicle scrappage did not include a dynamic response to new vehicle price, but recent literature has continued to illustrate that this an omission which could rival the rebound effect in magnitude (Jacobsen & van Bentham, 2015). For this reason, we worked to develop an econometric survival model which captures the effect of increasing the price of new vehicles on the survival rate of used vehicles discussed in the following sections and in more detail in the PRIA Chapter 8. We discuss the literature on vehicle scrappage rate and discuss in the succeeding section. A brief explanation of why we develop our own models and the data sources and econometric estimations we use to do so, follows. We conclude the discussion of the updates to vehicle survival estimates with a summary of the results, a description of how we use them in the CAFE model, and finally, how the updated schedules compare with the previous static scrappage schedules.

(1) What does the literature say about the relationship?

(a) How Fuel Economy Standards Impact Vehicle Scrappage

The effects of differentiated regulation²⁷⁵ in the context of fuel economy (particularly, emission standards only affecting new vehicles) was discussed in detail in Gruenspecht (1981) and (1982), and has since been coined the “Gruenspecht effect.” Gruenspecht recognized that because fuel economy standards affect only new vehicles, any increase in price (net of the portion of reduced fuel savings valued by consumers) will increase the expected life of used vehicles and reduce the number of new vehicles entering the fleet. In this way, increased fuel economy standards slow the turnover of the fleet and the entrance of any regulated attributes tied only to new vehicles. Although Gruenspecht acknowledges that a structural model which allows new vehicle prices to affect used vehicle scrappage only through their effect on used vehicle prices would be preferable, the data available on used vehicle prices was (and still is) limited. Instead he tested his hypothesis in his 1981 dissertation using new vehicle price and other determinants of used car prices as a

reduced form to approximate used car scrappage in response to increasing fuel economy standards.

Greenspan & Cohen (1996) offer additional foundations from which to think about vehicle stock and scrappage. Their work identifies two types of scrappage: Engineering scrappage and cyclical scrappage. Engineering scrappage represents the physical wear on vehicles, which results in their being scrapped. Cyclical scrappage represents the effects of macroeconomic conditions on the relative value of new and used vehicles; under economic growth the demand for new vehicles increases and the value of used vehicles declines, resulting in increased scrappage. In addition to allowing new vehicle prices to affect cyclical vehicle scrappage à la the Gruenspecht effect, Greenspan and Cohen also note that engineering scrappage seems to increase where EPA emission standards also increase; as more costs goes towards compliance technologies, it becomes more expensive to maintain and repair more complicated parts, and scrappage increases. In this way, Greenspan and Cohen identify two ways that fuel economy standards could affect vehicle scrappage: (1) Through increasing new vehicle prices, thereby increasing used vehicle prices, and finally, reducing on-road vehicle scrappage, and (2) by shifting resources towards fuel-saving technologies—potentially reducing the durability of new vehicles by making them more complex.

(b) Aggregate vs. Atomic Data Source in the Literature

One important distinction between the literatures on vehicles scrappage is between those that use atomic vehicle data, data following specific individual vehicles, and those that use some level of aggregated data, data that counts the total number of vehicles of a given type. The decision to scrap a vehicle is an atomic one—that is, made on an individual vehicle basis. The decision relates to the cost of maintaining a vehicle, and the value of the vehicle both on the used car market, and as scrap metal. Generally, a used car owner will decide to scrap a vehicle where the value of the vehicle is less than the value of the vehicle as scrap metal plus the cost to maintain or repair the vehicle. In other words, the owner gets more value from scrapping the vehicle than continuing to drive it or from selling it.

Recent work is able to model scrappage as an atomic decision due to the availability of a large database of used vehicle transactions. Following works by other authors including:

²⁷⁵ Differentiated regulations are regulations affecting segments of the market differently; here, it references the fact that emission and fuel economy standards have largely only applied to new and not used vehicles.

Busse, Knittel, & Zettelmeyer (2013); Sallee, West, & Fan (2010); Alcott & Wozny (2013); and Li, Timmins, & von Haefen (2009)—Jacobsen & van Benthem (2015) considers the impact of changes in gasoline prices on used vehicle values and scrappage rates. In turn, they consider the impact of an increase in used vehicle values on the scrappage rate of those vehicles. They find that increases in gasoline price result in a reduction in the scrappage rate of the most fuel efficient vehicles and an increase in the scrappage rate of the least fuel efficient vehicles. This has important implications for the validity of the average fuel economy values linked to model years and assumed to be constant over the life of that model year fleet within this study. Future iterations of this study could further investigate the relationship between fuel economy, vehicle usage, and scrappage, as noted in other places in this discussion.

While the decision to scrap a vehicle is made atomically, the data available to NHTSA on scrappage rates and variables that influence these scrappage rates are aggregate measures. This influences the best available methods to measure the impacts of new vehicle prices on existing vehicle scrappage. The result is that this study models aggregate trends in vehicle scrappage and not the atomic decisions that make up these trends. Many other works within the literature use the same data source and general scrappage construct, such as: Walker (1968); Park (1977), Greene & Chen (1981); Gruenspecht (1981); Gruenspecht (1982); Feeney & Cardebring (1988); Greenspan & Cohen (1996); Jacobsen & van Benthem (2015); and Bento, Roth, & Zhuo (2016) all use the same aggregate vehicle registration data as the source to compute vehicle scrappage.

Walker (1968) and Bento, Roth, & Zhuo (2016) use aggregate data to directly compute the elasticity of scrappage from measures of used vehicle prices. Walker (1968) uses the ratio of used vehicle Consumer Price Index (CPI) to repair and maintenance CPI. Bento, Roth, & Zhuo (2016) use used vehicle prices directly. While the direct measurement of the elasticity of scrappage is preferable in a theoretical sense, the CAFE model does not predict future values of used vehicles, only future prices of new vehicles. For this reason, any model compatible with the current CAFE model must estimate a reduced form similar to Park (1977); Gruenspecht (1981); Greenspan & Cohen (1996), who use some form of new vehicle prices or the ratio of new vehicle prices to maintenance and

repair prices to impute some measure of the effect of new vehicle prices on vehicle scrappage.

(c) Historical Trends in Vehicle Durability

Waker (1968); Park (1977); Feeney & Cardebring (1988); Hamilton & Macauley (1999); and Bento, Ruth, & Zhuo (2016) all note that vehicles change in durability over time. Walker (1968) simply notes a significant distinction in expected vehicle lifetimes pre- and post-World War I. Park (1977) discusses a ‘durability factor’ set by the producer for each year so that different vintages and makes will have varying expected lifecycles. Feeney & Cardebring (1988) show that durability of vehicles appears to have generally increased over time both in the U.S. and Swedish fleets using registration data from each country. They also note that the changes in median lifetime between the Swedish and U.S. fleet track well, with a 1.5 year lag in the U.S. fleet. This lag is likely due to variation in how the data is collected—the Swedish vehicle registry requires a title to unregister a vehicle, and therefore gets immediate responses, where the U.S. vehicle registry requires re-registration, which creates a lag in reporting.

Hamilton & Macauley (1999) argue for a clear distinction between embodied versus disembodied impacts on vehicle longevity. They define embodied impacts as inherent durability similar to Park’s producer supplied ‘durability factor’ and Greenspan’s ‘engineering scrappage’ and disembodied effects those which are environmental, not unlike Greenspan and Cohen’s ‘cyclical scrappage.’ They use calendar year and vintage dummy variables to isolate the effects—concluding that the environmental factors are greater than any pre-defined ‘durability factor.’ Some of their results could be due to some inflexibility of assuming model year coefficients are constant over the life of a vehicle, and there may be some correlation between the observed life of the later model years of their sample and the ‘stagflation’²⁷⁶ of the 1970’s. Bento, Ruth, & Zhuo (2016) find that the average vehicle lifetime has increased 27% from 1969 to 2014 by sub-setting their data into three model year cohorts. To implement these findings in the scrappage model incorporated into the CAFE model, this study takes pains to estimate the effect of durability changes in such a way that the historical durability trend can be projected into the future; for this reason, a continuous

²⁷⁶ Continued high inflation combined with high unemployment and slow economic growth.

‘durability’ factor as a function of model year vintage is included.

(d) Models of the Gruenspecht Effect Used in Other Policy Analyses

This is not the first estimation of the ‘Gruenspecht Effect’ for policy considerations. In their Technical Support Document (TSD) for the 2004 proposal to reduce greenhouse gas emissions from motor vehicles, California Air Resources Board (CARB) outlines how they utilized the CARBITS vehicle transaction choice model in an attempt to capture the effect of increasing new vehicle prices on vehicle replacement rates. They consider data from the National Personal Transportation Survey (NPTS) as a source of revealed preferences and a University of California (UC) study as a source of stated preferences for the purchase and sale of household fleets under different prices and attributes (including fuel economy) of new vehicles.

The transaction choice model represents the addition and deletion of a vehicle from a household fleet within a short period of time as a “replacement” of a vehicle, rather than as two separate actions. Their final data set consists of 790 vehicle replacements, 292 additions, and 213 deletions; they do not include the deletions, but assume any vehicle over 19 years old that is sold is scrapped. This allows them to capture a slowing of vehicle replacement under higher new vehicle prices, but because their model does not include deletions, does not explicitly model vehicle scrappage, but assumes all vehicles aged 20 and older are scrapped rather than resold. They calibrate the model so that the overall fleet size is benchmarked to Emissions Factors (EMFAC) fleet predictions for the starting year; the simulation then produces estimates that match the EMFAC predictions without further calibration.

The CARB study captures the effect on new vehicle prices on the fleet replacement rates and offers some precedence for including some estimate of the Gruenspecht Effect. One important thing to note is that because vehicles that exited the fleet without replacement were excluded, the effect of new vehicle prices on scrappage rates where the scrapped vehicle is not replaced is not captured. Because new and used vehicles are substitutes, it is expected that used vehicle prices will increase with new vehicle prices. Because higher used vehicle prices will lower the number of vehicles whose cost of maintenance is higher than their value, it is expected that not only will

replacements of used vehicles slow, but also, that some vehicles that would have been scrapped without replacement under lower new vehicle prices will now remain on the road because their value will have increased. Aggregate measures of the Gruenspecht effect will include changes to scrappage rates both from slower replacement rates, and slower non-replacement scrappage rates.

(2) Description of Data Sources

NHTSA purchases proprietary data on the registered vehicle population from IHS/Polk for safety analyses. IHS/Polk has annual snapshots of registered vehicle counts beginning in calendar year (CY) 1975 and continuing until calendar year 2015. The data includes the following regulatory classes as defined by NHTSA: Passenger cars, light trucks (classes 1 and 2a), and medium and heavy-duty trucks (classes 2b and 3). Polk separates these vehicles into another classification scheme: Cars and trucks. Under their schema, pickups, vans, and SUVs are treated as trucks, and all other body styles are included as cars. In order to build scrappage models to support the model year (MY) 2021–2026 light duty vehicle (LDV) standards, it was important to separate these vehicle types in a way compatible with the existing CAFE model.

There were two compatible choices to aggregate scrappage rates: (1) By regulatory class or (2) by body style. Because for NHTSA's purposes vans/SUVs are sometimes classified as passenger cars and sometimes as light trucks, and there was no quick way to reclassify some SUVs as passenger cars within the Polk dataset, NHTSA chose to aggregate survival schedules by body style. This approach is also preferable because NHTSA uses body style specific lifetime VMT schedules. Vehicles experience increased wear with use; many maintenance and repair events are closely tied to the number of miles on a vehicle. The current version of the CAFE model considers separate lifetime VMT schedules for cars, vans/SUVs, pickups and classes 2b and 3 vehicles. These vehicles are assumed to serve different purposes and, as a result, are modelled to have different average lifetime VMT patterns. These different uses likely also result in different lifetime scrappage patterns.

Once stratified into body style level buckets, the data can be aggregated into population counts by vintage and age. These counts represent the population of vehicles of a given body style and vintage in a given calendar year. The difference between the counts of a given vintage and vehicle type from one calendar year to the next is assumed to

represent the number of vehicles of that vintage and type scrapped in a given year. There were a couple other important data considerations for the calculations of the historical scrappage rates not discussed here but discussed in detail in the PRIA Chapter 8.²⁷⁷

For historical data on vehicle transaction prices, the models use data from the National Automobile Dealers Association (NADA), which records the average transaction price of all light-duty vehicles. These transaction prices represent the prices consumers paid for new vehicles but do not include any value of vehicles that may have been traded in to dealers. Importantly, these transaction prices were not available by vehicle body styles; thus, the models will miss any unique trends that may have occurred for a particular vehicle body style. This may be particularly relevant for pickup trucks, which observed considerable average price increases as luxury and high option pickups entered the market. Future models will further consider incorporating price series that consider the price trends for cars, SUVs and vans, and pickups separately.²⁷⁸

The models use the NADA price series rather than the Bureau of Labor Statistics (BLS) New Vehicle Consumer Price Index (CPI), used by Park (1977) and Greenspan & Cohen (1997), because the BLS New Vehicle CPI makes quality adjustments to the new vehicle prices. BLS assumes that additions of safety and fuel economy equipment are a quality adjustment to a vehicle model, which changes the good and should not be represented as an increase in its price. While this is good for some purposes, it presumes consumers fully value technologies that improve fuel economy. Because it is the purpose to this study to measure whether this is true, it is important that vehicle prices adjusted to fully value fuel economy improving technologies, which would obscure the ability to measure the

²⁷⁷ The first is any discontinuity caused by a change in how Polk collected their data beginning in calendar year 2010, and the second is the use of the adjustment described in Greenspan & Cohen (1996).

²⁷⁸ Note: Using historical data aggregated by body styles to capture differences in price trends by body style does not require the assertion technology costs are or are not borne by the body style to which they are applied. If the body-style level average price change is used, then the assumption is manufacturers do not cross-subsidize across body styles, whereas if the average price change is used then the assumption is they would proportion costs equally for each vehicle. These are implementation questions to be worked out once NHTSA has a historical data source separating price series by body styles, but these do not matter in the current model which only considers the average price of all light-duty vehicles.

preference for more fuel efficient and expensive new vehicles, are not used. As further justification for using the NADA price series over the BLS New Vehicle CPI, Park (1977) cites a discontinuity found in the amount of quality adjustments made to the series so that more adjustments are made over time. This could further limit the ability for the BLS New Vehicle CPI to predict changes in vehicle scrappage.

Vehicle scrappage rates are also influenced by fuel economy and fuel prices. Historical data on the fuel economy by vehicle style from model years 1979–2016 was obtained from the 2016 EPA Motor Trends Report.²⁷⁹ The van/SUV fuel economy values represent a sales-weighted harmonic average of the individual body styles. Fuel prices were obtained from Department of Energy (DOE) historical values, and future fuel prices within the CAFE model use the Annual Energy Outlook (AEO) future oil price projections.²⁸⁰ From these values the average cost per 100 miles of travel for the cohort of new vehicles in a given calendar year and the average cost per 100 miles of travel for each used model year cohort in that same calendar year are computed.²⁸¹ It is expected that as the new vehicle fleet becomes more efficient (holding all other attributes constant) that it will be more desirable, and the demand for used vehicles should decrease (increasing their scrappage). As a given model year cohort becomes more expensive to operate due to increases in fuel prices, it is expected the scrappage of that model year will increase. It is perhaps worth noting that more efficient model year vintages will be less susceptible to changes in fuel prices, as

²⁷⁹ *Light-Duty Automotive Technology, Carbon Dioxide Emissions, and Fuel Economy Trends: 1975 Through 2016*. U.S. EPA (Nov. 2016), available at <https://nepis.epa.gov/Exe/ZyPDF.cgi?Dockey=P100PKK8.pdf>.

²⁸⁰ Note: The central analysis uses the AEO reference fuel price case, but sensitivity analysis also considers the possibility of AEO's low and high fuel price cases.

²⁸¹ Work by Jacobsen and van Bentham suggests that these initial average fuel economy values may not represent the average fuel economy of a model year cohort as it ages—mainly, they find that the most fuel efficient vehicles scrap earlier than the least fuel efficient models in a given cohort. This may be an important consideration in future endeavors that work to link fuel economy, vehicle miles travelled (VMT), and scrappage. Studies on “the rebound effect” suggest that lowering the fuel cost per driven mile increases the demand for VMT. With more miles, a vehicle will be worth less as its perceived remaining useful life will be shorter; this will result in the vehicle being more likely to be scrapped. A rebound effect is included in the CAFE model, but because reliable data on how average VMT by age has varied over calendar year and model year vintage is not available, expected lifetime VMT is not included within the current dynamic scrappage model.

absolute changes in their cost per mile will be smaller. The functional forms of the cost per mile measures are further discussed in the model specification subsection 3 below.

Aggregate measures that cyclically affect the value of used vehicles include macroeconomic factors like the real interest rate, the GDP growth rate, unemployment rates, cost of maintenance and repairs, and the value of a vehicle as scrap metal or as parts. Here only the GDP growth rate is discussed, as this is the only measure included in the final model. Extended reasoning as to why other variables are not included in the final model in the PRIA Chapter 8 is offered, but the discussion was omitted here for brevity in describing only the final model. Generally economic growth will result in a higher demand for new vehicles—cars in aggregate are normal goods—and a reduction in the value of used vehicles. The result should be an increase in the scrappage rate of existing vehicles so that we expect the GDP growth rate to be an important predictor of vehicle scrappage rates.

NHTSA sourced the GDP growth rate from the 2017 OASDI Trustees Report.²⁸² The Trustees Report offers credible projections beyond 2032. Because the purpose of building this scrappage model is to project vehicle survival rates under different fuel economy alternatives and the current fuel economy projections go as far forward as calendar year 2032, using a data set that encompasses projections at least through 2032 is an essential characteristic of any source used for this analysis.

(3) Summary of Model Estimation

The most predictive element of vehicle scrappage is what Greenspan

and Cohen deem ‘engineering scrappage.’ This source of scrappage is largely determined by the age of a vehicle and the durability of a specific model year vintage. Vehicle scrappage typically follows a roughly logistic function with age—that is, instantaneous scrappage increases to some peak, and then declines, with age as noted in Walker (1968); Park (1977); Greene & Chen (1981); Gruenspecht (1981); Feeney & Cardebring (1988); Greenspan & Cohen (1996); Hamilton & Macauley (1999); and Bento, Roth, & Zhuo (2016). Thus, this analysis also uses a logistic function to capture this trend of vehicle scrappage with age but allows non-linear terms to capture any skew to the logistic relationship. Specific details about the final and considered forms of engineering scrappage by body styles is presented in the PRIA Chapter 8.

The final and considered independent variables intended to capture cyclical elements of vehicle scrappage and the considered forms of each are discussed in PRIA Chapter 8; here only inclusion of the GDP growth rate is discussed. The GDP growth rate is not a single-period effect; both the current and previous GDP growth rates will affect vehicle scrappage rates. A single year increase will affect scrappage differently than a multi-period trend. For this reason, an optimal number of lagged terms are included: The within-period GDP growth rate, the previous period GDP growth rate, and the growth rate from two prior years for the car model, while for vans/SUVs, and pickups, the current and previous period GDP growth rate are sufficient.

Similarly, the considered model allows that one-period changes in new vehicle prices will affect the used vehicle market differently than a

consistent trend in new vehicle prices. The optimal number of lags is three so that the price trend from the current year and the three prior years influences the demand for and scrappage of used vehicles. *Note:* The average lease length is three years²⁸³ so that the price of an average vehicle coming off lease is estimated to affect the scrappage rate of used vehicles—this is a major source of the newest used vehicles that enter the used car fleet. Further, because increases in new vehicle prices due to increased stringency of CAFE standards is the primary mechanism through which CAFE standards influence vehicle scrappage and the CAFE Model assumes that usage, efficiency, and safety vary with the age of the vehicle, particular attention is paid to the form of this effect. It is important to know the likelihood of scrappage by the age of the vehicle to correctly account for the additional costs of additional fatalities and increased fuel consumption from deferred scrappage. Thus, the influence of increasing new vehicle prices is allowed to influence the demand for used vehicles (and reduce their scrappage) differently for different ages of vehicles in the scrappage model. We discuss both how we determined the correct form and number of lags for each body style in PRIA Chapter 8.

The final cyclical factor affecting vehicle scrappage in the preferred model is the cost per 100 miles of travel both of new vehicles and of the vehicle which is the subject of the decision to scrap or not to scrap. The new vehicle cost per 100 miles is defined as the ratio of the average fuel price faced by new vehicles in a given calendar year and the average new vehicle fuel economy for 100 miles in the same calendar year, and varies only with calendar year:

$$New\ CPM100 = \frac{Per\ Gallon\ Avg.\ Fuel\ Price}{New\ Vehicle\ Avg.\ Fuel\ Economy} * 100$$

The cost per 100 miles of the potentially scrapped vehicle is described as the ratio of the average fuel

price faced by that model year vintage in a given calendar year and the average fuel economy for 100 miles of travel for

that model year when it was new, and varies both with calendar year and model year:

$$CPM100 = \frac{Per\ Gallon\ Avg.\ Fuel\ Price}{MY\ Vintage\ Avg.\ Fuel\ Economy} * 100$$

²⁸² *The 2017 Annual Report of the Board of Trustees of the Federal Old-Age and Survivors Insurance and Federal Disability Insurance Trust Funds*, Social Security Administration (2017),

available at <https://www.ssa.gov/oact/tr/2017/tr2017.pdf>.

²⁸³ See e.g., *Edmunds January 2017 Lease Market Report*, Edmunds (Jan. 2017), [https://](https://dealers.edmunds.com/static/assets/articles/lease-report-jan-2017.pdf)

dealers.edmunds.com/static/assets/articles/lease-report-jan-2017.pdf.

The average per-gallon fuel price faced by a model year vintage in a given calendar year is the annual average fuel price of all fuel types present in that

model year fleet for the given calendar year, weighted by the share of each fuel type in that model year fleet. Or the following, where FT represents the set

of fuel types present in a given model year vintage:

$$\text{Per Gallon Avg. Fuel Price}_{MY,CY} = \sum_{FT} \text{Fuel Share}_{MY,FT} * \text{Avg. Fuel Price}_{CY,FT}$$

For these variables, the best fit model includes the cost per mile of both the new and the used vehicle for the current and prior year. This is congruent with research that suggests consumers respond to current fuel prices and fuel price changes. The selection process of this form for the cost per mile and the implications is discussed in PRIA Chapter 8.

There are a couple other controlling factors considered in our final model. The 2009 Car Allowance Rebate System (CARS) is not outlined here but is outlined in PRIA Chapter 8. This program aimed to accelerate the retirement of less fuel efficient vehicles and replace them with more fuel efficient vehicles. Further discussion of how this is controlled for is located in PRIA Chapter 8. Finally, evidence of autocorrelation was found, and including three lagged values of the dependent variable addresses the concern. Treatment of autocorrelation is discussed in PRIA Chapter 8.

One additional issue encountered in the estimations of scrappage rates is that the models predict too many vehicles remain on the road in the later years. This issue occurs because the data beyond age 15 are progressively more sparsely populated; vehicles over 15 years were not captured in the Polk data until 1994, when each successive collection year added an additional age of vehicles until 2005 when all ages began to be collected. This means that for vehicles over the age of 25 there are only 10 years of data. In order to correct for this issue the fact that the final fleet share converges to roughly the same share for most model years for a given vehicle type is used. The predicted versus historical relationships seem to deviate beginning around age 20; thus, for scrappage rates for vehicles beyond age 20 an exponential decay function which guarantees that by age 40 the final fleet share reaches the convergence level observed in the historical data is applied. The application of the decay function and mathematical definition is further defended in PRIA Chapter 8.

A sensitivity case is also developed to isolate the magnitude of the Greunspecht effect. The impacts on costs and benefits are presented in

section VII.H.1 of this document. In order to isolate the effect, the price of new vehicles is held constant at CY 2016 levels. The specific methodology used to do so is described in detail in PRIA Chapter 8, as is the leakage implied by comparing the reference and no Greunspecht effect sensitivity cases. It is important to note here that the leakage calculated ranges between 12 and 18% across regulatory alternatives. This is in line with Jacobsen & van Bentham (2015) estimates which put leakage for their central case between 13 and 16%. Their high gasoline price case is more in line this analysis' central case—with fuel prices of \$3/gallon—and predicts leakage of 21%. This further validates the scrappage model effects against examples in the literature.

The models used for this analysis are able to capture the relationship for vehicle scrappage as it varies with age and how this relationship changes with increases to new vehicle price, the cost per mile of travel of new and used vehicles, and how the rate varies cyclically with the GDP growth rate. It also controls for the CARS program and checks the influence of a change in Polk's data collection procedures. The goodness of fit measures and the plausibility of the predictions of the model are discussed at some length in PRIA Chapter 8. In the next section, the impacts of updating the static scrappage models to the dynamic models on average vehicle age and usage, by body styles, and across different regulatory assumptions are discussed.

(c) What is the estimated effect on vehicle retirement and how do results compare to previously estimated fleets and VMT?

The expected lifetime of a car estimated using the static scrappage schedule from the 2012 final rule, both in years and miles, is between the expected lifetime of the dynamic scrappage model in the absence of CAFE standards and under the baseline standards. Estimated by the dynamic scrappage model, the average vehicle is expected to live 15.1 years under the influence of only market demand for new technology, and 15.6 years under the baseline scenario, a four percent

increase. However, given the distribution of the mileage accumulation schedule by age, this amounts only to a two percent increase in the expected lifetime mileage accumulation of an individual vehicle. This range is consistent with DOT expectations in terms of direction and magnitude.

The use of a static retirement schedule, while deemed a reasonable approach in the past, is a limited representation of scrappage behavior. It fails to account for increasing vehicle durability—occurring for the last several decades—and the resulting increase in average vehicle age in the on-road fleet, which has nearly doubled since 1980.²⁸⁴ Thus, turning off the dynamic scrappage model described above would not impose a perspective on the analysis that is neutral with respect to observed scrappage behavior but would instead represent a strong assumption that asserts important trends in the historical record will abruptly cease or change direction.

As discussed above, the dynamic scrappage model implemented to support this proposal affects total fleet size through several mechanisms. Although the model accounts for the influence of changes to average new vehicle price and U.S. GDP growth, the most influential mechanism, by far, is the observed trend of increasing vehicle durability over successive model years. This phenomenon is prominently discussed in the academic literature related to vehicle retirement, where there is no disagreement about its existence or direction.²⁸⁵ In fact, when the CAFE model is exercised in a way that keeps average new vehicle prices at (approximately) MY 2016 levels, the on-road fleet grows from an initial level of 228 million in 2016 to 340 million in 2050, an increase of 49% over the 35-year period from 2016 to 2050.

The historical data show the size of the registered vehicle population (*i.e.*, the on-road fleet) growing by about 60% in the 35 years between 1980 and

²⁸⁴ Based on data from FHWA and IHS/Polk.

²⁸⁵ Waker (1968); Park (1977); Feeney & Cardebring (1988); Hamilton & Macauley (1999); and Bento, Ruth, & Zhuo (2016) note that vehicles change in durability over time.

2015.²⁸⁶ In the 35 years between 2016 and 2050, our simulation shows the on-road fleet growing from about 230 million vehicles to about 345 million vehicles when the market adopts only the amount of fuel economy, which it naturally demands. The simulated growth over this period is about 50% from today's level, rather than the 60% observed in the historical data over the last 35 years. Under the baseline regulatory scenario, the growth over the next 35 years is simulated to be about 54%—still short of the observed growth over a comparable period of time. In fact, the simulated annual growth rate in the size of the on-road fleet in this analysis, about 1.3%, is lower than the long-term average annual growth rate of about two percent dating back to the 1970s.²⁸⁷

Additionally, there are inherent precision limitations in measuring something as vast and complex as the registered vehicle population. For decades, the two authoritative sources for the size of the on-road fleet have been R.L. Polk (now IHS/Polk) and FHWA. For two decades these two sources differed by more than 10% each year, only lately converging to within a few percent of each other. These discrepancies over the correct interpretation of the data by each source have consistently represented differences of more than 10 million vehicles.

The total number of new vehicles projected to enter the fleet is slightly higher than the historical trend (though the impact of the great recession makes it hard to say by how much). More generally, the projections used in the analysis cover long periods of time without exhibiting the kinds of fluctuation that are present in the historical record. For example, the forecast of GDP growth in our analysis posits a world in which the United States sees uninterrupted positive annual growth in real GDP for four decades. The longest such period in the historical record is 17 years and still included several years of low (but positive) growth during that interval.

Over such a long period of time, in the absence of deep insight into the future of the U.S. auto industry, it is sensible to assume that the trends

observed over the course of decades are likely to persist. Analyzing fuel economy standards requires an understanding of the mechanisms that influence new vehicle sales, the size of the on-road fleet, and vehicle miles traveled. It is upon these mechanisms that the policy acts: Increasing/decreasing new vehicle prices changes the rate at which new vehicles are sold, changing the attributes and prices of these vehicles influences the rates at which all used vehicles are retired, the overall size of the on-road fleet determines the total amount of VMT, which in turn affects total fuel consumption, fatalities, and other externalities. The fact that DOT's bottom-up approach produces results in line with historical trends is both expected and intended.

This is not to say that all details of this new approach will be immediately intuitive for reviewers accustomed to results that do not include a dynamic sales model or dynamic scrappage model, much less results that combine the two. For example, some reviewers may observe that today's analysis shows that, compared to the baseline standards, the proposed standards produce a somewhat smaller on-road fleet (*i.e.*, fewer vehicles in service) despite somewhat increased sales of new vehicles (consistent with reduced new vehicle prices) and decreased prices for used vehicles. While it might be natural to assume that reduced prices of new vehicles and increased sales should lead to a larger on-road fleet, in our modelling, the increased sales are more than offset by the somewhat accelerated scrappage that accompanies the estimated decrease in new vehicle prices. This outcome represents an on-road fleet that is both smaller and a little younger on average (relative to the baseline) and "turns over" more quickly.

To further test the validity of the scrappage model, a dynamic forecast was constructed for calendar years 2005 through 2015 to see how well it predicts the fleet size for this period. The last true population the scrappage model "sees" is the 2005 registered vehicle population. It then takes in known production volumes for the new model year vehicles and dynamically estimates instantaneous scrappage rates for all registered vehicles at each age for CYs 2006–2015, based only on the observed exogenous values that inform the model (GDP growth rate, observed new vehicle prices, and cost per mile of operation), fleet attributes of the vehicles (body style, age, cost per mile of operation), and estimated scrappage rates at earlier ages. Within this exercise, the scrappage

model relies on its own estimated values as the previous scrappage rates at earlier ages, forcing any estimation errors to propagate through to future years. This exercise is discussed further in PRIA Chapter VII. While the years of the recession represent a significant shock to the size of the fleet, briefly reversing many years of annual growth, the model recovers quickly and produces results within one percent of the actual fleet size, as it did prior to the recession.

In order to compare the magnitudes of the sales and scrappage effects across different fuel economy standards considered it is important to define comparable measures. The sales effect in a single calendar year is simply the difference in new vehicle sales across alternatives. However, the scrappage effect in a single calendar year is not simply the change in fleet size across regulatory alternatives. The scrappage model predicts the probability that a vehicle will be scrapped in the next year conditional on surviving to that age; the absolute probability that a vehicle survives to a given age is conditional on the scrappage effect for all previous analysis years. In other words, if successive calendar years observe lower average new vehicle prices, the effect of increased scrappage on fleet size will accumulate with each successive calendar year—because fewer vehicles survived to previous ages, the same probability of scrappage would result in a smaller fleet size for the following year as well, though fewer vehicles will have been scrapped than in the previous year.

To isolate the number of vehicles not scrapped in a single calendar year because of the change in standards, the first step is to calculate the number of vehicles scrapped in every calendar year for both the proposed standards and the baseline; this is calculated by the inter-annual change in the size of the used vehicle fleet (vehicles ages 1–39) for each alternative. The difference in this measure across regulatory alternatives represents the change in vehicle scrappage because of a change in the standards. The resulting scrappage effect for a single calendar year can be compared to the difference across regulatory alternatives in new vehicle sales for the same calendar year as a comparison of the relative magnitudes of the two effects. In most years, under the proposed standards relative to the baseline standards, the analysis shows that for each additional new vehicles sold, two to four used vehicles are removed from the fleet. Over the time period of the analysis these predicted differences in the numbers of vehicles accumulate, resulting in a maximum of

²⁸⁶ There are two measurements of the size of the registered vehicle population that are considered to be authoritative. One is produced by the Federal Highway Administration, and the other by R.L. Polk (now part of IHS). The Polk measurement shows fleet growth between 1980 and 2015 of about 85%, while the FHWA measurement shows a slower growth rate over that period, only about 60%.

²⁸⁷ Based on calculations using Polk's National Vehicle Population Profile (NVPP).

seven million fewer vehicles by CY 2033 for the proposed CAFE standards relative to the augural standards, and nine million fewer vehicles by CY 2035 for the proposed GHG standards relative to the current GHG standards. Tables 11–29 and 11–30 in the PRIA show the difference in the fleet size by calendar year for the proposed standards relative to the augural standards for the CAFE and GHG programs, respectively.

To understand why the sales and scrappage effects do not perfectly offset each other to produce a constant fleet size across regulatory alternatives it is important to remember that the decision to buy a new vehicle and the decision to scrap a used vehicle are often not made by the same household as a joint decision. The average length of initial ownership for new vehicles is approximately 6.5 years (and increasing over time). Cumulative scrappage up to age seven is typically less than 10% of the initial fleet. This suggests that most vehicles belong to more than one household over the course of their lifetimes. The household that is deciding whether or not to purchase a new vehicle is rarely the same household deciding whether or not to scrap a vehicle. So a vehicle not scrapped in a given year is seldom the direct substitute for a new vehicle purchased by that household. Considering this, it is not expected that for every additional vehicle scrapped, there is also an additional new one sold, under the proposed standards relative to the baseline standards.

Further, while sales and scrappage decisions are both influenced by changes in new vehicle prices, the mechanism through which these decisions change are different for the two effects. A decrease in average new vehicle prices will directly increase the demand for new vehicles along the same demand curve. This decrease in new vehicle prices will cause a substitution towards new vehicles and away from used vehicles, shifting the entire demand curve for used vehicles downwards. This will decrease both the equilibrium prices of used vehicles, as shown in Figure 8–16 of the PRIA. Since the decision to scrap a vehicle in a given year is closely related to the difference between the vehicle's value and the cost to maintain it, if the value of a vehicle is lower than the cost to maintain it, the current owner will not choose to maintain the vehicle for their own use or for resale in the used car market, and the vehicle will be scrapped. That is, a current owner will only supply a

vehicle to the used car market if the price of the vehicle is greater than the cost of supplying it. Lowering the equilibrium price of used vehicles will lower the increase the number of scrapped vehicles, lowering the supply of used vehicles, and decreasing the equilibrium quantity. The change in new vehicle sales is related to demand of new vehicles at a given price, but the change in used vehicle scrappage is related to the shift in the demand curve for used vehicles, and the resulting change in the quantity current owners will supply; these effects are likely not exactly offsetting.

Our models indicate that the ratio of the magnitude of the scrappage effect to the sales effect is greater than one so that the fleet grows under more stringent scenarios. However, it is important to remember that not all vehicles are driven equally; used vehicles are estimated to deliver considerably less annual travel than new vehicles. Further, used vehicles only have a portion of their original life left so that it will take more than one used vehicle to replace the full lifetime of a new vehicle, at least in the long-run. The result of the lower annual VMT and shorter remaining lifetimes of used vehicles, is that although the fleet is 1.5% bigger in CY 2050 for the augural baseline than it is for the proposed standards, the total non-rebound VMT for CY 2050 is 0.4% larger in the augural baseline than in the proposed standards. This small increase in VMT is consistent with a larger fleet size; if more used vehicles are supplied, there likely is some small resulting increase in VMT.

Our models face some limitations, and work will continue toward developing methods for estimating vehicle sales, scrappage, and mileage accumulation. For example, our scrappage model assumes that the average VMT for a vehicle of a particular vintage is fixed—that is, aside from rebound effects, vehicles of a particular vintage drive the same amount annually, regardless of changes to the average expected lifetimes. The agencies seek comment on ways to further integrate the survival and mileage accumulation schedules. Also, our analysis uses sales and scrappage models that do not dynamically interact (though they are based on similar sets of underlying factors); while both models are informed by new vehicle prices, the model of vehicle sales does not respond to the size and age profile of the on-road fleet, and the model of vehicle

scrappage rates does not respond to the quantity of new vehicles sold. As one potential option for development, the potential for an integrated model of sales and scrappage, or for a dynamic connection between the two models will be considered. Comment is sought on both the sales and scrappage models, on potential alternatives, and on data and methods that may enable practicable integration of any alternative models into the CAFE model.

7. Accounting for the Rebound Effect Caused by Higher Fuel Economy

(a) What is the rebound effect and how is it measured?

Amending and establishing fuel economy and GHG standards at a lesser stringency than the augural standards for future model years will lead to comparatively lower fuel economy for new cars and light trucks, thus increasing the amount of fuel they consume in traveling each mile than they would under the augural standard. The resulting increase in their per-mile fuel and total driving costs will lead to a reduction in the number of miles they are driven each year over their lifetimes, and example of the rebound effect that is usually associated with energy efficiency improvements working in reverse. The fuel economy rebound effect—a specific example of the energy efficiency rebound effect for the case of motor vehicles—refers to the well-documented tendency of vehicles' use to increase when their fuel economy is improved and the cost of driving each mile declines as a result.

(b) What does the literature say about the magnitude of this effect?

Table–II–43 summarizes estimates of the fuel economy rebound effect for light-duty vehicles from studies conducted through 2008, when the agencies originally surveyed research on this subject.²⁸⁸ After summarizing all of the estimates reported in published and other publicly-available research available at that time, it distinguishes among estimates based on the type of data used to develop them. As the table reports, estimates of the rebound effect ranged from 6% to as high as 75%, and the range spanned by published estimates was nearly as wide (7–75%).

²⁸⁸ Complete references to the studies summarized in Table 8–2 are included in the PRIA, and many of the unpublished studies are available in the docket for this rulemaking.

Most studies reported more than one empirical estimate, and the authors of published studies typically identified

the single estimate in which they were most confident; these preferred

estimates spanned only a slightly narrower range (9–75%).

Table-II-43 - Summary of Research on the Fuel Economy Rebound Effect through 2008

Category of Estimates	Number of Studies	Number of Estimates	Range		Distribution		
			Low	High	Median	Mean	Std. Dev.
All Estimates	27	87	6%	75%	19%	22%	13%
Published Estimates	20	68	7%	75%	19%	23%	13%
Authors' Preferred Estimates	20	20	9%	75%	22%	22%	15%
U.S. Time-Series Estimates	7	34	7%	45%	14%	18%	9%
Household Survey Estimates	17	38	6%	75%	22%	25%	15%
Pooled U.S. State Estimates	3	15	8%	58%	22%	23%	12%

Despite their wide range, these estimates displayed a strong central tendency, as Table-II-43 also shows. The average values of all estimates, those that were published, and authors' preferred estimates from published studies were 22–23%, and the median estimates in each category were close to these values, indicating nearly symmetric distributions. The estimates in each category also clustered fairly tightly around their respective average values, as shown by their standard deviations in the table's last column. When classified by the type of data they relied on, U.S. aggregate time-series data produced slightly smaller values (averaging 18%) than did panel-type data for individual states (23%) or household survey data (25%). In each category, the median estimate was again quite close to the average reported value, and comparing the standard deviations of estimates based on each type of data again suggests a fairly tight scatter around their respective means.

Of these studies, a then recently-published analysis by Small & Van Dender (2007), which reported that the rebound effect appeared to be declining over time in response to increasing income of drivers, was singled out. These authors theorized that rising income increased the opportunity cost of drivers' time, leading them to be less responsive over time to reductions in the fuel cost of driving each mile. Small and Van Dender reported that while the rebound effect averaged 22% over the entire time period they analyzed (1967–2001), its value had declined by half—or to 11%—during the last five years they studied (1997–2001). Relying primarily on forecasts of its continued decline over time, the analysis reduced the 20% rebound effect that NHTSA used to analyze the effects of CAFE standards for light trucks produced during model years 2005–07 and 2008–11 to 10% for their analysis of CAFE and GHG standards for MY 2012–16 passenger cars and light trucks.

Table-II-44 summarizes estimates of the rebound effect reported in research that has become available since the agencies' original survey, which extended through 2008, and the following discussion briefly summarizes the approaches used by these more recent studies. Bento *et al.* (2009) combined demographic characteristics of more than 20,000 U.S. households, the manufacturer and model of each vehicle they owned, and their annual usage of each vehicle from the 2001 National Household Travel Survey with detailed data on fuel economy and other attributes for each vehicle model obtained from commercial publications. The authors aggregated vehicle models into 350 categories representing combinations of manufacturer, vehicle type, and age, and use the resulting data to estimate the parameters of a complex model of households' joint choices of the number and types of vehicles to own, and their annual use of each vehicle.

Table-II-44 - Recent Estimates of the Fuel Economy Rebound Effect

Authors (Date)	Nation	Time Period	Data	Range of Estimates
Barla et al. (2009)	Canada	1990-2004	10 Canadian provinces	8-20%
Bento (2009)	U.S.	2001	~150,000 household vehicles	21-38%
Waddud (2009)	U.S.	1984-2003	U.S income quintiles	1-25%
West and Pickrell (2011)	U.S.	2009	120,000 household vehicles	9-34%
Anjovic and Haas (2012)	E.U.	1970-2007	6 E.U. nations	44%
Su (2012)	U.S.	2009	45,000 households	11-19%
Linn (2013)	U.S.	2009	230,000 household vehicles	20-40%
Frondel and Vance (2013)	Germany	1997-2009	2,165 households	46-70%
Liu (2014)	U.S.	2009	1,420 households	39-40%
Gillingham (2014)	California	2001-09	5 million vehicles	22-23%
Weber and Farsi (2014)	Switzerland	2010	8,000 household vehicles	19-81%
Hymel & Small (2015)	U.S.	2003-09	50 U.S. states	18%
West et al. (2015)	U.S.	2009	166,000 new vehicles	0%
DeBorger (2016)	Denmark	2001-11	23,000 households	8-10%
Stapleton et al. (2016,2017)	Great Britain	1970-2012	average annual values	14-30%

Bento *et al.* estimate the effect of vehicles' operating costs per mile, including fuel costs, which depend in part on each vehicle's fuel economy, as well as maintenance and insurance expenses, on households' annual use of each vehicle they own. Combining the authors' estimates of the elasticity of vehicle use with respect to per-mile operating costs with the reported fraction of total operating costs accounted for by fuel (slightly less than one-half) yields estimates of the rebound effect. The resulting values vary by household composition, vehicle size and type, and vehicle age, ranging from 21 to 38%, with a composite estimate of 34% for all households, vehicle models, and ages. The smallest values apply to new luxury cars, while the largest estimates are for light trucks and households with children, but the implied rebound effects differ little by vehicle age.

Barla *et al.* (2009) analyzed the responses of car and light truck ownership, vehicle travel, and average fuel efficiency to variation in fuel prices

and aggregate economic activity (measured by gross product) using panel-type data for the 10 Canadian provinces over the period from 1990 through 2004. The authors estimated a system of equations for these three variables using statistical procedures appropriate for models where the variables of interest are simultaneously determined (that is, where each variable is one of the factors explaining variation in the others). This procedure enabled them to control for the potential "reverse influence" of households' demand for vehicle travel on their choices of how many vehicles to own and their fuel efficiency levels when estimating the effect of variation in fuel efficiency on vehicle use.

Their analysis found that provincial-level aggregate economic activity had moderately strong effects on car and light truck ownership and use but that fuel prices had only modest effects on driving and the average fuel efficiency of the light-duty vehicle fleet. Each of these effects became considerably stronger over the long term than in the

year when changes in economic activity and fuel prices initially occurred, with three to five years typically required for behavioral adjustments to stabilize. After controlling for the joint relationship among vehicle ownership, driving demand, and the fuel efficiency of cars and light trucks, Barla *et al.* estimated elasticities of average vehicle use with respect to fuel efficiency that corresponded to a rebound effect of eight percent in the short run, rising to nearly 20% within five years. A notable feature of their analysis was that variation in average fuel efficiency among the individual Canadian provinces and over the time period they studied was adequate to identify its effect on vehicle use, without the need to combine it with variation in fuel prices in order to identify its effect.

Wadud *et al.* (2009) combine data on U.S. households' demographic characteristics and expenditures on gasoline over the period 1984–2003 from the Consumer Expenditure Survey with data on gasoline prices and an estimate of the average fuel economy of

vehicles owned by individual households (constructed from a variety of sources). They employ these data to explore variation in the sensitivity of individual households' gasoline consumption to differences in income, gasoline prices, the number of vehicles owned by each household, and their average fuel economy. Using an estimation procedure intended to account for correlation among unmeasured characteristics of households and among estimation errors for successive years, the authors explore variation in the response of fuel consumption to fuel economy and other variables among households in different income categories and between those residing in urban and rural areas.

Dividing U.S. households into five equally-sized income categories, Wadud *et al.* estimate rebound effects ranging from 1–25%, with the smallest estimates (8% and 1%) for the two lowest income categories, and significantly larger estimates for the middle (18%) and two highest income groups (18 and 25%). In a separate analysis, the authors estimate rebound effects of seven percent for households of all income levels residing in U.S. urban areas and 21% for rural households.

West & Pickrell (2011) analyzed data on more than 100,000 households and 300,000 vehicles from the 2009 Nationwide Household Transportation Survey to explore how households owning multiple vehicles chose which of them to use and how much to drive each one on the day the household was surveyed. Their study focused on how the type and fuel economy of each vehicle a household owned, as well as its demographic characteristics and location, influenced household members' decisions about whether and how much to drive each vehicle. They also investigated whether fuel economy and fuel prices exerted similar influences on vehicle use, and whether households owning more than one vehicle tended to substitute use of one for another—or vary their use of all of them similarly—in response to fluctuations in fuel prices and differences in their vehicles' fuel economy.

Their estimates of the fuel economy rebound effect ranged from as low as nine percent to as high as 34%, with their lowest estimates typically applying to single-vehicle households and their highest values to households owning three or more vehicles. They generally found that differences in fuel prices faced by households who were surveyed on different dates or who lived in different regions of the U.S. explained more of the observed variation in daily

vehicle use than did differences in vehicles' fuel economy. West and Pickrell also found that while the rebound effect for households' use of passenger cars appeared to be quite large—ranging from 17% to nearly twice that value—it was difficult to detect a consistent rebound effect for SUVs.

Anjovic & Haas (2012) examined variation in vehicle use and fuel efficiency among six European nations over an extended period (1970–2006), using an elaborate model and estimation procedure intended to account for the existence of common underlying trends among the variables analyzed and thus avoid identifying spurious or misleading relationships among them. The six nations included in their analysis were Austria, Germany, Denmark, France, Italy, and Sweden; the authors also conducted similar analyses for the six nations combined. The authors focused on the effects of average income levels, fuel prices, and the fuel efficiency of each nation's fleet of cars on the total distance they were driven each year and their total fuel energy consumption. They also tested whether the responses of energy consumption to rising and falling fuel prices appeared to be symmetric in the different nations.

Anjovic and Haas report a long-run aggregate rebound effect of 44% for the six nations their study included, with corresponding values for individual nations ranging from a low of 19% (for Austria) to as high as 56% (Italy). These estimates are based on the estimated response of vehicle use to variation in average fuel cost per kilometer driven in each of the six nations and for their combined total. Other information reported in their study, however, suggests lower rebound effects; their estimates of the response of total fuel energy consumption to fuel efficiency appear to imply an aggregate rebound effect of 24% for the six nations, with values ranging from as low as 0–3% (for Austria and Denmark) to as high as 70% (Sweden), although the latter is very uncertain. These results suggest that vehicle use in European nations may be somewhat less sensitive to variation in driving costs caused by changes in fuel efficiency than to changes in driving costs arising from variation in fuel prices, but they find no evidence of asymmetric responses of total fuel consumption to rising and falling prices. Using data on household characteristics and vehicle use from the 2009 Nationwide Household Transportation Survey (NHTS), Su (2012) analyzes the effects of locational and demographic factors on household vehicle use and investigates how the magnitude of the rebound effect varies with vehicles'

annual use. Using variation in the fuel economy and per-mile cost of and detailed controls for the demographic, economic, and locational characteristics of the households that owned them (*e.g.*, road and population density) and each vehicle's main driver (as identified by survey respondents), the author employs specialized regression methods to capture the variation in the rebound effect across 10 different categories of vehicle use.

Su estimated the overall rebound effect for all vehicles in the sample averaged 13%, and that its magnitude varied from 11–19% among the 10 different categories of annual vehicle use. The smallest rebound effects were estimated for vehicles at the two extremes of the distribution of annual use—those driven comparatively little, and those used most intensively—while the largest estimated effects applied to vehicles that were driven slightly more than average. Controlling for the possibility that high-mileage drivers respond to the increased importance of fuel costs by choosing vehicles that offer higher fuel economy narrowed the range of Su's estimated rebound effects slightly (to 11–17%), but did not alter the finding that they are smallest for lightly- and heavily-driven vehicles and largest for those with slightly above average use.

Linn (2013) also uses the 2009 NHTS to develop a linear regression approach to estimate the relationship between the VMT of vehicles belonging to each household and a variety of different factors: Fuel costs, vehicle characteristics other than fuel economy (*e.g.*, horsepower, the overall "quality" of the vehicle), and household characteristics (*e.g.*, age, income). Linn reports a fuel economy rebound effect with respect to VMT of between 20–40%.

One interesting result of the study is that when the fuel efficiency of all vehicles increases, which would be the long-run effect of rising fuel efficiency standards, two factors have opposing effects on the VMT of a particular vehicle. First, VMT increases when that vehicle's fuel efficiency increases. But the increase in the fuel efficiency of the household's other vehicles causes the vehicle's own VMT to decrease. Because the effect of a vehicle's own fuel efficiency is larger than the other vehicles' fuel efficiency, VMT increases if the fuel efficiency of all vehicles increases proportionately. Linn also finds that VMT responds much more strongly to vehicle fuel economy than to gasoline prices, which is at variance with the Hymel *et al.* and Greene results discussed above.

Like Su and Linn, Liu *et al.* (2014) employed the 2009 NHTS to develop an elaborate model of an individual household's choices about how many vehicles to own, what types and ages of vehicles to purchase, and how much combined driving to do using all of them. Their analysis used a complex mathematical formulation and statistical methods to represent and measure the interdependence among households' choices of the number, types, and ages of vehicles to purchase, as well as how intensively to use them.

Liu *et al.* employed their model to simulate variation in households' total vehicle use to changes in their income levels, neighborhood characteristics, and the per-mile fuel cost of driving averaged over all vehicles each household owns. The complexity of the relationships among the number of vehicles owned, their specific types and ages, fuel economy levels, and use incorporated in their model required them to measure these effects by introducing variation in income, neighborhood attributes, and fuel costs, and observing the response of households' annual driving. Their results imply a rebound effect of approximately 40% in response to significant (25–50%) variation in fuel costs, with almost exactly symmetrical responses to increases and declines.

A study of the rebound effect by Frondel *et al.* (2012) used data from travel diaries recorded by more than 2,000 German households from 1997 through 2009 to estimate alternative measures of the rebound effect, and to explore variation in their magnitude among households. Each household participating in the survey recorded its automobile travel and fuel purchases over a period of one to three years and supplied information on its composition and the personal characteristics of each of its members. The authors converted households' travel and fuel consumption to a monthly basis, and used specialized estimation procedures (quantile and random-effects panel regression) to analyze monthly variation in their travel and fuel use in relation to differences in fuel prices, the fuel efficiency of each vehicle a household owned, and the fuel cost per mile of driving each vehicle.

Frondel *et al.* estimate four separate measures of the rebound effect, three of which capture the response of vehicle use to variation in fuel efficiency, fuel price, and fuel cost per mile traveled, and a fourth capturing the response of fuel consumption to changes in fuel price. Their first three estimates range from 42% to 57%, while their fourth estimate corresponds to a rebound effect

of 90%. Although their analysis finds no significant variation of the rebound effect with household income, vehicle ownership, or urban versus rural location, it concludes that the rebound effect is substantially larger for households that drive less (90%) than for those who use their vehicles most intensively (56%).

Gillingham (2014) analyzed variation in the use of approximately five million new vehicles sold in California from 2001 to 2003 during the first several years after their purchase, focusing particularly on how their use responded to geographic and temporal variation in fuel prices. His sample consisted primarily of personal or household vehicles (87%) but also included some that were purchased by businesses, rental car companies, and government agencies. Using county-level data, he analyzed the effect of differences in the monthly average fuel price paid by their drivers on variation in their monthly use and explored how that effect varied with drivers' demographic characteristics and household incomes.

Gillingham's analysis did not include a measure of vehicles' fuel economy or fuel cost per mile driven, so he could not measure the rebound effect directly, but his estimates of the effect of fuel prices on vehicle use correspond to a rebound effect of 22–23% (depending on whether he controlled for the potential effect of gasoline demand on its retail price). His estimation procedure and results imply that vehicle use requires nearly two years to adjust fully to changes in fuel prices. He found little variation in the sensitivity of vehicle use to fuel prices among car buyers with different demographic characteristics, although his results suggested that it increases with their income levels.

Weber & Farsi (2014) analyzed variation in the use of more than 70,000 individual cars owned by Swiss households who were included in a 2010 survey of travel behavior. Their analysis focuses on the simultaneous relationships among households' choices of the fuel efficiency and size (weight) of the vehicles they own, and how much they drive each one, although they recognize that fuel efficiency cannot be chosen independently of vehicle weight. The authors employ a model specification and statistical estimation procedures that account for the likelihood that households intending to drive more will purchase more fuel-efficient cars but may also choose more spacious and comfortable—and thus heavier—models, which affects their fuel efficiency indirectly, since heavier

vehicles are generally less fuel-efficient. The survey data they rely on includes both owners' estimates of their annual use of each car and the distance it was actually driven on a specific day; because they are not closely correlated, the authors employ them as alternative measures of vehicle use to estimate the rebound effect, but this restricts their sample to the roughly 8,100 cars for which both measures are available. Weber and Farsi's estimates of the rebound effect are extremely large: 75% using estimated annual driving and 81% when they measure vehicle use by actual daily driving. Excluding vehicle size (weight) and limiting the choices that households are assumed to consider simultaneously to just vehicles' fuel efficiency and how much to drive approximately reverses these estimates, but both are still very large. Using a simpler procedure that does not account for the potential effect of driving demand on households' choices among vehicle models of different size and fuel efficiency produces much smaller values for the rebound effect: 37% using annual driving and 19% using daily travel. The authors interpret these latter estimates as likely to be too low because actual on-road fuel efficiency has not improved as rapidly as suggested by the manufacturer-reported measure they employ. This introduces an error in their measure that may be related to a vehicle's age, and their more complex estimation procedure may reduce its effect on their estimates. Nevertheless, even their lower estimates exceed those from many other studies of the rebound effect, as Table 8–2 shows.

Hymel, Small, & Van Dender (2010)—and more recently, Hymel & Small (2015)—extended the simultaneous equations analysis of time-series and state-level variation in vehicle use originally reported in Small & Van Dender (2007) and to test the effect of including more recent data. As in the original 2007 study, both subsequent extensions found that the fuel economy rebound effect had declined over time in response to increasing personal income and urbanization but had risen during periods when fuel prices increased. Because they rely on the response of vehicle use to fuel cost per mile to estimate the rebound effect, however, none of these three studies is able to detect whether its apparent decline in response to rising income levels over time truly reflects its effect on drivers' responses to changing fuel economy—the rebound effect itself—or simply captures the effect of rising income on their sensitivity to fuel

prices.²⁸⁹ These updated studies each revised Small and Van Dender's original estimate of an 11% rebound effect for 1997–2011 upward when they included more recent experience: To 13% for the period 2001–04, and subsequently to 18% for 2000–2009.

In their 2015 update, Hymel and Small hypothesized that the recent increase in the rebound effect could be traced to a combination of expanded media coverage of changing fuel prices, increased price volatility, and an asymmetric response by drivers to variation in fuel costs. The authors estimated that about half of the apparent increase in the rebound effect for recent years could be attributed to greater volatility in fuel prices and more media coverage of sudden price changes. Their results also suggest that households curtail their vehicle use within the first year following an increase in fuel prices and driving costs, while the increase in driving that occurs in response to declining fuel prices—and by implication, to improvements in fuel economy—occurs more slowly.

West *et al.* (2015) attempted to infer the fuel economy rebound effect using data from Texas households who replaced their vehicles with more fuel-efficient models under the 2009 “Cash for Clunkers” program, which offered sizeable financial incentives to do so. Under the program, households that retired older vehicles with fuel economy levels of 18 miles per gallon (MPG) or less were eligible for cash incentives ranging from \$3,500–4,000, while those retiring vehicles with higher fuel economy were ineligible for such rebates. The authors examined the fuel economy, other features, and subsequent use of new vehicles households in Texas purchased to replace older models that narrowly qualified for the program's financial incentives because their fuel economy was only slightly below the 18 MPG threshold. They then compared these to the fuel economy, features, and use of new vehicles that demographically comparable households bought to replace older models, but whose slightly higher fuel economy—19 MPG or

above—made them barely *ineligible* for the program.

The authors reported that the higher fuel economy of new models that eligible households purchased in response to the generous financial incentives offered under the “Cash for Clunkers” did not prompt their buyers to use them more than the older, low-MPG vehicles they replaced. They attributed this apparent absence of a fuel economy rebound effect—which they described as an “attribute-adjusted” measure of its magnitude—to the fact that eligible households chose to buy less expensive, smaller, and lower-performing models to replace those they retired. Because these replacements offered lower-quality transportation service, their buyers did not drive them more than the vehicles they replaced.

The applicability of this result to the proposal's analysis is doubtful because previous regulatory analyses assumed that manufacturers could achieve required improvements in fuel economy without compromising the performance, carrying and towing capacity, comfort, or safety of cars and light trucks from recent model years.²⁹⁰ While this may be technically true, doing so would come at a combined greater cost. If this argument is correct, then amending future standards at a reduced stringency from their previously-adopted levels would lead to less driving attributable to rebound, and should therefore not lead to artificial constraints in new vehicles' other features that offset the reduction in their use stemming from lower fuel economy.

Most recently, De Borger *et al.* (2017) analyze the response of vehicle use to changes in fuel economy among a sample of nearly 350,000 Danish households owning the same model vehicle, of which almost one-third replaced it with a different model sometime during the period from 2001 to 2011. By comparing the changes in households' driving from the early years of this period to its later years among those who replaced their vehicles during the intervening period to the changes in driving among households who kept their original vehicles, the authors attempted to isolate the effect of changes in fuel economy on vehicle use from those of other factors. They measured the rebound effect as the

change in households' vehicle use in response to differences in the fuel economy between vehicles they had owned previously and the new models they purchased to replace them, over and above any change in vehicle use among households who did not buy new cars (and thus saw no change in fuel economy).

These authors' data enabled them to control for the effects of changes over time in household characteristics and vehicle features other than fuel economy that were likely to have contributed to observed changes in vehicle use. They also employed complex statistical methods to account for the fact that some households replacing their vehicles may have done so in anticipation of changes in their driving demands (rather than the reverse), as well as for the possibility that some households who replaced their cars may have done so because their driving behavior was more sensitive to fuel prices than other households. Their estimates ranged from 8–10%, varying only minimally among alternative model specifications and statistical estimation procedures or in response to whether their sample was restricted to households that replaced their vehicles or also included households that kept their original vehicles throughout the period.²⁹¹ Finally, De Borger *et al.* found no evidence that the rebound effect is smaller among lower-income households than among their higher-income counterparts.

(c) What value have the agencies assumed in this rule?

On the basis of all of the evidence summarized here, a fuel economy rebound effect of 20% has been chosen to analyze the effects of the proposed action. This is a departure from the 10% value used in regulatory analyses for MYs 2012–2016 and previous analyses for MYs 2017–2025 CAFE and GHG standards and represents a return to the value employed in the analyses for MYs 2005–2011 CAFE standards. There are several reasons the estimate of the fuel economy rebound effect for this analysis has been increased.

First, the 10% value is inconsistent with nearly all research on the magnitude of the rebound effect, as Table-II-43 and Table-II-44 indicate. Instead, it is based almost exclusively

²⁸⁹ DeBorger *et al.* (2016) analyze the separate effects of variation in household income on the sensitivity of their vehicle use to fuel prices and the fuel economy of vehicles they own. Their results imply the decline in the fuel economy rebound effect with income reported in Small & Van Dender (2007) and its subsequent extensions appears to result entirely from a reduction in drivers' sensitivity to fuel prices as their incomes rise, rather than from any effect of rising income on the sensitivity of vehicle use to improving fuel economy; *i.e.*, on the fuel economy rebound effect itself.

²⁹⁰ As discussed, this does not mean attributes of future cars and light trucks will be anything close to those manufacturers could have offered if lower standards had remained in effect. Instead, the agencies asserted features other than fuel economy could be maintained at the levels offered in recent model years—that features will not likely be removed, but may not be improved.

²⁹¹ This latter result suggests their estimates were not biased by any tendency for households whose demographic characteristics, economic circumstances, or driving demands changed over the period in ways that prompted them to replace their vehicles with models offering different fuel economy.

on the finding of the 2007 study by Small and Van Dender that the rebound effect had been declining over time in response to drivers' rising incomes and on extending that decline through future years using an assumption of steady income growth. As indicated above, however, subsequent extensions of Small and Van Dender's original research have produced larger estimates of the rebound effect for recent years: While their original study estimated the rebound effect at 11% for 1997–2001, the 2010 update by Hymel, Small, and Van Dender reported a value of 13% for 2004, and Hymel and Small's 2015 update estimated the rebound effect at 18% for 2003–09. Further, the issues with state-level measures of vehicle use, fuel consumption, and fuel economy identified previously raise some doubt about the reliability of these studies' estimates of the rebound effect.

At the same time, the continued increases in income that were anticipated to produce a continued decline in the rebound effect have not materialized. The income measure (real personal income per Capita) used in these analyses has grown only approximately one percent annually over the past two decades and is projected to grow at approximately 1.5% for the next 30 years, in contrast to the two to three percent annual growth assumed by the agencies when developing earlier forecasts of the future rebound effect. Further, another recent study by DeBorger *et al.* (2016) analyzed the separate effects of variation in household income on the sensitivity of their vehicle use to fuel prices and the fuel economy of vehicles they own. These authors' results indicate that the decline in the fuel economy rebound effect with income reported in Small & Van Dender (2007) and subsequent research results entirely from a reduction in drivers' sensitivity to fuel prices as their incomes rise rather than from any effect of rising income on the sensitivity of vehicle use to fuel economy itself. This latter measure, which DeBorger *et al.* find has not changed significantly as incomes have risen over time, is the correct measure of the fuel economy rebound effect, so their analysis calls into question its assumed sensitivity to income.

Some studies of households' use of individual vehicles also find that the fuel economy rebound effect increases with the number of vehicles they own. Because vehicle ownership is strongly associated with household income, this common finding suggests that the overall value of the rebound effect is unlikely to decline with rising incomes as the agencies had previously assumed.

In addition, buyers of new cars and light trucks belong disproportionately to higher-income households that already own multiple vehicles, which further suggests that the higher values of the rebound effect estimated by many studies for such households are more relevant for analyzing use of newly-purchased cars and light trucks.

Finally, research on the rebound effect conducted since the agencies' original 2008 review of evidence almost universally reports estimates in the 10–40% (and larger) range, as Table II–43 shows. Thus, the 20% rebound effect used in this analysis more accurately represents the findings from both the studies considered in 2008 review and the more recent analyses.

(1) What are the implications of the rebound effect for VMT?

The assumed rebound effect not only influences the use of new vehicles in today's analysis but also affects the response of the initial registered vehicle population to changes in fuel price throughout their remaining useful lives. The fuel prices used in this analysis are lower than the projections used to inform the 2012 Final Rule but generally increase from today's level over time. As they do so, the rebound effect acts as a price elasticity of demand for travel—as the cost-per-mile of travel increases, owners of all vehicles in the registered population respond by driving less. In particular, they drive 20% less than the difference between the cost-per-mile of travel when they were observed in calendar year 2016 and the relevant cost-per-mile at any future age. For the new vehicles subject to this proposal (and explicitly simulated by the CAFE model), fuel economies increase relative to MY 2016 levels, and generally improve enough to offset the effect of rising fuel prices—at least during the years covered by the proposal. For those vehicles, the difference between the initial cost-per-mile of travel and future travel costs is negative. As the vehicles become less expensive to operate, they are driven more (20% more than the difference between initial and present travel costs, precisely). Of course, each of the regulatory alternatives considered in the analysis would result in lower fuel economy levels for vehicles produced in model year 2020 and later than if the baseline standards remained in effect, so total VMT is lower under these alternatives than under the baseline.

(2) What is the mobility benefit that accrues to vehicle owners?

The increase in travel associated with the rebound effect produces additional

benefits to vehicle owners, which reflect the value to drivers and other vehicle occupants of the added (or more desirable) social and economic opportunities that become accessible with additional travel. As evidenced by the fact that they elect to make more frequent or longer trips when the cost of driving declines, the benefits from this added travel exceed drivers' added outlays for the fuel it consumes (measured at the improved level of fuel economy resulting from stricter CAFE standards). The amount by which the benefits from this increased driving travel exceed its increased fuel costs measures the net benefits they receive from the additional travel, usually are referred to as increased consumer surplus.

NHTSA's analysis estimates the economic value of the decreased consumer surplus provided by reduced driving using the conventional approximation, which is one half of the product of the increase in vehicle operating costs per vehicle-mile and the resulting decrease in the annual number of miles driven. Because it depends on the extent of the change in fuel economy, the value of economic impacts from decreased vehicle use changes by model year and varies among alternative CAFE standards.

(d) Societal Externalities Associated With CAFE Alternatives

(1) Energy Security Externalities

Higher U.S. fuel consumption will produce a corresponding increase in the nation's demand for crude petroleum, which is traded actively in a worldwide market. The U.S. accounts for a large enough share of global oil consumption that the resulting boost in global demand will raise its worldwide price. The increase in global petroleum prices that results from higher U.S. demand causes a transfer of revenue to oil producers worldwide from not only buyers of new cars and light trucks, but also other consumers of petroleum products in the U.S. and throughout the world, all of whom pay the higher price that results.

Although these effects will be tempered by growing U.S. oil production, uncertainty in the long-term import-export balance makes it difficult to precisely project how these effects might change in response to that increased production. Growing U.S. petroleum consumption will also increase potential costs to all U.S. petroleum users from possible interruptions in the global supply of petroleum or rapid increases in global oil prices, not all of which are borne by

the households or businesses who increase their petroleum consumption (that is, they are partly “external” to petroleum users). If U.S. demand for imported petroleum increases, it is also possible that increased military spending to secure larger oil supplies from unstable regions of the globe will be necessary.

These three effects are often referred to collectively as “energy security externalities” resulting from U.S. petroleum consumption, and increases in their magnitude are sometimes cited as potential social costs of increased U.S. demand for oil. To the extent that they represent real economic costs that would rise incrementally with increases in U.S. petroleum consumption of the magnitude likely to result from less stringent CAFE and GHG standards, these effects represent potential additional costs of this proposed action. Chapter 7 of the Regulatory Impact Analysis for this proposed action defines each of these energy security externalities in detail, assesses whether its magnitude is likely to change as a consequence of this action, and identifies whether that change represents a real economic cost or benefit of this action.

(2) Environmental Externalities

The change in criteria pollutant emissions that result from changes in vehicle usage and fuel consumption is estimated as part of this analysis. Criteria air pollutants include carbon monoxide (CO), hydrocarbon compounds (usually referred to as “volatile organic compounds,” or VOC), nitrogen oxides (NO_x), fine particulate matter (PM_{2.5}), and sulfur oxides (SO_x). These pollutants are emitted during vehicle storage and use, as well as throughout the fuel production and distribution system. While increases in domestic fuel refining, storage, and distribution that result from higher fuel consumption will increase emissions of these pollutants, reduced vehicle use associated with the fuel economy rebound effect will decrease their emissions. The net effect of less stringent CAFE standards on total emissions of each criteria pollutant depends on the relative magnitudes of increases in its emissions during fuel refining and distribution, and decreases in its emissions resulting from additional vehicle use. Because the relationship between emissions in fuel refining and vehicle use is different for each criteria pollutant, the net effect of increased fuel consumption from the proposed standards on total emissions of each pollutant is likely to differ.

The social damage costs associated with changes in the emissions of criteria pollutants and CO₂ was calculated, attributing benefits and costs to the regulatory alternatives considered based on the sign of the change in each pollutant. In previous rulemakings, the agencies have considered the social cost of CO₂ emissions from a global perspective, accumulating social costs for CO₂ emissions based on adverse outcomes attributable to climate change in any country. In this analysis, however, the costs of CO₂ emissions and resulting climate damages from both domestic and global perspectives were considered. Chapter 9 of the Regulatory Impact Analysis provides a detailed discussion of how the agencies estimate changes in emissions of criteria air pollutants and CO₂ and reports the values the agencies use to estimate benefits or costs associated with those changes in emissions.

(3) Traffic Externalities (Congestion, Noise)

Increased vehicle use associated with the rebound effect also contributes to increased traffic congestion and highway noise. To estimate the economic costs associated with these consequences of added driving, the estimates of per-mile congestion and noise costs caused by increased use of automobiles and light trucks developed previously by the Federal Highway Administration (FHWA) were applied. These values are intended to measure the increased costs resulting from added congestion and the delays it causes to other drivers and passengers and noise levels contributed by automobiles and light trucks. NHTSA previously employed these estimates in its analysis accompanying the MY 2011 final CAFE rule as well as in its analysis of the effects of higher CAFE standards for MY 2012–16 and MY 2017–2021. After reviewing the procedures used by FHWA to develop them and considering other available estimates of these values and recognizing that no commenters have addressed these costs directly in their comments on previous rules, the values continue to be appropriate for use in this proposal. For this analysis, FHWA’s estimates of per-mile costs are multiplied by the annual increases in automobile and light truck use from the rebound effect to yield the estimated increases in total congestion and noise externality costs during each year over the lifetimes of the cars and light trucks in the on-road fleet. Due to the fact that this proposal represents a decrease in stringency, the fuel economy rebound effect results in fewer miles driven under the action alternatives relative to

the baseline, which generates savings in congestion and road noise relative to the baseline.

F. Impact of CAFE Standards on Vehicle Safety

In past CAFE rulemakings, NHTSA has examined the effect of CAFE standards on vehicle mass and the subsequent effect mass changes will have on vehicle safety. While setting standards based on vehicle footprint helps reduce potential safety impacts associated with CAFE standards as compared to setting standards based on some other vehicle attribute, footprint-based standards cannot entirely eliminate those impacts. Although prior analyses noted that there could also be impacts because of other factors besides mass changes, those impacts were not estimated quantitatively.²⁹² In this current analysis, the safety analysis has been expanded to include a broader and more comprehensive measure of safety impacts, as discussed below. A number of factors can influence motor vehicle fatalities directly by influencing vehicle design or indirectly by influencing consumer behavior. These factors include:

(1) Changes, which affect the crashworthiness of vehicles impact other vehicles or roadside objects, in vehicle mass made to reduce fuel consumption. NHTSA’s statistical analysis of historical crash data to understand effects of vehicle mass and size on safety indicates reducing mass in light trucks generally improves safety, while reducing mass in passenger cars generally reduces safety. NHTSA’s crash simulation modeling of vehicle design concepts for reducing mass revealed similar trends.²⁹³

(2) The delay in the pace of consumer acquisition of newer safer vehicles that results from higher vehicle prices associated with technologies needed to meet higher CAFE standards. Because of a combination of safety regulations and voluntary safety improvements, passenger vehicles have become safer over time. Compared to prior decades, fatality rates have declined significantly

²⁹² NHTSA included a quantification of rebound-associated safety impacts in its Draft TAR analysis, but because the scrappage model is new for this rulemaking, did not include safety impacts associated with the effect of standards on new vehicle prices and thus on fleet turnover. The fact that the scrappage model did not exist previously does not mean that the effects that it aims to show were not important considerations, simply that the agency was unable to account for them quantitatively prior to the current analysis.

²⁹³ DOT HS 812051a—Methodology for evaluating fleet protection of new vehicle designs Application to lightweight vehicle designs, DOT HS 812051b Methodology for evaluating fleet protection of new vehicle designs Appendices.

because of technological safety improvements as well as behavioral shifts such as increased seat belt use. The results of this analysis project that vehicle prices will be nearly \$1,900 higher under the augural CAFE standards compared to the preferred alternative that would hold stringency at MY 2020 levels in MYs 2021–2026. This will induce some consumers to delay or forgo the purchase of newer safer vehicles and slow the transition of the on-road fleet to one with the improved safety available in newer vehicles. This same factor can also shift the mix of passenger cars and light trucks.

(3) Increased driving because of better fuel economy. The “rebound effect” predicts consumers will drive more when the cost of driving declines. More stringent CAFE standards reduce vehicle operating costs, and in response, some consumers may choose to drive more. Driving more increases exposure to risks associated with on-road transportation, and this added exposure translates into higher fatalities.

Although all three factors influence predicted fatality levels that may occur, only two of them, the changes in vehicle mass and the changes in the acquisition of safer vehicles—are actually imposed on consumers by CAFE standards. The safety of vehicles has improved over time and is expected to continue improving in the future commensurate with the pace of safety technology innovation and implementation and motor vehicle safety regulation. Safety improvements will likely continue regardless of changes to CAFE standards. However, its pace may be modified if manufacturers choose to delay or forgo investments in safety technology because of the demand CAFE standards impose on research, development, and manufacturing budgets. Increased driving associated with rebound is a consumer choice. Improved CAFE will reduce driving costs, but nothing in the higher CAFE standards compels consumers to drive additional miles. If consumers choose to do so, they are making a decision that the utility of more driving exceeds the marginal operating costs as well as the added crash risk it entails. Thus, while the predicted fatality impacts with all three factors embedded into the model are measured, the fatalities associated with consumer choice decisions are accounted for separately from those resulting from technologies implemented in response to CAFE regulations or economic limitations resulting from CAFE regulation. Only those safety impacts associated with mass reduction and those resulting from

higher vehicle prices are directly attributed to CAFE standards.²⁹⁴ This is reflected monetarily by valuing extra rebound miles at the full value of their added driving cost plus the added safety risk consumers experience, which completely offsets the societal impact of any added fatalities from this voluntary consumer choice.

The safety component of CAFE analysis has evolved over time. In the 2012 final rule, the analysis accounted for the change in projected fatalities attributable to mass reduction of new vehicles. The model assumed that manufacturers would choose mass reduction as a compliance method across vehicle classes such that the net effect of mass reduction on fatalities was zero. However, in the 2016 draft Technical Assessment Report, DOT made two consequential changes to the analysis of fatalities associated with the CAFE standards. In particular, first, the modelling assumed that mass reduction technology was available to all vehicles, regardless of net safety impact, and second, it accounted for the incremental safety costs associated with additional miles traveled due to the rebound effect. The current analysis extends the analysis to report incremental fatality impacts associated with additional miles traveled due to the rebound effect, and identifies the increase in fatalities associated with additional driving separately from changes in fatalities attributable other sources.²⁹⁵

The current analysis adds another element: The effect that higher new vehicle prices have on new vehicle sales and on used vehicle scrappage, which influences total expected fatalities

²⁹⁴ It could be argued fatalities resulting from consumer’s decision to delay the purchase of newer safer vehicles is also a market decision implying consumers fully accept the added safety risk associated with this delay and value the time value of money saved by the delayed purchase more than this risk. This scenario is likely accurate for some purchasers. For others, the added cost may represent a threshold price increase effectively preventing them from being financially able to purchase a new vehicle. Presently there is no way to determine the proportion of lost sales reflected by these two scenarios. The added driving from the rebound effect results from a positive benefit of CAFE, which reduces the cost of driving. By contrast, the effect of retaining older vehicles longer results from costs imposed on consumers, which potentially limit their purchase options. Thus, fatalities are attributed to retaining older vehicles due to CAFE but not those resulting from decisions to drive more. Comments are sought on this assumption.

²⁹⁵ Drivers who travel additional miles are assumed to experience benefits that at least offset the costs they incur in doing so, including the increased safety risks they face. Thus while the number of additional fatalities resulting from increased driving is reported, the associated costs are not included among the social costs of the proposal.

because older vehicle vintages are associated with higher rates of involvement in fatal crashes than newer vehicles. Finally, a dynamic fleet share model also predicts the effects of changes in the standards on the share of light trucks and passenger cars in future model year light-duty vehicle fleets. Vehicles of different body styles have different rates of involvement in fatal crashes, so that changing the share of each in the projected future fleet has safety impacts; the implied safety effects are captured in the current modelling. The agencies seek comment on changes to the safety analysis made in this proposal, they seek particular comment on the following changes:

(1) *The sales scrappage models as independent models*: Two separate models capture the effects of new vehicle prices on new vehicle demand and used vehicle retirement rates—the sales model and the scrappage model, respectively. We seek public comment on the methods used for each of these models, in particular we seek comment on:

- The assumptions and variables included in the independent models
- The techniques and data used to estimate the independent models
- The structure and implementation of the independent models

(2) *Integration of the sales and scrappage models*: The new sales and scrappage models use many of the same predictors, but are not directly integrated. We seek public comment on, and data supporting whether integrating the two models is appropriate.

(3) *Integration of the scrappage rates and mileage accumulation*: The current model assumes that annual mileage accumulation and scrappage rates are independent of one another. We seek public comment on the appropriateness of this assumption, and data that would support developing an interaction between scrappage rates and mileage accumulation, or testing whether such an interaction is important to include.

(4) *Increased risk of older vehicles*: The observed increase in crash and injury risk associated with older vehicles is likely due to a combination of vehicle factors and driver factors. For example, older vehicles are less crashworthy because in general they’re equipped with fewer or less modern safety features, and drivers of older cars are on average younger and may be less skilled drivers or less risk-averse than drivers of new vehicles. We fit a model which includes both an age and vintage affect, but assume that the age effect is entirely a result of changes in average driver demographics, and not impacted by changes in CAFE or GHG standards. We seek comment on this approach for attributing increased older vehicle risk. Is the analysis likely to overestimate or underestimate the safety benefits under the proposed alternative?

(5) *Changes in the mix of light trucks and passenger cars*: The dynamic fleet share model predicts changes in the future share of light truck and passenger car vehicles. Changes in the mix of vehicles may result in

increased or decreased fatalities. Does the dynamic fleet share model reasonably capture consumers' decisions about how they substitute between different types and sizes of vehicles depending on changes in fuel economy, relative and absolute prices, and other vehicle attributes? We seek comment on whether our safety analysis provides a reasonable estimate of the effects of changes in fleet mix on future fatalities.

1. Impact of Weight Reduction on Safety

The primary goals of CAFE and CO₂ standards are reducing fuel consumption and CO₂ emissions from the on-road light-duty vehicle fleet; in addition to these intended effects, the potential of the standards to affect vehicle safety is also considered.²⁹⁶ As a safety agency, NHTSA has long considered the potential for adverse safety consequences when establishing CAFE standards, and under the CAA, EPA considers factors related to public health and human welfare, including safety, in regulating emissions of air pollutants from mobile sources.

Safety trade-offs associated with fuel economy increases have occurred in the past, particularly before NHTSA CAFE standards were attribute-based; past safety trade-offs may have occurred because manufacturers chose at the time, in response to CAFE standards, to build smaller and lighter vehicles. Although the agency now uses attribute-based standards, in part to protect against excessive vehicle downsizing, the agency must be mindful of the possibility of related safety trade-offs in the future. In cases where fuel economy improvements were achieved through reductions in vehicle size and mass, the smaller, lighter vehicles did not fare as well in crashes as larger, heavier vehicles, on average.

Historically, as shown in FARS data analyzed by NHTSA, the safest cars generally have been heavy and large, while cars with the highest fatal-crash rates have been light and small. The question, then, is whether past is necessarily a prologue when it comes to potential changes in vehicle size (both footprint and "overhang") and mass in

²⁹⁶ In this rulemaking document, "vehicle safety" is defined as societal fatality rates per vehicle mile of travel (VMT), including fatalities to occupants of all vehicles involved in collisions, plus any pedestrians. Injuries and property damage are not within the scope of the statistical models discussed in this section because of data limitations (e.g., limited information on observed or potential relationships between safety standards and injury and property damage outcomes, consistency of reported injury severity levels). Rather, injuries and property damage are represented within the CAFE model through adjustment factors based on observed relationships between societal costs of fatalities and societal injury and property damage costs.

response to the more stringent future CAFE and GHG standards.

Manufacturers stated they will reduce vehicle mass as one of the cost-effective means of increasing fuel economy and reducing CO₂ to meet standards, and this approach is incorporated this expectation into the modeling analysis supporting the standards. Because the analysis discerns a historical relationship between vehicle mass, size, and safety, it is reasonable to assume these relationships will continue in the future.

(a) Historical Analyses of Vehicle Mass and Safety

Researchers have been using statistical analysis to examine the relationship of vehicle mass and safety in historical crash data for many years and continue to refine their techniques. In the MY 2012–2016 final rule, the agencies stated we would conduct further study and research into the interaction of mass, size, and safety to assist future rulemakings and start to work collaboratively by developing an interagency working group between NHTSA, EPA, DOE, and CARB to evaluate all aspects of mass, size, and safety. The team would seek to coordinate government-supported studies and independent research to the greatest extent possible to ensure the work is complementary to previous and ongoing research and to guide further research in this area.

The agencies also identified three specific areas to direct research in preparation for future CAFE/CO₂ rulemaking regarding statistical analysis of historical data. First, NHTSA would contract with an independent institution to review statistical methods NHTSA and DRI used to analyze historical data related to mass, size, and safety, and to provide recommendations on whether existing or other methods should be used for future statistical analysis of historical data. This study would include a consideration of potential near multicollinearity in the historical data and how best to address it in a regression analysis. The 2010 NHTSA report (*hereinafter* 2010 Kahane report) was also peer reviewed by two other experts in the safety field—Farmer (Insurance Institute for Highway Safety) and Lie (Swedish Transport Administration).²⁹⁷

Second, NHTSA and EPA, in consultation with DOE, would update the MY 1991–1999 database where

²⁹⁷ All three peer reviews are available in Docket No. NHTSA–2010–0152, *Relationships Between Fatality Risk, Mass, and Footprint*, <https://www.regulations.gov/docket?D=NHTSA-2010-0152>.

safety analyses in the NPRM and final rule are based with newer vehicle data and create a common database that could be made publicly available to address concerns that differences in data were leading to different results in statistical analyses by different researchers.

And third, to assess if the design of recent model year vehicles incorporating various mass reduction methods affect relationships among vehicle mass, size, and safety, the agencies sought to identify vehicles using material substitution and smart design and to assess if there is sufficient crash data involving those vehicles for statistical analysis. If sufficient data exists, statistical analysis would be conducted to compare the relationship among mass, size, and safety of these smart design vehicles to vehicles of similar size and mass with more traditional designs.

By the time of the MY 2017–2025 final rule, significant progress was made on these tasks: The independent review of recent and updated statistical analyses of the relationship between vehicle mass, size, and crash fatality rates had been completed. NHTSA contracted with the University of Michigan Transportation Research Institute (UMTRI) to conduct this review, and the UMTRI team led by Green evaluated more than 20 papers, including studies done by NHTSA's Kahane, Wenzel of the U.S. Department of Energy's Lawrence Berkeley National Laboratory, Dynamic Research, Inc., and others. UMTRI's basic findings are discussed in Chapter 11 of the PRIA accompanying this NPRM.

Some commenters in recent CAFE rulemakings, including some vehicle manufacturers, suggested designs and materials of more recent model year vehicles may have weakened the historical statistical relationships between mass, size, and safety. It was agreed that the statistical analysis would be improved by using an updated database reflecting more recent safety technologies, vehicle designs and materials, and reflecting changes in the vehicle fleet. An updated database was created and employed for assessing safety effects for that final rule. The agencies also believed, as UMTRI found, different statistical analyses may have produced different results because they used slightly different datasets for their analyses.

To try to mitigate this issue and to support the current rulemaking, NHTSA created a common, updated database for statistical analysis consisting of crash data of model years 2000–2007 vehicles in calendar years 2002–2008, as

compared to the database used in prior NHTSA analyses, which was based on model years 1991–1999 vehicles in calendar years 1995–2000. The new database was the most up-to-date possible, given the processing lead time for crash data and the need for enough crash cases to permit statistically meaningful analyses. NHTSA made the preliminary version of the new database, which was the basis for NHTSA’s 2011 preliminary report (*hereinafter* 2011 Kahane report), available to the public in May 2011, and an updated version in April 2012 (used in NHTSA’s 2012 final report, *hereinafter* 2012 Kahane report),²⁹⁸ enabling other researchers to analyze the same data and hopefully minimize discrepancies in results because of inconsistencies across databases.²⁹⁹

Since the publication of the MYs 2017–2025 final rule, NHTSA has sponsored, and is sponsoring, new studies and research to inform the current CAFE and CO₂ rulemaking. In addition, the National Academy of Sciences published a new report in this area.³⁰⁰ Throughout the rulemaking process, NHTSA’s goal is to publish as much of our research as possible. In establishing standards, all available data, studies, and information objectively without regard to whether they were sponsored by the agencies, will be considered.

Undertaking these tasks has helped come closer to resolving ongoing debates in statistical analysis research of historical crash data. It is intended that these conclusions will be applied going forward in future rulemakings, and it is believed the research will assist the public discussion of the issues. Specific historical analyses (in addition to NHTSA’s own analysis) on vehicle mass and safety used to support this rulemaking include:

- The 2011 and 2013 NHTSA Workshops on Vehicle Mass, Size, and Safety;
- the University of Michigan Transportation Research Institute (UMTRI) independent review of a set of statistical relationships between vehicle curb weight, footprint variables (track width, wheelbase), and fatality rates from vehicle crashes;
- the 2012 Lawrence Berkeley National Laboratory (LBNL) Phase 1 and Phase 2 reports on the sensitivity of

NHTSA’s baseline results and casualty risk per VMT;

- the 2012 DRI reports on, among other things, the effects of mass reduction on crash frequency and fatality risk per crash;
- LBNL’s subsequent review of DRI’s study;
- the 2015 National Academy of Sciences Report; and
- the 2017 NBER working paper analyzing the relationships among traffic fatalities, CAFE standards, and distributions of MY 1989–2005 light-duty vehicle curb weights.

A detailed discussion of each analysis is discussed in Chapter 11 of the PRIA accompanying this proposed rule.

(b) Recent NHTSA Analysis Supporting CAFE Rulemaking

As mentioned previously, NHTSA and EPA’s 2012 joint final rule for MYs 2017 and beyond set “footprint-based” standards, with footprint being defined as roughly equal to the wheelbase multiplied by the average of the front and rear track widths. Basing standards on vehicle footprint ideally helps to discourage vehicle manufacturers from downsizing their vehicles; the agencies set higher (more stringent) mile per gallon (mpg) targets for smaller-footprint vehicles but would not similarly discourage mass reduction that maintains footprint while potentially improving fuel economy. Several technologies, such as substitution of light, high-strength materials for conventional materials during vehicle redesigns, have the potential to reduce weight and conserve fuel while maintaining a vehicle’s footprint and maintaining or possibly improving the vehicle’s structural strength and handling.

In considering what technologies are available for improving fuel economy, including mass reduction, an important corollary issue for NHTSA to consider is the potential effect those technologies may have on safety. NHTSA has thus far specifically considered the likely effect of mass reduction that maintains footprint on fatal crashes. The relationship between a vehicle’s mass, size, and fatality risk is complex, and it varies in different types of crashes. As mentioned above, NHTSA, along with others, has been examining this relationship for more than a decade.³⁰¹

The safety chapter of NHTSA’s April 2012 final regulatory impact analysis (FRIA) of CAFE standards for MY 2017–

2021 passenger cars and light trucks included a statistical analysis of relationships between fatality risk, mass, and footprint in MY 2000–2007 passenger cars and LTVs (light trucks and vans), based on calendar year (CY) 2002–2008 crash and vehicle-registration data;³⁰² this analysis was also detailed in the 2012 Kahane report.

The principal findings and conclusions of the 2012 Kahane report were mass reduction in the lighter cars, even while holding footprint constant, would significantly increase fatality risk, whereas mass reduction in the heavier LTVs would reduce societal fatality risk by reducing the fatality risk of occupants of lighter vehicles colliding with those heavier LTVs. NHTSA concluded, as a result, any *reasonable* combination of mass reductions that held footprint constant in MY 2017–2021 vehicles—concentrated, at least to some extent, in the heavier LTVs and limited in the lighter cars—would likely be approximately safety-neutral; it would not significantly increase fatalities and might well decrease them.

NHTSA released a preliminary report (2016 Puckett and Kindelberger report) on the relationship between fatality risk, mass, and footprint in June 2016 in advance of the Draft TAR. The preliminary report covered the same scope as the 2012 Kahane report, offering a detailed description of the databases, modeling approach, and analytical results on relationships among vehicle size, mass, and fatalities that informed the Draft TAR. Results in the Draft TAR and the 2016 Puckett and Kindelberger report are consistent with results in the 2012 Kahane report; chiefly, societal effects of mass reduction are small, and mass reduction concentrated in larger vehicles is likely to have a beneficial effect on fatalities, while mass reduction concentrated in smaller vehicles is likely to have a detrimental effect on fatalities.

For the 2016 Puckett and Kindelberger report and Draft TAR, NHTSA, working closely with EPA and the DOE, performed an updated statistical analysis of relationships between fatality rates, mass and footprint, updating the crash and exposure databases to the latest available model years. The agencies analyzed updated databases that included MY 2003–2010 vehicles in CY 2005–2011 crashes. For this proposed

²⁹⁸ Those databases are available at <ftp://ftp.nhtsa.dot.gov/CAFE/>.

²⁹⁹ See 75 FR 25324, 25395–25396 (May 7, 2010) (for a discussion of planned statistical analyses).

³⁰⁰ *Cost, Effectiveness and Deployment of Fuel Economy Technologies for Light-Duty Vehicles*, National Academy of Sciences (2015).

³⁰¹ A complete discussion of the historical analysis of vehicle mass and safety is located in Chapter 10 of the PRIA accompanying this proposed rulemaking.

³⁰² Kahane, C.J. *Relationships Between Fatality Risk, Mass, and Footprint in Model Year 2000–2007 Passenger Cars and LTVs—Final Report*, National Highway Traffic Safety Administration (Aug. 2012), available at <https://crashstats.nhtsa.dot.gov/Api/Public/ViewPublication/811665>.

rule, databases are the most up-to-date possible (MY 2004–2011 vehicles in CY 2006–2012), given the processing time for crash data and the need for enough crash cases to permit statistically meaningful analyses. As in previous analyses, NHTSA has made the new databases available to the public on its website, enabling other researchers to analyze the same data and hopefully minimizing discrepancies in results that would have been because of inconsistencies across databases.

(c) Updated Analysis for This Rulemaking

The basic analytical method used to analyze the impacts of weight reduction on safety in this proposed rule is the same as in NHTSA's 2012 Kahane report, 2016 Puckett and Kindelberger report, and the Draft TAR: The agency analyzed cross sections of the societal fatality rate per billion vehicle miles of travel (VMT) by mass and footprint, while controlling for driver age, gender, and other factors, in separate logistic regressions by vehicle class and crash type. "Societal" fatality rates include fatalities to occupants of all the vehicles involved in the collisions, plus any pedestrians.

The temporal range of the data is now MY 2004–2011 vehicles in CY 2006–2012, updated from previous databases of MY 2000–2007 vehicles in CY 2002–2008 (2012 Kahane Report) and MY 2003–2010 vehicles in CY 2005–2011 (2016 Puckett and Kindelberger report and Draft TAR). NHTSA purchased a file of odometer readings by make, model, and model year from Polk that helped inform the agency's improved VMT estimates. As in the 2012 Kahane report, 2016 Puckett and Kindelberger report, and the Draft TAR, the vehicles are grouped into three classes: Passenger cars (including both two-door and four-door cars); CUVs and minivans; and truck-based LTVs.

There are nine types of crashes specified in the analysis. Single-vehicle crashes include first-event rollovers, collisions with fixed objects, and collisions with pedestrians, bicycles and motorcycles. Two-vehicle crashes include collisions with: heavy-duty vehicles; car, CUV, or minivan < 3,187 pounds (the median curb weight of other, non-case, cars, CUVs and

minivans in fatal crashes in the database); car, CUV, or minivan \geq 3,187 pounds; truck-based LTV < 4,360 pounds (the median curb weight of other truck-based LTVs in fatal crashes in the database); and truck-based LTV \geq 4,360 pounds. An additional crash type includes all other fatal crash types (e.g., collisions involving more than two vehicles, animals, or trains). Splitting the "other" vehicles into a lighter and a heavier group permits more accurate analyses of the mass effect in collisions of two light vehicles. Grouping partner-vehicle CUVs and minivans with cars rather than LTVs is more appropriate because their front-end profile and rigidity more closely resembles a car than a typical truck-based LTV.

The curb weight of passenger cars is formulated, as in the 2012 Kahane report, 2016 Puckett and Kindelberger report, and Draft TAR, as a two-piece linear variable to estimate one effect of mass reduction in the lighter cars and another effect in the heavier cars. The boundary between "lighter" and "heavier" cars is 3,201 pounds (which is the median mass of MY 2004–2011 cars in fatal crashes in CY 2006–2012, up from 3,106 for MY 2000–2007 cars in CY 2002–2008 in the 2012 NHTSA safety database, and up from 3,197 for MY 2003–2010 cars in CY 2005–2011 in the 2016 NHTSA safety database).

Likewise, for truck-based LTVs, curb weight is a two-piece linear variable with the boundary at 5,014 pounds (again, the MY 2004–2011 median, higher than the median of 4,594 for MY 2000–2007 LTVs in CY 2002–2008 and the median of 4,947 for MY 2003–2010 LTVs in CY 2005–2011). Curb weight is formulated as a simple linear variable for CUVs and minivans. Historically, CUVs and minivans have accounted for a relatively small share of new-vehicle sales over the range of the data, resulting in less crash data available than for cars or truck-based LTVs.

For a given vehicle class and weight range (if applicable), regression coefficients for mass (while holding footprint constant) in the nine types of crashes are averaged, weighted by the number of baseline fatalities that would have occurred for the subgroup MY 2008–2011 vehicles in CY 2008–2012 if these vehicles had all been equipped with electronic stability control (ESC).

The adjustment for ESC, a feature of the analysis added in 2012, takes into account results will be used to analyze effects of mass reduction in future vehicles, which will all be ESC-equipped, as required by NHTSA's regulations.

Techniques developed in the 2011 (preliminary) and 2012 (final) Kahane reports have been retained to test statistical significance and to estimate 95 percent confidence bounds (sampling error) for mass effects and to estimate the combined annual effect of removing 100 pounds of mass from every vehicle (or of removing different amounts of mass from the various classes of vehicles), while holding footprint constant.

NHTSA considered the near multicollinearity of mass and footprint to be a major issue in the 2010 Kahane report³⁰³ and voiced concern about inaccurately estimated regression coefficients.³⁰⁴ High correlations between mass and footprint and variance inflation factors (VIF) have not changed from MY 1991–1999 to MY 2004–2011; large vehicles continued to be, on the average, heavier than small vehicles to the same extent as in the previous decade.³⁰⁵

Nevertheless, multicollinearity appears to have become less of a problem in the 2012 Kahane, 2016 Puckett and Kindelberger/Draft TAR, and current NHTSA analyses. Ultimately, only three of the 27 core models of fatality risk by vehicle type in the current analysis indicate the potential presence of effects of multicollinearity, with estimated effects of mass and footprint reduction greater than two percent per 100-pound mass reduction and one-square-foot footprint reduction, respectively; these three models include passenger cars and CUVs in first-event rollovers, and CUVs in collisions with LTVs greater than 4,360 pounds. This result is consistent with the 2016 Puckett and Kindelberger report, which also found only three cases out of 27 models with estimated effects of mass and footprint reduction greater than two percent per 100-pound mass reduction and one-square-foot footprint reduction.

Table II–45 presents the estimated percent increase in U.S. societal fatality risk per 10 billion VMT for each 100-

³⁰³ Kahane, C. J. *Relationships Between Fatality Risk, Mass, and Footprint in Model Year 1991–1999 and Other Passenger Cars and LTVs* (Mar. 24, 2010), in *Final Regulatory Impact Analysis: Corporate Average Fuel Economy for MY 2012–MY 2016 Passenger Cars and Light Trucks*, National Highway Traffic Safety Administration (Mar. 2010) at 464–542.

³⁰⁴ Van Auken and Green also discussed the issue in their presentations at the NHTSA Workshop on Vehicle Mass-Size-Safety in Washington, DC February 25, 2011. More information on the NHTSA Workshop on Vehicle Mass-Size-Safety is available at <https://one.nhtsa.gov/Laws-&Regulations/CAFE-%E2%80%93-Fuel-Economy/NHTSA-Workshop-on-Vehicle-Mass%E2%80%93Size%E2%80%93Safety>.

³⁰⁵ Greene, W. H. *Econometric Analysis* 266–68 (Macmillan Publishing Company 2d ed. 1993); Paul D. Allison, *Logistic Regression Using the SAS System* 48–51 (SAS Institute Inc. 2001). VIF scores are in the 6–9 range for curb weight and footprint in NHTSA's new database—i.e., in the somewhat unfavorable 2.5–10 range where near multicollinearity begins to become a concern in logistic regression analyses.

pound reduction in vehicle mass, while holding footprint constant, for each of the five vehicle classes:

Table II-45 - Fatality Increase (%) per 100-Pound Mass Reduction While Holding Footprint Constant: MY 2004-2011, CY 2006-2012

	Point Estimate	95% Confidence Bounds
Cars < 3,197 pounds	1.20	-.35 to +2.75
Cars ≥ 3,197 pounds	0.42	-.67 to +1.50
CUVs and minivans	-0.25	-1.55 to +1.04
Truck-based LTVs < 4,947 pounds	0.31	-.51 to +1.13
Truck-based LTVs ≥ 4,947 pounds	-0.61	-1.46 to +.25

None of the estimated effects have 95-percent confidence bounds that exclude zero, and thus are not statistically significant at the 95-percent confidence level. Two estimated effects are statistically significant at the 85-percent level. Societal fatality risk is estimated to: (1) Increase by 1.2 percent if mass is reduced by 100 pounds in the lighter cars; and (2) decrease by 0.61 percent if mass is reduced by 100 pounds in the heavier truck-based LTVs. The

estimated increases in societal fatality risk for mass reduction in the heavier cars and the lighter truck-based LTVs, and the estimated decrease in societal fatality risk for mass reduction in CUVs and minivans are not significant, even at the 85-percent confidence level.

Confidence bounds estimate only the sampling error internal to the data used in the specific analysis that generated the point estimate. Point estimates are also sensitive to the modification of

components of the analysis, as discussed at the end of this section. However, this degree of uncertainty is methodological in nature rather than statistical.

It is useful to compare the new results in Table II-45 to results in the 2012 Kahane report (MY 2000–2007 vehicles in CY 2002–2008) and the 2016 Puckett and Kindelberger report and Draft TAR (MY 2003–2010 vehicles in CY 2005–2011), presented in Table II-46 below:

Table II-46 - Fatality Increase (%) per 100-Pound Mass Reduction While Holding Footprint Constant

Vehicle Class ³⁰⁶	2012 Report Point Estimate	2016 Report/Draft TAR Point Estimate	2012 Report 95% Confidence Bounds	2016 Report 95% Confidence Bounds
Lighter Passenger Cars	1.56	1.49	+.39 to +2.73	-.30 to +3.27
Heavier Passenger Cars	.51	.50	-.59 to 1.60	-.59 to +1.60
CUVs and minivans	-.37	-.99	-1.55 to +.81	-2.17 to +.19
Lighter Truck-based LTVs	.52	-.10	-.45 to +1.48	-1.08 to +.88
Heavier Truck-based LTVs	-.34	-.72	-.97 to +.30	-1.45 to +.02

New results are directionally the same as in 2012; in the 2016 analysis, the estimate for lighter LTVs was of opposite sign (but small magnitude). Consistent with the 2012 Kahane and 2016 Puckett and Kindelberger reports, mass reductions in lighter cars are estimated to lead to increases in fatalities, and mass reductions in heavier LTVs are estimated to lead to decreases in fatalities. However, NHTSA does not consider this conclusion to be definitive because of the relatively wide confidence bounds of the estimates. The estimated mass effects are similar among analyses for both classes of

passenger cars; for all reports, the estimate for lighter passenger cars is statistically significant at the 85-percent confidence level, while the estimate for heavier passenger cars is insignificant.

The estimated mass effect for heavier truck-based LTVs is stronger in this analysis and in the 2016 Puckett and Kindelberger report than in the 2012 Kahane report; both estimates are statistically significant at the 85-percent confidence level, unlike the corresponding insignificant estimate in the 2012 Kahane report. The estimated mass effect for lighter truck-based LTVs is insignificant and positive in this analysis and the 2012 Kahane report,

while the corresponding estimate in the 2016 Puckett and Kindelberger report was insignificant and negative.

Vehicle mass continued an historical upward trend across the MYs in the newest databases. The average (VMT-weighted) masses of passenger cars and CUVs both increased by approximately three percent from MYs 2004 to 2011 (3,184 pounds to 3,289 pounds for passenger cars, and 3,821 pounds to 3,924 pounds for CUVs). Over the same period, the average mass of minivans increased by six percent (from 4,204 pounds to 4,462 pounds), and the average mass of LTVs increased by 10% (from 4,819 pounds to 5,311 pounds).

³⁰⁶ Median curb weights in the 2012 Kahane report: 3,106 pounds for cars, 4,594 pounds for

truck-based LTVs. Median curb weights in the 2016

Puckett and Kindelberger report: 3,197 pounds for cars, 4,947 pounds for truck-based LTVs.

Historical reasons for mass increases within vehicle classes include: Manufacturers discontinuing lighter models; manufacturers re-designing models to be heavier and larger; and shifting consumer preferences with respect to cabin size and overall vehicle size.

The principal difference between heavier vehicles, especially truck-based LTVs, and lighter vehicles, especially passenger cars, is mass reduction has a different effect in collisions with another car or LTV. When two vehicles of unequal mass collide, the change in velocity (delta V) is greater in the lighter

vehicle. Through conservation of momentum, the degree to which the delta V in the lighter vehicle is greater than in the heavier vehicle is proportional to the ratio of mass in the heavier vehicle to mass in the lighter vehicle:

$$\Delta v_1 = \frac{m_2}{m_1} \Delta v_2$$

Where:

Δv_1 is the delta V for a focal vehicle,

Δv_2 is the delta V for a partner vehicle, and

$\frac{m_2}{m_1}$ is the mass of the partner vehicle divided by the mass of the focal vehicle.

Because fatality risk is a positive function of delta V, the fatality risk in the lighter vehicle in two-vehicle collisions is also higher. Removing some mass from the heavy vehicle reduces delta V in the lighter vehicle, where fatality risk is higher, resulting in a large benefit, offset by a small penalty because delta V increases in the heavy vehicle where fatality risk is low—adding up to a net societal benefit. Removing some mass from the lighter vehicle results in a large penalty offset by a small benefit—adding up to net harm.

These considerations drive the overall result: Mass reduction is associated with an increase in fatality risk in lighter cars, a decrease in fatality risk in heavier LTVs, CUVs, and minivans, and has smaller effects in the intermediate groups. Mass reduction may also be harmful in a crash with a movable object such as a small tree, which may break if hit by a high mass vehicle resulting in a lower delta V than may occur if hit by a lower mass vehicle which does not break the tree and therefore has a higher delta V. However, in some types of crashes not involving collisions between cars and LTVs, especially first-event rollovers and impacts with fixed objects, mass reduction may not be harmful and may be beneficial. To the extent lighter vehicles may respond more quickly to braking and steering, or may be more stable because their center of gravity is

lower, they may more successfully avoid crashes or reduce the severity of crashes.

Farmer, Green, and Lie, who reviewed the 2010 Kahane report, again peer-reviewed the 2011 Kahane report.³⁰⁷ In preparing his 2012 report (along with the 2016 Puckett and Kindelberger report and Draft TAR), Kahane also took into account Wenzel's³⁰⁸ assessment of the preliminary report and its peer reviews, DRI's analyses published early in 2012, and public comments such as the International Council on Clean Transportation's comments submitted on NHTSA and EPA's 2010 notice of joint rulemaking.³⁰⁹ These comments prompted supplementary analyses, especially sensitivity tests, discussed at the end of this section.

³⁰⁷ Items 0035 (Lie), 0036 (Farmer) and 0037 (Green) in Docket No. NHTSA-2010-0152.

³⁰⁸ Wenzel, T. *An Analysis of the Relationship Between Casualty Risk Per Crash and Vehicle Mass and Footprint for Model Year 2000–2007 Light Duty Vehicles*, Lawrence Berkeley National Laboratory (Dec. 2011), available at <http://eta-publications.lbl.gov/sites/default/files/lbnl-5695e.pdf>; Tom Wenzel, Lawrence Berkeley National Laboratory -Assessment of NHTSA Report Relationships Btw Fatality Risk Mass and Footprint in MY 2000–2007 PC and LTV," Docket NHTSA-2010-0131-0315; and a peer review of Wenzel's reports—*Peer Review of LBNL Statistical Analysis of the Effect of Vehicle Mass & Footprint Reduction on Safety (LBNL Phase 1 and 2 Reports)*, prepared for U.S. EPA (Feb. 2012), available at Docket ID NHTSA-2010-0131-0328.

³⁰⁹ Comment by International Council on Clean Transportation, Docket ID NHTSA-2010-0131-0258.

The regression results are best suited to predict the effect of a small change in mass, leaving all other factors, including footprint, the same. With each additional change from the current environment (e.g., the scale of mass change, presence and prevalence of safety features, demographic characteristics), the model may become less accurate. It is recognized that the light-duty vehicle fleet in the MY 2021–2026 timeframe will be different from the MY 20042011 fleet analyzed here.

Nevertheless, one consideration provides some basis for confidence in applying regression results to estimate effects of relatively large mass reductions or mass reductions over longer periods. This is NHTSA's sixth evaluation of effects of mass reduction and/or downsizing,³¹⁰ comprising

³¹⁰ As outlined throughout this section, NHTSA's six related studies include the new analysis supporting this rulemaking, and: Kahane, C. J. *Vehicle Weight, Fatality Risk and Crash Compatibility of Model Year 1991–99 Passenger Cars and Light Trucks*, National Highway Traffic Safety Administration (Oct. 2003), available at <https://crashstats.nhtsa.dot.gov/Api/Public/ViewPublication/809662>; Kahane, C. J. *Relationships Between Fatality Risk, Mass, and Footprint in Model Year 1991–1999 and Other Passenger Cars and LTVs* (Mar. 24, 2010), in *Final Regulatory Impact Analysis: Corporate Average Fuel Economy for MY 2012–MY 2016 Passenger Cars and Light Trucks*, National Highway Traffic Safety Administration (Mar. 2010) at 464–542; Kahane, C. J. *Relationships Between Fatality Risk, Mass, and Footprint in Model Year 2000–2007 Passenger Cars and LTVs—Preliminary Report*, National Highway Traffic Safety Administration (Nov. 2011), available at Docket ID NHTSA-2010-0152-0023); Kahane, C.

databases ranging from MYs 1985 to 2011.

Results of the six studies are not identical, but they have been consistent to a point. During this time period, many makes and models have increased substantially in mass, sometimes as much as 30–40%.³¹¹ If the statistical analysis has, over the past years, been able to accommodate mass increases of this magnitude, perhaps it will also succeed in modeling effects of mass reductions of approximately 10–20%, should they occur in the future.

J. Relationships Between Fatality Risk, Mass, and Footprint in Model Year 2000–2007 Passenger Cars and LTVs: Final Report, NHTSA Technical Report. Washington, DC: NHTSA, Report No. DOT-HS-811-665; and Puckett, S. M., & Kindelberger, J. C. *Relationships between Fatality Risk, Mass, and Footprint in Model Year 2003–2010 Passenger Cars and LTVs—Preliminary Report*, National Highway Traffic Safety Administration (June 2016), available at <https://www.nhtsa.gov/sites/nhtsa.dot.gov/files/2016-prelim-relationship-fatalityrisk-mass-footprint-2003-10.pdf>.

³¹¹ For example, one of the most popular models of small 4-door sedans increased in curb weight from 1,939 pounds in MY 1985 to 2,766 pounds in MY 2007, a 43% increase. A high-sales mid-size sedan grew from 2,385 to 3,354 pounds (41%); a best-selling pickup truck from 3,390 to 4,742 pounds (40%) in the basic model with two-door cab and rear-wheel drive; and a popular minivan from 2,940 to 3,862 pounds (31%).

(d) Calculation of MY 2021–2026 Safety Impact

Neither CAFE standards nor this analysis mandate mass reduction, or mandate mass reduction occur in any specific manner. However, mass reduction is one of the technology applications available to manufacturers, and thus a degree of mass reduction is allowed within the CAFE model to: (1) Determine capabilities of manufacturers; and (2) to predict cost and fuel consumption effects of improved CAFE standards.

The agency utilized the relationships between weight and safety from the new NHTSA analysis, expressed as percentage increases in fatalities per 100-pound weight reduction, and examined the weight impacts assumed in this CAFE analysis. The effects of mass reduction on safety were estimated relative to estimated baseline levels of safety across vehicle classes and model years. To identify baseline levels of safety, the agency examined effects of identifiable safety trends over lifetimes of vehicles produced in each model year. The projected effectiveness of existing and forthcoming safety technologies and expected on-road fleet penetration of safety technologies were incorporated into observed trends in fatality rates to estimate baseline fatality rates in future years across vehicle classes and model years.

The agency assumed safety trends will result in a reduction in the target population of fatalities from which the vehicle mass impacts are derived. Table II–47 through Table II–52 show results of NHTSA’s vehicle mass-size-safety analysis over the cumulative lifetime of MY 1977–2029 vehicles, for both the CAFE and GHG programs, based on the MY 2016 baseline fleet, accounting for the projected safety baselines. The reported fatality impacts are undiscounted, but the monetized safety impacts are discounted at three-percent and seven-percent discount rates. The reported fatality impacts are estimated increases or decreases in fatalities over the lifetime of the model year fleet. A positive number means that fatalities are projected to increase; a negative number (in parentheses) means that fatalities are projected to decrease.

Results are driven extensively by the degree to which mass is reduced in relatively light passenger cars and in relatively heavy vehicles because their coefficients in the logistic regression analysis have the most significant values. We assume any impact on fatalities will occur over the lifetime of the vehicle, and the chance of a fatality occurring in any particular year is directly related to the weighted vehicle miles traveled in that year.

Table II-47 - Comparison of the Calculated Vehicle-Mass-Related Fatality Impacts over the Lifetime of MY 1977 through MY 2029 Light-Duty Vehicles, by CAFE Policy Alternative, Relative to Augural Standards, Fatalities Undiscounted, Dollars Discounted at 3% and 7%

	Alternative							
	#1	#2	#3	#4	#5	#6	#7	#8
Model Years Affected by Policy	2021-2026	2021-2026	2021-2026	2021-2026	2022-2026	2021-2026	2021-2026	2022-2026
Annual Rate of Stringency Increase	0.0%/Year PC 0.0%/Year LT	0.5%/Year PC 0.5%/Year LT	0.5%/Year PC 0.5%/Year LT	1.0%/Year PC 2.0%/Year LT	1.0%/Year PC 2.0%/Year LT	2.0%/Year PC 3.0%/Year LT	2.0%/Year PC 3.0%/Year LT	2.0%/Year PC 3.0%/Year LT
AC/Off-Cycle Procedures	No Change	No Change	Phaseout 2022- 2026	No Change	No Change	No Change	Phaseout 2022- 2026	No Change
Fatalities	-160	-147	-143	-173	-152	-73	-12	-30
Fatality Costs (\$ Billion, 3% Discount Rate)	-0.9	-0.9	-0.8	-1.1	-0.9	-0.4	-0.1	-0.2
Fatality Costs (\$ Billion, 7% Discount Rate)	-0.5	-0.5	-0.5	-0.6	-0.5	-0.2	0.0	-0.1
Non-Fatal Crash Costs (\$ Billion, 3% Discount Rate)	-1.5	-1.3	-1.3	-1.7	-1.5	-0.7	-0.1	-0.3
Non-Fatal Crash Costs (\$ Billion, 7% Discount Rate)	-0.8	-0.7	-0.7	-1.0	-0.8	-0.4	-0.1	-0.2
Total Crash Costs (\$ Billion, 3% Discount Rate)	-2.4	-2.2	-2.1	-2.7	-2.4	-1.1	-0.2	-0.5
Total Crash Costs (\$ Billion, 7% Discount Rate)	-1.3	-1.2	-1.2	-1.6	-1.4	-0.6	-0.1	-0.3

Table II-48 - Comparison of the Calculated Vehicle-Mass-Related Fatality Impacts over the Lifetime of MY 1977 through MY 2029 Passenger Cars, by CAFE Policy Alternative, Relative to Augural Standards, Fatalities Undiscounted, Dollars Discounted at 3% and 7%

	Alternative							
	#1	#2	#3	#4	#5	#6	#7	#8
Model Years Affected by Policy	2021-2026	2021-2026	2021-2026	2021-2026	2022-2026	2021-2026	2021-2026	2022-2026
Annual Rate of Stringency Increase	0.0%/Year PC 0.0%/Year LT	0.5%/Year PC 0.5%/Year LT	0.5%/Year PC 0.5%/Year LT	1.0%/Year PC 2.0%/Year LT	1.0%/Year PC 2.0%/Year LT	2.0%/Year PC 3.0%/Year LT	2.0%/Year PC 3.0%/Year LT	2.0%/Year PC 3.0%/Year LT
AC/Off-Cycle Procedures	No Change	No Change	Phaseout 2022-2026	No Change	No Change	No Change	Phaseout 2022-2026	No Change
Fatalities	-281	-262	-234	-197	-167	-87	-17	-42
Fatality Costs (\$ Billion, 3% Discount Rate)	-1.7	-1.6	-1.4	-1.2	-1.0	-0.5	-0.1	-0.3
Fatality Costs (\$ Billion, 7% Discount Rate)	-1.0	-0.9	-0.8	-0.7	-0.6	-0.3	-0.1	-0.1
Non-Fatal Crash Costs (\$ Billion, 3% Discount Rate)	-2.7	-2.5	-2.3	-1.9	-1.6	-0.8	-0.2	-0.4
Non-Fatal Crash Costs (\$ Billion, 7% Discount Rate)	-1.6	-1.5	-1.3	-1.1	-0.9	-0.5	-0.1	-0.2
Total Crash Costs (\$ Billion, 3% Discount Rate)	-4.4	-4.2	-3.7	-3.1	-2.6	-1.4	-0.3	-0.7
Total Crash Costs (\$ Billion, 7% Discount Rate)	-2.5	-2.4	-2.1	-1.8	-1.5	-0.8	-0.1	-0.4

Table II-49 - Comparison of the Calculated Vehicle-Mass-Related Fatality Impacts over the Lifetime of MY 1977 through MY 2029 Light Trucks, by CAFE Policy Alternative, Relative to Augural Standards, Fatalities Undiscounted, Dollars Discounted at 3% and 7%

	Alternative							
	#1	#2	#3	#4	#5	#6	#7	#8
Model Years Affected by Policy	2021-2026	2021-2026	2021-2026	2021-2026	2022-2026	2021-2026	2021-2026	2022-2026
Annual Rate of Stringency Increase	0.0%/Year PC 0.0%/Year LT	0.5%/Year PC 0.5%/Year LT	0.5%/Year PC 0.5%/Year LT	1.0%/Year PC 2.0%/Year LT	1.0%/Year PC 2.0%/Year LT	2.0%/Year PC 3.0%/Year LT	2.0%/Year PC 3.0%/Year LT	2.0%/Year PC 3.0%/Year LT
AC/Off-Cycle Procedures	No Change	No Change	Phaseout 2022- 2026	No Change	No Change	No Change	Phaseout 2022- 2026	No Change
Fatalities	120	116	92	25	15	14	6	12
Fatality Costs (\$ Billion, 3% Discount Rate)	0.8	0.8	0.6	0.2	0.1	0.1	0.0	0.1
Fatality Costs (\$ Billion, 7% Discount Rate)	0.5	0.5	0.4	0.1	0.1	0.1	0.0	0.0
Non-Fatal Crash Costs (\$ Billion, 3% Discount Rate)	1.2	1.2	0.9	0.2	0.2	0.1	0.1	0.1
Non-Fatal Crash Costs (\$ Billion, 7% Discount Rate)	0.8	0.7	0.6	0.1	0.1	0.1	0.0	0.1
Total Crash Costs (\$ Billion, 3% Discount Rate)	2.0	2.0	1.5	0.4	0.3	0.2	0.1	0.2
Total Crash Costs (\$ Billion, 7% Discount Rate)	1.3	1.2	1.0	0.2	0.2	0.1	0.0	0.1

Table II-50 - Comparison of the Calculated Vehicle-Mass-Related Fatality Impacts over the Lifetime of MY 1977 through MY 2029 Light-Duty Vehicles, by GHG Policy Alternative, Relative to Augural Standards, Fatalities Undiscounted, Dollars Discounted at 3% and 7%

	Alternative							
	#1	#2	#3	#4	#5	#6	#7	#8
Model Years Affected by Policy	2021-2026	2021-2026	2021-2026	2021-2026	2022-2026	2021-2026	2021-2026	2022-2026
Annual Rate of Stringency Increase	0.0%/Year PC 0.0%/Year LT	0.5%/Year PC 0.5%/Year LT	0.5%/Year PC 0.5%/Year LT	1.0%/Year PC 2.0%/Year LT	1.0%/Year PC 2.0%/Year LT	2.0%/Year PC 3.0%/Year LT	2.0%/Year PC 3.0%/Year LT	2.0%/Year PC 3.0%/Year LT
AC/Off-Cycle Procedures	No Change	No Change	Phaseout 2022-2026	No Change	No Change	No Change	Phaseout 2022-2026	No Change
Fatalities	-468	-461	-410	-297	-219	-186	-111	-85
Fatality Costs (\$ Billion, 3% Discount Rate)	-2.9	-2.9	-2.6	-1.9	-1.4	-1.2	-0.7	-0.5
Fatality Costs (\$ Billion, 7% Discount Rate)	-1.7	-1.7	-1.5	-1.1	-0.8	-0.7	-0.5	-0.3
Non-Fatal Crash Costs (\$ Billion, 3% Discount Rate)	-4.6	-4.5	-4.0	-2.9	-2.2	-1.9	-1.1	-0.8
Non-Fatal Crash Costs (\$ Billion, 7% Discount Rate)	-2.7	-2.7	-2.4	-1.7	-1.3	-1.1	-0.7	-0.5
Total Crash Costs (\$ Billion, 3% Discount Rate)	-7.5	-7.4	-6.6	-4.8	-3.5	-3.1	-1.9	-1.4
Total Crash Costs (\$ Billion, 7% Discount Rate)	-4.4	-4.4	-3.9	-2.8	-2.1	-1.9	-1.2	-0.8

Table II-51 - Comparison of the Calculated Vehicle-Mass-Related Fatality Impacts over the Lifetime of MY 1977 through MY 2029 Passenger Cars, by GHG Policy Alternative, Relative to Augural Standards, Fatalities Undiscounted, Dollars Discounted at 3% and 7%

	Alternative							
	#1	#2	#3	#4	#5	#6	#7	#8
Model Years Affected by Policy	2021-2026	2021-2026	2021-2026	2021-2026	2022-2026	2021-2026	2021-2026	2022-2026
Annual Rate of Stringency Increase	0.0%/Year PC 0.0%/Year LT	0.5%/Year PC 0.5%/Year LT	0.5%/Year PC 0.5%/Year LT	1.0%/Year PC 2.0%/Year LT	1.0%/Year PC 2.0%/Year LT	2.0%/Year PC 3.0%/Year LT	2.0%/Year PC 3.0%/Year LT	2.0%/Year PC 3.0%/Year LT
AC/Off-Cycle Procedures	No Change	No Change	Phaseout 2022-2026	No Change	No Change	No Change	Phaseout 2022-2026	No Change
Fatalities	-567	-551	-502	-389	-242	-205	-139	-92
Fatality Costs (\$ Billion, 3% Discount Rate)	-3.6	-3.5	-3.2	-2.5	-1.5	-1.3	-0.9	-0.6
Fatality Costs (\$ Billion, 7% Discount Rate)	-2.1	-2.1	-1.9	-1.5	-0.9	-0.8	-0.6	-0.3
Non-Fatal Crash Costs (\$ Billion, 3% Discount Rate)	-5.6	-5.5	-5.0	-3.9	-2.4	-2.1	-1.4	-0.9
Non-Fatal Crash Costs (\$ Billion, 7% Discount Rate)	-3.3	-3.3	-3.0	-2.3	-1.4	-1.3	-0.9	-0.5
Total Crash Costs (\$ Billion, 3% Discount Rate)	-9.2	-9.0	-8.2	-6.4	-3.9	-3.4	-2.3	-1.5
Total Crash Costs (\$ Billion, 7% Discount Rate)	-5.5	-5.3	-4.9	-3.8	-2.3	-2.0	-1.5	-0.9

Table II-52 - Comparison of the Calculated Vehicle-Mass-Related Fatality Impacts over the Lifetime of MY 1977 through MY 2029 Light Trucks, by GHG Policy Alternative, Relative to Augural Standards, Fatalities Undiscounted, Dollars Discounted at 3% and 7%

	Alternative							
	#1	#2	#3	#4	#5	#6	#7	#8
Model Years Affected by Policy	2021-2026	2021-2026	2021-2026	2021-2026	2022-2026	2021-2026	2021-2026	2022-2026
Annual Rate of Stringency Increase	0.0%/Year PC 0.0%/Year LT	0.5%/Year PC 0.5%/Year LT	0.5%/Year PC 0.5%/Year LT	1.0%/Year PC 2.0%/Year LT	1.0%/Year PC 2.0%/Year LT	2.0%/Year PC 3.0%/Year LT	2.0%/Year PC 3.0%/Year LT	2.0%/Year PC 3.0%/Year LT
AC/Off-Cycle Procedures	No Change	No Change	Phaseout 2022- 2026	No Change	No Change	No Change	Phaseout 2022- 2026	No Change
Fatalities	98	90	91	92	23	19	28	6
Fatality Costs (\$ Billion, 3% Discount Rate)	0.7	0.6	0.6	0.6	0.2	0.1	0.2	0.0
Fatality Costs (\$ Billion, 7% Discount Rate)	0.4	0.4	0.4	0.4	0.1	0.1	0.1	0.0
Non-Fatal Crash Costs (\$ Billion, 3% Discount Rate)	1.0	1.0	1.0	1.0	0.2	0.2	0.3	0.1
Non-Fatal Crash Costs (\$ Billion, 7% Discount Rate)	0.7	0.6	0.6	0.6	0.1	0.1	0.2	0.0
Total Crash Costs (\$ Billion, 3% Discount Rate)	1.7	1.6	1.6	1.6	0.4	0.3	0.5	0.1
Total Crash Costs (\$ Billion, 7% Discount Rate)	1.1	1.0	1.0	1.0	0.2	0.2	0.3	0.0

For all light-duty vehicles, mass changes are estimated to lead to a

decrease in fatalities over the cumulative lifetime of MY 1977-2029

vehicles in all alternatives evaluated. The effects of mass changes on fatalities

range from a combined decrease (relative to the augural standards, the baseline) of 12 fatalities for Alternative #7 to a combined decrease of 173 fatalities for Alternative #4. The difference in results by alternative depends upon how much weight reduction is used in that alternative and the types and sizes of vehicles to which the weight reduction applies. The decreases in fatalities are driven by impacts within passenger cars (decreases of between 17 and 281 fatalities) and are offset by impacts within light trucks (increases of between 6 and 120 fatalities).

Additionally, social effects of increasing fatalities can be monetized using NHTSA's estimated comprehensive cost per life of \$9,900,000 in 2016 dollars. This consists of a value of a statistical life of \$9.6 million in 2015 dollars plus external economic costs associated with fatalities such as medical care, insurance administration costs and legal costs, updated for inflation to 2016 dollars.

Typically, NHTSA would also estimate the effect on injuries and add

that to social costs of fatalities, but in this case NHTSA does not have a model estimating the effect of vehicle mass on injuries. Blincoe *et al.* estimates that fatalities account for 39.5% of total comprehensive costs due to injury.³¹² If vehicle mass impacts non-fatal injuries proportionally to its impact on fatalities, then total costs would be approximately 2.53 (1/.395) times the value of fatalities alone or around \$25.07 million per fatality. NHTSA has selected this value as representative of the relationship between fatality costs and injury costs because this approach is internally consistent among NHTSA studies.

Changes in vehicle mass are estimated to decrease social safety costs over the lifetime of the nine model years by between \$176 million (for Alternative #7) and \$2.7 billion (for Alternative #4)

³¹² Blincoe, L. *et al.*, *The Economic and Social Impact of Motor Vehicle Crashes, 2010 (Revised)*, National Highway Traffic Safety Administration (May 2015), available at <https://crashstats.nhtsa.dot.gov/Api/Public/ViewPublication/812013>. The estimate of 39.5% (see Table 1–8) is equal to the estimated value of MAIS6 (fatal) injuries in vehicle incidents divided by the estimated value of MAIS0–MAIS6 (non-fatal and fatal) injuries in vehicle incidents.

relative to the augural standards at a three-percent discount rate and by between \$97 million and \$1.6 billion at a seven-percent discount rate. The estimated decreases in social safety costs are driven by estimated decreases in costs associated with passenger cars, ranging from \$264 million (for Alternative #7) to \$4.4 billion (for Alternative #1) relative to the Augural standards at a three-percent discount rate and by between \$146 million and \$2.5 billion at a seven-percent discount rate. The estimated decreases in costs associated with passenger cars are offset by estimated increases in costs associated with light trucks, ranging from \$88 million (for Alternative #7) to \$2.0 billion (for Alternative #1) relative to the Augural standards at a three-percent discount rate and by between \$49 million and \$1.3 billion at a seven-percent discount rate.

Table II–53 through Table II–55 presents average annual estimated safety effects of vehicle mass changes, for CYs 2035–2045:

Table II-53 - Comparison of the Calculated Annual Average Vehicle-Mass-Related Fatality Impacts for CY 2035-2045 in Light-Duty Vehicles, by CAFE Policy Alternative, Relative to Augural Standards, Fatalities Undiscounted, Dollars Discounted at 3% and 7%

	Alternative							
	#1	#2	#3	#4	#5	#6	#7	#8
Model Years Affected by Policy	2021-2026	2021-2026	2021-2026	2021-2026	2022-2026	2021-2026	2021-2026	2022-2026
Annual Rate of Stringency Increase	0.0%/Year PC 0.0%/Year LT	0.5%/Year PC 0.5%/Year LT	0.5%/Year PC 0.5%/Year LT	1.0%/Year PC 2.0%/Year LT	1.0%/Year PC 2.0%/Year LT	2.0%/Year PC 3.0%/Year LT	2.0%/Year PC 3.0%/Year LT	2.0%/Year PC 3.0%/Year LT
AC/Off-Cycle Procedures	No Change	No Change	Phaseout 2022-2026	No Change	No Change	No Change	Phaseout 2022-2026	No Change
Fatalities	-22	-19	-17	-17	-16	-6	0	-2
Fatality Costs (\$ Billion, 3% Discount Rate)	-0.11	-0.10	-0.08	-0.08	-0.08	-0.03	0.00	-0.01
Fatality Costs (\$ Billion, 7% Discount Rate)	-0.04	-0.04	-0.03	-0.03	-0.03	-0.01	0.00	0.0
Non-Fatal Crash Costs (\$ Billion, 3% Discount Rate)	-0.17	-0.15	-0.13	-0.13	-0.13	-0.05	0.00	-0.02
Non-Fatal Crash Costs (\$ Billion, 7% Discount Rate)	-0.07	-0.06	-0.05	-0.05	-0.05	-0.02	0.00	0.0
Total Crash Costs (\$ Billion, 3% Discount Rate)	-0.27	-0.24	-0.22	-0.21	-0.21	-0.07	0.00	-0.03
Total Crash Costs (\$ Billion, 7% Discount Rate)	-0.11	-0.10	-0.09	-0.09	-0.09	-0.03	0.00	-0.01

Table II-54 - Comparison of the Calculated Annual Average Vehicle-Mass-Related Fatality Impacts for CY 2035-2045 in Passenger Cars, by CAFE Policy Alternative, Relative to Augural Standards, Fatalities Undiscounted, Dollars Discounted at 3% and 7%

	Alternative							
	#1	#2	#3	#4	#5	#6	#7	#8
Model Years Affected by Policy	2021-2026	2021-2026	2021-2026	2021-2026	2022-2026	2021-2026	2021-2026	2022-2026
Annual Rate of Stringency Increase	0.0%/Year PC 0.0%/Year LT	0.5%/Year PC 0.5%/Year LT	0.5%/Year PC 0.5%/Year LT	1.0%/Year PC 2.0%/Year LT	1.0%/Year PC 2.0%/Year LT	2.0%/Year PC 3.0%/Year LT	2.0%/Year PC 3.0%/Year LT	2.0%/Year PC 3.0%/Year LT
AC/Off-Cycle Procedures	No Change	No Change	Phaseout 2022-2026	No Change	No Change	No Change	Phaseout 2022-2026	No Change
Fatalities	-33	-31	-27	-20	-18	-8	-1	-3
Fatality Costs (\$ Billion, 3% Discount Rate)	-0.17	-0.15	-0.13	-0.10	-0.09	-0.04	0.00	-0.02
Fatality Costs (\$ Billion, 7% Discount Rate)	-0.07	-0.06	-0.05	-0.04	-0.04	-0.02	0.00	-0.01
Non-Fatal Crash Costs (\$ Billion, 3% Discount Rate)	-0.26	-0.24	-0.21	-0.16	-0.14	-0.06	-0.01	-0.02
Non-Fatal Crash Costs (\$ Billion, 7% Discount Rate)	-0.11	-0.10	-0.09	-0.06	-0.06	-0.02	0.00	-0.01
Total Crash Costs (\$ Billion, 3% Discount Rate)	-0.42	-0.39	-0.34	-0.26	-0.23	-0.10	-0.01	-0.04
Total Crash Costs (\$ Billion, 7% Discount Rate)	-0.18	-0.16	-0.14	-0.11	-0.09	-0.04	-0.01	-0.02

Table II-55 - Comparison of the Calculated Annual Average Vehicle-Mass-Related Fatality Impacts for CY 2035-2045 in Light Trucks, by CAFE Policy Alternative, Relative to Auggural Standards, Fatalities Undiscounted, Dollars Discounted at 3% and 7%

	Alternative							
	#1	#2	#3	#4	#5	#6	#7	#8
Model Years Affected by Policy	2021-2026	2021-2026	2021-2026	2021-2026	2022-2026	2021-2026	2021-2026	2022-2026
Annual Rate of Stringency Increase	0.0%/Year PC 0.0%/Year LT	0.5%/Year PC 0.5%/Year LT	0.5%/Year PC 0.5%/Year LT	1.0%/Year PC 2.0%/Year LT	1.0%/Year PC 2.0%/Year LT	2.0%/Year PC 3.0%/Year LT	2.0%/Year PC 3.0%/Year LT	2.0%/Year PC 3.0%/Year LT
AC/Off-Cycle Procedures	No Change	No Change	Phaseout 2022-2026	No Change	No Change	No Change	Phaseout 2022-2026	No Change
Fatalities	12	11	10	4	2	2	1	1
Fatality Costs (\$ Billion, 3% Discount Rate)	0.06	0.06	0.05	0.02	0.01	0.01	0.00	0.01
Fatality Costs (\$ Billion, 7% Discount Rate)	0.02	0.02	0.02	0.01	0.00	0.00	0.00	0.00
Non-Fatal Crash Costs (\$ Billion, 3% Discount Rate)	0.09	0.09	0.08	0.03	0.01	0.01	0.01	0.01
Non-Fatal Crash Costs (\$ Billion, 7% Discount Rate)	0.04	0.04	0.03	0.01	0.01	0.01	0.00	0.00
Total Crash Costs (\$ Billion, 3% Discount Rate)	0.15	0.15	0.12	0.05	0.02	0.02	0.01	0.01
Total Crash Costs (\$ Billion, 7% Discount Rate)	0.06	0.06	0.05	0.02	0.01	0.01	0.00	0.01

Table II-56 - Comparison of the Calculated Annual Average Vehicle-Mass-Related Fatality Impacts for CY 2035-2045 in Light-Duty Vehicles, by GHG Policy Alternative, Relative to Augural Standards, Fatalities Undiscounted, Dollars Discounted at 3% and 7%

	Alternative							
	#1	#2	#3	#4	#5	#6	#7	#8
Model Years Affected by Policy	2021-2026	2021-2026	2021-2026	2021-2026	2022-2026	2021-2026	2021-2026	2022-2026
Annual Rate of Stringency Increase	0.0%/Year PC 0.0%/Year LT	0.5%/Year PC 0.5%/Year LT	0.5%/Year PC 0.5%/Year LT	1.0%/Year PC 2.0%/Year LT	1.0%/Year PC 2.0%/Year LT	2.0%/Year PC 3.0%/Year LT	2.0%/Year PC 3.0%/Year LT	2.0%/Year PC 3.0%/Year LT
AC/Off-Cycle Procedures	No Change	No Change	Phaseout 2022-2026	No Change	No Change	No Change	Phaseout 2022-2026	No Change
Fatalities	-56	-52	-42	-34	-15	-13	-8	-5
Fatality Costs (\$ Billion, 3% Discount Rate)	-0.27	-0.25	-0.21	-0.17	-0.08	-0.07	-0.04	-0.02
Fatality Costs (\$ Billion, 7% Discount Rate)	-0.11	-0.11	-0.09	-0.07	-0.03	-0.03	-0.02	-0.01
Non-Fatal Crash Costs (\$ Billion, 3% Discount Rate)	-0.43	-0.40	-0.32	-0.26	-0.12	-0.11	-0.06	-0.04
Non-Fatal Crash Costs (\$ Billion, 7% Discount Rate)	-0.18	-0.16	-0.13	-0.11	-0.05	-0.04	-0.03	-0.02
Total Crash Costs (\$ Billion, 3% Discount Rate)	-0.70	-0.65	-0.53	-0.43	-0.19	-0.17	-0.10	-0.06
Total Crash Costs (\$ Billion, 7% Discount Rate)	-0.29	-0.27	-0.22	-0.18	-0.08	-0.07	-0.04	-0.02

Table II-57 - Comparison of the Calculated Annual Average Vehicle-Mass-Related Fatality Impacts for CY 2035-2045 in Passenger Cars, by GHG Policy Alternative, Relative to Augural Standards, Fatalities Undiscounted, Dollars Discounted at 3% and 7%

	Alternative							
	#1	#2	#3	#4	#5	#6	#7	#8
Model Years Affected by Policy	2021-2026	2021-2026	2021-2026	2021-2026	2022-2026	2021-2026	2021-2026	2022-2026
Annual Rate of Stringency Increase	0.0%/Year PC 0.0%/Year LT	0.5%/Year PC 0.5%/Year LT	0.5%/Year PC 0.5%/Year LT	1.0%/Year PC 2.0%/Year LT	1.0%/Year PC 2.0%/Year LT	2.0%/Year PC 3.0%/Year LT	2.0%/Year PC 3.0%/Year LT	2.0%/Year PC 3.0%/Year LT
AC/Off-Cycle Procedures	No Change	No Change	Phaseout 2022- 2026	No Change	No Change	No Change	Phaseout 2022- 2026	No Change
Fatalities	-65	-61	-53	-39	-20	-16	-11	-8
Fatality Costs (\$ Billion, 3% Discount Rate)	-0.32	-0.30	-0.26	-0.19	-0.10	-0.08	-0.06	-0.04
Fatality Costs (\$ Billion, 7% Discount Rate)	-0.13	-0.12	-0.11	-0.08	-0.04	-0.03	-0.02	-0.02
Non-Fatal Crash Costs (\$ Billion, 3% Discount Rate)	-0.50	-0.47	-0.41	-0.30	-0.15	-0.12	-0.09	-0.06
Non-Fatal Crash Costs (\$ Billion, 7% Discount Rate)	-0.21	-0.19	-0.17	-0.12	-0.06	-0.05	-0.04	-0.02
Total Crash Costs (\$ Billion, 3% Discount Rate)	-0.82	-0.77	-0.67	-0.49	-0.25	-0.20	-0.14	-0.10
Total Crash Costs (\$ Billion, 7% Discount Rate)	-0.41	-0.37	-0.25	-0.38	-0.23	-0.49	-0.33	-0.44

Table II-58 - Comparison of the Calculated Annual Average Vehicle-Mass-Related Fatality Impacts for CY 2035-2045 in Light Trucks, by GHG Policy Alternative, Relative to Auggural Standards, Fatalities Undiscounted, Dollars Discounted at 3% and 7%

	Alternative							
	#1	#2	#3	#4	#5	#6	#7	#8
Model Years Affected by Policy	2021-2026	2021-2026	2021-2026	2021-2026	2022-2026	2021-2026	2021-2026	2022-2026
Annual Rate of Stringency Increase	0.0%/Year PC 0.0%/Year LT	0.5%/Year PC 0.5%/Year LT	0.5%/Year PC 0.5%/Year LT	1.0%/Year PC 2.0%/Year LT	1.0%/Year PC 2.0%/Year LT	2.0%/Year PC 3.0%/Year LT	2.0%/Year PC 3.0%/Year LT	2.0%/Year PC 3.0%/Year LT
AC/Off-Cycle Procedures	No Change	No Change	Phaseout 2022-2026	No Change	No Change	No Change	Phaseout 2022-2026	No Change
Fatalities	10	9	10	5	5	2	3	3
Fatality Costs (\$ Billion, 3% Discount Rate)	0.05	0.05	0.05	0.02	0.02	0.01	0.02	0.02
Fatality Costs (\$ Billion, 7% Discount Rate)	0.02	0.02	0.02	0.01	0.01	0.00	0.01	0.01
Non-Fatal Crash Costs (\$ Billion, 3% Discount Rate)	0.08	0.07	0.08	0.04	0.04	0.02	0.03	0.02
Non-Fatal Crash Costs (\$ Billion, 7% Discount Rate)	0.03	0.03	0.03	0.02	0.01	0.01	0.01	0.01
Total Crash Costs (\$ Billion, 3% Discount Rate)	0.12	0.12	0.14	0.06	0.06	0.03	0.04	0.04
Total Crash Costs (\$ Billion, 7% Discount Rate)	0.05	0.05	0.06	0.03	0.02	0.01	0.02	0.02

For all light-duty vehicles, mass changes are estimated to lead to an

average annual decrease in fatalities in all alternatives evaluated for CYs 2035-

2045. The effects of mass changes on fatalities range from a combined

decrease (relative to the Augural standards) of 1 fatality per year for Alternative #7 to a combined increase of 22 fatalities per year for Alternative #1. The difference in the results by alternative depends upon how much weight reduction is used in that alternative and the types and sizes of vehicles to which the weight reduction applies. The decreases in fatalities are generally driven by impacts within passenger cars (decreases of between 1 and 33 fatalities per year relative to the Augural standards) and are generally offset by impacts within light trucks (increases of between 1 and 12 fatalities per year).

Changes in vehicle mass are estimated to decrease average annual social safety

costs in CY 2035–2045 by between \$2 million (for Alternative #7) and \$271 million (for Alternative #1) relative to the Augural standards at a three-percent discount rate and by between \$1 million and \$111 million at a seven-percent discount rate. The estimated decreases in social safety costs are generally driven by estimated decreases in costs associated with passenger cars, decreasing between \$13 million (for Alternative #7) and \$424 million (for Alternative #1) relative to the Augural standards at a three-percent discount rate and decreasing between \$5 million and \$175 million at a seven-percent discount rate. The estimated decreases in costs associated with passenger cars are generally offset by estimated

increases in costs associated with light trucks, decreasing between \$11 million (for Alternative #7) and \$153 million (for Alternative #1) relative to the Augural standards at a three-percent discount rate and decreasing between \$5 million and \$64 million at a seven-percent discount rate.

To help illuminate effects at the model year level, Table II–59 presents the lifetime fatality impacts associated with vehicle mass changes for passenger cars, light trucks, and all light-duty vehicles by model year under Alternative #1, relative to the Augural standards for the CAFE Program. Table II–59 presents an analogous table for the GHG Program.

Table II-59 - Comparison of Lifetime Vehicle-Mass-Related Fatality Impacts by Model Year for CAFE Program under Alternative #1, Relative to Augural Standards, Fatalities Undiscounted

	MY 1977 - 2016	MY 2017	MY 2018	MY 2019	MY 2020	MY 2021	MY 2022	MY 2023	MY 2024	MY 2025	MY 2026	MY 2027	MY 2028	MY 2029	TOTAL
Passenger Cars	-2	-3	-2	-3	-5	-11	-16	-29	-30	-37	-35	-35	-36	-36	-280
Light Trucks	-2	-1	-1	3	2	11	13	12	13	12	14	14	14	14	118
Total	-3	-3	-3	0	-3	1	-3	-16	-17	-24	-23	-22	-22	-22	-160

Table II-60 - Comparison of Lifetime Vehicle-Mass-Related Fatality Impacts by Model Year for GHG Program under Alternative #1, Relative to Augural Standards, Fatalities Undiscounted

	MY 1977 - 2016	MY 2017	MY 2018	MY 2019	MY 2020	MY 2021	MY 2022	MY 2023	MY 2024	MY 2025	MY 2026	MY 2027	MY 2028	MY 2029	TOTAL
Passenger Cars	-2	-4	-9	-10	-22	-29	-37	-49	-57	-60	-68	-74	-75	-72	-568
Light Trucks	-2	-1	0	1	2	10	13	11	12	13	11	7	9	11	97
Total	-5	-4	-10	-9	-20	-19	-24	-38	-45	-47	-57	-66	-65	-60	-469

Under Alternative #1, passenger car fatalities associated with mass changes are estimated to decrease generally from MY 2017 (decrease of three fatalities) through MY 2029 (decrease of 36

fatalities), peaking in MY 2025 (37 fatalities). Corresponding estimates of light truck fatalities associated with mass changes are generally positive, ranging from a decrease of one fatality

in MYs 2017 and 2018 to an increase of 14 fatalities in MYs 2026 through 2029. Altogether, light-duty vehicle fatality reductions associated with mass changes under Alternative #1 are

estimated to be concentrated among MY 2023 through MY 2029 vehicles (146 out of 165, or 91% of net fatalities mitigated).

Table II-61 and Table II-62 present estimates of monetized lifetime social safety costs associated with mass changes by model year at three-percent and seven-percent discount rates,

respectively for the CAFE Program. Table II-63 and Table II-64 show comparable tables from the perspective of the GHG Program.

Table II-61 - Comparison of Lifetime Social Safety Costs Associated with Mass Changes for CAFE Program by Model Year under Alternative #1, Relative to Augural Standards, Dollars Discounted at 3%

	MY 1977- 2016	MY 2017	MY 2018	MY 2019	MY 2020	MY 2021	MY 2022	MY 2023	MY 2024	MY 2025	MY 2026	MY 2027	MY 2028	MY 2029	TOTAL
Passenger Cars	-0.01	-0.02	-0.02	-0.01	-0.03	-0.07	-0.11	-0.19	-0.20	-0.23	-0.22	-0.21	-0.21	-0.20	-1.73
Light Trucks	-0.01	0.00	-0.01	0.02	0.02	0.08	0.10	0.08	0.09	0.08	0.08	0.09	0.09	0.08	0.79
Total	-0.02	-0.02	-0.02	0.01	-0.01	0.01	-0.01	-0.10	-0.11	-0.15	-0.14	-0.13	-0.13	-0.12	-0.94

Table II-62 - Comparison of Lifetime Social Safety Costs Associated with Mass Changes for CAFE Program by Model Year under Alternative #1, Relative to Augural Standards, Dollars Discounted at 7%

	MY 1977- 2016	MY 2017	MY 2018	MY 2019	MY 2020	MY 2021	MY 2022	MY 2023	MY 2024	MY 2025	MY 2026	MY 2027	MY 2028	MY 2029	TOTAL
Passenger Cars	-0.01	-0.01	-0.01	-0.01	-0.02	-0.04	-0.07	-0.12	-0.12	-0.14	-0.13	-0.12	-0.11	-0.10	-0.99
Light Trucks	0.00	0.00	0.00	0.02	0.02	0.06	0.06	0.06	0.05	0.05	0.05	0.05	0.05	0.04	0.49
Total	-0.01	-0.01	-0.01	0.01	0.00	0.01	0.00	-0.06	-0.07	-0.09	-0.08	-0.07	-0.06	-0.06	-0.50

Table II-63 - Comparison of Lifetime Social Safety Costs Associated with Mass Changes for GHG Program by Model Year under Alternative #1, Relative to Augural Standards, Dollars Discounted at 3%

	MY 1977- 2016	MY 2017	MY 2018	MY 2019	MY 2020	MY 2021	MY 2022	MY 2023	MY 2024	MY 2025	MY 2026	MY 2027	MY 2028	MY 2029	TOTAL
Passenger Cars	-0.01	-0.03	-0.06	-0.07	-0.16	-0.20	-0.25	-0.33	-0.37	-0.38	-0.42	-0.44	-0.44	-0.41	-3.59
Light Trucks	-0.01	0.00	0.00	0.01	0.02	0.07	0.09	0.08	0.08	0.08	0.07	0.05	0.06	0.07	0.67
Total	-0.02	-0.03	-0.07	-0.06	-0.14	-0.13	-0.16	-0.25	-0.29	-0.30	-0.35	-0.40	-0.38	-0.34	-2.92

Table II-64 - Comparison of Lifetime Social Safety Costs Associated with Mass Changes for GHG Program by Model Year under Alternative #1, Relative to Augural Standards, Dollars Discounted at 7%

	MY 1977- 2016	MY 2017	MY 2018	MY 2019	MY 2020	MY 2021	MY 2022	MY 2023	MY 2024	MY 2025	MY 2026	MY 2027	MY 2028	MY 2029	TOTAL
Passenger Cars	-0.01	-0.02	-0.05	-0.05	-0.11	-0.14	-0.17	-0.21	-0.23	-0.23	-0.24	-0.25	-0.23	-0.21	-2.13
Light Trucks	0.00	0.00	0.00	0.01	0.02	0.05	0.06	0.05	0.05	0.05	0.04	0.03	0.03	0.03	0.43
Total	-0.01	-0.02	-0.05	-0.04	-0.10	-0.08	-0.10	-0.16	-0.18	-0.18	-0.20	-0.22	-0.20	-0.17	-1.70

Lifetime social safety costs are estimated to decrease generally by

model year, with decreases associated with passenger cars generally offset

partially by increases associated with light trucks. At a three-percent discount

rate, decreases in lifetime social safety costs related to passenger cars are estimated to range from \$13 million for existing (MY 1977 through MY 2016) cars, to \$230 million for MY 2025 cars. The corresponding estimates at a seven-percent discount rate range from \$7 million to \$136 million. At a three-percent discount rate, impacts on lifetime social safety costs related to light trucks are estimated to range from a decrease of \$5 million for MY 2017 light trucks to an increase of \$96 million for MY 2022 light trucks. The corresponding estimates at a seven-percent discount rate range from \$3 million to \$65 million.

Consistent with the analysis of fatality impacts by model year in Table II-61, decreases in lifetime social safety costs associated with mass changes are generally concentrated in MY 2023 through MY 2029 light-duty vehicles under Alternative #1. At a three-percent discount rate, 93% of the reduction in total lifetime costs (\$872 million out of \$937 million) is attributed to MY 2023 through MY 2029 light-duty vehicles; at

a seven-percent discount rate, 97% of the reduction in total lifetime costs (\$486 million out of \$501 million) is attributed to MY 2023 through MY 2029 light-duty vehicles.

(e) Sensitivity Analyses

Table II-65 shows the principal findings and includes sampling-error confidence bounds for the five parameters used in the CAFE model. The confidence bounds represent the statistical uncertainty that is a consequence of having less than a census of data. NHTSA's 2011, 2012, and 2016 reports acknowledged another source of uncertainty: The baseline statistical model can be varied by choosing different control variables or redefining the vehicle classes or crash types, which for example, could produce different point estimates.

Beginning with the 2012 Kahane report, NHTSA has provided results of 11 plausible alternative models that serve as sensitivity tests of the baseline model. Each alternative model was tested or proposed by: Farmer (IIHS) or

Green (UMTRI) in their peer reviews; Van Auken (DRI) in his public comments; or Wenzel in his parallel research for DOE. The 2012 Kahane and 2016 Puckett and Kindelberger reports provide further discussion of the models and the rationales behind them.

Alternative models use NHTSA's databases and regression-analysis approach but differ from the baseline model in one or more explanatory variables, assumptions, or data restrictions. NHTSA applied the 11 techniques to the latest databases to generate alternative CAFE model coefficients. The range of estimates produced by the sensitivity tests offers insight to the uncertainty inherent in the formulation of the models, subject to the caveat these 11 tests are, of course, not an exhaustive list of conceivable alternatives.

The baseline and alternative results follow, ordered from the lowest to the highest estimated increase in societal risk per 100-pound reduction for cars weighing less than 3,201 pounds:

Table II-65 - Fatality Increase (%) Per 100-Pound Mass Reduction While Holding Footprint* Constant

		Cars	Cars	CUVs &	LTVs†	LTVs†
		< 3,201	≥ 3,201	Minivans	< 5,104	≥ 5,104
Baseline Estimate		1.2	0.42	-0.25	0.31	-0.61
95% confidence bounds	Lower:	-0.35	-0.67	-1.55	-0.51	-1.46
(sampling error)	Upper:	2.75	1.5	1.04	1.13	0.25
11 Alternative Models						
1. Without CY control variables		0.26	-0.07	-0.58	0.35	-0.24
2. By track width & wheelbase		0.66	0.54	-0.48	-0.44	-0.90
3. Track width/wheelbase w. stopped veh data		0.73	-0.02	-0.18	-0.77	-1.91
4. Without non-significant control variables		0.98	0.26	0.14	0.36	-0.50
5. With stopped-vehicle State data		1.32	-0.17	-0.08	0.21	-1.55
6. CUVs/minivans weighted by 2010 sales		1.2	0.42	-0.06	0.31	-0.61
7. Including muscle/police/AWD cars/big vans		1.56	1.01	-0.25	0.87	0.43
8. Limited to drivers with BAC=0		1.72	1.33	0.01	0.35	-0.74
9. Control for vehicle manufacturer		2.09	1.51	-0.01	1.12	0.3
10. Limited to good drivers‡		2.15	1.8	-0.33	0.4	-0.45
11. Control for vehicle manufacturer/nameplate		2.26	2.7	-0.55	1.13	0.50

*While holding track width and wheelbase constant (rather than footprint) in alternative model nos. 2 and 3.

†Excluding CUVs and minivans.

‡BAC=0, no drugs, valid license, at most one crash and one violation during the past three years.

For example, in cars weighing less than 3,201 pounds, the baseline estimate associates 100- pound mass reduction, while holding footprint constant, with a 1.56% increase in societal fatality risk. The corresponding estimates for the 11 sensitivity tests range from a 0.26 to a 2.15% increase.

The sensitivity tests illustrate both the fragility and the robustness of baseline estimates. On the one hand, the variation among NHTSA's coefficients is quite large relative to the baseline estimate: In the preceding example of cars < 3,201 pounds, the estimated coefficients range from almost zero to almost double the baseline estimate. This result underscores the key relationship that the societal effect of mass reduction is small and, as Wenzel has said, it "is overwhelmed by other known vehicle, driver, and crash factors."³¹³ In other words, varying how to model some of these other vehicle, driver, and crash factors, which is exactly what sensitivity tests do, can appreciably change the estimate of the societal effect of mass reduction.

On the other hand, variations are not particularly large in absolute terms. The ranges of alternative estimates are generally in line with the sampling-error confidence bounds for the baseline estimates. Generally, in alternative models as in the baseline models, mass reduction tends to be relatively more harmful in the lighter vehicles and more beneficial in the heavier vehicles, just as they are in the central analysis. In all models, the point estimate of NHTSA's coefficient is positive for the lightest vehicle class, cars < 3,201 pounds. In nine out of 11 models, the point estimate is negative for CUVs and minivans, and in eight out of 11 models the point estimate is negative for LTVs ≥ 5,014 pounds.

(f) Fleet Simulation Model

NHTSA has traditionally used real world crash data as the basis for projecting the future safety implications for regulatory changes. However, because lightweight vehicle designs are introducing fundamental changes to the structure of the vehicle, there is some concern that historical safety trends may not apply. To address this concern, NHTSA developed an approach to utilize lightweight vehicle designs to evaluate safety in a subset of real-world representative crashes. The methodology focused on frontal crashes because of the availability of existing vehicle and occupant restraint models. Representative crashes were simulated between baseline and lightweight vehicles against a range of vehicles and roadside objects using two different size belted driver occupants (adult male and small female) only. No passenger(s) or

unbelted driver occupants were considered in this fleet simulation. The occupant injury risk from each simulation was calculated and summed to obtain combined occupant injury risk. The combined occupant injury risk was weighted according to the frequency of real world occurrences to develop overall societal risk for baseline and light-weighted vehicles. Note: The generic restraint system developed and used in the baseline occupant simulations was also used in the light-weighted vehicle occupant simulations as the purpose of this fleet simulation was to understand changes in societal injury risks because of mass reduction for different classes of vehicles in frontal crashes. No modifications to the restraint systems were made for light-weighted vehicle occupant simulations. Any modifications to restraint systems to improve occupant injury risks or societal injury risks in the light-weighted vehicle would have conflated results without identifying effects of mass reduction only. The following sections provide an overview of the fleet simulation study:

NHTSA contracted with George Washington University to develop a fleet simulation model³¹⁴ to study the impact and relationship of light-weighted vehicle design with injuries and fatalities. In this study, there were eight vehicles as follows:

- 2001 model year Ford Taurus finite element model baseline and two simple design variants included a 25% lighter vehicle while maintaining the same vehicle front end stiffness and 25% overall stiffer vehicle while maintaining the same overall vehicle mass.³¹⁵
- 2011 model year Honda Accord finite element baseline vehicle and its 20% light-weight vehicle designed by Electricore. (This mass reduction study was sponsored by NHTSA).³¹⁶

³¹⁴ Samaha, R. R. *et al.*, *Methodology for Evaluating Fleet Protection of New Vehicle Designs: Application to Lightweight Vehicle Designs*, National Highway Traffic Safety Administration (Aug. 2014), available at <https://www.nhtsa.gov/crashworthiness/vehicle-aggressivity-and-fleet-compatibility-research> (accessed by clicking on the .zip file for DOT HS 812 051).

³¹⁵ Samaha, R. R. *et al.*, *Methodology for Evaluating Fleet Protection of New Vehicle Designs: Application to Lightweight Vehicle Designs, appendices*, National Highway Traffic Safety Administration (Aug. 2014), available at <https://www.nhtsa.gov/crashworthiness/vehicle-aggressivity-and-fleet-compatibility-research> (accessed by clicking on the .zip file for DOT HS 812 051 [appendices are Part 2]).

³¹⁶ Singh, H. *et al.*, *Update to future midsize lightweight vehicle findings in response to manufacturer review and IIHS small-overlap testing*, National Highway Traffic Safety Administration (Feb. 2016), available at https://www.nhtsa.gov/sites/nhtsa.dot.gov/files/812237_lightweightvehiclereport.pdf.

- 2009/2010 model year Toyota Venza finite element baseline vehicle and two design variants included a 20% light-weight vehicle model (2010 Venza) (Low option mass reduction vehicle funded by EPA and International Council on Clean Transportation (ICCT)) and a 35% light-weight vehicle (2009 Venza) (High option mass reduction vehicle funded by California Air Resources Board).³¹⁷

Light weight vehicles were designed to have similar vehicle crash pulses as baseline vehicles. More than 440 vehicle crash simulations were conducted for the range of crash speeds and crash configurations to generate crash pulse and intrusion data points. The crash pulse data and intrusion data points will be used as inputs in the occupant simulation models.

For vehicle to vehicle impact simulations, four finite element models were chosen to represent the fleet. The partner vehicle models were selected to represent a range of vehicle types and weights. It was assumed vehicle models would reflect the crash response for all vehicles of the same type, *e.g.* mid-size car. Only the safety or injury risk for the driver in the target vehicle and in the partner vehicle were evaluated in this study.

As noted, vehicle simulations generated vehicle deformations and acceleration responses utilized to drive occupant restraint simulations and predict the risk of injury to the head, neck, chest, and lower extremities. In all, more than 1,520 occupant restraint simulations were conducted to evaluate the risk of injury for mid-size male and small female drivers.

The computed societal injury risk (SIR) for a target vehicle *v* in frontal crashes is an aggregate of individual serious crash injury risks weighted by real-world frequency of occurrence (*v*) of a frontal crash incident. A crash incident corresponds to a crash with different partners (Npartner) at a given impact speed (Pspeed), for a given driver occupant size (Loccsize), in the target or partner vehicle (T/P), in a given crash configuration (Mconfig), and in a single- or two-vehicle crash (Kevent). CIR (*v*) represents the combined injury risk (by body region) in a single crash incident. (*v*) designates the weighting factor, *i.e.*, percent of occurrence, derived from National Automotive Sampling System Crashworthiness Data System (NASS CDS) for the crash incident. A driver age group of 16 to 50

³¹⁷ *Light-Duty Vehicle Mass Reduction and Cost Analysis — Midsize Crossover Utility Vehicle*, U.S. EPA (Aug. 2012), https://cfpub.epa.gov/si/si_public_record_report.cfm?dirEntryID=230748.

³¹³ Wenzel, T. *Assessment of NHTSA's Report "Relationships Between Fatality Risk, Mass, and Footprint in Model Year 2000–2007 Passenger Cars and LTVs,"* Lawrence Berkeley National Laboratory and iv (Nov. 2011), available at Docket ID NHTSA–2010–0152–0026.

years old was chosen to provide a population with a similar, *i.e.*, more consistent, injury tolerance.

The fleet simulation was performed using the best available engineering models, with base vehicle restraint and airbag settings, to estimate societal risks of future lightweight vehicles. The range of the predicted risks for the baseline vehicles is from 1.25% to 1.56%, with an average of 1.39%, for the NASS frontal crashes that were simulated. The change in driver injury risk between the baseline and light-weighted vehicles

will provide insight into the estimate of modification needed in the restraint and airbag systems of lightweight vehicles. If the difference extends beyond the expected baseline vehicle restraint and airbag capability, then adjustments to the structural designs would be needed. Results from the fleet simulation study show the trend of increased societal injury risk for light-weighted vehicle designs, as compared to their baselines, occurs for both single vehicle and two-vehicle crashes. Results are listed in Table II-66.

In general, the societal injury risk in the frontal crash simulation associated with the small size driver is elevated when compared to that of the mid-size driver. However, both occupant sizes had reasonable injury risk in the simulated impact configurations representative of the regulatory and consumer information testing. NHTSA examined three methods for combining injuries with different body regions. One observation was the baseline mid-size CUV model was more sensitive to leg injuries.

Table II-66 - Overall Societal Risk Calculation Results for Model Runs, with Base Vehicle Restraint and Airbag Settings Being the same for All Vehicles, in Frontal Crash Only

Target Vehicle	Passenger Car Baseline	Passenger Car LW	CUV Baseline	CUV Low Option	CUV High Option
Weight (lbs)	3681	2964	3980	3313	2537
reduction		716		668	1444
% mass reduction		19%		17%	36%
Societal Risk I	1.56%	1.73%	1.36%	1.46%	1.57%
Delta Increase		0.17%		0.10%	0.21%
Societal Risk II	1.43%	1.57%	1.14%	1.20%	1.30%
Delta Increase		0.14%		0.06%	0.16%
Societal Risk IIP	1.44%	1.59%			
Delta Increase		0.15%			
Societal Risk I - Target + Partner Combined AIS3+ risk of Head, Neck, Chest & Femur					
Societal Risk II - Target + Partner Combined AIS3+ risk of Head, Neck, and Chest					
Societal Risk IIP - Target + Partner Combined AIS3+ risk of Head, Neck, and Chest with A-Pillar Intrusion Penalty					

This study only looked at lightweight designs for a midsize sedan and a mid-size CUV and did not examine safety implications for heavier vehicles. The study was also limited to only frontal crash configurations and considered just mid-size CUVs whereas the statistical regression model considered all CUVs and all crash modes.

The change in the safety risk from the MY 2010 fleet simulation study was directionally consistent with results for passenger cars from NHTSA 2012 regression analysis study,³¹⁸ which covered data for MY 2000–MY 2007. The NHTSA 2012 regression analysis study was updated in 2016 to reflect newer MY 2003 to MY 2010. Comparing

the fleet simulation societal risk to the 2016 update of the NHTSA 2012 regression analysis and the updated analysis used in this NPRM, the risk assessment from the fleet simulation is similarly directionally consistent with the passenger car risk assessment from the regression analysis. As noted, fleet simulations were performed only in frontal crash mode and did not consider other crash modes including rollover crashes.³¹⁹

This fleet simulation study does not provide information that can be used to modify coefficients derived for the NPRM regression analysis because of the restricted types of crashes³²⁰ and

vehicle designs. As explained earlier, the fleet simulation study assumed restraint equipment to be as in the baseline model, in which restraints/airbags are not redesigned to be optimal with light-weighting.

2. Impact of Vehicle Scrappage and Sales Response on Fatalities

Previous versions of the CAFE model, and the accompanying regulatory analyses relying on it, did not carry a representation of the full on-road vehicle population, only those vehicles from model years regulated under proposed (or final) standards. The omission of an on-road fleet implicitly assumed the population of vehicles registered at the time a set of CAFE standards is promulgated is not affected by those standards. However, there are several mechanisms by which CAFE standards can affect the existing vehicle

³¹⁸ The 2012 Kahane study considered only fatalities, whereas, the fleet simulation study considered severe (AIS 3+) injuries and fatalities (DOT HS 811 665).

³¹⁹ The risk assessment for CUV in the regression model combined CUVs and minivans in all crash modes and included belted and unbelted occupants.

³²⁰ The fleet simulation considered only frontal crashes.

population. The most significant of these is deferred retirement of older vehicles. CAFE standards force manufacturers to apply fuel saving technologies to offered vehicles and then pass along the cost of those technologies (to the extent possible) to buyers of new vehicles. These price increases affect the length of loan terms and the desired length of ownership for new vehicle buyers and can discourage some buyers on the margin from buying a new vehicle in a given year. To the extent new vehicle purchases offset pending vehicle retirements, delaying new purchases in favor of continuing to use an aging vehicle affects the overall safety of the on-road fleet even if the vehicle whose retirement was delayed was not directly subject to a binding CAFE standard in the model year during its production.

The sales response in the CAFE model acts to modify new vehicle sales in two ways:

1. Changes in new vehicle prices either increase or decrease total sales (passenger cars and light trucks combined) each year in the context of forecasted macroeconomic conditions.

2. Changes in new vehicle attributes and fuel prices influence the share of new vehicles sold that are light trucks, and therefore also passenger cars.

These two responses change the total number of new vehicles sold in each model year across regulatory alternatives and the relative proportion of new vehicles that are passenger cars and light trucks. This response has two effects on safety. The first response slows the rate at which new vehicles, and their associated safety improvements, enter the on-road population. The second response influences the mix of vehicles on the road—with more stringent CAFE standards leading to a higher share of light trucks sold in the new vehicle market, assuming all else is equal. Light trucks have higher rates of fatal crashes when interacting with passenger cars and, as earlier sections discussed, different directional responses to mass reduction technology based on the existing mass and body style of the vehicle.

The sales response and scrappage response influence safety outcomes through the same basic mechanism, fleet turnover. In the case of the scrappage response, delaying fleet turnover keeps drivers in older vehicles likely to be less safe than newer model year vehicles that could replace them. Similarly, delaying the sale of new vehicles can force households to keep older vehicles in use longer, reallocate VMT within their household fleet, and generally

meet travel demand through the use of older, less safe vehicles. As an illustration, if we simplify by ignoring that the share of new vehicles that are passenger cars changes with the stringency of the alternatives, simply changing the number of new vehicles between scenarios affects the mileage accumulation of the fleet and therefore all fleet level effects. Reducing the number of new vehicles sold, relative to a baseline forecasted value, reduces the size of the registered vehicle fleet that is able to service the underlying demand for travel.

Consider a simple example where we show sales effects operating on a micro-scale for a single household whose choices of whether to purchase a new vehicle is affected by vehicle price. A household starts with three vehicles, aged three, five, and eight years old. In a scenario with no CAFE standards and therefore no related changes in vehicle sales prices, the household buys a new car and scraps the eight-year old car; the other two cars in the fleet each get a year older. In a scenario where CAFE standards become more stringent causing vehicle sales prices to increase, this household chooses to delay buying a new car and each of their three existing cars gets a year older. In both cases, all three vehicles (including the new car in the first scenario, and the year-year-old car in the second scenario) have to serve the family's travel demand.

The scrappage effect is visible in the household's vehicle fleet as it moves from the first scenario to the second scenario with changes in CAFE standards. In the second scenario, the nine-year-old car remains in the household's fleet to service demand for travel, when it would otherwise have been retired. While the scrappage effect can be symmetrical to the sales effect, it need not be. The "new car" in the scenario without CAFE standards could be a new vehicle from the current model year or a used car that is of a newer vintage than the 8-year-old vehicle it replaces. The latter instance is an effect of scrappage decisions that do not directly affect new vehicle sales. Eventually, new vehicles transition to the used car market, but that on average take several years, and the shift is slow. At the household level, the scrappage decision occurs in a single year, each year, for every vehicle in the fleet. To the extent CAFE standards affect new vehicle prices and fuel economies, relative to vehicles already owned, scrappage could accelerate or decelerate depending upon the direction (and magnitude) of the changes.

3. Safety Model

The analysis supporting the CAFE rule for MYs 2017 and beyond did not account for differences in exposure or inherent safety risk as vehicles aged throughout their useful lives. However, the relationship between vehicle age and fatality risk is an important one. In a 2013 Research Note,³²¹ NHTSA's National Center for Statistics and Analysis concluded a driver of a vehicle that is four to seven years old is 10% more likely to be killed in a crash than the driver of a vehicle zero to three years old, accounting for the other factors related to the crash. This trend continued for older vehicles more generally, with a driver of a vehicle 18 years or older being 71% more likely to be killed in a crash than a driver in a new vehicle. While there are more registered vehicles that are zero to three years old than there are 20 years or older (nearly three times as many) because most of the vehicles in earlier vintages are retired sooner, the average age of vehicles in the United States is 11.6 years old and has risen significantly in the past decade.³²² This relationship reflects a general trend visible in the Fatality Analysis Reporting System (FARS) when looking at a series of calendar years: Newer vintages are safer than older vintages, over time, at each age. This is likely because of advancements in safety technology, like side-impact airbags, electronic stability control, and (more recently) sophisticated crash avoidance systems starting to work their way into the vehicle population. In fact, the 2013 Research Note indicated that the percentage of occupants fatally injured in fatal crashes increased with vehicle age: From 27% for vehicles three or fewer years old, to 41% for vehicles 12–14 years old, to 50% for vehicles 18 or more years old.

With an integrated fleet model now part of the analytical framework for CAFE analysis, any effects on fleet turnover (either from delayed vehicle retirement or deferred sales of new vehicles) will affect the distribution of both ages and model years present in the on-road fleet. Because each of these vintages carries with it inherent rates of fatal crashes, and newer vintages are generally safer than older ones, changing that distribution will change

³²¹ National Center for Statistics and Analysis, *How Vehicle Age and Model Year Relate to Driver Injury Severity in Fatal Crashes*, National Highway Traffic Safety Administration (Aug. 2013), available at <https://crashstats.nhtsa.dot.gov/Api/Public/ViewPublication/811825>.

³²² Based on data acquired from Ward's Automotive.

the total number of on-road fatalities under each regulatory alternative.

To estimate the empirical relationship between vehicle age, model year vintage, and fatalities, DOT conducted a statistical analysis linking data from the FARS database, a time series of Polk registration data to represent the on-road vehicle population, and assumed per-vehicle mileage accumulation rates (the derivation of which is discussed in detail in PRIA Chapter 11). These data were used to construct per-mile fatality rates that varied by vehicle vintage, accounting for the influence of vehicle age. However, unlike the NCSA study referenced above, any attempt to account for this relationship in the CAFE analysis faces two challenges. The first challenge is the CAFE model lacks the internal structure to account for other factors related to observed fatal crashes—for example, vehicle speed, seat belt use, drug use, or age of involved drivers or passengers. Vehicle interactions are simply not modeled at

this level; the safety analysis in the CAFE model is statistical, using aggregate values to represent the totality of fleet interactions over time. The second challenge is perhaps the more significant of the two: The CAFE analysis is inherently forward-looking. To implement a statistical model analogous to the one developed by NCSA, the CAFE model would require forecasts of all factors considered in the NCSA model—about vehicle speeds in crashes, driver behavior, driver and passenger ages, vehicle vintages, and so on. In particular, the model would require distributions (joint distributions, in most cases) of these factors over a period of time spanning decades. Any such forecasts would be highly uncertain and would be likely to assume a continuation of current conditions.

Instead of trying to replicate the NCSA work at a similar level of detail, DOT conducted a simpler statistical analysis to separate the safety impact of the two factors the CAFE model

explicitly accounts for: The distribution of vehicle ages in the fleet and the number of miles driven by those vehicles at each age. To accomplish this, DOT used data from the FARS database at a lower level of resolution; rather than looking at each crash and the specific factors that contributed to its occurrence, staff looked at the total number of fatal crashes involving light-duty vehicles over time with a focus on the influence of vehicle *age* and vehicle *vintage*. When considering the number of fatalities relative to the number of registered vehicles for a given model year (without regard to the passenger car/light-truck distinction, which has evolved over time and can create inconsistent comparisons), a somewhat noisy pattern develops. Using data from calendar year 1996 through 2015, some consistent stories develop. The points in Figure II-4 represent the number of fatalities per registered vehicle with darker circles associated with increasingly current calendar years.

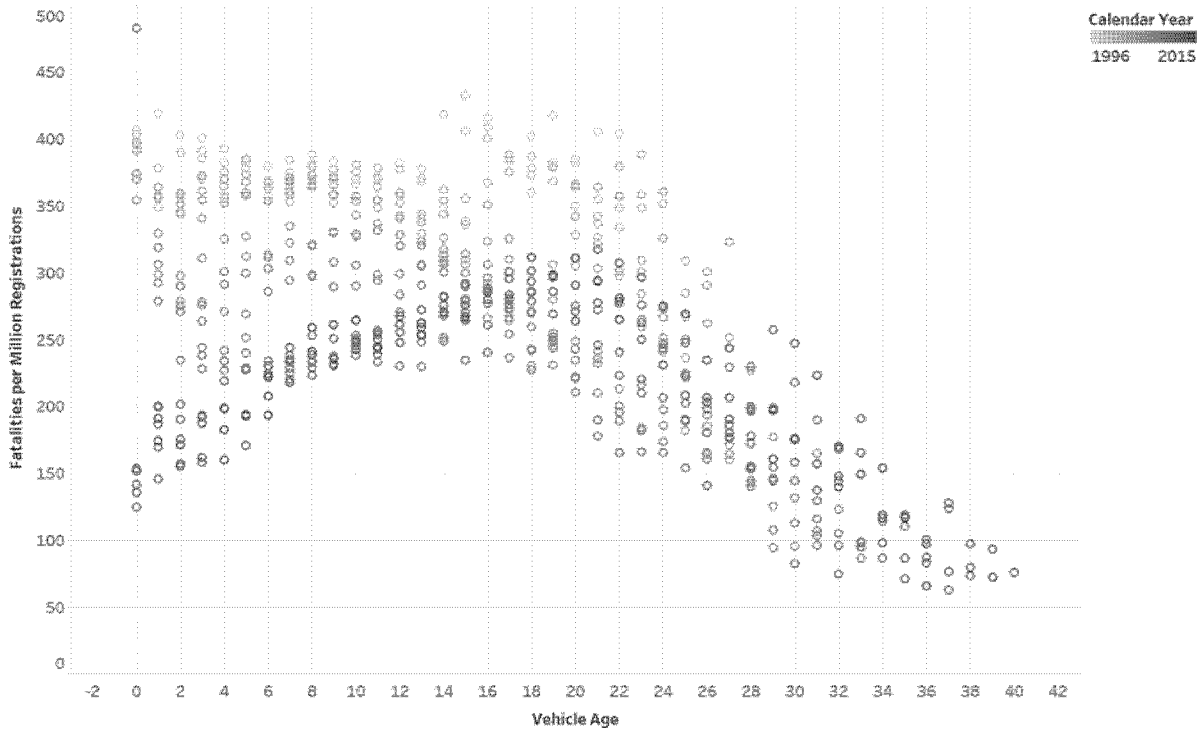

Figure II-4 - Fatalities per million registered vehicles, 1996 -2015

As shown in Figure II-4, fatalities per registered vehicle have generally declined over time across all vehicle ages (the darker points representing newer vintages being closer to the x-axis) and, across most recent calendar years, fatality rates (per registered

vehicle) start out at a low point, rise through age 15 or so, then decline through age 30 (at which point little of the initial model year cohort is still registered). While this pattern is evident in the registration data, it is magnified by imposing a mileage accumulation

schedule on the registered population and examining fatalities per billion miles of VMT.

The mileage accumulation schedule used in this analysis was developed using odometer readings of vehicles aged 0-15 years in calendar year 2015.

The years spanned by the FARS database cover all model years from calendar year 1996 through 2015. Given that there is a significant number of years between the older vehicles in the 1996 CY data and the most recent model years in the odometer data the informed the mileage accumulation schedules, staff applied an elasticity of -0.20 to the change in the average cost per mile of vehicles over their lives. While the older vehicles had lower fuel

economies, which would be associated with higher per-mile driving costs, they also (mostly) faced lower fuel prices. This adjustment increased the mileage accumulation for older vehicles, but not by large amounts. Because the CAFE model uses the mileage accumulation schedule and applies it to all vehicles in the fleet, it is necessary to use the same schedule to estimate per-mile fatality rates in the statistical analysis—even if the schedule is based on vehicles that

look different than the oldest vehicles in the FARS dataset.

When the per-vehicle fatality rates are converted into per-mile fatality rates, the pattern observed in the registration comparison becomes clearer. As Figure II-5 shows, the trend present in the fatality data on a per-registration basis is even clearer on a per-mile basis: Newer vintages are safer than older vintages, at each age, over time.

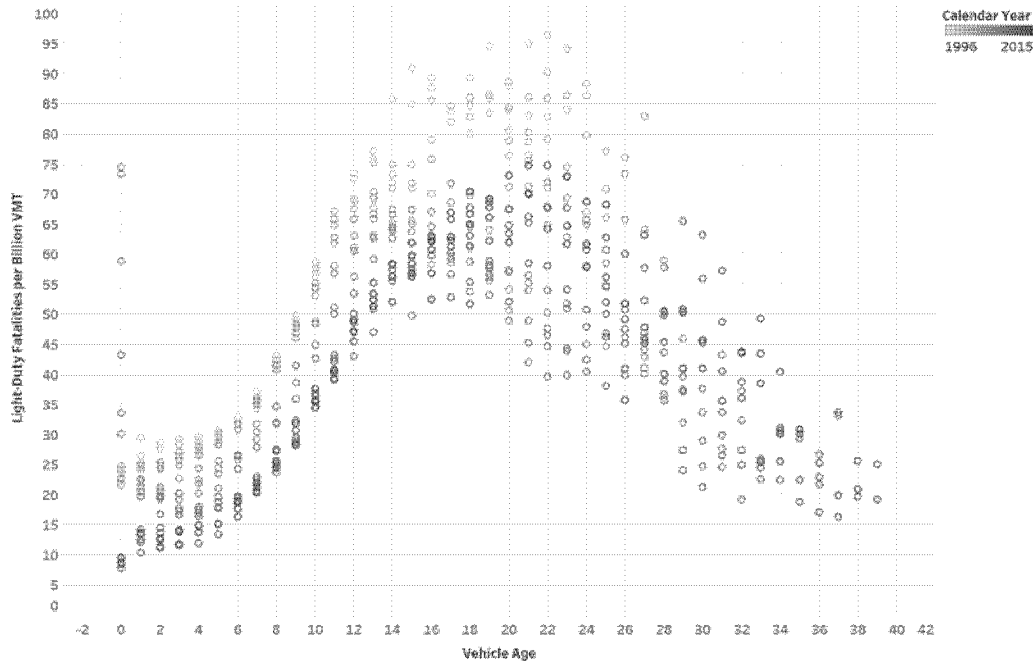

Figure II-5 - Fatalities per billion VMT, 1996 - 2015

The shape of the curve in Figure II-5 suggests a polynomial relationship between fatality rate and vehicle age, so

DOT’s statistical model is based on that structure.

The final model is a weighted quartic polynomial regression (by number of

registered vehicles) on vehicle age with fixed effects for the model years present in the dataset:³²³

$$\text{Fatalities per billion miles} = \beta_0 * \text{Age} + \beta_1 * \text{Age}^2 + \beta_2 * \text{Age}^3 + \beta_3 * \text{Age}^4 + \sum \beta_i * \text{MY}_i,$$

for $i = \{1976, 1977, \dots, 2014\}$.

The coefficient estimates and model summary are in Table II-67.

³²³ Note: The dataset included MY 1975, but that fixed effect is excluded from the set. The constant

term acts as the fixed effect for 1975 and all others are relative to that one.

Table II-67 - Description of statistical model

Coefficients:	Estimate	Std. Error
(Intercept)	28.59***	3.067
Vehicle Age	-3.63***	0.2298
Age ²	0.76***	0.03016
Age ³	-0.04***	0.001453
Age ⁴	0.0005***	2.25E-05
MY 1976	-0.72	3.621
MY 1977	-2.24	3.425
MY 1978	-1.53	3.324
MY 1979	-4.46	3.268
MY 1980	-3.78	3.437
MY 1981	-2.88	3.38
MY 1982	-4.42	3.329
MY 1983	-4.93	3.236
MY 1984	-4.71	3.142
MY 1985	-4.78	3.113
MY 1986	-5.54.	3.092
MY 1987	-5.86.	3.086
MY 1988	-4.37	3.079
MY 1989	-4.78	3.074
MY 1990	-5.17.	3.077
MY 1991	-5.84.	3.072
MY 1992	-7.26*	3.07
MY 1993	-7.92**	3.062
MY 1994	-9.69**	3.058
MY 1995	-10.61***	3.053
MY 1996	-12.07***	3.06
MY 1997	-12.8***	3.056
MY 1998	-13.88***	3.057
MY 1999	-14.91***	3.055
MY 2000	-15.68***	3.054
MY 2001	-16.33***	3.059
MY 2002	-17.1***	3.06
MY 2003	-17.7***	3.065
MY 2004	-18.24***	3.069
MY 2005	-18.91***	3.074

MY 2006	-19.24***	3.083
MY 2007	-19.85***	3.09
MY 2008	-20.09***	3.108
MY 2009	-20.11***	3.17
MY 2010	-20.5***	3.172
MY 2011	-20.74***	3.196
MY 2012	-20.77***	3.229
MY 2013	-21.49***	3.294
MY 2014	-21.98***	3.528
Degrees of Freedom	565	
R-Squared	0.9459	
F-Statistic	248.1	
Residual Std. Error	6.949	

Significance codes: *** = 0; ** = 0.001; * = 0.05; . = .01

This function is now embedded in the CAFE model, so the combination of VMT per vehicle and the distribution of ages and model years present in the on-road fleet determine the number of fatalities in a given calendar year. The model reproduces the observed fatalities of a given model year, at each age, reasonably well with more recent model years (to which the VMT schedule is a better match) estimated with smaller errors.

While the final specification was not the only one considered, the fact this model was intended to live inside the CAFE model to dynamically estimate fatalities for a dynamically changing on-road vehicle population was a constraining factor.

(a) Predicting Future Safety Trends

The base model predicts a net increase in fatalities due primarily to slower adoption of safer vehicles and added driving because of less costly vehicle operating costs. In earlier calendar years, the improvement in safety of the on-road fleet produces a net reduction in fatalities, but from the mid-2020s forward, the baseline model predicts no further increase in safety, and the added risk from more VMT and older vehicles produces a net increase in fatalities. This model thus reflects a conservative limitation; it implicitly assumes the trend toward increasingly safe vehicles that has been apparent for the past 3 decades will flatten in mid-2020s. The agency does not assert this is the most likely case. In fact, the development of advanced crash avoidance technologies in recent years indicates some level of safety

improvement is almost certain to occur. The difficulty is for most of these technologies, their effectiveness against fatalities and the pace of their adoption are highly uncertain. Moreover, autonomous vehicles offer the possibility of significantly reducing or eventually even eliminating the effect of human error in crash causation, a contributing factor in roughly 94% of all crashes. This conservative assumption may cause the NPRM to understate the beneficial effect of proposed standards on improving (reducing) the number of fatalities.

Advanced technologies that are currently deployed or in development include:

Forward Collision Warning (FCW) systems are intended to passively assist the driver in avoiding or mitigating the impact of rear-end collisions (*i.e.*, a vehicle striking the rear portion of a vehicle traveling in the same direction directly in front of it). FCW uses forward-looking vehicle detection capability, such as RADAR, LIDAR (laser), camera, etc., to detect other vehicles ahead and use the information from these sensors to warn the driver and to prevent crashes. FCW systems provide an audible, visual, or haptic warning, or any combination thereof, to alert the driver of an FCW-equipped vehicle of a potential collision with another vehicle or vehicles in the anticipated forward pathway of the vehicle.

Crash Imminent Braking (CIB) systems are intended to actively assist the driver by mitigating the impact of rear-end collisions. These safety systems have forward-looking vehicle detection

capability provided by sensing technologies such as RADAR, LIDAR, video camera, etc. CIB systems mitigate crash severity by automatically applying the vehicle's brakes shortly before the expected impact (*i.e.*, without requiring the driver to apply force to the brake pedal).

Dynamic Brake Support (DBS) is a technology that actively increases the amount of braking provided to the driver during a rear-end crash avoidance maneuver. If the driver has applied force to the brake pedal, DBS uses forward-looking sensor data provided by technologies such as RADAR, LIDAR, video cameras, etc. to assess the potential for a rear-end crash. Should DBS ascertain a crash is likely (*i.e.*, the sensor data indicate the driver has not applied enough braking to avoid the crash), DBS automatically intervenes. Although the manner in which DBS has been implemented differs among vehicle manufacturers, the objective of the interventions is largely the same: To supplement the driver's commanded brake input by increasing the output of the foundation brake system. In some situations, the increased braking provided by DBS may allow the driver to avoid a crash. In other cases, DBS interventions mitigate crash severity.

Pedestrian AEB (PAEB) systems provide automatic braking for vehicles when pedestrians are in the forward path of travel and the driver has taken insufficient action to avoid an imminent crash. Like CIB, PAEB safety systems use information from forward-looking sensors to automatically apply or supplement the brakes in certain driving

situations in which the system determines a pedestrian is in imminent danger of being hit by the vehicle. Many PAEB systems use the same sensors and technologies used by CIB and DBS.

Rear Automatic Braking feature means installed vehicle equipment that has the ability to sense the presence of objects behind a reversing vehicle, alert the driver of the presence of the object(s) via auditory and visual alerts, and automatically engage the available braking system(s) to stop the vehicle.

Semi-automatic Headlamp Beam Switching device provides either automatic or manual control of headlamp beam switching at the option of the driver. When the control is automatic, headlamps switch from the upper beam to the lower beam when illuminated by headlamps on an approaching vehicle and switch back to the upper beam when the road ahead is dark. When the control is manual, the driver may obtain either beam manually regardless of the conditions ahead of the vehicle.

Rear Turn Signal Lamp Color Turn signal lamps are the signaling element of a turn signal system, which indicates the intention to turn or change direction by giving a flashing light on the side toward which the turn will be made.

FMVSS No. 108 permits a rear turn signal lamp color of amber or red.

Lane Departure Warning (LDW) system is a driver assistance system that monitors lane markings on the road and alerts the driver when their vehicle is about to drift beyond a delineated edge line of their current travel lane.

Blind Spot Detection (BSD) systems uses digital camera imaging technology or radar sensor technology to detect one or more vehicles in either of the adjacent lanes that may not be apparent to the driver. The system warns the driver of an approaching vehicle's presence to help facilitate safe lane changes.

These technologies are either under development or are currently being offered, typically in luxury vehicles, as either optional or standard equipment.

To estimate baseline fatality rates in future years, NHTSA examined predicted results from a previous NCSA study³²⁴ that measured the effect of known safety regulations on fatality rates. This study relied on statistical evaluations of the effectiveness of motor vehicle safety technologies based on real world performance in the on-road vehicle fleet to determine the effectiveness of each safety technology. These effectiveness rates were applied

to existing fatality target populations and adjusted for current technology penetration in the on-road fleet, taking into account the retirement of existing vehicles and the pace of future penetration required to meet statutory compliance requirements, as well as adjustments for overlapping target populations. Based on these factors, as well as assumptions regarding future VMT, the study predicted future fatality levels and rates. Because the safety impact in the CAFE model independently predicts future VMT, we removed the VMT growth rate from the NCSA study and developed a prediction of vehicle fatality trends based only on the penetration pace of new safety technologies into the on-road fleet. These data were then normalized into relative safety factors with CY 2015 as the baseline (to match the baseline fatality year used in this CAFE analysis). These factors were then converted into equivalent fatality rates/100 million VMT by anchoring them to the 2015 fatality rate/100 million VMT published by NHTSA. Figure II-6 below illustrates the modelling output and projected fatality trend from the analysis of the NCSA study, prior to adjustment to fatality rates/100 million VMT.

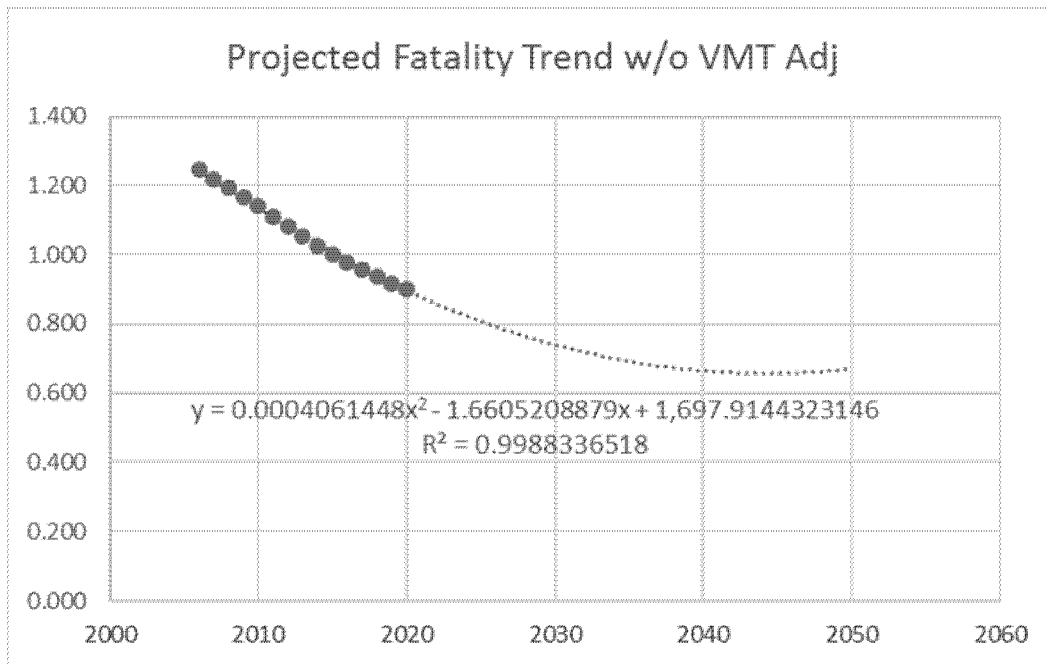

Figure II-6 - Projected Fatality Trend without VMT Adjustment

³²⁴ Blincoe, L. & Shankar, U. *The Impact of Safety Standards and Behavioral Trends on Motor Vehicle*

Fatality Rates, National Highway Traffic Safety Administration (Jan. 2007), available at [https://](https://www.nhtsa.gov/sites/nhtsa.dot.gov/files/documents/810777v3.pdf)

www.nhtsa.gov/sites/nhtsa.dot.gov/files/documents/810777v3.pdf.

This model was based on inputs representing the impact of technology improvement through CY 2020. Projecting this trend beyond 2020 can be justified based on the continued transformation of the on-road fleet to 100% inclusion of the known safety technologies. Based on projections in the NCSA study, significant further technology penetration can be expected in the on-road fleet for side impact improvements (FMVSS 214), electronic stability control (FMVSS 126), upper interior head impact protection (FMVSS 301), tire pressure monitoring systems (FMVSS 138), ejection mitigation (FMVSS 226), and

heavy truck stopping distance improvements (FMVSS 121). These technologies were estimated to be installed in only 40–70% of the on-road fleet as of CY 2020, implying further safety improvement well beyond the 2020 calendar year.

The NCSA study focused on projections to reflect known technology adaptation requirements, but it was conducted prior to the 2008 recession, which disrupted the economy and changed travel patterns throughout the country. Thus, while the relative trends it predicts seem reasonable, they cannot account for the real-world disruption and recovery that occurred in the 2008–

2015 timeframe. In addition, the NCSA study did not attempt to adjust for safety impacts that may have resulted from changes in the vehicle sales mix (vehicle types and sizes creating different interactions in crashes), in commuting patterns, or in shopping or socializing habits associated with internet access and use. To address this, NHTSA also examined the actual change in the fatality rate as measured by fatality counts and VMT estimates. Figure II–7 below illustrates the actual fatality rates measured from 2000 through 2016 and the modeled fatality rate trend based on these historical data.

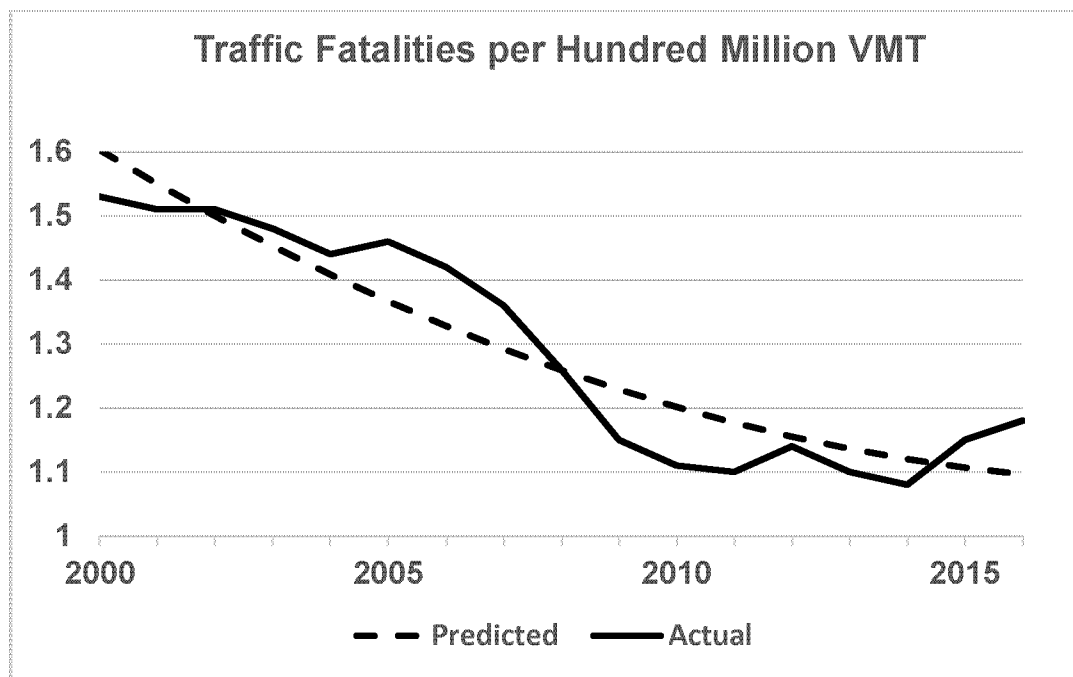

Figure II-7 - Traffic Fatalities per Hundred Million VMT

The effect of the recession and subsequent recovery can be seen in chaotic shift in the fatality rate trend starting in 2008. The generally gradual decline that had been occurring over the previous decade was interrupted by a slowdown in the rate of change followed by subsequent upward and downward shifts. More recently, the rate has begun to increase. These shifts reflect some combination of factors not captured in the NCSA analysis mentioned above. The significance of this is that although there was a steady increase in the penetration of safety technologies into the on-road fleet between 2008 and 2015, other unknown factors offset their positive influence and eventually reversed the trend in

vehicle safety rates. Because of the upward shift over the 2014–2015 period, this model, which does not reflect technology trend savings after 2015, will predict an upward shift of fatality rates after 2020.

Predicting future safety trends has significant uncertainty. Although further safety improvements are expected because of advanced safety technologies such as automatic braking and eventually, fully automated vehicles, the pace of development and extent of consumer acceptance of these improvements is uncertain. Thus, two imperfect models exist for predicting future safety trends. The NCSA model reflects the expected trend from required technologies and indicates

continued improvement well beyond the 2020 timeframe, which is when the historical fatality rate based model breaks down. By contrast, the historical fatality rate model reflects shifts in safety not captured by the NCSA model, but gives arguably implausible results after 2020. It essentially represents a scenario in which economic, market, or behavioral factors minimize or offset much of the potential impact of future safety technology.

For the NPRM, the analysis examines a scenario projecting safety improvements beyond 2015 using a simple average of the NCSA and historical fatality rate models, accepting each as an illustration of different and conflicting possible future scenarios. As

both models eventually curve up because of their quadratic form, each models' results are flattened at the point where they begin to trend upward. This occurs in 2045 for the NCSA model and in 2021 for the historical model. The results are shown in Figure II-8 below.

The results indicate roughly a 19% reduction in fatality rates between 2015 and 2050. This is a slower pace than what has historically occurred over the past several decades, but the biggest influence on historical rates was significant improvement in safety belt

use, which was below 10% in 1960 and had risen to roughly 70% by 2000, and is now more than 90%. Because belt use is now above 90%, further such improvements are unlikely unless they come from new technologies.

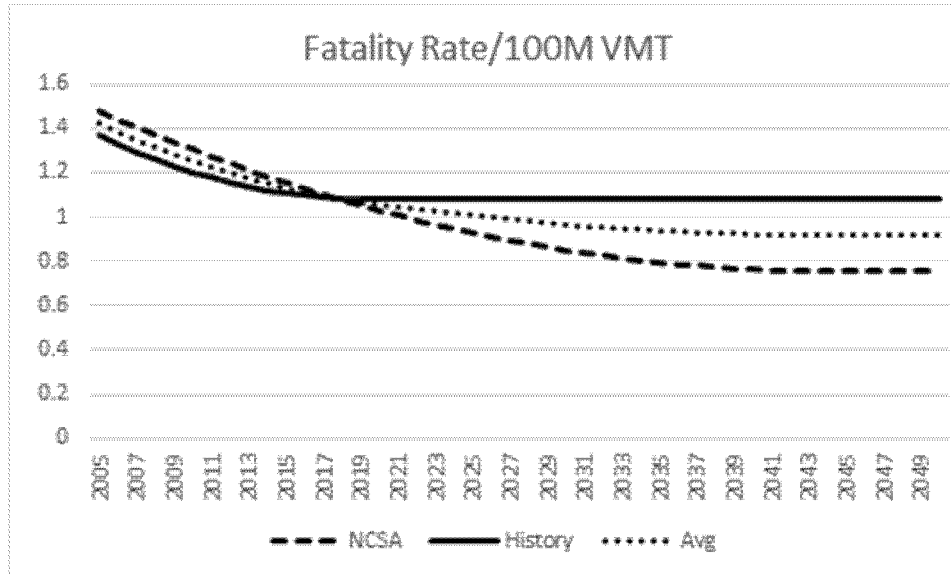

Figure II-8 - Fatality Rate per 100M Vehicle Miles Traveled

A difficulty with these trend models is they are based on calendar year predictions, which are derived from the full on-road vehicle fleet rather than the model year fleet, which is the basis for calculations in the CAFE model. As such they are useful primarily as indicators that vehicle safety has steadily improved over the past several decades, and given the advanced safety technologies under current development, we would expect some continuation of improvement in MY vehicle safety over the near and mid-term future. To account for this, NHTSA approximated a model year safety trend continuing through about 2035 (Figure II-9). For this trend the agency used actual data from FARS to calculate the change in fatality rates through 2007. The recession, which struck our economy in 2008, distorted normal behavioral patterns and affected both

VMT and the mix of drivers and type of driving to an extent we do not believe the recession era gives an accurate picture of the safety trends inherent in the vehicles themselves. Therefore, beginning in 2008, NHTSA approximated a trend for safety improvement through about MY 2035 to reflect the continued effect of improved safety technologies such as advanced automatic braking, which manufacturers have announced will be in all new vehicles by MY 2022. The agency recognize this is only an estimate, and actual MY trends could be above or below this line. NHTSA examined alternate trends in a sensitivity analysis and request comments on the best way to address future safety trends. NHTSA also notes although we project vehicles will continue to become safer going forward to about 2035, we do not have corresponding cost information

for technologies enabling this improvement. In a standard elasticity model, sales impacts are a function of the percent change in vehicle price. Hypothetically, increasing the base price for added safety technologies would decrease the impact of higher prices due to impacts of CAFE standards on vehicle sales. The percentage change in baseline price would decrease, which would mean a lower elasticity effect, which would mean a lower impact on sales. NHTSA will consider possible ways to address this issue before the final rule, and we request comments on the need and/or practicability for such an adjustment, as well as any data and other relevant information that could support such an analysis of these costs, as well as the future pace of technological adoption within the vehicle fleet.

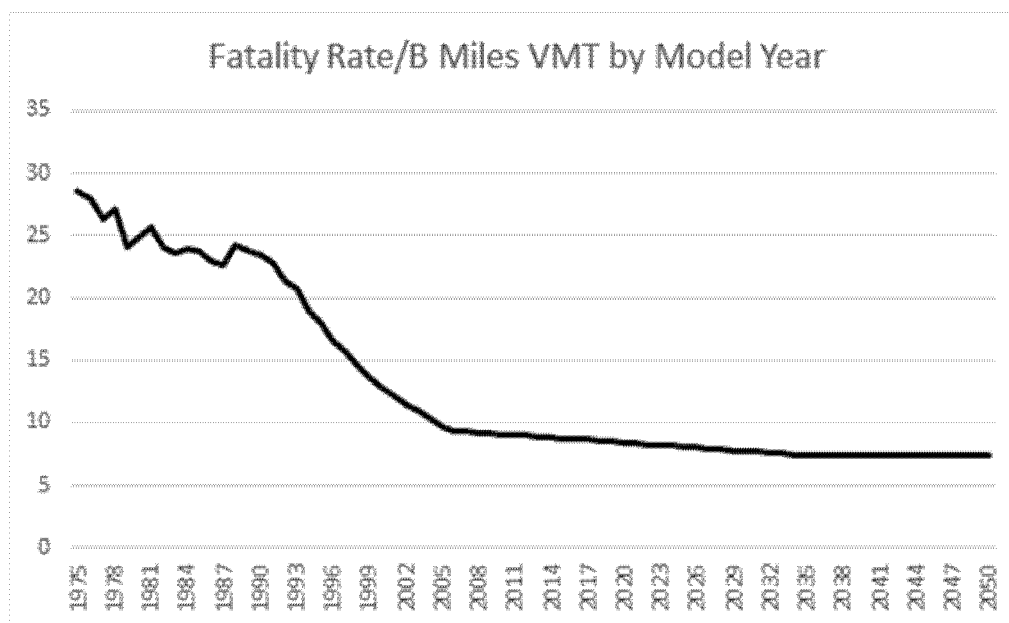

Figure II-9 - Fatality Rate: Billion Miles VMT by Model Year

(b) Adjusting for Behavioral Impacts

The influence of delayed purchases of new vehicles is estimated to have the most significant effect on safety imposed by CAFE standards. Because of a combination of safety regulations and voluntary safety improvements, passenger vehicles have become safer over time. Compared to prior decades, fatality rates have declined significantly because of technological improvements, as well as behavioral shifts, such as increased seat belt use. As these safer vehicles replace older less safe vehicles in the fleet, the on-road fleet is replaced with vehicles reflecting the improved fatality rates of newer, safer vehicles. However, fatality rates associated with different model year vehicles are influenced by the vehicle itself and by driver behavior. Over time, used vehicles are purchased by drivers in different demographic circumstances who also tend to have different behavioral characteristics. Drivers of older vehicles, on average, tend to have lower belt use rates, are more likely to drive inebriated, and are more likely to drive over the speed limit. Additionally, older vehicles are more likely to be driven on rural roadways, which typically have higher speeds and produce more serious crashes. These relationships are illustrated graphically in Chapter 11 of the PRIA accompanying this proposed rule.

The behavior being modelled and ascribed to CAFE involves decisions by drivers who are contemplating buying a new vehicle, and the purchase of a

newer vehicle will not in itself cause those drivers to suddenly stop wearing seat belts, speed, drive under the influence, or shift driving to different land use areas. The goal of this analysis is to measure the effect of different vehicle designs that change by model year. The modelling process for estimating safety essentially involves substituting fatality rates of older MY vehicles for improved rates that would have been experienced with a newer vehicle. Therefore, it is important to control for behavioral aspects associated with vehicle age so only vehicle design differences are reflected in the estimate of safety impacts. To address this, the CAFE safety model was run to control for vehicle age. That is, it does not reflect a decision to replace an older model year vehicle that is, for example, 10 years old with a new vehicle. Rather, it reflects the difference in the average fatality rate of each model year across its entire lifespan. This will account for most of the difference because of vehicle age, but it may still reflect a bias caused by the upward trend in societal seat belt use over time. Because of this secular trend, each subsequent model year's useful life will occur under increasingly higher average seat belt use rates. This could cause some level of behavioral safety improvement to be ascribed to the model year instead of the driver cohort. However, it is difficult to separate this effect from the belt use impacts of changing driver cohorts as vehicles age.

Glassbrenner (2012) analyzed the effect of improved safety in newer

vehicles for model years 2001 through 2008. She developed several statistical regression models that specifically controlled for most behavioral factors to isolate model year vehicle characteristics. However, her study did not specifically report the change in MY fatality rates—rather, she reported total fatalities that could have been saved in a baseline year (2008) had all vehicles in the on-road fleet had the same safety features as the MY 2001 through MY 2008 vehicles. This study potentially provides a basis for comparison with results of the CAFE safety estimates. To make this comparison, the CY 2008 passenger car and light truck fatalities total from FARS results were modified by subtracting the values found in Figure II-9 of her study. This gives a stream of comparable hypothetical CY 2008 fatality totals under progressively less safe model year designs. Results indicated that had the 2008 on-road fleet been equipped with MY 2008 safety equipment and vehicle characteristics, total fatalities would have been reduced by 25% compared to vehicles that were actually on the road in 2008. Similar results were calculated for each model years' vehicle characteristics back to 2001.

For comparison, predicted MY fatality rates were derived from the CAFE safety model and applied to the CY 2008 VMT calculated by that model. This gives an estimate of CY 2008 fatalities under each model years' fatality rate, which, when compared to the predicted CY fatality total, gives a trendline

comparable to the Glassbrenner trendline illustrating the change in MY fatality rates. Both models are sensitive to the initial 2008 baseline fatality total, and because the predicted CAFE total is somewhat lower than the actual total, the agency ran a third trendline to examine the influence of this difference. Results are shown in Figure II-10.

Using the corrected fatality count, but retaining the predicted VMT changes the initial 2018 CY fatality rate to 12.62

(instead of 12.15) and produces the result shown in Figure II-10. The CAFE model trendline shifts up, which narrows the difference in early years but expands it in later years. However, VMT and fatalities are linked in the CAFE model, so the actual level of the MY safety predicted by the CAFE curve has uncertainty. Perhaps the most meaningful result from this comparison is the difference in slopes; the CAFE model predicts more rapid change

through 2006, but in the last few years change decreases. This might reflect the trend in societal belt use, which rose steadily through 2005 and levelled off. Later model years' fatality rates would benefit from this trend while earlier model years would suffer. This seems consistent with our using lifetime MY fatality rates to reflect MY change rather than first year MY fatality rates (although even first year rates would reflect this bias, but not as much).

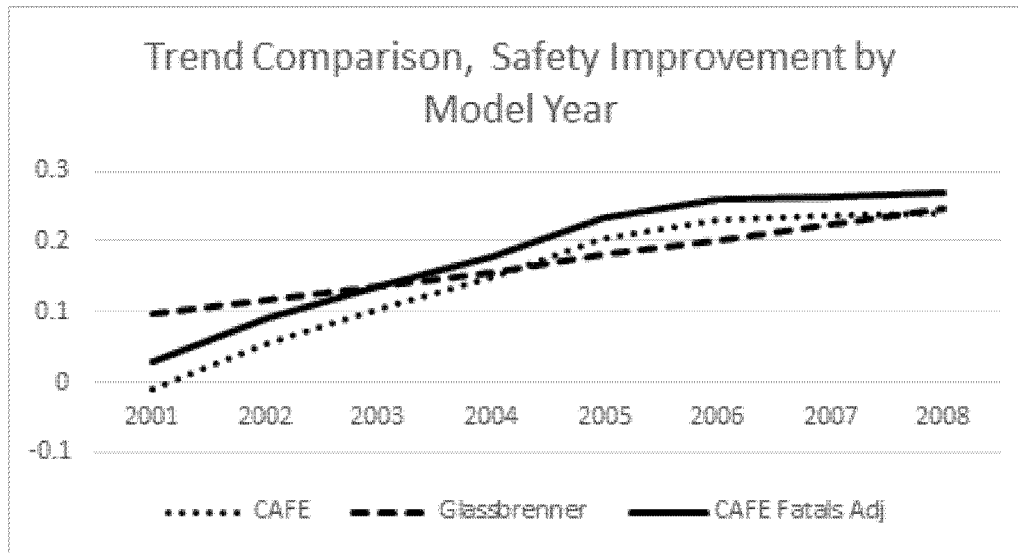

Figure II-10 - Safety Improvement Trend by Model Year

To provide another perspective on safety impacts, NHTSA accessed data from a comprehensive study of the effects of safety technologies on motor vehicle fatalities. Kahane (2015)³²⁵ examined all safety effects of vehicle safety technologies from 1960 through 2012 and found these technologies saved more than 600,000 lives during

that time span. Kahane is currently working under contract for NHTSA to update this study through 2016. At NHTSA's request, Kahane accessed his database to provide a measure of relative MY vehicle design safety by controlling for seat belt use. The result was a MY safety index illustrating the progress in vehicle safety by model year

which isolates vehicle design from the primary behavioral impact—seat belt usage. We normalized Kahane's index to MY 1975 and did the same to the "fixed effects" we are currently using from our safety model to compare the trends in MY safety from the two methods. Results are shown in Figure II-11.

³²⁵ Kahane, C.J. *Lives Saved by Safety Standards and Associated Vehicle Safety Technologies, 1960–2012—Passenger Cars and LTVs—with Reviews of*

26 FMVSS and the Effectiveness of their Associated Safety Technologies in Reducing Fatalities, Injuries, and Crashes, National Highway Traffic Safety

Administration (Jan. 2015), available at <https://crashstats.nhtsa.dot.gov/Api/Public/ViewPublication/812069>.

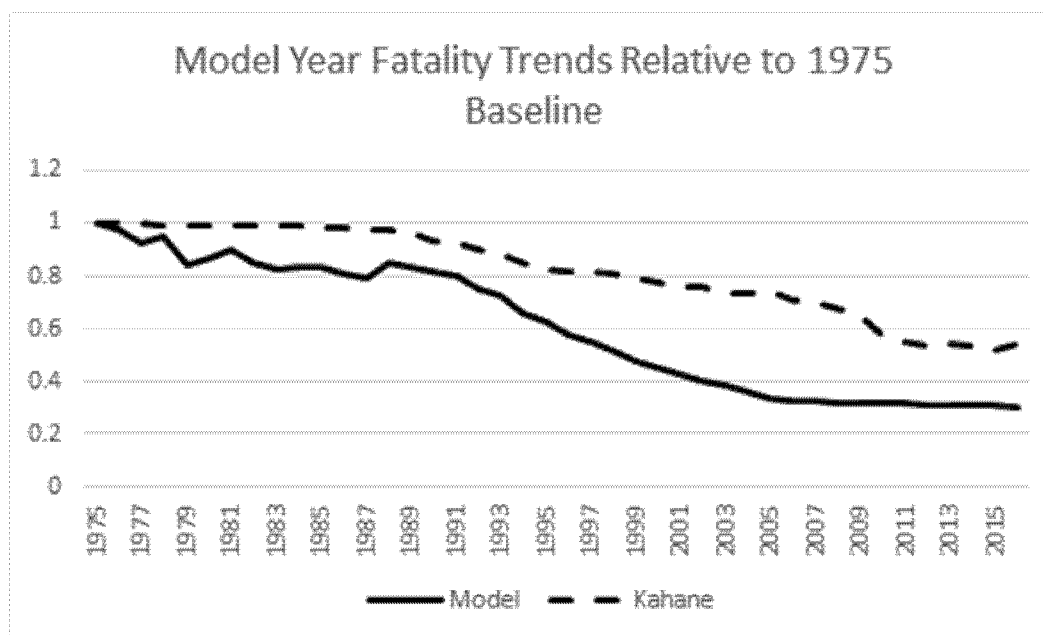

Figure II-11 - Fatality Trends Relative to 1975

From Figure II-11 both approaches show similar long-term downward trends, but this model shows a steeper slope than Kahane's model. The two models involve completely different approaches, so some difference is to be expected. However, it is also possible this reflects different methods used to isolate vehicle design safety from behavioral impacts. As discussed previously, NHTSA addressed this issue by removing vehicle age impacts from its model, whereas Kahane's model does it by controlling for belt use. As noted previously, aside from the age impact on belt use associated with the different

demographics driving older vehicles, there is a secular trend toward more belt use reflecting the increase in societal awareness of belt use importance over time. This trend is illustrated in Figure II-12 below.³²⁶ NHTSA's current approach removes the age trend in belt use, but it's not clear whether it accounts for the full impacts of the secular trend as well. If not, some portion of the gap between the two trendlines could reflect behavioral impacts rather than vehicle design.

These models (NHTSA, Glassbrenner, and Kahane) involve differing approaches and assumptions

contributing to uncertainty, and given this, their differences are not surprising. It is encouraging they show similar directional trends, reinforcing the basic concept we are measuring. NHTSA recognizes predicting future fatality impacts, as well as sales impacts that cause them, is a difficult and imprecise task. NHTSA will continue to investigate this issue, and we seek comment on these estimates as well as alternate methods for predicting the safety effects associated with delayed new vehicle purchases.

³²⁶ Note: The drop occurring in 1994 reflects a shift in the basis for determining belt use rates. Effective in 1994, data were reported from the

National Occupant Protection Survey (NOPUS). Prior to this, a conglomeration of state studies provided the basis. It is likely the pre-NOPUS

surveys produced inflated results, especially in the 1991-1993 period.

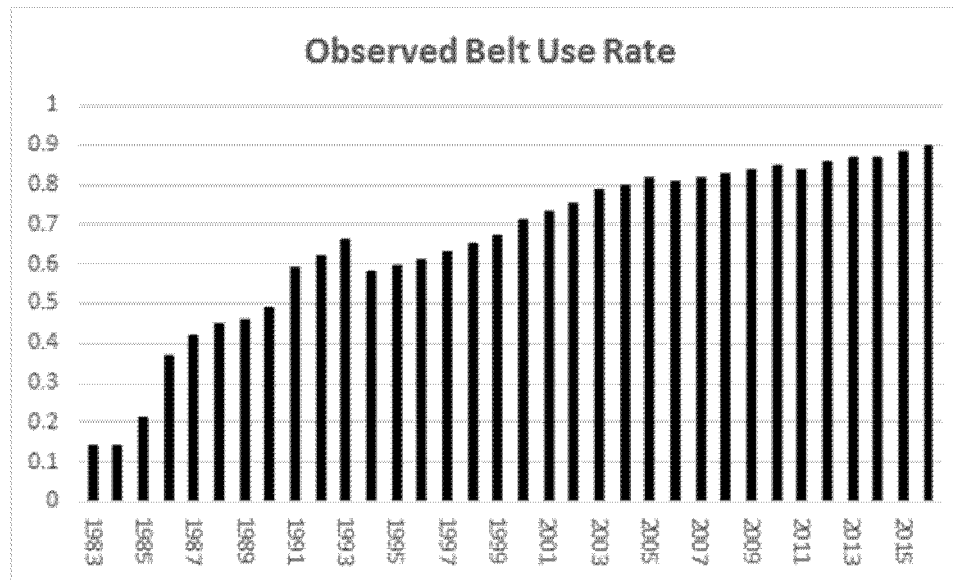

Figure II-12 - Observed Seat Belt Use Rate

4. Impact of Rebound Effect on Fatalities

Based on historical data, it is possible to calculate a baseline fatality rate for vehicles of any model year vintage. By simply taking the total number of vehicles involved in fatal accidents over all ages for a model year and dividing by the cumulative VMT over the useful life of every vehicle produced in that model year, one arrives at a baseline hazard rate denominated in fatalities per billion miles. The fatalities associated with vehicles produced in that model year are then proportional to the cumulative lifetime VMT, where total fatalities equal the product of the baseline hazard rate and VMT. A more comprehensive discussion of the rebound effect and the basis for calculating its impact on mileage and risk is in Chapter 8 of the PRIA accompanying this proposed rule.

5. Adjustment for Non-Fatal Crashes

Fatalities estimated to be caused by various alternative CAFE standards are valued as a societal cost within the CAFE models' cost/benefit accounting. Their value is based on the comprehensive value of a fatality derived from data in Blincoe *et al.* (2015), adjusted to 2016 economics and updated to reflect the official DOT guidance on the value of a statistical life

in 2016. This gives a societal value of \$9.9 million for each fatality. The CAFE safety model estimates effects on traffic fatalities but does not address corresponding effects on non-fatal injuries and property damage that would result from the same factors influencing fatalities. To address this, we developed an adjustment factor that would account for these crashes.

Development of this factor is based on the assumption nonfatal crashes will be affected by CAFE standards in proportion to their nationwide incidence and severity. That is, NHTSA assumes the same injury profile, the relative number of cases of each injury severity level, that occur nationwide, will be increased or decreased because of CAFE. The agency recognizes this may not be the case, but the agency does not have data to support individual estimates across injury severities. There are reasons why this may not be true. For example, because older model year vehicles are generally less safe than newer vehicles, fatalities may make up a larger portion of the total injury picture than they do for newer vehicles. This would imply lower ratios across the non-fatal injury and PDO profile and would imply our adjustment may overstate total societal impacts. NHTSA requests comments on this assumption

and alternative methods to estimate injury impacts.

The adjustment factor is derived from Tables 1–8 and I–3 in Blincoe *et al.* (2015). Incidence in Table I–3 reflects the Abbreviated Injury Scale (AIS), which ranks nonfatal injury severity based on an ascending 5 level scale with the most severe injuries ranked as level 5. More information on the basis for these classifications is available from the Association for the Advancement of Automotive Medicine at <https://www.aaam.org/abbreviated-injury-scale-ais/>.

Table 1–3 in Blincoe lists injured persons with their highest (maximum) injury determining the AIS level (MAIS). This scale is represented in terms of MAIS level, or maximum abbreviated injury scale. MAIS0 refers to uninjured occupants in injury vehicles, MAIS1 are generally considered minor injuries, MAIS2 moderate injuries, MAIS3 serious injuries, MAIS4 severe injuries, and MAIS5 critical injuries. PDO refers to property damage only crashes, and counts for PDOs refer to vehicles in which no one was injured. From Table II–68, ratios of injury incidence/fatality are derived for each injury severity level as follows:

**Table II-68 - Ratio of Injury Incidence/Fatality
Police-Reported and Unreported Crashes**

Injury Level	Ratio
PDO	560.88
MAIS0	138.89
MAIS1	104.83
MAIS2	10.26
MAIS3	3.05
MAIS4	0.52
MAIS5	0.17
Fatal	1

For each fatality that occurs nationwide in traffic crashes, there are 561 vehicles involved in PDOs, 139 uninjured occupants in injury vehicles, 105 minor injuries, 10 moderate injuries, 3 serious injuries, and fractional numbers of the most serious categories which include severe and critical nonfatal injuries. For each fatality ascribed to CAFE it is assumed there will be nonfatal crashes in these same ratios.

Property damage costs associated with delayed new vehicle purchases must be treated differently because crashes that subsequently occur damage older used vehicles instead of newer vehicles. Used

vehicles are worth less and will cost less to repair, if they are repaired at all. The consumer's property damage loss is thus reduced by longer retention of these vehicles. To estimate this loss, average new and used vehicle prices were compared. New vehicle transaction prices were estimated from a study published by Kelley Blue Book.³²⁷ Based on these data, the average new vehicle transaction price in January 2017 was \$34,968. Used vehicle transaction prices were obtained from Edmonds Used Vehicle Market Report published in February of 2017.³²⁸ Edmonds data indicate the average used vehicle transaction price was \$19,189 in

2016. There is a minor timing discrepancy in these data because the new vehicle data represent January 2017, and the used vehicle price is for the average over 2016. NHTSA was unable to locate exact matching data at this time, but the agency believes the difference will be minor.

Based on these data, new vehicles are on average worth 82% more than used vehicles. To estimate the effect of higher property damage costs for newer vehicles on crashes, the per unit property damage costs from Table I-9 in Blincoc *et al.* (2015) were multiplied by this factor. Results are illustrated in Table II-69.

Table II-69 - Property Damage Unit Cost Savings from Retained Used Cars

	Original	Unit Cost
Injury Level	Unit Cost	Savings
PDO	\$2,444	\$2,007
MAIS0	\$1,828	\$1,501
MAIS1	\$5,404	\$4,438
MAIS2	\$5,778	\$4,745
MAIS3	\$10,882	\$8,937
MAIS4	\$16,328	\$13,409
MAIS5	\$15,092	\$12,394
Fatal	\$11,212	\$9,208

The total property damage cost reduction was then calculated as a function of the number of fatalities reduced or increased by CAFE as follows:

$$S = \sum_{i=8}^n F r_n p_n$$

Where:

S = total property damage savings from retaining used vehicles longer

F = change in fatalities estimated for CAFE due to retaining used vehicles
r = ratio of nonfatal injuries or PDO vehicles to fatalities (F)
p = value of property damage prevented by retaining older vehicle

³²⁷ Press Release, Kelley Blue Book, New-Car Transaction Prices Remain High, Up More Than 3 Percent Year-Over-Year in January 2017, According to Kelley Blue Book (Feb. 1, 2017), <https://>

mediaroom.kbb.com/2017-02-01-New-Car-Transaction-Prices-Remain-High-Up-More-Than-3-Percent-Year-Over-Year-In-January-2017-According-To-Kelley-Blue-Book.

³²⁸ Edmonds Used Vehicle Market Report, Edmonds (Feb. 2017), https://dealers.edmunds.com/static/assets/articles/2017_Feb_Used_Market_Report.pdf.

n = the 8 injury severity categories

The number of fatalities ascribed to CAFE because of older vehicle retention was multiplied by the unit cost per fatality from Table I-9 in Blincoe *et al.* (2015) to determine the societal impact accounted for by these fatalities.³²⁹ From Table I-8 in Blincoe *et al.* (2015), NHTSA subtracted property damage costs from all injury severity levels and recalculated the total comprehensive value of societal losses from crashes. The agency then divided the portion of these crashes because of fatalities by the resulting total to estimate the portion of crashes excluding property damage that are accounted for by fatalities. Results indicate fatalities accounted for approximately 40% of all societal costs exclusive of property damage. NHTSA then divided the total cost of the added fatalities by 0.4 to estimate the total cost of all crashes prevented exclusive of the savings in property damage. After subtracting the total savings in property damage from this value, we divided the fatality cost by it to estimate that overall, fatalities account for 43% of the total costs that would result from older vehicle retention.

For the fatalities that occur because of mass effects or to the rebound effect, the

calculation was more direct, a simple application of the ratio of the portion of costs produced by fatalities. In this case, there is no need to adjust for property damage because all impacts were derived from the mix of vehicles in the on-road fleet. Again, from Table I-8 in Blincoe *et al.* (2015), we derive this ratio based on all cost factors including property damage to be .36. These calculations are summarized as follows:

$$SV = Fv / (Fv/x - S) + M/c$$

Where:

- SV = Value of societal Impacts of all crashes
- F = change in fatalities estimated for CAFE due to retaining used vehicles
- v = Comprehensive societal value of preventing 1 fatality
- x = Percent of total societal loss from crashes excluding property damage accounted for by fatalities
- S = total property damage savings from retaining used vehicles longer
- M = change in fatalities due to changes in vehicle mass to meet CAFE standards
- c = Percent of total societal loss from all cost factors in all crashes accounted for by fatalities

For purposes of application in the CAFE model, these two factors were combined based on the relative

contribution to total fatalities of different factors. As noted, although a safety impact from the rebound effect is calculated, these impacts are considered to be freely chosen rather than imposed by CAFE and imply personal benefits at least equal to the sum of their added costs and safety consequences. The impacts of this nonfatal crash adjustment affect costs and benefits equally. When considering safety impacts actually imposed by CAFE standards, only those from mass changes and vehicle purchase delays are considered. NHTSA has two different factors depending on which metric is considered. The agency created these factors by weighting components by the relative contribution to changes in fatalities associated with each component. This process and results are shown in Table II-70. Note: For the NPRM, NHTSA applied the average weighted factor to all fatalities. This will tend to slightly overstate costs because of sales and scrappage and understate costs associated with mass and rebound. The agency will consider ways to adjust this minor discrepancy for the final rule.

Table II-70 – Contributing Factors of Societal Impacts

	Fatalities		Weights -
	Portion of	Weights -	CAFE Imposed
Contributing Factor	Crash Costs	All Factors	Factors
Sales and Scrappage	0.4323	0.4107	0.935
Rebound Effect	0.3611	0.5607	
Mass	0.3611	0.0286	0.065
Total	NA	1	1
Weighted Factor		0.39	0.43

Table II-71, Table II-72, Table II-73, and Table II-74 summarize the safety effects of CAFE standards across the various alternatives under the 3% and

7% discount rates. As noted in Section II.F.5, societal impacts are valued using a \$9.9 million value per statistical life (VSL). Fatalities in these tables are

undiscounted; only the monetized societal impact is discounted.

³²⁹ Note: These calculations used the original values in the Blincoe *et al.* (2015) tables without

adjusting for economics. These calculations

produce ratios and are thus not sensitive to adjustments for inflation.

**Table II-71 - Change in Safety Parameters from CAFE Augural Standards Baseline
Average Annual Fatalities, CY 2036-2045, 3% Discount Rate**

Change in Safety Parameters from Augural Standards Baseline								
Average Annual Fatalities, CY 2036-2045, 3% Discount Rate								
	Alt 1	Alt 2	Alt 3	Alt 4	Alt 5	Alt 6	Alt 7	Alt 8
<u>Fatalities</u>								
Mass changes	-22	-19	-17	-17	-16	-6	0	-2
Sales Impacts	-180	-162	-151	-112	-76	-59	-24	-33
Subtotal CAFE Atrb.	-202	-181	-168	-129	-92	-65	-24	-35
Rebound effect	-692	-650	-605	-511	-392	-317	-174	-219
Total	-894	-831	-773	-640	-484	-382	-198	-254
<u>Fatalities Societal \$B</u>								
Mass changes	-0.11	-0.10	-0.08	-0.08	-0.08	-0.03	0.00	-0.01
Sales Impacts	-0.90	-0.81	-0.76	-0.56	-0.38	-0.30	-0.12	-0.16
Subtotal CAFE Atrb.	-1.01	-0.91	-0.84	-0.64	-0.46	-0.33	-0.12	-0.17
Rebound effect	-3.43	-3.21	-3.00	-2.53	-1.94	-1.57	-0.86	-1.09
Total	-4.44	-4.12	-3.84	-3.18	-2.40	-1.90	-0.98	-1.26
<u>Nonfatal Societal \$B</u>								
Mass changes	-0.17	-0.15	-0.13	-0.13	-0.13	-0.05	0.00	-0.02
Sales Impacts	-1.41	-1.27	-1.18	-0.88	-0.59	-0.46	-0.19	-0.26
Subtotal CAFE Atrb.	-1.58	-1.42	-1.31	-1.01	-0.72	-0.51	-0.19	-0.27
Rebound effect	-5.36	-5.03	-4.69	-3.96	-3.04	-2.46	-1.35	-1.70
Total	-6.94	-6.45	-6.00	-4.97	-3.76	-2.97	-1.53	-1.97
<u>Total Societal \$B</u>								
Mass changes	-0.27	-0.24	-0.22	-0.21	-0.21	-0.07	0.00	-0.03
Sales Impacts	-2.31	-2.08	-1.94	-1.44	-0.97	-0.76	-0.30	-0.42
Subtotal CAFE Atrb.	-2.59	-2.33	-2.15	-1.65	-1.18	-0.83	-0.31	-0.45
Rebound effect	-8.79	-8.24	-7.69	-6.49	-4.98	-4.03	-2.21	-2.79
Total	-11.4	-10.6	-9.84	-8.15	-6.16	-4.87	-2.51	-3.23

**Table II-72 - Change in Safety Parameters from CAFE Augural Standards Baseline
Average Annual Fatalities, CY 2036-2045, 7% Discount Rate**

Change in Safety Parameters from Augural Standards Baseline								
Average Annual Fatalities, CY 2036-2045, 7% Discount Rate								
	Alt 1	Alt 2	Alt 3	Alt 4	Alt 5	Alt 6	Alt 7	Alt 8
<u>Fatalities</u>								
Mass changes	-22	-19	-17	-17	-16	-6	0	-2
Sales Impacts	-180	-162	-151	-112	-76	-59	-24	-33
Subtotal CAFE Attrib.	-202	-181	-168	-129	-92	-65	-24	-35
Rebound effect	-692	-650	-605	-511	-392	-317	-174	-219
Total	-894	-831	-773	-640	-484	-382	-198	-254
<u>Fatalities Societal \$B</u>								
Mass changes	-0.04	-0.04	-0.03	-0.03	-0.03	-0.01	0.00	0.00
Sales Impacts	-0.38	-0.34	-0.32	-0.24	-0.16	-0.12	-0.05	-0.07
Subtotal CAFE Attrib.	-0.42	-0.38	-0.35	-0.27	-0.19	-0.14	-0.05	-0.07
Rebound effect	-1.42	-1.33	-1.24	-1.05	-0.80	-0.65	-0.36	-0.45
Total	-1.84	-1.71	-1.59	-1.32	-1.00	-0.79	-0.41	-0.52
<u>Nonfatal Societal \$B</u>								
Mass changes	-0.07	-0.06	-0.05	-0.05	-0.05	-0.02	0.00	-0.01
Sales Impacts	-0.59	-0.53	-0.50	-0.37	-0.25	-0.19	-0.08	-0.11
Subtotal CAFE Attrib.	-0.66	-0.60	-0.55	-0.42	-0.30	-0.21	-0.08	-0.11
Rebound effect	-2.22	-2.08	-1.94	-1.64	-1.26	-1.02	-0.56	-0.70

Total	-2.88	-2.67	-2.49	-2.06	-1.56	-1.23	-0.64	-0.82
<u>Total Societal \$B</u>								
Mass changes	-0.11	-0.10	-0.09	-0.09	-0.09	-0.03	0.00	-0.01
Sales Impacts	-0.97	-0.88	-0.81	-0.61	-0.41	-0.32	-0.13	-0.18
Subtotal CAFE Atrb.	-1.09	-0.98	-0.90	-0.69	-0.50	-0.35	-0.13	-0.19
Rebound effect	-3.64	-3.41	-3.18	-2.69	-2.06	-1.67	-0.92	-1.15
Total	-4.72	-4.38	-4.08	-3.38	-2.56	-2.02	-1.04	-1.34

**Table II-73 - Change in Safety Parameters from CAFE Augural Standards Baseline
Total Fatalities MY 1977-2029, 3% Discount Rate**

Change in Safety Parameters from Augural Standards Baseline								
Total Fatalities MY 1977-2029, 3% Discount Rate								
	Alt 1	Alt 2	Alt 3	Alt 4	Alt 5	Alt 6	Alt 7	Alt 8
<u>Fatalities</u>								
Mass changes	-160	-147	-143	-173	-152	-73	-12	-30
Sales Impacts	-6,180	-5,680	-5,260	-4,280	-3,170	-2,550	-1,030	-1,480
Subtotal CAFE Atrb.	-6,340	-5,830	-5,400	-4,460	-3,330	-2,630	-1,050	-1,520
Rebound effect	-6,340	-5,960	-5,620	-4,850	-3,610	-3,320	-2,200	-2,170
Total	-12,700	-11,800	-11,000	-9,300	-6,940	-5,950	-3,240	-3,690
<u>Fatalities Societal \$B</u>								
Mass changes	-0.9	-0.9	-0.8	-1.1	-0.9	-0.4	-0.1	-0.2
Sales Impacts	-34.4	-31.6	-29.3	-23.9	-17.6	-14.4	-6.2	-8.3
Subtotal CAFE Atrb.	-35.4	-32.4	-30.1	-24.9	-18.5	-14.8	-6.3	-8.4
Rebound effect	-41.7	-39.2	-37.0	-31.9	-23.7	-22.1	-14.8	-14.3
Total	-77.0	-71.6	-67.1	-56.9	-42.2	-36.9	-21.1	-22.8
<u>Nonfatal Societal \$B</u>								
Mass changes	-1.5	-1.3	-1.3	-1.7	-1.5	-0.7	-0.1	-0.3
Sales Impacts	-53.8	-49.4	-45.8	-37.3	-27.5	-22.5	-9.7	-12.9
Subtotal CAFE Atrb.	-55.3	-50.7	-47.1	-39.0	-29.0	-23.2	-9.8	-13.2
Rebound effect	-65.2	-61.3	-57.9	-50.0	-37.0	-34.6	-23.2	-22.4
Total	-120	-112	-105	-89.0	-66.0	-57.8	-33.0	-35.6
<u>Total Societal \$B</u>								
Mass changes	-2.4	-2.2	-2.1	-2.7	-2.4	-1.1	-0.2	-0.5
Sales Impacts	-88.2	-81.0	-75.1	-61.2	-45.1	-36.9	-15.9	-21.2
Subtotal CAFE Atrb.	-90.7	-83.1	-77.2	-63.9	-47.5	-38.0	-16.0	-21.6
Rebound effect	-107	-101	-94.9	-81.9	-60.7	-56.7	-38.0	-36.7
Total	-197	-184	-172	-146	-108	-94.7	-54.1	-58.4

**Table II-74 - Change in Safety Parameters from CAFE Augural Standards Baseline
Total Fatalities MY 1977-2029, 7% Discount Rate**

Change in Safety Parameters from Augural Standards Baseline								
Total Fatalities MY 1977-2029, 7% Discount Rate								
	Alt 1	Alt 2	Alt 3	Alt 4	Alt 5	Alt 6	Alt 7	Alt 8
Fatalities								
Mass changes	-160	-147	-143	-173	-152	-73	-12	-30
Sales Impacts	-6,180	-5,680	-5,260	-4,280	-3,170	-2,550	-1,030	-1,480
Subtotal CAFE Atrb.	-6,340	-5,830	-5,400	-4,460	-3,330	-2,630	-1,050	-1,520
Rebound effect	-6,340	-5,960	-5,620	-4,850	-3,610	-3,320	-2,200	-2,170
Total	-12,700	-11,800	-11,000	-9,300	-6,940	-5,950	-3,240	-3,690
Fatalities Societal \$B								
Mass changes	-0.5	-0.5	-0.5	-0.6	-0.5	-0.2	0.0	-0.1
Sales Impacts	-17.9	-16.4	-15.2	-12.5	-9.2	-7.7	-3.6	-4.4
Subtotal CAFE Atrb.	-18.4	-16.9	-15.7	-13.1	-9.7	-8.0	-3.7	-4.5
Rebound effect	-25.8	-24.3	-22.9	-19.8	-14.6	-13.9	-9.5	-8.9
Total	-44.3	-41.1	-38.6	-33.0	-24.3	-21.9	-13.2	-13.3
Nonfatal Societal \$B								
Mass changes	-0.8	-0.7	-0.7	-1.0	-0.8	-0.4	-0.1	-0.2
Sales Impacts	-28.0	-25.7	-23.8	-19.6	-14.3	-12.1	-5.7	-6.8
Subtotal CAFE Atrb.	-28.8	-26.4	-24.5	-20.5	-15.2	-12.5	-5.7	-7.0
Rebound effect	-40.4	-38.0	-35.9	-31.0	-22.8	-21.7	-14.9	-13.9
Total	-69.2	-64.3	-60.4	-51.5	-38.0	-34.2	-20.6	-20.8
Total Societal \$B								
Mass changes	-1.3	-1.2	-1.2	-1.6	-1.4	-0.6	-0.1	-0.3
Sales Impacts	-45.9	-42.1	-39.0	-32.1	-23.5	-19.8	-9.3	-11.2
Subtotal CAFE Atrb.	-47.2	-43.3	-40.2	-33.6	-24.9	-20.5	-9.4	-11.4
Rebound effect	-66.2	-62.3	-58.8	-50.8	-37.4	-35.6	-24.4	-22.8
Total	-114	-105	-99.0	-84.5	-62.3	-56.1	-33.8	-34.1

Table II-75 through Table II-78 summarize the safety effects of GHG standards across the various alternatives under the 3% and 7% discount rates. As

noted in Section II.F.5, societal impacts are valued using a \$9.9 million value per statistical life (VSL). Fatalities in these tables are undiscounted; only the

monetized societal impact is discounted.

**Table II-75 - Change in Safety Parameters from GHG Augural Standards Baseline
Average Annual Fatalities, CY 2036-2045, 3% Discount Rate**

Change in Safety Parameters from Augural Standards Baseline								
Average Annual Fatalities, CY 2036-2045, 3% Discount Rate								
	Alt 1	Alt 2	Alt 3	Alt 4	Alt 5	Alt 6	Alt 7	Alt 8
<u>Fatalities</u>								
Mass changes	-56	-52	-42	-34	-15	-13	-8	-5
Sales Impacts	-221	-213	-177	-131	-93	-66	-34	-36
Subtotal CAFE Atrb.	-277	-265	-219	-165	-108	-79	-42	-41
Rebound effect	-872	-838	-726	-594	-415	-336	-165	-215
Total	-1,150	-1,100	-945	-759	-523	-415	-207	-256
<u>Fatalities Societal \$B</u>								
Mass changes	-0.27	-0.25	-0.21	-0.17	-0.08	-0.07	-0.04	-0.02
Sales Impacts	-1.11	-1.07	-0.89	-0.66	-0.47	-0.33	-0.17	-0.18
Subtotal CAFE Atrb.	-1.39	-1.33	-1.10	-0.83	-0.54	-0.40	-0.21	-0.21
Rebound effect	-4.31	-4.15	-3.60	-2.94	-2.05	-1.66	-0.82	-1.06
Total	-5.70	-5.47	-4.69	-3.76	-2.59	-2.06	-1.03	-1.27
<u>Nonfatal Societal \$B</u>								
Mass changes	-0.43	-0.40	-0.32	-0.26	-0.12	-0.11	-0.06	-0.04
Sales Impacts	-1.74	-1.68	-1.39	-1.03	-0.73	-0.52	-0.27	-0.29
Subtotal CAFE Atrb.	-2.17	-2.07	-1.71	-1.29	-0.85	-0.62	-0.33	-0.32
Rebound effect	-6.75	-6.48	-5.62	-4.60	-3.21	-2.60	-1.28	-1.66
Total	-8.92	-8.56	-7.34	-5.89	-4.06	-3.22	-1.60	-1.99
<u>Total Societal \$B</u>								
Mass changes	-0.70	-0.65	-0.53	-0.43	-0.19	-0.17	-0.10	-0.06
Sales Impacts	-2.85	-2.75	-2.28	-1.69	-1.20	-0.85	-0.44	-0.47
Subtotal CAFE Atrb.	-3.56	-3.40	-2.81	-2.12	-1.39	-1.02	-0.54	-0.53
Rebound effect	-11.1	-10.6	-9.22	-7.54	-5.26	-4.26	-2.10	-2.72
Total	-14.6	-14.0	-12.0	-9.65	-6.65	-5.28	-2.63	-3.26

**Table II-76 - Change in Safety Parameters from GHG Augural Standards Baseline
Average Annual Fatalities, CY 2036-2045, 7% Discount Rate**

Change in Safety Parameters from Augural Standards Baseline								
Average Annual Fatalities, CY 2036-2045. 7% Discount Rate								
	Alt 1	Alt 2	Alt 3	Alt 4	Alt 5	Alt 6	Alt 7	Alt 8
<u>Fatalities</u>								
Mass changes	-56	-52	-42	-34	-15	-13	-8	-5
Sales Impacts	-221	-213	-177	-131	-93	-66	-34	-36
Subtotal CAFE Attrib.	-277	-265	-219	-165	-108	-79	-42	-41
Rebound effect	-872	-838	-726	-594	-415	-336	-165	-215
Total	-1,150	-1,100	-945	-759	-523	-415	-207	-256
<u>Fatalities Societal \$B</u>								
Mass changes	-0.11	-0.11	-0.09	-0.07	-0.03	-0.03	-0.02	-0.01
Sales Impacts	-0.47	-0.45	-0.37	-0.28	-0.20	-0.14	-0.07	-0.08
Subtotal CAFE Attrib.	-0.58	-0.56	-0.46	-0.35	-0.23	-0.17	-0.09	-0.09
Rebound effect	-1.78	-1.71	-1.49	-1.22	-0.85	-0.69	-0.34	-0.44
Total	-2.36	-2.27	-1.95	-1.56	-1.08	-0.86	-0.43	-0.53
<u>Nonfatal Societal \$B</u>								
Mass changes	-0.18	-0.16	-0.13	-0.11	-0.05	-0.04	-0.03	-0.02
Sales Impacts	-0.73	-0.71	-0.59	-0.44	-0.31	-0.22	-0.11	-0.12
Subtotal CAFE Attrib.	-0.91	-0.87	-0.72	-0.54	-0.36	-0.26	-0.14	-0.14
Rebound effect	-2.79	-2.68	-2.32	-1.90	-1.33	-1.07	-0.53	-0.69

Total	-3.70	-3.55	-3.04	-2.44	-1.68	-1.34	-0.67	-0.83
<u>Total Societal \$B</u>								
Mass changes	-0.29	-0.27	-0.22	-0.18	-0.08	-0.07	-0.04	-0.02
Sales Impacts	-1.20	-1.16	-0.96	-0.72	-0.51	-0.36	-0.19	-0.20
Subtotal CAFE Atrb.	-1.49	-1.43	-1.18	-0.89	-0.59	-0.43	-0.23	-0.22
Rebound effect	-4.57	-4.39	-3.81	-3.12	-2.18	-1.76	-0.87	-1.13
Total	-6.06	-5.82	-4.99	-4.00	-2.76	-2.20	-1.09	-1.35

**Table II-77 - Change in Safety Parameters from GHG Augural Standards Baseline
Total Fatalities MY 1977-2029, 3% Discount Rate**

Change in Safety Parameters from Augural Standards Baseline								
Total Fatalities MY 1977-2029, 3% Discount Rate								
	Alt 1	Alt 2	Alt 3	Alt 4	Alt 5	Alt 6	Alt 7	Alt 8
<u>Fatalities</u>								
Mass changes	-468	-461	-410	-297	-219	-186	-111	-85
Sales Impacts	-7,880	-7,600	-6,630	-5,460	-4,150	-3,240	-1,530	-2,090
Subtotal CAFE Atrb.	-8,350	-8,060	-7,040	-5,760	-4,370	-3,430	-1,640	-2,170
Rebound effect	-7,300	-6,930	-6,340	-5,250	-3,480	-3,260	-2,110	-2,010
Total	-15,600	-15,000	-13,400	-11,000	-7,850	-6,690	-3,760	-4,190
<u>Fatalities Societal \$B</u>								
Mass changes	-2.9	-2.9	-2.6	-1.9	-1.4	-1.2	-0.7	-0.5
Sales Impacts	-43.3	-41.7	-36.6	-30.1	-22.5	-18.0	-8.9	-11.6
Subtotal CAFE Atrb.	-46.2	-44.6	-39.2	-32.0	-23.9	-19.2	-9.7	-12.1
Rebound effect	-47.8	-45.3	-41.6	-34.4	-22.7	-21.5	-14.2	-13.3
Total	-94.0	-89.9	-80.8	-66.4	-46.6	-40.7	-23.8	-25.4
<u>Nonfatal Societal \$B</u>								
Mass changes	-4.6	-4.5	-4.0	-2.9	-2.2	-1.9	-1.1	-0.8
Sales Impacts	-67.8	-65.2	-57.3	-47.1	-35.2	-28.2	-13.9	-18.1
Subtotal CAFE Atrb.	-72.3	-69.7	-61.3	-50.0	-37.3	-30.0	-15.1	-18.9
Rebound effect	-74.7	-70.8	-65.0	-53.9	-35.6	-33.7	-22.1	-20.8
Total	-147	-141	-126	-104	-72.9	-63.7	-37.2	-39.7
<u>Total Societal \$B</u>								
Mass changes	-7.5	-7.4	-6.6	-4.8	-3.5	-3.1	-1.9	-1.4
Sales Impacts	-111	-107	-93.9	-77.2	-57.7	-46.2	-22.8	-29.7
Subtotal CAFE Atrb.	-119	-114	-101	-82.0	-61.2	-49.2	-24.8	-31.0
Rebound effect	-123	-116	-107	-88.3	-58.3	-55.2	-36.3	-34.1
Total	-241	-231	-207	-170	-120	-104	-61.0	-65.1

**Table II-78 - Change in Safety Parameters from GHG Augural Standards Baseline
Total Fatalities MY 1977-2029, 7% Discount Rate**

Change in Safety Parameters from Augural Standards Baseline								
Total Fatalities MY 1977-2029, 7% Discount Rate								
	Alt 1	Alt 2	Alt 3	Alt 4	Alt 5	Alt 6	Alt 7	Alt 8
<u>Fatalities</u>								
Mass changes	-468	-461	-410	-297	-219	-186	-111	-85
Sales Impacts	-7,880	-7,600	-6,630	-5,460	-4,150	-3,240	-1,530	-2,090
Subtotal CAFE Attrib.	-8,350	-8,060	-7,040	-5,760	-4,370	-3,430	-1,640	-2,170
Rebound effect	-7,300	-6,930	-6,340	-5,250	-3,480	-3,260	-2,110	-2,010
Total	-15,600	-15,000	-13,400	-11,000	-7,850	-6,690	-3,760	-4,190
<u>Fatalities Societal \$B</u>								
Mass changes	-1.7	-1.7	-1.5	-1.1	-0.8	-0.7	-0.5	-0.3
Sales Impacts	-22.1	-21.2	-18.8	-15.5	-11.3	-9.4	-5.0	-6.0
Subtotal CAFE Attrib.	-23.8	-22.9	-20.4	-16.6	-12.1	-10.1	-5.5	-6.3
Rebound effect	-29.4	-27.8	-25.7	-21.3	-14.0	-13.4	-9.0	-8.3
Total	-53.2	-50.7	-46.0	-37.8	-26.1	-23.6	-14.4	-14.6
<u>Nonfatal Societal \$B</u>								
Mass changes	-2.7	-2.7	-2.4	-1.7	-1.3	-1.1	-0.7	-0.5
Sales Impacts	-34.6	-33.1	-29.4	-24.2	-17.7	-14.7	-7.8	-9.4
Subtotal CAFE Attrib.	-37.3	-35.8	-31.8	-25.9	-19.0	-15.9	-8.5	-9.9
Rebound effect	-46.0	-43.5	-40.1	-33.3	-21.9	-21.0	-14.1	-12.9
Total	-83.3	-79.3	-72.0	-59.2	-40.8	-36.9	-22.6	-22.8
<u>Total Societal \$B</u>								
Mass changes	-4.4	-4.4	-3.9	-2.8	-2.1	-1.9	-1.2	-0.8
Sales Impacts	-56.7	-54.3	-48.2	-39.7	-29.0	-24.1	-12.8	-15.4
Subtotal CAFE Attrib.	-61.1	-58.7	-52.2	-42.5	-31.1	-26.0	-14.0	-16.2
Rebound effect	-75.4	-71.3	-65.8	-54.6	-35.9	-34.4	-23.1	-21.2
Total	-137	-130	-118	-97.0	-66.9	-60.5	-37.0	-37.4

While NHTSA notes the value of rebound effect fatalities, as well as total fatalities from all causes, the agency does not add rebound effects to the other CAFE-related impacts because rebound-related fatalities and injuries result from risk that is freely chosen and offset by societal valuations that at a minimum exceed the aggregate value of safety consequences plus added vehicle operating and maintenance costs.³³⁰

These costs implicitly involve a cost and a benefit that are offsetting. The relevant safety impacts attributable to CAFE are highlighted in bold in the above tables.

G. How the Model Analyzes Different Potential CAFE and CO₂ Standards

1. Specification of No-Action and Other Regulatory Alternatives
 - (a) Mathematical Functions Defining Passenger Car and Light Trucks Standards for Each Model Year During 2016–2032

In the U.S. market, the stringency of CAFE and CO₂ standards can influence the design of new vehicles offered for sale by requiring manufacturers to produce increasingly fuel efficient vehicles in order to meet program

³³⁰ It would also include some level of consumer surplus, which we have estimated using the standard triangular function. This is discussed in Chapter 8.5.1 of the PRIA.

requirements. This is also true in the CAFE model simulation, where the standards can be defined with a great deal of flexibility to examine the impact of different program specifications on the auto industry. Standards are defined for each model year and can represent different slopes that relate fuel economy to footprint, different regions of flat slopes, and different rates of increase for each of three regulatory classes covered by the CAFE program (domestic passenger cars, imported passenger cars, and light trucks).

The CAFE model takes, as inputs, the coefficients of the mathematical functions described in Sections III and IV. It uses these coefficients and the function to which they belong to define the target for each vehicle in the fleet, then computes the standard using the harmonic average of the targets for each manufacturer and fleet. The model also allows the user to define the extent and duration of various compliance flexibilities (*e.g.*, limits on the amount of credit that a manufacturer may claim related to air conditioning efficiency improvements or off-cycle fuel economy adjustments) as well as limits on the number of years that CAFE credits may be carried forward or the amount that may be transferred between a manufacturer's fleets.

(b) Off-Cycle and A/C Efficiency Adjustments Anticipated for Each Model Year

Another aspect of credit accounting is partially implemented in the CAFE model at this point—those related to the application of off-cycle and A/C efficiency adjustments, which manufacturers earn by taking actions such as special window glazing or using reflective paints that provide fuel economy improvements in real-world operation but do not produce measurable improvements in fuel consumption on the 2-cycle test.

NHTSA's inclusion of off-cycle and A/C efficiency adjustments began in MY 2017, while EPA has collected several years' worth of submissions from manufacturers about off-cycle and A/C efficiency technology deployment. Currently, the level of deployment can vary considerably by manufacturer with several claiming extensive Fuel Consumption Improvement Values (FCIV) for off-cycle and A/C efficiency technologies and others almost none. The analysis of alternatives presented here does not attempt to project how future off-cycle and A/C efficiency technology use will evolve or speculate about the potential proliferation of FCIV proposals submitted to the agencies. Rather, this analysis uses the off-cycle credits submitted by each manufacturer for MY 2017 compliance and carries

these forward to future years with a few exceptions. Several of the technologies described in Section II.D are associated with A/C efficiency and off-cycle FCIVs. In particular, stop-start systems, integrated starter generators, and full hybrids are assumed to generate off-cycle adjustments when applied to vehicles to improve their fuel economy. Similarly, higher levels of aerodynamic improvements are assumed to include active grille shutters on the vehicle, which also qualify for off-cycle FCIVs.

The analysis assumes that any off-cycle FCIVs that are associated with actions outside of the technologies discussed in Section II.D (either chosen from the pre-approved "pick list," or granted in response to individual manufacturer petitions) remain at the levels claimed by manufacturers in MY 2017. Any additional A/C efficiency and off-cycle adjustments that accrue as the result of explicit technology application are calculated dynamically in each model year for each alternative. The off-cycle FCIVs for each manufacturer and fleet, denominated in grams CO₂ per mile,³³¹ are provided in Table II-79.

³³¹ For the purpose of estimating their contribution to CAFE compliance, the grams CO₂/mile values in Table II-79 are converted to gallons/mile and applied to a manufacturer's 2-cycle CAFE performance. When calculating compliance with EPA's GHG program, there is no conversion necessary (as standards are also denominated in grams/mile).

Table II-79 - Off-Cycle Fuel Economy Adjustments (Exclusive of Technology Tree)

Manufacturer	Off-Cycle Adjustments	
	PC	LT
BMW	1.70	2.60
Daimler	1.60	0.50
FCA	2.90	7.30
Ford	1.80	3.40
General Motors	2.20	4.00
Honda	1.90	1.60
Hyundai Kia-H	0.90	5.00
Hyundai Kia-K	1.00	3.00
JLR	0.50	4.20
Mazda	-	-
Nissan Mitsubishi	1.90	3.00
SUBARU	-	-
Tesla	-	-
TOYOTA	0.60	2.80
Volvo	-	-
VWA	-	-

The model currently accounts for any off-cycle adjustments associated with technologies that are included in the set of fuel-saving technologies explicitly simulated as part of this proposal (for example, start-stop systems that reduce fuel consumption during idle or active grille shutters that improve aerodynamic drag at highway speeds) and accumulates these adjustments up to the 10 g/mi cap. As a practical matter, most of the adjustments for which manufacturers are claiming off-cycle FCIV exist outside of the technology tree, so the cap is rarely reached during compliance simulation. If those FCIVs become a more important compliance mechanism, it may be necessary to model their application explicitly. However, doing so will require data on which vehicle models already possess these improvements as well as the cost and expected value of applying them to other models in the future. Comment is sought on both the data requirements and strategic decisions associated with manufacturers' use of A/C efficiency and off-cycle technologies to improve CAFE and CO₂ compliance.

(c) Civil Penalty Rate and OEMs' Anticipated Willingness To Treat Civil Penalties as a Program Flexibility

Throughout the history of the CAFE program, some manufacturers have

consistently achieved fuel economy levels below their standard. As in previous versions of the CAFE model, the current version allows the user to specify inputs identifying such manufacturers and to consider their compliance decisions as if they are willing to pay civil penalties for non-compliance with the CAFE program. The assumed civil penalty rate in the current analysis is \$5.50 per 1/10 of a mile per gallon, per vehicle sold.

It is worth noting that treating a manufacturer as if they are willing to pay civil penalties does not necessarily mean that it is expected to pay penalties in reality. It merely implies that the manufacturer will only apply fuel economy technology up to a point, and then stop, regardless of whether or not its corporate average fuel economy is above its standard. In practice, we expect that many of these manufacturers will continue to be active in the credit market, using trades with other manufacturers to transfer credits into specific fleets that are challenged in any given year, rather than paying penalties to resolve CAFE deficits. The CAFE model calculates the amount of penalties paid by each manufacturer, but it does not simulate trades between manufacturers. In practice, some (possibly most) of the total estimated

penalties may be a transfer from one OEM to another.

While the Energy Policy and Conservation Act (EPCA), as amended in 2007 by the Energy Independence and Security Act, prescribes these specific civil penalty provisions for CAFE standards, the Clean Air Act (CAA) does not contain similar provisions. Rather, the CAA's provisions regarding noncompliance constitute a de facto prohibition against selling vehicles failing to comply with emissions standards. Therefore, inputs regarding civil penalties—including inputs regarding manufacturers' potential willingness to treat civil penalty payment as an economic choice—apply only to simulation of CAFE standards.

(d) Treatment of Credit Provisions for "Standard Setting" and "Unconstrained" Analyses

NHTSA may not consider the application of CAFE credits toward compliance with new standards when establishing the standards themselves.³³² As such, this analysis considers 2020 to be the last model year in which carried-forward or transferred credits can be applied for the CAFE program. Beginning in model year 2021,

³³² 49 U.S.C. 32902(h) (2007).

today's "standard setting" analysis is conducted assuming each fleet must comply with the CAFE standard separately in every model year.

The "unconstrained" perspective acknowledges that these flexibilities exist as part of the program and, while not considered in NHTSA's decision of the preferred alternative, are important to consider when attempting to estimate the real impact of any alternative. Under the "unconstrained" perspective, credits may be earned, transferred, and applied to deficits in the CAFE program throughout the full range of model years in the analysis. The Draft Environmental Impact Analysis (DEIS) accompanying today's NPRM presents results of "unconstrained" modeling. Also, because the CAA provides no direction regarding consideration of any CO₂ credit provisions, today's analysis includes simulation of carried-forward and transferred CO₂ credits in all model years.

(e) Treatment of AFVs for "Standard Setting" and "Unconstrained" Analyses

NHTSA is also prohibited from considering the possibility that a manufacturer might produce alternatively fueled vehicles as a compliance mechanism,³³³ taking advantage of credit provisions related to AFVs that significantly increase their fuel economy for CAFE compliance purposes. Under the "standard setting" perspective, these technologies (pure battery electric vehicles and fuel cell vehicles³³⁴) are not available in the compliance simulation to improve fuel economy. Under the "unconstrained" perspective, such as is documented in the DEIS, the CAFE model considers these technologies in the context of all other available technologies and may apply them if they represent cost-effective compliance pathways. However, under both perspectives, the analysis continues to include dedicated AFVs that already exist in the MY 2016 fleet (and their projected future volumes) in CAFE calculations. Also, because the CAA provides no direction regarding consideration of alternative fuels, today's analysis includes simulation of the potential that some manufacturers might introduce new AFVs in response to CO₂ standards. To fully represent the compliance benefit from such a response, NHTSA modified the CAFE model to include the specific provisions related to AFVs under the CO₂ standards. In particular, the CAFE

model now carries a full representation of the production multipliers related to electric vehicles, fuel cell vehicles, plug-in hybrids, and CNG vehicles, all of which vary by year through MY 2021.

2. Simulation of Manufacturers' [and Buyers'] Potential Responses to Each Alternative

The CAFE model provides a way of estimating how manufacturers could attempt to comply with a given CAFE standard by adding technology to fleets that the agencies anticipate they will produce in future model years. This exercise constitutes a simulation of manufacturers' decisions regarding compliance with CAFE or CO₂ standards.

This compliance simulation begins with the following inputs: (a) The analysis fleet of vehicles from model year 2016 discussed above in Section II.B, (b) fuel economy improving technology estimates discussed above in Section II.D, (c) economic inputs discussed above in Section II.E, and (d) inputs defining baseline and potential new CAFE standards. For each manufacturer, the model applies technologies in both a logical sequence and a cost-minimizing strategy in order to identify a set of technologies the manufacturer could apply in response to new CAFE or CO₂ standards. The model applies technologies to each of the projected individual vehicles in a manufacturer's fleet, considering the combined effect of regulatory and market incentives while attempting to account for manufacturers' production constraints. Depending on how the model is exercised, it will apply technology until one of the following occurs:

(1) The manufacturer's fleet achieves compliance³³⁵ with the applicable standard and continuing to add technology in the current model year would be attractive neither in terms of stand-alone (*i.e.*, absent regulatory need) cost-effectiveness nor in terms of facilitating compliance in future model years;

(2) The manufacturer "exhausts" available technologies;³³⁶ or

³³⁵ When determining whether compliance has been achieved in the CAFE program, existing CAFE credits that may be carried over from prior model years or transferred between fleets are also used to determine compliance status. For purposes of determining the effect of maximum feasible CAFE standards, NHTSA cannot consider these mechanisms for years being considered (though does so for model years that are already final) and exercises the CAFE model without enabling these options.

³³⁶ In a given model year, it is possible that production constraints cause a manufacturer to "run out" of available technology before achieving compliance with standards. This can occur when: (a) An insufficient volume of vehicles are expected

(3) For manufacturers assumed to be willing to pay civil penalties (in the CAFE program), the manufacturer reaches the point at which doing so would be more cost-effective (from the manufacturer's perspective) than adding further technology.

The model accounts explicitly for each model year, applying technologies when vehicles are scheduled to be redesigned or freshened and carrying forward technologies between model years once they are applied (until, if applicable, they are superseded by other technologies). The model then uses these simulated manufacturer fleets to generate both a representation of the U.S. auto industry and to modify a representation of the entire light-duty registered vehicle population. From these fleets, the model estimates changes in physical quantities (gallons of fuel, pollutant emissions, traffic fatalities, etc.) and calculates the relative costs and benefits of regulatory alternatives under consideration.

The CAFE model accounts explicitly for each model year, in turn, because manufacturers actually "carry forward" most technologies between model years, tending to concentrate the application of new technology to vehicle redesigns or mid-cycle "freshenings," and design cycles vary widely among manufacturers and specific products. Comments by manufacturers and model peer reviewers strongly support explicit year-by-year simulation. Year-by-year accounting also enables accounting for credit banking (*i.e.*, carry-forward), as discussed above, and at least four environmental organizations recently submitted comments urging the agencies to consider such credits, citing NHTSA's 2016 results showing impacts of carried-forward credits.³³⁷ Moreover, EPCA/EISA requires that NHTSA make a year-by-year determination of the appropriate level of stringency and then set the standard at that level, while ensuring ratable increases in average fuel economy through MY 2020. The multi-year planning capability, (optional) simulation of "market-driven overcompliance," and EPCA credit mechanisms (again, for purposes of modeling the CAFE program) increase the model's ability to simulate manufacturers' real-world behavior, accounting for the fact that

to be redesigned, (b) vehicles have moved to the ends of each (relevant) technology pathway, after which no additional options exist, or (c) engineering aspects of available vehicles make available technology inapplicable (*e.g.*, secondary axle disconnect cannot be applied to two-wheel drive vehicles).

³³⁷ Comment by Environmental Law & Policy Center, Natural Resources Defense Council (NRDC), Public Citizen, and Sierra Club, Docket ID EPA-HQ-OAR-2015-0827-9826, at 28-29.

³³³ *Id.*

³³⁴ Dedicated compressed natural gas (CNG) vehicles should also be excluded in this perspective but are not considered as a compliance strategy under any perspective in this analysis.

manufacturers will seek out compliance paths for several model years at a time, while accommodating the year-by-year requirement. This same multi-year planning structure is used to simulate responses to standards defined in grams CO₂/mile, and utilizing the set of specific credit provisions defined under EPA's program.

(a) Representation of Manufacturers' Production Constraints

After the light-duty rulemaking analysis accompanying the 2012 final rule that finalized NHTSA's standards through MY 2021, NHTSA began work on changes to the CAFE model with the intention of better reflecting constraints of product planning and cadence for which previous analyses did not account.

(b) Product Cadence

Past comments on the CAFE model have stressed the importance of product cadence—*i.e.*, the development and periodic redesign and freshening of vehicles—in terms of involving technical, financial, and other practical constraints on applying new technologies, and DOT has steadily made changes to both the CAFE model and its inputs with a view toward accounting for these considerations. For example, early versions of the model added explicit “carrying forward” of applied technologies between model years, subsequent versions applied assumptions that most technologies will be applied when vehicles are freshened or redesigned, and more recent versions applied assumptions that manufacturers would sometimes apply technology earlier than “necessary” in order to facilitate compliance with standards in ensuing model years. Thus, for example, if a manufacturer is expected to redesign many of its products in model years 2018 and 2023, and the standard's stringency increases significantly in model year 2021, the CAFE model will estimate the potential that the manufacturer will add more technology than necessary for compliance in MY 2018, in order to carry those product changes forward through the next redesign and contribute to compliance with the MY 2021 standard. This explicit simulation of multiyear planning plays an important role in determining year-by-year analytical results.

As in previous iterations of CAFE rulemaking analysis, the simulation of compliance actions that manufacturers might take is constrained by the pace at which new technologies can be applied in the new vehicle market. Operating at the Make/Model level (*e.g.*, Toyota

Camry) allows the CAFE model to explicitly account for the fact that individual vehicle models undergo significant redesigns relatively infrequently. Many popular vehicle models are only redesigned every six years or so, with some larger/legacy platforms (the old Ford Econoline Vans, for example) stretching more than a decade between significant redesigns. Engines, which are often shared among many different models and platforms for a single manufacturer, can last even longer—eight to ten years in most cases.

While these characterizations of product cadence are important to any evaluation of the impacts of CAFE or CO₂ standards, they are not known with certainty—even by the manufacturers themselves over time horizons as long as those covered by this analysis. However, lack of certainty about redesign schedules is not license to ignore them. Indeed, when manufacturers meet with the agencies to discuss manufacturers' plans vis-à-vis CAFE and CO₂ requirements, manufacturers typically present specific and detailed year-by-year information that explicitly accounts for anticipated redesigns. Such year-by-year analysis is also essential to manufacturers' plans to make use of provisions (for CAFE, statutory and specific) allowing credits to be carried forward to future model years, carried back from future model years, transferred between regulated fleets, and traded with other manufacturers. Manufacturers are never certain about future plans, but they spend considerable effort developing, continually adjusting, and implementing them.

For every model that appears in the MY 2016 analysis fleet, the model years have been estimated in which future redesigns (and less significant “freshenings,” which offer manufacturers the opportunity to make less significant changes to models) will occur. These appear in the market data file for each model variant. Mid-cycle freshenings provide additional opportunities to add some technologies in years where smaller shares of a manufacturer's portfolio is scheduled to be redesigned. In addition, the analysis accounts for multiyear planning—that is, the potential that manufacturers may apply “extra” technology in an early model year with many planned redesigns in order to carry technology forward to facilitate compliance in a later model year with fewer planned redesigns. Further, the analysis accounts for the potential that manufacturers could earn CAFE and/or CO₂ credits in some model years and use those credits in later model years, thereby providing

another compliance option in years with few planned redesigns. Finally, it should be noted that today's analysis does not account for future new products (or discontinued products)—past trends suggest that some years in which an OEM had few redesigns may have been years when that OEM introduced significant new products. Such changes in product offerings can obviously be important to manufacturers' compliance positions but cannot be systematically and transparently accounted for with a fleet forecast extrapolated forward 10 or more years from a largely-known fleet. While manufacturers' actual plans reflect intentions to discontinue some products and introduce others, those plans are considered CBI. Further research would be required in order to determine whether and, if so, how it would be practicable to simulate such decisions, especially without relying on CBI.

Additionally, each technology considered for application by the CAFE model is assigned to either a “refresh” or “redesign” cadence that dictates when it can be applied to a vehicle. Technologies that are assigned to “refresh/redesign” can be applied at either a refresh or redesign, while technologies that are assigned to “redesign” can only be applied during a significant vehicle redesign. Table II-80 and Table II-81 show the technologies available to manufacturers in the compliance simulation, the level at which they are applied (described in greater detail in the CAFE model documentation), whether they are available outside of a vehicle redesign, and a short description of each. A brief examination of the tables shows that most technologies are only assumed to be available during a vehicle redesign—and nearly all engine improvements are assumed to be available only during redesign. In a departure from past CAFE analyses, all transmission improvements are assumed to be available during refresh as well as redesign. While there are past and recent examples of mid-cycle product changes, it seems reasonable to expect that manufacturers will tend to attempt to keep engineering and other costs down by applying most major changes mainly during vehicle redesigns and some mostly modest changes during product freshenings. As mentioned below, comment is sought on the approach to account for product cadence.

(c) Component Sharing and Inheritance (Engines, Transmissions, and Platforms)

In practice, manufacturers are limited in the number of engines and transmissions that they produce.

Typically, a manufacturer produces a number of engines—perhaps six or eight engines for a large manufacturer—and tunes them for slight variants in output for a variety of car and truck applications. Manufacturers limit complexity in their engine portfolio for much the same reason as they limit complexity in vehicle variants: They face engineering manpower limitations, and supplier, production, and service costs that scale with the number of parts produced.

In previous analyses that used the CAFE model (with the exception of the 2016 Draft TAR), engines and transmissions in individual vehicle models were allowed relative freedom in technology application, potentially leading to solutions that would, if followed, create many more unique engines and transmissions than exist in the analysis fleet (or in the market) for a given model year. This multiplicity likely failed to sufficiently account for costs associated with such increased complexity in the product portfolio and may have represented an unrealistic diffusion of products for manufacturers that are consolidating global production to increasingly smaller numbers of shared engines and platforms.³³⁸ The lack of a constraint in this area allowed the model to apply different levels of technology to the engine in each vehicle in which it was present at the time that vehicle was redesigned or refreshed, independent of what was done to other vehicles using a previously identical engine.

One peer reviewer of the CAFE model recently commented, “The integration of inheritance and sharing of engines, transmissions, and platforms across a manufacturer’s light duty fleet and separately across its light duty truck fleet is standard practice within the industry.” In the current version of the CAFE model, engines and transmissions that are shared between vehicles must apply the same levels of technology, in all technologies, dictated by engine or transmission inheritance. This forced adoption is referred to as “engine inheritance” in the model documentation. In practice, the model first chooses an “engine leader” among vehicles sharing the same engine—the vehicle with the highest sales in MY 2016. If there is a tie, the vehicle with the highest average MSRP is chosen, representing the idea that manufacturers will choose to pilot the newest technology on premium vehicles if possible. The model applies the same logic with respect to the application of transmission changes. After the model

modifies the engine on the “engine leader” (or “transmission leader”), the changes to that engine propagate through to the other vehicles that share that engine (or transmission) in subsequent years as those vehicles are redesigned. The CAFE model has been modified to provide additional flexibility vis-à-vis product cadence. In a recent public comment, NRDC noted:

EPA and NHTSA currently constrain their model to apply significant fuel-efficient technologies mainly during a product-redesign as opposed to product-refresh (or mid-cycle). This was identified as one of the most sensitive assumptions affecting overall program costs by NHTSA in the TAR. By constraining the model, the agencies have likely under-estimated the ability of auto manufacturers to incorporate some technologies during their product refreshes. This is particularly true regarding the critical powertrain technologies which are undergoing continuous improvement. The agency should account for these trends and incorporate greater flexibility for automakers—within their models—to incorporate more mid-cycle enhancements.³³⁹

While engine redesigns are only applied to the engine leader when it is redesigned in the model, followers may now inherit upgraded engines (that they share with the leader) at either refresh or redesign. All transmission changes, whether upgrades to the “leader” or inheritance to “followers” can occur at refresh as well as redesign. This provides additional opportunities for technology diffusion within manufacturers’ product portfolios.

While “follower” vehicles are awaiting redesign (or, for transmissions, refreshing as applicable), they carry a legacy version of the shared engine or transmission. As one peer reviewer recently stated, “*Most of the time a manufacturer will convert only a single plant within a model year. Thus both the ‘old’ and ‘new’ variant of the engine (or transmission) will produced for a finite number of years.*”³⁴⁰ The CAFE model currently carries no additional cost associated with producing both earlier revisions of an engine and the updated version simultaneously. Further research would be needed to determine whether sufficient data is likely to be available to explicitly specify and apply additional costs involved with continuing to produce an existing engine or transmission for some vehicles that have not yet progressed to a newer version of that engine or transmission. Comment is sought on

possible data sources and approaches that could be used to represent any additional costs associated with phased introduction of new engines or transmissions.

There are some logical consequences of this approach, the first of which is that forcing engine and transmission changes to propagate through to other vehicles in this way effectively dictates the pace at which new technology can be applied and limits the total number of unique engines that the model simulates. In the past, NHTSA used “phase-in caps” (see discussion below) to limit the amount of technology that can be applied to any vehicle in a given year. However, by explicitly tying the engine changes to a specific vehicle’s product cadence, rather than letting the timing of changes vary across all the vehicles that share an engine, the model ensures that an engine is only changed when its leader is redesigned (at most). Given that most vehicle redesign cycles are five to eight years, this approach still represents shorter average lives than most engines in the market, which tend to be in production for eight to ten years or more. It is also the case that vehicles which share an engine in the analysis fleet (MY 2016, for this analysis) are assumed to share that same engine throughout the analysis—unless one or both of them are converted to power-split hybrids (or farther) on the electrification path. In the market, this is not true—since a manufacturer will choose an engine from among the engines it produces to fulfill the efficiency and power demands of a vehicle model upon redesign. That engine need not be from the same family of engines as the prior version of that vehicle. This is a simplifying assumption in the model. While the model already accommodates detailed inputs regarding redesign schedules for specific vehicles and commercial information sources are available to inform these inputs, further research would be needed to determine whether design schedules for specific engines and transmissions can practicably be simulated.

The CAFE model has implemented a similar structure to address shared vehicle platforms. The term “platform” is used loosely in industry but generally refers to a common structure shared by a group of vehicle variants. The degree of commonality varies with some platform variants exhibiting traditional “badge engineering” where two products are differentiated by little more than insignias, while other platforms may be used to produce a broad suite of vehicles that bear little outer resemblance to one another.

³³⁹ Comment by Environmental Law & Policy Center, Natural Resources Defense Council (NRDC), Public Citizen, and Sierra Club, Docket ID EPA-HQ-OAR-2015-0827-9826, at 32.

³⁴⁰ CAFE Model Peer Review, p. 19.

³³⁸ 2015 NAS Report, at pg. 258–259.

Given the degree of commonality between variants of a single platform, manufacturers do not have complete freedom to apply technology to a vehicle: While some technologies (e.g. low rolling resistance tires) are very nearly “bolt-on” technologies, others involve substantial changes to the structure and design of the vehicle, and therefore necessarily are constant among vehicles that share a common platform. NHTSA has, therefore, modified the CAFE model such that all mass reduction technologies are forced to be constant among variants of a platform.

Within the analysis fleet, each vehicle is associated with a specific platform. Similar to the application of engine and transmission technologies, the CAFE model defines a platform “leader” as the vehicle variant of a given platform that has the highest level of observed mass reduction present in the analysis fleet. If there is a tie, the CAFE model begins mass reduction technology on the vehicle with the highest sales in model year 2016. If there remains a tie, the model begins by choosing the vehicle with the highest MSRP in MY 2016. As the model applies technologies, it effectively levels up all variants on a platform to the highest level of mass reduction technology on the platform. So, if the platform leader is already at MR3 in MY 2016, and a “follower” starts at MR0 in MY 2016, the follower will get MR3 at its next redesign (unless the leader is redesigned again before that time, and further increases the MR level associated with that platform, then the follower would receive the new MR level).

In the 2015 NPRM proposing new fuel consumption and GHG standards for heavy-duty pickups and vans, NHTSA specifically requested comment on the general use of shared engines, transmissions, and platforms within CAFE rulemakings. While no commenter responded to this specific request, comments from some environmental organizations cited examples of technology sharing between light- and heavy-duty products. NHTSA has continued to refine its implementation of an approach accounting for shared engines, transmissions, and platforms, and again seeks comment on the approach, recommendations regarding any other approaches, and any information that would facilitate implementation of the agency’s current approach or any alternative approaches.

(d) Phase-In Caps

The CAFE model retains the ability to use phase-in caps (specified in model inputs) as proxies for a variety of

practical restrictions on technology application, including the improvements described above. Unlike vehicle-specific restrictions related to redesign, refreshes or platforms/engines, phase-in caps constrain technology application at the vehicle manufacturer level for a given model year. Introduced in the 2006 version of the CAFE model, they were intended to reflect a manufacturer’s overall resource capacity available for implementing new technologies (such as engineering research and development personnel and financial resources), thereby ensuring that resource capacity is accounted for in the modeling process.

Compared to prior analyses of light-duty standards, these model changes result in some changes in the broad characteristics of the model’s application of technology to manufacturers’ fleets. Since the use of phase-in caps has been de-emphasized and manufacturer technology deployment remains tied strongly to estimated product redesign and freshening schedules, technology penetration rates may jump more quickly as manufacturers apply technology to high-volume products in their portfolio. As a result, the model will ignore a phase-in cap to apply inherited technology to vehicles on shared engines, transmissions, and platforms.

In previous CAFE rulemakings, redesign/refresh schedules and phase-in caps were the primary mechanisms to reflect an OEM’s limited pool of available resources during the rulemaking time frame and the years preceding it, especially in years where many models may be scheduled for refresh or redesign. The newly-introduced representation of platform-, engine-, and transmission-related considerations discussed above augment the model’s preexisting representation of redesign cycles and eliminate the need to rely on phase-in caps. By design, restrictions that enforce commonality of mass reduction on variants of a platform, and those that enforce engine and transmission inheritance, will result in fewer vehicle-technology combinations in a manufacturer’s future modeled fleet. The integration of shared components and product cadence as a mechanism to control the pace of technology application also more accurately represents each manufacturer’s unique position in the market and its existing technology footprint, rather than a technology-specific phase-in cap that is uniformly applied to all manufacturers in a given year. Comment is sought regarding this shift away from relying

on phase-in caps and, if greater reliance on phase-in caps is recommended, what approach and information can be used to define and apply these caps.

(e) Interactions Between Regulatory Classes

Like earlier versions, the current CAFE model provides the capability for integrated analysis spanning different regulatory classes, accounting both for standards that apply separately to different classes and for interactions between regulatory classes. Light vehicle CAFE and CO₂ standards are specified separately for passenger cars and light trucks. However, there is considerable sharing between these two regulatory classes—where a single engine, transmission, or platform can appear in both the passenger car and light truck regulatory class. For example, some sport-utility vehicles are offered in 2WD versions classified as passenger cars and 4WD versions classified as light trucks. Integrated analysis of manufacturers’ passenger car and light truck fleets provides the ability to account for such sharing and reduces the likelihood of finding solutions that could involve introducing impractical levels of complexity in manufacturers’ product lines. Additionally, integrated fleet analysis provides the ability to simulate the potential that manufacturers could earn CAFE and CO₂ credits by over complying with the standard in one fleet and use those credits toward compliance with the standard in another fleet (*i.e.*, to simulate credit transfers between regulatory classes).

While previous versions of the CAFE model have represented manufacturers’ fleets by drawing a distinction between passenger cars and light trucks, the current version of the CAFE model adds a further distinction, capturing the difference between passenger cars classified as domestic passenger cars and those classified as imports. The CAFE program regulates those passenger cars separately, and the current version of the CAFE model simulates all three CAFE regulatory classes separately: Domestic Passenger Cars (DC), Imported Passenger Cars (IC), and Light Trucks (LT). CAFE regulations state that standards, fuel economy levels, and compliance are all calculated separately for each class. These requirements are specified explicitly by the Energy Policy and Conservation Act (EPCA), with the 2007 Energy Independence and Security Act (EISA) having added the requirement to enforce minimum standards for domestic passenger cars. This update to the accounting imposes two additional constraints on

manufacturers that sell vehicles in the U.S.: (1) The domestic minimum floor, and (2) Limited transfers between cars classified as “domestic” versus those classified as “imported.” The domestic minimum floor creates a threshold that every manufacturer’s domestic car fleet must exceed without the application of CAFE credits. If a manufacturer’s calculated standard is below the domestic minimum floor, then the domestic floor is the binding constraint (even for manufacturers that are assumed to be willing to pay fines for non-compliance). The second constraint poses challenges for manufacturers that sell cars from both the domestic and imported passenger car categories.

While previous versions of the CAFE model considered those fleets as a single fleet (*i.e.*, passenger cars), the model now forces them to comply separately and limits the volume of credits that can be shifted between them for compliance. However, the CAA provides no direction regarding compliance by domestic and imported vehicles; EPA has not adopted provisions similar to the aforementioned EPCA/EISA requirements and is not doing so today. Therefore, consistent with current and proposed CO₂ regulations, the CAFE model determines compliance for manufacturers’ overall passenger car fleets for EPA’s program.

During 2015–2016, a single version of the CAFE model was applied to produce analyses supporting both a rulemaking regarding heavy-duty pickups and vans (HD PUV) and the 2016 draft TAR regarding CAFE standards for passenger cars and light trucks. Both analyses

reflected integrated analysis of the light-duty and HD PUV fleets, thereby accounting for sharing between the fleets. However, for most OEMs, that analysis showed considerably less sharing between light-duty and HD PUV fleets than initially expected. Today’s analysis includes only vehicles subject to CAFE and light-duty CO₂ standards, and the agencies invite comment on whether integrated analysis of the two fleets should be pursued further.

3. Technology Application Algorithm

(a) Technology Representation and Pathways

While some properties of the technologies included in the analysis are specified by the user (*e.g.*, cost of the technology), the set of included technologies is part of the model itself, which contains the information about the relationships between technologies.³⁴¹ In particular, the CAFE model contains the information about the sequence of technologies, the paths on which they reside, any prerequisites associated with a technology’s application, and any exclusions that naturally follow once it is applied.

³⁴¹ Unlike the 2012 Final Rule, where each technology had a single effectiveness value for the CAFE analysis, technology effectiveness in the current version of the CAFE model is based on the ANL simulation project and defined for each combination of technologies, resulting in more than 100,000 technology effectiveness values for each of ten technology classes. This large database is extracted locally the first time the model is run and can be modified by the user in that location to reflect alternative assumptions about technology effectiveness.

The “application level” describes the system of the vehicle to which the technology is applied, which in turn determines the extent to which that decision affects other vehicles in a manufacturer’s fleet. For example, if a technology is applied at the “engine” level, it naturally affects all other vehicles that share that same engine (though not until they themselves are redesigned, if it happens to be in a future model year). Technologies applied at the “vehicle” level can be applied to a vehicle model without impacting the other models with which it shares components. Platform-level technologies affect all of the vehicles on a given platform, which can easily span technology classes, regulatory classes, and redesign cycles.

The “application schedule” identifies when manufacturers are assumed to be able to apply a given technology—with many available only during vehicle redesigns. The application schedule also accounts for which technologies the CAFE model tracks but does not apply. These enter as part of the analysis fleet (“Baseline Only”), and while they are necessary for accounting related to cost and incremental fuel economy improvement, they do not represent a choice that manufacturers make in the model. As discussed in Section II.B, the analysis fleet contains the information about each vehicle model, engine, and transmission selected for simulation and defines the initial technology state of the fleet relative to the sets of technologies in Table II–80 and Table II–81.

Table II-80 - CAFE Model Technologies (1)

Technology	Application Level	Application Schedule	Description
SOHC	Engine	Baseline Only	Single Overhead Camshaft Engine
DOHC	Engine	Baseline Only	Double Overhead Camshaft Engine
OHV	Engine	Baseline Only	Overhead Valve Engine (maps to SOHC)
VVT	Engine	Baseline Only	Variable Valve Timing
VVL	Engine	Redesign Only	Variable Valve Lift
SGDI	Engine	Redesign Only	Stoichiometric Gasoline Direct Injection
DEAC	Engine	Redesign Only	Cylinder Deactivation
HCR	Engine	Redesign Only	High Compression Ratio Engine
HCR2	Engine	Redesign Only	High Compression Ratio Engine with DEAC and CEGR
TURBO1	Engine	Redesign Only	Turbocharging and Downsizing, Level 1 (18 bar)
TURBO2	Engine	Redesign Only	Turbocharging and Downsizing, Level 2 (24 bar)
CEGR1	Engine	Redesign Only	Cooled Exhaust Gas Recirculation, Level 1 (24 bar)
ADEAC	Engine	Redesign Only	Advanced Cylinder Deactivation
CNG	Engine	Baseline Only	Compressed Natural Gas Engine
ADSL	Engine	Redesign Only	Advanced Diesel Engine
DSLI	Engine	Redesign Only	Diesel engine improvements

Table II-81 - CAFE Model Technologies (2)

Technology	Application Level	Application Schedule	Description
MT5	Transmission	Refresh/Redesign	5-Speed Manual Transmission
MT6	Transmission	Refresh/Redesign	6-Speed Manual Transmission
MT7	Transmission	Refresh/Redesign	7-Speed Manual Transmission
AT5	Transmission	Refresh/Redesign	5-Speed Automatic Transmission
AT6	Transmission	Refresh/Redesign	6-Speed Automatic Transmission
AT6L2	Transmission	Refresh/Redesign	6-Speed Automatic Transmission level 2
AT6L3	Transmission	Refresh/Redesign	6-Speed Automatic Transmission level 3
AT8	Transmission	Refresh/Redesign	8-Speed Automatic Transmission
AT8L2	Transmission	Refresh/Redesign	8-Speed Automatic Transmission level 2
AT8L3	Transmission	Refresh/Redesign	8-Speed Automatic Transmission level 3
DCT6	Transmission	Refresh/Redesign	6-Speed Dual Clutch Transmission
DCT8	Transmission	Refresh/Redesign	8-Speed Dual Clutch Transmission
CVT	Transmission	Refresh/Redesign	Continuously Variable Transmission
CVT2	Transmission	Refresh/Redesign	Continuously Variable Transmission level 2
EPS	Vehicle	Refresh/Redesign	Electric Power Steering
IACC	Vehicle	Refresh/Redesign	Improved Accessories (w/ Alternator Regen and 70% Efficient Alternator)
SS12V	Vehicle	Redesign Only	12V Micro-Hybrid (Stop-Start)
BISG	Vehicle	Redesign Only	Belt Mounted Integrated Starter/Generator
CISG	Vehicle	Redesign Only	Crank Mounted Integrated Starter/Generator
SHEVP2	Vehicle	Redesign Only	P2 Strong Hybrid/Electric Vehicle
SHEVPS	Vehicle	Redesign Only	Power Split Strong Hybrid/Electric Vehicle
PHEV30	Vehicle	Redesign Only	30-mile Plug-In Hybrid/Electric Vehicle
PHEV50	Vehicle	Redesign Only	50-mile Plug-In Hybrid/Electric Vehicle
BEV200	Vehicle	Redesign Only	200-mile Electric Vehicle
FCV	Vehicle	Redesign Only	Fuel Cell Vehicle
LDB	Vehicle	Refresh/Redesign	Low Drag Brakes
SAX	Vehicle	Refresh/Redesign	Secondary Axle Disconnect
ROLL10	Vehicle	Refresh/Redesign	Low Rolling Resistance Tires, Level 1 (10% Reduction)
ROLL20	Vehicle	Refresh/Redesign	Low Rolling Resistance Tires, Level 2 (20% Reduction)
MR1	Platform	Refresh/Redesign	Mass Reduction, Level 1 (5% Reduction in Glider Weight)
MR2	Platform	Redesign Only	Mass Reduction, Level 2 (7.5% Reduction in Glider Weight)
MR3	Platform	Redesign Only	Mass Reduction, Level 3 (10% Reduction in Glider Weight)
MR4	Platform	Redesign Only	Mass Reduction, Level 4 (15% Reduction in Glider Weight)
MR5	Platform	Redesign Only	Mass Reduction, Level 5 (20% Reduction in Glider Weight)
AERO5	Vehicle	Refresh/Redesign	Aero Drag Reduction, Level 1 (5% Reduction)
AERO10	Vehicle	Redesign Only	Aero Drag Reduction, Level 2 (10% Reduction)
AERO15	Vehicle	Redesign Only	Aero Drag Reduction, Level 3 (15% Reduction)
AERO20	Vehicle	Redesign Only	Aero Drag Reduction, Level 4 (20% Reduction)

As Table II-80 and Table II-81 show, all of the engine technologies may only be applied (for the first time) during redesign. New transmissions can be applied during either refresh or redesign, except for manual transmissions, which can only be upgraded during redesign. Unlike previous versions of the model, which only allowed significant changes to vehicle powertrains at redesign, this version allows vehicles to *inherit*

updates to shared components during refresh. For example, assume Vehicle A and Vehicle B share Engine 1, and engine 1 is redesigned as part of Vehicle A's redesign in MY 2020. Vehicle B is not redesigned until 2025 but is refreshed in MY 2022. In the current version of the CAFE model, Vehicle B would inherit the updated version of Engine 1 when it is freshened in MY 2022. This change allows more rapid diffusion of powertrain updates (for

example) throughout a manufacturer's portfolio and reduces the number of years during which a manufacturer would build both new and legacy versions of the same engine. Despite increasing the rate of technology diffusion, this change still restricts the pace at which new engines (for example) can be designed and built (*i.e.*, no faster than the redesign schedule of the "leader" vehicle to which they are tied). The only technology for which

this does not hold is mass reduction improvements; these occur at the platform level, and each model on that platform must be redesigned (not merely refreshed) in order to receive the newest version of the platform that contains the most current mass reduction technology.

The CAFE model defines several “technology classes” and “technology pathways” for logically grouping all available technologies for application on a vehicle. Technology classes provide costs and improvement factors shared by all vehicles with similar body styles, curb weights, footprints, and engine types, while technology pathways establish a logical progression of technologies on a vehicle within a

system or sub-system (e.g., engine technologies).

Technology classes, shown in Table–II–82, are a means for specifying common technology input assumptions for vehicles that share similar characteristics. Predominantly, these classes signify the degree of applicability of each of the available technologies to a specific class of vehicles and represent a specific set of Autonomie simulations (conducted as part of the Argonne National Lab large-scale simulation study) that determine the effectiveness of each technology to improve fuel economy. The vehicle technology classes also define, for each technology, the additional cost associated with application.³⁴² Like the

TAR analysis, the model uses separate technology classes for compact cars, midsize cars, small SUVs, large SUVs, and pickup trucks. However, in this analysis, each of those distinctions also has a “performance” version, that represents another class with similar body style but higher levels of performance attributes (for a total of 10 technology classes). As the model simulates compliance, identifying technologies that can be applied to a given manufacturer’s product portfolio to improve fleet fuel economy, it relies on the vehicle class to provide relevant cost and effectiveness information for each vehicle model.

Table-II-82 - Vehicle Technology Classes

Class	Description
SmallCar	Small passenger cars
MedCar	Medium to large passenger cars
SmallSUV	Small sport utility vehicles and station wagons
MedSUV	Medium to large sport utility vehicles, minivans, and passenger vans
Pickup	Light duty pickups and other vehicles with ladder frame construction

The model defines technology pathways for grouping and establishing a logical progression of technologies on a vehicle. Each pathway (or path) is evaluated independently and in parallel, with technologies on these paths being considered in sequential order. As the model traverses each path, the costs and fuel economy improvements are accumulated on an incremental basis with relation to the preceding technology. The system stops examining a given path once a combination of one or more technologies results in a “best” technology solution for that path. After

evaluating all paths, the model selects the most cost-effective solution among all pathways. This parallel path approach allows the modeling system to progress through technologies in any given pathway without being unnecessarily prevented from considering technologies in other paths.

Rather than rely on a specific set of technology combinations or packages, the model considers the universe of applicable technologies, dynamically identifying the most cost-effective combination of technologies for each manufacturer’s vehicle fleet based on each vehicle’s initial technology content and the assumptions about each

technology’s effectiveness, cost, and interaction with all other technologies both present and available.

(b) Technology Paths

The modeling system incorporates 16 technology pathways for evaluation as shown in Table–II–83. Similar to individual technologies, each path carries an intrinsic application level that denotes the scope of applicability of all technologies present within that path and whether the pathway is evaluated on one vehicle at a time, or on a collection of vehicles that share the same platform, engine, or transmission.

³⁴² Inputs are specified to assign each vehicle in the analysis fleet to one of these technology classes, as discussed in Section II.B.

Table-II-83 - Technology Pathways

Technology Pathway	Application Level
Basic Engine Path	Engine
Turbo Engine Path	Engine
HCR Engine Path	Engine
Advanced DEAC Path	Engine
Advanced Diesel Engine Path	Engine
Manual Transmission Path	Transmission
Automatic Transmission Path	Transmission
CVT path	Transmission
Dual Clutch Transmission Path	Transmission
Electrification Path	Vehicle
Hybrid/Electric Path	Vehicle
Advanced Hybrid/Electric Path	Vehicle
Dynamic Load Reduction Path	Vehicle
Low Rolling Resistance Tires Path	Vehicle
Aerodynamic Improvements Path	Vehicle
Mass Reduction Path	Platform

The technologies that comprise the five Engine-Level paths available within the model are presented in Figure-II-13. Note: The baseline-level technologies (SOHC, DOHC, OHV, and CNG) appear in gray boxes. These technologies are used to inform the modeling system of the initial engine's configuration and are not otherwise applicable during the analysis. Additionally, the VCR path (intended to house fuel economy improvements from variable

compression ratio engines) was not used in this analysis but is present within the model. Unlike earlier versions of the CAFE model, that enforced strictly sequential application of technologies like VVL and SGDI, this version of the CAFE model allows basic engine technologies to be applied in any order once an engine has VVT (the base state of all ANL simulations). Once the model progresses past the basic engine path, it considers all of the more advanced

engine paths (Turbo, HCR, Diesel, and ADEAC) simultaneously. They are assumed to be mutually exclusive. Once one path is taken, it locks out the others to avoid situations where the model could be perceived to force manufacturers to radically change engine architecture with each redesign, incurring stranded capital costs and lost opportunities for learning.

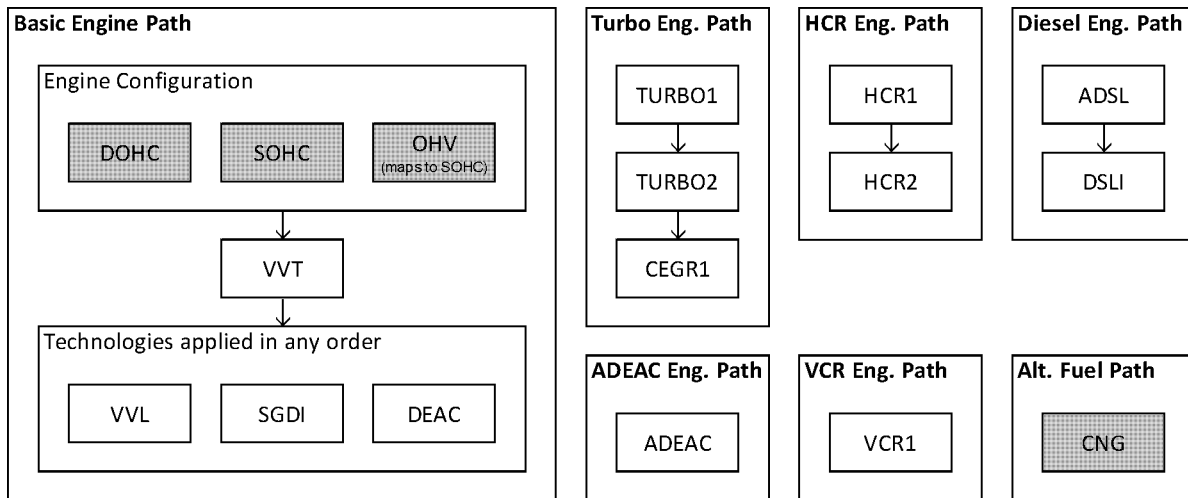

Figure-II-13 - Engine Paths

For all pathways, the technologies are evaluated and applied to a vehicle in sequential order, as shown from top to bottom. In some cases, however, if a

technology is deemed ineffective, the system will bypass it and skip ahead to the next technology. If the modeling system applies a technology that resides

later in the pathway, it will "backfill" anything that was previously skipped in order to fully account for costs and fuel economy improvements of the full

technology combination.³⁴³ For any technology that is already present on a vehicle (either from the MY 2016 fleet or previously applied by the model), the system skips over those technologies as well and proceeds to the next. These skipped technologies, however, will not be applied again during backfill.

While costs are still purely incremental, technology effectiveness is no longer constructed that way. The non-sequential nature of the basic engine technologies have no obvious preceding technology except for VVT, the root of our engine path. It was a natural extension to carry this approach to the other branches as well. The technology effectiveness estimates are now an integrated part of the CAFE model and represent a translation of the Argonne simulation database that compares the fuel consumption of any combination of technologies (across all paths) to the base vehicle (that has only VVT, 5-speed automatic transmission, no electrification, and no body-level improvements).³⁴⁴

³⁴³ More detail about how the Argonne simulation database was integrated into the CAFE model can be found in PRIA Chapter 6.

³⁴⁴ This is true for all combinations other than those containing manual transmissions. Because the model does not convert automatic transmissions to

The Basic Engine path begins with SOHC, DOHC, and OHV technologies defining the initial configuration of the vehicle's engine. Since these technologies are not available during modeling, the system evaluates this pathway starting with VVT. Whenever a technology pathway forks into two or more branch points, as the engine path does at the end of the basic engine path, all of the branches are treated as mutually exclusive. The model evaluates all technologies forming the branch simultaneously and selects the most cost-effective for the application, while disabling the unchosen remaining paths.

The technologies that make up the four Transmission-Level paths defined by the modeling system are shown in Figure-II-14. The baseline-level technologies (AT5, MT5 and CVT) appear in gray boxes and are only used to represent the initial configuration of a vehicle's transmission. For simplicity, all manual transmissions with five forward gears or fewer have been assigned the MT5 technology in the

manual transmissions, nor the inverse, technology combinations containing manual transmissions use a reference point identical to the base vehicle description, but containing a 5-speed manual rather than automatic transmission.

analysis fleet. Similarly, all automatic transmissions with five forward gears or fewer have been assigned the AT5 technology. The model preserves the initial configuration for as long as possible, and prohibits manual transmissions from becoming automatic transmissions at any point. Automatic transmissions may become CVT level 2 after progressing through the 6-speed automatic. While the structure of the model still allows automatic transmissions to consider the move to DCT, in practice they are restricted from doing so in the market data file. This allows vehicles that enter with a DCT to improve it (if opportunities to do so exist) but does not allow automatic transmissions to become DCTs, in recognition of low consumer enthusiasm for the earlier versions the transmission that have been introduced over the last decade. The model does not attempt to simulate "reversion" to less advanced transmission technologies, such as replacing a 6-speed AT with a DCT and then replacing that DCT with a 10-speed AT. The agencies invite comment on whether or not the model should be modified to simulate such "reversion" and, if so, how this possible behavior might be practicably simulated.

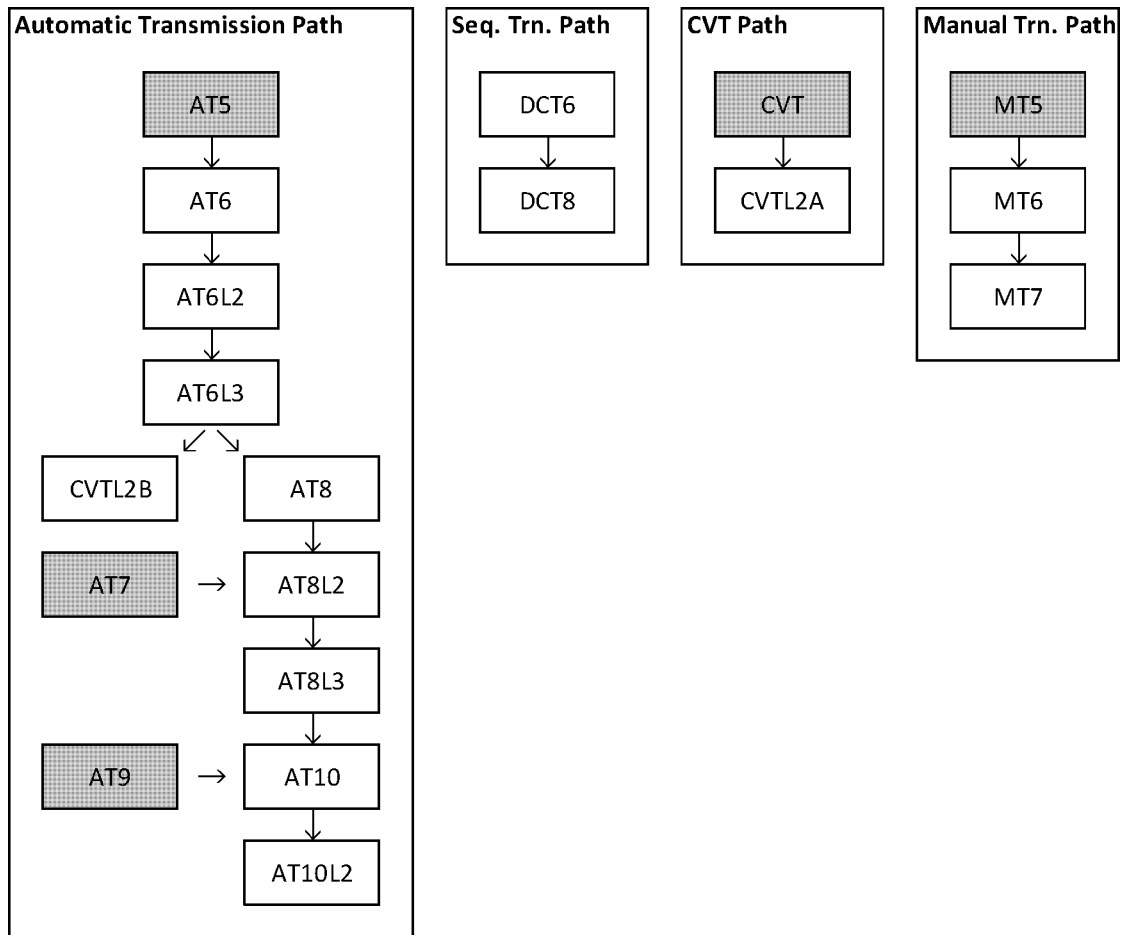

Figure-II-14 - Transmission Paths

The root of the Electrification path, shown in Figure-II-15, is a conventional powertrain (CONV) with no electrification. The two strong hybrid technologies (SHEVP2 and SHEVPS) on the Hybrid/Electric path, are defined as stand-alone and mutually exclusive. These technologies are not incremental over each other for cost or effectiveness and do not follow a traditional progression logic present on other paths. While the SHEVP2 represents a hybrid system paired with the existing engine on a given vehicle, the SHEVPS removes and replaces that engine, making it the

larger architectural change of the two. In general, the electrification technologies are applied as vehicle-level technologies, meaning that the model applies them without affecting components that might be shared with other vehicles. In the case of the more advanced electrification technologies, where engines and transmissions are removed or replaced, the model will choose a new vehicle to be the leader on that component (if necessary) and will not force other vehicles sharing that engine or transmission to become hybrids (or EVs). In addition to the

electrification technologies, there are two electrical system improvements, electric power steering (EPS) and accessory improvements (IACC), which were not part of the ANL simulation project and are applied by the model as fixed percentage improvements to all technology combinations in a particular technology class. Their improvements are superseded by technologies in the other electrification paths, BISG or CISC, in the case of EPS, and strong hybrids (and above) in the case of IACC, which are assumed to include those improvements already.

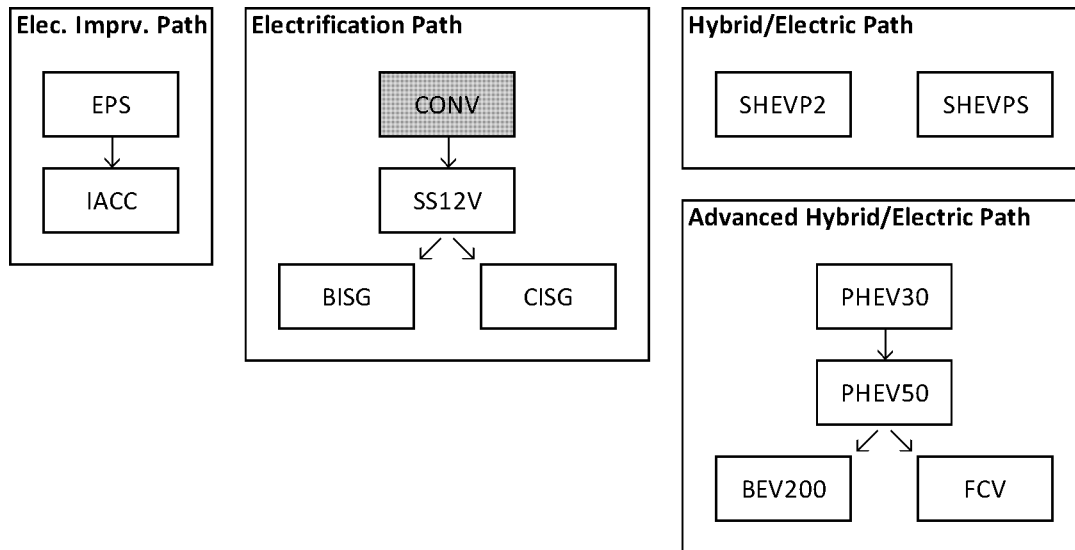

Figure-II-15 - Electrification Technology Path

The technology paths related to load reduction of the vehicle are shown in Figure-II-16. Of these, only the Mass Reduction (MR) path is applied at the platform level, thus affecting all vehicles (across classes and body styles) on a given platform. The remaining technology paths are all applied at the

vehicle level, and technologies within each path are considered purely sequential. For mass reduction, aerodynamic improvements, and reductions in rolling resistance, the base level of each path is the “zero state,” in which a vehicle has exhibited none of the improvements associated with the

technology path. In addition to choosing among possible engine, transmission, and electrification improvements to improve a vehicle’s fuel economy, the CAFE model will consider technologies each of the possible load improvement paths simultaneously.

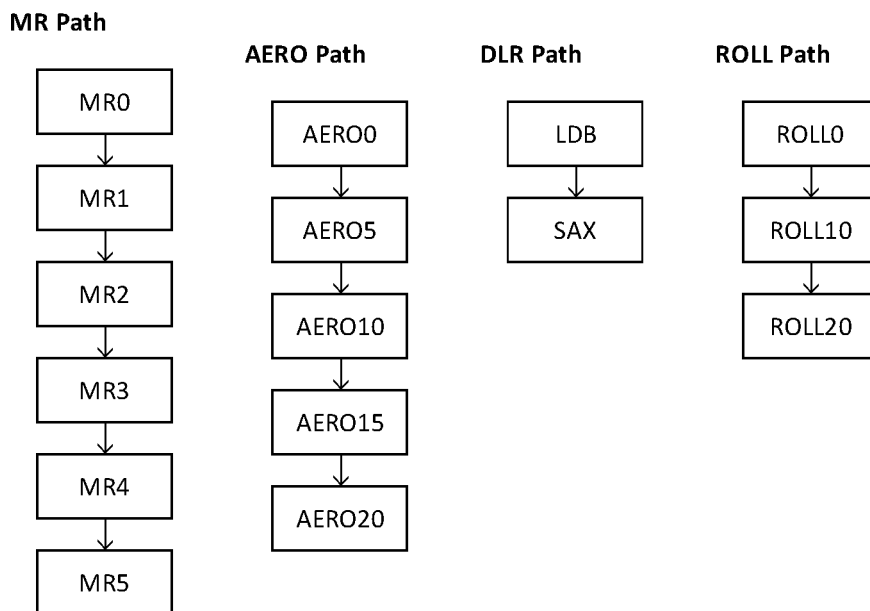

Figure-II-16 - Load Reduction Technology Paths

Even though the model evaluates each technology path independently, some of

the pathways are interconnected to allow for additional logical progression

and incremental accounting of technologies. For example, the cost of

SHEVPS (power-split strong hybrid/electric) on the Hybrid/Electric path is defined as incremental over the complete basic engine path (an engine that contains VVT, VVL, SGDI, and DEAC), the AT5 (5-speed automatic) technology on the Automatic Transmission path, and the CISG (crank mounted integrated starter/generator) technology on the Electrification path. For that reason, whenever the model evaluates the SHEVPS technology for application on a vehicle, it ensures that, at a minimum, all the aforementioned technologies (as well as their predecessors) have already been applied

on that vehicle. However, if it becomes necessary for a vehicle to progress to the power-split hybrid, the model will virtually apply the technologies associated with the reference point in order to evaluate the attractiveness of transitioning to the strong hybrid.

Of the 17 technology pathways present in the model, all Engine paths, the Automatic Transmission path, the Electrification path, and both Hybrid/Electric paths are logically linked for incremental technology progression. Some of the technology pathways, as defined in the model and shown in Figure-II-17, may not be compatible with a vehicle given its state at the time

of evaluation. For example, a vehicle with a 6-speed automatic transmission will not be able to get improvements from a Manual Transmission path. For this reason, the model implements logic to explicitly disable certain paths whenever a constraining technology from another path is applied on a vehicle. On occasion, not all of the technologies present within a pathway may produce compatibility constraints with another path. In such a case, the model will selectively disable a conflicting pathway (or part of the pathway) as required by the incompatible technology.

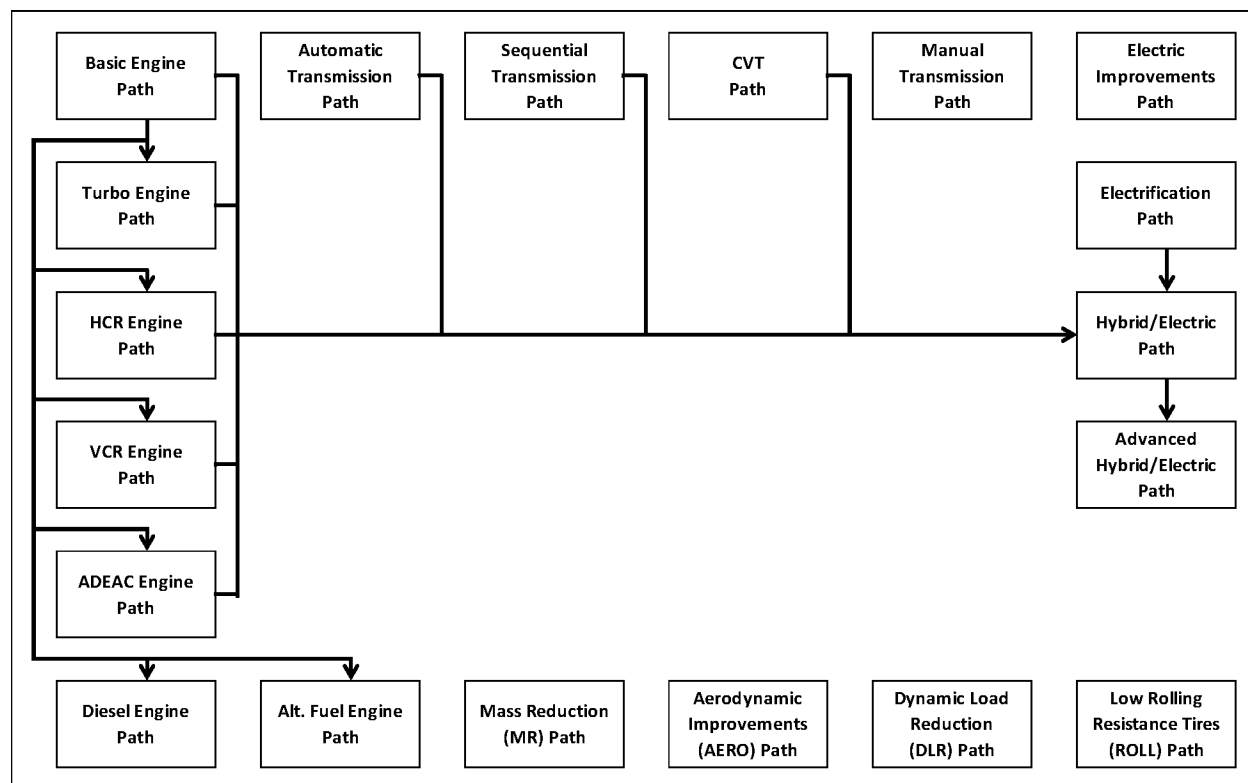

Figure-II-17 - All Technology Pathways

For any interlinked technology pathways shown in Figure-II-17, the model also disables all preceding technology paths whenever a vehicle transitions to a succeeding pathway. For example, if the model applies SHEVPS technology on a vehicle, the model disables the Turbo, HCR, ADEAC, and Diesel Engine paths, as well as the Basic Engine, the Automatic Transmission, and the Electrification paths (all of which precede the Hybrid/Electric path).³⁴⁵ This implicitly forces vehicles

³⁴⁵ The only notable exception to this rule occurs whenever SHEVP2 technology is applied on a

vehicle. This technology may be present in conjunction with any engine-level technology, and as such, the Basic Engine path is not disabled upon application of SHEVP2 technology, even though this pathway precedes the Hybrid/Electric path.

4. Simulating Manufacturer Compliance With Standards

As a starting point, the model needs enough information to represent each manufacturer covered by the program. As discussed above in Section II.B, the

MY 2016 analysis fleet contains information about each manufacturer's:

- Vehicle models offered for sale—their current (*i.e.*, MY 2016) production volumes, manufacturer suggested retail prices (MSRPs), fuel saving technology content (relative to the set of technologies described in Table II-80 and Table II-81), and other attributes (curb weight, drive type, assignment to technology class and regulatory class),

- Production constraints—product cadence of vehicle models (*i.e.*, schedule of model redesigns and “freshenings”), vehicle platform membership, degree of engine and/or transmission sharing (for each model variant) with other vehicles in the fleet,

• Compliance constraints and flexibilities—historical preference for full compliance or penalty payment/credit application, willingness to apply additional cost-effective fuel saving technology in excess of regulatory requirements, projected applicable flexible fuel credits, and current credit balance (by model year and regulatory class) in first model year of simulation.

Each manufacturer's regulatory requirement represents the production-weighted harmonic mean of their vehicle's targets in each regulated fleet. This means that no individual vehicle has a "standard," merely a target, and each manufacturer is free to identify a compliance strategy that makes the most sense given its unique combination of vehicle models, consumers, and competitive position in the various market segments. As the CAFE model provides flexibility when defining a set of regulatory standards, each manufacturer's requirement is dynamically defined based on the specification of the standards for any simulation and the distribution of footprints within each fleet.

Given this information, the model attempts to apply technology to each manufacturer's fleet in a manner that minimizes "effective costs." The effective cost captures more than the incremental cost of a given technology; it represents the difference between their incremental cost and the value of fuel savings to a potential buyer over the first 30 months of ownership.³⁴⁶ In addition to the technology cost and fuel savings, the effective cost also includes the change in fines from applying a given technology and any estimated welfare losses associated with the technology (*e.g.*, earlier versions of the CAFE model simulated low-range electric vehicles that produced a welfare loss to buyers who valued standard operating ranges between re-fueling events). The effective cost metric applied by the model does not attempt to reflect *all* costs of vehicle ownership. Further research would be required in order to support simulation that assumes buyers behave as if they actually consider all ownership costs, and that assumes manufacturers respond accordingly. The agencies will continue to consider the metric applied to represent manufacturers' approach to making decisions regarding the application of fuel-saving technologies and invite comment regarding any practicable changes that might make

³⁴⁶ The length of time over which to value fuel savings in the effective cost calculation is a model input that can be modified by the user. This analysis uses 30 months' worth of fuel savings in the effective cost calculation, using the price of fuel at the time of vehicle purchase.

this aspect of the model even more realistic.

This construction allows the model to choose technologies that both improve a manufacturer's regulatory compliance position and are most likely to be attractive to its consumers. This also means that different assumptions about future fuel prices will produce different rankings of technologies when the model evaluates available technologies for application. For example, in a high fuel price regime, an expensive but very efficient technology may look attractive to manufacturers because the value of the fuel savings is sufficiently high to both counteract the higher cost of the technology and, implicitly, satisfy consumer demand to balance price increases with reductions in operating cost. Similarly, technologies for which there exist consumer welfare losses (discussed in Section II.E) will be seen as less attractive to manufacturers who may be concerned about their ability to recover the full amount of the technology cost during the sale of the vehicle. The model continues to add technology until a manufacturer either: (a) Reaches compliance with regulatory standards (possibly through the accumulation and application of overcompliance credits), (b) reaches a point at which it is more cost effective to pay penalties than to add more technology (for CAFE), or (c) reaches a point beyond compliance where the manufacturer assumes its consumers will be unwilling to pay for additional fuel saving/emissions reducing technologies.

In general, the model adds technology for several reasons but checks these sequentially. The model then applies any "forced" technologies. Currently, only VVT is forced to be applied to vehicles at redesign since it is the root of the engine path and the reference point for all future engine technology applications.³⁴⁷ The model next applies any inherited technologies that were applied to a leader vehicle and carried forward into future model years where follower vehicles (on the shared system) are freshened or redesigned (and thus eligible to receive the updated version of the shared component). In practice, very few vehicle models enter without VVT, so inheritance is typically the first step in the compliance loop. Then the model evaluates the manufacturer's compliance status, applying all cost-effective technologies regardless of compliance status (essentially any

³⁴⁷ As a practical matter, this affects very few vehicles. More than 95% of vehicles in the market file either already have VVT present or have surpassed the basic engine path through the application of hybrids or electric vehicles.

technology for which the effective cost is negative). Then the model applies expiring overcompliance credits (if allowed to under the perspective of either the "unconstrained" or "standard setting" analysis, for CAFE purposes). At this point, the model checks the manufacturer's compliance status again. If the manufacturer is still not compliant (and is unwilling to pay civil penalties, again for CAFE), the model will add technologies that are not cost-effective until the manufacturer reaches compliance. If the manufacturer exhausts opportunities to comply with the standard by improving fuel economy/reducing emissions (typically due to a limited percentage of its fleet being redesigned in that year), the model will apply banked CAFE or CO₂ credits to offset the remaining deficit. If no credits exist to offset the remaining deficit, the model will reach back in time to alter technology solutions in earlier model years.

The CAFE model implements multi-year planning by looking back, rather than forward. When a manufacturer is unable to comply through cost-effective (*i.e.*, producing effective cost values less than zero) technology improvements or credit application in a given year, the model will "reach back" to earlier years and apply the most cost-effective technologies that were not applied at that time and then carry those technologies forward into the future and re-evaluate the manufacturer's compliance position. The model repeats this process until compliance in the current year is achieved, dynamically rebuilding previous model year fleets and carrying them forward into the future, accumulating CAFE or CO₂ credits from over-compliance with the standard wherever appropriate.

In a given model year, the model determines applicability of each technology to each vehicle model, platform, engine, and transmission. The compliance simulation algorithm begins the process of applying technologies based on the CAFE or CO₂ standards specified during the current model year. This involves repeatedly evaluating the degree of noncompliance, identifying the next "best" technology (ranked by the effective cost discussed earlier) available on each of the parallel technology paths described above and applying the best of these. The algorithm combines some of the pathways, evaluating them sequentially instead of in parallel, in order to ensure appropriate incremental progression of technologies.

The algorithm first finds the best next applicable technology in each of the technology pathways then selects the

best among these. For CAFE purposes, the model applies the technology to the affected vehicles if a manufacturer is either unwilling to pay penalties or if applying the technology is more cost-effective than paying penalties. Afterwards, the algorithm reevaluates the manufacturer's degree of noncompliance and continues application of technology. Once a manufacturer reaches compliance (*i.e.*, the manufacturer would no longer need to pay penalties), the algorithm proceeds to apply any additional technology determined to be cost-effective (as discussed above). Conversely, if a manufacturer is assumed to prefer to pay penalties, the algorithm only applies technology up to the point where doing so is less costly than paying penalties. The algorithm stops applying additional technology to this manufacturer's products once no more cost-effective solutions are encountered. This process is repeated for each manufacturer present in the input fleet. It is then repeated again for each model year. Once all model years have been processed, the compliance simulation algorithm concludes. The process for CO₂ standard compliance simulation is similar, but without the option of penalty payment.

(a) Compliance Example

The following example will illustrate the features discussed above for the CAFE program. While the example describes the actions that General Motors takes to modify the Chevrolet Equinox in order to comply with the augural standards (the baseline in this analysis), and the logical consequences of these actions, a similar example would develop if instead simulating compliance with the EPA standards for those years. The structure of GM's fleet and the mechanisms at work in the CAFE model are identical in both cases, but different features of each program (unlimited credit transfers between fleets, for example) would likely cause the model to choose different technology solutions.

At the start of the simulation in MY 2016, GM has 30 unique engines shared across over 33 unique nameplates, 260 model variants, and three regulatory classes. As discussed earlier, the CAFE model will attempt to preserve that level of sharing across GM's fleets to avoid introducing additional production complexity for which the agencies do not estimate additional costs. An even smaller number of transmissions (16) and platforms (12) are shared across the same set of nameplates, model variants, and regulatory classes.

The Chevrolet Equinox is represented in the model inputs as a single nameplate, with five model variants distinguished by the presence of all-wheel drive and four distinct powertrain configurations (two engines paired with two different transmissions). Across all five model variants, GM produced above 220,000 units of the Equinox nameplate. About 150,000 units of that production volume is regulated as Domestic Passenger Car, with the remainder regulated as Light Trucks. The easiest way to describe the actions taken by the CAFE model is to focus on a single model variant of the Equinox (one row in the market data file). The model variant of the Equinox with the highest production volume, about 130,000 units in MY 2016, is vehicle code 110111.³⁴⁸ This unique model variant is the basis for the example. However, because it is only one of five variants on the Equinox nameplate, the modifications made to that model in the simulation will affect the rest of the Equinox variants and other vehicles across all fleets.

The example Equinox variant is designated as an engine and platform leader. As discussed earlier, this implies that modifications to its engine (11031, a 2.4L I-4) are tied to the redesign cadence of this Equinox, as are modifications to its platform (Theta/TE). The engine is shared by the Buick LaCrosse, Regal, and Verano, and by the GMC Terrain (as well as appearing in two other variants of the Equinox). So those vehicles, if redesigned after this Equinox, will inherit changes to engine 11031 when they are redesigned, carrying the legacy version of the engine until then. Similarly, this Equinox shares its platform with the Cadillac SRX and GMC Terrain, which will inherit changes made to this platform when they are redesigned (if later than the Equinox, as is the case with the SRX).

This specific Equinox is a transmission "follower," getting updates made to its transmission leader (the Chevrolet Malibu) when it is freshened or redesigned. Additionally, two other variants of the Equinox nameplate (the more powerful versions, containing a 3.6L V-6 engine) are not "leaders" on any of the primary components. Those variants are built on the same platform as the example Equinox variant but share their engine with the Buick Enclave and LaCrosse, the Cadillac SRX

³⁴⁸ This numeric designation is not important to understand the example but will allow an interested reader to identify the vehicle in model outputs to either recreate the example or use it as a template to create similar examples for other manufacturers and vehicles.

and XTS,³⁴⁹ the Chevrolet Colorado, Impala and Traverse (which is the designated "leader"), and the GMC Acadia, Canyon, and Terrain. This is an example of how shared and inherited components interact with product cadence: when the Equinox nameplate is redesigned, the CAFE model has more leverage over some variants than others and cannot make changes to the engines of the variants of the Equinox with V-6 unless that change is consistent with all of the other nameplates just listed. The transmissions on the other variants of the Equinox are similarly widely shared and represent the same kind of production constraint just described with respect to the engine. When accounting for the full set of engines, transmissions, and platforms represented across the Equinox nameplate's five variants, components are shared across all three regulatory classes.

This example uses a "standard setting" perspective to minimize the amount of credit generation and application, in order to focus on the mechanics of technology application and component sharing. The actions taken by the CAFE model when operating on the example Equinox during GM's compliance simulation are shown in Table II-84. In general, the example Equinox begins the compliance simulation with the technology observed in its MY 2016 incarnation—a 2.6L I-4 with VVT and SGDI, a 6-speed automatic transmission, low rolling resistance tires (ROLL20) and a 10% realized improvement in aerodynamic drag (AERO10). In MY 2018, the Equinox is redesigned, at which time the engine adds VVL and level-1 turbocharging. The transmission on the Malibu is upgraded to an 8-speed automatic in 2018, which the Equinox also gets. The platform, for which this Equinox is the designated leader, gets level-4 mass reduction. The CAFE model also applies a few vehicle-level technologies: low-drag brakes, electronic accessory improvements, and additional aerodynamic improvements (AERO20). Upon refresh in MY 2021, it acquires an upgraded 10-speed transmission (AT10) from the Malibu.

³⁴⁹ The agencies recognized that GM last produced the Cadillac SRX for MY 2016, and note this as one example of the limitations of using an analysis fleet defined in terms of even a recent actual model year. Section II.B discusses these tradeoffs, and the tentative judgment that, as a foundation for analysis presented here, it was better to develop the analysis fleet using the best information available for MY 2016 than to have used manufacturers' CBI to construct an analysis fleet that, though more current, would have limited the agencies' ability to make public all analytical inputs and outputs.

Then in MY 2025 it is redesigned again and upgrades the engine to level-2 turbocharging, replaces the 10-speed automatic transmission with a 8-speed automatic transmission, adds a P2 strong hybrid, and further reduces the

mass of the platform (MR5). Using an “unconstrained” perspective would possibly lead to additional actions taken after MY 2025, where GM may have been simulated to use credits earned in earlier model years to offset small,

persistent CAFE deficits in one or more fleets. In the “standard setting” perspective, that forces compliance without the use of CAFE credits, this is not an issue.

Table-II-84 - Summary of Example Equinox Technology Application

Model Year	State	FE Target	MPG	Cost (\$)	Action
2016	Refresh	34.9	34.1	43	Starts with VVT; SGDI; AT6; ROLL20; AERO10
2017		36.9	34.1	37	
2018	Redesign	38.3	47.1	3,470	Applied: VVL, TURBO1, AT8, IACC, BISG, LDB, MR4, AERO20
2019		39.7	47.1	3,280	
2020		41.3	47.1	3,125	
2021	Refresh	43.0	47.6	3,070	Applied: AT10
2022		45.0	47.6	2,960	
2023		47.1	47.6	2,870	
2024		49.4	47.6	2,780	
2025	Redesign	51.7	52.3	5,020	Applied: TURBO2, AT8, SHEVP2, MR5
2026		51.7	52.3	4,870	
2027		51.7	52.3	4,735	
2028	Refresh	51.7	52.3	4,620	
2029		51.7	52.3	4,510	
2030		51.7	52.3	4,410	
2031		51.7	52.3	4,320	
2032	Redesign	51.7	52.3	4,260	

The technology applications described in Table-II-84 have consequences beyond the single variant of the Equinox shown in the table. In particular, two other variants of the Equinox (both of which are regulated as Light Trucks) get the upgraded engine, which they share with the example, in MY 2018. Thus, this application of engine technology to a single variant of the Equinox in the Domestic Car fleet, “spills over” into the Light Truck fleet, generating improvements in fuel economy and additional costs. Furthermore, the Buick LaCrosse and Regal, and the GMC Terrain also get the same engine, which they share with the example, in MY 2018. Those vehicles also span the Domestic Car and Light Truck fleets. However, the Buick Verano, which is not redesigned until MY 2019, continues with the legacy (i.e., MY 2016) version of the shared engine until it is redesigned. When it inherits the new engine in MY 2019, it does so without modification; the

engine it inherits is the same one that was redesigned in MY 2018. This means that the Verano will improve its fuel economy in MY 2019 when the new engine is inherited but only to the extent that the new version of the engine is an improvement over the legacy version in the context of the Verano’s other technology (which it is—the Verano moves from 32 MPG to 44 MPG when accounting for the other technologies added during the MY 2019 redesign).

This same story continues with the diffusion of platform improvements simulated by the CAFE model in MY 2018. The GMC Terrain is simulated to be redesigned in MY 2018, in conjunction with the Equinox. The performance variants of the Equinox, with a 3.5L V-6, also upgrade their engines in MY 2018 (in conjunction with the estimated Chevrolet Traverse redesign). However, when the Equinox is next redesigned in MY 2025, the engine shared with the Traverse is not

upgraded again until MY 2026, so the performance versions of the Equinox continue with the 2018 version of the engine throughout the remainder of the simulation. While these inheritances and sharing dynamics are not a perfect representation of each manufacturer’s specific constraints, nor the flexibilities available to shift strategies in real-time as a response to changing market or regulatory conditions, they are a reasonable way to consider the resource constraints that prohibit fleet-wide technology diffusion over shorter windows than have been observed historically and for which the agencies have no way to impose additional costs.

Aside from the technology application and its consequences throughout the GM product portfolio, discussed above, there are other important conclusions to draw from the technology application example. The first of these is that product cadence matters, and only by taking a year-by-year perspective can this be seen. When the example Equinox

is redesigned in MY 2018, the CAFE model takes actions that cause the redesigned Equinox to significantly exceed its fuel economy target. While no single vehicle has a “standard,” having high volume vehicles significantly below their individual targets can present compliance challenges for manufacturers who must compensate by exceeding targets on other vehicles. While the example Equinox exceeds its MY 2018 target by almost 9 mpg, this version of the Equinox is not eligible to see significant technology changes again before MY 2025 (except for the transmission upgrade that occurs in MY 2021). Thus, the CAFE model is redesigning the Equinox in MY 2018 with respect to future targets and standards—this Equinox is nearly 2 mpg below its target in MY 2024 before being redesigned in MY 2025. This reflects a real challenge that manufacturers face in the context of continually increasing CAFE standards, and represents a clear example of why considering two model year snapshots where all vehicles are assumed to be redesigned is unrealistically simplistic. The MY 2018 version of the example Equinox persists (with little change) through six model

years and the standards present in those years. This is one reason why the CAFE model, rather than OMEGA, was chosen to examine the impacts of the proposed standards in this analysis.

Another feature of note in Table–II–84 is the cost of applying these technologies. The costs are all denominated in dollars and represent incremental cost increases relative to the MY 2016 version of the Equinox. Aside from the cost increase of over \$5,000 in MY 2025 when the vehicle is converted to a strong hybrid, the incremental technology costs display a consistent trend between application events—decreasing steadily over time as the cost associated with each given combination of technologies “learns down.” By MY 2032, even the most expensive version of the example Equinox costs nearly \$800 less to produce than it did in MY 2025.

The technology application in the example occurs in the context of GM’s attempt to comply with the augural standards. As some of the components on the Equinox nameplate are shared across all three regulated fleets, Table–II–85 shows the compliance status of each fleet in MYs 2016–2025. In MY 2017, the CAFE model applies expiring

credits to offset deficits in the DC and LT fleets. In MY 2028, when GM is simulated to aggressively apply technology to the example Equinox, the DC fleet exceeds its standard while the LT fleet still generates deficits. The CAFE model offset that deficit with expiring (and possibly transferred) credits. However, by MY 2020 the “standard setting” perspective removes the option of using CAFE credits to offset deficits and GM exceeds the standard in all three fleets, though by almost 2 mpg in DC and LT. As the Equinox example showed, many of the vehicles redesigned in MY 2020 will still be produced at the MY 2020 technology level in MY 2025 where GM is simulated to comply exactly across all three fleets. Under an “unconstrained” perspective, the CAFE model would use the CAFE credits earned through over-compliance with the standards in MYs 2020–2023 to offset deficits created by under-compliance as the standards continued to increase, pushing some technology application until later years when the standards stabilized and those credits expired. The CAFE model simulates compliance through MY 2032 to account for this behavior.

Table-II-85 - GM compliance pathway under augural standards, “standard setting” perspective

Model Year	Regulatory Class	Standard	CAFE
2016	DC	36.2	35.1
	IC	39.9	41.9
	LT	27.1	24.9
2017	DC	38.3	37.9
	IC	42.3	43.0
	LT	27.5	25.6
2018	DC	39.7	41.5
	IC	43.9	43.9
	LT	27.9	27.4
2019	DC	41.1	42.5
	IC	45.5	43.7
	LT	28.3	29.8
2020	DC	42.8	45.3
	IC	47.3	47.3
	LT	28.8	31.0
2021	DC	44.6	48.3
	IC	49.3	52.5
	LT	30.6	34.6
2022	DC	46.7	49.9
	IC	51.7	56.7
	LT	32.1	34.9
2023	DC	48.8	51.3
	IC	54.1	57.3
	LT	33.6	35.1
2024	DC	51.1	52.3
	IC	56.6	57.8
	LT	35.2	35.2
2025	DC	53.5	53.5
	IC	59.3	59.3
	LT	36.8	36.8

(b) Representation of OEMs’ Potential Responsiveness to Buyers’ Willingness To Pay for Fuel Economy Improvements

The CAFE model simulates manufacturer responses to both regulatory standards and technology availability. In order to do so, it requires assumptions about how the industry views consumer demand for additional fuel economy because manufacturer responses to potential standards depend not just on what they think they are best off producing to satisfy regulatory requirements (considering the

consequences of not satisfying those requirements), but also on what they think they can sell, technology-wise, to consumers. In the 2012 final rule, the agencies analyzed alternatives under the assumption that manufacturers would not improve the fuel economy of new vehicles at all unless compelled to do so by the existence of increasingly stringent CAFE and GHG standards.³⁵⁰ This “flat baseline” assumption led the agencies to attribute all of the fuel

³⁵⁰ See, e.g., 75 FR 62844, 75 FR 63105.

savings that occurred in the simulation after MY 2016 to the proposed standards because none of the fuel economy improvements were considered likely to occur in the absence of increasing standards. However, this assumption contradicted much of the literature on this topic and the industry’s recent experience with CAFE compliance, and for CAFE standards, the analysis published in 2016 applied a reference case estimate that manufacturers will treat all technologies that pay for themselves within the first three years

of ownership (through reduced expenditures on fuel) as if the cost of that technology were negative.³⁵¹

The industry has exceeded the required CAFE level for both passenger cars and light trucks in the past; notably, by almost 5 mpg during the fuel price spikes of the 2000s when CAFE standards for passenger cars were still frozen at levels established for the 1990 model year.³⁵² In fact, a number of manufacturers that traditionally paid CAFE civil penalties even reached compliance during years with sufficiently high fuel prices.³⁵³ The model attempts to account for this observed consumer preference for fuel economy, above and beyond that required by the regulatory standards, by allowing fuel price to influence the ranking of technologies that the model considers when modifying a manufacturer's fleet in order to achieve compliance. In particular, the model ranks available technology not by cost, but by "effective cost."

When the model chooses which technology to apply *next*, it calculates the effective cost of available technologies and chooses the technology with the lowest effective cost. The "effective cost" itself is a combination of the technology cost, the fuel savings that would occur if that technology were applied to a given vehicle, the resulting change in CAFE penalties (as appropriate), and the affected volumes. User inputs determine how much fuel savings manufacturers believe new car buyers will pay for (denominated in the number of years before a technology "pays back" its cost).

Because the civil penalty provisions specified for CAFE in EPCA do not apply to CO₂ standards, the effective cost calculation applied when simulating compliance with CO₂ standards uses an estimate of the potential value of CO₂ credits. Including a valuation of CO₂ credits in the effective cost metric provides a potential basis for future explicit modeling of credit trading.³⁵⁴ Manufacturers,

though, have thus far declined to disclose the actual terms of CAFE or CO₂ credit trades, so this calculation currently uses the CAFE civil penalty rate as the basis to estimate this value. It seems reasonable to assume that the CAFE civil penalty rate likely sets an effective ceiling on the price of any traded CAFE credits, and considering that each manufacturer can only produce one fleet of vehicles for sale in the U.S., prices of CO₂ credits might reasonably be expected to be equivalent to prices of CAFE credits. However, the current CAFE model does not explicitly simulate credit trading; therefore, the change in the value of CO₂ credits should only capture the change in manufacturer's own cost of compliance, so the compliance simulation algorithm applies a ceiling at 0 (zero) to each calculated value of the CO₂ credits.³⁵⁵

Just as manufacturers' actual approaches to vehicle pricing are closely held, manufacturers' *actual* future approaches to making decisions about technology are not perfectly knowable. The CAFE model is intended to illustrate ways manufacturers *could* respond to standards, given a set of production constraints, *not* to predict how they *will* respond. Alternatives to these "effective cost" metrics have been considered and will continue to be considered. For example, instead of using a dollar value, the model could use a ratio, such as the net cost (technology cost minus fuel savings) of an application of technology divided by corresponding quantity of avoided fuel consumption or CO₂ emissions. Any alternative metric has the potential to shift simulated choices among technology application options, and some metrics would be less suited to the CAFE model's consideration of multiyear product planning, or less adaptable than others to any future simulation of credit trading. Comment is sought regarding the definition and application of criteria to select among technology options and determine when to stop applying technology (consider not only standards, but also factors such as fuel prices, civil penalties for CAFE, and the potential value of credits for both programs), and this aspect of the model may be further revised. Any future revision to the effective cost would be considered in light of

and future efforts will focus consideration on more plausible imperfect trading.

³⁵⁵ Having the model continue to add technology in order to build a surplus of credits as warranted by the estimated (whether specified as a model input or calculated dynamically as a clearing price) market value of credits would provide part of the basis for having the model build the supply side of an explicitly-simulated credit trading market.

manufacturers different compliance positions relative to the standards, and in light of the likelihood that some OEMs will continue to use civil penalties as a means to resolve CAFE deficits (at least for some fleets).

While described in greater detail in the CAFE model documentation, the effective cost reflects an assumption not about consumers' actual willingness to pay for additional fuel economy but about what manufacturers believe consumers are willing to pay. The reference case estimate for today's analysis is that manufacturers will treat all technologies that pay for themselves within the first 2½ years of ownership (through reduced expenditures on fuel) as if the cost of that technology were negative. Manufacturers have repeatedly indicated to the agencies that new vehicle buyers are only willing to pay for fuel economy-improving technology if it pays back within the first two to three years of vehicle ownership.³⁵⁶ NHTSA has therefore incorporated this assumption (of willingness to pay for technology that pays back within 30 months) into today's analysis. Alternatives to this 30-month estimate are considered in the sensitivity analysis included in today's notice. In the current version of the model, this assumption holds whether or not a manufacturer has already achieved compliance. This means that the most cost-effective technologies (those that pay back within the first 2½ years) are applied to new vehicles even in the absence of regulatory pressure. However, because the value of fuel savings depends upon the price of fuel, the model will add more technology even without regulatory pressure when fuel prices are high compared to simulations where fuel prices are assumed to be low. This assumption is consistent with observed historical compliance behavior (and consumer demand for fuel economy in the new vehicle market), as discussed above.

One implication of this assumption is that futures with higher, or lower, fuel prices produce different sets of attractive technologies (and at different times). For example, if fuel prices were above \$7/gallon, many of the technologies in this analysis could pay for themselves within the first year or two and would be applied at high rates in all of the alternatives. Similarly, at the other extreme (significantly reduced fuel prices), almost no additional fuel economy would be observed.

³⁵⁶ This is supported by the 2015 NAS study, which found that consumers seek to recoup added upfront purchasing costs within two or three years. See 2015 NAS Report, at pg. 317.

³⁵¹ Draft TAR, p. 13–10, available at <https://www.nhtsa.gov/staticfiles/rulemaking/pdf/cale/Draft-TAR-Final.pdf> (last accessed June 15, 2018).

³⁵² NHTSA, *Summary of Fuel Economy Performance*, 2014, available at <https://www.nhtsa.gov/sites/nhtsa.dot.gov/files/performance-summary-report-12152014-v2.pdf> (last accessed June 27, 2018).

³⁵³ *Ibid.* Additional data available at https://one.nhtsa.gov/cale_pic/CAFE_PIC_Mfr_LIVE.html (last accessed June 27, 2018).

³⁵⁴ By treating all passenger cars and light trucks as being manufactured by a single "OEM," inputs to the CAFE model can be structured to simulate perfect trading. However, competitive and other factors make perfect trading exceedingly unlikely,

While these assumptions about desired payback period and consumer preferences for fuel economy may not affect the eventual level of achieved CAFE and CO₂ emissions in the later years of the program, they will affect the amount of additional technology cost and fuel savings that are attributable to the standard. The approach currently only addresses the inherent trade-off between additional technology cost and the value of fuel savings, but other costs could be relevant as well. Further research would be required to support simulations that assume buyers behave as if they consider all ownership costs (e.g., additional excise taxes and insurance costs) at the time of purchase and that manufacturers respond accordingly. Comment is sought on the approach described above, the current values ascribed to manufacturers' belief about consumer willingness-to-pay for fuel economy, and practicable suggestions for future improvements and refinements, considering the model's purpose and structure.

(c) Representation of Some OEMs' Willingness To Treat Civil Penalties as a Program Flexibility

When considering technology applications to improve fleet fuel economy, the model will add technology up to the point at which the

effective cost of the technology (which includes technology cost, consumer fuel savings, consumer welfare changes, and the cost of penalties for non-compliance with the standard) is less costly than paying civil penalties or purchasing credits. Unlike previous versions of the model, the current implementation further acknowledges that some manufacturers experience transitions between product lines where they rely heavily on credits (either carried forward from earlier model years or acquired from other manufacturers) or simply pay penalties in one or more fleets for some number of years. The model now allows the user to specify, when appropriate for the regulatory program being simulated, on a year-by-year basis, whether each manufacturer should be considered as willing to pay penalties for non-compliance. This provides additional flexibility, particularly in the early years of the simulation. As discussed above, this assumption is best considered as a method to allow a manufacturer to under-comply with its standard in some model years—treating the civil penalty rate and payment option as a proxy for other actions it may take that are not represented in the CAFE model (e.g., purchasing credits from another manufacturer, carry-back from future

model years, or negotiated settlements with NHTSA to resolve deficits).

In the current analysis, NHTSA has relied on past compliance behavior and certified transactions in the credit market to designate some manufacturers as being willing to pay CAFE penalties in some model years. The full set of assumptions regarding manufacturer behavior with respect to civil penalties is presented in Table-II-86, which shows all manufacturers are assumed to be willing to pay civil penalties prior to MY 2020. This is largely a reflection of either existing credit balances (which manufacturers will use to offset CAFE deficits until the credits reach their expiration dates) or assumed trades between manufacturers that are likely to happen in the near-future based on previous behavior. The manufacturers in the table whose names appear in bold all had at least one regulated fleet (of three) whose CAFE was below its standard in MY 2016. Because the analysis began with the MY 2016 fleet, and no technology can be added to vehicles that are already designed and built, all manufacturers can generate civil penalties in MY 2016. However, once a manufacturer is designated as unwilling to pay penalties, the CAFE model will attempt to add technology to the respective fleets to avoid shortfalls.

Table-II-86 - Assumed Manufacturer Willing to Pay Civil Penalties

Manufacturer	2017	2018	2019	2020	2021	2022	2023	2024	2025	2026
BMW	Y	Y	Y	Y	Y	Y	Y	Y	Y	Y
Daimler	Y	Y	Y	Y	Y	Y	Y	Y	Y	Y
FCA	Y	Y	Y	Y	Y	Y	Y	Y	Y	N
Ford	Y	Y	Y	N	N	N	N	N	N	N
General Motors	Y	Y	Y	N	N	N	N	N	N	N
Honda	Y	Y	Y	N	N	N	N	N	N	N
Hyundai Kia-H	Y	Y	Y	N	N	N	N	N	N	N
Hyundai Kia-K	Y	Y	Y	N	N	N	N	N	N	N
JLR	Y	Y	Y	Y	Y	Y	Y	Y	Y	Y
Mazda	Y	Y	Y	N	N	N	N	N	N	N
Nissan Mitsubishi	Y	Y	Y	N	N	N	N	N	N	N
Subaru	Y	Y	Y	N	N	N	N	N	N	N
Tesla	Y	Y	Y	N	N	N	N	N	N	N
Toyota	Y	Y	Y	N	N	N	N	N	N	N
Volvo	Y	Y	Y	Y	Y	Y	Y	Y	Y	Y
VWA	Y	Y	Y	N	N	N	N	N	N	N

Several of the manufacturers in Table–II–86 that are assumed to be willing to pay civil penalties in the early years of the program have no history of paying civil penalties. However, several of those manufacturers have either bought or sold credits—or transferred credits from one fleet to another to offset a shortfall in the underperforming fleet. As the CAFE model does not simulate credit trades between manufacturers, providing this additional flexibility in the modeling avoids the outcome where the CAFE model applies more technology than would be needed in the context of the full set of compliance flexibilities at the industry level. By statute, NHTSA cannot consider credit flexibilities when setting standards, so most manufacturers (those without a history of civil penalty payment) are assumed to comply with their standard through fuel economy improvements for the model years being considered in this analysis. The notable exception to this is FCA, who we expect will still satisfy the requirements of the program through a combination of credit application and civil penalties through MY 2025 before eventually complying exclusively through fuel economy improvements in MY 2026.

As mentioned above, the CAA does not provide civil penalty provisions similar to those specified in EPCA/EISA, and the above-mentioned corresponding inputs apply only to simulation of compliance with CAFE standards.

(d) Representation of CAFE and CO₂ Credit Provisions

The model's approach to simulating compliance decisions accounts for the potential to earn and use CAFE credits as provided by EPCA/EISA. The model similarly accumulates and applies CO₂ credits when simulating compliance with EPA's standards. Like past versions, the current CAFE model can be used to simulate credit carry-forward (a.k.a. banking) between model years and transfers between the passenger car and light truck fleets but not credit carry-back (a.k.a. borrowing) from future model years or trading between manufacturers. Some manufacturers have made occasional use of credit carry-back provisions, although the analysis does not assume use of carry-back as a compliance strategy because of the risk in relying on future improvements to offset earlier

compliance deficits. Thus far, NHTSA has not attempted to include simulation of credit carry-back or trading in the CAFE model. Unlike past versions, the current CAFE model provides a basis to specify (in model inputs) CAFE credits available from model years earlier than those being simulated explicitly. For example, with this analysis representing model years 2016–2032 explicitly, credits earned in model year 2012 are made available for use through model year 2017 (given the current five-year limit on carry-forward of credits). The banked credits are specific to both model year and fleet in which they were earned. Comment and supporting information are invited regarding whether and, if so, how the CAFE model and inputs might practicably be modified to account for trading of credits between manufacturers and/or carry-back of credits from later to earlier model years.

As discussed in the CAFE model documentation, the model's default logic attempts to maximize credit carry-forward—that is, to “hold on” to credits for as long as possible. If a manufacturer needs to cover a shortfall that occurs when insufficient opportunities exist to add technology in order to achieve compliance with a standard, the model will apply credits. Otherwise it carries forward credits until they are about to expire, at which point it will use them before adding technology that is not considered cost-effective. The model attempts to use credits that will expire within the next three years as a means to smooth out technology application over time to avoid both compliance shortfalls and high levels of over-compliance that can result in a surplus of credits. As further discussed in the CAFE model documentation, model inputs can be used to adjust this logic to shift the use of credits ahead by one or more model years. In general, the logic used to generate credits and apply them to compensate for compliance shortfalls, both in a given fleet and across regulatory fleets, is an area that requires more attention in the next phase of model development. While the current model correctly accounts for credits earned when a manufacturer exceeds its standard in a given year, the strategic decision of whether to earn additional credits to bank for future years (in the current fleet or to transfer into another regulatory fleet) and when to optimally apply them to deficits is

challenging to simulate. This will be an area of focus moving forward.

NHTSA introduced the CAFE Public Information Center³⁵⁷ to provide public access to a range of information regarding the CAFE program, including manufacturers' credit balances. However, there is a data lag in the information presented on the CAFE PIC that may not capture credit actions across the industry for as much as several months. Additionally, CAFE credits that are traded between manufacturers are adjusted to preserve the gallons saved that each credit represents.³⁵⁸ The adjustment occurs at the time of application rather than at the time the credits are traded. This means that a manufacturer who has acquired credits through trade, but has not yet applied them, may show a credit balance that is either considerably higher or lower than the real value of the credits when they are applied. For example, a manufacturer that buys 40 million credits from Tesla, may show a credit balance in excess of 40 million. However, when those credits are applied, they may be worth only 1/10 as much—making that manufacturer's true credit balance closer to 4 million than 40 million.

Having reviewed credit balances (as of October 23, 2017) and estimated the potential that some manufacturers could trade credits, NHTSA developed inputs that make carried-forward credits available as summarized in Table–II–87, Table–II–88, and Table–II–89, after subtracting credits assumed to be traded to other manufacturers, adding credits assumed to be acquired from other manufacturers through such trades, and adjusting any traded credits (up or down) to reflect their true value for the fleet and model year into which they were traded.³⁵⁹ While the CAFE model will transfer expiring credits into another fleet (e.g., moving expiring credits from the domestic car credit bank into the light truck fleet), some of these credits were moved in the initial banks to improve the efficiency of application and to better reflect both the projected shortfalls of each manufacturer's regulated fleets, and to represent observed behavior. For context, a manufacturer that produces one million vehicles in a given fleet, and experiences a shortfall of 2 mpg, would need 20 million credits to completely offset the shortfall.

³⁵⁷ CAFE Public Information Center, http://www.nhtsa.gov/CAFE_PIC/CAFE_PIC_Home.htm (last visited June 22, 2018).

³⁵⁸ GHG credits for EPA's program are denominated in metric tons of CO₂ rather than gram/mile compliance credits and require no

adjustment when traded between manufacturers or fleets.

³⁵⁹ The adjustments, which are based upon the standard, CAFE and year of both the party originally earning the credits and the party applying them, were implemented assuming the credits

would be applied to the model year in which they were set to expire. For example, credits traded into a domestic passenger car fleet for MY 2014 were adjusted assuming they would be applied in the domestic passenger car fleet for MY 2019.

Table-II-87 - Estimated Domestic Car CAFE Credit Banks, MY 2011 -2015

Manufacturer	Model Year				
	2011	2012	2013	2014	2015
BMW	-	-	-	-	-
Daimler	-	-	-	-	-
FCA	3,533,996	18,886,353	42,604,131	1,682,307	-
Ford	24,094,037	26,139,750	40,611,410	30,152,856	7,089,840
General Motors	7,682,752	7,246,220	24,976,993	7,338,835	-
Honda	99	1,379,203	813,612	39,580,944	52,537,420
Hyundai Kia-H	-	-	-	-	-
Hyundai Kia-K	-	-	-	-	-
JLR	-	-	-	-	-
Mazda	15,526	-	-	-	-
Nissan Mitsubishi	-	1,564,100	26,451,158	52,774,443	62,285,009
Subaru	-	-	-	589,594	2,880,250
Tesla	-	164,504	491,723	363,905	25,369,142
Toyota	31,937,216	29,691,134	17,474,425	12,181,000	4,828,440
Volvo	-	-	-	-	-
VWA	-	1,529,328	2,836,482	4,390,945	4,479,510

Table-II-88 - Estimated Imported Car CAFE Credit Banks, MY 2011-2015

Manufacturer	Model Year				
	2011	2012	2013	2014	2015
BMW	-	-	-	4,163,432	6,329,325
Daimler	-	-	-	-	-
FCA	-	6,326,946	-	-	-
Ford	-	-	1,385,379	-	-
General Motors	1,576,672	251,275	2,780,629	3,646,294	1,304,196
Honda	101	99	5,431,859	2,142,966	1,356,300
Hyundai Kia-H	28,338,076	16,403,710	44,063,236	10,185,700	9,658,416
Hyundai Kia-K	15,078,920	12,759,767	11,603,509	-	-
JLR	-	-	-	1,270,772	293,436
Mazda	5,617,262	322,320	-	15,430,643	13,254,400
Nissan Mitsubishi	1,953,364	1,606,363	894,783	2,161,883	9,086,088
Subaru	-	6,804,584	1,894,165	22,616,350	1,867,661
Tesla	-	-	-	-	-
Toyota	39,697,080	62,935,487	66,791,277	47,709,001	50,293,119
Volvo	-	-	-	-	-
VWA	8,593,792	-	-	-	-

Table-II-89 - Estimated Light Truck CAFE Credit Banks, MY 2011-2015

Manufacturer	Model Year				
	2011	2012	2013	2014	2015
BMW	-	-	-	235,952	1,132,000
Daimler	-	-	-	-	-
FCA	-	-	2,822,581	-	-
Ford	5,829,495	701,227	3,699,786	-	-
General Motors	4,181,275	-	-	10,481,490	-
Honda	-	100	373,308	9,823,076	12,807,872
Hyundai Kia-H	-	-	-	-	-
Hyundai Kia-K	2,314,000	2,285,440	1,618,398	-	-
JLR	-	-	-	66,174	-
Mazda	-	-	1,405,139	1,970,650	1,260,688
Nissan Mitsubishi	23,239	300,112	372,970	1,168,917	4,915,173
Subaru	369,021	3,441,060	-	-	9,158,682
Tesla	-	-	-	-	-
Toyota	14,507,492	9,082,704	17,975,353	6,810,262	-
Volvo	-	-	-	-	-
VWA	644,980	77,809	790,875	621,144	-

In addition to the inclusion of these existing credit banks, the CAFE model also updated its treatment of credits in the rulemaking analysis. Congress has declared that NHTSA set CAFE standards at maximum feasible levels for each model year under consideration without consideration of the program's credit mechanisms. However, as CAFE rulemakings have evaluated longer time periods in recent years, the early actions taken by manufacturers required more nuanced representation. Therefore, the CAFE model now allows a "last year to consider credits," set at the last year for which new standards are not being considered (MY 2019 in this analysis). This allows the model to replicate the practical application of existing credits toward CAFE compliance in early years

but to examine the impact of proposed standards based solely on fuel economy improvements in all years for which new standards are being considered. Comment is sought regarding the model's representation of the CAFE and CO₂ credit provisions, recommendations regarding any other options, and any information that could help to refine the current approach or develop and implement an alternative approach.

The CAFE model has also been modified to include a similar representation of existing credit banks in EPA's CO₂ program. While the life of a CO₂ credit, denominated in metric tons CO₂, has a five-year life, matching the lifespan of CAFE credits, credits earned in the early years of the EPA program, MY 2009–2011, may be used through MY 2021.³⁶⁰ The CAFE model

was not modified to allow exceptions to the life-span of compliance credits treating them all as if they may be carried forward for no more than five years, so the initial credit banks were modified to anticipate the years in which those credits might be needed. The fact that MY 2016 is simulated explicitly prohibited the inclusion of these banked credits in MY 2016 (which could be carried forward from MY 2016 to MY 2021), and thus underestimates the extent to which individual manufacturers, and the industry as a whole, may rely on these early credits to comply with EPA standards between MY 2016 and MY 2021. The credit banks with which the simulations in this analysis were conducted are presented in the following tables:

³⁶⁰ In response to comments, EPA placed limits on credits earned in MY 2009, causing them to

expire prior to this rule. However, credits generated in MYs 2010–2011 may be carried forward, or

traded, and applied to deficits generated through MY 2021.

Table-II-90 - Estimated Passenger Car CO₂ Credit Banks, MY 2011-2015

Manufacturer	Model Year				
	2011	2012	2013	2014	2015
BMW	790,137	1,213,000	1,558,000	1,833,000	2,089,000
Daimler	688,000	777,000	899,000	1,199,000	1,443,000
FCA	4,089,000	4,554,000	5,142,000	6,574,000	7,318,000
Ford	1,911,000	2,546,000	3,485,000	4,743,000	4,216,000
General Motors	2,040,000	3,804,000	3,487,000	4,882,000	4,588,000
Honda				600,000	2,000,000
Hyundai Kia-H					
Hyundai Kia-K	114,000	1,236,000	548,000	973,000	1,161,000
JLR	278,000	343,000	355,000	392,000	379,000
Mazda					600,000
Nissan Mitsubishi				765,000	1,863,000
Subaru	511,000	611,000	1,000,000	1,200,000	1,400,000
Tesla					
Toyota					450,000
Volvo	32,000	102,000	169,000	89,000	143,000
VWA	1,215,000	1,343,000	1,700,000	2,065,000	2,444,000

Table-II-91 - Estimated Light Truck CO₂ Credit Banks, MY 2011-2015

Manufacturer	Model Year				
	2011	2012	2013	2014	2015
BMW	112,314	-	-	-	-
Daimler	870,000	914,000	1,149,000	274,000	446,000
FCA	7,756,000	6,106,000	2,742,000	1,920,000	3,614,000
Ford	6,366,000	2,875,000	4,656,000	6,089,000	2,122,000
General Motors	11,318,000	11,216,000	9,164,000	6,049,000	4,829,000
Honda				945,000	1,400,000
Hyundai Kia-H	140,000	153,000	218,000	300,000	300,000
Hyundai Kia-K	556,000	591,000	981,000	973,000	1,219,000
JLR	1,715,000	1,635,000	1,973,000	1,940,000	2,168,000
Mazda			200,000	450,000	500,000
Nissan Mitsubishi					
Subaru					193,000
Tesla					
Toyota	8,701,000	8,710,000	8,545,000	9,045,000	8,000,000
Volvo			37,000	50,000	50,000
VWA	729,000	384,000	134,000	370,000	547,000

While the CAFE model does not simulate the ability to trade credits between manufacturers, it does simulate

the strategic accumulation and application of compliance credits, as well as the ability to transfer credits

between fleets to improve the compliance position of a less efficient fleet by leveraging credits earned by a

more efficient fleet. The model prefers to hold on to earned compliance credits within a given fleet, carrying them forward into the future to offset potential future deficits. This assumption is consistent with observed strategic behavior dating back to 2009.

From 2009 to present, no manufacturer has transferred CAFE credits into a fleet to offset a deficit in the same year in which they were earned. This has occurred with credits acquired from other manufacturers via trade but not with a manufacturer's own credits. Therefore, the current representation of credit transfers between fleets—where the model prefers to transfer expiring, or soon-to-be-expiring credits rather than newly earned credits—is both appropriate and consistent with observed industry behavior.

This may not be the case for GHG standards, though it is difficult to be certain at this point. The GHG program seeded the industry with a large quantity of early compliance credits (earned in MYs 2009–2011³⁶¹) prior to the existence formal standards of the EPA program. These early credits do not expire until 2021. So, for manufacturers looking to offset deficits, it is more sensible to use current-year credits that expire in the next five years, rather than draw down the bank of credits that can be used until MY 2021. The first model year for which earned credits outlive the initial bank is MY 2017, for which final compliance actions and deficit resolutions are still pending. Regardless, in order to accurately represent some of the observed behavior in the GHG credit system, the CAFE model allows (and encourages) within-year transfers between regulated fleets for the purpose of simulating compliance with the GHG standards.

In addition to more rigorous accounting of CAFE and CO₂ credits, the model now also accounts for air conditioning efficiency and off-cycle adjustments. NHTSA's program considers those adjustments in a manufacturer's compliance calculation starting in MY 2017, and the current model uses the adjustments claimed by each manufacturer in MY 2016 as the starting point for all future years. Because the air conditioning and off-cycle adjustments are not credits in NHTSA's program, but rather adjustments to compliance fuel economy (much like the Flexible Fuel Vehicle adjustments that are due to

phase out in MY 2019), they may be included under either a "standard setting" or "unconstrained" analysis perspective.

When the CAFE model simulates EPA's program, the treatment of A/C efficiency and off-cycle credits is similar, but the model also accounts for A/C leakage (which is not part of NHTSA's program). When determining the compliance status of a manufacturer's fleet (in the case of EPA's program, PC and LT are the only fleet distinctions), the CAFE model weighs future compliance actions against the presence of existing (and expiring) CO₂ credits resulting from over-compliance with earlier years' standards, A/C efficiency credits, A/C leakage credits, and off-cycle credits.

5. Impacts on Each OEM and Overall Industry

(a) Technology Application and Penetration Rates

The CAFE model tracks and reports technology application and penetration rates for each manufacturer, regulatory class, and model year, calculated as the volume of vehicles with a given technology divided by the total volume. The "application rate" accounts only for those technologies applied by the model during the compliance simulation, while the "penetration rate" accounts for the total percentage of a technology present in a given fleet, whether applied by the CAFE model or already present at the start of the simulation.

In addition to the aggregate representation of technology penetration, the model also tracks each individual vehicle model on which it has operated. Each row in the market data file (the representation of vehicles offered for sale in MY 2016 in the U.S., discussed in detail in Section II.B.a and PRIA Chapter 6) contains a record for every model year and every alternative, that identifies with which technologies the vehicle started the simulation, which technologies were applied, and whether those technologies were applied directly or through inheritance (discussed above). Interested parties may use these outputs to assess how the compliance simulation modified any vehicle that was offered for sale in MY 2016 in response to a given regulatory alternative.

(b) Required and Achieved CAFE and Average CO₂ Levels

The model fully represents the required CAFE (and now, CO₂) levels for every manufacturer and every fleet. The standard for each manufacturer is based on the harmonic average of footprint

targets (by volume) within a fleet, just as the standards prescribe. Unlike earlier versions of the CAFE model, the current version further disaggregates passenger cars into domestic and imported classes (which manufacturers report to NHTSA and EPA as part of their CAFE compliance submissions). This allows the CAFE model to more accurately estimate the requirement on the two passenger car fleets, represent the domestic passenger car floor (which must be exceeded by every manufacturer's domestic fleet, without the use of credits, but with the possibility of civil penalty payment), and allows it to enforce the transfer cap limit that exists between domestic and imported passenger cars, all for purposes of the CAFE program.

In calculating the achieved CAFE level, the model uses the prescribed harmonic average of fuel economy ratings within a vehicle fleet. Under an "unconstrained" analysis, or in a model year for which standards are already final, it is possible for a manufacturer's CAFE to fall below its required level without generating penalties because the model will apply expiring or transferred credits to deficits if it is strategically appropriate to do so. Consistent with current EPA regulations, the model applies simple (not harmonic) production-weighted averaging to calculate average CO₂ levels.

(c) Costs

For each technology that the model adds to a given vehicle, it accumulates cost. The technology costs are defined incrementally and vary both over time and by technology class, where the same technology may cost more to apply to larger vehicles as it involves more raw materials or requires different specifications to preserve some performance attributes. While learning-by-doing can bring down cost, and should reasonably be implemented in the CAFE model as a rate of cost reduction that is applied to the cumulative volume of a given technology produced by either a single manufacturer or the industry as a whole, in practice this notion is implemented as a function of time, rather than production volume. Thus, depending upon where a given technology starts along its learning curve, it may appear to be cost-effective in later years where it was not in earlier years. As the model carries forward technologies that it has already applied to future model years, it similarly adjusts the costs of those technologies based on their individual learning rates.

³⁶¹ In response to public comment, EPA eliminated the use of credits earned in MY 2009 for future model years. However, credits earned in MY 2010 and MY 2011 remain.

The other costs that manufacturers incur as a result of CAFE standards are civil penalties resulting from non-compliance with CAFE standards. The CAFE model accumulates costs of \$5.50 per 1/10-MPG under the standard, multiplied by the number of vehicles produced in that fleet, in that model year. The model reports as the full "regulatory cost," the sum of total technology cost and total fines by the manufacturer, fleet, and model year. As mentioned above, the relevant EPCA/EISA provisions do not also appear in the CAA, so this option and these costs apply only to simulated compliance with CAFE standards.

(d) Sales

In all previous versions of the CAFE model, the total number of vehicles sold in any model year, in fact the number of each individual vehicle model sold in each year, has been a static input that did not vary in response to price increases induced by CAFE standards, nor changes in fuel prices, or any other input to the model. The only way to alter sales, was to update the entire forecast in the market input file. However, in the 2012 final rule, NHTSA included a dynamic fleet share model that was based on a module in the Energy Information Administration's NEMS model. This fleet share model did not change the size of the new vehicle fleet in any year, but it did change the share of new vehicles that were classified as passenger cars (or light trucks). That capability was not included in the central analysis but was included in the uncertainty analysis, which looked at the baseline and preferred alternative in the context of thousands of possible future states of the world. As some of those futures contained extreme cases of fuel prices, it was important to ensure consistent modeling responses within that context. For example, at a gasoline price of \$7/gallon, it would be unrealistic to expect the new vehicle market's light truck share to be the same as the future where gasoline cost \$2/gallon. The current model has slightly modified, and fully integrated, the dynamic fleet share model. Every regulatory alternative and sensitivity case considered in this analysis reflects a dynamically responsive fleet mix in the new vehicle market.

While the dynamic fleet share model adjusts unit sales across body styles (cars, SUVs, and trucks), it does not modify the total number of new vehicles sold in a given year. The CAFE model now includes a separate function to account for changes in the total number of new vehicles sold in a given year

(regardless of regulatory class or body style), in response to certain macroeconomic inputs and changes in the average new vehicle price. The price impact is modest relative to the influence of the macroeconomic factors in the model. The combination of these two models modify the total number of new vehicles, the share of passenger cars and light trucks, and, as a consequence, the number of each given model sold by a given manufacturer. However, these two factors are insufficient to cause large changes to the composition of any of a manufacturer's fleets. In order to significantly change the mix of models produced within a given fleet, the CAFE model would require a way to trade off the production of one vehicle versus another both within a manufacturer's fleet and across the industry. While NHTSA has experimented with fully-integrated consumer choice models, their performance has yet to satisfy the requirements of a rulemaking analysis.

There are multiple levels of sales impacts that could result from increasing the prices of new vehicles across the industry. Any estimate of impacts at the manufacturer, or model, level would be subject to an assumed pricing strategy that spreads technology cost increases across available models in a way that may cross-subsidize specific models or segments at the expense of others. However, at the industry level, it is reasonable to assume that all incremental technology costs can be captured by the average price of a new vehicle. To the extent that this factor influences the total number of new vehicles sold in a given model year, it can be included in an empirical model of annual sales. However, there is limited historical evidence that the average price of a new vehicle is a strong determining factor in the total number of annual new vehicle sales.

6. National Impacts

(a) Vehicle Stock and Fleet Turnover

The CAFE model carries a complete representation of the registered vehicle population in each calendar year, starting with an aggregated version of the most recent available data about the registered population for the first year of the simulation. In this analysis, the first model year considered is MY 2016, and the registered vehicle population enters the model as it appeared at the end of calendar year 2015. The initial vehicle population is stratified by age (or model year cohort) and regulatory class—to which the CAFE model assigns average fuel economies based on the reported regulatory class industry average

compliance value in each model year (and class). Once the simulation begins, new vehicles are added to the population from the market data file and age throughout their useful lives during the simulation, with some fraction of them being retired (or scrapped) along the way. For example, in calendar year 2017, the new vehicles (age zero) are MY 2017 vehicles (added by the CAFE model simulation and represented at the same level of detail used to simulate compliance), the age one vehicles are MY 2016 vehicles (added by the CAFE model simulation), and the age two vehicles are MY 2015 vehicles (inherited from the registered vehicle population and carried through the analysis with less granularity). This national registered fleet is used to calculate annual fuel consumption, vehicle miles traveled (VMT), pollutant emissions, and safety impacts under each regulatory alternative.

In addition to dynamically modifying the total number of new vehicles sold, a dynamic model of vehicle retirement, or scrappage, has also been implemented. The model implements the scrappage response by defining the instantaneous scrappage rate at any age using two functions. For ages less than 20, instantaneous scrappage is defined as a function of vehicle age, new vehicle price, cost per mile of driving (the ratio of fuel price and fuel economy), and a small number of macroeconomic factors. For ages greater than 20, the instantaneous scrappage rate is a simple exponential function of age. While the scrappage response does not affect manufacturer compliance calculations, it impacts the lifetime mileage accumulation (and thus fuel savings) of all vehicles. Previous CAFE analyses have focused exclusively on new vehicles, tracing the fuel consumption and social costs of these vehicles throughout their useful lives; the scrappage effect also impacts the registered vehicle fleet that exists when a set of standards is implemented.

As new vehicles enter the registered population their retirement rates are governed by the scrappage model, so are the vehicles already registered at the start of model year 2016. To the extent that a given set of CAFE or CO₂ standards accelerates or decelerates the retirement of those vehicles, additional fuel consumption and social costs may accrue to those vehicles under that standard. The CAFE model accounts for those costs and benefits, as well as tracking all of the standard benefits and costs associated with the lifetimes of new vehicles produced under the rule. For more detail about the derivation of the scrappage functions, see Section

I.E, and PRIA Chapter 8. Comment is sought on the specification and inclusion of these factors in the current model.

(b) Highway Travel

In support of prior CAFE rulemakings, the CAFE model accounted for new travel that results from fuel economy improvements that reduce the cost of driving. The magnitude of the increase in travel demand is determined by the rebound effect. In both previous versions and the current version of the CAFE model, the amount of travel demanded by the existing fleet of vehicles is also responsive to the rebound effect (representing the price elasticity of demand for travel)—increasing when fuel prices decrease relative to the fuel price when the VMT on which our mileage accumulation schedules were built was observed. Since the fuel economy of those vehicles is already fixed, only the fuel price influences their travel demand relative to the mileage accumulation schedule and so is identical for all regulatory alternatives.

While the average mileage accumulation per vehicle by age is not influenced by the rebound effect in a way that differs by regulatory alternative, three other factors influence total VMT in the model in a way that produces different total mileage accumulation by regulatory alternative. The first factor is the total industry sales response: New vehicles are both driven more than older vehicles and are more fuel efficient (thus producing more rebound miles). To the extent that more (or fewer) of these new models enter the vehicle fleet in each model year, total VMT will increase (or decrease) as a result. The second factor is the dynamic fleet share model. The fleet share influences not only the fuel economy distribution of the fleet, as light trucks are less efficient than passenger cars on average, but the total miles are influenced by fact that light trucks are driven more than passenger cars as well. Both of the first two factors can magnify the influence of the rebound effect on vehicles that go through the compliance simulation (MY 2016–2032) in the manner discussed above and in Section I.E. The third factor influencing total annual VMT is the scrappage model. By modifying the retirement rates of on-road vehicles under each regulatory alternative, the scrappage model either increases or decreases the lifetime miles that accrue to vehicles in a given model year cohort.

(c) Fuel Consumption and GHG Emissions

For every vehicle model in the market file, the model estimates the VMT per vehicle (using the assumed VMT schedule, the vehicle fuel economy, fuel price, and the rebound assumption). Those miles are multiplied by the volume for each vehicle. Fuel consumption is the product of miles driven and fuel economy, which can be tracked by model year cohort in the model. Carbon dioxide emissions from vehicle tailpipes are the simple product of gallons consumed and the carbon content of each gallon.

In order to calculate calendar year fuel consumption, the model needs to account for the inherited on-road fleet in addition to the model year cohorts affected by this proposed rule. Using the VMT of the average passenger car and light truck from each cohort, the model computes the fuel consumption of each model year class of vehicles for its age in a given CY. The sum across all ages (and thus, model year cohorts) in a given CY provides estimated CY fuel consumption.

Rather than rely on the compliance values of fuel economy for either historical vehicles or vehicles that go through the full compliance simulation, the model applies an “on-road gap” to represent the expected difference between fuel economy on the laboratory test cycle and fuel economy under real-world operation. This was a topic of interest in the recent peer review of the CAFE model. While the model currently allows the user to specify an on-road gap that varies by fuel type (gasoline, E85, diesel, electricity, hydrogen, and CNG), it does not vary over time, by vehicle age, or by technology combination. It is possible that the “gap” between laboratory fuel economy and real-world fuel economy has changed over time, that fuel economy degrades over time as a vehicle ages, or that specific combinations of fuel-saving technologies have a larger discrepancy between laboratory and real-world fuel economy than others. Further research would be required to determine whether the model should include a functional representation of the on-road gap to address these various factors, and comment is sought on the data sources and implementation strategies available to do so.

Because the model produces an estimate of the aggregate number of gallons sold in each CY, it is possible to calculate both the total expenditures on motor fuel and the total contribution to the Highway Trust Fund (HTF) that result from that fuel consumption. The

Federal fuel excise tax is levied on every gallon of gasoline and diesel sold in the U.S., with diesel facing a higher per-gallon tax rate. The model uses a national perspective, where the state taxes present in the input files represent an estimated average fuel tax across all U.S. states. Accordingly, while the CAFE model cannot reasonably estimate potential losses to state fuel tax revenue from increasingly the fuel economy of new vehicles, it can do so for the HTF, and the agencies invite comment on the proposed standards’ implications for the HTF.

In addition to the tailpipe emissions of carbon dioxide, each gallon of gasoline produced for consumption by the on-road fleet has associated “upstream” emissions that occur in the extraction, transportation, refining, and distribution of the fuel. The model accounts for these emissions as well (on a per-gallon basis) and reports them accordingly.

(d) Criteria Pollutant Emissions

The CAFE model uses the entire on-road fleet, calculated VMT (discussed above), and emissions factors (which are an input to the CAFE model, specified by model year and age) to calculate tailpipe emissions associated with a given alternative. Just as it does for additional GHG emissions associated with upstream emissions from fuel production, the model captures criteria pollutants that occur during other parts of the fuel life cycle. While this is typically a function of the number of gallons of gasoline consumed (and miles driven, for tailpipe criteria pollutant emissions), the CAFE model also estimates electricity consumption and the associated upstream emissions (resource extraction and generation, based on U.S. grid mix).

(e) Highway Fatalities

Earlier versions of the CAFE model accounted for the safety impacts associated with reducing vehicle mass in order to improve fuel economy. In particular, NHTSA’s safety analysis estimated the additional fatalities that would occur as a result of new vehicles getting lighter, then interacting with the on-road vehicle population. In general, taking mass out of the heaviest new vehicles improved safety outcomes, while taking mass from the lightest new vehicles resulted in a greater number of expected highway fatalities. However, the change in fatalities did not adequately account for changes in exposure that occur as a result of increased demand for travel as vehicles become cheaper to operate. The current version of the model resolves that

limitation and addresses additional sources of fatalities that can result from the implementation of CAFE or CO₂ standards. These are discussed in greater detail in Section 0 and PRIA Chapter 11.

NHTSA has observed that older vehicles in the population are responsible for a disproportionate number of fatalities, both by number of registrations and by number of miles driven. Accordingly, any factor that causes the population of vehicles to turn over more slowly will induce additional fatalities—as those older vehicles continue to be driven, rather than being retired and replaced with newer (even if not brand new) vehicle models. The scrappage effect, which delays (or

accelerates) the retirement of registered vehicles, impacts the number of fatalities through this mechanism—importantly affecting not just new vehicles sold from model years 2016–2032 but existing vehicles that are already part of the on-road fleet. Similarly, to the extent that a CAFE or CO₂ alternative reduces new vehicle sales, it can slow the transition from older vehicles to newer vehicles, reducing the share of total vehicle miles that are driven by newer, more technologically advanced vehicles. Accounting for the change in vehicle miles traveled that occurs when vehicles become cheaper to operate has led to a number of fatalities that can be attributed to the rebound effect,

independent of any changes to new vehicle mass, price, or longevity.

The CAFE model now estimates fatalities by combining the effects discussed above. In particular, the model estimates the fatality rate per billion miles VMT for each model year vehicle in the population (the newest of which are the new vehicles produced that model year). This estimate is independent of regulatory class and varies only by year (and not vehicle age). The estimated fatality rate is then multiplied by the estimated VMT for each vehicle in the population and the product of the change in curb weight and the relevant safety coefficient, as in the equation below.

$$Fatalities = \frac{VMT}{1e9} * FatalityEstimate * (1 + ChangePer100Lbs * \frac{\Delta(CurbWeight, Threshold)}{100})$$

For the vehicles in the historical fleet, meaning all those vehicles that are already part of the registered vehicle population in CY 2016, only the model year effect that determines the “FatalityEstimate” is relevant. However, each vehicle that is simulated explicitly by the CAFE model, and is eligible to receive mass reduction technologies, must also consider the change between its curb weight and the threshold weights that are used to define safety classes. For vehicles above the threshold, reducing vehicle mass can have a smaller negative impact on fatalities (or even reduce fatalities, in the case of the heaviest light trucks). The “ChangePer100Lbs” depends upon this difference. The sum of all estimated fatalities for each model year vehicle in the on-road fleet determines the reported fatalities, which can be summarized by either model year or calendar year.

(f) Costs and Benefits

As the CAFE model simulates manufacturer compliance with regulatory alternatives, it estimates and tracks a number of consequences that

generate social costs. The most obvious cost associated with the program is the cost of additional fuel economy improving/CO₂ emissions reducing technology that is added to new vehicles as a result of the rule. However, the model does not inherently draw a distinction between costs and benefits. For example, the model tracks fuel consumption and the dollar value of fuel consumed. This is the cost of travel under a given alternative (including the baseline). The “cost” or “benefit” associated with the value of fuel consumed is determined by the reference point against which each alternative is considered. The CAFE model reports absolute values for the amount of money spent on fuel in the baseline, then reports the amount spent on fuel in the alternatives relative to the baseline. If the baseline standard were fixed at the current level, and an alternative achieves 100 mpg by 2025, the total expenditures on fuel in the alternative would be lower, creating a fuel savings “benefit.” This analysis uses a baseline that is more stringent than each alternative considered, so the

incremental fuel expenditures are greater for the alternatives than for the baseline.

Other social costs and benefits emerge as the result of physical phenomena, like tailpipe emissions or highway fatalities, which are the result of changes in the composition and use of the on-road fleet. The social costs associated with those quantities represent an economic estimate of the social damages associated with the changes in each quantity. The model tracks and reports each of these quantities by: Model year and vehicle age (the combination of which can be used to produce calendar year totals), regulatory class, fuel type, and social discount rate.

The full list of potential costs and benefits is presented in Table–II–92 as well as the population of vehicles that determines the size of the factor (either new vehicles or all registered vehicles) and the mechanism that determines the size of the effect (whether driven by the number of miles driven, the number of gallons consumed, or the number of vehicles produced).

Table-II-92 - Social Costs and Benefits in CAFE Model

Cost/Benefit	Population	Mechanism
Technology Cost	New vehicles	Production volume
Maintenance/Repair	New vehicles	Production volume
Relative Value Loss	New vehicles	Production volume
Pre-Tax Fuel Savings	All Vehicles	Gallons
Fuel Tax Revenue	All Vehicles	Gallons
Mobility Benefit	New vehicles	Miles
Energy Security Cost	All Vehicles	Gallons
Congestion	All Vehicles	Miles
Accidents	All Vehicles	Miles
Noise Costs	All Vehicles	Miles
Non-Fatal Injuries	All Vehicles	Miles
CO Damages	All Vehicles	Miles, Gallons
NO _x Damages	All Vehicles	Miles, Gallons
SO ₂ Damages	All Vehicles	Miles, Gallons
PM Damages	All Vehicles	Miles, Gallons
Social CO ₂ Damages	All Vehicles	Gallons

III. Proposed CAFE and CO₂ Standards for MYs 2021–2026

A. Form of the Standards

NHTSA and EPA are proposing that the form of the CAFE and CO₂ standards for MYs 2021–2026 would follow the form of those standards in prior model years. NHTSA has specific statutory requirements for the form of CAFE standards: Specifically, EPCA, as amended by EISA, requires that CAFE standards be issued separately for passenger cars and light trucks, and that each standard be specified as a mathematical function expressed in terms of one or more vehicle attributes related to fuel economy. Although the CAA does not have comparable specific requirements for the form of CO₂ standards for light-duty vehicles, EPA has concluded that it is appropriate to set CO₂ standards according to vehicle footprint, consistent with the EPCA/EISA requirements, which simplifies compliance for the industry.³⁶²

For MYs since 2011 for CAFE and since 2012 for CO₂, standards have taken the form of fuel economy and CO₂ targets expressed as functions of vehicle footprint (the product of vehicle wheelbase and average track width). NHTSA and EPA continue to believe that footprint is the most appropriate attribute on which to base the proposed standards, as discussed in Section II.C. Under the footprint-based standards, the function defines a CO₂ or fuel economy performance target for each unique footprint combination within a car or truck model type. Using the functions, each manufacturer thus will have a CAFE and CO₂ average standard for each year that is unique to each of its fleets,³⁶³ depending on the footprints and production volumes of the vehicle models produced by that manufacturer. A manufacturer will have separate footprint-based standards for cars and for trucks. The functions are mostly sloped, so that generally, larger vehicles (*i.e.*, vehicles with larger footprints) will be subject to lower CAFE mpg targets

and higher CO₂ grams/mile targets than smaller vehicles. This is because, generally speaking, smaller vehicles are more capable of achieving higher levels of fuel economy/lower levels of CO₂ emissions, mostly because they tend not to have to work as hard to perform their driving task. Although a manufacturer's fleet average standards could be estimated throughout the model year based on the projected production volume of its vehicle fleet (and are estimated as part of EPA's certification process), the standards to which the manufacturer must comply will be determined by its final model year production figures. A manufacturer's calculation of its fleet average standards as well as its fleets' average performance at the end of the model year will thus be based on the production-weighted average target and performance of each model in its fleet.³⁶⁴

For passenger cars, consistent with prior rulemakings, NHTSA is proposing to define fuel economy targets as follows:

³⁶² Such an approach is permissible under section 202(a) of the CAA and EPA has used the attribute-based approach in issuing standards under analogous provisions of the CAA.

³⁶³ EPCA/EISA requires NHTSA to separate passenger cars into domestic and import passenger

car fleets whereas EPA combines all passenger cars into one fleet.

³⁶⁴ As in prior rulemakings, a manufacturer may have some vehicle models that exceed their target and some that are below their target. Compliance with a fleet average standard is determined by

comparing the fleet average standard (based on the production-weighted average of the target levels for each model) with fleet average performance (based on the production-weighted average of the performance of each model).

$$TARGET_{FE} = \frac{1}{MIN \left[MAX \left(c \times FOOTPRINT + d, \frac{1}{a} \right), \frac{1}{b} \right]}$$

Where:

$TARGET_{FE}$ is the fuel economy target (in mpg) applicable to a specific vehicle model type with a unique footprint combination,

a is a minimum fuel economy target (in mpg),
 b is a maximum fuel economy target (in mpg),

c is the slope (in gallons per mile per square foot, or gpm, per square foot) of a line relating fuel consumption (the inverse of fuel economy) to footprint, and
 d is an intercept (in gpm) of the same line.

Here, MIN and MAX are functions that take the minimum and maximum values, respectively, of the set of

included values. For example, $MIN[40,35] = 35$ and $MAX(40, 25) = 40$, such that $MIN[MAX(40, 25), 35] = 35$.

For light trucks, also consistent with prior rulemakings, NHTSA is proposing to define fuel economy targets as follows:

$TARGET_{FE}$

$$= MAX \left(\frac{1}{MIN \left[MAX \left(c \times FOOTPRINT + d, \frac{1}{a} \right), \frac{1}{b} \right]}, \frac{1}{MIN \left[MAX \left(g \times FOOTPRINT + h, \frac{1}{e} \right), \frac{1}{f} \right]} \right)$$

Where:

$TARGET_{FE}$ is the fuel economy target (in mpg) applicable to a specific vehicle model type with a unique footprint combination,

$a, b, c,$ and d are as for passenger cars, but taking values specific to light trucks,
 e is a second minimum fuel economy target (in mpg),

f is a second maximum fuel economy target (in mpg),

g is the slope (in gpm per square foot) of a second line relating fuel consumption (the inverse of fuel economy) to footprint, and

h is an intercept (in gpm) of the same second line.

Although the general model of the target function equation is the same for each vehicle category (passenger cars and light trucks) and each model year, the parameters of the function equation differ for cars and trucks. For MYs 2020–2026, the parameters are unchanged, resulting in the same stringency in each of those model years.

Mathematical functions defining the proposed CO₂ targets are expressed as

functions that are similar, with coefficients a – h corresponding to those listed above.³⁶⁵ For passenger cars, EPA is proposing to define CO₂ targets as follows:

$$TARGET_{CO2} = MIN[b, MAX[a, c \times FOOTPRINT + d]]$$

Where:

$TARGET_{CO2}$ is the CO₂ target (in grams per mile, or g/mi) applicable to a specific vehicle model configuration,

a is a minimum CO₂ target (in g/mi),

b is a maximum CO₂ target (in g/mi),

c is the slope (in g/mi, per square foot) of a line relating CO₂ emissions to footprint, and

d is an intercept (in g/mi) of the same line.

For light trucks, CO₂ targets are defined as follows:

$$TARGET_{CO2} = MIN[MIN[b, MAX[a, c \times FOOTPRINT + d]], MIN[f, MAX[e, g \times FOOTPRINT + h]]$$

Where:

$TARGET_{CO2}$ is the CO₂ target (in g/mi) applicable to a specific vehicle model configuration,

$a, b, c,$ and d are as for passenger cars, but taking values specific to light trucks,
 e is a second minimum CO₂ target (in g/mi),
 f is a second maximum CO₂ target (in g/mi),
 g is the slope (in g/mi per square foot) of a second line relating CO₂ emissions to footprint, and

h is an intercept (in g/mi) of the same second line.

To be clear, as has been the case since the agencies began establishing attribute-based standards, no vehicle need meet the specific applicable fuel economy or CO₂ targets, because compliance with either CAFE or CO₂ standards is determined based on corporate *average* fuel economy or fleet average CO₂ emission rates. The required CAFE level applicable to a given fleet in a given model year is determined by calculating the production-weighted harmonic average of fuel economy targets applicable to specific vehicle model configurations in the fleet, as follows:

$$CAFE_{required} = \frac{\sum_i PRODUCTION_i}{\sum_i \frac{PRODUCTION_i}{TARGET_{FE,i}}}$$

Where:

$CAFE_{required}$ is the CAFE level the fleet is required to achieve,

i refers to specific vehicle model/configurations in the fleet,

$PRODUCTION_i$ is the number of model configuration i produced for sale in the U.S., and

$TARGET_{FE,i}$ the fuel economy target (as defined above) for model configuration i .

Similarly, the required average CO₂ level applicable to a given fleet in a given model year is determined by calculating the production-weighted

³⁶⁵ EPA regulations use a different but mathematically equivalent approach to specify targets. Rather than using a function with nested minima and maxima functions, EPA regulations

specify requirements separately for different ranges of vehicle footprint. Because these ranges reflect the combined application of the listed minima, maxima, and linear functions, it is mathematically

equivalent and more efficient to present the targets as in this Section.

average (not harmonic) of CO₂ targets applicable to specific vehicle model configurations in the fleet, as follows:

$$CO2_{required} = \frac{\sum_i PRODUCTION_i \times TARGET_{CO2,i}}{\sum_i PRODUCTION_i}$$

Where:

CO2_{required} is the average CO₂ level the fleet is required to achieve,
i refers to specific vehicle model/ configurations in the fleet,
PRODUCTION_i is the number of model configuration *i* produced for sale in the U.S., and
TARGET_{CO2,i} is the CO₂ target (as defined above) for model configuration *i*.

Today's action would set standards that only apply to fuel economy and CO₂. EPA seeks comment on this approach.

Comment is sought on the proposed standards and on the analysis presented here; we seek any relevant data and information and will review responses. That review could lead to selection of

one of the other regulatory alternatives for the final rule.

B. Passenger Car Standards

For passenger cars, NHTSA and EPA are proposing CAFE and CO₂ standards, respectively, for MYs 2021–2026 that are defined by the following coefficients:

Table III-1 - Characteristics of Preferred Alternative – Passenger Cars

	2021	2022	2023	2024	2025	2026
Fuel Economy Targets						
<i>a (mpg)</i>	48.74	48.74	48.74	48.74	48.74	48.74
<i>b (mpg)</i>	36.47	36.47	36.47	36.47	36.47	36.47
<i>c (gpm per s.f.)</i>	0.000460	0.000460	0.000460	0.000460	0.000460	0.000460
<i>d (gpm)</i>	0.00164	0.00164	0.00164	0.00164	0.00164	0.00164
CO₂ Targets						
<i>a (g/mi)</i>	182	182	182	182	182	182
<i>b (g/mi)</i>	244	244	244	244	244	244
<i>c (g/mi per s.f.)</i>	4.09	4.09	4.09	4.09	4.09	4.09
<i>d (g/mi)</i>	14.6	14.6	14.6	14.6	14.6	14.6

Section II.C above discusses in detail how the coefficients in Table III–1 were developed for this proposal. The

coefficients result in the footprint-dependent targets shown graphically below for MYs 2021–2026. The MYs

2017–2020 standards are also shown for comparison.

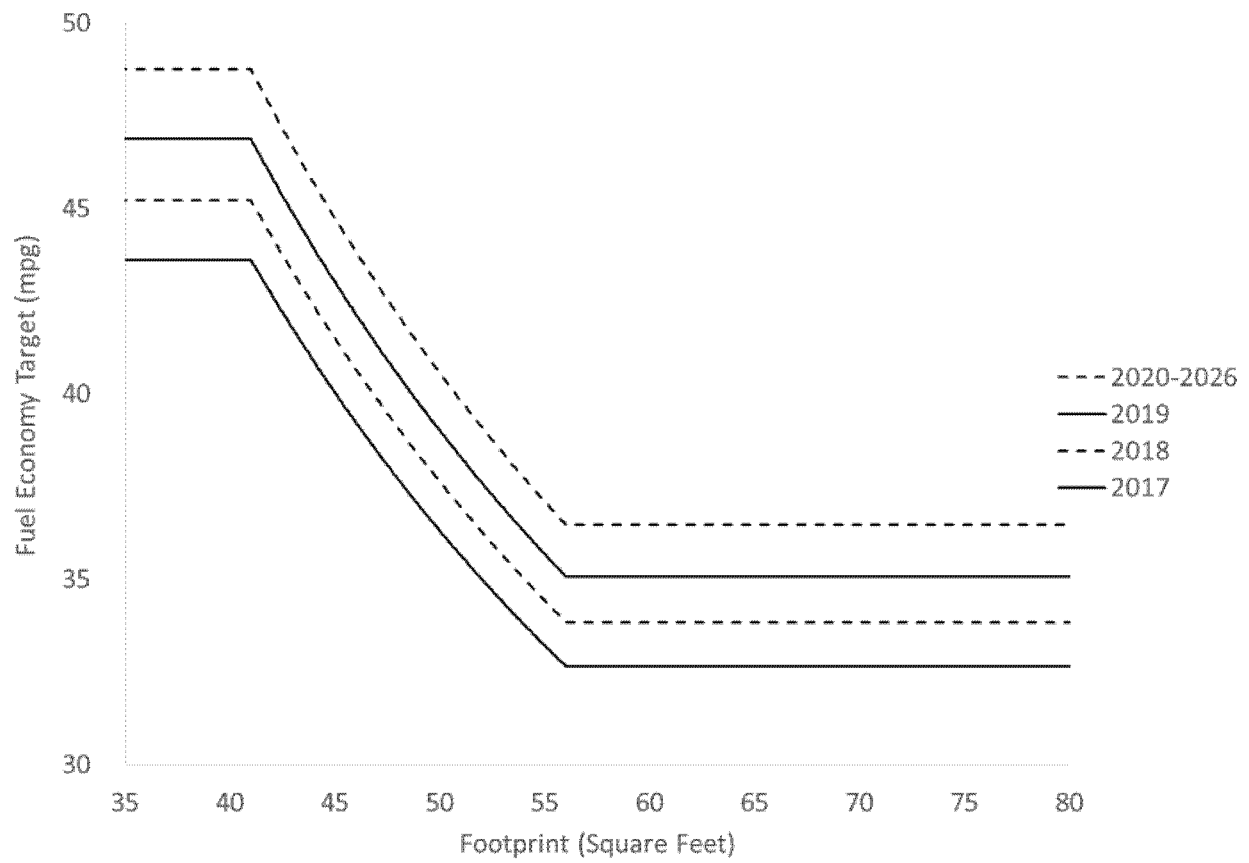

Figure III-1 -Passenger Car Fuel Economy Targets

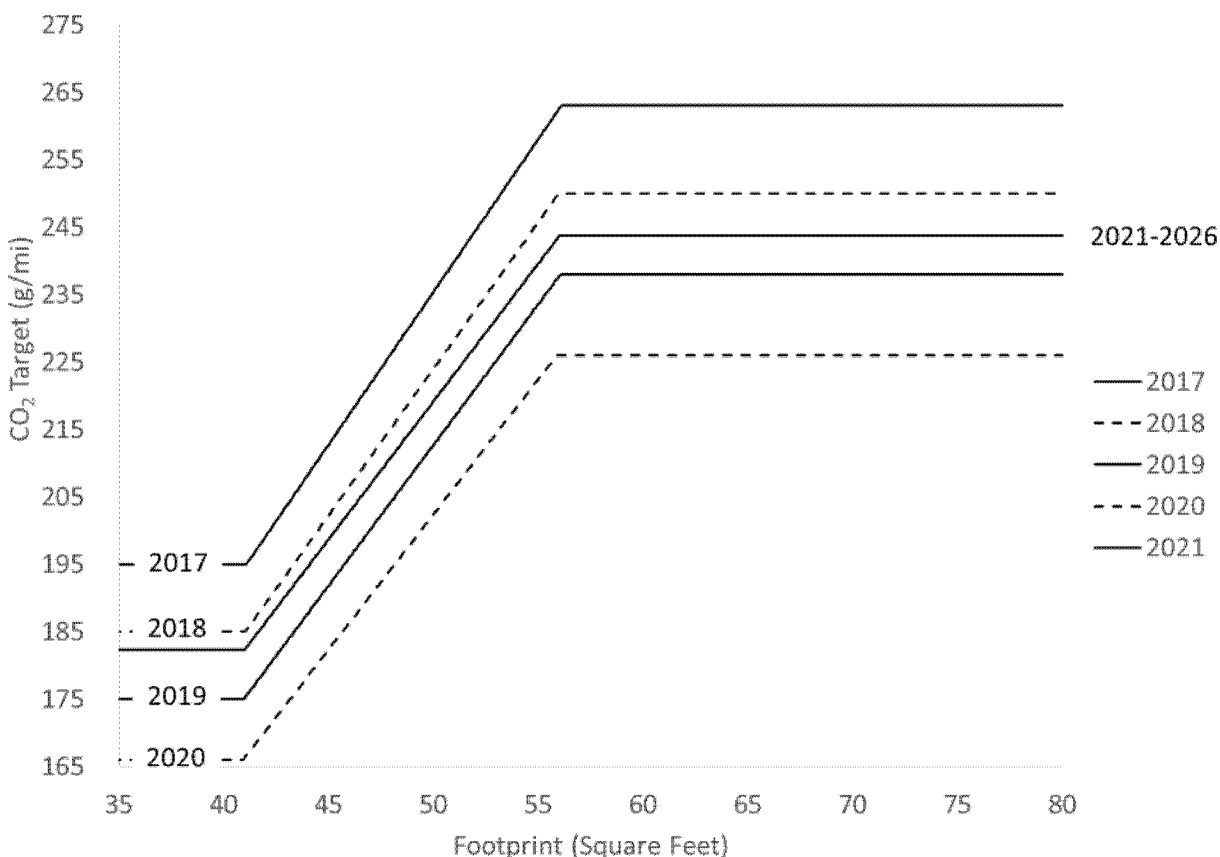

Figure III-2 - Passenger Car CO₂ Targets³⁶⁶

While we do not know yet with certainty what CAFE and CO₂ levels will ultimately be required of individual manufacturers, because those levels will depend on the mix of vehicles that they produce for sale in future model years, based on the market forecast of future sales that was used to examine today's proposed standards, we currently estimate that the target functions shown above would result in the following average required fuel economy and CO₂ emissions levels for individual manufacturers during MYs 2021–2026. Prior to MY 2021, average required CO₂ levels reflect underlying target functions (specified above) that reflect the use of automotive refrigerants with reduced global warming potential (GWP) and/or the use of technologies that reduce the refrigerant leaks. EPA is proposing to exclude air conditioning refrigerants and leakage, and nitrous oxide and methane GHGs from average performance calculations after model year 2020; CO₂ targets and resultant fleet average requirements for model

years 2021 and beyond do not reflect these adjustments.

EPA seeks comments on whether to proceed with this proposal to discontinue accounting for A/C leakage, methane emissions, and nitrous oxide emissions as part of the CO₂ emissions standards to provide for better harmony with the CAFE program, or whether to continue to consider these factors toward compliance and retain that as a feature that differs between the programs. A/C leakage credits, which are accounted for in the baseline model, have been extensively generated by manufacturers, and make up a portion of their compliance with EPA's CO₂ standards. In the 2016 MY, manufacturers averaged six grams per mile equivalent in A/C leakage credits,

³⁶⁶ Prior to MY 2021, CO₂ targets include adjustments reflecting the use of automotive refrigerants with reduced global warming potential (GWP) and/or the use of technologies that reduce the refrigerant leaks and optionally nitrous oxide and methane emissions. EPA is proposing to exclude air conditioning refrigerants and leakage, and nitrous oxide and methane GHGs from average performance calculations after model year 2020; CO₂ targets (and resultant fleet average requirements) for model years 2021 and beyond do not reflect these adjustments.

ranging from three grams per mile equivalent for Hyundai and Kia, to 17 grams per mile equivalent for Jaguar Land Rover.³⁶⁷ As related to methane (CH₄) and nitrous oxide (N₂O) emissions, manufacturers averaged 0.1 grams per mile equivalent in deficits for the 2016 MY, with deficits ranging from 0.1 grams per mile equivalent for GM, Mazda, and Toyota, to 0.6 grams per mile equivalent for Nissan.³⁶⁸

EPA notes that since the 2010 rulemaking on this subject, the agencies have accounted for the ability to apply A/C leakage credits by increasing EPA's CO₂ standard stringency by the average anticipated amount of credits when compared to the CAFE stringency requirements.³⁶⁹ For model years 2021–2025, the A/C leakage offset, or

³⁶⁷ Other manufacturers' A/C leakage credit grams per mile equivalent include: BMW, Honda, Mitsubishi, Nissan, Toyota, and Volkswagen at 5 g/mi; Mercedes at 6 g/mi; Ford, GM, and Volvo at 7 g/mi; and FCA at 14 g/mi.

³⁶⁸ Other manufacturers' methane and nitrous oxide deficit grams per mile equivalent include BMW at 0.2 g/mi, and Ford at 0.3 g/mi. FCA and Volkswagen numbers are not reported due to an ongoing investigation and/or corrective actions.

³⁶⁹ 75 FR 25330, May 7, 2010.

equivalent stringency increase compared to the CAFE standard, is 13.8 g/mi equivalent for passenger cars and 17.2 g/mi equivalent for light trucks.³⁷⁰ For those model years, manufacturers are currently allowed to apply A/C leakage credits capped at 18.8 g/mi equivalent for passenger cars and 24.4 g/mi equivalent for light trucks.³⁷¹

For methane and nitrous oxide emissions, as part of the MY 2012–2016 rulemaking, EPA finalized standards to cap emissions of N₂O at 0.010 g/mile and CH₄ at 0.030 g/mile for MY 2012 and later vehicles.³⁷² However, EPA also provided an optional CO₂-equivalent approach to address industry concerns about technological feasibility and leadtime for the CH₄ and N₂O standards for MY 2012–2016 vehicles. The CO₂ equivalent standard option allowed manufacturers to fold all 2-cycle weighted N₂O and CH₄ emissions, on a CO₂-equivalent basis, along with CO₂, into their CO₂ emissions fleet average compliance level.³⁷³ EPA estimated that on a CO₂ equivalent

basis, folding in all N₂O and CH₄ emissions could add up to 3–4 g/mile to a manufacturer’s overall CO₂ emissions level because the equivalent standard must be used for the entire fleet, not just for “problem vehicles.”³⁷⁴ To address this added difficulty, EPA amended the MY 2012–2016 standards to allow manufacturers to use CO₂ credits, on a CO₂-equivalent basis, to meet the light-duty N₂O and CH₄ standards in those model years. EPA subsequently extended that same credit provision to MY 2017 and later vehicles. EPA seeks comment on whether to change existing methane and nitrous oxide standards that were finalized in the 2012 rule. Specifically, EPA seeks information from the public on whether the existing standards are appropriate, or whether they should be revised to be less stringent or more stringent based on any updated data.

If the agency moves forward with its proposal to eliminate these factors, EPA would consider whether it is appropriate to initiate a new rulemaking

to regulate these programs independently, which could include an effective date that would result in no lapse in regulation of A/C leakage or emissions of nitrous oxide and methane. If the agency decides to retain the A/C leakage and nitrous oxide and methane emissions provisions for CO₂ compliance, it would likely re-insert the current A/C leakage offset and increase the stringency levels for CO₂ compliance by the offset amounts described above (*i.e.*, 13.8 g/mi equivalent for passenger cars and 17.2 g/mi equivalent for light trucks), and retain the current caps (*i.e.*, 18.8 g/mi equivalent for passenger cars and 24.4 g/mi equivalent for light trucks). The agency will publish an analysis of this alternative approach in a memo to the docket for this rulemaking. The agency seeks comment on whether the current offsets and caps would continue to be appropriate in such circumstances or whether changes are warranted.

Table III-2 - Average of OEMs’ CAFE and CO₂ Requirements for Passenger Cars

Model Year	Avg. of OEMs’ Requirements	
	CAFE (mpg)	CO ₂ (g/mi)
2017	39.1	220
2018	40.5	210
2019	42.0	201
2020	43.7	191
2021	43.7	204
2022	43.7	204
2023	43.7	204
2024	43.7	204
2025	43.7	204
2026	43.7	204

We emphasize again that the values in these tables are estimates, and not necessarily the ultimate levels with which each of these manufacturers will have to comply, for the reasons described above.

C. Minimum Domestic Passenger Car Standards

EPCA has long required manufacturers to meet the passenger car

CAFE standard with both their domestically-manufactured and imported passenger car fleets—that is, domestic and imported passenger car fleets must comply separately with the passenger car CAFE standard in each model year.³⁷⁵ In doing so, they may use whatever flexibilities are available to them under the CAFE program, such as using credits “carried forward” from prior model years, transferred from

another fleet, or acquired from another manufacturer. On top of this requirement, EISA expressly requires each manufacturer to meet a minimum flat fuel economy standard for domestically manufactured passenger cars.³⁷⁶ According to the statute, the minimum standard shall be the greater of (A) 27.5 miles per gallon; or (B) 92% of the average fuel economy projected by DOT for the combined domestic and

³⁷⁰ 77 FR 62805, Oct. 15, 2012.

³⁷¹ 77 FR 62649, Oct. 15, 2012.

³⁷² 75 FR 25421–24, May 7, 2010.

³⁷³ 77 FR 62798, Oct. 15, 2012.

³⁷⁴ In the final rule for MYs 2012–2016, EPA acknowledged that advanced diesel or lean-burn gasoline vehicles of the future may face greater challenges meeting the CH₄ and N₂O standards than the rest of the fleet. [See 75 FR 25422, May 7, 2010].

³⁷⁵ 49 U.S.C. 32904(b) (2007).

³⁷⁶ Transferred or traded credits may not be used, pursuant to 49 U.S.C. 32903(g)(4) and (f)(2), to meet the domestically manufactured passenger automobile minimum standard specified in 49 U.S.C. 32902(b)(4) and in 49 CFR 531.5(d).

nondomestic passenger automobile fleets manufactured for sale in the United States by all manufacturers in the model year, which projection shall be published in the **Federal Register** when the standard for that model year is promulgated.³⁷⁷ NHTSA discusses

this requirement in more detail in Section V.A.1 below.

The following table lists the proposed minimum domestic passenger car standards (which very likely will be updated for the final rule as the agency updates its overall analysis and resultant projection), highlighted as

“Preferred (Alternative 3)” and calculates what those standards would be under the no action alternative (as issued in 2012, and as updated by today’s analysis) and under the other alternatives described and discussed further in Section IV, below.

Table III-3 - Minimum Standards for Domestic Passenger Car Fleets

Alternative	2021	2022	2023	2024	2025	2026
No Action (2012)	42.7	44.7	46.8	49.0	51.3	
No Action (updated)	41.9	43.8	45.9	48.0	50.3	50.3
Preferred (Alternative 1)	40.2	40.2	40.2	40.2	40.2	40.2
Alternative 2	40.4	40.6	40.8	41.0	41.2	41.4
Alternative 3	40.4	40.6	40.8	41.0	41.2	41.4
Alternative 4	40.6	41.0	41.4	41.8	42.2	42.7
Alternative 5	41.9	42.3	42.7	43.1	43.6	44.0
Alternative 6	41.0	41.8	42.7	43.5	44.4	45.3
Alternative 7	41.0	41.8	42.7	43.5	44.4	45.3
Alternative 8	41.9	42.7	43.6	44.5	45.4	46.3

D. Light Truck Standards

For light trucks, NHTSA and EPA are proposing CAFE and CO₂ standards,

respectively, for MYs 2021–2026 that are defined by the following coefficients:

Table III-4 - Characteristics of Preferred Alternative – Light Trucks

	2021	2022	2023	2024	2025	2026
Fuel Economy Targets						
<i>a (mpg)</i>	39.11	39.11	39.11	39.11	39.11	39.11
<i>b (mpg)</i>	25.25	25.25	25.25	25.25	25.25	25.25
<i>c (gpm per s.f.)</i>	0.000514	0.000514	0.000514	0.000514	0.000514	0.000514
<i>d (gpm)</i>	0.00449	0.00449	0.00449	0.00449	0.00449	0.00449
<i>e (mpg)</i>	35.41	35.41	35.41	35.41	35.41	35.41
<i>f (mpg)</i>	25.25	25.25	25.25	25.25	25.25	25.25
<i>g (gpm per s.f.)</i>	0.000455	0.000455	0.000455	0.000455	0.000455	0.000455
<i>h (gpm)</i>	0.00960	0.00960	0.00960	0.00960	0.00960	0.00960
CO₂ Targets						
<i>a (g/mi)</i>	227	227	227	227	227	227
<i>b (g/mi)</i>	352	352	352	352	352	352
<i>c (g/mi per s.f.)</i>	4.57	4.57	4.57	4.57	4.57	4.57
<i>d (g/mi)</i>	39.9	39.9	39.9	39.9	39.9	39.9
<i>e (g/mi)</i>	251	251	251	251	251	251
<i>f (g/mi)</i>	352	352	352	352	352	352
<i>g (g/mi per s.f.)</i>	4.04	4.04	4.04	4.04	4.04	4.04
<i>h (g/mi)</i>	85.3	85.3	85.3	85.3	85.3	85.3

³⁷⁷ 49 U.S.C. 32902(b)(4).

Section II.C above discusses in detail how the coefficients in Table III-4 were developed for this proposal. The

coefficients result in the footprint-dependent targets shown graphically below for MYs 2021-2026. The MYs

2017-2020 standards are also shown for comparison.

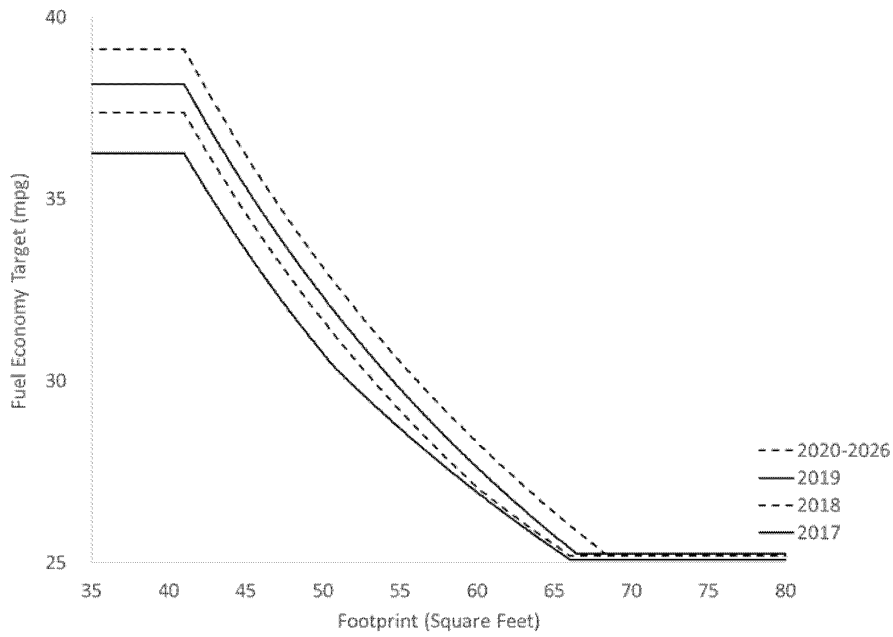

Figure III-3 - Light Truck Fuel Economy Targets

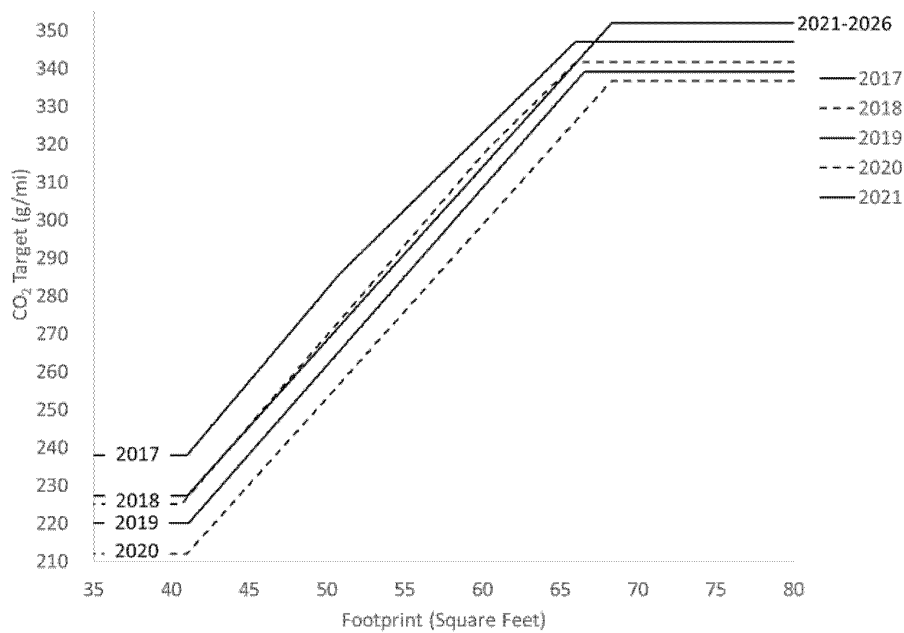

Figure III-4 - Light Truck CO₂ Targets³⁷⁸

³⁷⁸ Prior to MY 2021, average achieved CO₂ levels include adjustments reflecting the use of automotive refrigerants with reduced global warming potential (GWP) and/or the use of

technologies that reduce the refrigerant leaks. Because EPA is today proposing to exclude air conditioning refrigerants and leakage, and nitrous oxide and methane GHGs from average performance

calculations after MY 2020, CO₂ targets and resultant fleet average requirements for MYs 2021 and beyond do not reflect these adjustments.

While we do not know yet with certainty what CAFE and CO₂ levels will ultimately be required of individual manufacturers, because those levels will depend on the mix of vehicles that they produce for sale in future model years, based on the market forecast of future sales that were used to examine today's proposed standards, we currently estimate that the target functions shown

above would result in the following average required fuel economy and CO₂ emissions levels for individual manufacturers during MYs 2021–2026. Prior to MY 2021, average required CO₂ levels reflect underlying target functions (specified above) that reflect the use of automotive refrigerants with reduced global warming potential (GWP) and/or the use of technologies that reduce the

refrigerant leaks. Because EPA is today proposing to exclude air conditioning refrigerants and leakage, and nitrous oxide and methane GHGs from average performance calculations after model year 2020, CO₂ targets and resultant fleet average requirements for model years 2021 and beyond do not reflect these adjustments.

Table III-5 - Average of OEMs' CAFE and CO₂ Requirements for Light Trucks

Model Year	Avg. of OEMs' Requirements	
	CAFE (mpg)	CO ₂ (g/mi)
2017	29.5	294
2018	30.1	284
2019	30.6	277
2020	31.3	269
2021	31.3	284
2022	31.3	284
2023	31.3	284
2024	31.3	284
2025	31.3	284
2026	31.3	284

We emphasize again the values in these tables are estimates and not necessarily the ultimate levels with which each of these manufacturers will have to comply for reasons described above.

IV. Alternative CAFE and GHG Standards Considered for MYs 2021–22–2026

Agencies typically consider regulatory alternatives in proposals as a way of evaluating the comparative effects of different potential ways of accomplishing their desired goal.³⁷⁹ Alternatives analysis begins with a “no-action” alternative, typically described as what would occur in the absence of any regulatory action. Today's proposal includes a no-action alternative, described below, as well as seven “action alternatives” besides the proposal. The proposal may, in places, be referred to as the “preferred alternative,” which is NEPA parlance, but NHTSA and EPA intend “proposal,” “proposed action,” and “preferred alternative” to be used interchangeably for purposes of this rulemaking.

³⁷⁹ As Section V.A.3 explains, NEPA requires agencies to compare the potential environmental impacts of their proposed actions to those of a reasonable range of alternatives. Executive Orders 12866 and 13563 and OMB Circular A–4 also encourage agencies to evaluate regulatory alternatives in their rulemaking analyses.

As discussed above in Chapter II, today's notice also presents the results of analysis estimating impacts under a range of other regulatory alternatives the agencies are considering. Aside from the no-action alternative, NHTSA and EPA defined the different regulatory alternatives in terms of percent-increases in CAFE and GHG stringency from year to year. Under some alternatives, the rate of increase is the same for both passenger cars and light trucks; under others, the rate of increase differs. Two alternatives also involve a gradual discontinuation of CAFE and average GHG adjustments reflecting the application of technologies that improve air conditioner efficiency or, in other ways, improve fuel economy under conditions not represented by long-standing fuel economy test procedures. For increased harmonization with NHTSA CAFE standards, which cannot account for such issues, under Alternatives 1–8, EPA would regulate tailpipe CO₂ independently of A/C refrigerant leakage, nitrous oxide and methane emissions. Under the no action alternative, EPA would continue to regulate A/C refrigerant leakage, nitrous oxide and methane emissions under the overall CO₂ standard.³⁸⁰ Like the

³⁸⁰ For the CAFE program, carbon-based tailpipe emissions (including CO₂, CH₄ and CO) are measured, and fuel economy is calculated using a carbon balance equation. EPA uses carbon-based emissions (CO₂, CH₄ and CO, the same as for CAFE)

baseline no-action alternative, all of the alternatives are more stringent than the preferred alternative.

EPA also seeks comment on retaining the existing credit program for regulation of A/C refrigerant leakage, nitrous oxide, and methane emissions as part of the CO₂ standard.

The agencies have examined these alternatives because the agencies intend to continue considering them as options for the final rule. The agencies seek comment on these alternatives and on the analysis presented here, seek any relevant data and information, and will review responses. That review could lead the agencies to select one of the

to calculate tailpipe CO₂ for its standards. In addition, under the no action alternative EPA adds CO₂ equivalent (using Global Warming Potential (GWP) adjustment) for AC refrigerant leakage and nitrous oxide and methane emissions. The CAFE program does not include A/C refrigerant leakage, nitrous oxide and methane emissions because they do not impact fuel economy. Under Alternatives 1–8, the standards are completely aligned for gasoline because compliance is based on tailpipe CO₂, CH₄ and CO for both programs and not emissions unrelated to fuel economy. Diesel and alternative fuel vehicles would continue to be treated differently between the CAFE and CO₂ programs. While harmonization would be significantly improved, standards would not be fully aligned because of the small fraction of the fleet that uses diesel and alternative fuels (e.g., about four percent of the MY 2016 fleet), as well as differences involving EPCA/EISA provisions EPA, lacking any specific direction under the CAA, has declined to adopt, such as minimum standards for domestic passenger cars and limits on credit transfers between regulated fleets.

other regulatory alternatives for the final rule. *A. What alternatives did NHTSA and EPA consider?*

The table below shows the different alternatives evaluated in this proposal.

Table IV-1 - Regulatory Alternatives Currently under Consideration

Alternative	Change in stringency	A/C efficiency and off-cycle provisions	CO ₂ Equivalent AC Refrigerant Leakage, Nitrous Oxide and Methane Emissions Included for Compliance?
Baseline/ No-Action	MY 2021 standards remain in place; MYs 2022-2025 augural CAFE standards are finalized and GHG standards remain unchanged; MY 2026 standards are set at MY 2025 levels	No change	Yes, for all MYs ³⁸¹
1 (Proposed)	Existing standards through MY 2020, then 0%/year increases for both passenger cars and light trucks, for MYs 2021-2026	No change	No, beginning in MY 2021 ³⁸²
2	Existing standards through MY 2020, then 0.5%/year increases for both passenger cars and light trucks, for MYs 2021-2026	No change	No, beginning in MY 2021
3	Existing standards through MY 2020, then 0.5%/year increases for both passenger cars and light trucks, for MYs 2021-2026	Phase out these adjustments over MYs 2022-2026	No, beginning in MY 2021
4	Existing standards through MY 2020, then 1%/year increases for passenger cars and 2%/year increases for light trucks, for MYs 2021-2026	No change	No, beginning in MY 2021
5	Existing standards through MY 2021, then 1%/year increases for passenger cars and 2%/year increases for light trucks, for MYs 2022-2026	No change	No, beginning in MY 2021
6	Existing standards through MY 2020, then 2%/year increases for passenger cars and 3%/year increases for light trucks, for MYs 2021-2026	No change	No, beginning in MY 2021
7	Existing standards through MY 2020, then 2%/year increases for passenger cars and 3%/year increases for light trucks, for MYs 2021-2026	Phase out these adjustments over MYs 2022-2026	No, beginning in MY 2021
8	Existing standards through MY 2021, then 2%/year increases for passenger cars and 3%/year increases for light trucks, for MYs 2022-2026	No change	No, beginning in MY 2021

Also, as mentioned previously in Section III.B., EPA seeks comments on

³⁸¹ Carbon dioxide equivalent of air conditioning refrigerant leakage, nitrous oxide and methane emissions are included for compliance with the EPA standards for all MYs under the baseline/no action alternative. Carbon dioxide equivalent is calculated using the Global Warming Potential (GWP) of each of the emissions.

³⁸² Beginning in MY 2021, air conditioning refrigerant leakage, nitrous oxide, and methane

whether to proceed with this proposal to discontinue accounting for A/C leakage, methane emissions, and nitrous oxide emissions as part of the CO₂ emissions standards to provide for

emissions may be regulated independently by EPA. The GWP equivalent of each of the emissions would no longer be included with the tailpipe CO₂ for compliance with tailpipe CO₂ standards. A lengthier discussion of this issue can be found in Section III.B.

better harmony with the CAFE program or whether to continue to consider these factors toward compliance and retain that as a feature that differs between the programs. EPA seeks comment on whether to change existing methane and nitrous oxide standards that were finalized in the 2012 rule. Specifically, EPA seeks information from the public on whether the existing standards are appropriate, or whether they should be

revised to be less stringent or more stringent based on any updated data.

Additionally, the agencies note that this proposal also seeks comment on a number of additional compliance flexibilities for the programs. See Section X below, and EPA specifically

draws attention the discussion of “enhanced flexibilities” in Section X.C.

B. Definition of Alternatives

1. No-Action Alternative

The No-Action Alternative applies the augural CAFE and final GHG targets announced in 2012 for MYs 2021–2025.

For MY 2026, this alternative applies the same targets as for MY 2025. Carbon dioxide equivalent of air conditioning refrigerant leakage, nitrous oxide, and methane emissions are included for compliance with the EPA standards for all model years under the baseline/no action alternative.

Table IV-2 - Characteristics of No-Action Alternative – Passenger Cars

	2021	2022	2023	2024	2025	2026
Fuel Economy Targets						
<i>a (mpg)</i>	50.83	53.21	55.71	58.32	61.07	61.07
<i>b (mpg)</i>	38.02	39.79	41.64	43.58	45.61	45.61
<i>c (gpm per s.f.)</i>	0.000442	0.000423	0.000404	0.000387	0.000370	0.000370
<i>d (gpm)</i>	0.00155	0.00146	0.00137	0.00129	0.00121	0.00121
CO₂ Targets						
<i>a (g/mi)</i>	157	150	143	137	131	131
<i>b (g/mi)</i>	215	205	196	188	179	179
<i>c (g/mi per s.f.)</i>	3.84	3.69	3.54	3.40	3.26	3.26
<i>d (g/mi)</i>	-0.4	-1.1	-1.8	-2.5	-3.2	-3.2

Table IV-3 - Characteristics of No-Action Alternative – Light Trucks

	2021	2022	2023	2024	2025	2026
Fuel Economy Targets						
<i>a (mpg)</i>	41.80	43.79	45.89	48.09	50.39	50.39
<i>b (mpg)</i>	25.25	26.29	27.53	28.83	30.19	30.19
<i>c (gpm per s.f.)</i>	0.000482	0.000461	0.000440	0.000421	0.000402	0.000402
<i>d (gpm)</i>	0.00416	0.00394	0.00373	0.00353	0.00334	0.00334
<i>e (mpg)</i>	35.41	35.41	35.41	35.41	35.41	35.41
<i>f (mpg)</i>	25.25	25.25	25.25	25.25	25.25	25.25
<i>g (gpm per s.f.)</i>	0.000455	0.000455	0.000455	0.000455	0.000455	0.000455
<i>h (gpm)</i>	0.00960	0.00960	0.00960	0.00960	0.00960	0.00960
CO₂ Targets						
<i>a (g/mi)</i>	195	186	176	168	159	159
<i>b (g/mi)</i>	335	321	306	291	277	277
<i>c (g/mi per s.f.)</i>	4.28	4.09	3.91	3.74	3.58	3.58
<i>d (g/mi)</i>	19.8	17.8	16.0	14.2	12.5	12.5
<i>e (g/mi)</i>	318	318	318	318	318	318
<i>f (g/mi)</i>	342	342	342	342	342	342
<i>g (g/mi per s.f.)</i>	4.04	4.04	4.04	4.04	4.04	4.04
<i>h (g/mi)</i>	75.0	75.0	75.0	75.0	75.0	75.0

2. Alternative 1 (Proposed)

Alternative 1 holds the stringency of targets constant and MY 2020 levels through MY 2026. Beginning in MY 2021, air conditioning refrigerant leakage, nitrous oxide, and methane emissions are no longer included with the tailpipe CO₂ for compliance with

tailpipe CO₂ standards. Section III, above, defines this alternative in greater detail.

3. Alternative 2

Alternative 2 increases the stringency of targets annually during MYs 2021–2026 (on a gallon per mile basis, starting from MY 2020) by 0.5% for passenger

cars and 0.5% for light trucks. Section III describes the proposed standards included in the preferred alternative. Beginning in MY 2021, air conditioning refrigerant leakage, nitrous oxide, and methane emissions are no longer included with the tailpipe CO₂ for compliance with tailpipe CO₂ standards.

Table IV-4 - Characteristics of Alternative 2 – Passenger Cars

	2021	2022	2023	2024	2025	2026
Fuel Economy Targets						
<i>a (mpg)</i>	48.99	49.23	49.48	49.73	49.98	50.23
<i>b (mpg)</i>	36.65	36.84	37.02	37.21	37.39	37.58
<i>c (gpm per s.f.)</i>	0.000458	0.000456	0.000453	0.000451	0.000449	0.000447
<i>d (gpm)</i>	0.00163	0.00163	0.00162	0.00161	0.00160	0.00159
CO₂ Targets						
<i>a (g/mi)</i>	181	181	180	179	178	177
<i>b (g/mi)</i>	242	241	240	239	238	236
<i>c (g/mi per s.f.)</i>	4.07	4.05	4.03	4.01	3.99	3.97
<i>d (g/mi)</i>	14.5	14.5	14.4	14.3	14.2	14.2

Table IV-5 - Characteristics of Alternative 2 – Light Trucks

	2021	2022	2023	2024	2025	2026
Fuel Economy Targets						
<i>a (mpg)</i>	39.31	39.51	39.70	39.90	40.10	40.31
<i>b (mpg)</i>	25.37	25.50	25.63	25.76	25.89	26.02
<i>c (gpm per s.f.)</i>	0.000511	0.000509	0.000506	0.000504	0.000501	0.000499
<i>d (gpm)</i>	0.00447	0.00445	0.00443	0.00440	0.00438	0.00436
<i>e (mpg)</i>	35.41	35.41	35.41	35.41	35.41	35.41
<i>f (mpg)</i>	25.25	25.25	25.25	25.25	25.25	25.25
<i>g (gpm per s.f.)</i>	0.000455	0.000455	0.000455	0.000455	0.000455	0.000455
<i>h (gpm)</i>	0.00960	0.00960	0.00960	0.00960	0.00960	0.00960
CO₂ Targets						
<i>a (g/mi)</i>	226	225	224	223	222	220
<i>b (g/mi)</i>	350	348	347	345	343	342
<i>c (g/mi per s.f.)</i>	4.55	4.52	4.50	4.48	4.45	4.43
<i>d (g/mi)</i>	39.7	39.5	39.3	39.1	38.9	38.8
<i>e (g/mi)</i>	251	251	251	251	251	251
<i>f (g/mi)</i>	352	352	352	352	352	352
<i>g (g/mi per s.f.)</i>	4.04	4.04	4.04	4.04	4.04	4.04
<i>h (g/mi)</i>	85.3	85.3	85.3	85.3	85.3	85.3

4. Alternative 3

Alternative 3 phases out A/C and off-cycle adjustments and increases the stringency of targets annually during MYs 2021–2026 (on a gallon per mile basis, starting from MY 2020) by 0.5% for passenger cars and 0.5% for light

trucks. The cap on adjustments for AC efficiency improvements declines from 6 grams per mile in MY 2021 to 5, 4, 3, 2, and 0 grams per mile in MYs 2022, 2023, 2024, 2025, and 2026, respectively. The cap on adjustments for off-cycle improvements declines from 10 grams per mile in MY 2021 to 8, 6,

4, 2, and 0 grams per mile in MYs 2022, 2023, 2024, 2025, and 2026, respectively. Beginning in MY 2021, air conditioning refrigerant leakage, nitrous oxide, and methane emissions are no longer included with the tailpipe CO₂ for compliance with tailpipe CO₂ standards.

Table IV-6 - Characteristics of Alternative 3 – Passenger Cars

	2021	2022	2023	2024	2025	2026
Fuel Economy Targets						
<i>a (mpg)</i>	48.99	49.23	49.48	49.73	49.98	50.23
<i>b (mpg)</i>	36.65	36.84	37.02	37.21	37.39	37.58
<i>c (gpm per s.f.)</i>	0.000458	0.000456	0.000453	0.000451	0.000449	0.000447
<i>d (gpm)</i>	0.00163	0.00163	0.00162	0.00161	0.00160	0.00159
CO₂ Targets						
<i>a (g/mi)</i>	181	181	180	179	178	177
<i>b (g/mi)</i>	242	241	240	239	238	236
<i>c (g/mi per s.f.)</i>	4.07	4.05	4.03	4.01	3.99	3.97
<i>d (g/mi)</i>	14.5	14.5	14.4	14.3	14.2	14.2

Table IV-7 - Characteristics of Alternative 3 – Light Trucks

	2021	2022	2023	2024	2025	2026
Fuel Economy Targets						
<i>a (mpg)</i>	39.31	39.51	39.70	39.90	40.10	40.31
<i>b (mpg)</i>	25.37	25.50	25.63	25.76	25.89	26.02
<i>c (gpm per s.f.)</i>	0.000511	0.000509	0.000506	0.000504	0.000501	0.000499
<i>d (gpm)</i>	0.00447	0.00445	0.00443	0.00440	0.00438	0.00436
<i>e (mpg)</i>	35.41	35.41	35.41	35.41	35.41	35.41
<i>f (mpg)</i>	25.25	25.25	25.25	25.25	25.25	25.25
<i>g (gpm per s.f.)</i>	0.000455	0.000455	0.000455	0.000455	0.000455	0.000455
<i>h (gpm)</i>	0.00960	0.00960	0.00960	0.00960	0.00960	0.00960
CO₂ Targets						
<i>a (g/mi)</i>	226	225	224	223	222	220
<i>b (g/mi)</i>	350	348	347	345	343	342
<i>c (g/mi per s.f.)</i>	4.55	4.52	4.50	4.48	4.45	4.43
<i>d (g/mi)</i>	39.7	39.5	39.3	39.1	38.9	38.8
<i>e (g/mi)</i>	251	251	251	251	251	251
<i>f (g/mi)</i>	352	352	352	352	352	352
<i>g (g/mi per s.f.)</i>	4.04	4.04	4.04	4.04	4.04	4.04
<i>h (g/mi)</i>	85.3	85.3	85.3	85.3	85.3	85.3

5. Alternative 4

Alternative 4 increases the stringency of targets annually during MYs 2021–

2026 (on a gallon per mile basis, starting from MY 2020) by 1.0% for passenger cars and 2.0% for light trucks. Beginning in MY 2021, air conditioning

refrigerant leakage, nitrous oxide, and methane emissions are no longer included with the tailpipe CO₂ for compliance with tailpipe CO₂ standards.

Table IV-8 - Characteristics of Alternative 4 – Passenger Cars

	2021	2022	2023	2024	2025	2026
Fuel Economy Targets						
<i>a (mpg)</i>	49.23	49.73	50.23	50.74	51.25	51.77
<i>b (mpg)</i>	36.84	37.21	37.58	37.96	38.35	38.73
<i>c (gpm per s.f.)</i>	0.000456	0.000451	0.000447	0.000442	0.000438	0.000433
<i>d (gpm)</i>	0.00163	0.00161	0.00159	0.00158	0.00156	0.00155
CO₂ Targets						
<i>a (g/mi)</i>	181	179	177	175	173	172
<i>b (g/mi)</i>	241	239	236	234	232	229
<i>c (g/mi per s.f.)</i>	4.05	4.01	3.97	3.93	3.89	3.85
<i>d (g/mi)</i>	14.5	14.3	14.2	14.0	13.9	13.7

Table IV-9 - Characteristics of Alternative 4 – Light Trucks

	2021	2022	2023	2024	2025	2026
Fuel Economy Targets						
<i>a (mpg)</i>	39.91	40.72	41.56	42.40	43.27	44.15
<i>b (mpg)</i>	25.76	26.29	26.82	27.37	27.93	28.50
<i>c (gpm per s.f.)</i>	0.000504	0.000494	0.000484	0.000474	0.000465	0.000455
<i>d (gpm)</i>	0.00440	0.00432	0.00423	0.00415	0.00406	0.00398
<i>e (mpg)</i>	35.41	35.41	35.41	35.41	35.41	35.41
<i>f (mpg)</i>	25.25	25.25	25.25	25.25	25.25	25.25
<i>g (gpm per s.f.)</i>	0.000455	0.000455	0.000455	0.000455	0.000455	0.000455
<i>h (gpm)</i>	0.00960	0.00960	0.00960	0.00960	0.00960	0.00960
CO₂ Targets						
<i>a (g/mi)</i>	223	218	214	210	205	201
<i>b (g/mi)</i>	345	338	331	325	318	312
<i>c (g/mi per s.f.)</i>	4.48	4.39	4.30	4.21	4.13	4.05
<i>d (g/mi)</i>	39.1	38.4	37.6	36.8	36.1	35.4
<i>e (g/mi)</i>	251	251	251	251	251	251
<i>f (g/mi)</i>	352	352	352	352	352	352
<i>g (g/mi per s.f.)</i>	4.04	4.04	4.04	4.04	4.04	4.04
<i>h (g/mi)</i>	85.3	85.3	85.3	85.3	85.3	85.3

6. Alternative 5

Alternative 5 increases the stringency of targets annually during MYs 2022–2026 (on a gallon per mile basis, starting

from MY 2021) by 1.0% for passenger cars and 2.0% for light trucks. Beginning in MY 2021, air conditioning refrigerant leakage, nitrous oxide, and methane emissions are no longer

included with the tailpipe CO₂ for compliance with tailpipe CO₂ standards, and MY 2021 CO₂ targets are adjusted accordingly.

Table IV-10 - Characteristics of Alternative 5 – Passenger Cars

	2021	2022	2023	2024	2025	2026
Fuel Economy Targets						
<i>a (mpg)</i>	50.83	51.34	51.86	52.39	52.92	53.45
<i>b (mpg)</i>	38.02	38.40	38.79	39.18	39.58	39.98
<i>c (gpm per s.f.)</i>	0.000442	0.000437	0.000433	0.000429	0.000425	0.000420
<i>d (gpm)</i>	0.00155	0.00154	0.00152	0.00151	0.00149	0.00148
CO₂ Targets						
<i>a (g/mi)</i>	175	173	171	170	168	166
<i>b (g/mi)</i>	234	231	229	227	225	222
<i>c (g/mi per s.f.)</i>	3.93	3.89	3.85	3.81	3.77	3.73
<i>d (g/mi)</i>	13.8	13.7	13.5	13.4	13.3	13.1

Table IV-11 - Characteristics of Alternative 5 – Light Trucks

	2021	2022	2023	2024	2025	2026
Fuel Economy Targets						
<i>a (mpg)</i>	41.80	42.65	43.52	44.41	45.32	46.24
<i>b (mpg)</i>	25.25	25.76	26.29	26.82	27.37	27.93
<i>c (gpm per s.f.)</i>	0.000482	0.000472	0.000463	0.000454	0.000445	0.000436
<i>d (gpm)</i>	0.00416	0.00408	0.00400	0.00392	0.00384	0.00376
<i>e (mpg)</i>	35.41	35.41	35.41	35.41	35.41	35.41
<i>f (mpg)</i>	25.25	25.25	25.25	25.25	25.25	25.25
<i>g (gpm per s.f.)</i>	0.000455	0.000455	0.000455	0.000455	0.000455	0.000455
<i>h (gpm)</i>	0.00960	0.00960	0.00960	0.00960	0.00960	0.00960
CO₂ Targets						
<i>a (g/mi)</i>	213	208	204	200	196	192
<i>b (g/mi)</i>	352	345	338	331	325	318
<i>c (g/mi per s.f.)</i>	4.28	4.20	4.11	4.03	3.95	3.87
<i>d (g/mi)</i>	37.0	36.3	35.5	34.8	34.1	33.4
<i>e (g/mi)</i>	251	251	251	251	251	251
<i>f (g/mi)</i>	352	352	352	352	352	352
<i>g (g/mi per s.f.)</i>	4.04	4.04	4.04	4.04	4.04	4.04
<i>h (g/mi)</i>	85.3	85.3	85.3	85.3	85.3	85.3

7. Alternative 6

Alternative 6 increases the stringency of targets annually during MYs 2021–

2026 (on a gallon per mile basis, starting from MY 2020) by 2.0% for passenger cars and 3.0% for light trucks. Beginning in MY 2021, air conditioning

refrigerant leakage, nitrous oxide, and methane emissions are no longer included with the tailpipe CO₂ for compliance with tailpipe CO₂ standards.

Table IV-12 - Characteristics of Alternative 7 – Passenger Cars

	2021	2022	2023	2024	2025	2026
Fuel Economy Targets						
<i>a (mpg)</i>	49.74	50.75	51.79	52.84	53.92	55.02
<i>b (mpg)</i>	37.21	37.97	38.75	39.54	40.34	41.17
<i>c (gpm per s.f.)</i>	0.000451	0.000442	0.000433	0.000425	0.000416	0.000408
<i>d (gpm)</i>	0.00161	0.00158	0.00155	0.00152	0.00149	0.00146
CO₂ Targets						
<i>a (g/mi)</i>	179	175	172	168	165	162
<i>b (g/mi)</i>	239	234	229	225	220	216
<i>c (g/mi per s.f.)</i>	4.01	3.93	3.85	3.77	3.70	3.62
<i>d (g/mi)</i>	14.3	14.0	13.7	13.5	13.2	12.9

Table IV-13 - Characteristics of Alternative 6 – Light Trucks

	2021	2022	2023	2024	2025	2026
Fuel Economy Targets						
<i>a (mpg)</i>	40.32	41.57	42.85	44.18	45.55	46.95
<i>b (mpg)</i>	26.03	26.83	27.66	28.52	29.40	30.31
<i>c (gpm per s.f.)</i>	0.000499	0.000484	0.000469	0.000455	0.000441	0.000428
<i>d (gpm)</i>	0.00436	0.00423	0.00410	0.00398	0.00386	0.00374
<i>e (mpg)</i>	35.41	35.41	35.41	35.41	35.41	35.41
<i>f (mpg)</i>	25.25	25.25	25.25	25.25	25.25	25.25
<i>g (gpm per s.f.)</i>	0.000455	0.000455	0.000455	0.000455	0.000455	0.000455
<i>h (gpm)</i>	0.00960	0.00960	0.00960	0.00960	0.00960	0.00960
CO₂ Targets						
<i>a (g/mi)</i>	220	214	207	201	195	189
<i>b (g/mi)</i>	341	331	321	312	302	293
<i>c (g/mi per s.f.)</i>	4.43	4.30	4.17	4.04	3.92	3.80
<i>d (g/mi)</i>	38.7	37.6	36.5	35.4	34.3	33.3
<i>e (g/mi)</i>	251	251	251	251	251	251
<i>f (g/mi)</i>	352	352	352	352	352	352
<i>g (g/mi per s.f.)</i>	4.04	4.04	4.04	4.04	4.04	4.04
<i>h (g/mi)</i>	85.3	85.3	85.3	85.3	85.3	85.3

8. Alternative 7

Alternative 7 phases out A/C and off-cycle adjustments and increases the stringency of targets annually during MYs 2021–2026 (on a gallon per mile basis, starting from MY 2020) by 1.0% for passenger cars and 2.0% for light

trucks. The cap on adjustments for AC efficiency improvements declines from 6 grams per mile in MY 2021 to 5, 4, 3, 2, and 0 grams per mile in MYs 2022, 2023, 2024, 2025, and 2026, respectively. The cap on adjustments for off-cycle improvements declines from 10 grams per mile in MY 2021 to 8, 6,

4, 2, and 0 grams per mile in MYs 2022, 2023, 2024, 2025, and 2026, respectively. Beginning in MY 2021, air conditioning refrigerant leakage, nitrous oxide, and methane emissions are no longer included with the tailpipe CO₂ for compliance with tailpipe CO₂ standards.

Table IV-14 - Characteristics of Alternative 7 – Passenger Cars

	2021	2022	2023	2024	2025	2026
Fuel Economy Targets						
<i>a (mpg)</i>	49.74	50.75	51.79	52.84	53.92	55.02
<i>b (mpg)</i>	37.21	37.97	38.75	39.54	40.34	41.17
<i>c (gpm per s.f.)</i>	0.000451	0.000442	0.000433	0.000425	0.000416	0.000408
<i>d (gpm)</i>	0.00161	0.00158	0.00155	0.00152	0.00149	0.00146
CO₂ Targets						
<i>a (g/mi)</i>	179	175	172	168	165	162
<i>b (g/mi)</i>	239	234	229	225	220	216
<i>c (g/mi per s.f.)</i>	4.01	3.93	3.85	3.77	3.70	3.62
<i>d (g/mi)</i>	14.3	14.0	13.7	13.5	13.2	12.9

Table IV-15 - Characteristics of Alternative 7 – Light Trucks

	2021	2022	2023	2024	2025	2026
Fuel Economy Targets						
<i>a (mpg)</i>	40.32	41.57	42.85	44.18	45.55	46.95
<i>b (mpg)</i>	26.03	26.83	27.66	28.52	29.40	30.31
<i>c (gpm per s.f.)</i>	0.000499	0.000484	0.000469	0.000455	0.000441	0.000428
<i>d (gpm)</i>	0.00436	0.00423	0.00410	0.00398	0.00386	0.00374
<i>e (mpg)</i>	35.41	35.41	35.41	35.41	35.41	35.41
<i>f (mpg)</i>	25.25	25.25	25.25	25.25	25.25	25.25
<i>g (gpm per s.f.)</i>	0.000455	0.000455	0.000455	0.000455	0.000455	0.000455
<i>h (gpm)</i>	0.00960	0.00960	0.00960	0.00960	0.00960	0.00960
CO₂ Targets						
<i>a (g/mi)</i>	220	214	207	201	195	189
<i>b (g/mi)</i>	341	331	321	312	302	293
<i>c (g/mi per s.f.)</i>	4.43	4.30	4.17	4.04	3.92	3.80
<i>d (g/mi)</i>	38.7	37.6	36.5	35.4	34.3	33.3
<i>e (g/mi)</i>	251	251	251	251	251	251
<i>f (g/mi)</i>	352	352	352	352	352	352
<i>g (g/mi per s.f.)</i>	4.04	4.04	4.04	4.04	4.04	4.04
<i>h (g/mi)</i>	85.3	85.3	85.3	85.3	85.3	85.3

9. Alternative 8

Alternative 8 increases the stringency of targets annually during MYs 2022–2026 (on a gallon per mile basis, starting

from MY 2021) by 2.0% for passenger cars and 3.0% for light trucks. Beginning in MY 2021, air conditioning refrigerant leakage, nitrous oxide, and methane emissions are no longer

included with the tailpipe CO₂ for compliance with tailpipe CO₂ standards, and MY 2021 CO₂ targets are adjusted accordingly.

Table IV-16 - Characteristics of Alternative 8 – Passenger Cars

	2021	2022	2023	2024	2025	2026
Fuel Economy Targets						
<i>a (mpg)</i>	50.83	51.87	52.93	54.01	55.11	56.23
<i>b (mpg)</i>	38.02	38.80	39.59	40.40	41.22	42.06
<i>c (gpm per s.f.)</i>	0.000442	0.000433	0.000424	0.000416	0.000408	0.000399
<i>d (gpm)</i>	0.00155	0.00152	0.00149	0.00146	0.00143	0.00141
CO₂ Targets						
<i>a (g/mi)</i>	175	171	168	165	161	158
<i>b (g/mi)</i>	234	229	224	220	216	211
<i>c (g/mi per s.f.)</i>	3.93	3.85	3.77	3.70	3.62	3.55
<i>d (g/mi)</i>	13.8	13.5	13.3	13.0	12.7	12.5

Table IV-17 - Characteristics of Alternative 8 – Light Trucks

	2021	2022	2023	2024	2025	2026
Fuel Economy Targets						
<i>a (mpg)</i>	41.80	43.09	44.42	45.80	47.21	48.67
<i>b (mpg)</i>	25.25	26.03	26.83	27.66	28.52	29.40
<i>c (gpm per s.f.)</i>	0.000482	0.000468	0.000453	0.000440	0.000427	0.000414
<i>d (gpm)</i>	0.00416	0.00404	0.00392	0.00380	0.00369	0.00358
<i>e (mpg)</i>	35.41	35.41	35.41	35.41	35.41	35.41
<i>f (mpg)</i>	25.25	25.25	25.25	25.25	25.25	25.25
<i>g (gpm per s.f.)</i>	0.000455	0.000455	0.000455	0.000455	0.000455	0.000455
<i>h (gpm)</i>	0.00960	0.00960	0.00960	0.00960	0.00960	0.00960
CO₂ Targets						
<i>a (g/mi)</i>	213	206	200	194	188	183
<i>b (g/mi)</i>	352	341	331	321	312	302
<i>c (g/mi per s.f.)</i>	4.28	4.15	4.03	3.91	3.79	3.68
<i>d (g/mi)</i>	37.0	35.9	34.8	33.8	32.8	31.8
<i>e (g/mi)</i>	251	251	251	251	251	251
<i>f (g/mi)</i>	352	352	352	352	352	352
<i>g (g/mi per s.f.)</i>	4.04	4.04	4.04	4.04	4.04	4.04
<i>h (g/mi)</i>	85.3	85.3	85.3	85.3	85.3	85.3

V. Proposed Standards, the Agencies’ Statutory Obligations, and Why the Agencies Propose To Choose Them Over the Alternatives

A. NHTSA’s Statutory Obligations and Why the Proposed Standards Appear to be Maximum Feasible

1. EPCA, as Amended by EISA

EPCA, as amended by EISA, contains a number of provisions regarding how NHTSA must set CAFE standards. NHTSA must establish separate CAFE standards for passenger cars and light trucks³⁸³ for each model year,³⁸⁴ and each standard must be the maximum feasible that NHTSA believes the manufacturers can achieve in that

model year.³⁸⁵ In determining the maximum feasible level achievable by the manufacturers, EPCA requires that NHTSA consider the four statutory factors of technological feasibility, economic practicability, the effect of other motor vehicle standards of the Government on fuel economy, and the need of the United States to conserve energy.³⁸⁶ In addition, NHTSA has the authority to (and traditionally does) consider other relevant factors, such as the effect of the CAFE standards on motor vehicle safety and consumer preferences.³⁸⁷ The ultimate

determination of what standards can be considered maximum feasible involves a weighing and balancing of these factors, and the balance may shift depending on the information before NHTSA about the expected circumstances in the model years covered by the rulemaking. The agency’s decision must also support the overarching purpose of EPCA, energy conservation, while balancing these factors.³⁸⁸

Besides the requirement that the standards be maximum feasible for the fleet in question and the model year in question, EPCA/EISA also contain

³⁸⁵ *Id.*

³⁸⁶ 49 U.S.C. 32902(f) (2007).

³⁸⁷ Both of these additional considerations also relate, to some extent, to economic practicability, but NHTSA also has the authority to consider them independently of that statutory factor.

³⁸⁸ *Center for Biological Diversity v. NHTSA*, 538 F. 3d 1172, 1197 (9th Cir. 2008) (“Whatever method it uses, NHTSA cannot set fuel economy standards that are contrary to Congress’ purpose in enacting the EPCA—energy conservation.”)

³⁸³ 49 U.S.C. 32902(b)(1) (2007).

³⁸⁴ 49 U.S.C. 32902(a) (2007).

several other requirements as explained below.

(a) Lead Time

EPCA requires that NHTSA prescribe new CAFE standards at least 18 months before the beginning of each model year.³⁸⁹ For light-duty vehicles, NHTSA has consistently interpreted the “beginning of each model year” as September 1 of the CY prior, such that the beginning of MY 2019 would be September 1, 2018. Thus, if the first year for which NHTSA is proposing to set new standards in this NPRM is MY 2022, NHTSA interprets this provision as requiring us to issue a final rule covering MY 2022 standards no later than April 1, 2020.

For amendments to existing standards, EPCA requires that if the amendments make an average fuel economy standard more stringent, at least 18 months of lead time must be provided.³⁹⁰ EPCA contains no lead time requirement unless amendments make an average fuel economy standard less stringent. NHTSA therefore interprets EPCA as allowing amendments to reduce a standard’s stringency up until the beginning of the model year in question. In this rulemaking, NHTSA is proposing to amend the standards for model year 2021. Since the agency proposes to reduce these standards, this action is not subject to a lead time requirement.

(b) Separate Standards for Cars and Trucks, and Minimum Standards for Domestic Passenger Cars

As discussed above, EPCA requires NHTSA to set separate CAFE standards for passenger cars and light trucks for each model year.³⁹¹ NHTSA interprets this requirement as preventing the agency from setting a single combined CAFE standard for cars and trucks together, based on the plain language of the statute. Congress originally intended separate CAFE standards for cars and trucks to reflect the different fuel economy capabilities of those different types of vehicles, and over the history of the CAFE program, has never revised this requirement. Even as many cars and trucks have come to resemble each other more closely over time—many crossover and sport-utility models, for example, come in versions today that may be subject to either the car standards or the truck standards depending on their characteristics—it is still accurate to say that vehicles with truck-like characteristics such as 4 wheel drive,

cargo-carrying capability, etc., need to use more fuel per mile to perform those jobs than vehicles without these characteristics. Thus, regardless of the plain language of the statute, NHTSA believes that the different fuel economy capabilities of cars and trucks would generally make separate standards appropriate for these different types of vehicles.

EPCA, as amended by EISA, also requires another separate standard to be set for domestically-manufactured³⁹² passenger cars. Unlike under the standards for passenger cars and light trucks described above, the compliance burden of the minimum domestic passenger car standard is the same for all manufacturers; the statute clearly states that any manufacturer’s domestically-manufactured passenger car fleet must meet the greater of either 27.5 mpg on average, or

. . . 92 percent of the average fuel economy projected by the Secretary for the combined domestic and non-domestic passenger automobile fleets manufactured for sale in the United States by all manufacturers in the model year, which projection shall be published in the **Federal Register** when the standard for that model year is promulgated in accordance with [49 U.S.C. 32902(b)].³⁹³

Since that requirement was promulgated, the “92 percent” has always been greater than 27.5 mpg. NHTSA published the 92-percent minimum domestic passenger car standards for model years 2017–2025 at 49 CFR 531.5(d) as part of the 2012 final rule. For MYs 2022–2025, 531.5(e) states that these were to be applied if, when actually proposing MY 2022 and subsequent standards, the previously identified standards for those years are deemed maximum feasible, but if NHTSA determines that the previously identified standards are not maximum feasible, the 92-percent minimum domestic passenger car standards would also change. This is consistent with the statutory language that the 92-percent standards must be determined at the time an overall passenger car standard is promulgated and published in the **Federal Register**. Thus, any time NHTSA establishes or changes a passenger car standard for a model year, the minimum domestic passenger car

³⁹² In the CAFE program, “domestically-manufactured” is defined by Congress in 49 U.S.C. § 32904(b). The specifics of the definition are too many for a footnote, but roughly, a passenger car is “domestically manufactured” as long as at least 75% of the cost to the manufacturer is attributable to value added in the United States, Canada, or Mexico, unless the assembly of the vehicle is completed in Canada or Mexico and the vehicle is imported into the United States more than 30 days after the end of the model year.

³⁹³ 49 U.S.C. § 32902(b)(4) (2007).

standard for that model year will also be evaluated or reevaluated and established accordingly. NHTSA explained this in the rulemaking to establish standards for MYs 2017 and beyond and received no comments.³⁹⁴

The 2016 Alliance/Global petition for rulemaking asked NHTSA to retroactively revise the 92-percent minimum domestic passenger car standards for MYs 2012–2016 “to reflect 92 percent of the required average passenger car standard taking into account the fleet mix as it actually occurred, rather than what was forecast.” The petitioners stated that doing so would be “fully consistent with the statute.”³⁹⁵

NHTSA understands that determining the 92 percent value ahead of the model year to which it applies, based on the information then available to the agency, results in a different mpg number than if NHTSA determined the 92 percent value based on the information available at the end of the model year in question. NHTSA further understands that determining the 92 percent value ahead of time can make the domestic minimum passenger car standard more stringent than it could be if it were determined at the end of the model year, *if* manufacturers end up producing more larger-footprint passenger cars than NHTSA originally anticipated.

Accordingly, NHTSA seeks comment on this request by Alliance/Global. Additionally, recognizing the uncertainty inherent in projecting specific mpg values far into the future, it is possible that NHTSA could define the mpg values associated with a CAFE standard (*i.e.*, the footprint curve) as a range rather than as a single number. For example, the sensitivity analysis included in this proposal and in the accompanying PRIA could provide a basis for such an mpg range “defining” the passenger car standard in any given model year. If NHTSA took that approach, 92 percent of that “standard” would also, necessarily, be a range. We also seek comment on this or other similar approaches.

(c) Attribute-Based and Defined by Mathematical Function

EISA requires NHTSA to set CAFE standards that are “based on 1 or more

³⁹⁴ 77 FR 62624, 63028 (Oct. 15, 2012).

³⁹⁵ Automobile Alliance and Global Automakers Petition for Direct Final Rule with Regard to Various Aspects of the Corporate Average Fuel Economy Program and the Greenhouse Gas Program (June 20, 2016) at 5, 17–18, available at https://www.epa.gov/sites/production/files/2016-09/documents/petition_to_epa_from_auto_alliance_and_global_automakers.pdf [hereinafter *Alliance/Global Petition*].

³⁸⁹ 49 U.S.C. 32902(a) (2007).

³⁹⁰ 49 U.S.C. 32902(g)(2) (2007).

³⁹¹ 49 U.S.C. 32902(b)(1) (2007).

attributes related to fuel economy and express[ed] . . . in the form of a mathematical function.”³⁹⁶ NHTSA has thus far based standards on vehicle footprint and proposes to continue to do so for all the reasons described in previous rulemakings. As in previous rulemakings, NHTSA proposes to define the standards in the form of a constrained linear function that generally sets higher (more stringent) targets for smaller-footprint vehicles and lower (less stringent) targets for larger-footprint vehicles. These footprint curves are discussed in much greater detail in Section II.C above. We seek comment both on the choice of footprint as the relevant attribute and on the rationale for the constrained linear functions chosen to represent the standards.

(d) Number of Model Years for Which Standards May Be Set at a Time

EISA also states that NHTSA shall “issue regulations under this title prescribing average fuel economy standards for at least 1, but not more than 5, model years.”³⁹⁷ In the 2012 final rule, NHTSA interpreted this provision as preventing the agency from setting final standards for all of MYs 2017–2025 in a single rulemaking action, so the MYs 2022–2025 standards were termed “augural,” meaning “that they represent[ed] the agency’s current judgment, based on the information available to the agency [then], of what levels of stringency would be maximum feasible in those model years.”³⁹⁸ That said, NHTSA also repeatedly clarified that the augural standards were in no way final standards and that a future *de novo* rulemaking would be necessary in order to both propose and promulgate final standards for MYs 2022–2025.

Today, NHTSA proposes to establish new standards for MYs 2022–2026 and to revise the previously-established final standards for MY 2021. Legislative history suggests that Congress included the five year maximum limitation so NHTSA would issue standards for a period of time where it would have reasonably realistic estimates of market conditions, technologies, and economic practicability (*i.e.*, not set standards too far into the future).³⁹⁹ However, the concerns Congress sought to address by imposing those limitations are not present for nearer model years where NHTSA already has existing standards. Revisiting existing standards is contemplated by both 49 U.S.C.

32902(c) and 32902(g). We therefore believe that it is reasonable to interpret section 32902(b)(3)(B) as applying only to the establishing of *new* standards rather than to the combined action of establishing new standards and amending existing standards.

Moreover, we believe it would be an absurd result not intended by Congress if the five year maximum limitation were interpreted to prevent NHTSA from revising a previously-established standard that we have determined to be beyond maximum feasible, while concurrently setting five years of standards not so distant from today. The concerns Congress sought to address are much starker when NHTSA is trying to determine what standards would be maximum feasible 10 years from now as compared to three years from now.

(e) Maximum Feasible

As discussed above, EPCA requires NHTSA to consider four factors in determining what levels of CAFE standards would be maximum feasible, and NHTSA presents in the sections below its understanding of what those four factors mean. All factors should be considered, in the manner appropriate, and then the maximum feasible standards should be determined.

(1) Technological Feasibility

“Technological feasibility” refers to whether a particular method of improving fuel economy is available for deployment in commercial application in the model year for which a standard is being established. Thus, NHTSA is not limited in determining the level of new standards to technology that is already being commercially applied at the time of the rulemaking. For this proposal, NHTSA is considering a wide range of technologies that improve fuel economy, subject to the constraints of EPCA regarding how to treat alternative fueled vehicles, and considering the need to account for which technologies have already been applied to which vehicle model/configuration, and the need to realistically estimate the cost and fuel economy impacts of each technology. NHTSA has not attempted to account for every technology that might conceivably be applied to improve fuel economy and considers it unnecessary to do so given that many technologies address fuel economy in similar ways.⁴⁰⁰ Technological

⁴⁰⁰ For example, NHTSA has not considered high-speed flywheels as potential energy storage devices for hybrid vehicles; while such flywheels have been demonstrated in the laboratory and even tested in concept vehicles, commercially available hybrid vehicles currently known to NHTSA use chemical batteries as energy storage devices, and the agency

feasibility and economic practicability are often conflated, as will be covered further in the following section. To be clear, whether a fuel-economy-improving technology does or will exist (technological feasibility) is a different question from what economic consequences could ensue if NHTSA effectively requires that technology to become widespread in the fleet and the economic consequences of the absence of consumer demand for technology that are projected to be required (economic practicability). It is therefore possible for standards to be technologically feasible but still beyond the level that NHTSA determines to be maximum feasible due to consideration of the other relevant factors.

(2) Economic Practicability

“Economic practicability” has traditionally referred to whether a standard is one “within the financial capability of the industry, but not so stringent as to” lead to “adverse economic consequences, such as a significant loss of jobs or unreasonable elimination of consumer choice.”⁴⁰¹ In evaluating economic practicability, NHTSA considers the uncertainty surrounding future market conditions and consumer demand for fuel economy alongside consumer demand for other vehicle attributes. NHTSA has explained in the past that this factor can be especially important during rulemakings in which the auto industry is facing significantly adverse economic conditions (with corresponding risks to jobs). Consumer acceptability is also a major component to economic practicability,⁴⁰² which can involve consideration of anticipated consumer responses not just to increased vehicle cost, but also to the way manufacturers may change vehicle models and vehicle sales mix in response to CAFE standards. In attempting to determine the economic practicability of attribute-based standards, NHTSA considers a wide variety of elements, including the annual rate at which manufacturers can increase the percentage of their fleet that employs a particular type of fuel-saving technology,⁴⁰³ the specific fleet mixes of

has considered a range of hybrid vehicle technologies that do so.

⁴⁰¹ 67 FR 77015, 77021 (Dec. 16, 2002).

⁴⁰² See, e.g., *Center for Auto Safety v. NHTSA* (CAS), 793 F.2d 1322 (D.C. Cir. 1986) (Administrator’s consideration of market demand as component of economic practicability found to be reasonable); *Public Citizen v. NHTSA*, 848 F.2d 256 (Congress established broad guidelines in the fuel economy statute; agency’s decision to set lower standards was a reasonable accommodation of conflicting policies).

⁴⁰³ For example, if standards effectively require manufacturers to widely apply technologies that

³⁹⁶ 49 U.S.C. 32902(b)(3)(A).

³⁹⁷ 49 U.S.C. 32902(b)(3)(B).

³⁹⁸ 77 FR 62623, 62630 (Oct. 15, 2012).

³⁹⁹ See 153 Cong. Rec. 2665 (Dec. 28, 2007).

different manufacturers, and assumptions about the cost of standards to consumers and consumers' valuation of fuel economy, among other things.

Prior to the MYs 2005–2007 rulemaking under the non-attribute-based (fixed value) CAFE standards, NHTSA generally sought to ensure the economic practicability of standards in part by setting them at or near the capability of the “least capable manufacturer” with a significant share of the market, *i.e.*, typically the manufacturer whose fleet mix was, on average, the largest and heaviest, generally having the highest capacity and capability so as to not limit the availability of those types of vehicles to consumers. In the first several rulemakings establishing attribute-based standards, NHTSA applied marginal cost-benefit analysis, considering both overall societal impacts and overall consumer impacts. Whether the standards maximize net benefits has thus been a touchstone in the past for NHTSA's consideration of economic practicability. Executive Order 12866, as amended by Executive Order 13563, states that agencies should “select, in choosing among alternative regulatory approaches, those approaches that maximize net benefits . . .” In practice, however, agencies, including NHTSA, must consider situations in which the modeling of net benefits does not capture all of the relevant considerations of feasibility. Therefore, as in past rulemakings, NHTSA is considering net societal impacts, net consumer impacts, and other related elements in the consideration of economic practicability.

NHTSA's consideration of economic practicability depends on a number of elements. Expected availability of capital to make investments in new technologies matters; manufacturers' expected ability to sell vehicles with certain technologies matters; likely consumer choices matter and so forth. NHTSA's analysis of the impacts of this proposal incorporates assumptions to capture aspects of consumer preferences, vehicle attributes, safety, and other elements relevant to an impacts estimate; however, it is difficult to capture every such constraint. Therefore, it is well within the agency's discretion to deviate from the level at which modeled net benefits are maximized if the agency concludes that that level would not represent the maximum feasible level for future CAFE

consumers do not want, or to widely apply technologies before they are ready to be widespread, NHTSA believes that these standards could potentially be beyond economically practicable.

standards. Economic practicability is complex, and like the other factors must also be considered in the context of the overall balancing and EPCA's overarching purpose of energy conservation. Depending on the conditions of the industry and the assumptions used in the agency's analysis of alternative standards, NHTSA could well find that standards that maximize net benefits, or that are higher or lower, could be at the limits of economic practicability, and thus potentially the maximum feasible level, depending on how the other factors are balanced.

While we discuss safety as a separate consideration, NHTSA also considers safety as closely related to, and in some circumstances a subcomponent of economic practicability. On a broad level, manufacturers have finite resources to invest in research and development. Investment into the development and implementation of fuel saving technology necessarily comes at the expense of investing in other areas such as safety technology. On a more direct level, when making decisions on how to equip vehicles, manufacturers must balance cost considerations to avoid pricing further consumers out of the market. As manufacturers add technology to increase fuel efficiency, they may decide against installing new safety equipment to reduce cost increases. And as the price of vehicles increase beyond the reach of more consumers, such consumers continue to drive or purchase older, less safe vehicles. In assessing practicability, NHTSA also considers the harm to the nation's economy caused by highway fatalities and injuries.

(3) The Effect of Other Motor Vehicle Standards of the Government on Fuel Economy

“The effect of other motor vehicle standards of the Government on fuel economy” involves analysis of the effects of compliance with emission, safety, noise, or damageability standards on fuel economy capability and thus on average fuel economy. In many past CAFE rulemakings, NHTSA has said that it considers the adverse effects of other motor vehicle standards on fuel economy. It said so because, from the CAFE program's earliest years⁴⁰⁴ until recently, the effects of such compliance on fuel economy capability over the history of the CAFE program have been negative ones. For example, safety standards that have the effect of

increasing vehicle weight thereby lower fuel economy capability, thus decreasing the level of average fuel economy that NHTSA can determine to be feasible. NHTSA has considered the additional weight that it estimates would be added in response to new safety standards during the rulemaking timeframe.⁴⁰⁵ NHTSA has also accounted for EPA's “Tier 3” standards for criteria pollutants in its estimates of technology effectiveness.⁴⁰⁶

In the 2012 final rule establishing CAFE standards for MYs 2017–2021, NHTSA also discussed whether EPA GHG standards and California GHG standards should be considered and accounted for as “other motor vehicle standards of the Government.” NHTSA recognized that “To the extent the GHG standards result in increases in fuel economy, they would do so almost exclusively as a result of inducing manufacturers to install the same types of technologies used by manufacturers in complying with the CAFE standards.”⁴⁰⁷ NHTSA concluded that “the agency had already considered EPA's [action] and the harmonization benefits of the National Program in developing its own [action],” and that “no further action was needed.”⁴⁰⁸

Considering the issue afresh in this proposal, and looking only at the words in the statute, obviously EPA's GHG standards applicable to light-duty vehicles are literally “other motor vehicle standards of the Government,” in that they are standards set by a Federal agency that apply to motor vehicles. Basic chemistry makes fuel economy and tailpipe CO₂ emissions two sides of the same coin, as discussed at length above, and when two agencies functionally regulate both (because by regulating fuel economy, you regulate CO₂ emissions, and vice versa), it would be absurd not to link their standards.⁴⁰⁹ The global warming potential of N₂O, CH₄, and HFC emissions are not closely linked with fuel economy, but neither do they affect fuel economy capabilities. How, then, should NHTSA consider EPA's various GHG standards?

NHTSA is aware that some stakeholders believe that NHTSA's obligation to set maximum feasible CAFE standards can best be executed by letting EPA decide what GHG standards

⁴⁰⁵ PRIA, Chapter 5.

⁴⁰⁶ PRIA, Chapter 6.

⁴⁰⁷ 77 FR 62624, 62669 (Oct. 15, 2012).

⁴⁰⁸ *Id.*

⁴⁰⁹ In fact, EPA includes tailpipe CH₄, CO, and CO₂ in the measurement of tailpipe CO₂ for GHG compliance using a carbon balance equation so that the measurement of tailpipe CO₂ exactly aligns with the measurement of fuel economy for the CAFE compliance.

⁴⁰⁴ 42 FR 63184, 63188 (Dec. 15, 1977). *See also* 42 FR 33534, 33537 (June 30, 1977).

are appropriate and reasonable under the CAA. NHTSA disagrees. While EPA and NHTSA consider some similar factors under the CAA and EPCA/EISA, respectively, they are not identical. Standards that are appropriate under the CAA may not be “maximum feasible” under EPCA/EISA, and vice versa. Moreover, considering EPCA’s language in the context in which it was written, it seems unreasonable to conclude that Congress intended EPA to dictate CAFE stringency. In fact, Congress clearly separated NHTSA’s and EPA’s responsibilities for CAFE under EPCA by giving NHTSA authority to set standards and EPA authority to measure and calculate fuel economy. If Congress had wanted EPA to set CAFE standards, it could have given that authority to EPA in EPCA or at any point since Congress amended EPCA.⁴¹⁰

NHTSA and EPA are obligated by Congress to exercise their own independent judgment in fulfilling their statutory missions, even though both agencies’ regulations affect both fuel economy and CO₂ emissions. Because of this relationship, it is incumbent on both agencies to coordinate and look to one another’s actions to avoid unreasonably burdening industry through inconsistent regulations, but both agencies must be able to defend their programs on their own merits. As with other recent CAFE and GHG rulemakings, the agencies are continuing to do all of these things in this proposal.

With regard to standards issued by the State of California, State tailpipe standards (whether for greenhouse gases or for other pollutants) do not qualify as “other motor vehicle standards of the Government” under 49 U.S.C. 32902(f); therefore, NHTSA will not consider them as such in proposing maximum feasible average fuel economy standards. States may not adopt or enforce tailpipe greenhouse gas emissions standards when such standards relate to fuel economy standards and are therefore preempted under EPCA, regardless of whether EPA granted any waivers under the Clean Air Act (CAA).⁴¹¹

Preempted standards of a State or a political subdivision of a State include, for example:

- (1) A fuel economy standard; and
- (2) A law or regulation that has the direct effect of a fuel economy standard,

⁴¹⁰ We note, for instance, that EISA was passed after the *Massachusetts v. EPA* decision by the Supreme Court. If Congress had wanted to amend EPCA in light of that decision, they would have done so at the time. They did not.

⁴¹¹ This topic is discussed further in Section VI below.

but is not labeled as one (*i.e.*, a State tailpipe CO₂ standard or prohibition on CO₂ emissions).

NHTSA and EPA agree that state tailpipe greenhouse gas emissions standards do not become Federal standards and qualify as “other motor vehicle standards of the Government,” when subject to a CAA preemption waiver. EPCA’s legislative history supports this position.

EPCA, as initially passed in 1975, mandated average fuel economy standards for passenger cars beginning with model year 1978. The law required the Secretary of Transportation to establish, through regulation, maximum feasible fuel economy standards⁴¹² for model years 1981 through 1984 with the intent to provide steady increases to achieve the standard established for 1985 and thereafter authorized the Secretary to adjust that standard.

For the statutorily-established standards for model years 1978–1980, EPCA provided each manufacturer with the right to petition for changes in the standards applicable to that manufacturer. A petitioning manufacturer had the burden of demonstrating a “Federal fuel economy standards reduction” was likely to exist for that manufacturer in one or more of those model years and that it had made reasonable technology choices. “Federal standards,” for that limited purpose, included not only safety standards, noise emission standards, property loss reduction standards, and emission standards issued under various Federal statutes, but also “*emissions standards applicable by reason of section 209(b) of [the CAA].*”⁴¹³ (Emphasis added). Critically, all definitions, processes, and required findings regarding a Federal fuel economy standards reduction were located within a single self-contained subsection of 15 U.S.C. 2002 that applied only to model years 1978–1980.⁴¹⁴

In 1994, Congress recodified EPCA. As part of this recodification, the CAFE provisions were moved to Title 49 of the United States Code. In doing so,

⁴¹² As is the case today, EPCA required the Secretary to determine “maximum feasible average fuel economy” after considering technological feasibility, economic practicability, the effect of other Federal motor vehicle standards on fuel economy, and the need of the Nation to conserve energy. 15 U.S.C. 2002(e) (recodified July 5, 1994).

⁴¹³ Section 202 of the CAA (42 U.S.C. 7521) requires EPA to prescribe air pollutant emission standards for new vehicles; Section 209 of the CAA (42 U.S.C. 7543) preempts state emissions standards but allows California to apply for a waiver of such preemption.

⁴¹⁴ As originally enacted as part of Public Law 94–163, that subsection was designated as section 502(d) of the Motor Vehicle Information and Cost Savings Act.

unnecessary provisions were deleted. Specifically, the recodification eliminated subsection (d). The House report on the recodification declared that the subdivision was “executed,” and described its purpose as “[p]rovid[ing] for modification of average fuel economy standards for model years 1978, 1979, and 1980.”⁴¹⁵ It is generally presumed, when Congress includes text in one section and not in another, that Congress knew what it was doing and made the decision deliberately.

NHTSA has previously considered the impact of California’s Low Emission Vehicle standards in establishing fuel economy standards and occasionally has done so under the “other standards” sections.⁴¹⁶ During the 2012 rulemaking, NHTSA sought comment on the appropriateness of considering California’s tailpipe GHG emission standards in this section and concluded that doing so was unnecessary.⁴¹⁷ In light of the legislative history discussed above, however, NHTSA now determines that this was not appropriate. Notwithstanding the improper categorization of such discussions, NHTSA may consider elements not specifically designated as factors to be considered under EPCA, given the breadth of such factors as technological feasibility and economic practicability, and such consideration was appropriate.⁴¹⁸

(4) The Need of the United States To Conserve Energy

“The need of the United States to conserve energy” means “the consumer cost, national balance of payments, environmental, and foreign policy implications of our need for large quantities of petroleum, especially imported petroleum.”⁴¹⁹

(i) Consumer Costs and Fuel Prices

Fuel for vehicles costs money for vehicle owners and operators. All else equal, consumers benefit from vehicles that need less fuel to perform the same amount of work. Future fuel prices are a critical input into the economic

⁴¹⁵ H.R. Rep. No. 103–180, at 583–584, tbl. 2A.

⁴¹⁶ See, e.g., 68 FR 16896, 71 FR 17643.

⁴¹⁷ See 77 FR 62669.

⁴¹⁸ See, e.g., discussion in *Center for Automotive Safety v. National Highway Traffic Safety Administration*, et al., 793 F.2d 1322 (D.C. Cir. 1986) at 1338, *et seq.*, providing that NHTSA may consider consumer demand in establishing standards, but not “to such an extent that it ignored the overarching goal of fuel conservation. At the other extreme, a standard with harsh economic consequences for the auto industry also would represent an unreasonable balancing of EPCA’s policies.”

⁴¹⁹ 42 FR 63184, 63188 (Dec. 15, 1977).

analysis of potential CAFE standards because they determine the value of fuel savings both to new vehicle buyers and to society, the amount of fuel economy that the new vehicle market is likely to demand in the absence of new standards, and they inform NHTSA about the “consumer cost . . . of our need for large quantities of petroleum.” In this proposal, NHTSA’s analysis relies on fuel price projections from the U.S. Energy Information Administration’s (EIA) Annual Energy Outlook (AEO) for 2017. Federal government agencies generally use EIA’s price projections in their assessment of future energy-related policies.

(ii) National Balance of Payments

Historically, the need of the United States to conserve energy has included consideration of the “national balance of payments” because of concerns that importing large amounts of oil created a significant wealth transfer to oil-exporting countries and left the U.S. economically vulnerable.⁴²⁰ As recently as 2009, nearly half the U.S. trade deficit was driven by petroleum,⁴²¹ yet this concern has largely laid fallow in more recent CAFE actions, arguably in part because other factors besides petroleum consumption have since played a bigger role in the U.S. trade deficit. Given significant recent increases in U.S. oil production and corresponding decreases in oil imports, this concern seems likely to remain fallow for the foreseeable future.⁴²² Increasingly, changes in the price of fuel have come to represent transfers between domestic consumers of fuel and domestic producers of petroleum rather than gains or losses to foreign entities. Some commenters have lately

⁴²⁰ See 42 FR 63184, 63192 (Dec. 15, 1977) “A major reason for this need [to reduce petroleum consumption] is that the importation of large quantities of petroleum creates serious balance of payments and foreign policy problems. The United States currently spends approximately \$45 billion annually for imported petroleum. But for this large expenditure, the current large U.S. trade deficit would be a surplus.”

⁴²¹ See *Today in Energy: Recent improvements in petroleum trade balance mitigate U.S. trade deficit*, U.S. Energy Information Administration (July 21, 2014), <https://www.eia.gov/todayinenergy/detail.php?id=17191>.

⁴²² For an illustration of recent increases in U.S. production, see, e.g., *U.S. crude oil and liquid fuels production, Short-Term Energy Outlook*, U.S. Energy Information Administration (June 2018), <https://www.eia.gov/outlooks/steo/images/fig13.png>. While it could be argued that reducing oil consumption frees up more domestically-produced oil for exports, and thereby raises U.S. GDP, that is neither the focus of the CAFE program nor consistent with Congress’ original intent in EPCA. EIA’s Annual Energy Outlook (AEO) series provides midterm forecasts of production, exports, and imports of petroleum products, and is available at <https://www.eia.gov/outlooks/aeo/>.

raised concerns about potential economic consequences for automaker and supplier operations in the U.S. due to disparities between CAFE standards at home and their counterpart fuel economy/efficiency and GHG standards abroad. NHTSA finds these concerns more relevant to technological feasibility and economic practicability than to the national balance of payments. Moreover, to the extent that an automaker decides to globalize a vehicle platform to meet more stringent standards in other countries, that automaker would comply with United States’ standards and additionally generate overcompensation credits that it can save for future years if facing compliance concerns, or sell to other automakers. While CAFE standards are set at maximum feasible rates, efforts of manufacturers to exceed those standards are rewarded not only with additional credits but a market advantage in that consumers who place a large weight on fuel savings will find such vehicles that much more attractive.

(iii) Environmental Implications

Higher fleet fuel economy can reduce U.S. emissions of various pollutants by reducing the amount of oil that is produced and refined for the U.S. vehicle fleet but can also increase emissions by reducing the cost of driving, which can result in increased vehicle miles traveled (*i.e.*, the rebound effect). Thus, the net effect of more stringent CAFE standards on emissions of each pollutant depends on the relative magnitudes of its reduced emissions in fuel refining and distribution and increases in its emissions from vehicle use. Fuel savings from CAFE standards also necessarily results in lower emissions of CO₂, the main GHG emitted as a result of refining, distribution, and use of transportation fuels. Reducing fuel consumption directly reduces CO₂ emissions because the primary source of transportation-related CO₂ emissions is fuel combustion in internal combustion engines.

NHTSA has considered environmental issues, both within the context of EPCA and the context of the National Environmental Policy Act (NEPA), in making decisions about the setting of standards since the earliest days of the CAFE program. As courts of appeal have noted in three decisions stretching over the last 20 years,⁴²³

⁴²³ *CAS*, 793 F.2d 1322, 1325 n. 12 (D.C. Cir. 1986); *Public Citizen*, 848 F.2d 256, 262–63 n. 27 (D.C. Cir. 1988) (noting that “NHTSA itself has interpreted the factors it must consider in setting CAFE standards as including environmental effects”); *CBD*, 538 F.3d 1172 (9th Cir. 2007).

NHTSA defined “the need of the United States to conserve energy” in the late 1970s as including, among other things, environmental implications. In 1988, NHTSA included climate change concepts in its CAFE notices and prepared its first environmental assessment addressing that subject.⁴²⁴ It cited concerns about climate change as one of its reasons for limiting the extent of its reduction of the CAFE standard for MY 1989 passenger cars.⁴²⁵ Since then, NHTSA has considered the effects of reducing tailpipe emissions of CO₂ in its fuel economy rulemakings pursuant to the need of the United States to conserve energy by reducing petroleum consumption.

(iv) Foreign Policy Implications

U.S. consumption and imports of petroleum products impose costs on the domestic economy that are not reflected in the market price for crude petroleum or in the prices paid by consumers for petroleum products such as gasoline. These costs include (1) higher prices for petroleum products resulting from the effect of U.S. oil demand on world oil prices, (2) the risk of disruptions to the U.S. economy caused by sudden increases in the global price of oil and its resulting impact of fuel prices faced by U.S. consumers, and (3) expenses for maintaining the strategic petroleum reserve (SPR) to provide a response option should a disruption in commercial oil supplies threaten the U.S. economy, to allow the U.S. to meet part of its International Energy Agency obligation to maintain emergency oil stocks, and to provide a national defense fuel reserve.⁴²⁶ Higher U.S. consumption of crude oil or refined petroleum products increases the magnitude of these external economic costs, thus increasing the true economic cost of supplying transportation fuels above the resource costs of producing them. Conversely, *reducing* U.S. consumption of crude oil or refined petroleum products (by reducing motor fuel use) can reduce these external costs.

While these costs are considerations, the United States has significantly increased oil production capabilities in

⁴²⁴ 53 FR 33080, 33096 (Aug. 29, 1988).

⁴²⁵ 53 FR 39275, 39302 (Oct. 6, 1988).

⁴²⁶ While the U.S. maintains a military presence in certain parts of the world to help secure global access to petroleum supplies, that is neither the primary nor the sole mission of U.S. forces overseas. Additionally, the scale of oil consumption reductions associated with CAFE standards would be insufficient to alter any existing military missions focused on ensuring the safe and expedient production and transportation of oil around the globe. See Chapter 7 of the PRIA for more information on this topic.

recent years to the extent that the U.S. is currently producing enough oil to satisfy nearly all of its energy needs and is projected to continue to do so or become a net energy exporter. This has added new stable supply to the global oil market and reduced the urgency of the U.S. to conserve energy. We discuss this issue in more detail below.

(5) Factors That NHTSA Is Prohibited From Considering

EPCA also provides that in determining the level at which it should set CAFE standards for a particular model year, NHTSA may not consider the ability of manufacturers to take advantage of several EPCA provisions that facilitate compliance with CAFE standards and thereby reduce the costs of compliance.⁴²⁷ As discussed further in Section X.B.1.c) below, NHTSA cannot consider compliance credits that manufacturers earn by exceeding the CAFE standards and then use to achieve compliance in years in which their measured average fuel economy falls below the standards. NHTSA also cannot consider the use of alternative fuels by dual fuel vehicles nor the availability of dedicated alternative fuel vehicles in any model year. EPCA encourages the production of alternative fuel vehicles by specifying that their fuel economy is to be determined using a special calculation procedure that results in those vehicles being assigned a higher fuel economy level than they actually achieve.

The effect of the prohibitions against considering these statutory flexibilities in setting the CAFE standards is that the flexibilities remain voluntarily-employed measures. If NHTSA were instead to assume manufacturer use of those flexibilities in setting new standards, higher standards would appear less costly and therefore more feasible, which would thus tend to require manufacturers to use those flexibilities in order to meet higher standards. By keeping NHTSA from including them in our stringency determination, the provision ensures that these statutory credits remain true compliance flexibilities.

Additionally, for non-statutory incentives that NHTSA developed by regulation, NHTSA does not consider these subject to the EPCA prohibition on considering flexibilities, either. EPCA is very clear as to which flexibilities are not to be considered. When the agency has introduced additional flexibilities such as A/C efficiency and “off-cycle” technology fuel economy improvement values, NHTSA has considered those

technologies as available in the analysis. Thus, today’s analysis includes assumptions about manufacturers’ use of those technologies, as detailed in Section X.B.1.c)(4)

(f) EPCA/EISA Requirements That No Longer Apply Post-2020

Congress amended EPCA through EISA to add two requirements not yet discussed in this section relevant to determination of CAFE standards during the years between MY 2011 and MY 2020 but not beyond. First, Congress stated that, regardless of NHTSA’s determination of what levels of standards would be maximum feasible, standards must be set at levels high enough to ensure that the combined U.S. passenger car and light truck fleet achieves an average fuel economy level of not less than 35 mpg no later than MY 2020.⁴²⁸ And second, between MYs 2011 and 2020, the standards must “increase ratably” in each model year.⁴²⁹ Neither of these requirements apply after MY 2020, so given that this rulemaking concerns the standards for MY 2021 and after, they are not relevant to this rulemaking.

(g) Other Considerations in Determining Maximum Feasible Standards

NHTSA has historically considered the potential for adverse safety consequences in setting CAFE standards. This practice has been consistently approved in case law. As courts have recognized, “NHTSA has always examined the safety consequences of the CAFE standards in its overall consideration of relevant factors since its earliest rulemaking under the CAFE program.” *Competitive Enterprise Institute v. NHTSA*, 901 F.2d 107, 120 n. 11 (D.C. Cir. 1990) (“*CEI-I*”) (citing 42 FR 33534, 33551 (June 30, 1977)). The courts have consistently upheld NHTSA’s implementation of EPCA in this manner. *See, e.g., Competitive Enterprise Institute v. NHTSA*, 956 F.2d 321, 322 (D.C. Cir. 1992) (“*CEI-II*”) (in determining the maximum feasible fuel economy standard, “NHTSA has always taken passenger safety into account”) (citing *CEI-I*, 901 F.2d at 120 n. 11); *Competitive Enterprise Institute v. NHTSA*, 45 F.3d 481, 482–83 (D.C. Cir. 1995) (“*CEI-III*”) (same); *Center for Biological Diversity v. NHTSA*, 538 F.3d 1172, 1203–04 (9th Cir. 2008) (upholding NHTSA’s analysis of vehicle safety issues associated with weight in connection with the MYs 2008–2011 light truck CAFE rulemaking). Thus, in

evaluating what levels of stringency would result in maximum feasible standards, NHTSA assesses the potential safety impacts and considers them in balancing the statutory considerations and to determine the maximum feasible level of the standards.

The attribute-based standards that Congress requires NHTSA to set help to mitigate the negative safety effects of the historical “flat” standards originally required in EPCA, in recent rulemakings, NHTSA limited the consideration of mass reduction in lower weight vehicles in its analysis, which impacted the resulting assessment of potential adverse safety effects. That analytical approach did not reflect, however, the likelihood that automakers may pursue the most cost effective means of improving fuel efficiency to comply with CAFE requirements. For this rulemaking, the modeling does not limit the amount of mass reduction that is applied to any segment but rather considers that automakers may apply mass reduction based upon cost-effectiveness, similar to most other technologies. NHTSA does not, of course, mandate the use of any particular technology by manufacturers in meeting the standards. The current proposal, like the Draft TAR, also considers the safety effect associated with the additional vehicle miles traveled due to the rebound effect.

In this rulemaking, NHTSA is considering the effect of additional expenses in fuel savings technology on the affordability of vehicles—the likelihood that increased standards will result in consumers being priced out of the new vehicle market and choosing to keep their existing vehicle or purchase a used vehicle. Since new vehicles are significantly safer than used vehicles, slowing fleet turnover to newer vehicles results in older and less safe vehicles remaining on the roads longer. This significantly affects the safety of the United States light duty fleet, as described more fully in Section 0 above and in Chapter 11 of the PRIA accompanying this proposal. Furthermore, as fuel economy standards become more stringent, and more fuel efficient vehicles are introduced into the fleet, fueling costs are reduced. This results in consumers driving more miles, which results in more crashes and increased highway fatalities.

2. Administrative Procedure Act

To be upheld under the “arbitrary and capricious” standard of judicial review in the APA, an agency rule must be rational, based on consideration of the relevant factors, and within the scope of

⁴²⁸ 49 U.S.C. 32902(b)(2)(A).

⁴²⁹ 49 U.S.C. 32902(b)(2)(C).

⁴²⁷ 49 U.S.C. 32902(h).

the authority delegated to the agency by the statute. The agency must examine the relevant data and articulate a satisfactory explanation for its action including a “rational connection between the facts found and the choice made.” *Burlington Truck Lines, Inc., v. United States*, 371 U.S. 156, 168 (1962).

Statutory interpretations included in an agency’s rule are subject to the two-step analysis of *Chevron, U.S.A. v. Natural Resources Defense Council*, 467 U.S. 837 (1984). Under step one, where a statute “has directly spoken to the precise question at issue,” *id.* at 842, the court and the agency “must give effect to the unambiguously expressed intent of Congress,” *id.* at 843. If the statute is silent or ambiguous regarding the specific question, the court proceeds to step two and asks “whether the agency’s answer is based on a permissible construction of the statute.” *Id.*

If an agency’s interpretation differs from the one that it has previously adopted, the agency need not demonstrate that the prior position was wrong or even less desirable. Rather, the agency would need only to demonstrate that its *new* position is consistent with the statute and supported by the record and acknowledge that this is a departure from past positions. The Supreme Court emphasized this in *FCC v. Fox Television*, 556 U.S. 502 (2009). When an agency changes course from earlier regulations, “the requirement that an agency provide a reasoned explanation for its action would ordinarily demand that it display awareness that it *is* changing position,” but “need not demonstrate to a court’s satisfaction that the reasons for the new policy are *better* than the reasons for the old one; it suffices that the new policy is permissible under the statute, that there are good reasons for it, and that the agency *believes* it to be better, which the conscious change of course adequately indicates.”⁴³⁰ The APA also requires that agencies provide notice and comment to the public when proposing regulations,⁴³¹ as we are doing today.

3. National Environmental Policy Act

As discussed above, EPCA requires NHTSA to determine the level at which to set CAFE standards for each model year by considering the four factors of technological feasibility, economic practicability, the effect of other motor vehicle standards of the Government on fuel economy, and the need of the United States to conserve energy. The National Environmental Policy Act (NEPA) directs that environmental

considerations be integrated into that process.⁴³² To accomplish that purpose, NEPA requires an agency to compare the potential environmental impacts of its proposed action to those of a reasonable range of alternatives.

To explore the environmental consequences of this proposed rule in depth, NHTSA has prepared a Draft Environmental Impact Statement (“DEIS”). The purpose of an EIS is to “provide full and fair discussion of significant environmental impacts and [to] inform decisionmakers and the public of the reasonable alternatives which would avoid or minimize adverse impacts or enhance the quality of the human environment.”⁴³³

NEPA is “a procedural statute that mandates a process rather than a particular result.” *Stewart Park & Reserve Coal, Inc. v. Slater*, 352 F.3d 545, 557 (2d Cir. 2003). The agency’s overall EIS-related obligation is to “take a ‘hard look’ at the environmental consequences before taking a major action.” *Baltimore Gas & Elec. Co. v. Natural Resources Defense Council, Inc.*, 462 U.S. 87, 97 (1983). Significantly, “[i]f the adverse environmental effects of the proposed action are adequately identified and evaluated, the agency is not constrained by NEPA from deciding that other values outweigh the environmental costs.” *Robertson v. Methow Valley Citizens Council*, 490 U.S. 332, 350 (1989).

The agency must identify the “environmentally preferable” alternative but need not adopt it. “Congress in enacting NEPA . . . did not require agencies to elevate environmental concerns over other appropriate considerations.” *Baltimore Gas & Elec. Co. v. Natural Resources Defense Council, Inc.*, 462 U.S. 87, 97 (1983). Instead, NEPA requires an agency to develop alternatives to the proposed action in preparing an EIS. 42 U.S.C. 4322(2)(C)(iii). The statute does not command the agency to favor an environmentally preferable course of action, only that it make its decision to proceed with the action after taking a hard look at the environmental consequences.

We seek comment on the DEIS associated with this NPRM.

4. Evaluating the EPCA Factors and Other Considerations To Arrive at the Proposed Standards

NHTSA well recognizes that the decision it proposes to make in today’s NPRM is different from the one made in

the 2012 final rule that established standards for MY 2021 and identified “augural” standard levels for MYs 2022–2025. Not only do we believe that the facts before us have changed, but we believe that those facts have changed sufficiently that the balancing of the EPCA factors and other considerations must also change. The standards we are proposing today reflect that balancing.

The overarching purpose of EPCA is energy conservation; that fact remains the same. Examining that phrasing afresh, Merriam-Webster states that to “conserve” means, in relevant part, “to keep in a safe or sound state; especially, to avoid wasteful or destructive use of.”⁴³⁴ This is consistent with our understanding of Congress’ original intent for the CAFE program: To raise fleet-wide fuel economy levels in response to the Arab oil embargo in the 1970s and protect the country from further gasoline price shocks and supply shortages. Those price shocks, while they were occurring, were disruptive to the U.S. economy and significantly affected consumers’ daily lives. Congress therefore sought to keep U.S. energy consumption in a safe and sound state for the sake of consumers and the economy and avoid such shocks in the future.

Today, the conditions that led both to those price shocks and to U.S. energy vulnerability overall have changed significantly. In the late 1970s, the U.S. was a major oil importer and changes (intentional or not) in the global oil supply had massive domestic consequences, as Congress saw. While oil consumption exceeded domestic production for many years after that, net energy imports peaked in 2005, and since then, oil imports have declined while exports have increased.

The relationship between the U.S. and the global oil market has changed for two principal reasons. The first reason is that the U.S. now consumes a significantly smaller share of global oil production than it did in the 1970s. At the time of the Arab oil embargo, the U.S. consumed about 17 million barrels per day of the globe’s approximately 55 million barrels per day.⁴³⁵ While OPEC (particularly Saudi Arabia) still has the ability to influence global oil prices by imposing discretionary supply restrictions, the greater diversity of both suppliers and consumers since the 1970s has reduced the degree to which

⁴³⁴ “Conserve,” Merriam-Webster, available at <https://www.merriam-webster.com/dictionary/conserve> (last visited June 25, 2018).

⁴³⁵ *Short-Term Energy Outlook*, U.S. Energy Information Administration (June 2018), available at https://www.eia.gov/outlooks/steo/pdf/steo_full.pdf.

⁴³⁰ *Ibid.*, 1181.

⁴³¹ 5 U.S.C. 553.

⁴³² NEPA is codified at 42 U.S.C. 4321–47.

⁴³³ 40 CFR 1502.1.

a single actor (or small collection of actors) can impact the welfare of individual consumers. Oil is a fungible global commodity, though there are limits to the substitutability of different types of crude for a given application. The global oil market can, to a large extent, compensate for any producer that chooses not to sell to a given buyer by shifting other supply toward that buyer. And while regional proximity, comparability of crude oil, and foreign policy considerations can make some transactions more or less attractive, as long as exporters have a vested interest in preserving the stability (both in terms of price and supply) of the global oil market, coordinated, large-scale actions (like the multi-nation sanctions against Iran in recent years) would be required to impose costs or welfare losses on one specific player in the global market. As a corollary to the small rise in U.S. petroleum consumption over the last few decades, the oil intensity of U.S. GDP has continued to decline since the Arab oil embargo, suggesting that U.S. GDP is less susceptible to increases in global petroleum prices (sudden or otherwise) than it was at the time of EPCA's passage or when these policies were last considered in 2012. While the U.S. still has a higher energy intensity of GDP than some other developed nations, our energy intensity has been declining since 1950 (shrinking by about 60% since 1950 and almost 30% between 1990 and 2015).⁴³⁶

The second factor that has changed the United States' relationship to the global oil market is the changing U.S. reliance on imported oil over the last decade. U.S. domestic oil production began rising in 2009 with more cost-effective drilling and production technologies.⁴³⁷ Domestic oil production became more cost-effective for two basic reasons. First, technology improved: The use of horizontal drilling in conjunction with hydraulic fracturing has greatly expanded the ability of producers to profitably recover natural gas and oil from low-permeability geologic plays—particularly, shale plays—and consequently, oil production from shale plays has grown rapidly in recent years.⁴³⁸ And second,

⁴³⁶ *Today in Energy: Global energy intensity continues to decline*, U.S. Energy Information Administration (July 12, 2016), <https://www.eia.gov/todayinenergy/detail.php?id=27032>.

⁴³⁷ *Energy Explained*, U.S. Energy Information Administration, <https://www.eia.gov/energyexplained/index.cfm> (last visited June 25, 2018).

⁴³⁸ *Review of Emerging Resources: U.S. Shale Gas and Shale Oil Plays*, U.S. Energy Information Administration (July 8, 2011), <https://www.eia.gov/analysis/studies/usshalegas/>. Practical application of horizontal drilling to oil production began in the early 1980s, by which time the advent of improved

rising global oil prices themselves made using those technologies more feasible. As a hypothetical example, if it costs \$79 per barrel to extract oil from a shale play, when the market price for that oil is \$60 per barrel, it is not worth the producer's cost to extract the oil; when the market price is \$80 per barrel, it becomes cost-effective.

Recent analysis further suggests that the U.S. oil supply response to a rise in global prices is much larger now due to the shale revolution, as compared to what it was when U.S. production depended entirely on conventional wells. Unconventional wells may be not only capable of producing more oil over time but also may be capable of responding faster to price shocks. One 2017 study concluded that “The long-run price responsiveness of supply is about 6 times larger for tight oil on a per well basis, and about 9 times larger when also accounting for the rise in unconventional-directed drilling.” That same study further found that “Given a price rise to \$80 per barrel, U.S. oil production could rise by 0.5 million barrels per day in 6 months, 1.2 million in 1 year, 2 million in 2 years, and 3 million in 5 years.”⁴³⁹ Some analysts suggest that shale drillers can respond more quickly to market conditions because, unlike conventional drillers, they do not need to spend years looking for new deposits, because there are simply so many shale oil wells being drilled, and because they are more productive (although their supply may be exhausted more quickly than a conventional well, the sheer numbers appear likely to make up for that concern).⁴⁴⁰ Some commenters disagree and suggest that the best deposits are already known and tapped.⁴⁴¹ Other

downhole drilling motors and the invention of other necessary supporting equipment, materials, and technologies (particularly, downhole telemetry equipment) had brought some applications within the realm of commercial viability. EIA's AEO 2018 also projects that by the early 2040s, tight oil production will account for nearly 70% of total U.S. production, up from 54% of the U.S. total in 2017. See also, *Tight oil remains the leading source of future U.S. crude oil production*, U.S. Energy Information Administration (Feb. 22, 2018), <https://www.eia.gov/todayinenergy/detail.php?id=35052>.

⁴³⁹ Newell, R. G. & Prest, B.C. *The Unconventional Oil Supply Boom: Aggregate Price Response from Microdata*, Working Paper 23973, National Bureau of Economic Research (Oct. 2017), available at <http://www.nber.org/papers/w23973> (last visited June 25, 2018).

⁴⁴⁰ Ip, G. *America's Emerging Petro Economy Flips the Impact of Oil*, Wall Street Journal (Feb. 21, 2018), available at <https://www.wsj.com/articles/americas-emerging-petro-economy-flips-the-impact-of-oil-1519209000> (last visited June 25, 2018).

⁴⁴¹ Olson, B. *Shale Trailblazer Turns Skeptic on Soaring U.S. Oil Production*, Wall Street Journal (Mar. 5, 2018), available at <https://www.wsj.com/articles/shale-trailblazer-turns-skeptic-on-soaring-u-s-oil-production-1520257595>.

commenters raise the possibility that even if the most productive deposits are already tapped, any rises in global oil prices should spur technology development that improves output of less productive deposits.⁴⁴² Moreover, even if U.S. production increases more slowly than, for example, EIA currently estimates, all increases in U.S. production help to temper global prices and the risk of oil shocks because they reduce the influence of other producing countries who might experience supply interruptions due to geopolitical instability or deliberately reduce supply in an effort to raise prices.⁴⁴³

These changes in U.S. oil intensity, production, and capacity cannot entirely insulate consumers from the effects of price shocks at the gas pump, because although domestic production may be able to satisfy domestic energy demand, we cannot predict whether domestically produced oil will be distributed domestically or more broadly to the global market. But it appears that domestic supply may dampen the magnitude, frequency, and duration of price shocks. As global per-barrel oil prices rise, U.S. production is now much better able to (and does) ramp up in response, pulling those prices back down. Corresponding per-gallon gas prices may not fall overnight,⁴⁴⁴ but it is foreseeable that they could moderate over time and likely respond faster than prior to the shale revolution. EIA's Annual Energy Outlook for 2018 acknowledges uncertainty regarding these new oil sources but projects that while retail prices of gasoline and diesel will increase between 2018 and 2050, annual average gasoline prices would not exceed \$4/gallon (in real dollars) during that timeframe under EIA's “reference

⁴⁴² LeBlanc, R. *In the Sweet Spot: The Key to Shale*, Wall Street Journal (Mar. 6, 2018), available at <http://partners.wsj.com/ceraweek/connection/sweet-spot-key-shale/>.

⁴⁴³ Alessi, C. & Sider, A. *U.S. Oil Output Expected to Surpass Saudi Arabia, Rivaling Russia for Top Spot*, Wall Street Journal (Jan. 19, 2018), available at <https://www.wsj.com/articles/u-s-crude-production-expected-to-surpass-saudi-arabia-in-2018-1516352405>.

⁴⁴⁴ To be clear, the fact that the risk of gasoline price shocks may now be lower than in the past is different from arguing that gasoline prices will never rise again at all. The Energy Information Administration tracks and reports on pump prices around the country, and we refer readers to their website for the most up-to-date information. EIA projects under its “reference case” assumptions that the structural changes in the oil market will keep prices below \$4/gallon through 2050. Prices will foreseeably continue to rise and fall with supply and demand changes; the relevant question for the need of the U.S. to conserve energy is not whether there will be any movement in prices but whether that movement is likely to be sudden and large.

case” projection.⁴⁴⁵ The International Energy Agency (IEA)’s Oil 2018 report suggests some concern that excessive focus on investing in U.S. shale oil production may increase price volatility after 2023 if investment is not applied more broadly but also states that U.S. shale oil is capable of and expected to respond quickly to rising prices in the future, and that American influence on global oil markets is expected to continue to rise.⁴⁴⁶ From the supply side, it is possible that the oil market conditions that created the price shocks in the 1970s may no longer exist.

Regardless of changes in the oil supply market, on the demand side, conditions are also significantly different from the 1970s. If gasoline prices increase suddenly and dramatically, in today’s market American consumers have more options for fuel-efficient new vehicles. Fuel-efficient vehicles were available to purchasers in the 1970s, but they were generally small entry-level vehicles with features that did not meet the needs and preferences of many consumers. Today, most U.S. households maintain a household vehicle fleet that serves a variety of purposes and represents a variety of fuel efficiency levels. Manufacturers have responded to fuel economy standards and to consumer demand over the last decade to offer a wide array of fuel-efficient vehicles in different segments and with a wide range of features. A household may now respond to short-term increases in fuel price by shifting vehicle miles traveled within their household fleet away from less-efficient vehicles and toward models with higher fuel economy. A similar option existed in the 1970s, though not as widely as today, and vehicle owners in 2018 do not have to sacrifice as much utility as owners did

in the 1970s when making fuel-efficiency trade-offs within their household fleets (or when replacing household vehicles at the time of purchase). On a longer-term basis, if oil prices rise, consumers have more options to invest in additional fuel economy when purchasing new vehicles than at any other time in history.

Global oil demand conditions are also different than in previous years. Countries that had very small markets for new light-duty vehicles in the 1970s are now driving global production as their economies improve and growing numbers of middle-class consumers are able to purchase vehicles for personal use. The global increase in drivers inevitably affects global oil demand, which affects oil prices. However, these changes generally occur gradually over time, unlike a disruption that causes a gasoline price shock. Market growth happens relatively gradually and is subject to many different factors. Oil supply markets likely have time to adjust to increases in demand from higher vehicle sales in countries like China and India, and in fact, those increases in demand may temper global prices by keeping production increasing more steadily than if demand was less certain; clear demand rewards increased production and encourages additional resource development over time. It therefore seems unlikely that growth in these vehicle markets could lead to gasoline price shocks. Moreover, even as these vehicle markets grow, it is possible that these and other vehicle markets may be moving away from petroleum usage under the direction of their governments.⁴⁴⁷ If this occurs, global oil production will fall in response to reduced global demand, but latent production capacity would exist to offset the impacts of unexpected supply interruptions and maintain a level of global production that is accessible to petroleum consumers. This, too, would seem likely to reduce the risk of gasoline price shocks.

Considering all of the above factors, if gasoline price shocks are no longer as much of a threat as they were when EPCA was originally passed, it seems reasonable to consider what the need of the United States to conserve oil is today and going forward. Looking to the discussion above on what factors are relevant to the need of the United States to conserve oil, one may conclude that the U.S. is no longer as dependent upon petroleum as the engine of economic

prosperity as it was when EPCA was passed. The national balance of payments considerations are likely drastically less important than they were in the 1970s, at least in terms of oil imports and vehicle fuel economy. Foreign policy considerations appear to have shifted along with the supply shifts also discussed above.

Whether and how environmental considerations create a need for CAFE standards is, perhaps, more complicated. As discussed earlier in this document, carbon dioxide is a direct byproduct of the combustion of carbon-based fuels in vehicle engines.⁴⁴⁸ Many argue that it is likely that human activities, especially emissions of greenhouse gases like carbon dioxide, contribute to the observed climate warming since the mid-20th century.⁴⁴⁹ Even taking that premise as given, it is reasonable to ask whether rapid ongoing increases in CAFE stringency (or even, for that matter, electric vehicle mandates) can sufficiently address climate change to merit their costs. To “conserve,” again, means “to avoid wasteful or destructive use of.”

Some commenters have argued essentially that any petroleum use is destructive because it all adds incrementally to climate change. They argue that as CAFE standards increase, petroleum use will decrease; therefore CAFE standard stringency should increase as rapidly as possible. Other commenters, recognizing that economic practicability is also relevant, have argued essentially that because more stringent CAFE standards produce less CO₂ emissions, NHTSA should simply set CAFE standards to increase at the most rapid of the alternative rates that NHTSA cannot prove is economically impracticable. The question here, again, is whether the *additional* fuel saved (and CO₂ emissions avoided) by more rapidly increasing CAFE standards better satisfies the U.S.’s need to avoid destructive or wasteful use of energy than more moderate approaches that more appropriately balance other statutory considerations.

In the context of climate change, NHTSA believes it is hard to say that increasing CAFE standards is necessary to avoid destructive or wasteful use of energy as compared to somewhat-less-rapidly-increasing CAFE standards. The most stringent of the regulatory

⁴⁴⁵ *Annual Energy Outlook 2018*, U.S. Energy Information Administration (Feb. 6, 2018) at 57, 58, available at <https://www.eia.gov/outlooks/aeo/pdf/AEO2018.pdf>. The U.S. Energy Information Administration (EIA) is the statistical and analytical agency within the U.S. Department of Energy (DOE). EIA is the nation’s premier source of energy information and every fuel economy rulemaking since 2002 (and every joint CAFE and CO₂ rulemaking since 2009) has applied fuel price projections from EIA’s *Annual Energy Outlook* (AEO). AEO projections, documentation, and underlying data and estimates are available at <https://www.eia.gov/outlooks/aeo/>.

⁴⁴⁶ See *Oil 2018: Analysis and Forecasts to 2023 Executive Summary*, International Energy Agency (2018), available at <http://www.iea.org/Textbase/npsum/oil2018MRSsum.pdf> (last visited June 25, 2018). See also Kent, S. & Puko, T. *U.S. Will Be the World’s Largest Oil Producer by 2023*, Says IEA, Wall Street Journal (Mar. 5, 2018), available at <https://www.wsj.com/articles/u-s-will-be-the-worlds-largest-oil-producer-by-2023-says-iea-1520236810> (reporting on remarks at the 2018 CERA Week energy conference by IEA Executive Director Fatih Birol).

⁴⁴⁷ Lynes, M. *Plug-in electric vehicles: future market conditions and adoption rates*, U.S. Energy Information Administration (Oct. 23, 2017), <https://www.eia.gov/outlooks/ieo/pev.php>.

⁴⁴⁸ Depending on the energy source, it may also be a byproduct of consumption of electricity by vehicles.

⁴⁴⁹ Climate Science Special Report: Fourth National Climate Assessment, Volume I (Wuebbles, D.J. et al., eds. 2017), available at <https://science2017.globalchange.gov/> (last accessed Feb. 23, 2018).

alternatives considered in the 2012 final rule and FRIA (under much more optimistic assumptions about technology effectiveness), which would have required a seven percent average annual fleetwide increase in fuel economy for MYs 2017–2025 compared to MY 2016 standards, was forecast to only decrease global temperatures in 2100 by 0.02 °C in 2100. Under NHTSA's current proposal, we anticipate that global temperatures would increase by 0.003 °C in 2100 compared to the aural standards. As reported in NHTSA's Draft EIS, compared to the average global mean surface temperature for 1986–2005, global surface temperatures are still forecast to increase by 3.484–3.487 °C, depending on the alternative. Because the impacts of any standards are small, and in fact several-orders-of-magnitude smaller, as compared to the overall forecast increases, this makes it hard for NHTSA to conclude that the climate change effects potentially attributable to the additional energy used, even over the full lifetimes of the vehicles in question, is “destructive or wasteful” enough that the “need of the U.S. to conserve energy” requires NHTSA to place an outsized emphasis on this consideration as opposed to others.⁴⁵⁰

Consumer costs are the remaining issue considered in the context of the need of the U.S. to conserve energy. NHTSA has argued in the past, somewhat paternalistically, that CAFE standards help to solve consumers' “myopia” about the value of fuel savings they could receive, when buying a new vehicle if they chose a more fuel-efficient model. There has been extensive debate over how much consumers do (and/or should) value fuel savings and fuel economy as an attribute in new vehicles, and that debate is addressed in Section II.E. For purposes of considering the need of the U.S. to conserve energy, the question of consumer costs may be closer to whether U.S. consumers *so need* to save money on fuel that they must be required to save substantially more fuel (through purchasing a new vehicle made more fuel-efficient by more stringent CAFE standards) than they would otherwise choose.

Again, when EPCA originally passed, Congress was trying to protect U.S. consumers from the negative effects of another gasoline price shock. It appears

much more likely today that oil prices will rise only moderately in the future and that price shocks are less likely. Accordingly, it is reasonable to believe that U.S. consumers value future fuel savings accurately and choose new vehicles based on that view. This is particularly true, since Federal law requires that new vehicles be posted with a window sticker providing estimated costs or savings over a five year period compared to average new vehicles.⁴⁵¹ Even if consumers do not explicitly think to themselves “this new car will save me \$5,000 in fuel costs over its lifetime compared to that other new car,” gradual and relatively predictable fuel price increases in the foreseeable future allow consumers to roughly estimate the comparative value of fuel savings among vehicles and choose the amount of fuel savings that they want, in light of the other vehicle attributes they value. It seems, then, that consumer cost as an element of the need of the U.S. to conserve energy is also less urgent in the context of the structural changes in oil markets over the last several years.

Given the discussion above, NHTSA tentatively concludes that the need of the U.S. to conserve energy may no longer function as assumed in previous considerations of what CAFE standards would be maximum feasible. The overall risks associated with the need of the U.S. to conserve oil have entered a new paradigm with the risks substantially lower today and projected into the future than when CAFE standards were first issued and in the recent past. The effectiveness of CAFE standards in reducing the demand for fuel combined with the increase in domestic oil production have contributed significantly to the current situation and outlook for the near- and mid-term future. The world has changed, and the need of the U.S. to conserve energy, at least in the context of the CAFE program, has also changed.

Of the other factors under 32902(g), the changes are perhaps less significant. We continue to believe that technological feasibility, *per se*, is not limiting during this rulemaking time frame. The technologies considered in this analysis either are already in commercial production or likely will be by MY 2021—some at great expense. Based on our analysis, all of the alternatives appear as though they could narrowly be considered *technologically* feasible, in that they could be achieved based on the existence or the projected future existence of technologies that could be incorporated on future

vehicles. Any of the alternatives could thus be achieved on a technical basis alone but only if the level of resources that might be required to implement the technologies is not considered. However, as discussed above, we no longer view the need of the U.S. to conserve energy as nearly infinite, which means that it no longer combines with boundless technological feasibility to quickly push stringency upward.

The effect of other motor vehicle standards of the Government on fuel economy is similarly not limiting during this rulemaking time frame. As discussed above, the analysis projects that safety standards will add some mass to new vehicles during this time frame and accounts for Tier 3 compliance in estimates of technology effectiveness, but neither of these things appear likely to make it significantly harder for industry to comply with more stringent CAFE standards. In terms of EPA's GHG standards, as also discussed above, NHTSA and EPA's coordination in this proposal should make the two sets of standards similarly binding, although differences in compliance provisions remain such that which standards are more binding will vary somewhat between manufacturers and over time.

The remaining factor to consider is economic practicability. NHTSA has typically defined economic practicability, as discussed above, as whether a given CAFE standard is “within the financial capability of the industry but not so stringent as” to lead to “adverse economic consequences, such as a significant loss of jobs or unreasonable elimination of consumer choice.” As part of that definition, NHTSA looks at a variety of elements that can lead to adverse economic consequences. All of the alternatives considered today arguably raise economic practicability issues. NHTSA believes there could be potential for unreasonable elimination of consumer choice, loss of U.S. jobs, and a number of adverse economic consequences under nearly all if not all of the regulatory alternatives considered today.

If a potential CAFE standard requires manufacturers to add technology to new vehicles that consumers do not want, or to skip adding technology to new vehicles that consumers do want, it would seem to present issues with elimination of consumer choice. Depending on the extent and expense of required fuel saving technology, that elimination of consumer choice could be unreasonable.

When deciding on which new vehicle to purchase, American consumers

⁴⁵⁰ The question of whether or how rapidly to increase CAFE stringency is different from the question of whether to set CAFE standards at all. *Massachusetts v. EPA*, 549 U.S. 497 (2007) (“Agencies, like legislatures, do not generally resolve massive problems in one fell regulatory swoop.”)

⁴⁵¹ 49 CFR 575.401; 40 CFR 600.302–12.

generally tend not to be interested in better fuel economy above other attributes, particularly when gasoline prices are low.⁴⁵² Manufacturers have repeatedly indicated to the agencies that new vehicle buyers are only willing to pay for fuel economy-improving technology if it pays back within the first two to three years of vehicle ownership.⁴⁵³ NHTSA has therefore incorporated this assumption (of willingness to pay for technology that pays back within 30 months) into today's analysis. As a result, NHTSA's analysis finds that the most cost-effective technology is applied with or without CAFE (or CO₂) standards, diminishing somewhat the incremental cost-effectiveness of new CAFE standards.

Consumers not being interested in better fuel economy can take two forms: First, it can dampen sales of vehicles with the additional technology required to meet the standards, and second, it

can increase sales of vehicles that do not help manufacturers meet the standards (such as vehicles that fall significantly short of their fuel economy targets, due to higher levels of performance (e.g., larger, less efficient engines) or other features). Over the last several years, despite record sales overall, most manufacturers have been managing their CAFE compliance obligations through use of credits,⁴⁵⁴ because many consumers have chosen to buy vehicles that do not improve manufacturers' compliance positions.

Consumer decisions to purchase relatively low-fuel economy vehicles might seem irrational if gasoline prices were expected to rebound in the future, but current indicators suggest this is not particularly likely. Although we know of no clear "tipping point" for gasoline prices at which American consumers suddenly become more interested in

fuel economy over other attributes, In addition, EIA's latest AEO 2018 suggests, based on current assumptions, that per-gallon prices are likely to stay under \$4 through 2050.⁴⁵⁵ It therefore seems unlikely that consumer preferences are going to change dramatically in the foreseeable future and certainly not within the time frame of the standards covered by this proposal.

Thus, if manufacturers are not currently able to sell higher-fuel economy vehicles without heavy subsidization, particularly HEVs, PHEVs, and EVs, it seems unlikely that their ability to do so will improve unless consumer preferences change or fuel prices rise significantly, either of which seem unlikely. Today's analysis indicates, perhaps predictably, that electrification rates must increase as stringency increases among the options the agencies are considering.

⁴⁵² See, e.g., Comment by Global Automakers, Docket ID NHTSA-2016-0068-0062 (citing a 2014 study by Strategic Vision that found that ". . . generally, customers as a whole place a higher priority on handling and ride than fuel economy.").

⁴⁵³ This is supported by the 2015 NAS study, which found that consumers seek to recoup added upfront purchasing costs within two or three years. See 2015 NAS Report, at pg. 317.

⁴⁵⁴ See CAFE Public Information Center, National Highway Traffic Safety Administration, https://one.nhtsa.gov/cafe_pic/CAFE_PIC_Mfr_LIVE.html (last visited June 25, 2018). Readers can examine achieved versus required fuel economy by model year and by individual manufacturer or by entire fleets. When a manufacturer's achieved fuel economy falls short of required fuel economy but the manufacturer has not paid civil penalties, the manufacturer is using credits somehow to make up the shortfall.

⁴⁵⁵ As noted elsewhere in this proposal, the agencies based analysis on AEO 2017 projections of, for instance, fuel prices, as it was the best available information at the time the analysis was conducted. As such, where possible, the agency incorporated latest AEO 2018 projections into the discussion, in effort to re-confirm no discernible impact to analysis results or to provide the best possible information for the discussion.

Table V-1 - Projected Levels of Electrification Technology Required on the Overall Passenger Car Fleet to Comply with CAFE Alternatives

	Alternative								
	No Action	1*	2*	3*	4*	5*	6*	7*	8*
Model Years	2017-2021	2021-2026	2021-2026	2021-2026	2021-2026	2022-2026	2021-2026	2021-2026	2022-2026
Annual Rate of Increase in Stringency 1	Augural Standards	0.0%/Year PC 0.0%/Year LT	0.5%/Year PC 0.5%/Year LT	0.5%/Year PC 0.5%/Year LT	1.0%/Year PC 2.0%/Year LT	1.0%/Year PC 2.0%/Year LT	2.0%/Year PC 3.0%/Year LT	2.0%/Year PC 3.0%/Year LT	2.0%/Year PC 3.0%/Year LT
AC/Off-Cycle Procedures	No Change	No Change	No Change	Phaseout 2022-2026	No Change	No Change	No Change	Phaseout 2022-2026	No Change
Mild Hybrid Electric Systems (48v)	20%	1%	1%	3%	1%	7%	8%	10%	8%
Strong Hybrid Electric Systems	24%	4%	4%	4%	4%	4%	6%	12%	7%
Sum of Strong Hybrid and Mild Hybrid	44%	4%	4%	6%	4%	10%	14%	22%	15%
Plug-In Hybrid Electric Vehicles (PHEVs)	1%	1%	1%	1%	1%	1%	1%	1%	1%
Dedicated Electric Vehicles (EVs)	1%	1%	1%	1%	1%	1%	1%	1%	1%
Sum of Plug-in Vehicles	2%	1%	1%	1%	1%	1%	1%	2%	2%
<i>Total of All Electrified Vehicles</i>	46%	6%	6%	8%	6%	12%	15%	24%	17%

Table V-3 - Projected Levels of Electrification Technology Required on the Overall Passenger Car Fleet to Comply with GHG Alternatives

	Alternative								
	No Action	1*	2*	3*	4*	5*	6*	7*	8*
Model Years	2017-2021	2021-2026	2021-2026	2021-2026	2021-2026	2022-2026	2021-2026	2021-2026	2022-2026
Annual Rate of Increase in Stringency 1	Augural Standards	0.0%/Year PC 0.0%/Year LT	0.5%/Year PC 0.5%/Year LT	0.5%/Year PC 0.5%/Year LT	1.0%/Year PC 2.0%/Year LT	1.0%/Year PC 2.0%/Year LT	2.0%/Year PC 3.0%/Year LT	2.0%/Year PC 3.0%/Year LT	2.0%/Year PC 3.0%/Year LT
AC/Off-Cycle Procedures	No Change	No Change	No Change	Phaseout 2022-2026	No Change	No Change	No Change	Phaseout 2022-2026	No Change
Mild Hybrid Electric Systems (48v)	20%	0%	0%	0%	1%	6%	7%	16%	9%
Strong Hybrid Electric Systems	24%	3%	3%	3%	3%	4%	6%	15%	11%
Sum of Strong Hybrid and Mild Hybrid	44%	3%	3%	3%	4%	10%	13%	30%	20%
Plug-In Hybrid Electric Vehicles (PHEVs)	2%	0%	0%	0%	0%	0%	0%	0%	0%
Dedicated Electric Vehicles (EVs)	1%	1%	1%	1%	1%	1%	1%	1%	1%
Sum of Plug-in Vehicles	3%	1%	1%	1%	1%	1%	1%	1%	1%
<i>Total of All Electrified Vehicles</i>	47%	4%	4%	4%	5%	11%	14%	31%	21%

Table V-2 - Projected Levels of Electrification Technology Required on the Overall Light Truck Fleet to Comply with CAFE Alternatives

	Alternative								
	No Action	1*	2*	3*	4*	5*	6*	7*	8*
Model Years	2017-2021	2021-2026	2021-2026	2021-2026	2021-2026	2022-2026	2021-2026	2021-2026	2022-2026
Annual Rate of Increase in Stringency 1	Augural Standards	0.0%/Year PC 0.0%/Year LT	0.5%/Year PC 0.5%/Year LT	0.5%/Year PC 0.5%/Year LT	1.0%/Year PC 2.0%/Year LT	1.0%/Year PC 2.0%/Year LT	2.0%/Year PC 3.0%/Year LT	2.0%/Year PC 3.0%/Year LT	2.0%/Year PC 3.0%/Year LT
AC/Off-Cycle Procedures	No Change	No Change	No Change	Phaseout 2022-2026	No Change	No Change	No Change	Phaseout 2022-2026	No Change
Mild Hybrid Electric Systems (48v)	46%	0%	0%	2%	5%	20%	35%	55%	55%
Strong Hybrid Electric Systems	24%	1%	1%	1%	1%	1%	2%	13%	6%
Sum of Strong Hybrid and Mild Hybrid	69%	1%	1%	3%	6%	21%	37%	68%	62%
Plug-In Hybrid Electric Vehicles (PHEVs)	1%	0%	0%	0%	0%	0%	0%	0%	0%
Dedicated Electric Vehicles (EVs)	0%	0%	0%	0%	0%	0%	0%	0%	0%
Sum of Plug-in Vehicles	1%	1%	1%	1%	1%	1%	1%	1%	1%
<i>Total of All Electrified Vehicles</i>	70%	1%	1%	3%	7%	21%	37%	69%	62%

Table V-4 - Projected Levels of Electrification Technology Required on the Overall Light Truck Fleet to Comply with GHG Alternatives

	Alternative								
	No Action	1*	2*	3*	4*	5*	6*	7*	8*
Model Years	2017-2021	2021-2026	2021-2026	2021-2026	2021-2026	2022-2026	2021-2026	2021-2026	2022-2026
Annual Rate of Increase in Stringency 1	Augural Standards	0.0%/Year PC 0.0%/Year LT	0.5%/Year PC 0.5%/Year LT	0.5%/Year PC 0.5%/Year LT	1.0%/Year PC 2.0%/Year LT	1.0%/Year PC 2.0%/Year LT	2.0%/Year PC 3.0%/Year LT	2.0%/Year PC 3.0%/Year LT	2.0%/Year PC 3.0%/Year LT
AC/Off-Cycle Procedures	No Change	No Change	No Change	Phaseout 2022-2026	No Change	No Change	No Change	Phaseout 2022-2026	No Change
Mild Hybrid Electric Systems (48v)	56%	3%	4%	8%	10%	22%	27%	47%	45%
Strong Hybrid Electric Systems	17%	1%	1%	1%	2%	3%	4%	9%	5%
Sum of Strong Hybrid and Mild Hybrid	73%	4%	4%	9%	12%	26%	31%	56%	51%
Plug-In Hybrid Electric Vehicles (PHEVs)	0%	0%	0%	0%	0%	0%	0%	0%	0%
Dedicated Electric Vehicles (EVs)	1%	0%	0%	0%	0%	0%	0%	1%	0%
Sum of Plug-in Vehicles	1%	0%	0%	0%	0%	0%	0%	1%	0%
<i>Total of All Electrified Vehicles</i>	74%	4%	5%	9%	13%	26%	32%	57%	51%

Manufacturers have commented to the agencies that “Although automakers are offering more of these models every year, with improved technology and

options, sales of these vehicles are not growing,” noting that even for hybrid

vehicles, which require no adaptation by consumers (for example, to range limits or refueling by charging), sales “have declined from a peak of a 3.1 percent share of the market (in 2013) to . . . 1.8 percent [in 2016].”⁴⁵⁶ The same source further stated that this decline was despite the technology being available in the market for more than 15 years, and that in 2016, “close to 75 percent of the people who have traded in a hybrid or electric car to a dealer have replaced it with a conventional (non-hybrid) gasoline-powered car.”⁴⁵⁷ While some consumers continue to seek out hybrid and electric vehicles, then, many other consumers seem uninterested in them, even given the generous incentives and subsidies often available for consumers in the form of tax credits, government rebates, High Occupancy Vehicle Lane access, preferred and/or subsidized parking, among others. Despite this broad ongoing lack of consumer interest, a number of manufacturers nonetheless continue to increase their offerings of these vehicles. At best, this trend seems economically inefficient; more concerning for economic practicability, it seems likely to impact consumer choice (as discussed further below) in ways that could weigh heavily on sales, jobs, and consumers themselves. We seek comment on this issue.

If the evidence indicates that hybrid sales are declining as gasoline prices remain low, it seems reasonable to conclude that consumers will not choose to buy more of them going forward as gasoline prices are forecast to remain low. This is consistent with the analysis discussed in Section II.E, that even while some consumers may be willing to pay between \$2,000 and \$3,000 more for vehicles with electrified technologies, that incremental willingness-to-pay falls well short of the

additional costs projected for HEVs, PHEVs, and EVs. This trend may well extend beyond electrification technologies to other technologies. When costs for fuel economy-improving technology exceed the fuel savings, consumers may very well be unwilling to pay the full cost for vehicles with higher fuel economy that would be increasingly needed as to comply as the stringency of the alternatives increases.

If consumers are not willing to pay the full cost for vehicles with higher fuel economy, it seems reasonably foreseeable that they will consider vehicles made more expensive by higher CAFE standards to be not “available” to them to purchase—or put more simply, that they will be turned off by more expensive vehicles with technologies they do not want, and seek instead to purchase cheaper vehicles without that technology (or with different technologies, such as those that improve performance or safety). Manufacturers have long cross-subsidized vehicle models in their lineups in order to recoup costs in cases where they do not believe they can pass the full costs of development and production forward as price increases for the vehicle model in question. Given that this cross-subsidization is ongoing, however, and possibly deepening as manufacturers have had to meet increasingly stringent CAFE standards over the past several years, it is unclear how much additional distribution of costs could be supported by the market. Certainly, if CAFE standards continue to increase in stringency as gasoline prices stay relatively low and consumer willingness to pay for significant additional fuel economy improvements remains correspondingly low, then additional cross-subsidization of products to try to ease those products into consumer acceptance seems likely to impair consumer choice, insofar as the vehicles they want to buy will cost more and may have technology for which they are unwilling to pay. Models that have historically been able to bear higher percentages of the cross-subsidization burden may not be able to bear much more—a pickup truck buyer, for example, may eventually decide to purchase a used vehicle, another type of

vehicle, or a pickup made by a different manufacturer rather than pay the extra cost that the manufacturer is trying to recoup from higher-fuel economy vehicles that had to be artificially discounted to be sold. We seek comment on the effect of fuel economy standards on cross-subsidization across models.

Moreover, assuming that manufacturers try to pass the costs of those technologies on to consumers in the form of higher new vehicle prices, rather than absorbing them and hurting profitability, this can affect consumers’ ability to afford new vehicles. The analysis assumes that the increased cost of meeting standards is passed on to consumers through higher new vehicle prices, and looks at those increases as a one-time payment. In the context of, for example, a \$30,000 new vehicle, another \$2,000 may not seem significant to some readers. Yet manufacturers and dealers have repeatedly commented to NHTSA that the overall price of the vehicle is less relevant to the majority of consumers than the monthly payment amount, which is a significant factor in consumers’ ability to purchase or lease a new vehicle. Amortizing a \$2,000 price increase over, for example, 48 months may also not seem like a large amount to some readers, even accounting for interest payments. Yet the corresponding up-front and monthly costs may pose a challenge to low-income or credit-challenged purchasers. As discussed previously, such increased costs will price many consumers out of the market—leaving them to continue driving an older, less safe, less efficient, and more polluting vehicle, or purchasing another used vehicle that would likewise be less safe, less efficient, and more polluting than an equivalent new vehicle.

For example, the average MY 2025 prices estimated here under the baseline and proposed CAFE standards are about \$34,800 and \$32,750, respectively (and \$34,500 and \$32,550 under the baseline and proposed GHG standards). The buyer of a new MY 2025 vehicle might thus avoid the following purchase and first-year ownership costs under the proposed standards:

⁴⁵⁶ Comment by Global Automakers, Docket ID NHTSA–2016–0068–0062, citing IHS Global New Vehicle Registration Data for 2013, 2015, and January–June 2016.

⁴⁵⁷ *Id.* at B–6 and B–7, citing Matt Richtel, *American Drivers Regain Appetite for Gas Guzzlers*, *New York Times* (June 24, 2016), <https://www.nytimes.com/2016/06/28/science/cars-gas-global-warming.html>.

Table V-5 - Example Calculation of Transactional Costs Associated with New Vehicle Purchases under Baseline and Proposed Standards

	Due at Purchase			Monthly		
	Standards		Savings	Standards		
	Baseline	Proposed		Baseline	Proposed	Savings
Down Payment ⁴⁵⁸	\$4,056	\$4,056				
Taxes & Fees ⁴⁵⁹	\$1,900	\$1,791	\$109			
Loan Payments ⁴⁶⁰				\$698	\$652	\$46
Collision & Comp. (1 st Year) ⁴⁶¹				\$53	\$50	\$3
Total	\$5,956	\$5,847	\$109	\$751	\$702	\$49

While the buyer of the average vehicle would also purchase somewhat more fuel under the proposed standards, this difference might average only five gallons per month during the first year of ownership.⁴⁶² Some purchasers may consider it more important to avoid these very certain (*e.g.*, being reflected in signed contracts) cost savings than the comparatively uncertain (because, *e.g.*, some owners drive considerably less than others, and may purchase fuel in small increments as needed) fuel savings. For some low-income purchasers or credit-challenged purchasers, the cost savings may make the difference between being able or not to purchase the desired vehicle. As vehicles get more expensive in response to higher CAFE standards, it will get

more and more difficult for manufacturers and dealers to continue creating loan terms that both keep monthly payments low and do not result in consumers still owing significant amounts of money on the vehicle by the time they can be expected to be ready for a new vehicle.

Over the last decade, as vehicle sales have rebounded in the wake of the recession, historically low interest rates and increases in the average duration of financing terms have helped manufacturers and dealers keep consumers' monthly payments low. These trends (low interest rates and longer loan periods), along with pent-up demand for new vehicles, have helped keep vehicle sales high. As interest rates have increased, and most predict will continue to rise, monthly payments will

foreseeably increase, and the ability to offset such increases by extending finance terms to account for increased finance charges and vehicle prices due to CAFE standards is limited by the fact that doing so increases the amount of time before consumers will have positive equity in their vehicles (and able to trade in the vehicle for a newer model). This reduces the mechanisms that manufacturers, captive finance companies, dealers, and independent lenders have in order to maintain sales at comparable levels. In other words, if vehicle sales have not already hit the breaking point, they may be close.⁴⁶³ The agencies seek comment on the impact that increased prices, interest rates, and financing terms are likely to have on the new vehicle market.

⁴⁵⁸ Using down payment assumption of \$4,056. See Press Release, Edmunds, New Vehicle Prices Climb to All-Time High in December (Jan. 3, 2018), <https://www.edmunds.com/about/press/new-vehicle-prices-climb-to-all-time-high-in-december.html>.

⁴⁵⁹ Using average rate of 5.46% (discussed above in Section II.E).

⁴⁶⁰ Using average rate of 4.25% (discussed above in Section II.E).

⁴⁶¹ Using average rate of 1.83% (discussed above in Section II.E).

⁴⁶² Based on estimated sales volumes and average fuel consumption discussed below in Section VI, and on average vehicle survival and mileage accumulation rates (discussed above in Section II.E) indicating that the average vehicle delivers about 11% of its lifetime service (*i.e.*, distance driven) during the first year of operation.

⁴⁶³ See, *e.g.*, Comment by Global Automakers, Docket ID NHTSA-2016-0068-0062, at 10

("Current sales are a poor predictor of future sales. Many of the macroeconomic factors that have contributed to the current boom may not exist six to nine years into the future [*i.e.*, during the mid-2020s]. The low interest loans and extended time loans that are now readily available may not be available then. The automotive industry is a cyclical business, and it appears to be near the top of a cycle now.")

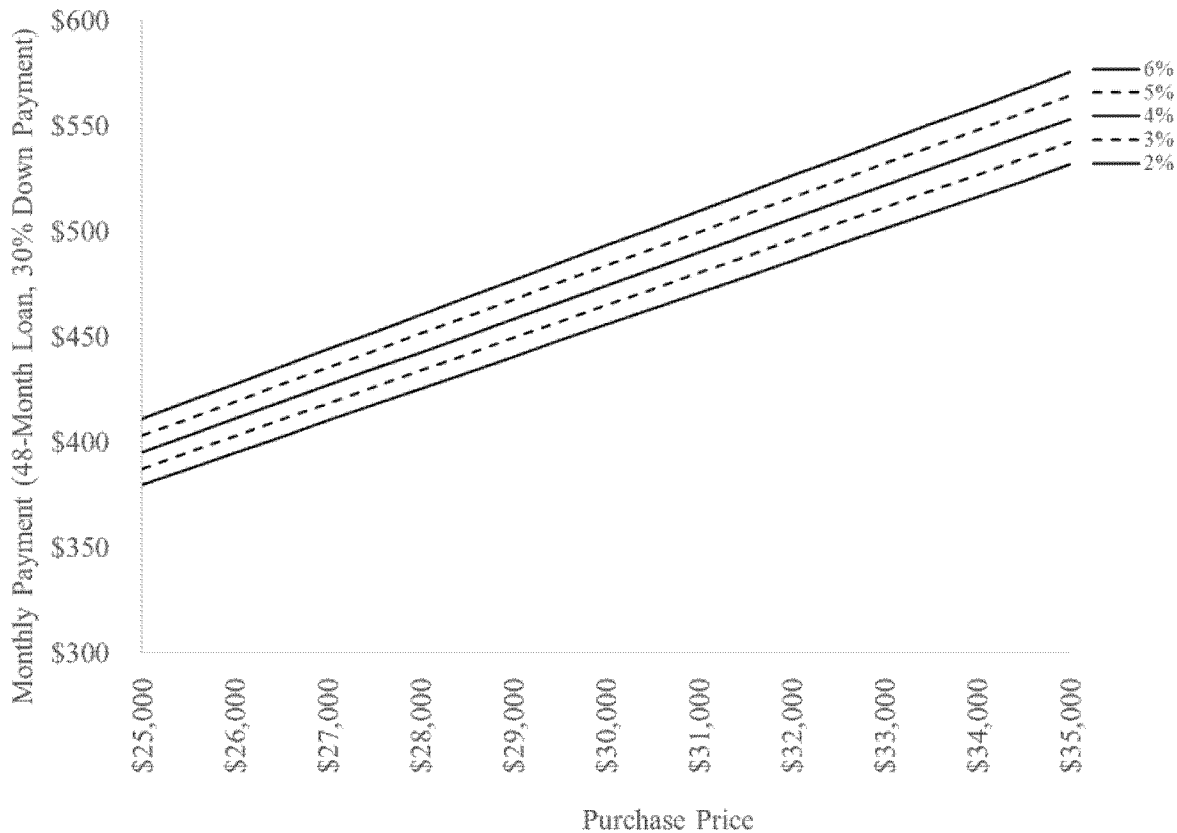

Figure V-1 – Monthly Payment, Interest Rate, and Purchase Price Trends

The increasing risk that manufacturers and dealers will hit a wall in their ability to keep monthly payments low may fall disproportionately on new and low-income buyers. To build on the discussion above, manufacturers often purposely cross-subsidize the prices of entry-level vehicles to keep monthly payments low and attract new and young consumers to their brand. Higher CAFE standard stringency leads to higher costs for technology across manufacturers’ fleets, meaning that more and more cross-subsidization becomes necessary to maintain affordability for entry-level vehicle purchasers. While this is clearly an economic issue for industry, it may also slow fleet-wide improvement in vehicle characteristics like safety—both in terms of manufacturers having to divert resources to adding technology to vehicles that consumers do not want and then figuring out how to get consumers to buy them and in terms of new vehicles potentially becoming unaffordable for certain groups of consumers, meaning that they must either defer new vehicle purchases or

turn to the used vehicle market, where levels of safety may not be comparable. We seek comment on these considerations.

Alternatively, rather than or in addition to continuing to cross-subsidize fuel economy improvements that consumers are unwilling to pay for directly, manufacturers may choose to try to improve their compliance position under higher CAFE standards by restricting sales of certain vehicle models or options. If consumers tend to want the 6-cylinder engine version of a vehicle rather than the 4-cylinder version, for example, the manufacturer may choose to make fewer 6-cylinders available. This solution, if chosen, would directly impact consumer choice. It seems increasingly likely that this solution could be chosen as CAFE stringency increases.

In terms of risks to employment, today’s analysis focuses on employment as a function of estimated changes in vehicle price in response to different levels of standards and assumes that all cost increases to vehicle models are passed forward to consumers in the form of price increases for that vehicle

model. As Section VII.C on today’s sales and employment analysis indicates, the sales function of the CAFE model appears fairly accurate at predicting sales trends but does not presume that sales are particularly responsive to changes in vehicle price. We are concerned, however, that the sales model as it currently functions may miss two key points about potential future sales and employment effects.

First, the analysis does not account for the risk discussed above that manufacturers and dealers may not be able to continue keeping monthly new vehicle payments low, for a variety of reasons. Interest rates and inflation may rise; further lengthening loan terms may not be practical as they increase the period of time that the purchaser has negative equity (which has secondary impacts described above). While these may be not-entirely-negative things for the economy as a whole, they would create negative pressure on vehicle sales or employment associated with those sales.

Second, as the cost of compliance increases with CAFE stringency, it is possible that manufacturers may shift

production overseas to locations where labor is cheaper. The CAFE program contains no mandates with regard to where vehicles are manufactured and arguably disincentivizes domestic production of passenger cars through the minimum domestic passenger car standard. If it becomes substantially more expensive for manufacturers to meet their CAFE obligations, they may seek to cut costs wherever they can, which could include layoffs or changing production locations.

There may be other adverse economic consequences besides those discussed above. If manufacturers seek to avoid

losing sales by absorbing the additional costs of meeting higher CAFE standards, it is foreseeable that absorbing those costs would hurt company profits. If manufacturers choose that approach year after year to avoid losing market share, continued falling profits would lead to negative earnings reports and risks to companies' long-term viability. Thus, even if sales levels are maintained despite higher standards, it seems possible that industry could face adverse economic consequences.

More broadly, when gasoline prices stay relatively low (as they are expected to remain through the lifetime of nearly

all vehicles covered by the rulemaking time frame), higher stringency standards are increasingly less cost-beneficial. As shown and discussed in Section VII.C, the analysis of consumer impacts shows that consumers recoup only a portion of the costs associated with increasing stringency under all of the alternatives. The fuel savings resulting from each of the alternatives is substantially less than the costs associated with the alternative, meaning that net savings for consumers improves as stringency decreases. Figure V-2 below illustrates this trend.⁴⁶⁴

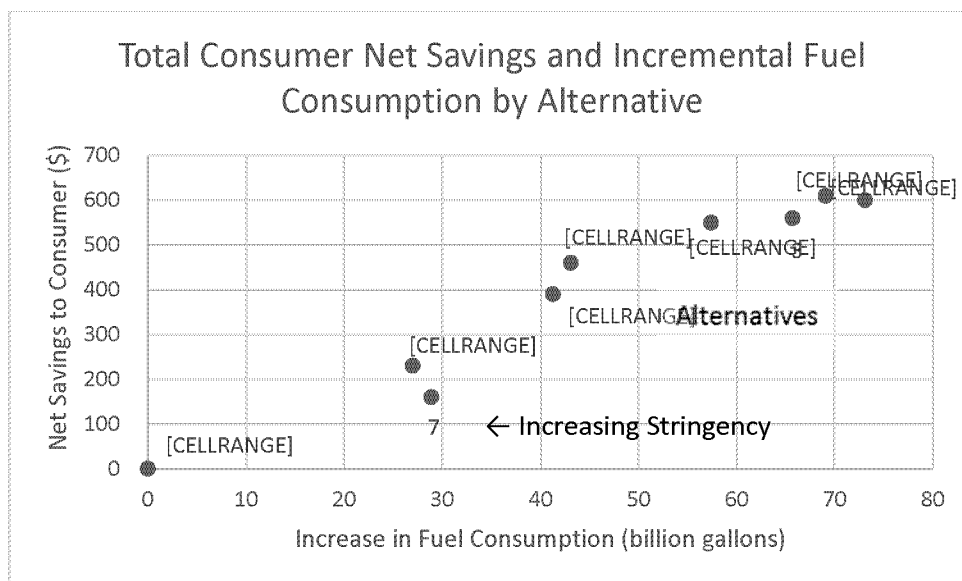

Figure V-2 - Total Consumer Net Savings and Incremental Fuel Consumption by Alternative

We recognize that this is a significantly different analytical result from the 2012 final rule, which showed the opposite trend. Using the projections available to the agencies for the 2012 rulemaking, all of the alternatives considered in that rulemaking were projected to have net savings to consumers and to society overall, and those net savings improved as stringency increased. Put simply, the result is different today from what it was in 2012 because the facts and the analysis are also different. While the differences in the facts and the analysis are described extensively in Section II above and in the PRIA accompanying this proposal, a few noteworthy ones include:

- In 2012, we assumed in the main analysis that manufacturers would add no more technology than needed for compliance, while today's analysis assumes logically that manufacturers will add technologies that pay for themselves within 2.5 years, consistent with manufacturer information on payback period.
- In 2012, we measured impacts of the post-2017 standards relative to compliance with pre-2017 standards, which meant that a lot of cost-effective technology attributable to the 2017–2020 standards was “counted” toward the 2025 standards.
- In 2012, we used analysis fleets based on 2008 or 2010 technology. Today's analysis uses a 2016-based analysis fleet.

These three points above mean that, overall, the current analysis fleet reflects the application of much additional technology than the 2012-final-rule

analysis fleet reflected. When technology is used by the analysis fleet, it is “unavailable” to be used again for compliance with future standards because the same technology cannot be used twice (once by a manufacturer for its own reasons and then again by the model to simulate manufacturer responses to higher standards). Some of this would happen necessarily in an updated rulemaking because a later-in-time analysis fleet inevitably includes more technology; in this particular case, 2016 happened to be a somewhat technology-heavy year, and 2008 and 2010 (the fleets used in 2012) arguably did not reflect the state of technology in 2012 well.

Furthermore, readers should note the following changes:

⁴⁶⁴ For the reader's reference, Alternatives 3 and 7 phase out A/C and off-cycle procedures, while the other alternatives leave those procedures

unchanged. Phasing out these procedures increases compliance costs and reduces net savings relative

to leaving the procedures unchanged, net savings to consumer with seven percent discount rate.

- Estimates of effectiveness and cost are different for a number of technologies, as discussed in Section II above and in Chapter 6 of the PRIA, and indirect costs are determined using the RPE rather than the ICM;

- Fuel prices forecasts are considerably lower in AEO 2017 than they were in AEO 2012;
- The current analysis uses a rebound effect value of 20% instead of 10%;
- The current analysis newly accounts for price impacts on fleet turnover;
- The social cost of carbon is different and accounts only for domestic (not international) impacts;
- The current analysis does not attempt to purposely limit the appearance of potential safety effects, and the value of a statistical life is higher than in 2012.

All of these changes, together, mean that the standards under any of the regulatory alternatives (compared to the preferred alternative) are more expensive and have lower benefits than if they had been calculated using the inputs and assumptions of the 2012 analysis. This, in turn, helps lead the agency to a different conclusion about what standards might be maximum feasible in the model years covered by the rulemaking. NHTSA has thus both relied on new facts and circumstances in developing today's proposal and reasonably rejected prior facts and analyses relied on in the 2012 final rule.⁴⁶⁵

By directing NHTSA to determine maximum feasible standards by considering the four factors, Congress recognized that "maximum feasible" may change over time as the agency assessed the relative importance of each factor.⁴⁶⁶ If one factor appears to be more important than the others in the time frame to be covered by the standards, it makes sense to give it more weight in the agency's determination of maximum feasible standards for those model years. If no factor appears to be particularly paramount, it makes sense to determine maximum feasible standards by more generally weighing each factor, as long as EPCA's direction to establish maximum feasible standards continues to be fulfilled in a manner that does not undermine energy conservation.

NHTSA tentatively concludes that proposing CAFE standards that hold the MY 2020 curves for passenger cars and light trucks constant through MY 2026 would be the maximum feasible standards for those fleets and would

fulfill EPCA's overarching purpose of energy conservation in light of the facts before the agency today and as we expect them to be in the rulemaking time frame. In the 2012 final rule that established CAFE standards for MYs 2017–2021, and presented augural CAFE standards for MYs 2022–2025, NHTSA stated that "maximum feasible standards would be represented by the mpg levels that we could require of the industry before we reach a tipping point that presents risk of significantly adverse economic consequences."⁴⁶⁷ However, the context of that rulemaking was meaningfully different from the current context. At that time, NHTSA understood the need of the U.S. to conserve energy as necessarily pushing the agency toward setting stricter and stricter standards. Combining a then-paramount need of the U.S. to conserve energy with the perception that technological feasibility should no longer be seen as an important limiting factor, NHTSA then concluded that only significant economic harm would be a basis for controlling the pace at which CAFE stringency increased over time.

Today, the relative importance of the need of the U.S. to conserve energy has changed when compared to the beginning of the CAFE program and a great deal even since the 2012 rulemaking. As discussed above, the effectiveness of CAFE standards in reducing the demand for fuel combined with the increase in domestic oil production have contributed significantly to the current situation and outlook for the near- and mid-term future. The world has changed, and the need of the U.S. to conserve energy may no longer disproportionately outweigh other statutorily-mandated considerations such as economic practicability—even when considering fuel savings from potentially more-stringent standards.

Thus, while more stringent standards may be possible, insofar as production-ready technology exists that the industry could physically employ to reach higher standards, it is not clear that higher standards are now economically practicable in light of current U.S. consumer needs to conserve energy. While vehicles can be built with advanced fuel economy-improving technology, this does not mean that consumers will buy the new vehicles that might be required to include such technology; that industry could continue to subsidize their production and sale; or that adverse economic consequences would not result from doing so. The effect of other

motor vehicle standards of the Government is minimal when the two agencies regulating the same aspects of vehicle performance are working together to develop those regulations. Therefore, NHTSA views the determination of maximum feasible standards as a question of the appropriateness of standards given that their need—either from the societal-benefits perspective in terms of risk associated with gasoline price shocks or other related catastrophes, or from the private-benefits perspective in terms of consumer willingness to purchase new vehicles with expensive technologies that may allow them to save money on future fuel purchases—seems likely to remain low for the foreseeable future.

When determining the maximum feasible standards, and in particular the economic practicability of higher standards, we also note that the proposed standards have the most positive effect on on-road safety as compared to the alternatives considered. The analysis indicates that, compared to the baseline standards defining the No-Action alternative, any regulatory alternatives under consideration would improve overall highway safety. Some of this estimated reduction is attributable to vehicles, themselves, being generally safer if they do not apply as much mass reduction to passenger cars as might be applied under the baseline standards. Additionally, the analysis estimates that the alternatives to the baseline standards would cause the fleet to turn over to newer and safer vehicles, which will also be more fuel efficient than the vehicles being replaced, more quickly than otherwise anticipated. Furthermore, the analysis estimates that the alternatives to the baseline standard would involve reduced overall demand for highway travel. As discussed above in Section II.F, and in Chapter 11 of the accompanying PRIA, most of the estimated overall improvement in highway safety from this proposal is attributable to reduced travel demand (attributable to the rebound effect) and accelerated turnover to safer vehicles. The trend in these results is clear, with the less stringent alternatives producing the greatest estimated improvement in highway safety and the proposed standards producing the most favorable outcomes from a highway safety perspective. These considerations bolster our determination that the proposed standards are maximum feasible based upon current and projected technology for the model years in question.

Standards that retain the MY 2020 curves through MY 2026 will save fuel

⁴⁶⁵ See *Fox v. FCC*, 556 U.S. at 514–515; see also *NAHB v. EPA*, 682 F.3d 1032 (D.C. Cir. 2012).

⁴⁶⁶ If this were not accurate, it seems illogical that Congress would have, at various times, set specific mpg goals for the CAFE program (e.g., 35 mpg by 2020).

⁴⁶⁷ 77 FR 62624, 63039 (Oct. 15, 2012).

beyond what the market would achieve on its own for vehicles manufactured during the rulemaking time frame and will result in the highest net benefits both for consumers and for society. Such standards would avoid the risks identified in the discussion of economic practicability for more stringent standards and are consistent with the relatively lower need of the United States to conserve energy and the impact that has on consumer choice. Moreover, as the fuel economy of the new vehicle fleet improves over time, the marginal benefits of continued improvements diminish, making the consumer willingness to bear them and the economic practicability of them diminish. It is much more expensive, and saves much less fuel, for a vehicle to improve from 40 to 50 mpg, than for a vehicle to improve from 15 to 20 mpg.⁴⁶⁸ If obtaining the marginal benefits of new cars and their fuel economy technologies becomes too expensive for consumers, some consumers will choose to drive less efficient used vehicles longer.

NHTSA recognizes that the Ninth Circuit has previously held that NHTSA must consider whether a “backstop” is necessary for the CAFE standards based on the EPCA factors in 49 U.S.C. 32902(f), given that the overarching purpose of EPCA is energy conservation.⁴⁶⁹ NHTSA and EPA discussed the concept of backstops in the context of the modern CAFE program (as opposed to the CAFE program at issue in the Ninth Circuit decision) in the 2010 final rule establishing CAFE and GHG standards for MYs 2012–2016. In that document, the agencies explained that even if the statute did not preclude a backstop beyond what was already provided for in the minimum domestic passenger car

⁴⁶⁸ As the base level of fuel economy improves, there are fewer gallons to be saved from improving further. A typical assumption is that vehicles are driven 15,000 miles per year. A vehicle that improves from 30 mpg to 40 mpg reduces its annual fuel consumption from 500 gallons/year to 375 gallons/year at 15,000 miles/year or by 125 gallons. A vehicle that improves from 15 mpg to 20 mpg, on the other hand, reduces its annual fuel consumption from 1,000 gallons/year to 750 gallons/year—twice as much as the first example, even though the mpg improvement is only half as large. Going from 40 to 50 mpg would save only 75 gallons/year at 15,000 miles/year. If fuel prices are high, the value of those gallons may be sufficient to offset the cost of improving further, but (1) EIA does not currently anticipate particularly high fuel prices in the foreseeable future, and (2) as the baseline level of fuel economy continues to increase, the marginal cost of the next gallon saved similarly increases with the cost of the technologies required to meet the savings.

⁴⁶⁹ *CBD v. NHTSA*, 508 F.3d 508, 537 (9th Cir. 2007), opinion vacated and superseded on denial of reh’g, 538 F.3d 1172 (9th Cir. 2008).

CAFE standard and in the “flat” portions of the footprint curves at the larger-footprint end, designing an appropriate backstop was likely to be fairly complex and likely to undermine Congress’ objective in requiring attribute-based standards. See, particularly, 75 FR at 25369–70 (May 7, 2010).

As in 2010, NHTSA believes that additional backstop standards are not necessary. The current proposal is based on the agency’s best current understanding of the need of the U.S. to conserve energy now and going forward, in light of changed circumstances and balanced against the other EPCA factors. We seek comment on how an additional backstop standard might be constructed that addresses the concerns raised in the 2010 final rule and that also does not obviate the agency’s assessment of what CAFE levels would be maximum feasible.

We seek comment on all aspects of the above discussion.

B. EPA’s Statutory Obligations and Why the Proposed Standards Appear To Be Appropriate and Reasonable

1. Basis for the CO₂ Standards Under Section 202(a) of the Clean Air Act

Title II of the Clean Air Act (CAA) provides for comprehensive regulation of mobile sources, authorizing EPA to regulate emissions of air pollutants from all mobile source categories. Under Section 202(a)⁴⁷⁰ and relevant case law, as discussed below, EPA considers such issues as technology effectiveness, its cost (both per vehicle, per manufacturer, and per consumer), the lead time necessary to implement the technology, and based on this the feasibility and practicability of potential standards; the impacts of potential standards on emissions reductions of both GHGs and non-GHGs; the impacts of standards on oil conservation and energy security; the impacts of standards on fuel savings by consumers; the impacts of standards on the auto industry; other energy impacts; as well as other relevant factors such as impacts on safety.

This proposed rule would implement a specific provision from Title II, section 202(a).⁴⁷¹ Section 202(a)(1) of the Clean Air Act (CAA) states that “the Administrator shall by regulation prescribe (and from time to time revise) . . . standards applicable to the emission of any air pollutant from any class or classes of new motor vehicles . . . , which in his judgment cause, or contribute to, air pollution which may

reasonably be anticipated to endanger public health or welfare.” If EPA makes the appropriate endangerment and cause or contribute findings, then section 202(a) authorizes EPA to issue standards applicable to emissions of those pollutants. Indeed, EPA’s obligation to do so is mandatory: *Coalition for Responsible Regulation*, 684 F.3d at 114; *Massachusetts v. EPA*, 549 U.S. at 533. Moreover, EPA’s mandatory legal duty to promulgate these emission standards derives from “a statutory obligation wholly independent of DOT’s mandate to promote energy efficiency.” *Massachusetts*, 549 U.S. at 532. Consequently, EPA has no discretion to decline to issue greenhouse standards under section 202(a) or to defer issuing such standards due to NHTSA’s regulatory authority to establish fuel economy standards. Rather, “[j]ust as EPA lacks authority to refuse to regulate on the grounds of NHTSA’s regulatory authority, EPA cannot defer regulation on that basis.” *Coalition for Responsible Regulation*, 684 F.3d at 127.

Any standards under CAA section 202(a)(1) “shall be applicable to such vehicles . . . for their useful life.” Emission standards set by the EPA under CAA section 202(a)(1) are technology-based, as the levels chosen must be premised on a finding of technological feasibility. Thus, standards promulgated under CAA section 202(a) are to take effect only after providing “such period as the Administrator finds necessary to permit the development and application of the requisite technology, giving appropriate consideration to the cost of compliance within such period” (CAA section 202(a)(2); see also *NRDC v. EPA*, 655 F.2d 318, 322 (D.C. Cir. 1981)). EPA must consider costs to those entities which are directly subject to the standards. *Motor & Equipment Mfrs. Ass’n Inc. v. EPA*, 627 F.2d 1095, 1118 (D.C. Cir. 1979). Thus, “the [s]ection 202(a)(2) reference to compliance costs encompasses only the cost to the motor-vehicle industry to come into compliance with the new emission standards.” *Coalition for Responsible Regulation*, 684 F.3d at 128; see also *id.* at 126–27 (rejecting arguments that EPA was required to consider or should have considered costs to other entities, such as stationary sources, which are not directly subject to the emission standards). EPA is afforded considerable discretion under section 202(a) when assessing issues of technical feasibility and availability of lead time to implement new technology. Such determinations are “subject to the

⁴⁷⁰ 42 U.S.C. 7521(a).

⁴⁷¹ 42 U.S.C. 7521(a).

restraints of reasonableness,” which “does not open the door to ‘crystal ball’ inquiry.” *NRDC*, 655 F. 2d at 328 (quoting *International Harvester Co. v. Ruckelshaus*, 478 F. 2d 615, 629 (D.C. Cir. 1973)). In developing such technology-based standards, EPA has the discretion to consider different standards for appropriate groupings of vehicles (“class or classes of new motor vehicles”), or a single standard for a larger grouping of motor vehicles (*NRDC*, 655 F. 2d at 338). Finally, with respect to regulation of vehicular greenhouse gas emissions, EPA is not “required to treat NHTSA’s . . . regulations as establishing the baseline for the [section 202(a) standards].” *Coalition for Responsible Regulation*, 684 F.3d at 127 (noting further that “the [section 202 (a)standards] provid[e] benefits above and beyond those resulting from NHTSA’s fuel-economy standards”).

Although standards under CAA section 202(a)(1) are technology-based, they are not based exclusively on technological capability. EPA has the discretion to consider and weigh various factors along with technological feasibility, such as the cost of compliance (see section 202(a)(2)), lead time necessary for compliance (section 202(a)(2)), safety (see *NRDC*, 655 F.2d at 336 n. 31) and other impacts on consumers,⁴⁷² and energy impacts associated with use of the technology (see *George E. Warren Corp. v. EPA*, 159 F.3d 616, 623–624 (D.C. Cir. 1998) (ordinarily permissible for EPA to consider factors not specifically enumerated in the Act)).

In addition, EPA has clear authority to set standards under CAA section 202(a) that are technology forcing when EPA considers that to be appropriate but is not required to do so (as compared to standards set under provisions such as section 202(a)(3) and section 213(a)(3)). EPA has interpreted a similar statutory provision, CAA section 231, as follows:

While the statutory language of section 231 is not identical to other provisions in title II of the CAA that direct EPA to establish technology-based standards for various types of engines, EPA interprets its authority under section 231 to be somewhat similar to those provisions that require us to identify a reasonable balance of specified emissions reduction, cost, safety, noise, and other factors. See, e.g., *Husqvarna AB v. EPA*, 254

F.3d 195 (D.C. Cir. 2001) (upholding EPA’s promulgation of technology-based standards for small non-road engines under section 213(a)(3) of the CAA). However, EPA is not compelled under section 231 to obtain the “greatest degree of emission reduction achievable” as per sections 213 and 202 of the CAA, and so EPA does not interpret the Act as requiring the agency to give subordinate status to factors such as cost, safety, and noise in determining what standards are reasonable for aircraft engines. Rather, EPA has greater flexibility under section 231 in determining what standard is most reasonable for aircraft engines, and is not required to achieve a “technology forcing” result.⁴⁷³

This interpretation was upheld as reasonable in *NACAA v. EPA* (489 F.3d 1221, 1230 (D.C. Cir. 2007)). CAA section 202(a) does not specify the degree of weight to apply to each factor, and EPA accordingly has discretion in choosing an appropriate balance among factors. See *Sierra Club v. EPA*, 325 F.3d 374, 378 (D.C. Cir. 2003) (even where a provision is technology-forcing, the provision “does not resolve how the Administrator should weigh all [the statutory] factors in the process of finding the ‘greatest emission reduction achievable’ ”); see also *Husqvarna AB v. EPA*, 254 F. 3d 195, 200 (D.C. Cir. 2001) (great discretion to balance statutory factors in considering level of technology-based standard, and statutory requirement “[to give] appropriate consideration to the cost of applying . . . technology” does not mandate a specific method of cost analysis); *Hercules Inc. v. EPA*, 598 F. 2d 91, 106–07 (D.C. Cir. 1978) (“In reviewing a numerical standard, we must ask whether the agency’s numbers are within a ‘zone of reasonableness,’ not whether its numbers are precisely right”); *Permian Basin Area Rate Cases*, 390 U.S. 747, 797 (1968) (same); *Federal Power Commission v. Conway Corp.*, 426 U.S. 271, 278 (1976) (same); *Exxon Mobil Gas Marketing Co. v. FERC*, 297 F. 3d 1071, 1084 (D.C. Cir. 2002) (same).

As noted above, EPA has found that the elevated concentrations of greenhouse gases in the atmosphere may reasonably be anticipated to endanger public health and welfare.⁴⁷⁴ EPA defined the “air pollution” referred to in CAA section 202(a) to be the combined mix of six long-lived and directly emitted GHGs: Carbon dioxide (CO₂), methane (CH₄), nitrous oxide (N₂O), hydrofluorocarbons (HFCs), perfluorocarbons (PFCs), and sulfur hexafluoride (SF₆). The EPA further found under CAA section 202(a) that emissions of the single air pollutant

defined as the aggregate group of these same six greenhouse gases from new motor vehicles and new motor vehicle engines contribute to air pollution. As a result of these findings, section 202(a) requires EPA to issue standards applicable to emissions of that air pollutant. New motor vehicles and engines emit CO₂, CH₄, N₂O, and HFC. EPA has established standards and other provisions that control emissions of CO₂, HFCs, N₂O, and CH₄. EPA has not set any standards for PFCs or SF₆ as they are not emitted by motor vehicles.

2. EPA’s Tentative Conclusion That the Proposed CO₂ Standards Are Appropriate and Reasonable

In this section, EPA discusses the factors, data and analysis the Administrator has considered in the selection of the EPA’s proposed revised GHG emission standards for MYs 2021 and later. EPA requests comment on all aspects of the proposed revised standards, including all Alternatives discussed in this section and section IV of this preamble.

As discussed in Sections I and V.B of this preamble, the primary purpose of Title II of the Clean Air Act is the protection of public health and welfare. EPA’s light-duty vehicle GHG standards serve this purpose, as the GHG emissions from light-duty vehicles have been found by EPA to endanger public health and welfare (see EPA’s 2009 Endangerment Finding for on-highway motor vehicles), and the goal of these standards is to reduce these emissions that contribute to climate change.

CAA section 202(a)(2) states when setting emission standards for new motor vehicles, the standards “shall take effect after such period as the Administrator finds necessary to permit the development and application of the requisite technology, giving appropriate consideration to the cost of compliance within such period.” 42 U.S.C. 7521(a)(2). That is, when establishing emissions standards, the Administrator must consider both the lead time necessary for the development of technology which can be used to achieve the emissions standards and the resulting costs of compliance on those entities that are directly subject to the standards.

The Administrator is not limited to consideration of the factors specified in CAA section 202(a)(2) when establishing standards for light-duty vehicles. In addition to feasibility and cost of compliance, the Administrator may (and historically has) considered such factors as safety, energy use and security, degree of reduction of both GHG and non-GHG pollutants,

⁴⁷² Since its earliest Title II regulations, EPA has considered the safety of pollution control technologies. See 45 FR 14496, 14503 (March 5, 1980). (“EPA would not require a particulate control technology that was known to involve serious safety problems. If during the development of the trap-oxidizer safety problems are discovered, EPA would reconsider the control requirements implemented by this rulemaking.”)

⁴⁷³ 70 FR 69664, 69676 (Nov. 17, 2005).

⁴⁷⁴ 74 FR 66496 (Dec. 15, 2009).

technology cost-effectiveness, and costs and other impacts on consumers. As discussed in prior rulemakings setting GHG standards,⁴⁷⁵ EPA may establish technology-forcing standards under section 202(a), but when it does so it must provide sufficient basis for its belief that the industry can develop the needed technology in the available time. However, EPA is not *required* to set technology-forcing standards under section 202(a). Rather, because section 202(a), unlike the text of section 202(a)(3) and section 213(a)(3),⁴⁷⁶ does not specify that standards shall obtain “the greatest degree of emission reduction achievable,” EPA retains considerable discretion under section 202(a) in deciding how to weigh the various factors, consistent with the language and purpose of the Clean Air Act, to determine what standards are appropriate.

The analysis of alternatives supports the Administrator’s consideration of a range of alternative standards, from the existing standards to several alternatives that are less stringent. Specifically, the analysis supports the consideration of this range of alternative standards due to factors relevant under the EPA’s authority pursuant to section 202(a), such as GHG emissions reductions, the necessary technology and associated lead-time, the costs of compliance on automakers, the impact on consumers with respect to cost and vehicle choice, and effects on safety. These factors, and the Administrator’s proposed conclusion, after consideration of these factors, indicate that Alternative 1 represents the most appropriate standards for model years 2021 and beyond are discussed further below.

(a) Consideration of the Development and Application of Technology To Reduce CO₂ Emissions

When EPA establishes emissions standards under section 202, it considers both what technologies are currently available and what technologies under development may become available. For today’s proposal, EPA takes note of the analysis of the potential penetration into the future

vehicle fleet of a wide range of technologies that both reduce CO₂ and improve fuel economy (see PRIA Chapter 6). The majority of these technologies have already been developed, have been commercialized, and are in-use on vehicles today. These technologies include, but are not limited to, engine and transmission technologies, vehicle mass reduction technologies, technologies to reduce the vehicles’ aerodynamic drag, and a range of electrification technologies. The electrification technologies include 12-Volt stop-start systems, 48-Volt mild hybrids, strong hybrid systems, plug-in hybrid electric vehicles, and dedicated electric vehicles.

If the Administrator’s consideration of the appropriateness of the standards were based solely on an assessment of technology availability and development, the Administrator might consider a wide range of standards to be appropriate. As shown in Sections VII.B.2 and VIII.B.1.b), and in PRIA Chapter 6.3.2, the projected penetration of technologies varies across the Alternatives presented in today’s proposal. In general, the existing EPA standards are projected to result in the highest penetration of advanced technologies, in particular mild hybrid and strong hybrid technologies. Lower stringency Alternatives in general are projected to result in lower penetration of technologies, in particular for the mild hybrid and strong hybrid technologies, with the Preferred Alternative projected to result in the lowest level of electrification technology penetration. For example, the existing CO₂ standards are projected to require a combined passenger car and truck fleet penetration of mild hybrids plus strong hybrids of 58% of new vehicle sales in MY 2030, while Alternative 8 projects a 34% penetration, Alternative 6 projects a 22% penetration, Alternative 4 projects an 8% penetration, and the Proposed Alternative (Alternative 1) projects a 4% penetration. These technologies are available and in production today, and MY 2020 through MY 2025 standards are still a number of years away. In light of the wide range of existing technologies that have already been developed, have been commercialized, and are in-use on vehicles today, including those developed since the 2012 rule, technology availability, development and application, if it were considered in isolation, is not necessarily a limiting factor in the Administrator’s selection of which standards are appropriate within the range of the Alternatives presented in this proposal. However, as described

below, the Administrator weighs technology availability along with several other factors, including costs, emissions impacts, safety, and consumer impacts in determining the appropriate standards under the Clean Air Act.

(b) Consideration of the Cost of Compliance

EPA is required to consider costs in compliance before setting standards under section 202(a). Compared to the proposed standards, the EPA MY 2020–2025 standards announced in 2012 would cost the automotive industry an estimated total of \$260 billion for the vehicles produced from MY 2016 through MY 2029, as shown in Table VIII–9. The additional per-vehicle technology costs for these previously-issued standards would be an estimated \$2,260 in MY 2030, relative to the proposed standards, as shown in Table VIII–31 and Table VIII–32. Especially considering the change in reference point, these costs are considerably larger than EPA projected in 2012. Less stringent standards would be less burdensome. For example, compared to the proposed standards, Alternative 8 is projected to increase the per-vehicle cost by \$1,510 (also in MY 2030), Alternative 6 increases the per-vehicle costs by \$1,120, and Alternative 4 increases the per-vehicle costs by \$490.

(c) Consideration of Costs to Consumers

In addition to the costs to the automotive industry described above, which could be passed on to consumers, the analysis estimates increased costs for the consumer for changes in maintenance, financing, insurance, taxes, and other fees, as shown in Table VIII–31 and Table VIII–32. Considering these additional costs, EPA’s previously-issued standards for MYs 2020–2025 would increase the projected per-vehicle costs in MY 2030 to an estimated \$2,810 relative to the proposed standards, at a seven percent discount rate. The lower the increased stringency of the Alternative, the lower the total per-vehicle costs increase for the consumer. For example, Alternative 8 increases the total costs for the consumer on a per-vehicle basis by \$2,270 (in MY 2030 compared to the costs of the proposed standards), Alternative 6 increases the costs to the consumer by \$1,400 per-vehicle, and Alternative 4 increases the costs by \$610 per-vehicle, all at a seven percent discount rate.

The analysis also projects the fuel savings for the vehicle owner over the life of the vehicles that come with lower levels of CO₂ emissions. For example, as

⁴⁷⁵ See, e.g., 77 FR 62624, 62673 (Oct. 15, 2012).

⁴⁷⁶ Section 202(a)(3) provides that regulations applicable to emissions of certain specified pollutants from heavy-duty vehicles or engines “shall contain standards which reflect the greatest degree of emission reduction achievable through the application of technology which the Administrator determines will be available . . . giving appropriate consideration to cost, energy, and safety factors associated with the application of such technology.” 42 U.S.C. 7521(a)(3). Section 213(a)(3) contains a similar provision for new nonroad engines and new nonroad vehicles (other than locomotives or engines used in locomotives). 42 U.S.C. 7547(a)(3).

shown in Table VIII–32 (at a seven percent discount rate), for the previously-announced EPA standards for MYs 2021–2025 (in MY 2030 compared to the costs of the proposed standards), the analysis projects a per-vehicle life-time fuel savings, including retail taxes, of \$1,510 per vehicle, as well as an additional savings to the consumer from rebound driving and time saved refueling the vehicle of \$610 per vehicle, for a total savings of \$2,120. However, these savings to the consumer are not enough to offset the accompanying projected \$2,810 increase in consumer costs. Compared to the proposed standards, the previously-issued EPA standards for MYs 2021–2025 would increase net costs to consumers by \$690 over the lifetime of the MY 2030 vehicles. This imbalance between costs and fuel savings contrasts sharply with what EPA projected in 2012 when setting those standards then, and the fuel savings is considerably smaller (this is due in large part to lower current and projected fuel prices). Also, relative to the proposed standards, and over the lifetime of MY 2030 vehicles, the projected net cost increase to consumers from adopting Alternative 8 is \$300, Alternative 6 projects a net cost increase to consumers of \$100, Alternative 4 projects a net savings to consumers of \$60, and Alternative 2 projects a net savings to consumers of \$10.

(d) Consideration of GHG Emissions

As discussed above, the purpose of CO₂ standards established under CAA Section 202 is to reduce GHG emissions, which contribute to climate change. As shown in Table VIII–34, the analysis projects that, compared to the baseline standards, the proposed CO₂ standards for MYs 2021–2026 would increase vehicle CO₂ emissions by 713 million metric tons (MMT) over the lifetime of the vehicles produced from MY 1979 through MY 2029, with an additional 159 MMT in CO₂ reduction from upstream sources for a total increase of 872 MMT. The modeling of proposed revised and alternative standards projects that more stringent standards will result in smaller increases in GHG emissions (also compared to the baseline standards. Compared to the baseline standards, Alternative 8 is projected to increase CO₂ emissions by 264 MMT from combined vehicle tailpipe and upstream reductions over the lifetime of the vehicles produced through MY 2029. Alternative 6 is projected to increase CO₂ emissions by 422 MMT, Alternative 4 by 649 MMT of CO₂, and Alternative 2 by 825 MMT of

CO₂.⁴⁷⁷ As noted above, the purpose of Title II emissions standards is to protect the public health and welfare, and in establishing emissions standards the Administrator is cognizant of the importance of this goal. At the same time, as discussed above, unlike other provisions in Title II, Section 202(a) does not require the Administrator to set standards which result in the greatest degree of emissions control achievable, though the Administrator has the discretion to do so. Thus, in setting these standards, the Administrator takes into consideration other factors discussed above and below, including not only technological feasibility, lead-time, and the cost of compliance but also potential impacts of vehicle emission standards on safety and other impacts on consumers. Notwithstanding the fact that GHG emissions reductions would be lower under today's proposal than for the existing EPA standards, in light of the new assessment indicating higher vehicle costs and associated impacts on consumers, and safety impacts, the Administrator believes from a cost/benefit perspective that the foregone GHG emission reduction benefits from the proposed standards are warranted.

(e) Consideration of Consumer Choice

As discussed previously, the EPA CO₂ standards are based on vehicle footprint, and in general smaller footprint vehicles have individual CO₂ targets that are lower (more stringent) than larger footprint vehicles. The passenger car fleet has footprint curves that are distinct from the light-truck fleet. One of the goals EPA had in designing the program with footprint-based standards, in considering the shape, slope, and stringency of the footprint standard curves, and in adopting many compliance flexibilities (*e.g.*, the

⁴⁷⁷ This preamble and the PRIA document estimates annual GHG emissions from light-duty vehicles under the baseline CO₂ standards, the proposed standards, and the standards defined by each of the other regulatory alternatives under consideration. For the final rule issued in 2012, EPA estimated changes in atmospheric CO₂, global temperature, and sea level rise using GCAM and MAGICC with outputs from its OMEGA model. Because the agencies are now using the same model and inputs, outputs from NHTSA's DEIS (that also used GCAM and MAGICC) were analyzed. Today's analysis estimates that annual GHG emissions from light-duty vehicles under the CO₂ standards defined by each regulatory alternative would be within about one percent of emissions under the corresponding CAFE standards. Especially considering the uncertainties involved in estimating future climate impacts, the very similar estimates of future GHG emissions under CO₂ standards and corresponding CAFE standards means that climate impacts presented in NHTSA's draft EIS represent well the potential climate impacts of the proposed and alternative CO₂ standards.

emissions averaging, banking, and trading program; air-conditioning program credits; flexibility in how to comply with the N₂O and methane standard; off-cycle credit program, etc.) was to maintain consumer choice. The EPA standards are designed to require reductions of CO₂ emissions over time from the vehicle fleet as a whole but also to provide sufficient flexibility to the automotive manufacturers so that firms can produce vehicles which serve the needs of their customers. EPA believes the past several model years in the market place show the benefits of this approach. Automotive companies have been able to reduce their fleet-wide CO₂ emissions while continuing to produce and sell the many diverse products that serve the needs of consumers in the market, *e.g.*, full-size pick-up trucks with high towing capabilities, minivans, cross-over vehicles, SUVs, and passenger cars; vehicles with off-road capabilities; luxury/premium vehicles, supercars, performance vehicles, entry level vehicles, etc.

At the same, the Administrator recognizes that automotive customers are a diverse group, that automotive companies do not all compete for the same segments of the market, and that increasing stringency in the standards can be expected to have different effects not just on certain vehicle segments but on certain manufacturers who have developed market strategies around those vehicle segments. The Administrator further recognizes that the diversity of the automotive customer base, combined with the analysis, raises concerns that the existing standards, if they are not adjusted, may not continue to fulfill the agency's goal of providing sufficient manufacturer flexibility to meet consumer needs and consumer choice preferences. The analysis projects that high penetrations of hybridized vehicles would be required to achieve the previously-issued EPA MYs 2021–2025 standards, specifically 37% mild hybrid penetration and 21% strong hybrids for the new vehicle fleet in MY 2030 (See Table VIII–24). For the passenger car fleet, the projection is 20% mild hybrid and 24% strong hybrid, and for the light-truck fleet 56% mild hybrid and 17% strong hybrid (See Table VIII–26 and Table VIII–28).

The Administrator is concerned that this projected level of hybridization, and the associated vehicle costs, arising from the existing standards may be too high from a consumer-choice perspective. While consumers have benefited from improvements over several decades in traditional vehicle technologies, such as advancements in

transmissions and internal combustion engines, advanced electrification technologies are a departure from what consumers have traditionally purchased. Strong hybrid and other advanced electrification technologies have been available for many years (20 years for strong hybrids and eight years for plug-in and all electric vehicles), and sales levels have been relatively low, on the order of two to three percent per year for strong hybrids.⁴⁷⁸ As discussed above, the analysis projects that the 2012 EPA standards are projected to require a significant increase in hybridization over the next 7 to 12 model years. This large increase may require automotive companies to change the choice of vehicle types and the utility of the vehicles available to customers from what the companies would otherwise offer in the absence of the existing standards.

EPA notes that in the EPA's annual Manufacturer Performance Report on the compliance status of the automotive companies for the EPA GHG standards, EPA has reported that emissions trading has occurred a number of times in the past several years.⁴⁷⁹ Through MY 2016, these trades have included 12 firms, with five firms trading CO₂ credits to seven firms, and thus far in the EPA GHG program credits generated in MY 2010 through MY 2016 have been traded. This represents about one-half of the automotive companies selling vehicles in the U.S. market, but since several of these firms are small players, it is less than half of the volume. In total, approximately 30 million Megagrams of CO₂ have been traded between firms, which is approximately 10% of the MY 2016 industry-wide bank of credits. Credit trading between firms can lower the costs of compliance for firms, both for those selling and those purchasing credits, and this program compliance flexibility is another tool by which auto firms can provide the types of vehicle offerings that customers want. However, long-term planning is an important consideration for automakers, and an OEM who may want to purchase credits as part of a future compliance strategy cannot be guaranteed they will be able to find credits.

⁴⁷⁸ *Light-Duty Automotive Technology, Carbon Dioxide Emissions, and Fuel Economy Trends: 1975 Through 2017*, U.S. EPA Table 5.1 (Jan. 2018), available at <https://nepis.epa.gov/Exe/ZyPDF.cgi?Dockey=P100TGDW.pdf>.

⁴⁷⁹ See *Greenhouse Gas Emission Standards for Light-Duty Vehicles: Manufacturer Performance Report for the 2016 Model Year (EPA Report 420-R18-002)*, U.S. EPA (Jan. 2018), available at <https://nepis.epa.gov/Exe/ZyPDF.cgi?Dockey=P100TGIA.pdf>.

The automotive industry is highly competitive, and firms may be reluctant to base their future product strategy on an uncertain future credit availability. As can be seen in Table VIII–24, the analysis projects that lower levels of stringency (Alternatives 1–8) will require lower penetrations of mild hybrids and strong hybrids as compared to the 2012 EPA standards. For example, Alternative 8 projects a 34% penetration of mild and strong hybrid new vehicle sales in MY 2030, Alternative 6 projects a 22% penetration of these technologies, Alternative 4 projects an eight percent penetration, and Alternative 2 projects a four percent penetration of mild and strong hybrids in MY 2030. The EPA proposal, Alternative 1, projects a two percent penetration of mild hybrids and a two percent penetration of strong hybrids. These are levels similar to what auto manufacturers are selling today, suggesting that auto companies will be able to produce vehicles in the future that meet the full range of needs from consumers, thus preserving consumer choice.

(f) Consideration of Safety

EPA has long considered the effects on safety of its emission standards. See 45 FR 14496, 14503 (1980) (“EPA would not require a particulate control technology that was known to involve serious safety problems.”). More recently, EPA has considered the potential impacts of emissions standards on safety in past rulemakings on GHG standards, including the 2010 rule which established the 2012–2016 light-duty vehicle GHG standards, and the 2012 rule which previously established the 2017–2025 light-duty vehicle GHG standards. Indeed, section 202(a)(4)(A) specifically prohibits the use of an emission control device, system or element of design that will cause or contribute to an unreasonable risk to public health, welfare, or safety. 42 U.S.C. 7521(a)(4)(A).

The proposal's safety analysis projects that the 2012 EPA GHG standards for MYs 2021 and later would increase vehicle fatalities due to several reasons, namely increased vehicle prices resulting in delayed turnover of the vehicle fleet to newer, safer vehicles, increased fatalities and accidents due the rebound effect, and passenger car mass reduction. The assessment is discussed in Section 0 of this preamble and is detailed in Chapter 11 of the PRIA. The assessment projects that Alternative 1, which includes no change in the GHG emissions standards for MY 2021 and later, would yield the lowest number of vehicle fatalities. The analysis projects that, compared to the

proposed standards, the previously-issued EPA standards would increase highway fatalities by 15,680 over the lifetime of vehicles produced through MY 2029 (See Table VII–89).

EPA views the potential impacts of emission standards on safety as an important consideration in determining the appropriate standards under section 202. The analysis projects adverse impacts on safety that are significantly different from the analysis included and considered in the 2012 rule which established the MY 2021–25 GHG standards and the 2016 Draft Technical Assessment Report. As discussed previously in this document, previous analyses limited the amount of mass reduction assumed for certain vehicles, while acknowledging that manufacturers would not necessarily choose to avoid mass reductions in the ways that the agencies assumed. The current analysis eliminates this constraint. The Administrator considers this difference to be a significant factor indicating that it is appropriate to consider a range of alternative revised standards, including Alternative 1, the preferred alternative.

(g) Balancing of Factors and EPA's Proposed Revised Standards for MY 2021 and Later

As discussed in this section, the Administrator is required to consider a number of factors when establishing emission standards under Section 202(a)(2) of the Clean Air Act: The standards “shall take effect after such period as the Administrator finds necessary to permit the development and application of the requisite technology, giving appropriate consideration to the cost of compliance within such period.” 42 U.S.C. 7521(a)(2). For this proposal, the Administrator has considered a wide range of potential emission standards (Alternatives 1 through 9), ranging from the existing EPA MY 2021 to MY 2025 standards, through a number of less stringent alternatives, including Alternative 1, the preferred Alternative. In addition to technological feasibility, lead-time, and the costs of compliance, the Administrator has also considered the impact of various standards on projected emissions reductions, consumer choice, and vehicle safety. The Administrator believes the existing EPA standards for MY 2021 and later, considered as a whole, are too stringent. The Administrator gives particular consideration to the high projected costs of the standards and the impact of the standards on vehicle safety. The analysis projects that, compared to the proposed standards, the previously-

issued EPA standards for MYs 2021–2025 would increase MY 2030 compliance costs by nearly \$1,900 per vehicle. Although EPA projected a similar cost⁴⁸⁰ increase in the 2012 rule announcing standards through 2025, this prior estimate was relative to an indefinite continuation of standards for MY 2016, and assuming that absent regulation, manufacturers would not increase fuel economy at all. In addition, as mentioned above, the analysis projects that, compared to the proposed standards, the previously-issued EPA standards would increase highway fatalities by 12,903 over the lifetime of vehicles produced through MY 2029. In evaluating the other Alternatives under consideration, the Administrator notes that Alternative 1 has the lowest cost of compliance and the lowest number of fatalities. He also notes that Alternative 1 will preserve consumer choice in the vehicle market and will provide a relatively high net savings to consumers, when assessing the increased costs of vehicles against fuel savings over the lifetime of the vehicle.

The Administrator recognizes that Alternative 1 is projected to result in less CO₂ reductions compared to the existing EPA standards and is not projected to achieve additional GHG reductions beyond the MY 2020 standards. However, the Administrator notes that, unlike other provisions in Title II referenced above, section 202(a) does not require the Administrator to set standards which result in the “greatest degree of emissions control achievable.” In light of this statutory discretion and the range of factors that the statute authorizes and permits the Administrator to consider, and his consideration of the factors discussed above, the EPA proposes to conclude that maintaining the MY 2020 standards going forward is an appropriate approach under section 202(a). Therefore, based on the data and analysis detailed in this proposal, the Administrator is proposing that the existing MY 2021 and later GHG standards are too stringent and is proposing to revise the MY 2021 and later standards to maintain the MY 2020 levels in subsequent model years. EPA requests comment on all aspects of this proposal and supporting assessments, including the Administrator’s consideration of the relevant factors under section 202(a) of the Clean Air Act, the proposed Alternative 1, the previously-established EPA GHG standards, and all of the Alternatives discussed in section IV of this preamble.

⁴⁸⁰ 77 FR 62624, 62665 (Oct. 15, 2012).

VI. Preemption of State and Local Laws

Accomplishing the goals of EPCA requires a set of uniform national fuel economy standards. Achieving this national standard requires the agencies to clearly discuss the extent to which state and local standards are expressly or impliedly preempted. As described herein, doing so is fundamental to the effectiveness of the new proposed set of fuel economy standards and to the critical importance of ensuring that the proposed Federal standards will constitute uniform national requirements, as Congress intended. This is also a fundamental reason that EPA is proposing the withdrawal of CAA preemption waivers granted to California relating to its GHG standards and Zero Emissions Vehicle (ZEV) mandate.

A. Preemption Under the Energy Policy and Conservation Act

1. History of EPCA Preemption Discussions in Rulemakings

NHTSA has asserted the preemption of certain State emissions standards under EPCA a number of times in CAFE rulemakings dating back to 2002.⁴⁸¹ The initial rulemaking discussion was prompted by a court filing by the State of California claiming that NHTSA did not treat California’s Greenhouse Gas Emissions regulation as preempted.⁴⁸² This continuous dialogue involves a variety of parties (*i.e.*, the states, the Federal government—especially EPA—and the general public) and occurs through a variety of means, including several rulemaking proceedings. After NHTSA first raised the issue of preemption in 2002 when proposing standards for MYs 2005–2007 light trucks, the agency explored preemption at great length in response to extensive public comment in its August 2005 NPRM and its April 2006 final rule for MYs 2008–2011 light trucks.

During the period between the NPRM and the final rule for MYs 2008–2011 light trucks, California separately requested that the EPA grant a waiver of CAA preemption, pursuant to Section 209 of that act, for its Greenhouse Gas Emissions regulation. If EPA granted the waiver, the CAA would under certain circumstances allow other states to adopt the same regulation pursuant to CAA Section 177, without being preempted by the CAA.

In 2007, the Supreme Court ruled in *Massachusetts v. EPA* that carbon

⁴⁸¹ 67 FR 77025 (December 16, 2002).

⁴⁸² See Appellants Opening Brief filed on behalf Michael P. Kenny in *Central Valley Chrysler-Plymouth, Inc. et al. v. Michael P. Kenny*, No. 02–16395, at p. 33 (9th Cir. 2002).

dioxide is an “air pollutant” within the meaning of the CAA and thus potentially subject to regulation under that statute. The Supreme Court did not consider the issue of preemption under EPCA of state laws or regulations regulating CO₂ tailpipe emissions from automobiles, but it did address the relationship between EPA and NHTSA rulemaking obligations.⁴⁸³ Later that year, two Federal district courts in Vermont and California ruled that the GHG motor vehicle emission standards adopted by those states were not preempted under EPCA.⁴⁸⁴ Still later that year, Congress enacted EISA, amending EPCA by mandating annual increases in passenger car and light truck CAFE standards through MY 2020 and maximum feasible fuel economy standards subsequently.⁴⁸⁵

In March 2008, EPA denied California’s request for a waiver of CAA preemption.⁴⁸⁶ In May 2008, NHTSA issued a proposal for MYs 2011–2015 standards, which included a significant discussion of EPCA preemption and a proposed regulatory statement to provide that state vehicle tailpipe CO₂ standards are related to fuel economy and therefore expressly preempted under EPCA, and that they conflict with the goals and objectives of EPCA and therefore also impliedly preempted.⁴⁸⁷ The Bush Administration did not issue a final rule for MYs 2011–2015.

A number of significant actions happened in quick succession at the beginning of the prior Administration. The first day post-inauguration, CARB petitioned for reconsideration of EPA’s denial of a waiver of CAA preemption for California’s GHG emissions standards for 2009 and later model year vehicles.⁴⁸⁸ Several days later, on January 26, 2009, President Obama issued a memorandum requesting, among other things (including

⁴⁸³ The Court reasoned that the fact that NHTSA “sets mileage standards in no way licenses EPA to shirk its environmental responsibilities. EPA has been charged with protecting the public’s ‘health’ and ‘welfare,’ . . . a statutory obligation wholly independent of DOT’s mandate to promote energy efficiency. . . . The two obligations may overlap, but there is no reason to think the two agencies cannot both administer their obligations and yet avoid inconsistency.” *Massachusetts v. EPA*, 549 U.S. 497, 532 (2007).

⁴⁸⁴ *Green Mountain Chrysler v. Crombie*, 508 F.Supp.2d 295 (D. Vt. 2007); *Central Valley Chrysler-Jeep, Inc. v. Goldstene*, 529 F.Supp.2d 1151 (E.D. Cal. 2007), *as corrected* (Mar. 26, 2008).

⁴⁸⁵ Public Law 110–140 (2007).

⁴⁸⁶ 73 FR 12156 (Mar. 6, 2008).

⁴⁸⁷ 73 FR 24352 (May 2, 2008).

⁴⁸⁸ For background on CARB’s petition, see EPA’s Notice of Decision Granting a Waiver of Clean Air Act Preemption for California’s 2009 and Subsequent Model Year Greenhouse Gas Emission Standards for New Motor Vehicles, 74 FR 32744 (Jul. 8, 2009).

consideration of EPCA preemption in light of *Massachusetts v. EPA* and other laws), that NHTSA's rulemaking be divided into two parts—one regulation establishing standards for model year 2011 only, and another for subsequent years. Less than two months after that memorandum, on March 6, 2009, NHTSA issued its final rule for MY 2011 vehicles and announced that it would consider EPCA preemption in subsequent rulemakings.⁴⁸⁹ Then, on May 19, 2009, the White House announced a coordinated program addressing motor vehicle fuel economy and greenhouse gas emissions, to be known as the “National Program,” whereby NHTSA and EPA would jointly establish rules to harmonize compliance requirements for manufacturers. As part of the National Program, several manufacturers and their trade associations announced their commitment to take several actions, including agreeing not to contest forthcoming CAFE and GHG standards for MYs 2012–2016; not to challenge any grant of a CAA preemption waiver for California's GHG standards for certain model years; and to stay and then dismiss all pending litigation challenging California's regulation of GHG emissions, including litigation concerning EPCA preemption of state GHG standards.⁴⁹⁰

Less than two months later, in July 2009, EPA granted California's January 2009 request for reconsideration of the CAA preemption waiver denial, allowing California to establish its own GHG standards under the CAA.⁴⁹¹ In granting the preemption waiver, EPA acknowledged that its analysis was based solely on CAA considerations and did not “attempt to interpret or apply EPCA,” concluding that “EPA takes no position regarding whether or not California's GHG standards are preempted under EPCA.”⁴⁹²

In the subsequent MYs 2012–2016 CAFE rulemaking, NHTSA elected to defer consideration of EPCA preemption concerns because of the “consistent and coordinated Federal standards that apply nationally under the National Program.”⁴⁹³ Later, in establishing MYs 2017–2021 CAFE standards, NHTSA pointed out that after finalization of the MYs 2012–2016 CAFE standards, California amended its GHG regulations to provide that manufacturers could elect to comply with the EPA GHG

requirements and be deemed to comply with California's standards, and that this amendment facilitated the National Program by allowing a manufacturer to “meet all standards with a single national fleet.”⁴⁹⁴ NHTSA, at the time, erroneously saw this as obviating consideration of EPCA preemption. At the same time, the agency did not address whether California's ZEV program would be preempted since it has never been part of the National Program.

2. Preemption Analysis

Present circumstances require NHTSA to address the issue of preemption. Despite past attempts by NHTSA and EPA to harmonize their respective and related regulations, the automotive industry and U.S. consumers now face regulatory uncertainty and increased costs, in no small part as a result of California's separate GHG emissions and ZEV program. NHTSA and EPA now seek to address these concerns with this rulemaking proposal, in the interest of regulatory certainty and the clear prospect for disharmony with conflicting state requirements.⁴⁹⁵ NHTSA is also guided by a desire to obtain comments from state and local officials and other members of the public to inform fully the agency's position on this important issue.⁴⁹⁶

(a) EPCA Preemption

EPCA's express preemption language is broad and clear:

When an average fuel economy standard prescribed under this chapter is in effect, a State or a political subdivision of a State may not adopt or enforce a law or regulation related to fuel economy standards or average fuel economy standards for automobiles covered by an average fuel economy standard under this chapter.⁴⁹⁷

Unlike the CAA, EPCA does not allow for a waiver of preemption. Nor does EPCA allow for states to establish or enforce an identical or equivalent

regulation. In a further indication of Congress' intent to ensure that state regulatory schemes do not impinge upon EPCA's goals, the statute preempts state laws merely *related to* fuel economy standards or average fuel economy standards. Here, NHTSA intends to assert preemption only over state requirements that directly affect corporate average fuel economy.

The Supreme Court has interpreted similar statutory preemption language on several occasions, concluding that a state law “relates to” a Federal law if it “has a connection with or refers to” the subject of the Federal law.⁴⁹⁸ The Court, citing similar Federal statutory language, extended the application of the “related to” standard to the Airline Deregulation Act in *Morales v. Trans World Airlines, Inc.*,⁴⁹⁹ concluding that, “[f]or purposes of the present case, the key phrase, obviously, is ‘relating to.’ The ordinary meaning of these words is a broad one—‘to stand in some relation; to have bearing or concern; to pertain; refer; to bring into association with or connection with,’ . . .—and the words thus express a broad pre-emptive purpose.”⁵⁰⁰ Courts look “both to the objectives of the . . . statute as a guide to the scope of the state law that Congress understood would survive, [and] to the nature of the effect of the state law on [the Federal standards].”⁵⁰¹

One of Congress' objectives in EPCA was to create a national fuel economy standard, as clearly expressed in 49 U.S.C. 32919(a). In addition to the statute's plain language, which controls, the legislative history of that provision further confirms that Congress intended the provision to be broadly preemptive. As Congress debated proposals that would eventually become EPCA, the Senate bill⁵⁰² sought to preempt State laws only if they were “inconsistent” with Federal fuel economy standards, labeling, or advertising, while the House bill⁵⁰³ sought to preempt State laws only if they were not “identical to” a Federal requirement. The express preemption provision, as enacted, preempts *all* State laws that relate to fuel economy standards. No exception is made for State laws on the ground that

⁴⁹⁴ 76 FR 74854, 74863 (Dec. 1, 2011).

⁴⁹⁵ While California's “deem to comply” provision provided some temporary relief from three different sets of standards, its regulations still mandate that some manufacturers comply with burdensome filing requirements and California may act to revoke the provision. In fact, California is already seeking comment on potentially changing the regulation to provide that manufacturers would only be deemed to comply with CARB requirements if meeting the currently-final EPA standards. See https://www.arb.ca.gov/msprog/levprog/leviii/leviii_dtc_notice05072018.pdf (last accessed May 17, 2018). Moreover, the “deem to comply” provision applies only to tailpipe CO₂ emissions requirements—not to the ZEV program.

⁴⁹⁶ See also E.O. 13132 (Federalism); E.O. 12988 sec. 3(b)(1)(B) (Civil Justice Reform); 54 FR 11765 (Mar. 22, 1989); 58 FR 68274 (Dec. 23, 1993); and 70 FR 21844 (Apr. 27, 2005).

⁴⁹⁷ 49 U.S.C. 32919.

⁴⁹⁸ *Shaw v. Delta Airlines, Inc.*, 463 U.S. 85, 97 (1983) (ERISA case).

⁴⁹⁹ 504 U.S. 374, 383–84 (1992).

⁵⁰⁰ *Id.* at 383.

⁵⁰¹ *California Div. of Labor Standards Enforcement v. Dillingham Constr., N.A., Inc.*, 519 U.S. 316, 325 (1997), (quoting *N.Y. Conference of Blue Cross & Blue Shield Plans v. Travelers Ins. Co.*, 514 U.S. 645, 656 (1995)).

⁵⁰² S. 1883, 94th Cong., 1st Sess., Section 509.

⁵⁰³ H.R. 7014, 94th Cong., 1st Sess., Section 507 as introduced, Section 509 as reported.

⁴⁸⁹ 74 FR 14196 (Mar. 6, 2009).

⁴⁹⁰ 75 FR 25324, 25328 (May 7, 2010).

⁴⁹¹ 74 FR 32744 (Jul. 8, 2009).

⁴⁹² 74 FR at 32783 (Jul. 8, 2009).

⁴⁹³ 75 FR 25324, 25546 (May 7, 2010); see also 74 FR 49454, 49635 (Sep. 28, 2009).

they are consistent with or identical to Federal requirements.⁵⁰⁴

In enacting EISA, Congress did not repeal or amend EPCA's express preemption provision. Congress did, however, adopt a savings provision regarding the effect of EISA, and the amendments made by it:

Nothing in this Act or an amendment made by this Act supersedes, limits the authority provided or responsibility conferred by, or authorizes any violation of any provision of law (including a regulation), including any energy or environmental law or regulation.

We understand this statutory language to prevent EISA from limiting pre-existing authority or responsibility conferred by any law or from authorizing violation of any law. By the same token, the savings provision does not purport to expand pre-existing authority or responsibility. Thus, to the extent that EPCA's express preemption provision limited State authority and responsibility *prior* to the enactment of EISA, it continues to limit such authority and responsibility to the same extent *after* the enactment of EISA. We recognize that the Congressional Record contains statements regarding the savings provision indicating that certain members of Congress may have considered this language as allowing California to set tailpipe GHG emissions standards in contravention of EPCA's express preemption provision. Note, however, that statements made on the floor of the Senate or House before the votes on EISA cannot expand the scope of the savings provision or even be used to "clarify" it, given the unambiguous plain meaning of both the savings provision and EPCA's express preemption provision. If Congress had wanted to narrow the express preemption provision, it could have chosen to include such an amendment in EISA. It did not.

(b) Tailpipe CO₂ Emissions Regulations or Prohibitions are Related to Fuel Economy Standards

This broad statutory preemption provision also necessarily governs state regulations over greenhouse gas emissions. GHG emissions, and particularly CO₂ emissions, are mathematically linked to fuel economy; therefore, regulations limiting tailpipe CO₂ emissions are directly related to fuel economy.⁵⁰⁵ To summarize, most light vehicles are powered by gasoline internal combustion engines. The combustion of gasoline produces CO₂ in amounts that can be readily calculated. CO₂ emissions are always and directly

linked to fuel consumption because CO₂ is a necessary and inevitable byproduct of burning gasoline. The more fuel a vehicle burns or consumes, the more CO₂ it emits. To the extent that light vehicles are *not* powered by internal combustion engines, their use generally involves some release of CO₂ or other GHG emissions, even if indirectly, associated with the vehicle performing its work of traveling down the road. CNG and LPG vehicles release CO₂ during combustion. Even for battery-electric vehicles, fossil fuels are used in at least some part of production of electricity in virtually all parts of the country, and that electricity is used to move the vehicles. And with hydrogen vehicles, methane remains a major part of the generation of hydrogen fuel, which is also used to move those vehicles. Carbon dioxide is thus a byproduct of moving virtually if not literally all light-duty vehicles, and the amount of CO₂ released directly correlates to the amount of fossil fuels used to power the vehicle so it can move.

EPCA has specified since its inception that compliance with CAFE standards is to be determined in accordance with test and calculation procedures established by EPA.⁵⁰⁶ More specifically, the tests are to be performed using "the same procedures for passenger automobiles the Administrator used for model year 1975 . . . procedures that give comparable results." Under these procedures, compliance with the CAFE standards is and has always been based on the rates of emission of CO₂, CO, and hydrocarbons from covered vehicles, but primarily on the emission rates of CO₂. In the measurement and calculation of a given vehicle model's fuel economy for purposes of determining a manufacturer's compliance with Federal fuel economy standards, the role of CO₂ is approximately 100 times greater than the combined role of the other two relevant carbon exhaust gases. Given that the amount of CO₂, CO, and hydrocarbons emitted from a vehicle's tailpipe relates directly to the amount of fuel it consumes, EPA can reliably and accurately convert the amount of those gases emitted by that vehicle into the miles per gallon achieved by that vehicle. In recognizing that 1975 test procedures were sufficient to measure fuel economy performance, Congress recognized the direct relationship between CO₂ emissions and fuel economy standards, while in the same piece of legislation expressly

preempting state standards that are related to fuel economy standards, when Federal fuel economy standards are in place.

In mandating Federal fuel economy standards under EPCA, Congress has expressly preempted any state laws or regulations relating to fuel economy standards. A state requirement limiting tailpipe CO₂ emissions is such a law or regulation because it has the direct effect of regulating fuel consumption.

Given that substantially reducing CO₂ tailpipe emissions from automobiles is unavoidably and overwhelmingly dependent upon substantially increasing fuel economy through installation of engine technologies, transmission technologies, accessory technologies, vehicle technologies, and hybrid technologies, increases in fuel economy inevitably produce commensurate reductions in CO₂ tailpipe emissions. Since there is but one pool of technologies⁵⁰⁷ for reducing tailpipe CO₂ emissions and increasing fuel economy available now and for the foreseeable future, regulation of CO₂ emissions and fuel consumption are inextricably linked. Such state regulations are therefore unquestionably "related" and expressly preempted under 49 U.S.C. 32919.

Moreover, state standards that have the effect of regulating tailpipe CO₂ emissions or fuel economy are likewise related to fuel economy standards and likewise preempted. For instance, if a state were to regulate *all* tailpipe GHG emissions from a vehicle, and not *just* CO₂, the state would nonetheless regulate tailpipe CO₂ emissions, since CO₂ emissions comprise the overwhelming majority of tailpipe carbon emissions. EPCA preempts such a standard.

Likewise, a state law prohibiting *all* tailpipe emissions, carbon or otherwise, from some or all vehicles sold in the state, would relate to fuel economy standards and be preempted by EPCA, since the majority of tailpipe emissions consist of CO₂. We recognize that this preempts state programs, such as California's ZEV mandate, that establish requirements that a portion of a vehicle's fleet sold or purchased consist of vehicles that produce no tailpipe emissions.

(c) Other GHG Emissions Requirements May Not Be Preempted by EPCA

While EPCA expressly preempts state tailpipe CO₂ emission limits, some GHG emissions from vehicles have no

⁵⁰⁴ See 71 FR 17566, 17657 (April 6, 2006).

⁵⁰⁵ 71 FR at 17659, *et seq.*

⁵⁰⁶ 49 U.S.C. 32904(c).

⁵⁰⁷ With the minor exception of regulating the carbon intensity of fuels—an activity not preempted by EPCA.

relation to fuel economy and are therefore outside the scope of EPCA preemption. For instance, vehicle air conditioning units can cause GHG emissions by leaking refrigerants when the system is recharged or when it is crushed at the end of the vehicle's life. Since such emissions have no bearing on a vehicle's fuel economy performance or tailpipe CO₂ emissions, states can pass laws specifically regulating or even prohibiting such vehicular refrigerant leakage without relating to fuel economy if doing so would be otherwise consistent with Federal law. Therefore, EPCA would not preempt such laws, if narrowly drafted so as not to include tailpipe CO₂ emissions. If, however, a state law sought to limit the combined GHG emissions from a motor vehicle, in a manner that *would include* tailpipe CO₂ emissions, EPCA would preempt that portion of the law limiting tailpipe CO₂ emissions.

Similarly, state safety requirements may have a merely incidental impact on fuel economy and not relate to fuel economy. For instance, a state may mandate that children traveling in motor vehicles sit in child safety seats. Child safety seats add weight, and added weight has an impact on fuel economy. This impact is merely incidental, however, and does not directly relate to fuel economy standards.

Likewise, EPA has recognized that California may apply for a waiver of CAA preemption for vehicle emissions, which must be granted in certain circumstances. That said, EPCA does preempt any regulation limiting or prohibiting CO₂ emissions or *all* tailpipe emissions, as such regulations have the effect of regulating CO₂ emissions and relate to fuel economy standards.⁵⁰⁸

⁵⁰⁸ NHTSA notes that over the last decade CARB has complicated its regulation of smog-forming emissions (the original purpose of the Section 209 CAA waiver) by combining it with regulation of GHG and, principally, CO₂ emissions as well as the ZEV mandate. Since EPCA prohibits state regulation of CO₂ emissions, a state program that combines regulation of the two groups of pollutants is preempted to the extent that the program relates to fuel economy. A regulatory regime in which smog-forming pollutants are addressed without also directly or indirectly regulating fuel economy is not preempted under EPCA.

Additionally, NHTSA notes that some suggest that insofar as carbon dioxide emissions cause global climate change, they indirectly worsen air quality by (1) increasing formation of smog, because the chemical process that forms ground-level ozone occurs faster at higher temperatures, and (2) increasing ragweed pollen, which can cause asthma attacks in allergy sufferers. Comment is sought on the extent to which the zero-tailpipe-emissions vehicles compelled to be sold by California's ZEV program reduce temperatures in the parts of California which are in non-attainment for ozone

NHTSA invites comments on the extent to which a state standard can have some incidental impact on fuel economy or CO₂ emissions without being "related to" fuel economy standards.

(d) A Waiver of CAA Preemption Does Not Affect, in Any Way, EPCA Preemption

When a state establishes a standard related to fuel economy, it does so in violation of EPCA's preemption statute and the standard is therefore void *ab initio*.

Federal preemption is rooted in the Supremacy Clause of the U.S. Constitution.⁵⁰⁹ Courts have long recognized that the Supremacy Clause of the Constitution gives Congress the power to specifically preempt State law.⁵¹⁰ Broadly speaking, the United States Supreme Court has long held that "an act done in violation of a statutory prohibition is void,"⁵¹¹ and has specifically noted that such acts are not merely "voidable at the instance of the government" but void from the outset.⁵¹² The Ninth Circuit stated it more plainly: "Under Federal law, an act occurring in violation of a statutory mandate is void *ab initio*."⁵¹³ Discussing the Supremacy Clause, the Supreme Court explicitly explained that, "[i]t is basic to this constitutional command that all conflicting state provisions be without effect."⁵¹⁴ And at least one Federal Court of Appeals explicitly stated that the Supremacy Clause means "state laws that 'interfere with, or are contrary to the laws of Congress' are void *ab initio*."⁵¹⁵

While both the CAA and EPCA may preempt state laws limiting GHG emissions from motor vehicles, avoiding preemption (by waiver or otherwise) under one Federal law has no bearing on the other Federal law's preemptive effect. Section 209 of the CAA, which provides for the possible waiver of CAA

and which contain dense populations of allergy sufferers.

⁵⁰⁹ U.S. Const. art VI, cl. 2.

⁵¹⁰ See *Gibbons v. Ogden*, 22 U.S. 1 (1824).

⁵¹¹ *Ewert v. Bluejacket*, 259 U.S. 129, 138 (1922), quoting *Waskey v. Hammer*, 223 U.S. 85, 94 (1912).

⁵¹² *Waskey*, 223 U.S. at 92.

⁵¹³ *Cabazon Band of Mission Indians v. City of Indio, Cal.*, 694 F.2d 634, 637 (9th Cir. 1982).

⁵¹⁴ *Maryland v. Louisiana*, 451 U.S. 725, 746 (1981) (citing *McCulloch v. Maryland*, 4 Wheat. 316, 427 (1819)). Other courts have used similar language to describe the impact of preemption. See, e.g., *Nathan Kimmel, Inc. v. DowElanco*, 275 F.3d 1199, 1203 (9th Cir. 2002) (explaining preempted state laws are "without effect"); *Sweat v. Hull*, 200 F.Supp.2d 1162, 1172 (D. Ariz. 2001) (explaining preempted state laws are "ineffective.").

⁵¹⁵ *Antilles Cement Corp. v. Fortuno*, 670 F.3d 310, 323 (1st Cir. 2012) (quoting *Gibbons v. Ogden*, 22 U.S. (9 Wheat.) 1 (1824)).

preemption, makes clear that waiver of preemption under that statute operates only to relieve "application of this section"—the preemption provision of the CAA—and not application of other statutes.⁵¹⁶ EPA and NHTSA tentatively agree that a waiver under the CAA does not also waive EPCA preemption.

The Vermont and California Federal district court decisions mentioned above involved challenges to a California Air Resources Board regulation establishing vehicle tailpipe GHG emission standards. The courts concluded that EPCA did not preempt such standards. In both decisions, the courts placed much weight upon the fact that California had petitioned EPA for a waiver of CAA preemption pursuant to 42 U.S.C. 7543(b).

NHTSA and EPA do not agree with the district courts' express preemption analyses. EPCA preempts state laws and regulations "related to fuel economy standards or average fuel economy standards for automobiles covered by an average fuel economy standard."⁵¹⁷ The courts in *Green Mountain Chrysler* and *Central Valley Chrysler-Jeep* recognized the relationship between CO₂ emissions and fuel economy. Nonetheless, they erroneously concluded that the "related to" language in EPCA's preemption clause should be construed "very narrowly" and adopted a novel interpretation of "related to."⁵¹⁸ The courts failed to recognize precedent providing broad effect to other preemption statutes using terms similar to "related to," as discussed above.

(e) A Clean Air Act Waiver Does Not "Federalize" EPCA-Preempted State Standards

The district court in *Green Mountain Chrysler* concluded that it could resolve the challenge to Vermont's regulations without directly considering the application of EPCA's preemption provision. The court said that the dispute did not concern preemption but concerned reconciling two different Federal statutes (EPCA and the CAA). In this regard, the district court stated that if EPA approved California's waiver petition (which had not yet occurred), then Vermont's GHG regulations become "other motor vehicle standards" that NHTSA must consider in setting

⁵¹⁶ 42 U.S.C. 7543(b)(1) (emphasis added); see also 42 U.S.C. 7543(b)(3) ("compliance with such State standards shall be treated as compliance with applicable Federal standards for purposes of this subchapter") (emphasis added).

⁵¹⁷ 49 U.S.C. 32919(a) (emphasis added).

⁵¹⁸ *E.g.*, 529 F.Supp.2d at 1176.

CAFE standards.⁵¹⁹ In the court's view, once EPA grants a waiver, compliance with California's standards is deemed to satisfy all Federal standards—not just those of the CAA. In states that adopt California's standards, compliance with that standard would be deemed to satisfy all Federal standards as well. With this Federal accommodation of state standards, the court concluded, Vermont's regulations would stand.

The court's premise that preemption provisions and principles do not apply is not based on precedent and is not supported by applicable law. In fact, the district court in *Central Valley Chrysler-Jeep* recognized that “[t]he Green Mountain court never actually offers a legal foundation for the conclusion that a state regulation granted waiver under [CAA] section 209 [42 U.S.C. 7543] is essentially a federal regulation such that any conflict between the state regulation and EPCA is a conflict between federal regulations.”⁵²⁰ NHTSA and EPA disagree with the conclusion of these decisions and reaffirm the longstanding position that state standards regulating tailpipe GHG emissions, such as the standards challenged in the California and Vermont district court cases, are preempted by EPCA because they “relate to” fuel economy standards. We also note that those courts failed to consider, much less give any weight to, NHTSA's views of preemption, as the expert agency with authority over the Federal fuel economy program.⁵²¹ The United States opposed, as *amicus curiae*, the *Green Mountain Chrysler* decision on appeal to the Second Circuit, but the Second Circuit did not issue a decision on appeal⁵²² due to the

automotive industry's withdrawal of appeals. As explained above, the withdrawal of those appeals was a precondition to the 2010 issuance of the final rule establishing the “National Program” of fuel economy standards and GHG emission standards for MYs 2012–2016.

In their appeals of the *Green Mountain Chrysler* decision, the vehicle manufacturer associations argued that the operation of EPCA's express preemption provision does not require that a conflict be shown between the Federal and state standards, that the Federal and state standards be identical, or that the Federal and state standards serve the same purpose. We agree. The conflict principles of implied preemption do not apply in fields where Congress has enacted an express preemption provision prohibiting even the existence of state standards. The statutory test, whether the state standards are “related to” the Federal standards, is met by showing that the state GHG emission standards are not simply related to, but actually the functional equivalent of, the Federal fuel economy standards. The district court itself recognized that “there is a near-perfect correlation between fuel consumed and carbon dioxide released.” Neither the inclusion in the state standard of emissions for which that relationship does not exist, nor the assigning to the state standard of a purpose other than energy conservation, diminishes the statutory implications of the state standard's meeting the relatedness test. Those unrelated types of emissions constitute a very low percentage of the overall tailpipe emissions. Finally, while there are means of compliance with the state standard other than improving fuel economy, their contributions to compliance are minor. Improving fuel economy is the only feasible method of achieving full compliance. Again, NHTSA and EPA agree.

The *Central Valley Chrysler-Jeep* court went further, noting that while NHTSA is required to give consideration to “other standards,” including those “promulgated by EPA,” “[t]here is no corresponding duty by EPA to give consideration to EPCA's regulatory scheme. This asymmetrical allocation by Congress of the duty to consider other governmental regulations indicates that Congress intended that DOT, through NHTSA, is to have the burden to conform its CAFE program under EPCA to EPA's determination of

what level of regulation is necessary to secure public health and welfare.”⁵²³

In support of its position, the *Central Valley Chrysler-Jeep* found persuasive the *Green Mountain Chrysler* court's view that California emissions regulations under CAA Section 209 have always been considered “other standards” on fuel economy. As mentioned previously in the discussion of the “other standards” to be considered as factors in establishing maximum feasible fuel economy standards, EPCA, as originally enacted, contained a specific self-contained provision that provided that any manufacturer could apply to DOT for modification of an average fuel economy standard for model years 1978 through 1980 if it could show the likely existence of a “Federal standards fuel economy reduction,” defined to include EPA-approved California emissions standards that reduce fuel economy. The court reasoned that “in 1975 when EPCA was passed, Congress unequivocally stated that federal standards included EPA-approved California emissions standards.”⁵²⁴ However, when EPCA was recodified in 1994, “all reference to the modification process applicable for model years 1978 through 1980, including the categories of federal standards, was omitted as executed.”⁵²⁵ The court noted that the legislative intent of the 1994 recodification was not intended to make a substantive change to the law.⁵²⁶ Thus, the court concluded that “[i]f the recodification worked no substantive change in the law, then the term ‘other motor vehicle standards of the Government’ continues to include both emission standards issued by EPA and emission standards for which EPA has issued a waiver under Section 209(b) of the CAA, as it did when enacted in 1975.”⁵²⁷

NHTSA believes that the district court misread EPCA to the point of turning it on its head. As discussed previously in this document, the “federal standards” definition discussed by the court existed in a self-contained scheme allowing manufacturers to petition NHTSA for modification of the fuel economy requirements *only* between 1978 and

⁵¹⁹ *Green Mountain Chrysler*, 508 F.Supp.2d at 398.

⁵²⁰ *Central Valley Chrysler-Jeep*, 529 F.Supp.2d at 1165. Congress must state its intention clearly to accord a state law the status of Federal law, which it did not do in either in Section 209(b) of the CAA or in EPCA. See, e.g., *Indep. Cmty. Bankers Ass'n v. Bd. of Governors*, 820 F.2d 428, 436–37 (D.C. Cir. 1987) (recognizing that, although Congress “has the power to assimilate state law,” “[s]uch decisions require an unequivocal congressional expression” because “some [state] restrictions would in all likelihood conflict with [other] existing Federal laws”).

⁵²¹ See *Geier v. American Honda Motor Co.*, 529 U.S. 861, 883 (2000) (“Congress has delegated to DOT authority to implement the statute; the subject matter is technical; and the relevant history and background are complex and extensive. The agency is likely to have a thorough understanding of its own regulation and its objectives and is ‘uniquely qualified’ to comprehend the likely impact of state requirements.”); *Medtronic, Inc. v. Lohr*, 518 U.S. 470, 496 (1996) (“agency is uniquely qualified to determine whether a particular form of state law stands as an obstacle to the accomplishment and execution of the full purposes and objectives of Congress”) (internal quotation marks omitted).

⁵²² See Proof Brief for the United States as Amicus Curiae, 07–4342–cv (2d Cir. filed Apr. 16, 2008).

⁵²³ *Central Valley Chrysler-Jeep*, 529 F.Supp.2d at 1168.

⁵²⁴ *Central Valley Chrysler-Jeep*, 529 F.Supp.2d at 1173 (quoting *Green Mountain Chrysler*, 508 F.Supp.2d at 345). EPCA Section 502(d)(3)(D)(i) provided: “Each of the following is a category of Federal standards: . . . Emissions standards under Section 202 of the Clean Air Act, and emissions standards applicable by reason of Section 209(b) of such Act.”

⁵²⁵ *Id.*

⁵²⁶ *Id.*

⁵²⁷ *Id.*

1980, and thus has no application either at the time of the decision or today. And even if that definition of “federal standards” were applied to EPCA generally, NHTSA would balance that against other factors enumerated in EPCA that it “shall” consider in setting maximum feasible fuel economy standards. However, the district courts’ view is that this factor instead creates an “obligation” to “harmonize” CAFE standards with state emissions regulations under a CAA Section 209 waiver.⁵²⁸ In other words, under the district courts’ opinions, a state standard controls what NHTSA does, and the agency therefore has no further discretion to consider the other factors Congress directed it to consider. Consistent with the legislative history and NHTSA’s long-standing interpretations, NHTSA interprets EPCA, a statute which it administers in implementing the national fuel economy program, as providing that the requirement to “consider” the four EPCA statutory factors set forth in 49 U.S.C. 32902(f) does not mean the agency is obligated to harmonize CAFE standards with state tailpipe CO₂ emissions standards. EPA concurs that a CAA waiver does not also waive the effect of any other Federal law, including EPCA.

As discussed above in the “other standards” section of this rulemaking, NHTSA further believes that the district courts in *Green Mountain Chrysler* and *Central Valley Chrysler-Jeep* misconstrued the provision in EPCA as enacted in 1975 that allowed manufacturers to petition NHTSA to reduce CAFE standards that Congress had set for model years 1978, 1979, and 1980 if there was a “Federal standards fuel economy reduction.”⁵²⁹ This provision did not involve a factor to be balanced in determining fuel economy standards. It provided for a reduction in fuel economy standards for cars at a time when only conventional pollutants were regulated. The provision was specifically designed to address California’s then-existing smog regulations, particularly with regard to the additional weight (which other things being equal reduces fuel economy) associated with catalytic converters. In so doing, Congress recognized the potential interplay for three model years between California’s smog regulations and the possibility that it could reduce Federal fuel economy standards for those model years.⁵³⁰

⁵²⁸ *Id.* at 1170.

⁵²⁹ Public Law 94–163 sec. 502(d), 89 Stat. 904–05.

⁵³⁰ See H.R. No. 94–340, at 87.

Thus, EPCA went on to include “Emissions standards under Section 202 of the CAA, and emissions standards applicable by reason of Section 209(b) of such Act” in its list of “categor[ies] of Federal standards.”⁵³¹

Because California standards to combat smog (not GHG regulations) “by reason of section 209(b)” could be considered to reduce federal fuel economy standards for three years, the district courts erroneously believed that state CO₂ regulations are somehow now “federal” standards under 49 U.S.C. 32902(f). On its face, this language applied only to three long past model years and only to reducing standards, not setting them. “For purposes of this subsection” referred to section 502(d) of EPCA—not EPCA section 502(e) [now 49 U.S.C. 32902(f)] which sets forth the EPCA factor of “the effect of other Federal motor vehicle standards on fuel economy.” After MY 1980, section 502(d) became obsolete. When EPCA was recodified in 1994, section 502(d) was dropped as executed and therefore surplusage. As the listing of Federal standards in 502(d) never had any application outside that subsection and ceased to have significance when that subsection became obsolete, it had and has no bearing on the recodified version of EPCA. The recodification to rescind this subsection, which had no substantive significance for 14 years, was entirely non-substantive.⁵³²

NHTSA believes that the district courts in *Green Mountain Chrysler* and *Central Valley Chrysler-Jeep* sought to give a CAA waiver for the California GHG regulation an effect far beyond the terms of the CAA provision authorizing such a waiver. As discussed previously, the courts overlooked the fact that the CAA itself makes clear that waiver of preemption under that statute operates only to relieve application of the CAA preemption statute.⁵³³ State GHG regulations, even if subject to an EPA waiver, would remain regulations “adopt[ed] or enforc[ed]” by “a State or political subdivision of a State” and therefore would be subject to preemption by EPCA.⁵³⁴

The courts’ view suggests an apparent misunderstanding of the underlying concerns and purposes of the

⁵³¹ *Id.* § 502(d)(3)(D).

⁵³² The recodification was “[t]o revise, codify, and enact without substantive change” laws related to transportation. Public Law 103–272 (emphasis added).

⁵³³ 42 U.S.C. 7543(b)(1) (emphasis added); see also 42 U.S.C. 7543(b)(3) (“compliance with such State standards shall be treated as compliance with applicable Federal standards for purposes of this subchapter”) (emphasis added).

⁵³⁴ 49 U.S.C. 32919(a).

requirement to consider other standards. There is no hint in the histories of either EPCA or EISA of an intent to give other standards special, much less superior, status under EPCA. The limited concerns and purpose were to ensure that any adverse effects of other standards on fuel economy considered in connection with the fuel economy standards. Those concerns are evident in a 1974 report, entitled “Potential for Motor Vehicle Fuel Economy Improvement,” submitted to Congress by the Department of Transportation and EPA.⁵³⁵ That report noted that the weight added by safety standards *would* and one set of emissions standards *might* temporarily reduce the level of achievable fuel economy.⁵³⁶ These concerns can also be found in the congressional reports on EPCA.⁵³⁷

(f) State Tailpipe GHG Emissions Standards Conflict With EPCA and are Therefore Preempted Impliedly

Notwithstanding that state standards limiting or prohibiting tailpipe CO₂ emissions are expressly preempted by EPCA, they also clearly conflict with the objectives of EPCA and would therefore also be impliedly preempted.

State regulation of CO₂ emissions would frustrate Congress’ objectives in establishing the CAFE program and conflict with NHTSA’s efforts to implement the program in a manner consistent with EPCA. While the overarching purpose of EPCA may be energy conservation, Congress directed NHTSA to consider four factors in establishing maximum feasible fuel economy standards. NHTSA balances these factors to determine, through the CAFE program, the amount of energy the light-duty vehicle fleet should conserve. Allowing a state to make a state-specific determination for how much energy should be conserved (in the same way that the CAFE program conserves energy) necessarily frustrates NHTSA’s efforts to make that determination for the country as a whole because it sends the industry in different directions in order to try to meet multiple standards at once rather than allowing the industry to focus its resources and efforts on the path laid out at the Federal level. This is particularly true when considering that when California sets standards, other states can choose to adopt those

⁵³⁵ This report was prepared in compliance with Section 10 of the Energy Supply and Environmental Coordination Act of 1974, Public Law 93–319.

⁵³⁶ See *id.* at 6–8 and 91–93.

⁵³⁷ See page 22 of Senate Report 94–179, pages 88 and 90 of House Report 94–340, and pages 155–7 of the Conference Report, Senate Report 94–516.

standards and thereby further increase the compliance complexity.

A critical objective of EPCA was to establish a single national program to regulate vehicle fuel economy. Congress, in passing EPCA, accomplished this objective by providing broad preemptive power established in the language codified at 49 U.S.C. 32919(a). Other congressional objectives underlying EPCA include avoiding serious adverse economic effects on manufacturers and maintaining a reasonable amount of consumer choice among a broad variety of vehicles. To guide the agency toward the selection of standards meeting these competing objectives, Congress specified four factors that NHTSA must consider in determining the maximum feasible level of average fuel economy and thus the level at which each standard must be set. As discussed above, since the only practical way to reduce tailpipe CO₂ emissions is to improve fuel economy, it would be impossible for a state tailpipe CO₂ emissions standard to be adopted without interfering with CAFE standards. If a state were to establish standards that have the effect of requiring a lower level of fuel economy than CAFE standards, those standards would be meaningless since they would not reduce CO₂ emissions. Instead, a State could only establish a standard that has the effect of requiring a *higher* level of average fuel economy. Setting standards that are more stringent than the fuel economy standards promulgated under EPCA would upset the efforts of NHTSA to balance and achieve Congress's competing goals. Setting a standard above the level judged by NHTSA to be consistent with the statutory consideration after careful consideration of these issues in a rulemaking proceeding would negate the agency's careful analysis and decision-making.

For the same reasons, a state regulation *having the effect of* regulating tailpipe carbon dioxide emissions or fuel economy is likewise impliedly preempted under 49 U.S.C. Chapter 329.

The Vermont and California district court decisions discussed above addressed conflict preemption. The *Green Mountain Chrysler* court concluded that the Vermont GHG standards presented no conflict preemption concerns and rejected the contention that Vermont's GHG regulations would conflict with Congress' intent that there be a single, nationwide fuel economy standard and that those regulations upset NHTSA's careful balancing of the EPCA statutory factors in its rulemaking proceedings. In

rejecting the manufacturers' arguments, the court held that the Vermont standards do not create an obstacle to achieving EPCA's goals because the Vermont standards are, in the court's judgment, consistent with EPCA's standard setting criteria. In reaching that conclusion, the court did not consider the impact of the Vermont standards on the balancing done by NHTSA in setting CAFE standards. For its part, the court in *Central Valley Chrysler-Jeep* concluded that there *was* no conflict preemption, since if California's standards were granted a waiver under CAA section 209 by EPA, they would satisfy CAA objectives and be consistent with EPCA.⁵³⁸ The court simply assumed consistency. If this assumption proved incorrect, to the extent of any incompatibility between the two regimes, "NHTSA is empowered to revise its standards" to take into account California's regulations, according to that court.

NHTSA disagreed with the two district court rulings at the time and continues to do so now. We note that the Vermont decision was appealed and briefed (including an Amicus Brief filed by the United States) prior to the stay and withdrawal of the litigation pursuant to the National Program arrangement described previously. NHTSA was not a party to those cases and is not bound by these decisions. Those erroneous decisions further support the need for NHTSA, as the agency with expert authority to interpret EPCA, to reaffirm its longstanding view of the preemption provision. Moreover, EPA, as the agency charged with administering the CAA, further determines that CAA waivers do not "federalize" state standards; therefore, state standards directly affecting fuel economy are subject to EPCA preemption even if there is a CAA waiver in place.

(g) ZEV Mandates

Another form of EPCA-preempted state regulation is a zero-emission vehicle (ZEV) mandate. Such laws require that a certain number or percentage of vehicles sold or delivered for sale within a state must be ZEVs, vehicles that produce neither smog-forming nor CO₂ tailpipe emissions. ZEV mandates may require either that actual ZEVs be sold or delivered for sale or provide for generation and application of ZEV credits, which may or may not be traded. While NHTSA has not previously commented on the relationship between the ZEV mandates and the CAFE program because the only

feasible means to eliminate tailpipe CO₂ emissions is by eliminating the use of petroleum fuel (*i.e.*, electric or fuel cell propulsion), and because the purpose of the ZEV program is to affect fuel economy,⁵³⁹ ZEV mandates directly relate to fuel economy and are thereby expressly preempted. ZEV mandates are also intended to *force* the development and commercial deployment of ZEVs—regardless of the technological feasibility or economic practicability of doing so—putting the program entirely at odds with critical factors that Congress required NHTSA to consider in establishing fuel economy standards. Therefore, ZEV mandates also interfere with achieving the goals of EPCA and are therefore impliedly preempted.

California's ZEV mandate represents the most prominent example. California initially launched its ZEV mandate in 1990 to force the development and deployment of ZEVs to reduce smog-forming emissions. As California's Low Emission Vehicle and EPA's Tier 3 standards for criteria pollutant emissions have become increasingly stringent, the greater impact of California's ZEV mandate is the reduction of tailpipe GHG emissions. In its latest iteration the ZEV mandate no longer focuses on tailpipe smog forming emissions, a fact that CARB acknowledged in 2012 when applying for a waiver for its Advanced Clean Car Program, in stating "[t]here is no criteria emissions benefit from including the ZEV proposal in terms of vehicle (tank-to-wheel or TTW) emissions. The LEV III criteria pollutant fleet standard is responsible for those emission reductions in the fleet; the fleet would become cleaner regardless of the ZEV regulation because manufacturers would adjust their compliance response to the standard by making less polluting conventional vehicles."⁵⁴⁰

In its current configuration, the ZEV mandate requires manufacturers to generate credits based upon the number of vehicles delivered for retail sale. Vehicles earn varying amounts of ZEV credits depending upon technology and range, with some vehicles earning several credits. Manufacturers delivering for sale certain plug-in hybrid

⁵³⁹ See, e.g., *Fact Sheet: 2003 Zero Emission Vehicle Program*, California Air Resources Board (March 18, 2004), available at <https://www.arb.ca.gov/msprog/zevprog/factsheets/2003zevchanges.pdf> (stating that one of the "significant features of the April 2003 changes to the ZEV regulation" included removal of "all references to fuel economy or efficiency," after a 2002 lawsuit asserting that AT PZEV provisions pertaining to the fuel economy of hybrid electric vehicles were preempted by EPCA).

⁵⁴⁰ Docket No. EPA-HQ-OAR-2012-0562, Pp. 15-16.

⁵³⁸ 529 F.Supp.2d at 1179.

vehicles earn some limited ZEV credits, even though they are not truly ZEVs, but such credits can only satisfy a portion of a manufacturer's ZEV credit requirements. The credit requirements increase annually, with the number of required credits equaling 4.5% of a manufacturer's light duty vehicle sales in 2018, rising to 22% in 2025.⁵⁴¹ To hit this 22% credit requirement, a manufacturer would need to deliver for sale ZEVs totaling somewhere between less than eight percent and 15.4% of their light duty sales in California, per various projections.⁵⁴² With advance notice, manufacturers may elect to use credits earned from over-complying with vehicle tailpipe GHG emission requirements toward partial satisfaction of the ZEV mandate.

The EPA has granted a waiver of CAA preemption under Section 209 of the CAA for California's Advanced Clean Car program, which includes California's ZEV mandate in addition to California's GHG regulation and LEV program. Nine other states have elected to adopt the ZEV mandate pursuant to Section 177 of the CAA⁵⁴³—which, combined with California, represent approximately 30% of United States light duty vehicle sales annually.⁵⁴⁴ Manufacturers must satisfy the ZEV mandate for each state. While, traditionally, manufacturers could apply credits earned in one state to satisfy the requirements of another state, this “travel” provision is limited only to fuel cell electric vehicles beginning with MY 2018.

Accordingly, manufacturers must endeavor to design, produce, and deliver for sale significant numbers of vehicles that produce zero tailpipe CO₂ emissions within *each* state that has adopted the California ZEV mandate.

⁵⁴¹ Cal. Code Regs. tit.13, sec. 1962.2(b).

⁵⁴² The Air Resources Board initially projected that 15.4% of new vehicles delivered for sale would consist of ZEVs. *See, e.g., Staff Report: Initial Statement of Reasons 2012 Proposed Amendments to the California Zero Emission Vehicle Program Regulations*, California Air Resources Board at 48 (Dec. 7, 2011), available at <https://www.arb.ca.gov/regact/2012/zev2012/zevisor.pdf> (stating “[b]y model year 2025, staff expects 15.4 percent of new sales will be ZEVs and [Plug-In Hybrids].”) However, an increased supply of credits and projected increases in battery electric range has resulted in others projecting reduced required ZEV fleet penetration. *See, e.g., What is ZEV?*, Union of Concerned Scientists (Oct. 31, 2016), <https://www.ucsusa.org/clean-vehicles/california-and-western-states/what-is-zev> (projecting “about 8 percent of sales to be ZEVs” in 2025).

⁵⁴³ These states are Connecticut, Maine, Maryland, Massachusetts, New Jersey, New York, Oregon, Rhode Island, and Vermont.

⁵⁴⁴ *See Automotive Retailing: State by State*, National Automobile Dealers Association, <https://www.nada.org/statedata/> (last visited June 25, 2018) (estimating that these states represented 28.6% of new motor vehicle registrations in 2016).

This involves implementation of some of the most expensive and advanced technologies in the automotive industry, regardless of consumer demand (which tends to be lower during periods of sustained relatively-low gasoline prices). The California Air Resources Board's own midterm review report for their Advanced Clean Car program cites estimates from the 2016 Draft Technical Assessment Report relating to the incremental vehicle costs of ZEVs over 2016 vehicles with internal combustion engines.⁵⁴⁵ While stating marginal increased costs have fallen when compared to previous estimates, CARB nevertheless still shows battery electric subcompact vehicles with 75 miles of range, for which consumer demand remains very low, as costing \$7,505 more than ones with an internal combustion engine, with large cars costing \$11,355 more. Battery electric subcompacts with a 200-mile range, for which consumer demand is slightly higher than a 75-mile range, were estimated to cost \$12,001 more than comparable vehicles with internal combustion engines, and large cars \$16,746 more. Even subcompact plug-in hybrids with 40 miles of electric range cost \$9,260 more than internal combustion engine equivalents, and \$13,991 more for large cars. And as discussed above, consumers have not been willing to pay the full cost of this technology—meaning manufacturers are likely to spread the costs of the ZEV mandate to non-ZEV vehicles (and to vehicles sold in other states). This expensive and market-distorting mandate for manufacturers to eliminate vehicle tailpipe CO₂ emissions (and thus petroleum fuel use) for part of their fleets has always interfered with NHTSA's balancing of statutory factors in establishing maximum feasible fuel economy standards, and increasing ZEV credit requirements through 2025 make it all-the-more of an obstacle to accomplishing EPCA's goal of establishing a coherent national fuel economy program. Unlike NHTSA's CAFE program, the ZEV mandate forces investment in specific technology (electric and fuel cell technology) rather than allowing manufacturers to improve fuel economy through more cost-effective technologies that better reflect consumer demand.⁵⁴⁶ This appears to conflict directly with Congress' intent that CAFE standards be performance-

⁵⁴⁵ California Air Resources Board, California's Advanced Clean Cars Midterm Review, Appendix C, Zero Emission Vehicle and Plug-in Hybrid Electric Vehicle Technology Assessment, Table 8, at C-64 (Jan. 18, 2017), available at https://www.arb.ca.gov/msprog/acc/mtr/appendix_c.pdf.

⁵⁴⁶ 13 Cal. Code of Regulations 1962.2.

based rather than design mandates. Moreover, by forcing manufacturers to design, produce, and deliver for sale vehicles that produce no tailpipe CO₂ emissions, the ZEV mandate forces further expensive investments in fuel-saving technology than NHTSA has determined appropriate to require in setting fuel economy standards.⁵⁴⁷ We seek comment on the extent to which compliance with the ZEV mandate frustrates manufacturers' efforts to comply with CAFE standards.

For the reasons outlined above, the California ZEV mandate is expressly and impliedly preempted by EPCA. While EPA had previously granted a waiver of CAA preemption for California's Advanced Clean Car Program, which includes the California ZEV mandate, this waiver has no effect on EPCA preemption of the ZEV mandate, as described above.

3. Conclusion and Severability

Given the importance of an effective, smooth functioning national program to regulate fuel economy and in light of the failure of two Federal district courts to consider NHTSA's analysis and carefully crafted position on preemption, NHTSA is considering taking the further step of summarizing that position in an appendix to be added to the parts in the Code of Federal Regulations setting forth the passenger car and light truck CAFE standards. That proposed regulatory text may be found at the end of this preamble.

NHTSA considers its proposed decision on the maximum feasible CAFE standards for MY 2021–2026 to be severable from its decision on EPCA preemption. Our proposed interpretation of 49 U.S.C. 32919 does not depend on our decision to finalize and a court's decision to uphold, the CAFE standards being proposed today under 49 U.S.C. 32902. NHTSA solicits comment on the severability of these actions.

⁵⁴⁷ *See, e.g., Alan, J., Hardman, S. & Carley, S. Cost implications for automakers' compliance with emission standards from Zero Emissions Vehicle mandate*, TRB 2018 Annual Meeting paper submittal, <https://trid.trb.org/view/1495714> (last accessed June 28, 2018) (finding based on independent research that in 2025, costs reach approximately \$1,500 per vehicle on average to comply with CAFE alone and increase to around \$2,100 per vehicle on average to comply with both CAFE and ZEV).

B. Preemption Under the Clean Air Act

1. Background

(a) Statutory Background: Clean Air Act Section 209(a) Preemption, Section 209(b)(1) California Waiver, and Section 209(b)(1)(A)–(C) Prohibitions on Waiver

EPA's regulation of new motor vehicles under Title II generally preempts state standards in the same subject area. Section 209(a) of the Act provides that:

“No State or any political subdivision thereof shall adopt or attempt to enforce any standard relating to the control of emissions from new motor vehicles or new motor vehicle engines subject to this part. No State shall require certification, inspection or any other approval relating to the control of emissions from any new motor vehicle or new motor vehicle engine as condition precedent to the initial retail sale, titling (if any), or registration of such motor vehicle, motor vehicle engine, or equipment.”⁵⁴⁸

However, Title II affords special treatment to California: Subject to certain conditions, it may obtain from EPA a waiver of section 209(a) preemption. Specifically, section 209(b)(1) of the Act requires the Administrator, after an opportunity for public hearing, to waive application of the prohibitions of section 209(a) to California, if California determines that its State standards will be, in the aggregate, at least as protective of public health and welfare as applicable Federal standards.⁵⁴⁹ A waiver under section 209(b)(1) allows California to “adopt [and] enforce a[] standard relating to the control of emissions from new motor vehicles or new motor vehicle engines.” CAA section 209(a), 42 U.S.C. 7543(a).

But California's ability to obtain a waiver is not unlimited. The statute provides that “no such waiver will be granted” if the Administrator finds *any* of the following: “(A) [California's] determination [that its standards in the aggregate will be at least as protective] is arbitrary and capricious, (B) [California] does not need such State standards to meet compelling and extraordinary conditions, or (C) such State standards and accompanying enforcement procedures are not consistent with section [202(a)].”

⁵⁴⁸ Clean Air Act (CAA) section 209(a), 42 U.S.C. 7543(a).

⁵⁴⁹ CAA section 209(b), 42 U.S.C. 7543(b). The provision does not identify California by name. Rather, it applies on its face to “any State which has adopted standards (other than crankcase emission standards) for the control of emissions from new motor vehicles or new motor vehicle engines prior to March 30, 1966.” California is the only State that meets this requirement. See S. Rep. No. 90–403 at 632 (1967). This proposal refers interchangeably to “California” and “CARB” (the California Air Resources Board).

Section 209(b)(1)(A)–(C), 42 U.S.C. 7543(b)(1)(A)–(C) (Emphasis added).⁵⁵⁰ Any one of these three findings operates to forbid a waiver.

(1) EPA's Proposed Action

EPA is proposing to withdraw the January 9, 2013 waiver of preemption for California's Advanced Clean Car (ACC) program, Zero Emissions Vehicle (ZEV) mandate, and Greenhouse Gas (GHG) standards that are applicable to new model year (MY) 2021 through 2025. 78 FR 2145 (January 9, 2013.)^{551 552} EPA proposes to do so on multiple grounds.

First, EPA notes that elsewhere in this notice NHTSA has proposed to find that California's GHG and ZEV standards are preempted under EPCA. Although EPA has historically declined to consider as part of the waiver process whether California standards are constitutional or otherwise legal under other Federal statutes apart from the Clean Air Act, EPA believes that this notice presents a unique situation and that it is appropriate to consider the implications of NHTSA's proposed conclusion as part of EPA's reconsideration of the waiver. In this regard, EPA is proposing to conclude that state standards preempted under EPCA cannot be afforded a valid waiver of preemption under CAA 209(b). Accordingly, EPA is proposing to conclude that if NHTSA finalizes a determination that California's GHG and ZEV standards are preempted, then it would be necessary to withdraw the waiver separate and apart from the analysis under section 209(b)(1)(B), (C) that follows.

Second, under section 209(b)(1)(B) (compelling and extraordinary

⁵⁵⁰ As presented in the United States Code, the cross-reference in prong (C) is to “section 7521(a) of this title,” *i.e.*, CAA section 201(a), 42 U.S.C. 7521(a), which governs EPA's administration of “Emission standards for new motor vehicles or new motor vehicle engines administration of “Emissions standards for new motor vehicles or new motor vehicle engines.”

⁵⁵¹ This proposed action does not address whether the statutory interpretations and their policy consequences laid out in the proposal may have implications for past waivers granted to California for other standards besides its GHG and ZEV standards. EPA proposes to take this action in the context of this joint rulemaking with NHTSA, and the California standards identified herein are the focus of EPA's proposal. As circumstances require and resources permit, EPA may in future actions consider whether this proposal, if finalized, makes it appropriate or necessary to revisit past grants of other waivers beyond those granted with respect to California's GHG and ZEV program.

⁵⁵² EPA proposes to withdraw the waiver for these model years because these are the model years at issue in NHTSA's proposal. EPA solicits comment on whether one or more of the grounds supporting the proposed withdrawal of this waiver would also support withdrawing other waivers that it has previously granted.

conditions), EPA proposes to find that California does not need its GHG and ZEV standards to meet compelling and extraordinary conditions because those standards address environmental problems that are not particular or unique to California, that are not caused by emissions or other factors particular or unique to California, and for which the standards will not provide any remedy particular or unique to California.

Third, under section 209(b)(1)(C) (consistency with section 202(a)), EPA proposes to find that California's GHG and ZEV standards are inconsistent with section 202(a) because they are technologically infeasible in that they provide sufficient lead time to permit the development of necessary technology, giving appropriate consideration to compliance costs.⁵⁵³

EPA therefore proposes to make findings under sections 209(b)(1)(B) and (C), either of which, as discussed above, independently triggers the statutory prohibition that “no such waiver will be granted.”

In addition, EPA proposes to conclude that States may not adopt California's GHG standards pursuant to section 177 because the text, context, and purpose of section 177 support the conclusion that this provision is limited to providing States the ability, under certain circumstances and with certain conditions, to adopt and enforce standards designed to control criteria pollutants to address NAAQS nonattainment.

(2) History of Waiver for California GHG and ZEV Standards, and Associated Issues of Statutory Interpretation

In December 2005, California for the first time applied to EPA for a preemption waiver for GHG standards for MY 2009 and following. EPA denied this request in March 2008, relying on the second prong under section 209(b)(1)(B) and finding that California did not need those standards to meet compelling and extraordinary conditions. In doing so, it noted that GHG standards, unlike prior standards for which California had requested and received waivers, are designed to address *global* air pollution problems—not air pollution problems specific to California. 73 FR 12156, March 6, 2008.

⁵⁵³ Under section 209(b)(1)(C) of the CAA, EPA must deny California's waiver request if EPA finds that California's standards and accompanying enforcement procedures are not consistent with section 202(a). Section 202(a) provides that an emission standard shall take effect after such period of time as the Administrator finds necessary to permit development and application of the requisite technology, giving appropriate consideration to compliance costs.

Due to this new circumstance, EPA reconsidered its historic interpretation and application of section 209(b)(1)(B). Although today's proposal contains proposed findings under each prong of 209(b)(1), prong (B) was the only one at issue in the 2008 waiver denial (and EPA's subsequent reversal), and it merits extended discussion at the outset due to its central significance in the policy and legal context and the history underlying today's proposal.

As a general matter, EPA had historically interpreted section 209(b)(1)(B) to require EPA to consider whether, to meet compelling and extraordinary conditions in California, the state needs to have its own separate new motor vehicle program *in the aggregate*.⁵⁵⁴ Under this historical approach, EPA considered California's need for a separate program as a whole, rather than California's need for the particular aspect of the program for which California sought a waiver in any particular instance. (Typically, prior to its ACC program waiver request, California would seek a waiver for only particular aspects of its new motor vehicle program.) In the 2008 GHG waiver denial, EPA determined that this interpretation was inappropriate under the circumstances.

In its 2008 waiver denial, EPA proceeded under two alternative constructions of the statute. Under both of these constructions, EPA determined that it was a reasonable interpretation of section 209(b)(1)(B) to require a separate review of California's need for standards designed to address a global air pollution problem and its effects, as distinct from other portions of California's new motor vehicle program, which up until then had been designed to address local or regional air pollution problems.⁵⁵⁵ Under the first construction, EPA found it relevant that elevated GHG concentrations in California were similar to concentrations found elsewhere in the world, and that local conditions in California, such as the local topography, the local climate, and the significant number of motor vehicles in California, were not the determining factors causing the elevated GHG concentrations found in California and elsewhere. In sum, EPA found that California did not need its GHG standards to meet "compelling and extraordinary conditions"—interpreting "compelling and extraordinary

conditions" to mean environmental problems with *causes* that were specific to California—given that those standards were designed to address global air pollution problems as compared to local or regional air pollution problems caused specifically by certain conditions in California.

EPA in the 2008 waiver denial also applied a second, alternative construction of section 209(b)(1)(B). Under this alternative construction, EPA considered whether the impacts of climate change in California were sufficiently different enough from the impacts felt in the rest of the country such that California could be considered to need its GHG standards to meet compelling and extraordinary conditions—interpreting "compelling and extraordinary conditions" to mean environmental *effects* specific to California.

The next year, following a presidential election and change in administration, EPA reconsidered the 2008 denial at California's request. On reconsideration, EPA reversed course and granted a waiver for California's GHG standards. 74 FR 32744 (July 9, 2009). In granting the waiver, EPA reverted to its historical interpretation of section 209(b)(1)(B), under which it had construed "compelling and extraordinary conditions" to mean environmental problems caused by conditions specific to California and/or effects experienced to a unique degree or in a unique manner in California, and under which it had evaluated California's need for its own, separate new motor vehicle program as a whole, rather than California's need for the specific aspects of its separate program for which it was seeking a waiver. In reverting to this determination, the EPA necessarily determined that it makes no difference whether California seeks a waiver to implement separate standards in response to its own specific, local air pollution problems, or whether California seeks a waiver to implement separate standards designed to address a global air pollution problem.

Since 2009, EPA has continued to adhere to this interpretation and application of section 209(b)(1)(B) when reviewing CARB's waiver requests, regardless of whether the waiver was requested with regard to standards designed to address traditional, local environmental problems, or global climate issues. In this proposal, the EPA proposes to determine that this reversion to the pre-2008 interpretation was not appropriate.

On January 9, 2013, EPA granted CARB's request for a waiver of preemption to enforce its ACC program

regulations pursuant to CAA section 209(b). 78 FR 2112. The ACC program is a single coordinated package comprising regulations for ZEV and low-emission vehicles (LEV) regulations,⁵⁵⁶ for new passenger cars, light-duty trucks, medium-duty passenger vehicles, and certain heavy-duty vehicles, for MY 2015 through 2025. Thus, in terms of proportion, the ACC program is comparable to the combined Federal Tier 3 Motor Vehicle Emissions Standards *and* the 2017 and later MY Light-duty Vehicle GHG Standards.⁵⁵⁷ According to CARB, the ACC program was intended to address California's near and long-term smog issues as well as certain specific GHG emission reduction goals.⁵⁵⁸ 78 FR 2114. See also 78 FR 2122, 2130–31.

The ACC program regulations impose multiple and varying complex compliance obligations that have simultaneous, and sometimes overlapping, deadlines with each

⁵⁵⁶ The LEV regulations in question include standards for both GHG and criteria pollutants (including ozone and PM). Amendments for the LEV III program included replacement of separate nonmethane organic gas (NMOG) and oxides of nitrogen (NO_x) standards with combined NMOG plus NO_x standards, which provides automobile manufacturers with additional flexibility in meeting the new stringent standards; an increase of full useful life durability requirements from 120,000 miles to 150,000 miles, which guarantees vehicles sustain these extremely low emission levels longer; a backstop to assure continued production of super-ultra-low-emission vehicles after partial-zero-emission vehicles (PZEVs) as a category are moved from the ZEV regulations to the LEV regulations in 2018; more stringent particulate matter (PM) standards for light- and medium-duty vehicles, which will reduce the health effects and premature deaths associated with these emissions; zero fuel evaporative emission standards for PCs and LDTs, and more stringent standards for medium- and heavy-duty vehicles (MDVs); and, more stringent supplemental federal test procedure (SFTP) standards for PC and LDTs, which reflect more aggressive real world driving and, for the first time, require MDVs to meet SFTP standards. 78 FR 2114.

⁵⁵⁷ 78 FR 23641, April 22, 2016; 77 FR 62624, October 15, 2012.

⁵⁵⁸ "The Advanced Clean Cars program . . . will reduce criteria pollutants . . . and . . . help achieve attainment of air quality standards; The Advanced Clean Cars Program will also reduce greenhouse gases emissions as follows: by 2025, CO₂ equivalent emissions will be reduced by 13 million metric tons (MMT) per year, which is 12 percent from base line levels; the reduction increases in 2035 to 31 MMT/year, a 27 percent reduction from baseline levels; by 2050, the proposed regulation would reduce emissions by more than 40 MMT/year, a reduction of 33 percent from baseline levels; and viewed cumulatively over the life of the regulation (2017–2050), the proposed Advanced Clean Cars regulation will reduce by more than 850 MMT CO₂-equivalent, which will help achieve the State's climate change goals to reduce the threat that climate change poses to California's public health, water resources, agriculture industry, ecology and economy." 78 FR 2114. CARB Resolution 12–11, at 19, (January 26, 2012), available in the docket for the January 2013 waiver action, Document No. EPA–HQ–OAR–2012–0562, the docket for the ACC program waiver.

⁵⁵⁴ See, e.g., 49 FR 18887 (May 3, 1984).

⁵⁵⁵ Criteria pollutants generally present public health and environmental concern in proportion to their ambient local concentration and California has long had unusually severe problems in this regard.

standard. These deadlines began in 2015 and are scheduled to be phased in through 2025. For example, compliance with the GHG requirements began in 2017 and will be phased-in through 2025. The implementation schedule and the interrelationship of regulatory provisions with each of the three standards together demonstrates that CARB intended that at least the GHG and ZEV standards, if not also the LEV standards, would be implemented as a cohesive program. For example, in its ACC waiver request, CARB stated that the “ZEV regulation must be considered in conjunction with the proposed LEV III amendments. Vehicles produced as a result of the ZEV regulation are part of a manufacturer’s light-duty fleet and are therefore included when calculating fleet averages for compliance with the LEV III GHG amendments.” CARB’s Initial Statement of Reasons at 62–63.⁵⁵⁹ CARB also noted “[b]ecause the ZEVs have ultra-low GHG emission levels that are far lower than non-ZEV technology, they are a critical component of automakers’ LEV III GHG standard compliance strategies.” *Id.* CARB further explained that “the ultra-low GHG ZEV technology is a major component of compliance with the LEV III GHG fleet standards for the overall light duty fleet.” *Id.* CARB’s request also repeatedly touted the GHG emissions benefits of the ACC program.

Up until the ACC program waiver request, CARB had relied on the ZEV requirements as a compliance option for reducing criteria pollutants. Specifically, California first included the ZEV requirement as part of its first LEV program, which was then known as LEV I, that mandated a ZEV sales requirement that phased-in starting with the 1998 MY through 2003 MY. EPA issued a waiver of preemption for these regulations on January 13, 1993 (58 FR 4166 (January 13, 1993)). Since this initial waiver of preemption, California has made multiple amendments to the ZEV requirements and EPA has subsequently granted waivers for those amendments. In the ACC program waiver request California also included a waiver of preemption request for ZEV amendments that related to 2012 MY through 2017 MY and imposed new requirements for 2018 MY through 2025 MY (78 FR 2118–9). Regarding the ACC program ZEV requirements, CARB’s waiver request noted that there was no criteria emissions benefit in terms of vehicle (tank-to-wheel—TTW) emissions because its LEV III criteria

pollutant fleet standard was responsible for those emission reductions.⁵⁶⁰ CARB further noted that its ZEV regulation was intended to focus primarily on zero emission drive—that is, battery electric (BEVs), plug-in hybrid electric vehicles (PHEVs), and hydrogen fuel cell vehicles (FCVs)—in order to move advanced, low GHG vehicles from demonstration phase to commercialization (78 FR 2122, 2130–31). Specifically, for 2018 MY through 2025 MY, the ACC program ZEV requirements mandate use of technologies such as BEVs, PHEVs and FCVs, in up to 15% of a manufacturer’s California fleet and in each of the section 177 States by MY 2025⁵⁶¹ (78 FR 2114). Additionally, the ACC program regulations provide various compliance flexibilities allowing for substitution of compliance with one program requirement for another. For instance, manufacturers may opt to over-comply with the GHG fleet standard in order to offset a portion of their ZEV compliance requirement for MY 2018 through 2021. Further, until MY 2018, sales of BEVs (since MY 2018, limited to FCVs) in California count toward a manufacturer’s credit requirement in section 177 States. This is known as the “travel provision” (78 FR 2120).⁵⁶² For their part, the GHG emission regulations include an optional compliance provision that allows manufacturers to demonstrate compliance with CARB’s GHG standards by complying with applicable Federal GHG standards. This is known as the “deemed to comply” provision.⁵⁶³ A complete description of

⁵⁶⁰ CARB ACC waiver request at EPA–HQ–OAR–2012–0562–0004.

⁵⁶¹ Under section 177, any State that has state implementation plan provisions approved under part D of Subchapter I of the Act may opt to adopt and enforce standards that are identical to standards for which EPA has granted a waiver of preemption to California under CAA section 209(b). EPA’s longstanding interpretation of section 209(b) and its relationship with section 177 is that it is not appropriate under section 209(b)(1)(C) to review California regulations, submitted by CARB, through the prism of adopted or potentially adopted regulations by section 177 States.

⁵⁶² On March 11, 2013, the Association of Global Automakers and Alliance of Automobile Manufacturers filed a petition for reconsideration of the January 2013 waiver grant, requesting that EPA reconsider the decision to grant a waiver for MYs 2018 through 2025 ZEV standards on technological feasibility grounds. Petitioners also asked for consideration of the impact of the travel provision, which they argue raise technological feasibility issues in section 177 States, as part of the agency’s review under section 209(b)(1)(C). EPA continues to evaluate the petition.

⁵⁶³ On May 7, 2018, California issued a notice seeking comments on “potential alternatives to a potential clarification” of this provision for MY vehicles that would be affected by revisions to the Federal GHG standards. The notice is available at

the ACC program can be found in CARB’s waiver request, located in the docket for the January 2013 waiver action, Docket No. EPA–HQ–OAR–2012–0562.

2. Statutory Provisions Applicable to the Proposed Action

Under section 209(b) of the Clean Air Act, EPA may reconsider a grant of a waiver of preemption and withdraw same if the Administrator makes any one of the three findings in section 209(b)(1)(A), (B) and (C). EPA’s authority to reconsider and withdraw the grant of a waiver for the ACC program is implicit in section 209(b) given that the authority to revoke a grant of authority is implied in the authority for such a grant. Further support for EPA’s authority is based on the legislative history for section 209(b), and the judicial principle that agencies possess inherent authority to reconsider their decisions.⁵⁶⁴ The legislative history from the 1967 CAA amendments where Congress enacted the provisions now codified in section 209(a) and (b) provides support for this view. The Administrator has “the right . . . to withdraw the waiver at any time [if] after notice and an opportunity for public hearing he finds that the State of California no longer complies with the conditions of the waiver.” S. Rep. No. 50–403, at 34 (1967). Additionally, subject to certain limitations, administrative agencies possess inherent authority to reconsider their decisions in response to changed circumstances. It is well settled that EPA has inherent authority to reconsider, revise, or repeal past decisions to the extent permitted by law so long as the Agency provides a reasoned explanation. This authority exists in part because EPA’s interpretations of the statutes it administers “are not carved in stone.” *Chevron U.S.A. Inc. v. NRDC, Inc.*, 467 U.S. 837, 863 (1984). An agency “must consider varying interpretations and the wisdom of its policy on a continuing basis.” *Id.* at 863–64. This is true when, as is the case here, review is undertaken “in response to . . . a change in administration.” *National Cable & Telecommunications Ass’n v. Brand X internet Services*, 545 U.S. 967, 981 (2005). The EPA must also be cognizant

https://www.arb.ca.gov/msprog/levprog/leviii/leviii_dtc_notice05072018.pdf.

⁵⁶⁴ In 2009, EPA reconsidered the 2008 GHG waiver denial at CARB’s request and granted it upon reconsideration. 72 FR 32744. The EPA noted the authority to “withdraw a waiver in the future if circumstances make such action appropriate.” See 74 FR 32780 n.222; see also 32752–53 n.50 (citing 50 S. Rep. No. 403, at 33–34), 32755 n.74.

⁵⁵⁹ Available in the docket for the January 2013 waiver decision, Docket No. EPA–HQ–OAR–2012–0562.

where it is changing a prior position and articulate a reasoned basis for the change. *FCC v. Fox Television Stations, Inc.*, 556 U.S. 502, 515 (2009). This proposal reflects changed circumstances that have arisen since the initial grant of the 2013 ACC program waiver of preemption. They include the agency's reconsideration of California's record support for, and EPA's decision and underlying statutory interpretation on, California's need for GHG and ZEV standards, as well as costs and technological feasibility considerations that differ from California's assumptions and which were bases for agency conclusions that were made at that time.

When California submits a package of standards for EPA review pursuant to CAA section 209, EPA has long interpreted the statute as authorizing EPA to approve certain provisions and defer action on others. EPA believes this approach of partially approving submissions is implicit in section 209, particularly given the fact that EPA's evaluation of the technological feasibility of standards is best understood as in effect an evaluation of each standard for each year (*i.e.*, standards that are submitted together may vary substantially in their effect and some may require longer lead time than others). Furthermore, since California always retains the authority as a matter of state law to determine whether to implement state standards for which a waiver of preemption has been granted, we do not believe this approach poses the risk that a partial approval could force California to implement a program they would not have chosen had they anticipated EPA's decision. EPA believes that because its authority to grant waivers of preemption is best understood as applying on a granular level—where the feasibility of compliance for a particular year can be assessed—rather than being limited to approving or disapproving preemption for an entire package of standards submitted together, it follows that EPA's authority to withdraw the grant of waiver of preemption should also apply on a granular level, *i.e.*, for any model year for which EPA concludes the conditions for waiver of preemption no longer exist or for which it concludes that it erred in its prior determination that one of the conditions triggering a denial a waiver was not met. Further, because neither the Clean Air Act nor the Administrative Procedure Act specify deadlines for reconsideration of agency action, EPA may, issue a new final action to change a prior action,

taking into account statutory mandates and any applicable court orders.⁵⁶⁵

EPA is proposing to withdraw the grant of a waiver of preemption for California to enforce the GHG and ZEV standards of the ACC program for MY 2021–2025. EPA proposes to withdraw due to separate proposed findings under section 209(b)(1)(B), and (C).⁵⁶⁶

Under section 209(b)(1)(B), EPA is proposing to find that California does not need its ZEV and GHG standards to meet compelling and extraordinary conditions in California. EPA is proposing to find that CARB does not need its own GHG and ZEV standards to meet compelling and extraordinary conditions in California given that “compelling and extraordinary conditions” mean environmental problems with causes and effects in California whereas GHG emissions present global air pollution problems. Additionally, California does not need the ZEV requirements to meet “compelling and extraordinary” conditions in California given that it allows manufacturers to generate credits in section 177 states as a means to satisfy those manufacturers' obligations to comply with the mandate that a certain percentage of their vehicles sold in California be ZEV (or be credited as such from sales in section 177 States).

Under section 209(b)(1)(C), EPA is proposing to find that CARB's GHG and ZEV standards are not consistent with section 202(a) based on changed circumstances since the January 2013 waiver. Specifically, the agency is, in this action, jointly proposing with NHTSA revisions to the Federal GHG and fuel economy standards based on proposed conclusions that the current (or augural) standards for MY 2021 through 2025 are not feasible. The proposed findings in this notice call into question CARB's projections and assumptions that underlay the technological feasibility findings for its waiver application for the GHG standards and thus the technological findings made by EPA in 2013 in connection with the grant of the waiver for the ACC program.

Similarly, with regard to ZEV standards, this notice also raises

⁵⁶⁵ On March 11, 2013, EPA received a petition for reconsideration from the Association of Global Automakers and Alliance of Automobile Manufacturers of the decision to grant a waiver for MYs 2018 through 2025 ZEV standards.

⁵⁶⁶ Under this provision, a waiver is not permitted if (A) the protectiveness determination of the State is arbitrary and capricious; (B) the State does not need such State standards to meet compelling and extraordinary conditions; or (C) such State standards and accompanying enforcement procedures are not consistent with section 202(a) of the Act.

questions as to CARB's technological projections for ZEV-type technologies, which are a compliance option for both the ZEV mandate and GHG standards. As also previously discussed, above, CARB's ZEV regulations include the travel provision, which previously allowed manufacturers to earn credit for ZEVs sold in California (which, despite very slow ZEV sales, far outpaces any other State in these sales) to comply with credit requirements in section 177 States. Starting with MY 2018, this provision only applies to FCVs. When the travel provision was adopted, it was anticipated that by MY 2018, incentives of this type for BEV sales would no longer be necessary—*i.e.*, that consumers would adopt such vehicles on their own. Unfortunately, there has been a serious lack of market penetration, consumer demand levels, and lack of or slow development of necessary infrastructure for any ZEVs—BEV or otherwise—in such States. This in turn means that manufacturers' sales of ZEVs in section 177 States are unlikely, contrary to CARB's projections in its submissions to support its application for the ACC waiver, to generate sufficient credits to satisfy those manufacturers' obligations to comply with the mandate that a certain percentage of their vehicles sold in California be ZEV (or be credited as such from sales in section 177 States). In short, EPA is now of the view that CARB's projections and assumptions at the time of the waiver request were overly ambitious and likely will not be realized within the provided lead time. Thus, EPA is also proposing to find that CARB's ZEV standards for MY 2021 through 2025, and the GHG standards which rely on the ZEV requirement as a compliance option, are technologically infeasible and therefore, not consistent with section 209(b)(1)(C).

As described above, EPA is proposing to withdraw the waiver with respect to California's ZEV standards based on findings made pursuant to sections 209(b)(1)(B) and 209(b)(1)(C). EPA is proposing to withdraw the waiver with respect to California's GHG standards based on findings made under these three prongs as well as a separate finding made under section 209(b)(1)(B). Additionally, because the ZEV and GHG standards are closely interrelated, as demonstrated by the description above of their complex, overlapping compliance regimes, EPA is proposing to withdraw the waiver of preemption for ZEV standards under the second and third prongs of section 209(b)(1).

EPA believes that a finding made pursuant to any of the prongs of section 209(b)(1) is an independent and

adequate ground to withdraw the waiver. In this regard, EPA notes that the statute provides that “No such waiver shall be granted if the Administrator finds that—(B) the State does not need such State standards to meet compelling and extraordinary conditions; or (C) such State standards and accompanying enforcement procedures are not consistent with section 202(a) of the Act.” (Emphasis added.) Consequently, a final waiver withdrawal decision that relies on more than one of these provisions would present independent and severable bases for the decision to withdraw. And, separate and apart from its analysis under 209(b)(1)(A)–(C), EPA proposes to determine that if NHTSA finalizes its proposed determination that EPCA preempts California’s standards, that would provide an independent and adequate ground to withdraw the waiver for those standards. EPA proposes to interpret section 209(b)(1) to only authorize it to waive CAA preemption for standards that are not independently preempted by EPCA.

Additionally, under CAA section 177, States that have designated nonattainment areas may opt to adopt and enforce standards that are identical to standards for which EPA has granted a waiver of preemption to California under CAA section 209(b). For States that have adopted the ZEV standards, the consequence of any final withdrawal action would be that they cannot implement these standards. (A State may not “make attempt[s] to enforce” California standards for which EPA has not waived preemption. *Motor Vehicle Mfrs. Ass’n v. NYS Dep. of Env’tl Conservation*, 17 F.3d 521, 534 (2d Cir. 1994)). Where states have adopted CARB’s ZEV and GHG standards into their SIPs, under section 177, the provisions of the SIP would continue to be enforceable until revised. If this proposal is finalized, EPA may subsequently consider whether to employ the appropriate provisions of the CAA to identify provisions in section 177 states’ SIPs that may require amendment and to require submission of such amendments.

EPA is taking comments on all aspects of this proposal.

(a) Burden and Standard of Proof in Waiver Decisions

Here, the Administrator is proposing the withdrawal of a previously granted waiver of preemption. As discussed in section III.A. below, EPA proposes to find that there is clear and compelling evidence that California’s protectiveness determination for its ZEV and GHG standards was arbitrary and capricious.

Motor and Equip. Mfrs. Ass’n v. EPA, 627 F.2d 1095, 1112 (D.C. Cir. 1979) (*MEMA I*). Additionally, as discussed in section III.B, below, EPA proposes to find that there is clear and compelling evidence that California does not need its ZEV and GHG standards to meet compelling and extraordinary conditions. Similarly, as discussed in section III.C, below, there is clear and compelling evidence that both the ZEV and GHG standards are not technologically feasible.⁵⁶⁷

In *MEMA I*, 627 F.2d 1095, the U.S. Court of Appeals for D.C. Circuit found that “the burden of proving [that California’s regulations do not comply with the CAA] is on whoever attacks them. California must present its regulations and findings at the hearing and thereafter the parties opposing the waiver request bear the burden of persuading the Administrator that the waiver request should be denied.”⁵⁶⁸

MEMA I dealt with a challenge brought by Motor and Equipment Manufacturers Association against EPA’s grant of a waiver of preemption for California’s accompanying enforcement procedures, which in this instance were vehicle in-use maintenance regulations. The specific challenge to EPA’s action contested EPA’s findings that section 209 allowed for a waiver of preemption for CARB’s in-use maintenance regulations. *MEMA I* also specifically considered the standards of proof for two findings that EPA must make in order to grant a waiver for an “accompanying enforcement procedure” (as opposed to standards): (1) Protectiveness in the aggregate and (2) consistency with section 202(a) findings. The court instructed that “the standard of proof must take account of the nature of the risk of error involved in any given decision, and it therefore varies with the finding involved. We need not decide how this standard operates in every waiver decision.”⁵⁶⁹

The court upheld the Agency’s position that denying a waiver required “clear and compelling evidence” to show that proposed enforcement procedures undermine the protectiveness of California’s standards.⁵⁷⁰ The court noted that this standard of proof “also accords with the congressional intent to provide

California with the broadest possible discretion in setting regulations it finds protective of the public health and welfare.”⁵⁷¹

With respect to the consistency finding, *MEMA I* did not articulate a standard of proof applicable to all proceedings but found that the opponents of the waiver were unable to meet their burden of proof even if the standard were a mere preponderance of the evidence.

As the agency has consistently explained, although *MEMA I* did not explicitly consider the standard of proof for “standards,” as compared to “accompanying enforcement procedures,” nothing in the opinion suggests that the court’s analysis would not apply with equal force to such determinations.⁵⁷² Moreover, the normal standard of proof in civil matters is a preponderance of the evidence. *International Harvester Co. v. Ruckelshaus*, 478 F.2d 615, 643 (D.C. Cir. 1979).

The role of the Administrator in considering California’s application for a preemption waiver is to make a reasonable evaluation of the information in the record in coming to the waiver decision. The Administrator is required to “consider all evidence that passes the threshold test of materiality and . . . thereafter assess such material evidence against a standard of proof to determine whether the parties favoring a denial of the waiver have shown that the factual circumstances exist in which Congress intended a denial of the waiver.”⁵⁷³

As the court in *MEMA I* stated, if the Administrator ignores evidence demonstrating that the waiver should not be granted, or if he seeks to overcome that evidence with unsupported assumptions of his own, he runs the risk of having his waiver decision set aside as “arbitrary and capricious.”⁵⁷⁴ Therefore, the Administrator’s burden is to act “reasonably.”⁵⁷⁵

The instant action involves a decision whether to withdraw a previous grant of a waiver of preemption as compared to the initial evaluation of and decision whether to grant a waiver request from California. Specifically, as discussed in Section III, below, EPA is proposing findings for the withdrawal of preemption for CARB’s ACC program under multiple criteria set out in section 209(b)(1). For example, EPA is proposing to withdraw the waiver based

⁵⁶⁷ EPA is assuming without agreeing that the burden of proof requires clear and compelling evidence but believes a preponderance of the evidence is the proper burden of proof. Regardless, EPA firmly believes that it has clear and compelling evidence to support the agency’s statutory findings.

⁵⁶⁸ *MEMA I*, 627 F.2d at 1122.

⁵⁶⁹ *Id.*

⁵⁷⁰ *Id.*

⁵⁷¹ *Id.*

⁵⁷² 74 FR 32748.

⁵⁷³ *MEMA I*, 627 F.2d at 1122.

⁵⁷⁴ *Id.* at 1126.

⁵⁷⁵ *Id.*

on considerations such as the nature of GHG concentrations as a global air pollution problem, rather than a regional or local air pollution problem, whether or not CARB's particular GHG standards actually would reduce GHG emissions in California, whether a waiver for CARB's GHG standards is permissible if those regulations are preempted by EPCA, and the effect of technological infeasibility for the 2012 Federal GHG standards for MY 2021–2025. *Natural Resources Defense Council v. EPA*, 655 F.2d 318, 331 (D.C. Cir. 1981) (“[T]here is *substantial room for deference* to the EPA’s expertise in projecting the likely course of [technological] development.”) (Emphasis added.) EPA believes that these are kinds of issues that extend well beyond the boundaries of California’s authority under section 209(b). EPA posits, therefore, that the decision to withdraw the waiver would warrant exercise of the Administrator’s judgment.

Furthermore, that decision entails matters not only of policy judgment but of statutory interpretation, chief among which is the question of what is the appropriate inquiry under section 209(b)(1) when the Administrator is faced with a request for a preemption waiver for standards designed to address a global environmental problem. EPA has previously expressed the view that certain waiver requests might call for the Administrator to exercise judgment in determining California’s need for particular standards, under section 209(b)(1)(B). Specifically, in the March 6, 2008 GHG waiver denial, EPA posited that it was neither required nor appropriate for the Agency to defer to California on the statutory interpretation of the Clean Air Act, including the issue of the confines or limits of state authority established by section 209(b)(1)(B), especially given that EPA’s evaluation of California’s request for a waiver to enforce GHG standards would relate to the limits of California’s authority to regulate GHG emissions from new motor vehicles, instead of particular regulatory provisions that California was seeking to enforce. There, EPA construed section 209(b)(1)(B) as calling for either a consideration of environmental problems with *causes* that were specific to California, or in the alternative, environmental *effects* specific to California in comparison to the rest of the nation. EPA further explained that this interpretation called for its own judgment because it necessitated a determination of whether elevated concentrations of GHGs lie within the

confines of state air pollution programs as covered by section 209(b)(1)(B). It would also be consistent with the GHG waiver denial for EPA to exercise its own judgment in making the requisite findings called for under section 209(b)(1)(B) in the instant action.

EPA is, thus, soliciting comments on the appropriate burden and standard of proof for withdrawing a previously issued waiver, taking into consideration that different approaches may apply to the various criteria of Section 209(b) and that EPA is not merely responsible for evaluating a request by California and comments thereon but is proposing withdrawal of a grant of preemption.

3. Discussion: Analysis Under Section 209(b)(1)(B), (C)

(a) Proposed Finding Under Section 209(b)(1)(B): California Does Not Need its Standards To Meet Compelling and Extraordinary Conditions

(1) Introduction

Section 209(b)(1)(B) provides that no waiver of section 209(a) preemption will be granted if the Administrator finds that California does not need “such standards to meet compelling and extraordinary conditions.” EPA is proposing to withdraw the grant of waiver of preemption for CARB’s GHG and ZEV standards for 2021 MY through 2025 MY based on a finding that California does not *need* these standards to meet *compelling and extraordinary conditions*, as contemplated under section 209(b)(1)(B). As shown below, EPA is proposing to determine that the ACC program GHG and ZEV standards are standards that would not meaningfully address global air pollution problems posed by GHG emissions in contrast to local or regional air pollution problem with causal ties to conditions in California. As also shown below, EPA is proposing to find that while potential conditions related to global climate change in California could be substantial, they are not sufficiently different from the potential conditions in the nation as a whole to justify separate state standards under CAA section 209(b)(1)(B). Moreover, the GHG and ZEV standards would not have a meaningful impact on the potential conditions related to global climate change. EPA is thus proposing to find that California does not *need* GHG standards to meet *compelling and extraordinary conditions*, as contemplated under section 209(b)(1)(B). Additionally, California does not need the ZEV requirements to meet “compelling and extraordinary” conditions in California given that it allows manufacturers to generate credits

in section 177 states as a means to satisfy those manufacturers’ obligations to comply with the mandate that a certain percentage of their vehicles sold in California be ZEV (or be credited as such from sales in section 177 States). This finding is premised on agency review of the interpretation and application of section 209(b)(1)(B) in the January 2013 ACC waiver request. Thus, EPA is required to articulate a reasoned basis for the change in its position. *FCC v. Fox Television Stations, Inc.*, 556 U.S. 502, 515 (2009).

(2) Historical Waiver Practices Under Section 209(b)(1)(B)

Up until the 2008 GHG waiver denial, EPA had interpreted section 209(b)(1)(B) as requiring a consideration of California’s need for a separate motor vehicle program designed to address local or regional air pollution problems and not whether the specific standard that is the subject of the waiver request is necessary to meet such conditions (73 FR 12156; March 6, 2008). Additionally, California typically would seek a waiver of particular aspects of its new motor vehicle program up until the ACC program waiver request. In the 2008 GHG waiver denial, which was a waiver request for only GHG emissions standards, however, EPA determined that its prior interpretation of section 209(b)(1)(B) was not appropriate for GHG standards because such standards are designed to address global air pollution problems in contrast to local or regional air pollution problems specific to and caused by conditions specific to California (73 FR 12156–60).

In the 2008 denial, EPA further explained that its previous reviews of California’s waiver request under section 209(b)(1)(B) had usually been cursory and undisputed, as the fundamental factors leading to California’s air pollution problems—geography, local climate conditions (like thermal inversions), significance of the motor vehicle population—had not changed over time and over different local and regional air pollutants. These fundamental factors applied similarly for all of California’s air pollution problems that are local or regional in nature.

In the 2008 denial, EPA noted that atmospheric concentrations of GHG are substantially uniform across the globe, based on their long atmospheric life and the resulting mixing in the atmosphere. Therefore, with regard to atmospheric GHG concentrations and their environmental effects, the California-specific causal factors that EPA had considered when reviewing previous waiver applications under section

209(b)(1)(B)—the geography and climate of California, and the large motor vehicle population in California, which were considered the fundamental causes of the air pollution in California—do not have the same relevance to the question at hand. The atmospheric concentration of GHG in California is not affected by the geography and climate of California. The long duration of these gases in the atmosphere means they are well-mixed throughout the global atmosphere, such that their concentrations over California and the U.S. are substantially the same as the global average. The number of motor vehicles in California, while still a notable percentage of the national total and still a notable source of GHG emissions in the State, is not a significant percentage of the global vehicle fleet and bears no closer relation to the levels of GHG in the atmosphere over California than any other comparable source or group of sources of GHG anywhere in the world. Emissions of greenhouse gases from California cars do not generally remain confined within California's local environment but instead become one part of the global pool of GHG emissions, with this global pool of emissions leading to a relatively homogenous concentration of GHG over the globe. Thus, the emissions of motor vehicles in California do not affect California's air pollution problem in any way different from emissions from vehicles and other pollution sources all around the world. Similarly, the emissions from California's cars do not only affect the atmosphere in California but in fact become one part of the global pool of GHG emissions that affect the atmosphere globally and are distributed throughout the world, resulting in basically a uniform global atmospheric concentration.

EPA then applied the reasoning laid out above to the GHG standards at issue in the 2008 waiver denial. Having limited the meaning of this provision to situations where the air pollution problem was local or regional in nature, EPA found that California's GHG standards did not meet this criterion.

In the 2008 waiver denial, EPA also applied an alternative interpretation where EPA would consider effects of the global air pollution problem in California in comparison to the effects on the rest of the country and again addressed the GHG standards separately from the rest of California's motor vehicle program. Under this alternative interpretation, EPA considered whether impacts of global climate change in California were sufficiently different from impacts on the rest of the country such that California could be considered

to need its GHG standards to meet compelling and extraordinary conditions. EPA determined that the waiver should be denied under this alternative interpretation as well.

(3) Interpretation of Section 209(b)(1)(B)

Under section 209(b)(1)(B), EPA cannot grant a waiver request if EPA finds that California “does not need such State standards to meet compelling and extraordinary conditions.” The statute does not define the phrase “compelling and extraordinary conditions,” and EPA considers the text of section 209(b)(1)(B), and in particular the meaning and scope of this phrase, to be ambiguous.

First, the provision is ambiguous with respect to the scope of EPA's analysis. It is unclear whether EPA is meant to evaluate the particular standard or standards at issue in the waiver request or all of California's standards in the aggregate. Section 209(b)(1)(B) references the need for “such State standards.” Section 209(b)(1)(B) does not specifically employ terms that could only be construed as calling for a standard-by-standard analysis or each individual standard. For example, it does not contain phrases such as “each State standard” or “the State standard.” Nor does the use of the plural term “standards” definitively answer the question of the proper scope of EPA's analysis, given that the variation in the use of singular and plural form of a word in the same law⁵⁷⁶ is often insignificant and a given waiver request typically encompasses multiple “standards.” Thus, while it is clear that “such State standards” refers at least to all of the standards that are the subject of the particular waiver request before the Administrator, that phrase can reasonably be considered as referring either to the standards in the entire California program, the program for similar vehicles, or the particular standards for which California is requesting a waiver under the pending request.

There are reasons to doubt that the phrase “such State standards” in section 209(b)(1)(B) is intended to refer to all standards in California's program, including all the standards it has historically adopted and obtained waivers for previously. The waiver under 209(b) is a waiver of, and is logically dependent on and presupposes the existence of, the prohibition under 209(a), which forbids (absent a waiver) any state to “adopt or attempt to enforce

any standard [singular] relating to the control of emissions from new motor vehicles or new motor vehicle engines subject to this part.” (Emphasis added.) States are forbidden from adopting a standard, singular; California requests waivers *seriatim* by submitting a standard or package of standards to EPA; follows that EPA considers those submissions as it receives them, individually, not in the aggregate with all standards for which it has previously granted waivers.

Furthermore, reading the phrase “such State standards” as requiring EPA always and only to consider California's entire program in the aggregate limits the application of the criterion. Once EPA had determined that California needed its very first set of submitted standards to meet extraordinary and compelling conditions, it is unclear that EPA would ever have the discretion to determine that California did not need any subsequent standards for which it sought a successive waiver—unless EPA is authorized to consider a later submission separate from its earlier finding. Moreover, up until the ACC program waiver request, California's waiver request involved individual standards or particular aspects of California's new motor vehicle program.⁵⁷⁷ As previously explained, however, the ACC waiver program could be considered as the entire new motor vehicle program for California given that it is a single coordinated program comprising a suite of standards that California intended to be a cohesive program for addressing emissions from a wide variety of vehicles, specifically, new passenger cars, light duty trucks, medium passenger vehicles, and certain heavy duty vehicles.

The application of the phrase “such State standards” to state standards in the aggregate may have appeared more reasonable in the context of, for example, the 1984 PM waiver request, as opposed to the present context, as it relates to an application for a waiver with regard to GHG and ZEV standards.⁵⁷⁸ In the 1984 request, the agency confronted the need for a reading of “such State standards” in section 209(b)(1)(B) that would be consistent with the State's “in the aggregate, at least as protective” finding under the root text of 209(b)(1),”

⁵⁷⁷ The 2009 and Subsequent MY GHG standards for New Motor Vehicles, 73 FR 12156 (March 6, 2008); The On-Board diagnostics system requirements (OBD II) 81 FR 78144 (November 7, 2016); The ZEV program regulations 76 FR 61096 (October 3, 2011); 71 FR 78190 (December 26, 2006)) and the Heavy-duty Truck idling requirements 77 FR 9239 (February 16, 2012).

⁵⁷⁸ 49 FR 18887 (May 3, 1984).

⁵⁷⁶ “Words [in Acts of Congress] importing the singular include and apply to several persons.” 1 U.S.C. 1.

because Congress explicitly allows California to adopt some standards that are less stringent than Federal standards. EPA explained that the phrase “in the aggregate” was specifically aimed at allowing California to adopt less stringent CO standards at the same time when California wanted to adopt NO_x standards that were tighter than the Federal NO_x standards, to address ozone problems.⁵⁷⁹ California reasoned that a relaxed CO standard would facilitate the technological feasibility of the desired more stringent NO_x standards. When evaluating that waiver request, EPA noted that it would be inconsistent for Congress to allow EPA to look at each air pollutant separately for purposes of determining compelling and extraordinary conditions for that air pollution problem, while at the same time allowing California to adopt standards for a particular air pollutant that was less stringent than the Federal standards for that same pollutant. EPA proposes to determine that the balance of textual, contextual, purposive, and legislative-history evidence at minimum supports the conclusion that it is ambiguous whether the Administrator may consider whether California needs the *particular* standard or standards under review to meet compelling and extraordinary conditions.

Second, the statute does not speak with precision as to the *substance* of EPA’s analysis. “Compelling and extraordinary conditions,” as the history of the 2008 waiver denial and 2009 reconsideration and grant narrated above demonstrates, is a phrase susceptible of multiple interpretations, particularly in the context of GHG emissions and associated, global environmental problems. EPA believes that the term “extraordinary” is most reasonably read to refer to circumstances that are specific to California and the term is reasonably interpreted to refer to circumstances that are primarily responsible for causing the air pollution problems that the standards are designed to address, such as thermal inversions resulting from California’s local geography and wind patterns. (Conditions that are similar on a global scale are not

“extraordinary,” especially where “extraordinary” conditions are a predicate for a local deviation from national standards.) Support for this interpretation can be found in pertinent legislative history that refers to California’s “peculiar local conditions” and “unique problems.” S. Rep. No. 403, 90th Cong. 1st Sess., at 32 (1967). This legislative history also indicates that California is to demonstrate “compelling and extraordinary circumstances *sufficiently different from the nation as a whole* to justify standards on automobile emissions which may, from time to time, need to be more stringent than national standards.” *Id.* (Emphasis added.) EPA believes this is evidence of Congressional intent that separate standards in California are justified only by a showing of particular circumstances in California that are different from circumstances in the nation as a whole to justify separate standards in California. EPA thus, reads the term “extraordinary” in this statutory context as referring primarily to factors that tend to produce higher levels of pollution: Geographical and climatic conditions (like thermal inversions) that in combination with large numbers and high concentrations of automobiles, create serious air pollution problems in California (73 FR 12156, 12159–60).

Additional relevant legislative history supports a decision to examine California’s need for GHG standards “in the context of global climate change.” *See, e.g.*, 73 FR 12161. Specifically, this legislative history demonstrates that Congress did not justify this provision based on the need for California to enact separate standards to address pollution problems of a more national or global nature. Rather relevant legislative history “indicates that Congress allowed waivers of preemption for California motor vehicle standards based on the particular effects of local conditions in California on the air pollution problems in California.” Congress discussed “the unique problems faced in California as a result of its climate and topography.” H.R. Rep. No. 728, 90th Cong. 1st Sess., at 21 (1967). *See also* Statement of Cong. Holifield (CA), 113 Cong. Rec. 30942–43 (1967). Congress also noted the large effect of local vehicle pollution on such local problems. *See, e.g.*, Statement of Cong. Bell (CA) 113 Cong. Rec. 30946. In particular, Congress focused on California’s smog problem, which is especially affected by local conditions and local pollution. *See* Statement of Cong. Smith (CA) 113 Cong. Rec. 30940–41 (1967); Statement of Cong.

Holifield (CA), *id.*, at 30942. *See also*, *MEMA I*, 627 F.2d at 1109 (noting the discussion of California’s “peculiar local conditions” in the legislative history).

The EPA thus, believes that it is appropriate, in evaluating California’s need for a waiver under section 209(b)(1)(B), to examine California’s program as a whole to the extent that the problem is designed to address local or regional air pollution problems, particularly in light of the fact that the State’s aggregate analysis under the root text of 209(1)(b)(1) is designed in part to permit California to adopt standards for some criteria pollutants that are less stringent than the Federal standards as a trade-off for standards for other criteria pollutants, where the levels of criteria pollutants addressed by California’s standards are caused by conditions specific to California, and contribute primarily to environmental effects that are specific to California. EPA could also review California’s GHG standards themselves even where, as in the instant ACC waiver package, the waiver request is for a single coordinated package of requirements and amendments that include standards designed to address global environmental effects caused by a globally distributed pollutant, such as GHGs as well as requirements for a compliance mechanism that could likely address both criteria pollutants and GHG emissions, which in this instance are the ZEV requirements. The EPA further notes that in keeping with its pre-2008 interpretation, its review of California’s ACC program request under section 209(b)(1)(B) was cursory and undisputed, given that view that the fundamental factors leading to California’s air pollution problems—geography, local climate conditions (like thermal inversions), significance of the motor vehicle population—had not changed over time and over different local and regional air pollutants. Additionally, as previously explained, up until the ACC program waiver, California had relied on the ZEV requirements as a compliance mechanism for criteria pollutants as compared to the ACC program, where CARB for the first time relied on it for GHG emissions reductions. Here, as previously explained, CARB specifically noted that that there was no criteria emissions benefit for its ZEV standards in terms of vehicle emissions because its LEV III criteria pollutant fleet standard was responsible for those emission

⁵⁷⁹ The intent of the 1977 amendment was to accommodate California’s particular concern with NO_x, which the State regards as a more serious threat to public health and welfare than carbon monoxide. California was eager to establish oxides of nitrogen standards considerably higher than applicable Federal standards, but technological developments posed the possibility that emission control devices could not be constructed to meet both the high California oxides of nitrogen standard and the high Federal carbon monoxide standard. *MEMA I*, 627 F.2d at 1110 n.32.

reductions.⁵⁸⁰ The EPA therefore, believes a review of the grant of the ACC program waiver and the agency reasoning underpinning the grant are appropriate at this time. As previously explained, an agency “must consider . . . the wisdom of its policy on a continuing basis.” *Chevron*, 467 U.S. at 863–64. This is true when, as is the case here, review is undertaken “in response to . . . a change in administration.” *Brand X Internet Services*, 545 U.S. at 981. In sum, EPA proposed to conclude that the pre-2008 interpretation of section 209(b)(1)(B) would allow for review of California’s GHG standards in themselves, given that the ACC program is a single coordinated motor vehicle emission control program that is designed to address both traditional, local environmental causes and effects (including via criteria pollutants) and global air pollution problems. Thus, EPA is proposing that at this time its review has led it to propose to determine that California does not need its own GHG and ZEV standards, to the extent California intended the ZEV requirements to serve as a compliance option for GHG standards, because GHG emissions do not present conditions specific to California—in the terms of the legislative history discussed above, GHG emissions do not present “unique problems” in California as compared to the whole country. As shown below, GHG emissions could be associated with potential adverse effects in California, but EPA does not believe that these would be sufficiently different from potential adverse effects in either coastal States like Florida, Massachusetts, and Louisiana or the nation as a whole, to constitute a “need” for separate state standards under section 209(b)(1)(B). EPA is of the view, therefore, that GHG emissions would not be associated with “peculiar local conditions” in California that Congress alluded to in promulgating section 209(b)(1)(B). In the alternative, EPA is proposing to determine that California does not need the ACC program GHG and ZEV standards to address compelling and extraordinary conditions, because they will not meaningfully address global air pollution problems like the kinds associated with GHG emissions and would not have any meaningful impact on potential adverse effects related to global climate change in California. As shown below, based on this reading of section 209(b)(1)(B), the agency is proposing to find that GHG emissions impacts cannot be considered

“compelling and extraordinary conditions” such that California “need[s]” separate GHG and ZEV standards for new motor vehicles for MY 2021 through MY 2025.

(4) Proposed Determination That California Does Not Need Its ACC Program Regulations To Meet Compelling and Extraordinary Conditions

EPA is proposing to withdraw the waiver of preemption of the GHG and ZEV standards on two alternative grounds: (1) California “does not need” the standards “to meet compelling and extraordinary conditions,” under section 209(b)(1)(B); (2) even if California does have compelling and extraordinary conditions in the context of global climate change, California does not “need” these standards under section 209(b)(1)(B) because they will not meaningfully address global air pollution problems of the sort associated with GHG emissions. EPA is interpreting section 209(b)(1)(B) to permit the Agency to specifically review California’s need for GHG standards—*i.e.*, standards for a globally distributed air pollutant which is of concern for its connection to global environmental effects—as opposed to reviewing California’s need for its motor vehicle program as a whole (including both its GHG-targeting and non-GHG-targeting components), in part because the rest of California’s ACC program consists of standards that are designed to address local or regional air pollution problems. Accordingly, EPA is proposing to find that GHG emitted by California motor vehicles become part of the global pool of GHG emissions that affect concentrations of GHGs on a uniform basis throughout the world. The local climate and topography in California have no significant impact on the long-term atmospheric concentrations of greenhouse gases in California. More importantly, California’s standards for GHG emissions (both the GHG and ZEV standards) would not materially affect global concentrations of GHG levels. Accordingly, even if EPA were to assume California had compelling and extraordinary conditions that were uniquely impacted by high levels of GHGs, California’s GHG and ZEV standards would not meaningfully address those concerns and conditions.

In the alternative, EPA believes that even if California has compelling and extraordinary conditions, California does not need these standards under section 209(b)(1)(B) because they will not meaningfully address global air pollution problems like the kinds associated with GHG emissions. EPA

believes that the number of motor vehicles in California bears no significant relationship to the levels of GHGs in California. This is because GHGs emissions from cars located in California are relatively small part of the global pool of GHG emissions. Thus, GHG emissions of motor vehicles in California do not affect California’s conditions related to global climate change in any way different from emissions from vehicles and other pollution sources all around the world. Similarly, the GHG emissions from cars in California become one part of the global pool of GHG emissions that affect the atmosphere globally and are distributed throughout the world, resulting in basically a uniform global atmospheric concentration. This is in contrast to the kinds of motor vehicle emissions normally associated with ozone levels, such as VOCs and NO_x, and the local climate and topography that in the past have led to the conclusion that California has the need for state standards to meet compelling and extraordinary conditions. Therefore, California does not need its GHG and ZEV standards to “meet” the conditions: a problem does not cause you to “need” something that would not meaningfully address the problem.

In justifying the need for its GHG standards, CARB extensively described climatic conditions in California. “Record-setting fires, deadly heat waves, destructive storm surges, loss of winter snowpack—California has experienced all of these in the past decade and will experience more in the coming decades. California’s climate—much of what makes the state so unique and prosperous—is already changing, and those changes will only accelerate and intensify in the future. Extreme weather will be increasingly common as a result of climate change. In California, extreme events such as floods, heat waves, droughts and severe storms will increase in frequency and intensity. Many of these extreme events have the potential to dramatically affect human health and well-being, critical infrastructure and natural systems” (78 FR 2129). CARB also provided a summary report on the third assessment from the California Climate Change Center (2012), which described dramatic sea level rises and increases in temperatures (78 FR 2129). These are similar, if not identical to, the justifications that EPA addressed and rejected in the 2008 GHG waiver denial. Notably, in the 2008 denial EPA observed that some of these events—increased temperatures, heat waves, sea level rises, wildfires—were also

⁵⁸⁰ CARB ACC waiver request at EPA–HQ–OAR–2012–0562–0004.

occurring across the U.S. (73 FR 12163, 12165–68). CARB further noted that the South Coast and San Joaquin Valley Air Basins continue to experience some of the worst air quality in the nation and continue to be in non-attainment with the PM and ozone national ambient air quality standards (78 FR 2128–9). The EPA has typically considered nonattainment air quality in California as falling within the purview of “compelling and extraordinary conditions.” California however, did not indicate how the GHG standards would help California in the attainment efforts for these areas. Moreover, as previously noted, the ACC ZEV requirements are intended in part as a GHG compliance mechanism for MYs 2018 through 2025.

EPA believes that any effects of global climate change would apply to the nation, indeed the world, in ways similar to the conditions noted in California.⁵⁸¹ For instance, California’s claims that it is uniquely susceptible to certain risks because it is a coastal State does not differentiate California from other coastal States such as Massachusetts, Florida, and Louisiana.⁵⁸² Any effects of global climate change (e.g. water supply issues, increases in wildfires, effects on agriculture) could certainly affect California. But those effects would also affect other parts of the United States. Many parts of the United States, especially western States, may have issues related to drinking water (e.g., increased salinity) and wildfires, and effects on agriculture; these occurrences are by no means limited to California. These are issues of national, indeed international, concern. Further, these are some of the effects that EPA considered as bases for the section 202(a) GHG endangerment finding, which was a prerequisite for the Federal GHG standards for motor vehicles.⁵⁸³ EPA has also previously opined that evaluation of whether California’s standards are necessary to meet compelling and extraordinary conditions is not contingent on or directly related to EPA’s cause or contribution finding for the section 202(a) GHG endangerment finding, which was a completely different

determination than whether California needs its mobile source pollution program to meet compelling and extraordinary conditions in California (79 FR 46256, 46262; August 7, 2014).

See also *Utility Air Regulatory Group v. EPA*, 134 S. Ct. 2427 (2014) (partially reversing the GHG “Tailoring” Rule on grounds that the section 202(a) endangerment finding for GHG emissions from motor vehicles did not compel regulation of all sources of GHG emissions under the Prevention of Significant Deterioration and Title V permit programs).

As also previously indicated, California is to demonstrate “compelling and extraordinary circumstances sufficiently different from the nation as a whole to justify standards on automobile emissions which may, from time to time, need to be more stringent than national standards.” S. Rep. No. 403, 90th Cong. 1st Sess., at 32 (1967). (Emphasis added.) EPA does not believe that these conditions, mentioned above, merit separate GHG standards in California. Rather, these effects, as previously explained, are widely shared and do not present “unique problems” with respect to the nature or degree of the effect California would experience. In sum, EPA finds that any effects of global climate change in California are not “extraordinary” as compared to the rest of the country. EPA is thus, proposing to find that CARB has not demonstrated that these negative impacts it attributes to global climate change are “extraordinary” to merit separate GHG and ZEV standards.

The ACC program waiver contained references to the potential GHG benefits or attributes of CARB’s GHG and ZEV standards program (78 FR 2114, 2130–2131). CARB repeatedly touted the benefits of both the ZEV and GHG standards as it related to the GHG emissions reductions in California. In one instance, CARB stated that the ACC program regulations for the 2017 through 2025 MYs were designed to respond to California’s identified goals of reducing GHG emissions to 80% below 1990 levels by 2050 and in the near term to reduce GHG levels to 1990 levels by 2020 (78 FR 2114, 2130–31). CARB’s Resolution 12–11, (January 26, 2012),⁵⁸⁴ In another instance, CARB noted that the ZEV regulation amendments were intended to focus primarily on zero emission drive—that is BEVs, FCVs, and PHEVs in order to move advanced, low GHG vehicles from

demonstration phase to commercialization (78 FR 2130). CARB further noted that “ZEVs have ultra-low GHG emission levels that are far lower than non-ZEV technology” (78 FR 2139). In yet another instance, CARB relied on conclusions from the September 2010 Joint Technical Assessment Report (TAR), which was developed by EPA, NHTSA, and CARB, on effects of the ZEV requirements on GHG standards. This report concluded that “electric drive vehicles including hybrid(s) . . . battery electric vehicles . . . plug-in hybrid(s) . . . and hydrogen fuel cell vehicles . . . can dramatically reduce petroleum consumption and GHG emissions compared to conventional technologies. The future rate of penetration of these technologies into the vehicle fleet is not only related to future GHG and corporate average fuel economy (CAFE) standards, but also to future reductions in HEV/PHEV/EV battery costs, [and] the overall performance and consumer demand for the advanced technologies” (78 FR 2142). But nowhere does CARB either show or purport to show a causal connection between its GHG standards and reducing any adverse effects of climate change in California. EPA does not believe that identifying methods for reducing GHG emissions and then noting the potential dangers of climate change are sufficient to demonstrate that California needs its standards to meet compelling and extraordinary circumstances as contemplated under section 209(b)(1)(B). California also does not need the ZEV requirements to meet “compelling and extraordinary” conditions in California given that the FCV “travel provision” allow manufacturers to generate credits in section 177 states as a means to satisfy those manufacturers’ obligations to comply with the mandate that a certain percentage of their vehicles sold in California be ZEV (or be credited as such from sales in section 177 States). In sum, California did not quantify and demonstrate climate benefits in California that may result from the GHG standards. EPA therefore, proposes to find that it is not appropriate to waive preemption for California to enforce its GHGs standards. EPA continues to believe that any problems related to atmospheric concentrations of GHG are global in nature and any reductions achieved as a result of California’s separate GHG standards will not accrue meaningful benefits to California. Thus, GHG emissions raise issues that do not bear the same causal link between local emissions and local benefits to health and welfare in California as do local or

⁵⁸¹ IPCC. 2015. Intergovernmental Panel on Climate Change (IPCC) Observed Climate Change Impacts Database, available at http://sedac.ipcc-data.org/ddc/observed_ar5/index.html.

⁵⁸² They are also similar to previous claims marshalled by Massachusetts over a decade ago. *Massachusetts v. EPA*, 549 U.S. 497, 522–24 (2007). According to Massachusetts, at the time, global sea levels rose between 10 and 20 centimeters over the 20th century as a result of global warming and had begun to swallow its coastal areas.

⁵⁸³ 74 FR 66496, 66517–19, 66533 (December 15, 2009).

⁵⁸⁴ Available in the docket for the January 2013 waiver decision, Docket No. EPA–HQ–OAR–2012–0562.

regional air pollution problems (such as criteria pollutants). EPA further finds that atmospheric concentrations of GHGs are not the kind of local or regional air pollution problem Congress intended to identify in the second criterion of section 209(b)(1)(B). These findings also apply to the ZEV provisions given that CARB, in a change from prior practice, and as previously explained, cited its ZEV standards as a means to reduce GHG emissions instead of criteria pollutants for MY 2021 through MY 2025. Thus, EPA is proposing to withdraw the waiver of preemption for the GHG and ZEV requirements for MYs 2021 through 2025 because California does not need these provisions to meet compelling and extraordinary conditions.

(b) Proposed Finding Under Section 209(b)(1)(C): California's Standards Are Not Consistent With Section 202(a)

(1) Introduction

Under section 209(b)(1)(C), EPA cannot grant a waiver request if EPA finds that California's "standards and accompanying enforcement procedures are not consistent with section 202(a) of the Act."⁵⁸⁵ The EPA is also proposing to find that both ZEV and GHG standards for new MY 2021 through 2025 are not consistent with Section 202(a) of the Clean Air Act, as contemplated by section 209(b)(1)(C). Specifically, EPA is proposing to determine that there is inadequate lead time to permit the development of technology necessary to meet those requirements, giving appropriate consideration to cost of compliance within the lead time provided in the 2013 waiver. This finding reflects the assessments in today's proposal on the technological feasibility of the Federal GHG standards for MY 2021 through 2025.⁵⁸⁶

As previously explained, the MY 2021 through 2025 Federal and CARB GHG standards were the results of collaboration between CARB and EPA. The respective standards are equally stringent and have the same lead time. (78 FR 2135) CARB's GHG standards

also rely on emerging technology that are similar to the ones for the Federal GHG standards, including ZEV-type technologies (78 FR 2136–7). Most importantly, CARB's feasibility finding, and EPA's decision to grant the waiver, noted a "deemed to comply" provision that allowed manufacturers of advanced technology vehicles to comply with CARB GHG standards through compliance with the Federal GHG standards as well as utilize the EPA accounting provisions for these vehicles (78 FR 2136). Revisions to the Federal GHG standards, in light of the technology development and availability assessment for those standards, would therefore, implicate the technological feasibility findings that served as the underpinning for EPA's grant of CARB's GHG standards waiver.

Further, because EPA believes that the ZEV and GHG standards are intertwined as shown in some of the program complexities discussed above, EPA believes that this provides further justification for withdrawing the waiver of preemption for both standards, under section 209(b)(1)(C). For example, in the waiver request CARB stated that the "ZEV regulation must be considered in conjunction with the proposed LEV III amendments. Vehicles produced as a result of the ZEV regulation are part of a manufacturer's light-duty fleet and are therefore included when calculating fleet averages for compliance with the LEV III GHG amendments." CARB's Initial Statement of Reasons at 62–63, which is in the docket for the waiver decision.⁵⁸⁷ CARB also noted "[b]ecause the ZEVs have ultra-low GHG emission levels that are far lower than non-ZEV technology, they are a critical component of automakers' LEV III GHG standard compliance strategies." *Id.* CARB further explained that "the ultra-low GHG ZEV technology is a major component of compliance with the LEV III GHG fleet standards for the overall light duty fleet." *Id.*

Similarly, with regard to CARB's ZEV standards, EPA is now cognizant that certain ZEV sales requirements mandated by CARB are technologically infeasible within the provided lead-time for purposes of CAA 209(b)(1)(C). Specifically, today's proposal also raises questions as to CARB's technological projections for ZEV-type technologies, which are a compliance option for both the ZEV mandate and GHG standards. CARB's ZEV regulations also include the travel provision, which allowed manufacturers of ZEVs sold in California to count toward compliance

in section 177 States, but which was limited to FCVs starting with MY 2018. The manufacturer credit system was premised on ever increasing numbers of ZEVs that would be sold in each of the section 177 States. Challenges for ZEVs in these States include lack of market penetration, consumer demand levels that are lower than projections at the time of the grant of the ACC waiver in 2013, and lack of or slow development of necessary infrastructure. This in turn means that manufacturers in section 177 States are unlikely to meet CARB's projections that their sales in those States will generate the necessary credits as CARB projected to support the ZEV sales requirement mandate in the lead time provided.

Today's proposal indicates challenges for the adoption of all ZEV technologies such as lack of required infrastructure and a lower level of consumer demand for FCVs in both California and individual section 177 States, and EPA believes it is now unlikely that manufacturers will be able to generate requisite credits in section 177 States in the lead time provided. In short, EPA is now of the view that CARB's projections and assumptions that underlay its ACC program and its 2013 waiver application were overly ambitious and likely will not be realized within the provided lead time. Thus, EPA is also proposing to find that CARB's ZEV standards for MY 2021 through 2025 are not technologically feasible and therefore, are not consistent with section 209(b)(1)(C).

(2) Historical Waiver Practices Under Section 209(b)(1)(C)

In prior waivers of Federal preemption, under section 209(b), EPA has explained that California's standards are not consistent with section 202(a) if there is inadequate lead time to permit the development of technology necessary to meet those requirements, given appropriate consideration to the cost of compliance within that time. California's accompanying enforcement procedures would also be inconsistent with section 202(a) if the Federal and California test procedures were inconsistent.

EPA also relies on two key decisions handed down by the U.S. Court of Appeals for the D.C. Circuit for guidance regarding the lead time requirements of section 202(a): *Natural Resources Defense Council v. EPA (NRDC)*, 655 F.2d 318 (D.C. Cir. 1981) (upholding EPA's lead time projections for emerging technologies as reasonable), and *International Harvester v. Ruckelshaus (International Harvester)*, 478 F.2d 615 (D.C. Cir. 1979)

⁵⁸⁵ Section 202(a) provides that an emission standard shall take effect after such period of time as the Administrator finds necessary to permit development and application of the requisite technology, giving appropriate consideration to compliance costs.

⁵⁸⁶ Although this section generally discusses the technological feasibility of CARB's GHG standards for MY 2021–2025, we believe the current Federal standards are sufficiently similar to (if not less stringent than) the current California standards to serve as an appropriate proxy for considering the technological feasibility of the current California standards. *Compare* Cal. Code Regs. Tit. 13, § 1961.3 with 40 CFR 89.1818–12.

⁵⁸⁷ Docket ID No. EPA-HQ-OAR-2012-0562.

(reversing EPA's refusal to extend compliance deadline where technology was presently available on grounds that hardship would likely result if it were a wrongful denial of compliance deadline extension.). EPA further notes the court's conclusion in *NRDC*.

Given this time frame [a 1980 decision on 1985 model year standards], we feel that there is *substantial room for deference* to the EPA's expertise in projecting the likely course of development. The essential question in this case is the pace of that development, and absent a revolution in the study of industry, defense of such a projection can never possess the inescapable logic of a mathematical deduction. We think that the EPA will have demonstrated the reasonableness of its basis for projection if it answers any theoretical objections to the [projected control technology], identifies the major steps necessary in refinement of the technology, and offers plausible reasons for believing that each of those steps can be completed in the time available.

NRDC, 655 F.2d at 331 (emphasis added).

With regard to appropriate lead time in the section 209(b) waiver context, EPA considers whether adequate control technology is presently available or already in existence and in use at the time CARB adopts standards for which it seeks a waiver. If adequate control technology is not presently available, EPA determines whether CARB has provided adequate lead time for the development and application of necessary technology prior to the effective date of applicable standards. As explained above, considerations under this criterion include adequacy of lead time, technological feasibility and costs as well as test procedures consistency. Notably, there are similar considerations for Federal standards setting under section 202(a). For example, in adopting the MY 2017 through 2025 GHG standards, section 202(a) required and EPA found in October 2012 that the MY 2017 through 2025 GHG standards are feasible in the lead time provided and that technology costs were reasonable (77 FR 62671–73; October 15, 2012). Even where technology is available, EPA can consider hardships that could result to manufacturers from either a short lead time or not granting a compliance extension. *International Harvester*, 478 F.2d at 626.

Where CARB relies on emerging technology (*i.e.*, where technology is unavailable at time of grant of waiver), EPA will review CARB's prediction of future technological developments and determine whether CARB has provided reasoned explanations for the time period selected. Any projections by CARB would have to be subject to

“restraints of reasonableness and does not open the door to crystal ball inquiry.” *NRDC v. EPA*, 655 F.2d at 329. “The Clean Air Act requires the EPA to look to the future in setting standards, but the agency must also provide a reasoned explanation of its basis for believing that its projection is reliable.” *Id.*

EPA will make a consistency finding where CARB provides for longer lead time in instances in of emerging or unavailable technology at the time CARB adopts its standards. In sum, EPA's review of CARB's technological feasibility involves both evaluations of predictions for future technological advances and presently available technology. EPA also believes that a longer lead time would allow CARB “modify its standards if the actual future course of technology diverges from expectation.” *Id.*

As previously mentioned above, costs considerations are also tied to the compliance timing for a particular standard and are thus, relevant for purposes of the consistency determination called for by the third waiver criterion under section 209(b)(1)(C). In evaluating compliance costs for CARB standards, EPA considers the actual cost of compliance in the time provided by applicable California regulations. Compliance costs “relates to the timing of standards and procedures.” *MEMA I*, 627 F.2d at 1118 (emphasis in original). Where technology is not presently available, EPA also considers the period necessary to permit development and application of the requisite technology.

In terms of waiver practice, EPA has previously taken the position that technology control costs must be excessive for EPA to find that California's standards are inconsistent with section 202(a).⁵⁸⁸ (*See MEMA I*, 627 F.2d at 1118 “Congress wanted to avoid undue economic disruption in the automotive manufacturing industry and also sought to avoid doubling or tripling of the cost of motor vehicles to purchasers.”) Consistent with this practice, in the ACC program waiver, EPA contended that control costs for the ZEV standards were “not excessive.” “Under EPA's traditional analysis of cost in the waiver context, because [an incremental cost of \$12,900 in MY 2020] does not represent a ‘doubling or tripling’ of the vehicle cost, such cost is not excessive nor does it represent an infeasible standard” (78 FR 2142). EPA now believes that its prior view that a

doubling or tripling of vehicle cost constitutes an excessive cost or represents an infeasible standard was incorrect. Such a bright line (and extreme) test is inappropriate. Instead, the agency should holistically consider whether technology control costs are infeasible by considering the availability of the technology, the reasonableness of costs associated with adopting it within the required lead time, and consumer acceptance.

(3) Interpretation of Section 209(b)(1)(C)

EPA cannot grant a waiver, under section 209(b)(1)(C), if California's “standards and accompanying enforcement procedures are not consistent with section [202(a)].” Relevant legislative history from the 1967 CAA amendments indicates that EPA is to grant a waiver unless it finds that there is “inadequate time to permit the development of the necessary technology given the cost of compliance within that time period.” This is similar to language found in section 202(a), which is discussed below. Additional relevant legislative history indicates that EPA is not to grant a waiver where “California standards are not consistent with the intent of section 202(a) of the Act, including economic practicability and technological feasibility.” The cross-reference to section 202(a) is an indication of the role EPA plays in reviewing California's waiver request under section 209(b)(1)(C).

With regard to section 202(a), standards promulgated under section 202(a)(1) “shall take effect after such period as the Administrator finds necessary to permit the development and application of the requisite technology, giving appropriate consideration to the cost of compliance within such period.” Section 202(a). Pertinent legislative history from the 1970 and 1977 amendments indicate that EPA “was expected to press for the development and application of improved technology rather than be limited by that which exists today.” S. Rep. No. 1196, 91st Cong., 2d Sess. 24 (1970); H.R. Rep. No. 294, 95th Cong., 1st Sess. 273 (1977). In sum, EPA believes that section 202(a) allows for a projection of lead time as to future technological developments.

(4) Proposed Finding That California's Standards Are Not Consistent With Section 202(a)

As previously mentioned, today's proposal now cast significant doubts on EPA's predictions for future and timely availability of emerging technologies for compliance with Federal GHG standards for MY 2021–2025. It highlights in

⁵⁸⁸ 74 FR 32744, 32774 (July 8, 2009); 47 FR 7306, 7309 (February 18, 1982); 46 FR 26371, 26373 (May 12, 1981), 43 FR 25735 (June 14, 1978).

particular challenges for ZEV-type technologies, such as BEVs and PHEVs, that California relied on as compliance options for the ZEV mandate requirements and GHG standards. As also previously mentioned CARB's GHG standards were developed jointly by EPA and CARB with the result that CARB's GHG standards share a similar structure with EPA GHG standards in terms of both lead time and stringency. For instance, the methodology and underlying data used by CARB to assess technologies and costs were similar to and, in many instances, the same as those used by EPA to assess the Federal GHG standards (78 FR 2136). Also, the technological feasibility analyses underlying CARB's standards were based on several emerging technologies similar to control technologies considered by EPA and NHTSA in evaluating Federal GHG standards for MYs 2021–2025. *Id.* Additionally, CARB's feasibility finding was premised on a finding of reduced compliance costs and flexibility because of the deemed to comply provisions, which allowed for compliance with Federal GHG standards in lieu of California's standards.⁵⁸⁹ In sum, EPA's findings of technological feasibility for the GHG and ZEV standards were premised on the availability of both current and emerging technologies in the lead-time CARB provided for new MY 2021–2025 motor vehicles (78 FR 2138–2139, 2143). These kinds of control technologies would include ZEV-type technologies, which are used as a compliance option for CARB's GHG standards because their GHG emissions levels are significantly lower than non-ZEV technology. As the NPRM

⁵⁸⁹ On May 7, 2018, California issued a notice seeking comments on “potential alternatives to a potential clarification” of this provision for MY vehicles that would be affected by revisions to the Federal GHG standards. The notice is available at: https://www.arb.ca.gov/msprog/levprog/leviii/leviii_dtc_notice05072018.pdf. EPA proposes to determine that the “deemed to comply” provision in California's program does not prevent EPA from finding that California's ZEV and GHG standards are inconsistent with section 202(a), for two reasons. First, the “deemed to comply” provision is in flux; the state process that may “clarify[]” it renders it unclear whether California will continue to deem a program that may be revised as proposed in this joint rulemaking to comply with its own program. Second, EPA proposes to determine that a “deemed to comply” provision is logically incompatible with a preemption waiver analysis. The entire premise of 209(a) preemption and 209(b)(1) waivers is that California's standards will differ from the Federal standards. If “deemed to comply” provisions in California's program prevented EPA from determining that California's standards are inconsistent with section 202(a), then those provisions' presence would prevent EPA's analysis under this prong (209(b)(1)(C)) from denying it a waiver no matter the content of those standards.

discusses, certain control technology would likely not be fully developed in time for deployment in MY 2021 through 2025 motor vehicles.

With regard to the ZEV standards, CARB's waiver request contained projections and explanations for ZEVs that included projected sales of FCVs in both California and section 177 States. Specifically, CARB's projections, at the time, were that nearly every vehicle manufacturer would be introducing BEVs and PHEVs within the next one to three years, and five manufacturers would be commercially introducing FCVs by 2015.⁵⁹⁰ As explained above, the ZEV regulations contains the travel provision that allow manufacturers to comply with the ZEV sales mandate by generating credits for vehicle sales in section 177 States and vice versa. At the grant of the ACC program waiver, EPA found CARB's assumptions and projections appeared reasonable within the provided lead time for MYs 2021 through 2025 (78 FR 2141–42).

Technological challenges may serve as basis for either a future compliance deadline extension or modifications to the federal GHG standards that would be consistent with today's proposal and would then raise questions as to CARB's predictions and projections of technological feasibility and costs. At this time, however, CARB has shown no indication that it intends to either extend the compliance deadline for or modify its standards by providing additional compliance flexibilities. EPA believes it is reasonable, therefore, to consider any expected hardship that would be posed to manufacturers if EPA does not withdraw CARB's waiver. *NRDC*, 655 F.2d at 330. An early withdrawal of the waiver would also provide a measure of certainty to all manufacturers. “[T]he base hour for commencement of production is relatively distant, and until that time the probable effect of a relaxation of the standard would be to mitigate the consequences of any strictness in the final rule, not to create new hardships.”⁵⁹¹ Further, from past experience with waivers for challenging standards, EPA is aware that CARB has subsequently either modified compliance deadlines or provided additional compliance flexibilities for such standards.⁵⁹² EPA also notes that

⁵⁹⁰ CARB waiver request at 27–28, which can be found in Docket ID No. EPA–HQ–OAR–2012–0562.

⁵⁹¹ *Id.* The “hardships” referred to are hardships that would be created for manufacturers able to comply with the more stringent standards being relaxed late in the process.

⁵⁹² For example, CARB has made multiple revisions to its on-Board diagnostics (OBD) (81 FR

even at the time of the waiver request, CARB was already cognizant of challenges presented by both ZEV and GHG standards. CARB noted that although several individual technologies offered substantial CO₂ reduction potential many of the technologies had only limited deployment in new vehicle models (78 FR 2136). CARB also extended the travel provisions beyond 2017 for FCVs due to insufficient refueling infrastructure in section 177 States as compared to other kinds of ZEV technologies (78 FR 2120; CARB Resolution 12–11 at 15). EPA is, therefore, acting in anticipation of the challenges presented by its GHG and ZEV standards. As previously explained, a late modification or extension of time carries attendant hardships for technologically advanced manufacturers who might have made major investment commitments (*International Harvester*, 478 F.2d 615). EPA believes that today's proposal, when finalized, would be sufficiently ahead of the compliance deadline for MY 2021 through 2025 and thus, manufacturers would not incur any hardships. Indeed, the expectation is that the proposed withdrawal would provide notice to manufacturers of the intended compliance deadline modifications for MYs 2021 through 2025.

Finally, the agency is acting on the likelihood of increased compliance costs as shown in today's proposal. (These are costs that will likely be passed on to consumers in most instances.) As previously explained, because compliance technologies that California relied on for both ZEV and GHG standards are similar to the technologies considered by EPA in evaluating the feasibility of standards for MYs 2021 through 2025, economies of scale were expected to drive down both manufacturing and technology costs. The EPA, however, now expects that manufacturers may no longer be willing to commit to investments for a limited market as compared to the broader national market, which was contemplated by the federal and California GHG standards.

Today's proposal also confirms slower pace of development of ZEV technology and differences in projected manufacturing costs in states that have adopted these standards under section 177 as well as lower consumer demands for FCVs. The EPA also now expects that the pace of technological developments as it relates to infrastructure for FCVs will slow down.

78144 (November 7, 2016)) and the ZEV program regulations (76 FR 61096 (October 3, 2011)).

The EPA is thus, proposing to find that CARB's ZEV standards for MYs 2021 through 2025 are technologically infeasible in the lead time provided and therefore, that CARB's ZEV standards are not consistent with section 202(a).

As previously mentioned EPA is proposing to withdraw the grant of waiver for both standards on grounds that they are not consistent with section 202(a). In light of all the foregoing, the agency finds that is necessary and reasonable to reconsider the grant of waiver for CARB's GHG and ZEV standards. EPA requests comments on all aspects of this proposal, especially specific costs for the ZEV requirements as it relates to MYs 2021 through 2025.

4. States Cannot Adopt California's GHG Standards for NAAQS Nonattainment Purposes Under Section 177

As explained above, CAA section 177 provides that other States, under certain circumstances and with certain conditions, may "adopt and enforce" standards that are "identical to the California standards for which a waiver has been granted for [a given] model year." 42 U.S.C. 7507. The EPA proposes to determine that this section does not apply to CARB's GHG standards.

In this regard, the EPA notes that the section is titled "New motor vehicle emission standards in nonattainment areas" and that its application is limited to "any State which has [state implementation] plan provisions approved under this part"—*i.e.*, under CAA title I part D, which governs "Plan requirements for nonattainment areas." Areas are only designated nonattainment with respect to criteria pollutants for which EPA has issued a NAAQS, and nonattainment SIPs are intended to assure that those areas attain the NAAQS. It would be illogical to require approved nonattainment SIP provisions as a predicate for allowing States to adopt California's standards if states could use this authority to adopt California standards that addressed environmental problems other than nonattainment of criteria pollutant standards. Furthermore, the placement of section 177 in title I part D, rather than title II (the location of the California waiver provision) would make no sense if it functioned as a waiver applicable to all subjects, as does the California-focused provision under section 209(b), rather than as a provision specifically targeting criteria pollutants and nonattainment areas, as does the rest of title I part D.

Therefore, the text, context, and purpose of section 177 suggest, and the EPA proposes to conclude, that it is

limited to providing States the ability, under certain circumstances and with certain conditions, to adopt and enforce standards identical to those for which California has obtained a waiver—provided that those standards are designed to control criteria pollutants to address NAAQS nonattainment. EPA solicits comment on how and when this new interpretation should be adopted and implemented, if finalized (*e.g.*, whether EPA should adopt it as of the effective date of a final rule, or as of a later date, such as model year 2021 or calendar year 2020, in order to allow additional time for planning and transition).

5. Severability and Judicial Review

EPA considers its proposed decision on the appropriate federal standards for light duty greenhouse gas vehicles for MY 2021–2025 to be severable from its decision on withdrawing the ACC waiver, particularly with respect to the requirements of CAA 209(b)(1)(B). Our proposed interpretation of CAA 209(b)(1)(B), and our evaluation of the ACC waiver under that provision, does not depend on our decision to finalize, and a court's decision to uphold, the light duty vehicles standards being proposed today under CAA 202(a). EPA solicits comment on the severability of these actions, particularly with respect to the other criteria of CAA 209(b).

Section 307(b)(1) of the CAA provides in which Federal courts of appeal petitions of review of final actions by EPA must be filed. This section provides, in part, that petitions for review must be filed in the Court of Appeals for the District of Columbia Circuit if (i) the Agency action consists of "nationally applicable regulations promulgated, or final action taken, by the Administrator," or (ii) such action is locally or regionally applicable, but "such action is based on a determination of nationwide scope or effect and if in taking such action the Administrator finds and publishes that such action is based on such a determination." Separate and apart from whether a court finds this action to be locally or regionally applicable, the Administrator is proposing to find that any final action resulting from this rulemaking is based on a determination of "nationwide scope or effect" within the meaning of section 307(b)(1).

This decision, when finalized, will affect persons in California and those manufacturers and/or owners/operators of new motor vehicles nationwide who must comply with California's new motor vehicle requirements. For instance, manufacturers may generate credits in section 177 states as a means

to satisfy those manufacturers' obligations to comply with the mandate that a certain percentage of their vehicles sold in California be ZEV (or be credited as such from sales in section 177 States). In addition, because other states have adopted aspects of California's ACC program this decision would also affect those states and those persons in such states, which are located in multiple EPA regions and federal circuits. For these reasons, EPA determines and finds for purposes of section 307(b)(1) that any final withdrawal action would be of national applicability, and also that such action would be based on a determination of nationwide scope or effect for purposes of section 307(b)(1). Pursuant to section 307(b)(1), judicial review of this final action may be sought only in the United States Court of Appeals for the District of Columbia Circuit. Judicial review of any final action may not be obtained in subsequent enforcement proceedings, pursuant to section 307(b)(2).

VII. Impacts of the Proposed CAFE and CO₂ Standards

A. Overview

New CAFE and CO₂ standards will have a range of impacts. EPCA/EISA and NEPA require DOT to consider such impacts when making decisions about new CAFE standards, and the CAA requires EPA to do so when making decisions about new emissions standards. Like past rulemakings, today's announcement is supported by the analysis of many potential impacts of new standards. Today's announcement proposes new standards through model year 2026, explicitly estimates manufacturers' responses to standards through model year 2029, and considers impacts, throughout those vehicles' useful lives. The agencies do not *know* today what would actually come to pass decades from now under the proposed standards or under any of alternatives under consideration. The analysis is thus properly interpreted not as a forecast, but rather as an assessment—reflecting the best judgments regarding many different factors—of impacts that *could* occur.⁵⁹³ As discussed below, the analysis was conducted to explore the sensitivity of this assessment to a variety of potential changes in key analytical inputs (*e.g.*, fuel prices).

This section summarizes various impacts of the preferred alternative (*i.e.*, the proposed standards) defined above in Section III. The no-action alternative

⁵⁹³ "Prediction is very difficult, especially if it's about the future." Attributed to Niels Bohr, Nobel laureate in Physics.

defined in Section IV provides the baseline relative to which all impacts are shown. Because the proposed standards (and other standards considered below), being of a “deregulatory” nature, are less stringent than the no-action alternative, all impacts are directionally opposite impacts reported in recent CAFE and CO₂ rulemakings. For example, while past rulemakings reported positive values for fuel consumption avoided under new standards, today’s proposal reports negative values, as fuel consumption will be somewhat greater under today’s proposed standards than under standards defining the baseline no-action alternative. Reported negative values for avoided fuel consumption could also be properly interpreted as simply “additional fuel consumption.” Similarly, reported negative values for costs could be properly interpreted as “avoided costs” or “benefits,” and reported negative values for benefits could be properly interpreted as “foregone benefits” or “costs.” However, today’s notice retains reporting conventions consistent with past rulemakings, anticipating that, compared to other options, doing so will facilitate review by most stakeholders.

Today’s analysis presents results for individual model years in two different ways. The first way is similar to past rulemakings and shows how manufacturers could respond in each model year under the proposed standards and each alternative covering MYs 2021/2–2026. The second, expanding on the information provided in past rulemakings, evaluates incremental impacts of new standards proposed for each model year, in turn. In past rulemaking analyses, NHTSA modeled year-by-year impacts under the aggregation of standards applied in all model years, and EPA modeled manufacturers’ hypothetical compliance with a single model years’ standards in that model year. Especially considering multiyear planning effects, neither approach provides a clear basis to attribute impacts to specific standards first introduced in each of a series of model years. For example, of the technology manufacturers applied in MY 2016, some would have been applied even under the MY 2014 standards, and some were likely applied to position manufacturers toward compliance with (including credit banking to be used toward) MY 2018 standards. Therefore, of the impacts attributable to the model year 2016 *fleet*, only a portion can be properly attributed to the MY 2016 *standards*, and the impacts of the MY 2016

standards involve fleets leading up and extending well beyond MY 2016. Considering this, the proposed standards were examined on an incremental basis, modeling each new model year’s standards over the entire span of included model years, using those results as a baseline relative to which to measure impacts attributable to the next model year’s standards. For example, incremental costs attributable to the standards proposed today for MY 2023 are calculated as follows:

$$COST_{Proposed,MY\ 2023} = (COST_{Proposed_through_MY\ 2023} - COST_{No-Action_through_MY\ 2023}) - (COST_{Proposed_through_MY\ 2022} - COST_{No-Action_through_MY\ 2022})$$

Where:

COST_{Proposed,MY 2023}: Incremental technology cost during MYs 2017–2030 and attributable to the standards proposed for MY 2023.

COST_{Proposed,through,MY 2022}: Technology cost for MYs 2017–2030 under standards proposed through MY 2022.

COST_{Proposed,through,MY 2023}: Technology cost for MYs 2017–2030 under standards proposed through MY 2023.

COST_{No-Action,through,MY 2022}: Technology cost for MYs 2017–2030 under no-action alternative standards through MY 2022.

COST_{No-Action,through,MY 2023}: Technology cost for MYs 2017–2030 under no-action alternative standards through MY 2023.

Additionally, today’s analysis includes impacts on new vehicle sales volumes and the use (*i.e.*, survival) of vehicles of all model years, such that standards introduced in a model year produce impacts attributable to vehicles having been in operation for some time. For example, as modeled here, standards for MY 2021 will impact the prices of new vehicles starting in MY 2017, and those price impacts will affect the survival of all vehicles still in operation in calendar years 2017 and beyond (*e.g.*, MY 2021 standards impact the operation of MY 2007 vehicles in calendar year 2027). Therefore, while past rulemaking analyses focused largely on impacts over the useful lives of the explicitly modeled fleets, much of today’s analysis considers all model years through 2029, as operated, throughout those vehicles’ useful lives. For some impacts, such as on technology penetration rates, average vehicle prices, and average vehicle ownership costs, the focus was on the useful life of the MY 2030 fleet, as the simulation of manufacturers’ technology application and credit use (when included in the analysis) continues to evolve after model year 2026, stabilizing by model year 2030.

Effects were evaluated from four perspectives: The social perspective, the manufacturer perspective, the private perspective, and the physical

perspective. The social perspective focuses on economic benefits and costs, setting aside economic transfers such as fuel taxes but including economic externalities such as the social cost of CO₂ emissions. The manufacturer perspective focuses on average requirements and levels of performance (*i.e.*, average fuel economy level and CO₂ emission rates), compliance costs, and degrees of technology application. The private perspective focuses on costs of vehicle purchase and ownership, including outlays for fuel (and fuel taxes). The physical perspective focuses on national-scale highway travel, fuel consumption, highway fatalities, and greenhouse gas and criteria pollutant emissions.

This analysis does not explicitly identify “co-benefits” from its proposed action to change fuel economy standards, as such a concept would include all benefits other than cost savings to vehicle buyers. Instead, it distinguishes between private benefits—which include economic impacts on vehicle manufacturers, buyers of new cars and light trucks, and owners (or users) of used cars and light trucks—and external benefits, which represent indirect benefits (or costs) to the remainder of the U.S. economy that stem from the proposal’s effects on the behavior of vehicle manufacturers, buyers, and users. In this accounting framework, changes in fuel use and safety impacts resulting from the proposal’s effects on the number of used vehicles in use represent an important component of its private benefits and costs, despite the fact that previous analyses have failed to recognize these effects. The agency’s presentation of private costs and benefits from its proposed action clearly distinguishes between those that would be experienced by owners and users of cars and light trucks produced during previous model years and those that would be experienced by buyers and users of cars and light trucks produced during the model years it would affect. Moreover, it clearly separates these into benefits related to fuel consumption and those related to safety consequences of vehicle use. This is more meaningful and informative than simply identifying all impacts other than changes in fuel savings to buyers of new vehicles as “co-benefits.”

For the social perspective, the following effects for model years through 2029 as operated throughout those vehicles’ useful lives are summarized:

- *Technology Costs*: Incremental cost, as expected to be paid by vehicle purchasers, of

fuel-saving technology beyond that added under the no-action alternative.

- *Welfare Loss*: Loss of value to vehicle owners resulting from incremental increases in the numbers of strong and plug-in hybrid electric vehicles (strong HEVs or SHEVs, and PHEVs) and/or battery electric vehicles (BEVs), beyond increases occurring under the no-action alternative. The loss of value is a function of the factors that lead to different valuations for conventional and electric versions of similar-size vehicles (e.g., differences in: travel range, recharging time versus refueling time, performance, and comfort).

- *Pre-tax Fuel Savings*: Incremental savings, beyond those achieved under the no-action alternative, in outlays for fuel purchases, setting aside fuel taxes.

- *Mobility Benefit*: Value of incremental travel, beyond that occurring under the no-action alternative.

- *Refueling Benefit*: Value of incremental reduction, compared to the no-action alternative, of time spent refueling vehicles.

- *Non-Rebound Fatality Costs*: Social value of additional fatalities, beyond those occurring under the no-action alternative, setting aside any additional travel attributable to the rebound effect.

- *Rebound Fatality Costs*: Social value of additional fatalities attributable to the rebound effect, beyond those occurring under the no-action alternative.

- *Benefits Offsetting Rebound Fatality Costs*: Assumed further value, offsetting rebound fatality costs, of additional travel attributed to the rebound effect.

- *Non-Rebound Non-Fatal Crash Costs*: Social value of additional crash-related losses (other than fatalities), beyond those occurring under the no-action alternative, setting aside any additional travel attributable to the rebound effect.

- *Rebound Non-Fatal Crash Costs*: Social value of additional crash-related losses (other than fatalities) attributable to the rebound effect, beyond those occurring under the no-action alternative.

- *Benefits Offsetting Rebound Non-Fatal Crash Costs*: Assumed further value, offsetting rebound non-fatal crash costs, of additional travel attributed to the rebound effect.

- *Additional Congestion and Noise (Costs)*: Value of additional congestion and noise resulting from incremental travel, beyond that occurring under the no-action alternative.

- *Energy Security Benefit*: Value of avoided economic exposure to petroleum price “shocks,” the avoided exposure resulting from incremental reduction of fuel consumption beyond that occurring under the no-action alternative.

- *Avoided CO₂ Damages (Benefits)*: Social value of incremental reduction of CO₂ emissions, compared to emissions occurring under the no-action alternative.

- *Other Avoided Pollutant Damages (Benefits)*: Social value of incremental reduction of criteria pollutant emissions, compared to emissions occurring under the no-action alternative.

- *Total Costs*: Sum of incremental technology costs, welfare loss, fatality costs,

non-fatal crash costs, and additional congestion and noise costs.

- *Total Benefits*: Sum of pretax fuel savings, mobility benefits, refueling benefits, Benefits Offsetting Rebound Fatality Costs, Benefits Offsetting Rebound Non-Fatal Crash Costs, energy security benefits, and benefits from reducing emissions of CO₂, other GHGs, and criteria pollutants.

- *Net Benefits*: Total benefits minus total costs.

- *Retrievable Electrification Costs*: The portion of HEV, PHEV, and BEV technology costs which can be passed onto consumers, using the willingness to pay analysis described above.

- *Electrification Tax Credits*: Estimates of the portion of HEV, PHEV, and BEV technology costs which are covered by federal or state tax incentives.

- *Irrecoverable Electrification Costs*: The portion of HEV, PHEV, and BEV technology costs OEM's must either absorb as a profit loss, or cross-subsidize with the prices of internal combustion engine (ICE) vehicles.

- *Total Electrification Costs*: Total incremental technology costs attributable to HEV, PHEV, or BEV vehicles.

For the manufacturer perspective, the following effects for the aggregation of model years 2017–2029 are summarized:

- *Average Required Fuel Economy*: Average of manufacturers' CAFE requirements for indicated fleet(s) and model year(s).

- *Percent Change in Stringency from Baseline*: Percentage difference between averages of fuel economy requirements under no-action and indicated alternatives.

- *Average Required Fuel Economy*: Industry-wide average of fuel economy levels achieved by indicated fleet(s) in indicated model year(s).

- *Percent Change in Stringency from Baseline*: Percentage difference between averages of fuel economy levels achieved under no-action and indicated alternatives.

- *Total Technology Costs (\$b)*: Cost of fuel-saving technology beyond that applied under no-action alternative.

- *Total Civil Penalties (\$b)*: Cost of civil penalties (for the CAFE program) beyond those levied under no-action alternative.

- *Total Regulatory Costs (\$b)*: Sum of technology costs and civil penalties.

- *Sales Change (millions)*: Change in number of vehicles produced for sale in U.S., relative to the number estimated to be produced under the no-action alternative.

- *Revenue Change (\$b)*: Change in total revenues from vehicle sales, relative to total revenues occurring under the no-action alternative.

- *Curb Weight Reduction*: Reduction of average curb weight, relative to MY 2016.

- *Technology Penetration Rates*: MY 2030 average technology penetration rate for indicated ten technologies (three engine technologies, advanced transmissions, and six degrees of electrification).

- *Average Required CO₂*: Average of manufacturers' CO₂ requirements for indicated fleet(s) and model year(s).

- *Percent Change in Stringency from Baseline*: Percentage difference between

averages of CO₂ requirements under no-action and indicated alternatives.

- *Average Achieved CO₂*: Average of manufacturers' CO₂ emission rates for indicated fleet(s) and model year(s).

For the private perspective, the following effects for the MY 2030 fleet are summarized:

- *Average Price Increase*: Average increase in vehicle price, relative to the average occurring under the no-action alternative.

- *Welfare Loss (Costs)*: Average loss of value to vehicle owners resulting from incremental increases in the numbers of strong HEVs, PHEVs) and/or BEVs, beyond increases occurring under the no-action alternative. The loss of value is a function of the factors that lead to different valuations for conventional and electric versions of similar-size vehicles (e.g., differences in: Travel range, recharging time versus refueling time, performance, and comfort).

- *Ownership Costs*: Average increase in some other costs of vehicle ownership (taxes, fees, financing), beyond increase occurring under no-action alternative.

- *Fuel Savings*: Average of fuel outlays (including taxes) avoided over a vehicles' expected useful lives, compared to outlays occurring under no-action alternative.

- *Mobility Benefit*: Average incremental value of additional travel over average vehicles' useful lives, compared to travel occurring under no-action alternative.

- *Refueling Benefit*: Average incremental value of avoided time spent refueling over average vehicles' useful lives, compared to time spent refueling under no-action alternative.

- *Total Costs*: Sum of average price increase, welfare loss, and ownership costs.

- *Total Benefits*: Sum of fuel savings, mobility benefit, and refueling benefit.

- *Net Benefits*: Total benefits minus total costs.

For the physical perspective, the following effects for model years through 2029 as operated throughout those vehicles' useful lives are summarized:

- *Greenhouse gases* include carbon dioxide (CO₂), methane (CH₄), and nitrous oxide (N₂O), and values are reported separately for vehicles (tailpipe) and upstream processes (combining fuel production, distribution, and delivery) and shown as reductions relative to the no-action alternative.

- *Criteria pollutants* include carbon monoxide (CO), volatile organic compounds (VOC), nitrogen oxides (NO_x), sulfur dioxide (SO₂) and particulate matter (PM), and values are shown as reductions relative to the no-action alternative.

- *Fuel consumption* aggregates all fuels, with electricity, hydrogen, and compressed natural gas (CNG) included on a gasoline-equivalent-gallon (GEG) basis, and values are shown as reductions relative to the no-action alternative.

- *VMT, with rebound (billion miles)*: Increase in highway travel (as vehicle miles traveled), relative to the no-action alternative, and including the rebound effect.

- *VMT, without rebound (billion miles)*: Increase in highway travel (as vehicle miles traveled), relative to the no-action alternative, and excluding the rebound effect.

- *Fatalities, with rebound*: Increase in highway fatalities, relative to the no-action alternative, and including the rebound effect.

- *Fatalities, without rebound*: Increase in highway fatalities, relative to the no-action alternative, and excluding the rebound effect.

- *Fuel Consumption, with rebound (billion gallons)*: Reduction of fuel consumption, relative to the no-action alternative, and including the rebound effect.

- *Fuel Consumption, without rebound (billion gallons)*: Reduction of fuel consumption, relative to the no-action alternative, and excluding the rebound effect.

Below, this section tabulates results for each of these four perspectives and does so separately for the proposed CAFE and CO₂ standards. More detailed results are presented in the Preliminary Regulatory Impact Analysis (PRIA) accompanying today's notice, and additional and more detailed analysis of environmental impacts for CAFE regulatory alternatives is provided in the corresponding Draft Environmental Impact Statement (DEIS). Underlying CAFE model output files are available (along with input files, model, source code, and documentation) on NHTSA's website.⁵⁹⁴ Summarizing and tabulating results for presentation here involved considerable "off model" calculations (e.g., to combine results for selected model years and calendar years, and to combine various components of social and private costs and benefits); tools Volpe Center staff used to perform these calculations are also available on NHTSA's website.⁵⁹⁵

While the National Environmental Policy Act (NEPA) requires NHTSA to prepare an EIS documenting estimating environmental impacts of the regulatory alternatives under consideration in

CAFE rulemakings, NEPA does not require EPA to do so for EPA rulemakings. CO₂ standards for each regulatory alternative being harmonized as practical with corresponding CAFE standards, environmental impacts of GHG standards should be directionally identical and similar in magnitude to those of CAFE standards. Nevertheless, in this section, following the series of tables below, today's announcement provides a more detailed analysis of estimated impacts of the proposed CAFE and CO₂ standards. Results presented herein for the CAFE standards differ slightly from those presented in the DEIS; while, as discussed above, EPCA/EISA requires that the Secretary determine the maximum feasible levels of CAFE standards in manner that, as presented here, sets aside the potential use of CAFE credits or application of alternative fuels toward compliance with new standards, NEPA does not impose such constraints on analysis presented in corresponding DEISs, and the DEIS presents results of an "unconstrained" analysis that considers manufacturers' potential application of alternative fuels and use of CAFE credits.

In terms of all estimated impacts, including estimated costs and benefits, results of today's analysis are different for CAFE and CO₂ standards. Differences arise because, even when the mathematical functions defining fuel economy and CO₂ targets are "harmonized," surrounding regulatory provisions may not be. For example, while both CAFE and CO₂ standards allow credits to be transferred between fleets and traded between manufacturers, EPCA/EISA places explicit and specific limits on the use of such credits, such as by requiring that each domestic passenger car fleet meet a minimum CAFE standard (as discussed above). The CAA provides no specific direction regarding CO₂ standards, and while EPA has adopted many regulatory provisions harmonized with specific EPCA/EISA provisions (e.g., separate standards for passenger cars and light trucks), EPA has not

adopted all such provisions. For example, EPA has not adopted the EPCA/EISA provisions limiting transfers between regulated fleet or requiring separate compliance by domestic and imported passenger car fleets. Such differences introduce differences between impacts estimated under CAFE standards and under CO₂ standards. Also, as mentioned above, Congress has required that new CAFE standards be considered in a manner that sets aside the potential use of CAFE credits and the potential additional application of alternative fuel vehicles (such as electric vehicles) during the model years under consideration. Congress has provided no corresponding direction regarding the analysis of potential CO₂ standards, and today's analysis does consider these potential responses to CO₂ standards.

As mentioned above, analysis was conducted to examine the sensitivity of results to changes in key inputs. Following the detailed consideration of potential environmental impacts, this section concludes with a tabular summary of results of this sensitivity analysis.

B. Impacts of Proposed Standards on Requirements, Performance, and Costs to Manufacturers in Specific Model Years

As mentioned above, impacts are presented from two different perspectives for today's proposal. From either perspective, overall impacts are the same. The first perspective, following the approach taken by NHTSA in past CAFE rulemakings, examines impacts of the overall proposal—*i.e.*, the entire series of year-by-year standards—on each model year. This perspective is especially relevant to understanding how the overall proposal may impact manufacturers in terms of year-by-year compliance, technology pathways, and costs. The second, presented below in Section VII.C, provides a clearer characterization of the incremental impacts attributable to standards introduced in each successive model year.

⁵⁹⁴ *Compliance and Effects Modeling System*, National Highway Traffic Safety Administration, <https://www.nhtsa.gov/corporate-average-fuel-economy/compliance-and-effects-modeling-system> (last visited June 25, 2018).

⁵⁹⁵ These tools, available at the same location, are scripts executed using R, a free software environment for statistical computing. R is available through <https://www.r-project.org/>.

Table VII-1 - Required and Achieved CAFE Levels in MYs 2016-2029 under Baseline CAFE Standards (No-Action Alternative)

Manufacturer		2016	2017	2018	2019	2020	2021	2022	2023	2024	2025	2026	2027	2028	2029
BMW	Required	34.3	36.0	37.2	38.3	39.7	41.7	43.6	45.7	47.8	50.1	50.0	50.0	50.0	50.0
BMW	Achieved	32.4	34.3	35.3	36.5	37.0	37.0	37.5	37.8	37.9	37.9	38.1	38.1	38.1	38.1
Daimler	Required	33.4	34.8	35.8	36.9	38.2	40.2	42.1	44.0	46.1	48.2	48.2	48.2	48.1	48.1
Daimler	Achieved	31.2	32.9	32.9	35.3	35.4	35.9	36.4	36.7	36.8	36.8	36.9	36.9	36.9	36.9
Fiat Chrysler	Required	30.9	31.9	32.7	33.3	34.3	36.4	38.1	39.9	41.7	43.7	43.7	43.6	43.6	43.6
Fiat Chrysler	Achieved	27.9	30.0	33.5	35.5	35.9	38.1	38.9	39.8	39.8	40.6	43.7	43.7	44.0	44.1
Ford	Required	30.9	31.9	32.5	33.2	34.0	35.9	37.6	39.4	41.2	43.1	43.0	43.0	42.9	42.9
Ford	Achieved	29.7	31.3	31.6	32.0	36.9	40.5	42.2	42.3	43.0	43.1	43.1	43.3	43.2	43.2
General Motors	Required	30.8	31.7	32.3	33.1	34.0	35.8	37.5	39.2	41.1	43.0	43.0	42.9	42.9	42.9
General Motors	Achieved	28.9	30.2	32.4	34.5	36.3	39.9	40.6	41.1	41.4	42.9	43.1	43.1	43.1	43.0
Honda	Required	34.3	35.8	36.8	38.0	39.2	41.3	43.3	45.3	47.4	49.6	49.6	49.6	49.6	49.6
Honda	Achieved	36.7	39.0	40.8	41.5	41.7	44.0	47.2	49.2	49.5	49.6	49.7	49.9	50.1	50.1
Hyundai	Required	36.7	38.7	40.1	41.6	43.2	45.1	47.2	49.4	51.7	54.2	54.2	54.2	54.2	54.2
Hyundai	Achieved	39.0	41.8	43.0	44.9	45.8	49.5	52.4	53.0	54.0	54.2	54.4	54.4	54.3	54.3
Kia	Required	35.3	37.1	38.3	39.6	41.0	43.0	45.0	47.1	49.3	51.7	51.6	51.6	51.6	51.6
Kia	Achieved	35.1	36.8	38.9	40.1	41.7	47.2	48.5	50.0	52.3	52.4	52.5	52.6	52.5	52.5
Jaguar/Land Rover	Required	30.2	30.9	31.6	32.3	33.2	35.4	37.0	38.8	40.6	42.5	42.5	42.5	42.5	42.5
Jaguar/Land Rover	Achieved	26.0	27.3	27.9	28.8	29.3	30.7	30.9	31.3	31.3	31.6	31.6	31.6	31.6	31.7
Mazda	Required	35.1	36.8	37.9	39.1	40.4	42.6	44.6	46.7	48.9	51.1	51.1	51.1	51.1	51.1
Mazda	Achieved	38.8	39.4	42.9	43.4	44.6	44.8	45.7	52.2	52.4	52.5	52.5	52.5	52.5	52.5
Nissan Mitsubishi	Required	34.9	36.5	37.6	38.9	40.2	42.3	44.3	46.3	48.5	50.8	50.8	50.7	50.6	50.6
Nissan Mitsubishi	Achieved	37.0	38.2	38.7	41.2	43.7	47.6	49.1	49.9	51.1	52.3	52.4	52.4	52.4	52.4
Subaru	Required	33.9	35.3	36.3	37.3	38.4	40.7	42.7	44.6	46.8	49.0	49.0	49.0	48.9	48.9
Subaru	Achieved	36.5	40.0	40.0	40.3	41.7	47.5	48.8	49.1	49.1	49.1	49.3	49.5	49.5	49.5

Tesla	Required	31.5	32.6	33.4	34.4	35.4	37.1	38.8	40.6	42.5	44.5	44.5	44.5	44.4	44.4
Tesla	Achieved	228.5	260.2	259.6	259.8	260.6	260.5	260.4	260.3	260.2	260.1	260.1	259.8	259.6	259.6
Toyota	Required	33.4	34.7	35.6	36.6	37.7	39.8	41.6	43.6	45.6	47.7	47.7	47.7	47.6	47.6
Toyota	Achieved	33.0	33.9	36.7	38.4	42.0	46.0	46.5	46.6	47.6	47.9	48.4	48.4	48.4	48.5
Volvo	Required	31.6	32.6	33.4	34.3	35.4	37.5	39.2	41.0	43.0	45.0	45.0	45.0	44.9	44.9
Volvo	Achieved	31.4	32.3	32.3	34.9	34.9	34.9	35.0	35.9	36.1	36.1	36.1	36.4	36.4	36.4
VWA	Required	36.0	37.7	39.0	40.3	41.7	43.8	45.8	47.9	50.2	52.5	52.5	52.5	52.5	52.5
VWA	Achieved	34.7	38.8	42.3	43.5	45.7	46.4	48.5	49.8	53.3	54.8	55.0	55.1	55.2	55.2
Ave./Total	Required	32.8	34.0	34.9	35.8	36.9	39.0	40.8	42.7	44.7	46.8	46.7	46.7	46.7	46.6
Ave./Total	Achieved	32.2	33.9	35.8	37.3	39.4	42.4	43.7	44.5	45.1	45.7	46.3	46.3	46.4	46.4

Table VII-2 - Required and Achieved CAFE Levels in MYs 2016-2029 under Proposed CAFE Standards (Preferred Alternative)

Manufacturer		2016	2017	2018	2019	2020	2021	2022	2023	2024	2025	2026	2027	2028	2029
BMW	Required	34.3	36.0	37.2	38.3	39.7	39.7	39.7	39.7	39.7	39.7	39.8	39.8	39.7	39.8
BMW	Achieved	32.4	34.3	35.2	36.4	36.9	36.9	37.3	37.6	37.8	37.8	38.0	38.0	38.1	38.1
Daimler	Required	33.4	34.8	35.8	36.9	38.2	38.2	38.2	38.2	38.2	38.2	38.2	38.2	38.2	38.2
Daimler	Achieved	31.2	32.9	32.9	35.3	35.4	35.9	36.3	36.6	36.7	36.7	36.9	36.9	36.9	36.9
Fiat Chrysler	Required	30.9	31.9	32.7	33.3	34.3	34.3	34.3	34.3	34.3	34.3	34.3	34.3	34.3	34.3
Fiat Chrysler	Achieved	27.9	29.8	32.0	32.5	32.8	33.8	34.1	34.4	34.4	34.6	35.6	35.6	35.7	35.8
Ford	Required	30.9	31.9	32.5	33.2	34.0	33.9	34.0	34.0	34.0	34.0	34.0	34.0	34.0	34.0
Ford	Achieved	29.7	31.3	31.4	31.6	34.2	34.8	35.0	35.1	35.2	35.2	35.3	35.4	35.4	35.4
General Motors	Required	30.8	31.7	32.3	33.1	34.0	33.9	34.0	34.0	34.0	34.0	34.0	34.0	34.0	34.0
General Motors	Achieved	28.9	30.1	31.5	32.7	34.0	35.5	35.6	35.6	35.7	36.1	36.3	36.3	36.3	36.3
Honda	Required	34.3	35.8	36.8	38.0	39.2	39.2	39.2	39.2	39.2	39.2	39.3	39.3	39.2	39.3
Honda	Achieved	36.7	37.9	38.8	39.3	39.4	39.6	41.3	42.1	42.1	42.2	42.2	42.6	42.6	42.6
Hyundai	Required	36.7	38.7	40.1	41.6	43.2	43.2	43.2	43.2	43.2	43.2	43.2	43.2	43.2	43.2
Hyundai	Achieved	39.0	41.8	43.0	44.6	45.4	47.8	48.3	48.4	48.5	48.5	48.8	48.8	48.8	48.8
Kia	Required	35.3	37.1	38.3	39.6	41.0	41.0	41.0	41.0	41.0	41.0	41.0	41.0	41.0	41.0
Kia	Achieved	35.1	36.8	38.8	40.0	41.0	44.4	44.5	45.3	46.2	46.2	46.3	46.5	46.5	46.5
Jaguar/Land Rover	Required	30.2	30.9	31.6	32.3	33.2	33.2	33.2	33.2	33.2	33.2	33.2	33.2	33.2	33.2
Jaguar/Land Rover	Achieved	26.0	27.3	27.9	28.8	29.3	30.7	30.9	31.3	31.3	31.6	31.6	31.6	31.6	31.7
Mazda	Required	35.1	36.8	37.9	39.1	40.4	40.4	40.4	40.4	40.5	40.5	40.5	40.5	40.5	40.5
Mazda	Achieved	38.8	39.4	42.1	42.6	43.0	43.1	43.2	43.6	43.6	43.7	43.7	43.7	44.0	44.0
Nissan Mitsubishi	Required	34.9	36.5	37.6	38.9	40.2	40.2	40.2	40.2	40.2	40.2	40.3	40.3	40.3	40.3
Nissan Mitsubishi	Achieved	37.0	38.2	38.7	40.1	42.1	43.1	43.8	44.0	44.1	44.2	44.3	44.3	44.3	44.3
Subaru	Required	33.9	35.3	36.3	37.3	38.4	38.4	38.4	38.4	38.4	38.4	38.4	38.4	38.4	38.4
Subaru	Achieved	36.5	39.9	39.9	40.2	40.6	42.4	42.6	42.7	42.7	42.7	43.2	43.3	43.3	43.3
Tesla	Required	31.5	32.6	33.4	34.4	35.4	35.1	35.1	35.1	35.1	35.2	35.2	35.2	35.2	35.2

Tesla	Achieved	228.5	260.2	259.6	259.8	260.6	260.5	260.6	260.6	260.6	260.8	261.0	260.9	260.9	260.9
Toyota	Required	33.4	34.7	35.6	36.6	37.7	37.7	37.7	37.7	37.7	37.8	37.8	37.8	37.8	37.8
Toyota	Achieved	33.0	33.9	36.2	37.6	39.5	41.0	41.4	41.4	41.6	41.7	42.2	42.2	42.2	42.2
Volvo	Required	31.6	32.6	33.4	34.3	35.4	35.3	35.4	35.4	35.4	35.4	35.4	35.4	35.4	35.4
Volvo	Achieved	31.4	32.3	32.3	34.9	34.9	34.9	34.9	35.8	35.9	35.9	35.9	36.3	36.3	36.3
VWA	Required	36.0	37.7	39.0	40.3	41.7	41.7	41.7	41.7	41.7	41.7	41.8	41.8	41.8	41.8
VWA	Achieved	34.7	37.9	40.1	40.9	42.2	42.3	42.9	43.0	43.0	43.1	43.2	43.2	43.2	43.3
Ave./Total	Required	32.8	34.0	34.9	35.8	36.9	36.9	36.9	36.9	37.0	37.0	37.0	37.0	37.0	37.0
Ave./Total	Achieved	32.2	33.7	35.0	36.0	37.2	38.3	38.7	39.0	39.1	39.2	39.5	39.6	39.6	39.7

Table VII-3 - Undiscounted Regulatory Costs (\$b) in MYs 2017-2029 under Baseline and Proposed CAFE Standards

Manufacturer		2017	2018	2019	2020	2021	2022	2023	2024	2025	2026	2027	2028	2029	Sum
BMW	Costs under Baseline	0.0	0.1	0.1	0.2	0.2	0.3	0.3	0.3	0.4	0.4	0.4	0.4	0.4	3.4
BMW	Chg. under Proposal	0.0	0.0	0.0	0.0	0.0	-0.1	-0.1	-0.2	-0.2	-0.2	-0.2	-0.2	-0.2	-1.5
Daimler	Costs under Baseline	0.1	0.1	0.2	0.2	0.2	0.3	0.3	0.3	0.4	0.4	0.4	0.4	0.4	3.4
Daimler	Chg. under Proposal	0.0	0.0	0.0	0.0	0.0	-0.1	-0.1	-0.1	-0.2	-0.2	-0.2	-0.2	-0.2	-1.2
Fiat Chrysler	Costs under Baseline	1.1	3.3	5.1	5.1	6.2	6.6	7.2	7.2	7.7	9.5	9.4	9.4	9.3	87.0
Fiat Chrysler	Chg. under Proposal	-0.6	-2.3	-3.7	-3.6	-4.5	-4.7	-5.2	-5.2	-5.7	-7.0	-6.8	-6.8	-6.7	-62.7
Ford	Costs under Baseline	0.2	0.5	1.2	5.3	7.8	8.6	8.4	8.6	8.3	8.1	8.0	7.8	7.7	80.7
Ford	Chg. under Proposal	0.0	-0.2	-0.7	-3.6	-6.1	-6.8	-6.6	-6.8	-6.6	-6.4	-6.3	-6.1	-6.0	-62.3
General Motors	Costs under Baseline	0.7	2.7	4.2	5.0	7.5	8.1	8.4	8.5	9.8	9.7	9.6	9.5	9.3	92.9
General Motors	Chg. under Proposal	-0.3	-1.5	-2.7	-3.1	-5.2	-5.9	-6.3	-6.3	-7.6	-7.4	-7.3	-7.2	-7.0	-67.7
Honda	Costs under Baseline	0.3	0.6	0.7	0.8	1.7	2.8	3.8	3.9	3.9	3.8	3.9	3.9	3.8	33.9
Honda	Chg. under Proposal	-0.2	-0.4	-0.4	-0.4	-1.4	-2.3	-3.2	-3.3	-3.2	-3.2	-3.2	-3.2	-3.2	-27.6
Hyundai	Costs under Baseline	0.1	0.1	0.2	0.3	0.5	0.7	0.8	0.9	0.9	1.0	1.0	0.9	0.9	8.2
Hyundai	Chg. under Proposal	0.0	0.0	0.0	-0.1	-0.2	-0.4	-0.5	-0.7	-0.7	-0.7	-0.7	-0.7	-0.7	-5.2
Kia	Costs under Baseline	0.3	0.4	0.4	0.6	1.2	1.5	1.7	1.9	1.9	1.8	1.8	1.8	1.8	17.0
Kia	Chg. under Proposal	0.0	0.0	0.0	-0.1	-0.6	-1.0	-1.1	-1.3	-1.3	-1.3	-1.3	-1.2	-1.2	-10.5
JLR	Costs under Baseline	0.1	0.1	0.1	0.1	0.2	0.2	0.2	0.3	0.3	0.3	0.3	0.3	0.3	2.8

JLR	Chg. under Proposal	0.0	0.0	0.0	0.0	0.0	-0.1	-0.1	-0.1	-0.1	-0.1	-0.1	-0.1	-0.1	-1.0
Mazda	Costs under Baseline	0.0	0.1	0.1	0.3	0.3	0.5	1.3	1.3	1.2	1.2	1.2	1.2	1.1	9.9
Mazda	Chg. under Proposal	0.0	-0.1	-0.1	-0.2	-0.2	-0.4	-1.2	-1.2	-1.1	-1.1	-1.1	-1.0	-1.0	-8.7
Nissan/Mitsubishi	Costs under Baseline	0.2	0.2	0.5	1.0	1.5	1.6	1.7	1.9	2.1	2.1	2.0	2.0	2.0	18.9
Nissan/Mitsubishi	Chg. under Proposal	0.0	0.0	-0.2	-0.3	-0.7	-0.8	-0.8	-1.0	-1.2	-1.2	-1.2	-1.2	-1.2	-9.9
Subaru	Costs under Baseline	0.3	0.3	0.3	0.6	1.0	1.1	1.1	1.1	1.0	1.0	1.0	1.0	1.0	11.0
Subaru	Chg. under Proposal	0.0	0.0	0.0	-0.2	-0.5	-0.7	-0.7	-0.7	-0.6	-0.6	-0.6	-0.6	-0.6	-5.9
Tesla	Costs under Baseline	0.0	0.0	0.0	0.0	0.0	0.0	0.0	0.0	0.0	0.0	0.0	0.0	0.0	0.0
Tesla	Chg. under Proposal	0.0	0.0	0.0	0.0	0.0	0.0	0.0	0.0	0.0	0.0	0.0	0.0	0.0	0.0
Toyota	Costs under Baseline	0.0	1.4	2.0	3.7	5.4	5.4	5.3	5.8	5.9	5.9	5.8	5.8	5.9	58.4
Toyota	Chg. under Proposal	0.0	-0.4	-0.7	-1.8	-3.2	-3.2	-3.2	-3.6	-3.7	-3.7	-3.6	-3.6	-3.6	-34.2
Volvo	Costs under Baseline	0.0	0.0	0.0	0.0	0.0	0.0	0.1	0.1	0.1	0.1	0.1	0.1	0.1	0.6
Volvo	Chg. under Proposal	0.0	0.0	0.0	0.0	0.0	0.0	0.0	0.0	0.0	0.0	0.0	0.0	0.0	-0.3
VWA	Costs under Baseline	0.9	1.5	1.6	2.0	2.0	2.3	2.5	2.9	3.0	2.9	2.8	2.8	2.7	30.0
VWA	Chg. under Proposal	-0.5	-0.9	-1.0	-1.1	-1.2	-1.4	-1.7	-2.1	-2.2	-2.1	-2.1	-2.0	-2.0	-20.2
Ave./Total	Costs under Baseline	4.3	11.4	16.8	25.0	35.7	40.0	43.1	45.0	46.9	48.2	47.7	47.3	46.7	458.2
Ave./Total	Chg. under Proposal	-1.6	-5.8	-9.5	-14.5	-24.0	-27.9	-30.8	-32.6	-34.6	-35.2	-34.7	-34.3	-33.8	-319.1

Table VII-4 - Average Price Increases (\$) in MYs 2017-2029 under Baseline and Proposed CAFE Standards

Manufacturer		2017	2018	2019	2020	2021	2022	2023	2024	2025	2026	2027	2028	2029
BMW	Costs under Baseline	50	200	350	400	500	600	700	850	950	950	900	900	900
BMW	Chg. under Proposal	0	0	0	0	-100	-200	-300	-400	-550	-500	-500	-500	-500
Daimler	Costs under Baseline	200	250	450	500	600	750	850	950	1,050	1,050	1,000	1,000	1,000
Daimler	Chg. under Proposal	0	0	0	0	-100	-200	-300	-400	-500	-500	-500	-500	-500
Fiat Chrysler	Costs under Baseline	550	1,550	2,300	2,300	2,800	2,950	3,200	3,200	3,450	4,250	4,150	4,150	4,100
Fiat Chrysler	Chg. under Proposal	-300	-1,050	-1,700	-1,600	-2,000	-2,100	-2,300	-2,350	-2,550	-3,100	-3,050	-3,000	-2,950
Ford	Costs under Baseline	100	250	550	2,300	3,400	3,750	3,650	3,750	3,650	3,550	3,500	3,400	3,300
Ford	Chg. under Proposal	0	-100	-300	-1,600	-2,650	-2,950	-2,900	-3,000	-2,900	-2,800	-2,750	-2,650	-2,600
General Motors	Costs under Baseline	250	1,000	1,550	1,850	2,700	2,950	3,050	3,100	3,600	3,550	3,500	3,450	3,350
General Motors	Chg. under Proposal	-100	-550	-1,000	-1,150	-1,900	-2,150	-2,300	-2,300	-2,750	-2,700	-2,650	-2,600	-2,500
Honda	Costs under Baseline	150	350	400	400	900	1,450	1,950	2,000	2,000	1,950	2,000	2,000	1,950
Honda	Chg. under Proposal	-150	-200	-200	-200	-700	-1,200	-1,650	-1,700	-1,650	-1,650	-1,650	-1,650	-1,600
Hyundai	Costs under Baseline	100	150	250	350	650	900	1,000	1,200	1,250	1,300	1,250	1,250	1,250
Hyundai	Chg. under Proposal	0	0	-50	-100	-300	-550	-650	-850	-900	-900	-900	-900	-900
Kia	Costs under Baseline	350	450	500	700	1,500	1,950	2,100	2,400	2,400	2,350	2,350	2,300	2,250

Kia	Chg. under Proposal	0	0	0	-200	-850	-1,250	-1,400	-1,700	-1,650	-1,650	-1,650	-1,600	-1,550
JLR	Costs under Baseline	200	250	350	350	600	700	800	900	1,000	1,000	1,000	950	950
JLR	Chg. under Proposal	0	0	0	0	-100	-200	-300	-400	-450	-450	-450	-450	-450
Mazda	Costs under Baseline	50	250	300	650	600	950	2,600	2,600	2,500	2,450	2,400	2,350	2,300
Mazda	Chg. under Proposal	0	-100	-100	-400	-400	-750	-2,400	-2,350	-2,300	-2,250	-2,200	-2,100	-2,050
Nissan/Mitsubishi	Costs under Baseline	100	150	350	700	1,000	1,100	1,150	1,300	1,400	1,400	1,400	1,400	1,350
Nissan/Mitsubishi	Chg. under Proposal	0	0	-100	-200	-450	-500	-600	-700	-850	-850	-850	-850	-850
Subaru	Costs under Baseline	600	600	600	1,000	1,600	1,750	1,800	1,750	1,700	1,700	1,700	1,650	1,600
Subaru	Chg. under Proposal	-50	-50	-50	-400	-900	-1,050	-1,100	-1,100	-1,050	-1,000	-1,000	-950	-950
Tesla	Costs under Baseline	0	0	0	0	0	0	0	0	0	0	0	0	0
Tesla	Chg. under Proposal	0	0	0	0	0	0	0	0	0	0	0	0	0
Toyota	Costs under Baseline	0	550	750	1,450	2,100	2,100	2,100	2,250	2,300	2,300	2,300	2,250	2,300
Toyota	Chg. under Proposal	0	-150	-250	-700	-1,250	-1,250	-1,250	-1,400	-1,450	-1,450	-1,400	-1,400	-1,450
Volvo	Costs under Baseline	50	50	200	250	350	400	550	650	750	750	750	750	750
Volvo	Chg. under Proposal	0	0	0	0	-100	-200	-250	-350	-450	-450	-450	-450	-450
VWA	Costs under Baseline	1,550	2,600	2,750	3,300	3,350	3,800	4,200	4,850	4,950	4,850	4,750	4,650	4,550
VWA	Chg. under Proposal	-800	-1,550	-1,600	-1,900	-2,000	-2,400	-2,800	-3,500	-3,650	-3,550	-3,500	-3,450	-3,350
Ave./Total	Costs under Baseline	250	650	950	1,400	2,000	2,250	2,450	2,550	2,650	2,700	2,700	2,650	2,600
Ave./Total	Chg. under Proposal	-100	-350	-550	-800	-1,350	-1,550	-1,750	-1,850	-1,950	-2,000	-1,950	-1,950	-1,900

Table VII-5 - Technology Costs, Average Prices, Sales, and Labor Utilization under Baseline and Proposed CAFE Standards

MY	Costs (\$b) for Tech. (beyond MY 2016)				Average Vehicle Prices (\$)				Annual Sales (million units)				Labor (1000s of Job-Years)			
	Standards		Change		Standards		Change*		Standards		Change		Standards		Change	
	Baseline	Proposed	Abs.	%	Baseline	Proposed	Abs.	%	Baseline	Proposed	Abs.	%	Baseline	Proposed	Abs.	%
2017	4	2	-2	-41%	32,300	32,250	-100	0%	16.8	16.8	-	0.0%	1,170	1,170	0	0%
2018	11	5	-6	-53%	32,800	32,450	-350	-1%	17.2	17.2	-	0.0%	1,210	1,200	-10	-1%
2019	16	7	-10	-58%	33,050	32,550	-550	-2%	17.5	17.5	-	0.0%	1,240	1,220	-20	-1%
2020	25	10	-15	-59%	33,500	32,700	-800	-2%	17.7	17.7	-	0.0%	1,260	1,240	-30	-2%
2021	35	11	-24	-68%	34,100	32,750	-1,350	-4%	17.7	17.7	-	0.0%	1,290	1,240	-50	-4%
2022	40	12	-28	-70%	34,350	32,800	-1,600	-5%	17.8	17.8	0.0	0.2%	1,300	1,250	-50	-4%
2023	43	12	-30	-71%	34,550	32,800	-1,750	-5%	17.7	17.8	0.1	0.3%	1,310	1,250	-60	-4%
2024	44	12	-32	-72%	34,700	32,800	-1,900	-5%	17.7	17.8	0.1	0.6%	1,310	1,250	-50	-4%
2025	46	12	-34	-73%	34,800	32,750	-2,050	-6%	17.7	17.9	0.2	0.9%	1,310	1,250	-50	-4%
2026	48	13	-35	-73%	34,850	32,800	-2,100	-6%	17.7	17.9	0.2	1.1%	1,310	1,260	-60	-4%
2027	47	13	-34	-73%	34,850	32,800	-2,100	-6%	17.7	17.9	0.2	1.1%	1,310	1,260	-50	-4%
2028	47	13	-34	-72%	34,850	32,800	-2,050	-6%	17.8	18.0	0.2	0.9%	1,320	1,260	-60	-4%
2029	46	13	-33	-72%	34,800	32,750	-2,050	-6%	17.9	18.0	0.1	0.7%	1,320	1,260	-60	-4%

2030	45	13	-33	-72%	34,750	32,750	-2,000	-6%	17.9	18.0	0.1	0.6%	1,320	1,270	-60	-4%
------	----	----	-----	------	--------	--------	--------	-----	------	------	-----	------	-------	-------	-----	-----

*The change in MSRP may not match the change in technology costs reported in other tables. The change in MSRP noted here will include shifts in the average value of a vehicle, before technology application, due to the dynamic fleet share model (more light trucks are projected under the augural standards than the proposed standards, and light trucks are on average more expensive than passenger cars), in addition to the price changes from differential technology application and civil penalties, reported elsewhere.

Table VII-10 - Technology Penetration under Baseline and Proposed CAFE Standards – Ford

Technology		2017	2018	2019	2020	2021	2022	2023	2024	2025	2026	2027	2028	2029
Curb Weight (lb.)	Baseline	4040	4040	4040	3920	3910	3890	3890	3890	3880	3880	3870	3870	3870
Curb Weight (lb.)	Proposal	4040	4040	4040	3940	3930	3910	3910	3900	3900	3890	3870	3870	3870
High CR NA Engines	Baseline	3%	3%	3%	3%	3%	3%	3%	3%	3%	3%	3%	3%	3%
High CR NA Engines	Proposal	3%	3%	3%	3%	3%	3%	3%	3%	3%	3%	3%	3%	3%
Turbo SI Engines	Baseline	46%	48%	55%	76%	89%	94%	95%	96%	97%	97%	97%	97%	97%
Turbo SI Engines	Proposal	46%	46%	54%	67%	68%	68%	68%	68%	68%	68%	68%	68%	68%
Dynamic Deac	Baseline	0%	0%	0%	0%	0%	0%	0%	0%	0%	0%	0%	0%	0%
Dynamic Deac	Proposal	0%	0%	0%	0%	0%	0%	0%	0%	0%	0%	0%	0%	0%
Adv. Transmission	Baseline	41%	47%	47%	70%	63%	58%	59%	56%	56%	56%	57%	57%	57%
Adv. Transmission	Proposal	41%	47%	47%	81%	85%	85%	86%	86%	86%	86%	86%	86%	86%
12V SS Systems	Baseline	8%	10%	10%	9%	2%	2%	2%	0%	0%	0%	0%	0%	0%
12V SS Systems	Proposal	8%	8%	8%	8%	8%	8%	8%	8%	8%	8%	8%	8%	8%
Mild HEVs	Baseline	0%	3%	11%	41%	59%	63%	63%	64%	64%	64%	64%	64%	64%
Mild HEVs	Proposal	0%	0%	0%	0%	0%	0%	0%	0%	0%	0%	0%	0%	0%
Strong HEVs	Baseline	2%	2%	2%	13%	24%	29%	29%	32%	32%	32%	32%	32%	32%
Strong HEVs	Proposal	2%	2%	2%	2%	2%	2%	2%	2%	2%	2%	2%	2%	2%
Plug-In HEVs	Baseline	1%	1%	1%	1%	1%	1%	1%	1%	1%	1%	1%	1%	1%
Plug-In HEVs	Proposal	1%	1%	1%	1%	1%	1%	1%	1%	1%	1%	1%	1%	1%
Dedicated EVs	Baseline	0%	0%	0%	0%	0%	0%	0%	0%	0%	0%	0%	0%	0%
Dedicated EVs	Proposal	0%	0%	0%	0%	0%	0%	0%	0%	0%	0%	0%	0%	0%
Fuel Cell Vehicles	Baseline	0%	0%	0%	0%	0%	0%	0%	0%	0%	0%	0%	0%	0%
Fuel Cell Vehicles	Proposal	0%	0%	0%	0%	0%	0%	0%	0%	0%	0%	0%	0%	0%

Table VII-22 - Required and Achieved Ave. CO₂ Levels in MYs 2016-2029 under Baseline CO₂ Standards (No-Action Alternative)

Manufacturer		2016	2017	2018	2019	2020	2021	2022	2023	2024	2025	2026	2027	2028	2029
BMW	Required	248	240	229	220	211	198	189	180	172	163	163	163	163	163
BMW	Achieved	250	236	225	203	198	196	186	177	171	164	163	163	163	163
Daimler	Required	256	248	238	229	219	206	196	187	178	169	169	169	169	170
Daimler	Achieved	269	253	246	210	210	199	183	176	173	173	171	171	169	169
Fiat Chrysler	Required	277	272	262	254	245	228	217	207	197	188	188	188	188	188
Fiat Chrysler	Achieved	302	284	250	232	225	209	205	202	202	201	193	192	188	187
Ford	Required	277	272	263	256	248	232	221	211	201	191	191	191	191	191
Ford	Achieved	286	273	269	264	231	212	205	204	201	201	197	193	191	192
General Motors	Required	278	273	265	257	247	232	221	210	201	191	191	192	192	192
General Motors	Achieved	293	286	264	246	234	212	210	208	206	203	201	199	194	192
Honda	Required	248	241	231	222	213	200	190	181	172	164	164	164	164	165
Honda	Achieved	222	220	216	214	213	201	180	170	167	166	166	165	165	165
Hyundai	Required	232	222	213	203	194	183	174	166	158	150	150	150	150	150
Hyundai	Achieved	209	198	192	185	181	169	165	164	162	162	158	151	151	150
Kia	Required	241	232	222	213	203	193	183	175	166	158	158	158	158	158
Kia	Achieved	234	231	218	211	202	176	173	167	160	160	160	158	159	159
Jaguar/Land Rover	Required	283	282	270	262	254	234	223	213	202	192	192	192	192	192
Jaguar/Land Rover	Achieved	316	313	304	280	262	221	216	183	183	181	194	194	194	188
Mazda	Required	242	234	224	216	206	194	185	176	167	159	159	159	159	159
Mazda	Achieved	214	210	196	194	189	189	186	167	167	164	154	154	152	153
Nissan Mitsubishi	Required	244	236	226	217	208	195	186	177	168	161	161	161	161	161
Nissan Mitsubishi	Achieved	220	216	213	205	199	189	185	182	166	158	159	159	159	159
Subaru	Required	251	245	234	225	217	202	192	183	174	165	165	166	166	166
Subaru	Achieved	224	217	217	215	214	185	179	178	174	174	168	167	167	167
Tesla	Required	282	275	265	256	246	230	219	209	199	190	190	190	190	190

Tesla	Achieved	(19)	(19)	(19)	(19)	(19)	(19)	(19)	(19)	(19)	(19)	129	129	129	129
Toyota	Required	256	249	239	231	222	208	198	189	179	171	171	171	172	172
Toyota	Achieved	254	252	232	220	202	188	186	186	184	181	171	171	170	169
Volvo	Required	270	266	256	246	237	221	210	201	191	181	181	182	182	182
Volvo	Achieved	260	255	255	207	208	208	209	183	178	178	179	180	179	180
VWA	Required	236	228	218	209	200	188	180	170	163	154	154	155	155	155
VWA	Achieved	244	221	202	197	186	182	175	160	155	154	157	152	151	151
Ave./Total	Required	260	254	244	236	227	212	202	193	183	175	175	175	175	175
Ave./Total	Achieved	259	251	236	225	213	198	192	187	183	182	178	176	175	174

Table VII-23 - Required and Achieved Ave. CO₂ Levels in MYs 2016-2029 under Proposed CO₂ Standards (Preferred Alternative)

Manufacturer		2016	2017	2018	2019	2020	2021	2022	2023	2024	2025	2026	2027	2028	2029
BMW	Required	248	240	229	221	211	224	224	224	224	224	223	223	223	223
BMW	Achieved	250	238	229	214	212	225	222	220	220	220	222	222	221	221
Daimler	Required	256	248	239	229	219	232	232	232	232	232	232	232	232	232
Daimler	Achieved	269	256	254	226	224	233	231	229	229	229	229	229	228	228
Fiat Chrysler	Required	277	272	262	254	245	259	259	259	259	259	259	259	259	259
Fiat Chrysler	Achieved	302	286	265	255	250	259	259	258	258	258	256	252	250	249
Ford	Required	277	272	263	256	248	261	261	261	261	261	261	261	261	261
Ford	Achieved	286	273	270	269	251	262	260	260	259	259	259	258	258	258
General Motors	Required	278	273	265	257	247	261	261	261	261	261	261	261	261	261
General Motors	Achieved	293	288	274	262	253	256	256	255	254	253	253	253	253	252
Honda	Required	248	241	231	222	213	227	227	227	227	227	226	226	226	226
Honda	Achieved	222	221	218	216	215	227	216	211	211	211	211	209	209	208
Hyundai	Required	232	222	213	203	194	206	206	206	206	206	206	206	206	206
Hyundai	Achieved	209	198	192	185	182	186	184	184	183	183	182	182	182	182
Kia	Required	241	232	222	213	203	217	217	217	217	217	217	217	217	217
Kia	Achieved	234	232	219	212	207	203	204	200	196	196	196	195	195	195
Jaguar/Land Rover	Required	283	282	270	262	253	268	268	268	268	268	268	268	268	268
Jaguar/Land Rover	Achieved	316	313	304	288	282	267	265	261	261	260	260	260	260	260
Mazda	Required	242	234	224	216	206	219	219	219	219	219	219	219	219	219
Mazda	Achieved	214	210	196	194	192	206	206	203	203	203	203	203	202	202
Nissan Mitsubishi	Required	244	236	226	217	208	221	221	221	221	221	221	221	221	221
Nissan Mitsubishi	Achieved	220	216	213	206	202	213	211	210	210	209	210	209	210	209
Subaru	Required	251	245	234	225	217	231	231	231	231	231	231	231	231	231
Subaru	Achieved	224	217	217	215	215	221	220	219	219	219	218	218	218	218
Tesla	Required	282	275	265	256	246	260	260	260	260	259	259	259	259	259
Tesla	Achieved	(19)	(19)	(19)	(19)	(19)	(4)	(4)	(4)	(4)	(4)	125	125	125	125

Toyota	Required	256	249	239	231	222	236	236	236	236	235	235	235	235
Toyota	Achieved	254	252	240	234	226	235	234	233	232	232	230	230	230
Volvo	Required	270	266	256	246	237	252	252	252	252	252	251	251	251
Volvo	Achieved	260	256	256	237	238	254	255	249	248	248	249	247	247
VWA	Required	236	228	218	209	200	213	213	213	213	213	213	213	213
VWA	Achieved	244	224	211	206	200	213	212	211	211	210	212	212	211
Ave./Total	Required	260	254	244	236	227	241	241	241	241	240	240	240	240
Ave./Total	Achieved	259	252	243	235	228	236	234	233	232	232	232	230	230

Table VII-24 - Undiscounted Regulatory Costs (\$b) in MYs 2017-2029 under Baseline and Proposed CO₂ Standards

Manufacturer		2017	2018	2019	2020	2021	2022	2023	2024	2025	2026	2027	2028	2029	Sum
BMW	Costs under Baseline	0.1	0.4	0.8	0.9	0.9	1.2	1.4	1.5	1.7	1.8	1.8	1.8	1.7	15.9
BMW	Chg. under Proposal	-0.1	-0.2	-0.5	-0.6	-0.6	-0.8	-1.0	-1.2	-1.3	-1.5	-1.4	-1.4	-1.4	-12.0
Daimler	Costs under Baseline	0.2	0.3	0.8	0.7	0.9	1.3	1.4	1.5	1.5	1.6	1.5	1.6	1.5	14.8
Daimler	Chg. under Proposal	-0.1	-0.2	-0.4	-0.4	-0.6	-0.9	-1.0	-1.1	-1.1	-1.2	-1.2	-1.2	-1.2	-10.7
Fiat Chrysler	Costs under Baseline	1.3	3.4	5.1	5.5	6.7	7.1	7.6	7.4	7.5	8.6	8.6	9.3	9.2	87.1
Fiat Chrysler	Chg. under Proposal	-0.6	-2.1	-3.3	-3.6	-4.4	-4.9	-5.4	-5.2	-5.4	-6.4	-6.4	-7.0	-6.9	-61.5
Ford	Costs under Baseline	0.2	0.5	0.9	3.8	5.6	6.1	6.1	6.3	6.1	7.0	7.8	7.9	7.8	66.1
Ford	Chg. under Proposal	0.0	-0.2	-0.6	-3.0	-4.6	-5.2	-5.1	-5.3	-5.2	-6.1	-6.9	-7.0	-6.9	-56.0
General Motors	Costs under Baseline	0.4	2.2	3.4	3.8	5.6	5.9	6.1	6.3	7.2	7.6	7.9	8.7	9.4	74.6
General Motors	Chg. under Proposal	-0.3	-1.6	-2.5	-2.7	-4.2	-4.5	-4.7	-4.8	-5.6	-5.9	-6.3	-7.1	-7.8	-57.9
Honda	Costs under Baseline	0.1	0.2	0.3	0.3	1.1	2.3	3.4	3.6	3.6	3.5	3.6	3.6	3.6	29.2
Honda	Chg. under Proposal	0.0	-0.1	-0.1	-0.1	-0.8	-1.8	-2.8	-3.0	-3.0	-2.9	-2.9	-3.0	-2.9	-23.3
Hyundai	Costs under Baseline	0.1	0.1	0.2	0.2	0.3	0.4	0.4	0.4	0.4	0.7	0.9	0.9	0.9	5.8
Hyundai	Chg. under Proposal	0.0	0.0	0.0	0.0	0.0	-0.1	-0.1	-0.1	-0.2	-0.4	-0.6	-0.6	-0.7	-2.8
Kia	Costs under Baseline	0.0	0.1	0.2	0.4	0.9	1.0	1.2	1.4	1.4	1.4	1.4	1.4	1.4	12.0
Kia	Chg. under Proposal	0.0	0.0	0.0	-0.1	-0.5	-0.7	-0.8	-1.0	-1.0	-1.0	-1.0	-1.0	-1.0	-8.1
JLR	Costs under Baseline	0.0	0.0	0.4	0.5	1.2	1.2	1.8	1.7	1.7	1.7	1.6	1.6	1.9	15.3

JLR	Chg. under Proposal	0.0	0.0	-0.2	-0.4	-0.6	-0.7	-1.3	-1.2	-1.2	-1.2	-1.2	-1.1	-1.5	-10.7
Mazda	Costs under Baseline	0.0	0.1	0.1	0.2	0.2	0.2	0.9	0.9	0.9	1.3	1.3	1.3	1.3	8.6
Mazda	Chg. under Proposal	0.0	0.0	0.0	-0.1	-0.1	-0.1	-0.8	-0.8	-0.8	-1.2	-1.2	-1.2	-1.2	-7.3
Nissan/Mitsubishi	Costs under Baseline	0.0	0.0	0.2	0.4	0.7	0.8	0.9	1.4	1.7	1.7	1.7	1.7	1.7	12.7
Nissan/Mitsubishi	Chg. under Proposal	0.0	0.0	0.0	-0.1	-0.4	-0.5	-0.6	-1.0	-1.3	-1.3	-1.3	-1.3	-1.3	-9.3
Subaru	Costs under Baseline	0.0	0.0	0.0	0.1	0.5	0.6	0.6	0.6	0.6	0.7	0.8	0.8	0.8	6.1
Subaru	Chg. under Proposal	0.0	0.0	0.0	0.0	-0.4	-0.5	-0.5	-0.5	-0.5	-0.6	-0.7	-0.7	-0.7	-4.9
Tesla	Costs under Baseline	0.0	0.0	0.0	0.0	0.0	0.0	0.0	0.0	0.0	0.0	0.0	0.0	0.0	0.0
Tesla	Chg. under Proposal	0.0	0.0	0.0	0.0	0.0	0.0	0.0	0.0	0.0	0.0	0.0	0.0	0.0	0.0
Toyota	Costs under Baseline	0.0	1.0	1.5	2.5	3.3	3.4	3.4	3.8	4.3	5.6	5.6	5.7	5.9	46.1
Toyota	Chg. under Proposal	0.0	-0.7	-1.1	-1.9	-2.5	-2.6	-2.6	-3.0	-3.5	-4.7	-4.8	-4.9	-5.0	-37.5
Volvo	Costs under Baseline	0.0	0.0	0.3	0.2	0.2	0.2	0.4	0.4	0.4	0.4	0.4	0.4	0.3	3.6
Volvo	Chg. under Proposal	0.0	0.0	-0.2	-0.2	-0.2	-0.2	-0.4	-0.4	-0.4	-0.3	-0.3	-0.3	-0.3	-3.3
VWA	Costs under Baseline	0.4	0.9	1.0	1.4	1.5	1.8	2.6	2.8	2.8	2.8	3.0	3.0	2.9	26.9
VWA	Chg. under Proposal	-0.3	-0.6	-0.6	-1.0	-1.1	-1.3	-2.2	-2.3	-2.3	-2.3	-2.6	-2.5	-2.5	-21.7
Ave./Total	Costs under Baseline	3.0	9.2	14.9	20.9	29.5	33.6	38.0	40.0	41.7	46.2	47.9	49.6	50.2	424.8
Ave./Total	Chg. under Proposal	-1.4	-5.7	-9.5	-14.2	-21.0	-24.9	-29.1	-31.1	-32.8	-37.2	-38.8	-40.4	-41.0	-327.0

Table VII-25 - Average Price Increases (\$) in MYs 2017-2029 under Baseline and Proposed CO₂ Standards

Manufacturer		2017	2018	2019	2020	2021	2022	2023	2024	2025	2026	2027	2028	2029
BMW	Costs under Baseline	350	850	1,850	2,050	2,100	2,850	3,250	3,650	4,100	4,450	4,300	4,250	4,150
BMW	Chg. under Proposal	-250	-550	-1,200	-1,350	-1,300	-1,950	-2,400	-2,800	-3,250	-3,650	-3,550	-3,500	-3,400
Daimler	Costs under Baseline	550	750	2,200	2,100	2,600	3,650	4,000	4,250	4,100	4,400	4,350	4,500	4,350
Daimler	Chg. under Proposal	-300	-450	-1,250	-1,200	-1,550	-2,600	-2,950	-3,250	-3,100	-3,450	-3,400	-3,550	-3,450
Fiat Chrysler	Costs under Baseline	600	1,600	2,350	2,500	3,000	3,200	3,400	3,300	3,350	3,850	3,850	4,100	4,050
Fiat Chrysler	Chg. under Proposal	-300	-950	-1,500	-1,600	-2,000	-2,200	-2,400	-2,350	-2,400	-2,850	-2,800	-3,050	-3,000
Ford	Costs under Baseline	100	200	400	1,650	2,450	2,700	2,650	2,750	2,650	3,050	3,400	3,450	3,350
Ford	Chg. under Proposal	0	-100	-250	-1,300	-2,000	-2,250	-2,250	-2,300	-2,250	-2,650	-3,000	-3,050	-2,950
General Motors	Costs under Baseline	150	850	1,250	1,400	2,050	2,150	2,250	2,300	2,600	2,750	2,850	3,150	3,400
General Motors	Chg. under Proposal	-100	-600	-900	-1,000	-1,550	-1,650	-1,700	-1,750	-2,050	-2,150	-2,300	-2,550	-2,800
Honda	Costs under Baseline	50	100	150	150	550	1,200	1,700	1,850	1,850	1,800	1,850	1,850	1,800
Honda	Chg. under Proposal	0	-50	-50	-50	-400	-950	-1,400	-1,550	-1,550	-1,500	-1,500	-1,500	-1,500
Hyundai	Costs under Baseline	100	150	200	250	400	500	500	550	550	900	1,150	1,200	1,250
Hyundai	Chg. under Proposal	0	0	0	0	-50	-150	-150	-200	-200	-500	-800	-850	-900
Kia	Costs under Baseline	50	150	250	450	1,100	1,250	1,500	1,750	1,750	1,750	1,800	1,750	1,750
Kia	Chg. under Proposal	0	0	0	-200	-650	-850	-1,050	-1,250	-1,250	-1,250	-1,250	-1,250	-1,250
JLR	Costs under Baseline	0	50	1,200	1,800	3,800	4,050	5,800	5,600	5,500	5,300	5,150	5,000	5,950

JLR	Chg. under Proposal	0	0	-700	-1,200	-2,100	-2,350	-4,150	-4,000	-3,950	-3,800	-3,700	-3,600	-4,600
Mazda	Costs under Baseline	50	150	200	300	300	500	1,750	1,750	1,800	2,650	2,550	2,700	2,650
Mazda	Chg. under Proposal	0	0	0	-100	-100	-300	-1,550	-1,500	-1,550	-2,400	-2,350	-2,450	-2,400
Nissan/Mitsubishi	Costs under Baseline	0	0	100	250	450	550	600	950	1,150	1,150	1,150	1,150	1,150
Nissan/Mitsubishi	Chg. under Proposal	0	0	0	-100	-250	-350	-400	-700	-900	-900	-900	-900	-900
Subaru	Costs under Baseline	50	50	50	100	800	950	950	1,050	1,050	1,200	1,250	1,250	1,250
Subaru	Chg. under Proposal	0	0	0	-50	-600	-750	-750	-850	-850	-1,000	-1,050	-1,050	-1,050
Tesla	Costs under Baseline	0	0	0	0	0	0	0	0	0	0	0	0	0
Tesla	Chg. under Proposal	0	0	0	0	0	0	0	0	0	0	0	0	0
Toyota	Costs under Baseline	0	400	600	1,000	1,300	1,300	1,300	1,500	1,650	2,200	2,200	2,250	2,300
Toyota	Chg. under Proposal	0	-300	-450	-750	-1,000	-1,000	-1,000	-1,200	-1,350	-1,850	-1,900	-1,900	-1,950
Volvo	Costs under Baseline	50	50	2,650	2,550	2,450	2,350	3,850	4,050	3,900	3,750	3,650	3,550	3,450
Volvo	Chg. under Proposal	-50	-50	-2,450	-2,350	-2,250	-2,200	-3,600	-3,800	-3,650	-3,500	-3,350	-3,250	-3,150
VWA	Costs under Baseline	750	1,500	1,650	2,400	2,500	2,950	4,400	4,650	4,650	4,650	5,050	5,000	4,850
VWA	Chg. under Proposal	-450	-1,000	-1,050	-1,750	-1,750	-2,200	-3,650	-3,900	-3,900	-3,950	-4,350	-4,300	-4,200
Ave./Total	Costs under Baseline	200	550	850	1,200	1,650	1,900	2,150	2,250	2,350	2,600	2,700	2,800	2,800
Ave./Total	Chg. under Proposal	-100	-350	-550	-800	-1,200	-1,400	-1,650	-1,750	-1,850	-2,100	-2,200	-2,250	-2,300

Table VII-26 - Technology Costs, Average Prices, Sales, and Labor Utilization under Baseline and Proposed CO₂ Standards

MY	Costs (\$b) for Tech. (beyond MY 2016)				Average Vehicle Prices (\$)				Annual Sales (million units)				Labor (1000s of Job-Years)			
	Standards		Change		Standards		Change*		Standards		Change		Standards		Change	
	Baseline	Proposed	Abs.	%	Baseline	Proposed	Abs.	%	Baseline	Proposed	Abs.	%	Baseline	Proposed	Abs.	%
2017	3	2	-1	-48%	32,250	32,150	-100	0%	16.8	16.8	-	0.0%	1,170	1,170	0	0%
2018	9	4	-6	-61%	32,650	32,350	-350	-1%	17.2	17.2	-	0.0%	1,210	1,200	-10	-1%
2019	15	5	-10	-64%	32,950	32,400	-550	-2%	17.5	17.5	-	0.0%	1,230	1,220	-20	-1%
2020	21	7	-14	-68%	33,300	32,450	-800	-2%	17.7	17.7	-	0.0%	1,260	1,230	-20	-2%
2021	30	8	-21	-71%	33,750	32,550	-1,200	-4%	17.8	17.8	-	0.0%	1,280	1,240	-40	-3%
2022	34	9	-25	-74%	34,000	32,550	-1,400	-4%	17.7	17.8	0.0	0.3%	1,290	1,240	-40	-3%
2023	38	9	-29	-76%	34,250	32,600	-1,700	-5%	17.7	17.8	0.1	0.5%	1,290	1,250	-50	-4%
2024	40	9	-31	-78%	34,400	32,600	-1,800	-5%	17.7	17.8	0.1	0.6%	1,290	1,250	-50	-4%
2025	42	9	-33	-79%	34,500	32,550	-1,950	-6%	17.7	17.9	0.1	0.8%	1,300	1,250	-50	-4%
2026	46	9	-37	-80%	34,750	32,550	-2,200	-6%	17.7	17.9	0.2	1.0%	1,310	1,250	-50	-4%
2027	48	9	-39	-81%	34,900	32,550	-2,350	-7%	17.8	18.0	0.2	1.0%	1,310	1,260	-60	-4%
2028	50	9	-40	-81%	35,000	32,550	-2,450	-7%	17.8	18.0	0.2	0.9%	1,320	1,260	-60	-5%
2029	50	9	-41	-82%	35,050	32,550	-2,500	-7%	17.8	18.0	0.2	1.0%	1,320	1,260	-60	-5%

2030	50	9	-40	-81%	35,000	32,550	-2,500	-7%	17.9	18.0	0.2	0.9%	1,330	1,260	-60	-5%
------	----	---	-----	------	--------	--------	--------	-----	------	------	-----	------	-------	-------	-----	-----

*The change in MSRP may not match the change in technology costs reported in other tables. The change in MSRP noted here will include shifts in the average value of a vehicle, before technology application, due to the dynamic fleet share model (more light trucks are projected under the augural standards than the proposed standards, and light trucks are on average more expensive than passenger cars), in addition to the price changes from differential technology application and civil penalties, reported elsewhere.

Table VII-41 - Technology Penetration under Baseline and Proposed CO₂ Standards – Volvo

Technology		2017	2018	2019	2020	2021	2022	2023	2024	2025	2026	2027	2028	2029
Curb Weight (lb.)	Baseline	4170	4170	4020	4020	4020	4020	3970	3950	3950	3950	3950	3950	3960
Curb Weight (lb.)	Proposal	4170	4170	4070	4070	4070	4070	4070	4050	4050	4050	4050	4040	4040
High CR NA Engines	Baseline	0%	0%	0%	0%	0%	0%	0%	0%	0%	0%	0%	0%	0%
High CR NA Engines	Proposal	0%	0%	0%	0%	0%	0%	0%	0%	0%	0%	0%	0%	0%
Turbo SI Engines	Baseline	100%	100%	100%	100%	100%	100%	100%	100%	100%	100%	100%	100%	100%
Turbo SI Engines	Proposal	100%	100%	100%	100%	100%	100%	100%	100%	100%	100%	100%	100%	100%
Dynamic Deac	Baseline	0%	0%	0%	0%	0%	0%	0%	0%	0%	0%	0%	0%	0%
Dynamic Deac	Proposal	0%	0%	0%	0%	0%	0%	0%	0%	0%	0%	0%	0%	0%
Adv. Transmission	Baseline	70%	71%	48%	54%	54%	54%	20%	12%	12%	12%	12%	12%	12%
Adv. Transmission	Proposal	70%	71%	91%	98%	98%	98%	98%	98%	98%	98%	98%	98%	98%
12V SS Systems	Baseline	69%	69%	38%	38%	38%	38%	1%	0%	0%	0%	0%	0%	0%
12V SS Systems	Proposal	70%	71%	70%	70%	70%	70%	70%	70%	70%	70%	70%	70%	70%
Mild HEVs	Baseline	2%	2%	10%	10%	10%	10%	12%	12%	12%	12%	12%	12%	12%
Mild HEVs	Proposal	0%	0%	0%	0%	0%	0%	0%	0%	0%	0%	0%	0%	0%
Strong HEVs	Baseline	0%	0%	43%	43%	43%	43%	78%	85%	85%	85%	85%	85%	85%
Strong HEVs	Proposal	0%	0%	0%	0%	0%	0%	0%	0%	0%	0%	0%	0%	0%
Plug-In HEVs	Baseline	2%	2%	2%	2%	2%	2%	2%	3%	3%	3%	3%	3%	3%
Plug-In HEVs	Proposal	2%	2%	2%	2%	2%	2%	2%	2%	2%	2%	2%	2%	2%
Dedicated EVs	Baseline	0%	0%	0%	0%	0%	0%	0%	0%	0%	0%	0%	0%	0%
Dedicated EVs	Proposal	0%	0%	0%	0%	0%	0%	0%	0%	0%	0%	0%	0%	0%
Fuel Cell Vehicles	Baseline	0%	0%	0%	0%	0%	0%	0%	0%	0%	0%	0%	0%	0%
Fuel Cell Vehicles	Proposal	0%	0%	0%	0%	0%	0%	0%	0%	0%	0%	0%	0%	0%

Table VII-42 - Technology Penetration under Baseline and Proposed CO₂ Standards – VW

Technology		2017	2018	2019	2020	2021	2022	2023	2024	2025	2026	2027	2028	2029
Curb Weight (lb.)	Baseline	3480	3420	3400	3360	3360	3320	3300	3290	3280	3260	3250	3240	3240
Curb Weight (lb.)	Proposal	3480	3420	3400	3360	3360	3320	3320	3320	3310	3310	3310	3310	3310
High CR NA Engines	Baseline	0%	0%	0%	0%	0%	0%	0%	0%	0%	0%	0%	0%	0%
High CR NA Engines	Proposal	0%	0%	0%	0%	0%	0%	0%	0%	0%	0%	0%	0%	0%
Turbo SI Engines	Baseline	91%	95%	95%	95%	95%	96%	85%	85%	85%	85%	76%	76%	76%
Turbo SI Engines	Proposal	91%	95%	95%	95%	95%	96%	96%	96%	97%	97%	97%	97%	97%
Dynamic Deac	Baseline	0%	0%	0%	0%	0%	0%	0%	0%	0%	0%	0%	0%	0%
Dynamic Deac	Proposal	0%	0%	0%	0%	0%	0%	0%	0%	0%	0%	0%	0%	0%
Adv. Transmission	Baseline	45%	45%	55%	55%	55%	47%	24%	10%	5%	2%	2%	2%	2%
Adv. Transmission	Proposal	45%	54%	64%	74%	74%	74%	74%	74%	74%	73%	73%	73%	73%
12V SS Systems	Baseline	44%	41%	41%	41%	40%	32%	11%	0%	0%	0%	0%	0%	0%
12V SS Systems	Proposal	17%	17%	17%	17%	17%	17%	17%	17%	17%	17%	17%	17%	17%
Mild HEVs	Baseline	4%	11%	14%	14%	14%	15%	16%	13%	7%	3%	3%	3%	3%
Mild HEVs	Proposal	0%	0%	0%	0%	0%	0%	0%	0%	0%	0%	0%	0%	0%
Strong HEVs	Baseline	0%	9%	9%	25%	26%	40%	52%	66%	73%	77%	67%	68%	68%
Strong HEVs	Proposal	0%	0%	0%	0%	0%	0%	0%	0%	0%	0%	0%	0%	0%
Plug-In HEVs	Baseline	1%	1%	1%	1%	1%	1%	13%	13%	13%	13%	22%	22%	22%
Plug-In HEVs	Proposal	1%	1%	1%	1%	1%	1%	1%	1%	1%	1%	1%	1%	1%
Dedicated EVs	Baseline	1%	1%	1%	1%	1%	1%	1%	1%	1%	1%	1%	1%	1%
Dedicated EVs	Proposal	1%	1%	1%	1%	1%	1%	1%	1%	1%	1%	1%	1%	1%
Fuel Cell Vehicles	Baseline	0%	0%	0%	0%	0%	0%	0%	0%	0%	0%	0%	0%	0%
Fuel Cell Vehicles	Proposal	0%	0%	0%	0%	0%	0%	0%	0%	0%	0%	0%	0%	0%

C. Incremental Impacts of Standards Proposed for Each Model Year
 As mentioned above, impacts are presented from two different perspectives for today's proposal. From either perspective, overall impacts are

the same. The first perspective, taken above in VI.A, examines impacts of the overall proposal — *i.e.*, the entire series of year-by-year standards — on each model year. The second perspective, presented here, provides a clearer

characterization of the incremental impacts attributable to standards introduced in each successive model year. For example, the standards proposed for MY 2023 are likely to impact manufacturers' application of

technology in model years prior to MY 2023, as well as model years after MY 2023. By conducting analysis that successively introduces standards for each MY, in turn, isolates the incremental impacts attributable to new standards introduced in each MY, considering the entire span of MYs (1977–2029) included in the underlying modeling, throughout those vehicles’

useful lives. Tables appearing below summarize results as aggregated across these model and calendar years. Underlying model output files⁵⁹⁶ report physical impacts and specific monetized costs and benefits attributable to each model year in each calendar (thus providing information needed to, for example, differentiate between impacts attributable to the MY

1977–2016 and MY 2017–2029 cohorts). The PRIA presents costs and benefits for individual model years (with MY’s 1977–2016 in a single bucket) for the preferred alternative.

1. What are the Social Costs and Benefits of the Proposed Standards?

(a) CAFE Standards

Table VII-43 - Combined LDV Societal Net Benefits for MYs 1977-2029, CAFE Program, Undiscounted

Model Year Standards Through	MY 2021	MY 2022	MY 2023	MY 2024	MY 2025	MY 2026	TOTAL
Societal Costs and Benefits Through MY 2029 (\$b)							
Technology Costs	-37.3	-50.2	-64.3	-91.9	-71.5	0.0	-315.2
Pre-tax Fuel Savings	-44.3	-29.0	-37.6	-48.8	-34.4	0.0	-194.1
Mobility Benefit	-20.5	-15.9	-18.8	-21.7	-16.7	0.0	-93.6
Refueling Benefit	-2.8	-1.7	-2.4	-3.1	-2.3	0.0	-12.3
Non-Rebound Fatality Costs	-11.5	-8.4	-12.7	-15.2	-15.1	0.0	-62.9
Rebound Fatality Costs	-13.8	-9.5	-12.5	-15.1	-11.8	0.0	-62.7
Benefits Offsetting Rebound Fatality Costs	-13.8	-9.5	-12.5	-15.1	-11.8	0.0	-62.7
Non-Rebound Non-Fatal Crash Costs	-17.9	-13.1	-19.9	-23.8	-23.6	0.0	-98.3
Rebound Non-Fatal Crash Costs	-21.6	-14.9	-19.6	-23.6	-18.4	0.0	-98.1
Benefits Offsetting Rebound Non-Fatal Crash Costs	-21.6	-14.9	-19.6	-23.6	-18.4	0.0	-98.1
Congestion and Noise	-17.0	-12.4	-16.8	-20.7	-18.3	0.0	-85.2
Energy Security Benefit	-3.6	-2.4	-3.1	-4.0	-3.0	0.0	-16.0
CO ₂ Damages	-1.5	-0.9	-1.2	-1.6	-1.1	0.0	-6.4
Other Pollutant Damages	-0.6	-0.2	-0.2	-0.2	0.4	0.0	-0.8
Total Costs	-119.0	-108.0	-146.0	-190.0	-159.0	0.0	-722.0
Total Benefits	-109.0	-74.5	-95.3	-118.0	-87.2	0.0	-484.0
Net Benefits	10.5	33.9	50.5	72.3	71.4	0.0	238.6

⁵⁹⁶ Available at <https://www.nhtsa.gov/corporate-average-fuel-economy/compliance-and-effects-modeling-system>.

Table VII-44– Combined LDV Estimated Electrification Cost Coverage for MYs 2017-2029, CAFE Program, Undiscounted, Millions of \$2016

Model Year Standards Through	MY 2021	MY 2022	MY 2023	MY 2024	MY 2025	MY 2026	TOTAL
Retrievable Electrification Costs	-24.2	-2.09	0.164	-691	-781	0.00	-1500
Electrification Tax Credits	-0.112	-35.3	0.197	0.112	0.000	0.00	-35.1
Irretrievable Electrification Costs	-3.41	-37.1	-22.3	-132	-184	0.00	-379
Total Electrification costs	-27.7	-74.5	-21.9	-823	-965	0.00	-1910

Table VII-45 - Combined LDV Societal Net Benefits for MYs 1977-2029, CAFE Program, 3% Discount Rate

Model Year Standards Through	MY 2021	MY 2022	MY 2023	MY 2024	MY 2025	MY 2026	TOTAL
Societal Costs and Benefits Through MY 2029 (\$b)							
Technology Costs	-30.5	-40.4	-51.4	-73.9	-56.4	0.0	-252.6
Pre-tax Fuel Savings	-30.8	-19.8	-25.5	-33.2	-23.6	0.0	-132.9
Mobility Benefit	-13.7	-10.4	-12.2	-14.1	-10.7	0.0	-61.1
Refueling Benefit	-2.0	-1.2	-1.6	-2.1	-1.6	0.0	-8.5
Non-Rebound Fatality Costs	-6.8	-4.7	-7.2	-8.6	-8.2	0.0	-35.4
Rebound Fatality Costs	-9.4	-6.3	-8.3	-10.0	-7.6	0.0	-41.7
Benefits Offsetting Rebound Fatality Costs	-9.4	-6.3	-8.3	-10.0	-7.6	0.0	-41.7
Non-Rebound Non-Fatal Crash Costs	-10.7	-7.3	-11.2	-13.4	-12.7	0.0	-55.3
Rebound Non-Fatal Crash Costs	-14.8	-9.9	-12.9	-15.6	-11.9	0.0	-65.1
Benefits Offsetting Rebound Non-Fatal Crash Costs	-14.8	-9.9	-12.9	-15.6	-11.9	0.0	-65.1
Congestion and Noise	-10.8	-7.6	-10.2	-12.6	-10.7	0.0	-51.9
Energy Security Benefit	-2.5	-1.6	-2.1	-2.7	-2.0	0.0	-10.9
CO ₂ Damages	-1.0	-0.6	-0.8	-1.1	-0.8	0.0	-4.3
Other Pollutant Damages	-0.5	-0.2	-0.3	-0.3	0.1	0.0	-1.2
Total Costs	-83.0	-76.3	-101.0	-134.0	-108.0	0.0	-502.1
Total Benefits	-74.7	-50.1	-63.7	-79.1	-58.2	0.0	-325.8
Net Benefits	8.4	26.2	37.4	55.0	49.4	0.0	176.4

Table VII-46 – Combined LDV Estimated Electrification Cost Coverage for MYs 2017-2029, CAFE Program, 3% Discount Rate, Millions of \$2016

Model Year Standards Through	MY 2021	MY 2022	MY 2023	MY 2024	MY 2025	MY 2026	TOTAL
Retrieval Electrification Costs	-18.6	-1.61	0.124	-572	-606	0.00	-1200
Electrification Tax Credits	-0.0919	-28.8	0.158	0.0885	0.00	0.00	-28.6
Irretrieval Electrification Costs	-2.70	-27.0	-17.2	-119	-148	0.00	-314
Total Electrification costs	-21.3	-57.4	-16.9	-692	-755	0.00	-1540

Table VII-47 - Combined LDV Societal Net Benefits for MYs 1977-2029, CAFE Program, 7% Discount Rate

Model Year Standards Through	MY 2021	MY 2022	MY 2023	MY 2024	MY 2025	MY 2026	TOTAL
Societal Costs and Benefits Through MY 2029 (\$b)							
Technology Costs	-23.9	-31.0	-39.0	-56.5	-41.9	0.0	-192.3
Pre-tax Fuel Savings	-20.0	-12.6	-16.0	-20.8	-14.8	0.0	-84.2
Mobility Benefit	-8.6	-6.3	-7.3	-8.5	-6.3	0.0	-37.1
Refueling Benefit	-1.3	-0.8	-1.0	-1.4	-1.0	0.0	-5.4
Non-Rebound Fatality Costs	-3.8	-2.4	-3.7	-4.5	-4.0	0.0	-18.4
Rebound Fatality Costs	-6.1	-3.9	-5.1	-6.2	-4.6	0.0	-25.8
Benefits Offsetting Rebound Fatality Costs	-6.1	-3.9	-5.1	-6.2	-4.6	0.0	-25.8
Non-Rebound Non-Fatal Crash Costs	-6.0	-3.8	-5.8	-7.0	-6.2	0.0	-28.8
Rebound Non-Fatal Crash Costs	-9.5	-6.2	-7.9	-9.6	-7.2	0.0	-40.4
Benefits Offsetting Rebound Non-Fatal Crash Costs	-9.5	-6.2	-7.9	-9.6	-7.2	0.0	-40.4
Congestion and Noise	-6.6	-4.4	-5.8	-7.2	-5.8	0.0	
Energy Security Benefit	-1.6	-1.0	-1.3	-1.7	-1.3	0.0	-6.9
CO ₂ Damages	-0.6	-0.4	-0.5	-0.7	-0.5	0.0	-2.7
Other Pollutant Damages	-0.4	-0.2	-0.2	-0.3	0.0	0.0	-1.1
Total Costs	-55.8	-51.7	-67.2	-90.9	-69.6	0.0	-335.2
Total Benefits	-48.1	-31.4	-39.4	-49.2	-35.8	0.0	-203.9
Net Benefits	7.7	20.3	27.8	41.7	33.9	0.0	131.4

Table VII-48– Combined LDV Estimated Electrification Cost Coverage for MYs 2017-2029, CAFE Program, 7% Discount Rate, Millions of \$2016

Model Year Standards Through	MY 2021	MY 2022	MY 2023	MY 2024	MY 2025	MY 2026	TOTAL
Retrieval Electrification Costs	-13.3	-1.15	0.0875	-456	-441	0.00	-911
Electrification Tax Credits	-0.0716	-22.1	0.119	0.0652	0.00	0.00	-22.0
Irretrieval Electrification Costs	-2.01	-17.9	-12.4	-105	-113	0.00	-250
Total Electrification costs	-15.3	-41.2	-12.2	-561	-554	0.00	-1180

(b) CO₂ Standards**Table VII-49 - Combined LDV Societal Net Benefits for MYs 1977-2029, GHG Program, Undiscounted**

Model Year Standards Through	MY 2021	MY 2022	MY 2023	MY 2024	MY 2025	MY 2026	TOTAL
Societal Costs and Benefits Through MY 2029 (\$b)							
Technology Costs	-51.4	-57.0	-59.4	-82.0	-77.2	0.0	-327.0
Pre-tax Fuel Savings	-54.0	-55.0	-31.7	-36.1	-31.6	0.0	-208.4
Mobility Benefit	-25.9	-26.6	-16.7	-20.2	-17.5	0.0	-106.9
Refueling Benefit	-3.3	-3.5	-2.1	-2.5	-2.3	0.0	-13.6
Non-Rebound Fatality Costs	-11.9	-15.6	-14.6	-20.4	-20.2	0.0	-82.7
Rebound Fatality Costs	-16.8	-18.2	-11.4	-13.5	-12.3	0.0	-72.2
Benefits Offsetting Rebound Fatality Costs	-16.8	-18.2	-11.4	-13.5	-12.3	0.0	-72.2
Non-Rebound Non-Fatal Crash Costs	-18.6	-24.3	-22.8	-31.8	-31.6	0.0	-129.1
Rebound Non-Fatal Crash Costs	-26.3	-28.4	-17.9	-21.1	-19.3	0.0	-113.0
Benefits Offsetting Rebound Non-Fatal Crash Costs	-26.3	-28.4	-17.9	-21.1	-19.3	0.0	-113.0
Congestion and Noise	-19.3	-22.0	-17.2	-22.9	-22.3	0.0	-103.7
Energy Security Benefit	-4.4	-4.5	-2.6	-3.1	-2.8	0.0	-17.3
CO ₂ Damages	-1.8	-1.8	-1.0	-1.2	-1.0	0.0	-6.8
Other Pollutant Damages	-0.9	-0.7	0.0	0.7	0.9	0.0	0.1
Total Costs	-144.0	-166.0	-143.0	-192.0	-183.0	0.0	-828.0
Total Benefits	-133.0	-139.0	-83.4	-96.9	-85.9	0.0	-538.2
Net Benefits	10.9	27.0	59.9	94.8	97.0	0.0	289.6

Table VII-50– Combined LDV Estimated Electrification Cost Coverage for MYs 2017-2029, GHG Program, Undiscounted, Millions of \$2016

Model Year Standards Through	MY 2021	MY 2022	MY 2023	MY 2024	MY 2025	MY 2026	TOTAL
Retrieval Electrification Costs	-61.1	0.905	-933	-60.6	-843	0.00	-1900
Electrification Tax Credits	0.00	0.00	0.00	-133	-16.0	0.00	-149
Irretrieval Electrification Costs	-12.3	0.102	-77.2	-236	-206	0.00	-531
Total Electrification costs	-73.4	1.01	-1010	-430	-1060	0.00	-2570

Table VII-51 - Combined LDV Societal Net Benefits for MYs 1977-2029, GHG Program, 3% Discount Rate

Model Year Standards Through	MY 2021	MY 2022	MY 2023	MY 2024	MY 2025	MY 2026	TOTAL
Societal Costs and Benefits Through MY 2029 (\$b)							
Technology Costs	-42.0	-45.8	-46.9	-65.0	-60.1	0.0	-259.8
Pre-tax Fuel Savings	-36.9	-37.2	-22.1	-25.3	-22.3	0.0	-143.8
Mobility Benefit	-17.3	-17.4	-10.8	-13.0	-11.1	0.0	-69.6
Refueling Benefit	-2.3	-2.4	-1.4	-1.7	-1.6	0.0	-9.4
Non-Rebound Fatality Costs	-7.2	-9.0	-8.0	-11.2	-10.9	0.0	-46.3
Rebound Fatality Costs	-11.4	-12.1	-7.5	-8.8	-8.0	0.0	-47.8
Benefits Offsetting Rebound Fatality Costs	-11.4	-12.1	-7.5	-8.8	-8.0	0.0	-47.8
Non-Rebound Non-Fatal Crash Costs	-11.2	-14.1	-12.5	-17.5	-17.0	0.0	-72.3
Rebound Non-Fatal Crash Costs	-17.9	-18.9	-11.7	-13.8	-12.4	0.0	-74.7
Benefits Offsetting Rebound Non-Fatal Crash Costs	-17.9	-18.9	-11.7	-13.8	-12.4	0.0	-74.7
Congestion and Noise	-12.4	-13.7	-10.2	-13.4	-12.8	0.0	-62.5
Energy Security Benefit	-3.0	-3.0	-1.8	-2.2	-2.0	0.0	-11.9
CO ₂ Damages	-1.2	-1.2	-0.7	-0.8	-0.7	0.0	-4.7
Other Pollutant Damages	-0.7	-0.6	-0.2	0.3	0.4	0.0	-0.8
Total Costs	-102.0	-114.0	-96.8	-130.0	-121.0	0.0	-563.8
Total Benefits	-90.7	-92.7	-56.2	-65.3	-57.7	0.0	-362.6
Net Benefits	11.3	20.9	40.7	64.4	63.5	0.0	200.8

Table VII-52– Combined LDV Estimated Electrification Cost Coverage for MYs 2017-2029, GHG Program, 3% Discount Rate, Millions of \$2016

Model Year Standards Through	MY 2021	MY 2022	MY 2023	MY 2024	MY 2025	MY 2026	TOTAL
Retrieval Electrification Costs	-49.1	0.685	-717	-48.0	-679	0.00	-1490
Electrification Tax Credits	0.00	0.00	0.00	-114	-13.3	0.00	-127
Irretrieval Electrification Costs	-10.4	0.0803	-63.9	-187	-175	0.00	-436
Total Electrification costs	-59.5	0.766	-781	-349	-867	0.00	-2060

Table VII-53 - Combined LDV Societal Net Benefits for MYs 1977-2029, GHG Program, 7% Discount Rate

Model Year Standards Through	MY 2021	MY 2022	MY 2023	MY 2024	MY 2025	MY 2026	TOTAL
Societal Costs and Benefits Through MY 2029 (\$b)							
Technology Costs	-32.8	-34.9	-34.9	-48.9	-44.1	0.0	-195.6
Pre-tax Fuel Savings	-23.5	-23.3	-14.1	-16.2	-14.3	0.0	-91.4
Mobility Benefit	-10.7	-10.5	-6.4	-7.7	-6.6	0.0	-41.9
Refueling Benefit	-1.5	-1.5	-0.9	-1.1	-1.0	0.0	-6.0
Non-Rebound Fatality Costs	-4.1	-4.9	-4.0	-5.6	-5.3	0.0	-23.8
Rebound Fatality Costs	-7.3	-7.5	-4.6	-5.3	-4.8	0.0	-29.4
Benefits Offsetting Rebound Fatality Costs	-7.3	-7.5	-4.6	-5.3	-4.8	0.0	-29.4
Non-Rebound Non-Fatal Crash Costs	-6.3	-7.6	-6.3	-8.8	-8.3	0.0	-37.3
Rebound Non-Fatal Crash Costs	-11.4	-11.7	-7.2	-8.4	-7.5	0.0	-46.1
Benefits Offsetting Rebound Non-Fatal Crash Costs	-11.4	-11.7	-7.2	-8.4	-7.5	0.0	-46.1
Congestion and Noise	-7.5	-7.9	-5.6	-7.3	-6.8	0.0	-35.0
Energy Security Benefit	-1.9	-1.9	-1.1	-1.4	-1.3	0.0	-7.6
CO ₂ Damages	-0.8	-0.8	-0.5	-0.5	-0.5	0.0	-3.0
Other Pollutant Damages	-0.5	-0.5	-0.2	0.0	0.1	0.0	-1.0
Total Costs	-69.3	-74.5	-62.4	-84.2	-76.6	0.0	-367.0
Total Benefits	-57.6	-57.6	-34.9	-40.7	-35.7	0.0	-226.5
Net Benefits	11.7	16.9	27.5	43.6	40.9	0.0	140.6

Table VII-54 – Combined LDV Estimated Electrification Cost Coverage for MYs 2017-2029, GHG Program, 7% Discount Rate, Millions of \$2016

Model Year Standards Through	MY 2021	MY 2022	MY 2023	MY 2024	MY 2025	MY 2026	TOTAL
Retrievable Electrification Costs	-37.4	0.481	-514	-35.9	-523	0.00	-1110
Electrification Tax Credits	0.00	0.00	0.00	-93.3	-10.4	0.00	-104
Irretrievable Electrification Costs	-8.49	0.0590	-50.1	-139	-144	0.00	-342
Total Electrification costs	-45.9	0.540	-564	-269	-678	0.00	-1560

2. What are the private costs and benefits of the proposed standards, relative to the no-action alternative?

(a) What are the impacts on producers of new vehicles?

(b) CAFE Standards

Table VII-55 - Combined Light-Duty CAFE Compliance Impacts and Cumulative Industry Costs through MY 2029

Model Year Standards Through	MY 2021	MY 2022	MY 2023	MY 2024	MY 2025	MY 2026	TOTAL
Fuel Economy							
Average Required Fuel Economy - MY 2026+ (mpg)	37.0	37.0	37.0	37.0	37.0	37.0	N/A
Percent Change in Stringency from Baseline	-5.4%	-10.2%	-15.3%	-20.6%	-26.0%	-26.0%	N/A
Average Achieved Fuel Economy - MY 2030 (mpg)	39.7	39.7	39.7	39.7	39.7	39.7	N/A
Average Achieved Fuel Economy - MY 2020 (mpg)	37.2	37.2	37.2	37.2	37.2	37.2	N/A
Total Regulatory Costs Through MY 2029 Vehicles (7% discount rate)							
Total Technology Costs (\$b)	-23.9	-31.0	-39.0	-56.5	-41.9	0.0	-192.3
Total Civil Penalties (\$b)	-0.7	-0.6	-0.6	-0.1	-0.1	0.0	-2.1
Total Regulatory Costs (\$b)	-24.5	-31.6	-39.6	-56.6	-41.9	0.0	-194.2
Sales and Revenue Impacts Through MY 2029 Vehicles (7% discount rate for Revenue Change)							
Sales Change (millions)	0.1	0.2	0.2	0.3	0.2	0.0	1.0
Revenue Change (\$b)	-23.8	-30.2	-36.8	-52.7	-38.9	0.0	-182.4

Table VII-56 - Combined Light-Duty Fleet Penetration for MY 2030, CAFE Program

Model Year Standards Through	MY 2021	MY 2022	MY 2023	MY 2024	MY 2025	MY 2026
Technology Use Under CAFE Alternative in MY 2030 (total fleet penetration)						
Curb Weight Reduction (percent change from MY 2016)	4.3%	4.3%	4.3%	4.3%	4.3%	4.3%
High Compression Ratio Non-Turbo Engines	17.2%	17.2%	17.2%	17.2%	17.2%	17.2%
Turbocharged Gasoline Engines	51.1%	51.1%	51.1%	51.1%	51.1%	51.1%
Dynamic Cylinder Deactivation	0.0%	0.0%	0.0%	0.0%	0.0%	0.0%
Advanced Transmissions	92.9%	92.9%	92.9%	92.9%	92.9%	92.9%
Stop-Start 12V (Non-Hybrid)	13.7%	13.7%	13.7%	13.7%	13.7%	13.7%
Mild Hybrid Electric Systems (48v)	0.4%	0.4%	0.4%	0.4%	0.4%	0.4%
Strong Hybrid Electric Systems	2.3%	2.3%	2.3%	2.3%	2.3%	2.3%
Plug-In Hybrid Electric Vehicles (PHEVs)	0.5%	0.5%	0.5%	0.5%	0.5%	0.5%
Dedicated Electric Vehicles (EVs)	0.5%	0.5%	0.5%	0.5%	0.5%	0.5%
Fuel Cell Vehicles (FCVs)	0.0%	0.0%	0.0%	0.0%	0.0%	0.0%

Table VII-57 - Light Truck CAFE Compliance Impacts and Cumulative Industry Costs through MY 2029

Model Year Standards Through	MY 2021	MY 2022	MY 2023	MY 2024	MY 2025	MY 2026	TOTAL
Fuel Economy							
Average Required Fuel Economy - MY 2026+ (mpg)	31.3	31.3	31.3	31.3	31.3	31.3	N/A
Percent Change in Stringency from Baseline	-6.6%	-11.7%	-17.0%	-22.6%	-28.3%	-28.3%	N/A
Average Achieved Fuel Economy - MY 2030 (mpg)	33.6	33.6	33.6	33.6	33.6	33.6	N/A
Average Achieved Fuel Economy - MY 2020 (mpg)	31.6	31.6	31.6	31.6	31.6	31.6	N/A
Total Regulatory Costs Through MY 2029 Vehicles (7% discount rate)							
Total Technology Costs (\$b)	-13.1	-20.1	-18.9	-35.8	-20.2	0.0	-108.1
Total Civil Penalties (\$b)	-0.3	-0.3	-0.4	0.0	-0.1	0.0	-1.0
Total Regulatory Costs (\$b)	-13.4	-20.4	-19.2	-35.8	-20.2	0.0	-109.0
Sales and Revenue Impacts Through MY 2029 Vehicles (7% discount rate for Revenue Change)							
Sales Change (millions)	-0.4	-0.4	-0.2	-0.1	-0.1	0.0	-1.1
Revenue Change (\$b)	-20.6	-27.1	-23.0	-37.0	-21.7	0.0	-129.4

Table VII-58 - Light Truck Fleet Penetration for MY 2030, CAFE Program

Model Year Standards Through	MY 2021	MY 2022	MY 2023	MY 2024	MY 2025	MY 2026
Technology Use Under CAFE Alternative in MY 2030 (total fleet penetration)						
Curb Weight Reduction (percent change from MY 2016)	4.4%	4.4%	4.4%	4.4%	4.4%	4.4%
High Compression Ratio Non-Turbo Engines	8.1%	8.1%	8.1%	8.1%	8.1%	8.1%
Turbocharged Gasoline Engines	53.1%	53.1%	53.1%	53.1%	53.1%	53.1%
Dynamic Cylinder Deactivation	0.0%	0.0%	0.0%	0.0%	0.0%	0.0%
Advanced Transmissions	98.3%	98.3%	98.3%	98.3%	98.3%	98.3%
Stop-Start 12V (Non-Hybrid)	12.3%	12.3%	12.3%	12.3%	12.3%	12.3%
Mild Hybrid Electric Systems (48v)	0.0%	0.0%	0.0%	0.0%	0.0%	0.0%
Strong Hybrid Electric Systems	0.9%	0.9%	0.9%	0.9%	0.9%	0.9%
Plug-In Hybrid Electric Vehicles (PHEVs)	0.3%	0.3%	0.3%	0.3%	0.3%	0.3%
Dedicated Electric Vehicles (EVs)	0.3%	0.3%	0.3%	0.3%	0.3%	0.3%
Fuel Cell Vehicles (FCVs)	0.0%	0.0%	0.0%	0.0%	0.0%	0.0%

Table VII-59 - Passenger Car CAFE Compliance Impacts and Cumulative Industry Costs through MY 2029

Model Year Standards Through	MY 2021	MY 2022	MY 2023	MY 2024	MY 2025	MY 2026	TOTAL
Fuel Economy							
Average Required Fuel Economy - MY 2026+ (mpg)	43.7	43.7	43.7	43.7	43.7	43.7	N/A
Percent Change in Stringency from Baseline	-4.3%	-9.2%	-14.3%	-19.6%	-25.2%	-25.2%	N/A
Average Achieved Fuel Economy - MY 2030 (mpg)	46.7	46.7	46.7	46.7	46.7	46.7	N/A
Average Achieved Fuel Economy - MY 2020 (mpg)	43.9	43.9	43.9	43.9	43.9	43.9	N/A
Total Regulatory Costs Through MY 2029 Vehicles (7% discount rate)							
Total Technology Costs (\$b)	-10.8	-10.9	-20.1	-20.7	-21.6	0.0	-84.1
Total Civil Penalties (\$b)	-0.4	-0.4	-0.2	-0.1	0.0	0.0	-1.0
Total Regulatory Costs (\$b)	-11.1	-11.3	-20.4	-20.8	-21.7	0.0	-85.3
Sales and Revenue Impacts Through MY 2029 Vehicles (7% discount rate for Revenue Change)							
Sales Change (millions)	0.5	0.5	0.4	0.4	0.3	0.0	2.1
Revenue Change (\$b)	-3.3	-3.1	-13.7	-15.7	-17.2	0.0	-52.9

Table VII-60 - Passenger Car Fleet Penetration for MY 2030, CAFE Program

Model Year Standards Through	MY 2021	MY 2022	MY 2023	MY 2024	MY 2025	MY 2026
Technology Use Under CAFE Alternative in MY 2030 (total fleet penetration)						
Curb Weight Reduction (percent change from MY 2016)	4.1%	4.1%	4.1%	4.1%	4.1%	4.1%
High Compression Ratio Non-Turbo Engines	24.7%	24.7%	24.7%	24.7%	24.7%	24.7%
Turbocharged Gasoline Engines	49.5%	49.5%	49.5%	49.5%	49.5%	49.5%
Dynamic Cylinder Deactivation	0.0%	0.0%	0.0%	0.0%	0.0%	0.0%
Advanced Transmissions	88.5%	88.5%	88.5%	88.5%	88.5%	88.5%
Stop-Start 12V (Non-Hybrid)	15.0%	15.0%	15.0%	15.0%	15.0%	15.0%
Mild Hybrid Electric Systems (48v)	0.7%	0.7%	0.7%	0.7%	0.7%	0.7%
Strong Hybrid Electric Systems	3.5%	3.5%	3.5%	3.5%	3.5%	3.5%
Plug-In Hybrid Electric Vehicles (PHEVs)	0.7%	0.7%	0.7%	0.7%	0.7%	0.7%
Dedicated Electric Vehicles (EVs)	0.7%	0.7%	0.7%	0.7%	0.7%	0.7%
Fuel Cell Vehicles (FCVs)	0.0%	0.0%	0.0%	0.0%	0.0%	0.0%

Table VII-61 - Domestic Car CAFE Compliance Impacts and Cumulative Industry Costs through MY 2029

Model Year Standards Through	MY 2021	MY 2022	MY 2023	MY 2024	MY 2025	MY 2026	TOTAL
Fuel Economy							
Average Required Fuel Economy - MY 2026+ (mpg)	43.2	43.2	43.2	43.2	43.2	43.2	N/A
Percent Change in Stringency from Baseline	-4.3%	-9.1%	-14.2%	-19.6%	-25.2%	-25.2%	N/A
Average Achieved Fuel Economy - MY 2030 (mpg)	46.5	46.5	46.5	46.5	46.5	46.5	N/A
Average Achieved Fuel Economy - MY 2020 (mpg)	43.6	43.6	43.6	43.6	43.6	43.6	N/A
Total Regulatory Costs Through MY 2029 Vehicles (7% discount rate)							
Total Technology Costs (\$b)	-6.1	-9.1	-13.9	-12.6	-14.3	0.0	-56.1
Total Civil Penalties (\$b)	-0.1	-0.1	0.0	0.0	0.2	0.0	0.0
Total Regulatory Costs (\$b)	-6.2	-9.3	-14.0	-12.5	-14.3	0.0	-56.3
Sales and Revenue Impacts Through MY 2029 Vehicles (7% discount rate for Revenue Change)							
Sales Change (millions)	0.3	0.3	0.3	0.2	0.2	0.0	1.2
Revenue Change (\$b)	-1.8	-4.7	-10.3	-9.7	-11.8	0.0	-38.4

Table VII-62 - Domestic Car Fleet Penetration for MY 2030, CAFE Program

Model Year Standards Through	MY 2021	MY 2022	MY 2023	MY 2024	MY 2025	MY 2026
Technology Use Under CAFE Alternative in MY 2030 (total fleet penetration)						
Curb Weight Reduction (percent change from MY 2016)	4.8%	4.8%	4.8%	4.8%	4.8%	4.8%
High Compression Ratio Non-Turbo Engines	12.7%	12.7%	12.7%	12.7%	12.7%	12.7%
Turbocharged Gasoline Engines	61.9%	61.9%	61.9%	61.9%	61.9%	61.9%
Dynamic Cylinder Deactivation	0.0%	0.0%	0.0%	0.0%	0.0%	0.0%
Advanced Transmissions	91.1%	91.1%	91.1%	91.1%	91.1%	91.1%
Stop-Start 12V (Non-Hybrid)	11.5%	11.5%	11.5%	11.5%	11.5%	11.5%
Mild Hybrid Electric Systems (48v)	0.1%	0.1%	0.1%	0.1%	0.1%	0.1%
Strong Hybrid Electric Systems	1.0%	1.0%	1.0%	1.0%	1.0%	1.0%
Plug-In Hybrid Electric Vehicles (PHEVs)	0.6%	0.6%	0.6%	0.6%	0.6%	0.6%
Dedicated Electric Vehicles (EVs)	0.6%	0.6%	0.6%	0.6%	0.6%	0.6%
Fuel Cell Vehicles (FCVs)	0.0%	0.0%	0.0%	0.0%	0.0%	0.0%

Table VII-63 - Imported Car CAFE Compliance Impacts and Cumulative Industry Costs through MY 2029

Model Year Standards Through	MY 2021	MY 2022	MY 2023	MY 2024	MY 2025	MY 2026	TOTAL
Fuel Economy							
Average Required Fuel Economy - MY 2026+ (mpg)	44.2	44.2	44.2	44.2	44.2	44.2	N/A
Percent Change in Stringency from Baseline	-4.3%	-9.2%	-14.3%	-19.6%	-25.3%	-25.3%	N/A
Average Achieved Fuel Economy - MY 2030 (mpg)	47.0	47.0	47.0	47.0	47.0	47.0	N/A
Average Achieved Fuel Economy - MY 2020 (mpg)	44.1	44.1	44.1	44.1	44.1	44.1	N/A
Total Regulatory Costs Through MY 2029 Vehicles (7% discount rate)							
Total Technology Costs (\$b)	-4.6	-1.8	-6.2	-8.1	-7.3	0.0	-27.9
Total Civil Penalties (\$b)	-0.2	-0.3	-0.2	-0.2	-0.1	0.0	-1.0
Total Regulatory Costs (\$b)	-4.9	-2.0	-6.4	-8.3	-7.4	0.0	-29.0
Sales and Revenue Impacts Through MY 2029 Vehicles (7% discount rate for Revenue Change)							
Sales Change (millions)	0.2	0.2	0.2	0.1	0.1	0.0	0.9
Revenue Change (\$b)	-1.4	1.6	-3.4	-6.0	-5.4	0.0	-14.6

Table VII-64 - Imported Car Fleet Penetration for MY 2030, CAFE Program

Model Year Standards Through	MY 2021	MY 2022	MY 2023	MY 2024	MY 2025	MY 2026
Technology Use Under CAFE Alternative in MY 2030 (total fleet penetration)						
Curb Weight Reduction (percent change from MY 2016)	3.2%	3.2%	3.2%	3.2%	3.2%	3.2%
High Compression Ratio Non-Turbo Engines	39.0%	39.0%	39.0%	39.0%	39.0%	39.0%
Turbocharged Gasoline Engines	34.7%	34.7%	34.7%	34.7%	34.7%	34.7%
Dynamic Cylinder Deactivation	0.0%	0.0%	0.0%	0.0%	0.0%	0.0%
Advanced Transmissions	85.4%	85.4%	85.4%	85.4%	85.4%	85.4%
Stop-Start 12V (Non-Hybrid)	19.1%	19.1%	19.1%	19.1%	19.1%	19.1%
Mild Hybrid Electric Systems (48v)	1.3%	1.3%	1.3%	1.3%	1.3%	1.3%
Strong Hybrid Electric Systems	6.5%	6.5%	6.5%	6.5%	6.5%	6.5%
Plug-In Hybrid Electric Vehicles (PHEVs)	0.8%	0.8%	0.8%	0.8%	0.8%	0.8%
Dedicated Electric Vehicles (EVs)	0.9%	0.9%	0.9%	0.9%	0.9%	0.9%
Fuel Cell Vehicles (FCVs)	0.0%	0.0%	0.0%	0.0%	0.0%	0.0%

(c) CO₂ Standards**Table VII-65 - Combined Light-Duty CO₂ Compliance Impacts and Cumulative Industry Costs through MY 2029**

Model Year Standards Through	MY 2021	MY 2022	MY 2023	MY 2024	MY 2025	MY 2026	TOTAL
Average CO ₂ Emission Rate							
Average Required CO ₂ - MY 2026+ (g/mi)	240.0	240.0	240.0	240.0	240.0	240.0	N/A
Percent Change in Stringency from Baseline	-13.3%	-18.5%	-24.4%	-30.5%	-36.9%	-36.9%	N/A
Average Achieved CO ₂ - MY 2030 (g/mi)	229.0	229.0	229.0	229.0	229.0	229.0	N/A
Total Regulatory Costs Through MY 2029 Vehicles (7% discount rate)							
Total Technology Costs (\$b)	-32.8	-34.9	-34.9	-48.9	-44.1	0.0	-195.6
Total Civil Penalties (\$b)	N/A	N/A	N/A	N/A	N/A	N/A	N/A
Total Regulatory Costs (\$b)	-32.8	-34.9	-34.9	-48.9	-44.1	0.0	-195.6
Sales and Revenue Impacts Through MY 2029 Vehicles (7% discount rate for Revenue Change)							
Sales Change (millions)	0.2	0.2	0.2	0.2	0.2	0.0	1.1
Revenue Change (\$b)	-31.1	-34.2	-32.4	-45.8	-41.6	0.0	-185.1

Table VII-66 - Combined Light-Duty Fleet Penetration for MY 2030, CO₂ Program

Model Year Standards Through	MY 2021	MY 2022	MY 2023	MY 2024	MY 2025	MY 2026
Technology Use Under CAFE Alternative in MY 2030 (total fleet penetration)						
Curb Weight Reduction (percent change from MY 2016)	4.0%	4.0%	4.0%	4.0%	4.0%	4.0%
High Compression Ratio Non-Turbo Engines	12.4%	12.4%	12.4%	12.4%	12.4%	12.4%
Turbocharged Gasoline Engines	40.8%	40.8%	40.8%	40.8%	40.8%	40.8%
Dynamic Cylinder Deactivation	0.0%	0.0%	0.0%	0.0%	0.0%	0.0%
Advanced Transmissions	93.6%	93.6%	93.6%	93.6%	93.6%	93.6%
Stop-Start 12V (Non-Hybrid)	11.1%	11.1%	11.1%	11.1%	11.1%	11.1%
Mild Hybrid Electric Systems (48v)	1.5%	1.5%	1.5%	1.5%	1.5%	1.5%
Strong Hybrid Electric Systems	1.8%	1.8%	1.8%	1.8%	1.8%	1.8%
Plug-In Hybrid Electric Vehicles (PHEVs)	0.3%	0.3%	0.3%	0.3%	0.3%	0.3%
Dedicated Electric Vehicles (EVs)	0.5%	0.5%	0.5%	0.5%	0.5%	0.5%
Fuel Cell Vehicles (FCVs)	0.0%	0.0%	0.0%	0.0%	0.0%	0.0%

Table VII-67 - Light Truck CO₂ Compliance Impacts and Cumulative Industry Costs through MY 2029

Model Year Standards Through	MY 2021	MY 2022	MY 2023	MY 2024	MY 2025	MY 2026	TOTAL
Average CO ₂ Emission Rate							
Average Required CO ₂ - MY 2026+ (g/mi)	284.0	284.0	284.0	284.0	284.0	284.0	N/A
Percent Change in Stringency from Baseline	-14.1%	-19.8%	-25.7%	-32.1%	-39.2%	-39.2%	N/A
Average Achieved CO ₂ - MY 2030 (g/mi)	268.0	268.0	268.0	268.0	268.0	268.0	N/A
Total Regulatory Costs Through MY 2029 Vehicles (7% discount rate)							
Total Technology Costs (\$b)	-16.2	-18.9	-17.0	-29.3	-22.1	0.0	-103.5
Total Civil Penalties (\$b)	N/A	N/A	N/A	N/A	N/A	N/A	N/A
Total Regulatory Costs (\$b)	-16.2	-18.9	-17.0	-29.3	-22.1	0.0	-103.5
Sales and Revenue Impacts Through MY 2029 Vehicles (7% discount rate for Revenue Change)							
Sales Change (millions)	-0.4	-0.7	-0.2	-0.1	-0.1	0.0	-1.5
Revenue Change (\$b)	-23.6	-31.8	-21.1	-31.9	-24.1	0.0	-132.5

Table VII-68 - Light Truck Fleet Penetration for MY 2030, CO₂ Program

Model Year Standards Through	MY 2021	MY 2022	MY 2023	MY 2024	MY 2025	MY 2026
Technology Use Under CAFE Alternative in MY 2030 (total fleet penetration)						
Curb Weight Reduction (percent change from MY 2016)	4.4%	4.4%	4.4%	4.4%	4.4%	4.4%
High Compression Ratio Non-Turbo Engines	6.3%	6.3%	6.3%	6.3%	6.3%	6.3%
Turbocharged Gasoline Engines	42.1%	42.1%	42.1%	42.1%	42.1%	42.1%
Dynamic Cylinder Deactivation	0.0%	0.0%	0.0%	0.0%	0.0%	0.0%
Advanced Transmissions	98.6%	98.6%	98.6%	98.6%	98.6%	98.6%
Stop-Start 12V (Non-Hybrid)	10.2%	10.2%	10.2%	10.2%	10.2%	10.2%
Mild Hybrid Electric Systems (48v)	3.1%	3.1%	3.1%	3.1%	3.1%	3.1%
Strong Hybrid Electric Systems	0.7%	0.7%	0.7%	0.7%	0.7%	0.7%
Plug-In Hybrid Electric Vehicles (PHEVs)	0.1%	0.1%	0.1%	0.1%	0.1%	0.1%
Dedicated Electric Vehicles (EVs)	0.3%	0.3%	0.3%	0.3%	0.3%	0.3%
Fuel Cell Vehicles (FCVs)	0.0%	0.0%	0.0%	0.0%	0.0%	0.0%

Table VII-69 - Passenger Car CO₂ Compliance Impacts and Cumulative Industry Costs through MY 2029

Model Year Standards Through	MY 2021	MY 2022	MY 2023	MY 2024	MY 2025	MY 2026	TOTAL
Average CO ₂ Emission Rate							
Average Required CO ₂ - MY 2026+ (g/mi)	204.0	204.0	204.0	204.0	204.0	204.0	N/A
Percent Change in Stringency from Baseline	-12.7%	-17.9%	-24.4%	-30.8%	-36.9%	-36.9%	N/A
Average Achieved CO ₂ - MY 2030 (g/mi)	197.0	198.0	198.0	198.0	198.0	198.0	N/A
Total Regulatory Costs Through MY 2029 Vehicles (7% discount rate)							
Total Technology Costs (\$b)	-16.6	-16.1	-17.9	-19.5	-22.0	0.0	-92.1
Total Civil Penalties (\$b)	N/A	N/A	N/A	N/A	N/A	N/A	N/A
Total Regulatory Costs (\$b)	-16.6	-16.1	-17.9	-19.5	-22.0	0.0	-92.1
Sales and Revenue Impacts Through MY 2029 Vehicles (7% discount rate for Revenue Change)							
Sales Change (millions)	0.6	0.9	0.4	0.4	0.3	0.0	2.6
Revenue Change (\$b)	-7.4	-2.4	-11.4	-13.9	-17.5	0.0	-52.7

Table VII-70 - Passenger Car Fleet Penetration for MY 2030, CO₂ Program

Model Year Standards Through	MY 2021	MY 2022	MY 2023	MY 2024	MY 2025	MY 2026
Technology Use Under CAFE Alternative in MY 2030 (total fleet penetration)						
Curb Weight Reduction (percent change from MY 2016)	3.4%	3.4%	3.4%	3.4%	3.4%	3.4%
High Compression Ratio Non-Turbo Engines	17.4%	17.4%	17.4%	17.4%	17.4%	17.4%
Turbocharged Gasoline Engines	39.8%	39.8%	39.8%	39.8%	39.8%	39.8%
Dynamic Cylinder Deactivation	0.0%	0.0%	0.0%	0.0%	0.0%	0.0%
Advanced Transmissions	89.5%	89.5%	89.5%	89.5%	89.5%	89.5%
Stop-Start 12V (Non-Hybrid)	11.9%	11.9%	11.9%	11.9%	11.9%	11.9%
Mild Hybrid Electric Systems (48v)	0.1%	0.1%	0.1%	0.1%	0.1%	0.1%
Strong Hybrid Electric Systems	2.8%	2.8%	2.8%	2.8%	2.8%	2.8%
Plug-In Hybrid Electric Vehicles (PHEVs)	0%	0.4%	0.4%	0.4%	0.4%	0.4%
Dedicated Electric Vehicles (EVs)	0.7%	0.7%	0.7%	0.7%	0.7%	0.7%
Fuel Cell Vehicles (FCVs)	0.0%	0.0%	0.0%	0.0%	0.0%	0.0%

(d) What are the impacts on buyers of new vehicles?

(e) CAFE Standards

Table VII-71 - Impacts to the Average Consumer of a MY 2030 Vehicle under CAFE Program, 3% Discount Rate

Model Year Standards Through	MY 2021	MY 2022	MY 2023	MY 2024	MY 2025	MY 2026	TOTAL
Per Vehicle Consumer Impacts for MY 2030 (\$)							
Average Price Increase	-200	-280	-380	-500	-490	0	-1,850
Ownership Costs	-60	-70	-100	-130	-130	0	-490
Fuel Savings	-270	-190	-300	-370	-340	0	-1,470
Mobility Benefit	-80	-70	-90	-100	-90	0	-430
Refueling Benefit	-10	-10	-10	-10	-10	0	-50
Total Costs	-260	-350	-480	-640	-610	0	-2,340
Total Benefits	-360	-270	-390	-500	-430	0	-1,950
Net Benefits	-110	100	70	150	180	0	390

(f) CO₂ Standards

Table VII-72 - Impacts to the Average Consumer of a MY 2030 Vehicle under CAFE Program, 7% Discount Rate

Model Year Standards Through	MY 2021	MY 2022	MY 2023	MY 2024	MY 2025	MY 2026	TOTAL
Per Vehicle Consumer Impacts for MY 2030 (\$)							
Average Price Increase	-200	-280	-380	-500	-490	0	-1,850
Ownership Costs	-50	-70	-90	-120	-110	0	-440
Fuel Savings	-220	-160	-240	-310	-280	0	-1,210
Mobility Benefit	-80	-70	-90	-100	-90	0	-430
Refueling Benefit	-10	-10	-10	-10	-10	0	-50
Total Costs	-250	-350	-470	-620	-610	0	-2,300
Total Benefits	-320	-230	-340	-430	-370	0	-1,690
Net Benefits	-60	110	120	210	220	0	600

Table VII-73 - Impacts to the Average Consumer of a MY 2030 Vehicle under CO₂ Program, 3% Discount Rate

Model Year Standards Through	MY 2021	MY 2022	MY 2023	MY 2024	MY 2025	MY 2026	TOTAL
Per Vehicle Consumer Impacts for MY 2030 (\$)							
Average Price Increase	-240	-340	-420	-580	-680	0	-2,260
Ownership Costs	-70	-90	-110	-160	-180	0	-610
Fuel Savings	-320	-410	-300	-380	-420	0	-1,830
Mobility Benefit	-100	-130	-90	-110	-110	0	-540
Refueling Benefit	-10	-20	-10	-10	-20	0	-70
Total Costs	-310	-430	-530	-740	-860	0	-2,870
Total Benefits	-430	-550	-410	-510	-540	0	-2,440
Net Benefits	-120	-130	130	230	320	0	430

Table VII-74 - Impacts to the Average Consumer of a MY 2030 Vehicle under CO₂ Program, 7% Discount Rate

Model Year Standards Through	MY 2021	MY 2022	MY 2023	MY 2024	MY 2025	MY 2026	TOTAL
Per Vehicle Consumer Impacts for MY 2030 (\$)							
Average Price Increase	-240	-340	-420	-580	-680	0	-2,260
Ownership Costs	-60	-90	-100	-140	-160	0	-550
Fuel Savings	-260	-340	-250	-320	-340	0	-1,510
Mobility Benefit	-100	-130	-90	-110	-110	0	-540
Refueling Benefit	-10	-20	-10	-10	-20	0	-70
Total Costs	-300	-420	-520	-730	-840	0	-2,810
Total Benefits	-370	-480	-360	-440	-470	0	-2,120
Net Benefits	-70	-60	170	280	370	0	690

D. What are the Energy and Environmental Impacts?

Today’s proposal directly involves the fuel economy and average CO₂ emissions of light-duty vehicles, and the proposal is expected to most directly and significantly impact national fuel consumption and CO₂ emissions. Fuel economy and CO₂ emissions are so closely related that it is expected the

impacts on national fuel consumption and national CO₂ emissions will track in virtual lockstep with each other.

Today’s proposal does *not* directly involve pollutants such as carbon monoxide, smog-forming pollutants (nitrogen oxides and unburned hydrocarbons), final particles, or “air toxics” (e.g., formaldehyde, acetaldehyde, benzene). While today’s

proposal is expected to indirectly impact such emissions (by reducing travel demand and accelerating fleet turnover to newer and cleaner vehicles on one hand while, on the other, increasing activity at refineries and in the fuel distribution system), it is expected that these impacts will be much smaller than impacts on fuel use and CO₂ emissions because standards

for these other pollutants are independent of those for CO₂ emissions.

Following decades of successful regulation of criteria pollutants and air toxics, modern vehicles are already

vastly cleaner than in the past, and it is expected that new vehicles will continue to improve. For example, the following chart shows trends in new vehicles' emission rates for volatile

organic compounds (VOCs) and nitrogen oxides (NO_x) — the two motor vehicle criteria pollutants that contribute to the formation of smog.

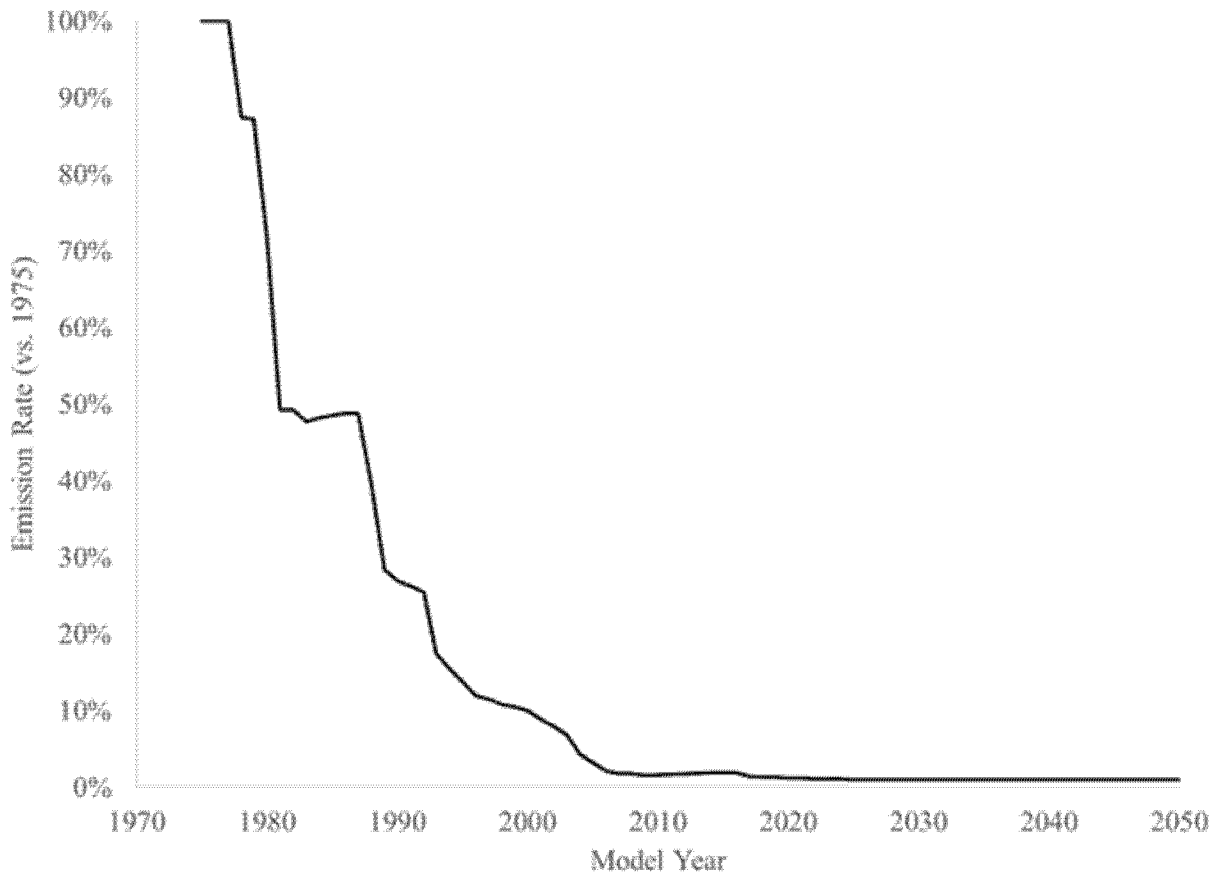

Figure VII-1 - New Passenger Car Emission Rates Relative to 1975 Level – Smog-Forming Pollutants

Because new vehicles are so much cleaner than older models, it is expected that under any of the alternatives considered here for fuel economy and CO₂ standards, emissions of smog-

forming pollutants would continue to decline nearly identically over the next two decades. The following chart shows estimated total fuel consumption, CO₂ emissions, and smog-forming emissions

under the baseline and proposed standards (CAFE standards — trends for CO₂ standards would be very similar), using units that allow the three to be shown together:

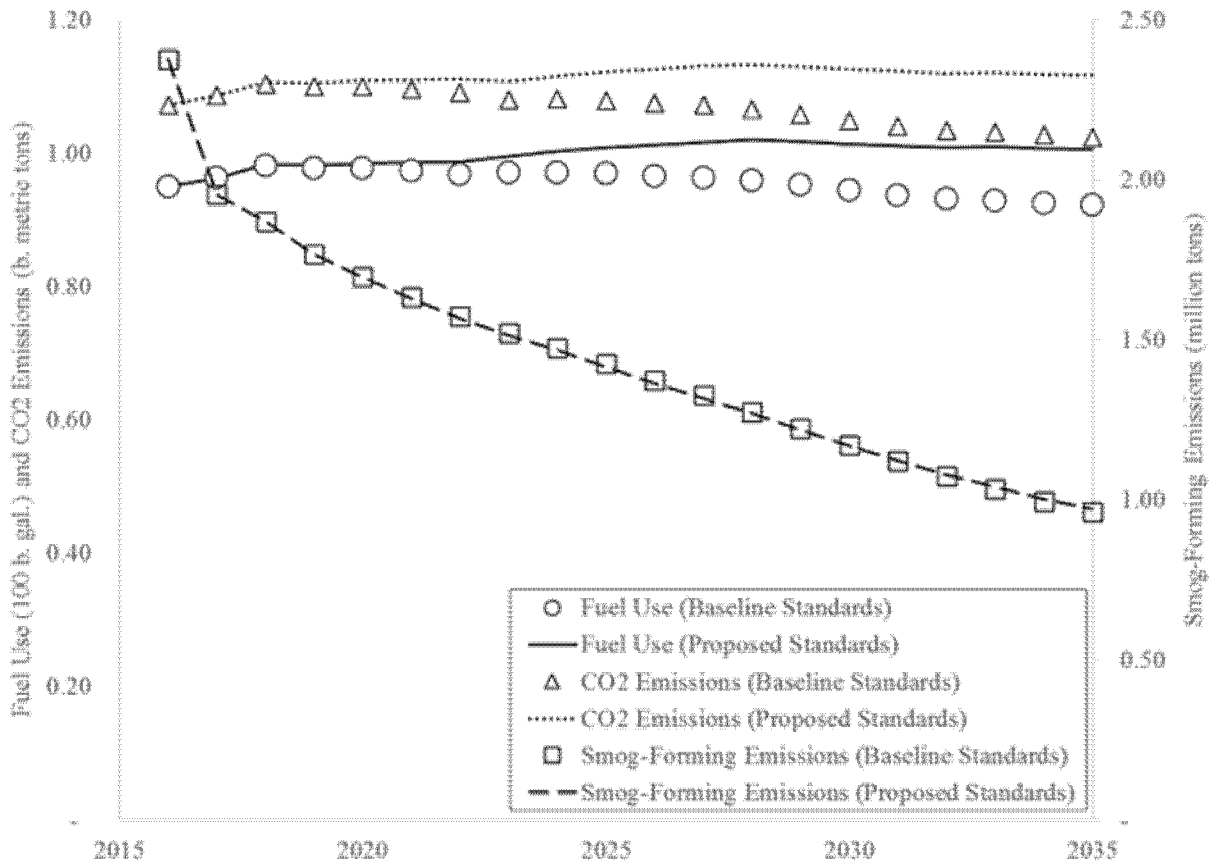

Figure VII-2 - Annual Fuel Consumption and Emissions under Baseline and Preferred CAFE Standards

While the differences in fuel use and CO₂ emissions trends under the baseline and proposed standards are clear, the

corresponding difference in smog-forming emissions trends is too small to discern. For these three measures, the

following table shows percentage differences between the amounts shown above:

Table VII-75 - Impact of Proposed CAFE Standards on Annual Fuel Use and Emissions

Year	Fuel Use	CO ₂ Emissions	Smog-Forming Emissions
2016	0.0%	0.0%	0.0%
2017	0.1%	0.1%	0.0%
2018	0.2%	0.2%	0.0%
2019	0.4%	0.4%	-0.1%
2020	0.7%	0.7%	-0.1%
2021	1.3%	1.3%	-0.2%
2022	1.9%	1.9%	-0.3%
2023	2.6%	2.5%	-0.5%
2024	3.3%	3.3%	-0.6%
2025	4.0%	4.0%	-0.6%
2026	4.8%	4.8%	-0.6%
2027	5.5%	5.5%	-0.6%
2028	6.3%	6.2%	-0.5%
2029	6.9%	6.9%	-0.3%
2030	7.4%	7.4%	-0.1%
2031	7.9%	7.9%	0.1%
2032	8.3%	8.2%	0.3%
2033	8.6%	8.6%	0.6%
2034	8.9%	8.9%	0.8%
2035	9.2%	9.1%	1.0%

As indicated, for most of the coming two decades, it is estimated that, even as fuel consumption and CO₂ emissions would increase under the proposed standards (compared to fuel consumption and CO₂ emissions under the baseline standards), smog-forming pollution would actually *decrease*. During the two decades shown above, it is estimated that the proposed standards would increase aggregate fuel consumption and CO₂ emissions by about four percent but would *decrease* aggregate smog-forming pollution by about 0.1% (because impacts of the reduced travel and accelerated fleet turnover would outweigh those of increased refining and fuel distribution).

As the analysis affirms, while fuel economy and CO₂ emissions are two sides (or, arguably, the same side) of the same coin, fuel economy and CO₂ are only incidentally related to pollutants

such as smog, and any positive or negative impacts of today's notice on these other air quality problems would most likely be far too small to observe.

The remainder of this section summarizes the impacts on fuel consumption and emissions for both the proposed CAFE standards and the proposed CO₂ standards.

1. Energy and Warming Impacts

Section V discusses, among other things, the need of the Nation to conserve energy, providing context for the estimated impacts on national-scale fuel consumption summarized below. Corresponding to these changes in fuel consumption, the agencies estimate that today's proposal will impact CO₂ emissions. CO₂ is one of several greenhouse gases that absorb infrared radiation, thereby trapping heat and making the planet warmer. The most important greenhouse gases directly

emitted by human activities include carbon dioxide (CO₂), methane (CH₄), nitrous oxide (N₂O), and several fluorine-containing halogenated substances. Although CO₂, CH₄, and N₂O occur naturally in the atmosphere, human activities have changed their atmospheric concentrations. From the pre-industrial era (*i.e.*, ending about 1750) to 2016, concentrations of these greenhouse gases have increased globally by 44, 163, and 22%, respectively.⁵⁹⁷ The Draft Environmental Impact Analysis (DEIS) accompanying today's notice discusses potential impacts of greenhouse gases at greater length, and also summaries analysis quantifying some of these impacts (*e.g.*, average temperatures) for each of the considered regulatory alternatives.

(a) CAFE Standards

⁵⁹⁷ Impacts and U.S. emissions of GHGs are discussed at greater length in EPA's 2018 *Inventory*

of U.S. Greenhouse Gas Emissions and Sinks (EPA 430-R-18-003) (Apr. 12, 2018), available at [https://](https://www.epa.gov/sites/production/files/2018-01/documents/2018_complete_report.pdf)

www.epa.gov/sites/production/files/2018-01/documents/2018_complete_report.pdf.

Table VII-76 - Cumulative Changes in Fuel Consumption and GHG Emissions for MY's 1977-2029 Under CAFE Program

Model Year Standards Through	MY 2021	MY 2022	MY 2023	MY 2024	MY 2025	MY 2026	TOTAL
Upstream Emissions							
CO ₂ (million metric tons)	37.2	23.8	30.4	37.8	21.9	0.0	151
CH ₄ (thousand metric tons)	330	214	274	358	251	0.0	1,430
N ₂ O (thousand metric tons)	5.0	3.2	4.1	5.4	3.9	0.0	21.5
Tailpipe Emissions							
CO ₂ (million metric tons)	149	97	125	165	122	0.0	658
CH ₄ (thousand metric tons)	-2.5	-1.9	-2.4	-2.9	-2.4	0.0	-12.0
N ₂ O (thousand metric tons)	-2.2	-1.7	-2.1	-2.5	-2.0	0.0	-10.6
Total Emissions							
CO ₂ (million metric tons)	186	121	156	203	144	0.0	810
CH ₄ (thousand metric tons)	327	212	272	355	249	0.0	1,420
N ₂ O (thousand metric tons)	2.8	1.5	2.0	2.9	1.9	0.0	11.0
Fuel Consumption (billion Gallons)	16.7	10.9	14.1	18.3	13.1	0.0	73.1

Table VII-77 - Cumulative Changes in Criteria Pollutant Emissions for MY's 1977-2029 Under CAFE Program

Model Year Standards Through	MY 2021	MY 2022	MY 2023	MY 2024	MY 2025	MY 2026	TOTAL
Upstream Emissions							
CO (million metric tons)	0.0	0.0	0.0	0.0	0.0	0.0	0.1
VOC (thousand metric tons)	48.7	31.6	41.2	53.8	39.4	0.0	215
NO _x (thousand metric tons)	27.4	17.5	22.7	28.7	18.7	0.0	115
SO ₂ (thousand metric tons)	20.3	12.6	15.8	18.2	6.8	0.0	73.7
PM (thousand metric tons)	2.1	1.3	1.7	2.2	1.5	0.0	8.8
Tailpipe Emissions							
CO (million metric tons)	-1.0	-0.8	-1.0	-1.3	-1.1	0.0	-5.2
VOC (thousand metric tons)	-64.2	-52.2	-65.9	-84.8	-64.7	0.0	-332
NO _x (thousand metric tons)	-56.4	-42.1	-53.1	-66.7	-52.2	0.0	-271
SO ₂ (thousand metric tons)	-0.6	-0.4	-0.5	-0.6	-0.5	0.0	-2.5
PM (thousand metric tons)	-2.2	-1.8	-2.3	-2.9	-2.4	0.0	-11.7
Total Emissions							
CO (million metric tons)	-1.0	-0.8	-1.0	-1.3	-1.1	0.0	-5.2
VOC (thousand metric tons)	-15.5	-20.6	-24.7	-31.0	-25.3	0.0	-117
NO _x (thousand metric tons)	-29.0	-24.5	-30.4	-38.1	-33.5	0.0	-156
SO ₂ (thousand metric tons)	19.7	12.2	15.3	17.7	6.4	0.0	71.3
PM (thousand metric tons)	-0.1	-0.5	-0.6	-0.7	-1.0	0.0	-2.9

(b) CO₂ Standards

Table VII-78 - Cumulative Changes in Fuel Consumption and GHG Emissions for MY's 1977-2029 Under CO₂ Program

Model Year Standards Through	MY 2021	MY 2022	MY 2023	MY 2024	MY 2025	MY 2026	TOTAL
Upstream Emissions							
CO ₂ (million metric tons)	45.2	45.4	26.4	24.5	17.6	0.0	159
CH ₄ (thousand metric tons)	398	403	234	268	234	0.0	1,540
N ₂ O (thousand metric tons)	6.0	6.0	3.5	4.1	3.7	0.0	23.3
Tailpipe Emissions							
CO ₂ (million metric tons)	180	182	106	128	117	0.0	713
CH ₄ (thousand metric tons)	-2.8	-3.2	-2.5	-3.1	-2.7	0.0	-14.2
N ₂ O (thousand metric tons)	-2.5	-3.0	-2.2	-2.6	-2.3	0.0	-12.6
Total Emissions							
CO ₂ (million metric tons)	225	228	133	153	134	0.0	873
CH ₄ (thousand metric tons)	396	400	232	265	231	0.0	1,520
N ₂ O (thousand metric tons)	3.5	3.1	1.3	1.5	1.4	0.0	10.7
Fuel Consumption (billion Gallons)	20.3	20.5	12.0	13.8	12.3	0.0	78.9

Table VII-79 - Cumulative Changes in Criteria Pollutant Emissions for MY's 1977-2029 Under GHG Program

Model Year Standards Through	MY 2021	MY 2022	MY 2023	MY 2024	MY 2025	MY 2026	TOTAL
Upstream Emissions							
CO (million metric tons)	0.0	0.0	0.0	0.0	0.0	0.0	0.1
VOC (thousand metric tons)	59.1	59.8	34.9	41.3	37.3	0.0	232
NO _x (thousand metric tons)	33.2	33.1	19.5	19.9	16.2	0.0	122
SO ₂ (thousand metric tons)	24.6	24.0	14.2	8.5	2.6	0.0	73.9
PM (thousand metric tons)	2.5	2.5	1.5	1.6	1.3	0.0	9.4
Tailpipe Emissions							
CO (million metric tons)	-1.2	-1.3	-1.0	-1.4	-1.2	0.0	-6.1
VOC (thousand metric tons)	-74.6	-76.2	-62.1	-84.9	-74.5	0.0	-372
NO _x (thousand metric tons)	-63.0	-65.3	-51.7	-69.8	-61.9	0.0	-312
SO ₂ (thousand metric tons)	-0.6	-0.7	-0.5	-0.6	-0.5	0.0	-3.0
PM (thousand metric tons)	-2.5	-2.9	-2.4	-3.1	-2.9	0.0	-13.8
Total Emissions							
CO (million metric tons)	-1.1	-1.2	-1.0	-1.4	-1.2	0.0	-6.0
VOC (thousand metric tons)	-15.5	-16.5	-27.2	-43.6	-37.2	0.0	-140
NO _x (thousand metric tons)	-29.8	-32.2	-32.2	-49.9	-45.7	0.0	-190
SO ₂ (thousand metric tons)	24.0	23.3	13.7	7.9	2.1	0.0	71.0
PM (thousand metric tons)	0.0	-0.4	-0.9	-1.6	-1.6	0.0	-4.4

2. How would the proposal impact emissions of criteria and toxic pollutants?

Although this proposal focuses on standards for fuel economy and CO₂, it will also have an impact on criteria and air toxic pollutant emissions, although as discussed above, it is expected that

incremental impacts on criteria and air toxic pollutant emissions would be too small to observe under any of the regulatory alternatives under consideration. Nevertheless, the following sections detail the criteria pollutant and air toxic inventory impacts of this proposal; the

methodology used to calculate those impacts; the health and environmental effects associated with the criteria and toxic air pollutants that are being impacted by this proposal; the potential impact of this proposal on concentrations of criteria and air toxic pollutants in the ambient air; and other

unquantified health and environmental effects.

Today's analysis reflects the combined result of several underlying impacts, all discussed above. CAFE and CO₂ standards are estimated to impact new vehicle prices, fuel economy levels, and CO₂ emission rates. These changes are estimated to impact the size and composition of the new vehicle fleet and to impact the retention of older vehicles (*i.e.*, vehicle survival and scrappage) that tend to have higher criteria and toxic pollutant emission rates. Along with the rebound effect, these lead to changes in the overall amount of highway travel and the distribution among different vehicles in the on-road fleet. Vehicular emissions depend on the overall amount of highway travel and the distribution of that travel among different vehicles, and emissions from "upstream" processes (*e.g.*, petroleum refining, electricity generation) depend on the total consumption of different types of fuels for light-duty vehicles.

(a) Impacts

In addition to affecting fuel consumption and emissions of greenhouse gases, this rule would influence "non-GHG" pollutants, *i.e.*, "criteria" air pollutants and their precursors, and air toxics. The proposal would affect emissions of carbon monoxide (CO), fine particulate matter (PM_{2.5}), sulfur dioxide (SO_x), volatile organic compounds (VOC), nitrogen oxides (NO_x), benzene, 1,3-butadiene, formaldehyde, acetaldehyde, and acrolein. Consistent with the evaluation conducted for the Environmental Impact Statement accompanying this NPRM, the agency analyzed criteria air pollutant impacts in 2025 and 2035 (as a representation of future program impacts). Estimates of these non-GHG emission impacts are shown by pollutant in Table VII-80 through Table VII-87 and are broken down by the two drivers of these changes: (a) "downstream" emission changes, reflecting the estimated effects of VMT rebound (discussed in Chapter 8.7 of the PRIA), changes in vehicle fleet age, changes in vehicle emission standards, and changes in fuel consumption; and (b) "upstream" emission increases because of increased refining and distribution of motor vehicle gasoline relative to the baseline. Program impacts on criteria and toxics emissions are discussed below, followed by individual discussions of the methodology used to

calculate each of these three sources of impacts.⁵⁹⁸

As shown in Table VII-80, it is estimated in 2025 the light duty vehicle CAFE scenarios would result in reductions of NO_x, VOC, and CO, and increases in PM_{2.5} and SO_x.⁵⁹⁹ For NO_x, VOC, and CO, it is estimated net reductions result from lower downstream, or tailpipe emissions in the scenarios evaluated. This is a result of reduced VMT rebound as well as fewer older vehicles in the scenarios as compared to the baseline. Because the scenarios result in greater fuel consumption than the baseline, however, upstream emissions associated with fuel refining and distribution increase for all pollutants in all scenarios as compared to the baseline. Tailpipe emissions reductions for NO_x, VOC, and CO more than compensate for this increase in 2025. PM_{2.5} and SO_x, tailpipe emissions reductions are not

⁵⁹⁸The agencies have employed the same methodology in this rulemaking to estimate the effect of each alternative on emissions of PM and other criteria pollutants emissions as they have previously applied in the other rulemakings under the National Program. Briefly, emissions from vehicle use are estimated for each calendar year of the analysis period by applying emission rates per vehicle-mile of travel to estimates of VMT for cars and light trucks produced during each model year making up the vehicle fleet. These emission rates are derived from EPA's Motor Vehicle Emissions Simulator (MOVES); they reflect normal increases in vehicles' emission rates as they age and accumulate mileage, as well as adopted and pending vehicle emission standards and regulations on fuel composition. "Upstream" emissions from crude oil production, fuel refining, and fuel distribution are estimated from the total energy content of fuels produced and consumed (gasoline, diesel, ethanol, and electricity), using separate emission factors per unit of fuel energy for each phase of fuel production and distribution derived from Argonne National Laboratories' Greenhouse Gases and Regulated Emissions in Transportation (GREET) fuel cycle model. This procedure accounts for differences in domestic emissions associated with refining fuel from imported and domestically-supplied crude petroleum, as well as from importing fuel that has been refined outside the U.S. Economic damages caused by emissions from vehicle use and from fuel production and distribution are monetized using different per-ton values, which reflect differences in the locations where emissions occur and resulting variation in population exposure to their potential adverse health effects. However, we note that in some other rules affecting tailpipe emissions of criteria pollutants, EPA has employed more detailed methods for estimating emissions associated with different phases of fuel production and distribution, and has also used more detailed estimates of their per-ton health damage costs that reflect variation in population exposure to emissions occurring during different phases of fuel production and distribution. The agencies will consider whether to employ these more detailed procedures in their analysis supporting the final rule.

⁵⁹⁹While estimates for CY 2025 and 2035 are shown here, estimates through 2050 are shown in PRIA Chapter 5.

great enough to compensate for increased emissions from fuel refining and distribution and therefore an overall increase in total PM_{2.5} and SO_x is seen in 2025. Similar results can be seen in Table VII-81 which shows results for the CO₂ target scenarios.

In 2035, Table VII-82 shows decreases in total CO result from all CAFE scenarios, while NO_x, VOC, SO₂, and PM_{2.5} increase. Tailpipe CO emissions reductions more than offset increases in upstream CO emissions. For NO_x, VOC, SO₂, and PM_{2.5} however, upstream emissions increases are not offset by tailpipe NO_x, VOC, SO₂, and PM_{2.5} emissions reductions. Similar results can be seen in the CO₂ target scenarios for 2035 shown in Table VII-83, with the exception that NO_x emission decrease for scenarios 1-4 and increase for scenarios 5-8. For all criteria pollutants, the overall impact of the proposed program would be small compared to total U.S. inventories across all sectors.

Table VII-80 - Criteria Emissions in 2025 (1,000 metric tons) under Fuel Economy Targets

Pollutant		Alt. 1	Alt. 2	Alt. 3	Alt. 4	Alt. 5	Alt. 6	Alt. 7	Alt.8
CO	tailpipe	-174.789	-163.704	-155.704	-136.685	-102.784	-98.207	-71.136	-58.049
	upstream	3.087	2.901	2.771	2.396	1.723	1.720	1.299	1.083
	total	-171.703	-160.802	-152.933	-134.289	-101.061	-96.487	-69.837	-56.966
VOC	tailpipe	-15.250	-14.308	-13.596	-12.117	-9.260	-8.862	-6.460	-5.285
	upstream	11.485	10.825	10.346	9.020	6.595	6.566	5.009	4.269
	total	-3.765	-3.482	-3.249	-3.097	-2.664	-2.295	-1.451	-1.016
NO _x	tailpipe	-11.506	-10.732	-10.220	-8.980	-6.708	-6.550	-4.810	-3.786
	upstream	6.275	5.900	5.636	4.886	3.532	3.522	2.668	2.241
	total	-5.231	-4.832	-4.584	-4.094	-3.176	-3.027	-2.141	-1.546
SO ₂	tailpipe	-0.073	-0.068	-0.064	-0.054	-0.037	-0.035	-0.025	-0.020
	upstream	4.078	3.806	3.630	3.074	2.104	2.119	1.553	1.202
	total	4.005	3.738	3.566	3.021	2.067	2.084	1.528	1.182
PM _{2.5}	tailpipe	-0.303	-0.283	-0.270	-0.235	-0.175	-0.167	-0.120	-0.098
	upstream	0.474	0.446	0.426	0.370	0.268	0.267	0.203	0.171
	total	0.171	0.162	0.156	0.135	0.093	0.100	0.082	0.073

Table VII-81 - Criteria Emissions in 2025 (1,000 metric tons) under CO₂ Targets

Pollutant		Alt. 1	Alt. 2	Alt. 3	Alt. 4	Alt. 5	Alt. 6	Alt. 7	Alt.8
CO	tailpipe	-140.738	-133.545	-127.227	-99.668	-55.956	-60.866	-39.908	-27.145
	upstream	2.528	2.430	2.276	1.784	1.006	1.078	0.725	0.501
	total	-138.210	-131.115	-124.951	-97.884	-54.949	-59.788	-39.183	-26.644
VOC	tailpipe	-11.916	-11.283	-10.812	-8.599	-4.906	-5.447	-3.636	-2.492
	upstream	9.242	8.879	8.331	6.571	3.793	4.043	2.638	1.960
	total	-2.674	-2.404	-2.481	-2.028	-1.114	-1.404	-0.999	-0.532
NO _x	tailpipe	-9.160	-8.650	-8.280	-6.440	-3.547	-3.923	-2.607	-1.724
	upstream	5.104	4.905	4.596	3.609	2.049	2.193	1.451	1.030
	total	-4.057	-3.745	-3.684	-2.832	-1.497	-1.730	-1.157	-0.694
SO ₂	tailpipe	-0.064	-0.061	-0.057	-0.043	-0.022	-0.023	-0.014	-0.009
	upstream	3.504	3.370	3.143	2.428	1.290	1.397	0.849	0.573
	total	3.440	3.309	3.086	2.385	1.268	1.374	0.836	0.564
PM _{2.5}	tailpipe	-0.247	-0.234	-0.223	-0.173	-0.096	-0.104	-0.068	-0.045
	upstream	0.384	0.369	0.346	0.272	0.155	0.166	0.115	0.078
	total	0.137	0.135	0.123	0.099	0.059	0.062	0.047	0.033

Table VII-82 - Criteria Emissions in 2035 (1,000 metric tons) under Fuel Economy Targets

Pollutant		Alt. 1	Alt. 2	Alt. 3	Alt. 4	Alt. 5	Alt. 6	Alt. 7	Alt.8
CO	tailpipe	-286.582	-266.262	-248.134	-204.450	-151.495	-121.828	-57.583	-74.726
	upstream	6.487	6.064	5.685	4.802	3.643	2.936	1.571	1.947
	total	-280.095	-260.197	-242.449	-199.647	-147.852	-118.892	-56.012	-72.779
VOC	tailpipe	-14.905	-13.911	-13.015	-10.979	-8.287	-6.869	-3.568	-4.259
	upstream	24.869	23.369	21.978	18.879	14.687	12.120	7.070	8.556
	total	9.964	9.458	8.964	7.900	6.400	5.252	3.502	4.297
NO _x	tailpipe	-13.034	-12.097	-11.285	-9.301	-6.889	-5.585	-2.689	-3.422
	upstream	13.144	12.307	11.550	9.821	7.528	6.123	3.400	4.171
	total	0.110	0.210	0.265	0.520	0.639	0.538	0.711	0.750
SO ₂	tailpipe	-0.196	-0.181	-0.167	-0.130	-0.090	-0.068	-0.029	-0.039
	upstream	8.374	7.771	7.255	5.977	4.351	3.367	1.515	1.979
	total	8.178	7.591	7.087	5.846	4.261	3.298	1.486	1.940
PM _{2.5}	tailpipe	-0.719	-0.669	-0.622	-0.507	-0.372	-0.297	-0.139	-0.180
	upstream	0.999	0.936	0.879	0.749	0.577	0.471	0.265	0.324
	total	0.279	0.267	0.256	0.242	0.204	0.174	0.126	0.144

Table VII-83 - Criteria Emissions in 2035 (1,000 metric tons) under CO₂ Targets

Pollutant		Alt. 1	Alt. 2	Alt. 3	Alt. 4	Alt. 5	Alt. 6	Alt. 7	Alt.8
CO	tailpipe	-297.466	-283.552	-254.042	-191.790	-129.900	-101.308	-41.239	-50.995
	upstream	6.499	6.218	5.517	4.282	2.917	2.337	1.274	1.291
	total	-290.967	-277.334	-248.525	-187.508	-126.982	-98.971	-39.965	-49.704
VOC	tailpipe	-14.669	-13.976	-12.652	-9.731	-6.593	-5.418	-2.444	-2.750
	upstream	24.139	23.108	20.631	16.221	11.366	9.299	4.247	5.353
	total	9.471	9.132	7.979	6.490	4.773	3.881	1.804	2.604
NO _x	tailpipe	-13.452	-12.810	-11.487	-8.645	-5.830	-4.577	-1.885	-2.291
	upstream	12.989	12.430	11.055	8.627	5.946	4.802	2.431	2.697
	total	-0.463	-0.380	-0.432	-0.018	0.116	0.225	0.546	0.406
SO ₂	tailpipe	-0.223	-0.212	-0.187	-0.136	-0.085	-0.062	-0.025	-0.029
	upstream	8.797	8.409	7.407	5.653	3.704	2.875	1.047	1.492
	total	8.574	8.196	7.220	5.517	3.620	2.812	1.023	1.463
PM _{2.5}	tailpipe	-0.757	-0.723	-0.650	-0.488	-0.324	-0.252	-0.101	-0.122
	upstream	0.980	0.938	0.835	0.653	0.452	0.366	0.230	0.206
	total	0.223	0.215	0.185	0.165	0.128	0.114	0.129	0.084

As shown in Table VII-84 through Table VII-87, it is estimated that the proposed program would result in small changes for air toxic emissions compared to total U.S. inventories across all sectors. In 2025, it is estimated the scenarios evaluated would reduce total acetaldehyde, acrolein, benzene, butadiene, and formaldehyde,

toxics as compared to the baseline. This result is caused by greater VMT rebound miles assumed in the augural scenario and fewer rebound VMT in scenarios 1-8, and fewer older vehicles in the scenarios as compared to the baseline. Similarly, in 2035, acetaldehyde, benzene, butadiene, acrolein, and formaldehyde would all be reduced as

compared to the baseline. As is the case with criteria emissions, upstream toxic emissions generally increase in the evaluated scenarios as compared to the baseline because of the greater amount of gasoline and diesel being refined and distributed.

Table VII-84 - Toxic Emissions in 2025 (1,000 metric tons) under Fuel Economy Targets

Pollutant		Alt. 1	Alt. 2	Alt. 3	Alt. 4	Alt. 5	Alt. 6	Alt. 7	Alt.8
Acetaldehyde	tailpipe	-0.117	-0.109	-0.104	-0.091	-0.067	-0.064	-0.046	-0.038
	upstream	0.002	0.002	0.002	0.002	0.001	0.001	0.001	0.001
	total	-0.114	-0.107	-0.102	-0.089	-0.066	-0.063	-0.046	-0.037
Acrolein	tailpipe	-0.006	-0.006	-0.005	-0.005	-0.004	-0.003	-0.002	-0.002
	upstream	0.000	0.000	0.000	0.000	0.000	0.000	0.000	0.000
	total	-0.006	-0.005	-0.005	-0.005	-0.003	-0.003	-0.002	-0.002
Benzene	tailpipe	-0.457	-0.428	-0.407	-0.361	-0.274	-0.263	-0.192	-0.156
	upstream	0.044	0.041	0.040	0.034	0.025	0.025	0.019	0.016
	total	-0.413	-0.387	-0.368	-0.327	-0.249	-0.238	-0.172	-0.140
Butadiene	tailpipe	-0.054	-0.051	-0.048	-0.043	-0.032	-0.031	-0.022	-0.018
	upstream	0.000	0.000	0.000	0.000	0.000	0.000	0.000	0.000
	total	-0.054	-0.050	-0.048	-0.042	-0.032	-0.031	-0.022	-0.018
Formaldehyde	tailpipe	-0.092	-0.086	-0.082	-0.072	-0.055	-0.052	-0.038	-0.031
	upstream	0.016	0.015	0.015	0.013	0.009	0.009	0.007	0.006
	total	-0.076	-0.071	-0.068	-0.060	-0.045	-0.043	-0.031	-0.025

Table VII-85 - Toxic Emissions in 2025 (1,000 metric tons) under CO₂ Targets

Pollutant		Alt. 1	Alt. 2	Alt. 3	Alt. 4	Alt. 5	Alt. 6	Alt. 7	Alt.8
Acetaldehyde	tailpipe	-0.095	-0.090	-0.086	-0.067	-0.037	-0.040	-0.026	-0.018
	upstream	0.002	0.002	0.002	0.001	0.001	0.001	0.000	0.000
	total	-0.093	-0.088	-0.084	-0.065	-0.036	-0.039	-0.025	-0.017
Acrolein	tailpipe	-0.005	-0.005	-0.004	-0.004	-0.002	-0.002	-0.001	-0.001
	upstream	0.000	0.000	0.000	0.000	0.000	0.000	0.000	0.000
	total	-0.005	-0.005	-0.004	-0.003	-0.002	-0.002	-0.001	-0.001
Benzene	tailpipe	-0.361	-0.341	-0.327	-0.258	-0.146	-0.161	-0.107	-0.073
	upstream	0.035	0.034	0.032	0.025	0.015	0.015	0.010	0.008
	total	-0.325	-0.308	-0.295	-0.233	-0.132	-0.146	-0.097	-0.066
Butadiene	tailpipe	-0.043	-0.041	-0.039	-0.031	-0.018	-0.019	-0.012	-0.009
	upstream	0.000	0.000	0.000	0.000	0.000	0.000	0.000	0.000
	total	-0.043	-0.041	-0.039	-0.031	-0.017	-0.019	-0.012	-0.009
Formaldehyde	tailpipe	-0.074	-0.070	-0.067	-0.052	-0.029	-0.032	-0.021	-0.015
	upstream	0.013	0.013	0.012	0.009	0.005	0.006	0.004	0.003
	total	-0.061	-0.057	-0.055	-0.043	-0.024	-0.026	-0.017	-0.012

Table VII-86 - Toxic Emissions in 2035 (1,000 metric tons) under Fuel Economy Targets

Pollutant		Alt. 1	Alt. 2	Alt. 3	Alt. 4	Alt. 5	Alt. 6	Alt. 7	Alt.8
Acetaldehyde	tailpipe	-0.275	-0.255	-0.238	-0.195	-0.144	-0.115	-0.054	-0.070
	upstream	0.005	0.004	0.004	0.004	0.003	0.002	0.001	0.002
	total	-0.270	-0.251	-0.234	-0.192	-0.141	-0.113	-0.052	-0.069
Acrolein	tailpipe	-0.014	-0.013	-0.012	-0.010	-0.008	-0.006	-0.003	-0.004
	upstream	0.001	0.001	0.001	0.000	0.000	0.000	0.000	0.000
	total	-0.014	-0.013	-0.012	-0.010	-0.007	-0.006	-0.003	-0.004
Benzene	tailpipe	-0.535	-0.499	-0.466	-0.391	-0.294	-0.241	-0.120	-0.149
	upstream	0.095	0.090	0.084	0.072	0.056	0.047	0.027	0.033
	total	-0.440	-0.409	-0.382	-0.318	-0.237	-0.194	-0.092	-0.116
Butadiene	tailpipe	-0.083	-0.077	-0.072	-0.060	-0.045	-0.037	-0.018	-0.023
	upstream	0.001	0.001	0.001	0.001	0.001	0.001	0.000	0.000
	total	-0.082	-0.076	-0.071	-0.060	-0.045	-0.036	-0.018	-0.023
Formaldehyde	tailpipe	-0.140	-0.130	-0.121	-0.101	-0.075	-0.061	-0.029	-0.038
	upstream	0.035	0.033	0.031	0.027	0.021	0.017	0.010	0.012
	total	-0.104	-0.097	-0.090	-0.074	-0.055	-0.044	-0.019	-0.026

Table VII-87 - Toxic Emissions in 2035 (1,000 metric tons) under CO₂ Targets

Pollutant		Alt. 1	Alt. 2	Alt. 3	Alt. 4	Alt. 5	Alt. 6	Alt. 7	Alt.8
Acetaldehyde	tailpipe	-0.288	-0.275	-0.246	-0.185	-0.125	-0.097	-0.039	-0.048
	upstream	0.005	0.004	0.004	0.003	0.002	0.002	0.001	0.001
	total	-0.283	-0.270	-0.242	-0.182	-0.123	-0.095	-0.038	-0.047
Acrolein	tailpipe	-0.015	-0.014	-0.012	-0.010	-0.007	-0.005	-0.002	-0.003
	upstream	0.001	0.001	0.001	0.000	0.000	0.000	0.000	0.000
	total	-0.014	-0.013	-0.012	-0.009	-0.006	-0.005	-0.002	-0.003
Benzene	tailpipe	-0.537	-0.512	-0.461	-0.354	-0.242	-0.194	-0.084	-0.099
	upstream	0.092	0.088	0.079	0.062	0.044	0.036	0.016	0.021
	total	-0.445	-0.424	-0.382	-0.292	-0.198	-0.158	-0.067	-0.079
Butadiene	tailpipe	-0.084	-0.080	-0.072	-0.055	-0.038	-0.030	-0.013	-0.016
	upstream	0.001	0.001	0.001	0.001	0.000	0.000	0.000	0.000
	total	-0.083	-0.079	-0.071	-0.055	-0.038	-0.030	-0.012	-0.015
Formaldehyde	tailpipe	-0.143	-0.136	-0.122	-0.093	-0.064	-0.050	-0.021	-0.026
	upstream	0.034	0.033	0.029	0.023	0.016	0.013	0.006	0.008
	total	-0.109	-0.103	-0.093	-0.070	-0.048	-0.037	-0.015	-0.018

(b) Methodology

For the downstream analysis, emission factors in grams per mile for VOC, CO, NO_x, PM_{2.5}, and air toxics by vehicle model year and age were taken from the current version of the EPA "Motor Vehicle Emission Simulator" (MOVES2014a) and multiplied in the CAFE model by assumed VMT to estimate mass VOC, CO, NO_x, PM_{2.5}, and air toxics emissions. Additional

emissions from light duty cars and trucks attributable to the rebound effect were also calculated using the CAFE model. A more complete discussion of the inputs, methodology, and results is contained in PRIA Chapter 6. This proposal also assumes implementation of EPA's Tier 3 emission standards.⁶⁰⁰

⁶⁰⁰ See 79 FR 23414 (April 28, 2014). EPA's Tier 3 emissions standards included standards for

For a more detailed description of the method used to estimate emissions, please refer to pages 104–106 of the CAFE model documentation.

For the purposes of this emission analysis, it is assumed that all gasoline in the timeframe of the analysis is blended with 10% ethanol (E10). While electric vehicles have zero tailpipe

vehicle emissions and the sulfur content of gasoline.

emissions, it is assumed that manufacturers will plan for these vehicles in their regulatory compliance strategy for non-GHG emissions standards, and will not over-comply with those standards. Because the Tier 3 emissions standards are fleet-average standards (for all pollutants except formaldehyde and PM_{2.5}), it is assumed that if a manufacturer introduces EVs into its fleet, that it would correspondingly compensate through changes to vehicles elsewhere in its fleet, rather than meet an overall lower fleet-average emissions level. Consequently, no tailpipe pollutant benefit (other than CO₂, formaldehyde, and PM_{2.5}) is assumed. The analysis does not estimate evaporative emissions from light-duty vehicles. Other factors which may impact downstream non-GHG emissions, but are not estimated in this analysis, include the potential for decreased criteria pollutant emissions because of increased air conditioner efficiency; reduced refueling emissions because of less frequent refueling events and reduced annual refueling volumes resulting from the CO₂ standards; and increased hot soak evaporative emissions because of the likely increase in number of trips associated with VMT rebound modeled in this proposal. In all, these additional analyses would likely result in small changes relative to the national inventory.

To determine the impacts of increased fuel production on upstream emissions, the impact of increased gasoline consumption by light-duty vehicles on the extraction and transportation of crude oil, refining of crude oil, and distribution and storage of finished gasoline was estimated. To assess the resulting increases in domestic emissions, the fraction of increased gasoline consumption that would be supplied by additional domestic refining of gasoline, and the fraction of that gasoline that would be refined from domestic crude oil was estimated. Using NEMS, it was estimated that 50% of increased gasoline consumption would be supplied by increased domestic refining and that 90% of this additional refining would use imported crude petroleum. Emission factors for most upstream emission sources are based on the DOE Argonne National Laboratory's GREET 2017 model,⁶⁰¹ but emission factors developed by EPA were relied on for the air toxics estimated in this analysis: benzene, 1,3-butadiene, acetaldehyde, acrolein, and

formaldehyde. These emission factors came from the MOVES 2014a model and were incorporated into the CAFE model.

Emission factors for electricity upstream emissions were also based on GREET 2017. GREET allows the user to either select a region of the country for the electricity upstream emissions or to use the U.S. average of electricity emissions. The regional emission factors reflect the specific mix of fuels used to generate electricity in the selected region. The U.S. mix provides an average of electricity-related emissions (in grams per million Btu) in the U.S. in a given calendar year. The GREET 2017 U.S. mix emission factors were used for the analysis. In order to capture projected changes in upstream emissions over time, upstream emission factors for gasoline, diesel, and electricity were taken from the GREET 2017 model in five year increments, beginning in 1995 and ending in 2040.

For the downstream analysis of emissions, there are a number of uncertainties associated with the method, such as: Emission factors are based on samples of tested vehicles and these samples may not represent average emissions for the full in-use fleet; and there is considerable uncertainty in estimating total vehicle use (VMT). For the upstream analysis of emissions, there are uncertainties related to the projection of emissions associated with fossil fuel extraction, refining, and mode split for transportation of fuels. In addition, projections for electricity-related upstream emissions are based on assumptions about the fuels and technologies used to generate electricity which may not represent actual conditions through 2050.

E. Health Effects of Non-GHG Pollutants

This section discusses health effects associated with exposure to some of the criteria and air toxic pollutants impacted by the proposed vehicle standards.

1. Particulate Matter

(a) Background

Particulate matter is a highly complex mixture of solid particles and liquid droplets distributed among numerous atmospheric gases which interact with solid and liquid phases. Particles range in size from those smaller than 1 nanometer (10⁻⁹ meter) to more than 100 micrometers (μm, or 10⁻⁶ meter) in diameter (for reference, a typical strand of human hair is 70 μm in diameter and a grain of salt is approximately 100 μm). Atmospheric particles can be grouped into several classes according to their aerodynamic and physical sizes.

Generally, the three broad classes of particles include ultrafine particles (UFPs, generally considered as particulates with a diameter less than or equal to 0.1 μm [typically based on physical size, thermal diffusivity or electrical mobility]), "fine" particles (PM_{2.5}; particles with a nominal mean aerodynamic diameter less than or equal to 2.5 μm), and "thoracic" particles (PM₁₀; particles with a nominal mean aerodynamic diameter less than or equal to 10 μm).⁶⁰² Particles that fall within the size range between PM_{2.5} and PM₁₀, are referred to as "thoracic coarse particles" (PM_{10-2.5}, particles with a nominal mean aerodynamic diameter less than or equal to 10 μm and greater than 2.5 μm). EPA currently has standards that regulate PM_{2.5} and PM₁₀.⁶⁰³

Particles span many sizes and shapes and may consist of hundreds of different chemicals. Particles are emitted directly from sources and are also formed through atmospheric chemical reactions; the former are often referred to as "primary" particles, and the latter as "secondary" particles. Particle concentration and composition varies by time of year and location, and, in addition to differences in source emissions, is affected by several weather-related factors, such as temperature, clouds, humidity, and wind. A further layer of complexity comes from particles' ability to shift between solid/liquid and gaseous phases, which is influenced by concentration and meteorology, especially temperature.

Fine particles are produced primarily by combustion processes and by transformations of gaseous emissions (e.g., sulfur oxides (SO_x), oxides of nitrogen, and volatile organic compounds (VOC)) in the atmosphere. The chemical and physical properties of PM_{2.5} may vary greatly with time, region, meteorology, and source category. Thus, PM_{2.5} may include a complex mixture of different components including sulfates, nitrates, organic compounds, elemental carbon and metal compounds. These particles can remain in the atmosphere for days

⁶⁰² U.S. EPA. (2009). Integrated Science Assessment for Particulate Matter (Final Report). U.S. Environmental Protection Agency, Washington, DC, EPA/600/R-08/139F. Figure 3-1.

⁶⁰³ Regulatory definitions of PM size fractions, and information on reference and equivalent methods for measuring PM in ambient air, are provided in 40 CFR parts 50, 53, and 58. With regard to national ambient air quality standards (NAAQS) which provide protection against health and welfare effects, the 24-hour PM₁₀ standard provides protection against effects associated with short-term exposure to thoracic coarse particles (i.e., PM_{10-2.5}).

⁶⁰¹ Greenhouse Gas, Regulated Emissions, and Energy Use in Transportation model (GREET), U.S. Department of Energy, Argonne National Laboratory, <https://greet.es.anl.gov/>.

to weeks and travel hundreds to thousands of kilometers.

(b) Health Effects of PM

Scientific studies show exposure to ambient PM is associated with a broad range of health effects. These health effects are discussed in detail in the 2009 Integrated Science Assessment for Particulate Matter (PM ISA), which was used as the basis of the 2012 NAAQS.⁶⁰⁴ The PM ISA summarizes health effects evidence for short- and long-term exposures to PM_{2.5}, PM_{10-2.5}, and ultrafine particles.⁶⁰⁵ The PM ISA concludes that human exposures to ambient PM_{2.5} are associated with a number of adverse health effects and characterizes the weight of evidence for broad health categories (e.g., cardiovascular effects, respiratory effects, etc.).⁶⁰⁶ The discussion below highlights the PM ISA's conclusions pertaining to health effects associated with both short- and long-term PM exposures. Further discussion of health effects associated with PM can also be found in the rulemaking documents for the most recent review of the PM NAAQS completed in 2012.^{607 608}

EPA has concluded that “a causal relationship exists” between both long- and short-term exposures to PM_{2.5} and premature mortality and cardiovascular effects and that “a causal relationship is likely to exist” between long- and short-term PM_{2.5} exposures and respiratory effects. Further, there is evidence “suggestive of a causal relationship” between long-term PM_{2.5} exposures and other health effects, including developmental and reproductive effects (e.g., low birth weight, infant mortality) and carcinogenic, mutagenic, and genotoxic effects (e.g., lung cancer mortality).⁶⁰⁹

As summarized in the final rule promulgating the 2012 PM NAAQS, and discussed extensively in the 2009 PM ISA, the available scientific evidence significantly strengthens the link between long- and short-term exposure to PM_{2.5} and mortality, while providing indications that the magnitude of the PM_{2.5}-mortality association with long-term exposures may be larger than previously estimated.^{610 611} The strongest evidence comes from recent studies investigating long-term exposure to PM_{2.5} and cardiovascular-related mortality. The evidence supporting a causal relationship between long-term PM_{2.5} exposure and mortality also includes consideration of studies that demonstrated an improvement in community health following reductions in ambient fine particles.

The 2009 PM ISA examined the association between cardiovascular effects and long-term PM_{2.5} exposures in multi-city epidemiological studies conducted in the U.S. and Europe. These studies have provided new evidence linking long-term exposure to PM_{2.5} with an array of cardiovascular effects such as heart attacks, congestive heart failure, stroke, and mortality. This evidence is coherent with epidemiological studies of effects associated with short-term exposure to PM_{2.5} that have observed associations with a continuum of effects ranging from subtle changes in indicators of cardiovascular health to serious clinical events, such as increased hospitalizations and emergency department visits due to cardiovascular disease and cardiovascular mortality.⁶¹²

As detailed in the 2009 PM ISA, extended analyses of seminal epidemiological studies, as well as more recent epidemiological studies conducted in the U.S. and abroad, provide strong evidence of respiratory-related morbidity effects associated with long-term PM_{2.5} exposure. The strongest evidence for respiratory-related effects

is from studies that evaluated decrements in lung function growth (in children), increased respiratory symptoms, and asthma development. The strongest evidence from short-term PM_{2.5} exposure studies has been observed for increased respiratory-related emergency department visits and hospital admissions for chronic obstructive pulmonary disease (COPD) and respiratory infections.⁶¹³

The body of scientific evidence detailed in the 2009 PM ISA is still limited with respect to associations between long-term PM_{2.5} exposures and developmental and reproductive effects as well as cancer, mutagenic, and genotoxic effects. The strongest evidence for an association between PM_{2.5} and developmental and reproductive effects comes from epidemiological studies of low birth weight and infant mortality, especially due to respiratory causes during the post-neonatal period (i.e., 1 month to 12 months of age).⁶¹⁴ With regard to cancer effects, “[m]ultiple epidemiologic studies have shown a consistent positive association between PM_{2.5} and lung cancer mortality, but studies have generally not reported associations between PM_{2.5} and lung cancer incidence.”⁶¹⁵

In addition to evaluating the health effects attributed to short- and long-term exposure to PM_{2.5}, the 2009 PM ISA also evaluated whether specific components or sources of PM_{2.5} are more strongly associated with specific health effects. The 2009 PM ISA concluded that “many [components] of PM can be linked with differing health effects, and the evidence is not yet sufficient to allow differentiation of those [components] or sources that are more closely related to specific health outcomes.”⁶¹⁶

For PM_{10-2.5}, the 2009 PM ISA concluded that available evidence was “suggestive of a causal relationship” between short-term exposures to PM_{10-2.5} and cardiovascular effects (e.g., hospital admissions and Emergency Department (ED) visits, changes in

⁶⁰⁴ U.S. EPA. (2009). Integrated Science Assessment for Particulate Matter (Final Report). U.S. Environmental Protection Agency, Washington, DC, EPA/600/R-08/139F.

⁶⁰⁵ The ISA also evaluated evidence for individual PM components but did not reach causal determinations for components.

⁶⁰⁶ The causal framework draws upon the assessment and integration of evidence from across epidemiological, controlled human exposure, and toxicological studies, and the related uncertainties that ultimately influence our understanding of the evidence. This framework employs a five-level hierarchy that classifies the overall weight of evidence and causality using the following categorizations: Causal relationship, likely to be causal relationship, suggestive of a causal relationship, inadequate to infer a causal relationship, and not likely to be a causal relationship (U.S. EPA. (2009). Integrated Science Assessment for Particulate Matter (Final Report). U.S. Environmental Protection Agency, Washington, DC, EPA/600/R-08/139F, Table 1-3).

⁶⁰⁷ 78 FR 3103-3104 (Jan. 15, 2013).

⁶⁰⁸ 77 FR 38906-38911 (June 29, 2012).

⁶⁰⁹ These causal inferences are based not only on the more expansive epidemiological evidence

available in this review but also reflect consideration of important progress that has been made to advance our understanding of a number of potential biologic modes of action or pathways for PM-related cardiovascular and respiratory effects (U.S. EPA. (2009). Integrated Science Assessment for Particulate Matter (Final Report). U.S. Environmental Protection Agency, Washington, DC, EPA/600/R-08/139F, Chapter 5).

⁶¹⁰ 78 FR 3103-3104 (Jan. 15, 2013).

⁶¹¹ U.S. EPA. (2009). Integrated Science Assessment for Particulate Matter (Final Report). U.S. Environmental Protection Agency, Washington, DC, EPA/600/R-08/139F, Chapter 6 (Section 6.5) and Chapter 7 (Section 7.6).

⁶¹² U.S. EPA. (2009). Integrated Science Assessment for Particulate Matter (Final Report). U.S. Environmental Protection Agency, Washington, DC, EPA/600/R-08/139F, Chapter 2 (Section 2.3.1 and 2.3.2) and Chapter 6.

⁶¹³ U.S. EPA. (2009). Integrated Science Assessment for Particulate Matter (Final Report). U.S. Environmental Protection Agency, Washington, DC, EPA/600/R-08/139F, Chapter 2 (Section 2.3.1 and 2.3.2) and Chapter 6.

⁶¹⁴ U.S. EPA. (2009). Integrated Science Assessment for Particulate Matter (Final Report). U.S. Environmental Protection Agency, Washington, DC, EPA/600/R-08/139F, Chapter 2 (Section 2.3.1 and 2.3.2) and Chapter 7.

⁶¹⁵ U.S. EPA. (2009). Integrated Science Assessment for Particulate Matter (Final Report). U.S. Environmental Protection Agency, Washington, DC, EPA/600/R-08/139F, pg 2-13.

⁶¹⁶ U.S. EPA. (2009). Integrated Science Assessment for Particulate Matter (Final Report). U.S. Environmental Protection Agency, Washington, DC, EPA/600/R-08/139F, pg 2-26.

cardiovascular function), respiratory effects (e.g., ED visits and hospital admissions, increase in markers of pulmonary inflammation), and premature mortality. The scientific evidence was “inadequate to infer a causal relationship” between long-term exposure to PM_{10-2.5} and various health effects.^{617 618 619}

For UFPs, the 2009 PM ISA concluded that the evidence was “suggestive of a causal relationship” between short-term exposures and cardiovascular effects, including changes in heart rhythm and vasomotor function (the ability of blood vessels to expand and contract). It also concluded that there was evidence “suggestive of a causal relationship” between short-term exposure to UFPs and respiratory effects, including lung function and pulmonary inflammation, with limited and inconsistent evidence for increases in ED visits and hospital admissions. Scientific evidence was “inadequate to infer a causal relationship” between short-term exposure to UFPs and additional health effects including premature mortality as well as long-term exposure to UFPs and all health outcomes evaluated.^{620 621}

The 2009 PM ISA conducted an evaluation of specific groups within the general population potentially at increased risk for experiencing adverse health effects related to PM exposures.^{622 623 624 625} The evidence detailed in the 2009 PM ISA expands our understanding of previously identified at-risk populations and lifestages (i.e., children, older adults, and individuals with pre-existing heart and lung disease) and supports the identification of additional at-risk populations (e.g., persons with lower socioeconomic status, genetic differences). Additionally, there is emerging, though still limited, evidence

for additional potentially at-risk populations and lifestages, such as those with diabetes, people who are obese, pregnant women, and the developing fetus.⁶²⁶

2. Ozone

(a) Background

Ground-level ozone pollution is typically formed through reactions involving VOC and NO_x in the lower atmosphere in the presence of sunlight. These pollutants, often referred to as ozone precursors, are emitted by many types of sources, such as highway and nonroad motor vehicles and engines, power plants, chemical plants, refineries, makers of consumer and commercial products, industrial facilities, and smaller area sources.

The science of ozone formation, transport, and accumulation is complex. Ground-level ozone is produced and destroyed in a cyclical set of chemical reactions, many of which are sensitive to temperature and sunlight. When ambient temperatures and sunlight levels remain high for several days and the air is relatively stagnant, ozone and its precursors can build up and result in more ozone than typically occurs on a single high-temperature day. Ozone and its precursors can be transported hundreds of miles downwind from precursor emissions, resulting in elevated ozone levels even in areas with low local VOC or NO_x emissions.

(b) Health Effects of Ozone

This section provides a summary of the health effects associated with exposure to ambient concentrations of ozone.⁶²⁷ The information in this section is based on the information and conclusions in the February 2013 Integrated Science Assessment for Ozone (Ozone ISA), which formed the basis for EPA’s revision to the primary and secondary standards in 2015.⁶²⁸ The Ozone ISA concludes that human exposures to ambient concentrations of ozone are associated with a number of adverse health effects and characterizes

the weight of evidence for these health effects.⁶²⁹ The discussion below highlights the Ozone ISA’s conclusions pertaining to health effects associated with both short-term and long-term periods of exposure to ozone.

For short-term exposure to ozone, the Ozone ISA concludes that respiratory effects, including lung function decrements, pulmonary inflammation, exacerbation of asthma, respiratory-related hospital admissions, and mortality, are causally associated with ozone exposure. It also concludes that cardiovascular effects, including decreased cardiac function and increased vascular disease, and total mortality are likely to be causally associated with short-term exposure to ozone, and that evidence is suggestive of a causal relationship between central nervous system effects and short-term exposure to ozone.

For long-term exposure to ozone, the Ozone ISA concludes that respiratory effects, including new onset asthma, pulmonary inflammation and injury, are likely to be causally related with ozone exposure. The Ozone ISA characterizes the evidence as suggestive of a causal relationship for associations between long-term ozone exposure and cardiovascular effects, reproductive and developmental effects, central nervous system effects and total mortality. The evidence is inadequate to infer a causal relationship between chronic ozone exposure and increased risk of lung cancer.

Finally, inter-individual variation in human responses to ozone exposure can result in some groups being at increased risk for detrimental effects in response to exposure. In addition, some groups are at increased risk of exposure due to their activities, such as outdoor workers or children. The Ozone ISA identified several groups that are at increased risk for ozone-related health effects. These groups are people with asthma, children and older adults, individuals with reduced intake of certain nutrients (i.e., Vitamins C and E), outdoor workers, and individuals having certain genetic variants related to oxidative metabolism or inflammation. Ozone exposure during childhood can have lasting effects through adulthood. Such effects include altered function of the

⁶²⁹ The ISA evaluates evidence and draws conclusions on the causal nature of relationship between relevant pollutant exposures and health effects, assigning one of five “weight of evidence” determinations: Causal relationship, likely to be a causal relationship, suggestive of, but not sufficient to infer, a causal relationship, inadequate to infer a causal relationship, and not likely to be a causal relationship. For more information on these levels of evidence, please refer to Table II in the Preamble of the ISA.

⁶¹⁷ U.S. EPA. (2009). Integrated Science Assessment for Particulate Matter (Final Report). U.S. Environmental Protection Agency, Washington, DC, EPA/600/R-08/139F. Section 2.3.4 and Table 2-6.

⁶¹⁸ 78 FR 3167-3168 (Jan. 15, 2013).

⁶¹⁹ 77 FR 38947-38951 (June 29, 2012).

⁶²⁰ U.S. EPA. (2009). Integrated Science Assessment for Particulate Matter (Final Report). U.S. Environmental Protection Agency, Washington, DC, EPA/600/R-08/139F. Section 2.3.5 and Table 2-6.

⁶²¹ 78 FR 3121 (Jan. 15, 2013).

⁶²² U.S. EPA. (2009). Integrated Science Assessment for Particulate Matter (Final Report). U.S. Environmental Protection Agency, Washington, DC, EPA/600/R-08/139F. Chapter 8 and Chapter 2.

⁶²³ 77 FR 38890 (June 29, 2012).

⁶²⁴ 78 FR 3104 (Jan. 15, 2013).

⁶²⁵ U.S. EPA. (2011). Policy Assessment for the Review of the PM NAAQS. U.S. Environmental Protection Agency, Washington, DC, EPA/452/R-11-003. Section 2.2.1.

⁶²⁶ U.S. EPA. (2009). Integrated Science Assessment for Particulate Matter (Final Report). U.S. Environmental Protection Agency, Washington, DC, EPA/600/R-08/139F. Chapter 8 and Chapter 2 (Section 2.4.1).

⁶²⁷ Human exposure to ozone varies over time due to changes in ambient ozone concentration and because people move between locations which have notable different ozone concentrations. Also, the amount of ozone delivered to the lung is not only influenced by the ambient concentrations but also by the individuals breathing route and rate.

⁶²⁸ U.S. EPA. Integrated Science Assessment of Ozone and Related Photochemical Oxidants (Final Report). U.S. Environmental Protection Agency, Washington, DC, EPA/600/R-10/076F, 2013. The ISA is available at <http://cfpub.epa.gov/ncea/isa/recordisplay.cfm?deid=247492#Download>.

respiratory and immune systems. Children absorb higher doses (normalized to lung surface area) of ambient ozone, compared to adults, due to their increased time spent outdoors, higher ventilation rates relative to body size, and a tendency to breathe a greater fraction of air through the mouth. Children also have a higher asthma prevalence compared to adults.

3. Nitrogen Oxides

(a) Background

Oxides of nitrogen (NO_x) refers to nitric oxide and nitrogen dioxide (NO₂). For the NO_x NAAQS, NO₂ is the indicator. Most NO₂ is formed in the air through the oxidation of nitric oxide (NO) emitted when fuel is burned at a high temperature. NO_x is also a major contributor to secondary PM_{2.5} formation. NO_x and VOC are the two major precursors of ozone.

(b) Health Effects of Nitrogen Oxides

The most recent review of the health effects of oxides of nitrogen completed by EPA can be found in the 2016 Integrated Science Assessment for Oxides of Nitrogen—Health Criteria (Oxides of Nitrogen ISA).⁶³⁰ The primary source of NO₂ is motor vehicle emissions, and ambient NO₂ concentrations tend to be highly correlated with other traffic-related pollutants. Thus, a key issue in characterizing the causality of NO₂-health effect relationships was evaluating the extent to which studies supported an effect of NO₂ that is independent of other traffic-related pollutants. EPA concluded that the findings for asthma exacerbation integrated from epidemiologic and controlled human exposure studies provided evidence that is sufficient to infer a causal relationship between respiratory effects and short-term NO₂ exposure. The strongest evidence supporting an independent effect of NO₂ exposure comes from controlled human exposure studies demonstrating increased airway responsiveness in individuals with asthma following ambient-relevant NO₂ exposures. The coherence of this evidence with epidemiologic findings for asthma hospital admissions and ED visits as well as lung function decrements and increased pulmonary inflammation in children with asthma describe a plausible pathway by which NO₂ exposure can cause an asthma exacerbation. The 2016 ISA for Oxides

of Nitrogen also concluded that there is likely to be a causal relationship between long-term NO₂ exposure and respiratory effects. This conclusion is based on new epidemiologic evidence for associations of NO₂ with asthma development in children combined with biological plausibility from experimental studies.

In evaluating a broader range of health effects, the 2016 ISA for Oxides of Nitrogen concluded evidence is “suggestive of, but not sufficient to infer, a causal relationship” between short-term NO₂ exposure and cardiovascular effects and mortality and between long-term NO₂ exposure and cardiovascular effects and diabetes, birth outcomes, and cancer. In addition, the scientific evidence is inadequate (insufficient consistency of epidemiologic and toxicological evidence) to infer a causal relationship for long-term NO₂ exposure with fertility, reproduction, and pregnancy, as well as with postnatal development. A key uncertainty in understanding the relationship between these non-respiratory health effects and short- or long-term exposure to NO₂ is copollutant confounding, particularly by other roadway pollutants. The available evidence for non-respiratory health effects does not adequately address whether NO₂ has an independent effect or whether it primarily represents effects related to other or a mixture of traffic-related pollutants.

The 2016 ISA for Oxides of Nitrogen concluded that people with asthma, children, and older adults are at increased risk for NO₂-related health effects. In these groups and lifestages, NO₂ is consistently related to larger effects on outcomes related to asthma exacerbation, for which there is confidence in the relationship with NO₂ exposure.

4. Sulfur Oxides

(a) Background

Sulfur dioxide (SO₂), a member of the sulfur oxide (SO_x) family of gases, is formed from burning fuels containing sulfur (*e.g.*, coal or oil derived), extracting gasoline from oil, or extracting metals from ore. SO₂ and its gas phase oxidation products can dissolve in water droplets and further oxidize to form sulfuric acid which reacts with ammonia to form sulfates, which are important components of ambient PM.

(b) Health Effects of SO₂

Information on the health effects of SO₂ can be found in the 2008 Integrated

Science Assessment for Sulfur Oxides—Health Criteria (SO_x ISA).⁶³¹ Short-term peaks (5–10 minutes) of SO₂ have long been known to cause adverse respiratory health effects, particularly among individuals with asthma. In addition to those with asthma (both children and adults), potentially at-risk lifestages include all children and the elderly. During periods of elevated ventilation, asthmatics may experience symptomatic bronchoconstriction within minutes of exposure. Following an extensive evaluation of health evidence from epidemiologic and laboratory studies, EPA concluded that there is a causal relationship between respiratory health effects and short-term exposure to SO₂. Separately, based on an evaluation of the epidemiologic evidence of associations between short-term exposure to SO₂ and mortality, EPA concluded that the overall evidence is suggestive of a causal relationship between short-term exposure to SO₂ and mortality.

5. Carbon Monoxide

(a) Background

Carbon monoxide is a colorless, odorless gas emitted from combustion processes. Nationally, particularly in urban areas, the majority of CO emissions to ambient air come from mobile sources.⁶³²

(b) Health Effects of Carbon Monoxide

Information on the health effects of CO can be found in the January 2010 Integrated Science Assessment for Carbon Monoxide (CO ISA) associated with the 2010 evaluation of the NAAQS.⁶³³ The CO ISA presents conclusions regarding the presence of causal relationships between CO exposure and categories of adverse health effects. This section provides a summary of the health effects associated with exposure to ambient concentrations of CO, along with the ISA conclusions.⁶³⁴

⁶³¹ U.S. EPA. (2008). *Integrated Science Assessment (ISA) for Sulfur Oxides—Health Criteria (Final Report)*. EPA/600/R-08/047F. Washington, DC: U.S. Environmental Protection Agency.

⁶³² U.S. EPA. (2010). *Integrated Science Assessment for Carbon Monoxide (Final Report)*. U.S. Environmental Protection Agency, Washington, DC, EPA/600/R-09/019F, 2010. Available at <http://cfpub.epa.gov/ncea/cfm/recordisplay.cfm?deid=218686>. See Section 2.1.

⁶³³ U.S. EPA. (2010). *Integrated Science Assessment for Carbon Monoxide (Final Report)*. U.S. Environmental Protection Agency, Washington, DC, EPA/600/R-09/019F, 2010. Available at <http://cfpub.epa.gov/ncea/cfm/recordisplay.cfm?deid=218686>.

⁶³⁴ Personal exposure includes contributions from many sources and in many different environments. Total personal exposure to CO includes both

⁶³⁰ U.S. EPA. *Integrated Science Assessment for Oxides of Nitrogen—Health Criteria (2016 Final Report)*. U.S. Environmental Protection Agency, Washington, DC, EPA/600/R-15/068, 2016.

Controlled human exposure studies of subjects with coronary artery disease show a decrease in the time to onset of exercise-induced angina (chest pain) and electrocardiogram changes following CO exposure. In addition, epidemiologic studies observed associations between short-term CO exposure and cardiovascular morbidity, particularly increased emergency room visits and hospital admissions for coronary heart disease (including ischemic heart disease, myocardial infarction, and angina). Some epidemiologic evidence is also available for increased hospital admissions and emergency room visits for congestive heart failure and cardiovascular disease as a whole. The CO ISA concludes that a causal relationship is likely to exist between short-term exposures to CO and cardiovascular morbidity. It also concludes that available data are inadequate to conclude that a causal relationship exists between long-term exposures to CO and cardiovascular morbidity.

Animal studies show various neurological effects with in-utero CO exposure. Controlled human exposure studies report central nervous system and behavioral effects following low-level CO exposures, although the findings have not been consistent across all studies. The CO ISA concludes the evidence is suggestive of a causal relationship with both short- and long-term exposure to CO and central nervous system effects.

A number of studies cited in the CO ISA have evaluated the role of CO exposure in birth outcomes such as preterm birth or cardiac birth defects. There is limited epidemiologic evidence of a CO-induced effect on preterm births and birth defects, with weak evidence for a decrease in birth weight. Animal toxicological studies have found perinatal CO exposure to affect birth weight, as well as other developmental outcomes. The CO ISA concludes the evidence is suggestive of a causal relationship between long-term exposures to CO and developmental effects and birth outcomes.

Epidemiologic studies provide evidence of associations between short-term CO concentrations and respiratory morbidity such as changes in pulmonary function, respiratory symptoms, and hospital admissions. A limited number of epidemiologic studies considered copollutants such as ozone, SO₂, and PM in two-pollutant models and found that CO risk estimates

ambient and nonambient components; both components may contribute to adverse health effects.

were generally robust, although this limited evidence makes it difficult to disentangle effects attributed to CO itself from those of the larger complex air pollution mixture. Controlled human exposure studies have not extensively evaluated the effect of CO on respiratory morbidity. Animal studies at levels of 50–100 ppm CO show preliminary evidence of altered pulmonary vascular remodeling and oxidative injury. The CO ISA concludes that the evidence is suggestive of a causal relationship between short-term CO exposure and respiratory morbidity, and inadequate to conclude that a causal relationship exists between long-term exposure and respiratory morbidity.

Finally, the CO ISA concludes that the epidemiologic evidence is suggestive of a causal relationship between short-term concentrations of CO and mortality. Epidemiologic evidence suggests an association exists between short-term exposure to CO and mortality, but limited evidence is available to evaluate cause-specific mortality outcomes associated with CO exposure. In addition, the attenuation of CO risk estimates which was often observed in copollutant models contributes to the uncertainty as to whether CO is acting alone or as an indicator for other combustion-related pollutants. The CO ISA also concludes that there is not likely to be a causal relationship between relevant long-term exposures to CO and mortality.

6. Diesel Exhaust

(a) Background

Diesel exhaust consists of a complex mixture composed of particulate matter, carbon dioxide, oxygen, nitrogen, water vapor, carbon monoxide, nitrogen compounds, sulfur compounds and numerous low-molecular-weight hydrocarbons. A number of these gaseous hydrocarbon components are individually known to be toxic, including aldehydes, benzene and 1,3-butadiene. The diesel particulate matter present in diesel exhaust consists mostly of fine particles (<2.5 μm), of which a significant fraction is ultrafine particles (< 0.1 μm). These particles have a large surface area which makes them an excellent medium for adsorbing organics, and their small size makes them highly respirable. Many of the organic compounds present in the gases and on the particles, such as polycyclic organic matter, are individually known to have mutagenic and carcinogenic properties.

Diesel exhaust varies significantly in chemical composition and particle sizes between different engine types (heavy-

duty, light-duty), engine operating conditions (idle, acceleration, deceleration), and fuel formulations (high/low sulfur fuel). Also, there are emissions differences between on-road and nonroad engines because the nonroad engines are generally of older technology. After being emitted in the engine exhaust, diesel exhaust undergoes dilution as well as chemical and physical changes in the atmosphere. The lifetime for some of the compounds present in diesel exhaust ranges from hours to days.

(b) Health Effects of Diesel Exhaust

In EPA's 2002 Diesel Health Assessment Document (Diesel HAD), exposure to diesel exhaust was classified as likely to be carcinogenic to humans by inhalation from environmental exposures, in accordance with the revised draft 1996/1999 EPA cancer guidelines.^{635 636} A number of other agencies (National Institute for Occupational Safety and Health, the International Agency for Research on Cancer, the World Health Organization, California EPA, and the U.S. Department of Health and Human Services) made similar hazard classifications prior to 2002. EPA also concluded in the 2002 Diesel HAD that it was not possible to calculate a cancer unit risk for diesel exhaust due to limitations in the exposure data for the occupational groups or the absence of a dose-response relationship.

In the absence of a cancer unit risk, the Diesel HAD sought to provide additional insight into the significance of the diesel exhaust cancer hazard by estimating possible ranges of risk that might be present in the population. An exploratory analysis was used to characterize a range of possible lung cancer risk. The outcome was that environmental risks of cancer from long-term diesel exhaust exposures could plausibly range from as low as 10⁻⁵ to as high as 10⁻³. Because of uncertainties, the analysis acknowledged that the risks could be lower than 10⁻⁵, and a zero risk from diesel exhaust exposure could not be ruled out.

Non-cancer health effects of acute and chronic exposure to diesel exhaust emissions are also of concern to EPA. EPA derived a diesel exhaust reference

⁶³⁵ U.S. EPA. (March 2005). *Guidelines for Carcinogen Risk Assessment* EPA/630/P-03/001F, <https://www.epa.gov/risk/guidelines-carcinogen-risk-assessment> (Last accessed July 2018).

⁶³⁶ U.S. EPA (2002). *Health Assessment Document for Diesel Engine Exhaust*. EPA/600/8-90/057F Office of Research and Development, Washington, DC. Retrieved on March 17, 2009 from <http://cfpub.epa.gov/ncea/cfm/recordisplay.cfm?deid=29060> (last accessed July 2018). pp. 1-1 1-2.

concentration (RfC) from consideration of four well-conducted chronic rat inhalation studies showing adverse pulmonary effects. The RfC is 5 µg/m³ for diesel exhaust measured as diesel particulate matter. This RfC does not consider allergenic effects such as those associated with asthma or immunologic or the potential for cardiac effects. There was emerging evidence in 2002, discussed in the Diesel HAD, that exposure to diesel exhaust can exacerbate these effects, but the exposure-response data were lacking at that time to derive an RfC based on these then-emerging considerations. The EPA Diesel HAD states, “With [diesel particulate matter] being a ubiquitous component of ambient PM, there is an uncertainty about the adequacy of the existing [diesel exhaust] noncancer database to identify all of the pertinent [diesel exhaust]-caused noncancer health hazards.” The Diesel HAD also notes “that acute exposure to [diesel exhaust] has been associated with irritation of the eye, nose, and throat, respiratory symptoms (cough and phlegm), and neurophysiological symptoms such as headache, lightheadedness, nausea, vomiting, and numbness or tingling of the extremities.” The Diesel HAD noted that the cancer and noncancer hazard conclusions applied to the general use of diesel engines then on the market and as cleaner engines replace a substantial number of existing ones, the applicability of the conclusions would need to be reevaluated.

It is important to note that the Diesel HAD also briefly summarizes health effects associated with ambient PM and discusses EPA’s then-annual PM_{2.5} NAAQS of 15 µg/m³. In 2012, EPA revised the annual PM_{2.5} NAAQS to 12 µg/m³. There is a large and extensive body of human data showing a wide spectrum of adverse health effects associated with exposure to ambient PM, of which diesel exhaust is an important component. The PM_{2.5} NAAQS is designed to provide protection from the noncancer health effects and premature mortality attributed to exposure to PM_{2.5}. The contribution of diesel PM to total ambient PM varies in different regions of the country and also, within a region, from one area to another. The contribution can be high in near-roadway environments, for example, or in other locations where diesel engine use is concentrated.

Since 2002, several new studies have been published which continue to report increased lung cancer risk with occupational exposure to diesel exhaust from older engines. Of particular note

since 2011 are three new epidemiology studies which have examined lung cancer in occupational populations, for example, truck drivers, underground nonmetal miners and other diesel motor-related occupations. These studies reported increased risk of lung cancer with exposure to diesel exhaust with evidence of positive exposure-response relationships to varying degrees.^{637 638 639} These newer studies (along with others that have appeared in the scientific literature) add to the evidence EPA evaluated in the 2002 Diesel HAD and further reinforces the concern that diesel exhaust exposure likely poses a lung cancer hazard. The findings from these newer studies do not necessarily apply to newer technology diesel engines b the newer engines have large reductions in the emission constituents compared to older technology diesel engines.

In light of the growing body of scientific literature evaluating the health effects of exposure to diesel exhaust, in June 2012 the World Health Organization’s International Agency for Research on Cancer (IARC), a recognized international authority on the carcinogenic potential of chemicals and other agents, evaluated the full range of cancer-related health effects data for diesel engine exhaust. IARC concluded that diesel exhaust should be regarded as “carcinogenic to humans.”⁶⁴⁰ This designation was an update from its 1988 evaluation that considered the evidence to be indicative of a “probable human carcinogen.”

7. Air Toxics

(a) Background

Light-duty vehicle emissions contribute to ambient levels of air toxics that are known or suspected human or animal carcinogens, or that have noncancer health effects. The population experiences an elevated risk of cancer and other noncancer health effects from exposure to the class of

⁶³⁷ Garshick, E., Laden, F., Hart, J.E., Davis, M.E., Eisen, E.A., & Smith T.J. 2012. Lung cancer and elemental carbon exposure in trucking industry workers. *Environmental Health Perspectives*. 120(9): 1301–1306.

⁶³⁸ Silverman, D.T., Samanic, C.M., Lubin, J.H., Blair, A.E., Stewart, P.A., Vermeulen, R., & Attfield, M.D. (2012). The diesel exhaust in miners study: a nested case-control study of lung cancer and diesel exhaust. *Journal of the National Cancer Institute*.

⁶³⁹ Olsson, A.C., et al. “Exposure to diesel motor exhaust and lung cancer risk in a pooled analysis from case-control studies in Europe and Canada.” *American Journal of Respiratory and Critical Care Medicine* 183(7). (2011): 941–948.

⁶⁴⁰ IARC [International Agency for Research on Cancer]. (2013). Diesel and gasoline engine exhausts and some nitroarenes. IARC Monographs Volume 105. [Online at <http://monographs.iarc.fr/ENG/Monographs/vol105/index.php>].

pollutants known collectively as “air toxics.”⁶⁴¹ These compounds include, but are not limited to, benzene, 1,3-butadiene, formaldehyde, acetaldehyde, acrolein, polycyclic organic matter, and naphthalene. These compounds were identified as national or regional risk drivers or contributors in the 2011 National-scale Air Toxics Assessment and have significant inventory contributions from mobile sources.⁶⁴²

(b) Benzene

EPA’s Integrated Risk Information System (IRIS) database lists benzene as a known human carcinogen (causing leukemia) by all routes of exposure and concludes that exposure is associated with additional health effects, including genetic changes in both humans and animals and increased proliferation of bone marrow cells in mice.^{643 644 645} EPA states in its IRIS database that data indicate a causal relationship between benzene exposure and acute lymphocytic leukemia and suggest a relationship between benzene exposure and chronic non-lymphocytic leukemia and chronic lymphocytic leukemia. EPA’s IRIS documentation for benzene also lists a range of 2.2 x 10⁻⁶ to 7.8 x 10⁻⁶ per µg/m³ as the unit risk estimate (URE) for benzene.^{646 647} The International Agency for Research on Cancer (IARC) has determined that benzene is a human carcinogen and the U.S. Department of Health and Human Services (DHHS) has characterized benzene as a known human carcinogen.^{648 649}

⁶⁴¹ U.S. EPA. (2015) Summary of Results for the 2011 National-Scale Assessment. <http://www3.epa.gov/sites/production/files/2015-12/documents/2011-nata-summary-results.pdf>.

⁶⁴² U.S. EPA (2015) 2011 National Air Toxics Assessment. <http://www3.epa.gov/national-air-toxics-assessment/2011-national-air-toxics-assessment>.

⁶⁴³ U.S. EPA. (2000). Integrated Risk Information System File for Benzene. This material is available electronically at: <https://www.epa.gov/iris> (Last accessed July 2018)

⁶⁴⁴ International Agency for Research on Cancer, IARC monographs on the evaluation of carcinogenic risk of chemicals to humans, Volume 29, some industrial chemicals and dyestuffs, International Agency for Research on Cancer, World Health Organization, Lyon, France 1982.

⁶⁴⁵ Irons, R.D.; Stillman, W.S.; Colagiovanni, D.B.; Henry, V.A. (1992). Synergistic action of the benzene metabolite hydroquinone on myelopoietic stimulating activity of granulocyte/macrophage colony-stimulating factor in vitro. *Proc. Natl. Acad. Sci.* 89:3691–3695.

⁶⁴⁶ A unit risk estimate is defined as the increase in the lifetime risk of an individual who is exposed for a lifetime to 1 µg/m³ benzene in air.

⁶⁴⁷ U.S. EPA. (2000). Integrated Risk Information System File for Benzene. This material is available electronically at: <http://www3.epa.gov/iris/subst/0276.htm>.

⁶⁴⁸ International Agency for Research on Cancer (IARC). (1987). Monographs on the evaluation of carcinogenic risk of chemicals to humans, Volume

A number of adverse noncancer health effects including blood disorders, such as pre-leukemia and aplastic anemia, have also been associated with long-term exposure to benzene. The most sensitive noncancer effect observed in humans, based on current data, is the depression of the absolute lymphocyte count in blood. EPA's inhalation reference concentration (RfC) for benzene is 30 µg/m³. The RfC is based on suppressed absolute lymphocyte counts seen in humans under occupational exposure conditions. In addition, recent work, including studies sponsored by the Health Effects Institute, provides evidence that biochemical responses are occurring at lower levels of benzene exposure than previously known.^{650 651 652 653} EPA's IRIS program has not yet evaluated these new data. EPA does not currently have an acute reference concentration for benzene. The Agency for Toxic Substances and Disease Registry (ATSDR) Minimal Risk Level (MRL) for acute exposure to benzene is 29 µg/m³ for 1–14 days exposure.

(c) 1,3-Butadiene

EPA has characterized 1,3-butadiene as carcinogenic to humans by inhalation.^{654 655} The IARC has determined that 1,3-butadiene is a human carcinogen and the U.S. DHHS has characterized 1,3-butadiene as a

29, Supplement 7, Some industrial chemicals and dyestuffs, World Health Organization, Lyon, France.

⁶⁴⁹NTP. (2014). 13th Report on Carcinogens. Research Triangle Park, NC: U.S. Department of Health and Human Services, Public Health Service, National Toxicology Program.

⁶⁵⁰Qu, O.; Shore, R.; Li, G.; Jin, X.; Chen, C.L.; Cohen, B.; Melikian, A.; Eastmond, D.; Rappaport, S.; Li, H.; Rupa, D.; Suramaya, R.; Songnian, W.; Huifant, Y.; Meng, M.; Winnik, M.; Kwok, E.; Li, Y.; Mu, R.; Xu, B.; Zhang, X.; Li, K. (2003). HEI Report 115, Validation & Evaluation of Biomarkers in Workers Exposed to Benzene in China.

⁶⁵¹Qu, Q., R. Shore, G. Li, X. Jin, L.C. Chen, B. Cohen, *et al.* (2002). Hematological changes among Chinese workers with a broad range of benzene exposures. *American Journal of Industrial Medicine*. 42: 275–285.

⁶⁵²Lan, Qing, Zhang, L., Li, G., Vermeulen, R., *et al.* (2004). Hematotoxicity in Workers Exposed to Low Levels of Benzene. *Science* 306: 1774–1776.

⁶⁵³Turtletaub, K.W. and Mani, C. (2003). Benzene metabolism in rodents at doses relevant to human exposure from Urban Air. Research Reports Health Effect Inst. Report No.113.

⁶⁵⁴U.S. EPA. (2002). Health Assessment of 1,3-Butadiene. Office of Research and Development, National Center for Environmental Assessment, Washington Office, Washington, DC. Report No. EPA600-P-98-001F. This document is available electronically at <http://www3.epa.gov/iris/supdocs/buta-sup.pdf>.

⁶⁵⁵U.S. EPA. (2002). “Full IRIS Summary for 1,3-butadiene (CASRN 106–99–0)” Environmental Protection Agency, Integrated Risk Information System (IRIS), Research and Development, National Center for Environmental Assessment, Washington, DC <http://www3.epa.gov/iris/subst/0139.htm>.

known human carcinogen.^{656 657 658} There are numerous studies consistently demonstrating that 1,3-butadiene is metabolized into genotoxic metabolites by experimental animals and humans. The specific mechanisms of 1,3-butadiene-induced carcinogenesis are unknown; however, the scientific evidence strongly suggests that the carcinogenic effects are mediated by genotoxic metabolites. Animal data suggest that females may be more sensitive than males for cancer effects associated with 1,3-butadiene exposure; there are insufficient data in humans from which to draw conclusions about sensitive subpopulations. The URE for 1,3-butadiene is 3×10^{-5} per µg/m³.⁶⁵⁹ 1,3-butadiene also causes a variety of reproductive and developmental effects in mice; no human data on these effects are available. The most sensitive effect was ovarian atrophy observed in a lifetime bioassay of female mice.⁶⁶⁰ Based on this critical effect and the benchmark concentration methodology, an RfC for chronic health effects was calculated at 0.9 ppb (approximately 2 µg/m³).

(d) Formaldehyde

In 1991, EPA concluded that formaldehyde is a carcinogen based on nasal tumors in animal bioassays.⁶⁶¹ An Inhalation URE for cancer and a Reference Dose for oral noncancer effects were developed by the agency and posted on the IRIS database. Since that time, the National Toxicology

⁶⁵⁶International Agency for Research on Cancer (IARC). (1999). Monographs on the evaluation of carcinogenic risk of chemicals to humans, Volume 71, Re-evaluation of some organic chemicals, hydrazine and hydrogen peroxide and Volume 97 (in preparation), World Health Organization, Lyon, France.

⁶⁵⁷International Agency for Research on Cancer (IARC). (2008). Monographs on the evaluation of carcinogenic risk of chemicals to humans, 1,3-Butadiene, Ethylene Oxide and Vinyl Halides (Vinyl Fluoride, Vinyl Chloride and Vinyl Bromide) Volume 97, World Health Organization, Lyon, France.

⁶⁵⁸NTP. (2014). 13th Report on Carcinogens. Research Triangle Park, NC: U.S. Department of Health and Human Services, Public Health Service, National Toxicology Program.

⁶⁵⁹U.S. EPA. (2002). “Full IRIS Summary for 1,3-butadiene (CASRN 106–99–0)” Environmental Protection Agency, Integrated Risk Information System (IRIS), Research and Development, National Center for Environmental Assessment, Washington, DC https://cfpub.epa.gov/ncea/iris2/chemical/Landing.cfm?substance_nmbr=139 (Last accessed July 10, 2018).

⁶⁶⁰Bevan, C.; Stadler, J.C.; Elliot, G.S.; *et al.* (1996). Subchronic toxicity of 4-vinylcyclohexene in rats and mice by inhalation. *Fundamental Applied Toxicology*. 32:1–10.

⁶⁶¹EPA. Integrated Risk Information System. Formaldehyde (CASRN 50–00–0) https://cfpub.epa.gov/ncea/iris/iris_documents/documents/subst/0419_summary.pdf (Last accessed July 2018).

Program (NTP) and International Agency for Research on Cancer (IARC) have concluded that formaldehyde is a known human carcinogen.^{662 663}

The conclusions by IARC and NTP reflect the results of epidemiologic research published since 1991 in combination with previous animal, human and mechanistic evidence. Research conducted by the National Cancer Institute reported an increased risk of nasopharyngeal cancer and specific lymph hematopoietic malignancies among workers exposed to formaldehyde.^{664 665 666} A National Institute of Occupational Safety and Health study of garment workers also reported increased risk of death due to leukemia among workers exposed to formaldehyde.⁶⁶⁷ Extended follow-up of a cohort of British chemical workers did not report evidence of an increase in nasopharyngeal or lymph hematopoietic cancers, but a continuing statistically significant excess in lung cancers was reported.⁶⁶⁸ Finally, a study of embalmers reported formaldehyde exposures to be associated with an increased risk of myeloid leukemia but not brain cancer.⁶⁶⁹

Health effects of formaldehyde in addition to cancer were reviewed by the Agency for Toxic Substances and

⁶⁶²NTP. (2014). 13th Report on Carcinogens. Research Triangle Park, NC: U.S. Department of Health and Human Services, Public Health Service, National Toxicology Program.

⁶⁶³IARC Monographs on the Evaluation of Carcinogenic Risks to Humans Volume 100F (2012): Formaldehyde.

⁶⁶⁴Hauptmann, M., Lubin, J. H., Stewart, P. A., Hayes, R. B., & Blair, A. 2003. Mortality from lymphohematopoietic malignancies among workers in formaldehyde industries. *Journal of the National Cancer Institute* 95: 1615–1623.

⁶⁶⁵Hauptmann, M., Lubin, J. H., Stewart, P. A., Hayes, R. B., & Blair, A. 2004. Mortality from solid cancers among workers in formaldehyde industries. *American Journal of Epidemiology* 159: 1117–1130.

⁶⁶⁶Beane Freeman, L. E., Blair, A., Lubin, J. H., Stewart, P. A., Hayes, R. B., Hoover, R. N., & Hauptmann, M. 2009. Mortality from lymph hematopoietic malignancies among workers in formaldehyde industries: The National Cancer Institute cohort. *Journal of the National Cancer Institute*. 101: 751–761.

⁶⁶⁷Pinkerton, L. E. 2004. Mortality among a cohort of garment workers exposed to formaldehyde: an update. *Occupational Environmental Medicine* 61: 193–200.

⁶⁶⁸Coggon, D., Harris, E. C. Poole, J., & Palmer, K. T. 2003. Extended follow-up of a cohort of British chemical workers exposed to formaldehyde. *Journal of the National Cancer Institute*. 95:1608–1615.

⁶⁶⁹Hauptmann, M., Stewart P. A., Lubin J. H., Beane Freeman, L. E., Hornung, R. W., Herrick, R. F., Hoover, R. N., Fraumeni, J. F., & Hayes, R. B. 2009. Mortality from lymph hematopoietic malignancies and brain cancer among embalmers exposed to formaldehyde. *Journal of the National Cancer Institute* 101:1696–1708.

Disease Registry in 1999,⁶⁷⁰ supplemented in 2010,⁶⁷¹ and by the World Health Organization.⁶⁷² These organizations reviewed the scientific literature concerning health effects linked to formaldehyde exposure to evaluate hazards and dose response relationships and defined exposure concentrations for minimal risk levels (MRLs). The health endpoints reviewed included sensory irritation of eyes and respiratory tract, reduced pulmonary function, nasal histopathology, and immune system effects. In addition, research on reproductive and developmental effects and neurological effects were discussed along with several studies that suggest that formaldehyde may increase the risk of asthma, particularly in the young.

EPA released a draft Toxicological Review of Formaldehyde—Inhalation Assessment through the IRIS program for peer review by the National Research Council (NRC) and public comment in June 2010.⁶⁷³ The draft assessment reviewed more recent research from animal and human studies on cancer and other health effects. The NRC released their review report in April 2011.⁶⁷⁴ EPA is currently developing a revised draft assessment in response to this review.

(e) Acetaldehyde

Acetaldehyde is classified in EPA's IRIS database as a probable human carcinogen, based on nasal tumors in rats, and is considered toxic by the inhalation, oral, and intravenous routes.⁶⁷⁵ The URE in IRIS for acetaldehyde is 2.2×10^6 per $\mu\text{g}/\text{m}^3$.⁶⁷⁶ Acetaldehyde is reasonably

anticipated to be a human carcinogen by the U.S. DHHS in the 13th Report on Carcinogens and is classified as possibly carcinogenic to humans (Group 2B) by the IARC.^{677 678} Acetaldehyde is currently listed on the IRIS Program Multi-Year Agenda for reassessment within the next few years.

The primary noncancer effects of exposure to acetaldehyde vapors include irritation of the eyes, skin, and respiratory tract.⁶⁷⁹ In short-term (four week) rat studies, degeneration of olfactory epithelium was observed at various concentration levels of acetaldehyde exposure.^{680 681} Data from these studies were used by EPA to develop an inhalation reference concentration of $9 \mu\text{g}/\text{m}^3$. Some asthmatics have been shown to be a sensitive subpopulation to decrements in functional expiratory volume (FEV1 test) and bronchoconstriction upon acetaldehyde inhalation.⁶⁸²

(f) Acrolein

EPA most recently evaluated the toxicological and health effects literature related to acrolein in 2003 and concluded that the human carcinogenic potential of acrolein could not be determined because the available data were inadequate. No information was available on the carcinogenic effects of acrolein in humans and the animal data provided inadequate evidence of carcinogenicity.⁶⁸³ The IARC determined in 1995 that acrolein was

not classifiable as to its carcinogenicity in humans.⁶⁸⁴

Lesions to the lungs and upper respiratory tract of rats, rabbits, and hamsters have been observed after subchronic exposure to acrolein.⁶⁸⁵ The agency has developed an RfC for acrolein of $0.02 \mu\text{g}/\text{m}^3$ and an RfD of $0.5 \mu\text{g}/\text{kg}\text{-day}$.⁶⁸⁶

Acrolein is extremely acrid and irritating to humans when inhaled, with acute exposure resulting in upper respiratory tract irritation, mucus hypersecretion and congestion. The intense irritancy of this carbonyl has been demonstrated during controlled tests in human subjects, who suffer intolerable eye and nasal mucosal sensory reactions within minutes of exposure.⁶⁸⁷ These data and additional studies regarding acute effects of human exposure to acrolein are summarized in EPA's 2003 Toxicological Review of Acrolein.⁶⁸⁸ Studies in humans indicate that levels as low as 0.09 ppm (0.21 mg/m^3) for five minutes may elicit subjective complaints of eye irritation with increasing concentrations leading to more extensive eye, nose and respiratory symptoms. Acute exposures in animal studies report bronchial hyper-responsiveness. Based on animal data (more pronounced respiratory irritancy in mice with allergic airway disease in comparison to non-diseased mice⁶⁸⁹) and demonstration of similar effects in humans (e.g., reduction in

available electronically at <http://www3.epa.gov/iris/subst/0290.htm>.

⁶⁷⁷ NTP. (2014). 13th Report on Carcinogens. Research Triangle Park, NC: U.S. Department of Health and Human Services, Public Health Service, National Toxicology Program.

⁶⁷⁸ International Agency for Research on Cancer (IARC). (1999). Re-evaluation of some organic chemicals, hydrazine, and hydrogen peroxide. IARC Monographs on the Evaluation of Carcinogenic Risk of Chemicals to Humans, Vol 71. Lyon, France.

⁶⁷⁹ U.S. EPA (1991). Integrated Risk Information System File of Acetaldehyde. This material is available electronically at <http://www3.epa.gov/iris/subst/0290.htm>.

⁶⁸⁰ U.S. EPA. (2003). Integrated Risk Information System File of Acrolein. Research and Development, National Center for Environmental Assessment, Washington, DC. This material is available electronically at <http://www3.epa.gov/iris/subst/0364.htm>.

⁶⁸¹ Appleman, L.M., Woutersen, R. A., & Feron, V. J. (1982). Inhalation toxicity of acetaldehyde in rats. I. Acute and subacute studies. *Toxicology*. 23: 293–297.

⁶⁸² Myou, S., Fujimura, M., Nishi, K., Ohka, T., & Matsuda, T. (1993) Aerosolized acetaldehyde induces histamine-mediated bronchoconstriction in asthmatics. *Am. Rev. Respir. Dis.* 148(4 Pt 1): 940–943.

⁶⁸³ U.S. EPA. (2003). Integrated Risk Information System File of Acrolein. Research and Development, National Center for Environmental Assessment, Washington, DC. This material is available at <http://www3.epa.gov/iris/subst/0364.htm>.

⁶⁸⁴ International Agency for Research on Cancer (IARC). (1995). Monographs on the evaluation of carcinogenic risk of chemicals to humans, Volume 63. Dry cleaning, some chlorinated solvents and other industrial chemicals, World Health Organization, Lyon, France.

⁶⁸⁵ U.S. EPA. (2003). Integrated Risk Information System File of Acrolein. Office of Research and Development, National Center for Environmental Assessment, Washington, DC. This material is available at <http://www3.epa.gov/iris/subst/0364.htm>.

⁶⁸⁶ U.S. EPA. (2003). Integrated Risk Information System File of Acrolein. Office of Research and Development, National Center for Environmental Assessment, Washington, DC. This material is available at <http://www3.epa.gov/iris/subst/0364.htm>.

⁶⁸⁷ U.S. EPA. (2003) Toxicological review of acrolein in support of summary information on Integrated Risk Information System (IRIS) National Center for Environmental Assessment, Washington, DC. EPA/635/R-03/003. p. 10. Available online at: <http://www3.epa.gov/ncea/iris/toxreviews/0364tr.pdf>.

⁶⁸⁸ U.S. EPA. (2003) Toxicological review of acrolein in support of summary information on Integrated Risk Information System (IRIS) National Center for Environmental Assessment, Washington, DC. EPA/635/R-03/003. Available online at: <https://cfpub.epa.gov/ncea/risk/recordisplay.cfm?deid=51977> (Last accessed July 10 2018).

⁶⁸⁹ Morris, J. B., Symanowicz, P. T., Olsen, J. E., et al. (2003). Immediate sensory nerve-mediated respiratory responses to irritants in healthy and allergic airway-diseased mice. *Journal of Applied Physiology*. 94(4):1563–1571.

⁶⁷⁰ ATSDR. 1999. Toxicological Profile for Formaldehyde, U.S. Department of Health and Human Services (HHS), July 1999.

⁶⁷¹ ATSDR. 2010. Addendum to the Toxicological Profile for Formaldehyde. U.S. Department of Health and Human Services (HHS), October 2010.

⁶⁷² IPCS. 2002. Concise International Chemical Assessment Document 40. Formaldehyde. World Health Organization.

⁶⁷³ EPA (U.S. Environmental Protection Agency). 2010. Toxicological Review of Formaldehyde (CAS No. 50–00–0)—Inhalation Assessment: In Support of Summary Information on the Integrated Risk Information System (IRIS). External Review Draft. EPA/635/R-10/002A. U.S. Environmental Protection Agency, Washington DC [online]. Available: http://cfpub.epa.gov/ncea/irs_drats/recordisplay.cfm?deid=223614.

⁶⁷⁴ NRC (National Research Council). 2011. Review of the Environmental Protection Agency's Draft IRIS Assessment of Formaldehyde. Washington DC: National Academies Press. http://books.nap.edu/openbook.php?record_id=13142.

⁶⁷⁵ U.S. EPA (1991). Integrated Risk Information System File of Acetaldehyde. Research and Development, National Center for Environmental Assessment, Washington, DC. This material is available electronically at <http://www3.epa.gov/iris/subst/0290.htm>.

⁶⁷⁶ U.S. EPA (1991). Integrated Risk Information System File of Acetaldehyde. This material is

respiratory rate), individuals with compromised respiratory function (e.g., emphysema, asthma) are expected to be at increased risk of developing adverse responses to strong respiratory irritants such as acrolein. EPA does not currently have an acute reference concentration for acrolein. The available health effect reference values for acrolein have been summarized by EPA and include an ATSDR MRL for acute exposure to acrolein of 7 µg/m³ for 1–14 days' exposure; and Reference Exposure Level (REL) values from the California Office of Environmental Health Hazard Assessment (OEHHA) for one-hour and 8-hour exposures of 2.5 µg/m³ and 0.7 µg/m³, respectively.⁶⁹⁰

(g) Polycyclic Organic Matter

The term polycyclic organic matter (POM) defines a broad class of compounds that includes the polycyclic aromatic hydrocarbon compounds (PAHs). One of these compounds, naphthalene, is discussed separately below. POM compounds are formed primarily from combustion and are present in the atmosphere in gas and particulate form. Cancer is the major concern from exposure to POM. Epidemiologic studies have reported an increase in lung cancer in humans exposed to diesel exhaust, coke oven emissions, roofing tar emissions, and cigarette smoke; all of these mixtures contain POM compounds.^{691 692} Animal studies have reported respiratory tract tumors from inhalation exposure to benzo[a]pyrene and alimentary tract and liver tumors from oral exposure to benzo[a]pyrene.⁶⁹³ In 1997 EPA classified seven PAHs (benzo[a]pyrene, benz[a]anthracene, chrysene, benzo[b]fluoranthene, benzo[k]fluoranthene, dibenz[a,h]anthracene, and

indeno[1,2,3-cd]pyrene) as Group B2, probable human carcinogens.⁶⁹⁴ Since that time, studies have found that maternal exposures to PAHs in a population of pregnant women were associated with several adverse birth outcomes, including low birth weight and reduced length at birth, as well as impaired cognitive development in preschool children (three years of age).^{695 696} These and similar studies are being evaluated as a part of the ongoing IRIS reassessment of health effects associated with exposure to benzo[a]pyrene.

(h) Naphthalene

Naphthalene is found in small quantities in gasoline and diesel fuels. Naphthalene emissions have been measured in larger quantities in both gasoline and diesel exhaust compared with evaporative emissions from mobile sources, indicating it is primarily a product of combustion. Acute (short-term) exposure of humans to naphthalene by inhalation, ingestion, or dermal contact is associated with hemolytic anemia and damage to the liver and the nervous system.⁶⁹⁷ Chronic (long term) exposure of workers and rodents to naphthalene has been reported to cause cataracts and retinal damage.⁶⁹⁸ EPA released an external review draft of a reassessment of the inhalation carcinogenicity of naphthalene based on a number of

recent animal carcinogenicity studies. The draft reassessment completed external peer review.⁶⁹⁹ Based on external peer review comments received, a revised draft assessment that considers all routes of exposure, as well as cancer and noncancer effects, is under development. The external review draft does not represent official agency opinion and was released solely for the purposes of external peer review and public comment. The National Toxicology Program listed naphthalene as “reasonably anticipated to be a human carcinogen” in 2004 on the basis of bioassays reporting clear evidence of carcinogenicity in rats and some evidence of carcinogenicity in mice.⁷⁰⁰ California EPA has released a new risk assessment for naphthalene, and the IARC has reevaluated naphthalene and re-classified it as Group 2B: Possibly carcinogenic to humans.⁷⁰¹

Naphthalene also causes a number of chronic non-cancer effects in animals, including abnormal cell changes and growth in respiratory and nasal tissues. The current EPA IRIS assessment includes noncancer data on hyperplasia and metaplasia in nasal tissue that form the basis of the inhalation RfC of 3 µg/m³.⁷⁰² The ATSDR MRL for acute exposure to naphthalene is 0.6 mg/kg/day.

(i) Other Air Toxics

In addition to the compounds described above, other compounds in gaseous hydrocarbon and PM emissions from motor vehicles will be affected by this action. Mobile source air toxic compounds that will potentially be impacted include ethylbenzene, propionaldehyde, toluene, and xylene. Information regarding the health effects of these compounds can be found in EPA's IRIS database.⁷⁰³

⁶⁹⁰ U.S. EPA. (2009). Graphical Arrays of Chemical-Specific Health Effect Reference Values for Inhalation Exposures (Final Report). U.S. Environmental Protection Agency, Washington, DC. EPA/600/R-09/061, 2009. <http://cfpub.epa.gov/ncea/cfm/recordisplay.cfm?deid=211003> (last accessed July 10 2018).

⁶⁹¹ Agency for Toxic Substances and Disease Registry (ATSDR). (1995). Toxicological profile for Polycyclic Aromatic Hydrocarbons (PAHs). Atlanta, GA: U.S. Department of Health and Human Services, Public Health Service. Available electronically at <http://www.atsdr.cdc.gov/ToxProfiles/TP.asp?id=122&tid=25>.

⁶⁹² U.S. EPA (2002). *Health Assessment Document for Diesel Engine Exhaust*. EPA/600/8-90/057F Office of Research and Development, Washington DC. <http://cfpub.epa.gov/ncea/cfm/recordisplay.cfm?deid=29060> (last accessed July 10 2018).

⁶⁹³ International Agency for Research on Cancer (IARC). (2012). *Monographs on the Evaluation of the Carcinogenic Risk of Chemicals for Humans, Chemical Agents and Related Occupations*. Vol. 100F. Lyon, France.

⁶⁹⁴ U.S. EPA (1997). Integrated Risk Information System File of indeno (1,2,3-cd) pyrene. Research and Development, National Center for Environmental Assessment, Washington, DC. This material is available electronically at <https://cfpub.epa.gov/ncea/risk/recordisplay.cfm?deid=2776> (Last accessed July 10 2018).

⁶⁹⁵ Perera, F. P., Rauh, V., Tsai, W. Y., et al. (2002). Effect of transplacental exposure to environmental pollutants on birth outcomes in a multiethnic population. *Environmental Health Perspectives*. 111: 201–205.

⁶⁹⁶ Perera, F. P., Rauh, V., Whyatt, R. M., Tsai, W. Y., Tang, D., Diaz, D., Hoepner, L., Barr, D., Tu, Y. H., Camann, D., & Kinney, P. (2006). Effect of prenatal exposure to airborne polycyclic aromatic hydrocarbons on neurodevelopment in the first 3 years of life among inner-city children. *Environmental Health Perspectives*. 114: 1287–1292.

⁶⁹⁷ U. S. EPA. 1998. Toxicological Review of Naphthalene (Reassessment of the Inhalation Cancer Risk), Environmental Protection Agency, Integrated Risk Information System, Research and Development, National Center for Environmental Assessment, Washington, DC. This material is available electronically at https://cfpub.epa.gov/ncea/iris/iris_documents/documents/toxreviews/0436tr.pdf (last accessed July 10 2018).

⁶⁹⁸ U. S. EPA. 1998. Toxicological Review of Naphthalene (Reassessment of the Inhalation Cancer Risk), Environmental Protection Agency, Integrated Risk Information System, Research and Development, National Center for Environmental Assessment, Washington, DC. This material is available electronically at https://cfpub.epa.gov/ncea/iris/iris_documents/documents/toxreviews/0436tr.pdf (last accessed July 10 2018)

⁶⁹⁹ Oak Ridge Institute for Science and Education. (2004). External Peer Review for the IRIS Reassessment of the Inhalation Carcinogenicity of Naphthalene. August 2004. <http://cfpub.epa.gov/ncea/cfm/recordisplay.cfm?deid=84403>.

⁷⁰⁰ NTP. (2014). 13th Report on Carcinogens. U.S. Department of Health and Human Services, Public Health Service, National Toxicology Program.

⁷⁰¹ International Agency for Research on Cancer (IARC). (2002). *Monographs on the Evaluation of the Carcinogenic Risk of Chemicals for Humans*. Vol. 82. Lyon, France.

⁷⁰² U.S. EPA. (1998). Toxicological Review of Naphthalene. Environmental Protection Agency, Integrated Risk Information System (IRIS), Research and Development, National Center for Environmental Assessment, Washington, DC https://cfpub.epa.gov/ncea/iris/iris_documents/documents/toxreviews/0436tr.pdf (last accessed July 10 2018).

⁷⁰³ U.S. EPA Integrated Risk Information System (IRIS) database is available at: <https://www.epa.gov/iris> (last accessed July 10 2018)

(j) Exposure and Health Effects Associated With Traffic

Locations in close proximity to major roadways generally have elevated concentrations of many air pollutants emitted from motor vehicles. Hundreds of such studies have been published in peer-reviewed journals, concluding that concentrations of CO, NO, NO₂, benzene, aldehydes, particulate matter, black carbon, and many other compounds are elevated in ambient air within approximately 300–600 meters (approximately 1,000–2,000 feet) of major roadways. Highest concentrations of most pollutants emitted directly by motor vehicles are found at locations within 50 meters (approximately 165 feet) of the edge of a roadway's traffic lanes.

A large-scale review of air quality measurements in the vicinity of major roadways between 1978 and 2008 concluded that the pollutants with the steepest concentration gradients in vicinities of roadways were CO, ultrafine particles, metals, elemental carbon (EC), NO, NO_x, and several VOCs.⁷⁰⁴ These pollutants showed a large reduction in concentrations within 100 meters downwind of the roadway. Pollutants that showed more gradual reductions with distance from roadways included benzene, NO₂, PM_{2.5}, and PM₁₀. In the review article, results varied based on the method of statistical analysis used to determine the trend.

For pollutants with relatively high background concentrations relative to near-road concentrations, detecting concentration gradients can be difficult. For example, many aldehydes have high background concentrations as a result of photochemical breakdown of precursors from many different organic compounds. This can make detection of gradients around roadways and other primary emission sources difficult. However, several studies have measured aldehydes in multiple weather conditions and found higher concentrations of many carbonyls downwind of roadways.^{705 706} These

⁷⁰⁴ Karner, A. A., Eisinger, D. S., & Niemeier, D. A. (2010). Near-roadway air quality: synthesizing the findings from real-world data. *Environmental Science Technology*. 44: 5334–5344.

⁷⁰⁵ Liu, W., Zhang, J., Kwon, J. et al. (2006). Concentrations and source characteristics of airborne carbonyl compounds measured outside urban residences. *Journal of the Air Waste Management Association* 56: 1196–1204.

⁷⁰⁶ Cahill, T. M., Charles, M. J., & Seaman, V. Y. (2010). Development and application of a sensitive method to determine concentrations of acrolein and other carbonyls in ambient air. *Health Effects*

findings suggest a substantial roadway source of these carbonyls.

In the past 15 years, many studies have been published with results reporting that populations who live, work, or go to school near high-traffic roadways experience higher rates of numerous adverse health effects, compared to populations far away from major roads.⁷⁰⁷ In addition, numerous studies have found adverse health effects associated with spending time in traffic, such as commuting or walking along high-traffic roadways; however, it is difficult to fully control for confounding in such studies.^{708 709 710 711} The health outcomes with the strongest evidence linking them with traffic-associated air pollutants are respiratory effects, particularly in asthmatic children, and cardiovascular effects.

Numerous reviews of this body of health literature have been published as well. In 2010, an expert panel of the Health Effects Institute (HEI) published a review of hundreds of exposure, epidemiology, and toxicology studies.⁷¹² The panel rated how the evidence for each type of health outcome supported a conclusion of a causal association with traffic-associated air pollution as either “sufficient,” “suggestive but not

Institute Research Report 149. Available at <https://www.healtheffects.org/publication/development-and-application-sensitive-method-determine-concentrations-acrolein-and-other> (last accessed July 10 2018)

⁷⁰⁷ In the widely-used PubMed database of health publications, between January 1, 1990 and August 18, 2011, 605 publications contained the keywords “traffic, pollution, epidemiology,” with approximately half the studies published after 2007.

⁷⁰⁸ Laden, F., Hart, J. E., Smith, T. J., Davis, M. E., & Garshick, E. (2007) Cause-specific mortality in the unionized U.S. trucking industry. *Environmental Health Perspectives* 115:1192–1196.

⁷⁰⁹ Peters, A., von Klot, S., Heier, M., Trentinaglia, I., Hörmann, A., Wichmann, H. E., & Löwel, H. (2004) Exposure to traffic and the onset of myocardial infarction. *New England Journal of Medicine*. 351: 1721–1730.

⁷¹⁰ Zanobetti, A., Stone, P. H., Spelzer, F. E., Schwartz, J. D., Coull, B. A., Suh, H. H., Nearling, B. D., Mittleman, M. A., Verrier, R. L., & Gold, D. R. (2009) T-wave alternans, air pollution and traffic in high-risk subjects. *American Journal of Cardiology*. 104: 665–670.

⁷¹¹ Dubowsky Adar, S., Adamkiewicz, G., Gold, D. R., Schwartz, J., Coull, B. A., & Suh, H. (2007) Ambient and microenvironmental particles and exhaled nitric oxide before and after a group bus trip. *Environmental Health Perspectives*. 115: 507–512.

⁷¹² Health Effects Institute Panel on the Health Effects of Traffic-Related Air Pollution. (2010). Traffic-related air pollution: A critical review of the literature on emissions, exposure, and health effects. HEI Special Report 17. Available at <http://www.healtheffects.org>.

sufficient,” or “inadequate and insufficient.” The panel categorized evidence of a causal association for exacerbation of childhood asthma as “sufficient.” The panel categorized evidence of a causal association for new onset asthma as between “sufficient” and “suggestive but not sufficient.” “Suggestive of a causal association” was how the panel categorized evidence linking traffic-associated air pollutants with exacerbation of adult respiratory symptoms and lung function decrement. It categorized as “inadequate and insufficient” evidence of a causal relationship between traffic-related air pollution and health care utilization for respiratory problems, new onset adult asthma, chronic obstructive pulmonary disease (COPD), nonasthmatic respiratory allergy, and cancer in adults and children. Other literature reviews have been published with conclusions generally similar to the HEI panel's.^{713 714 715 716} However, in 2014, researchers from the U.S. Centers for Disease Control and Prevention (CDC) published a systematic review and meta-analysis of studies evaluating the risk of childhood leukemia associated with traffic exposure and reported positive associations between “postnatal” proximity to traffic and leukemia risks, but no such association for “prenatal” exposures.⁷¹⁷

Health outcomes with few publications suggest the possibility of other effects still lacking sufficient evidence to draw definitive conclusions. Among these outcomes with a small number of positive studies are neurological impacts (e.g., autism and reduced cognitive function) and reproductive outcomes (e.g., preterm

⁷¹³ Boothe, V. L. & Shendell, D. G. (2008). Potential health effects associated with residential proximity to freeways and primary roads: review of scientific literature, 1999–2006. *Journal of Environmental Health*. 70: 33–41.

⁷¹⁴ Salam, M. T., Islam, T., & Gilliland, F. D. (2008). Recent evidence for adverse effects of residential proximity to traffic sources on asthma. *Curr Opin Pulm Med* 14: 3–8.

⁷¹⁵ Sun, X., Zhang, S., & Ma, X. (2014) No association between traffic density and risk of childhood leukemia: a meta-analysis. *Asia Pacific Journal of Cancer Prevention*. 15: 5229–5232.

⁷¹⁶ Raaschou-Nielsen, O. & Reynolds, P. (2006). Air pollution and childhood cancer: A review of the epidemiological literature. *International Journal of Cancer*. 118: 2920–9.

⁷¹⁷ Boothe, V. L., Boehmer, T. K., Wendel, A. M., & Yip, F. Y. (2014) Residential traffic exposure and childhood leukemia: a systematic review and meta-analysis. *American Journal of Preventive Medicine*. 46: 413–422.

birth, low birth weight).^{718 719 720 721}

In addition to health outcomes, particularly cardiopulmonary effects, conclusions of numerous studies suggest mechanisms by which traffic-related air pollution affects health. Numerous studies indicate that near-roadway exposures may increase systemic inflammation, affecting organ systems, including blood vessels and lungs.^{722 723 724 725} Long-term exposures in near-road environments have been associated with inflammation-associated conditions, such as atherosclerosis and asthma.^{726 727 728}

Several studies suggest that some factors may increase susceptibility to the effects of traffic-associated air pollution. Several studies have found

stronger respiratory associations in children experiencing chronic social stress, such as in violent neighborhoods or in homes with high family stress.^{729 730 731}

The risks associated with residence, workplace, or schools near major roads are of potentially high public health significance due to the large population in such locations. According to the 2009 American Housing Survey, more than 22 million homes (17% of all U.S. housing units) were located within 300 feet of an airport, railroad, or highway with four or more lanes. This corresponds to a population of more than 50 million U.S. residents in close proximity to high-traffic roadways or other transportation sources. Based on 2010 Census data, a 2013 publication estimated that 19% of the U.S. population (more than 59 million people) lived within 500 meters of roads with at least 25,000 annual average daily traffic (AADT), while about 3.2% of the population lived within 100 meters (about 300 feet) of such roads.⁷³² Another 2013 study estimated that 3.7% of the U.S. population (about 11.3 million people) lived within 150 meters (about 500 feet) of interstate highways or other freeways and expressways.⁷³³ On average, populations near major roads have higher fractions of minority residents and lower socioeconomic status. Furthermore, on average, Americans spend more than an hour traveling each day, bringing nearly all residents into a high-exposure microenvironment for part of the day.

In light of these concerns, EPA has required through the NAAQS process that air quality monitors be placed near high-traffic roadways for determining concentrations of CO, NO₂, and PM_{2.5} (in addition to those existing monitors located in neighborhoods and other locations farther away from pollution

sources). Near-roadway monitors for NO₂ begin operation between 2014 and 2017 in Core Based Statistical Areas (CBSAs) with population of at least 500,000. Monitors for CO and PM_{2.5} begin operation between 2015 and 2017. These monitors will further our understanding of exposure in these locations.

EPA and DOT continue to research near-road air quality, including the types of pollutants found in high concentrations near major roads and health problems associated with the mixture of pollutants near roads.

8. Environmental Justice

Environmental justice (EJ) is a principle asserting that all people deserve fair treatment and meaningful involvement with respect to environmental laws, regulations, and policies. EPA seeks to provide the same degree of protection from environmental health hazards for all people. DOT shares this goal and is informed about the potential environmental impacts of its rulemakings through its NEPA process (see NHTSA's DEIS). As referenced below, numerous studies have found that some environmental hazards are more prevalent in areas where non-white, Hispanic and people with low socioeconomic status (SES) represent a higher fraction of the population compared with the general population. In addition, compared to non-Hispanic whites, some subpopulations defined by race and ethnicity have been shown to have greater levels of some health conditions during some life stages. For example, in 2014, about 13% of Black, non-Hispanic and 24% of Puerto Rican children were estimated to currently have asthma, compared with eight percent of white, non-Hispanic children.⁷³⁴

As discussed in the DEIS, concentrations of many air pollutants are elevated near high-traffic roadways. If minority populations and low-income populations disproportionately live near such roads, then an issue of EJ may be present. We reviewed existing scholarly literature examining the potential for disproportionate exposure among people with low SES, and we conducted our own evaluation of two national datasets: The U.S. Census Bureau's American Housing Survey for calendar year 2009 and the U.S. Department of Education's database of school locations.

Publications that address EJ issues generally report that populations living near major roadways (and other types of

⁷³⁴ http://www.cdc.gov/asthma/most_recent_data.htm.

⁷¹⁸ Volk, H. E., Hertz-Picciotto, I., Delwiche, L., et al. (2011). Residential proximity to freeways and autism in the CHARGE study. *Environmental Health Perspectives*. 119: 873–877.

⁷¹⁹ Franco-Suglia, S., Gryparis, A., Wright, R. O., et al. (2007). Association of black carbon with cognition among children in a prospective birth cohort study. *American Journal of Epidemiology*. doi: 10.1093/aje/kwm308. [Online at <http://dx.doi.org>].

⁷²⁰ Power, M. C., Weisskopf, M. G., Alexeef, S. E., et al. (2011). Traffic-related air pollution and cognitive function in a cohort of older men. *Environmental Health Perspectives*. 2011: 682–687.

⁷²¹ Wu, J., Wilhelm, M., Chung, J., et al. (2011). Comparing exposure assessment methods for traffic-related air pollution in and adverse pregnancy outcome study. *Environmental Research*. 111: 685–6692.

⁷²² Riediker, M. (2007). Cardiovascular effects of fine particulate matter components in highway patrol officers. *Inhal Toxicol* 19: 99–105. doi: 10.1080/08958370701495238 Available at <http://dx.doi.org>.

⁷²³ Alexeef, S. E., Coull, B. A., Gryparis, A., et al. (2011). Medium-term exposure to traffic-related air pollution and markers of inflammation and endothelial function. *Environmental Health Perspectives*. 119: 481–486. doi:10.1289/ehp.1002560 Available at <http://dx.doi.org>.

⁷²⁴ Eckel, S. P., Berhane, K., Salam, M. T., et al. (2011). Traffic-related pollution exposure and exhaled nitric oxide in the Children's Health Study. *Environmental Health Perspectives*. (IN PRESS). doi:10.1289/ehp.1103516. Available at <http://dx.doi.org>.

⁷²⁵ Zhang, J., McCreanor, J. E., Cullinan, P., et al. (2009). Health effects of real-world exposure diesel exhaust in persons with asthma. *Res Rep Health Effects Inst* 138. [Online at <http://www.healtheffects.org>].

⁷²⁶ Adar, S. D., Klein, R., Klein, E. K., et al. (2010). Air pollution and the microvasculature: a cross-sectional assessment of in vivo retinal images in the population-based Multi-Ethnic Study of Atherosclerosis. *PLoS Med* 7(11): E1000372. doi:10.1371/journal.pmed.1000372. Available at <http://dx.doi.org>.

⁷²⁷ Kan, H., Heiss, G., Rose, K. M., et al. (2008). Prospective analysis of traffic exposure as a risk factor for incident coronary heart disease: the Atherosclerosis Risk in Communities (ARIC) study. *Environmental Health Perspectives*. 116: 1463–1468. doi:10.1289/ehp.11290. Available at <http://dx.doi.org>.

⁷²⁸ McConnell, R., Islam, T., Shankardass, K., et al. (2010). Childhood incident asthma and traffic-related air pollution at home and school. *Environmental Health Perspectives*. 1021–1026.

⁷²⁹ Islam, T., Urban, R., Gauderman, W. J., et al. (2011). Parental stress increases the detrimental effect of traffic exposure on children's lung function. *American Journal of Respiratory Critical Care Medicine*. (In press).

⁷³⁰ Clougherty, J. E., Levy, J. I., Kubzansky, L. D., et al. (2007). Synergistic effects of traffic-related air pollution and exposure to violence on urban asthma etiology. *Environmental Health Perspectives*. 115: 1140–1146.

⁷³¹ Chen, E., Schrier, H. M., Strunk, R. C., et al. (2008). Chronic traffic-related air pollution and stress interact to predict biologic and clinical outcomes in asthma. *Environmental Health Perspectives*. 116: 970–5.

⁷³² Rowangould, G. M. (2013) A census of the U.S. near-roadway population: public health and environmental justice considerations. *Transportation Research Part D* 25: 59–67.

⁷³³ Boehmer, T. K., Foster, S. L., Henry, J. R., Woghiren-Akinnifesi, E. L., & Yip, F. Y. (2013) Residential proximity to major highways—United States, 2010. *Morbidity and Mortality Weekly Report* 62 (3); 46–50.

transportation infrastructure) tend to be composed of larger fractions of nonwhite residents. People living in neighborhoods near such sources of air pollution also tend to be lower in income than people living elsewhere. Numerous studies evaluating the demographics and socioeconomic status of populations or schools near roadways have found that they include a greater percentage of minority residents, as well as lower SES (indicated by variables such as median household income). Locations in these studies include Los Angeles, CA; Seattle, WA; Wayne County, MI; Orange County, FL; and California.^{735 736 737 738 739 740} Such disparities may be due to multiple factors.⁷⁴¹

People with low SES often live in neighborhoods with multiple environmental stressors and higher rates of health risk factors, including reduced health insurance coverage rates, higher smoking and drug use rates, limited access to fresh food, visible neighborhood violence, and elevated rates of obesity and some diseases such as asthma, diabetes, and ischemic heart disease. Although questions remain, several studies find stronger associations between air pollution and health in locations with such chronic neighborhood stress, suggesting that populations in these areas may be more susceptible to the effects of air pollution.^{742 743 744 745} Household-level

stressors such as parental smoking and relationship stress also may increase susceptibility to the adverse effects of air pollution.^{746 747}

Two national databases were analyzed that allowed evaluation of whether homes and schools were located near a major road and whether disparities in exposure may be occurring in these environments. The American Housing Survey (AHS) includes descriptive statistics of over 70,000 housing units across the nation. The study survey is conducted every two years by the U.S. Census Bureau. The second database we analyzed was the U.S. Department of Education's Common Core of Data, which includes enrollment and location information for schools across the U.S.

In analyzing the 2009 AHS, the focus was on whether or not a housing unit was located within 300 feet of "4-or-more lane highway, railroad, or airport."⁷⁴⁸ Whether there were differences between households in such locations compared with those in locations farther from these same transportation facilities was analyzed.⁷⁴⁹ Other variables, such as

land use category, region of country, and housing type were included.

In examining schools near major roadways, the Common Core of Data (CCD) from the U.S. Department of Education, which includes information on all public elementary and secondary schools and school districts nationwide, was examined.⁷⁵⁰ To determine school proximities to major roadways, a geographic information system (GIS) to map each school and roadways based on the U.S. Census's TIGER roadway file was used.⁷⁵¹ Non-white students were found to be overrepresented at schools within 200 meters of the largest roadways, and schools within 200 meters of the largest roadways also had higher than expected numbers of students eligible for free or reduced-price lunches. For example, Black students represent 22% of students at schools located within 200 meters of a primary road, whereas Black students represent 17% of students in all U.S. schools. Hispanic students represent 30% of students at schools located within 200 meters of a primary road, whereas Hispanic students represent 22% of students in all U.S. schools.

Overall, there is substantial evidence that people who live or attend school near major roadways are more likely to be non-white, Hispanic ethnicity, and/or low SES. The emission reductions from these proposed standards will likely result in widespread air quality improvements, but the impact on pollution levels in close proximity to roadways will be most direct. Thus, these proposed standards will likely help in mitigating the disparity in racial, ethnic, and economically based exposures.

9. Environmental Effects of Non-GHG Pollutants

(a) Visibility

Visibility can be defined as the degree to which the atmosphere is transparent to visible light.⁷⁵² Visibility impairment is caused by light scattering and absorption by suspended particles and gases. Visibility is important because it has direct significance to people's enjoyment of daily activities in all parts of the country. Individuals value good visibility for the well-being it provides

⁷³⁵ Marshall, J. D. (2008) Environmental inequality: air pollution exposures in California's South Coast Air Basin.

⁷³⁶ Su, J. G., Larson, T., Gould, T., Cohen, M., & Buzzelli, M. (2010) Transboundary air pollution and environmental justice: Vancouver and Seattle compared. *GeoJournal* 57: 595–608. doi:10.1007/s10708-009-9269-6 [Online at <http://dx.doi.org>].

⁷³⁷ Chakraborty, J. & Zandbergen, P. A. (2007) Children at risk: measuring racial/ethnic disparities in potential exposure to air pollution at school and home. *Journal of Epidemiol Community Health* 61: 1074–1079. doi: 10.1136/jech.2006.054130 [Online at <http://dx.doi.org>].

⁷³⁸ Green, R. S., Smorodinsky, S., Kim, J. J., McLaughlin, R., & Ostro, B. (2003) Proximity of California public schools to busy roads. *Environmental Health Perspectives*. 112: 61–66. doi:10.1289/ehp.6566 [<http://dx.doi.org>].

⁷³⁹ Wu, Y. & Batterman, S. A. (2006) Proximity of schools in Detroit, Michigan to automobile and truck traffic. *Journal of Exposure Science & Environmental Epidemiology*. doi:10.1038/sj.jes.7500484 [Online at <http://dx.doi.org>].

⁷⁴⁰ Su, J. G., Jerrett, M., de Nazelle, A., & Wolch, J. (2011) Does exposure to air pollution in urban parks have socioeconomic, racial, or ethnic gradients? *Environmental Research*. 111: 319–328.

⁷⁴¹ Depro, B. & Timmins, C. (2008) Mobility and environmental equity: do housing choices determine exposure to air pollution? North Carolina State University Center for Environmental and Resource Economic Policy

⁷⁴² Clougherty, J. E. & Kubzansky, L. D. (2009) A framework for examining social stress and susceptibility to air pollution in respiratory health. *Environmental Health Perspectives*. 117: 1351–

1358. Doi:10.1289/ehp.0900612 [Online at <http://dx.doi.org>].

⁷⁴³ Clougherty, J. E., Levy, J. I., Kubzansky, L. D., Ryan, P. B., Franco Suglia, S., Jacobson Canner, M., & Wright, R. J. (2007) Synergistic effects of traffic-related air pollution and exposure to violence on urban asthma etiology. *Environmental Health Perspectives*. 115: 1140–1146. doi:10.1289/ehp.9863 [Online at <http://dx.doi.org>].

⁷⁴⁴ Finkelstein, M. M., Jerrett, M., DeLuca, P., Finkelstein, N., Verma, D. K., Chapman, K., & Sears, M. R. (2003) Relation between income, air pollution and mortality: A cohort study. *Canadian Medical Association Journal*. 169: 397–402.

⁷⁴⁵ Shankardass, K., McConnell, R., Jerrett, M., Milam, J., Richardson, J., & Berhane, K. (2009) Parental stress increases the effect of traffic-related air pollution on childhood asthma incidence. *Proc National Academy of Science*. 106: 12406–12411. doi:10.1073/pnas.0812910106 [Online at <http://dx.doi.org>].

⁷⁴⁶ Lewis, A. S., Sax, S. N., Wason, S. C. & Campleman, S. L. (2011) Non-chemical stressors and cumulative risk assessment: an overview of current initiatives and potential air pollutant interactions. *International Journal of Environmental Research in Public Health*. 8: 2020–2073. Doi:10.3390/ijerph8062020 [Online at <http://dx.doi.org>].

⁷⁴⁷ Rosa, M. J., Jung, K. H., Perzanowski, M. S., Kelvin, E. A., Darling, K.W., Camann, D. E., Chillrud, S. N., Whyatt, R. M., Kinney, P. L., Perera, F. P., & Miller, R. L. (2010) Prenatal exposure to polycyclic aromatic hydrocarbons, environmental tobacco smoke and asthma. *Respiratory Medicine*. (In press). doi:10.1016/j.rmed.2010.11.022 [Online at <http://dx.doi.org>].

⁷⁴⁸ This variable primarily represents roadway proximity. According to the Central Intelligence Agency's World Factbook, in 2010, the United States had 6,506,204 km or roadways, 224,792 km of railways, and 15,079 airports. Highways thus represent the overwhelming majority of transportation facilities described by this factor in the AHS.

⁷⁴⁹ Bailey, C. (2011) Demographic and Social Patterns in Housing Units Near Large Highways and other Transportation Sources. Memorandum to docket.

⁷⁵⁰ <http://nces.ed.gov/ccd/>.

⁷⁵¹ Pedde, M. & Bailey, C. (2011) Identification of Schools within 200 Meters of U.S. Primary and Secondary Roads. Memorandum to the docket.

⁷⁵² National Research Council, (1993). Protecting Visibility in National Parks and Wilderness Areas. National Academy of Sciences Committee on Haze in National Parks and Wilderness Areas. National Academy Press, Washington, DC. This book can be viewed on the National Academy Press website at <http://www.nap.edu/books/0309048443/html/>.

them directly, where they live and work, and in places where they enjoy recreational opportunities. Visibility is also highly valued in significant natural areas, such as national parks and wilderness areas, and special emphasis is given to protecting visibility in these areas. For more information on visibility see the final 2009 PM ISA.⁷⁵³

EPA is working to address visibility impairment. Reductions in air pollution from implementation of various programs associated with the Clean Air Act Amendments of 1990 (CAAA) provisions have resulted in substantial improvements in visibility and will continue to do so in the future. Because trends in haze are closely associated with trends in particulate sulfate and nitrate due to the relationship between their concentration and light extinction, visibility trends have improved as emissions of SO₂ and NO_x have decreased over time due to air pollution regulations such as the Acid Rain Program.⁷⁵⁴

In the Clean Air Act Amendments of 1977, Congress recognized visibility's value to society by establishing a national goal to protect national parks and wilderness areas from visibility impairment caused by manmade pollution.⁷⁵⁵ In 1999, EPA finalized the regional haze program to protect the visibility in Mandatory Class I Federal areas.⁷⁵⁶ There are 156 national parks, forests and wilderness areas categorized as Mandatory Class I Federal areas.⁷⁵⁷ These areas are defined in CAA Section 162 as those national parks exceeding 6,000 acres, wilderness areas and memorial parks exceeding 5,000 acres, and all international parks which were in existence on August 7, 1977.

EPA has also concluded that PM_{2.5} can cause adverse effects on visibility in other areas that are not targeted by the Regional Haze Rule, such as urban areas, depending on PM_{2.5} concentrations and other factors such as dry chemical composition and relative humidity (*i.e.*, an indicator of the water composition of the particles).⁷⁵⁸ In December 2012, EPA revised the primary (health-based) PM_{2.5} standards in order to increase public health protection. As part of that same review,

the EPA generally retained the secondary (welfare-based) PM_{2.5} standards, concluding that the target level of protection against PM-related visibility impairment would be achieved in areas meeting the existing secondary standards for PM_{2.5}.

(b) Plant and Ecosystem Effects of Ozone

The welfare effects of ozone can be observed across a variety of scales, *i.e.* subcellular, cellular, leaf, whole plant, population and ecosystem. Ozone can produce both acute and chronic injury in sensitive species depending on the concentration level and the duration of the exposure.⁷⁵⁹ In those sensitive species,⁷⁶⁰ effects from repeated exposure to ozone throughout the growing season of the plant tend to accumulate, so that even low concentrations experienced for a longer duration have the potential to create chronic stress on vegetation.⁷⁶¹ Ozone damage to sensitive species includes impaired photosynthesis and visible injury to leaves. The impairment of photosynthesis, the process by which the plant makes carbohydrates (its source of energy and food), can lead to reduced crop yields, timber production, and plant productivity and growth. Impaired photosynthesis can also lead to a reduction in root growth and carbohydrate storage below ground, resulting in other, more subtle plant and ecosystem impacts.⁷⁶² These latter impacts include increased susceptibility of plants to insect attack, disease, harsh weather, interspecies competition and overall decreased plant vigor. The adverse effects of ozone on areas with sensitive species could potentially lead to species shifts and loss from the affected ecosystems,⁷⁶³ resulting in a loss or reduction in associated ecosystem goods and services. Additionally, visible ozone injury to leaves can result in a loss of aesthetic

value in areas of special scenic significance like national parks and wilderness areas and reduced use of sensitive ornamentals in landscaping.⁷⁶⁴

The most recent Integrated Science Assessment (ISA) for Ozone presents more detailed information on how ozone affects vegetation and ecosystems.⁷⁶⁵ The ISA concludes that ambient concentrations of ozone are associated with a number of adverse welfare effects and characterizes the weight of evidence for different effects associated with ozone.⁷⁶⁶ The ISA concludes that visible foliar injury effects on some vegetation, reduced vegetation growth, reduced productivity in terrestrial ecosystems, reduced yield and quality of some agricultural crops, and alteration of below-ground biogeochemical cycles are causally associated with exposure to ozone. It also concludes that reduced carbon sequestration in terrestrial ecosystems, alteration of terrestrial ecosystem water cycling, and alteration of terrestrial community composition are likely to be causally associated with exposure to ozone.

(c) Atmospheric Deposition

Wet and dry deposition of ambient particulate matter delivers a complex mixture of metals (*e.g.*, mercury, zinc, lead, nickel, aluminum, and cadmium), organic compounds (*e.g.*, polycyclic organic matter, dioxins, and furans), and inorganic compounds (*e.g.*, nitrate, sulfate) to terrestrial and aquatic ecosystems. The chemical form of the compounds deposited depends on a variety of factors including ambient conditions (*e.g.*, temperature, humidity, oxidant levels) and the sources of the material. Chemical and physical transformations of the compounds occur in the atmosphere as well as the media onto which they deposit. These transformations in turn influence the fate, bioavailability and potential toxicity of these compounds.

Adverse impacts to human health and the environment can occur when particulate matter is deposited to soils,

⁷⁵⁹ 73 FR 16486 (Mar. 27, 2008).

⁷⁶⁰ 73 FR 16491 (Mar. 27, 2008). Only a small percentage of all the plant species growing within the U.S. (over 43,000 species have been catalogued in the USDA PLANTS database) have been studied with respect to ozone sensitivity.

⁷⁶¹ The concentration at which ozone levels overwhelm a plant's ability to detoxify or compensate for oxidant exposure varies. Thus, whether a plant is classified as sensitive or tolerant depends in part on the exposure levels being considered. Chapter 9, Section 9.3.4 of U.S. EPA, 2013 Integrated Science Assessment for Ozone and Related Photochemical Oxidants. Office of Research and Development/National Center for Environmental Assessment. U.S. Environmental Protection Agency. EPA 600/R-10/076F.

⁷⁶² 73 FR 16492 (Mar. 27, 2008).

⁷⁶³ 73 FR 16493-16494 (Mar. 27, 2008). Ozone impacts could be occurring in areas where plant species sensitive to ozone have not yet been studied or identified.

⁷⁶⁴ 73 FR 16490-16497 (Mar. 27, 2008).

⁷⁶⁵ U.S. EPA. Integrated Science Assessment of Ozone and Related Photochemical Oxidants (Final Report). U.S. Environmental Protection Agency, Washington, DC, EPA/600/R-10/076F, 2013. The ISA is available at <http://cfpub.epa.gov/ncea/isa/recordisplay.cfm?deid=247492#Download>.

⁷⁶⁶ The Ozone ISA evaluates the evidence associated with different ozone related health and welfare effects, assigning one of five "weight of evidence" determinations: Causal relationship, likely to be a causal relationship, suggestive of a causal relationship, inadequate to infer a causal relationship, and not likely to be a causal relationship. For more information on these levels of evidence, please refer to Table II of the ISA.

⁷⁵³ U.S. EPA. (2009). Integrated Science Assessment for Particulate Matter (Final Report). U.S. Environmental Protection Agency, Washington, DC, EPA/600/R-08/139F.

⁷⁵⁴ U.S. EPA. 2009 Final Report: Integrated Science Assessment for Particulate Matter. U.S. Environmental Protection Agency, Washington, DC, EPA/600/R-08/139F, 2009.

⁷⁵⁵ See Section 169(a) of the Clean Air Act.

⁷⁵⁶ 64 FR 35714 (July 1, 1999).

⁷⁵⁷ 62 FR 38680-38681 (July 18, 1997).

⁷⁵⁸ 78 FR 3226, January 15, 2013.

water, and biota.⁷⁶⁷ Deposition of heavy metals or other toxics may lead to the human ingestion of contaminated fish, impairment of drinking water, damage to terrestrial, freshwater and marine ecosystem components, and limits to recreational uses. Atmospheric deposition has been identified as a key component of the environmental and human health hazard posed by several pollutants including mercury, dioxin and PCBs.⁷⁶⁸

The ecological effects of acidifying deposition and nutrient enrichment are detailed in the Integrated Science Assessment for Oxides of Nitrogen and Sulfur-Ecological Criteria.⁷⁶⁹ Atmospheric deposition of nitrogen and sulfur contributes to acidification, altering biogeochemistry and affecting animal and plant life in terrestrial and aquatic ecosystems across the United States. The sensitivity of terrestrial and aquatic ecosystems to acidification from nitrogen and sulfur deposition is predominantly governed by geology. Prolonged exposure to excess nitrogen and sulfur deposition in sensitive areas acidifies lakes, rivers, and soils. Increased acidity in surface waters creates inhospitable conditions for biota and affects the abundance and biodiversity of fishes, zooplankton, macroinvertebrates, and ecosystem function. Over time, acidifying deposition also removes essential nutrients from forest soils, depleting the capacity of soils to neutralize future acid loadings and negatively affecting forest sustainability. Major effects in forests include a decline in sensitive tree species, such as red spruce (*Picea rubens*) and sugar maple (*Acer saccharum*). In addition to the role nitrogen deposition plays in acidification, nitrogen deposition also leads to nutrient enrichment and altered biogeochemical cycling. In aquatic systems increased nitrogen can alter species assemblages and cause eutrophication. In terrestrial systems nitrogen loading can lead to loss of nitrogen-sensitive lichen species, decreased biodiversity of grasslands, meadows and other sensitive habitats,

⁷⁶⁷ U.S. EPA. Integrated Science Assessment for Particulate Matter (Final Report). U.S. Environmental Protection Agency, Washington, DC, EPA/600/R-08/139F, 2009.

⁷⁶⁸ U.S. EPA. (2000). Deposition of Air Pollutants to the Great Waters: Third Report to Congress. Office of Air Quality Planning and Standards. EPA-453/R-00-0005.

⁷⁶⁹ NO_x and SO_x secondary ISA U.S. EPA. Integrated Science Assessment (ISA) for Oxides of Nitrogen and Sulfur Ecological Criteria (Final Report). U.S. Environmental Protection Agency, Washington, DC, EPA/600/R-08/082F, 2008.

and increased potential for invasive species.

Building materials including metals, stones, cements, and paints undergo natural weathering processes from exposure to environmental elements (e.g., wind, moisture, temperature fluctuations, sunlight, etc.). Pollution can worsen and accelerate these effects. Deposition of PM is associated with both physical damage (materials damage effects) and impaired aesthetic qualities (soiling effects). Wet and dry deposition of PM can physically affect materials, adding to the effects of natural weathering processes, by potentially promoting or accelerating the corrosion of metals, by degrading paints and by deteriorating building materials such as stone, concrete and marble.⁷⁷⁰ The effects of PM are exacerbated by the presence of acidic gases and can be additive or synergistic due to the complex mixture of pollutants in the air and surface characteristics of the material. Acidic deposition has been shown to have an effect on materials including zinc/galvanized steel and other metal, carbonate stone (as monuments and building facings), and surface coatings (paints).⁷⁷¹ The effects on historic buildings and outdoor works of art are of particular concern because of the uniqueness and irreplaceability of many of these objects.

(d) Environmental Effects of Air Toxics

Emissions from producing, transporting, and combusting fuel contribute to ambient levels of pollutants that contribute to adverse effects on vegetation. Volatile organic compounds, some of which are considered air toxics, have long been suspected to play a role in vegetation damage.⁷⁷² In laboratory experiments, a wide range of tolerance to VOCs has been observed.⁷⁷³ Decreases in harvested seed pod weight have been reported for the more sensitive plants, and some studies have reported effects

⁷⁷⁰ U.S. Environmental Protection Agency (U.S. EPA). 2009. Integrated Science Assessment for Particulate Matter (Final Report). EPA-600-R-08-139F. National Center for Environmental Assessment—RTP Division. December. Available on the internet at <http://cfpub.epa.gov/ncea/cfm/recordisplay.cfm?deid=216546>.

⁷⁷¹ Irving, P.M., e.d. 1991. Acid Deposition: State of Science and Technology, Volume III, Terrestrial, Materials, Health, and Visibility Effects, The U.S. National Acid Precipitation Assessment Program, Chapter 24, page 24-76.

⁷⁷² U.S. EPA. (1991). Effects of organic chemicals in the atmosphere on terrestrial plants. EPA/600/3-91/001.

⁷⁷³ Cape J. N., Leith, I. D., Binnie, J., Content, J., Donkin, M., Skewes, M., Price, D. N., Brown, A. R., & Sharpe, A. D. (2003). Effects of VOCs on herbaceous plants in an open-top chamber experiment. *Environmental Pollution*. 124:341-343.

on seed germination, flowering and fruit ripening. Effects of individual VOCs or their role in conjunction with other stressors (e.g., acidification, drought, temperature extremes) have not been well studied. In a recent study of a mixture of VOCs including ethanol and toluene on herbaceous plants, significant effects on seed production, leaf water content, and photosynthetic efficiency were reported for some plant species.⁷⁷⁴

Research suggests an adverse impact of vehicle exhaust on plants, which has in some cases been attributed to aromatic compounds and in other cases to nitrogen oxides.^{775 776 777}

F. Air Quality Impacts of Non-GHG Pollutants

Changes in emissions of non-GHG pollutants due to these rules will impact air quality. Information on current air quality and the results of our air quality modeling of the projected impacts of these rules are summarized in the following section.

1. Current Concentrations of Non-GHG Pollutants

Nationally, levels of PM_{2.5}, ozone, NO_x, SO_x, CO, and air toxics have declined significantly in the last 30 years and are continuing to drop as previously promulgated regulations come into full effect. However, as of April 22, 2016, more than 125 million people lived in counties designated nonattainment for one or more of the NAAQS, and this figure does not include the people living in areas with a risk of exceeding a NAAQS in the future. Many Americans continue to be exposed to ambient concentrations of air toxics at levels which have the potential to cause adverse health effects. In addition, populations who live, work, or attend school near major roads experience elevated exposure concentrations to a wide range of air pollutants.

⁷⁷⁴ Cape, J. N., Leith, I. D., Binnie, J., Content, J., Donkin, M., Skewes, M., Price, D. N., Brown, A. R., & Sharpe, A. D. (2003). Effects of VOCs on herbaceous plants in an open-top chamber experiment. *Environmental Pollution*. 124:341-343.

⁷⁷⁵ Viskari E. L. (2000). Epicuticular wax of Norway spruce needles as indicator of traffic pollutant deposition. *Water, Air, and Soil Pollution*. 121:327-337.

⁷⁷⁶ Ugrekheldidze, D., Korte, F., & Kvesitadze, G. (1997). Uptake and transformation of benzene and toluene by plant leaves. *Ecotox. Environ. Safety* 37:24-29.

⁷⁷⁷ Kammerbauer H., Selinger, H., on Rommelt, R., Ziegler-Jons, A., Knoppik, D., & Hock, B. (1987). Toxic components of motor vehicle emissions for the spruce *Picea abies*. *Environmental Pollution*. 48:235-243.

(a) Particulate Matter

There are two primary NAAQS for PM_{2.5}: An annual standard (12.0 micrograms per cubic meter (µg/m³)) set in 2012 and a 24-hour standard (35 µg/m³) set in 2006, and two secondary NAAQS for PM_{2.5}: An annual standard (15.0 µg/m³) set in 1997 and a 24-hour standard (35 µg/m³) set in 2006.

There are many areas of the country that are currently in nonattainment for the annual and 24-hour primary PM_{2.5} NAAQS. As of April 22, 2016, more than 23 million people lived in the seven areas that are still designated as nonattainment for the 1997 annual PM_{2.5} NAAQS. These PM_{2.5} nonattainment areas are comprised of 33 full or partial counties. As of April 22, 2016, nine areas are redesignated as nonattainment for the 2012 annual PM_{2.5} NAAQS; these areas are composed of 20 full or partial counties with a population of more than 23 million. As of April 22, 2016, 16 areas are designated as nonattainment for the 2006 24-hour PM_{2.5} NAAQS, these areas are composed of 46 full or partial counties with a population of more than 32 million. In total, there are currently 24 PM_{2.5} nonattainment areas with a population of more than 39 million people.

The EPA has already adopted many mobile source emission control programs that are expected to reduce ambient PM concentrations. As a result of these and other federal, state and local programs, the number of areas that fail to meet the PM_{2.5} NAAQS in the future is expected to decrease. However, even with the implementation of all current state and federal regulations, there are projected to be counties violating the PM_{2.5} NAAQS well into the future. States will need to meet the 2006 24-hour standards in the 2015–2019 timeframe and the 2012 primary annual standard in the 2021–2025 timeframe.

Ozone

The primary and secondary NAAQS for ozone are eight-hour standards with a level of 0.07 ppm. The most recent revision to the ozone standards was in 2015; the previous eight-hour ozone primary standard, set in 2008, had a level of 0.075 ppm. As of April 22, 2016, there were 44 ozone nonattainment areas for the 2008 ozone NAAQS, composed of 216 full or partial counties, with a population of more than 120 million.

States with ozone nonattainment areas are required to take action to bring those areas into attainment. The attainment date assigned to an ozone nonattainment area is based on the area's classification. The attainment

dates for areas designated nonattainment for the 2008 eight-hour ozone NAAQS are in the 2015 to 2032 timeframe, depending on the severity of the problem in each area. Nonattainment area attainment dates associated with areas designated for the 2015 NAAQS will be in the 2020–2037 timeframe, depending on the severity of the problem in each area.

EPA has already adopted many emission control programs that are expected to reduce ambient ozone levels. As a result of these and other federal, state and local programs, eight-hour ozone levels are expected to improve in the future. However, even with the implementation of all current state and federal regulations, there are projected to be counties violating the ozone NAAQS well into the future.

(b) Nitrogen Dioxide

On April 6, 2018, based on a review of the full body of scientific evidence, EPA issued a decision to retain the current national ambient air quality standards (NAAQS) for oxides of nitrogen (NO_x). The EPA has concluded that the current NAAQS protect the public health, including the at-risk populations of older adults, children and people with asthma, with an adequate margin of safety. The NAAQS for nitrogen oxides are a one-hour standard at a level of 100 ppb based on the three-year average of 98th percentile of the yearly distribution of one-hour daily maximum concentrations, and an annual standard at a level of 53 ppb.

(c) Sulfur Dioxide

The EPA is currently reviewing the primary SO₂ NAAQS and has proposed to retain the current primary standard (83 FR 26752, June 8, 2018), which is a one-hour standard of 75 ppb established in June 2010. The EPA has been finalizing the initial area designations for the 2010 SO₂ NAAQS in phases and completed designations for most of the country in December 2017. The EPA is under a court order to finalize initial designations by December 31, 2020, for a remaining set of about 50 areas where states have deployed new SO₂ monitoring networks. As of July 2018, the EPA has designated 42 areas as nonattainment for the 2010 SO₂ NAAQS in actions taken in 2013, 2016, and 2017.⁷⁷⁸ There also remain nine nonattainment areas for the primary annual SO₂ NAAQS set in 1971.

⁷⁷⁸ 78 FR 47191, 81 FR 45049, 81 FR 89870, 83 FR 1098, and 83 FR 14597.

(d) Carbon Monoxide

There are two primary NAAQS for CO: An eight-hour standard (9 ppm) and a one-hour standard (35 ppm). The primary NAAQS for CO were retained in August 2011. There are currently no CO nonattainment areas; as of September 27, 2010, all CO nonattainment areas have been redesignated to attainment.

The past designations were based on the existing community-wide monitoring network. EPA is making changes to the ambient air monitoring requirements for CO. The new requirements are expected to result in approximately 52 CO monitors operating near roads within 52 urban areas by January 2015 (76 FR 54294, August 31, 2011).

(e) Diesel Exhaust PM

Because DPM is part of overall ambient PM and cannot be easily distinguished from overall PM, we do not have direct measurements of DPM in the ambient air. DPM concentrations are estimated using ambient air quality modeling based on DPM emission inventories. DPM emission inventories are computed as the exhaust PM emissions from mobile sources combusting diesel or residual oil fuel. DPM concentrations were recently estimated as part of the 2011 NATA. Areas with high concentrations are clustered in the Northeast, Great Lake States, California, and the Gulf Coast States and are also distributed throughout the rest of the U.S. The median DPM concentration calculated nationwide is 0.76 µg/m³.

(f) Air Toxics

The most recent available data indicate that the majority of Americans continue to be exposed to ambient concentrations of air toxics at levels which have the potential to cause adverse health effects. The levels of air toxics to which people are exposed vary depending on where people live and work and the kinds of activities in which they engage, as discussed in detail in EPA's most recent Mobile Source Air Toxics Rule. According to the National Air Toxic Assessment (NATA) for 2015, mobile sources were responsible for 50% of outdoor anthropogenic toxic emissions and were the largest contributor to cancer and noncancer risk from directly emitted pollutants. Mobile sources are also large contributors to precursor emissions which react to form air toxics. Formaldehyde is the largest contributor to cancer risk of all 71 pollutants quantitatively assessed in the 2011

NATA. Mobile sources were responsible for more than 25% of primary anthropogenic emissions of this pollutant in 2011 and are major contributors to formaldehyde precursor emissions. Benzene is also a large contributor to cancer risk, and mobile sources account for almost 80% of ambient exposure. Over the years, EPA has implemented a number of mobile source and fuel controls which have resulted in VOC reductions, which also reduced formaldehyde, benzene and other air toxic emissions.

2. Air Quality Impacts of Non-GHG Pollutants

(a) Impacts of Proposed Standards on Future Ambient Concentrations of PM_{2.5}, Ozone and Air Toxics

Full-scale photochemical air quality modeling is necessary to accurately project levels of criteria pollutants and air toxics. For the final rule, a national-scale air quality modeling analysis will be performed to analyze the impacts of the standards on PM_{2.5}, ozone, and selected air toxics (*i.e.*, benzene, formaldehyde, acetaldehyde, acrolein and 1,3-butadiene). The length of time needed to prepare the necessary

emissions inventories, in addition to the processing time associated with the modeling itself, has precluded us from performing air quality modeling for this proposal.

Section VI.D.2 of the preamble present projections of the changes in criteria pollutant and air toxics emissions because of the proposed vehicle standards; the basis for those estimates is set out in Chapter 10 of the PRIA. The atmospheric chemistry related to ambient concentrations of PM_{2.5}, ozone and air toxics is very complex, and making predictions based solely on emissions changes is extremely difficult.

3. Other Unquantified Health and Environmental Effects

In addition, the agencies seek comment on whether there are any other health and environmental impacts associated with advancements in technologies that should be considered. For example, the use of technologies and other strategies to reduce fuel consumption and/or GHG emissions could have effects on a vehicle's life-cycle impacts (*e.g.*, materials usage, manufacturing, end of life disposal),

beyond the issues regarding fuel production and distribution (upstream) GHG emissions discussed in Section VI.D.2. The agencies seek comment on any studies or research in this area that should be considered in the future to assess a fuller range of health and environmental impacts from the light-duty vehicle fleet shifting to different technologies and/or materials. At this point, it is unclear whether there is sufficient information about the lifecycle impacts of the myriad of available technologies, materials, and cradle-to-grave pathways to conduct the type of detailed assessments that would be needed in a regulatory context, but the agencies seek comment on any current or future studies and research underway on this topic, and how such analysis could practicably and in a balanced way be integrated in the modeling, especially considering the characterization of specific vehicles in the analysis fleet and the characterization of specific technology options.

G. What are the impacts on the total fleet size, usage, and safety?

1. CAFE Standards

Table VII-88 - Cumulative Changes in Fleet Size, Usage and Fatalities for MY's 1977-2029 Under CAFE Program

Model Year Standards Through	MY 2021	MY 2022	MY 2023	MY 2024	MY 2025	MY 2026	TOTAL
Cumulative Changes in Fleet Size, Usage and Fatalities Through MY 2029							
Fleet Size (millions)	-31	-28	-38	-48	-46	0	-190
Share LT, CY 2040	45%	45%	45%	45%	45%	45%	N/A
VMT, Fatalities, and Fuel Consumption for MY's 2017-2029							
VMT, with rebound (billion miles)	-222	-149	-200	-236	-219	0	-1,030
VMT, without rebound (billion miles)	-48	-29	-43	-46	-70	0	-235
Fatalities, with rebound	-1,840	-1,160	-1,740	-2,010	-1,880	0	-8,630
Fatalities, without rebound	-420	-175	-452	-442	-666	0	-2,160
Fuel Consumption, with rebound (billion gallons)	20	14	18	23	17	0	91
Fuel Consumption, without rebound (billion gallons)	26	18	23	29	21	0	116
VMT, Fatalities, and Fuel Consumption for MY's 1977-2016							
VMT, with rebound (billion miles)	-76.6	-70.4	-88.0	-115	-91.4	0	-441
VMT, without rebound (billion miles)	-79.3	-72.8	-91.0	-119	-94.5	0	-457
Fatalities, with rebound	-711	-646	-804	-1,060	-829	0	-4,050
Fatalities, without rebound	-737	-669	-832	-1,090	-856	0	-4,180
Fuel Consumption, with rebound (billion gallons)	-3.33	-2.87	-3.58	-4.65	-3.65	0	-18.1
Fuel Consumption, without rebound (billion gallons)	-3.46	-2.98	-3.71	-4.82	-3.78	0	-18.8

2. CO₂ Standards

Table VII-89 - Cumulative Changes in Fleet Size, Usage and Fatalities for MY's 1977-2029 Under CO₂ Program

Model Year Standards Through	MY 2021	MY 2022	MY 2023	MY 2024	MY 2025	MY 2026	TOTAL
cumulative Changes in Fleet Size, Usage and Fatalities Through MY 2029							
Fleet Size (millions)	-33	-41	-42	-60	-60	0	-235
Share LT, CY 2040	45%	45%	45%	45%	45%	45%	N/A
VMT, Fatalities, and Fuel Consumption for MY's 2017-2029							
VMT, with rebound (billion miles)	-245	-293	-214	-275	-271	0	-1,300
VMT, without rebound (billion miles)	-35	-66	-69	-104	-114	0	-387
Fatalities, with rebound	-2,050	-2,540	-1,890	-2,360	-2,330	0	-11,200
Fatalities, without rebound	-322	-676	-709	-963	-1,050	0	-3,720
Fuel Consumption, with rebound (billion gallons)	24	25	15	19	17	0	99
Fuel Consumption, without rebound (billion gallons)	32	32	20	24	21	0	128
VMT, Fatalities, and Fuel Consumption for MY's 1977-2016							
VMT, with rebound (billion miles)	-91.5	-94.5	-81.5	-116	-106	0	-490
VMT, without rebound (billion miles)	-94.8	-97.7	-84.2	-120	-110	0	-507
Fatalities, with rebound	-847	-866	-740	-1,060	-962	0	-4,480
Fatalities, without rebound	-878	-896	-765	-1,090	-994	0	-4,620
Fuel Consumption, with rebound (billion gallons)	-3.94	-3.98	-3.29	-4.70	-4.25	0	-20.2
Fuel Consumption, without rebound (billion gallons)	-4.09	-4.12	-3.41	-4.87	-4.40	0	-20.9

H. What other impacts (quantitative and unquantifiable) will these proposed standards have?

1. Sensitivity Analysis

As discussed at the beginning of this section, results presented today reflect the agencies' best judgments regarding many different factors. Based on analyses in past rulemakings, the agencies recognize that some analytical inputs are especially uncertain, some are likely to exert considerable influence over specific types of

estimated impacts, and some are likely to do so for the bulk of the analysis. To explore the sensitivity of estimated impacts to changes in model inputs, analysis was conducted using alternative values for a range of different inputs. Results of this sensitivity analysis are summarized below, and detailed model inputs and outputs are available on NHTSA's website.⁷⁷⁹ Regulatory alternatives are identical across all cases, except that one case includes an increase in civil penalty rate

starting in MY 2019; NHTSA may consider changing the civil penalty rate in a separate regulatory action, and depending on the timing of any such action, the final rule to follow today's proposal could reflect the change.⁷⁸⁰ The following table lists the cases included in the sensitivity analysis. The final rule could adopt any combination—or none—of these alternatives as reference case inputs, and the agencies invite comment on all of them.

⁷⁷⁹ The CAFE model and all inputs and outputs supporting today's proposal are available at [https://](https://www.nhtsa.gov/corporate-average-fuel-economy/compliance-and-effects-modeling-system)

www.nhtsa.gov/corporate-average-fuel-economy/compliance-and-effects-modeling-system.

⁷⁸⁰ 83 FR 13904 (Apr. 2, 2018).

Table VII-90 - Cases Included in Sensitivity Analysis

Sensitivity Case	Description
Reference Case	Reference case
Consumer Benefit at 50%	Assume 50% loss in consumer surplus – equivalent to the assumption that consumers will only value the calculated benefits they receive at 50 percent of the analysis estimates
Consumer Benefit at 75%	75% loss in consumer surplus
Fleet Share and Sales Response Disabled	New vehicle sales will remain at levels specified for MY 2016 in the market data input file
Disable Scrappage Price Effect	Keeps average new vehicle prices at MY 2016 levels within the scrappage model throughout the model simulation; this disables the effect of slower scrappage when new vehicle prices increase across more stringent scenarios.
Scrappage and Fleet Share Disabled	Disables both the scrappage price effect and the fleet share and sales response.
High Oil Price	High fuel price estimates
High Oil Price with 60 Month Payback	High fuel price estimates and a 60-mo. payback period
Low Oil Price	Low fuel price estimates
Low Oil Price with 12 Month Payback	Low fuel price estimates and a 12-mo. payback period
High GDP	High GDP growth rate
High GDP with High Oil Price	High GDP growth rate and high fuel price estimates
High GDP with Low Oil Price	High GDP growth rate and low fuel price estimates
Low GDP	Low GDP growth rate
Low GDP with High Oil Price	Low GDP growth rate and high fuel price estimates
Low GDP with Low Oil Price	Low GDP growth rate and low fuel price estimates
On Road Gap 0.10	On-road gap (difference between rated fuel economy and observed fuel economy) is set to 0.1.
On Road Gap 0.30	On-road gap is set to 0.3
12 Month Payback Period	12-month payback period (i.e., voluntary application of technologies paying back within first year of vehicle ownership)
24 Month Payback Period	24-month payback period
36 Month Payback Period	36-month payback period

Rebound Effect at 10%	Rebound effect, the increase miles traveled as the cost of travel decreases, is set to 10%
Rebound Effect at 30%	Rebound effect set to 30%
Long Fleet Redesign Cadence	Redesign cadence (schedule of major technology upgrades for vehicles, engines, etc.) is extended to 1.2 times that of the reference case (rounded to nearest MY)
Short Fleet Redesign Cadence	Redesign cadence shortened to a 0.8 times that of the reference case (rounded to nearest MY)
Safety Coefficient at 5th Percentile	Lower bounds of confidence interval of safety coefficients
Safety Coefficient at 95th Percentile	Upper bounds of confidence interval of safety coefficients
Fatalities Flat Earlier	Improvements in successive MY vehicles stabilize 5 years earlier than central case
Fatalities Flat Later	Improvements in successive MY vehicles stabilize 5 years later than central case
High Social Cost of Carbon	High social cost of carbon
Low Social Cost of Carbon	Low social cost of carbon
High HEV Battery Costs	HEV battery costs 1/3 more than in reference case
Low HEV Battery Costs	HEV battery costs 1/3 less than in reference case
Exclude Strong Hybrids	Strong hybrids are excluded from the analysis
Include HCR2 Engines	HCR2 (advanced high compression ratio engine) is included in the analysis
Fines at \$14 in 2019	CAFE compliance fines are set to \$14 beginning in 2019
Technology Cost Markup 1.10	Technology retail price equivalent (RPE) of 1.10 (i.e., 10% markup of direct costs)
Technology Cost Markup 1.19	Technology retail price equivalent (RPE) of 1.19 (i.e., 19% markup of direct costs)

Technology Cost Markup 1.24	Technology retail price equivalent (RPE) of 1.24 (i.e., 24% markup of direct costs)
Technology Cost Markup 1.37	Technology retail price equivalent (RPE) of 1.37 (i.e., 37% markup of direct costs)
Technology Cost Markup 1.75	Technology retail price equivalent (RPE) of 1.75 (i.e., 75% markup of direct costs)
Technology Cost Markup 2.00	Technology retail price equivalent (RPE) of 2.00 (i.e., 100% markup of direct costs)
AEO2018 Fuel Prices	Use AEO2018 reference fuel prices.
Utility Value Loss in HEVs	Include valuation of loss of utility of HEV, PHEV and EV.
Perfect Trading of CO ₂ Credits	Entire fleet treated as being produced by a single manufacturer.
Nonzero Valuation of CH ₄ and N ₂ O	CH ₄ and N ₂ O valued at \$209 and \$2491 per ton, respectively. ⁷⁸¹

The remaining tables in the section summarize various estimated impacts as estimated for all of the cases included in the sensitivity analysis.

⁷⁸¹ Climate-related economic damages caused by emissions of GHGs other than CO₂ were estimated by converting those emissions to their (mass) equivalents in CO₂ emissions and applying the per-ton damage costs used to monetize CO₂ emissions. Specifically, emissions of methane (CH₄) and nitrous oxide (N₂O) were converted to their equivalent in CO₂ emissions using the 100-year Global Warming Potentials (GWPs) for those gases,

which are 25 for CH₄ and 298 for N₂O. These GWPs were estimated by the United Nations Intergovernmental Panel on Climate Change in its 4th Assessment Report (available at https://www.ipcc.ch/publications_and_data/ar4/wg1/en/ch2s2-10-2.html; last accessed July 19, 2018). An alternative approach would be to develop direct estimates of the climate damage costs for these GHGs derived using the same process that was used to estimate the SCC, described previously in PRIA

Chapter 8.11.2 and the Appendix to Chapter 8. For comparison, using the alternative approach results in estimates which average \$256 per (metric) ton for CH₄ and \$2,820 for N₂O over the analysis period, or about 22% and 13% higher than the values used in this sensitivity case. A detailed description of the methods used to construct these alternative values is available in the docket for this rule. The agency will consider using this alternative approach in its analysis supporting the final rule.

Table VII-91 - Average Required and Achieved CAFE Levels, Vehicle Sales, and Employment Hours under Proposed CAFE Standards (MY 2029 Combined Fleet)

Sensitivity Case	Average Required CAFE Standard (mpg)	Average Achieved CAFE Level (mpg)	Vehicle Sales (x1,000)	Employment Hours (x1,000)
Reference Case	37.0	39.7	18,006	2,527,497
Consumer Benefit at 50%	37.0	39.7	18,006	2,527,497
Consumer Benefit at 75%	37.0	39.7	18,006	2,527,497
Fleet Share and Sales Response Disabled	36.9	39.5	16,578	2,339,120
Scrapage Price Effect Disabled	37.0	39.7	18,006	2,527,497
Scrapage and Fleet Share Disabled	36.9	39.5	16,578	2,339,120
High Oil Price	38.3	43.2	18,003	2,486,835
High Oil Price with 60 Month Payback	38.2	48.4	17,960	2,550,397
Low Oil Price	36.0	37.7	18,006	2,565,428
Low Oil Price with 12 Month Payback	36.0	37.6	18,000	2,568,164
High GDP	37.0	39.7	18,092	2,539,507
Low GDP	38.3	43.2	18,089	2,498,657
High GDP with High Oil Price	36.0	37.7	18,092	2,577,619
High GDP with Low Oil Price	37.0	39.7	17,457	2,450,393
Low GDP with High Oil Price	38.3	43.2	17,454	2,410,837
Low GDP with Low Oil Price	36.0	37.7	17,457	2,487,169
On Road Gap 0.10	37.0	39.5	18,004	2,527,780
On Road Gap 0.30	37.0	39.9	18,005	2,529,090
12 Month Payback Period	37.0	38.8	18,004	2,523,931
24 Month Payback Period	37.0	39.3	18,006	2,525,462
36 Month Payback Period	37.0	40.0	18,005	2,529,575
Rebound Effect at 10%	37.0	39.7	18,006	2,527,497
Rebound Effect at 30%	37.0	39.7	18,006	2,527,497
Long Fleet Redesign Cadence	37.0	39.9	18,000	2,533,310
Short Fleet Redesign Cadence	37.0	39.8	18,003	2,537,370
Safety Coefficient at 5th Percentile	37.0	39.7	18,006	2,527,497
Safety Coefficient at 95th Percentile	37.0	39.7	18,006	2,527,497
Fatalities Flat Earlier	37.0	39.7	18,006	2,527,497
Fatalities Flat Later	37.0	39.7	18,006	2,527,497
High Social Cost of Carbon	37.0	39.7	18,006	2,527,497
Low Social Cost of Carbon	37.0	39.7	18,006	2,527,497
High HEV Battery Costs	37.0	39.7	18,006	2,527,497
Low HEV Battery Costs	37.0	39.7	18,006	2,527,634
Exclude Strong Hybrids	37.0	39.8	18,006	2,527,741
Include HCR2 Engines	37.0	41.1	18,012	2,523,575
Fines at \$14 in 2019	37.0	39.8	18,007	2,528,506
Technology Cost Markup 1.10	37.0	40.5	18,012	2,530,142

Technology Cost Markup 1.19	37.0	40.2	18,011	2,528,548
Technology Cost Markup 1.24	37.0	40.3	18,009	2,529,575
Technology Cost Markup 1.37	37.0	39.8	18,010	2,526,972
Technology Cost Markup 1.75	37.0	39.4	18,001	2,527,326
Technology Cost Markup 2.00	37.0	39.2	17,995	2,528,328
AEO2018 Fuel Prices	37.2	39.8	18,007	2,520,290
Utility Value Loss in HEVs	37.0	39.7	18,006	2,527,497
Nonzero Valuation of CH ₄ and N ₂ O	37.0	39.7	18,006	2,527,497

Table VII-92 - Average Required and Achieved CO₂ Levels, Vehicle Sales, and Employment Hours under Proposed CO₂ Standards (MY 2029 Combined Fleet)

Sensitivity Case	Average Required CO ₂ Standard (g/mile)	Average Achieved CO ₂ Rating (g/mile)	Vehicle Sales (x1,000)	Employment Hours (x1,000)
Reference Case	240.1	229.6	18,016	2,519,524
Consumer Benefit at 50%	240.1	229.6	18,016	2,519,524
Consumer Benefit at 75%	240.1	229.6	18,016	2,519,524
Fleet Share and Sales Response Disabled	241.3	230.7	16,578	2,331,605
Scrapage Price Effect Disabled	240.1	229.6	18,016	2,519,524
Scrapage and Fleet Share Disabled	241.3	230.7	16,578	2,331,605
High Oil Price	231.8	207.3	18,006	2,485,426
High Oil Price with 60 Month Payback	232.7	186.6	17,965	2,547,313
Low Oil Price	246.2	242.8	18,019	2,554,288
Low Oil Price with 12 Month Payback	246.1	243.9	18,018	2,554,045
High GDP	240.1	230.1	18,102	2,530,790
Low GDP	231.8	207.3	18,092	2,497,237
High GDP with High Oil Price	246.2	242.8	18,105	2,566,418
High GDP with Low Oil Price	240.1	230.1	17,468	2,442,039
Low GDP with High Oil Price	231.8	207.3	17,457	2,409,607
Low GDP with Low Oil Price	246.2	242.4	17,469	2,476,916
On Road Gap 0.10	240.1	230.6	18,015	2,518,279
On Road Gap 0.30	240.2	227.7	18,014	2,520,876
12 Month Payback Period	239.8	237.2	18,019	2,511,392
24 Month Payback Period	240.0	232.5	18,018	2,515,942
36 Month Payback Period	240.2	226.2	18,012	2,523,599
Rebound Effect at 10%	240.1	229.6	18,016	2,519,524
Rebound Effect at 30%	240.1	229.6	18,016	2,519,524
Long Fleet Redesign Cadence	240.0	227.6	18,012	2,525,628
Short Fleet Redesign Cadence	240.3	227.8	18,014	2,524,315
Safety Coefficient at 5th Percentile	240.1	229.6	18,016	2,519,524
Safety Coefficient at 95th Percentile	240.1	229.6	18,016	2,519,524
Fatalities Flat Earlier	240.1	229.6	18,016	2,519,524
Fatalities Flat Later	240.1	229.6	18,016	2,519,524
High Social Cost of Carbon	240.1	229.6	18,016	2,519,524
Low Social Cost of Carbon	240.1	229.6	18,016	2,519,524
High HEV Battery Costs	240.1	229.6	18,016	2,519,524
Low HEV Battery Costs	240.0	230.0	18,017	2,517,939
Exclude Strong Hybrids	240.1	229.1	18,016	2,519,640
Include HCR2 Engines	240.1	220.0	18,016	2,516,858
Technology Cost Markup 1.10	240.2	222.1	18,017	2,523,878
Technology Cost Markup 1.19	240.2	224.6	18,018	2,521,079
Technology Cost Markup 1.24	240.1	226.6	18,019	2,518,399

Technology Cost Markup 1.37	240.1	228.5	18,018	2,519,133
Technology Cost Markup 1.75	240.0	230.9	18,015	2,519,214
Technology Cost Markup 2.00	239.9	233.3	18,012	2,516,794
AEO2018 Fuel Prices	239.1	228.7	18,017	2,512,451
Utility Value Loss in HEVs	240.1	229.6	18,016	2,519,524
Perfect Trading of CO ₂ Credits	239.8	233.1	18,023	2,511,294
Nonzero Valuation of CH ₄ and N ₂ O	240.1	229.6	18,016	2,519,524

Table VII-93 - Average MY 2029 New Vehicle Prices under Baseline and Proposed CAFE and CO₂ Standards (\$)

Sensitivity Case	CAFE Program			GHG Program		
	Initial Average Vehicle MSRP Model Year 2016	Average Vehicle MSRP Model Year 2029	Average Vehicle MSRP Model Year 2029, No-Action Alternative	Average Vehicle MSRP Model Year 2016	Average Vehicle MSRP Model Year 2029	Average Vehicle MSRP Model Year 2029, No-Action Alternative
Reference Case	32,048	32,774	34,813	32,048	32,550	35,031
Consumer Benefit at 50%	32,048	32,774	34,813	32,048	32,550	35,031
Consumer Benefit at 75%	32,048	32,774	34,813	32,048	32,550	35,031
Fleet Share and Sales Response Disabled	32,048	32,904	34,788	32,048	32,700	34,942
Scrapage Price Effect Disabled	32,048	32,774	34,813	32,048	32,550	35,031
Scrapage and Fleet Share Disabled	32,048	32,904	34,788	32,048	32,700	34,942
High Oil Price	32,048	32,133	33,709	32,048	32,069	33,811
High Oil Price with 60 Month Payback	32,048	33,234	33,833	32,048	33,147	33,681
Low Oil Price	32,048	33,357	35,634	32,048	33,083	35,909
Low Oil Price with 12 Month Payback	32,048	33,393	35,645	32,048	33,078	35,933
High GDP	32,048	32,774	34,813	32,048	32,541	35,038
Low GDP	32,048	32,133	33,709	32,048	32,069	33,812
High GDP with High Oil Price	32,048	33,357	35,634	32,048	33,084	35,910
High GDP with Low Oil Price	32,048	32,774	34,813	32,048	32,542	35,032
Low GDP with High Oil Price	32,048	32,131	33,711	32,048	32,069	33,811
Low GDP with Low Oil Price	32,048	33,357	35,634	32,048	33,091	35,912
On Road Gap 0.10	32,048	32,774	34,816	32,048	32,531	35,075
On Road Gap 0.30	32,048	32,804	34,772	32,048	32,592	35,004
12 Month Payback Period	32,048	32,720	34,833	32,048	32,421	35,161
24 Month Payback Period	32,048	32,745	34,823	32,048	32,496	35,078
36 Month Payback Period	32,048	32,811	34,767	32,048	32,636	34,996
Rebound Effect at 10%	32,048	32,774	34,813	32,048	32,550	35,031

Rebound Effect at 30%	32,048	32,774	34,813	32,048	32,550	35,031
Long Fleet Redesign Cadence	32,048	32,848	34,755	32,048	32,651	34,905
Short Fleet Redesign Cadence	32,048	32,854	34,850	32,048	32,658	35,021
Safety Coefficient at 5th Percentile	32,048	32,774	34,813	32,048	32,550	35,031
Safety Coefficient at 95th Percentile	32,048	32,774	34,813	32,048	32,550	35,031
Fatalities Flat Earlier	32,048	32,774	34,813	32,048	32,550	35,031
Fatalities Flat Later	32,048	32,774	34,813	32,048	32,550	35,031
High Social Cost of Carbon	32,048	32,774	34,813	32,048	32,550	35,031
Low Social Cost of Carbon	32,048	32,774	34,813	32,048	32,550	35,031
High HEV Battery Costs	32,048	32,774	34,813	32,048	32,550	35,031
Low HEV Battery Costs	32,048	32,770	34,625	32,048	32,527	34,778
Exclude Strong Hybrids	32,048	32,775	34,606	32,048	32,555	34,821
Include HCR2 Engines	32,048	32,686	34,136	32,048	32,527	34,177
Fines at \$14 in 2019	32,048	32,787	34,825	n/a	n/a	n/a
Technology Cost Markup 1.10	32,048	32,654	34,084	32,048	32,525	34,205
Technology Cost Markup 1.19	32,048	32,676	34,240	32,048	32,511	34,375
Technology Cost Markup 1.24	32,048	32,712	34,328	32,048	32,483	34,471
Technology Cost Markup 1.37	32,048	32,716	34,570	32,048	32,520	34,771
Technology Cost Markup 1.75	32,048	32,864	35,253	32,048	32,595	35,560
Technology Cost Markup 2.00	32,048	32,954	35,640	32,048	32,616	36,067
AEO2018 Fuel Prices	32,048	32,663	34,691	32,048	32,450	34,885
Utility Value Loss in HEVs	32,048	32,774	34,813	32,048	32,550	35,031
Perfect Trading of CO ₂ Credits	n/a	n/a	n/a	32,048	32,395	34,861
Nonzero Valuation of CH ₄ and N ₂ O	32,048	32,774	34,813	32,048	32,550	35,031

Table VII-94 - Cumulative Changes in Fleet Size, Travel (VMT), Fatalities, Fuel Consumption and CO₂ Emissions through MY 2029 under Proposed CAFE Standards

Sensitivity Case	Fleet Size (millions)	Share LT, CY 2040 (%)	CO ₂ (mmt)	VMT, Fatalities and Fuel Consumption with Rebound			VMT, Fatalities and Fuel Consumption without Rebound		
				VMT (billion Miles)	Fatalities	Fuel Cons. (billion gallons)	VMT (billion Miles)	Fatalities	Fuel Cons. (billion gallons)
Reference Case	-190	4538%	809	-1,470	-12,680	73.1	-690	-6,340	98
Consumer Benefit at 50%	-190	4538%	809	-1,470	-12,680	73.1	-690	-6,340	98
Consumer Benefit at 75%	-190	4538%	809	-1,470	-12,680	73.1	-690	-6,340	98
Fleet Share and Sales Response Disabled	-202	4627%	718	-1,550	-13,370	64.9	-830	-7,440	88
Scrapage Price Effect Disabled	-44	4572%	986	-920	-7,820	89.1	-140	-1,490	114
Scrapage and Fleet Share Disabled	-59	4663%	894	-1,010	-8,560	80.8	-280	-2,640	104
High Oil Price	-174	3383%	138	-1,510	-13,140	12.7	-680	-6,590	51
High Oil Price with 60 Month Payback	-51	3541%	65	-490	-4,300	6.2	-270	-2,720	23
Low Oil Price	-185	5364%	1,297	-1,250	-10,920	117.1	-630	-5,770	126
Low Oil Price with 12 Month Payback	-181	5338%	1,293	-1,240	-10,810	116.7	-610	-5,650	126
High GDP	-191	4540%	803	-1,460	-12,660	72.6	-690	-6,350	97
Low GDP	-174	3380%	136	-1,510	-13,100	12.5	-680	-6,580	51
High GDP with High Oil Price	-185	5368%	1,288	-1,250	-10,910	116.3	-630	-5,780	126
High GDP with Low Oil Price	-186	4532%	787	-1,430	-12,340	71.2	-670	-6,180	95
Low GDP with High Oil Price	-170	3388%	135	-1,470	-12,800	12.4	-670	-6,400	50
Low GDP with Low Oil Price	-180	5351%	1,260	-1,220	-10,670	113.8	-610	-5,650	123
On Road Gap 0.10	-192	4537%	747	-1,500	-12,980	67.6	-700	-6,440	90
On Road Gap 0.30	-181	4549%	889	-1,390	-12,000	80.4	-650	-5,950	108

12 Month Payback Period	-210	4493%	901	-1,670	-14,470	81.4	-780	-7,270	109
24 Month Payback Period	-202	4525%	854	-1,570	-13,600	77.2	-750	-6,860	103
36 Month Payback Period	-179	4550%	762	-1,370	-11,840	69.0	-640	-5,900	92
Rebound Effect at 10%	-190	4538%	945	-1,080	-9,510	85.4	-690	-6,340	98
Rebound Effect at 30%	-190	4538%	673	-1,860	-15,850	60.8	-690	-6,340	98
Long Fleet Redesign Cadence	-175	4508%	827	-1,390	-12,280	75.1	-630	-6,080	98
Short Fleet Redesign Cadence	-182	4541%	631	-1,330	-11,730	56.9	-680	-6,390	77
Safety Coefficient at 5th Percentile	-190	4538%	809	-1,470	-10,830	73.1	-690	-4,630	98
Safety Coefficient at 95th Percentile	-190	4538%	809	-1,470	-14,520	73.1	-690	-8,050	98
Fatalities Flat Earlier	-190	4538%	809	-1,470	-12,680	73.1	-690	-6,340	98
Fatalities Flat Later	-190	4538%	809	-1,470	-12,680	73.1	-1,470	-12,680	73
High Social Cost of Carbon	-190	4538%	809	-1,470	-12,680	73.1	-690	-6,340	98
Low Social Cost of Carbon	-190	4538%	809	-1,470	-12,680	73.1	-690	-6,340	98
High HEV Battery Costs	-190	4538%	809	-1,470	-12,680	73.1	-690	-6,340	98
Low HEV Battery Costs	-180	4539%	835	-1,450	-12,520	75.5	-670	-6,090	100
Exclude Strong Hybrids	-184	4542%	751	-1,420	-12,210	68.7	-690	-6,300	90
Include HCR2 Engines	-140	4551%	623	-1,140	-9,900	56.3	-530	-4,940	74
Fines at \$14 in 2019	-194	4538%	766	-1,460	-12,580	69.2	-710	-6,470	93
Technology Cost Markup 1.10	-142	4566%	695	-1,190	-10,310	62.9	-540	-4,950	84
Technology Cost Markup 1.19	-152	4560%	723	-1,250	-10,810	65.4	-570	-5,220	87
Technology Cost Markup 1.24	-154	4559%	715	-1,250	-10,770	64.7	-570	-5,240	86
Technology Cost Markup 1.37	-175	4545%	802	-1,400	-12,110	72.5	-640	-5,910	97
Technology Cost Markup 1.75	-214	4524%	837	-1,580	-13,650	75.7	-760	-7,000	101
Technology Cost Markup 2.00	-236	4509%	850	-1,660	-14,420	76.8	-820	-7,600	103
AEO2018 Fuel Prices	-196	4418%	768	-1,530	-13,180	69.5	-720	-6,620	96
Utility Value Loss in HEVs	-190	45.4	809	-1,470	-12,680	73.1	-690	-6,340	98
Nonzero Valuation of CH ₄ and N ₂ O	-190	45.4	809	-1,470	-12,680	73.1	-690	-6,340	98

Table VII-95 - Cumulative Changes in Fleet Size, Travel (VMT), Fatalities, Fuel Consumption and CO₂ Emissions through MY 2029 under Proposed CO₂ Standards

Sensitivity Case	Fleet Size (millions)	Share LT, CY 2040 (%)	CO ₂ (mmt)	VMT, Fatalities and Fuel Consumption with Rebound			VMT, Fatalities and Fuel Consumption without Rebound		
				VMT (billion Miles)	Fatalities	Fuel Cons. (billion gallons)	VMT (billion Miles)	Fatalities	Fuel Cons. (billion gallons)
Reference Case	-190	4538%	809	-1,470	-12,680	73.1	-690	-6,340	98
Consumer Benefit at 50%	-190	4538%	809	-1,470	-12,680	73.1	-690	-6,340	98
Consumer Benefit at 75%	-190	4538%	809	-1,470	-12,680	73.1	-690	-6,340	98
Fleet Share and Sales Response Disabled	-202	4627%	718	-1,550	-13,370	64.9	-830	-7,440	88
Scrappage Price Effect Disabled	-44	4572%	986	-920	-7,820	89.1	-140	-1,490	114
Scrappage and Fleet Share Disabled	-59	4663%	894	-1,010	-8,560	80.8	-280	-2,640	104
High Oil Price	-174	3383%	138	-1,510	-13,140	12.7	-680	-6,590	51
High Oil Price with 60 Month Payback	-51	3541%	65	-490	-4,300	6.2	-270	-2,720	23
Low Oil Price	-185	5364%	1,297	-1,250	-10,920	117.1	-630	-5,770	126
Low Oil Price with 12 Month Payback	-181	5338%	1,293	-1,240	-10,810	116.7	-610	-5,650	126
High GDP	-191	4540%	803	-1,460	-12,660	72.6	-690	-6,350	97
Low GDP	-174	3380%	136	-1,510	-13,100	12.5	-680	-6,580	51
High GDP with High Oil Price	-185	5368%	1,288	-1,250	-10,910	116.3	-630	-5,780	126
High GDP with Low Oil Price	-186	4532%	787	-1,430	-12,340	71.2	-670	-6,180	95
Low GDP with High Oil Price	-170	3388%	135	-1,470	-12,800	12.4	-670	-6,400	50
Low GDP with Low Oil Price	-180	5351%	1,260	-1,220	-10,670	113.8	-610	-5,650	123
On Road Gap 0.10	-192	4537%	747	-1,500	-12,980	67.6	-700	-6,440	90
On Road Gap 0.30	-181	4549%	889	-1,390	-12,000	80.4	-650	-5,950	108
12 Month Payback Period	-210	4493%	901	-1,670	-14,470	81.4	-780	-7,270	109
24 Month Payback Period	-202	4525%	854	-1,570	-13,600	77.2	-750	-6,860	103

36 Month Payback Period	-179	4550%	762	-1,370	-11,840	69.0	-640	-5,900	92
Rebound Effect at 10%	-190	4538%	945	-1,080	-9,510	85.4	-690	-6,340	98
Rebound Effect at 30%	-190	4538%	673	-1,860	-15,850	60.8	-690	-6,340	98
Long Fleet Redesign Cadence	-175	4508%	827	-1,390	-12,280	75.1	-630	-6,080	98
Short Fleet Redesign Cadence	-182	4541%	631	-1,330	-11,730	56.9	-680	-6,390	77
Safety Coefficient at 5th Percentile	-190	4538%	809	-1,470	-10,830	73.1	-690	-4,630	98
Safety Coefficient at 95th Percentile	-190	4538%	809	-1,470	-14,520	73.1	-690	-8,050	98
Fatalities Flat Earlier	-190	4538%	809	-1,470	-12,680	73.1	-690	-6,340	98
Fatalities Flat Later	-190	4538%	809	-1,470	-12,680	73.1	-1,470	-12,680	73
High Social Cost of Carbon	-190	4538%	809	-1,470	-12,680	73.1	-690	-6,340	98
Low Social Cost of Carbon	-190	4538%	809	-1,470	-12,680	73.1	-690	-6,340	98
High HEV Battery Costs	-190	4538%	809	-1,470	-12,680	73.1	-690	-6,340	98
Low HEV Battery Costs	-180	4539%	835	-1,450	-12,520	75.5	-670	-6,090	100
Exclude Strong Hybrids	-184	4542%	751	-1,420	-12,210	68.7	-690	-6,300	90
Include HCR2 Engines	-140	4551%	623	-1,140	-9,900	56.3	-530	-4,940	74
Technology Cost Markup 1.10	-142	4566%	695	-1,190	-10,310	62.9	-540	-4,950	84
Technology Cost Markup 1.19	-152	4560%	723	-1,250	-10,810	65.4	-570	-5,220	87
Technology Cost Markup 1.24	-154	4559%	715	-1,250	-10,770	64.7	-570	-5,240	86
Technology Cost Markup 1.37	-175	4545%	802	-1,400	-12,110	72.5	-640	-5,910	97
Technology Cost Markup 1.75	-214	4524%	837	-1,580	-13,650	75.7	-760	-7,000	101
Technology Cost Markup 2.00	-236	4509%	850	-1,660	-14,420	76.8	-820	-7,600	103
AEO2018 Fuel Prices	-196	4418%	768	-1,530	-13,180	69.5	-720	-6,620	96
Utility Value Loss in HEVs	-190	4538%	809	-1,470	-12,680	73.1	-690	-6,340	98
Perfect Trading of CO ₂ Credits	-242	44.9	848	-1,860	-16,460	76.3	-950	-9,060	106
Nonzero Valuation of CH ₄ and N ₂ O	-232	45.2	876	-1,780	-15,560	79.1	-880	-8,260	108

Table VII-96 - Change in Total Regulatory Costs during MYs 2017-2029 under Proposed CAFE and CO₂ Standards

Sensitivity Case	CAFE Standards		CO ₂ Standards	
	Total Regulatory Costs (\$b)	Percent Change from Reference Case	Total Regulatory Costs (\$b)	Percent Change from Reference Case
Reference Case	-319.1	n/a	-325.7	n/a
Consumer Benefit at 50%	-319.1	0.0	-325.7	0.0
Consumer Benefit at 75%	-319.1	0.0	-325.7	0.0
Fleet Share and Sales Response Disabled	-299.5	-6.2	-299.4	-8.1
Disable Scrapage Price Effect	-319.1	0.0	-325.7	0.0
Disable Scrapage Price Effect and Fleet Share and Sales Response	-299.5	-6.2	-299.4	-8.1
High Oil Price	-244.4	-23.4	-219.1	-32.7
High Oil Price with 60 Month Payback	-88.3	-72.3	-65.7	-79.8
Low Oil Price	-354.5	11.1	-371.5	14.1
Low Oil Price with 12 Month Payback	-353.1	10.6	-388.1	19.2
High GDP	-319.4	0.1	-327.2	0.5
High GDP with High Oil Price	-244.5	-23.4	-220.0	-32.5
High GDP with Low Oil Price	-354.8	11.2	-371.9	14.2
Low GDP	-307.9	-3.5	-314.8	-3.3
Low GDP with High Oil Price	-236.1	-26.0	-211.5	-35.1
Low GDP with Low Oil Price	-342.0	7.2	-358.0	9.9
On Road Gap 0.10	-321.4	0.7	-332.1	2.0
On Road Gap 0.30	-311.7	-2.3	-311.0	-4.5
12 Month Payback Period	-328.7	3.0	-356.7	9.5
24 Month Payback Period	-325.4	2.0	-335.8	3.1
36 Month Payback Period	-309.4	-3.1	-301.7	-7.4
Rebound Effect at 10%	-319.1	0.0	-325.7	0.0
Rebound Effect at 30%	-319.1	0.0	-325.7	0.0
Long Fleet Redesign Cadence	-306.7	-3.9	-321.6	-1.2
Short Fleet Redesign Cadence	-259.6	-18.7	-310.2	-4.7
Safety Coefficient at 5th Percentile	-319.1	0.0	-325.7	0.0
Safety Coefficient at 95th Percentile	-319.1	0.0	-325.7	0.0
Fatalities Flat Earlier	-319.1	0.0	-325.7	0.0
Fatalities Flat Later	-319.1	0.0	-325.7	0.0
High Social Cost of Carbon	-319.1	0.0	-325.7	0.0
Low Social Cost of Carbon	-319.1	0.0	-325.7	0.0
High HEV Battery Costs	-319.1	0.0	-325.7	0.0
Low HEV Battery Costs	-283.5	-11.2	-297.3	-8.7
Exclude Strong Hybrids	-280.7	-12.1	-295.7	-9.2
Include HCR2 Engines	-209.0	-34.5	-191.4	-41.2
Fines at \$14 in 2019	-310.7	-2.6	n/a	n/a
Technology Cost Markup 1.10	-219.3	-31.3	-209.3	-35.7

Technology Cost Markup 1.19	-241.2	-24.4	-234.2	-28.1
Technology Cost Markup 1.24	-250.1	-21.6	-248.8	-23.6
Technology Cost Markup 1.37	-288.3	-9.7	-290.1	-10.9
Technology Cost Markup 1.75	-377.8	18.4	-391.7	20.3
Technology Cost Markup 2.00	-429.0	34.4	-454.3	39.5
AEO2018 Fuel Prices	-318.1	-0.3	-317.0	-2.7
Utility Value Loss in HEVs	-319.1	0.0	-325.7	0.0
Perfect Trading of CO ₂ Credits	n/a	n/a	-284.5	-12.7
Nonzero Valuation of CH ₄ and N ₂ O	-319.1	0.0	-325.7	0.0

Table VII-97 - Incremental Costs and Benefits – Cumulative over Useful Life of MYs 2017-2029 under Proposed CAFE Standards

Sensitivity Case	Social Costs	Total Costs	Private Benefits	Total Benefits	Net Benefits
Reference Case	-51.9	-502.1	-176.4	-325.8	176.3
Consumer Benefit at 50%	-51.9	-502.1	-176.4	-259.3	242.8
Consumer Benefit at 75%	-51.9	-502.1	-176.4	-292.5	209.5
Fleet Share and Sales Response Disabled	-56.4	-503.2	-164.5	-296.8	206.4
Scrapage Price Effect Disabled	-33.5	-416.7	-176.9	-357.5	59.2
Scrapage and Fleet Share Disabled	-38.1	-418.1	-165.0	-328.7	89.4
High Oil Price	-54.8	-456.3	-274.1	-325.3	131.0
High Oil Price with 60 Month Payback	-17.9	-155.7	-80.4	-105.8	49.9
Low Oil Price	-43.2	-490.9	-121.0	-270.4	220.5
Low Oil Price with 12 Month Payback	-42.9	-487.7	-121.1	-269.9	217.8
High GDP	-51.9	-502.1	-175.8	-324.3	177.7
Low GDP	-54.7	-455.9	-273.0	-323.6	132.3
High GDP with High Oil Price	-43.2	-491.0	-120.6	-269.3	221.7
High GDP with Low Oil Price	-50.4	-486.0	-171.3	-316.4	169.6
Low GDP with High Oil Price	-53.3	-442.2	-266.8	-316.9	125.2
Low GDP with Low Oil Price	-42.2	-476.0	-117.5	-262.5	213.5
On Road Gap 0.10	-53.4	-510.8	-174.5	-311.8	199.0
On Road Gap 0.30	-49.2	-483.1	-178.3	-343.1	140.0
12 Month Payback Period	-58.9	-544.9	-199.9	-366.1	178.7
24 Month Payback Period	-55.6	-525.5	-187.6	-345.4	180.1
36 Month Payback Period	-48.4	-477.4	-165.7	-306.4	171.1
Rebound Effect at 10%	-37.0	-433.7	-93.5	-268.7	165.0
Rebound Effect at 30%	-66.9	-570.5	-259.2	-382.8	187.7
Long Fleet Redesign Cadence	-49.5	-487.0	-172.2	-323.7	163.3

Short Fleet Redesign Cadence	-45.4	-422.9	-145.5	-261.9	161.0
Safety Coefficient at 5th Percentile	-51.9	-471.9	-174.2	-323.6	148.3
Safety Coefficient at 95th Percentile	-51.9	-532.2	-178.5	-327.9	204.3
Fatalities Flat Earlier	-51.9	-502.1	-176.4	-325.8	176.3
Fatalities Flat Later	-51.9	-502.1	-69.5	-218.9	283.1
High Social Cost of Carbon	-51.9	-502.1	-176.4	-327.5	174.5
Low Social Cost of Carbon	-51.9	-502.1	-176.4	-322.2	179.9
High HEV Battery Costs	-51.9	-502.1	-176.4	-325.8	176.3
Low HEV Battery Costs	-51.5	-471.2	-178.9	-333.0	138.3
Exclude Strong Hybrids	-49.7	-460.0	-164.0	-299.1	160.9
Include HCR2 Engines	-40.2	-357.7	-135.3	-250.1	107.6
Fines at \$14 in 2019	-51.1	-485.5	-169.9	-311.4	174.2
Technology Cost Markup 1.10	-42.1	-375.8	-149.0	-276.7	99.1
Technology Cost Markup 1.19	-44.2	-403.2	-155.1	-288.0	115.2
Technology Cost Markup 1.24	-44.0	-409.0	-153.4	-284.9	124.1
Technology Cost Markup 1.37	-49.6	-466.7	-172.3	-319.9	146.8
Technology Cost Markup 1.75	-55.7	-567.1	-185.1	-339.7	227.3
Technology Cost Markup 2.00	-58.3	-621.5	-190.3	-347.8	273.7
AEO2018 Fuel Prices	-54.1	-511.5	-187.8	-339.3	172.2
Utility Value Loss in HEVs	-51.9	-547.9	-176.4	-325.8	222.2
Nonzero Valuation of CH ₄ and N ₂ O	-51.9	-502.1	-176.4	-326.0	176.1

Table VII-98 - Incremental Costs and Benefits – Cumulative over Useful Life of MYs 2017-2029 under Proposed CO₂ Standards

Sensitivity Case	Social Costs	Total Costs	Private Benefits	Total Benefits	Net Benefits
Reference Case	-62.1	-560.8	-201.7	-363.6	197.2
Consumer Benefit at 50%	-62.1	-560.8	-201.7	-291.4	269.4
Consumer Benefit at 75%	-62.1	-560.8	-201.7	-327.5	233.3
Fleet Share and Sales Response Disabled	-65.5	-550.6	-186.1	-329.3	221.3
Scrapage Price Effect Disabled	-40.6	-461.9	-202.1	-399.9	62.0
Scrapage and Fleet Share Disabled	-44.5	-453.8	-186.5	-365.1	88.7
High Oil Price	-55.5	-439.3	-259.6	-293.0	146.3
High Oil Price with 60 Month Payback	-14.9	-122.5	-73.3	-89.5	33.0
Low Oil Price	-52.0	-550.7	-138.9	-302.7	248.0
Low Oil Price with 12 Month Payback	-53.5	-572.0	-143.7	-313.5	258.5
High GDP	-62.4	-563.6	-201.6	-362.4	201.2
Low GDP	-55.5	-440.4	-259.7	-292.9	147.5

High GDP with High Oil Price	-52.0	-550.7	-138.5	-301.3	249.4
High GDP with Low Oil Price	-60.5	-544.5	-196.2	-353.4	191.1
Low GDP with High Oil Price	-53.8	-425.2	-252.2	-284.8	140.4
Low GDP with Low Oil Price	-50.6	-533.1	-134.6	-292.9	240.2
On Road Gap 0.10	-64.2	-576.6	-200.7	-349.3	227.3
On Road Gap 0.30	-58.8	-532.6	-201.4	-376.5	156.1
12 Month Payback Period	-74.4	-646.0	-240.9	-430.1	215.9
24 Month Payback Period	-65.6	-587.1	-213.2	-382.8	204.4
36 Month Payback Period	-55.9	-510.5	-180.5	-324.7	185.9
Rebound Effect at 10%	-44.8	-482.2	-106.8	-298.5	183.7
Rebound Effect at 30%	-79.4	-639.3	-296.6	-428.6	210.7
Long Fleet Redesign Cadence	-59.5	-545.2	-193.8	-351.8	193.4
Short Fleet Redesign Cadence	-56.1	-518.5	-179.4	-320.7	197.8
Safety Coefficient at 5th Percentile	-62.1	-512.8	-199.2	-361.0	151.7
Safety Coefficient at 95th Percentile	-62.1	-608.6	-204.2	-366.1	242.5
Fatalities Flat Earlier	-62.1	-560.8	-201.7	-363.6	197.2
Fatalities Flat Later	-62.1	-560.8	-79.2	-241.0	319.7
High Social Cost of Carbon	-62.1	-560.8	-201.7	-365.5	195.3
Low Social Cost of Carbon	-62.1	-560.8	-201.7	-359.7	201.1
High HEV Battery Costs	-62.1	-560.8	-201.7	-363.6	197.2
Low HEV Battery Costs	-60.7	-532.5	-203.6	-369.7	162.8
Exclude Strong Hybrids	-60.4	-529.0	-197.9	-355.5	173.5
Include HCR2 Engines	-43.9	-365.9	-140.2	-253.4	112.5
Technology Cost Markup 1.10	-45.9	-390.5	-151.6	-272.4	118.1
Technology Cost Markup 1.19	-50.9	-432.9	-169.2	-305.2	127.7
Technology Cost Markup 1.24	-53.3	-456.6	-176.9	-318.3	138.3
Technology Cost Markup 1.37	-58.2	-513.6	-192.9	-349.2	164.3
Technology Cost Markup 1.75	-66.2	-633.6	-208.9	-371.9	261.7
Technology Cost Markup 2.00	-71.6	-708.9	-220.2	-388.7	320.2
AEO2018 Fuel Prices	-63.5	-561.0	-211.0	-372.7	188.2
Utility Value Loss in HEVs	-62.1	-593.3	-201.7	-363.6	229.8
Perfect Trading of CO ₂ Credits	-64.2	-542.3	-205.0	-363.4	178.9
Nonzero Valuation of CH ₄ and N ₂ O	-62.1	-560.8	-201.7	-363.8	197.0

VIII. Impacts of Alternative CAFE and CO₂ Standards Considered for MYs 2021/22–2026

As discussed above, a range of regulatory alternatives are being considered. Section III defines the proposed preferred alternative, and Section IV defines the no-action alternative as well as the other seven alternatives. The potential impacts of each alternative in each case relative to the no-action alternative were estimated. For the preferred alternative, these impacts are presented above on an incremental basis, such that the impacts attributed separately to standards proposed in each model year. To facilitate comparison of different

alternatives, total estimated impacts (*i.e.*, summing impacts attributable to all model years' standards) were calculated under each alternative.

Tables in the remaining section summarize these estimated impacts for each alternative, considering the same measures as shown above for the preferred alternative. As for the preferred alternative, social costs and benefits, private costs and benefits, and environmental and energy impacts were evaluated, and were done so separately for CAFE and CO₂ standards defining each regulatory alternative. Also, as for the preferred alternative, the compliance-related private costs and benefits were evaluated separately for

domestic and imported passenger cars under CAFE standards but not under CO₂ standards because EPCA/EISA's requirement for separate compliance applies only to CAFE standards.

This analysis does not explicitly identify "co-benefits" from its proposed action to change fuel economy standards, as such a concept would include all benefits other than cost savings to vehicle buyers. Instead, it distinguishes between private benefits—which include economic impacts on vehicle manufacturers, buyers of new cars and light trucks, and owners (or users) of used cars and light trucks—and external benefits, which represent indirect benefits (or costs) to the

remainder of the U.S. economy that stem from the proposal's effects on the behavior of vehicle manufacturers, buyers, and users. In this accounting framework, changes in fuel use and safety impacts resulting from the proposal's effects on the number of used vehicles in use represent an important component of its private benefits and costs, despite the fact that previous analyses have failed to recognize these effects. The agency's presentation of private costs and benefits from its proposed action clearly distinguishes between those that would be experienced by owners and users of cars and light trucks produced during previous model years, and those that

would be experienced by buyers and users of cars and light trucks produced during the model years it would affect. Moreover, it clearly separates these into benefits related to fuel consumption and those related to safety consequences of vehicle use. This is more meaningful and informative than simply identifying all impacts other than changes in fuel savings to buyers of new vehicles as "co-benefits."

Like the preferred alternative, all other alternatives involve standards less stringent than the no-action alternative. Therefore, as discussed above, incremental benefits and costs for each alternative are negative—in other words, each alternative involves foregone benefits and avoided costs.

Environmental and energy impacts are correspondingly negative, involving foregone avoided CO₂ emissions and foregone avoided fuel consumption. For consistency with past rulemakings, these are reported as negative values rather than as additional CO₂ emissions and additional fuel consumption.

As discussed above, more detailed results are available in the PRIA and DEIS accompanying today's notice, as well as in underlying model output files posted on NHTSA's website.

A. What are the social costs and benefits of each alternative, relative to the no-action alternative?

1. CAFE Standards

Table VIII-1 - Combined LDV Societal Net Benefits for MYs 1977-2029, CAFE Program, Undiscounted

	Alternative								
	No Action	1	2	3	4	5	6	7	8
Model Years	2021-2025	2021-2026	2021-2026	2021-2026	2021-2026	2022-2026	2021-2026	2021-2026	2022-2026
Annual Rate of Stringency Increase	MY 2017-2021 Augural MY 2022-2025	0.0%/Year PC 0.0%/Year LT	0.5%/Year PC 0.5%/Year LT	0.5%/Year PC 0.5%/Year LT	1.0%/Year PC 2.0%/Year LT	1.0%/Year PC 2.0%/Year LT	2.0%/Year PC 3.0%/Year LT	2.0%/Year PC 3.0%/Year LT	2.0%/Year PC 3.0%/Year LT
AC/Off-Cycle Procedures	No Change	No Change	No Change	Phaseout 2022-2026	No Change	No Change	No Change	Phaseout 2022-2026	No Change
Societal Costs and Benefits Through MY 2029 (\$b)									
Technology Costs	-	-315	-303	-284	-261	-210	-188	-112	-124
Pre-tax Fuel Savings	-	-194	-184	-174	-152	-114	-109	-76	-71.6
Mobility Benefit	-	-93.6	-87.5	-81.7	-68.7	-50.3	-45.2	-28.2	-28.6
Refueling Benefit	-	-12.3	-11.7	-11.1	-9.8	-7.4	-7.1	-5.1	-4.7
Non-Rebound Fatality Costs	-	-62.8	-57.7	-53.5	-44.1	-32.9	-26.0	-10.4	-15.0
Rebound Fatality Costs	-	-62.7	-59.0	-55.7	-48.0	-35.7	-32.9	-21.8	-21.5
Benefits Offsetting Rebound Fatality Costs	-	-62.7	-59.0	-55.7	-48.0	-35.7	-32.9	-21.8	-21.5
Non-Rebound Non-Fatal Crash Costs	-	-98.2	-90.2	-83.7	-69.0	-51.5	-40.7	-16.2	-23.5
Rebound Non-Fatal Crash Costs	-	-98.1	-92.3	-87.1	-75.1	-55.9	-51.5	-34.0	-33.6

Benefits Offsetting Rebound Non-Fatal Crash Costs	-	-98.1	-92.3	-87.1	-75.1	-55.9	-51.5	-34.0	-33.6
Additional Congestion and Noise (Costs)	-	-85.3	-79.4	-74.2	-62.5	-46.7	-40.3	-22.0	-25.3
Energy Security Benefit	-	-16.0	-15.1	-14.4	-12.6	-9.5	-9.1	-6.4	-6.0
Avoided CO ₂ Damages (Benefits)	-	-6.4	-6.0	-5.7	-5.0	-3.8	-3.6	-2.5	-2.4
Other Avoided GHG Damages (Benefits)	-	0.0	0.0	0.0	0.0	0.0	0.0	0.0	0.0
Other Avoided Pollutant Damages (Benefits)	-	-0.8	-0.9	-0.9	-0.9	-0.5	-0.9	-1.0	-0.5
Total Costs	-	-722	-682	-638	-560	-433	-379	-216	-242
Total Benefits	-	-484	-456	-431	-372	-278	-260	-175	-169
Net Benefits	-	238	225	207	187	156	119	40.9	73.5

Table VIII-2 - Combined LDV Estimated Electrification Cost Coverage for MYs 2017-2029, CAFE Program, Undiscounted, Millions of \$2016

	Alternative								
	No Action	1	2	3	4	5	6	7	8
Model Years	2021-2025	2021-2026	2021-2026	2021-2026	2021-2026	2022-2026	2021-2026	2021-2026	2022-2026
Annual Rate of Stringency Increase	MY 2017-2021 Augural MY 2022-2025	0.0%/Year PC 0.0%/Year LT	0.5%/Year PC 0.5%/Year LT	0.5%/Year PC 0.5%/Year LT	1.0%/Year PC 2.0%/Year LT	1.0%/Year PC 2.0%/Year LT	2.0%/Year PC 3.0%/Year LT	2.0%/Year PC 3.0%/Year LT	2.0%/Year PC 3.0%/Year LT
AC/Off-Cycle Procedures	No Change	No Change	No Change	Phaseout 2022-2026	No Change	No Change	No Change	Phaseout 2022-2026	No Change
Retrievable Electrification Costs	1,540	-1,500	-1,470	-1,470	-1,470	-1,470	-1,240	-940	-939
Electrification Tax Credits	99.0	-35.1	-35.1	0.76	-35.1	0.46	0.53	0.52	0.34
Irretrievable Electrification Costs	440	-379	-376	-338	-376	-316	-318	-256	-256
Total Electrification costs	2,080	-1,910	-1,880	-1,810	-1,880	-1,790	-1,560	-1,200	-1,190

Table VIII-3 - Combined LDV Societal Net Benefits for MYs 1977-2029, CAFE Program, 3% Discount Rate

	Alternative								
	No Action	1	2	3	4	5	6	7	8
Model Years	2021-2025	2021-2026	2021-2026	2021-2026	2021-2026	2022-2026	2021-2026	2021-2026	2022-2026
Annual Rate of Stringency Increase	MY 2017-2021 Augural MY 2022-2025	0.0%/Year PC 0.0%/Year LT	0.5%/Year PC 0.5%/Year LT	0.5%/Year PC 0.5%/Year LT	1.0%/Year PC 2.0%/Year LT	1.0%/Year PC 2.0%/Year LT	2.0%/Year PC 3.0%/Year LT	2.0%/Year PC 3.0%/Year LT	2.0%/Year PC 3.0%/Year LT
AC/Off-Cycle Procedures	No Change	No Change	No Change	Phaseout 2022-2026	No Change	No Change	No Change	Phaseout 2022-2026	No Change
Societal Costs and Benefits Through MY 2029 (\$b)									
Technology Costs	-	-253	-243	-228	-209	-169	-151	-91.4	-99.5
Pre-tax Fuel Savings	-	-133	-125	-119	-104	-77.5	-74.5	-51.8	-48.2
Mobility Benefit	-	-61.0	-57.0	-53.3	-44.9	-32.7	-29.8	-18.9	-18.7
Refueling Benefit	-	-8.5	-8.0	-7.7	-6.8	-5.1	-4.9	-3.5	-3.2
Non-Rebound Fatality Costs	-	-35.4	-32.4	-30.1	-24.9	-18.5	-14.8	-6.3	-8.4
Rebound Fatality Costs	-	-41.7	-39.2	-37.0	-31.9	-23.7	-22.1	-14.8	-14.3
Benefits Offsetting Rebound Fatality Costs	-	-41.7	-39.2	-37.0	-31.9	-23.7	-22.1	-14.8	-14.3
Non-Rebound Non-Fatal Crash Costs	-	-55.3	-50.7	-47.1	-39.0	-29.0	-23.2	-9.8	-13.2
Rebound Non-Fatal Crash Costs	-	-65.2	-61.3	-57.9	-50.0	-37.0	-34.6	-23.2	-22.4

Benefits Offsetting Rebound Non-Fatal Crash Costs	-	-65.2	-61.3	-57.9	-50.0	-37.0	-34.6	-23.2	-22.4
Additional Congestion and Noise (Costs)	-	-51.9	-48.4	-45.3	-38.3	-28.5	-25.1	-14.3	-15.7
Energy Security Benefit	-	-10.9	-10.3	-9.8	-8.6	-6.4	-6.2	-4.3	-4.1
Avoided CO ₂ Damages (Benefits)	-	-4.3	-4.1	-3.9	-3.4	-2.5	-2.4	-1.7	-1.6
Other Avoided GHG Damages (Benefits)	-	0.0	0.0	0.0	0.0	0.0	0.0	0.0	0.0
Other Avoided Pollutant Damages (Benefits)	-	-1.2	-1.2	-1.2	-1.0	-0.7	-0.9	-0.8	-0.5
Total Costs	-	-502	-475	-445	-394	-306	-271	-160	-173
Total Benefits	-	-326	-307	-290	-250	-186	-175	-119	-113
Net Benefits	-	176	168	155	143	120	95.9	40.8	60.5

Table VIII-4 - Combined LDV Estimated Electrification Cost Coverage for MYs 2017-2029, CAFE Program, 3% Discount Rate, Millions of \$2016

	Alternative								
	No Action	1	2	3	4	5	6	7	8
Model Years	2021-2025	2021-2026	2021-2026	2021-2026	2021-2026	2022-2026	2021-2026	2021-2026	2022-2026
Annual Rate of Stringency Increase	MY 2017-2021 Augural MY 2022-2025	0.0%/Year PC 0.0%/Year LT	0.5%/Year PC 0.5%/Year LT	0.5%/Year PC 0.5%/Year LT	1.0%/Year PC 2.0%/Year LT	1.0%/Year PC 2.0%/Year LT	2.0%/Year PC 3.0%/Year LT	2.0%/Year PC 3.0%/Year LT	2.0%/Year PC 3.0%/Year LT
AC/Off-Cycle Procedures	No Change	No Change	No Change	Phaseout 2022-2026	No Change	No Change	No Change	Phaseout 2022-2026	No Change
Retrievable Electrification Costs	1,230	-1,200	-1,180	-1,180	-1,180	-1,180	-1,010	-775	-774
Electrification Tax Credits	85.8	-28.6	-28.6	0.62	-28.6	0.37	0.43	0.42	0.27
Irretrievable Electrification Costs	365	-315	-312	-285	-312	-268	-269	-219	-219
Total Electrification costs	1,680	-1,540	-1,520	-1,460	-1,520	-1,450	-1,280	-994	-993

Table VIII-5 - Combined LDV Societal Net Benefits for MYs 1977-2029, CAFE Program, 7% Discount Rate

	Alternative								
	No Action	1	2	3	4	5	6	7	8
Model Years	2021-2025	2021-2026	2021-2026	2021-2026	2021-2026	2022-2026	2021-2026	2021-2026	2022-2026
Annual Rate of Stringency Increase	MY 2017-2021 Augural MY 2022-2025	0.0%/Year PC 0.0%/Year LT	0.5%/Year PC 0.5%/Year LT	0.5%/Year PC 0.5%/Year LT	1.0%/Year PC 2.0%/Year LT	1.0%/Year PC 2.0%/Year LT	2.0%/Year PC 3.0%/Year LT	2.0%/Year PC 3.0%/Year LT	2.0%/Year PC 3.0%/Year LT
AC/Off-Cycle Procedures	No Change	No Change	No Change	Phaseout 2022-2026	No Change	No Change	No Change	Phaseout 2022-2026	No Change
Societal Costs and Benefits Through MY 2029 (\$b)									
Technology Costs	-	-192	-185	-173	-160	-129	-116	-71.3	-76.1
Pre-tax Fuel Savings	-	-84.3	-79.3	-75.3	-65.5	-48.5	-47.2	-32.8	-30.0
Mobility Benefit	-	-37.1	-34.6	-32.4	-27.3	-19.8	-18.4	-11.9	-11.4
Refueling Benefit	-	-5.4	-5.1	-4.9	-4.3	-3.2	-3.2	-2.3	-2.0
Non-Rebound Fatality Costs	-	-18.4	-16.9	-15.7	-13.1	-9.7	-8.0	-3.7	-4.5
Rebound Fatality Costs	-	-25.8	-24.3	-22.9	-19.8	-14.6	-13.9	-9.5	-8.9
Benefits Offsetting Rebound Fatality Costs	-	-25.8	-24.3	-22.9	-19.8	-14.6	-13.9	-9.5	-8.9
Non-Rebound Non-Fatal Crash Costs	-	-28.8	-26.4	-24.5	-20.5	-15.2	-12.5	-5.7	-7.0
Rebound Non-Fatal Crash Costs	-	-40.4	-38.0	-35.9	-31.0	-22.8	-21.7	-14.9	-13.9

Benefits Offsetting Rebound	-	-40.4	-38.0	-35.9	-31.0	-22.8	-21.7	-14.9	-13.9
Non-Fatal Crash Costs	-	-29.6	-27.6	-25.9	-22.0	-16.2	-14.7	-8.9	-9.1
Additional Congestion and Noise (Costs)	-	-6.9	-6.5	-6.2	-5.4	-4.0	-3.9	-2.8	-2.5
Energy Security Benefit	-	-2.7	-2.6	-2.5	-2.1	-1.6	-1.5	-1.1	-1.0
Avoided CO ₂ Damages (Benefits)	-	0.0	0.0	0.0	0.0	0.0	0.0	0.0	0.0
Other Avoided GHG Damages (Benefits)	-	-1.1	-1.1	-1.1	-0.9	-0.6	-0.7	-0.6	-0.4
Other Avoided Pollutant Damages (Benefits)	-	-335	-318	-298	-266	-207	-187	-114	-119
Total Costs	-	-204	-191	-181	-156	-115	-110	-75.7	-70.2
Total Benefits	-	132	126	117	110	92.1	76.6	38.3	49.2
Net Benefits	-								

Table VIII-6 - Combined LDV Estimated Electrification Cost Coverage for MYs 2017-2029, CAFE Program, 7% Discount Rate, Millions of \$2016

	Alternative								
	No Action	1	2	3	4	5	6	7	8
Model Years	2021-2025	2021-2026	2021-2026	2021-2026	2021-2026	2022-2026	2021-2026	2021-2026	2022-2026
Annual Rate of Stringency Increase	MY 2017-2021 Augural MY 2022-2025	0.0%/Year PC 0.0%/Year LT	0.5%/Year PC 0.5%/Year LT	0.5%/Year PC 0.5%/Year LT	1.0%/Year PC 2.0%/Year LT	1.0%/Year PC 2.0%/Year LT	2.0%/Year PC 3.0%/Year LT	2.0%/Year PC 3.0%/Year LT	2.0%/Year PC 3.0%/Year LT
AC/Off-Cycle Procedures	No Change	No Change	No Change	Phaseout 2022-2026	No Change	No Change	No Change	Phaseout 2022-2026	No Change
Retrievable Electrification Costs	938	-911	-898	-897	-898	-897	-782	-612	-612
Electrification Tax Credits	71.9	-22.0	-22.0	0.47	-22.0	0.28	0.33	0.32	0.21
Irretrievable Electrification Costs	290	-251	-249	-231	-249	-218	-219	-181	-181
Total Electrification costs	1,300	-1,180	-1,170	-1,130	-1,170	-1,110	-1,000	-793	-793

Table VIII-7 - Combined LDV Societal Net Benefits for MYs 1977-2029, CO₂ Program, Undiscounted

	Alternative								
	No Action	1	2	3	4	5	6	7	8
Model Years	2021-2025	2021-2026	2021-2026	2021-2026	2021-2026	2022-2026	2021-2026	2021-2026	2022-2026
Annual Rate of Stringency Increase	MY 2017-2021 Augural MY 2022-2025	0.0%/Year PC 0.0%/Year LT	0.5%/Year PC 0.5%/Year LT	0.5%/Year PC 0.5%/Year LT	1.0%/Year PC 2.0%/Year LT	1.0%/Year PC 2.0%/Year LT	2.0%/Year PC 3.0%/Year LT	2.0%/Year PC 3.0%/Year LT	2.0%/Year PC 3.0%/Year LT
AC/Off-Cycle Procedures	No Change	No Change	No Change	Phaseout 2022-2026	No Change	No Change	No Change	Phaseout 2022-2026	No Change
Societal Costs and Benefits Through MY 2029 (\$b)									
Technology Costs	-	-327	-318	-299	-266	-202	-191	-123	-121
Pre-tax Fuel Savings	-	-208	-197	-185	-155	-98.6	-101	-71.5	-62.5
Mobility Benefit	-	-107	-101	-92.4	-75.6	-50.0	-46.6	-28.7	-28.2
Refueling Benefit	-	-13.6	-12.9	-12.1	-10.2	-6.7	-6.7	-4.8	-4.2
Non-Rebound Fatality Costs	-	-82.6	-79.8	-69.7	-57.0	-43.2	-33.9	-16.3	-21.5
Rebound Fatality Costs	-	-72.2	-68.6	-62.8	-52.0	-34.5	-32.3	-20.9	-19.9
Benefits Offsetting Rebound Fatality Costs	-	-72.2	-68.6	-62.8	-52.0	-34.5	-32.3	-20.9	-19.9
Non-Rebound Non-Fatal Crash Costs	-	-129	-125	-109	-89.1	-67.6	-53.1	-25.4	-33.7
Rebound Non-Fatal Crash Costs	-	-113	-107	-98.2	-81.3	-53.9	-50.5	-32.7	-31.2

Benefits Offsetting Rebound Non-Fatal Crash Costs	-	-113	-107	-98.2	-81.3	-53.9	-50.5	-32.7	-31.2
Additional Congestion and Noise (Costs)	-	-104	-99.3	-88.5	-73.2	-52.4	-44.5	-24.5	-28.2
Energy Security Benefit	-	-17.3	-16.4	-15.5	-13.0	-8.5	-8.6	-6.1	-5.4
CO ₂ Damages (Benefits)	-	-6.8	-6.4	-6.1	-5.1	-3.2	-3.3	-2.4	-2.1
Other Avoided GHG Damages (Benefits)	-	0.0	0.0	0.0	0.0	0.0	0.0	0.0	0.0
Other Avoided Pollutant Damages (Benefits)	-	0.1	0.2	-0.1	0.1	0.9	0.2	-0.3	0.3
Total Costs	-	-828	-797	-728	-619	-454	-405	-243	-256
Total Benefits	-	-538	-509	-472	-392	-254	-248	-167	-153
Net Benefits	-	290	288	255	227	199	157	76	102

Table VIII-8 - Combined LDV Estimated Electrification Cost Coverage for MYs 2017-2029, GHG Program, Undiscounted, Millions of \$2016

	Alternative								
	No Action	1	2	3	4	5	6	7	8
Model Years	2021-2025	2021-2026	2021-2026	2021-2026	2021-2026	2022-2026	2021-2026	2021-2026	2022-2026
Annual Rate of Stringency Increase	MY 2017-2021 Augural MY 2022-2025	0.0%/Year PC 0.0%/Year LT	0.5%/Year PC 0.5%/Year LT	0.5%/Year PC 0.5%/Year LT	1.0%/Year PC 2.0%/Year LT	1.0%/Year PC 2.0%/Year LT	2.0%/Year PC 3.0%/Year LT	2.0%/Year PC 3.0%/Year LT	2.0%/Year PC 3.0%/Year LT
AC/Off-Cycle Procedures	No Change	No Change	No Change	Phaseout 2022-2026	No Change	No Change	No Change	Phaseout 2022-2026	No Change
Retrievable Electrification Costs	1,900	-1,900	-1,900	-1,900	-1,840	-1,840	-1,600	-822	-1,390
Electrification Tax Credits	149	-149	-149	-149	-149	-149	-149	-14.9	-15.5
Irretrievable Electrification Costs	532	-532	-532	-532	-519	-519	-521	-201	-289
Total Electrification costs	2,580	-2,580	-2,580	-2,580	-2,500	-2,500	-2,270	-1,040	-1,690

Table VIII-9 - Combined LDV Societal Net Benefits for MYs 1977-2029, CO₂ Program, 3% Discount Rate

	Alternative								
	No Action	1	2	3	4	5	6	7	8
Model Years	2021-2025	2021-2026	2021-2026	2021-2026	2021-2026	2022-2026	2021-2026	2021-2026	2022-2026
Annual Rate of Stringency Increase	MY 2017-2021 Augural MY 2022-2025	0.0%/Year PC 0.0%/Year LT	0.5%/Year PC 0.5%/Year LT	0.5%/Year PC 0.5%/Year LT	1.0%/Year PC 2.0%/Year LT	1.0%/Year PC 2.0%/Year LT	2.0%/Year PC 3.0%/Year LT	2.0%/Year PC 3.0%/Year LT	2.0%/Year PC 3.0%/Year LT
AC/Off-Cycle Procedures	No Change	No Change	No Change	Phascout 2022-2026	No Change	No Change	No Change	Phascout 2022-2026	No Change
Societal Costs and Benefits Through MY 2029 (\$b)									
Technology Costs	-	-260	-252	-238	-212	-160	-153	-99.6	-96.9
Pre-tax Fuel Savings	-	-144	-136	-127	-107	-68.6	-69.1	-48.7	-43.1
Mobility Benefit	-	-69.5	-65.7	-60.2	-49.2	-32.4	-30.6	-19.1	-18.5
Refueling Benefit	-	-9.4	-8.9	-8.3	-7.0	-4.7	-4.6	-3.3	-2.9
Non-Rebound Fatality Costs	-	-46.2	-44.6	-39.2	-32.0	-23.9	-19.2	-9.7	-12.1
Rebound Fatality Costs	-	-47.8	-45.3	-41.6	-34.4	-22.7	-21.5	-14.2	-13.3
Benefits Offsetting Rebound Fatality Costs	-	-47.8	-45.3	-41.6	-34.4	-22.7	-21.5	-14.2	-13.3
Non-Rebound Non-Fatal Crash Costs	-	-72.3	-69.7	-61.3	-50.0	-37.3	-30.0	-15.1	-18.9
Rebound Non-Fatal Crash Costs	-	-74.7	-70.8	-65.0	-53.9	-35.6	-33.7	-22.1	-20.8
Benefits Offsetting Rebound Non-Fatal Crash Costs	-	-74.7	-70.8	-65.0	-53.9	-35.6	-33.7	-22.1	-20.8
Additional Congestion and Noise (Costs)	-	-62.4	-59.6	-53.5	-44.2	-31.1	-27.1	-15.6	-17.1
Energy Security Benefit	-	-11.9	-11.3	-10.6	-8.9	-5.9	-5.9	-4.2	-3.7

Avoided CO ₂ Damages (Benefits)	-	-4.7	-4.4	-4.2	-3.5	-2.2	-2.3	-1.6	-1.4
Other Avoided GHG Damages (Benefits)	-	0.0	0.0	0.0	0.0	0.0	0.0	0.0	0.0
Other Avoided Pollutant Damages (Benefits)	-	-0.8	-0.7	-0.7	-0.5	0.1	-0.2	-0.4	0.0
Total Costs	-	-563	-542	-499	-426	-311	-285	-176	-179
Total Benefits	-	-363	-343	-318	-264	-172	-168	-114	-104
Net Benefits	-	201	199	181	162	139	117.0	62.6	75.3

Table VIII-10 - Combined LDV Estimated Electrification Cost Coverage for MYs 2017-2029, GHG Program, 3% Discount Rate, Millions of \$2016

	Alternative								
	No Action	1	2	3	4	5	6	7	8
Model Years	2021-2025	2021-2026	2021-2026	2021-2026	2021-2026	2022-2026	2021-2026	2021-2026	2022-2026
Annual Rate of Stringency Increase	MY 2017-2021 Augural MY 2022-2025	0.0%/Year PC 0.0%/Year LT	0.5%/Year PC 0.5%/Year LT	0.5%/Year PC 0.5%/Year LT	1.0%/Year PC 2.0%/Year LT	1.0%/Year PC 2.0%/Year LT	2.0%/Year PC 3.0%/Year LT	2.0%/Year PC 3.0%/Year LT	2.0%/Year PC 3.0%/Year LT
AC/Off-Cycle Procedures	No Change	No Change	No Change	Phaseout 2022-2026	No Change	No Change	No Change	Phaseout 2022-2026	No Change
Retrievable Electrification Costs	1,490	-1,490	-1,490	-1,490	-1,440	-1,440	-1,270	-663	-1,120
Electrification Tax Credits	127	-127	-127	-127	-127	-127	-127	-12.3	-12.9
Irretrievable Electrification Costs	436	-436	-436	-436	-426	-426	-427	-171	-244
Total Electrification costs	2,060	-2,060	-2,060	-2,060	-2,000	-2,000	-1,830	-847	-1,370

Table VIII-11 - Combined LDV Societal Net Benefits for MYs 1977-2029, CO₂ Program, 7% Discount Rate

	Alternative								
	No Action	1	2	3	4	5	6	7	8
Model Years	2021-2025	2021-2026	2021-2026	2021-2026	2021-2026	2022-2026	2021-2026	2021-2026	2022-2026
Annual Rate of Stringency Increase	MY 2017-2021 Augural MY 2022-2025	0.0%/Year PC 0.0%/Year LT	0.5%/Year PC 0.5%/Year LT	0.5%/Year PC 0.5%/Year LT	1.0%/Year PC 2.0%/Year LT	1.0%/Year PC 2.0%/Year LT	2.0%/Year PC 3.0%/Year LT	2.0%/Year PC 3.0%/Year LT	2.0%/Year PC 3.0%/Year LT
AC/Off-Cycle Procedures	No Change	No Change	No Change	Phaseout 2022-2026	No Change	No Change	No Change	Phaseout 2022-2026	No Change
Societal Costs and Benefits Through MY 2029 (\$b)									
Technology Costs	-	-196	-190	-180	-160	-121	-116	-76.8	-73.6
Pre-tax Fuel Savings	-	-91.5	-86.4	-81.0	-67.7	-43.9	-44.0	-30.9	-27.4
Mobility Benefit	-	-42.0	-39.6	-36.5	-29.8	-19.6	-18.7	-11.9	-11.3
Refueling Benefit	-	-6.0	-5.7	-5.3	-4.5	-3.0	-3.0	-2.1	-1.9
Non-Rebound Fatality Costs	-	-23.8	-22.9	-20.4	-16.6	-12.1	-10.1	-5.5	-6.3
Rebound Fatality Costs	-	-29.4	-27.8	-25.7	-21.3	-14.0	-13.4	-9.0	-8.3
Benefits Offsetting Rebound Fatality Costs	-	-29.4	-27.8	-25.7	-21.3	-14.0	-13.4	-9.0	-8.3
Non-Rebound Non-Fatal Crash Costs	-	-37.3	-35.8	-31.8	-25.9	-19.0	-15.9	-8.5	-9.9

Rebound Non-Fatal Crash Costs	-	-46.0	-43.5	-40.1	-33.3	-21.9	-21.0	-14.1	-12.9
Benefits Offsetting Rebound Non-Fatal Crash Costs	-	-46.0	-43.5	-40.1	-33.3	-21.9	-21.0	-14.1	-12.9
Additional Congestion and Noise (Costs)	-	-35.0	-33.3	-30.2	-24.9	-17.2	-15.5	-9.3	-9.7
Energy Security Benefit	-	-7.6	-7.2	-6.7	-5.7	-3.7	-3.7	-2.6	-2.4
Avoided CO ₂ Damages (Benefits)	-	-3.0	-2.8	-2.6	-2.2	-1.4	-1.4	-1.0	-0.9
Other Avoided GHG Damages (Benefits)	-	0.0	0.0	0.0	0.0	0.0	0.0	0.0	0.0
Other Avoided Pollutant Damages (Benefits)	-	-1.0	-0.9	-0.9	-0.7	-0.2	-0.3	-0.3	-0.2
Total Costs	-	-367	-353	-328	-282	-205	-192	-123	-121
Total Benefits	-	-226	-214	-199	-165	-108	-106	-72.0	-65.2
Net Benefits	-	141	139	129	117	97.0	86.8	51.2	55.4

Table VIII-12 - Combined LDV Estimated Electrification Cost Coverage for MYs 2017-2029, GHG Program, 3% Discount Rate, Millions of \$2016

	Alternative								
	No Action	1	2	3	4	5	6	7	8
Model Years	2021-2025	2021-2026	2021-2026	2021-2026	2021-2026	2022-2026	2021-2026	2021-2026	2022-2026
Annual Rate of Stringency Increase	MY 2017-2021 Augural MY 2022-2025	0.0%/Year PC 0.0%/Year LT	0.5%/Year PC 0.5%/Year LT	0.5%/Year PC 0.5%/Year LT	1.0%/Year PC 2.0%/Year LT	1.0%/Year PC 2.0%/Year LT	2.0%/Year PC 3.0%/Year LT	2.0%/Year PC 3.0%/Year LT	2.0%/Year PC 3.0%/Year LT
AC/Off-Cycle Procedures	No Change	No Change	No Change	Phaseout 2022-2026	No Change	No Change	No Change	Phaseout 2022-2026	No Change
Retrievable Electrification Costs	1,110	-1,110	-1,110	-1,110	-1,070	-1,070	-958	-512	-853
Electrification Tax Credits	104	-104	-104	-104	-104	-104	-104	-9.7	-10.1
Irretrievable Electrification Costs	342	-342	-342	-342	-334	-334	-335	-142	-198
Total Electrification costs	1,560	-1,560	-1,560	-1,560	-1,510	-1,510	-1,400	-663	-1,060

B. What are the private costs and benefits of each alternative, relative to the no-action alternative?

1. What are the impacts on producers of new vehicles?

(a) CAFE Standards

Table VIII-13 - Combined Light-Duty CAFE Compliance Impacts and Cumulative Industry Costs through MY 2029

	Alternative								
	No Action	1	2	3	4	5	6	7	8
Model Years	2021-2025	2021-2026	2021-2026	2021-2026	2021-2026	2022-2026	2021-2026	2021-2026	2022-2026
Annual Rate of Stringency Increase	Final 2017-2021, Augural 2022-2025	0.0%/Year PC 0.0%/Year LT	0.5%/Year PC 0.5%/Year LT	0.5%/Year PC 0.5%/Year LT	1.0%/Year PC 2.0%/Year LT	1.0%/Year PC 2.0%/Year LT	2.0%/Year PC 3.0%/Year LT	2.0%/Year PC 3.0%/Year LT	2.0%/Year PC 3.0%/Year LT
AC/Off-Cycle Procedures	No Change	No Change	No Change	Phaseout 2022-2026	No Change	No Change	No Change	Phaseout 2022-2026	No Change
Fuel Economy									
Average Required Fuel Economy – MY 2026+ (mpg)	46.7	37.0	38.1	38.1	40.5	42.1	43.0	43.0	44.2
Percent Change in Stringency from Baseline	-	-26.0%	-22.4%	-22.5%	-15.2%	-10.9%	-8.5%	-8.6%	-5.6%
Average Achieved Fuel Economy – MY 2030 (mpg)	46.4	39.7	40.1	39.2	41.3	42.4	43.1	42.9	44.2
Average Achieved Fuel Economy – MY 2020 (mpg)	39.4	37.2	37.4	37.5	37.7	38.2	38.0	38.3	38.6
Total Regulatory Costs Through MY 2029 Vehicles (7% discount rate)									
Total Technology Costs (\$b)	-	-192	-185	-173	-160	-129	-116	-71.3	-76.1
Total Civil Penalties (\$b)	-	-2.1	-1.9	-1.8	-1.5	-0.8	-1.0	-1.1	-0.7
Total Regulatory Costs (\$b)	-	-194	-186	-175	-161	-130	-117	-72.4	-76.7

Sales and Revenue Impacts Through MY 2029 Vehicles (7% discount rate for Revenue Change)									
Sales Change (millions)	-	1.0	1.0	1.0	0.9	0.7	0.6	0.4	0.4
Revenue Change (\$b)	-	-182	-175	-164	-150	-120	-109	-67.0	-70.8

Table VIII-14 - Combined Light-Duty Fleet Penetration for MY 2030, CAFE Program

	Alternative								
	No Action	1	2	3	4	5	6	7	8
Model Years	2021-2025	2021-2026	2021-2026	2021-2026	2021-2026	2022-2026	2021-2026	2021-2026	2022-2026
Annual Rate of Stringency Increase	Final 2017-2021 Augural 2022-2025	0.0%/Year PC 0.0%/Year LT	0.5%/Year PC 0.5%/Year LT	0.5%/Year PC 0.5%/Year LT	1.0%/Year PC 2.0%/Year LT	1.0%/Year PC 2.0%/Year LT	2.0%/Year PC 3.0%/Year LT	2.0%/Year PC 3.0%/Year LT	2.0%/Year PC 3.0%/Year LT
AC/Off-Cycle Procedures	No Change	No Change	No Change	Phaseout 2022-2026	No Change	No Change	No Change	Phaseout 2022-2026	No Change
Technology Use Under CAFE Alternative in MY 2030 (total fleet penetration)									
Curb Weight Reduction (percent change from MY 2016)	5.7%	4.3%	4.4%	4.6%	5.1%	5.4%	5.7%	5.8%	5.9%
High Compression Ratio Non-Turbo Engines	26.2%	17.2%	17.2%	17.1%	17.1%	20.9%	20.9%	20.9%	20.9%
Turbocharged Gasoline Engines	63.6%	51.1%	53.7%	53.8%	56.1%	58.7%	61.2%	62.7%	62.2%
Dynamic Cylinder Deactivation	6.3%	0.0%	0.0%	0.0%	0.0%	0.0%	0.0%	6.9%	3.5%
Advanced Transmissions	71.7%	92.9%	92.9%	92.9%	92.9%	93.0%	91.7%	83.5%	88.7%
Stop-Start 12V (Non-Hybrid)	14.1%	13.7%	13.8%	15.7%	16.1%	16.2%	16.0%	13.5%	17.1%
Mild Hybrid Electric Systems (48v)	32.5%	0.4%	0.3%	2.2%	2.7%	12.7%	20.5%	31.5%	30.1%

Table VIII-15 - Light Truck CAFE Compliance Impacts and Cumulative Industry Costs through MY 2029

	Alternative								
	No Action	1	2	3	4	5	6	7	8
Model Years	2021-2025	2021-2026	2021-2026	2021-2026	2021-2026	2022-2026	2021-2026	2021-2026	2022-2026
Annual Rate of Stringency Increase	Final 2017-2021, Augural 2022-2025	0.0%/Year PC 0.0%/Year LT	0.5%/Year PC 0.5%/Year LT	0.5%/Year PC 0.5%/Year LT	1.0%/Year PC 2.0%/Year LT	1.0%/Year PC 2.0%/Year LT	2.0%/Year PC 3.0%/Year LT	2.0%/Year PC 3.0%/Year LT	2.0%/Year PC 3.0%/Year LT
AC/Off-Cycle Procedures	No Change	No Change	No Change	Phaseout 2022-2026	No Change	No Change	No Change	Phaseout 2022-2026	No Change
Fuel Economy									
Average Required Fuel Economy – MY 2026+ (mpg)	40.1	31.3	32.2	32.2	35.3	36.9	37.5	37.5	38.8
Percent Change in Stringency from Baseline	-	-28.3%	-24.5%	-24.5%	-13.7%	-8.7%	-6.8%	-6.8%	-3.4%
Average Achieved Fuel Economy – MY 2030 (mpg)	40.0	33.6	34.1	33.4	35.7	36.9	37.5	37.4	38.6
Average Achieved Fuel Economy – MY 2020 (mpg)	33.7	31.6	31.8	32.0	32.3	32.7	32.7	33.1	33.2
Total Regulatory Costs Through MY 2029 Vehicles (7% discount rate)									
Total Technology Costs (\$b)	-	-108	-103	-95.1	-83.5	-65.1	-55.7	-24.8	-27.9
Total Civil Penalties (\$b)	-	-1.0	-1.0	-0.9	-0.7	-0.3	-0.5	-0.4	-0.3
Total Regulatory Costs (\$b)	-	-109	-103	-95.9	-84.1	-65.4	-56.1	-25.3	-28.1

Sales and Revenue Impacts Through MY 2029 Vehicles (7% discount rate for Revenue Change)									
Sales Change (millions)	-	-1.1	-1.0	-1.0	-0.7	-0.4	-0.3	-0.3	-0.2
Revenue Change (\$b)	-	-129	-123	-114	-97.9	-72.1	-62.4	-31.2	-31.1

Table VIII-16 - Light Truck Fleet Penetration for MY 2030, CAFE Program

	Alternative								
	No Action	1	2	3	4	5	6	7	8
Model Years	2021-2025	2021-2026	2021-2026	2021-2026	2021-2026	2022-2026	2021-2026	2021-2026	2022-2026
Annual Rate of Stringency Increase	Final 2017-2021 Augural 2022-2025	0.0%/Year PC 0.0%/Year LT	0.5%/Year PC 0.5%/Year LT	0.5%/Year PC 0.5%/Year LT	1.0%/Year PC 2.0%/Year LT	1.0%/Year PC 2.0%/Year LT	2.0%/Year PC 3.0%/Year LT	2.0%/Year PC 3.0%/Year LT	2.0%/Year PC 3.0%/Year LT
AC/Off-Cycle Procedures	No Change	No Change	No Change	Phaseout 2022-2026	No Change	No Change	No Change	Phaseout 2022-2026	No Change
Technology Use Under CAFE Alternative in MY 2030 (total fleet penetration)									
Curb Weight Reduction (percent change from MY 2016)	6.6%	4.4%	4.6%	4.9%	5.8%	6.3%	6.7%	6.8%	6.8%
High Compression Ratio Non-Turbo Engines	11.9%	8.1%	8.1%	8.1%	8.1%	10.8%	10.8%	10.8%	10.8%
Turbocharged Gasoline Engines	69.9%	53.1%	58.4%	58.4%	62.8%	66.9%	67.3%	69.0%	67.3%
Dynamic Cylinder Deactivation	12.7%	0.0%	0.0%	0.0%	0.0%	0.0%	0.0%	14.1%	6.8%
Advanced Transmissions	75.3%	98.3%	98.3%	98.3%	98.3%	98.3%	97.5%	86.7%	92.9%
Stop-Start 12V (Non-Hybrid)	11.4%	12.3%	12.4%	13.2%	14.0%	17.7%	19.1%	7.6%	12.1%
Mild Hybrid Electric Systems (48v)	45.9%	0.0%	0.0%	1.8%	5.2%	19.8%	34.9%	55.4%	55.4%

Table VIII-17 - Passenger Car CAFE Compliance Impacts and Cumulative Industry Costs through MY 2029

	Alternative								
	No Action	1	2	3	4	5	6	7	8
Model Years	2021-2025	2021-2026	2021-2026	2021-2026	2021-2026	2022-2026	2021-2026	2021-2026	2022-2026
Annual Rate of Stringency Increase	Final 2017-2021, Augural 2022-2025	0.0%/Year PC 0.0%/Year LT	0.5%/Year PC 0.5%/Year LT	0.5%/Year PC 0.5%/Year LT	1.0%/Year PC 2.0%/Year LT	1.0%/Year PC 2.0%/Year LT	2.0%/Year PC 3.0%/Year LT	2.0%/Year PC 3.0%/Year LT	2.0%/Year PC 3.0%/Year LT
AC/Off-Cycle Procedures	No Change	No Change	No Change	Phaseout 2022-2026	No Change	No Change	No Change	Phaseout 2022-2026	No Change
Fuel Economy									
Average Required Fuel Economy – MY 2026+ (mpg)	54.7	43.7	45.0	45.0	46.4	47.9	49.3	49.3	50.4
Percent Change in Stringency from Baseline	-	-25.2%	-21.5%	-21.6%	-17.9%	-14.2%	-10.9%	-10.9%	-8.6%
Average Achieved Fuel Economy – MY 2030 (mpg)	54.2	46.7	46.9	45.9	47.7	48.7	49.7	49.3	50.6
Average Achieved Fuel Economy – MY 2020 (mpg)	45.9	43.9	43.9	43.9	44.0	44.6	44.1	44.2	44.7
Total Regulatory Costs Through MY 2029 Vehicles (7% discount rate)									
Total Technology Costs (\$b)	-	-84.1	-81.9	-77.9	-76.1	-63.6	-60.6	-46.5	-48.2
Total Civil Penalties (\$b)	-	-1.0	-0.9	-0.9	-0.8	-0.5	-0.5	-0.6	-0.4
Total Regulatory Costs (\$b)	-	-85.3	-83.0	-78.8	-77.0	-64.2	-61.2	-47.1	-48.6

Sales and Revenue Impacts Through MY 2029 Vehicles (7% discount rate for Revenue Change)									
Sales Change (millions)	-	2.1	2.0	1.9	1.6	1.0	0.9	0.7	0.6
Revenue Change (\$b)	-	-53.0	-52.1	-49.4	-52.5	-48.4	-46.4	-35.8	-39.7

Table VIII-18 - Passenger Car Fleet Penetration for MY 2030, CAFE Program

	Alternative								
	No Action	1	2	3	4	5	6	7	8
Model Years	2021-2025	2021-2026	2021-2026	2021-2026	2021-2026	2022-2026	2021-2026	2021-2026	2022-2026
Annual Rate of Stringency Increase	Final 2017-2021 Augural 2022-2025	0.0%/Year PC 0.0%/Year LT	0.5%/Year PC 0.5%/Year LT	0.5%/Year PC 0.5%/Year LT	1.0%/Year PC 2.0%/Year LT	1.0%/Year PC 2.0%/Year LT	2.0%/Year PC 3.0%/Year LT	2.0%/Year PC 3.0%/Year LT	2.0%/Year PC 3.0%/Year LT
AC/Off-Cycle Procedures	No Change	No Change	No Change	Phaseout 2022-2026	No Change	No Change	No Change	Phaseout 2022-2026	No Change
Technology Use Under CAFE Alternative in MY 2030 (total fleet penetration)									
Curb Weight Reduction (percent change from MY 2016)	5.9%	4.1%	4.3%	4.4%	4.7%	5.1%	5.5%	5.8%	5.8%
High Compression Ratio Non-Turbo Engines	39.0%	24.7%	24.7%	24.7%	24.7%	29.7%	29.8%	29.8%	29.8%
Turbocharged Gasoline Engines	57.8%	49.5%	49.9%	49.9%	50.4%	51.5%	55.9%	57.1%	57.7%
Dynamic Cylinder Deactivation	0.5%	0.0%	0.0%	0.0%	0.0%	0.0%	0.0%	0.5%	0.5%
Advanced Transmissions	68.4%	88.5%	88.4%	88.3%	88.3%	88.3%	86.6%	80.6%	85.1%
Stop-Start 12V (Non-Hybrid)	16.5%	15.0%	15.0%	17.8%	17.8%	15.0%	13.3%	18.7%	21.5%
Mild Hybrid Electric Systems (48v)	20.4%	0.7%	0.5%	2.6%	0.5%	6.5%	7.9%	10.2%	7.7%

Table VIII-19 - Domestic Car CAFE Compliance Impacts and Cumulative Industry Costs through MY 2029

	Alternative								
	No Action	1	2	3	4	5	6	7	8
Model Years	2021-2025	2021-2026	2021-2026	2021-2026	2021-2026	2022-2026	2021-2026	2021-2026	2022-2026
Annual Rate of Stringency Increase	Final 2017-2021, Augural 2022-2025	0.0%/Year PC 0.0%/Year LT	0.5%/Year PC 0.5%/Year LT	0.5%/Year PC 0.5%/Year LT	1.0%/Year PC 2.0%/Year LT	1.0%/Year PC 2.0%/Year LT	2.0%/Year PC 3.0%/Year LT	2.0%/Year PC 3.0%/Year LT	2.0%/Year PC 3.0%/Year LT
AC/Off-Cycle Procedures	No Change	No Change	No Change	Phaseout 2022-2026	No Change	No Change	No Change	Phaseout 2022-2026	No Change
Fuel Economy									
Average Required Fuel Economy – MY 2026+ (mpg)	54.1	43.2	44.5	44.5	45.9	47.4	48.8	48.8	49.9
Percent Change in Stringency from Baseline	-	-25.2%	-21.6%	-21.6%	-17.9%	-14.2%	-10.9%	-10.9%	-8.6%
Average Achieved Fuel Economy – MY 2030 (mpg)	55.1	46.5	46.8	45.8	47.7	49.0	50.2	49.9	51.2
Average Achieved Fuel Economy – MY 2020 (mpg)	45.9	43.6	43.7	43.7	43.8	44.9	44.0	44.1	45.0
Total Regulatory Costs Through MY 2029 Vehicles (7% discount rate)									
Total Technology Costs (\$b)	-	-56.2	-54.8	-51.6	-50.9	-42.5	-39.7	-28.9	-31.3
Total Civil Penalties (\$b)	-	0.0	0.0	-0.1	0.0	0.1	0.0	-0.2	0.0
Total Regulatory Costs (\$b)	-	-56.3	-54.9	-51.7	-51.0	-42.5	-39.8	-29.0	-31.3

Sales and Revenue Impacts Through MY 2029 Vehicles (7% discount rate for Revenue Change)									
Sales Change (millions)	-	1.3	1.2	1.1	0.9	0.6	0.5	0.4	0.3
Revenue Change (\$b)	-	-38.4	-37.8	-35.4	-37.5	-33.8	-31.7	-22.7	-26.4

Table VIII-20 - Domestic Car Fleet Penetration for MY 2030, CAFE Program

	Alternative								
	No Action	1	2	3	4	5	6	7	8
Model Years	2021-2025	2021-2026	2021-2026	2021-2026	2021-2026	2022-2026	2021-2026	2021-2026	2022-2026
Annual Rate of Stringency Increase	Final 2017-2021 Augural 2022-2025	0.0%/Year PC 0.0%/Year LT	0.5%/Year PC 0.5%/Year LT	0.5%/Year PC 0.5%/Year LT	1.0%/Year PC 2.0%/Year LT	1.0%/Year PC 2.0%/Year LT	2.0%/Year PC 3.0%/Year LT	2.0%/Year PC 3.0%/Year LT	2.0%/Year PC 3.0%/Year LT
AC/Off-Cycle Procedures	No Change	No Change	No Change	Phaseout 2022-2026	No Change	No Change	No Change	Phaseout 2022-2026	No Change
Technology Use Under CAFE Alternative in MY 2030 (total fleet penetration)									
Curb Weight Reduction (percent change from MY 2016)	6.4%	4.8%	5.1%	5.1%	5.3%	5.8%	6.3%	6.6%	6.6%
High Compression Ratio Non-Turbo Engines	22.7%	12.7%	12.7%	12.6%	12.6%	17.5%	17.5%	17.4%	17.4%
Turbocharged Gasoline Engines	75.2%	61.9%	62.5%	62.6%	63.6%	64.3%	71.2%	72.0%	74.6%
Dynamic Cylinder Deactivation	1.0%	0.0%	0.0%	0.0%	0.0%	0.0%	0.0%	1.0%	1.0%
Advanced Transmissions	63.0%	91.1%	91.1%	91.1%	91.2%	91.2%	89.3%	81.7%	88.0%
Stop-Start 12V (Non-Hybrid)	11.2%	11.5%	11.5%	16.1%	17.1%	15.9%	12.8%	23.1%	26.6%
Mild Hybrid Electric Systems (48v)	23.3%	0.1%	0.1%	3.9%	0.1%	6.1%	9.3%	17.2%	8.7%

Table VIII-21 - Imported Car CAFE Compliance Impacts and Cumulative Industry Costs through MY 2029

	Alternative								
	No Action	1	2	3	4	5	6	7	8
Model Years	2021-2025	2021-2026	2021-2026	2021-2026	2021-2026	2022-2026	2021-2026	2021-2026	2022-2026
Annual Rate of Stringency Increase	Final 2017-2021, Augural 2022-2025	0.0%/Year PC 0.0%/Year LT	0.5%/Year PC 0.5%/Year LT	0.5%/Year PC 0.5%/Year LT	1.0%/Year PC 2.0%/Year LT	1.0%/Year PC 2.0%/Year LT	2.0%/Year PC 3.0%/Year LT	2.0%/Year PC 3.0%/Year LT	2.0%/Year PC 3.0%/Year LT
AC/Off-Cycle Procedures	No Change	No Change	No Change	Phaseout 2022-2026	No Change	No Change	No Change	Phaseout 2022-2026	No Change
Fuel Economy									
Average Required Fuel Economy – MY 2026+ (mpg)	55.3	44.2	45.5	45.5	46.9	48.5	49.9	49.9	51.0
Percent Change in Stringency from Baseline	-	-25.3%	-21.5%	-21.5%	-17.9%	-14.2%	-11.0%	-11.0%	-8.6%
Average Achieved Fuel Economy – MY 2030 (mpg)	53.3	47.0	47.1	46.0	47.6	48.4	49.0	48.6	49.8
Average Achieved Fuel Economy – MY 2020 (mpg)	45.8	44.1	44.1	44.1	44.1	44.3	44.3	44.3	44.4
Total Regulatory Costs Through MY 2029 Vehicles (7% discount rate)									
Total Technology Costs (\$b)	-	-27.9	-27.1	-26.3	-25.3	-21.1	-20.8	-17.7	-16.9
Total Civil Penalties (\$b)	-	-1.0	-0.9	-0.8	-0.8	-0.6	-0.5	-0.5	-0.4
Total Regulatory Costs (\$b)	-	-29.0	-28.1	-27.1	-26.0	-21.7	-21.4	-18.1	-17.3

Sales and Revenue Impacts Through MY 2029 Vehicles (7% discount rate for Revenue Change)									
Sales Change (millions)	-	0.9	0.8	0.8	0.7	0.4	0.4	0.3	0.2
Revenue Change (\$b)	-	-14.6	-14.3	-14.0	-15.1	-14.6	-14.7	-13.0	-13.3

Table VIII-22 - Imported Car Fleet Penetration for MY 2030, CAFE Program

	Alternative								
	No Action	1	2	3	4	5	6	7	8
Model Years	2021-2025	2021-2026	2021-2026	2021-2026	2021-2026	2022-2026	2021-2026	2021-2026	2022-2026
Annual Rate of Stringency Increase	Final 2017-2021 Augural 2022-2025	0.0%/Year PC 0.0%/Year LT	0.5%/Year PC 0.5%/Year LT	0.5%/Year PC 0.5%/Year LT	1.0%/Year PC 2.0%/Year LT	1.0%/Year PC 2.0%/Year LT	2.0%/Year PC 3.0%/Year LT	2.0%/Year PC 3.0%/Year LT	2.0%/Year PC 3.0%/Year LT
AC/Off-Cycle Procedures	No Change	No Change	No Change	Phaseout 2022-2026	No Change	No Change	No Change	Phaseout 2022-2026	No Change
Technology Use Under CAFE Alternative in MY 2030 (total fleet penetration)									
Curb Weight Reduction (percent change from MY 2016)	5.2%	3.2%	3.3%	3.5%	4.1%	4.2%	4.6%	4.8%	4.7%
High Compression Ratio Non-Turbo Engines	58.3%	39.0%	39.0%	39.1%	39.2%	44.1%	44.3%	44.4%	44.4%
Turbocharged Gasoline Engines	37.3%	34.7%	34.9%	34.8%	34.8%	36.4%	37.7%	39.4%	37.7%
Dynamic Cylinder Deactivation	0.0%	0.0%	0.0%	0.0%	0.0%	0.0%	0.0%	0.0%	0.0%
Advanced Transmissions	74.7%	85.4%	85.1%	85.0%	84.9%	84.9%	83.4%	79.3%	81.6%
Stop-Start 12V (Non-Hybrid)	22.8%	19.1%	19.1%	19.9%	18.7%	14.0%	13.9%	13.5%	15.4%
Mild Hybrid Electric Systems (48v)	17.0%	1.3%	1.1%	1.1%	1.1%	7.0%	6.2%	1.9%	6.5%

Strong Hybrid Electric Systems	17.1%	6.5%	6.8%	6.8%	7.0%	7.1%	8.8%	13.4%	10.8%
Plug-In Hybrid Electric Vehicles (PHEVs)	2.0%	0.8%	0.8%	0.9%	0.8%	0.9%	0.9%	1.1%	1.0%
Dedicated Electric Vehicles (EVs)	0.9%	0.9%	0.9%	0.9%	0.9%	0.9%	0.9%	0.9%	0.9%
Fuel Cell Vehicles (FCVs)	0.0%	0.0%	0.0%	0.0%	0.0%	0.0%	0.0%	0.0%	0.0%

(b) CO₂ Standards

Table VIII-23 - Combined Light-Duty CO₂ Compliance Impacts and Cumulative Industry Costs through MY 2029

	Alternative								
	No Action	1	2	3	4	5	6	7	8
Model Years	2021-2025	2021-2026	2021-2026	2021-2026	2021-2026	2022-2026	2021-2026	2021-2026	2022-2026
Annual Rate of Stringency Increase	Final 2017-2021, Augural 2022-2025	0.0%/Year PC 0.0%/Year LT	0.5%/Year PC 0.5%/Year LT	0.5%/Year PC 0.5%/Year LT	1.0%/Year PC 2.0%/Year LT	1.0%/Year PC 2.0%/Year LT	2.0%/Year PC 3.0%/Year LT	2.0%/Year PC 3.0%/Year LT	2.0%/Year PC 3.0%/Year LT
AC/Off-Cycle Procedures	No Change	No Change	No Change	Phaseout 2022-2026	No Change	No Change	No Change	Phaseout 2022-2026	No Change
Average CO ₂ Emission Rate									
Average Required CO ₂ – MY 2026+ (g/mi)	175.0	240.0	233.0	233.0	220.0	212.0	207.0	207.0	201.0
Percent Change in Stringency from Baseline	-	-36.9%	-33.0%	-33.1%	-25.2%	-20.7%	-17.9%	-18.1%	-14.7%
Average Achieved CO ₂ – MY 2030 (g/mi)	174.0	229.0	228.0	230.0	216.0	209.0	206.0	205.0	200.0
Total Regulatory Costs Through MY 2029 Vehicles (7% discount rate)									
Total Technology Costs (\$b)	-	-196.0	-190.0	-180.0	-160.0	-121.0	-116.0	-76.8	-73.6
Total Civil Penalties (\$b)	N/A	N/A	N/A	N/A	N/A	N/A	N/A	N/A	N/A
Total Regulatory Costs (\$b)	-	-196.0	-190.0	-180.0	-160.0	-121.0	-116.0	-76.8	-73.6
Sales and Revenue Impacts Through MY 2029 Vehicles (7% discount rate for Revenue Change)									
Sales Change (millions)	-	1.1	1.0	1.0	0.8	0.6	0.6	0.4	0.4
Revenue Change (\$b)	-	-185.0	-179.0	-170.0	-151.0	-113.0	-109.0	-71.4	-68.7

Table VIII-24 - Combined Light-Duty Fleet Penetration for MY 2030, CO₂ Program

	Alternative								
	No Action	1	2	3	4	5	6	7	8
Model Years	2021-2025	2021-2026	2021-2026	2021-2026	2021-2026	2022-2026	2021-2026	2021-2026	2022-2026
Annual Rate of Stringency Increase	Final 2017-2021 Augural 2022-2025	0.0%/Year PC 0.0%/Year LT	0.5%/Year PC 0.5%/Year LT	0.5%/Year PC 0.5%/Year LT	1.0%/Year PC 2.0%/Year LT	1.0%/Year PC 2.0%/Year LT	2.0%/Year PC 3.0%/Year LT	2.0%/Year PC 3.0%/Year LT	2.0%/Year PC 3.0%/Year LT
AC/Off-Cycle Procedures	No Change	No Change	No Change	Phaseout 2022-2026	No Change	No Change	No Change	Phaseout 2022-2026	No Change
Technology Use Under CAFE Alternative in MY 2030 (total fleet penetration)									
Curb Weight Reduction (percent change from MY 2016)	6.8%	4.0%	4.1%	4.4%	5.0%	5.5%	6.2%	6.4%	6.5%
High Compression Ratio Non-Turbo Engines	26.2%	12.4%	12.4%	13.1%	13.1%	22.5%	22.5%	22.8%	22.4%
Turbocharged Gasoline Engines	61.8%	40.8%	41.8%	48.2%	55.3%	56.6%	58.4%	60.9%	60.5%
Dynamic Cylinder Deactivation	6.5%	0.0%	0.0%	0.0%	0.0%	0.0%	0.0%	6.9%	0.0%
Advanced Transmissions	74.8%	93.6%	93.6%	93.4%	93.0%	92.1%	91.0%	84.1%	88.0%
Stop-Start 12V (Non-Hybrid)	14.6%	11.1%	11.1%	10.1%	11.5%	7.8%	8.7%	7.3%	14.6%
Mild Hybrid Electric Systems (48v)	37.3%	1.5%	1.7%	3.7%	5.1%	13.6%	16.5%	30.2%	26.2%

Table VIII-25 - Light Truck CO₂ Compliance Impacts and Cumulative Industry Costs through MY 2029

	Alternative								
	No Action	1	2	3	4	5	6	7	8
Model Years	2021-2025	2021-2026	2021-2026	2021-2026	2021-2026	2022-2026	2021-2026	2021-2026	2022-2026
Annual Rate of Stringency Increase	Final 2017-2021, Augural 2022-2025	0.0%/Year PC 0.0%/Year LT	0.5%/Year PC 0.5%/Year LT	0.5%/Year PC 0.5%/Year LT	1.0%/Year PC 2.0%/Year LT	1.0%/Year PC 2.0%/Year LT	2.0%/Year PC 3.0%/Year LT	2.0%/Year PC 3.0%/Year LT	2.0%/Year PC 3.0%/Year LT
AC/Off-Cycle Procedures	No Change	No Change	No Change	Phaseout 2022-2026	No Change	No Change	No Change	Phaseout 2022-2026	No Change
Average CO ₂ Emission Rate									
Average Required CO ₂ – MY 2026+ (g/mi)	204.0	284.0	276.0	276.0	252.0	241.0	237.0	237.0	229.0
Percent Change in Stringency from Baseline	-	-39.2%	-35.3%	-35.3%	-23.5%	-18.1%	-16.2%	-16.2%	-12.3%
Average Achieved CO ₂ – MY 2030 (g/mi)	203.0	268.0	266.0	268.0	251.0	243.0	238.0	237.0	231.0
Total Regulatory Costs Through MY 2029 Vehicles (7% discount rate)									
Total Technology Costs (\$b)	-	-103.0	-100.0	-95.8	-84.7	-64.0	-61.3	-38.7	-38.8
Total Civil Penalties (\$b)	N/A	N/A	N/A	N/A	N/A	N/A	N/A	N/A	N/A
Total Regulatory Costs (\$b)	-	-103.0	-100.0	-95.8	-84.7	-64.0	-61.3	-38.7	-38.8
Sales and Revenue Impacts Through MY 2029 Vehicles (7% discount rate for Revenue Change)									
Sales Change (millions)	-	-1.5	-1.4	-1.3	-1.1	-0.5	-0.5	-0.4	-0.2
Revenue Change (\$b)	-	-132.0	-127.0	-121.0	-105.0	-74.0	-70.3	-45.7	-42.2

Table VIII-26 - Light Truck Fleet Penetration for MY 2030, CO₂ Program

	Alternative								
	No Action	1	2	3	4	5	6	7	8
Model Years	2021-2025	2021-2026	2021-2026	2021-2026	2021-2026	2022-2026	2021-2026	2021-2026	2022-2026
Annual Rate of Stringency Increase	Final 2017-2021 Augural 2022-2025	0.0%/Year PC 0.0%/Year LT	0.5%/Year PC 0.5%/Year LT	0.5%/Year PC 0.5%/Year LT	1.0%/Year PC 2.0%/Year LT	1.0%/Year PC 2.0%/Year LT	2.0%/Year PC 3.0%/Year LT	2.0%/Year PC 3.0%/Year LT	2.0%/Year PC 3.0%/Year LT
AC/Off-Cycle Procedures	No Change	No Change	No Change	Phaseout 2022-2026	No Change	No Change	No Change	Phaseout 2022-2026	No Change
Technology Use Under CAFE Alternative in MY 2030 (total fleet penetration)									
Curb Weight Reduction (percent change from MY 2016)	8.1%	4.4%	4.5%	4.8%	5.7%	6.3%	7.4%	7.8%	7.9%
High Compression Ratio Non-Turbo Engines	12.0%	6.3%	6.3%	6.3%	6.3%	10.9%	10.9%	10.9%	10.9%
Turbocharged Gasoline Engines	68.0%	42.1%	44.2%	50.8%	61.5%	61.5%	61.5%	64.7%	63.9%
Dynamic Cylinder Deactivation	12.7%	0.0%	0.0%	0.0%	0.0%	0.0%	0.0%	13.8%	0.0%
Advanced Transmissions	81.5%	98.6%	98.6%	98.1%	97.0%	96.0%	95.2%	89.8%	94.0%
Stop-Start 12V (Non-Hybrid)	9.0%	10.2%	9.9%	7.9%	7.3%	3.2%	5.7%	3.9%	8.9%
Mild Hybrid Electric Systems (48v)	55.8%	3.1%	3.7%	7.8%	10.2%	22.4%	27.0%	46.5%	45.4%

Table VIII-27 - Passenger Car CO₂ Compliance Impacts and Cumulative Industry Costs through MY 2029

	Alternative								
	No Action	1	2	3	4	5	6	7	8
Model Years	2021-2025	2021-2026	2021-2026	2021-2026	2021-2026	2022-2026	2021-2026	2021-2026	2022-2026
Annual Rate of Stringency Increase	Final 2017-2021, Augural 2022-2025	0.0%/Year PC 0.0%/Year LT	0.5%/Year PC 0.5%/Year LT	0.5%/Year PC 0.5%/Year LT	1.0%/Year PC 2.0%/Year LT	1.0%/Year PC 2.0%/Year LT	2.0%/Year PC 3.0%/Year LT	2.0%/Year PC 3.0%/Year LT	2.0%/Year PC 3.0%/Year LT
AC/Off-Cycle Procedures	No Change	No Change	No Change	Phaseout 2022-2026	No Change	No Change	No Change	Phaseout 2022-2026	No Change
Average CO ₂ Emission Rate									
Average Required CO ₂ – MY 2026+ (g/mi)	149.0	204.0	198.0	198.0	192.0	186.0	180.0	180.0	176.0
Percent Change in Stringency from Baseline	-	-36.9%	-32.9%	-32.9%	-28.9%	-24.8%	-20.8%	-20.8%	-18.1%
Average Achieved CO ₂ – MY 2030 (g/mi)	148.0	198.0	196.0	198.0	187.0	180.0	177.0	177.0	172.0
Total Regulatory Costs Through MY 2029 Vehicles (7% discount rate)									
Total Technology Costs (\$b)	-	-92.1	-89.3	-84.2	-75.5	-56.5	-55.1	-38.1	-34.8
Total Civil Penalties (\$b)	N/A	N/A	N/A	N/A	N/A	N/A	N/A	N/A	N/A
Total Regulatory Costs (\$b)	-	-92.1	-89.3	-84.2	-75.5	-56.5	-55.1	-38.1	-34.8
Sales and Revenue Impacts Through MY 2029 Vehicles (7% discount rate for Revenue Change)									
Sales Change (millions)	-	2.6	2.5	2.3	1.9	1.2	1.1	0.8	0.5
Revenue Change (\$b)	-	-52.6	-51.9	-49.4	-46.6	-39.2	-38.8	-25.7	-26.5

Table VIII-28 - Passenger Car Fleet Penetration for MY 2030, CO₂ Program

	Alternative								
	No Action	1	2	3	4	5	6	7	8
Model Years	2021-2025	2021-2026	2021-2026	2021-2026	2021-2026	2022-2026	2021-2026	2021-2026	2022-2026
Annual Rate of Stringency Increase	Final 2017-2021 Augural 2022-2025	0.0%/Year PC 0.0%/Year LT	0.5%/Year PC 0.5%/Year LT	0.5%/Year PC 0.5%/Year LT	1.0%/Year PC 2.0%/Year LT	1.0%/Year PC 2.0%/Year LT	2.0%/Year PC 3.0%/Year LT	2.0%/Year PC 3.0%/Year LT	2.0%/Year PC 3.0%/Year LT
AC/Off-Cycle Procedures	No Change	No Change	No Change	Phaseout 2022-2026	No Change	No Change	No Change	Phaseout 2022-2026	No Change
Technology Use Under CAFE Alternative in MY 2030 (total fleet penetration)									
Curb Weight Reduction (percent change from MY 2016)	6.8%	3.4%	3.6%	4.0%	4.6%	5.4%	5.8%	6.1%	6.1%
High Compression Ratio Non-Turbo Engines	39.2%	17.4%	17.4%	18.8%	18.9%	32.5%	32.8%	33.6%	32.8%
Turbocharged Gasoline Engines	56.1%	39.8%	39.8%	46.1%	49.9%	52.4%	55.6%	57.4%	57.5%
Dynamic Cylinder Deactivation	0.8%	0.0%	0.0%	0.0%	0.0%	0.0%	0.0%	0.7%	0.0%
Advanced Transmissions	68.7%	89.5%	89.5%	89.6%	89.5%	88.8%	87.2%	79.0%	82.6%
Stop-Start 12V (Non-Hybrid)	19.7%	11.9%	12.1%	11.9%	15.0%	11.8%	11.4%	10.5%	19.7%

2. What are the impacts on buyers of new vehicles?

(a) CAFE Standards

Table VIII-29 - Impacts to the Average Consumer of a MY 2030 Vehicle under CAFE Program, 3% Discount Rate

	Alternative								
	No Action	1	2	3	4	5	6	7	8
Model Years	2021-2025	2021-2026	2021-2026	2021-2026	2021-2026	2022-2026	2021-2026	2021-2026	2022-2026
Annual Rate of Stringency Increase	Final 2017-2021 Augural 2022-2025	0.0%/Year PC 0.0%/Year LT	0.5%/Year PC 0.5%/Year LT	0.5%/Year PC 0.5%/Year LT	1.0%/Year PC 2.0%/Year LT	1.0%/Year PC 2.0%/Year LT	2.0%/Year PC 3.0%/Year LT	2.0%/Year PC 3.0%/Year LT	2.0%/Year PC 3.0%/Year LT
AC/Off-Cycle Procedures	No Change	No Change	No Change	Phaseout 2022-2026	No Change	No Change	No Change	Phaseout 2022-2026	No Change
Per Vehicle Consumer Impacts for MY 2030 (\$)									
Average Price Increase	-	-1,850	-1,770	-1,650	-1,450	-1,150	-950	-450	-620
Ownership Costs	-	-490	-470	-430	-380	-290	-240	-110	-150
Fuel Savings	-	-1,470	-1,370	-1,290	-1,090	-850	-690	-350	-470
Mobility Benefit	-	-430	-400	-370	-300	-230	-180	-90	-120
Refueling Benefit	-	-50	-50	-50	-40	-30	-30	-10	-20
Total Costs	-	-2,340	-2,240	-2,080	-1,830	-1,450	-1,190	-560	-770
Total Benefits	-	-1,950	-1,830	-1,700	-1,430	-1,110	-890	-460	-610
Net Benefits	-	390	420	380	390	340	290	110	170

Table VIII-30 - Impacts to the Average Consumer of a MY 2030 Vehicle under CAFE Program, 7% Discount Rate

	Alternative								
	No Action	1	2	3	4	5	6	7	8
Model Years	2021-2025	2021-2026	2021-2026	2021-2026	2021-2026	2022-2026	2021-2026	2021-2026	2022-2026
Annual Rate of Stringency Increase	Final 2017-2021 Augural 2022-2025	0.0%/Year PC 0.0%/Year LT	0.5%/Year PC 0.5%/Year LT	0.5%/Year PC 0.5%/Year LT	1.0%/Year PC 2.0%/Year LT	1.0%/Year PC 2.0%/Year LT	2.0%/Year PC 3.0%/Year LT	2.0%/Year PC 3.0%/Year LT	2.0%/Year PC 3.0%/Year LT
AC/Off-Cycle Procedures	No Change	No Change	No Change	Phaseout 2022-2026	No Change	No Change	No Change	Phaseout 2022-2026	No Change
Per Vehicle Consumer Impacts for MY 2030 (\$)									
Average Price Increase	-	-1,850	-1,770	-1,650	-1,450	-1,150	-950	-450	-620
Ownership Costs	-	-440	-420	-390	-340	-270	-220	-100	-140
Fuel Savings	-	-1,210	-1,130	-1,060	-900	-700	-570	-290	-390
Mobility Benefit	-	-430	-400	-370	-300	-230	-180	-90	-120
Refueling Benefit	-	-50	-50	-50	-40	-30	-30	-10	-20
Total Costs	-	-2,300	-2,200	-2,040	-1,790	-1,420	-1,170	-550	-760
Total Benefits	-	-1,690	-1,580	-1,480	-1,240	-960	-770	-390	-520
Net Benefits	-	600	610	560	550	460	390	160	230

Table VIII-31 - Impacts to the Average Consumer of a MY 2030 Vehicle under CO₂ Program, 3% Discount Rate

	Alternative								
	No Action	1	2	3	4	5	6	7	8
Model Years	2021-2025	2021-2026	2021-2026	2021-2026	2021-2026	2022-2026	2021-2026	2021-2026	2022-2026
Annual Rate of Stringency Increase	Final 2017-2021 Augural 2022-2025	0.0%/Year PC 0.0%/Year LT	0.5%/Year PC 0.5%/Year LT	0.5%/Year PC 0.5%/Year LT	1.0%/Year PC 2.0%/Year LT	1.0%/Year PC 2.0%/Year LT	2.0%/Year PC 3.0%/Year LT	2.0%/Year PC 3.0%/Year LT	2.0%/Year PC 3.0%/Year LT
AC/Off-Cycle Procedures	No Change	No Change	No Change	Phaseout 2022-2026	No Change	No Change	No Change	Phaseout 2022-2026	No Change
Per Vehicle Consumer Impacts for MY 2030 (\$)									
Average Price Increase	-	-2,260	-2,210	-2,000	-1,770	-1,410	-1,140	-570	-750
Ownership Costs	-	-610	-590	-530	-470	-370	-300	-150	-190
Fuel Savings	-	-1,830	-1,770	-1,540	-1,260	-890	-730	-340	-480
Mobility Benefit	-	-540	-520	-440	-350	-250	-190	-80	-120
Refueling Benefit	-	-70	-70	-60	-50	-40	-30	-10	-20
Total Costs	-	-2,870	-2,800	-2,540	-2,240	-1,780	-1,440	-710	-950
Total Benefits	-	-2,440	-2,350	-2,040	-1,660	-1,180	-950	-440	-620
Net Benefits	-	430	450	500	580	600	490	280	330

Table VIII-32 - Impacts to the Average Consumer of a MY 2030 Vehicle under CO₂ Program, 7% Discount Rate

	Alternative								
	No Action	1	2	3	4	5	6	7	8
Model Years	2021-2025	2021-2026	2021-2026	2021-2026	2021-2026	2022-2026	2021-2026	2021-2026	2022-2026
Annual Rate of Stringency Increase	Final 2017-2021 Augural 2022-2025	0.0%/Year PC 0.0%/Year LT	0.5%/Year PC 0.5%/Year LT	0.5%/Year PC 0.5%/Year LT	1.0%/Year PC 2.0%/Year LT	1.0%/Year PC 2.0%/Year LT	2.0%/Year PC 3.0%/Year LT	2.0%/Year PC 3.0%/Year LT	2.0%/Year PC 3.0%/Year LT
AC/Off-Cycle Procedures		No Change	No Change	Phaseout 2022-2026	No Change	No Change	No Change	Phaseout 2022-2026	No Change
Average Price Increase	-	-2,260	-2,210	-2,000	-1,770	-1,410	-1,140	-570	-750
Ownership Costs	-	-550	-540	-480	-420	-330	-270	-130	-170
Fuel Savings	-	-1,510	-1,460	-1,270	-1,040	-740	-600	-280	-400
Mobility Benefit	-	-540	-520	-440	-350	-250	-190	-80	-120
Refueling Benefit	-	-70	-70	-60	-50	-40	-30	-10	-20
Total Costs	-	-2,810	-2,740	-2,490	-2,200	-1,750	-1,410	-700	-930
Total Benefits	-	-2,120	-2,040	-1,770	-1,440	-1,020	-820	-380	-540
Net Benefits	-	690	700	720	750	720	590	320	390

C. What are the energy and environmental impacts?

1. CAFE Standards

Table VIII-33 - Cumulative Changes in Fuel Consumption and GHG Emissions for MYs 1977-2029 Under CAFE Program

	Alternative								
	No Action	1	2	3	4	5	6	7	8
Model Years	2021-2025	2021-2026	2021-2026	2021-2026	2021-2026	2022-2026	2021-2026	2021-2026	2022-2026
Annual Rate of Stringency Increase	Final 2017-2021 Augural 2022-2025	0.0%/Year PC 0.0%/Year LT	0.5%/Year PC 0.5%/Year LT	0.5%/Year PC 0.5%/Year LT	1.0%/Year PC 2.0%/Year LT	1.0%/Year PC 2.0%/Year LT	2.0%/Year PC 3.0%/Year LT	2.0%/Year PC 3.0%/Year LT	2.0%/Year PC 3.0%/Year LT
AC/Off-Cycle Procedures	No Change	No Change	No Change	Phaseout 2022-2026	No Change	No Change	No Change	Phaseout 2022-2026	No Change
Upstream Emissions									
CO ₂ (million metric tons)	-	151	142	135	116	84.8	81.3	55.1	49.9
CH ₄ (thousand metric tons)	-	1,430	1,350	1,280	1,120	836	803	560	521
N ₂ O (thousand metric tons)	-	21.6	20.4	19.4	16.9	12.7	12.2	8.6	8.0
Tailpipe Emissions									
CO ₂ (million metric tons)	-	658	623	592	518	391	375	263	247
CH ₄ (thousand metric tons)	-	-12.0	-11.1	-10.4	-8.6	-6.3	-5.4	-2.7	-3.1
N ₂ O (thousand metric tons)	-	-10.6	-9.8	-9.1	-7.5	-5.4	-4.6	-2.3	-2.6
Total Emissions									
CO ₂ (million metric tons)	-	809	765	726	634	475	456	318	297
CH ₄ (thousand metric tons)	-	1,410	1,340	1,270	1,110	830	797	557	518
N ₂ O (thousand metric tons)	-	11.0	10.6	10.3	9.5	7.3	7.7	6.4	5.3
Fuel Consumption (billion Gallons)	-	73.1	69.1	65.7	57.4	43.1	41.3	28.9	27.0

Table VIII-34 - Cumulative Changes in Fuel Consumption and GHG Emissions for MYs 1977-2029 Under CO₂ Program

	Alternative									
	No Action	1	2	3	4	5	6	7	8	
Model Years	2021-2025	2021-2026	2021-2026	2021-2026	2021-2026	2022-2026	2022-2026	2021-2026	2021-2026	2022-2026
Annual Rate of Stringency Increase	Final 2017-2021 Augural 2022-2025	0.0%/Year PC 0.0%/Year LT	0.5%/Year PC 0.5%/Year LT	0.5%/Year PC 0.5%/Year LT	1.0%/Year PC 2.0%/Year LT	1.0%/Year PC 2.0%/Year LT	2.0%/Year PC 3.0%/Year LT	2.0%/Year PC 3.0%/Year LT	2.0%/Year PC 3.0%/Year LT	2.0%/Year PC 3.0%/Year LT
AC/Off-Cycle Procedures	No Change	No Change	No Change	Phaseout 2022-2026	No Change	No Change	No Change	Phaseout 2022-2026	No Change	
Upstream Emissions										
CO ₂ (million metric tons)	-	159	149	140	114	67.6	69.0	48.4	40.4	
CH ₄ (thousand metric tons)	-	1,540	1,450	1,370	1,140	730	742	527	462	
N ₂ O (thousand metric tons)	-	23.3	22.0	20.8	17.4	11.2	11.4	8.1	7.2	
Tailpipe Emissions										
CO ₂ (million metric tons)	-	713	675	636	535	348	354	251	223	
CH ₄ (thousand metric tons)	-	-14.2	-13.6	-12.1	-9.8	-6.8	-5.7	-3.0	-3.4	
N ₂ O (thousand metric tons)	-	-12.6	-12.0	-10.6	-8.6	-5.8	-4.8	-2.4	-2.8	
Total Emissions										
CO ₂ (million metric tons)	-	872	825	775	649	416	422	300	264	
CH ₄ (thousand metric tons)	-	1,520	1,440	1,350	1,130	723	736	524	458	
N ₂ O (thousand metric tons)	-	10.7	10.0	10.2	8.9	5.4	6.7	5.7	4.4	
Fuel Consumption (billion Gallons)	-	78.9	74.6	70.2	58.8	37.8	38.3	27.2	24.0	

Table VIII-35 - Cumulative Changes in Criteria Pollutant Emissions for MYs 1977-2029 Under CAFE Program

	Alternative								
	No Action	1	2	3	4	5	6	7	8
Model Years	2021-2025	2021-2026	2021-2026	2021-2026	2021-2026	2022-2026	2021-2026	2021-2026	2022-2026
Annual Rate of Stringency Increase	Final 2017-2021 Augural 2022-2025	0.0%/Year PC 0.0%/Year LT	0.5%/Year PC 0.5%/Year LT	0.5%/Year PC 0.5%/Year LT	1.0%/Year PC 2.0%/Year LT	1.0%/Year PC 2.0%/Year LT	2.0%/Year PC 3.0%/Year LT	2.0%/Year PC 3.0%/Year LT	2.0%/Year PC 3.0%/Year LT
AC/Off-Cycle Procedures	No Change	No Change	No Change	Phaseout 2022-2026	No Change	No Change	No Change	Phaseout 2022-2026	No Change
Upstream Emissions									
CO (million metric tons)	-	0.1	0.1	0.1	0.0	0.0	0.0	0.0	0.0
VOC (thousand metric tons)	-	215	203	193	169	127	122	85.6	80.4
NO _x (thousand metric tons)	-	115	108	103	89.4	66.2	63.5	43.6	40.3
SO ₂ (thousand metric tons)	-	73.7	68.8	65.2	55.0	38.2	36.8	23.5	20.0
PM (thousand metric tons)	-	8.8	8.3	7.9	6.9	5.1	4.9	3.4	3.1
Tailpipe Emissions									
CO (million metric tons)	-	-5.2	-4.8	-4.5	-3.8	-2.9	-2.5	-1.3	-1.5
VOC (thousand metric tons)	-	-332	-310	-291	-251	-190	-171	-100	-103
NO _x (thousand metric tons)	-	-270	-251	-235	-200	-148	-132	-75.2	-77.8

SO ₂ (thousand metric tons)	-	-2.5	-2.3	-2.2	-1.8	-1.2	-1.1	-0.5	-0.6
PM (thousand metric tons)	-	-11.7	-10.8	-10.1	-8.5	-6.3	-5.4	-2.8	-3.2
Total Emissions									
CO (million metric tons)	-	-5.2	-4.8	-4.5	-3.8	-2.8	-2.5	-1.3	-1.5
VOC (thousand metric tons)	-	-117	-107	-97.8	-82.2	-62.3	-48.8	-14.7	-22.7
NO _x (thousand metric tons)	-	-155	-142	-132	-110	-81.4	-68.9	-31.5	-37.4
SO ₂ (thousand metric tons)	-	71.2	66.5	63.0	53.2	36.9	35.7	23.0	19.4
PM (thousand metric tons)	-	-2.9	-2.6	-2.3	-1.6	-1.2	-0.5	0.6	-0.1

Table VIII-36 - Cumulative Changes in Criteria Pollutant Emissions for MYs 1977-2029 Under GHG Program

	Alternative								
	No Action	1	2	3	4	5	6	7	8
Model Years	2021-2025	2021-2026	2021-2026	2021-2026	2021-2026	2022-2026	2021-2026	2021-2026	2022-2026
Annual Rate of Stringency Increase	Final 2017-2021 Augural 2022-2025	0.0%/Year PC 0.0%/Year LT	0.5%/Year PC 0.5%/Year LT	0.5%/Year PC 0.5%/Year LT	1.0%/Year PC 2.0%/Year LT	1.0%/Year PC 2.0%/Year LT	2.0%/Year PC 3.0%/Year LT	2.0%/Year PC 3.0%/Year LT	2.0%/Year PC 3.0%/Year LT
AC/Off-Cycle Procedures	No Change	No Change	No Change	Phaseout 2022-2026	No Change	No Change	No Change	Phaseout 2022-2026	No Change
Upstream Emissions									
CO (million metric tons)	-	0.1	0.1	0.1	0.0	0.0	0.0	0.0	0.0
VOC (thousand metric tons)	-	232	220	207	174	113	114	81.1	71.7
NO _x (thousand metric tons)	-	122	115	108	89.3	55.0	56.0	39.4	33.8
SO ₂ (thousand metric tons)	-	74.0	68.7	63.5	49.9	24.7	25.6	17.3	12.5
PM (thousand metric tons)	-	9.4	8.8	8.3	6.9	4.3	4.4	3.1	2.7
Tailpipe Emissions									
CO (million metric tons)	-	-6.1	-5.8	-5.2	-4.3	-3.1	-2.7	-1.5	-1.6
VOC (thousand metric tons)	-	-372	-356	-327	-275	-195	-178	-110	-112
NO _x (thousand metric tons)	-	-312	-297	-270	-224	-158	-140	-83.5	-87.4

SO ₂ (thousand metric tons)	-	-3.0	-2.9	-2.5	-2.0	-1.3	-1.1	-0.5	-0.6
PM (thousand metric tons)	-	-13.7	-13.2	-11.8	-9.8	-7.0	-5.9	-3.2	-3.6
Total Emissions									
CO (million metric tons)	-	-6.0	-5.7	-5.2	-4.3	-3.1	-2.6	-1.5	-1.6
VOC (thousand metric tons)	-	-140	-136	-120.0	-101.0	-82.9	-64.2	-28.9	-39.8
NO _x (thousand metric tons)	-	-190	-183	-162	-135	-103.0	-84.5	-44.1	-53.7
SO ₂ (thousand metric tons)	-	71.0	65.8	60.9	47.8	23.3	24.5	16.8	11.9
PM (thousand metric tons)	-	-4.4	-4.4	-3.5	-2.9	-2.7	-1.5	-0.1	-1.0

D. What are the impacts on the total fleet size, usage, and safety?

1. CAFE Standards

Table VIII-37 - Cumulative Changes in Fleet Size, Usage and Fatalities for MYs 1977-2029 Under CAFE Program

	Alternative								
	No Action	1	2	3	4	5	6	7	8
Model Years	2021-2025	2021-2026	2021-2026	2021-2026	2021-2026	2022-2026	2021-2026	2021-2026	2022-2026
Annual Rate of Stringency Increase	Final 2017-2021 Augural 2022-2025	0.0%/Year PC 0.0%/Year LT	0.5%/Year PC 0.5%/Year LT	0.5%/Year PC 0.5%/Year LT	1.0%/Year PC 2.0%/Year LT	1.0%/Year PC 2.0%/Year LT	2.0%/Year PC 3.0%/Year LT	2.0%/Year PC 3.0%/Year LT	2.0%/Year PC 3.0%/Year LT
AC/Off-Cycle Procedures	No Change	No Change	No Change	Phaseout 2022-2026	No Change	No Change	No Change	Phaseout 2022-2026	No Change
Cumulative Changes in Fleet Size, Usage and Fatalities Through MY 2029									
Fleet Size (millions)	-	-190	-177	-164	-137	-104	-85	-37	-52
Share LT, CY 2040	47%	45%	46%	46%	46%	46%	46%	47%	47%
VMT, Fatalities, and Fuel Consumption for MYs 2017-2029									
VMT, with rebound (billion miles)	-	-1,030	-949	-885	-728	-530	-450	-235	-281
VMT, without rebound (billion miles)	-	-235	-205	-183	-122	-79	-36	36	-11
Fatalities, with rebound	-	-8,630	-7,990	-7,460	-6,180	-4,540	-3,800	-1,970	-2,360
Fatalities, without rebound	-	-2,160	-1,890	-1,710	-1,230	-844	-398	273	-141
Fuel Consumption, with rebound (billion gallons)	-	91.2	86.1	81.6	71.2	53.6	50.8	34.5	32.8
Fuel Consumption, without rebound (billion gallons)	-	116	110	103	89.2	66.6	62.3	41.6	40.0
VMT, Fatalities, and Fuel Consumption for MYs 1977-2016									

VMT, with rebound (billion miles)	-	-442	-415	-390	-340	-262	-234	-137	-144
VMT, without rebound (billion miles)	-	-457	-429	-403	-352	-271	-242	-142	-149
Fatalities, with rebound	-	-4,050	-3,800	-3,570	-3,120	-2,400	-2,150	-1,270	-1,330
Fatalities, without rebound	-	-4,190	-3,930	-3,700	-3,230	-2,480	-2,230	-1,320	-1,370
Fuel Consumption, with rebound (billion gallons)	-	-18.1	-16.9	-15.9	-13.8	-10.6	-9.50	-5.65	-5.81
Fuel Consumption, without rebound (billion gallons)	-	-18.7	-17.5	-16.5	-14.3	-10.9	-9.86	-5.86	-6.03

Table VIII-38 - Cumulative Changes in Fleet Size, Usage and Fatalities for MYs 1977-2029 Under CO₂ Program

	Alternative								
	No Action	1	2	3	4	5	6	7	8
Model Years	2021-2025	2021-2026	2021-2026	2021-2026	2021-2026	2022-2026	2021-2026	2021-2026	2022-2026
Annual Rate of Stringency Increase	Final 2017-2021 Augural 2022-2025	0.0%/Year PC 0.0%/Year LT	0.5%/Year PC 0.5%/Year LT	0.5%/Year PC 0.5%/Year LT	1.0%/Year PC 2.0%/Year LT	1.0%/Year PC 2.0%/Year LT	2.0%/Year PC 3.0%/Year LT	2.0%/Year PC 3.0%/Year LT	2.0%/Year PC 3.0%/Year LT
AC/Off-Cycle Procedures	No Change	No Change	No Change	Phaseout 2022-2026	No Change	No Change	No Change	Phaseout 2022-2026	No Change
Cumulative Changes in Fleet Size, Usage and Fatalities Through MY 2029									
Fleet Size (millions)	6,665	-235	-227	-200	-167	-129	-103	-51	-67
Share LT, CY 2040	47%	45%	45%	46%	46%	46%	47%	47%	47%
VMT, Fatalities, and Fuel Consumption for MYs 2017-2029									
VMT, with rebound (billion miles)	-	-1,300	-1,240	-1,090	-885	-624	-509	-262	-319
VMT, without rebound (billion miles)	-	-387	-376	-299	-229	-189	-101	0	-68
Fatalities, with rebound	-	-11,200	-10,700	-9,410	-7,610	-5,380	-4,400	-2,290	-2,730
Fatalities, without rebound	-	-3,720	-3,630	-2,930	-2,240	-1,810	-1,050	-129	-664

Fuel Consumption, with rebound (billion gallons)	-	99.0	93.9	88.0	74.0	48.7	48.5	33.7	30.4
Fuel Consumption, without rebound (billion gallons)	-	128	121	113	94.0	61.8	60.7	40.9	37.6
VMT, Fatalities, and Fuel Consumption for MYs 1977-2016									
VMT, with rebound (billion miles)	-	-489	-470	-435	-372	-270	-250	-158	-159
VMT, without rebound (billion miles)	-	-506	-486	-449	-384	-279	-259	-164	-165
Fatalities, with rebound	-	-4,470	-4,290	-3,980	-3,400	-2,470	-2,290	-1,460	-1,460
Fatalities, without rebound	-	-4,630	-4,440	-4,110	-3,520	-2,550	-2,370	-1,510	-1,510
Fuel Consumption, with rebound (billion gallons)	-	-20.2	-19.3	-17.9	-15.2	-10.9	-10.2	-6.51	-6.47
Fuel Consumption, without rebound (billion gallons)	-	-20.9	-20.0	-18.5	-15.8	-11.3	-10.5	-6.76	-6.70

E. What are the Impacts on Employment?

As discussed in Section II.E, the analysis includes estimates of impacts on U.S. auto industry labor, considering the combined impact of changes in sales volumes and changes in outlays for additional fuel-saving technology. Note: This analysis does not consider the possibility that potential new jobs and plants attributable to increased stringency will not be located in the United States, or that increased stringency will not lead to the relocation of current jobs or plants to foreign countries. Compared to the no-action alternative (*i.e.*, the baseline standards), the proposed standards (alternative 1) and other regulatory alternatives under consideration all involve reduced regulatory costs expected to lead to reduced average vehicle prices and, in turn, increased sales. While the increased sales slightly increase estimated U.S. auto sector labor, because producing and selling more vehicles uses additional U.S. labor, the reduced outlays for fuel-saving technology slightly reduce estimated U.S. auto sector labor, because manufacturing, integrating, and selling less technology means using less labor to do so. Of course, this is technology that may not otherwise be produced or deployed were it not for regulatory mandate, and the additional costs of this technology would be borne by a reduced number of consumers given reduction in sales in response to increased prices. Today's analysis shows the negative impact of reduced mandatory technology outlays outweighing the positive impact of increased sales. However, both of these underlying factors are subject to uncertainty. For example, if fuel-saving technology that would have been applied under the baseline standards is more likely to have come from foreign suppliers than estimated here, less of the foregone labor to manufacture that technology would have been U.S. labor. Also, if sales would be more positively impacted by reduced vehicle prices than estimated here, correspondingly positive impacts on U.S. auto sector

labor could be magnified. Alternatively, if manufacturers are able to deploy technology to improve vehicle attributes that new car buyers prefer to fuel economy improvements, both technology spending and vehicle sales would correspondingly increase. As discussed above, the analysis of sales and employment may be updated for the final rule, and it is expected that doing so could possibly produce incremental changes opposite in sign from those presented below. In particular, comment is sought on the potential for changes in stringency to result in new jobs and plants being created in foreign countries or for current United States jobs and plants to be moved outside of the United States.

The employment analysis was focused on automotive labor because adjacent employment factors and consumer spending factors for other goods and services are uncertain and difficult to predict. How direct labor changes may affect the macro economy and possibly change employment in adjacent industries were not considered. For instance, possible labor changes in vehicle maintenance and repair were not considered, nor were changes in labor at retail gas stations considered. Possible labor changes due to raw material production, such as production of aluminum, steel, copper, and lithium were not considered, nor were possible labor impacts due to changes in production of oil and gas, ethanol, and electricity considered. Effects of how consumers could spend money saved due to improved fuel economy were not analyzed, nor were effects of how consumers would pay for more expensive fuel savings technologies at the time of purchase analyzed; either could affect consumption of other goods and services, and hence affect labor in other industries. The effects of increased usage of car-sharing, ride-sharing, and automated vehicles were not analyzed. How changes in labor from any industry could affect gross domestic product and possibly affect other industries as a result were not estimated.

Also, no assumptions were made about full-employment or not full-employment and the availability of

human resources to fill positions. When the economy is at full employment, a fuel economy regulation is unlikely to have much impact on net overall U.S. employment; instead, labor would primarily be shifted from one sector to another. These shifts in employment impose an opportunity cost on society, approximated by the wages of the employees, as regulation diverts workers from other activities in the economy. In this situation, any effects on net employment are likely to be transitory as workers change jobs (*e.g.*, some workers may need to be retrained or require time to search for new jobs, while shortages in some sectors or regions could bid up wages to attract workers). On the other hand, if a regulation comes into effect during a period of high unemployment, a change in labor demand due to regulation may affect net overall U.S. employment because the labor market is not in equilibrium. Schmalensee and Stavins point out that net positive employment effects are possible in the near term when the economy is at less than full employment due to the potential hiring of idle labor resources by the regulated sector to meet new requirements (*e.g.*, to install new equipment) and new economic activity in sectors related to the regulated sector longer run, the net effect on employment is more difficult to predict and will depend on the way in which the related industries respond to the regulatory requirements. For that reason, this analysis does not include multiplier effects but instead focuses on labor impacts in the most directly affected industries. Those sectors are likely to face the most concentrated labor impacts.

The tables presented below summarize these results for regulatory alternatives under consideration. While values are reported as thousands of job-years, changes in labor utilization would not necessarily involve the same number of changes in actual jobs, as auto industry employers may use a range of strategies (*e.g.*, shift changes, overtime) beyond simply adding or eliminating jobs.

1. CAFE Standards

Table VIII-39 - Estimated Labor (Hours, as 1000s of Job-Years) under CAFE Program

MY	Regulatory Alternative								
	Baseline	1	2	3	4	5	6	7	8
2017	1,169	1,166	1,166	1,166	1,166	1,167	1,167	1,167	1,168
2018	1,208	1,198	1,199	1,200	1,200	1,203	1,203	1,204	1,205
2019	1,237	1,220	1,221	1,223	1,224	1,227	1,228	1,231	1,233
2020	1,263	1,236	1,237	1,239	1,241	1,245	1,247	1,251	1,254
2021	1,293	1,244	1,246	1,249	1,252	1,260	1,263	1,272	1,275
2022	1,301	1,248	1,249	1,252	1,256	1,263	1,268	1,279	1,280
2023	1,306	1,249	1,251	1,254	1,258	1,266	1,271	1,283	1,284
2024	1,306	1,251	1,253	1,256	1,260	1,269	1,275	1,287	1,286
2025	1,309	1,253	1,255	1,258	1,263	1,273	1,278	1,292	1,290
2026	1,312	1,257	1,259	1,264	1,269	1,280	1,287	1,304	1,298
2027	1,315	1,260	1,262	1,265	1,271	1,281	1,287	1,300	1,297
2028	1,320	1,261	1,264	1,268	1,275	1,285	1,292	1,307	1,303
2029	1,323	1,264	1,266	1,270	1,277	1,288	1,295	1,310	1,306
2030	1,325	1,265	1,268	1,<272	1,279	1,290	1,297	1,312	1,308

2. CO₂ Standards

Table VIII-40 - Estimated Labor (Hours, as 1000s of Job-Years) under CO₂ Program

MY	Regulatory Alternative								
	Baseline	1	2	3	4	5	6	7	8
2017	1,169	1,167	1,167	1,167	1,167	1,168	1,167	1,168	1,168
2018	1,204	1,198	1,198	1,198	1,199	1,202	1,201	1,201	1,202
2019	1,231	1,220	1,220	1,220	1,222	1,227	1,224	1,228	1,229
2020	1,254	1,236	1,237	1,237	1,240	1,247	1,243	1,247	1,250
2021	1,278	1,247	1,248	1,249	1,254	1,263	1,259	1,264	1,269
2022	1,281	1,247	1,247	1,248	1,253	1,260	1,260	1,267	1,270
2023	1,285	1,249	1,250	1,251	1,255	1,264	1,263	1,272	1,275
2024	1,289	1,251	1,251	1,253	1,258	1,268	1,267	1,276	1,278
2025	1,291	1,253	1,254	1,255	1,261	1,271	1,271	1,281	1,283
2026	1,300	1,255	1,256	1,258	1,266	1,277	1,279	1,292	1,291
2027	1,309	1,259	1,260	1,262	1,270	1,281	1,286	1,298	1,298
2028	1,314	1,260	1,261	1,264	1,272	1,286	1,290	1,306	1,303
2029	1,318	1,263	1,264	1,266	1,276	1,288	1,294	1,310	1,307
2030	1,320	1,264	1,265	1,267	1,277	1,290	1,296	1,311	1,309

IX. Vehicle Classification

Vehicle classification, for purposes of the light-duty CAFE and CO₂ programs,⁷⁸² refers to whether a vehicle

is considered to be a passenger automobile (car) or a non-passenger automobile (light truck).⁷⁸³ As

regulatory definitions for determining which vehicles would be subject to which CO₂ standards.

⁷⁸³ EPA uses the terms “passenger automobile” and “non-passenger automobile;” NHTSA’s regulation on vehicle classification, 49 CFR part

discussed above in Section III, passenger cars and light trucks are subject to different fuel economy and CO₂ standards as required by EPCA/

523, further clarifies the EPCA definitions and introduces the term “light truck” as a plainer language alternative for “non-passenger automobile.”

⁷⁸² See 40 CFR 86.1803–01. For the MYs 2012–2016 standards, the MYs 2017–2025 standards, and this NPRM, EPA has agreed to use NHTSA’s

EISA and consistent with their different capabilities.

In EPCA, Congress designated some vehicles as passenger automobiles and some as non-passenger automobiles. Vehicles “capable of off-highway operation” are, by statute, *not* passenger automobiles. Determining “off-highway operation” is a two-part inquiry: First, does the vehicle have 4-wheel drive, or is it over 6,000 pounds gross vehicle weight rating (GVWR), and second, does the vehicle (that is either 4-wheel drive or over 6,000 pounds GVWR) also have “a significant feature designed for off-highway operation,” as defined by DOT regulations.⁷⁸⁴ Additionally, vehicles that DOT “decides by regulation [are] manufactured primarily for transporting not more than 10 individuals” are, by statute, passenger automobiles; that means that certain vehicles that DOT decides by regulation are *not* manufactured primarily for transporting not more than 10 passengers are *not* passenger automobiles. NHTSA’s regulation on vehicle classification,⁷⁸⁵ contains requirements for vehicles to be classified as light trucks either on the basis of off-highway capability⁷⁸⁶ or on the basis of having “truck-like characteristics.”⁷⁸⁷ Over time, NHTSA has refined the light truck vehicle classification by revising its regulations and issuing legal interpretations. However, based on agency observations of current vehicle design trends, compliance testing and evaluation, and discussions with stakeholders, NHTSA has become aware of vehicle designs that complicate light truck classification determinations for the CAFE and CO₂ programs. When there is uncertainty as to how vehicles should be classified, inconsistency in determining manufacturers’ compliance obligations can result, which is detrimental to the predictability and fairness of the program. While the agency has not assessed the magnitude of the classification issues and is not proposing any vehicle reclassifications at this time, NHTSA is interested in gathering more information from commenters on several of the light truck classification criteria, and therefore seeks comment on the issues discussed below.

A. Classification Based on “truck-like characteristics”

One of the “truck-like characteristics” that allows manufacturers to classify vehicles as light trucks is having at least

three rows of seats as standard equipment, as long as it also “permit[s] expanded use of the automobile for cargo-carrying purposes or other non-passenger-carrying purposes through the removal or stowing of foldable or pivoting seats so as to create a flat, leveled cargo surface extending from the forwardmost point of installation of those seats to the rear of the automobile’s interior.”⁷⁸⁸ NHTSA has identified two issues thus far with this criterion that various manufacturers appear to be approaching differently, which, again, could be causing unfairness in compliance obligations. Both relate to how to measure the cargo area when seats are moved out of the way. Given that the purpose of this criterion is to “permit expanded use of the automobile for cargo-carrying purposes or other non-passenger-carrying purposes,” the less cargo space the vehicle design can provide, the harder it is for NHTSA to agree that the vehicle is properly classified as a light truck.

The first issue is how to identify the “forwardmost point of installation” and how the location impacts the available cargo floor area and volume behind the seats. Seating configurations have evolved considerably over the last 20 years, as minivan seats are now very complex in design providing far more ergonomic functionality. For example, the market demand for increased rear seat leg room and the installation of rear seat air bag systems has resulted in the introduction of adjustable second row seats—second-row seats that remain upright, unable to articulate and stow into the vehicle floor. These seats provide adjustable leg room by sliding forward or backward on sliding tracks and aim to provide expanded cargo carrying room by moving forward against the back of the front seats. Earlier seating designs had fixed attachment points on the vehicle floor, and it was easy to identify the “forwardmost point of installation” because it was readily observable and did not change. When seats move forward and backward on sliding tracks, the “forwardmost point of installation” is less readily identifiable. Some manufacturers have argued that the forwardmost point of installation is the forwardmost point where the seat attaches to the sliding track with the seat positioned at its *rearmost* position on the track. This would allow vehicles with certain second-row seat designs to be considered as meeting this criterion (e.g., a second-row seat where the bottom cushion folds upward toward its

seatback, allowing the entire seat to slide forward up against the back of the front seat, beyond the identified forwardmost point of installation). Other approaches could include adjusting the seat to a position that can accommodate a 75-percentile male dummy. Selecting any of these positions will change the forwardmost point of installation and could ultimately impact the flat floor surface area and cargo volume, respectively. NHTSA seeks comment on how to determine the reference point of the forwardmost point of installation of these seats for vehicles to qualify as light trucks using this provision. Also, should NHTSA establish a minimum amount of cargo surface area for seats that remain within the vehicle?

The second issue is what makes a surface “flat and leveled.” Many SUVs have three rows of designated seating positions, where the second row has “captain’s seats” (*i.e.*, two independent bucket seats) rather than the traditional bench-style seating more common when the provision was added to NHTSA’s regulation. When captain seats are folded down, the seatback can form a flat surface for expanded cargo carrying purposes, but the surface of the seatbacks may not be level (*i.e.*, may be angled at some angle slightly greater than 0°), or may not be level with the rest of the cargo area (*i.e.*, horizontal surface of folded seats is 0° at a different height from horizontal surface of cargo area behind the seats). Captain seats, when folded flat, may also leave significant gaps around and between the seats. Some manufacturers have opted to use plastic panels to level the surface and to covers the gaps between seats, while others have left the space open and the surface non-level. NHTSA therefore seeks comment on the following questions related to the requirement for a flat leveled cargo surface:

- Does the cargo surface need to be flat and level in exactly the same plane, or does it fulfill the intent of the criterion and provide appropriate cargo-carrying functionality for the cargo surface to be other than flat and level in the same plane?

- Does the cargo surface need to be flat and level across the entire surface, or are (potentially large) gaps in that surface consistent with the intent of the criterion and providing appropriate cargo-carrying functionality? Should panels to fill gaps be required?

- Certain third row seats are located on top the rear axle causing them to sit higher and closer to the vehicle roof. When these seats fold flat the available cargo-carrying volume is reduced. Is cargo-carrying functionality better ensured by setting a minimum amount

⁷⁸⁴ 49 U.S.C. 32901(a)(18).

⁷⁸⁵ 49 CFR part 523.

⁷⁸⁶ 49 CFR 523.5(b).

⁷⁸⁷ 49 CFR 523.5(a).

⁷⁸⁸ 49 CFR 523.5(a)(5)(ii).

of useable cargo-carrying volume in a vehicle when seats fold flat?

B. Issues that NHTSA has Observed Regarding Classification Based on “off-road capability”

1. Measuring Vehicle Characteristics for Off-Highway Capability

For a vehicle to qualify as off-highway capable, in addition to either having 4WD or a GVWR more than 6,000 pounds, the vehicle must also have four out of five characteristics indicative of off-highway operation. These characteristics include:⁷⁸⁹

- An approach angle of not less than 28 degrees
- A breakover angle of not less than 14 degrees
- A departure angle of not less than 20 degrees
- A running clearance of not less than 20 centimeters
- Front and rear axle clearances of not less than 18 centimeters each

NHTSA’s regulations require manufacturers to measure these characteristics when a vehicle is at its curb weight, on a level surface, with the front wheels parallel to the automobile’s longitudinal centerline, and the tires inflated to the manufacturer’s recommended cold inflation pressure.⁷⁹⁰ Given that the regulations describe the vehicle’s physical position and characteristics at time of measurement, NHTSA previously assumed that manufacturers would use physical measurements of vehicles. In practice, NHTSA has instead received from manufacturers a mixture of angles and dimensions from design models (*i.e.*, the vehicle as designed, not as actually produced) and/or physical vehicle measurements.⁷⁹¹ When appropriate, the agency will verify reported values by measuring production vehicles in the field. NHTSA currently requires that manufacturers must use physical vehicle measurements as the basis for values reported to the agency for purposes of vehicle classification. NHTSA seeks comment on whether regulatory changes are needed with respect to this issue.

2. Approach, Breakover, and Departure Angles

Approach angle, breakover angle, and departure angle are relevant to determining off-highway capability.

Large approach and departure angles ensure the front and rear bumpers and valance panels have sufficient clearance for obstacle avoidance while driving off-road. The breakover angle ensures sufficient body clearance from rocks and other objects located between the front and rear wheels while traversing rough terrain. Both the approach and departure angles are derived from a line tangent to the front (or rear) tire static loaded radius arc extending from the ground near the center of the tire patch to the lowest contact point on the front or rear of the vehicle. The term “static loaded radius arc” is based upon the definitions in SAE J1100 and J1544. The term is defined as the distance from wheel axis of rotation to the supporting surface (ground) at a given load of the vehicle and stated inflation pressure of the tire (manufacturer’s recommended cold inflation pressure).⁷⁹²

The static loaded radius arc is easy to measure, but the imaginary line tangent to the static loaded radius arc is difficult to ascertain in the field. The approach and departure angles are the angles between the line tangent to the static loaded radius arc, as explained above, and the level ground on which the test vehicle rests. Simpler measurements, that provide good approximations for the approach and departure angles, involve using a line tangent to the outside diameter or perimeter of the tire, or a line that originates at the geometric center of the tire contact patch, and extends to the lowest contact point on the front or rear of the vehicle. The first method provides an angle slightly greater than, and the second method provides an angle slightly less than, the angle derived from the true static loaded radius arc. When appropriate, the agency would like the ability to measure these angles in the field to verify data submitted by the manufacturers used to determine light truck classification decisions. The agency understands that the term static loaded radius arc is unclear to many manufacturers. NHTSA seeks comment on what the effect would be if we replaced reference to the “static loaded arc radius,” with simpler terms like, “outside perimeter of the tire,” or “geometric center of the tire contact patch.” NHTSA would consider using the outside perimeter of the tire as a reliable method for ensuring repeatability and reproducibility and accepts that the approach would provide slightly larger approach and departure angles, thereby making it slightly easier to qualify as “off-highway capable.”

3. Running Clearance

NHTSA regulations define “running clearance” as “the distance from the surface on which an automobile is standing to the lowest point on the automobile, excluding unsprung weight.”⁷⁹³ Unsprung weight includes the components (*e.g.*, suspension, wheels, axles and other components directly connected to the wheels and axles) that are connected and translate with the wheels. Sprung weight, on the other hand, includes all components fixed underneath the vehicle and translate with the vehicle body (*e.g.*, mufflers and subframes). To clarify these requirements, NHTSA previously issued a letter of interpretation stating that certain parts of a vehicle, such as tire aero deflectors, which are made of flexible plastic, bend without breaking, and return to their original position, would not count against the 20-centimeter running clearance requirement.⁷⁹⁴ The agency explained that this does not mean a vehicle with less than 20-centimeters running clearance could be elevated by an upward force bending the deflectors and then be considered as compliant with the running clearance criterion, as it would be inconsistent with the conditions listed in the introductory paragraph of 49 CFR 523.5(b)(2). Further, NHTSA explained that without a flexible component installed, the vehicle must meet the 20-centimeter running clearance along its entire underside. This 20-centimeter clearance is required for all sprung weight components.

The agency is aware of vehicle designs that incorporate rigid (*i.e.*, inflexible) air dams, valance panels, exhaust pipes, and other components, equipped as manufacturers’ standard or optional equipment (*e.g.*, running boards and towing hitches), that likely do not meet the 20-centimeter running clearance requirement. Despite these rigid features, it appears manufacturers are not taking these components into consideration when making measurements. Additionally, we believe some manufacturers may provide dimensions for their base vehicles without considering optional or various trim level components that may reduce the vehicle’s ground clearance. Consistent with our approach to other measurements, NHTSA believes that ground clearance, as well as all the other suspension criteria for a light

⁷⁸⁹ 49 CFR 523.5(b)(2).

⁷⁹⁰ *Id.*

⁷⁹¹ NHTSA previously encountered a similar issue when manufacturers reported CAFE footprint information. In the October 2012 final rule, NHTSA clarified manufacturers must submit footprint measurements based upon production values. 77 FR 63138 (October 15, 2012).

⁷⁹² 49 CFR 523.2.

⁷⁹³ *Id.*

⁷⁹⁴ See letter to Mark D. Edie, Ford Motor Company, July 30, 2012. Available online at [https://isearch.nhtsa.gov/files/11-000612%20M.Edie%20\(Part%20523\).htm](https://isearch.nhtsa.gov/files/11-000612%20M.Edie%20(Part%20523).htm) (last accessed February 2, 2018).

truck determination, should use the measurements from vehicles with all standard and optional equipment installed, at time of first retail sale. The agency reiterates that the characteristics listed in 49 CFR 523.5(b)(2) are characteristics indicative of off-highway capability. A fixed feature, such as an air dam, which does not flex and return to its original state, or an exhaust, which could detach, inherently interfere with the off-highway capability of these vehicles. If manufacturers seek to classify these vehicles as light trucks under 49 CFR 523.5(b)(2) and the vehicles do not meet the four remaining characteristics to demonstrate off-highway capability, they must be classified as passenger cars. NHTSA seeks comment on the incorporation of air dams, exhaust pipes, and other hanging component features—especially those that are inflexible—and whether the agency should consider amending its existing regulations to account for new vehicle designs.

4. Front and Rear Axle Clearance

NHTSA regulations also state that front and rear axle clearances of not less than 18 centimeters are another of the criteria that can be used for designating a vehicle as off-highway capable.⁷⁹⁵ The agency defines “axle clearance” as the vertical distance from the level surface on which an automobile is standing to the lowest point on the axle differential of the automobile.⁷⁹⁶

The agency believes this definition may be outdated because of vehicle design changes including axle system components and independent front and rear suspension components. In the past, traditional light trucks with and without 4WD systems had solid rear axles with center-mounted differentials on the axle. For these trucks, the rear axle differential was closer to the ground than any other axle or suspension system component. This traditional axle design still exists today for some trucks with a solid chassis (also known as body-on-frame configuration). Today, many SUVs and CUVs that qualify as light trucks are constructed with a unibody frame⁷⁹⁷ and have unsprung (e.g., control arms,

tie rods, ball joints, struts, shocks, etc.) and sprung components (e.g., the axle subframes) connected together as a part of the axle assembly. These unsprung and sprung components are located under the axles, making them lower to the ground than the axles and the differential, and were not contemplated when NHTSA established the definition and the allowable clearance for axles. The definition also did not originally account for 2WD vehicles with GVWRs greater than 6,000 pounds that had one axle without a differential, such as the model year 2018 Ford Expedition. Vehicles with axle components that are low enough to interfere with the vehicle’s ability to perform off-road would seem inconsistent with the regulation’s intent of ensuring off-highway capability, as Congress sought.

NHTSA seeks comment on whether (and if so, how) to revise the definition of axle clearance in light of these issues. NHTSA seeks comment on what unsprung axle components should be considered when determining a vehicle’s axle clearance. Should the definition be modified to account for axles without differentials? NHTSA also seeks comment on whether the axle subframes surrounding the axle components but affixed directly to the vehicle unibody, as sprung mass (lower to the ground than the axles) should be considered in the allowable running clearance discussed above. Finally, should NHTSA consider replacing both the running and axle clearance criteria with a single ground clearance criterion underneath the vehicle that impact a vehicle’s off road capability?

X. Compliance and Enforcement

A. Overview

The CAFE and CO₂ emissions standards are both fleet-average standards, but for both programs, determining compliance begins, conceptually, by testing vehicles on dynamometers in a laboratory over pre-defined test cycles under controlled conditions.⁷⁹⁸ A machine is connected

to the vehicle’s tailpipe while it performs the test cycle, which collects and analyzes the resulting exhaust gases; a vehicle that has no tailpipe emissions has its performance measured differently, as discussed below. CO₂ quantities, as one of the exhaust gases, can be evaluated directly for vehicles that produce CO₂ emissions directly. Fuel economy is determined from the amount of CO₂ emissions, because the two are directly mathematically related.⁷⁹⁹ Manufacturers generally perform their own testing, and EPA confirms and validates those results by testing some number of vehicles at the National Vehicle and Fuel Emissions Laboratory (NVFEL) in Ann Arbor, Michigan. The results of this testing form the basis for determining a manufacturer’s compliance in a given model year: Each vehicle model’s performance on the test cycles is calculated; that performance is multiplied by the number of vehicles of that model that were produced; that number, in turn, is averaged with the performance and production volumes of the rest of the vehicles in the manufacturer’s fleet to calculate the fleet’s overall performance. That performance is then compared against the manufacturer’s unique compliance obligation, which is the harmonic average of the fuel economy and CO₂ targets for the footprints of the vehicles in the manufacturer’s fleet, also harmonically averaged and production-weighted. Using fuel economy targets to illustrate the concept, the following figure shows two vehicle models produced in a model year for which passenger cars are subject to a fuel economy target function that extends from about 30 mpg for the largest cars to about 41 mpg for the smallest cars:

“programs” are the “urban cycle,” or Federal Test Procedure (abbreviated as “FTP”) and the “highway cycle,” or Highway Fuel Economy Test (abbreviated as “HFET”), and they have not changed substantively since 1975. Each cycle is a designated speed trace (of vehicle speed versus time) that all certified vehicles must follow during testing—the FTP is meant to roughly simulate stop and go city driving, and the HFET is meant to roughly simulate steady flowing highway driving at about 50 mph.

⁷⁹⁹ Technically, for the CAFE program, carbon-based tailpipe emissions (including CO₂, CH₄, and CO) are measured and fuel economy is calculated using a carbon balance equation. EPA uses carbon-based emissions (CO₂, CH₄, and CO, the same as for CAFE) to calculate tailpipe CO₂ equivalent for the tailpipe portion of its standards.

⁷⁹⁵ 49 CFR 523.5(b)(2)(v).

⁷⁹⁶ 49 CFR 523.3.

⁷⁹⁷ Unibody frames integrate the frame and body components into a combined structure.

⁷⁹⁸ For readers unfamiliar with this process, it is not unlike running a car on a treadmill following a program—or more specifically, two programs. 49 U.S.C. 32904(c) states that EPA must “use the same procedures for passenger automobiles [that EPA] used for model year 1975 (weighted 55 percent urban cycle and 45 percent highway cycle), or procedures that give comparable results.” Thus, the

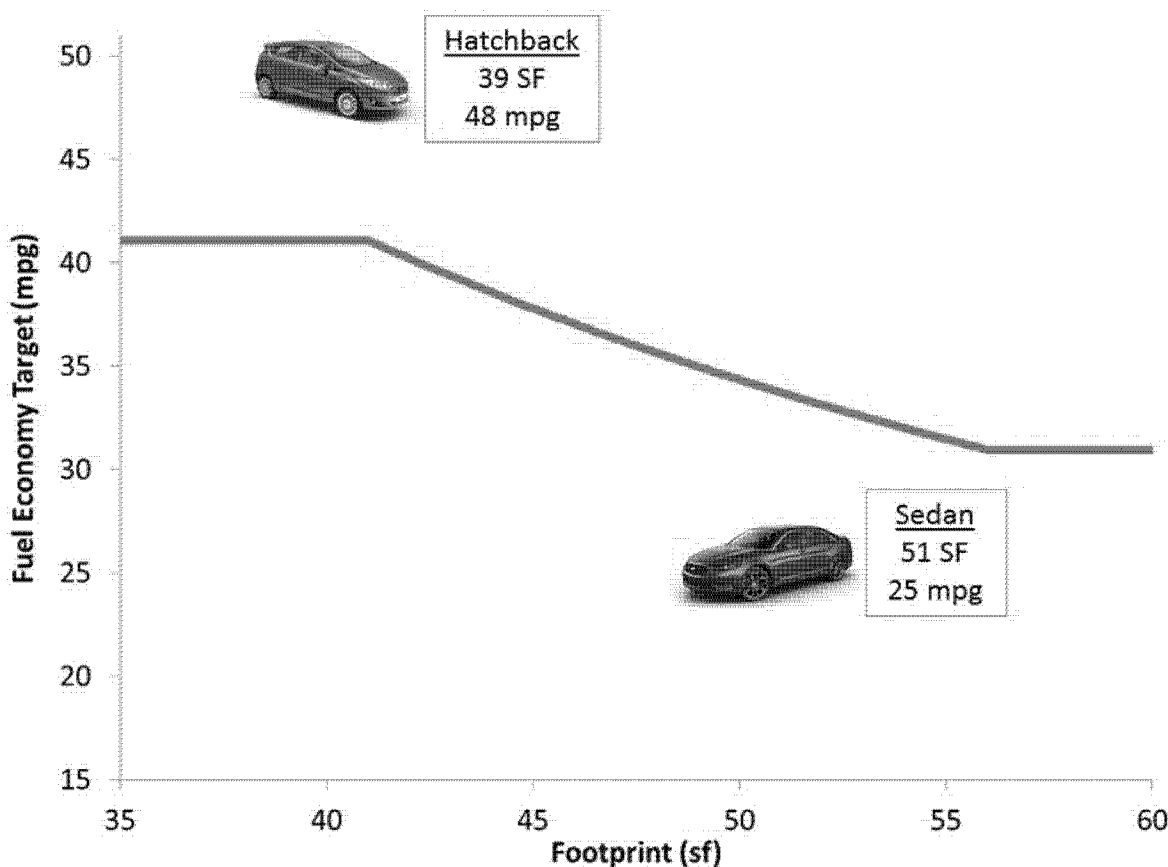

Figure X-1 - Illustration of Vehicle Models vs. Fuel Economy Targets

If these are the only two vehicles the manufacturer produces, the manufacturer's required CAFE level is determined by calculating the sales-weighted harmonic average of the targets applicable at the hatchback and sedan footprints (about 41 mpg for the hatchback and about 33 mpg for the sedan), and the manufacturer's achieved CAFE level is determined by calculating the sales-weighted harmonic average of the hatchback and sedan fuel economy levels (48 mpg for the hatchback and 25 mpg for the sedan). Depending on the relative mix of hatchbacks and sedans the manufacturer produces, the manufacturer produces a fleet for which the required and achieved levels are equal, or produce a fleet that either earns (if required CAFE is less than achieved CAFE) or applies (if required CAFE is greater than achieved CAFE) CAFE credits. Although the arithmetic is different for CO₂ standards (which do not involve harmonic averaging), the concept is the same.

There are thus two parts to the foundation of compliance with CAFE and CO₂ emissions standards: First, how well any given vehicle model performs

relative to its target, and second, how many of each vehicle model a manufacturer sells. While no given model need precisely meet its target (and virtually no model exactly meets its target in the real world), if a manufacturer finds itself producing and selling large numbers of vehicles that fall well short of their targets, it will have to find a way of offsetting that shortfall, either by increasing production of vehicles that exceed their targets, or by taking advantage of compliance flexibilities. Given that manufacturers typically need to sell vehicles that consumers want to buy, their options for pursuing the former approach can often be limited.

The CAFE and CO₂ programs both offer a number of compliance flexibilities, discussed in more detail below. Some flexibilities are provided for by statute, and some have been implemented voluntarily by the agencies through regulations. Compliance flexibilities for the CAFE and CO₂ programs have a great deal of theoretical attractiveness: If properly constructed, they can help to reduce overall regulatory costs while

maintaining or improving programmatic benefits. If poorly constructed, they may create significant potential for market distortion (for instance, when manufacturers, in response to an incentive to deploy a particular type of technology, produce vehicles for which there is no natural market, such vehicles must be discounted below their cost in order to sell).⁸⁰⁰ Use of compliance flexibilities without sufficient transparency may complicate the ability to understand manufacturers' paths to compliance. Overly-complicated flexibility programs can result in greater

⁸⁰⁰ Manufacturers are currently required by the state of California to produce certain percentages of their fleets with certain types of technologies, partly in order to help California meet self-imposed GHG reduction goals. While many manufacturers publicly discuss their commitment to these technologies, consumer interest in them thus far remains low despite often-large financial incentives from both manufacturers and the Federal and State governments in the form of tax credits. It is questionable whether continuing to provide significant compliance incentives for technologies that consumers appear not to want is an efficient means to achieve either compliance or national goals (see, e.g., Congress' phase-out of the AMFA dual-fueled vehicle incentive in EISA, 49 U.S.C. 32906).

expenditure of both private sector and government resources to track, account for, and manage. Moreover, targeting flexibilities toward specific technologies could theoretically distort the market. By these means, compliance flexibilities could create an environment in which entities are encouraged to invest in such government-favored technologies and, unless those technologies are independently supported by market forces, encourage rent seeking in order to protect, preserve, and enhance profits that are parasitic on the distortions created by government mandate.

Further, to the extent that there is a market demand for vehicles with lower CO₂ emissions and higher fuel economy, compliance flexibilities may create competitive disadvantages for some manufacturers if they become overly reliant on flexibilities rather than simply improving their vehicles to meet that market demand.

If standards are set at levels that are appropriate/maximum feasible, then the need for extensive compliance flexibilities should be low. Comment is sought on whether and how each agency's existing flexibilities might be amended, revised, or deleted to avoid

these potential negative effects. Specifically, comment is sought on the appropriate level of compliance flexibility, including credit trading, in a program that is correctly designed to be both appropriate and feasible. Comment is sought on allowing all incentive-based adjustments to expire except those that are mandated by statute, among other possible simplifications to reduce market distortion, improve program transparency and accountability, and improve overall performance of the compliance programs.

Table X-1 – Credit mechanisms for overcompliance with standards

	NHTSA			EPA		
	Authority	Current Program	NPRM	Authority	Current Program	NPRM
Earning	49 U.S.C. 32903(a)	Yes, denominated in tenths of a mpg	No change	CAA 202(a)	Yes, denominated in g/mi	No change
“Carry-forward”	49 U.S.C. 32903(a)(2)	5 MYs into the future	No change	CAA 202(a)	5 MYs into the future (except MYs 2010-2015 = credits may be carried forward through MY 2021)	seeking comment on extending carry-forward beyond 5 years or indefinitely
“Carry-back” (AKA “deficit carry-forward”)	49 U.S.C. 32903(a)(1)	3 MYs into the past	No change	CAA 202(a)	3 MYs into the past	No change
Transfer	49 U.S.C. 32903(g)	Up to 2 mpg per fleet; transferred credits may not be used to meet min DPC standard	No change; seeking comment on Alliance/Global request to reconsider prior interpretation	CAA 202(a)	Unlimited	No change
Trading	49 U.S.C. 32903(f)	Unlimited quantity; traded credits may not be used to meet min DPC standard	No change; seeking comment on eliminating	CAA 202(a)	Unlimited	No change

Table X-2 - Incentives that address gaps in compliance test procedures

Regulatory item	NHTSA			EPA		
	Authority	Current Program	NPRM	Authority	Current Program	NPRM
A/C efficiency		Allows mfrs to earn “fuel consumption improvement values” (FCIVs) equivalent to EPA credits starting in MY 2017	No change; seeking comment on eliminating; seeking comment on Alliance/Global request to allow retroactive starting in MY 2012 (propose to deny)	CAA 202(a)	“Credits” for A/C efficiency improvements up to caps of 5.0 g/mi for cars and 7.2 g/mi for trucks	Seeking comment on combining A/C efficiency menu items and thermal technologies menu items; seeking comment on adding combined caps of 8 g/mi for cars and 11.5 g/mi for trucks (thermal efficiency technologies are currently capped under the off-cycle menu at 10 g/mi)

Off-cycle		Allows mfrs to earn “fuel consumption improvement values” (FCIVs) equivalent to EPA credits starting in MY 2017	No change; seeking comment on eliminating; seeking comment on Alliance/Global request to allow retroactive starting in MY 2012 (propose to deny)	CAA 202(a)	“Menu” of pre-approved credits (~10), up to cap of 10 g/mi for MY 2014 and beyond; other pathways require EPA approval through either 5-cycle testing or through public notice and comment	Seeking comment on expanding to include: 2 new techs for menu (high efficiency alternators and advanced A/C compressors), increasing cap to 15 g/mi, ‘streamlining’ approval process, adding other techs to menu, updating menu values, allowing suppliers to seek approval (rather than just OEMs)
-----------	--	---	--	------------	--	---

Table X-3 - Incentives that encourage application of technologies

Pickup trucks		Allows mfrs to earn FCIVs equivalent to EPA credits starting in MY 2017	No change; seeking comment on extending availability of incentive past current expiration date	CAA 202(a)	10 g/mi for full-size pickups with mild hybrids OR overperforming target by 15% (MYs 2017-2021); 20 g/mi for full-size pickups with strong hybrids OR overperforming target by 20% (MYs 2017-2025)	Seeking comment on extending/expanding incentives to all light trucks and to passenger cars
---------------	--	---	--	------------	--	---

Table X-4 - Incentives that encourage alternative fuel vehicles

Dedicated alternative fuel vehicle	49 U.S.C. 32905(a) and (c)	Fuel economy calculated assuming gallon of liquid/gaseous alt fuel = 0.15 gallons of gasoline; for Evs, petroleum equivalency factor	No change	CAA 202(a)	Multiplier incentives for EVs, FCVs, NGVs (each vehicle counts as 2.0 vehicles); each EV = 0 g/mi upstream emissions through MY 2021 (then phases out based on per-mfr production cap of 200k vehicles)	Seeking comment on extending/expanding multipliers and on additional incentives for NGVs; seeking comment on extending 0 g/mi factor for upstream emissions
------------------------------------	----------------------------	--	-----------	------------	---	---

Dual-fueled vehicles	49 U.S.C. 32905(b), (d), and (e); 32906(a)	Alt fuel operation FE calc as above through MY 2019. Starting with MY 2020, NHTSA will begin using the SAE defined "Utilify Factor" methodology to account for actual potential use. However, NHTSA will continue to incorporate the 0.15 incentive factor that was intended by Congress.	no change	CAA 202(a)	Multiplier incentives for PHEVs (each vehicle counts as 1.5 vehicles); electric operation = 0 g/mi through MY 2021 (then phases out based on per-mfr production cap of 200k vehicles)	Seeking comment on extending/expanding multipliers and on additional incentives for NGVs; seeking comment on extending 0 g/mi
Connected/ Automated Vehicles				CAA 202(a)	Mfrs can petition for off-cycle credits	Seeking comment on providing new incentives
High octane fuel blends				CAA 202(a)		Seeking comment on if and how EPA could support the production and use of higher octane gasoline consistent with Title II of the CAA

BILLING CODE 4910-59-C

It is further noted that compliance is a measure of how a manufacturer's fleet performance compares to *its individual* compliance obligation and is generally not a measure of how the manufacturer's fleet performance compares to other manufacturers' fleets or to some industry-wide number.⁸⁰¹ This is because the standards are attribute-based, per Congress (in the case of CAFE, at least), rather than a single "flat" mpg or g/mi number which

each manufacturer's fleet must meet. This means that a manufacturer can produce, for example, much larger-footprint vehicles than it was expected to produce when the standards (*i.e.*, the curves) were set and still be in compliance because its fleet performance is better than its compliance obligation given the footprints of the vehicles it ended up producing. This also means that a manufacturer can produce plenty of small-footprint vehicles and still fall short of its compliance obligation if enough of its vehicles fall below their targets and the manufacturer has no other way of making up the shortfall.

Whether the vehicles a manufacturer produces are large or small therefore has no impact on compliance—compliance depends, instead, on the performance of a manufacturer's vehicles relative to their targets, averaged across the fleet as a whole.

The following sections discuss NHTSA's compliance and enforcement program, EPA's compliance and enforcement program, and seek comment on a variety of options with respect to the compliance flexibilities currently available under each program. More broadly, the agencies are taking the opportunity with this rulemaking to seek comment and suggestions relating

⁸⁰¹ The exception is the CAFE program's minimum standard for domestically-manufactured passenger cars, see Section III and V above and 49 U.S.C. 32902.

to the current flexibilities allowed under the existing CAFE and tailpipe CO₂ programs (including eliminating or expanding existing flexibilities). The agencies also seek comment on several outstanding petitions relating to existing or newly-proposed flexibilities, and the current credit trading system.

B. NHTSA Compliance and Enforcement

NHTSA's CAFE enforcement program is largely dictated by statute. As discussed earlier in this notice, each vehicle manufacturer is subject to separate CAFE standards for passenger cars and light trucks, and for the passenger car standards, a manufacturer's domestically-manufactured and imported passenger car fleets are required to comply separately.⁸⁰² Additionally, domestically-manufactured passenger cars are subject to the statutory minimum standard.⁸⁰³

EPA calculates the fuel economy level of each fleet produced by each manufacturer, and transmits that information to NHTSA;⁸⁰⁴ that calculation includes adjustments to the fuel economy of individual vehicles depending on whether they have certain incentivized technologies.⁸⁰⁵ Manufacturers also report early product projections to NHTSA per EPCA's reporting requirements, and NHTSA relies upon both this manufacturer data and EPA-validated data to conduct its own enforcement of the CAFE program. NHTSA also periodically releases public reports through its CAFE Public Information Center (PIC) to share recent CAFE program data.⁸⁰⁶

NHTSA then determines the manufacturer's compliance with each applicable standard and notifies manufacturers if any of their fleets have fallen short. Manufacturers have the option of paying civil penalties on any shortfall or can submit credit plans to NHTSA. Credits can either be earned or purchased and can be used either in the year they were earned or in several

years prior and following, subject to various statutory constraints.

EPCA and EISA specify several flexibilities that are available to help manufacturers comply with CAFE standards. Some flexibilities are defined by statute—for example, while Congress required that NHTSA allow manufacturers to transfer credits earned for over-compliance from their car fleet to their truck fleet and vice versa, Congress also limited the amount by which manufacturers could increase their CAFE levels using those transfers.⁸⁰⁷ NHTSA believes Congress balanced the energy-saving purposes of the statute against the benefits of certain flexibilities and incentives and intentionally placed some limits on certain statutory flexibilities and incentives. NHTSA has done its best in crafting the credit transfer and trading regulations authorized by EISA to ensure that total fuel savings are preserved when manufacturers exercise their statutorily-provided compliance flexibilities.

NHTSA and EPA have previously developed other compliance flexibilities for the CAFE program under EPA's EPCA authority to calculate manufacturer's fuel economy levels. As finalized in the 2012 final rule for MYs 2017 and beyond, EPA provides manufacturers "credits" under EPA's program and fuel economy "adjustments" or "improvement values" under NHTSA's program for: (1) Technologies that cannot be measured on the 2-cycle test procedure, *i.e.*, "off-cycle" technologies; and (2) air conditioning (A/C) efficiency improvements that also improve fuel economy that cannot be measured on the 2-cycle test procedure. Additionally, the programs give manufacturers compliance incentives for utilizing "game changing" technologies on pickup trucks, such as pickup truck hybridization.

The following sections outline how NHTSA determines whether manufacturers are in compliance with the CAFE standards for each model year, and how manufacturers may use compliance flexibilities to comply, or address non-compliance by paying civil penalties. As mentioned above, some compliance flexibilities are prescribed by statute and some are implemented through EPA's EPCA authority to measure fuel economy, such as fuel consumption improvement values for air conditioning efficiency and off-cycle technologies. This proposal includes language updating and clarifying existing regulatory text in this area.

Comment is sought on these changes, as well as on the general efficacy of these flexibilities and their role in the fuel economy and GHG programs.

Moreover, the following sections explain how manufacturers submit data and information to the agency—NHTSA is proposing to implement a new standardized template for manufacturers to use to submit CAFE data to the agency, as well as standardized templates for reporting credit transactions. Additionally, NHTSA is proposing to add requirements that specify the precision of the fuel savings adjustment factor in 49 CFR 536.4. These new proposals are intended to streamline reporting and data collection from manufacturers, in addition to helping the agency use the best available data to inform CAFE program decision making.

Finally, NHTSA provides an overview of CAFE compliance data for MYs 2011 through 2018 to demonstrate how manufacturers have responded to the progressively increasing CAFE standards for those years. NHTSA believes that providing this data is important because it gives the public a better understanding of current compliance trends and the potential impacts that CAFE compliance in those model years may have on the future model years addressed by this rulemaking.

This is, of course, only an overview description of CAFE compliance. NHTSA also granted a petition for rulemaking in 2016 requesting a number of changes to compliance-related topics.⁸⁰⁸ The responses to those requests are discussed below. In general, there is a tentatively decision to deny most of the Alliance and Global's requests as discussed in the sections that follow. Comment is sought on these tentative decisions, including what impact granting any of these individual requests could have on effective stringency and compliance pathways.

1. Light-Duty CAFE

(a) How does NHTSA determine compliance?

(1) Manufacturers Submit Data to NHTSA and EPA Facilitates CAFE Testing

EPCA, as amended by EISA, requires a manufacturer to submit reports to the Secretary of Transportation explaining whether the manufacturer will comply with an applicable CAFE standard for the model year for which the report is made; the actions a manufacturer has taken or intends to take to comply with

⁸⁰² 49 U.S.C. 32904(b).

⁸⁰³ 49 U.S.C. 32902(b)(4).

⁸⁰⁴ 49 U.S.C. 32904(c)–(e). EPCA granted EPA authority to establish fuel economy testing and calculation procedures; EPA uses a two-year early certification process to qualify manufacturers to start selling vehicles, coordinates manufacturer testing throughout the model year, and validates manufacturer-submitted final test results after the close of the model year.

⁸⁰⁵ For example, alternative fueled vehicles get special calculations under EPCA (49 U.S.C. 32905–32906), and fuel economy levels can also be adjusted to reflect air conditioning efficiency and "off-cycle" improvements, as discussed below.

⁸⁰⁶ NHTSA CAFE Public Information Center, https://one.nhtsa.gov/cafe_pic/CAFE_PIC_Home.htm.

⁸⁰⁷ See 49 U.S.C. 32903(g).

⁸⁰⁸ 81 FR 95553 (Dec. 28, 2016).

the standard; and other information the Secretary requires by regulation.⁸⁰⁹ A manufacturer must submit a report containing the above information during the 30-day period before the beginning of each model year, and during the 30-day period beginning the 180th day of the model year.⁸¹⁰ When a manufacturer decides it is unlikely to comply with its CAFE standard, the manufacturer must report additional actions it intends to take to comply and include a statement about whether those actions are sufficient to ensure compliance.⁸¹¹

To implement these reporting requirements, NHTSA issued 49 CFR part 537, “Automotive Fuel Economy Reports,” which specifies three types of CAFE reports that manufacturers must submit to comply. Manufacturers must first submit a pre-model year (PMY) report containing a manufacturer’s projected compliance information for that upcoming model year. The PMY report must be submitted before December 31st of the calendar year prior to the corresponding model year. Manufacturers must then submit a mid-model year (MMY) report containing updated information from manufacturers based upon actual and projected information known midway through the model year. The MMY report must be submitted by July 31 of the given model year. Finally, manufacturers must submit a supplementary report anytime the manufacturer needs to correct previously submitted information.

Manufacturers submit both non-confidential and confidential versions of CAFE reports to NHTSA. Confidential reports differ in that they include estimated production sales information that is withheld from public disclosure to protect each manufacturer’s competitive sales strategies.

Manufacturer reports include information on light-duty automobiles and medium-duty passenger vehicles for each model year and describe projected and actual fuel economy standards, fuel economy performance values, production volumes, information on vehicle design features (e.g., engine displacement and transmission class), and other vehicle attribute characteristics (e.g., track width, wheelbase, and other off-road features for light trucks). Beginning with MY 2017, manufacturers may also provide projected information on any air-conditioning (A/C) systems with improved efficiency, off-cycle technologies (e.g., stop-start systems),

and any hybrid/electric full-size pickup truck technologies used each model year to calculate the average fuel economy specified in 40 CFR 600.510–12(c). Manufacturers identify the makes and model types⁸¹² equipped with each technology, which compliance category those vehicles belong to, and the associated fuel economy adjustment value for each technology. In some cases, NHTSA may require manufacturers to provide supplemental information to justify or explain the benefits of these technologies. NHTSA requires manufacturers to provide detailed information on the model types using these technologies to gain fuel economy benefits. These details are necessary to facilitate NHTSA’s technical analyses and to ensure the agency can perform random enforcement audits when necessary.

NHTSA uses PMY, MMY, and supplemental reports to help the agency and manufacturers anticipate potential compliance issues as early as possible, and help manufacturers plan compliance strategies. NHTSA also uses the reports for auditing purposes, which helps manufacturers correct errors prior to the end of the model year and accordingly, submit accurate final reports to EPA. Additionally, NHTSA issues public reports twice a year that provide a summary of manufacturers’ final and projected fleet fuel economy performances values.

Throughout the model year, NHTSA also conducts vehicle testing as part of its footprint validation program, to confirm the accuracy of track width and wheelbase measurements submitted in manufacturer’s reports.⁸¹³ This helps the agency better understand how manufacturers may adjust vehicle characteristics to change a vehicle’s footprint measurement, and thus its fuel economy target.

NHTSA ultimately determines a manufacturer’s compliance based on CAFE data EPA receives in final model year reports. EPA verifies the information, accounting for NHTSA and EPA testing, and forwards the information to NHTSA. A manufacturer’s final model year report must be submitted to EPA no later than 90 days after December 31 of the model year.

⁸¹² NHTSA collects model type information based upon the EPA definition for “model type” in 40 CFR 600.002.

⁸¹³ U.S. Department of Transportation, NHTSA, Laboratory Test Procedure for 49 CFR part 537, Automobile Fuel Economy Attribute Measurements (Mar. 30, 2009), available at <http://www.nhtsa.gov/DOT/NHTSA/Vehicle%20Safety/Test%20Procedures/Associated%20Files/TP-537-01.pdf>.

(2) Proposed Changes to CAFE Reporting Requirements

NHTSA is proposing changes to CAFE reporting requirements with the intent to streamline reporting and data collection from manufacturers, in addition to helping the agency use the best available data to inform CAFE program decision-making. The agency requests comments on the following reporting requirements.

(i) Standardized CAFE Report Templates

In a 2015 rulemaking, NHTSA proposed to amend 49 CFR part 537 to require a new data format for light-duty vehicle CAFE reports.⁸¹⁴ NHTSA introduced a new standardized template for collecting manufacturer’s CAFE information under 49 CFR 537.7(b) and (c) in order to ensure the accuracy and completeness of data collected and to better align with the final data provided to EPA. NHTSA explained that for MYs 2013–2015, most manufacturer reports NHTSA received did not conform to all of the requirements specified in 49 CFR part 537. For example, NHTSA identified several instances where manufacturers’ CAFE reports included “yes” or “no” values in response to requests for a vehicle’s *numerical* ground clearance values.

Some manufacturers contend that the changes in reporting requirements may be one source of confusion. NHTSA is aware that manufacturers seem to be confused about what footprint data is required because of the modification to the base tire definition⁸¹⁵ in the 2012 final rule for MYs 2017 and beyond. Specifically, these manufacturers fail to understand the required reporting information for model types based upon footprint values. Beginning in MY 2013, manufacturers were to provide attribute-based target standards in consideration of the change in the base tire definition for each unique model type and footprint combination of the manufacturer’s automobiles. NHTSA has found cases where manufacturers did not aggregate their model types by each unique footprint combination. Likewise, NHTSA found other errors in manufacturers’ vehicle information submissions. A review of the MY 2015 PMY reports showed that several manufacturers provided the required information incorrectly.

Problems with inaccurate or missing data have become an even greater issue for manufacturers planning to use the new procedures for A/C efficiency and off-cycle technologies, and incentives

⁸¹⁴ 80 FR 40540 (Jul. 13, 2015).

⁸¹⁵ 49 CFR 523.2.

⁸⁰⁹ 49 U.S.C. 32907(a).

⁸¹⁰ *Id.*

⁸¹¹ *Id.*

for advanced full-sized pickup trucks.⁸¹⁶ Manufacturers seeking to take advantage of the new procedures and incentives must provide information on the model types equipped with the technologies. However, NHTSA has identified and contacted several manufacturers that have failed to submit the required information in their 2017 and 2018 PMY reports.

Therefore, as part of this rulemaking, NHTSA is proposing to adopt a standardized template for reporting all required data for PMY, MMY, and supplemental CAFE reports. The template will be available through the CAFE Public Information Center (PIC) website. NHTSA is also proposing to make the PMY and MMY reports exactly the same; many manufacturers already submit PMY reports and then update the MMY reports with the same type of information. NHTSA believes that this approach will further simplify reporting for manufacturers. Further, NHTSA is expanding its CAFE reporting requirements for manufacturers to provide additional vehicle descriptors, common EPA carline codes, and more information on emerging technologies. Additional data columns will be included in the reporting template for manufacturers to identify these emerging technologies.

NHTSA believes adopting a standardized template will ensure manufacturers provide the agency with all the necessary data in a simpler, compliant format. The template would organize the required data in a standardized and consistent manner, adopt formats for values consistent with those provided to EPA, and calculate manufacturer's target standards. This will also help NHTSA code CAFE electronic data for use in the agency's electronic database system. Overall, these changes are anticipated to drastically reduce manufacturer and government burden for reporting under both EPCA/EISA and the Paperwork Reduction Act.⁸¹⁷

NHTSA seeks comment on the use of a standardized reporting template, or on any possible changes to the proposed standardized template, which is located in NHTSA's docket for review. Information on fuel consumption improvement technologies (*i.e.*, off-cycle) in the template will be collected at the vehicle model type level. NHTSA plans to revise the template as part of the Paperwork Reduction Act process.

⁸¹⁶ NHTSA allows manufacturers to use these incentives for complying with standards starting in MY 2017.

⁸¹⁷ 44 U.S.C. 3501 *et seq.*

(ii) Standardized Credit Trade Documents

A credit trade is defined in 49 CFR 536.3 as the receipt by NHTSA of an instruction from a credit holder to place its credits in the account of another credit holder. Traded credits are moved from one credit holder to the recipient credit holder within the same compliance category for which the credits were originally earned. If a credit has been traded to another credit holder and is subsequently traded back to the originating manufacturer, it will be deemed not to have been traded for compliance purposes. NHTSA does not administer trade negotiations between manufacturers and when a trade document is received the agreement must be issued jointly by the current credit holder and the receiving party. NHTSA does not settle contractual or payment issues between trading manufacturers.

NHTSA created its CAFE database to maintain credit accounts for manufacturers and to track all credit transactions. Credit accounts consist of a balance of credits in each compliance category and vintage held by the holder. While maintaining accurate credit records is essential, it has become a challenging task for the agency given the recent increase in credit transactions. Manufacturers have requested NHTSA approve trade or transfer requests not only in response to end-of-model year shortfalls but also during the model year when purchasing credits to bank for future model years.

To reduce the burden on all parties, encourage compliance, and facilitate quicker NHTSA credit transaction approval, the agency is proposing to add a required template to standardize the information parties submit to NHTSA in reporting a credit transaction. Presently, manufacturers are inconsistent in submitting the information required by 49 CFR 536.8, creating difficulty for NHTSA in processing transactions. The template NHTSA is proposing is a simple spreadsheet that trading parties fill out. When completed, parties will be able to click a button on the spreadsheet to generate a transaction letter for the parties to sign and submit to NHTSA, along with the spreadsheet. Using this template simplifies the credit transaction process, and ensures that trading parties are following the requirements for a credit transaction in 49 CFR 536.8(a).⁸¹⁸

Additionally, the template includes an acknowledgement of the fraud/error

⁸¹⁸ Submitting a properly completed template and accompanying transaction letter will satisfy the trading requirements in 49 CFR part 536.

provisions in 49 CFR 536.8(f), and the finality provisions of 49 CFR 536.8(g). NHTSA seeks comment on this approach, as well as on any changes to the template that may be necessary to better facilitate manufacturer credit transaction requests. The agency's proposed template is located in NHTSA's docket for review. The finalized template would be available on the CAFE PIC site for manufacturers to use.

(iii) Credit Transaction Information

Though entities are permitted to trade CAFE credits, there is limited public information available on credit transactions.⁸¹⁹ As discussed earlier, NHTSA maintains an online CAFE database with manufacturer and fleetwide compliance information that includes year-by-year accounting of credit balances for each manufacturer. While NHTSA maintains this database, the agency's regulations currently state that it does not publish information on individual transactions,⁸²⁰ and historically, NHTSA has not required trading entities to submit information regarding the compensation (whether financial, or in terms of other credits) manufacturers receive in exchange for credits.⁸²¹ Thus, NHTSA's public database offers sparse information to those looking to determine the value of a credit.

The lack of information regarding credit transactions means entities wishing to trade credits have little, if any, information to determine the value of the credits they seek to buy or sell. It is widely assumed that the civil penalty for noncompliance with CAFE standards largely determines the value of a credit, because it is logical to assume that manufacturers would not purchase credits if it cost less to pay noncompliance penalties instead, but it is unknown how other factors affect the value. For example, a credit nearing the end of its five-model-year lifespan would theoretically be worth less than a credit with its full five-model-year lifespan remaining. In the latter case, the credit holder would value the credit more, as it can be used for a longer period of time.

In the interest of facilitating a transparent, efficient credit trading

⁸¹⁹ Manufacturers may generate credits, but non-manufacturers may also hold or trade credits. Thus, the word "entities" is used to refer to those that may be a party to a credit transaction.

⁸²⁰ 49 CFR 536.5(e)(1).

⁸²¹ NHTSA understands that not all credits are exchanged for monetary compensation. If NHTSA were to require entities to report compensation exchanged for credits, it would not be limited to reporting monetary compensation.

market, NHTSA is considering modifying its regulations to require trading parties to submit the amount of compensation exchanged for credits, in addition to the parties trading and the number of credits traded in a transaction. NHTSA is considering amending its regulations to permit the agency to publish information on these specific transactions. NHTSA seeks comment on requiring these disclosures when trades occur.

(iv) Precision of the CAFE Credit Adjustment Factor

EPCA, as amended by EISA, required the Secretary of Transportation to establish an adjustment factor to ensure total oil savings are preserved when manufacturers trade credits.⁸²² The adjustment factor applies to credits traded between manufacturers and to credits transferred across a manufacturer’s compliance fleets.

In establishing the adjustment factor, NHTSA did not specify the exact precision of the output of the equation in 49 CFR 536.4(b). NHTSA’s standard practice has been round to the nearest four decimal places (e.g., 0.0001) for the adjustment factor. However, in the absence of a regulatory requirement, many manufacturers have contacted NHTSA for guidance, and NHTSA has had to correct several credit transaction requests. In some instances, manufacturers have had to revise signed credit trade documents and submit additional trade agreements to properly address credit shortages.

NHTSA is proposing to add requirements to 49 CFR 536.4 specifying the precision of the adjustment factor by rounding to four decimal places (e.g., 0.0001). NHTSA has also included equations for the adjustment factor in its proposed credit transaction report template, mentioned above, with the same level of precision. NHTSA seeks comment on this approach.

(3) NHTSA Then Analyzes EPA-Certified CAFE Values for Compliance

After manufacturers complete certification testing and submit their

final compliance values to EPA, EPA verifies the data and issues final CAFE reports to manufacturers and NHTSA. NHTSA then identifies the manufacturers’ compliance categories (i.e., domestic passenger car, imported passenger car, and light truck fleets) that do not meet the applicable CAFE standards. NHTSA uses EPA-verified data to compare fleet average standards with actual fleet performance values in each compliance category. Each vehicle a manufacturer produces has a fuel economy target based on its footprint (footprint curves are discussed above in Section II.C), and each compliance category has a CAFE standard measured in miles per gallon (mpg). If a vehicle exceeds its target, it is a “credit generator,” if it falls short of its target, it is a “credit loser.” Averaging these vehicles across a compliance category, accounting for volume, equals a fleet average. A manufacturer complies with NHTSA’s fuel economy standard if its fleet average performance is greater than or equal to its required standard, or if it is able to use available compliance flexibilities, described below in Section X.B.1.e., to resolve any shortfall.

If the average fuel economy level of the vehicles in a compliance category falls below the applicable fuel economy standard, NHTSA provides written notification to the manufacturer that it has not met that standard. The manufacturer is required to confirm the shortfall and must either submit a plan indicating how it will allocate existing credits, or if it does not have sufficient credits available in that fleet, how it will earn, transfer and/or acquire credits, or pay the appropriate civil penalty. The manufacturer must submit a credit allocation plan or payment within 60 days of receiving agency notification.

NHTSA approves a credit allocation plan unless it finds the proposed credits are unavailable or that it is unlikely that the plan will result in the manufacturer earning sufficient credits to offset the projected shortfall. If a plan is approved, NHTSA revises the manufacturer’s credit account accordingly. If a plan is

rejected, NHTSA notifies the manufacturer and requests a revised plan or payment of the appropriate penalty. Similarly, if the manufacturer is delinquent in submitting a response within 60 days, NHTSA takes action to immediately collect a civil penalty. If NHTSA receives and approves a manufacturer’s plan to carryback future earned credits within the following three years in order to comply with current regulatory obligations, NHTSA will defer levying fines for non-compliance until the date(s) when the manufacturer’s approved plan indicates that the credits will be earned or acquired to achieve compliance. If the manufacturer fails to acquire or earn sufficient credits by the plan dates, NHTSA will initiate non-compliance proceedings.⁸²³

In the event that a manufacturer does not comply with a CAFE standard even after the consideration of credits, EPCA provides that the manufacturer is liable for a civil penalty.⁸²⁴ Presently, this penalty rate is set at \$5.50 for each tenth of a mpg that a manufacturer’s average fuel economy falls short of the standard for a given model year multiplied by the total volume of those vehicles in the affected compliance category manufactured for that model year.⁸²⁵ All penalties are paid to the U.S. Treasury and not to NHTSA itself.

(4) Civil Penalties for Non-Compliance

A manufacturer is liable to the Federal government for a civil penalty if it does not comply with its applicable average fuel economy standard, after considering credits available to the manufacturer.⁸²⁶

As previously mentioned, the potential civil penalty rate is currently \$5.50 for each tenth of a mpg that a manufacturer’s average fuel economy falls short of the average fuel economy standard for a model year, multiplied by the total volume of those vehicles in the compliance category.

$$\text{Potential Civil Penalty} = \$5.50 \times (\text{Avg. FE Performance} - \text{Avg. FE Standard}) \times 10 \times \text{Total Production}$$

Since the inception of the CAFE program, NHTSA has collected a total of \$890,427,578 in CAFE civil penalty

payments. Generally, import manufacturers have paid significantly more in civil penalties than domestic

manufacturers, with the majority of payments made by import manufacturers for passenger cars and

⁸²² 49 U.S.C. § 32903(f)(1).

⁸²³ See generally 49 CFR part 536.

⁸²⁴ 49 U.S.C. § 32912.

⁸²⁵ NHTSA proposed retaining the \$5.50 civil penalty rate in an April 2018 NPRM. See 83 FR 13904 (Apr. 2, 2018).

⁸²⁶ 49 U.S.C. §§ 32911–12.

not light trucks. Import passenger car manufacturers paid a total of \$890,057,188 in CAFE fines while domestic manufacturers paid a total of \$370,390.

Prior to the CAFE credit trade and transfer program, several manufacturers opted to pay civil penalties instead of complying with CAFE standards. Since NHTSA introduced trading and transferring, manufacturers have largely traded or transferred credits in lieu of paying civil penalties. NHTSA assumes that buying and selling credits is a more cost-effective strategy for manufacturers than paying civil penalties, in part because it seems logical that the price of a credit is directly related to the civil penalty rate and decreases as a credit life diminishes.⁸²⁷ Prior to trading and transferring, on average, manufacturers paid \$29,075,899 in civil penalty payments annually (a total of \$814,125,176 from model years 1982 to 2010). Since trading and transferring, manufacturers now pay an annual average of \$15,260,480 each model year. The agency notes that five manufacturers have paid civil penalties since 2011 totaling \$76,302,402, and no civil penalty payments were made in 2015. However, over the next several years, as stringency increases, manufacturers are expected to have challenges with CAFE standard compliance.

(b) What Exemptions and Exclusions does NHTSA allow?

(a) Emergency and Law Enforcement Vehicles

Under EPCA, manufacturers are allowed to exclude emergency vehicles from their CAFE fleet⁸²⁸ and all manufacturers that produce emergency vehicles have historically done so. NHTSA is not proposing any changes to this exclusion.

(b) Small Volume Manufacturers

Per 49 U.S.C. 32902(d), NHTSA established requirements for exempted small volume manufacturers in 49 CFR part 525, "Exemptions from Average Fuel Economy Standards." The small volume manufacturer exemption is available for any manufacturer whose projected or actual combined sales (whether in the United States or not) are fewer than 10,000 passenger automobiles in the model year two years before the model year for which the manufacturer seeks to comply. The manufacturer must submit a petition with information stating that the

applicable CAFE standard is more stringent than the maximum feasible average fuel economy level that the manufacturer can achieve. NHTSA must then issue by **Federal Register** notice an alternative average fuel economy standard for the passenger automobiles manufactured by the exempted manufacturer. The alternative standard is the maximum feasible average fuel economy level for the manufacturers to which the alternative standard applies. NHTSA is not proposing any changes to the small volume manufacturer provision or alternative standards regulations in this rulemaking.

(c) What compliance flexibilities and incentives are currently available under the CAFE program and how do manufacturers use them?

There are several compliance flexibilities that manufacturers can use to achieve compliance with CAFE standards beyond applying fuel economy-improving technologies. Some compliance flexibilities are statutorily mandated by Congress through EPCA and EISA, specifically program credits, including the ability to carry-forward, carry-back, trade and transfer credits, and special fuel economy calculations for dual- and alternative-fueled vehicles (discussed in turn, below). However, 49 U.S.C. 32902(h) expressly prohibits NHTSA from considering the availability of statutorily-established credits (either for building dual- or alternative-fueled vehicles or from accumulated transfers or traders) in determining the level of the standards. Thus, NHTSA may not raise CAFE standards because manufacturers have enough of those credits to meet higher standards. This is an important difference from EPA's authority under the CAA, which does not contain such a restriction, and which flexibility EPA has assumed in the past in determining appropriate levels of stringency for its program.

NHTSA also promulgated compliance flexibilities in response to EPA's exercise of discretion under its EPCA authority to calculate fuel economy levels for individual vehicles and for fleets. These compliance flexibilities, which were first introduced in the 2012 rule for MYs 2017 and beyond, include air conditioning efficiency improvement and "off cycle" adjustments, and incentives for advanced technologies in full size pick-up trucks, including incentives for mild and strong hybrid electric full-size pickup trucks and performance-based incentives in full-size pickup trucks. As explained above, comment is sought on all of these adjustments and incentives.

(1) Program Credits and Credit Trading

Generating, trading, transfer, and applying CAFE credits is fundamentally governed by statutory mandates defined by Congress. As discussed above in Section X.B.1., program credits are generated when a vehicle manufacturer's fleet over-complies with its determined standard for a given model year, meaning its vehicle fleet achieved a higher corporate average fuel economy value than the amount required by the CAFE program for that model year. Conversely, if the fleet average CAFE level does not meet the standard, the fleet would incur debits (also referred to as a shortfall). A manufacturer whose fleet generates credits in a given model year has several options for using those credits, including credit carry-back, credit carry-forward, credit transfers, and credit trading.

Credit "carry-back" means that manufacturers are able to use credits to offset a deficit that had accrued in a prior model year, while credit "carry-forward" means that manufacturers can bank credits and use them towards compliance in future model years. EPCA, as amended by EISA, requires NHTSA to allow manufacturers to carry back credits for up to three model years, and to carry forward credits for up to five model years.⁸²⁹ EPA also follows these same limitations under its GHG program.⁸³⁰

Credit "transfer" means the ability of manufacturers to move credits from their passenger car fleet to their light truck fleet, or vice versa. As part of the EISA amendments to EPCA, NHTSA was required to establish by regulation a CAFE credit transferring program, now codified at 49 CFR part 536, to allow a manufacturer to transfer credits between its car and truck fleets to achieve compliance with the standards. For example, credits earned by overcompliance with a manufacturer's car fleet average standard could be used to offset debits incurred because of that manufacturer's not meeting the truck fleet average standard in a given year. However, EISA imposed a cap on the amount by which a manufacturer could raise its CAFE standards through transferred credits: 1 mpg for MYs 2011–2013; 1.5 mpg for MYs 2014–2017; and 2 mpg for MYs 2018 and

⁸²⁹ 49 U.S.C. § 32903(a).

⁸³⁰ As part of its 2017–2025 GHG program final rulemaking, EPA did allow a one-time CO₂ carry-forward beyond five years, such that any credits generated from MYs 2010 through 2016 will be able to be used to comply with light duty vehicle GHG standards at any time through MY 2021.

⁸²⁷ See 49 CFR 536.4 for NHTSA's regulations regarding CAFE credits.

⁸²⁸ 49 U.S.C. § 32902(e).

beyond.⁸³¹ These statutory limits will continue to apply to the determination of compliance with the CAFE standards. EISA also prohibits the use of transferred credits to meet the minimum domestic passenger car fleet CAFE standard.⁸³²

In their 2016 petition for rulemaking, the Alliance of Automobile Manufacturers and Global Automakers (Alliance/Global or Petitioners) asked NHTSA to amend the definition of “transfer” as it pertains to compliance flexibilities.⁸³³ In particular, Alliance/Global requested that NHTSA add text to the definition of “transfer” stating that the statutory transfer cap in 49 U.S.C. 32903(g)(3) applies when the credits are transferred. Alliance/Global assert that adding this text to the definition is consistent with NHTSA’s prior position on this issue.

In the 2012–2016 final rule, NHTSA stated:

NHTSA interprets EISA not to prohibit the banking of transferred credits for use in later model years. Thus, NHTSA believes that the language of EISA may be read to allow manufacturers to transfer credits from one fleet that has an excess number of credits, within the limits specified, to another fleet that may also have excess credits instead of transferring only to a fleet that has a credit shortfall. This would mean that a manufacturer could transfer a certain number of credits each year and bank them, and then the credits could be carried forward or back ‘without limit’ later if and when a shortfall ever occurred in that same fleet.⁸³⁴

Following that final rule, NHTSA clarified via interpretation that the transfer cap from EISA does not limit how many credits may be *transferred* in a given model year, but it does limit the *application* of transferred credits to a compliance category in a model year.⁸³⁵ “Thus, manufacturers may transfer as many credits into a compliance category as they wish, but transferred credits may not increase a manufacturer’s CAFE level beyond the statutory limits.”⁸³⁶

NHTSA believes the transfer caps in 49 U.S.C. 32903(g)(3) are still properly read to limit the application of credits in excess of those values. NHTSA understands that the language in the 2012–2016 final rule could be read to

suggest that the transfer cap applies at the time credits are transferred. However, NHTSA believes its subsequent interpretation—that the transfer cap applies at the time the credits are used—is a more appropriate, plain language reading of the statute. While manufacturers have approached NHTSA with various interpretations that would allow them to circumvent the EISA transfer cap, NHTSA believes it is improper to ignore a transfer cap Congress clearly articulated. Therefore, NHTSA proposes to deny Alliance/Global’s petition to revise the definition of “transfer” in 49 CFR 536.3.

Credit “trading” means the ability of manufacturers to sell credits to, or purchase credits from, one another. EISA allowed NHTSA to establish by regulation a CAFE credit trading program, also now codified at 49 CFR part 536, to allow credits to be traded between vehicle manufacturers. EISA also prohibits manufacturers from using traded credits to meet the minimum domestic passenger car CAFE standard.⁸³⁷

Under 49 CFR part 536, credit holders (including, but not limited to manufacturers) have credit accounts with NHTSA where they can, as outlined above, hold credits, use them to achieve compliance with CAFE standards, transfer credits between compliance categories, or trade them. A credit may also be cancelled before its expiration date, if the credit holder so chooses. Traded and transferred credits are subject to an “adjustment factor” to ensure total oil savings are preserved, as required by EISA. EISA also prohibits credits earned before MY 2011 from being traded or transferred.

As discussed above, NHTSA is concerned with the potential for compliance flexibilities to have unintended consequences. Given that the credit trading program is optional under EISA, comment is sought on whether the credit trading provisions in 49 CFR part 536 should cease to apply beginning in MY 2022.

(a) Fuel Savings Adjustment Factor

Under NHTSA’s credit trading regulations, a fuel savings adjustment factor is applied when trading occurs between manufacturers, but not when a manufacturer carries credits forward or carries back credits within their own fleet. The Alliance/Global requested that NHTSA require manufacturers to apply the fuel savings adjustment factor when credits are carried forward or carried back within the same fleet, including for existing, unused credits.

Per EISA, total oil savings must be preserved in NHTSA’s credit trading program.⁸³⁸ The provisions for credit transferring within a manufacturer’s fleet⁸³⁹ do not include the same requirement; however, NHTSA prescribed a fuel savings adjustment factor that applies to both credit trades between manufacturers and credit transfers between a manufacturer’s compliance fleets.⁸⁴⁰

When NHTSA initially considered the preservation of oil savings, the agency explained how one credit is not necessarily equal to another. For example, the fuel savings lost if the average fuel economy of a manufacturer falls one-tenth of an mpg below the level of a relatively low standard are greater than the average fuel savings gained by raising the average fuel economy of a manufacturer one-tenth of a mpg above the level of a relatively high CAFE standard.⁸⁴¹ The effect of applying the adjustment factor is to increase the value of credits earned for exceeding a relatively low CAFE standard for credits that are intended to be applied to a compliance category with a relatively high CAFE standard, and to decrease the value of credits earned for exceeding a relatively high CAFE standard for credits that are intended to be applied to a compliance category with a relatively low CAFE standard.

Alliance/Global stated that while carry forward and carry back credits have been used for many years, the CAFE standards did not change during the Congressional CAFE freeze, meaning credits earned during those years were associated with the same amount of fuel savings from year to year.⁸⁴² Alliance/Global suggest that because there is no longer a Congressional CAFE freeze, NHTSA should apply the adjustment

⁸³⁸ 49 U.S.C. § 32903(f)(1).

⁸³⁹ 49 U.S.C. § 32903(g).

⁸⁴⁰ See 49 CFR 536.5. See also 74 FR 14430 (Mar. 30, 2009) (Per NHTSA’s final rule for MY 2011 Average Fuel Economy Standards for Passenger Cars and Light Trucks, “There is no other clear expression of congressional intent in the text of the statute suggesting that NHTSA would have authority to adjust transferred credits, even in the interest of preserving oil savings. However, the goal of the CAFE program is energy conservation; ultimately, the U.S. would reap a greater benefit from ensuring that fuel oil savings are preserved for both trades and transfers. Furthermore, accounting for traded credits differently than for transferred credits does add unnecessary burden on program enforcement. Thus, NHTSA will adjust credits both when they are traded and when they are transferred so that no loss in fuel savings occurs”).

⁸⁴¹ 74 FR 14432 (Mar. 30, 2009).

⁸⁴² Auto Alliance and Global Automakers Petition for rulemaking on Corporate Average Fuel Economy (June 20, 2016) at 10.

⁸³¹ 49 U.S.C. § 32903(g)(3).

⁸³² 49 U.S.C. § 32903(g)(4).

⁸³³ Auto Alliance and Global Automakers Petition for rulemaking on Corporate Average Fuel Economy (June 20, 2016) at 13.

⁸³⁴ 75 FR 25666 (May 7, 2010).

⁸³⁵ See, letter from O. Kevin Vincent, Chief Counsel, NHTSA to Tom Stricker, Toyota (July 5, 2011). Available online at <https://isearch.nhtsa.gov/files/10-004142%20-%20Toyota%20CAFE%20credit%20transfer%20banking%20-%2005%20Jul%2011%20final%20for%20signature.htm> (last accessed Apr. 18, 2018).

⁸³⁶ *Id.*

⁸³⁷ 49 U.S.C. § 32903(f)(2).

factor when moving credits within a manufacturer's fleet.

NHTSA has tentatively decided to deny Alliance/Global's request to apply the fuel savings adjustment factor to credits that are carried forward or carried back within the same fleet, to the extent that the request would impact credits carried forward or backward retroactively within manufacturer's compliance fleets (*i.e.*, credits that were generated prior to MY 2021, when this rule takes effect). NHTSA has tentatively determined that applying the adjustment factor to credits earned in model years past would be inequitable. Manufacturers planned compliance strategies based, at least in part, on how credits could be carried forward and backward, including the lack of an adjustment factor when credits are carried forward or backward within the same fleet. Thus, retroactively stating that manufacturers must apply the adjustment factor in this situation could disadvantage certain manufacturers, and result in windfalls for other manufacturers.

However, NHTSA seeks comment on whether the agency should apply the fuel savings adjustment factor to credits that are carried forward or carried back within the same fleet beginning with MY 2021.

(b) VMT Estimates for Fuel Savings Adjustment Factor

NHTSA uses a vehicle miles traveled (VMT) estimate as part of its fuel savings adjustment equation to ensure that when traded or transferred credits are used, fuel economy credits are adjusted to ensure fuel oil savings is preserved.⁸⁴³ For model years 2017–2025, NHTSA finalized VMT values of 195,264 miles for passenger car credits, and 225,865 miles for light truck credits.⁸⁴⁴ These VMT estimates harmonized with those used in EPA's GHG program. For model years 2011–2016, NHTSA estimated different VMTs by model year.

Alliance/Global requested that NHTSA apply fixed VMT estimates to the fuel savings adjustment factor for MYs 2011–2016, similar to how NHTSA handles MYs 2017–2021. NHTSA rejected a similar request from the Alliance in the 2017 and later rulemaking, citing lack of scope, and expressing concern about the potential loss of fuel savings.⁸⁴⁵

Alliance/Global argue that data from MYs 2011–2016 demonstrate that no fuel savings would have been lost, as

NHTSA had originally been concerned about. Alliance/Global assert that by not revising the MY 2012–2016 VMT estimates, credits earned during that timeframe were undervalued. Therefore, Alliance/Global argue that NHTSA should retroactively revise its VMT estimates to “reflect better the real world fuel economy results.”⁸⁴⁶

Such retroactive adjustments could unfairly penalize manufacturers for decisions they made based on the regulations as they existed at the time. As Alliance/Global acknowledge, adjusting vehicle miles travelled estimates would disproportionately affect manufacturers that have a credit deficit and were part of EPA's Temporary Lead-time Allowance Alternative Standards (TLAAS). The TLAAS program sunsets for model years 2021 and later. Given some manufacturers would be disproportionately harmed were we to accept Alliance/Global's suggestion, NHTSA has tentatively decided to deny Alliance/Global's request to retroactively change the agency's VMT schedules for model years 2011–2016. Alliance/Global's suggestion that a TLAAS manufacturer would be allowed to elect either approach does not change the fact that manufacturers in the TLAAS program made production decisions based on the regulations as understood at the time.

(2) Special Fuel Economy Calculations for Dual and Alternative Fueled Vehicles

As discussed at length in prior rulemakings, EPCA, as amended by EISA, encouraged manufacturers to build alternative-fueled and dual- (or flexible-) fueled vehicles by providing special fuel economy calculations for “dedicated” (that is, 100%) alternative fueled vehicles and “dual-fueled” (that is, capable of running on either the alternative fuel or gasoline/diesel) vehicles.

Dedicated alternative fuel automobiles include electric, fuel cell, and compressed natural gas vehicles, among others. NHTSA's provisions for dedicated alternative fuel vehicles in 49 U.S.C. 32905(a) state that the fuel economy of any dedicated automobile manufactured after 1992 shall be measured based on the fuel content of the alternative fuel used to operate the automobile. A gallon of liquid alternative fuel used to operate a dedicated automobile is deemed to contain .15 gallon of fuel. Under EPCA,

for dedicated alternative fuel vehicles, there are no limits or phase-out for this special fuel economy calculation, unlike for dual-fueled vehicles, as discussed below.

EPCA's statutory incentive for dual-fueled vehicles at 49 U.S.C. 32906 and the measurement methodology for dual-fueled vehicles at 49 U.S.C. 32905(b) and (d) expire in MY 2019; therefore, NHTSA had to examine the future of these provisions in the 2017 and later CAFE rulemaking.⁸⁴⁷ NHTSA and EPA concluded that it would be inappropriate to measure dual-fueled vehicles' fuel economy like that of conventional gasoline vehicles with no recognition of their alternative fuel capability, which would be contrary to the intent of EPCA/EISA. Accordingly, the agencies proposed that for MY 2020 and later vehicles, the general provisions authorizing EPA to establish testing and calculation procedures would provide discretion to set the CAFE calculation procedures for those vehicles.⁸⁴⁸ The methodology for EPA's approach is outlined in the 2012 final rule for MYs 2017 and beyond at 77 FR 63128 (Oct. 15, 2012). NHTSA seeks comment on the current approach.

(3) Incentives for Advanced Technologies in Full Size Pickup Trucks

In the 2012 final rule for MYs 2017 and beyond, EPA finalized criteria that would provide an adjustment to the fuel economy of a manufacturer's full size pickup trucks if the manufacturer employed certain defined hybrid technologies for a significant quantity of those trucks.⁸⁴⁹ Additionally, EPA finalized an adjustment to the fuel economy of a manufacturer's full sized pickup truck if it achieved a fuel economy performance level significantly above the CAFE target for its footprint.⁸⁵⁰ This performance-based incentive recognized that not all manufacturers may have wished to pursue hybridization, and aimed to reward manufacturers for applying fuel-saving technologies above and beyond what they might otherwise have done. EPA provided the incentive for its GHG program under its CAA authority, and for the CAFE program under its EPCA authority, similar to the A/C efficiency and off-cycle adjustment values described below.

EPA established limits on the vehicles eligible to qualify for these credits; a truck must meet minimum criteria for bed size and towing or payload

⁸⁴³ See 49 CFR § 536.4(c).

⁸⁴⁴ 77 FR 63130 (Oct. 15, 2012).

⁸⁴⁵ *Id.*

⁸⁴⁶ Auto Alliance and Global Automakers Petition for rulemaking on Corporate Average Fuel Economy (June 20, 2016) at 11.

⁸⁴⁷ 77 FR 62651 (Oct. 15, 2012).

⁸⁴⁸ 49 U.S.C. §§ 32904(a), (c).

⁸⁴⁹ 77 FR 62651 (Oct. 15, 2012).

⁸⁵⁰ *Id.*

capacity, and there are minimum sales thresholds (in terms of a percentage of a manufacturer's full-size pickup truck fleet) that a manufacturer must satisfy in order to qualify for the incentives. Additionally, the incentives phase out at different rates through 2025—the mild hybrid incentive phases out in MY 2021, the strong hybrid incentive phases out in 2025, the 15% performance incentive (10 g/mi) credit phases out in MY 2021, and the 20% performance incentive (20 g/mi) credit is available for a maximum of five years between MYs 2017–2025, provided the vehicle's CO₂ emissions level does not increase.⁸⁵¹

At the time of developing this proposal, no manufacturer has claimed these full-size pickup truck credits. Some vehicle manufacturers have announced potential collaborations, research projects, or possible future introduction these technologies for this segment.⁸⁵² Additionally, similar to the incentive for hybridized pickup trucks, the agency is not aware of any vehicle manufacturers currently benefiting from the performance-based incentive. Comment is sought on whether to extend either the incentive for hybrid full size pickup trucks or the performance-based incentive past the dates that EPA specified in the 2012 final rule for MYs 2017 and beyond.

(4) Air Conditioning Efficiency and Off-Cycle Adjustment Values

A/C efficiency and off-cycle fuel consumption improvement values (FCIVs) are compliance flexibilities made available under NHTSA's CAFE program through EPA's EPCA authority to calculate fuel economy levels for individual vehicles and for fleets. NHTSA modified its regulations in the 2012 final rule for MYs 2017 and beyond to reflect the fact that certain flexibilities, including A/C efficiency improving technologies and off-cycle technology fuel consumption improvement values (FCIVs), may be

used as part of the determination of a manufacturers' CAFE level.⁸⁵³

A/C is a virtually standard automotive accessory, with more than 95% of new cars and light trucks sold in the United States equipped with mobile air conditioning systems. A/C use places load on an engine, which results in additional fuel consumption; the high penetration rate of A/C systems throughout the light duty vehicle fleet means that they can significantly impact the total energy consumed, as well as GHG emissions resulting from refrigerant leakage.⁸⁵⁴ A number of methods related to the A/C system components and their controls can be used to improve A/C system efficiencies.⁸⁵⁵

“Off-cycle” technologies are those that reduce vehicle fuel consumption and CO₂ emissions but for which the fuel consumption reduction benefits are not recognized under the 2-cycle test procedure used to determine compliance with the fleet average standards. The CAFE city and highway test cycles, also commonly referred to together as the 2-cycle laboratory compliance tests (or 2-cycle tests), were developed in the early 1970s when few vehicles were equipped with A/C systems. The city test simulates city driving in the Los Angeles area at that time. The highway test simulates driving on secondary roads (not expressways). The cycles are effective in measuring improvements in most fuel economy improving technologies; however, they are unable to measure or underrepresent some fuel economy improving technologies because of limitations in the test cycles.

⁸⁵³ 77 FR 63130–34 (Oct. 15, 2012). Instead of manufacturers gaining credits as done under the GHG program, a direct adjustment is made to the manufacturer's fuel economy fleet performance value.

⁸⁵⁴ Notably, however, manufacturers cannot claim CAFE-related benefits for reducing A/C leakage or switching to an A/C refrigerant with a lower global warming potential, because while these improvements reduce GHGs consistent with the purpose of the CAA, they generally do not relate to fuel economy and thus are not relevant to the CAFE program.

⁸⁵⁵ The approach for recognizing potential A/C efficiency gains is to utilize, in most cases, existing vehicle technology/componentry but improve the energy efficiency of the technology designs and operation. For example, most of the additional air conditioning-related load on an engine is because of the compressor, which pumps the refrigerant around the system loop. The less the compressor operates, the less load the compressor places on the engine resulting in less fuel consumption and CO₂ emissions. Thus, optimizing compressor operation with cabin demand using more sophisticated sensors, controls and control strategies, is one path to improving the efficiency of the A/C system. For further discussion of A/C efficiency technologies, see Section II.D of this NPRM and Chapter 6 of the accompanying PRIA.

For example, air conditioning is turned off during 2-cycle testing. Any air conditioning system efficiency improvements that reduce load on the engine and improve fuel economy cannot be measured on the tests. Additionally, the city cycle includes less time at idle than today's real world driving, and the highway cycle is relatively low speed (average speed of 48 mph and peak speed of 60 mph). Other off-cycle technologies that improve fuel economy at idle, such as stop start, and those that improve fuel economy to the greatest extent at expressway speeds, such as active grille shutters which improve aerodynamics, receive less than their real-world benefits in the 2-cycle compliance tests.

Since EPA established its GHG program for light duty vehicles, NHTSA and EPA sought to harmonize their respective standards, despite separate statutory authorities limiting what the agencies could and could not consider. For example, for MYs 2012–2016, NHTSA was unable to consider improvements manufacturers made to passenger car A/C efficiency in calculating compliance.⁸⁵⁶ At that time, NHTSA stated that the agency's statutory authority did not allow NHTSA to provide test procedure flexibilities that would account for A/C system and off-cycle fuel economy improvements.⁸⁵⁷ Thus, NHTSA calculated its standards in a way that allowed manufacturers to comply with the CAFE standards using 2-cycle procedures alone.

Of the two agencies, EPA was the first to establish an off-cycle technology program. For MYs 2012–2016, EPA allowed manufacturers to request off-cycle credits for “new and innovative technologies that achieve GHG reductions that are not reflected on current test procedures . . .”⁸⁵⁸ In the subsequent 2017 and beyond rulemaking, off-cycle technology was no longer required to be new and innovative, but rather only required to demonstrate improvements not reflected on test procedures.

At that time (starting with MY 2017), NHTSA considered off-cycle technologies and A/C efficiency improvements when assessing compliance with the CAFE program. Accounting for off-cycle technologies and A/C efficiency improvements in the CAFE program allowed manufacturers to design vehicles with improved fuel

⁸⁵⁶ 74 FR 49700 (Sept. 28, 2009).

⁸⁵⁷ At that time, NHTSA stated “[m]odernizing the passenger car test procedures, or even providing similar credits, would not be possible under EPCA as currently written.” 75 FR 25557 (May 7, 2010).

⁸⁵⁸ 75 FR 25341 (May 7, 2010).

⁸⁵¹ 77 FR 62651–2 (Oct. 15, 2012).

⁸⁵² At the time of this proposal, there is awareness of some vehicle models that may qualify in future years should manufacturers choose to claim these credits. For example, the 2019 Ram 1500 introduces a mild hybrid “eTorque” system (Sam Abuelsamid, *2019 Ram 1500 Gets 48V Mild Hybrid On All Gas Engines*, Forbes (Jan. 15, 2019), <https://www.forbes.com/sites/samabuelsamid/2018/01/15/2019-ram-1500-gets-standard-48v-mild-hybrid-on-all-gas-engines/#2a0cc967e9e6>); Ford is expected to introduce a hybrid F-150 (Keith Naughton, *How Ford plans to market the gasoline-electric F-150*, Automotive News (November 30, 2017), <http://www.autonews.com/article/20171130/OEM05/171139990/ford-electric-f150-pickup-marketing>); and the Workhorse W-15 system includes both an electric battery pack and gasoline range extender (Workhorse W-15 Pickup, <http://workhorse.com/pickup/> (last accessed April 13, 2018)).

economy, even if the improvements would not show up on the 2-cycle compliance test. In adding off-cycle and A/C efficiency improvements to NHTSA's program, the agency was able to harmonize with EPA, which began accounting for these features in earlier GHG regulations.

(a) Distinguishing "Credits" From Air Conditioning Efficiency and Off-Cycle Benefits

It is important to note some important differences between consideration given to A/C efficiency improvement and off-cycle technologies, and other flexibilities in the CAFE program. NHTSA accounts for A/C efficiency and off-cycle improvements through EPA test procedural changes that determine *fuel consumption improvement values*. While regarded by some as "credits" either as shorthand, or because there are many terms that overlap between NHTSA's CAFE program and EPA's GHG program, NHTSA's CAFE program does not give manufacturers *credits* for implementing more efficient A/C systems, or introducing off-cycle technologies.⁸⁵⁹ That is, there is no bankable, tradable or transferrable credit earned by a manufacturer for implementing more efficient A/C systems or installing an off-cycle technology. In fact, the only credits provided for in NHTSA's CAFE program are those earned by overcompliance with a standard.⁸⁶⁰ What NHTSA does for off-cycle technologies and A/C efficiency improvements is adjust individual vehicle compliance values based on the fuel consumption improvement values of these technologies. As a result, a manufacturer's vehicle *as a whole* may exceed its fuel economy target, and be regarded as a credit-generating vehicle.

Illustrative of this confusion, in the 2016 Alliance/Global petition, the Petitioners asked NHTSA to avoid imposing unnecessary restrictions on the use of credits. Alliance/Global referenced language from an EPA report that stated compliance is assessed by measuring the tailpipe emissions of a manufacturer's vehicles, and then reducing vehicle compliance values depending on A/C efficiency improvements and off-cycle technologies.⁸⁶¹ This language is consistent with NHTSA's statement in the 2017 and later final rule, in which explained how the agencies coordinate

and apply off-cycle and A/C adjustments. "There will be separate improvement values for each type of credit, calculated separately for cars and for trucks. These improvement values are subtracted from the manufacturer's 2-cycle-based fleet fuel consumption value to yield a final new fleet fuel consumption value, which would be inverted to determine a final fleet fuel CAFE value."⁸⁶²

Alliance/Global say because of this process, "technology credits earned in the current model year must be immediately applied toward any deficits in the current model year. This approach forces manufacturers to use their credits in a sub-optimal way, and can result in stranded credits."⁸⁶³ As explained in this section, NHTSA does not issue credits to manufacturers for improving A/C efficiency, nor does it issue credits for implementing off-cycle technologies. EPA does adjust fuel economy compliance values on a vehicle level for those vehicles that implement A/C efficiency improvements and off-cycle technologies.

NHTSA therefore proposes to deny Alliance/Global's request because what the petitioners⁸⁶⁴ refer to as "technology credits" are actually fuel economy adjustment values applied to the fuel economy measurement of individual vehicles. Thus, these adjustments are not actually "credits," per the definition of a "credit" in EPCA/EISA and are not subject to the "carry forward" and "carry back" provisions in 49 U.S.C. 32903.

To alleviate confusion, and to ensure consistency in nomenclature, NHTSA is proposing to update language in its regulations to reflect that the use of the term "credits" to refer to A/C efficiency and off-cycle technology adjustments—should actually be termed fuel consumption improvement values (FCIVs).

(b) Petition Requests on A/C Efficiency and Off-Cycle Program Administration

As discussed above, NHTSA and EPA jointly administer the off-cycle program. The 2016 Alliance/Global petition requested that NHTSA and EPA make various adjustments to the off-cycle program; specifically, the petitioners requested that the agencies should:

- re-affirm that technologies meeting the stated definitions are entitled to the off-cycle credit at the values stated in the regulation;
- re-acknowledge that technologies shown to generate more emissions reductions than the pre-approved amount are entitled to additional credit;
- confirm that technologies not in the null vehicle set but which are demonstrated to provide emissions reductions benefits constitute off-cycle credits; and
- modify the off-cycle program to account for unanticipated delays in the approval process by providing that applications based on the 5-cycle methodology are to be deemed approved if not acted upon by the agencies within a specified timeframe (for instance 90 days), subject to any subsequent review of accuracy and good faith.

With respect to Alliance/Global's request regarding off-cycle technologies that demonstrate emissions reductions greater than what is allowable from the menu, today's preferred alternative retains this capability. As was the case for model years 2017–2021, a manufacturer is still eligible for a fuel consumption improvement value other than the default value provided for in the menu, provided the manufacturer demonstrates the fuel economy improvement.⁸⁶⁵ This would include the two-tiered process for demonstrating the CO₂ reductions and fuel economy improvement.⁸⁶⁶

The Alliance/Global's requests to streamline aspects of the A/C efficiency and off-cycle programs in response to the issues outlined above have been considered. Among other things, the Alliance/Global requested the agencies consider providing for a default acceptance of petitions for off-cycle credits, provided that all required information has been provided, to accelerate the processing of off-cycle credit requests. While it is agreed that any continuation of the A/C efficiency and off-cycle program should incorporate programmatic improvements, there are significant concerns with the concept of default accepting petition requests that do not address program issues like uncertainty in quantifying program benefits, or general program administration. Comment is requested comment on these issues.

Additionally, for a discussion of the consideration of inclusion of the off-cycle program in future CAFE and GHG standards, see Section X.D.

⁸⁶² 77 FR 62726 (Oct. 15, 2012).

⁸⁶³ *Id.* at 16.

⁸⁶⁴ The agencies also refer to A/C and off cycle technology adjustment values as "credits" sporadically throughout their regulations. The agencies propose to amend their respective regulatory texts to reflect these are adjustments and not actual credits that can be carried forward or back. For a further discussion, see above.

⁸⁶⁵ 77 FR 62837 (Oct. 15, 2012).

⁸⁶⁶ 40 CFR 86.1869–12.

⁸⁵⁹ This is not to be confused with EPA's parallel program, which refers to the GHG's consideration of A/C improvements and off-cycle technologies as "credits."

⁸⁶⁰ 49 U.S.C. 32903.

⁸⁶¹ See Alliance/Global petition at 15.

(c) Petition Requests on Including Air-Conditioning Efficiency Improvements in the CAFE Calculations for MYs 2010–2016

For model years 2012 through 2016, NHTSA was unable⁸⁶⁷ to consider improvements manufacturers made to passenger car A/C efficiency in calculating CAFE compliance.⁸⁶⁸ However, EPA did consider passenger car improvements to A/C efficiency for this timeframe. To allow manufacturers to build one fleet that complied with both EPA and NHTSA standards, NHTSA adjusted its standards to account for the differences borne out of A/C efficiency improvements. Specifically, the agencies converted EPA's g/mi standards to NHTSA mpg (CAFE) standards. Then, EPA then estimated the average amount of improvement manufacturers were expected to earn via improved A/C efficiency. From there, NHTSA took EPA's converted mpg standard and subtracted the average improvement attributable to improvement in A/C efficiency. NHTSA set its standard at this level to allow manufacturers to comply with both standards with similar levels of technology.⁸⁶⁹

In the Alliance/Global petition for rulemaking, the Petitioners requested that NHTSA and EPA revisit the average efficiency benefit calculated by EPA applicable to model years 2012 through 2016. The Alliance/Global argued that A/C efficiency improvements were not properly acknowledged in the CAFE program, and that manufacturers that exceeded the A/C efficiency improvements estimated by the agencies. The Petitioners request that EPA amend its regulations such that manufacturers would be entitled to additional A/C efficiency improvement benefits retroactively.

NHTSA has tentatively decided to retain the structure of the existing A/C efficiency program, and not extend it to model years 2010 through 2016. Likewise, EPA has tentatively decided not to modify its regulations to change the way A/C efficiency improvements are accounted for. It is believed this is appropriate as manufacturers decided what fuel economy-improving technologies to apply to vehicles based on the standards as finalized in 2010.⁸⁷⁰

⁸⁶⁷ At that time, NHTSA stated “[m]odernizing the passenger car test procedures, or even providing similar credits, would not be possible under EPCA as currently written.” 75 FR 25557 (May 7, 2010).

⁸⁶⁸ 74 FR 49700 (Sept. 28, 2009).

⁸⁶⁹ *Id.*

⁸⁷⁰ In the MY 2017 and beyond rulemaking, NHTSA reaffirmed its position it would not extend A/C efficiency improvement benefits to earlier model years. 77 FR 62720 (Oct. 15, 2012).

This included deciding whether to apply traditional tailpipe technologies, or A/C efficiency improvements, or both. Granting A/C efficiency adjustments to manufacturers retroactively could result in arbitrarily varying levels of adjustments granted to manufacturers, similar to the Alliance/Global request regarding retroactive off-cycle adjustments. Thus, it is tentatively believed the existing A/C efficiency improvement structure for model years 2010 through 2016 should remain unchanged.

(d) Petition Requests on Including Off-Cycle Improvements in the CAFE Calculations for MYs 2010–2016

As described above, NHTSA first allowed manufacturers to generate off-cycle technology fuel consumption improvement values equivalent to CO₂ off-cycle credits in MY 2017.⁸⁷¹ In finalizing the rule covering MYs 2017 and beyond, NHTSA declined to retroactively extend its off-cycle program to apply to model years 2012 through 2016,⁸⁷² explaining “NHTSA did not take [off-cycle credits] into account when adopting the CAFE standards for those model years. As such, extending the credit program to the CAFE program for those model years would not be appropriate.”⁸⁷³

The Alliance/Global petition for rulemaking asked NHTSA to reconsider calculating fuel economy for model years 2010 through 2016 to include off-cycle adjustments allowed under EPA's program during that period. The Petitioners argued that NHTSA incorrectly stated the agency had taken off-cycle adjustments into consideration when setting standards for model years 2017 through 2025, but not for model years 2010–2016. The Alliance/Global also argued that because neither NHTSA nor EPA considered off-cycle adjustments in formulating the stringency of the 2012–2016 standards, NHTSA should retroactively grant manufacturers off-cycle adjustments for those model years as EPA did. Doing so, they say, would maintain consistency between the agencies' programs.

Pursuant to the Alliance/Global request, NHTSA has reconsidered the idea of granting retroactive credits for model years 2010 through 2016. For the reasons that follow, NHTSA has tentatively decided that manufacturers should not be granted retroactive off-

cycle adjustments for model years 2010 through 2016.

Of the two agencies, EPA was the first to establish an off-cycle technology program. For model years 2012 through 2016, EPA allowed manufacturers to request off-cycle credits for “new and innovative technologies that achieve GHG reductions that are not reflected on current test procedures. . . .”⁸⁷⁴ In the subsequent 2017 and beyond rulemaking, NHTSA joined EPA and included an off-cycle program for CAFE compliance.

The Alliance/Global petition cites a statement in the 2012–2016 final rule as affirmation that NHTSA took off-cycle adjustments into account in formulating the 2012–2016 stringencies, and therefore should allow manufacturers earn off-cycle benefits in model years that have already passed. In particular, Alliance/Global point to a general statement where NHTSA, while discussing consideration of the effect of other motor vehicle standards of the Government on fuel economy, stated that that rulemaking resulted in consistent standards across the program.⁸⁷⁵ The Alliance/Global petition appears to take this statement as a blanket assertion that NHTSA's consideration of all “relevant technologies” included off-cycle technologies. To the contrary, as quoted above, NHTSA explicitly stated it had not considered these off-cycle technologies.⁸⁷⁶

The fact that NHTSA had not taken off-cycle adjustments into consideration in setting its 2012–2016 standards makes granting this request inappropriate. Doing so would result in a question as to whether the 2012–2016 standards were maximum feasible under 49 U.S.C. 32902(b)(2)(B). If NHTSA had not considered industry's ability to earn off-cycle adjustments—an incentive that allows manufacturers to utilize technologies other than those that were being modeled as part of NHTSA's analysis—the agency could have concluded more stringent standards were maximum feasible. Additionally, granting off-cycle adjustments to manufacturers retroactively raises questions of equity. NHTSA issued its 2012–2016 standards without an off-cycle program, and manufacturers had

⁸⁷⁴ 75 FR 25341, 25344 (May 7, 2010). EPA had also provided an option for manufacturers to claim “early” off-cycle credits in the 2009–2011 time frame.

⁸⁷⁵ *Id.*

⁸⁷⁶ Likewise, EPA stated it had not considered off-cycle technologies in finalizing the 2012–2016 rule. “Because these technologies are not nearly so well developed and understood, EPA is not prepared to consider them in assessing the stringency of the CO₂ standards.” *Id.* at 25438.

⁸⁷¹ 77 FR 62840 (Oct. 15, 2012).

⁸⁷² See *id.*; EPA decided to extend provisions from its MY 2017 and beyond off-cycle program to the 2012–2016 model years.

⁸⁷³ *Id.*

no reason to suspect that NHTSA would allow the use off-cycle technologies to meet fuel economy standards. Therefore, manufacturers made fuel economy compliance decisions with the expectation that they would have to meet fuel economy standards using on-cycle technologies. Generating off-cycle adjustments retroactively would arbitrarily reward (and potentially disadvantage other) manufacturers for compliance decisions they made without the knowledge such technologies would be eligible for NHTSA's off-cycle program. Thus, NHTSA has tentatively decided to deny Alliance/Global's request for retroactive off-cycle adjustments.

It is worth noting that in the model years 2017 and later rulemaking, NHTSA and EPA did include off-cycle technologies in establishing the stringency of the standards. As Alliance/Global note, NHTSA and EPA limited their consideration to start-stop and active aerodynamic features, because of limited technical information on these technologies. At that time, the agencies stated they "have virtually no data on the cost, development time necessary, manufacturability, etc [sic] of these technologies. The agencies thus cannot project that some of these technologies are feasible within the 2017–2025 timeframe."⁸⁷⁷

⁸⁷⁷ Draft Joint Technical Support Document: Rulemaking for 2017–2025 Light-Duty Vehicle Greenhouse Gas Emission Standards and Corporate Average Fuel Economy Standards (November 2011). P. 5–57.

(d) Light-Duty CAFE Compliance Data for MYs 2011–2018

This proposal examines how manufacturers could respond to potential future CAFE and CO₂ standards. For the reader's reference, this section provides a brief overview of how manufacturers *have* responded to the progressively increasing CAFE standards for MYs 2011–2018. NHTSA uses data from CAFE reports submitted by manufacturers to EPA or directly to NHTSA to evaluate compliance with the CAFE program. The data for model years 2011 through 2016 include manufacturers' final compliance data that has been verified by EPA.⁸⁷⁸ The data for model years 2017 and 2018 include the most recent estimated projections from manufacturers' pre- and mid-model year (PMY and MMY) reports required by 49 CFR part 537. Because the PMY and MMY data do not reflect final vehicle production levels, the final CAFE values may be different than the manufacturers' PMY and MMY estimates. Model year 2011 was selected as the start of the data because it represents the first compliance model year where manufacturers are permitted to trade and transfer credits. The overview of the data for model years 2011 to 2018 is important because it gives the public an understanding of current compliance trends and the potential impacts that these years may have on the future model years addressed by this rulemaking.

⁸⁷⁸ Volkswagen's model year 2016 final EPA verified compliance data is excluded due to ongoing enforcement activities by EPA and NHTSA for Volkswagen diesel vehicles.

Figure X–2 through Figure X–5 provide a graphical overview of fuel economy performance and standards for model years 2011 to 2018. There are separate graphs for the total overall industry fleet and each of the three compliance categories, domestic and import passenger cars and light trucks. Fuel economy performance is compared against the overall industry fuel economy standards for each model year. Fuel economy performance values include any increases from dual-fueled vehicles and for vehicles equipped with fuel consumption improving technologies.^{879 880} Compliance reflects the actual fuel economy performance of the fleet, and does not include the application of prior model year or future model year credits for overcompliance.

⁸⁷⁹ Congress established the Alternative Motor Fuels Act (AMFA) which allows manufacturers to increase their fleet fuel economy performance values by producing dual fueled vehicles. Incentives are allowed for building advanced technology vehicles such as hybrids and electric vehicles, compressed natural gas vehicles and building vehicles able to run on dual fuels such as E85 and gasoline. For model years 1993 through 2014, the maximum increase in CAFE performance for a manufacturer attributable to dual fueled vehicles is 1.2 miles per gallon for each model year and thereafter decreases by 0.2 miles per gallon each model year until ending in 2019 (see 49 U.S.C. 32906).

⁸⁸⁰ Under EPA's authority, NHTSA established provisions starting in model year 2017 allowing manufacturers to increase fuel economy performance using the fuel consumption benefits gained by technologies not accounted for during normal 2-cycle EPA compliance testing (*i.e.*, called off-cycle technologies for technologies such as stop-start systems) as well as for AC systems with improved efficiencies and for hybrid or electric full size pickup trucks.

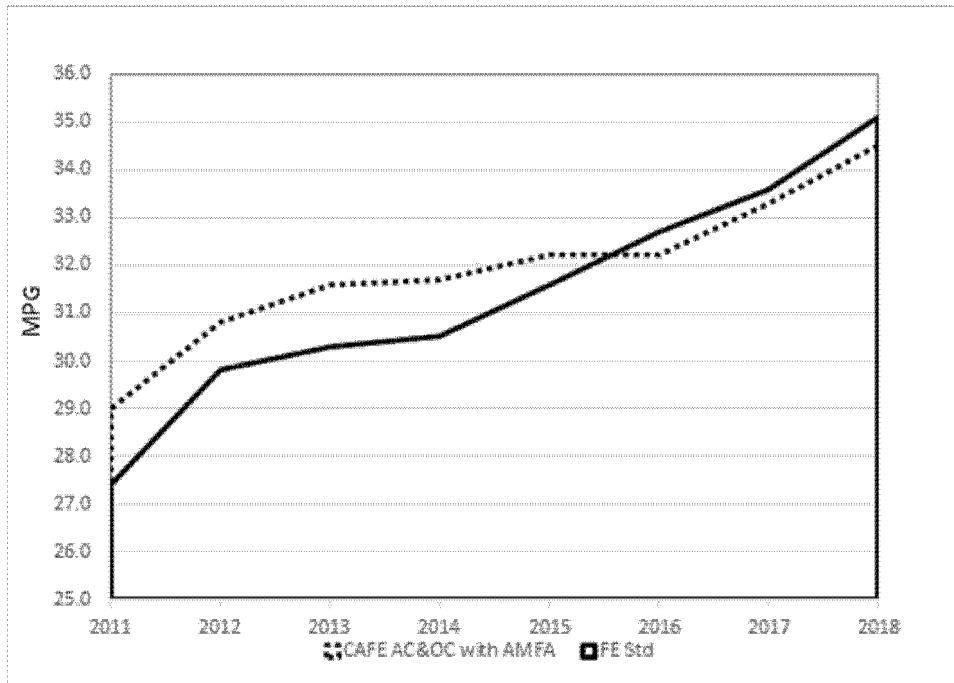

Figure X-2 Total Fleet Compliance Overview for MYs 2011 to 2018

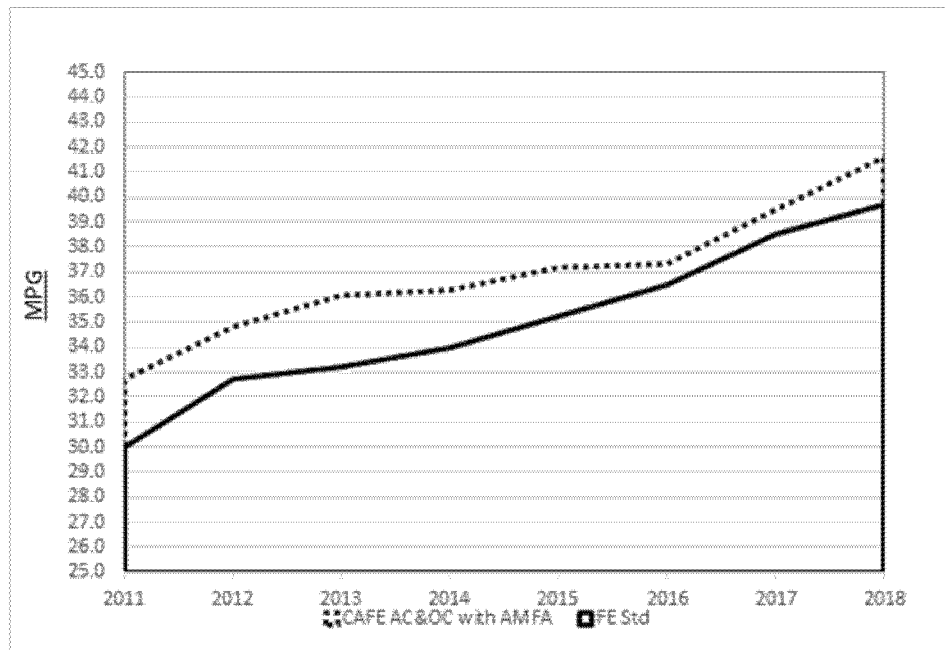

Figure X-3 Domestic Passenger Car Compliance Overview for MYs 2011 to 2018

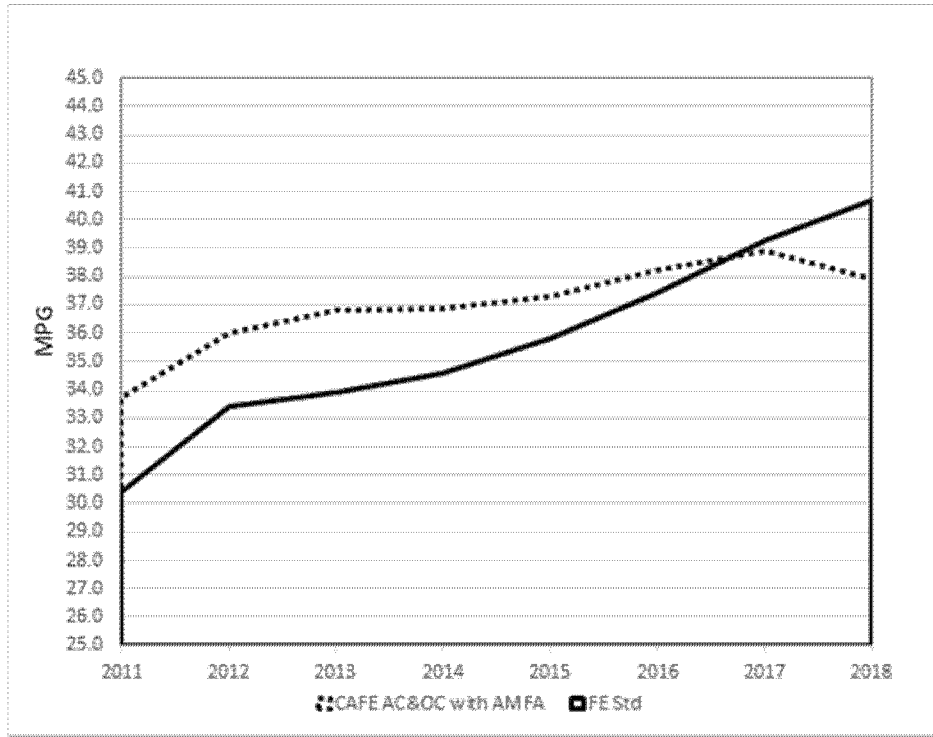

Figure X-4— Import Passenger Car Compliance Overview for MYs 2011 to 2018

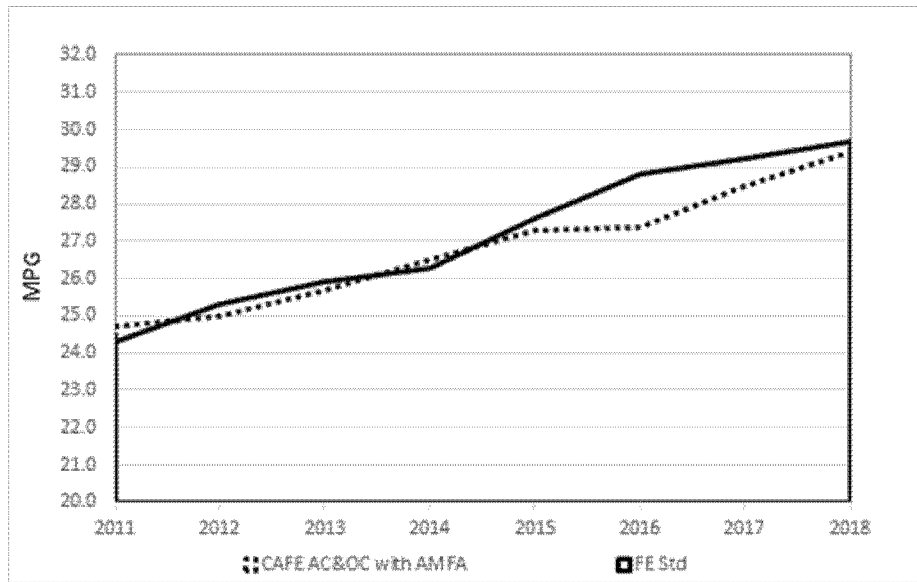

Figure X-5— Light Truck Compliance Overview for MYs 2011 to 2018

As shown in the figures, manufacturers fuel economy performance for the total fleet (the combination of all vehicles produced for sale during the model year) and for each compliance fleet are better than CAFE standards through MY 2015. On average, the total fleet exceeds CAFE standards by approximately 0.9 mpg for

MYs 2011 to 2015. Comparatively, domestic and import passenger cars exceeded standards on average by 2.1 mpg and 2.3 mpg, respectively. On average, light truck manufacturers fell short of standards by 0.3 mpg on average over MYs 2011–2015.

For MYs 2016–2018 the overall industry is or is estimated to fall short

of CAFE standards for the overall fleet and for light trucks and for import passenger cars fleets individually. For MYs 2016–2018, the total fleet has an average shortfall of 0.5 mpg. The largest individual shortfalls are 1.4 mpg for the light truck fleet in MY 2016 and 2.8 mpg for the import passenger car fleet in MY 2018. Domestic passenger car fleets are

expected to continue to exceed CAFE standards. NHTSA expects that on an overall industry basis, manufacturers will apply carry forward and traded CAFE credits to cover the MY 2016–2018 noncompliances.

Figure X–6 provides a historical overview of the industry’s use of CAFE compliance flexibilities for addressing shortfalls. MY 2015 is the latest model year for which CAFE compliance is

complete. Historically, manufacturers have generally resolved credit shortfalls first by carrying forward any earned credits and then applying traded credits. In model years 2014 and 2015, the amount of credit shortfalls are almost the same as the amount of carryforward and traded credits. Manufacturers occasionally carryback credits or opt to transfer earned credits between their fleets to resolve compliance shortfalls.

Trading credits from another manufacturer and transferring them across fleets occurs far more frequently. Also, credit trading has taken the place of civil penalty payments for resolving compliance shortfalls. Only a handful of manufacturers have had to make civil penalty payments since the implementation of the credit trading program.⁸⁸¹

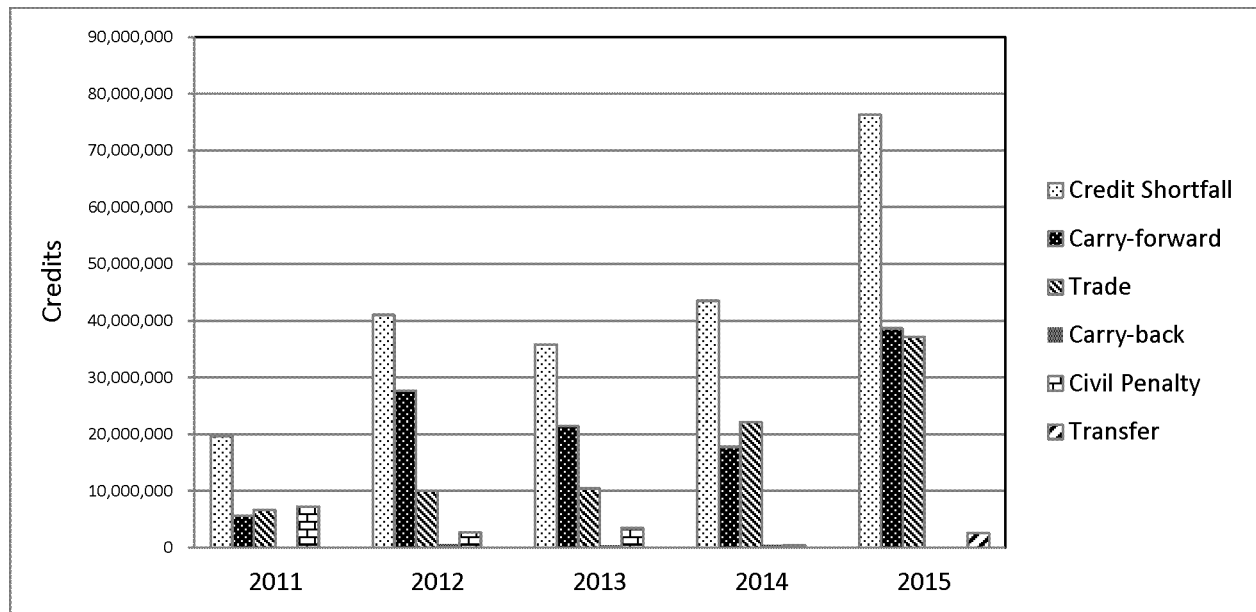

Figure X-6 – Industry Use of Compliance Flexibilities

2. Medium- and Heavy-Duty Technical Amendments

In today’s rule, NHTSA is proposing to make minor technical revisions to correct typographical mistakes and improper references adopted in the agency’s 2016 Phase 2 medium- and heavy-duty fuel efficiency rulemaking.⁸⁸² The proposed changes are as follows:

1. *NHTSA heavy-duty vehicles and engine fuel consumption credit equations.* In each credit equation in 49 CFR 535.7, the minus-sign in each multiplication factor was omitted in the final version of the rule sent to the **Federal Register**. For example, the credit equation in Part 535.7(b)(1) should be specified as, Total MY Fleet FCC (gallons) = (Std – Act) × (Volume) × (UL) × (10⁻²) instead of (10²) as currently existing. NHTSA is proposing to correct these omissions.

2. *The CO₂ to gasoline conversion factor.* In 49 CFR 535.6(a)(4)(ii) and (d)(5)(ii), NHTSA provides the methodology and equations for converting the CO₂ FELs/FCLs for heavy-duty pickups vans (gram per mile) and for engines (grams per hp-hr) to their gallon-of-gasoline equivalence. In each equation, NHTSA is proposing to change the conversion factor to 8,887 grams per gallon of gasoline fuel instead of a factor of 8,877 as currently existing.

3. *Curb weight definition.* In 40 CFR 523.2, the reference in the definition for curb weight is incorrect. NHTSA is proposing to correct the definition to incorporate the EPA reference in 40 CFR 86.1803 instead of 49 CFR 571.3.

C. EPA Compliance and Enforcement

EPA is requesting comment on a variety of “enhanced flexibilities” whereby EPA would make adjustments to current incentives and credits

provisions and potentially add new flexibility opportunities to broaden the pathways manufacturers would have to meet standards. Such an approach would support the increased application of technologies that the automotive industry is developing and deploying that could potentially lead to further long-term emissions reductions and allow manufacturers to comply with standards while reducing costs.

One category of flexibilities such as off-cycle credits and credit banking involve credits that are based on real world emissions reductions and do not represent a loss of overall emissions benefits or a reduction in program stringency, yet offer manufacturers with potentially lower-cost or more efficient paths to compliance. Another category of flexibilities described below as incentives, such as incentives for advanced technologies, hybrid technologies, and alternative fuels, do

⁸⁸¹ Only five manufacturers have paid CAFE civil penalties since credit trading began in 2011. Predominately, Jaguar Land Rover has paid the

largest amount of civil penalties, followed by Volvo. See Summary of CAFE Civil Penalties Collected, CAFE Public Information Center, <https://>

one.nhtsa.gov/cale_pic/CAFE_PIC_Fines_LIVE.html.

⁸⁸² 81 FR 73478 (Oct. 25, 2016).

result in a loss of emissions benefit and represent a reduction in the effective stringency of the standards to the extent the incentives are used by manufacturers. These incentives would help manufacturers meet a numerically more stringent standard but would not reduce real-world CO₂ emissions compared to a lower stringency option with fewer such incentives in the short term. A policy rationale for providing such incentives, as EPA articulated in the 2012 rulemakings,⁸⁸³ is that such provisions could incentivize advanced technologies with the potential to lead to greater GHG emissions reductions in the longer-term, where such technologies today are limited by higher costs, market barriers, infrastructure, and consumer awareness. Such incentive approaches would also result in rewarding automakers who invest in certain technological pathways, rather than being technology neutral.

Automakers and other stakeholders have expressed support for this type of approach. For example, Ford recently stated “[w]e support increasing clean car standards through 2025 and are not asking for a rollback. We want one set of standards nationally, along with additional flexibility to help us provide more affordable options for our customers.”⁸⁸⁴ Honda also recently stated their support for an approach that would retain the existing standards while extending the advanced technology multipliers for electrified vehicles, eliminate automakers’ responsibility for the impact of upstream emissions from the electric grid, and accommodate more off-cycle technologies.⁸⁸⁵

EPA has received input from automakers and other stakeholders, including suppliers and alternative fuels industries, supporting a variety of program flexibilities.⁸⁸⁶ EPA requests comments on the following and other flexibility concepts, including the scope of the flexibilities and the range of model years over which such provisions would be appropriate.

The concepts include but are not limited to:

⁸⁸³ See 77 FR 62810–62826, October 15, 2012.

⁸⁸⁴ “A Measure of Progress” By Bill Ford, Executive Chairman, Ford Motor Company, and Jim Hackett, President and CEO, Ford Motor Company, March 27, 2018, <https://medium.com/cityoftomorrow/a-measure-of-progress-bc34ad2b0ed>.

⁸⁸⁵ Honda Release “Our Perspective—Vehicle Greenhouse Gas and Fuel Economy Standards,” April 20, 2018, <http://news.honda.com/newsandviews/pov.aspx?id=10275-en>.

⁸⁸⁶ Memorandum to docket EPA–HQ–OAR–2018–0283 regarding meetings with the Alliance of Automobile Manufacturers on April 16, 2018 and Global Automakers on April 17, 2018.

Advanced Technology Incentives: The current EPA GHG program provides incentives for electric vehicles, fuel cell vehicles, plug-in hybrid vehicles, and natural gas vehicles. Currently, manufacturers are able to use a 0 g/mile emissions factor for all electric powered vehicles rather than having to account for the GHG emissions associated with upstream electricity generation up to a per-manufacturer cumulative production cap for MYs 2022–2025. The program also includes multiplier incentives that allow manufacturers to count advanced technology vehicles as more than one vehicle in the compliance calculations. The current multipliers begin with MY 2017 and end after MY 2021.⁸⁸⁷ Stakeholders have suggested that these incentives should be expanded to further support the production of advanced technologies by allowing manufacturers to continue to use the 0 g/mile emissions factor for electric powered vehicles rather than having to account for upstream electricity generation emissions and by extending and potentially increasing the multiplier incentives. EPA is considering a range of incentives to further encourage advanced technology vehicles. Examples of possible incentives and an estimate of their impact on the stringency of the standards is provided below. Global Automakers recently recommended a multiplier of 3.5 for EVs and fuel cell vehicles which falls within the range of the examples provided below.⁸⁸⁸ EPA requests comments on extending or increasing advanced technology incentives including the use of 0 g/mile emissions factor for electric powered vehicles and multiplier incentives, including multipliers in the range of 2–4.5.

Hybrid Incentives: The current program includes incentives for automakers to use strong and mild hybrids (or technologies that provide similar emissions benefits) in full size pick-up truck vehicles, provided the manufacturer meets specified production thresholds. Currently, the strong hybrid per vehicle credit is 20 g/mile, available through MY 2025, and the technology must be used on at least 10% of a company’s full-size pickups to receive the credit for the model year. The program also includes a credit for mild hybrids of 10 g/mi during MYs

⁸⁸⁷ The current multipliers are for EV/FCVs: 2017–2019—2.0, 2020—1.75, 2021—1.5; for PHEVs and dedicated and dual fuel CNG vehicles: 2017–2019—1.6, 2020—1.45, 2021—1.3.

⁸⁸⁸ Memorandum to docket EPA–HQ–OAR–2018–0283 regarding meetings with the Alliance of Automobile Manufacturers on April 16, 2018 and Global Automakers on April 17, 2018.

2017–2021. To be eligible a manufacturer would have to show that the mild hybrid technology is utilized in a specified portion of its truck fleet beginning with at least 20% of a company’s full-size pickup production in MY 2017 and ramping up to at least 80% in MY 2021.

EPA received input from automakers that these incentives should be extended and available to all light-duty trucks (e.g., cross-over vehicles, minivans, sport utility vehicles, smaller-sized pick-ups) and not only full size pick-up trucks. Automakers also recommended that the program’s production thresholds should be removed because they discourage the application of technology since manufacturers cannot be confident of achieving the sales thresholds. Some stakeholders have also suggested an additional credit for strong and mild hybrid passenger cars. EPA seeks comment on whether these incentives should be expanded along the lines suggested by stakeholders. For example, Global Automakers recommends a 20 g/mile credit for strong hybrid light trucks and a 10 g/mile credit for strong hybrid passenger cars. These incentives could lead to additional product offerings of strong hybrids, and technologies that offer similar emissions reductions, which could enable manufacturers to achieve additional long-term GHG emissions reductions.

Off-cycle Emission Credits: Starting with MY 2008, EPA started employing a “five-cycle” test methodology to measure fuel economy for the fuel economy label.⁸⁸⁹ However, for GHG and CAFE compliance, EPA continues to use the established “two-cycle” (city and highway test cycles, also known as the FTP and HFET) test methodology. As learned through development of the “five-cycle” methodology and prior rulemakings, there are technologies that provide real-world GHG emissions and fuel consumption improvements, but those improvements are not fully reflected on the “two-cycle” test. EPA established the off-cycle credit program to provide an incentive for technologies that achieve CO₂ reductions but normally would not be chosen as a GHG control strategy, as their GHG benefits are not measured on the specified 2-cycle test. Automakers as well as auto suppliers have recommended several changes to the current off-cycle credits program to help it achieve that goal.⁸⁹⁰

⁸⁸⁹ <https://www.epa.gov/vehicle-and-fuel-emissions-testing/dynamometer-drive-schedules>.

⁸⁹⁰ “Petition for Direct Final Rule with Regard to Various Aspects of the Corporate Average Fuel

Automakers and suppliers have suggested changes including:

- Streamlining the program in ways that would give auto manufacturers more certainty and make it easier for manufacturers to earn credits;
- Expanding the current pre-defined off-cycle credit menu to include additional technologies and increasing credit levels where appropriate;
- Eliminating or increasing the credit cap on the pre-defined list of off-cycle technologies and revising the thermal technology credit cap; and
- A role for suppliers to seek approval of their technologies.

Under EPA's existing regulations, there are three pathways by which a manufacturer may accrue off-cycle technology credits. The first is a predetermined list or "menu" of credit values for specific off-cycle technologies that may be used beginning for MY 2014.⁸⁹¹ This pathway allows manufacturers to use conservative credit values established by EPA for a wide range of off-cycle technologies, with minimal data submittal or testing requirements. In cases where additional laboratory testing can demonstrate emission benefits, a second pathway allows manufacturers to use 5-cycle testing to demonstrate and justify off-cycle CO₂ credits.⁸⁹² The additional emission tests allow emission benefits to be demonstrated over some elements of real-world driving not captured by the GHG compliance tests, including high speeds, rapid accelerations, and cold temperatures. Under this pathway, manufacturers submit test data to EPA, and EPA decides whether to approve the off-cycle credits without soliciting public comment on the data. The third and last pathway allows manufacturers to seek EPA approval, through a notice and comment process, to use an alternative methodology other than the menu of 5-cycle methodology for determining the off-cycle technology CO₂ credits.⁸⁹³

EPA requests comments on changes to the off-cycle process that would streamline the program. Currently, under the third pathway, manufacturers submit an application that includes their methodology to be used to determine the off-cycle credit value and data that then undergoes a public review and comment process prior to an EPA decision regarding the application. Each manufacturer separately submits

an application to EPA that must go through a public review and comment process even if the manufacturer uses a methodology previously approved by EPA. For example, under the current program, multiple manufacturers have submitted applications for high efficiency alternators and advanced air conditioning compressors using similar methodologies and producing similar levels of credits.

EPA requests comment on revising the regulations to allow all auto manufacturers to make use of a methodology once it has been approved by EPA without the subsequent applications from other manufacturers undergoing the public review process. This would reduce redundancy present in the current program. Manufacturers would need to provide EPA with at least the same level of data and detail for the technology and methodology as the firm that went through the public comment process.

EPA also requests comment on revising the regulations to allow EPA to, in effect, add technologies to the pre-approved credit menu without going through a subsequent rulemaking. For example, if one or more manufacturers submit applications with sufficient supporting data for the same or similar technology, the data from that application(s) could potentially be used by EPA as the basis for adding technologies to the menu. EPA is requesting comment on revising the regulations to allow EPA to establish through a decision document a credit value, or scalable value as appropriate, and technology definitions or other criteria to be used for determining whether a technology qualifies for the new menu credit. This streamlined process of adding a technology to the menu would involve an opportunity for public review but not a formal rulemaking to revise the regulations, allowing EPA to add technologies to the menu in a timely manner, where EPA believes that sufficient data exists to estimate an appropriate credit level for that technology across the fleet. In this process, EPA could issue a decision document, after considering public comments, making the new menu credits available to all manufacturers (effectively adding the technology to the menu without changing the regulations each time). By adding technologies to the menu, EPA would eliminate the need for manufacturers to subsequently submit individual applications for the technologies after the first application was approved.

In addition, EPA requests comments on modifying the menu through this current rulemaking to add technologies.

As noted above, EPA has received data from multiple manufacturers on high efficiency alternators and advanced air conditioning compressors that could serve as the basis for new menu credits for these technologies.⁸⁹⁴ EPA requests comments on adding these technologies to the menu including comments on credit level and appropriate definitions.⁸⁹⁵ EPA also requests comments on other off-cycle technologies that EPA could consider adding to the menu including supporting data that could serve as the basis for the credit.

In 2014, EPA approved additional credits for Mercedes-Benz⁸⁹⁶ stop-start system through the off-cycle credit process based on data submitted by Mercedes on fleet idle time and its system's real-world effectiveness (*i.e.*, how much of the time the system turns off the engine when the vehicle is stopped). Multiple auto manufacturers have requested that EPA revise the table menu value for stop-start technology based solely on one input value EPA considered, idle time, in the context of the Mercedes stop-start system, but no firms have provided additional data on any of the other factors which go into the consideration of a conservative value for stop-start systems. Systems vary significantly in hardware, design, and calibration, leading to wide variations in how much of the idle time the engine is actually turned off. EPA has learned that some stop-start systems may be less effective in the real world than the agency estimated in its 2012 rulemaking analysis, for example, due to systems having a disable switch available to the driver, or stop-start systems be disabled under certain temperature conditions or auxiliary loads, which would offset the benefits of the higher idle time estimates. EPA requests additional data from the OEMs, suppliers, and other stakeholders regarding a comprehensive update to the stop-start off-cycle credit table value.

The menu currently includes a fleetwide cap on credits of 10 g/mile⁸⁹⁷ to address the uncertainty surrounding the data and analysis used as the basis of the menu credits. Some stakeholders have expressed concern that the current

⁸⁹⁴ <https://www.epa.gov/vehicle-and-engine-certification/compliance-information-light-duty-greenhouse-gas-ghg-standards>

⁸⁹⁵ See EPA Memorandum to Docket EPA-HQ-OAR-2018-0283 "Potential Off-cycle Menu Credit Levels and Definitions for High Efficiency Alternators and Advanced Air Conditioning Compressors."

⁸⁹⁶ "EPA Decision Document: Mercedes-Benz Off-cycle Credits for MY 2012-2016," EPA-420-R-14-025, September 2014.

⁸⁹⁷ 40 CFR 86.1869-12(b)(2).

⁸⁹¹ See 40 CFR 86.1869-12(b).

⁸⁹² See 40 CFR 86.1869-12(c).

⁸⁹³ See 40 CFR 86.1869-12(d).

cap may constrain manufacturers ability in the future to fully utilize the menu especially if the menu is expanded to include additional technologies, as described above. For example, Global Automakers suggested that the cap be raised from 10 g/mi to 15 g/mi. EPA requests comments on increasing the current cap, for example from the current 10 g/mile to 15 g/mile to accommodate increased use of the menu. EPA also requests comment on a concept that would replace the current menu cap with an individual manufacturer cap that scales with the manufacturer's average fleetwide target levels. The cap would be based on a percentage of the manufacturer's fleetwide 2-cycle emissions performance, for example at 5–10% of CO₂ a manufacturer's emissions fleet wide target. With a cap of five for a manufacturer with a 2-cycle fleetwide average CO₂ level of 200 g/mile, for example, the cap would be 10 g/mile. EPA believes this may be a reasonable and more technically correct approach for the caps, recognizing that in many cases the emissions benefits of off-cycle technologies correlate with the CO₂ levels of the vehicles, providing more or less emissions reductions depending on the CO₂ levels of the vehicles in the fleet. For example, applying stop-start to vehicles with higher vehicle idle CO₂ levels provide more emissions reductions than when applied to vehicles with lower idle emissions. This approach also would help account for the uncertainty associated with the menu credits and help ensure that off-cycle menu credits do not become an overwhelming portion of the manufacturers overall emissions reduction strategy.

The current GHG rule contains a CO₂ credit program for improvements to the efficiency of the air conditioning system on light-duty vehicles (see § 86.1868–12). The total of A/C efficiency credits is calculated by summing the individual credit values for each efficiency improving technology used on a vehicle as specified in the air conditioning credit menu. The total credit sum for each vehicle is capped at 5.0 grams/mile for cars and 7.2 grams/mile for trucks. Additionally, the off-cycle credit program (see § 86.1869–12) contains credit earning opportunities for technologies that reduce the thermal loads on the vehicle from environmental conditions (solar loads, parked interior ambient air temperature). These menu-based thermal control credits have separate cap limits under the off-cycle program of 3.0 grams/mile for cars and 4.3 grams/mile for trucks. The AC

efficiency technologies and the thermal control technologies directly interact with each other because improved thermal control results in reduced air conditioning loads of the more efficient air conditioning technologies. Because of this interaction, an approach that would remove the thermal control credit program from the off-cycle credit program and combine them with the AC efficiency program would seem appropriate to quantify the combined impact. Additionally, a cap that reflects this combination of these two related programs may also be appropriate. For example, if combined, the credit cap for thermal controls and air conditioning efficiency could be the combined value of the current individual program caps of 8.0 grams/mile for cars and 11.5 grams/mile for trucks. This combined A/C efficiency and thermal controls cap would also apply to any additional thermal control or air conditioning efficiency technology credit generated through other off-cycle credit pathways. Also, by removing the thermal credits from the off-cycle menu, they would no longer be counted against the menu cap discussed above, representing a way to provide more room under the menu cap for other off-cycle technologies. Comment is sought on this approach and the appropriateness of the described per vehicle cap limits above.

As mentioned above, EPA has heard from many suppliers and their trade associations an interest in allowing suppliers to have a role in seeking off-cycle credits for their technologies. EPA requests comment on providing a pathway for suppliers, along with at least one auto OEM partner, to submit off-cycle applications for EPA approval. Auto manufacturers would remain entirely responsible for the full useful life emissions performance of the off-cycle technology as is currently the case, including, for example, existing responsibilities for defect reporting and the prohibition on defeat devices. Under such an approach, an application submitted by a supplier and vehicle manufacturer would establish a credit and/or methodology for demonstrating credits that all auto manufacturers could then use in their subsequent applications. This process could include full-vehicle simulation modeling that is compatible with EPA's ALPHA simulation tool. EPA requests comment on requiring that the supplier be partnered in a substantive way with one or more auto manufacturers to ensure that there is a practical interest in the technology prior to investing resources in the approval process. The supplier application would be subject to public

review and comment prior to an EPA decision. However, once approved, the subsequent auto manufacturer applications requesting credits based on the supplier methodology would not be subject to public review. EPA also requests comments on a concept where supplier (with at least one auto manufacturer partner) demonstrated credits would be available provisionally for a limited period of time, allowing manufacturers to implement the technology and collect data on their vehicles in order to support a continuation of credits for the technology in the longer term. Also, the provisional credits could be included under the menu credit cap since they would be based on a general analysis of the technology rather than manufacturer-specific data. EPA requests comments on all aspects of this approach.

Incentives for Connected or Autonomous Vehicles: Connected and autonomous vehicles have the potential to significantly impact vehicle emissions in the future, with their aggregate impact being either positive or negative, depending on a large number of vehicle-specific and system-wide factors. Currently, connected or autonomous vehicles would be eligible for credits under the off-cycle program if a manufacturer provides data sufficient to demonstrate the real-world emissions benefits of such technology. However, demonstrating the incremental real-world benefits of these emerging technologies will be challenging. Stakeholders have suggested that EPA should consider an incentive for these technologies without requiring individual manufacturers to demonstrate real world emissions benefits of the technologies. EPA believes that any near-term incentive program should include some demonstration that the technologies will be both truly new and have some connection to overall environmental benefits. EPA requests comment on such incentives as a way to facilitate increased use of these technologies, including some level of assurance that they will lead to future additional emissions reductions.

Among the possible approaches, the most basic credits could be awarded to manufacturers that produce vehicles with connected or automated technologies. For connected vehicles, a set amount of credit could be provided for each vehicle capable of Vehicle-to-Vehicle (V2V) or Vehicle-to-Infrastructure (V2I) communications. One possible example is to provide a set amount of credit, using the off-cycle menu, for any vehicle that can

communicate basic safety messages (as outlined in SAE J2735) to other vehicles. The credits provided would be an incentive to enable future transportation system efficiencies, as these technologies on an individual vehicle are unlikely to impact emissions in any meaningful way. However, if these technologies are dispersed widely across the fleet they could, under some circumstances, lead to future emission reductions, and an incentive available to manufacturers now could help facilitate that transformation.

The rationale for providing credits for vehicle automation is similar to that for connected vehicles. EPA could provide a set credit for vehicles that achieve some specific threshold of automation, perhaps based on the industry standard SAE definitions (SAE J3016). Individual autonomous vehicles might achieve some emissions reductions, but the impact may increase as larger numbers of autonomous vehicles are on the road and can coordinate and provide system efficiencies. Providing credits for autonomous vehicles, again through a set credit, would provide manufacturers a clear incentive to bring these technologies to market. It would be important for any such program to incentivize only those approaches that could reasonably be expected to provide additional contributions to overall emission reductions, taking system effects into account. As above, EPA believes that any near-term incentive program should include some demonstration that the technologies are truly new and have some connection to environmental benefits overall.

A number of stakeholders have also requested that EPA consider credits for automated and connected vehicles that are placed in ridesharing or other high mileage applications, where any potential environmental benefits could be multiplied due to the high utilization of these vehicles. That is, credits could take into account that the per-mile emission reduction benefits would accrue across a larger number of miles for shared-use vehicles. There are likely many possible approaches that could accomplish this objective. As one example, a manufacturer who owns or partners with a shared-use mobility entity could receive credit for ensuring that their autonomous vehicles are used throughout the life of the vehicle in shared-use fleets rather than as personally owned vehicles. Such credits would be based off of the assumption

that total vehicle miles travelled would be higher and, therefore, generate more emission reduction benefits, under the former case. Credits could be based off of the CO₂ emissions reduction of the autonomous fleet, taking into account the higher VMT of the shared-use fleet, relative to the average.

As suggested by this partial list of examples, a variety of approaches would be possible to incentivize the use of these technologies. EPA seeks comment on these and related approaches to incentivize autonomous and connected vehicle technologies where they would have the most beneficial effect on future emissions.

Credit Carry-forward: Currently, CO₂ credits may be carried forward, or banked, for five years, with the exception that MY 2010–2015 credits may be carried forward and used through MY 2021. Automakers have suggested a variety of ways in which GHG credit life could be extended under the Clean Air Act, including the ability for automakers to carry-forward MY 2010 and later banked credits out to MY 2025, extending the life of credits beyond five years, or even unlimited credit life where credits would not expire. EPA believes longer credit life would provide manufacturers with additional flexibility to further integrate banked credits into their product plans, potentially reducing costs. EPA requests comments on extending credit carry-forward beyond the current five years, including unlimited credit life.

Natural Gas Vehicle Credits: Vehicles that are able to run on compressed natural gas (CNG) currently are eligible for an advanced technology multiplier credit for MYs 2017–2021. Dual-fueled natural gas vehicles, which can run either on natural gas or on gasoline, are also eligible for an advanced technology multiplier credit if the vehicles meet minimum CNG range requirements. EPA received input from several industry stakeholders who supported expanding these incentives to further incentivize vehicles capable of operating on natural gas, including treating incentives for natural gas vehicles on par with those for electric vehicles and other advanced technologies, and adjusting or removing the minimum range requirements for dual-fueled CNG vehicles. EPA requests comments on these potential additional incentives for natural gas fueled vehicles.

High Octane Blends: EPA received input from renewable fuel industry stakeholders and from the automotive

industry supporting high octane blends as a way to enable GHG reducing technologies such as higher compression ratio engines. Stakeholders suggested that mid-level (e.g., E30) high octane ethanol blends should be considered and that EPA should consider requiring that mid-level blends be made available at service stations. Higher octane gasoline could provide manufacturers with more flexibility to meet more stringent standards by enabling opportunities for use of lower CO₂ emitting technologies (e.g., higher compression ratio engines, improved turbocharging, optimized engine combustion). EPA requests comment on if and how EPA could support the production and use of higher octane gasoline consistent with Title II of the Clean Air Act.

To illustrate how additional flexibilities would translate to a reduction in the stringency of the standards, EPA analyzed several examples as described below.⁸⁹⁸ The example flexibilities EPA selected for this analysis are (1) removing the requirement to account for upstream emissions associated with electricity use (i.e., extending the 0 g/mile emissions factor), (2) a range of higher multipliers for electric vehicles, and (3) additional credits for hybrids sold in the light-truck fleet. EPA estimated what each additional flexibility could contribute to estimate an equivalent percent per year CO₂ standard reduction it would represent on a fleetwide basis. The examples and results are provided in the table below for several example technology sales penetration values (three and six percent for battery electric vehicles, 10 and 20% for mild hybrid light-trucks, five and 10% for strong hybrid light-trucks). These examples were chosen to provide a sense of the relationship between the additional flexibility and program stringency. For each example scenario, EPA made a number of assumptions regarding the fleet penetration of the technology, car/truck mix, and others, which are documented in the docket. Additional flexibilities could be structured to provide a level of overall stringency equivalent to the full range of the Alternatives EPA is requesting comment on in this proposal, from the proposed standards through more stringent alternatives described above in this section, including the “No Action” alternative.

⁸⁹⁸ Memorandum, “Spreadsheet tool for the comparative analysis of program stringencies for

various light-duty vehicle GHG footprint curves and compliance flexibilities combinations,” July 2018,

Kevin Bolon, EPA Office of Air and Radiation. Docket No. EPA-HQ-OAR-2018-0283.

Table X-5 - Effect of Different Example Flexibilities in Reducing Program Stringency Compared to the Current EPA Standards (which average 4.7% per year stringency increase from MY 2020-2025)

Description of Flexibility	Equivalent fleetwide percent per year reduction in stringency provided by the flexibility
0 g/mile emissions factor for electricity	
@ 3 percent new electric vehicle sales	0.2%
@ 6 percent BEV new vehicle sales	0.4%
Multiplier of 2x for electric vehicles	
@ 3 percent BEV new vehicle sales	0.5%
@ 6 percent BEV new vehicle sales	0.9%
Multiplier of 4.5x for electric vehicles	
@ 3 percent BEV new vehicle sales	1.6%
@ 6 percent BEV new vehicle sales	3.2%
For all light trucks, 10 g/mile credit for mild hybrid and 20 g/mile for strong hybrid	
@ 10 percent mild & 5 percent strong hybrid penetration	0.1%
@ 20 percent mild & 10 percent strong hybrid penetration	0.2%
Combined effect of above flexibilities*	0.7% to 3.8%

(*) **Note:** Low end of combined effects includes 0 g/mi, three percent BEVs, 2x BEV multiplier, 10% mild hybrid light-truck penetration, and five percent strong hybrid light-truck penetration. High end of combined effects range includes 0 g/mi, six percent BEVs, 4.5x BEV multiplier, 20% mild hybrid light-truck penetration, and 10% strong hybrid light-truck penetration.

Table X-6 shows three examples of scenarios for how enhanced flexibilities could impact overall program stringency. Example A reduces the stringency of the EPA CO₂ standard from 4.7% per year to 4.0% per year. Example C, which includes the maximum incentive flexibilities shown in Table X-5, significantly reduces the EPA CO₂ program stringency from 4.7% per year to 0.8% per year. Increasing the BEV multipliers or hybrid credits beyond those listed in Table XX by EPA would have the effect of further

reducing the stringency of the standards. EPA requests comment on the potential use of enhanced program flexibilities as an alternative approach to establishing the appropriate CO₂ standards for MY 2021-2025.

EPA solicits comment on the individual options for flexibilities and on the potential for combining them as described in these example scenarios. For example, EPA solicits comments on how to take these flexibilities into account in considering the level of the standards and whether, for a given level

of overall stringency, the factors discussed in Section V above, regarding EPA Justification for the Proposed GHG Standards, would support a relatively less stringent standard with fewer flexibilities or a relatively more stringent standard with more flexibilities. EPA also solicits comment on whether any flexibilities or combinations of flexibilities in particular are more or less consistent with the Administrator's rationale for proposing Alternative 1.

Table X-6 - Effect of Different Example Flexibilities in Reducing Program Stringency Compared to the Current EPA Standards (which average 4.7% per year stringency increase from MY 2020-2025)

Example Enhanced Flexibility Scenarios	Average Year-over-Year Reduction in CO ₂ for MYs 2020-2025
No Action Alternative (the existing EPA standards)	4.7% per year
Example Enhanced Flexibility A: EPA extends the 0 g/mi factor and a multiplier of 2x for BEVs, and BEV sales achieve a level of 3% of new vehicle sales.	4.0% per year
Example Enhanced Flexibility B: EPA extends the 0 g/mi factor and a multiplier of 4.5x for BEVs, and BEV sales achieve a level of 3% of new vehicle sales.	2.8% per year
Example Enhanced Flexibility C: EPA extends the 0 g/mi factor and a multiplier of 4.5x for BEVs, and BEV sales achieve a level of 6% of new vehicle sales, mild hybrid light-trucks receive a 10g/mi credit and achieve 20% new sales, strong hybrid light-trucks receive a 20g/mi credit and achieve a 10% new sales level.	0.8% per year
Alternative 1 (EPA proposal)	0 % per year

D. Should NHTSA and EPA continue to account for air conditioning efficiency and off-cycle improvements?

As stated in the 2012 NPRM and final rules for MYs 2017 and beyond, the purpose of the off-cycle improvement incentive is to encourage the introduction and market penetration of off-cycle technologies that achieve real-world benefits.⁸⁹⁹ In the 2012 NPRM, NHTSA stated,

... because we and EPA do not believe that we can yet reasonably predict an average amount by which manufacturers will take advantage of [the off-cycle FCIV] opportunity, it did not seem reasonable for the proposed standards to include it in our stringency determination at this time. We expect to re-evaluate whether and how to include off-cycle credits in determining maximum feasible standards as the off-cycle technologies and how manufacturers may be expected to employ them become better defined in the future.⁹⁰⁰

By the 2012 final rule, NHTSA and EPA had determined that it was appropriate, under EPA's EPCA authority for testing and calculation procedures, for the agencies to provide a fuel economy adjustment factor for off-cycle technologies.⁹⁰¹ NHTSA assessed some amount of off-cycle credits in the determination of the maximum feasible

standards for the MYs covered by that rulemaking.⁹⁰²

The Draft TAR included an extended discussion of the history and technological underpinnings of the A/C efficiency and off-cycle FCIV measurement procedures;⁹⁰³ however, there is a belief that it is also appropriate to now revisit the basic question of, and accordingly comment is sought on, how A/C efficiency and off-cycle credits and FCIVs fit in setting maximum feasible CAFE standards under EPCA/EISA, and GHG standards consistent with EPA's authority under the CAA. It is believed that it would be prudent to revisit factors that EPA identified in their first 2009 NPRM to establish GHG emissions standards,⁹⁰⁴ such as how to best ensure that any off-cycle credits (and associated FCIVs) applied for using manufacturer proposed and agency approved test procedures are verifiable, reflect real-world reductions, are based on repeatable test procedures, and are developed through a transparent process along with appropriate opportunities for public comment. Whether the program is still serving its originally intended purpose is also a determination to be made.

1. Why were alternatives that phased out the A/C efficiency and off-cycle programs considered?

As part of this rulemaking, alternatives were considered that phase out the A/C efficiency and off-cycle compliance flexibilities to reassess the benefits and costs of including these flexibilities in the agencies' respective programs. The A/C efficiency and off-cycle programs have been the subject of discussion and debate since the MYs 2017 and beyond final rule. The Alliance of Automobile Manufacturers and Global Automakers petitioned the agencies to streamline aspects of both agencies' A/C efficiency and off-cycle programs as part of a 2016 request to more broadly harmonize the CAFE and GHG programs (further discussion of the Alliance/Global petition is located above). On the other hand, other stakeholders have questioned the purpose and efficacy of the off-cycle credit program, specifically, whether the agencies are accurately capturing technology benefits and whether the programs are unrealistically inflating manufacturers' compliance values. There are two factors that may be important to consider at this time, (1) manufacturer's increasing use of A/C efficiency and off-cycle technologies to achieve compliance in light of the program's increasing complexity; and (2) the questions of whether the agencies are accurately accounting for

⁸⁹⁹ 77 FR 63134 (Oct. 15, 2012).

⁹⁰⁰ 76 FR 75226 (Dec. 1, 2011).

⁹⁰¹ 77 FR 62628, 62649-50 (Oct. 15, 2012).

⁹⁰² 77 FR 62727, 63018 (Oct. 15, 2012).

⁹⁰³ See Draft TAR at 5-207 *et seq.*

⁹⁰⁴ See 74 FR 49482 (Sept. 28, 2009).

A/C efficiency and off-cycle benefits. In response to comments that the programs in their current form were actually impeding innovative technology growth, in particular from manufacturers, the concept was considered to, instead of continuing to grow the A/C efficiency and off-cycle flexibilities, assess two alternatives that would set standards without the availability of A/C efficiency and off-cycle credits for compliance. Each of these issues will be expanded upon, in turn.

(a) Manufacturers' Increasing Reliance on the A/C Efficiency and Off-cycle Programs To Achieve Compliance

Since the 2012 final rule for MYs 2017 and beyond and the Draft TAR, manufacturers have increasingly utilized A/C efficiency and off-cycle technology to achieve either credits under the GHG program, or fuel consumption improvement values (FCIVs) under the CAFE program. A/C efficiency and off-cycle technology use ranges among manufacturers, from some manufacturers claiming zero grams/mile (or the equivalent under the CAFE program), to some manufacturers claiming 7 grams/mile in MY 2016.⁹⁰⁵ Accordingly, with some manufacturers' potentially reaching the credit cap (10 grams/mile) during the timeframe contemplated by this rulemaking, if not before, considerations relating to manufacturers' increasing reliance on the A/C efficiency and off-cycle programs for compliance, and the agencies' administration of the programs, are presented for discussion.

These issues have not been raised *sua sponte*; rather, manufacturers' comments on the A/C efficiency and off-cycle programs have been increasing recently in volume. Specifically, manufacturers asserted in their 2016 comments to the Draft TAR that “[s]ignificant volumes of off-cycle credits will be essential for the industry in order to comply with the GHG and CAFE standards through 2025.”⁹⁰⁶

⁹⁰⁵ See *Greenhouse Gas Emission Standards for Light-Duty Vehicles: Manufacturer Performance Report for the 2016 Model Year* (EPA Report 420-R18-002), U.S. EPA (Jan. 2018), available at <https://nepis.epa.gov/Exe/ZyPDF.cgi?Dockey=P100TGIA.pdf>.

⁹⁰⁶ Comment by Alliance of Automobile Manufacturers, Docket ID NHTSA-2016-0068-0095, at 162. It is important to note the Alliance submitted this statement in context of the CAFE and GHG levels set in the 2012 final rule for MYs 2017 and beyond. Specifically, the Alliance asserted “[t]he Agencies included off-cycle credits from only two technologies in their analyses for setting the stringency of the standards (engine stop start and active aerodynamic features). However, because the fuel consumption benefits of many other technologies were overestimated in the Agencies' analyses, and the standards were

Similarly, in its request for the agencies to more fully incorporate estimated costs for A/C efficiency and off-cycle technologies in their analysis, ICCT noted that “companies are clearly prioritizing [off-cycle] technologies over more advanced test-cycle efficiency technologies.”⁹⁰⁷

Concurrent with the Alliance/Global's petition for the agencies to take action on various aspects of the A/C efficiency and off-cycle programs, other stakeholders raised issues about the programs that could be discussed at this time. For example, ACEEE commented on the Draft TAR that “an off-cycle technology that is common in current vehicles and is not reflected in the stringency of the standards has no place in the off-cycle credit program. The purpose of the program is to incentivize adoption of fuel saving technology, not to provide loopholes for manufacturers to achieve the standards on paper.”⁹⁰⁸

Compare these comments with EPA's 2017 *Light-Duty Automotive Technology, Carbon Dioxide Emissions, and Fuel Economy Trends: 1975 Through 2017* report, which estimated that A/C efficiency and off-cycle credits could, at most, “reduce adjusted MY 2016 CO₂ tailpipe emission values by about 7 g/mi, which would translate to an adjusted fuel economy increase of approximately 0.5 mpg.”⁹⁰⁹ A/C and off-cycle flexibilities allow manufacturers to optionally apply a wide array of technologies to improve fuel economy. While the agencies do not require or incentivize the adoption of any particular technologies, the industry is in fact expanding its use of more cost-effective A/C efficiency and off-cycle technologies rather than other technology pathways. Accordingly comment is sought on how large of a role A/C efficiency and off-cycle technology should play in manufacturer compliance. Is an adjusted fuel economy increase of approximately 0.5 mpg noteworthy?

Next, when manufacturers are increasingly reliant on A/C efficiency and off-cycle technology to achieve compliance, agency administration of the flexibility becomes more significant.

therefore set at very challenging levels, off-cycle technologies and the associated GHG and fuel economy benefits are viewed by the industry as a critical area that must become a major source of credits.”

⁹⁰⁷ Comment by ICCT, Docket ID EPA-HQ-OAR-2015-0827-4017, at 10.

⁹⁰⁸ Comment by ACEEE, Docket ID NHTSA-2016-0068-0078, at 14.

⁹⁰⁹ *Light-Duty Automotive Technology, Carbon Dioxide Emissions, and Fuel Economy Trends: 1975 Through 2017*, U.S. EPA at 141 (Jan. 2018), available at <https://nepis.epa.gov/Exe/ZyPDF.cgi?Dockey=P100TGDW.pdf>.

The Alliance commented that the industry “needs the off-cycle credit program to function effectively to fulfill the significant role that will be needed for generating large quantities of credits from [off-cycle] emission reduction.”⁹¹⁰ Moreover, the Alliance pointed out that “[l]imited Agency resources have delayed the processing of [petitions for off-cycle credits], and the delay impedes manufacturers' ability to plan for compliance or make investment decisions.”⁹¹¹ More specifically, the Alliance commented that:

[c]ase-by-case approvals for off-cycle credit applications is excessively burdensome due to slow agency response and unnecessary testing. The procedures for granting off-cycle GHG credits are not being implemented per the provisions of the regulation and are not functioning to the level necessary for industry for long-term compliance. Without timely processing, EPA works against its stated intent of ‘provid[ing] an incentive for CO₂ and fuel consumption reducing off-cycle technologies that would otherwise not be developed because they do not offer a significant 2-cycle benefit.’⁹¹²

Notably, the agencies' implementation of the off-cycle credit provisions has been described as “underperforming.”⁹¹³

The Alliance's “primarily regulatory need” as of the 2016 Draft TAR was “a renewed focus on removing all obstacles that are having the unintended result of slowing investment and implementation of [credit] technologies.”⁹¹⁴ The Alliance stated generally that “[w]ith the pre-approved credit list properly administered, the off-cycle program can be expected to grow toward the credit caps that were established in the regulation, and these credit caps will become binding constraints for many or most automobile manufacturers. At that point, the credit caps will be counterproductive since they will impede greater implementation of the beneficial off-cycle technologies.”⁹¹⁵ Similarly in regards to the agencies' refusal to grant off-cycle credits for technologies like driver assistance systems, the Alliance stated that “[t]he unintended consequence of this is that automakers may not be able to continue to pursue technologies that do not

⁹¹⁰ Comment by Alliance of Automobile Manufacturers, Docket ID NHTSA-2016-0068-0095, at 166.

⁹¹¹ *Id.* at 167.

⁹¹² Comment by Alliance of Automobile Manufacturers, Docket ID EPA-HQ-OA-2017-0190.

⁹¹³ Comment by Alliance of Automobile Manufacturers, Docket ID NHTSA-2016-0068-0095, at 166.

⁹¹⁴ *Id.* at xiv.

⁹¹⁵ *Id.* at 164.

provide certainty in supporting vehicle compliance.”⁹¹⁶

These comments highlight the challenges to assure improvement values from A/C efficiency and off-cycle technologies reflect verifiable, real-world fuel economy improvements, are attributable to specific vehicle models, are based on repeatable test procedures and are developed through a transparent process with appropriate opportunities for public comment. There is a belief this process and these considerations are important to assure the integrity and fairness of the A/C and off-cycle procedures. The menu and 5-cycle test methodologies are predefined and are not subject to the in-depth review that proposed new test procedures are subject to. Comment is sought on whether and how menu-based A/C and off-cycle credits should be implemented.

(b) Potential for Benefits To Be Double Counted

Next, the potential for technology benefits to be over-counted is worth mention, but it is noted that aspects of this issue are being addressed in this rulemaking. As stated in the 2012 final rule for MYs 2017 and beyond, fuel saving technologies integral to basic vehicle design (e.g., camless engines, variable compression ratio engines, micro air/hydraulic launch assist devices, advanced transmissions) should not be eligible for off-cycle credits. Specifically, “[b]eing integral, there is no need to provide an incentive for their use, and (more important), these technologies would be incorporated regardless. Granting credits would be a windfall.”⁹¹⁷ Assumedly, because these technologies are integral to basic vehicle design, their benefit would be appropriately captured on the 2-cycle tests and 5-cycle tests. Similarly, ICCT commented that, “[i]n theory, off-cycle credits are a good idea, as they encourage real-world fuel consumption reduction for technologies that are not fully included on the official test cycles. However, real-world benefits only accrue if double-counting is avoided and the amount of the real-world fuel consumption reduction is accurately measured.”⁹¹⁸

Broadly, there is agreement with the concept that capturing real-world driving behavior is essential to accurately measure the true benefits of A/C efficiency and off-cycle technologies. One example where this

holds true is in particular component testing as measured with the federal standardized testing procedure. For example, the federal test procedures provide specific guidance on how a vehicle should be installed on the dynamometer, if the vehicle’s windows should be open or closed, and the vehicle’s tire pressure. On the other hand, the regulations provide no specific guidance on how other components should be tested so the agencies and manufacturers can most accurately quantify benefits.

For example, to more accurately capture the benefit of a high efficiency alternator on the 2-cycle or 5-cycle test, the vehicle would need to run more systems that draw power from the alternator, like the infotainment system or temperature controlled seats. There is not guidance for these additional components in the tests as they are currently performed due to the complexity of systems available in the light duty vehicle market. Essentially, it is uncertain how to define in regulations what component systems need to be on or off during testing to accurately capture the benefit of component synergies. Developing guidance on specific systems would also likely require a significant amount of time and resources. Comment is sought on specific technologies that may be receiving more benefit based on the current test procedures, or more generally, any other issues related to integrated component testing.

It is noted, however, that the optional 5-cycle test procedure for determining A/C and off-cycle improvement values over-counts benefits. The 5-cycle test procedure weighs the 2-cycle tests used for compliance with three additional test cycles to better represent real-world factors impacting fuel economy and GHG emissions, including higher speeds and more aggressive driving, colder temperature operation, and the use of air conditioning. However, the current regulations erroneously do not require that the 2-cycle benefit be subtracted from the 5-cycle benefit, resulting in a credit calculation that is artificially too high and not reflecting actual real-world emission reductions that were intended. Since the 5-cycle test procedures include the 2-cycle tests used for compliance, it is believed the 2-cycle benefit should be subtracted from the 5-cycle benefit to avoid over-counting of benefits. Manufacturers interested in generating credits under the 5-cycle pathway identified this issue to the agencies, and have asked EPA to clarify the regulations. This issue is discussed in Section X.C, above, and comment is

sought on how to implement this correction.

2. Why was the phase-out as modeled (e.g., year over year reductions in available FCIVs) for certain alternatives proposed?

The CAFE model was used to assess the economic, technical, and environmental impacts of alternatives that kept the A/C efficiency and off-cycle programs as is and alternatives that phased those programs out. As described fully in Section II.B, the CAFE model is a software simulation that begins with a recently produced fleet of vehicles and applies cost effective technologies to each manufacturers’ fleet year-by-year, taking into consideration vehicle refresh and redesign schedules and common parts among vehicles. The CAFE model outputs technology pathways that manufacturers could use to comply with the proposed policy alternatives.

For this NPRM, the modeling analysis uses the off-cycle credits submitted by each manufacturer for MY 2017 compliance and carries these forward to future years with a few exceptions. Several technologies described in Section II.D are associated with off-cycle credits. In particular, stop-start systems, integrated starter generators, and full hybrids are assumed to generate off-cycle credits when applied to improve fuel economy. Similarly, higher levels of aerodynamic improvements are assumed to require active grille shutters on the vehicle, which also qualify for off-cycle credits. The analysis assumes that any off-cycle credits that are associated with actions outside of technologies discussed in Section II.D (either chosen from the pre-approved menu or petitioned for separately) remain at levels identified by manufacturers in MY 2017. Any additional off-cycle credits that accrue as the result of explicit technology application are calculated dynamically in each year, for each alternative. This method allows for the capture of benefits and costs from A/C efficiency and off-cycle technologies as compared to an alternative where those technologies are not used for compliance purposes.

In considering potential future actions regarding the A/C efficiency and off-cycle flexibilities, it was recognized that removing the programs immediately would present a considerable challenge for manufacturers. Based on compliance and mid-model year data for MY 2017, the first model year that NHTSA accepted FCIVs for CAFE compliance, manufacturers have reported A/C efficiency and off-cycle FCIVs at

⁹¹⁶ *Id.* at 126.

⁹¹⁷ 77 FR 62732 (Oct. 15, 2012).

⁹¹⁸ Comment by ICCT, Docket EPA-HQ-OAR-2015-0827-4017, at 10.

noteworthy levels. EPA's MY 2016 Performance Report reported wide penetration of FCIVs from menu technologies and noted some technologies widely employed by OEMs included active grill shutters, glass or glazing, and stop-start systems. Additional details of individual manufacturers' MY 2016 performance and individual A/C and off-cycle technology penetration can be found on EPA's website.⁹¹⁹ Accordingly, a phase-

out was identified as a reasonable option for manufacturers to come into compliance with GHG or fuel economy standards without using A/C efficiency and off-cycle improvements for compliance.

Throughout the joint CAFE and GHG programs, the agencies have phased out flexibility and incentive programs rather than ending those programs abruptly, such as with the alternative fuel vehicle program (as mandated by EISA)⁹²⁰ and

the credit program for advanced technologies in pickup trucks.⁹²¹ Accordingly, an incremental decrease in the maximum A/C efficiency and off-cycle FCIVs a manufacturer can receive starting in MY 2022 and ending in MY 2026 was modeled. Table X-7 below shows the incremental cap total starting in MY 2021 and reducing by the recommended value until MY 2026.

Table X-8 - Proposed A/C Efficiency and Off-Cycle Cap Reduction in Certain Alternatives

Passenger Car							
MY	2020	2021	2022	2023	2024	2025	2026
AC Efficiency Cap (g/mile)	5	6	5	4	3	2	0
Off-Cycle Cap (g/mile)	10	10	8	6	4	2	0
Light Truck							
MY	2020	2021	2022	2023	2024	2025	2026
AC Efficiency Cap (g/mile)	7.2	6	5	4	3	2	0
Off-Cycle Cap (g/mile)	10	10	8	6	4	2	0

The MY 2016 fleet final compliance data to identify the starting point for the FCIV phase-out was reviewed.⁹²² For A/C efficiency technologies, 6 grams/mile was used as the starting point, which was the highest FCIV a single manufacturer had received in MY 2016. For off-cycle technologies, the maximum allowable cap of 10 gram/mile set in the 2012 final rule for MYs 2017 and beyond was used. Although no manufacturer had reached the 10 gram/mile cap as of MY 2016, there is a belief that it is still feasible for some manufacturers to reach the cap in MYs prior to 2021. Comment is invited on this methodology.

3. What do the modeled alternatives show?

A lower⁹²³ and higher⁹²⁴ stringency alternative with and without the A/C efficiency and off-cycle flexibilities were modeled to see the impact on regulatory costs, average vehicle prices, societal costs and benefits, average achieved fuel economy, and fuel

consumption, among other attributes. The alternatives and associated impacts presented below are compared to a baseline where EPA's GHG emissions standards for MYs 2022-2025 remain in effect and NHTSA's augural CAFE standards would be in place (for further discussion of the interpretation of what baseline is appropriate, see preamble Section II.B and PRIA Chapter 6).

The modeling results indicated no significant change in the fleet average achieved fuel economy, which is expected because the model only applies technologies to a manufacturers' fleet until the standard is met. However, the change in regulatory costs, average vehicle prices, societal costs, and societal net benefits is noteworthy. Without A/C efficiency and off-cycle technologies available, the CAFE model applied more costly technologies to the fleet. This trend was less noticeable with the low stringency alternative; however, the advanced technology required to meet the high stringency

alternative without A/C efficiency or off-cycle technology was more expensive. Similarly, although the CAFE model only applied technology to the fleet until the fleet met the standards, alternatives that did not employ A/C efficiency and off-cycle technologies saved more fuel and reduced GHG emissions more than alternatives that did employ the A/C efficiency and off-cycle technologies, and in significantly higher amounts for the higher stringency alternative. On average, the modeling shows that phasing out the A/C efficiency and off-cycle programs decreases fuel consumption over the "no change" scenario but confirms that manufacturers will have to apply costlier technology to meet the standards.

The slight difference in fleet performance under the different alternatives confirms how the CAFE model considers the universe of applicable technologies and

⁹¹⁹ See *Greenhouse Gas Emission Standards for Light-Duty Vehicles: Manufacturer Performance Report for the 2016 Model Year (EPA Report 420-R18-002)*, U.S. EPA (Jan. 2018), available at <https://nepis.epa.gov/Exe/ZyPDF.cgi?Dockey=P100TGIA.pdf>.

⁹²⁰ 49 U.S.C. 32906.

⁹²¹ For further discussion of the advanced technology pickup truck program, see Section X.B.1.e.4, above.

⁹²² See *Greenhouse Gas Emission Standards for Light-Duty Vehicles: Manufacturer Performance Report for the 2016 Model Year (EPA Report 420-R18-002)*, U.S. EPA (Jan. 2018), available at <https://nepis.epa.gov/Exe/ZyPDF.cgi?Dockey=P100TGIA.pdf>.

⁹²³ Existing standards through MY 2020, then 0.5%/year increases for both passenger cars and light trucks for MYs 2021-2026.

⁹²⁴ Existing standards through MY 2020, then 2%/year increases for passenger cars and 3%/year increases for light trucks, for MYs 2021-2026.

dynamically identifies the most cost-effective combination of technologies for each manufacturer's vehicle fleet based on the assumptions about each technology's effectiveness, cost, and interaction with all other technologies. For further discussion of the technology pathways employed in the CAFE model, please refer to Section II.D above.

XI. Public Participation

NHTSA and EPA request comment on all aspects of this NPRM. This section describes how you can participate in this process.

A. How do I prepare and submit comments?

In this NPRM, there are many issues common to both NHTSA's and EPA's proposals. For the convenience of all parties, comments submitted to the NHTSA docket will be considered comments to the EPA docket and vice versa. An exception is that comments submitted to the NHTSA docket on NHTSA's Draft Environmental Impact Statement (EIS) will not be considered submitted to the EPA docket. Therefore, commenters only need to submit comments to either one of the two agency dockets, although they may submit comments to both if they so choose. Comments that are submitted for consideration by only one agency should be identified as such, and comments that are submitted for consideration by both agencies should also be identified as such. Absent such identification, each agency will exercise its best judgment to determine whether a comment is submitted on its proposal.

Further instructions for submitting comments to either the NHTSA or the EPA docket are described below.

NHTSA: Your comments must be written and in English. To ensure that your comments are correctly filed in the docket, please include the docket number NHTSA-2018-0067 in your comments. Your comments must not be more than 15 pages long.⁹²⁵ NHTSA established this limit to encourage you to write your primary comments in a concise fashion. However, you may attach necessary additional documents to your comments, and there is no limit on the length of attachments. If you are submitting comments electronically as a PDF (Adobe) file, we ask that the documents please be scanned using the Optical Character Recognition (OCR) process, thus allowing the agencies to search and copy certain portions of your submissions.⁹²⁶ Please note that

pursuant to the Data Quality Act, in order for substantive data to be relied upon and used by the agency, it must meet the information quality standards set forth in the OMB and DOT Data Quality Act guidelines. Accordingly, we encourage you to consult the guidelines in preparing your comments. OMB's guidelines may be accessed at <https://www.gpo.gov/fdsys/pkg/FR-2002-02-22/pdf/R2-59.pdf>. DOT's guidelines may be accessed at <https://www.transportation.gov/regulations/dot-information-dissemination-quality-guidelines>.

EPA: Direct your comments to Docket ID No. EPA-HQ-OAR-2018-0283. EPA's policy is that all comments received will be included in the public docket without change and may be made available online at <http://www.regulations.gov>, including any personal information provided, unless the comment includes information claimed to be Confidential Business Information (CBI) or other information whose disclosure is restricted by statute. Do not submit information that you consider to be CBI or otherwise protected through <http://www.regulations.gov> or email. The <http://www.regulations.gov> website is an "anonymous access" system, which means EPA will not know your identity or contact information unless you provide it in the body of your comment. If you send an email comment directly to EPA without going through <http://www.regulations.gov>, your email address will be automatically captured and included as part of the comment that is placed in the public docket and made available on the internet. If you submit an electronic comment, EPA recommends that you include your name and other contact information in the body of your comment and with any disk or CD-ROM you submit. If EPA cannot read your comment due to technical difficulties and cannot contact you for clarification, EPA may not be able to consider your comment. Electronic files should avoid the use of special characters, any form of encryption, and be free of any defects or viruses. For additional information about EPA's public docket visit the EPA Docket Center homepage at <https://www.epa.gov/dockets>.

B. Tips for Preparing Your Comments

When submitting comments, please remember to:

- Identify the rulemaking by docket number and other identifying information

scanned paper document or electronic fax file, into computer-editable text.

(subject heading, **Federal Register** date and page number).

- Explain why you agree or disagree, suggest alternatives, and substitute language for your requested changes.

- Describe any assumptions and provide any technical information and/or data that you used.

- If you estimate potential costs or burdens, explain how you arrived at your estimate in sufficient detail to allow for it to be reproduced.

- Provide specific examples to illustrate your concerns and suggest alternatives.

- Explain your views as clearly as possible, avoiding the use of profanity or personal threats.

- Make sure to submit your comments by the comment period deadline identified in the **DATES** section above.

C. How can I be sure that my comments were received?

NHTSA: If you submit your comments to NHTSA's docket by mail and wish DOT Docket Management to notify you upon its receipt of your comments, please enclose a self-addressed, stamped postcard in the envelope containing your comments. Upon receiving your comments, Docket Management will return the postcard by mail.

D. How do I submit confidential business information?

Any confidential business information (CBI) submitted to one of the agencies will also be available to the other agency. However, as with all public comments, any CBI information only needs to be submitted to either one of the agencies' dockets and it will be available to the other. Following are specific instructions for submitting CBI to either agency:

EPA: Do not submit CBI to EPA through <http://www.regulations.gov> or email. Clearly mark the part or all of the information that you claim to be CBI. For CBI information in a disk or CD-ROM that you mail to EPA, mark the outside of the disk or CD-ROM as CBI and then identify electronically within the disk or CD-ROM the specific information that is claimed as CBI. In addition to one complete version of the comment that includes information claimed as CBI, a copy of the comment that does not contain CBI must be submitted for inclusion in the public docket. Information so marked will not be disclosed except in accordance with the procedures set forth in 40 CFR part 2.

NHTSA: If you wish to submit any information under a claim of confidentiality, you should submit three copies of your complete submission, including the information you claim to be confidential business information, to the Chief Counsel, NHTSA, at the

⁹²⁵ 49 CFR 553.21.

⁹²⁶ Optical character recognition (OCR) is the process of converting an image of text, such as a

address given above under **FOR FURTHER INFORMATION CONTACT**. When you send a comment containing confidential business information, you should include a cover letter setting forth the information specified in 49 CFR part 512.

In addition, you should submit a copy from which you have deleted the claimed confidential business information to the Docket by one of the methods set forth above.

E. Will the agencies consider late comments?

NHTSA and EPA will consider all comments received before the close of business on the comment closing date indicated above under **DATES**. To the extent practicable, we will also consider comments received after that date. If interested persons believe that any information that the agencies place in the docket after the issuance of the NPRM affects their comments, they may submit comments after the closing date concerning how the agencies should consider that information for the final rule. However, the agencies' ability to consider any such late comments in this rulemaking will be limited due to the time frame for issuing a final rule.

If a comment is received too late for us to practicably consider in developing a final rule, we will consider that comment as an informal suggestion for future rulemaking action.

F. How can I read the comments submitted by other people?

You may read the materials placed in the dockets for this document (*e.g.*, the comments submitted in response to this document by other interested persons) at any time by going to <http://www.regulations.gov>. Follow the online instructions for accessing the dockets. You may also read the materials at the EPA Docket Center or the DOT Docket Management Facility by going to the street addresses given above under **ADDRESSES**.

G. How do I participate in the public hearings?

NHTSA and EPA will jointly host two public hearings on the dates and locations to be announced in a separate notice. At all hearings, both agencies will accept comments on the rulemaking, and NHTSA will also accept comments on the EIS.

NHTSA and EPA will conduct the hearings informally, and technical rules of evidence will not apply. We will arrange for a written transcript of each hearing, to be posted in the dockets as soon as it is available, and keep the official record of each hearing open for

30 days following that hearing to allow you to submit supplementary information.

XII. Regulatory Notices and Analyses

A. Executive Order 12866, Executive Order 13563

Executive Order 12866, "Regulatory Planning and Review" (58 FR 51735, Oct. 4, 1993), as amended by Executive Order 13563, "Improving Regulation and Regulatory Review" (76 FR 3821, Jan. 21, 2011), provides for making determinations whether a regulatory action is "significant" and therefore subject to the Office of Management and Budget (OMB) review and to the requirements of the Executive Order. Under section 3(f)(1) of Executive Order 12866, this action is an "economically significant regulatory action" because if adopted, it is likely to have an annual effect on the economy of \$100 million or more. Accordingly, EPA and NHTSA submitted this action to the OMB for review and any changes made in response to OMB recommendations have been documented in the docket for this action. The benefits and costs of this proposal are described above and in the Preliminary Regulatory Impact Analysis (PRIA), which is located in the docket and on the agencies' websites.

B. DOT Regulatory Policies and Procedures

The rule, if adopted, would also be significant within the meaning of the Department of Transportation's Regulatory Policies and Procedures. The benefits and costs of this proposal are described above and in the PRIA, which is located in the docket and on NHTSA's website.

C. Executive Order 13771 (Reducing Regulation and Controlling Regulatory Costs)

This proposed rule is expected to be an E.O. 13771 deregulatory action. Details on the estimated cost savings of this proposed rule can be found in PRIA, which is located in the docket and on the agencies' websites.

D. Executive Order 13211 (Energy Effects)

Executive Order 13211 applies to any rule that: (1) Is determined to be economically significant as defined under E.O. 12866, and is likely to have a significant adverse effect on the supply, distribution, or use of energy; or (2) that is designated by the Administrator of the Office of Information and Regulatory Affairs as a significant energy action. If the regulatory action meets either criterion, the agencies must evaluate the adverse

energy effects of the proposed rule and explain why the proposed regulation is preferable to other potentially effective and reasonably feasible alternatives considered.

The proposed rule seeks to establish passenger car and light truck fuel economy standards and greenhouse gas emissions standards. An evaluation of energy effects of the proposed action and reasonably feasible alternatives considered is provided in NHTSA's Draft EIS and in the PRIA. To the extent that EPA's CO₂ standards are substantially related to fuel economy and accordingly, petroleum consumption, the Draft EIS and PRIA analyses also provide an estimate of impacts of EPA's proposed rule.

E. Environmental Considerations

1. National Environmental Policy Act (NEPA)

Concurrently with this NPRM, NHTSA is releasing a Draft Environmental Impact Statement (Draft EIS), pursuant to the National Environmental Policy Act, 42 U.S.C. 4321–4347, and implementing regulations issued by the Council on Environmental Quality (CEQ), 40 CFR part 1500, and NHTSA, 49 CFR part 520. NHTSA prepared the Draft EIS to analyze and disclose the potential environmental impacts of the proposed CAFE standards and a range of alternatives. The Draft EIS analyzes direct, indirect, and cumulative impacts and analyzes impacts in proportion to their significance.

The Draft EIS describes potential environmental impacts to a variety of resources. Resources that may be affected by the proposed action and alternatives include fuel and energy use, air quality, climate, land use and development, hazardous materials and regulated wastes, historical and cultural resources, noise, and environmental justice. The Draft EIS also describes how climate change resulting from global GHG emissions (including the U.S. light duty transportation sector under the Proposed Action and alternatives) could affect certain key natural and human resources. Resource areas are assessed qualitatively and quantitatively, as appropriate, in the Draft EIS.

NHTSA has considered the information contained in the Draft EIS as part of developing its proposal. The Draft EIS is available for public comment; instructions for the submission of comments are included inside the document. NHTSA will simultaneously issue the Final Environmental Impact Statement and Record of Decision, pursuant to 49

U.S.C. 304a(b), and U.S. Department of Transportation *Final Guidance on MAP-21 Section 1319 Accelerated Decisionmaking in Environmental Reviews* (http://www.dot.gov/sites/dot.gov/files/docs/MAP-21_1319_Final_Guidance.pdf) unless it is determined that statutory criteria or practicability considerations preclude simultaneous issuance. For additional information on NHTSA's NEPA analysis, please see the Draft EIS.

2. Clean Air Act (CAA) as Applied to NHTSA's Action

The CAA (42 U.S.C. 7401 *et seq.*) is the primary Federal legislation that addresses air quality. Under the authority of the CAA and subsequent amendments, EPA has established National Ambient Air Quality Standards (NAAQS) for six criteria pollutants, which are relatively commonplace pollutants that can accumulate in the atmosphere as a result of human activity. EPA is required to review each NAAQS every five years and to revise those standards as may be appropriate considering new scientific information.

The air quality of a geographic region is usually assessed by comparing the levels of criteria air pollutants found in the ambient air to the levels established by the NAAQS (taking into account, as well, the other elements of a NAAQS: Averaging time, form, and indicator). Concentrations of criteria pollutants within the air mass of a region are measured in parts of a pollutant per million parts (ppm) of air or in micrograms of a pollutant per cubic meter ($\mu\text{g}/\text{m}^3$) of air present in repeated air samples taken at designated monitoring locations using specified types of monitors. These ambient concentrations of each criteria pollutant are compared to the levels, averaging time, and form specified by the NAAQS in order to assess whether the region's air quality is in attainment with the NAAQS.

When the measured concentrations of a criteria pollutant within a geographic region are below those permitted by the NAAQS, EPA designates the region as an attainment area for that pollutant, while regions where concentrations of criteria pollutants exceed Federal standards are called nonattainment areas. Former nonattainment areas that are now in compliance with the NAAQS are designated as maintenance areas. Each State with a nonattainment area is required to develop and implement a State Implementation Plan (SIP) documenting how the region will reach attainment levels within time periods specified in the CAA. For maintenance areas, the SIP must document how the

State intends to maintain compliance with the NAAQS. When EPA revises a NAAQS, each State must revise its SIP to address how it plans to attain the new standard.

No Federal agency may "engage in, support in any way or provide financial assistance for, license or permit, or approve" any activity that does not "conform" to a SIP or Federal Implementation Plan after EPA has approved or promulgated it.⁹²⁷ Further, no Federal agency may "approve, accept, or fund" any transportation plan, program, or project developed pursuant to title 23 or chapter 53 of title 49, U.S.C., unless the plan, program, or project has been found to "conform" to any applicable implementation plan in effect.⁹²⁸ The purpose of these conformity requirements is to ensure that Federally sponsored or conducted activities do not interfere with meeting the emissions targets in SIPs, do not cause or contribute to new violations of the NAAQS, and do not impede the ability of a State to attain or maintain the NAAQS or delay any interim milestones. EPA has issued two sets of regulations to implement the conformity requirements:

(1) The Transportation Conformity Rule⁹²⁹ applies to transportation plans, programs, and projects that are developed, funded, or approved under title 23 or chapter 53 of title 49, U.S.C.

(2) The General Conformity Rule⁹³⁰ applies to all other federal actions not covered under transportation conformity. The General Conformity Rule establishes emissions thresholds, or de minimis levels, for use in evaluating the conformity of an action that results in emissions increases.⁹³¹ If the net increases of direct and indirect emissions are lower than these thresholds, then the project is presumed to conform and no further conformity evaluation is required. If the net increases of direct and indirect emissions exceed any of these thresholds, and the action is not otherwise exempt, then a conformity determination is required. The conformity determination can entail air quality modeling studies, consultation with EPA and state air quality agencies, and commitments to revise the SIP or to implement measures to mitigate air quality impacts.

The proposed CAFE standards and associated program activities are not

developed, funded, or approved under title 23 or chapter 53 of title 49, U.S.C. Accordingly, this action and associated program activities are not subject to transportation conformity. Under the General Conformity Rule, a conformity determination is required where a Federal action would result in total direct and indirect emissions of a criteria pollutant or precursor originating in nonattainment or maintenance areas equaling or exceeding the rates specified in 40 CFR 93.153(b)(1) and (2). As explained below, NHTSA's proposed action results in neither direct nor indirect emissions as defined in 40 CFR 93.152.

The General Conformity Rule defines direct emissions as "those emissions of a criteria pollutant or its precursors that are caused or initiated by the Federal action and originate in a nonattainment or maintenance area and occur at the same time and place as the action and are reasonably foreseeable."⁹³² Because NHTSA's action would set fuel economy standards for light duty vehicles, it would cause no direct emissions consistent with the meaning of the General Conformity Rule.⁹³³

Indirect emissions under the General Conformity Rule are "those emissions of a criteria pollutant or its precursors (1) That are caused or initiated by the federal action and originate in the same nonattainment or maintenance area but occur at a different time or place as the action; (2) That are reasonably foreseeable; (3) That the agency can practically control; and (4) For which the agency has continuing program responsibility."⁹³⁴ Each element of the definition must be met to qualify as indirect emissions. NHTSA has determined that, for purposes of general conformity, emissions that may result from the proposed fuel economy standards would not be caused by NHTSA's action, but rather would occur because of subsequent activities the agency cannot practically control. "[E]ven if a Federal licensing, rulemaking, or other approving action is a required initial step for a subsequent activity that causes emissions, such initial steps do not mean that a Federal agency can practically control any resulting emissions."⁹³⁵

⁹³² 40 CFR 93.152.

⁹³³ *Department of Transportation v. Public Citizen*, 541 U.S. 752, 772 (2004) ("[T]he emissions from the Mexican trucks are not 'direct' because they will not occur at the same time or at the same place as the promulgation of the regulations."). NHTSA's action is to establish fuel economy standards for MY 2021–2026 passenger car and light trucks; any emissions increases would occur well after promulgation of the final rule.

⁹³⁴ 40 CFR 93.152.

⁹³⁵ 40 CFR 93.152.

⁹²⁷ 42 U.S.C. 7506(c)(1).

⁹²⁸ 42 U.S.C. 7506(c)(2).

⁹²⁹ 40 CFR part 51, subpart T, and part 93, subpart A.

⁹³⁰ 40 CFR part 51, subpart W, and part 93, subpart B.

⁹³¹ 40 CFR 93.153(b).

As the CAFE program uses performance-based standards, NHTSA cannot control the technologies vehicle manufacturers use to improve the fuel economy of passenger cars and light trucks. Furthermore, NHTSA cannot control consumer purchasing (which affects average achieved fleetwide fuel economy) and driving behavior (*i.e.*, operation of motor vehicles, as measured by VMT). It is the combination of fuel economy technologies, consumer purchasing, and driving behavior that results in criteria pollutant or precursor emissions. For purposes of analyzing the environmental impacts of the proposal and alternatives under NEPA, NHTSA has made assumptions regarding all of these factors. The agency's Draft EIS predicts that increases in air toxic and criteria pollutants would occur in some nonattainment areas under certain alternatives. However, the proposed standards and alternatives do not mandate specific manufacturer decisions, consumer purchasing, or driver behavior, and NHTSA cannot practically control any of them.⁹³⁶

In addition, NHTSA does not have the statutory authority to control the actual VMT by drivers. As the extent of emissions is directly dependent on the operation of motor vehicles, changes in any emissions that result from NHTSA's proposed standards are not changes the agency can practically control or for which the agency has continuing program responsibility. Therefore, the proposed CAFE standards and alternative standards considered by NHTSA would not cause indirect emissions under the General Conformity Rule, and a general conformity determination is not required.

3. National Historic Preservation Act (NHPA)

The NHPA (54 U.S.C. 300101 *et seq.*) sets forth government policy and procedures regarding "historic properties"—that is, districts, sites, buildings, structures, and objects included on or eligible for the National Register of Historic Places. Section 106 of the NHPA requires federal agencies to "take into account" the effects of their actions on historic properties.⁹³⁷ The agencies conclude that the NHPA is not applicable to this proposal because the promulgation of CAFE and GHG

emissions standards for light duty vehicles is not the type of activity that has the potential to cause effects on historic properties. However, NHTSA includes a brief, qualitative discussion of the impacts of the alternatives on historical and cultural resources in Section 7.3 of the Draft EIS.

4. Fish and Wildlife Conservation Act (FWCA)

The FWCA (16 U.S.C. 2901 *et seq.*) provides financial and technical assistance to States for the development, revision, and implementation of conservation plans and programs for nongame fish and wildlife. In addition, the Act encourages all Federal departments and agencies to utilize their statutory and administrative authorities to conserve and to promote conservation of nongame fish and wildlife and their habitats. The agencies conclude that the FWCA is not applicable to this proposal because it does not involve the conservation of nongame fish and wildlife and their habitats.

5. Coastal Zone Management Act (CZMA)

The Coastal Zone Management Act (16 U.S.C. 1451 *et seq.*) provides for the preservation, protection, development, and (where possible) restoration and enhancement of the nation's coastal zone resources. Under the statute, States are provided with funds and technical assistance in developing coastal zone management programs. Each participating State must submit its program to the Secretary of Commerce for approval. Once the program has been approved, any activity of a Federal agency, either within or outside of the coastal zone, that affects any land or water use or natural resource of the coastal zone must be carried out in a manner that is consistent, to the maximum extent practicable, with the enforceable policies of the State's program.⁹³⁸

The agencies conclude that the CZMA is not applicable to this proposal because it does not involve an activity within, or outside of, the nation's coastal zones that affects any land or water use or natural resource of the coastal zone. NHTSA has, however, conducted a qualitative review in its Draft EIS of the related direct, indirect, and cumulative impacts, positive or negative, of the alternatives on potentially affected resources, including coastal zones.

6. Endangered Species Act (ESA)

Under Section 7(a)(2) of the ESA federal agencies must ensure that actions they authorize, fund, or carry out are "not likely to jeopardize the continued existence" of any federally listed threatened or endangered species or result in the destruction or adverse modification of the designated critical habitat of these species. 16 U.S.C. 1536(a)(2). If a federal agency determines that an agency action may affect a listed species or designated critical habitat, it must initiate consultation with the appropriate Service—the U.S. Fish and Wildlife Service of the Department of the Interior and/or the National Oceanic and Atmospheric Administration's National Marine Fisheries Service of the Department of Commerce, depending on the species involved—in order to ensure that the action is not likely to jeopardize the species or destroy or adversely modify designated critical habitat. *See* 50 CFR 402.14. Under this standard, the federal agency taking action evaluates the possible effects of its action and determines whether to initiate consultation. *See* 51 FR 19926, 19949 (June 3, 1986).

Pursuant to Section 7(a)(2) of the ESA, the agencies have considered the effects of the proposed standards and have reviewed applicable ESA regulations, case law, and guidance to determine what, if any, impact there might be to listed species or designated critical habitat. The agencies have considered issues related to emissions of CO₂ and other GHGs and issues related to non-GHG emissions. Based on this assessment, the agencies have determined that the actions of setting CAFE and GHG emissions standards does not require consultation under Section 7(a)(2) of the ESA. Accordingly, NHTSA and EPA have concluded its review of this action under Section 7 of the ESA.

7. Floodplain Management (Executive Order 11988 and DOT Order 5650.2)

These Orders require Federal agencies to avoid the long- and short-term adverse impacts associated with the occupancy and modification of floodplains, and to restore and preserve the natural and beneficial values served by floodplains. Executive Order 11988 also directs agencies to minimize the impact of floods on human safety, health and welfare, and to restore and preserve the natural and beneficial values served by floodplains through evaluating the potential effects of any actions the agency may take in a floodplain and ensuring that its program

⁹³⁶ *See, e.g., Department of Transportation v. Public Citizen*, 541 U.S. 752, 772–73 (2004); *South Coast Air Quality Management District v. Federal Energy Regulatory Commission*, 621 F.3d 1085, 1101 (9th Cir. 2010).

⁹³⁷ Section 106 is now codified at 54 U.S.C. 306108. Implementing regulations for the Section 106 process are located at 36 CFR part 800.

⁹³⁸ 16 U.S.C. 1456(c)(1)(A).

planning and budget requests reflect consideration of flood hazards and floodplain management. DOT Order 5650.2 sets forth DOT policies and procedures for implementing Executive Order 11988. The DOT Order requires that the agency determine if a proposed action is within the limits of a base floodplain, meaning it is encroaching on the floodplain, and whether this encroachment is significant. If significant, the agency is required to conduct further analysis of the proposed action and any practicable alternatives. If a practicable alternative avoids floodplain encroachment, then the agency is required to implement it.

In this proposal, the agencies are not occupying, modifying and/or encroaching on floodplains. The agencies, therefore, conclude that the Orders are not applicable to this action. NHTSA has, however, conducted a review of the alternatives on potentially affected resources, including floodplains, in its Draft EIS.

8. Preservation of the Nation's Wetlands (Executive Order 11990 and DOT Order 5660.1a)

These Orders require Federal agencies to avoid, to the extent possible, undertaking or providing assistance for new construction located in wetlands unless the agency head finds that there is no practicable alternative to such construction and that the proposed action includes all practicable measures to minimize harms to wetlands that may result from such use. Executive Order 11990 also directs agencies to take action to minimize the destruction, loss or degradation of wetlands in "conducting Federal activities and programs affecting land use, including but not limited to water and related land resources planning, regulating, and licensing activities." DOT Order 5660.1a sets forth DOT policy for interpreting Executive Order 11990 and requires that transportation projects "located in or having an impact on wetlands" should be conducted to assure protection of the Nation's wetlands. If a project does have a significant impact on wetlands, an EIS must be prepared.

The agencies are not undertaking or providing assistance for new construction located in wetlands. The agencies, therefore, conclude that these Orders do not apply to this proposal. NHTSA has, however, conducted a review of the alternatives on potentially affected resources, including wetlands, in its Draft EIS.

9. Migratory Bird Treaty Act (MBTA), Bald and Golden Eagle Protection Act (BGEPA), Executive Order 13186

The MBTA (16 U.S.C. 703–712) provides for the protection of certain migratory birds by making it illegal for anyone to "pursue, hunt, take, capture, kill, attempt to take, capture, or kill, possess, offer for sale, sell, offer to barter, barter, offer to purchase, purchase, deliver for shipment, ship, export, import, cause to be shipped, exported, or imported, deliver for transportation, transport or cause to be transported, carry or cause to be carried, or receive for shipment, transportation, carriage, or export" any migratory bird covered under the statute.⁹³⁹

The BGEPA (16 U.S.C. 668–668d) makes it illegal to "take, possess, sell, purchase, barter, offer to sell, purchase or barter, transport, export or import" any bald or golden eagles.⁹⁴⁰ Executive Order 13186, "Responsibilities of Federal Agencies to Protect Migratory Birds," helps to further the purposes of the MBTA by requiring a Federal agency to develop a Memorandum of Understanding (MOU) with the Fish and Wildlife Service when it is taking an action that has (or is likely to have) a measurable negative impact on migratory bird populations.

The agencies conclude that the MBTA, BGEPA, and Executive Order 13186 do not apply to this proposal because there is no disturbance, take, measurable negative impact, or other covered activity involving migratory birds or bald or golden eagles involved in this rulemaking.

10. Department of Transportation Act (Section 4(f))

Section 4(f) of the Department of Transportation Act of 1966 (49 U.S.C. 303), as amended, is designed to preserve publicly owned park and recreation lands, waterfowl and wildlife refuges, and historic sites. Specifically, Section 4(f) provides that DOT agencies cannot approve a transportation program or project that requires the use of any publicly owned land from a public park, recreation area, or wildlife or waterfowl refuge of national, State, or local significance, or any land from a historic site of national, State, or local significance, unless a determination is made that:

- (1) There is no feasible and prudent alternative to the use of land, and
- (2) The program or project includes all possible planning to minimize harm to the property resulting from the use.

These requirements may be satisfied if the transportation use of a Section 4(f) property results in a de minimis impact on the area.

NHTSA concludes that Section 4(f) is not applicable to its proposal because this rulemaking is not an approval of a transportation program or project that requires the use of any publicly owned land.

11. Executive Order 12898: "Federal Actions to Address Environmental Justice in Minority Populations and Low-Income Populations"

Executive Order (E.O.) 12898 (59 FR 7629 (Feb. 16, 1994)) establishes federal executive policy on environmental justice. Its main provision directs federal agencies, to the greatest extent practicable and permitted by law, to make environmental justice part of their mission by identifying and addressing, as appropriate, disproportionately high and adverse human health or environmental effects of their programs, policies, and activities on minority populations and low-income populations in the United States.

With respect to GHG emissions, EPA has determined that this final rule will not have disproportionately high and adverse human health or environmental effects on minority or low-income populations because it impacts the level of environmental protection for all affected populations without having any disproportionately high and adverse human health or environmental effects on any population, including any minority or low-income population. The increases in CO₂ and other GHGs associated with the standards will affect climate change projections, and EPA has estimated marginal increases in projected global mean surface temperatures and sea-level rise in this NPRM. Within settlements experiencing climate change, certain parts of the population may be especially vulnerable; these include the poor, the elderly, those already in poor health, the disabled, those living alone, and/or indigenous populations dependent on one or a few resources. However, the potential increases in climate change impacts resulting from this rule are so small that the impacts are not considered "disproportionately high and adverse" on these populations.

For non-GHG co-pollutants such as ozone, PM_{2.5}, and toxics, EPA has concluded that reductions in downstream emissions would have beneficial human health or environmental effects on near-road populations. Therefore, the proposed rule would not result in "disproportionately high and adverse"

⁹³⁹ 16 U.S.C. 703(a).

⁹⁴⁰ 16 U.S.C. 668(a).

human health or environmental effects regarding these pollutants on minority and/or low income populations.

NHTSA has also evaluated whether its proposal would have disproportionately high and adverse human health or environmental effects on minority or low-income populations. The agency includes its analysis in Section 7.5 (*Environmental Justice*) of its Draft EIS.

12. Executive Order 13045: "Protection of Children from Environmental Health Risks and Safety Risks"

This action is subject to E.O. 13045 (62 FR 19885, April 23, 1997) because it is an economically significant regulatory action as defined by E.O. 12866, and the agencies have reason to believe that the environmental health or safety risks related to this action may have a disproportionate effect on children. Specifically, children are more vulnerable to adverse health effects related to mobile source emissions, as well as to the potential long-term impacts of climate change. Pursuant to E.O. 13045, NHTSA and EPA must prepare an evaluation of the environmental health or safety effects of the planned regulation on children and an explanation of why the planned regulation is preferable to other potentially effective and reasonably feasible alternatives considered by the agencies. Further, this analysis may be included as part of any other required analysis.

This preamble and NHTSA's Draft EIS discuss air quality, climate change, and their related environmental and health effects, noting where these would disproportionately affect children. The Administrator has also discussed the impact of climate-related health effects on children in the Endangerment and Cause or Contribute Findings for Greenhouse Gases Under Section 202(a) of the Clean Air Act (74 FR 66496, December 15, 2009). Additionally, this preamble explains why the agencies' proposal is preferable to other alternatives considered. Together, this preamble and NHTSA's Draft EIS satisfy the agencies' responsibilities under E.O. 13045.

F. Regulatory Flexibility Act

Pursuant to the Regulatory Flexibility Act (5 U.S.C. 601 *et seq.*, as amended by the Small Business Regulatory Enforcement Fairness Act (SBREFA) of 1996), whenever an agency is required to publish a notice of proposed rulemaking or final rule, it must prepare and make available for public comment a regulatory flexibility analysis that describes the effect of the rule on small entities (*i.e.*, small businesses, small organizations, and small governmental jurisdictions). No regulatory flexibility analysis is required if the head of an agency certifies the proposal will not have a significant economic impact on a substantial number of small entities. SBREFA amended the Regulatory

Flexibility Act to require Federal agencies to provide a statement of the factual basis for certifying that a proposal will not have a significant economic impact on a substantial number of small entities.

The agencies considered the impacts of this notice under the Regulatory Flexibility Act and certify that this rule would not have a significant economic impact on a substantial number of small entities. The following is the agencies' statement providing the factual basis for this certification pursuant to 5 U.S.C. 605(b).

Small businesses are defined based on the North American Industry Classification System (NAICS) code.⁹⁴¹ One of the criteria for determining size is the number of employees in the firm. For establishments primarily engaged in manufacturing or assembling automobiles, as well as light duty trucks, the firm must have less than 1,500 employees to be classified as a small business. This proposed rule would affect motor vehicle manufacturers. There are 14 small manufacturers of passenger cars and SUVs of electric, hybrid, and internal combustion engines.

⁹⁴¹ Classified in NAICS under Subsector 336—Transportation Equipment Manufacturing for Automobile Manufacturing (336111), Light Truck (336112), and Heavy Duty Truck Manufacturing (336120). <https://www.sba.gov/document/support-table-size-standards>.

Table XII-1 - Small Domestic Vehicle Manufacturers

Manufacturers	Founded	Employees ⁹⁴²	Estimated Annual Production ⁹⁴³	Sale Price per Unit
Karma Automotive	2014	625	900	\$130,000
BXR Motors	2008	< 10	< 100	\$155,000 to \$185,000
Falcon Motorsports	2009	5	< 100	\$300,000 to \$400,000
Lucra Cars	2005	8	< 100	\$100,000
Lyons Motor Car	2012	< 10	< 100	\$1,400,000
Rezvani Motors	2014	6	< 100	\$95,000 to \$270,000
Rossion Automotive	2007	6	< 100	\$90,000
Saleen	1984	51	< 100	\$100,000
Shelby American	1962	61	< 100	\$60,000 to \$250,000
Panoz	1988	20	< 100	\$155,000 to \$175,000
Faraday Future	2014	790	0	\$200,000 to \$300,000
Lucid Motor Car	2007	269	0	\$60,000
Rivian Automotive	2009	208	0	N/A
SF Motors	2016	204	0	N/A

NHTSA believes that the rulemaking would not have a significant economic impact on the small vehicle manufacturers because under 49 CFR part 525, passenger car manufacturers making less than 10,000 vehicles per year can petition NHTSA to have alternative standards set for those manufacturers. These manufacturers do not currently meet the 27.5 mpg standard and must already petition the agency for relief. If the standard is raised, it has no meaningful impact on these manufacturers—they still must go through the same process and petition for relief. Given there already is a mechanism for relieving burden on small businesses, which is the purpose of the Regulatory Flexibility Act, a regulatory flexibility analysis was not prepared.

EPA believes this rulemaking would not have a significant economic impact on a substantial number of small entities under the Regulatory Flexibility Act, as amended by the Small Business Regulatory Enforcement Fairness Act. EPA is exempting from the CO₂ standards any manufacturer, domestic or foreign, meeting SBA's size definitions of small business as described in 13 CFR 121.201. EPA adopted the same type of exemption for

small businesses in the 2017 and later rulemaking. EPA estimates that small entities comprise less than 0.1% of total annual vehicle sales and exempting them will have a negligible impact on the CO₂ emissions reductions from the standards. Because EPA is exempting small businesses from the CO₂ standards, we are certifying that the rule will not have a significant economic impact on a substantial number of small entities. Therefore, EPA has not conducted a Regulatory Flexibility Analysis or a SBREFA SBAR Panel for the rule.

EPA regulations allow small businesses to voluntarily waive their small business exemption and optionally certify to the CO₂ standards. This allows small entity manufacturers to earn CO₂ credits under the CO₂ program, if their actual fleetwide CO₂ performance is better than their fleetwide CO₂ target standard. However, the exemption waiver is optional for small entities and thus we believe that manufacturers opt into the CO₂ program if it is economically advantageous for them to do so, for example in order to generate and sell CO₂ credits. Therefore, EPA believes this voluntary option does not affect EPA's determination that the standards will impose no significant adverse impact on small entities.

G. Executive Order 13132 (Federalism)

Executive Order 13132 requires federal agencies to develop an accountable process to ensure “meaningful and timely input by State and local officials in the development of regulatory policies that have federalism implications.” The Order defines the term “Policies that have federalism implications” to include regulations that have “substantial direct effects on the States, on the relationship between the national government and the States, or on the distribution of power and responsibilities among the various levels of government.” Under the Order, agencies may not issue a regulation that has federalism implications, that imposes substantial direct compliance costs, unless the Federal government provides the funds necessary to pay the direct compliance costs incurred by State and local governments, or the agencies consult with State and local officials early in the process of developing the proposed regulation. The agencies complied with Order's requirements.

See Section VI above for further detail on the agencies' assessment of the federalism implications of this proposal.

⁹⁴² Number of employees as of March 2018, source: *LinkedIn.com*.

⁹⁴³ Rough estimate for model year 2017.

H. Executive Order 12988 (Civil Justice Reform)

Pursuant to Executive Order 12988, “Civil Justice Reform,”⁹⁴⁴ NHTSA has considered whether this rulemaking would have any retroactive effect. This proposed rule does not have any retroactive effect.

I. Executive Order 13175 (Consultation and Coordination With Indian Tribal Governments)

This proposed rule does not have tribal implications, as specified in Executive Order 13175 (65 FR 67249, November 9, 2000). This rule will be implemented at the Federal level and impose compliance costs only on vehicle manufacturers. Thus, Executive Order 13175 does not apply to this rule.

J. Unfunded Mandates Reform Act

Section 202 of the Unfunded Mandates Reform Act of 1995 (UMRA) requires Federal agencies to prepare a written assessment of the costs, benefits, and other effects of a proposed or final rule that includes a Federal mandate likely to result in the expenditure by State, local, or tribal governments, in the aggregate, or by the private sector, of more than \$100 million in any one year (adjusted for inflation with base year of 1995). Adjusting this amount by the implicit gross domestic product price deflator for 2016 results in \$148 million ($111.416/75.324 = 1.48$).⁹⁴⁵ Before promulgating a rule for which a written statement is needed, section 205 of UMRA generally requires NHTSA and EPA to identify and consider a reasonable number of regulatory alternatives and adopt the least costly, most cost-effective, or least burdensome alternative that achieves the objective of the rule. The provisions of section 205 do not apply when they are inconsistent with applicable law. Moreover, section 205 allows NHTSA and EPA to adopt an alternative other than the least costly, most cost-effective, or least burdensome alternative if the agency publishes with the proposed rule an explanation of why that alternative was not adopted.

This proposed rule will not result in the expenditure by State, local, or tribal governments, in the aggregate, of more than \$148 million annually, but it will result in the expenditure of that magnitude by vehicle manufacturers and/or their suppliers. In developing this proposal, NHTSA and EPA considered a variety of alternative

average fuel economy standards lower and higher than those proposed. The proposed fuel economy standards for MYs 2021–2026 are the least costly, most cost-effective, and least burdensome alternative that achieve the objective of the rule.

K. Regulation Identifier Number

The Department of Transportation assigns a regulation identifier number (RIN) to each regulatory action listed in the Unified Agenda of Federal Regulations. The Regulatory Information Service Center publishes the Unified Agenda in April and October of each year. You may use the RIN contained in the heading at the beginning of this document to find this action in the Unified Agenda.

L. National Technology Transfer and Advancement Act

Section 12(d) of the National Technology Transfer and Advancement Act (NTTAA) requires NHTSA and EPA to evaluate and use existing voluntary consensus standards in its regulatory activities unless doing so would be inconsistent with applicable law (e.g., the statutory provisions regarding NHTSA’s vehicle safety authority, or EPA’s testing authority) or otherwise impractical.⁹⁴⁶

Voluntary consensus standards are technical standards developed or adopted by voluntary consensus standards bodies. Technical standards are defined by the NTTAA as “performance-based or design-specific technical specification and related management systems practices.” They pertain to “products and processes, such as size, strength, or technical performance of a product, process or material.”

Examples of organizations generally regarded as voluntary consensus standards bodies include the American Society for Testing and Materials (ASTM), the Society of Automotive Engineers (SAE), and the American National Standards Institute (ANSI). If the agencies do not use available and potentially applicable voluntary consensus standards, we are required by the Act to provide Congress, through OMB, an explanation of the reasons for not using such standards.

For CO₂ emissions, EPA is proposing to collect data over the same tests that are used for the MY 2012–2016 CO₂ standards and for the CAFE program. This will minimize the amount of testing done by manufacturers, since manufacturers are already required to run these tests. For A/C credits, EPA is

proposing to use a consensus methodology developed by the Society of Automotive Engineers (SAE) and also a new A/C test. EPA knows of no consensus standard available for the A/C test.

There are currently no voluntary consensus standards that NHTSA administers relevant to today’s proposed CAFE standards.

M. Department of Energy Review

In accordance with 49 U.S.C. 32902(j)(1), NHTSA submitted this proposed rule to the Department of Energy for review.

N. Paperwork Reduction Act

The Paperwork Reduction Act (PRA) of 1995, Public Law 104–13,⁹⁴⁷ gives the Office of Management and Budget (OMB) authority to regulate matters regarding the collection, management, storage, and dissemination of certain information by and for the Federal government. It seeks to reduce the total amount of paperwork handled by the government and the public. The PRA requires Federal agencies to place a notice in the **Federal Register** seeking public comment on the proposed collection of information. NHTSA strives to reduce the public’s information collection burden hours each fiscal year by streamlining external and internal processes.

To this end, NHTSA seeks to continue to collect information to ensure compliance with its CAFE program. NHTSA intends to reinstate its previously-approved collection of information for Corporate Average Fuel Economy (CAFE) reports specified in 49 CFR part 537 (OMB control number 2127–0019), add the additional burden for reporting changes adopted in the October 15, 2012 final rule that recently came into effect (see 77 FR 62623), and account for the change in burden as proposed in this rule as well as for other CAFE reporting provisions required by Congress and NHTSA. NHTSA is also changing the name of this collection to more accurately represent the breadth of all CAFE regulatory reporting. Although NHTSA seeks to add additional burden hours to its CAFE report requirement in 49 CFR 537, the agency believes there will be a reduction in burden due to the standardization of data and the streamlined process. NHTSA is seeking public comment on this collection.

In compliance with the PRA, this notice announces that the information collection request (ICR) abstracted below has been forwarded to OMB for review and comment. The ICR describes

⁹⁴⁴ 61 FR 4729 (Feb. 7, 1996).

⁹⁴⁵ Bureau of Economic Analysis, National Income and Product Accounts (NIPA), Table 1.1.9 Implicit Price Deflators for Gross Domestic Product. https://bea.gov/iTable/index_nipa.cfm.

⁹⁴⁶ 15 U.S.C. 272.

⁹⁴⁷ Codified at 44 U.S.C. 3501 *et seq.*

the nature of the information collection and its expected burden.

Title: Corporate Average Fuel Economy.

Type of Request: Reinstatement and amendment of a previously approved collection.

OMB Control Number: 2127–0019.

Form Numbers: NHTSA Form 1474 (CAFE Projections Reporting Template) and NHTSA Form 1475 (CAFE Credit Template).

Requested Expiration Date of Approval: Three years from date of approval.

Summary of the collection of information: As part of this rulemaking, NHTSA is reinstating and modifying its previously-approved collection for CAFE-related collections of information. NHTSA and EPA have coordinated their compliance and reporting requirements in an effort not to impose duplicative burden on regulated entities. This information collection contains three different components: Burden related NHTSA's CAFE reporting requirements, burden related to CAFE compliance, but not via reporting requirements, and information gathered by NHTSA to help inform CAFE analyses. All templates referenced in this section will be available in the rulemaking docket for comment.

1. CAFE Compliance Reports

NHTSA seeks to reinstate⁹⁴⁸ its collection related to the reporting requirements in 49 U.S.C. 32907 "Reports and tests of manufacturers." In that section, manufacturers are statutorily required to submit CAFE compliance reports to the Secretary of Transportation.⁹⁴⁹ The reports must state if a manufacturer will comply with its applicable fuel economy standard(s), what actions the manufacturer intends to take to comply with the standard(s), and include other information as required by NHTSA. Manufacturers are required to submit two CAFE compliance reports—a pre-model year report (PMY) and mid-model year (MMY) reporter—each year. In the event a manufacturer needs to correct previously-submitted information, a manufacturer may need to file additional reports.⁹⁵⁰

⁹⁴⁸ This collection expired on April 30, 2016.

⁹⁴⁹ 49 U.S.C. 32907 (delegated to the NHTSA Administrator at 49 CFR 1.95). Because of this delegation, for purposes of discussion, statutory references to the Secretary of Transportation in this section will be discussed in terms of NHTSA or the NHTSA administrator.

⁹⁵⁰ Specifically, a manufacturer shall submit a report containing the information during the 30 days before the beginning of each model year, and during the 30 days beginning the 180th day of the model year. When a manufacturer decides that

To implement this statute, NHTSA issued 49 CFR part 537, "Automotive Fuel Economy Reports," which adds additional definition to § 32907. The first report, the PMY report must be submitted to NHTSA before December 31 of the calendar year prior to the corresponding model year and contain manufacturers' projected information for that upcoming model year. The second report, the MMY report must be submitted by July 31 of the given model year and contain updated information from manufacturers based upon actual and projected information known midway through the model year. Finally, the last report, a supplementary report, is required to be submitted anytime a manufacturer needs to correct information previously submitted to NHTSA.

Compliance reports must include information on passenger and non-passenger automobiles (trucks) describing the projected and actual fuel economy standards, fuel economy performance values, production sales volumes and information on vehicle design features (e.g., engine displacement and transmission class) and other vehicle attribute characteristics (e.g., track width, wheel base and other light truck off-road features). Manufacturers submit confidential and non-confidential versions of these reports to NHTSA. Confidential reports differ by including estimated or actual production sales information, which is withheld from public disclosure to protect each manufacturer's competitive sales strategies. NHTSA uses the reports as the basis for vehicle auditing and testing, which helps manufacturers correct reporting errors prior to the end of the model year and facilitate acceptance of their final CAFE report by the Environmental Protection Agency (EPA). The reports also help the agency, as well as the manufacturers who prepare them, anticipate potential compliance issues as early as possible, and help manufacturers plan their compliance strategies.

Further, NHTSA is modifying this collection to account for additional information manufacturers are required to include in their reports. In the 2017 and beyond final rule,⁹⁵¹ NHTSA allowed for manufacturers to gain additional fuel economy benefits by installing certain technologies on their

actions reported are not sufficient to ensure compliance with that standard, the manufacturer shall report additional actions it intends to take to comply with the standard and include a statement about whether those actions are sufficient to ensure compliance.

⁹⁵¹ 77 FR 62623 (Oct. 15, 2012).

vehicles beginning with MY 2017.⁹⁵² These technologies include air-conditioning systems with increased efficiency, off-cycle technologies whose benefits are not adequately captured on the Federal Test Procedure and/or the Highway Fuel Economy Test,⁹⁵³ and hybrid electric technologies installed on full-size pickup trucks. Prior to MY 2017, manufacturers were unable to earn a fuel economy benefit for these technologies, so NHTSA's reporting requirements did not include an opportunity to report them. Now, manufacturers must provide information on these technologies in their CAFE reports. NHTSA requires manufacturers to provide detailed information on the model types using these technologies to gain fuel economy benefits. These details are necessary to facilitate NHTSA's technical analyses and to ensure the agency can perform random enforcement audits when necessary.

In addition to a list of all fuel consumption improvement technologies utilized in their fleet, 49 CFR 537 requires manufacturers to report the make, model type, compliance category, and production volume of each vehicle equipped with each technology and the associated fuel consumption improvement value (FCIV). NHTSA is proposing to add the reporting and enforcement burden hours and cost for these new incentives to this collection. Manufacturers can also petition the EPA and NHTSA, in accordance with 40 CFR 86.1868–12 or 40 CFR 86.1869–12, to gain additional credits based upon the improved performance of any of the new incentivized technologies allowed for model year 2017. EPA approves these petitions in collaboration with NHTSA and any adjustments are taken into account for both programs. As a part of the agencies' coordination, NHTSA provides EPA with an evaluation of each new technology to ensure its direct impact on fuel economy and an assessment on the suitability of each technology for use in increasing a manufacturer's fuel economy performance. Furthermore, at times, NHTSA may independently request additional information from a manufacturer to support its evaluations. This information along with any research conclusions shared with EPA and NHTSA in the petitions is required to be submitted in manufacturer's CAFE reports.

⁹⁵² These technologies were not included in the burden for part 537 at the time as the additional reporting requirements would not take effect until years later.

⁹⁵³ E.g., engine idle stop-start systems, active transmission warmup systems, etc.

NHTSA is seeking to change the burden hours for its CAFE reporting requirements in 49 CFR part 537. NHTSA plans to reduce the total amount of time spent collecting the required reporting information by standardizing the required data and streamlining the collection process using a standardized reporting template. The standardized template will be used by manufacturers to collect all the required CAFE information under 49 CFR 537.7(b) and (c) and provides a format which ensures accuracy, completeness and better alignment with the final data provided to EPA.

2. Other CAFE Compliance Collections

NHTSA is proposing a new standardized template for manufacturers buying CAFE credits and for manufacturers submitting credit transactions in accordance with 49 CFR part 536. In 49 CFR part 536.5(d), NHTSA is required to assess compliance with fuel economy standards each year, utilizing the certified and reported CAFE data provided by the Environmental Protection Agency for enforcement of the CAFE program pursuant to 49 U.S.C. 32904(e). Credit values are calculated based on the CAFE data from the EPA. If a manufacturer's vehicles in a particular compliance category performs better than its required fuel economy standard, NHTSA adds credits to the manufacturer's account for that compliance category. If a manufacturer's vehicles in a particular compliance category performs worse than the required fuel economy standard, NHTSA will add a credit deficit to the manufacturer's account and will provide written notification to the manufacturer concerning its failure to comply. The manufacturer will be required to confirm the shortfall and must either: Submit a plan indicating how it will allocate existing credits or earn, transfer and/or acquire credits or pay the equivalent civil penalty. The manufacturer must submit a plan or payment within 60 days of receiving notification from NHTSA.

NHTSA is proposing for manufacturers to use the credit transaction template any time a credit transaction request is sent to NHTSA. For example, manufacturers that purchase credits and want to apply them to their credit accounts will use

the credit transaction template. The template NHTSA is proposing is a simple spreadsheet that trading parties fill out. When completed, parties will be able to click a button on the spreadsheet to generate a joint transaction letter for the parties to sign and submit to NHTSA, along with the spreadsheet. NHTSA believes these changes will significantly reduce the burden on manufacturers in managing their CAFE credit accounts.

Finally, NHTSA is accounting for the additional burden due to existing CAFE program elements. In 49 CFR part 525, small volume manufacturers submit petitions to NHTSA for exemption from an applicable average fuel economy standard and to request to comply with a less stringent alternative average fuel economy standard. In 49 CFR part 534, manufacturers are required to submit information to NHTSA when establishing a corporate controlled relationship with another manufacturer. A controlled relationship exists between manufacturers that control, are controlled by, or are under common control with, one or more other manufacturers. Accordingly, manufacturers that have entered into written contracts transferring rights and responsibilities to other manufacturers in controlled relationships for CAFE purposes are required to provide reports to NHTSA. There are additional reporting requirements for manufacturers submitting carry back plans and when manufacturers split apart from controlled relationships and must designate how credits are to be allocated between the parties.⁹⁵⁴ Manufacturers with credit deficits at the end of the model year, can carry back future earned credits up to three model years in advance of the deficit to resolve a current shortfall. The carryback plan proving the existence of a manufacturer's future earned credits must be submitted and approved by NHTSA, pursuant to 49 U.S.C. 32903(b).

3. Analysis Fleet Composition

As discussed in Section II., in setting CAFE standards, NHTSA creates an analysis fleet from which to model potential future economy improvements. To compose this fleet, the agency uses a mixture of compliance data and information from other sources to best replicate the fleet from a recent model year. While refining the analysis

fleet, NHTSA occasionally asks manufacturers for information that is similar to information submitted as part of EPA's final model year report (e.g., final model year vehicle volumes). Periodically, NHTSA may ask manufacturers for more detailed information than what is required for compliance (e.g., what engines are shared across vehicle models). Often, NHTSA requests this information from manufacturers after manufacturers have submitted their final model year reports to EPA, but before EPA processes and releases final model year reports.

Information like this, which is used to verify and supplement the data used to create the analysis fleet, is tremendously valuable to generating an accurate analysis fleet, and setting maximum feasible standards. The more accurate the analysis fleet is, the more accurate the modeling of what technologies could be applied will be. Therefore, NHTSA is accounting for the burden on manufacturers to provide the agency with this additional information. In almost all instances, manufacturers already have the information NHTSA seeks, but it might need to be reformatted or recompiled. Because of this, NHTSA believes the burden to provide this information will often be minimal.

Affected Public: Respondents are manufacturers of engines and vehicles within the North American Industry Classification System (NAICS) and use the coding structure as defined by NAICS including codes 33611, 336111, 336112, 33631, 33631, 33632, 336320, 33635, and 336350 for motor vehicle and parts manufacturing.

Respondent's obligation to respond: Regulated entities required to respond to inquiries covered by this collection. 49 U.S.C. 32907. 49 CFR part 525, 534, 536, and 537.

Frequency of response: Variable, based on compliance obligation. Please see PRA supporting documentation in the docket for more detailed information.

Average burden time per response: Variable, based on compliance obligation. Please see PRA supporting documentation in the docket for more detailed information.

Number of respondents: 23.

4. Estimated Total Annual Burden Hours and Costs

⁹⁵⁴ See 49 CFR part 536.

Table XII-2 - Estimated Burden for Reporting Requirements

	Manufacturers		Government	
	Hours	Cost	Hours	Cost
Prior Collection	3,189.00	\$24,573.50	975.00	\$31,529.00
Current Collection	5,337.50	\$266,326.83	3,038.00	\$141,246.78
Difference	2,148.50	\$241,753.33	2,023.00	\$109,717.78

O. Privacy Act

In accordance with 5 U.S.C. 553(c), the agencies solicit comments from the public to better inform the rulemaking process. These comments are posted, without edit, to *www.regulations.gov*, as described in DOT's system of records notice, DOT/ALL-14 FDMS, accessible through *www.transportation.gov/privacy*. In order to facilitate comment tracking and response, we encourage commenters to provide their name, or the name of their organization; however, submission of names is completely optional.

List of Subjects

49 CFR Parts 523, 531, and 533

Fuel economy.

49 CFR Parts 536 and 537

Fuel economy, Reporting and recordkeeping requirements.

Regulatory Text

In consideration of the foregoing, under the authority of 49 U.S.C. 32901, 32902, and 32903, and delegation of authority at 49 CFR 1.95, NHTSA proposes to amend 49 CFR Chapter V as follows:

PART 523—VEHICLE CLASSIFICATION

- 1. The authority citation for part 523 continues to read as follows:

Authority: 49 U.S.C 32901, delegation of authority at 49 CFR 1.95.

- 2. Amend § 523.2 by revising the definitions of “Curb weight” and “Full-size pickup truck” to read as follows:

§ 523.2 Definitions.

* * * * *

Curb weight has the meaning given in 40 CFR 86.1803.

* * * * *

Full-size pickup truck means a light truck or medium duty passenger vehicle that meets the requirements specified in 40 CFR 86.1803.

* * * * *

PART 531—PASSENGER AUTOMOBILE AVERAGE FUEL ECONOMY STANDARDS

- 3. The authority citation for part 531 continues to read as follows:

Authority: 49 U.S.C. 32902; delegation of authority at 49 CFR 1.95.

- 4. Amend § 531.5 by revising Table III to paragraph (c), and paragraph (d), deleting paragraph (e), and redesignating paragraph (f) as paragraph (e) to read as follows:

§ 531.5 Fuel economy standards.

* * * * *

(c) * * *

BILLING CODE 4910-59-P

**Table III – Parameters for the Passenger Automobile Fuel Economy Targets, MYs
2012-2026**

Model year	Parameters			
	<i>a</i> (mpg)	<i>b</i> (mpg)	<i>c</i> (gal/mi/ft ²)	<i>d</i> (gal/mi)
2012.....	35.95	27.95	0.0005308	0.006057
2013.....	36.80	28.46	0.0005308	0.005410
2014.....	37.75	29.03	0.0005308	0.004725
2015.....	39.24	29.90	0.0005308	0.003719
2016.....	41.09	30.96	0.0005308	0.002573

Model year	Parameters			
	<i>a</i> (mpg)	<i>b</i> (mpg)	<i>c</i> (gal/mi/ft ²)	<i>d</i> (gal/mi)
2017.....	43.61	32.65	0.0005131	0.001896
2018.....	45.21	33.84	0.0004954	0.001811
2019.....	46.87	35.07	0.0004783	0.001729
2020.....	48.74	36.47	0.0004603	0.001643
2021.....	48.74	36.47	0.0004603	0.001643

Model year	Parameters			
	<i>a</i> (mpg)	<i>b</i> (mpg)	<i>c</i> (gal/mi/ft ²)	<i>d</i> (gal/mi)
2022.....	48.74	36.47	0.0004603	0.001643
2023.....	48.74	36.47	0.0004603	0.001643
2024.....	48.74	36.47	0.0004603	0.001643
2025.....	48.74	36.47	0.0004603	0.001643
2026.....	48.74	36.47	0.0004603	0.001643

(d) In addition to the requirements of paragraphs (b) and (c) of this section,

each manufacturer shall also meet the minimum fleet standard for

domestically manufactured passenger automobiles expressed in Table IV:

Table IV – Minimum Fuel Economy Standards for Domestically Manufactured Passenger Automobiles, MYs 2011-2026

Model year	Minimum standard
2011.....	27.8
2012.....	30.7
2013.....	31.4
2014.....	32.1
2015.....	33.3
2016.....	34.7
2017.....	36.8
2018.....	38.0
2019.....	39.4
2020.....	40.9

Model year	Minimum standard
2021.....	40.2
2022.....	40.2
2023.....	40.2
2024.....	40.2
2025.....	40.2
2026.....	40.2

BILLING CODE 4910-59-C

* * * * *

■ 5. Amend § 531.6 by revising paragraphs (a) and (b) to read as follows:

§ 531.6 Measurement and calculation procedures.

(a) The fleet average fuel economy performance of all passenger automobiles that are manufactured by a manufacturer in a model year shall be determined in accordance with procedures established by the Administrator of the Environmental Protection Agency under 49 U.S.C. 32904 and set forth in 40 CFR part 600. For model years 2017 to 2026, a manufacturer is eligible to increase the fuel economy performance of passenger cars in accordance with procedures established by EPA set forth in 40 CFR 600, Subpart F, including any adjustments to fuel economy EPA allows, such as for fuel consumption improvements related to air conditioning efficiency and off-cycle technologies.

(1) A manufacturer that seeks to increase its fleet average fuel economy performance through the use of technologies that improve the efficiency of air conditioning systems must follow the requirements in 40 CFR 86.1868-12. Fuel consumption improvement values

resulting from the use of those air conditioning systems must be determined in accordance with 40 CFR 600.510-12(c)(3)(i).

(2) A manufacturer that seeks to increase its fleet average fuel economy performance through the use of off-cycle technologies must follow the requirements in 40 CFR 86.1869-12. A manufacturer is eligible to gain fuel consumption improvements for predefined off-cycle technologies in accordance with 40 CFR 86.1869-12(b) or for technologies tested using EPA's 5-cycle methodology in accordance with 40 CFR 86.1869-12(c). The fuel consumption improvement is determined in accordance with 40 CFR 600.510-12(c)(3)(ii).

(b) A manufacturer is eligible to increase its fuel economy performance through use of an off-cycle technology requiring an application request made to EPA in accordance with 40 CFR 86.1869-12(d). The request must be approved by EPA in consultation with NHTSA. To expedite NHTSA's consultation with EPA, a manufacturer shall concurrently submit its application to NHTSA if the manufacturer is seeking off-cycle fuel economy improvement values under the CAFE program for those technologies.

For off-cycle technologies that are covered under 40 CFR 86.1869-12(d), NHTSA will consult with EPA regarding NHTSA's evaluation of the specific off-cycle technology to ensure its impact on fuel economy and the suitability of using the off-cycle technology to adjust the fuel economy performance. NHTSA will provide its views on the suitability of the technology for that purpose to EPA. NHTSA's evaluation and review will consider:

(1) Whether the technology has a direct impact upon improving fuel economy performance;

(2) Whether the technology is related to crash-avoidance technologies, safety critical systems or systems affecting safety-critical functions, or technologies designed for the purpose of reducing the frequency of vehicle crashes;

(3) Information from any assessments conducted by EPA related to the application, the technology and/or related technologies; and

(4) Any other relevant factors.

* * * * *

■ 6. Add § 531.7 to read as follows:

§ 531.7 Preemption.

(a) *General.* When an average fuel economy standard prescribed under this chapter is in effect, a State or a political subdivision of a State may not adopt or

enforce a law or regulation related to fuel economy standards or average fuel economy standards for automobiles covered by an average fuel economy standard under this chapter.

(b) *Requirements Must Be Identical.*

When a requirement under section 32908 of this title is in effect, a State or a political subdivision of a State may adopt or enforce a law or regulation on disclosure of fuel economy or fuel operating costs for an automobile covered by section 32908 only if the law or regulation is identical to that requirement.

(c) *State and Political Subdivision Automobiles.* A State or a political subdivision of a State may prescribe requirements for fuel economy for automobiles obtained for its own use.

■ 7. Redesignate Appendix to Part 531—Example of Calculating Compliance under § 531.5(c) as Appendix A to Part 531—Example of Calculating Compliance under § 531.5(c) and amend newly redesignated Appendix A by removing all all references to “Appendix” and adding in their place, “Appendix A.”

■ 8. Add Appendix B to Part 531 to read as follows:

Appendix B to Part 531—Preemption

(a) Express Preemption:

(1) To the extent that any state law or regulation regulates or prohibits tailpipe carbon dioxide emissions from automobiles,

such a law or regulation relates to average fuel economy standards within the meaning of 49 U.S.C. 32919.

(A) Automobile fuel economy is directly and substantially related to automobile tailpipe emissions of carbon dioxide;

(B) Carbon dioxide is the natural by-product of automobile fuel consumption;

(C) The most significant and controlling factor in making the measurements necessary to determine the compliance of automobiles with the fuel economy standards in this Part is their rate of tailpipe carbon dioxide emissions;

(D) Almost all technologically feasible reduction of tailpipe emissions of carbon dioxide is achievable through improving fuel economy, thereby reducing both the consumption of fuel and the creation and emission of carbon dioxide;

(E) Accordingly, as a practical matter, regulating fuel economy controls the amount of tailpipe emissions of carbon dioxide, and regulating the tailpipe emissions of carbon dioxide controls fuel economy.

(2) As a state law or regulation related to fuel economy standards, any state law or regulation regulating or prohibiting tailpipe carbon dioxide emissions from automobiles is expressly preempted under 49 U.S.C. 32919.

(3) A state law or regulation having the direct effect of regulating or prohibiting tailpipe carbon dioxide emissions or fuel economy is a law or regulation related to fuel economy and expressly preempted under 49 U.S.C. 32919.

(b) Implied Preemption:

(1) A state law or regulation regulating tailpipe carbon dioxide emissions from automobiles, particularly a law or regulation

that is not attribute-based and does not separately regulate passenger cars and light trucks, conflicts with:

(A) The fuel economy standards in this Part;

(B) The judgments made by the agency in establishing those standards; and

(C) The achievement of the objectives of the statute (49 U.S.C. Chapter 329) under which those standards were established, including objectives relating to reducing fuel consumption in a manner and to the extent consistent with manufacturer flexibility, consumer choice, and automobile safety.

(2) Any state law or regulation regulating or prohibiting tailpipe carbon dioxide emissions from automobiles is impliedly preempted under 49 U.S.C. Chapter 329.

(3) A state law or regulation having the direct effect of regulating or prohibiting tailpipe carbon dioxide emissions or fuel economy is impliedly preempted under 49 U.S.C. Chapter 329.

PART 533—LIGHT TRUCK FUEL ECONOMY STANDARDS

■ 9. The authority citation for part 533 continues to read as follows:

Authority: 49 U.S.C. 32902; delegation of authority at 49 CFR 1.95.

■ 10. Amend § 533.5 by revising Table VII to paragraph (a) to read as follows and removing paragraph (k).

§ 533.5 Requirements.

(a) * * *

BILLING CODE 4910–59–P

Table VII – Parameters for the Light Truck Fuel Economy Targets for MYs 2017-2026

Model year	Parameters							
	<i>a</i> (mpg)	<i>b</i> (mpg)	<i>c</i> (gal/mi/f t ²)	<i>d</i> (gal/mi)	<i>e</i> (mpg)	<i>F</i> (mpg)	<i>g</i> (gal/mi/f t ²)	<i>h</i> (gal/mi)
2017	36.26	25.09	0.00054 84	0.00509 7	35.10	25.09	0.00045 46	0.009851
2018	37.36	25.20	0.00053 58	0.00479 7	35.31	25.20	0.00045 46	0.009682
2019	38.16	25.25	0.00052 65	0.00462 3	35.41	25.25	0.00045 46	0.009603
2020	39.11	25.25	0.00051 40	0.00449 4	35.41	25.25	0.00045 46	0.009603
2021	39.11	25.25	0.00051 40	0.00449 4	35.41	25.25	0.00045 46	0.009603
2022	39.11	25.25	0.00051	0.00449	35.41	25.25	0.00045	0.009603

			40	4			46	
2023	39.11	25.25	0.00051 40	0.00449 4	35.41	25.25	0.00045 46	0.009603
2024	39.11	25.25	0.00051 40	0.00449 4	35.41	25.25	0.00045 46	0.009603
2025	39.11	25.25	0.00051 40	0.00449 4	35.41	25.25	0.00045 46	0.009603
2026	39.11	25.25	0.00051 40	0.00449 4	35.41	25.25	0.00045 46	0.009603

BILLING CODE 4910-59-C

* * * * *

■ 11. Amend § 533.6 by revising paragraphs (b) and (c) as follows:

§ 533.6 Measurement and calculation procedures.

* * * * *

(b) The fleet average fuel economy performance of all light trucks that are manufactured by a manufacturer in a model year shall be determined in accordance with procedures established by the Administrator of the Environmental Protection Agency under 49 U.S.C. 32904 and set forth in 40 CFR part 600. For model years 2017 to 2026, a manufacturer is eligible to increase the fuel economy performance of light trucks in accordance with procedures established by EPA set forth in 40 CFR part 600, subpart F, including any adjustments to fuel economy EPA allows, such as for fuel consumption improvements related to air conditioning efficiency, off-cycle technologies, and hybridization and other performance-based technologies for full-size pickup trucks that meet the requirements specified in 40 CFR 86.1803.

(1) A manufacturer that seeks to increase its fleet average fuel economy

performance through the use of technologies that improve the efficiency of air conditioning systems must follow the requirements in 40 CFR 86.1868-12. Fuel consumption improvement values resulting from the use of those air conditioning systems must be determined in accordance with 40 CFR 600.510-12(c)(3)(i).

(2) A manufacturer that seeks to increase its fleet average fuel economy performance through the use of off-cycle technologies must follow the requirements in 40 CFR 86.1869-12. A manufacturer is eligible to gain fuel consumption improvements for predefined off-cycle technologies in accordance with 40 CFR 86.1869-12(b) or for technologies tested using the EPA's 5-cycle methodology in accordance with 40 CFR 86.1869-12(c). The fuel consumption improvement is determined in accordance with 40 CFR 600.510-12(c)(3)(ii).

(3) The eligibility of a manufacturer to increase its fuel economy using hybridized and other performance-based technologies for full-size pickup trucks must follow 40 CFR 86.1870-12 and the fuel consumption improvement of these full-size pickup truck technologies must

be determined in accordance with 40 CFR 600.510-12(c)(3)(iii).

(c) A manufacturer is eligible to increase its fuel economy performance through use of an off-cycle technology requiring an application request made to EPA in accordance with 40 CFR 86.1869-12(d). The request must be approved by EPA in consultation with NHTSA. To expedite NHTSA's consultation with EPA, a manufacturer shall concurrently submit its application to NHTSA if the manufacturer is seeking off-cycle fuel economy improvement values under the CAFE program for those technologies. For off-cycle technologies that are covered under 40 CFR 86.1869-12(d), NHTSA will consult with EPA regarding NHTSA's evaluation of the specific off-cycle technology to ensure its impact on fuel economy and the suitability of using the off-cycle technology to adjust the fuel economy performance. NHTSA will provide its views on the suitability of the technology for that purpose to EPA. NHTSA's evaluation and review will consider:

(1) Whether the technology has a direct impact upon improving fuel economy performance;

(2) Whether the technology is related to crash-avoidance technologies, safety critical systems or systems affecting safety-critical functions, or technologies designed for the purpose of reducing the frequency of vehicle crashes;

(3) Information from any assessments conducted by EPA related to the application, the technology and/or related technologies; and

(4) Any other relevant factors.

* * * * *

■ 12. Add § 533.7 to read as follows:

§ 533.7 Preemption.

(a) *General.* When an average fuel economy standard prescribed under this chapter is in effect, a State or a political subdivision of a State may not adopt or enforce a law or regulation related to fuel economy standards or average fuel economy standards for automobiles covered by an average fuel economy standard under this chapter.

(b) *Requirements Must Be Identical.* When a requirement under section 32908 of this title is in effect, a State or a political subdivision of a State may adopt or enforce a law or regulation on disclosure of fuel economy or fuel operating costs for an automobile covered by section 32908 only if the law or regulation is identical to that requirement.

(c) *State and Political Subdivision Automobiles.*—A State or a political subdivision of a State may prescribe requirements for fuel economy for automobiles obtained for its own use.

■ 13. Redesignate Appendix to Part 533—Example of Calculating Compliance under § 533.5(i) as Appendix A to Part 533—Example of Calculating Compliance under § 533.5(i) and amend newly redesignated Appendix A by removing all references to “Appendix” and adding in their place, “Appendix A”.

■ 14. Add Appendix B to Part 533 to read as follows:

Appendix B to Part 533—Preemption

(a) Express Preemption:

(1) To the extent that any state law or regulation regulates or prohibits tailpipe carbon dioxide emissions from automobiles, such a law or regulation relates to average fuel economy standards within the meaning of 49 U.S.C. 32919.

(A) Automobile fuel economy is directly and substantially related to automobile tailpipe emissions of carbon dioxide;

(B) Carbon dioxide is the natural by-product of automobile fuel consumption;

(C) The most significant and controlling factor in making the

measurements necessary to determine the compliance of automobiles with the fuel economy standards in this Part is their rate of tailpipe carbon dioxide emissions;

(D) Almost all technologically feasible reduction of tailpipe emissions of carbon dioxide is achievable through improving fuel economy, thereby reducing both the consumption of fuel and the creation and emission of carbon dioxide;

(E) Accordingly, as a practical matter, regulating fuel economy controls the amount of tailpipe emissions of carbon dioxide, and regulating the tailpipe emissions of carbon dioxide controls fuel economy.

(2) As a state law or regulation related to fuel economy standards, any state law or regulation regulating or prohibiting tailpipe carbon dioxide emissions from automobiles is expressly preempted under 49 U.S.C. 32919.

(3) A state law or regulation having the direct effect of regulating or prohibiting tailpipe carbon dioxide emissions or fuel economy is a law or regulation related to fuel economy and expressly preempted under 49 U.S.C. 32919.

(b) Implied Preemption:

(1) A state law or regulation regulating tailpipe carbon dioxide emissions from automobiles, particularly a law or regulation that is not attribute-based and does not separately regulate passenger cars and light trucks, conflicts with:

(A) The fuel economy standards in this Part;

(B) The judgments made by the agency in establishing those standards; and

(C) The achievement of the objectives of the statute (49 U.S.C. Chapter 329) under which those standards were established, including objectives relating to reducing fuel consumption in a manner and to the extent consistent with manufacturer flexibility, consumer choice, and automobile safety.

(2) Any state law or regulation regulating or prohibiting tailpipe carbon dioxide emissions from automobiles is impliedly preempted under 49 U.S.C. Chapter 329.

(3) A state law or regulation having the direct effect of regulating or prohibiting tailpipe carbon dioxide emissions or fuel economy is impliedly preempted under 49 U.S.C. Chapter 329.

PART 535—MEDIUM- AND HEAVY-DUTY VEHICLE FUEL EFFICIENCY PROGRAM

■ 15. The authority citation for part 535 continues to read as follows:

Authority: 49 U.S.C. 32902 and 30101; delegation of authority at 49 CFR 1.95.

■ 16. Amend § 535.6 by revising paragraph (a)(4)(ii) to read as follows:

* * * * *

(a) * * *

(4) * * *

(ii) Calculate the equivalent fuel consumption test group results as follows for spark-ignition vehicles and alternative fuel spark-ignition vehicles. CO₂ emissions test group result (grams per mile)/8,887 grams per gallon of gasoline fuel) × (10²) = Fuel consumption test group result (gallons per 100 mile).

* * * * *

■ 16. Amend § 535.6 by revising paragraphs (a)(4)(ii) and (d)(5)(ii) to read as follows:

* * * * *

(a) * * *

(4) * * *

(ii) Calculate the equivalent fuel consumption test group results as follows for spark-ignition vehicles and alternative fuel spark-ignition vehicles. CO₂ emissions test group result (grams per mile)/8,877 grams per gallon of gasoline fuel) × (10⁻²) = Fuel consumption test group result (gallons per 100 mile).

* * * * *

(d) * * *

(5) * * *

(ii) Calculate equivalent fuel consumption FCL values for spark-ignition engines and alternative fuel spark-ignition engines. CO₂ FCL value (grams per hp-hr)/8,887 grams per gallon of gasoline fuel) × (10⁻²) = Fuel consumption FCL value (gallons per 100 hp-hr).

* * * * *

■ 17. Amend § 535.7 by revising the equations in paragraphs (b)(1), (c)(1), (d)(1), (e)(2) and (f)(2)(iii)(E) to read as follows:

§ 535.7 Averaging, banking, and trading (ABT) credit program.

* * * * *

(b) * * *

(1) * * *

Total MY Fleet FCC (gallons) = (Std – Act) × (Volume) × (UL) × (10⁻²)

Where:

Std = Fleet average fuel consumption standard (gal/100 mile).

Act = Fleet average actual fuel consumption value (gal/100 mile).

Volume = the total U.S.-directed production of vehicles in the regulatory subcategory.

UL = the useful life for the regulatory subcategory. The useful life value for heavy-pickup trucks and vans manufactured for model years 2013 through 2020 is equal to the 120,000 miles. The useful life for model years 2021 and later is equal to 150,000 miles.

* * * * *

(c) * * *
 (1) * * *
 Vehicle Family FCC (gallons) =
 $(Std - FEL) \times (Payload) \times (Volume) \times$
 $(UL) \times (10^{-3})$

Where:
 Std = the standard for the respective vehicle
 family regulatory subcategory (gal/1000
 ton-mile).

FEL = family emissions limit for the vehicle
 family (gal/1000 ton-mile).
 Payload = the prescribed payload in tons for
 each regulatory subcategory as shown in
 the following table:

Regulatory subcategory	Payload (Tons)
Vocational LHD Vehicles	2.85
Vocational MHD Vehicles	5.60
Vocational HHD Vehicles	7.5
MDH Tractors	12.50
HHD Tractors, other than heavy-haul Tractors	19.00
Heavy-haul Tractors	43.00

Volume = the number of U.S.-directed
 production volume of vehicles in the
 corresponding vehicle family.

UL = the useful life for the regulatory
 subcategory (miles) as shown in the
 following table:

Regulatory subcategory	UL (miles)
LHD Vehicles	110,000 (Phase 1) 150,000 (Phase 2)
Vocational MHD Vehicles and tractors at or below 33,000 pounds GVWR	185,000
Vocation HHD Vehicles and tractors at or above 33,000 pounds GVWR	435,000

* * * * *
 (d) * * *
 (1) * * *

Engine Family FCC (gallons) =
 $(Std - FCL) \times (CF) \times (Volume) \times (UL)$
 $\times (10^{-2})$

Std = the standard for the respective engine
 regulatory subcategory (gal/100 hp-hr).
 FCL = family certification level for the engine
 family (gal/100 hp-hr).
 CF = a transient cycle conversion factor in
 hp-hr/mile which is the integrated total
 cycle horsepower-hour divided by the
 equivalent mileage of the applicable test
 cycle. For engines subject to spark-
 ignition heavy-duty standards, the

equivalent mileage is 6.3 miles. For
 engines subject to compression-ignition
 heavy-duty standards, the equivalent
 mileage is 6.5 miles.
 Volume = the number of engines in the
 corresponding engine family.
 UL = the useful life of the given engine
 family (miles) as shown in the following
 table:

Regulatory Subcategory	UL (miles)
SI and CI LHD Engines	120,000 (Phase 1) 150,000 (Phase 2)
CI MHD Engines	185,000
CI HHD Engines	435,000

* * * * *
 (e) * * *
 (2) * * *

Vehicle Family FCC (gallons) = (Std -
 FEL) \times (Payload) \times (Volume) \times (UL)
 $\times (10^{-3})$

Std = the standard for the respective vehicle
 family regulatory subcategory (gal/1000
 ton-mile).
 FEL = family emissions limit for the vehicle
 family (gal/1000 ton-mile).
 Payload = 10 tons for short box vans and 19
 tons for other trailers.
 Volume = the number of U.S.-directed
 production volume of vehicles in the
 corresponding vehicle family.

UL = the useful life for the regulatory
 subcategory. The useful life value for
 heavy-duty trailers is equal to the
 250,000 miles.

* * * * *
 (f) * * *
 (2) * * *
 (iii) * * *
 (E) * * *

Where:

Off-cycle FC credits = (CO₂ Credit/CF) × Production × VLM

Where:

CO₂ Credits = the credit value in grams per mile determined in 40 CFR 86.1869–12(c)(3), (d)(1), (d)(2) or (d)(3).

CF = conversion factor, which for spark-ignition engines is 8,887 and for compression-ignition engines is 10,180.

Production = the total production volume for the applicable category of vehicles.

VLM = vehicle lifetime miles, which for 2b–3 vehicles shall be 150,000 for the Phase 2 program.

The term (CO₂ Credit/CF) should be rounded to the nearest 0.0001.

* * * * *

PART 536—TRANSFER AND TRADING OF FUEL ECONOMY CREDITS

■ 18. The authority citation for part 536 continues to read as follows:

Authority: 49 U.S.C. 32903; delegation of authority at 49 CFR 1.95.

■ 19. Amend § 536.4 by revising paragraph (c) to read as follows:

§ 536.4 Credits.

* * * * *

(c) *Adjustment factor.* When traded or transferred and used, fuel economy credits are adjusted to ensure fuel oil savings is preserved. For traded credits,

the user (or buyer) must multiply the calculated adjustment factor by the number of its shortfall credits it plans to offset in order to determine the number of equivalent credits to acquire from the earner (or seller). For transferred credits, the user of credits must multiply the calculated adjustment factor by the number of its shortfall credits it plans to offset in order to determine the number of equivalent credits to transfer from the compliance category holding the available credits. The adjustment factor is calculated according to the following formula:

$$A = \frac{VMT_u * MPG_{ac} * MPG_{se}}{VMT_e * MPG_{au} * MPG_{su}}$$

Where:

A = Adjustment factor applied to traded and transferred credits when they are applied to an existing credit shortfall. The quotient shall be rounded to 4 decimal places;

* * * * *

■ 20. Amend § 536.5 by redesignating paragraphs (c)(1) and (c)(2) as paragraphs (c)(2) and (c)(3), respectively, adding paragraph (c)(1), and revising paragraph (d)(6) to read as follows:

§ 536.5 Trading infrastructure.

* * * * *

(c) * * *

(1) Entities trading credits must generate and submit trade documents using the NHTSA Credit Template (OMB Control No. 2127–0019, NHTSA Form 1475). Entities shall fill out the NHTSA Credit Template and use it to generate a credit trade summary and credit trade confirmation, the latter of which shall be signed by both trading entities. The credit trade confirmation serves as an acknowledgement that the parties have agreed to trade credits, and does not dictate terms, conditions, or other business obligations. Managers legally authorized to obligate the sale and purchase of the traded credits must sign the trade confirmation. The completed credit trade summary and a PDF copy of the signed trade confirmation must be submitted to NHTSA. The NHTSA Credit Template is available for download at <http://www.nhtsa.gov>.

* * * * *

(d) * * *

(6) Credit allocation plans received from a manufacturer will be reviewed and approved by NHTSA. Use the NHTSA Credit Template (OMB Control No. 2127–0019, NHTSA Form 1475) to record the credit transactions requested in the credit allocation plan. The template is a fillable form that has an option for recording and calculating credit transactions for credit allocation plans. The template calculates the required adjustments to the credits. The credit allocation plan and the completed transaction template must be submitted to NHTSA. NHTSA will approve the credit allocation plan unless it finds that the proposed credits are unavailable or that it is unlikely that the plan will result in the manufacturer earning sufficient credits to offset the subject credit shortfall. If the plan is approved, NHTSA will revise the respective manufacturer’s credit account accordingly. If the plan is rejected, NHTSA will notify the respective manufacturer and request a revised plan or payment of the appropriate fine.

* * * * *

PART 537—AUTOMOTIVE FUEL ECONOMY REPORTS

■ 21. The authority citation for part 537 continues to read as follows:

Authority: 49 U.S.C. 32907, delegation of authority at 49 CFR 1.95.

■ 24. Amend § 537.5 by revising paragraph (d) and adding paragraph (e) to read as follows:

§ 537.5 General requirements for reports.

* * * * *

(d) Beginning with MY 2019, each manufacturer shall generate reports required by this part using the NHTSA CAFE Projections Reporting Template (OMB Control No. 2127–0019, NHTSA Form 1474). The template is a fillable form.

(1) Select the option to identify the report as a pre-model year report, mid-model year report, or supplementary report as appropriate;

(2) Complete all required information for the manufacturer and for all vehicles produced for the current model year required to comply with CAFE standards. Identify the manufacturer submitting the report, including the full name, title, and address of the official responsible for preparing the report and a point of contact to answer questions concerning the report.

(3) Use the template to generate confidential and non-confidential reports for all the domestic and import passenger cars and light truck fleet produced by the manufacturer for the current model year. Manufacturers must submit a request for confidentiality in accordance with 49 CFR 512 to withhold projected production sales volume estimates from public disclosure. If the request is granted, NHTSA will withhold the projected production sales volume estimates from public disclosure until all the vehicles produced by the manufacturer have been made available for sale (usually one year after the current model year).

(4) Submit confidential reports and requests for confidentiality to NHTSA on CD-ROM in accordance with Part 537.12. Email copies of non-confidential

(i.e., redacted) reports to NHTSA's secure email address: *cafe@dot.gov*. Requests for confidentiality must be submitted in a PDF or MS Word format. Submit 2 copies of the CD-ROM to: Administrator, National Highway Traffic Administration, 1200 New Jersey Avenue SW, Washington, DC 20590, and submit emailed reports electronically to the following secure email address: *cafe@dot.gov*;

(5) Confidentiality Requests.

(i) Manufacturers can withhold information on projected production sales volumes under 5 U.S.C. 552(b)(4) and 15 U.S.C. 2005(d)(1). In accordance, the manufacturer must:

(A) Show that the item is within the scope of sections 552(b)(4) and 2005(d)(1);

(B) Show that disclosure of the item would result in significant competitive damage;

(C) Specify the period during which the item must be withheld to avoid that damage; and

(D) Show that earlier disclosure would result in that damage.

(ii) [Reserved]

(e) Each report required by this part must be based upon all information and data available to the manufacturer 30 days before the report is submitted to the Administrator.

■ 23. Amend § 537.6 by revising paragraphs (b) and (c) to read as follows:

§ 537.6 General content of reports.

* * * * *

(b) *Supplementary report*. Except as provided in paragraph (c) of this section, each supplementary report for each model year must contain the information required by and § 537.7(b) and (c) in accordance with § 537.8(b)(1), (2), (3), and (4) as appropriate.

(c) *Exceptions*. The pre-model year report, mid-model year report, and supplementary report(s) submitted by an incomplete automobile manufacturer for any model year are not required to contain the information specified in § 537.7(c)(4)(xv) through (xviii) and (c)(5). The information provided by the incomplete automobile manufacturer under § 537.7(c) shall be according to base level instead of model type or carline.

■ 24. Amend § 537.7 by revising paragraphs (a)(2) and (3) as follows:

§ 537.7 Pre-model year and mid-model year reports.

(a) * * *

(2) Provide a report with the information required by paragraph (a)(1) of this section by each domestic and import passenger automobile fleet, as specified in part 531 of this chapter, and

by each the light truck fleet, as specified in part 533 of this chapter, for the current model year.

(3) Provide the information required by paragraph (a)(1) for pre- and mid-model year reports using the NHTSA CAFE Projections Reporting Template, OMB Control No. 2127-0019, NHTSA Form 1474. The required reporting template can be downloaded from *http://www.nhtsa.gov*.

* * * * *

■ 25. Amend § 537.7 by revising paragraphs (b)(3), (b)(4), (b)(5), (c)(1), (c)(2), (c)(3) and (c)(7)(i), (c)(7)(ii) and (c)(7)(iii) to read as follows:

* * * * *

(b) * * *

(3) State the projected required fuel economy for the manufacturer's passenger automobiles and light trucks determined in accordance with 49 CFR 531.5(c) and 49 CFR 533.5 and based upon the projected sales figures provided under paragraph (c)(2) of this section. For each unique model type and footprint combination of the manufacturer's automobiles, provide the information specified in paragraph (b)(3)(i) and (ii) of this section and the CAFE Projections Reporting Template, OMB Control No. 2127-0019, NHTSA Form 1474.

(i) In the case of passenger automobiles:

(A) Beginning model year 2013, base tire as defined in 49 CFR 523.2,

(B) Beginning model year 2013, front axle, rear axle and average track width as defined in 49 CFR 523.2,

(C) Beginning model year 2013, wheelbase as defined in 49 CFR 523.2, and

(D) Beginning model year 2013, footprint as defined in 49 CFR 523.2.

(E) The fuel economy target value for each unique model type and footprint entry listed in accordance with the equation provided in 49 CFR parts 531.

(4) State the projected final required fuel economy that the manufacturer anticipates having if changes implemented during the model year will cause the targets to be different from the target fuel economy projected under paragraph (b)(3) of this section.

(5) State whether the manufacturer believes that the projections it provides under paragraphs (b)(2) and (b)(4) of this section, or if it does not provide an average or target under those paragraphs, the projections it provides under paragraphs (b)(1) and (b)(3) of this section, sufficiently represent the manufacturer's average and target fuel economy for the current model year for purposes of the Act. In the case of a manufacturer that believes that the

projections are not sufficiently representative for those purposes, state the specific nature of any reason for the insufficiency and the specific additional testing or derivation of fuel economy values by analytical methods believed by the manufacturer necessary to eliminate the insufficiency and any plans of the manufacturer to undertake that testing or derivation voluntarily and submit the resulting data to the Environmental Protection Agency under 40 CFR 600.509.

(c) * * *

(1) For each model type of the manufacturer's automobiles, provide the information specified in paragraph (c)(2) of this section in the NHTSA CAFE Projections Reporting Template (OMB Control No. 2127-0019, NHTSA Form 1474) and list the model types in order of increasing average inertia weight from top to bottom.

(2)(i) Combined fuel economy; and

(ii) Projected sales for the current model year and total sales of all model types.

(3) For each vehicle configuration whose fuel economy was used to calculate the fuel economy values for a model type under paragraph (c)(2) of this section, provide the information specified in paragraph (c)(4) of this section in the NHTSA CAFE Projections Reporting Template (OMB Control No. 2127-0019, NHTSA Form 1474).

* * * * *

(7) * * *

(i) Provide a list of each air conditioning efficiency improvement technology utilized in your fleet(s) of vehicles for each model year. For each technology identify vehicles by make and model types that have the technology, which compliance category those vehicles belong to and the number of vehicles for each model equipped with the technology. For each compliance category (domestic passenger car, import passenger car and light truck) report the air conditioning fuel consumption improvement value in gallons/mile in accordance with the equation specified in 40 CFR 600.510-12(c)(3)(i).

(ii) Provide a list of off-cycle efficiency improvement technologies utilized in your fleet(s) of vehicles for each model year that is pending or approved by EPA. For each technology identify vehicles by make and model types that have the technology, which compliance category those vehicles belong to, the number of vehicles for each model equipped with the technology, and the associated off-cycle credits (grams/mile) available for each technology. For each compliance

category (domestic passenger car, import passenger car and light truck) calculate the fleet off-cycle fuel consumption improvement value in gallons/mile in accordance with the equation specified in 40 CFR 600.510–12(c)(3)(ii).

(iii) Provide a list of full-size pick-up trucks in your fleet that meet the mild and strong hybrid vehicle definitions. For each mild and strong hybrid type, identify vehicles by make and model types that have the technology, the number of vehicles produced for each model equipped with the technology, the total number of full size pick-up trucks produced with and without the technology, the calculated percentage of hybrid vehicles relative to the total number of vehicles produced and the associated full-size pickup truck credits (grams/mile) available for each technology. For the light truck compliance category calculate the fleet Pick-up Truck fuel consumption improvement value in gallons/mile in accordance with the equation specified in 40 CFR 600.510–12(c)(3)(iii).

* * * * *

■ 26. Amend § 537.8 by revising paragraphs (a)(3), paragraph (b)(3)(i) and (ii), and paragraph (c)(1) and adding paragraphs (a)(4) and (b)(4) to read as follows:

§ 537.8 Supplementary reports.

(a) * * *

(3) Each manufacturer whose pre- or mid-model year report omits any of the information specified in § 537.7(b) or (c) shall file a supplementary report containing the information specified in paragraph (b)(3) of this section.

(4) Each manufacturer whose pre- or mid-model year report omits any of the information specified in § 537.5(c) shall file a supplementary report containing the information specified in paragraph (b)(4) of this section.

(b) * * *

(3) * * *

(i) All of the information omitted from the pre- or mid-model year report under § 537.7(b) and (c); and

(ii) Such revisions of and additions to the information submitted by the manufacturer in its pre-model year report regarding the automobiles produced during the current model year as are necessary to reflect the information provided under paragraph (b)(3)(i) of this section.

(4) The supplementary report required by paragraph (a)(4) of this section must contain:

(i) All information omitted from the pre-model year report under § 537.6(c)(2); and

(ii) Such revisions of and additions to the information submitted by the manufacturer in its pre-model year report regarding the automobiles produced during the current model year as are necessary to reflect the information provided under paragraph (b)(4)(i) of this section.

(c)(1) Each report required by paragraph (a)(1), (2), (3), or (4) of this section must be submitted in accordance with § 537.5(c) not more than 45 days after the date on which the manufacturer determined, or could have determined with reasonable diligence, that a report is required under paragraph (a)(1), (2), (3), or (4) of this section.

* * * * *

Environmental Protection Agency

List of Subjects

40 CFR Part 85

Confidential business information, Imports, Labeling, Motor vehicle pollution, Reporting and recordkeeping requirements, Research, Warranties.

40 CFR Part 86

Administrative practice and procedure, Confidential business information, Incorporation by reference, Labeling, Motor vehicle pollution, Reporting and recordkeeping requirements.

For the reasons stated in the preamble, the Environmental Protection Agency proposes to amend 40 CFR parts 85 and 86 as follows:

PART 85—CONTROL OF AIR POLLUTION FROM MOBILE SOURCES

■ 27. The authority citation for part 85 continues to read as follows:

Authority: 42 U.S.C. 7401–7671q.

Subpart F—[Amended]

■ 28. Amend § 85.525 by revising paragraphs (b)(1)(iii) and (b)(1)(iv) to read as follows:

§ 85.525 Applicable standards.

* * * * *

(b) * * *

(1) * * *

(iii) If the OEM complied with the nitrous oxide (N₂O) and methane (CH₄) standards and provisions set forth in 40 CFR 86.1818–12(f)(1) or (3), and the fuel conversion CO₂ measured value is lower than the in-use CO₂ exhaust emission standard, you also have the option through model year 2020 to convert the difference between the in-use CO₂ exhaust emission standard and the fuel conversion CO₂ measured value into GHG equivalents of CH₄ and/or N₂O,

using 298 g CO₂ to represent 1 g N₂O and 25 g CO₂ to represent 1 g CH₄. You may then subtract the applicable converted values from the fuel conversion measured values of CH₄ and/or N₂O to demonstrate compliance with the CH₄ and/or N₂O standards. This option may not be used for model year 2021 or later.

(iv) Optionally, through model year 2020, compliance with greenhouse gas emission requirements may be demonstrated by comparing emissions from the vehicle prior to the fuel conversion to the emissions after the fuel conversion. This comparison must be based on FTP test results from the emission data vehicle (EDV) representing the pre-conversion test group. The sum of CO₂, CH₄, and N₂O shall be calculated for pre- and post-conversion FTP test results, where CH₄ and N₂O are weighted by their global warming potentials of 25 and 298, respectively. The post-conversion sum of these emissions must be lower than the pre-conversion conversion greenhouse gas emission results. CO₂ emissions are calculated as specified in 40 CFR 600.113–12. If statements of compliance are applicable and accepted in lieu of measuring N₂O, as permitted by EPA regulation, the comparison of the greenhouse gas results also need not measure or include N₂O in the before and after emission comparisons. This option may not be used for model year 2021 or later.

* * * * *

PART 86—CONTROL OF EMISSIONS FROM NEW AND IN-USE HIGHWAY VEHICLES AND ENGINES

■ 29. The authority citation for part 86 continues to read as follows:

Authority: 42 U.S.C. 7401–7671q.

■ 30. Amend § 86.1818–12 as follows:

■ a. Revise paragraphs (c)(2)(i)(A) through (C);

■ b. Revise paragraphs (c)(3)(i)(A), (B) and (D);

■ c. Revise paragraph (f) introductory text; and paragraphs (f)(1) through (3).

The revisions read as follows:

§ 86.1818–12 Greenhouse gas emission standards for light-duty vehicles, light-duty trucks, and medium-duty passenger vehicles.

* * * * *

(c) * * *

(2) * * *

(i) * * *

(A) For passenger automobiles with a footprint of less than or equal to 41 square feet, the gram/mile CO₂ target value shall be selected for the

appropriate model year from Table 1 to Paragraph (c)(2)(i)(A).

BILLING CODE 4910-59-P

Table 1 to Paragraph (c)(2)(i)(A)

Model year	CO ₂ target value (grams/mile)
2012	244.0
2013	237.0
2014	228.0
2015	217.0
2016	206.0
2017	195.0
2018	185.0
2019	175.0
2020 and later	166.0

(B) For passenger automobiles with a footprint of greater than 56 square feet, the gram/mile CO₂ target value shall be

selected for the appropriate model year from Table 1 to Paragraph (c)(2)(i)(B).

Table 1 to Paragraph (c)(2)(i)(B)

Model year	CO ₂ target value (grams/mile)
2012	315.0
2013	307.0
2014	299.0
2015	288.0
2016	277.0
2017	263.0
2018	250.0
2019	238.0
2020 and later	226.0

(C) For passenger automobiles with a footprint that is greater than 41 square feet and less than or equal to 56 square feet, the gram/mile CO₂ target value shall be calculated using the following equation and rounded to the nearest 0.1

grams/mile, except that for any vehicle footprint the maximum CO₂ target value shall be the value specified for the same model year in paragraph (c)(2)(i)(B) of this section:

$$\text{Target CO}_2 = [a \times f] + b$$

Where:

f is the vehicle footprint, as defined in § 86.1803; and

a and *b* are selected from Table 1 to Paragraph (c)(2)(i)(C):

Table 1 to Paragraph (c)(2)(i)(C)

Model year	a	b
2012	4.72	50.5
2013	4.72	43.3
2014	4.72	34.8
2015	4.72	23.4
2016	4.72	12.7
2017	4.53	8.9
2018	4.35	6.5
2019	4.17	4.2
2020 and later	4.01	1.9

* * * * *

(3) * * *

(i) * * *

(A) For light trucks with a footprint of less than or equal to 41 square feet, the gram/mile CO₂ target value shall be selected for the appropriate model year

from Table 1 to Paragraph Table 1 to Paragraph (c)(3)(i)(A):

BILLING CODE 4910-59-C

Table 1 to Paragraph (c)(3)(i)(A):

Model year	CO ₂ target value (grams/mile)
2012	294.0
2013	284.0
2014	275.0
2015	261.0
2016	247.0
2017	238.0
2018	227.0
2019	220.0
2020 and later	212.0

(B) For light trucks with a footprint that is greater than 41 square feet and less than or equal to the maximum footprint value specified in the table below for each model year, the gram/mile CO₂ target value shall be calculated using the following equation and

rounded to the nearest 0.1 grams/mile, except that for any vehicle footprint the maximum CO₂ target value shall be the value specified for the same model year in paragraph (c)(3)(i)(D) of this section:

$$\text{Target CO}_2 = (a \times f) + b$$

Where:

f is the footprint, as defined in § 86.1803; and
a and *b* are selected from Table 1 to Paragraph Table 1 to Paragraph (c)(3)(i)(B): For the appropriate model year:

Table 1 to Table 1 to Paragraph (c)(3)(i)(B)

Model year	Maximum Footprint	a	b
2012	66.0	4.04	128.6
2013	66.0	4.04	118.7
2014	66.0	4.04	109.4
2015	66.0	4.04	95.1
2016	66.0	4.04	81.1
2017	50.7	4.87	38.3
2018	60.2	4.76	31.6
2019	66.4	4.68	27.7
2020 and later	68.3	4.57	24.6

* * * * *

(D) For light trucks with a footprint greater than the minimum value

specified in the table below for each model year, the gram/mile CO₂ target value shall be selected for the

appropriate model year from Table 1 to Paragraph Table 1 to Paragraph (c)(3)(i)(D):

Table 1 to Paragraph Table 1 to Paragraph (c)(3)(i)(D)

Model year	Minimum Footprint	CO ₂ target value (grams/mile)
2012	66.0	395.0
2013	66.0	385.0
2014	66.0	376.0
2015	66.0	362.0
2016	66.0	348.0
2017	66.0	347.0
2018	66.0	342.0
2019	66.4	339.0
2020 and later	68.3	337.0

* * * * *

(f) *Nitrous oxide (N₂O) and methane (CH₄) exhaust emission standards for passenger automobiles and light trucks.* Each manufacturer's fleet of combined passenger automobile and light trucks must comply with N₂O and CH₄ standards using either the provisions of paragraph (f)(1), or, through model year 2020, provisions of paragraphs (f)(2) or (3) of this section. Except with prior EPA approval, a manufacturer may not use the provisions of both paragraphs (f)(1) and (2) of this section in a model year. For example, a manufacturer may not use the provisions of paragraph (f)(1) of this section for their passenger automobile fleet and the provisions of paragraph (f)(2) for their light truck fleet in the same model year. The manufacturer may use the provisions of both paragraphs (f)(1) and (through model year 2020) (3) of this section in a model year. For example, a manufacturer may meet the N₂O standard in paragraph (f)(1)(i) of this section and an alternative CH₄ standard determined under paragraph (f)(3) of this section. Vehicles certified using the

N₂O data submittal waiver provisions of § 86.1829(b)(1)(iii)(G) are not required to be tested for N₂O under the in-use testing programs required by § 86.1845 and § 86.1846.

(1) *Standards applicable to each test group.* (i) Exhaust emissions of nitrous oxide (N₂O) shall not exceed 0.010 grams per mile at full useful life, as measured according to the Federal Test Procedure (FTP) described in subpart B of this part. Through model year 2020, manufacturers may optionally determine an alternative N₂O standard under paragraph (f)(3) of this section. This option may not be used for model year 2021 or later. (ii) Exhaust emissions of methane (CH₄) shall not exceed 0.030 grams per mile at full useful life, as measured according to the Federal Test Procedure (FTP) described in subpart B of this part. Through model year 2020, manufacturers may optionally determine an alternative CH₄ standard under paragraph (f)(3) of this section. This option may not be used for model year 2021 or later.

(2) *Include N₂O and CH₄ in fleet averaging program.* Through model year

2020, manufacturers may elect to not meet the emission standards in paragraph (f)(1) of this section. This option may not be used for model year 2021 or later. Manufacturers making this election shall include N₂O and CH₄ emissions in the determination of their fleet average carbon-related exhaust emissions, as calculated in 40 CFR part 600, subpart F. Manufacturers using this option must include both N₂O and CH₄ full useful life values in the fleet average calculations for passenger automobiles and light trucks. Use of this option will account for N₂O and CH₄ emissions within the carbon-related exhaust emission value determined for each model type according to the provisions of 40 CFR part 600. This option requires the determination of full useful life emission values for both the Federal Test Procedure and the Highway Fuel Economy Test. Manufacturers selecting this option are not required to demonstrate compliance with the standards in paragraph (f)(1) of this section.

(3) *Optional use of alternative N₂O and/or CH₄ standards.* Through model

year 2020, manufacturers may select an alternative standard applicable to a test group, for either N₂O or CH₄, or both. This option may not be used for model year 2021 or later. For example, a manufacturer may choose to meet the N₂O standard in paragraph (f)(1)(i) of this section and an alternative CH₄ standard in lieu of the standard in paragraph (f)(1)(ii) of this section. The alternative standard for each pollutant must be greater than the applicable exhaust emission standard specified in paragraph (f)(1) of this section. Alternative N₂O and CH₄ standards apply to emissions measured according to the Federal Test Procedure (FTP) described in Subpart B of this part for the full useful life, and become the applicable certification and in-use emission standard(s) for the test group. Manufacturers using an alternative standard for N₂O and/or CH₄ must calculate emission debits according to

the provisions of paragraph (f)(4) of this section for each test group/alternative standard combination. Debits must be included in the calculation of total credits or debits generated in a model year as required under § 86.1865–12(k)(5). For flexible fuel vehicles (or other vehicles certified for multiple fuels) you must meet these alternative standards when tested on any applicable test fuel type.

* * * * *
 ■ 31. Revise § 86.1867–12 to read as follows:

§ 86.1867–12 CO₂ credits for reducing leakage of air conditioning refrigerant.

Through model year 2020, manufacturers may generate credits applicable to the CO₂ fleet average program described in § 86.1865–12 by implementing specific air conditioning system technologies designed to reduce air conditioning refrigerant leakage over the useful life of their passenger

automobiles and/or light trucks. Manufacturers may not generate these credits for model year 2021 or later. Credits shall be calculated according to this section for each air conditioning system that the manufacturer is using to generate CO₂ credits. Manufacturers may also generate early air conditioning refrigerant leakage credits under this section for the 2009 through 2011 model years according to the provisions of § 86.1871–12(b).

Issued on August 1, 2018, in Washington, DC, under authority delegated in 49 CFR 1.95 and 501.5.

Heidi R. King,
Deputy Administrator, National Highway Traffic Safety Administration.

Andrew R. Wheeler,
Acting Administrator, Environmental Protection Agency.

[FR Doc. 2018–16820 Filed 8–23–18; 8:45 am]

BILLING CODE 4910–59–P