

T-MSIS Record Segment Definitions and Relationships

This document contains definitions and diagrams that depict TMSIS Record Segment Relationships. On all joins, the effective date of the child must fall completely with the set of effective date span of the active parent records. There shall be no dates where a child is active without a corresponding active parent.

Table 1: T-MSIS Record Segment Definitions

File Name	Record Segment Name	Record Identifier	Record Segment Definition	Record Segment Length
Claim Inpatient File	FILE-HEADER-RECORD-IP	CIP00001	A record containing metadata necessary to identify the file itself, when it was created and the number of records it contains.	2,100
Claim Inpatient File	CLAIM-HEADER-RECORD-IP	CIP00002	A record to capture data about an inpatient claim or encounter that applies to the claim in its totality.	2,100
Claim Inpatient File	CLAIM-LINE-RECORD-IP	CIP00003	A record to capture data about specific goods or services rendered to a Medicaid/CHIP enrollee during the hospital stay.	2,100
Claim Long-term Care File	FILE-HEADER-RECORD-LT	CLT00001	A record containing metadata necessary to identify the file itself, when it was created and the number of records it contains.	1,900
Claim Long-term Care File	CLAIM-HEADER-RECORD-LT	CLT00002	A record to capture data about a long-term care claim or encounter that applies to the claim in its totality.	1,900
Claim Long-term Care File	CLAIM-LINE-RECORD-LT	CLT00003	A record to capture data about specific goods or services rendered to a Medicaid/CHIP enrollee during a long-term care stay.	1,900
Claim Other File	FILE-HEADER-RECORD-OT	COT00001	A record containing metadata necessary to identify the file itself, when it was created and the number of records it contains.	1,750
Claim Other File	CLAIM-HEADER-RECORD-OT	COT00002	A record to capture data about another type of claim or encounter (besides IP, LT, and RX) that applies to the claim in its totality.	1,750

File Name	Record Segment Name	Record Identifier	Record Segment Definition	Record Segment Length
Claim Other File	CLAIM-LINE-RECORD-OT	COT00003	A record to capture data about specific goods or services rendered to a Medicaid/CHIP enrollee during an outpatient visit.	1,750
Claim Prescription File	FILE-HEADER-RECORD-RX	CRX00001	A record containing metadata necessary to identify the file itself, when it was created and the number of records it contains.	1,450
Claim Prescription File	CLAIM-HEADER-RECORD-RX	CRX00002	A record to capture data about a pharmacy claim or encounter that applies to the claim in its totality.	1,450
Claim Prescription File	CLAIM-LINE-RECORD-RX	CRX00003	A record to capture data about specific prescription goods or services rendered to a Medicaid/CHIP enrollee.	1,450
Eligible File	FILE-HEADER-RECORD-ELIGIBILITY	ELG00001	A record containing metadata necessary to identify the file itself, when it was created and the number of records it contains.	1,000
Eligible File	PRIMARY-DEMOGRAPHICS-ELIGIBILITY	ELG00002	A record to capture basic demographic information about the individual.	1,000
Eligible File	VARIABLE-DEMOGRAPHICS-ELIGIBILITY	ELG00003	A record to capture additional demographic information that is more prone to periodic changes than primary demographics.	1,000
Eligible File	ELIGIBLE-CONTACT-INFORMATION	ELG00004	A record to capture addresses and phone numbers of the individual.	1,000
Eligible File	ELIGIBILITY-DETERMINANTS	ELG00005	A record to capture factors that influence an individual's eligibility for basic Medicaid/CHIP, as well as the various waivers and demonstrations.	1,000
Eligible File	HEALTH-HOME-SPA-PARTICIPATION-INFORMATION	ELG00006	A record to capture the eligible person's participation in the state's health home initiative.	1,000
Eligible File	HEALTH-HOME-SPA-PROVIDERS	ELG00007	A record to capture the identity of the health home entity in which the eligible person is enrolled, as well as the identity of the provider with primary responsibility for coordinating the delivery of health home services.	1,000

File Name	Record Segment Name	Record Identifier	Record Segment Definition	Record Segment Length
Eligible File	HEALTH-HOME-CHRONIC-CONDITIONS	ELG00008	A record to capture an eligible person's chronic conditions that qualified him/her for participation in the health home initiative.	1,000
Eligible File	LOCK-IN-INFORMATION	ELG00009	A record to capture the provider, or providers, to whom the eligible person is restricted, as well as the time periods during which the lock-in provisions are in force.	1,000
Eligible File	MFP-INFORMATION	ELG00010	A record to capture information about an eligible person's participation in the Money Follows the Person demonstration program.	1,000
Eligible File	STATE-PLAN-OPTION-PARTICIPATION	ELG00011	A record to capture the identity of the State Plan Options in which an eligible person is enrolled.	1,000
Eligible File	WAIVER-PARTICIPATION	ELG00012	A record to capture the identity of the waivers in which an eligible person is enrolled.	1,000
Eligible File	LTSS-PARTICIPATION	ELG00013	A record to capture the level of care an eligible person receives at various points in time while in a long-term care facility.	1,000
Eligible File	MANAGED-CARE-PARTICIPATION	ELG00014	A record to capture information about an eligible person's enrollment in a managed care plan.	1,000
Eligible File	ETHNICITY-INFORMATION	ELG00015	A record to capture information about an eligible person's ethnicity.	1,000
Eligible File	RACE-INFORMATION	ELG00016	A record to capture information about an eligible person's race.	1,000
Eligible File	DISABILITY-INFORMATION	ELG00017	A record to capture information about an eligible person's disabilities.	1,000
Eligible File	1115A-DEMONSTRATION-INFORMATION	ELG00018	A record to capture an eligible person's 1115A participation.	1,000
Eligible File	HCBS-CHRONIC-CONDITIONS-NON-HEALTH-HOME	ELG00020	A record to capture an eligible person's chronic conditions for which an eligible person is receiving home and community-based care.	1,000
Eligible File	ENROLLMENT-TIME-SPAN-SEGMENT	ELG00021	A record to capture the eligible person's type of enrollment and time spans of enrollment.	1,000

File Name	Record Segment Name	Record Identifier	Record Segment Definition	Record Segment Length
Managed Care Plan Information File	FILE-HEADER-RECORD-MANAGED-CARE	MCR00001	A record containing metadata necessary to identify the file itself, when it was created and the number of records it contains.	1,000
Managed Care Plan Information File	MANAGED-CARE-MAIN	MCR00002	A record to capture basic, generally static information about a managed care entity.	1,000
Managed Care Plan Information File	MANAGED-CARE-LOCATION-AND-CONTACT-INFO	MCR00003	A record to capture addresses, phone numbers, fax numbers, and email addresses of the managed care organization.	1,000
Managed Care Plan Information File	MANAGED-CARE-SERVICE-AREA	MCR00004	A record to capture the zip codes, counties, or other geographic descriptors that define the managed care entity's service area.	1,000
Managed Care Plan Information File	MANAGED-CARE-OPERATING-AUTHORITY	MCR00005	A record to capture information about the operating authority, waivers and demonstrations under which a managed care entity is contracted with the state.	1,000
Managed Care Plan Information File	MANAGED-CARE-PLAN-POPULATION-ENROLLED	MCR00006	A record to capture the identity of the Medicaid/CHIP eligibility groups that the managed care entity is authorized to enroll.	1,000
Managed Care Plan Information File	MANAGED- CARE-ACCREDITATION-ORGANIZATION	MCR00007	A record to capture information concerning the accreditations that the managed care entity has.	1,000
Managed Care Plan Information File	NATIONAL-HEALTH-CARE-ENTITY-ID-INFO	MCR00008	A record to capture the national health plan identifiers associated with the managed care entity.	1,000
Managed Care Plan Information File	CHPID-SHPID-RELATIONSHIPS	MCR00009	A record to link a managed care entity Sub-Health Plan IDs with the appropriate Controlling Health Plan IDs.	1,000
Provider File	FILE-HEADER-RECORD-PROVIDER	PRV00001	A record containing metadata necessary to identify the file itself, when it was created and the number of records it contains.	1,100
Provider File	PROV-ATTRIBUTES-MAIN	PRV00002	A record to capture basic, generally static information about each provider.	1,100

File Name	Record Segment Name	Record Identifier	Record Segment Definition	Record Segment Length
Provider File	PROV-ATTRIBUTES-MAIN	PRV00002	A provider is an individual person (medical or non-medical), a group of individuals, or an organization (e.g. institution, facility, agency, hospital, nursing facility, home health agency, school, or transportation organization) that delivers or facilitates health-related treatments, health care services, or living supports.	1,100
Provider File	PROV-LOCATION-AND-CONTACT-INFO	PRV00003	A record to capture addresses, phone numbers, and email addresses of the provider.	1,100
Provider File	PROV-LOCATION-AND-CONTACT-INFO	PRV00003	Each PROV-LOCATION-AND-CONTACT-INFO record segment represents the set of contact information for a single provider location.	1,100
Provider File	PROV-LOCATION-AND-CONTACT-INFO	PRV00003	The state can enter as many sets of contact information (i.e., multiple PROV-LOCATION-AND-CONTACT-INFO record segments) as it considers necessary. The value selected for the ADDR-TYPE field describes the type of contact information on that particular record (e.g., provider service location, provider billing address, etc.). The PROV-LOCATION-ID differentiates one PROV-LOCATION-AND-CONTACT-INFO record segment from another when the ADDR-TYPE value on both records is the same.	1,100
Provider File	PROV-LICENSING-INFO	PRV00004	A record to capture licensing and accreditation information relevant to the provider.	1,100
Provider File	PROV-IDENTIFIERS	PRV00005	A record to capture the identifiers assigned to the provider entity by various governmental, professional, and payer entities.	1,100

File Name	Record Segment Name	Record Identifier	Record Segment Definition	Record Segment Length
Provider File	PROV-TAXONOMY-CLASSIFICATION	PRV00006	A record to classify the provider into areas of specialty, as well as the authorized categories of service for which the provider entity has been authorized by the state to render to Medicaid/CHIP eligibles.	1,100
Provider File	PROV-MEDICAID-ENROLLMENT	PRV00007	A record to capture the provider's periods of participation in the state's Medicaid/CHIP programs, and the reason for a change in enrollment status.	1,100
Provider File	PROV-AFFILIATED-GROUPS	PRV00008	A record to capture a provider's relationship(s) with other provider(s).	1,100
Provider File	PROV-AFFILIATED-PROGRAMS	PRV00009	A record to capture the Medicaid/CHIP health plans, waivers, health home entities, etc. that the provider entity is associated with.	1,100
Provider File	PROV-BED-TYPE-INFO	PRV00010	A record to capture the number on beds available for various categories of bed at provider entities that are facilities.	1,100
Third-party Liability File	FILE-HEADER-RECORD-TPL	TPL00001	A record containing metadata necessary to identify the file itself, when it was created and the number of records it contains.	900
Third-party Liability File	TPL-MEDICAID-ELIGIBLE-PERSON-MAIN	TPL00002	A record to capture basic, generally static information to identify Medicaid/CHIP enrollees for whom third party funds may be available to offset some or all of their Medicaid/CHIP costs.	900
Third-party Liability File	TPL-MEDICAID-ELIGIBLE-PERSON-HEALTH-INSURANCE-COVERAGE-INFO	TPL00003	A record to capture insurance policy information needed to facilitate pursuit of the third party liability.	900
Third-party Liability File	TPL-MEDICAID-ELIGIBLE-PERSON-HEALTH-INSURANCE-COVERAGE-CATEGORIES	TPL00004	A record to capture TPL insurance coverage information to support the applicability assessment of the third party insurance coverage to the Medicaid/CHIP costs incurred on behalf of the Medicaid/CHIP enrollee.	900

File Name	Record Segment Name	Record Identifier	Record Segment Definition	Record Segment Length
Third-party Liability File	TPL-MEDICAID-ELIGIBLE-OTHER-THIRD-PARTY-COVERAGE-INFORMATION	TPL00005	A record to flag Medicaid/CHIP enrollees who potentially have non-insurance sources of funds that could be used to offset Medicaid/CHIP expenditures.	900
Third-party Liability File	TPL-ENTITY-CONTACT-INFORMATION	TPL00006	A record to capture addresses and phone numbers of the entity providing TPL insurance coverage.	900

Diagram 1: Claim IP File - Claim Record Segment Relationships

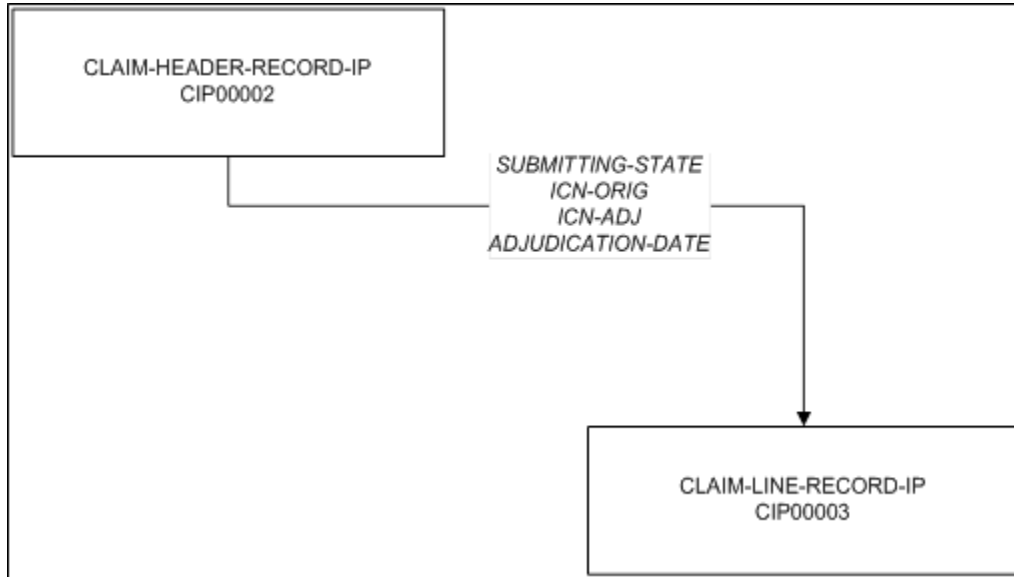

Description of Diagram 1:

Each claim record in the T-MSIS inpatient claims file is composed of two types of record segments: One claim header segment and multiple claim line segments. Each claim line segment joins to its claim header segment on the following four data elements:

1. SUBMITTING-STATE
2. ICN-ORIG

- 3. ICN-ADJ
- 4. ADJUDICATION-DATE

Diagram 2: Claim LT File – Claim Record Segment Relationships

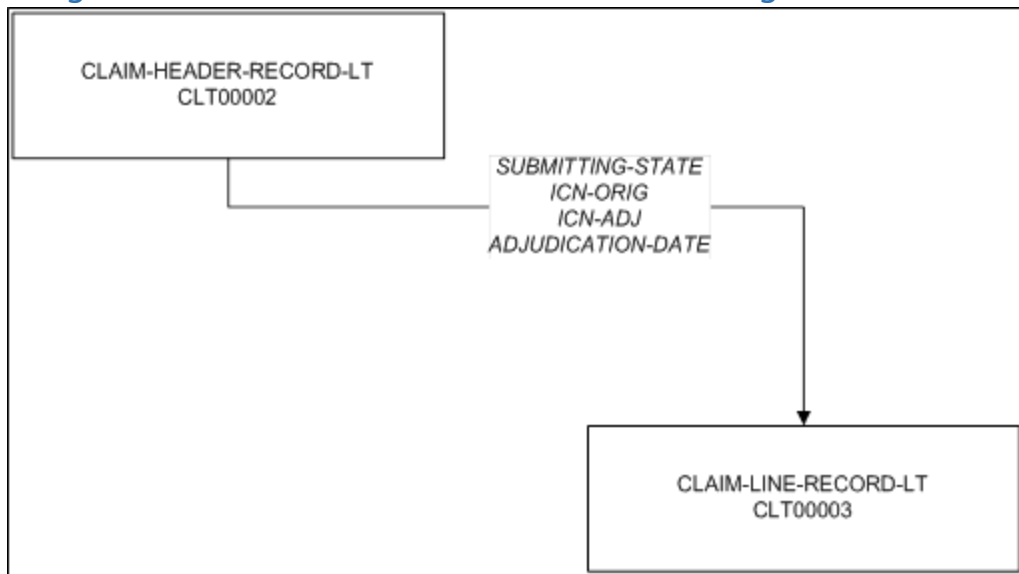

Description of Diagram 2:

Each claim record in the T-MSIS long-term care claims file is composed of two types of record segments: One claim header segment and multiple claim line segments. Each claim line segment joins to its claim header segment on the following four data elements:

- 1. SUBMITTING-STATE
- 2. ICN-ORIG
- 3. ICN-ADJ
- 4. ADJUDICATION-DATE

Diagram 3: Claim OT File – Claim Record Segment Relationships

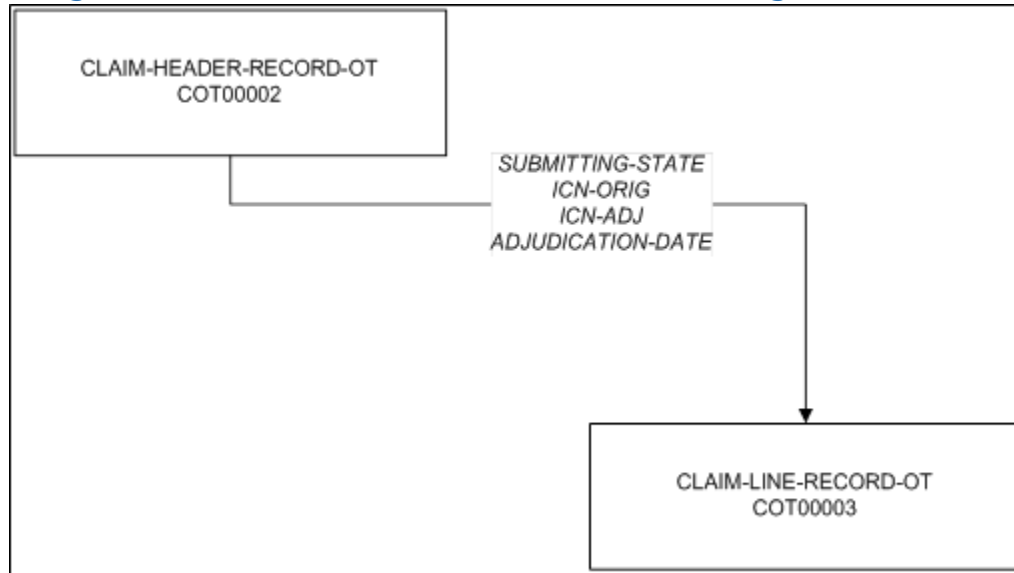

Description of Diagram 3:

Each claim record in the T-MSIS other claims file is composed of two types of record segments: One claim header segment and multiple claim line segments. Each claim line segment joins to its claim header segment on the following four data elements:

1. SUBMITTING-STATE
2. ICN-ORIG
3. ICN-ADJ
4. ADJUDICATION-DATE

Diagram 4: Claim Rx File – Claim Record Segment Relationships

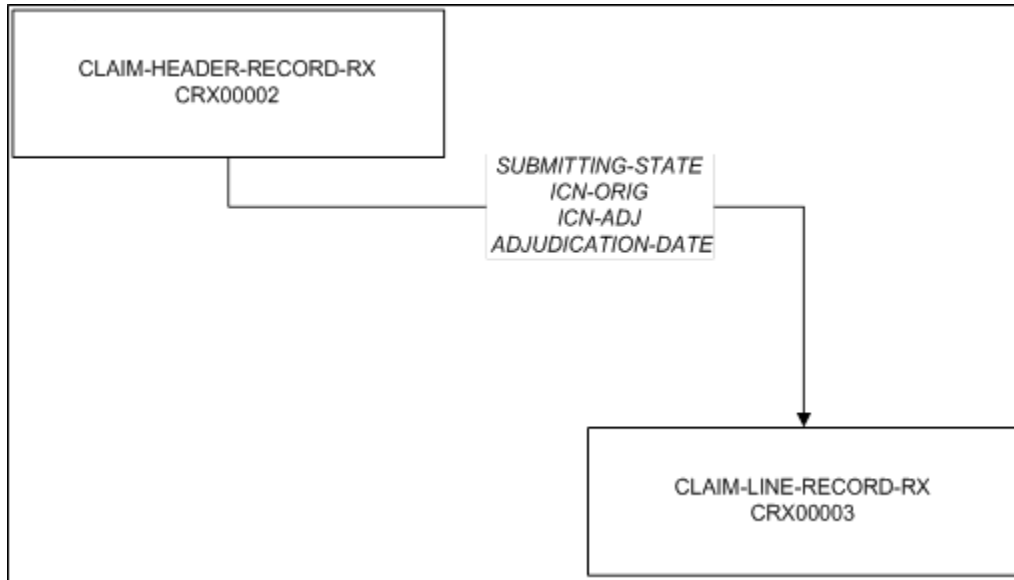

Description of Diagram 4:

Each claim record in the T-MSIS prescription drug (Rx) claims file is composed of two types of record segments: One claim header segment and multiple claim line segments. Each claim line segment joins to its claim header segment on the following four data elements:

1. SUBMITTING-STATE
2. ICN-ORIG
3. ICN-ADJ
4. ADJUDICATION-DATE

Diagram 5: Eligibles File – Eligible Person Record Segment Relationships

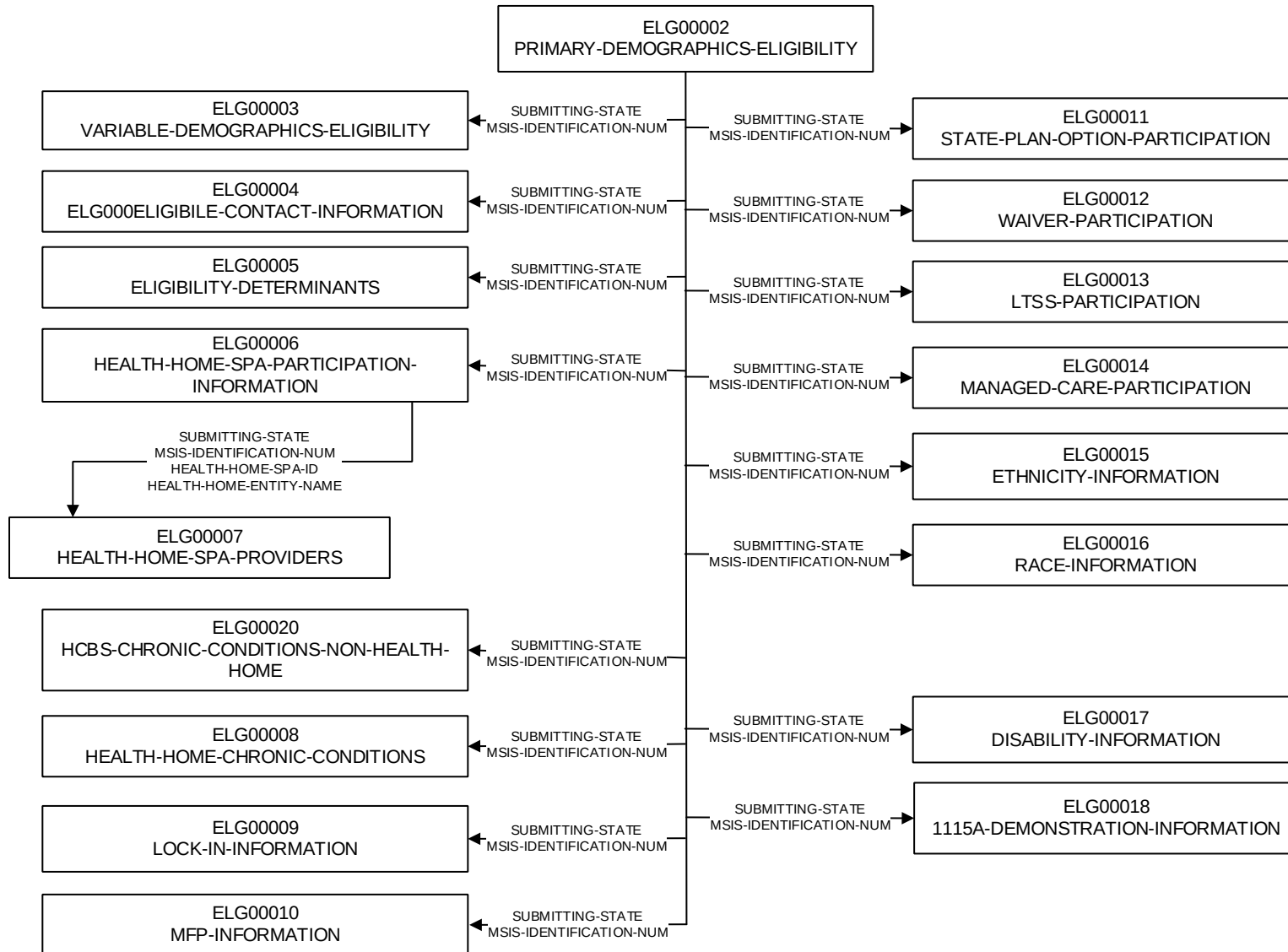

Description of Diagram 5:

Each eligible person in T-MSIS has a record in the T-MSIS eligibility file. Each of these records is comprised of up to eighteen different types of record segments. The PRIMARY-DEMOGRAPHICS-ELIGIBILITY (ELG00002) segment is the parent segment and all other segments, except for the HEALTH-HOME-SPA-PROVIDERS (ELG00007) segment, join to it on the following two data elements:

1. SUBMITTING-STATE
2. MSIS-IDENTIFICATION-NUM

The exception (the HEALTH-HOME-SPA-PROVIDERS (ELG00007) segment) is a child of the HEALTH-HOME-SPA-PARTICIPATION-INFORMATION (ELG00006) segment and joins to it on:

1. SUBMITTING-STATE
2. MSIS-IDENTIFICATION-NUM
3. HEALTH-HOME-SPA-ID
4. HEALTH-HOME ENTITY-NAME

Diagram 6: Providers File – Provider Record Segment Relationships

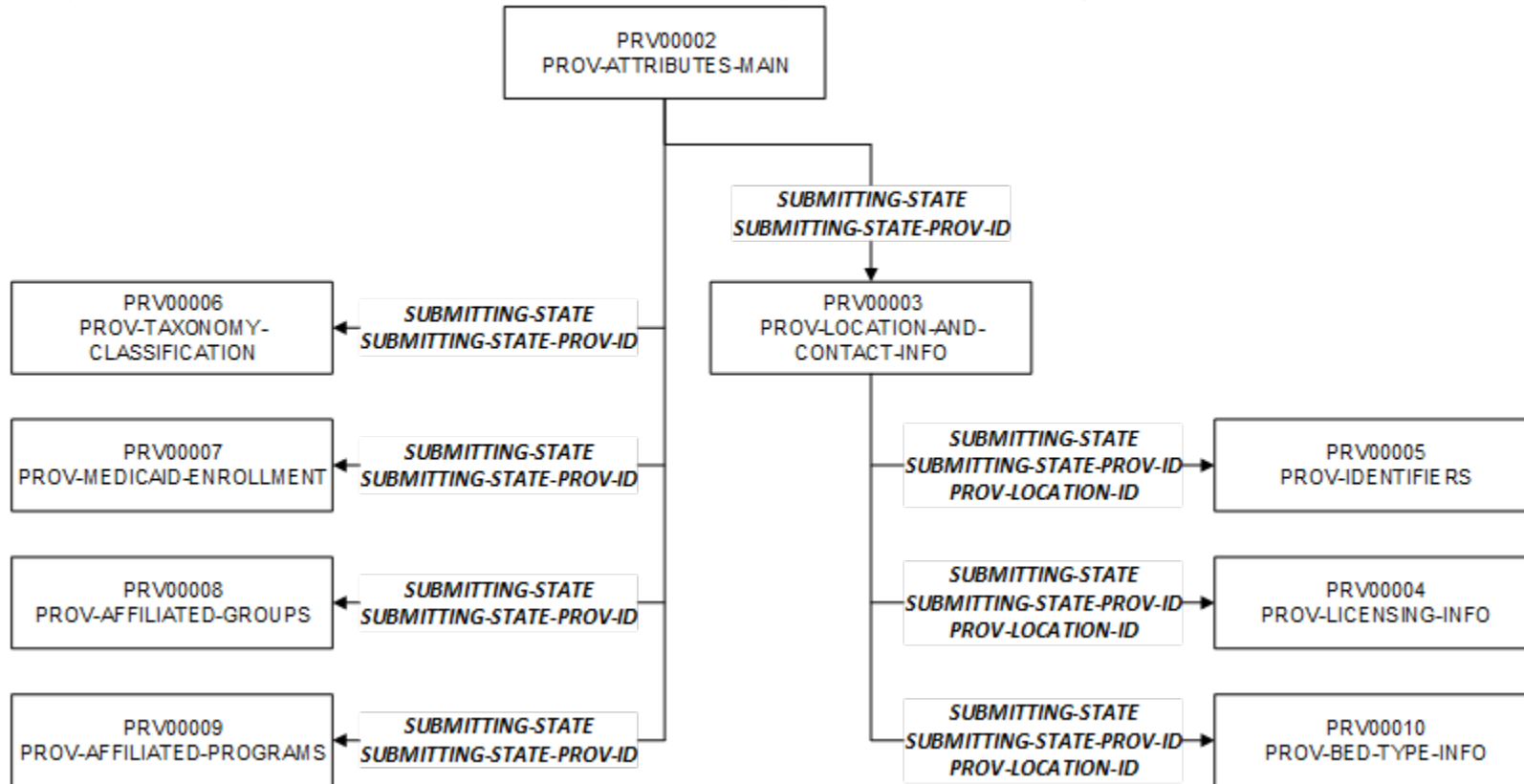

Description of Diagram 6:

Each provider in T-MSIS (regardless of whether the provider is a single individual, a group of practitioners, a facility, or a group of facilities) must have a record in the T-MSIS providers file. Each provider record is comprised of up to nine different types of record segments. The PROV-ATTRIBUTES-MAIN (PRV0002) segment is the parent segment to five segments: PROV-TAXONOMY-CLASSIFICATION (PRV0006), PROV-MEDICAID-ENROLLMENT (PRV0007), PROV-AFFILIATED-GROUPS (PRV0008), PROV-AFFILIATED-PROGRAMS (PRV0009), and PROV-LOCATION-AND-CONTACT-INFO (PRV0003), all of which join to PROV-ATTRIBUTES-MAIN on the following two data elements:

1. SUBMITTING-STATE
2. SUBMITTING-STATE-PROV-ID.

In addition, the PROV-LOCATION-AND-CONTACT-INFO (PRV00003) segment is a parent segment in its own right to three additional subordinate segments: PROV-IDENTIFIERS (PRV00005), PROV-LICENSING-INFO (PRV00004), PROV-BED-TYPE-INFO (PRV00010). These three segments join to the PROV-LOCATION-AND-CONTACT-INFO segment on:

1. SUBMITTING-STATE
2. SUBMITTING-STATE-PROV-ID
3. PROV-LOCATION-ID.

Diagram 7: Managed Care File – Managed Care Entity Record Segment Relationships

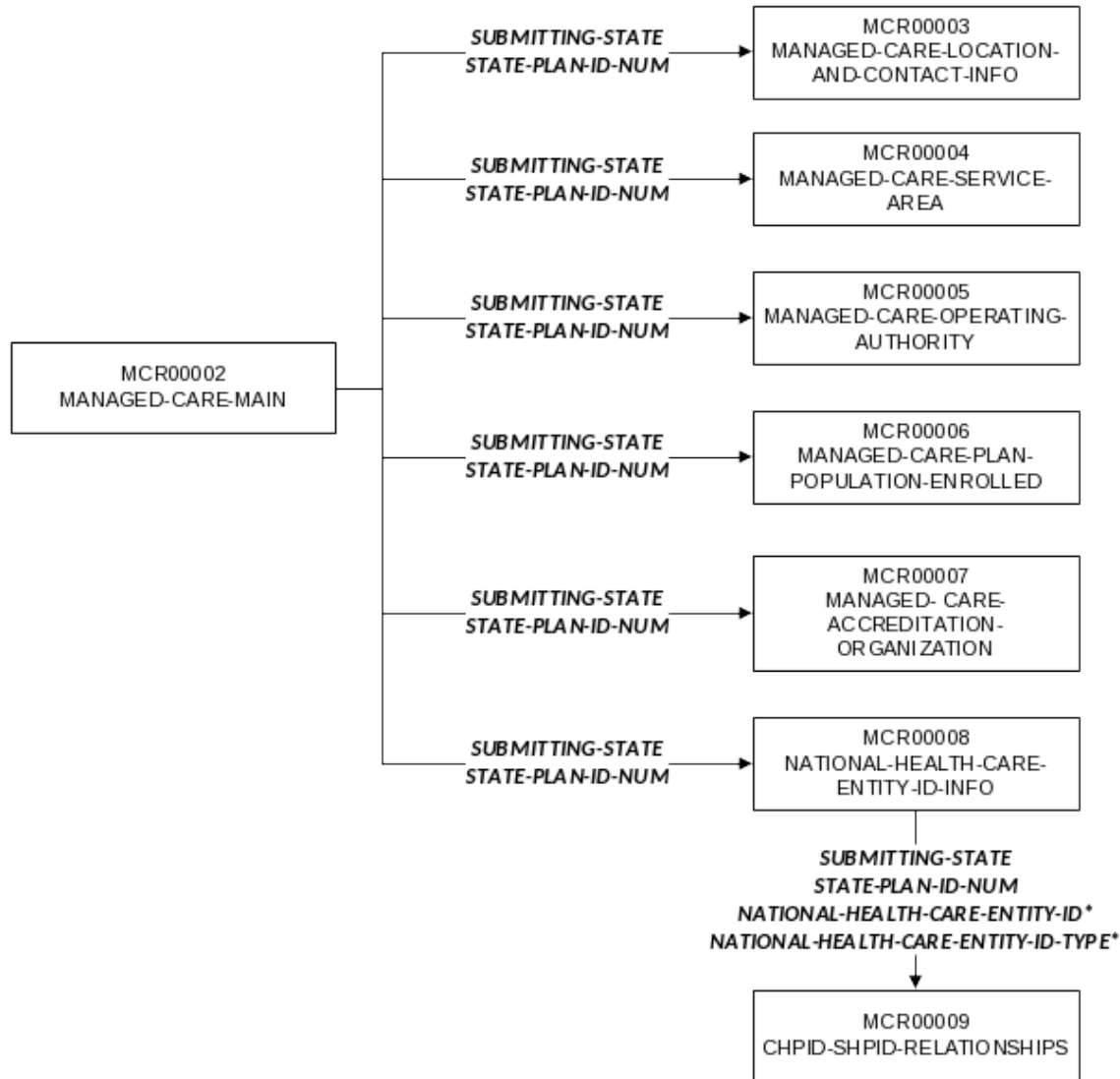

* = MCR00008.NATIONAL-HEALTH-CARE-ENTITY-ID would join to either MCR00009.CHPID or MCR00009.SHPID based on the value in MCR00008.NATIONAL-HEALTH-CARE-ENTITY-ID-TYPE.

Description of Diagram 7:

Each managed care entity in T-MSIS must have a record in the T-MSIS managed care file. Each managed care record is comprised of up to eight different types of record segments. The MANAGED-CARE-MAIN (MCR00002) segment is the parent segment to six segments: MANAGED-CARE-LOCATION-AND-CONTACT-INFO (MCR00003), MANAGED-CARE-SERVICE-AREA (MCR00004), MANAGED-CARE-OPERATING-AUTHORITY (MCR00005), MANAGED-CARE-PLAN-POPULATION-ENROLLED (MCR00006), MANAGED-CARE-ACCREDITATION-ORGANIZATION (MCR00007), and NATIONAL-HEALTH-CARE-ENTITY-ID-INFO (MCR00008), all of which join to PROV-ATTRIBUTES-MAIN on the following two data elements:

1. SUBMITTING-STATE
2. STATE-PLAN-ID-NUM

In addition, the NATIONAL-HEALTH-CARE-ENTITY-ID-INFO (MCR00008) segment is a parent segment in its own right to the CHPID-SHPID-RELATIONSHIPS (MCR00009) segment, which joins to the NATIONAL-HEALTH-CARE-ENTITY-ID-INFO segment on:

1. SUBMITTING-STATE
2. STATE-PLAN-ID-NUM
3. NATIONAL-HEALTH-CARE-ENTITY-ID*
4. NATIONAL-HEALTH-CARE-ENTITY-ID-TYPE*.

** = MCR00008.NATIONAL-HEALTH-CARE-ENTITY-ID would join to either MCR00009.CHPID or MCR00009.SHPID based on the value in MCR00008.NATIONAL-HEALTH-CARE-ENTITY-ID-TYPE.*

Diagram 8: Third-Party Liability (TPL) File – TPL Record Segment Relationships

**TPL Health Insurance Entity
Subject Area**

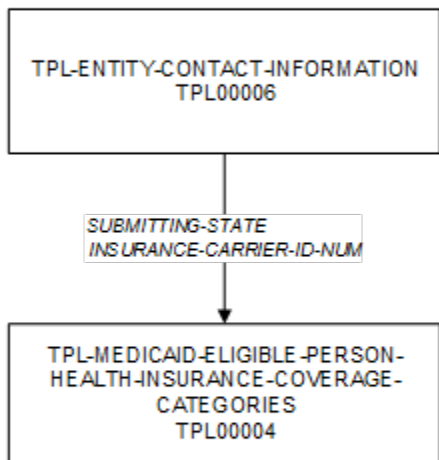

**Medicaid/CHIP Enrollees
with TPL Funding**

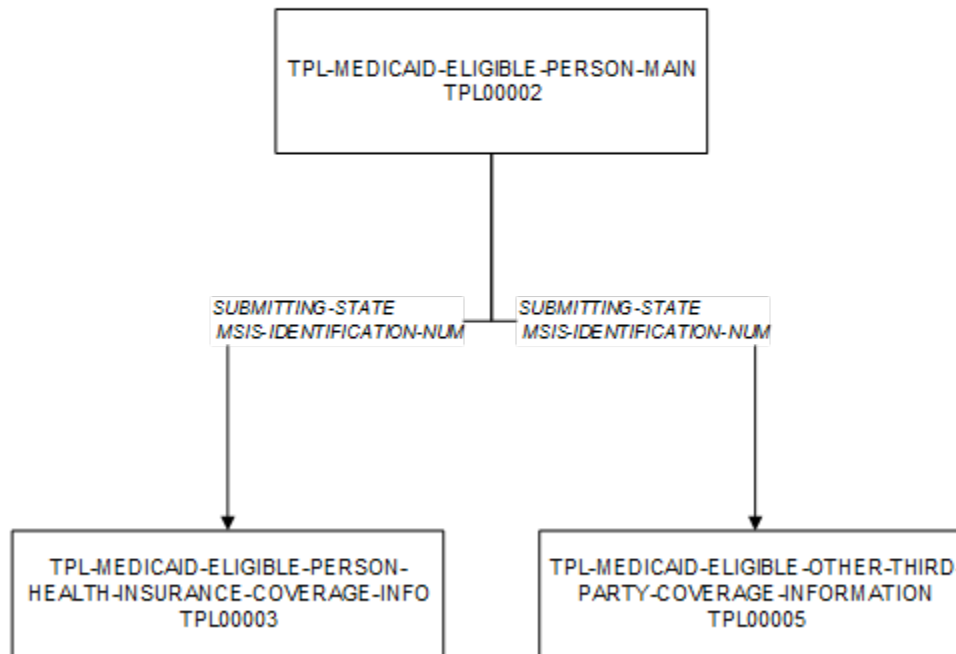

Description of Diagram 8:

Each instance of potential third-party liability for T-MSIS eligibles must have a record in the T-MSIS TPL file. There are actually two sets of information captured (called “subject areas”) in the TPL file: One set of records captures general information about non-Medicaid, non-Medicare health insurers, while the other set of records captures information about third party sources of funds that individual Medicaid/CHIP eligibles have.

TPL Health Insurance Entity Subject Area

Two types of record segments comprise the “TPL health insurance entity subject area:” the TPL-ENTITY-CONTACT-INFORMATION (TPL00006) and TPL-MEDICAID-ELIGIBLE-PERSON-HEALTH-INSURANCE-COVERAGE-CATEGORIES (TPL00004) segments. There is a one-to-many relationship between these segment types (one TPL-ENTITY-CONTACT-INFORMATION segment type to many TPL-MEDICAID-ELIGIBLE-PERSON-HEALTH-INSURANCE-COVERAGE-CATEGORIES segments). The TPL-MEDICAID-ELIGIBLE-PERSON-HEALTH-INSURANCE-COVERAGE-CATEGORIES segment joins to the TPL-ENTITY-CONTACT-INFORMATION segment on two fields:

1. SUBMITTING-STATE
2. INSURANCE-CARRIER-ID-NUM

Medicaid/CHIP Enrollees with TPL Funding Subject Area

Three types of segments make up the “Medicaid/CHIP Enrollees with TPL Funding Subject Area.” The TPL-MEDICAID-ELIGIBLE-PERSON-MAIN (TPL00002) segment type is the parent segment, with TPL-MEDICAID-ELIGIBLE-PERSON-HEALTH-INSURANCE-COVERAGE-INFO

(TPL00003) and TPL-MEDICAID-ELIGIBLE-OTHER-THIRD-PARTY-COVERAGE-INFORMATION (TPL00005) being the subordinate segments. The two subordinate segments join to TPL-MEDICAID-ELIGIBLE-PERSON-MAIN (TPL00002) segment on:

1. SUBMITTING-STATE
2. MSIS-IDENTIFICATION-NUM

PRA Disclosure Statement The Transformed Medicaid Statistical Information System (T-MSIS) is used to assist the Centers for Medicare & Medicaid Services (CMS) with monitoring and oversight of Medicaid and CHIP programs, to enable evaluation of demonstrations under section 1115 of the Social Security Act and to calculate quality measures and other metrics, including those reported through the new Medicaid and CHIP Scoreboard. Section 4735 of the Balanced Budget Act of 1997 included a statutory requirement for states to submit claims data, enrollee encounter data, and supporting information. Section 6504 of the Affordable Care Act strengthened this provision by requiring states to include data elements the Secretary determines necessary for program integrity, program oversight, and administration. Under the Privacy Act of 1974 any personally identifying information obtained will be kept private to the extent of the law. According to the Paperwork Reduction Act of 1995, no persons are required to respond to a collection of information unless it displays a valid OMB control number. The valid OMB control number for this information collection is 0938-0345 (Expires: 07/31/2019). The time required to complete this information collection is estimated to average 10 hours per response, including the time to review instructions, search existing data resources, gather the data needed, and complete and review the information collection. If you have comments concerning the accuracy of the time estimate(s) or suggestions for improving this form, please write to: CMS, 7500 Security Boulevard, Attn: PRA Reports Clearance Officer, Mail Stop C4-26-05, Baltimore, Maryland 21244-1850.