

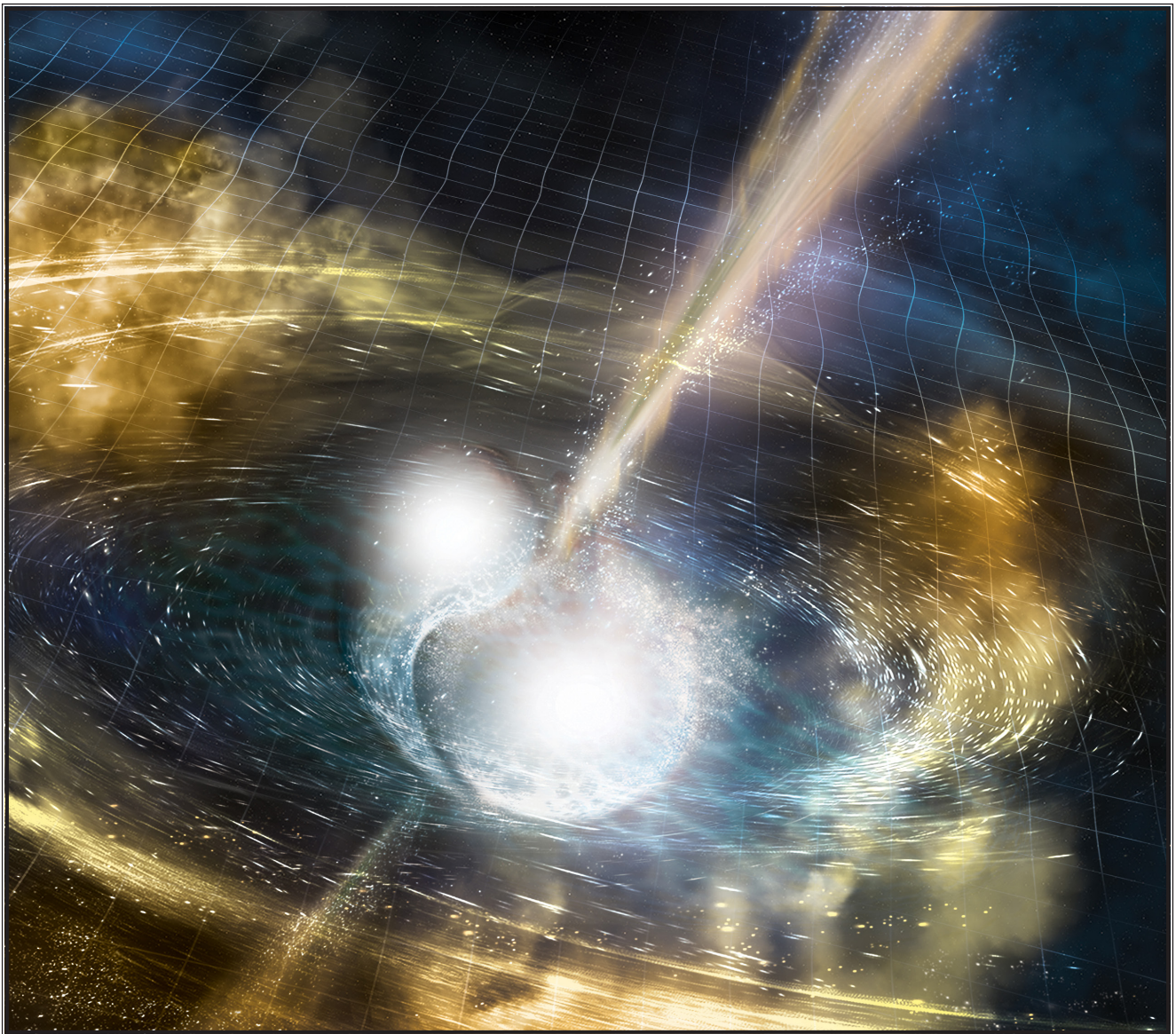

National Science Foundation

BUILDING THE FUTURE INVESTING IN DISCOVERY AND INNOVATION

NSF Strategic Plan for Fiscal Years (FY) 2018-2022



The Government Performance and Results Act (GPRA) (Public Law 103-62) and the GPRA Modernization Act of 2010 (Public Law 111-352) require Federal agencies to develop strategic plans setting forth long-term goals and objectives as well as examples of specific, near-term performance goals. Guidance on the development of agency strategic plans is included by the Office of Management and Budget (OMB) in OMB Circular A-11. These plans form part of the federal performance framework. “Building the Future: Investing in Discovery and Innovation” updates and replaces “Investing in Science, Engineering, and Education for the Nation’s Future: NSF Strategic Plan for Fiscal Years (FY) 2014-2018.” It has been prepared by the NSF staff, working with the National Science Board, with input from the science, engineering and education research communities, industry, and others.

About the cover:

For the first time, scientists have directly detected gravitational waves—ripples in space-time—in addition to light from the spectacular collision of two neutron stars. This marks the first time that a cosmic event has been observed in both gravitational waves and light. The discovery was made using the U.S.-based Laser Interferometer Gravitational-Wave Observatory (LIGO); the Europe-based Virgo detector; and some 70 ground- and space-based observatories. The cover image is an artist’s illustration of the two merging neutron stars. The narrow beams represent the gamma-ray burst while the rippling space-time grid indicates the isotropic gravitational waves that characterize the merger. Swirling clouds of material ejected from the merging stars are a possible source of the light that was seen at lower energies.

MESSAGE FROM THE NSF DIRECTOR

The National Science Foundation (NSF) is a U.S. federal agency with a global reputation for supporting groundbreaking research in science, engineering and learning. With strong, bipartisan support in Congress, NSF has made it possible for U.S. researchers to make discoveries that deepen our understanding of the universe and transform our daily lives.

That's why I'm so excited about this Strategic Plan. It lays out a vision for sustaining that momentum of discovery and ensuring the Nation remains a global leader in research and innovation. We've included examples of discoveries that NSF-supported researchers have made, and the impacts these have had on the Nation's economy and well-being. We've also laid out some exciting new opportunities for research at the frontiers of science and engineering.



Some of our toughest global challenges will rely on solutions grounded in science, which is one reason developed and developing countries are increasing their investments in fundamental research. Basic research investments are transforming entire industries, from transportation to computing, and from manufacturing to agriculture. They are also producing new technologies that have changed how we work and interact with each other. At the same time, the accelerated pace of discovery means that we as a Nation must be prepared for the changes that are coming so we can harness their potential. Part of that preparation begins with knowing what corners to look around and which questions to ask.

Scientific breakthroughs start with a question, a big idea, about the nature of things that often leads to a fundamental shift in thinking. The ability to pursue and investigate that question, and to innovate along the way, is what enables the discoveries that ultimately transform the world. This plan illustrates the opportunities ahead with examples from some of NSF's "10 Big Ideas" for future investment. These bold, long-term research questions consider critical societal challenges and important lines of scientific inquiry where NSF aims to catalyze new breakthroughs. Partnerships with other federal agencies, nonprofits, private-sector collaborators, industry partners and the public will help advance these research areas.

This plan also underscores where greater investments are needed; for example, in research infrastructure and broadening participation in the science, technology, engineering and mathematics (STEM) workforce. As highlighted in the 2018 Science and Engineering Indicators report, the number of non-STEM jobs requiring STEM skills is now on par with the number of STEM jobs in the U.S. As societies around the world transition to more knowledge-based economies, NSF is committed to preparing a 21st century workforce and ensuring that talented individuals from all sectors of our society have access to STEM learning.

With the support of the American people, NSF-funded researchers will continue to transform the world with their ingenuity and creativity, providing new knowledge and innovations that will propel our economy and enhance our lives. I appreciate your support and welcome your interest in the work that NSF does on behalf of the Nation.

France A. Córdova
Director, National Science Foundation

TABLE OF CONTENTS

I. INTRODUCTION	1
II. MISSION.	5
III. VISION	8
IV. CORE VALUES.	11
V. STRATEGIC PLANNING IN A DYNAMIC CONTEXT.	12
VI. STRATEGIC GOALS AND OBJECTIVES	17
VII. AGENCY PRIORITY GOAL	28
VIII. EXAMPLES OF LONG-TERM PERFORMANCE GOALS	29
IX. CORE STRATEGIES	30
X. EVIDENCE BUILDING	33
XI. APPENDICES	35
A.1 Stakeholder Engagement	35
A.2 Contributing Programs	35
IMAGE CREDITS	45

“There is nothing which can better deserve your patronage than the promotion of Science and Literature. Knowledge is in every country the surest basis of public happiness.”

George Washington,
First Annual Message to Congress on the State of the Union (1790)

I. INTRODUCTION

The National Science Foundation (NSF) is an independent Federal agency that supports fundamental research across virtually all fields of science, engineering, and education.

NSF enables society to discover more about the world that we inhabit and the universe that is expanding around us. By understanding how things work and how to build new complex systems, how people learn and interact, how to make new materials and observe the world better, we make possible advances in everything from manufacturing and education to food production, health, and national security.

NSF's investments in discovery and innovation provide the basis for new technologies and create a wealth of broader impacts for the U.S. Investments in research projects, people, and infrastructure have led to discoveries that have stimulated economic growth, improved the quality of life for many Americans, and deepened our understanding of the universe around us (see insets for examples). As emphasized by Congress, "Scientific and technological advancement have been the largest drivers of economic growth in the last 50 years, with the Federal Government being the largest investor in basic research."¹

NSF is a unique federal agency in terms of the wide range of fields it supports. NSF's science and engineering programs include the study of physical,

biological, engineered, and human systems. As a consequence, NSF is well positioned to address challenges and pursue opportunities that span multiple disciplines. In addition to advances in the underlying disciplines, such research challenges require strategies that promote convergence: the merging of ideas, approaches, tools, and technologies from widely diverse fields of knowledge to accelerate innovation and discovery.

LINKING ASTRONOMY AND CIVIL INFRASTRUCTURE

The ability to support those whose research bridges diverse fields is a unique value. For example, modern society relies on satellites for communication, for global positioning, for weather data, and for agricultural information. By studying stars, we understand more about our own star, the Sun, and how it interacts with the Earth's upper atmosphere. Integrating that knowledge with computational science and electrical engineering, researchers learn how to understand and predict geomagnetic storms high above the Earth's surface. This knowledge helps minimize disruptions to vital satellite services and electrical power grids.

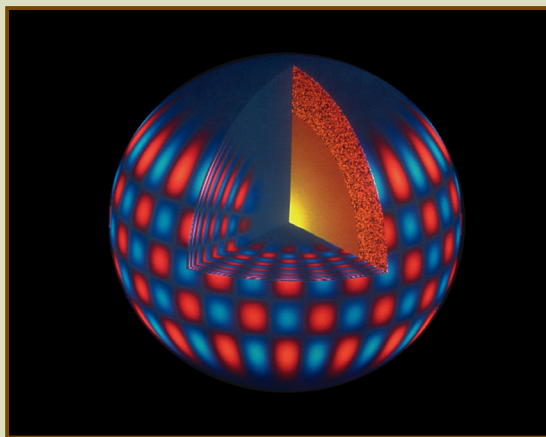

With an annual budget of about \$7.5 billion (fiscal year 2017), NSF is the funding source for approximately 24 percent of all federally supported fundamental research conducted by the faculty and students at America's colleges and universities. NSF also supports innovation by small businesses, partnerships among academia, industry and national laboratories, research in non-profit non-academic organizations, and entrepreneurship training for the academic research community.

NSF funds programs designed to foster the development of the high-quality, diverse workforce needed to carry out

the Nation's Science, Technology, Engineering, and Mathematics (STEM) research, building capacity for undergraduate, graduate, and post-doctoral research training.

NSF supports training in research integrity and the ethical conduct of research, the dissemination of the results of NSF-funded research, and infrastructure to provide access to the data generated in such research.

¹From Pub. L. 114-329, title II, §201(b)(1), 2017.

MAKING eCOMMERCE POSSIBLE

Secure communication has always been an important tool in the arsenal of militaries and diplomats. Governments and their citizens rely on keeping sensitive communication private. Beginning in the 1970s, NSF-funded researchers led a paradigm shift in secure communication.

Until then, the process of secret and secure communication meant that the communicating parties had to know each other and set up encoding and decoding procedures before corresponding. With the development of public-key cryptography, users can publish their “public keys,” just as one would publish one’s phone number in a telephone directory. For confidential communications, people can send secret and secure messages simply by using the other person’s public key.

This public-key cryptography technology is what makes eCommerce, a significant and growing fraction of our economy, possible today.

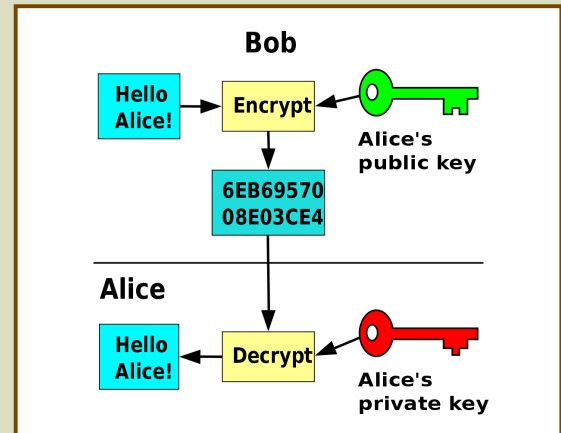

FINDING CANCERS

By supporting a broad spectrum of research domains, NSF facilitates the transfer of knowledge from one area to another. Digital mammography was developed from research funded by NSF that brought together astronomers and cancer researchers.



to detect micro-calcifications. Studies have shown that digital mammography may be more sensitive at locating breast cancer than film mammography. Digital mammography helps shorten the time to read and analyze mammograms from a few days to a few hours.

Astronomers and radiologists had a shared problem—they both needed to pinpoint critical spots against a cluttered, blurred background. Radiologists need to search images for micro-calcifications as signs of breast cancer. Astronomers look for features in images of the cosmos. Collaboration between astronomers and cancer researchers generated new software that allows radiologists greater ability to search mammograms for signs of breast cancer.

This particular link between astronomy and radiology resulted from an NSF grant that allowed astronomers and radiologists from Johns Hopkins University, Georgetown University’s Lombardi Cancer Research Center and the Space Telescope Science Institute to collaborate on using astronomical computer software (originally created to look at images of highly crowded regions of the sky containing millions of stars) to scan mammograms. When this software is applied to the examination of mammograms, it removes much of the background clutter in the image and makes it relatively simple

Each year, NSF receives about 50,000 competitive requests for funding and makes 11,000 to 12,000 new awards. To ensure that proposals are reviewed in a fair, competitive, transparent, and in-depth manner, the agency uses a rigorous merit review process. NSF’s

merit review uses two primary criteria to evaluate proposals for new activities—intellectual merit (meaning the potential to advance knowledge) and the project’s broader impacts (encompassing the potential to benefit society beyond increasing knowledge).

In FY 2017, NSF funding reached all 50 states, the District of Columbia, and 3 U.S. territories, primarily through grants to about 1,800 organizations. An estimated 350,000 people, including researchers, postdoctoral fellows, trainees, teachers, and students, were supported by NSF awards. Of these, approximately 100,000 were senior researchers, other professionals, post-doctoral associates, or graduate students.

international science and engineering enterprise, describing global trends in various aspects of research, technological development, education, and workforce (<https://www.nsf.gov/statistics/seind/>).

More than 220 Nobel Prize winners received support from NSF at some point in their careers, some beginning when they were graduate students.

EPSCoR IMPACT

NSF's Established Program to Stimulate Competitive Research (EPSCoR) has greatly increased the research capacity of many jurisdictions. Eighteen states plus Puerto Rico joined EPSCoR before 2000. The proportion of NSF's research funding that goes to these doubled between their first three years in the program and 2014 - 2016.

By 2016, EPSCoR had grown to 31 jurisdictions.

<https://www.nsf.gov/od/oia/programs/epscor/>

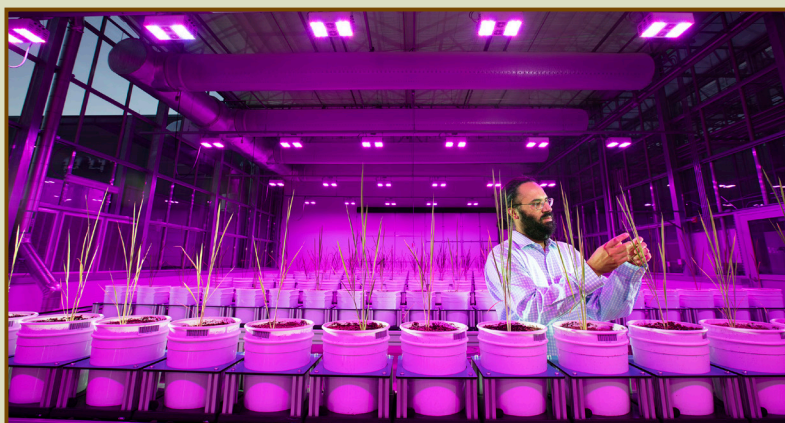

NSF supports an advanced research infrastructure that includes ships, planes and autonomous research platforms, astronomical observatories, particle accelerators, seismic observatories, U.S. research stations in Antarctica, advanced cyberinfrastructure, sustained large-scale surveys, and more.

Comprehensive reporting of the research infrastructure in countries around the world is provided by the National Center for Science and Engineering Statistics (NCSES), one of 13 Federal statistical agencies. NCSES is located within NSF. Every other year, it develops a broad base of high-quality quantitative data on the U.S. and

As the examples described in this Plan show, investing in scientific curiosity has resulted in wide-ranging benefits: new industries, technologies for better health care, more jobs, greater economic competitiveness, contributions to national security, and a deeper understanding of the universe. NSF remains committed to ensuring that the Nation will continue to profit from the fruits of basic research. Ultimately, it is curiosity-driven research that upends conventional thinking and reveals something previously unknown. NSF's goal is to fund transformative, curiosity-driven ideas that push the frontiers of discovery and innovation.

ARCTIC ICE

Arctic sea ice is an important and dynamic element in the global climate system. It is an obstacle to shipping routes across the top of the world, between Atlantic and Pacific industrial centers. It also hinders exploration of the resources on and under the floor of the Arctic Ocean. To learn more about the processes influencing the fate of the ice pack, to improve projections of its future state, and to understand the ice albedo (fraction of solar radiation reflected from the surface) and cloud radiation feedbacks, researchers conducted an interdisciplinary project, supported by both NSF and the Office of Naval Research.



The centerpiece of the Surface Heat Budget of the Arctic Ocean experiment (SHEBA) was the year-long drift of an icebreaker deliberately frozen into the Arctic ice pack. More than 180 researchers participated in the field campaign, spending from a few weeks to six months in the field. The focus was to sample, over an annual cycle, the physical properties of the atmosphere, ice, and ocean in an area equivalent to a grid cell in a high-resolution climate model. The project used satellites, aircraft, weather balloons, icebreakers, autonomous buoys, cloud radars, lidars (laser-based scanners) and, through the cooperation of the Navy, a submarine.

Amongst other achievements, SHEBA observations were used to develop and improve models of the evolution of Arctic sea ice and global Earth-system models.

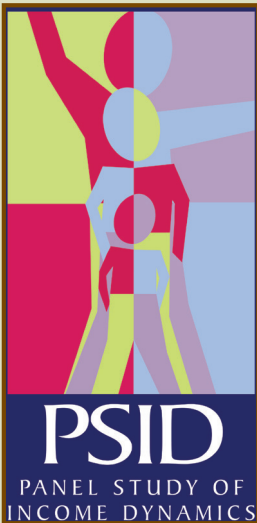

LEARNING ABOUT THE U.S.

The Panel Study of Income Dynamics (PSID) is a long-term study of a representative sample of people (men, women and children) and the families in which they reside. It emphasizes the dynamic aspects of economic and demographic behavior, but its content is broad, including sociological and psychological measures.

The PSID covers almost 50 years. It began in 1968 with a nationally distributed sample of over 18,000 individuals living in approximately 4,800 families. By 2013, the Survey comprised approximately 25,000 individuals in 9,000 families.

The PSID data sets have been central in research and knowledge building in key areas such as intergenerational relations; income, poverty, savings and wealth; demographic events such as teen childbearing, marriage and divorce, living arrangements and mortality; labor market behavior; and the effect of neighborhoods.

II. MISSION

The National Science Foundation was established by the NSF Act of 1950 (Public Law 81-507). NSF adopted the purpose of that Act as its mission: “to promote the progress of science; to advance the national health, prosperity, and welfare; to secure the national defense; and for other purposes.” This mission has guided NSF’s activities ever since.

NSF promotes the progress of science by investing in research to expand knowledge in science, engineering, and education, and by investing in actions that increase the capacity of the Nation to conduct and exploit science, technology, education, and mathematics research. NSF supports research on more effective approaches to teaching and pilot activities to test them.

NSF advances the national health, prosperity, and welfare through the contributions that NSF-funded research makes to the well-being of the Nation. NSF research has made possible many of the technological advances that

COUNTERING VIOLENT EXTREMISM

Why are extremist groups like ISIS so successful in recruiting new fighters? Many dismiss extremists as psychopaths or people seeking to achieve personal gain. Based on interviews with extremists in war zones, an NSF-funded researcher found that the truth is more complicated. New recruits are often motivated by ethical and moral beliefs, suggesting that strategies designed to disrupt recruitment must include moral alternatives to violent extremism as much as material ones, such as access to economic opportunities. This research is informing efforts by the Department of Defense and other agencies to better counter violent extremism at home and abroad.



NAVIGATING WITH MATHEMATICS

Asking strange questions can lead to huge impacts. While science had “known” for centuries that two parallel lines cannot meet, in the 19th century, some researchers decided to work out what geometry would be like in a world where parallel lines did meet. Now automobile drivers and smart bombs take advantage of their curiosity. It turns out that for accurate positioning, Global Positioning System (GPS) satellites have to be corrected for time dilation, a phenomenon associated with general relativity. General relativity tells us that space-time is curved, not flat, and the way to describe it is by using non-Euclidian geometry, the mathematics of spaces in which parallel lines can meet.



have improved medicine, communications, transportation, manufacturing, and the utilization of natural resources (see insets).

NSF’s contributions to *securing the national defense* include research in cryptography, cybersecurity, novel materials, advanced analytics for massive datasets, and research that helps troops communicate with populations in conflict zones.

Innovation is the creation and delivery of knowledge, products, or services with lasting societal benefits. NSF advances innovation through its funding of fundamental research and programs that foster the translation of scientific discoveries into new products or services. NSF programs for student training and research partnerships – between universities, industry, high-tech startups, and small businesses – support the technologies of tomorrow and speed new ideas from the lab to the marketplace.

As other countries rapidly advance the education and training of their citizens in STEM fields, deploy highly capable research infrastructure, and increase the

resources devoted to research, NSF's mission becomes ever more important. If the U.S. is to remain competitive in a world where economic and security advances are increasingly based on sophisticated technologies made possible by a deep scientific and engineering understanding, then NSF must continue to invest in a world-class research enterprise, support the development

of a globally competitive scientific and engineering workforce, and foster greater understanding of science and technology among the American public.

BAR CODES, FREEZE-RESISTANT PROTEINS, AND A NEW INDUSTRY

Bar codes help supermarkets, airlines and many other industries determine what products are marketed and where luggage should go. They are also used to help detect and determine consumers' buying trends. Scientists even tag penguins in Antarctica with bar codes to make data gathering faster and more precise, helping research into migration and penguin behavior.

NSF funding played a crucial role. In the early 1990s, research in computer vision conducted at the State University of New York-Stony Brook led to major advances in algorithms for bar code readers. That research led to commercial development of a new product line of bar code readers, described as a revolutionary advance, enabling bar code readers to operate under less than perfect conditions.



In the early 1970s, NSF-funded research identified glycoproteins as the “antifreeze” in some Antarctic fish. These compounds inhibit the growth of ice crystals, preventing damage to cells and tissues. Since this discovery, researchers have found similar compounds in other cold-water fish, insects, plants, fungi and bacteria. Because of the numerous potential benefits of protecting tissue from damage by freezing, private companies have begun to explore the use of these compounds to:

- increase freeze tolerance of commercial plants;
- improve farm fish production in cold climates;
- extend shelf life of frozen foods; and
- improve preservation of tissues for medical transplantation.

In the early 1990s, the Internet had fewer than 100 websites but the number was growing and the need for accessible interfaces to this collection became clear. To solve this problem, NSF led the multi-agency Digital Library Initiative (DLI). In 1994, the DLI made its first six awards, including a Stanford University project led by professors Héctor García-Molina and Terry Winograd.



Early search engines began indexing Web pages using keyword-based techniques to rank the results. Stanford graduate students Larry Page and Sergey Brin, who was supported by an NSF Graduate Research Fellowship, created a new way to search the Web by following links from page to page. They recognized that the act of linking one page to another required conscious effort, which was evidence of human judgment about the link's destination. Their new prototype could map out a family tree reflecting the links among the Web's pages. To calculate rankings on the tree, they developed the PageRank method that would rank a Web page higher if other highly ranked Web pages linked to it.

Their prototype was funded by the DLI project and industrial contributions. By the end of 1998, Page and Brin received outside funding and incorporated as Google, Inc.

NEW TECHNOLOGIES

Next-generation Forestry and Crop Management

In the Western U.S., NSF-funded researchers deployed a unique set of instruments, called the Internet of Trees Micrometeorological System, to monitor how trees respond to repeated droughts at the cellular level and across ecosystems. The researchers refined the instrumentation during the study and, with funding from NSF's Small Business Innovation Research (SBIR) and I-Corps programs, began rolling it out for commercial use. The new technology, called Arable, will help farmers and natural resource managers collect data on rainfall, microclimate, etc. Pilots are underway with large growers based in California and Australia.

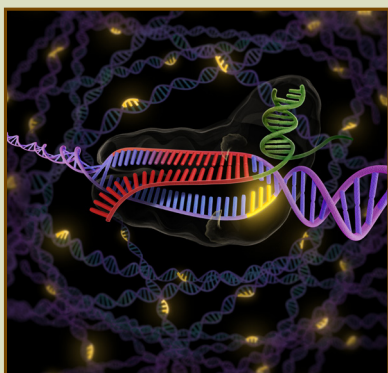

New Gene-Editing Tool

NSF-funded researchers studying how a bacterium's immune system fights off viruses uncovered a powerful new gene-editing technique called CRISPR-Cas9. CRISPR-Cas9 acts like a pair of molecular-sized scissors that researchers can wield to snip a segment of DNA; for example, to edit a segment that codes for a particular trait in an organism. Biomedical researchers are exploring CRISPR-Cas9's potential use for everything from treating genetic disorders and developing targeted cancer therapies to preventing vector-borne infectious diseases. The agricultural industry is also exploring whether CRISPR-Cas9 can help enhance crop production and livestock survival. (See also 'New Enabling Technologies' in Section V.)

Advancing Wireless Communications

The growing U.S. wireless industry, which reached nearly \$192 billion in 2015, relies on advances in wireless communications technologies made possible by NSF-funded research. One such advance is a discovery made in 1992 that enables wireless devices to simultaneously receive multiple input and multiple output (MIMO) data streams. MIMO technology dramatically increases the performance of wireless systems, allowing both higher data rates and wider coverage areas and underlies today's wireless networks (WiFi and LTE). This breakthrough was the basis for two companies that pioneered 4G wireless communications and WiMAX technologies and advanced the wireless communications sector.



III. VISION

A Nation that is the global leader in research and innovation.

A growing share of the world's economy and global well-being relies on advances in technology and knowledge derived from a deeper understanding of the fundamentals of physical, biological, and social processes. Greater access to information, and to sophisticated tools with which to analyze it, is becoming essential in a society that is increasingly knowledge-driven. Engineering and computer science increase our ability to design for the future. Research in these areas is vital to enhancing the security and resilience of the Nation's critical infrastructure. Technological innovation provides improved methods to generate, store, and manage energy.

LEARNING LESSONS FROM HONEY BEES

Researchers mimicked the food foraging behavior of honey bees to vastly improve how computer programs and devices work together in a rapidly growing global market worth over \$50 billion. Just as honey bees perform various tasks in a highly synchronized and adaptable manner to benefit the colony, the researchers designed a novel set of instructions to assign tasks to multiple computer servers. Major web hosting companies use the algorithm to analyze images, recognize objects and text, retrieve documents, and more. The algorithm also affects statistics, machine learning, data mining and other areas of computer science and engineering.



TOMORROW'S COMPUTER PROGRAMMERS



To increase the appeal of computer programming for young people, a team of NSF-funded researchers created a visual computer programming language called Scratch that allows users to develop software graphically instead of tediously typing lines of code. Launched a decade ago, Scratch helps children improve their mathematics, computation and problem-solving skills, even as they create games, animations and other fun projects. The number of users continues to grow, and the resource is used by students and teachers all over the world. In one month, November 2017, over 1 million new projects were created by over 400,000 individuals.

<https://scratch.mit.edu/about>

Advances in our capability to observe, model, comprehend, and predict the complexity of the world around us will provide us with a deeper understanding of the processes that underpin life, learning, and society. They will also open new ways to harness knowledge to enhance economic competitiveness and human welfare. For example, the emerging abilities to design inanimate materials at the molecular level, and to integrate design with molecular biology, open up new possibilities for engineered systems that could revolutionize food production, healthcare, and construction. This example illustrates the promise of research in which experts from different fields integrate their knowledge, data, and approaches to pursue common challenges. Researchers are increasingly pursuing collaborative, transdisciplinary routes to discovery. To achieve NSF's vision will require us to invest in new areas of research and learning and to adapt our approaches to fit the evolving nature of research.

TRADING WATER RESOURCES ONLINE

By 2025, two-thirds of the global population could face water shortages. Conflicts over water management are increasing, with large sums spent on litigation. To ease these challenges, Mammoth Trading launched an online market system to lease water rights. Mammoth grew out of NSF-funded research on the economic and environmental effects of groundwater pumping rights. It provides new risk management tools for farmers, reduces the cost of water reallocation, and leads to an increase in agricultural productivity and profits, while maintaining or improving environmental conditions and resource sustainability. The approach could extend to other natural resources as well.



The changing nature of work presents the Nation with both opportunities and challenges. The enabling and disruptive effects of innovation are transforming the nature and scope of available jobs with unprecedented speed. Technology has moved

from the factory floor to an expanding array of knowledge and service occupations. NSF has key roles to play as society navigates this complex and evolving landscape. NSF-supported research both contributes the technological innovations that create these changes, including designs motivated by social and behavioral sciences research, and explores the evolving human-technology workplace ecosystem.

To prosper from the changes in the nature of work and to deal with the global impacts of the expansion in human society, individuals' education needs are much greater than even a few decades ago. Now, they persist throughout life and must accommodate the growing pace of change in both work and workplaces. Renewing knowledge and skills is essential. NSF's investments in basic research on how people learn, in the traditional period stretching from pre-kindergarten to college as well as continually throughout life, will be crucial to the advances in U.S. education needed to ensure that the Nation thrives in a rapidly evolving 21st century world.

Human society shapes the world around it. However, recently, the scale and speed of society's impacts have become much larger and faster. Fundamental research in economic, social, and behavioral sciences is vital to provide the knowledge needed to understand how these impacts are realized and to give policy-makers effective tools to avoid or mitigate adverse outcomes. NSF helps ensure that the U.S. remains at the forefront of research and innovation in these sciences.

EYEWITNESS TESTIMONY THAT IS ROBUST AND RELIABLE

Crime investigators often rely on eyewitness testimony, yet misidentification is a primary cause of convictions of innocent people. NSF-supported scientists showed that changing how investigators conduct eyewitness procedures can reduce misidentification. Showing witnesses photographs one at a time (not side by side) and telling them the suspect may not be pictured are ways to reduce false positives. Additionally, having an officer who is unaware of the suspect's identity conduct these procedures reduces misidentification as the officer is less likely to unintentionally convey information via tone of voice or posture. The research led many states to reevaluate their eyewitness procedures and the Department of Justice to adopt new guidelines.



RESEARCH ON ROCK FRACTURES LEADS TO “FRACKING” REVOLUTION AND 725,000 JOBS

Terry Engelder, a structural geologist at Pennsylvania State University, was interested in black shale. As a Philadelphia news article describes it, “Terry Engelder spent most of his career toiling in obscurity, studying fracture behavior of these rocks. Even among geologists, he says, it was kind of a boring topic.”²

But Dr. Engelder found a natural process that broke the rocks. In 1983, he wrote a research proposal to the National Science Foundation entitled, “A test of the hypothesis that some joints formed as natural hydraulic fractures.” His thinking was this: as mud rich in organic matter is buried and heated, the organics break down, forming methane gas. The gas exerts pressure that breaks the rock and creates fractures. He was awarded an NSF grant to explore his insight. This research underpinned the development—30 years later—of a major natural gas boom.

By 2008, horizontal drilling had been developed and hydraulic fracturing techniques that had been developed in vertical wells were adapted to horizontal wells. Suddenly, oil and gas were being recovered from shales and other previously unproductive hydrocarbon-bearing rocks all across the United States, from Appalachia to Texas and the Rocky Mountains. Flow in pipelines changed direction to carry this new energy source to the coasts for export. Energy prices dropped. New scientific questions arose—about how to assess aquifer integrity, how to trace injected fluids, how to evaluate the possibility of induced seismicity—and NSF has awarded grants to additional researchers to explore these questions.



Our modern world has changed, quickly, in unexpected and unpredictable ways. And those changes built upon the observations and ideas of an NSF researcher who didn’t set out to discover a new energy source. The geoscientist whose papers once were scheduled on the last day of meetings found himself named a “top 100 global thinker” by Foreign Policy Magazine.³

Job Creation: A National Bureau of Economic Research study⁴ found that the fracking boom added about 725,000 jobs nationwide between 2005 and 2012, “Aggregating to the national level we conclude that aggregate employment rose by 725,000 jobs due to fracking, causing a reduction in the U.S. unemployment rate of 0.5 percent during the Great Recession,” according to a Reuters article about the study.⁵

A more recent study commissioned by the U.S. Chamber of Commerce’s 21st Century Energy Institute says that, “the extraction of ‘unconventional’ shale oil and gas through horizontal hydraulic fracturing – or fracking – has meant a job boom even in states that don’t actually have shale deposits, with 1.7 million jobs already created and a total of 3.5 million projected by 2035.”⁶

² Andrew Maykuth, May 14, 2013, Shale made Penn State professor a star. www.philly.com, accessed April 16, 2015.

³ <http://news.psu.edu/story/153476/2011/11/28/engelder-named-one-top-100-global-thinkers#nw1>

⁴ James Feyrer, Erin T. Mansur, Bruce Sacerdote, NBER Working Paper No. 21624.

⁵ www.reuters.com/article/usa-fracking-employment-study-idUSL8N13159X20151106

⁶ www.energyxxi.org/us-chamber%E2%80%99s-fracking-job-boom-behind-numbers

IV. CORE VALUES

NSF's core values are essential and enduring tenets that guide everyone in the organization as we support the agency's mission. They have been developed with the active engagement of NSF's staff and the National Science Board. These values identify who we are and what is important to us. They guide how we make decisions, set priorities, address challenges, manage tradeoffs, recruit and develop personnel, and work together with our awardees.

NSF's core values are ExPLICIT in what we do every day:

Excellence – We maintain the highest standards in merit review, financial management, and award administration. We use rigorous review by experts to ensure that only the best ideas are funded and that our investments further the national interest.

Public Service – We proudly value our role as public servants, enabling the research community to blaze new paths for expanding knowledge and addressing societal challenges.

Learning – We take advantage of opportunities to improve our skills and we provide all staff members with opportunities to develop. We question our

assumptions; we evaluate our activities; we learn what is effective and what can be improved.

Inclusion – We strive to maintain a staff that is representative of the broader national community. We endeavor to support outstanding researchers and innovative thinkers from across our Nation's diversity of regions, types of organizations, and demographic groups.

Collaboration – We work in a collaborative enterprise in which teamwork is essential. We value the perspectives and values of our fellow team members and recognize that combining our knowledge enables us to find more robust solutions; we acknowledge the contributions that we each make to our shared success; we are committed to listening, communicating effectively, and working collegially.

Integrity – We hold each other and our awardees to the highest standards of ethical behavior. We strive to ensure the trustworthiness of the results of NSF-funded research by promoting the responsible conduct of research.

Transparency – We operate with transparency and openness.

V. STRATEGIC PLANNING IN A DYNAMIC CONTEXT

The context in which NSF develops its strategic plans is constantly evolving. In this section, we describe the significant factors and opportunities that shape our goals and strategies.

SIGNIFICANT CONTEMPORARY FACTORS

Around the world, societies are transitioning to more knowledge-based economies. Global observations of the natural and human environments are revealing the growing footprint of human society. Advances in science

Competing Globally

The value to society of the fruits of basic research is recognized around the world. Most other developed and many developing countries are increasing their investments in fundamental research.

To capitalize on scientific and technological advances, countries need to prepare workforces with the technical skills to take advantage of the opportunities that these advances present. Maintaining American competitiveness requires that the American workforce receive the education and practical training in STEM that will be crucial in the new economy. NSF's research into how people learn, into the effectiveness of the

PULLING "DIAMONDS" OUT OF THE AIR

Carbon nanofibers are an exciting product of nano-technology. Like diamonds, they are a very organized form of carbon. Stronger and lighter than steel, they are being used in modern airliners and boats. Their electrical properties have prompted research on a wide range of applications in electronics and batteries. Typical methods to produce this amazing material in bulk are energy-intensive, making it very expensive.

NSF-funded researchers at George Washington University have developed a process to capture carbon dioxide from the air and use it to produce carbon nanofibers. The method requires much less energy, is much less expensive, and has the potential to transform a waste product of fossil-fueled power plants into a valuable commodity.

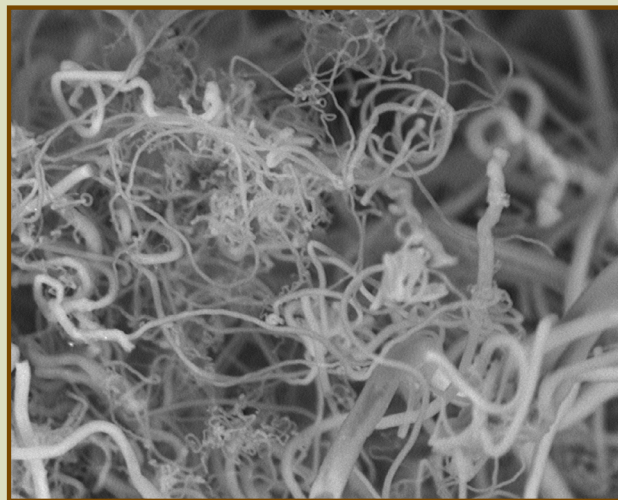

and engineering are making possible new technologies that accelerate opportunities for discovery and change our interactions with each other. There has been a growing appreciation of the potential for convergent research in which many types of scientists and engineers come together to bring a combined array of perspectives and techniques to bear on very challenging research questions with potentially high pay-offs.

Developments such as these underline the importance of continued investment in basic research in science, engineering, and learning, and of ensuring that the advances in understanding produced by research are integrated into education.

new learning technologies that are available in an increasingly digital and networked world, and into how learning can continue throughout a person's career, is crucial if we are to exploit these opportunities and maintain a competitive economy.

NSF invests especially heavily in STEM education at the undergraduate and graduate levels. Education research illustrates the potential benefits of transforming our approaches to graduate and undergraduate training. Partnerships with industry help focus how such training can be aligned with the needs of a modern scientific and engineering workforce. Modern scientific and technological workplaces increasingly rely on diverse teams of

individuals with the skills needed to work creatively in groups. The ability to bring together concepts and tools from different domains is critical to the solution of complex problems. An understanding of data science and analytics is becoming crucial in many scientific and engineering domains. The infusion of training in entrepreneurship into the undergraduate and graduate experiences can speed the translation of new discoveries into commercial applications. NSF supports research to understand what approaches will work, and catalyzes the adoption of these approaches by U.S. colleges and universities. NSF's research on the science of broadening participation and programs such as NSF INCLUDES develop understanding and prototype tools that are effective in including all Americans, rural and urban, women and men, minority and majority, in pathways to STEM careers.

New Enabling Technologies

Throughout the history of science, novel technologies have empowered scientists and engineers to make huge leaps forward. In past eras, the clock and the optical microscope both led to a string of discoveries that stretch down to today. More recent examples of technologies opening up new opportunities for research are the digital computer, high-throughput gene sequencers, gene-editing techniques, underwater robots, advanced research ships, and exquisitely sensitive detectors of ripples in space-time and cosmic neutrinos. For example, CRISPR-Cas9 gene-editing techniques (see earlier inset), coupled with greater understanding of molecular biological processes and design principles from engineering, open up a whole new realm of synthetic biology where both molecular machines and novel organisms can be constructed. These permit researchers to test theories about how life works at the molecular and cellular level. They make possible the development of a new bio-industry that ranges from novel sensors for environmental chemicals to new ways of manufacturing pharmaceuticals.

When it comes to providing America with state-of-the-art research infrastructure with unique capabilities, NSF plays multiple roles. It supports the basic research that makes possible the design of new technologies; it funds the development of ambitious new research

infrastructure that creates new opportunities for science, often a decades-long process; and it provides researchers with access to cutting-edge instruments so that they can pursue research never before possible, creating the opportunity for new breakthroughs.

Data-Intensive Science

Digital technologies – the computer; fast, high-density storage; and high-capacity, low-latency communications networks – together with digitally-based sensing systems and the shift of a great deal of human interaction to the digital realm, have led to an unprecedented wealth of data about the natural and human worlds, together with powerful new techniques to analyze very large quantities of data. While data have always been at the core of science and engineering, these recent advances have dramatically expanded the questions researchers can ask and answer. To take just one example, the ability to work with gene sequence data from a whole community of microorganisms, from a drop of ocean water or a sample of soil, has made it possible to investigate the relationship between the genetic make-up of an ecosystem and how it functions. The potential of data-intensive science cuts across many fields and is yet another emergent source of opportunity in which NSF will invest in the years ahead.

The Role of Complex Systems

Society increasingly depends on complicated systems that are products of humanity's ingenuity. Examples abound: software with millions of lines of code, the globally distributed infrastructure that is the Internet, next-generation electrical distribution networks, globally entangled economic and financial systems, modern cities, airplanes, and "smart" buildings are just a few. Some are carefully designed, but many develop more organically. Understanding and predicting the behavior of such systems is just as challenging as understanding the natural world. As society's reliance on complex systems grows, learning about their robustness and understanding how to strengthen them are of increasing importance.

Convergence Research

The world around us is a complex system with many interacting parts and processes. The nonlinearity of

many of the relationships among its components makes understanding and prediction difficult, yet the world around us has huge impacts on our quality of life. The ebbs and flows of the global economy, changes in the availability of water, and the emergence and spread of agricultural and human pathogens are just a few examples of how important it is to understand the complex system formed by our natural world and human society. We are learning that many of the challenging research questions that confront society can benefit from a convergence of the perspectives and expertise of practitioners from different fields of science and engineering. These span the range from how to develop new health technologies, to understanding the interplay between the availability and distribution of food, energy, and water.

STRATEGIC OPPORTUNITIES

New technologies, the new availability of data, and new, convergent approaches to doing science create a wealth of opportunities. NSF will remain open to creative ideas and novel approaches that exploit these. We will continue to use the advice of external experts and the knowledge of internal staff in our rigorous merit review system to identify bold, promising new ideas. We will not be afraid to take risks on original ideas and we will nurture imagination and risk-taking in the rising generation of researchers. We will continue to invest in cutting-edge infrastructure for research and in innovation in undergraduate and graduate education.

While we cannot predict what new ideas will emerge in the coming years, we can give examples of current opportunities for dramatic advances.

The Quantum Leap: Leading the Next Quantum Revolution

The development of quantum mechanics in the early 20th century disrupted our understanding of the world. It led to society-changing technological developments such as solid-state electronics, particularly semiconductors. The ideas of quantization, uncertainty, and duality remain fresh, often counterintuitive, and yet they describe and help us to predict the properties of the world around us. Today we are on the threshold of another quantum revolution, in which the power of

quantum mechanics will enable new technologies to transform science and society.

By exploiting quantum phenomena such as superposition, entanglement, and squeezing, research in this area will develop the foundations for and enable quantum computing, quantum sensors, quantum communications, quantum simulators, and other inherently quantum technologies, and inform discussions on the social impacts of quantum innovation.

Navigating the New Arctic

Rapid warming occurring in the Arctic is fundamentally altering global climate, weather, and ecosystems in ways that we do not yet understand, but which will have profound impacts on the world's economy and security, as well as on indigenous peoples and other Arctic residents. Further changes, including rapid loss of summer sea ice, will bring new access for industries and nations interested in Arctic natural resources such as fossil fuels, minerals, and fisheries. Ice loss from Greenland is increasingly affecting global and regional sea levels. Changes to permafrost and ecosystems are already disrupting Arctic societies.

An example of a high-impact, potential research activity is the development of a state-of-the-art, Pan-Arctic observing system. This would support the predictive capabilities needed to address ongoing and anticipated Arctic system changes and their global influences and impacts. Such a system would include advanced sensors and communication technologies able to operate in harsh and remote locations throughout the Arctic. Iterative exercises integrating observations and simulations would contribute to optimizing the observing system by refining data needs and simulation variables.

Arctic warming has far-reaching consequences that include biological, natural, physical, social, and man-made components throughout the Earth system. NSF-supported research will strengthen the Nation's capability to understand rapid changes in the Arctic region by using a systems-based approach, across the full range of science and engineering disciplines, that includes new sensors, wireless technology, and satellite communication, as well as new research approaches.

The Future of Work at the Human-Technology Frontier

Today we are engaged in a fourth industrial revolution—a revolution that is bringing an abundance of appealing goods and services, even as it changes the nature of work. Advances in industrial technology have provided consumers with high quality and lower prices in manufactured goods while reducing the number of workers required to produce those goods. In the service sector, e-commerce brings a dizzying variety of products to personal computers and smart phones while transforming the retail sector. The dramatic pace of change is exemplified by the personal transportation industry where the innovations in mobile computing and connectivity that made possible the ride-hailing model are being followed by the emergence of autonomous vehicles. Revolutionary artificial intelligence systems are now positioned to transform the practices of finance, law, and even medicine.

These trends are economically disruptive. NSF-supported research can help us to understand the evolving human-technology workplace ecosystem, and to provide the tools to enable society to manage better this transformation, mitigating negative consequences and reinforcing positive outcomes. In doing so, such research will strengthen the U.S. economy, improve worker performance and job satisfaction, and facilitate life-long learning of new skills. NSF has a key role in navigating this complex and ever-changing landscape and in cultivating outcomes that advance the quality of life of every American.

Understanding the Rules of Life: Predicting Phenotype

Imagine a world where we can forecast how life will respond to a changing planet and where we guide evolution to prevent the emergence of infectious diseases and other nuisance species; a world where a bio-economy uses bioengineered organisms to ensure human and environmental well-being and provide a safe and stable food supply; a world where genetic and neurodegenerative diseases are a thing of the past. Recent advances in understanding and shaping life at the fundamental level of the genome places us on the cusp of turning this vision into reality, of re-engineering cells, organisms, and natural systems, and creating innovative biomaterials and products that sustain a vibrant bio-economy. Understanding the rules that govern how

key features of life, such as robustness, resilience and adaptability, emerge from the interaction of genome, phenotype (the structure and properties of organisms), and environment, through convergent approaches harnessing a broad range of science and engineering domains, has the potential to transform the world.

Decades of investment in genetics has brought society to the point where we can read and edit natural genomes with precision, synthesize complex genomes de novo, and begin to understand how genetic endowment contributes to complex phenotypes, including patterns of behavior. This capability holds incredible promise to benefit the Nation's economy, and individual, social, and environmental well-being. Delivering on this promise requires a focus on discovering the rules that determine how life's properties (phenotypes) emerge from and modify the interaction of genomes with their environment. Recent discoveries, such as epigenetic mechanisms and the role of microbiomes, new sensor and high-throughput measurement technologies, big data analytic and computational capabilities, new technologies for measuring and modifying neural activity, and advances in the capabilities of synthetic biology, have transformed our understanding of phenotype. This progress has motivated a convergence of scientific, computational, and technological approaches. Investing now in research to predict and understand the emergence of phenotypes capitalizes on this convergence to rapidly advance understanding and enable societal benefits.

Developing a predictive understanding of how key properties of living systems emerge from the interaction of genomes, phenotypes, and environment is an audacious goal, but one for which substantial progress can be made through approaches that leverage research from multiple disciplines.

Windows on the Universe: The Era of Multi-Messenger Astrophysics

For millennia, humans have viewed the universe through the optical part of the electromagnetic spectrum to which our eyes are sensitive. Over the last half century, we have extended that range to observe electromagnetic radiation across the full spectrum from radio waves to X-rays and gamma rays. Observatories constructed and

operated over the past two decades have extended our view to include high-energy particles such as neutrinos and cosmic rays. Now, with the Laser Interferometer Gravitational-Wave Observatory (LIGO), researchers are finally able to view the universe through gravitational waves. Just as Galileo's observation of the larger moons of Jupiter through his early telescope ushered in a revolution in our understanding of the universe, so the new ability to detect gravitational waves heralds the dawn of a revolution in astrophysics.

The three “messengers”—electromagnetic radiation, high-energy astrophysical particles, and gravitational waves—each provide a different view of the universe, as if looking at the universe through a different “window,” and reveal aspects that are invisible in the other windows. Together, they paint a detailed picture. Looking through these different windows, we will understand matter, energy, and the cosmos in fundamentally new ways. Looking through these “Windows on the Universe” will enable researchers to address profound questions such as:

- How did the universe begin?
- Why is the expansion of the universe accelerating?
- What is the unseen matter that constitutes much of the universe?
- How does gravity work under the most extreme conditions?
- What are the properties of the most exotic objects in the universe?
- How do matter and energy evolve to produce the universe around us?

Harnessing the Data Revolution

With the rapidly increasing volume, variety, and velocity of data, new and fundamental data-driven research questions can now be addressed. At the same time, experts project a shortage of individuals with the skills necessary to understand and make decisions based on the new approaches to data analysis. Future generations of scientists and engineers must therefore be trained to be able to fully realize the potential of data-driven science and engineering. Stewardship and management of research data will be crucially linked to the credibility of research results and public access to those results.

Access to the next level of discovery relies on translating complex data from observations, experiments, and simulations into knowledge. To help close the loop from data generation to analysis and on to simulation and finally discovery requires: fundamental research in data science and engineering; the development of a cohesive, federated approach to the research data infrastructure needed to power this revolution; and the development of a 21st-century data-capable workforce. Advances in these areas will enable new modes of data-driven discovery, allowing researchers to ask and answer new questions in frontier science and engineering research, generate new knowledge and understanding, and accelerate discovery and innovation. Individuals, communities, and the Nation will benefit from new data-rich capabilities, infrastructure, and services that will arise as a result of research on data science and engineering.

Examples of science and engineering research that will advance as we harness the data revolution include:

- Multi-messenger astronomy and understanding the cosmos;
- Matter at the high energy and intensity frontier, furthering discovery of the fundamental laws of nature;
- Space weather prediction through data assimilation and uncertainty quantification;
- Structural and functional properties of solid matter, including synthesis, design, fabrication, analysis, performance, and function;
- Complexity in biological systems;
- Biochemical engineering, including reconstructing reaction pathways and optimizing catalysis;
- Smart and connected communities, including enhancing smart civil infrastructure;
- Dynamic data systems, enabling sensing, communications, and control; and
- Complexity in social, behavioral, and economic systems.

As the examples above demonstrate, there is no shortage of opportunities for investments in research that will transform our world.

VI. STRATEGIC GOALS AND OBJECTIVES

STRATEGIC GOAL 1

Expand knowledge in science, engineering, and learning.

The first part of NSF's mission is "to promote the progress of science." By expanding human knowledge, NSF-funded researchers provide the Nation with the capability to maintain scientific, technological, and economic leadership in a competitive world.

As Vannevar Bush pointed out, basic research is a capital investment for the Nation: "Basic research leads to new knowledge. It provides scientific capital. It creates the fund from which the practical applications of knowledge must be drawn. New products and new processes do not appear full-grown. They are founded on new principles and new conceptions that, in turn, are painstakingly developed by research in the purest realms of science."⁷ Those practical applications of knowledge are often not fully felt until decades after the initial basic research. A connection between fluid dynamics and an improved industrial process may be easier to foresee than the practical benefits of fundamental physics research into what Einstein called, "spooky action at a distance," but the initial research on quantum mechanics in the early 20th century prepared the ground for the development of new approaches to secure communications and more powerful computers that is underway in the 21st century.

Continuing the investment metaphor, just as modern-day financial advisors stress the importance of diversifying investments, so the benefits of research are maximized when a wealth of different fields and research questions are supported. NSF embodies this philosophy by supporting all basic science and engineering research with the exception of research with specific, disease-related goals. NSF welcomes proposals for original research, from individuals and groups, and for new tools such as advanced instrumentation, data analysis, computation, and novel facilities. Investment in competitively selected projects expands the knowledge base from which innovation

springs. A special role of NSF is to encourage broadly creative efforts that may not fit within the domain of specific mission agencies.

Proposals for research projects are competitively reviewed for intellectual merit and broader impacts by independent subject matter experts. NSF cultivates the spirit of exploration in researchers and students. Reviewers are encouraged to look for high potential rewards that justify taking risks to support projects that may not always work as planned.

NSF provides leadership in an evolving global

THE IMPACT OF CURIOSITY: ELECTROMAGNETISM

In the early 19th century, researchers were curious about whether an electrical current flowing through a wire would influence a nearby compass needle. Several showed that it did and the science of electromagnetism was born. At first, this was simply an interesting natural phenomenon. Seeking to understand it, scientists conducted experiments, developed theories, and learned how to predict the interaction between electricity and magnetism. Without their curiosity, today we would not have electric motors, computer memory, modern trains, planes and automobiles, many hospital technologies, the Internet, television, or the telephone.

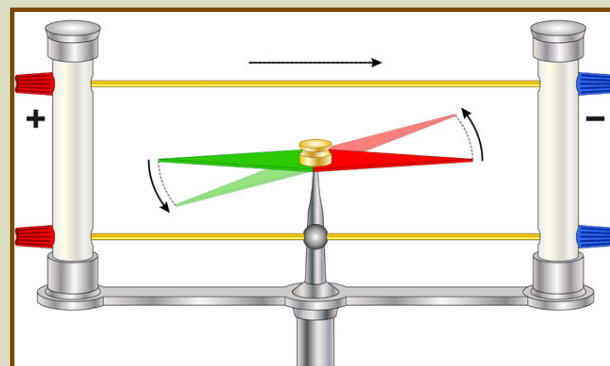

research enterprise by supporting modern, collaborative approaches to science, by funding research within and between traditional fields, and by strengthening interactions between U.S. researchers and their leading counterparts abroad. By supporting workshops and using novel funding mechanisms for exploratory research, NSF catalyzes and incubates new fields of research and the search for new insights that disrupt traditional understanding.

⁷V. Bush (1945). "Science: The Endless Frontier." *Transactions of the Kansas Academy of Science*, vol. 48, pp. 231-264.

Strategic Objective 1.1 – Knowledge

Advance knowledge through investments in ideas, people, and infrastructure.

NSF's core objective is to improve the collective understanding of the universe we inhabit. To achieve this, we invest in people who are curious, courageous, and collaborative. We seek the best research ideas, both those that advance current understanding and those that disrupt it. We support emerging paradigms such as convergence research. We support world-class scientific facilities for the Nation's researchers at home and abroad. We support the development and acquisition of research platforms and tools such as advanced instrumentation and cyberinfrastructure.

The outputs of these investments are new insights into the natural, built, and human world. They are captured and disseminated in research papers in journals and conferences, patents, new approaches to education and training, as start-up enterprises, and in technology licenses.

Strategic Objective 1.2 – Practice

Advance the practice of research.

NSF seeks to advance the state of the art in research by encouraging smart risk-taking, cultivating an inclusive research culture of exploration, embracing the adoption of convergence as an approach to discovery, and supporting new modes of research practice.

There is growing consensus that some of the most intractable problems in the scientific, technological, and social arenas require perspectives and approaches from multiple disciplines. Indicators include the proliferation of multidisciplinary institutes and centers in academia and the private sector, new faculty hires with joint appointments, and the merging of university departments. NSF has long recognized the potential synergies that result in such settings and the creativity that collaborative research and “team science” can bring to addressing some of society's most pressing research challenges.

Convergence research, together with open data sharing among disparate disciplines, can lead to unprecedented breakthroughs and nucleate entirely new disciplines. The implementation of the convergence paradigm involves framing challenging research questions at inception and fostering the long-term collaborations needed for successful inquiry. NSF remains committed to maintaining a wide variety of mechanisms for supporting collaborative and interdisciplinary research at scales from small teams to multi-institutional centers.

Particularly high-risk but potentially transformative research proposals that cross disciplinary boundaries can be submitted as Research Advanced by Interdisciplinary Science and Engineering (RAISE) proposals and reviewed internally. Ideas Labs encourage out-of-the-box, collaborative approaches to meet pressing research challenges. Realizing that cutting-edge interdisciplinary research projects may be perceived by reviewers as too risky, NSF continues to implement review processes tailored to interdisciplinary research and to enhance efforts to identify and recruit reviewers with experience in cross-cutting research.

Working with the research community, NSF promotes the use of best practices to ensure that research is reproducible, including emphasizing the open availability of results and the data that support them. NSF will promote a research culture that is broadly inclusive in its demography and range of intellectual ideas, has access to cutting-edge infrastructure, and is globally engaged, with increased opportunities for exchanging ideas and collaborating on an international scale. NSF will increase opportunities for broadening the training of U.S. graduate students and early-career researchers through international exchanges and partnerships with industry.

STRATEGIC GOAL 2

Advance the capability of the Nation to meet current and future challenges.

This goal flows from the latter part of the NSF mission statement—“to advance the national health, prosperity, and welfare; to secure the national defense; and for other purposes.” Through workshops, targeted

solicitations, and core programs, NSF helps focus the attention of the research community on fundamental aspects of high-priority national challenges. We support researchers in identifying particularly urgent questions and opening up new avenues to address these priorities. We provide funding to pursue better understanding of specific challenges that confront society. We enable collaborative teams to apply the methods of convergence research. These approaches promote impact-driven, use-inspired research.

Innovation is a key capability for the Nation. NSF's investments in science and engineering research and training foster innovation across a broad range of topics relevant to technological and economic competitiveness. Examples include advanced manufacturing, the design of innovative materials and building technologies, infrastructure resilience and sustainability, decision-making, cyber-security, and data analytics. Through its Innovation Corps (I-Corps) program, NSF fosters a national innovation

This strategic goal echoes the “broader impacts” merit review criterion that was developed by the National Science Board. Within this strategic goal, NSF also seeks to advance the state of the practice of achieving broader impacts.

Progress towards this goal often necessitates the formation of partnerships with industry, other agencies, and international sponsors to build capacity, leverage resources, and increase the speed of translation from discovery to innovation. NSF explores novel mechanisms to cultivate training in entrepreneurship among students and faculty, to facilitate the development of connections between academia and industry that can hasten the transfer of ideas between the two, and to accelerate innovation.

By funding the participation of undergraduates, graduate students and post-doctoral associates in research projects, as well as by providing graduate and post-doctoral fellowships and research experiences for undergraduates, K-12 students and teachers, NSF supports the

NSF's Innovation Corps (I-Corps) program prepares scientists and engineers to extend their focus beyond the laboratory, and broadens the impact of select, NSF-funded, basic-research projects.

I-Corps teaches NSF grantees to identify valuable product opportunities that can emerge from academic research, and offers entrepreneurship training to participants by established entrepreneurs through a targeted curriculum. It has immersed more than 1100 teams of scientists and engineers from over 230 universities in over 46 states and Puerto Rico in entrepreneurial training to extend their focus beyond the lab to the commercial potential and broader impact of their research. As a result, I-Corps participants have launched 440 startups, which have raised over \$250 million in seed capital.

The I-Corps program helps researchers translate discoveries into technologies with near-term benefits for the economy and society.

“I-Corps was eye opening. We interviewed 150 people in the gaming, movie and music spaces. We had some idea after I-Corps that we needed certain things to get ready for the market.”

Ramani Duraiswami, co-founder, VisiSonics. I-Corps Team December 2012



ecosystem by encouraging institutions, scientists, engineers, and entrepreneurs to identify and explore the innovation and commercial potential of their research.

development of the next generation of researchers, scholars, and knowledge workers. It prepares both future research leaders and a STEM workforce that is equipped with up-to-date knowledge and the experience needed to address society's current and future challenges.

The educational dimension is a key aspect of this strategic goal. NSF supports research on STEM education, and on effective approaches to preparing a diverse, globally competitive STEM workforce and a STEM-literate citizenry.

An important component of capacity-building is ensuring that all sectors of society have the opportunity to participate in and contribute to the Nation's research enterprise. The 2011-2012 report of the Committee on Equal Opportunities in Science and Engineering (CEOSE) requested that NSF launch a bold, new initiative for broadening participation with the goal of eventually having the participation of NSF-supported scientists and engineers in Science, Technology, Engineering, and Math (STEM) fields mirror the population of the Nation. NSF is committed to broadening participation by:

- Preparing a diverse, globally engaged science, technology, engineering, and mathematics workforce;
- Integrating research with education, and building capacity;
- Expanding efforts to broaden participation from underrepresented groups and diverse institutions across all geographical regions in all NSF activities; and
- Improving processes to recruit and select highly qualified reviewers and panelists that reflect the Nation's diversity.

Through programs such as NSF ADVANCE and NSF INCLUDES and their successors, NSF strives to foster institutional transformation within research organizations so that the Nation can capitalize on the talents and ideas of all parts of the population, in all parts of the country. NSF's Established Program to Stimulate Competitive Research (EPSCoR) seeks to advance research capacity in States that have traditionally received relatively small proportions of the federal research budget.

Strategic Objective 2.1 – Societal Impacts

Support research and promote partnerships to accelerate innovation and to provide new capabilities to meet pressing societal needs.

The first part of NSF's mission, as expounded by the first strategic goal, is to create new knowledge and expand the Nation's intellectual capital. However,

NSF's mission does not end there. In order to fulfill the second part of our mission, to advance the national prosperity, we must continue to invest in fundamental research that: (1) connects new knowledge to innovations that drive the Nation's competitiveness, thereby fueling the Nation's economic growth; and (2) addresses present and emerging societal needs. NSF will continue to pursue connections between new insights and global challenges (often involving essential interdisciplinary collaborations, prototypes, and technologies).

One approach to developing these connections is through partnerships to promote and catalyze the

PAWR: PLATFORMS FOR ADVANCED WIRELESS RESEARCH



The Platforms for Advanced Wireless Research (PAWR) program is an NSF-led public-private partnership to advance the development of next-generation wireless technologies and services. In 2016, NSF convened a consortium of over 30 leading companies and industry associations in the wireless sector, to include networking vendors, device manufacturers, and wireless carriers. Beginning in 2017, NSF is investing \$50 million over 7 years, together with an additional \$50 million in cash and in-kind contributions from the industry consortium, to design, develop, deploy, and operate four wireless research platforms.

At the scale of entire communities or cities when fully deployed, these wireless research platforms will allow academic researchers, entrepreneurs, and companies to test, prove, and refine next-generation wireless algorithms, technologies, and services in real-world settings. Ultimately, PAWR will serve as a key approach for sustaining U.S. leadership in wireless networking over the next decade, enabling experimentation that is simply not feasible through testing in university laboratories alone.

IMPROVING KIDNEY EXCHANGE

An NSF-funded economist applied the principles of game theory to the problem of matching kidney recipients with donors, laying the groundwork for today's national kidney exchange program. To date, the program has saved more than 4,000 lives in the U.S.—a number that continues to grow.

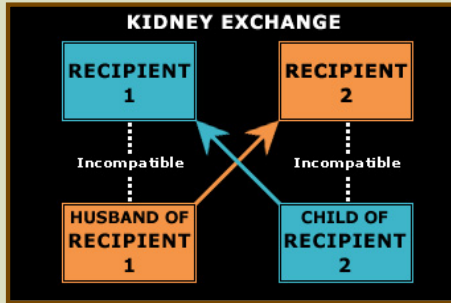

MORE RELIABLE AUTOMOBILE TRANSMISSIONS

Automatic transmissions allow cars and trucks to travel at sustained speeds. Their core technology, the one-way clutch, at one point failed more than any other component in some lines of automobiles. Los Gatos, California based Epilogics, a small business funded by NSF's SBIR program, developed a newer Mechanical Diode One-Way Clutch and licensed it to Means Industries. Means used it to replace the older one-way clutch, and it became the most successful, active, driveline component. More than 30 million Mechanical Diode One-Way Clutches have been installed.



translation of research into application. NSF will exploit partnerships with other government agencies, academia, and private and international entities. Such partnerships leverage NSF's resources, promoting efficiency while avoiding duplication of effort. They help ensure that fundamental research outcomes are translated into benefits to society.

3-D GEOLOGIC MAP LEADS TO PRECIOUS METAL DISCOVERY

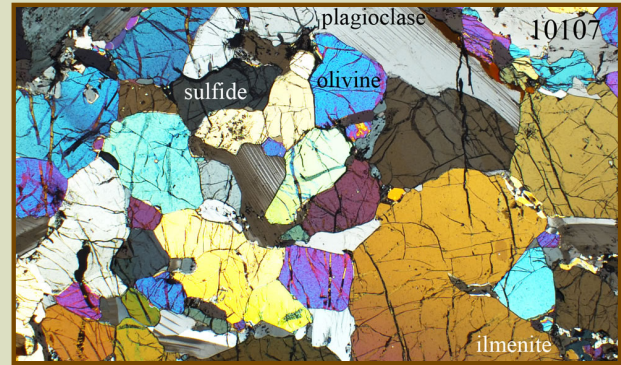

Using technology for 3-D electronic mapping originally developed by scientists working in the McMurdo Dry Valleys of Antarctica, NSF-funded researchers developed new insights about processes of magma crystallization which were in turn used to develop a new crystallization model. This new magma crystallization model was then used by exploration geologists to discover one of the world's largest precious metal deposits in northern Minnesota. The Nokomis Deposit is estimated to contain metal resources of approximately 10 billion pounds of copper, 3.1 billion pounds of nickel, 165 million pounds of cobalt, 4 million ounces of platinum, 9 million ounces of palladium and 2 million ounces of gold.

To accelerate both research and innovation, it is critical to make results and knowledge widely available. NSF will continue to promote the rapid and wide dissemination of the results of NSF-funded research with no or minimal restrictions from publication embargoes. It will encourage the exploitation of novel means of disseminating new knowledge. It will expand its efforts to ensure that the data cited to support published research are readily available to other researchers and are well curated. Access to data is important not only so that others can build on published results but also so that key results can be tested to ensure that they are reproducible.

Strategic Objective 2.2 – STEM Workforce
Foster the growth of a more capable and diverse research workforce and advance the scientific and innovation skills of the Nation.

Investing in the development of future generations of researchers and a scientifically skilled workforce is one of NSF's most important approaches to advancing the

discovery and innovation skills of the Nation. The Nation's global competitiveness depends critically on the readiness of the Nation's STEM workforce. NSF will continue to invest in programs that directly advance the STEM workforce. It will also invest in research on what the workforce of the future will require and on improved methods to provide the requisite skills and diversity.

of ideas and approaches that drive discovery and innovation in a way that would be impossible without this diversity.

The research in learning in which NSF invests is aimed at both formal and informal pathways. Formal education through the Nation's K-12 schools provides the foundation for citizens' understanding



NSF GRADUATE RESEARCH FELLOWS

Through its Graduate Research Fellowship Program (GRFP), NSF has funded thousands of graduate researchers, many of whom have made important discoveries while still in graduate school. For example, an NSF Graduate Research Fellow developed a touch screen to recognize multi-finger gestures for computer input—using two fingers on a screen to zoom in and out—a breakthrough technology that is now ubiquitous in smartphones and other mobile devices. Since 1952, this program has supported 42 students who went on to win Nobel Prizes.

NSF invests in post-doctoral, graduate, and undergraduate research training through funding for research projects, research centers, and research fellowships, and by providing research experiences for undergraduates at home and abroad. These investments help prepare the next generation of researchers to seek answers to the next generation of challenges. To strengthen the links between pre-college teaching and the frontiers of knowledge, NSF also supports research experiences for educators.

Institutions of higher education in the U.S. play an important role in educating a diverse STEM workforce beyond preparing students for careers in research. NSF invests in research on ways to improve graduate and undergraduate education to prepare students to participate in the Nation's scientific and technological workforce.

The effectiveness of NSF's investments to contribute to the Nation's STEM workforce through research training depends on the inclusion of people who traditionally are underrepresented in the scientific enterprise. A STEM workforce that reflects the diversity of our society is essential for the emergence of a rich set

of STEM and its uses in addressing the needs of society. The formal education process continues through our Nation's colleges and universities, where scholarship is the hallmark. Informal education is another powerful means to provide learning and instill interest in STEM topics in everyone throughout their lives. Citizen science, for example, fosters informal education and engages citizens in a meaningful, gratifying way, while also advancing science. NSF invests in research on education that is intended to develop more effective approaches to



Since the Sept. 11 terrorist attacks, NSF has supported the training of 2,200 cybersecurity experts through the CyberCorps®: Scholarships for Service program, which seeks to recruit and train the next generation of information technology professionals.



MATH ASSIST

Web-based platforms enhance teaching and learning in the classroom. Today, 100,000 students across the U.S. use an online mathematics tutoring and assessment program developed by an NSF-funded researcher. Called ASSISTments, the innovative platform helps students with their mathematics coursework and teachers with their mathematics instruction. In Maine, a recent study involving more than 2,800 students at 43 public schools found that the use of ASSISTments for a year was associated with significantly increased student scores on an end-of-the-year standardized mathematics assessment when compared with a control group. Students with low prior mathematics achievement benefited most.

BUILDING THE FOUNDATIONS FOR COMPUTER SCIENCE EDUCATION

NSF has long supported the development of a diverse workforce that understands foundational concepts of computing and information science and engineering, knows how to develop new computing and information methodologies and tools, has the capacity to interact with all sectors of our society, and is fully prepared to lead the 21st-century digital economy.

As part of these efforts, NSF funded the development of a new Advanced Placement® (AP®) Computer Science Principles (CSP) exam. Thousands of K-12 teachers and university faculty contributed to an 8-year effort leading to the course framework, AP exam, aligned instructional materials, and teacher professional development (PD). The first official AP CSP exam was held in May 2017 and was a record-breaking success:

- The 2016-17 CSP launch was the largest launch of any AP course in the 60-year history of The College Board's AP program: over 2,500 schools offered AP CSP courses, and they combined to enable more than 50,000 students to take the exam.
- The initial data confirmed that rigorous CS, taught in an engaging and inclusive manner, can attract a more diverse population of students. Compared to participation in the existing AP CS exam (CS A), African American participation was 7% in CSP (versus 4% in CS A); Hispanic participation was 19% (versus 11%), and female participation was 30% (versus 24%).

Several NSF-funded projects developed CSP instructional materials and PD aligned to the CSP framework. The three largest are endorsed by The College Board and are scaling nationally, having provided PD to over a thousand new CS teachers: the Beauty and Joy of Computing, Mobile CS Principles, and UTeach CS Principles.



engaging the public and to help citizens to develop a better understanding of science and the scientific process. NSF's investments in research on STEM education extend the reach of its science and engineering programs by paving the way to integrating their results into modern approaches to learning.

Through tailored, capacity-building programs, NSF enhances the ability of specialized institutions to draw diverse communities into research and the STEM workforce. Specialized programs can also help the

Nation meet emergent needs for a workforce trained in the new results of research in areas such as cyber-security.

STRATEGIC GOAL 3

Enhance NSF's performance of its mission.

The first two strategic goals are associated with quickly evolving challenges. Meeting these and effectively fulfilling NSF's mission requires blending strong scientific leadership with robust organizational leadership. Both are characterized by vision and flexibility. NSF will

provide its staff with the resources that are essential to carry out the agency's activities. NSF's management objectives have the goal of achieving organizational excellence through a continuous emphasis on efficiency and efficacy. NSF's employees strive to ensure that NSF's programs are effective and accountable, that the merit review process is of high quality and integrity, and that financial management and award oversight are rigorous without undue administrative burden.

Our core strength is our people, and the agency is committed to recruiting, retaining, and deepening the expertise and capabilities of our entire workforce. We embrace an inclusive, diverse, and continually changing workforce. NSF's commitment to the innovative management of agency operations leverages the creativity of NSF staff with the opportunities provided by advances in information technology and training. We aim to drive continuous improvements in our programs, processes, and systems, while providing stable, high-quality service and support to all of our stakeholders. We also strive to align operational plans, budgets, and management practices with agency goals and priorities. In this way, we create a common vision that permeates the many functions of NSF and enhances the performance of both individuals and internal organizations.

NSF has identified four key areas where advances will enhance our ability to achieve our mission. The first, in the area of workforce management, focuses on the alignment of the workforce and the work:

- Adapting the NSF workforce to the work.

The remaining three are focused on increasing efficiency and effectiveness:

- Making information technology work for us;
- Expanding public and private partnerships; and
- Streamlining, standardizing, and simplifying programs and processes.

Strategic Objective 3.1 – Human Capital *Attract, retain, and empower a talented and diverse workforce.*

Excellence as a federal agency begins with a workforce that is engaged, highly capable, and

diverse. While NSF strives to help prepare a diverse, globally competitive STEM national workforce and STEM-literate citizenry, these goals are also reflected inward. As an agency, NSF cultivates an increasingly adaptable, highly skilled, and engaged workforce that harnesses the diverse perspectives and creativity needed to achieve high levels of efficiency and effectiveness. This will ensure that the agency's workforce matches its current and future needs.

To be an effective organization, NSF cultivates capabilities that enable it to be nimble and innovative in a changing scientific and technological environment. From recruitment, to training, to retention of its administrative professionals, scientists, and engineers, NSF strives to enhance the agility of its dedicated personnel.

Adapting the NSF Workforce to the Work

Systematically reviewing the NSF workforce from top to bottom will enable NSF to revise position descriptions that are outdated or that do not reflect current and future work responsibilities. In this modernization effort, NSF will identify the portfolio of skills needed in today's work environment and the opportunities created by new, emerging skills. The results of the review will provide a framework for planning workforce hiring, training, and development that will enhance the ability of our workforce to meet the NSF mission efficiently and effectively.

NSF uses various hiring authorities to create a balanced workforce of permanent and rotating staff members. The recruitment and promotion processes are strengthened by internal training on the nature of unconscious bias and techniques to mitigate it. Diversity in backgrounds and perspectives is a powerful resource; NSF strives to maintain a workforce that is inclusive at all levels and in all units within the Foundation.

Through an emphasis on leadership training, coaching, and detail assignments, NSF nurtures the development of in-house managerial talent from within its ranks to complement the opportunities provided through external hiring. By recruiting rotators from academia and elsewhere, by the active engagement of

permanent staff in professional society conferences and research community workshops, and through its Independent Research/Development program, NSF maintains its essential, strong connection to the forefront of science, engineering, and education research.

A high performing workforce is crucial to the fulfillment of NSF's mission. NSF provides a wide array of continuous learning opportunities for staff members that strengthen the capacity of the Foundation. In addition to opportunities for external training, NSF maintains a strong internal resource, the NSF Academy, that develops and disseminates cutting-edge information aimed at enhancing the agency's human capital. In keeping with its aspiration to be a high-performing organization, NSF provides opportunities for its employees to learn how to work more efficiently and more creatively, furthering their skills in collaborative work, communication, and other tools to enable them to work in highly effective teams. NSF rewards exemplary performance through a variety of employee recognition programs. NSF provides its managers with the requisite toolkit for managing effectively, offering opportunities to learn and enhance skills that are tailored to new and experienced managers, as appropriate. The people who work at NSF learn and grow in important ways that contribute to the organization as a whole and enable NSF to function as a model federal agency.

NSF promotes strong internal and external communications, ensuring staff and community stakeholders are both engaged in and informed about organizational change.

Strategic Objective 3.2 – Processes and Operations ***Continually improve agency operations.***

In order to accomplish its mission in research and education while maintaining its outstanding stewardship of taxpayer resources, NSF requires a wide range of operational and administrative services. These include human resource management, procurement, information technology (IT), financial management, program management, project management, and administrative support. Built on a commitment to openness and transparency, we will follow a strategy of continuous

improvement in business processes, financial management, and associated infrastructure. This may include the pursuit of partnerships and shared services as a means of promoting excellence and efficiency, as well as innovation in support of a mobile workforce and the use of remote work practices.

NSF employs data-driven decision-making. Through an internal evaluation and assessment capability and through the use of tools such as strategic reviews, NSF will expand its capabilities to assess the performance and impacts of its business processes and programs.

Making Information Technology Work for Us

New information technologies and systems are available to drive our science and engineering mission forward in a more nimble, efficient structure. Cloud resources and shared service providers offer the potential for new efficiencies. New developments in software offer potential improvements in our core processes such as merit review and financial management. To continue funding cutting-edge science, engineering, and education research, we will exploit leading-edge information technology solutions that can adapt easily and quickly to our needs.

The potential for expansion of capabilities for analysis and knowledge management offers an opportunity that NSF will pursue vigorously. These are needed not only to assess internal operational performance and processes, but also to track and anticipate trends in research and to monitor and oversee progress in the construction of major facilities. NSF program officers and reviewers need high-quality information systems to enable the outstanding merit review process that undergirds NSF's global reputation.

Also essential is maintaining a safe and secure physical and cyber environment. NSF relies heavily on IT for all of its processes - financial transactions, merit review, and personnel records - but IT is also the gateway to communication and interaction with stakeholders in the research community. As trends towards a mobile workforce and remote work continue, IT will only become more important and critical to maintaining an agile and excellent organization.

Streamlining, Standardizing, and Simplifying Programs and Processes

NSF is committed to promoting efficiency and effectiveness by streamlining, standardizing, and simplifying programs and processes. This encompasses both our internal operations and the administrative and compliance requirements associated with our programs.

This commitment is in keeping with the Administration's emphasis on reducing burden for Federal agencies, as described in OMB memo M-17-26 (Reducing the Burden for Federal Agencies by Rescinding or Modifying OMB Memoranda, June 15, 2017). It is vital that we review our processes to determine whether established tasks and requirements achieve their intended result in an efficient and effective manner.

The requirements associated with NSF's program investments warrant a similar review. This was emphasized in the National Science Board's 2014 report Reducing Investigators' Administrative Workload for Federally Funded Research (NSB-14-18). The Board found that "for more than a decade, surveys and reports have highlighted an increase in administrative and compliance requirements associated with Federal research." (Page iv.) NSF will work internally and with the Office of Management and Budget and other science agencies to find opportunities to reduce administrative burden. For example, we will pursue the use of just-in-time submission of proposal components that are not needed for the initial parts of the merit review process.

Expanding Public and Private Partnerships

As noted in Strategic Objective 2.1, partnerships are one means to accelerating innovation and providing new capabilities to meet pressing societal needs. Partnerships with other federal agencies, private industry, foundations, and international organizations are an important means for NSF to maximize the

scientific, economic, and societal impacts of its investments. Partnerships are increasingly essential to advancing convergence science. The benefits of the expanded partnerships include leveraging expertise and resources in pursuit of innovations; enhancing research, education, and workforce capacity; and improving translation from discovery to products and services that benefit society. Partnerships among federal agencies enable synergies in areas where agency missions intersect. Engagements with private industry and foundations have the potential to accelerate areas of mutual interest and enhance the preparation of the next-generation workforce.^{8,9,10} Presently, the formation of partnerships is a time-consuming and resource-intensive process; government and agency processes can present obstacles and disincentives. We will explore process enhancements that facilitate an expansion of inter-agency and public-private partnerships, and work with stakeholders to remove barriers. We will identify important areas of science and engineering ripe for joint investment with the private sector and other partners and work to establish new partnerships in these areas. We will build on existing models of success, which have included joint solicitations with industry and international funders, and the creation of large-scale consortia. (For an example, see the inset describing PAWR on page 20.)

Managing Risk

NSF embraces enterprise risk management. This is applied throughout the life cycle of our awards and to our management of facilities awards, our physical and cyber security, and to our other operational processes. NSF has a dynamic organizational structure, which has enabled it to quickly and effectively adapt to transformations in the science, engineering, and education landscape. This structure also enables NSF to form effective partnerships across government, academia, and industry. This dynamism and the philosophy of striving for continuous improvement reflect an organization that is constantly learning and evolving. We have a workforce that is in constant transition, with a significant proportion of the scientific staff serving as rotators for one- to four-year terms. Maintaining resilience in such an environment requires

⁸2014 American Academy of Arts & Sciences report, "Restoring the Foundation: The Vital Role of Research in Preserving the American Dream," www.amacad.org/multimedia/pdfs/publications/researchpapersmonographs/AmericanAcad_RestoringtheFoundation_Brief.pdf.

⁹2015 Mathematical Sciences Research Institute report, "Partnerships: A Workshop on Collaborations between the NSF/MPS & Private Foundations," <http://library.msri.org/msri/Partnerships.pdf>.

¹⁰2016 Computing Community Consortium report, "The Future of Computing Research: Industry-Academic Collaborations," <http://cra.org/ccc/wp-content/uploads/sites/2/2016/06/15125-CCC-Industry-Whitepaper-v4-1.pdf>.

NSF to continue to identify and manage associated risks and opportunities. Examples of areas of risk and opportunity that we manage include staffing, continuity of operations, fluctuations in appropriations, physical and cyber security, emerging national priorities, and technological advances.

We will encourage the use of methodical risk analysis across the Foundation, including: identification, ranking, analyzing, tracking, controlling, and mitigating risks; development of associated contingency management plans; and planning and implementation of strategies that

effectively manage and mitigate risk factors. Management challenges identified by the Inspector General will be integrated into this risk management framework. NSF will continue to promulgate a highly consultative culture, in which appropriate stakeholders are engaged early and throughout risk management processes.

As part of our risk management framework, we will develop and maintain a risk profile that provides an analysis of the most significant risks and opportunities bearing on our ability to achieve our strategic objectives.

VII. AGENCY PRIORITY GOAL

A Performance Plan for FY 2019 has been developed in concert with this Strategic Plan. It includes the following Agency Priority Goal.

Expand public and private partnerships to enhance the impact of NSF's investments and contribute to American economic competitiveness and security.

By September 30, 2019, NSF's number of partnerships and/or award actions with other federal agencies, private industry, and foundations/philanthropies will grow by 5 percent, relative to the FY 2017 baseline, to make available infrastructure, expertise, and financial resources to the US scientific and engineering research and education enterprise.

Partnerships with private industry, foundations, international organizations, and other federal

agencies are an increasingly important means for NSF to maximize the scientific, economic, and societal impacts of its investments. In meeting this goal, NSF will improve the effectiveness of its investments by joining forces with industry and private foundations, and with other agencies with common goals, to optimize the development of scientific and engineering knowledge and its delivery to the economy.

The benefits of expanded partnerships include leveraging expertise and resources in pursuit of innovations; enhancing research, education, and workforce capacity; and improving translation from discovery to products and services that benefit society. Partnerships among federal agencies enable synergies in areas where agency missions intersect. Engagements with private industry and foundations have the potential to accelerate areas of mutual interest and enhance the preparation of the next-generation workforce.

VIII. EXAMPLES OF LONG-TERM PERFORMANCE GOALS

The foundation of NSF's Performance Plan rests on a set of performance goals. Each of the performance goals in the Performance Plan is associated with one or more strategic objectives in the Strategic Plan and will be reviewed annually in the strategic reviews as well as in quarterly performance reviews. These performance goals were created to provide a means by which NSF leadership can provide strategic monitoring and oversight of progress being made on the Foundation's most important activities: our priority program investments, research infrastructure investments, the satisfaction of proposers and reviewers, and key management initiatives. In addition to the Agency Priority Goal described above, brief descriptions of three examples of long-term performance goals from NSF's FY 2019 Performance Plan are included here.

1. Ensure that key FY 2019 NSF-wide program investments are implemented and on track.

Each year, NSF highlights a number of cross-agency investments in the NSF-Wide Investments chapter of its Budget Request to Congress. Although the overall impact of these investments will not be realized for many years, tracking near-term indicators of implementation and progress can help the agency

make formative changes or course corrections. This has been a goal since FY 2014. The list of monitored programs evolves based on investment priorities for a particular year.

2. Ensure program integrity and responsible stewardship of major research facilities and infrastructure.

NSF monitors the performance of major facility projects by monitoring cost and schedule variances using Earned Value, a standard measure of performance for construction projects.

3. Inform applicants whether their proposals have been declined or recommended for funding in a timely manner.

An important factor for principal investigators is the time it takes NSF to process proposals - the amount of time that passes between receipt of a proposal and notification to the principal investigator about the funding decision. Too long a time period delays the progress of research, but too short a time period may weaken the merit review process by forcing premature decisions. The optimal dwell time depends on a number of factors including the complexity of the proposed activity, the need for co-review by more than one program, the need for site review, infrastructure requirements of the proposed activity, and the potential size of the award. Large, complex proposals require more time under review to ensure that taxpayer dollars are invested wisely.

IX. CORE STRATEGIES

To achieve its strategic objectives, NSF uses a number of core strategies. Since the creation of NSF, a robust menu of such strategies has been developed by the NSF staff under the oversight of the National Science Board (NSB) and Congress, and in concert with the communities NSF serves. These evolve as NSF continuously seeks to improve its internal processes through internal innovation and by adapting effective approaches developed by other funding organizations. Within this context, the core strategies by which NSF addresses its mission are summarized below. Some are associated with the identification of areas for investment, some guide the selection of research projects for funding, and some are associated with enhancing agency operations.

OVERVIEW

NSF fulfills its mission by advancing discovery, preparing the STEM scholars of tomorrow, and continuously strengthening the Nation's innovation ecosystem. It does this by encouraging, receiving, reviewing, and funding proposals for specific activities. NSF receives about 50,000 proposals for research funding each year and 16,000 graduate research fellowship applications in virtually all areas of science, engineering, and education research. Since the agency can fund only a fraction of the meritorious proposals and applications received, NSF strives to maintain a balanced, geographically distributed portfolio of funded projects that: supports different approaches to significant research questions; addresses societal needs through basic research findings and related activities; builds capacity in new and promising research areas; supports high-risk proposals with potential for transformative advances in a field; integrates research and education; and broadens participation in STEM research. The review and decision process must be carried out with integrity and transparency to maintain trust that the resulting decisions are fair, forward-looking, and represent an optimal use of the limited resources available.

INVESTMENT AREAS

Based on its strategic goals, NSF works with the research community and other stakeholders to identify key areas for future investment. These areas may reflect emerging opportunities of great promise, address pressing challenges, or respond to critical national needs. They may involve NSF-wide activities and require sustained levels of investment over many years, or they may be more narrowly focused and change from year to year as promising opportunities arise.

NSF receives input on the identification and prioritization of investment areas from many sources. These are described in more detail in the next chapter, "Evidence Building." NSF emphasizes using a variety of mechanisms to envision the future of science and engineering through the eyes of the world's front-line researchers. These include the National Science Board, the National Academies, advisory committees, workshops, calls for white papers, and other community engagement activities.

Potential investment areas are evaluated against considerations that include the following:

- **Alignment with NSF's Mission.** Does the investment area further NSF's mission, vision, goals, and objectives as established by the NSF Strategic Plan, without duplicating the efforts of other agencies or funding organizations?
- **Budget.** Factors include whether the proposed level of investment is consistent with the opportunity, level of risk, relevance, and potential impact.
- **Potential for impact.** Examples of important factors include the extent to which investments: may transform a field of science or engineering; are broadly significant or of great interest to the community; position the U.S. at the forefront of an emerging field; promote teaching, learning, mentoring, training and outreach; contribute to national research and development priorities; sustain economic competitiveness; support the national defense; or enable other socially important outcomes.

- **Urgency and readiness.** Important factors include whether timing is critical to achieve optimum results, or investment is necessary to maintain long-term stability and progress in critical areas.
- **Integration of research with education and strengthening the connections between learning and inquiry.** Significant factors include whether investment areas present a rich environment for encouraging future scientists, engineers, and educators, and whether they provide opportunities for teachers and students to participate in research activities at the K-12, undergraduate, graduate, and postdoctoral levels.
- **Broadening participation.** Important factors include whether the investment area contributes to increasing the diversity of the U.S. population that participates in research and research training.
- **Collaborations.** Important factors include whether investments create opportunities for national and international partnerships, or augment other NSF activities, or leverage other community, industry, federal agency or international investments in research, education, and infrastructure. By using such partnerships, NSF avoids duplication and increases the efficiency of its investments.
- Partnering with other science sponsors and professional organizations;
- Welcoming interdisciplinary proposals and proposals that pursue novel approaches;
- Using, where appropriate, quantitative or other evidence-based evaluation of programs and investment areas;
- Maintaining up-to-date digital tools and business systems; and
- Complementing the expertise of NSF's permanent staff with the knowledge and up-to-date experience of leading researchers and educators on temporary assignment to NSF.

AGENCY OPERATIONS

Efficiency and Effectiveness

NSF brainstorming exercises produced strong suggestions for improving the efficiency and effectiveness of NSF through actions in three areas. We will increase efficiency and effectiveness by:

- **Making IT work for us:**
 - Harness new information technologies to enable us to achieve our mission more efficiently;
 - Leverage state-of-the-art IT solutions from the private and public sectors to develop flexible tools that support the formation of agile work teams, to drive changes in the way research is solicited, identified, and funded, and to ensure ease of use by internal and external users;
 - Take advantage of cloud resources and shared services that offer the potential for new efficiencies; and
 - Exploit new developments in software to improve the implementation of core processes such as merit review and financial management.

AWARD PORTFOLIO

Proposals for individual research projects are evaluated using the merit review criteria provided by the National Science Board. NSF strives to maximize the collective impact of these projects by using the following strategies:

- Maintaining a balanced portfolio that provides opportunities for original research in all fields of science, engineering, and learning;
- Maintaining the public's trust by operating with transparency, accountability, and integrity;
- Maintaining NSF's high-quality merit review process, while seeking continuous improvement;

- **Expanding public and private partnerships:**
 - Streamline agency processes to remove obstacles and disincentives to the formation of partnerships that are increasingly essential to advancing convergence research;
 - Catalog existing NSF partnerships and identify the best practices for building on these and the challenges to be addressed;
 - Modify current policies and practices that impede the establishment of partnerships;
 - Clarify terms and mechanisms for joint investments and partnerships such as donations, memoranda of understanding, and interagency agreements;
 - Streamline interagency activities; e.g., simplify the joint analysis of proposals and awards across federal agencies;
 - Explore other financial transfer authorities, providing alternate funding delivery models, beyond those that have been used traditionally by NSF; and
 - Establish new partnerships in research areas of special emphasis.
- **Streamlining, standardizing, and simplifying programs and processes:**
 - The tremendous variety in research topics and cultures has led to a decentralized structure within NSF. Where appropriate, we will move to more consistent and standardized processes and program structures, streamlining decision-making, and making it easier to review and fund cross-cutting research.
 - NSF's fine-grained structure of programs, with their often rigid definitions and deadlines, can present an obstacle to the submission of unusual ideas. We will diminish such obstacles by reducing the use of deadlines and introducing opportunities for proposals unconstrained by topic area.

Workforce Management

The changing nature of research, together with changes in the way we use information technology, expand our use of partnerships, and streamline our programs and processes, highlights the importance of aligning the skills and strengths of our workforce with this evolving landscape. We will pursue a strategy of:

- **Adapting the NSF workforce to the work:**
 - As science changes, we will augment the skills of the workforce with those needed to function effectively in more integrated, cross-cutting settings.
 - We will review and revise position descriptions to reflect the work responsibilities and portfolio of skills needed in today's work environment, and look for opportunities created by the emergence of new skills.
 - We will develop a framework for recruitment, training and development that will enhance the ability of the workforce to meet the NSF mission efficiently and effectively.

X. EVIDENCE BUILDING

NSF employs a variety of methods to develop evidence that is used to inform its strategic planning, assess progress on strategic objectives, and examine program effectiveness.

MANAGEMENT REVIEWS

Each quarter, NSF senior leadership reviews progress towards all performance goals of the agency in a data-driven review meeting led by the Chief Operating Officer and Performance Improvement Officer.

PERFORMANCE INDICATORS

NSF uses a balanced set of performance indicators, milestones, and measures. Due to the nature of NSF investments, the assessment of progress on its first two strategic goals tends to be based on output or outcomes. The third, more management-oriented goal is assessed with efficiency and customer-service measures, but also output and outcome measures relating to long-term activities such as strategic human capital management and diversity.

STRATEGIC REVIEWS

NSF's Strategic Review Process uses the results of existing assessments, evaluations, and reports as well as other sources of evidence such as analysis of administrative data. Because the Strategic Objectives in the NSF Strategic Plan are cross-cutting and do not mirror our organizational structure, the strategic reviews are also cross-cutting and conducted as cross-Foundational activities. The process draws upon existing, comprehensive assessment processes that already exist at NSF. For example, the periodic Merit Review Report to the National Science Board and the Committees of Visitors (COV) process, described below.

NATIONAL SCIENCE BOARD

The National Science Board (NSB), whose members are appointed by the President, reviews NSF's strategy, programs, and plans. It receives and acknowledges NSF's annual submission to the President's budget.

ADVISORY COMMITTEES

Each directorate has an external advisory committee that typically meets twice a year to review and advise on program management, discuss current issues, and review and provide advice on the impact of policies, programs, and activities in the disciplines and fields encompassed by the directorate or office.

In addition to directorate advisory committees, NSF has several committees that provide advice and recommendations on specific topics: astronomy and astrophysics; environmental research and education; equal opportunities in science and engineering; direction, development, and enhancements of innovations; polar programs; advanced cyberinfrastructure; international science and engineering; and business and operations.

COMMITTEES OF VISITORS

Committees of Visitors (COVs) are subcommittees of NSF directorate advisory committees. They provide NSF with external expert assessments of the quality and integrity of program operations, program management, and the breadth of program portfolios. COV reviews are conducted at intervals of approximately four years for programs and offices that recommend or award grants, cooperative agreements, or contracts and whose focus is the support of research and education activities.

A Committee of Visitors typically consists of a group of external experts, selected to ensure independence, programmatic coverage, and geographic balance. COV members come from academia, industry, government, and the public sector. Each COV prepares a report that is submitted to the parent advisory committee and thence to NSF. NSF provides the advisory committee with a response to the COV recommendations. The reports and responses are public and posted on NSF's website.

EVALUATIONS

NSF's directorates and program offices commission external evaluations of major programs and investments. Large projects, such as centers and facilities, undergo rigorous post-award evaluation by teams of external experts and NSF staff.

NSF recently established an Evaluation and Assessment Capability (EAC). Data and analytical tools developed by EAC inform NSF's strategic reviews. To enhance NSF's ability to develop evidence to guide planning and decision-making, EAC assists directorates commissioning external assessments of specific program areas. In the lifetime of this strategic plan, such assessments have the potential to improve NSF's design and implementation of cross-cutting program activities. EAC also provides training to NSF staff members to help them plan and use evaluations and assessments more effectively.

DECADAL SURVEYS AND COMMUNITY WORKSHOPS

An important source of input for identifying new research opportunities and prioritizing program investments are extended planning efforts undertaken by specific science and engineering communities. In some areas, such as astronomy and ocean sciences, these are referred to as "decadal surveys" and help prioritize which infrastructure investments are of highest priority for the field. In many domains, community planning often features workshops that draw together researchers in the field and produce reports that highlight new opportunities. In some instances, such as the visioning workshops organized by the Computing Community Consortium, a dialogue between industry and academia is involved.

NATIONAL ACADEMY STUDIES

The National Academies of Science, Engineering, Public Administration, and Medicine often undertake assessments of the state of a field, or promising directions for federal research investments, or provide advice about business and operational processes.

PUBLIC COMMENTS

In developing this strategic plan, NSF invited feedback on the major elements of the FY 2014 – FY 2018 NSF

Strategic Plan from the public, academia, industry, and professional science and engineering organizations. The comments received were summarized and used by the strategic plan writing team as it prepared the current plan.

MERIT REVIEW REPORT

NSF prepares a biennial statistical summary of the operation of the merit review process. This includes information on the number of proposals submitted, success rates, average award sizes and durations, and the diversity of proposers, awardees, and reviewers. The report is provided to the National Science Board, pursuant to Board resolutions 77-150, 84-114 and 2017-32. The Board reviews and publishes the document. By capturing trends, the report is valuable for identifying sources of stress in the merit review system. This information has stimulated the piloting of a number of potential enhancements to the merit review process. The effects of these merit review pilots are also described in the Merit Review Report.

CUSTOMER SATISFACTION SURVEY

From time to time, NSF conducts a survey of the researchers who submit proposals and those who review them. This information has proven helpful in understanding what changes to the merit review process are likely to have a significant impact. Beginning with the survey in 2015, NSF has begun conducting this survey biennially.

OTHER SOURCES OF EVIDENCE

Other sources of information that have been useful to NSF in both strategic planning and in refining its internal business processes include internal working groups, reports from the Government Accountability Office, and the results of the annual Federal Employment Viewpoint Survey.

APPENDICES

APPENDIX A.1.

STAKEHOLDER ENGAGEMENT

The first phase of the development of the updated strategic plan began in 2016 and included gathering suggestions from numerous stakeholders about how the current strategic plan should evolve. That process, together with plans for future stakeholder engagement is summarized below.

- From August to December 2016, NSF invited people inside and outside the Foundation to provide comments on the existing strategic plan. This included discussions among NSF staff, with the National Science Board, with external advisory committees, and an open invitation to professional societies and organizations to provide input.
- Through an online portal, NSF received over 100 public comments.
- NSF developed a skeleton draft of the updated strategic plan and discussed this with the National Science Board at its February 2017 meeting.
- A high-level summary of the revised strategic goals and objectives was shared with the Office of Management and Budget (OMB) in June 2017.
- A preliminary draft of the Strategic Plan incorporated suggestions received through the public portal, from advisory committees, from the National Science Board, and from NSF staff members. It was submitted to OMB in September 2017.
- After receiving feedback on the draft Strategic Plan from OMB, NSF shared the draft with Congress.
- Additional feedback was provided by the National Science Board in November 2017.
- The final version of the strategic plan will be provided to Congress in February 2018.

APPENDIX A.2.

CONTRIBUTING PROGRAMS

The GPRA Modernization Act of 2010 requires each agency to develop an inventory of all federal programs. In response to this requirement, NSF categorized its federal programs by initial topic area of investment. This approach mirrors its

budget structure and the programs presented here are consistent with the program activity (PA) lines presented in the President's Budget Appendix. This aligns with the way the agency executes its budget and is complementary with the expectations of external stakeholders. The ordering of this list follows the budget structure, with programs funded through the two program accounts (Research and Related Activities and Education and Human Resources) listed first, followed by Major Research Equipment and Facilities Construction, Agency Operations and Award Management, National Science Board, and the Office of Inspector General.

LIST OF NSF STRATEGIC GOALS AND OBJECTIVES 2018 – 2022

Strategic Goal 1

SG1. Expand knowledge in science, engineering, and learning.

Strategic Objective 1.1 – Knowledge

SO1.1. Advance knowledge through investments in ideas, people, and infrastructure.

Strategic Objective 1.2 – Practice

SO1.2. Advance the practice of research.

Strategic Goal 2

SG2. Advance the capability of the Nation to meet current and future challenges.

Strategic Objective 2.1 – Societal Impacts

SO2.1. Support research and promote partnerships to accelerate innovation and to provide new capabilities to meet pressing societal needs.

Strategic Objective 2.2 – STEM Workforce

SO2.2. Foster the growth of a more capable and diverse research workforce and advance the scientific and innovation skills of the Nation.

Strategic Goal 3

SG3. Enhance NSF's performance of its mission.

Strategic Objective 3.1 – Human Capital

SG3.1. Attract, retain, and empower a talented and diverse workforce.

Strategic Objective 3.2 – Processes and Operations

SG3.2. Continually improve agency operations.

LIST OF PROGRAMS

Biological Sciences (BIO)

Program Title	Biological Sciences (BIO)
Program Description	<p>This activity promotes scientific progress in biology through support of research on all levels, including molecules, cells, organisms, and ecosystems, and interactions across these levels of organization.</p> <p>The Divisions within the Directorate for Biological Sciences are:</p> <ul style="list-style-type: none"> • Biological Infrastructure (BIO/DBI) • Environmental Biology (BIO/DEB) • Emerging Frontiers (BIO/EF) • Integrative Organismal Systems (BIO/IOS) • Molecular and Cellular Biosciences (BIO/MCB) <p>Current information about the activity can be found at https://nsf.gov/about/budget/.</p>
Supported Strategic Goals	<p>SG1. Expand knowledge in science, engineering, and learning.</p> <p>SG2. Advance the capability of the Nation to meet current and future challenges.</p> <p>SG3. Enhance NSF's performance of its mission.</p>
Supported Strategic Objectives	SO1.1; SO1.2; SO2.1; SO2.2; SO3.1; SO3.2

Computer and Information Science and Engineering (CISE)

Program Title	Computer and Information Science and Engineering (CISE)
Program Description	<p>This activity supports investigator-initiated research in all areas of computer and information science and engineering that advances society, helps develop and maintain advanced cyberinfrastructure to enable and accelerate discovery and innovation across all disciplines, and contributes to the training of the next generation of computer and information scientists and engineers with skills essential for success in the increasingly competitive global market. The divisions and offices within the Directorate for Computer and Information Science and Engineering are:</p> <ul style="list-style-type: none"> • Office of Advanced Cyberinfrastructure (OAC) • Computing and Communication Foundations (CISE/CCF) • Computer and Network Systems (CISE/CNS) • Information & Intelligent Systems (CISE/IIS) • Information Technology Research (CISE/ITR) <p>Current information about the activity can be found at https://nsf.gov/about/budget/.</p>
Supported Strategic Goals	<p>SG1. Expand knowledge in science, engineering, and learning. SG2. Advance the capability of the Nation to meet current and future challenges. SG3. Enhance NSF's performance of its mission.</p>
Supported Strategic Objectives	SO1.1; SO1.2; SO2.1; SO2.2; SO3.1; SO3.2

Engineering (ENG)

Program Title	Engineering (ENG)
Program Description	<p>Research supported by this activity aims to increase U.S. engineering capability and strength, and focus that capability and strength on areas that are relevant to national problems and long-term needs. This activity also includes small business innovation research.</p> <p>The Divisions within the Engineering Directorate are:</p> <ul style="list-style-type: none"> • Chemical, Bioengineering, Environmental, and Transport Systems (ENG/CBET) • Civil, Mechanical, and Manufacturing Innovation (ENG/CMMI) • Electrical, Communications, and Cyber Systems (ENG/ECCS) • Engineering Education and Centers (ENG/EEC) • Emerging Frontiers in Research and Innovation (ENG/EFRI) • Industrial Innovation and Partnerships (ENG/IIP) <p>Current information about the activity can be found at https://nsf.gov/about/budget/.</p>
Supported Strategic Goals	<p>SG1. Expand knowledge in science, engineering, and learning.</p> <p>SG2. Advance the capability of the Nation to meet current and future challenges.</p> <p>SG3. Enhance NSF's performance of its mission.</p>
Supported Strategic Objectives	SO1.1; SO1.2; SO2.1; SO2.2; SO3.1; SO3.2

Geosciences (GEO)

Program Title	Geosciences (GEO)
Program Description	<p>This activity supports research and associated infrastructure to advance knowledge of the properties and dynamics of the planet on which we live. Research includes understanding the causes and implications of climate change, as well as disruptive processes such as earthquakes and storms.</p> <p>The divisions within the Geosciences Directorate are:</p> <ul style="list-style-type: none"> • Atmospheric and Geospace Sciences (GEO/AGS) • Earth Sciences (GEO/EAR) • Integrative and Collaborative Education and Research (GEO/ICER) • Ocean Sciences (GEO/OCE) <p>Current information about the activity can be found at https://nsf.gov/about/budget/.</p>
Supported Strategic Goals	<p>SG1. Expand knowledge in science, engineering, and learning.</p> <p>SG2. Advance the capability of the Nation to meet current and future challenges.</p> <p>SG3. Enhance NSF's performance of its mission.</p>
Supported Strategic Objectives	SO1.1; SO1.2; SO2.1; SO2.2; SO3.1; SO3.2

Mathematical and Physical Sciences (MPS)

Program Title	Mathematical and Physical Sciences (MPS)
Program Description	<p>This activity supports research and infrastructure directed at increasing understanding of natural laws and phenomena across the astronomical sciences, chemistry, materials sciences, mathematical sciences, and physics.</p> <p>The divisions within the Mathematical and Physical Sciences Directorate are:</p> <ul style="list-style-type: none"> • Astronomical Sciences (MPS/AST) • Chemistry (MPS/CHE) • Materials Research (MPS/DMR) • Mathematical Sciences (MPS/DMS) • Physics (MPS/PHY) • Office of Multidisciplinary Activities (MPS/OMA) <p>Current information about the activity can be found at https://nsf.gov/about/budget/.</p>
Supported Strategic Goals	<p>SG1. Expand knowledge in science, engineering, and learning.</p> <p>SG2. Advance the capability of the Nation to meet current and future challenges.</p> <p>SG3. Enhance NSF's performance of its mission.</p>
Supported Strategic Objectives	SO1.1; SO1.2; SO2.1; SO2.2; SO3.1; SO3.2

Social, Behavioral, and Economic Sciences (SBE)

Program Title	Social, Behavioral, and Economic Sciences (SBE)
Program Description	<p>This activity supports research and infrastructure in the social, behavioral, cognitive, and economic sciences and funds the collection and dissemination of statistics on the science and engineering enterprise.</p> <p>The Divisions within the Social, Behavioral, and Economic Sciences Directorate are:</p> <ul style="list-style-type: none"> • Social and Economic Sciences (SBE/SES) • Behavioral and Cognitive Sciences (SBE/BCS) • Office of Multidisciplinary Activities (SBE/SMA) • National Center for Science and Engineering Statistics (SBE/NCSES) <p>Current information about the activity can be found at https://nsf.gov/about/budget/.</p>
Supported Strategic Goals	<p>SG1. Expand knowledge in science, engineering, and learning.</p> <p>SG2. Advance the capability of the Nation to meet current and future challenges.</p> <p>SG3. Enhance NSF's performance of its mission.</p>
Supported Strategic Objectives	SO1.1; SO1.2; SO2.1; SO2.2; SO3.1; SO3.2

Office of International Science and Engineering (OISE)

Program Title	Office of International Science and Engineering (OISE)
Program Description	This activity promotes an integrated strategy for international science and engineering that complements and enhances NSF's broader research and education goals and facilitates international collaboration. Current information about the activity can be found at https://nsf.gov/about/budget/ .
Supported Strategic Goals	SG1. Expand knowledge in science, engineering, and learning. SG2. Advance the capability of the Nation to meet current and future challenges. SG3. Enhance NSF's performance of its mission.
Supported Strategic Objectives	SO1.1; SO1.2; SO2.1; SO2.2; SO3.1; SO3.2

Office of Polar Programs (OPP)

Program Title	Office of Polar Programs (OPP)
Program Description	This activity supports Arctic and Antarctic research and operational science support and other related activities for United States polar research programs, including the funding to reimburse Federal agencies for logistical and other related activities supported by the United States Antarctic Program (USAP). Research investments span the range of all NSF research Directorates. In addition, the USAP provides critical support that enables research and scientific observations in the Antarctic sponsored by NASA, NOAA, USGS, DOE, and DOD (Comprehensive Test Ban Treaty monitoring). Current information about the activity can be found at https://nsf.gov/about/budget/ .
Supported Strategic Goals	SG1. Expand knowledge in science, engineering, and learning. SG2. Advance the capability of the Nation to meet current and future challenges. SG3. Enhance NSF's performance of its mission.
Supported Strategic Objectives	SO1.1; SO1.2; SO2.1; SO2.2; SO3.1; SO3.2

Integrative Activities (IA)

Program Title	Integrative Activities (IA)
Program Description	<p>This activity supports emerging cross-disciplinary research efforts, major research instrumentation, capacity-building, planning, and policy support. This activity also provides support for the Science and Technology Policy Institute. The Established Program to Stimulate Competitive Research broadens participation of States and regions in science and engineering by helping institutions expand their research capacity and competitiveness.</p> <p>The subactivities housed within the Office of Integrative Activities are:</p> <ul style="list-style-type: none"> • Evaluation and Assessment Capability (EAC) • Established Program to Stimulate Competitive Research (EPSCoR) • Graduate Research Fellowships (GRF) • HBCU Excellence in Research (HBCU EIR) • Major Research Instrumentation (MRI) • Planning and Policy Support • Science and Technology Centers (STC) • Science and Technology Policy Institute (STPI)
Supported Strategic Goals	<p>SG1. Expand knowledge in science, engineering, and learning.</p> <p>SG2. Advance the capability of the Nation to meet current and future challenges.</p> <p>SG3. Enhance NSF's performance of its mission.</p>
Supported Strategic Objectives	SO1.1; SO1.2; SO2.1; SO2.2; SO3.1; SO3.2

United States Arctic Research Commission (USARC)

Program Title	United States Arctic Research Commission (USARC)
Program Description	<p>The United States Arctic Research Commission promotes Arctic research and recommends national Arctic research policies to guide Federal agencies in developing and implementing their research programs in the Arctic region.</p> <p>Current information about the activity can be found at https://nsf.gov/about/budget/.</p>
Supported Strategic Goals	<p>SG1. Expand knowledge in science, engineering, and learning.</p> <p>SG2. Advance the capability of the Nation to meet current and future challenges.</p>
Supported Strategic Objectives	SO1.1; SO2.1

Note that USARC is an independent agency that is included in NSF's program inventory but not covered by the NSF strategic plan.

Education and Human Resources (EHR)

Program Title	Education and Human Resources (EHR)
Program Description	<p>This activity supports a comprehensive set of programs in all areas of science, technology, engineering, and mathematics (STEM), at all levels, inside and outside of school, to build a diverse, globally competitive STEM workforce and a STEM- literate citizenry. EHR invests in research and development on STEM education and learning, and in scholarships and fellowships to build the STEM workforce.</p> <p>The divisions within the Education and Human Resources Directorate are:</p> <ul style="list-style-type: none"> • Research on Learning in Formal and Informal Settings (EHR/DRL) • Graduate Education (EHR/DGE) • Human Resource Development (EHR/HRD) • Undergraduate Education (EHR/DUE) <p>Current information about the activity can be found at https://nsf.gov/about/budget/.</p>
Supported Strategic Goals	<p>SG1. Expand knowledge in science, engineering, and learning.</p> <p>SG2. Advance the capability of the Nation to meet current and future challenges.</p> <p>SG3. Enhance NSF's performance of its mission.</p>
Supported Strategic Objectives	SO1.1; SO1.2; SO2.1; SO2.2; SO3.1; SO3.2

Major Research Equipment and Facilities Construction (MREFC)

Program Title	Major Research Equipment and Facilities Construction (MREFC)
Program Description	<p>The Major Research Equipment and Facilities Construction activity supports the acquisition, construction, and commissioning of unique national research platforms and major research facilities and equipment. Performance of each construction project is measured against an established baseline at regular intervals and at major milestones.</p> <p>Current information about the activity can be found at https://nsf.gov/about/budget/.</p>
Supported Strategic Goals	<p>SG1. Expand knowledge in science, engineering, and learning.</p> <p>SG3. Enhance NSF's performance of its mission.</p>
Supported Strategic Objectives	SO1.1; SO1.2; SO3.2

Agency Operations and Award Management (AOAM)

Program Title	Agency Operations and Award Management (AOAM)
Program Description	This account funds NSF's scientific, professional, and administrative workforce, the physical and technological infrastructure necessary for a productive, safe, and secure work environment, and the essential business operations critical to NSF's administrative processes. Current information about the activity can be found at https://nsf.gov/about/budget/ .
Supported Strategic Goals	SG1. Expand knowledge in science, engineering, and learning. SG2. Advance the capability of the Nation to meet current and future challenges. SG3. Enhance NSF's performance of its mission.
Supported Strategic Objectives	SO1.1; SO1.2; SO2.1; SO2.2; SO3.1; SO3.2

Office of the National Science Board (NSB)

Program Title	Office of the National Science Board (NSB)
Program Description	This appropriation provides policy-making and related responsibilities for NSF, and provides guidance on significant national policy issues in science and engineering research and education, as required by law. Current information about the activity can be found at https://nsf.gov/about/budget/ .
Supported Strategic Goals	SG1. Expand knowledge in science, engineering, and learning. SG2. Advance the capability of the Nation to meet current and future challenges. SG3. Enhance NSF's performance of its mission.
Supported Strategic Objectives	SO1.1; SO1.2; SO2.1; SO2.2; SO3.1; SO3.2

Office of Inspector General (OIG)

Program Title	Office of Inspector General (OIG)
Program Description	This appropriation provides agency-wide audit and investigative functions to identify and correct management and administrative deficiencies that create conditions for existing or potential instances of fraud, waste, and mismanagement, consistent with the Inspector General Act of 1978, as amended (5 U.S.C. App. 3). Current information about the activity can be found at https://nsf.gov/about/budget/ .
Supported Strategic Goals	SG3. Enhance NSF's performance of its mission.
Supported Strategic Objectives	SO3.2

IMAGE CREDITS

Cover: NSF/LIGO/Sonoma State University/A. Simonnet

Page 6: John W. Harvey, National Solar Observatory

Page 7: (top to bottom) David Göthberg, Sweden; karelnoppe/Shutterstock.com

Page 8: University Communication/University of Nebraska-Lincoln

Page 9: (top to bottom) Courtesy of U.S. Army Cold Regions Research and Engineering Laboratory; Panel Study of Income Dynamics (PSID)

Page 10: (top to bottom) NASA; U.S. Army

Page 11: (top to bottom) byggam.se/Shutterstock.com; Paul A. Cziko, University of Oregon; courtesy of Google

Page 12: (top to bottom) Arable Labs, Inc.; Jennifer Doudna, University of California, Berkeley; pixelrain/Shutterstock.com

Page 13: (top to bottom) Georgia Computes! Georgia Tech; ©iStock.com/bbraley

Page 14: (top to bottom) Ian Klufft, CC BY-SA 3.0; Photographee.eu/Shutterstock.com

Page 15: David R. Gribble, CC BY-SA 3.0

Page 17: Stuart Licht, Ph.D.

Page 22: Fouad A. Saad/Shutterstock.com

Page 24: I-Corps

Page 25: Platforms for Advanced Wireless Research (PAWR)

Page 26: (left top to bottom) S2N Media; ©iStock.com/Henrik5000; (right) Ruth Schulte, USGS

Page 27: (top to bottom) ©iStock.com/Ridofranz; CyberCorps

Page 28: (top to bottom) ASSISTments; michaeljung/Shutterstock.com

NSF 18-45



www.nsf.gov

National Science Foundation | 2415 Eisenhower Ave | Alexandria, VA 22314