

Characterization of the US Gulf of Mexico and Southeastern Atlantic Otter Trawl and Bottom Reef Fish Fisheries

Observer Training Manual



National Marine Fisheries Service
Southeast Fisheries Science Center
Galveston Laboratory

MARCH 2020

TABLE OF CONTENTS

SECTION 1 - INTRODUCTION

National Overview -----	1-1
National Observer Program FAQ-----	1-2
Penaeid Shrimp -----	1-3
Shrimp Observer Program Overview -----	1-4
Reef Fish Observer Program Overview -----	1-7
Observer Program Guidelines and Safety -----	1-10
Observer Safety -----	1-10
Medical Fitness for Sea -----	1-11
Training -----	1-11
Before Deployment on Vessel -----	1-11
Seven Steps to Survival -----	1-13
Donning an Immersion Suit -----	1-16
Safety aboard Vessels -----	1-18
General Safety Precautions -----	1-19
Safety At-Sea Transfers -----	1-20
Off-Shore Communications -----	1-21
Summary: What You Need to Know About Sea Survival -----	1-24
Deployment on Vessel -----	1-24
Living Conditions -----	1-24
Accident and Illness aboard -----	1-25
Seasickness -----	1-25
Observer Conduct -----	1-27
Regulations Applying to Observers -----	1-27
Collection Permits -----	1-27
Standards of Observer Behavior -----	1-27
Participation in Fishing/Vessel Operations -----	1-28
Observer Information -----	1-29
Data Confidentiality and Access -----	1-29
Photos and Videos -----	1-30
Data Submission -----	1-30
Being Subpoenaed to Testify in Court -----	1-31
Witnessing the Violations of Laws or Regulations -----	1-31
Boarding by USCG/NMFS Enforcement Personnel -----	1-31
Threats, Abuse, or Assaults by Captain or Crew -----	1-32
Personal Behavior -----	1-32
Personal Gain -----	1-32
Pay Eligibility -----	1-33

SECTION 2 – DATA COLLECTION – ALL TRIPS

BRD/Bycatch and Reef Fish Program Receipt and Instructions -----	2-1
BRD/Bycatch and Reef Fish Program Acknowledgement of Data Collected and Instructions -----	2-3
Data Collection -----	2-5
Cover Sheet Forms and Instructions (By-Catch and Reef Fish) -----	2-6
Trip Completion Form and Instructions -----	2-8
Observer Feedback Form and Instructions -----	2-10
Safety Check-off Form, Station Bill (Pages 1 & 2) and Instructions -----	2-12
OVATEK Check off Form and Instructions -----	2-16
Regulations and Compliance -----	2-18
Southeast Fisheries Observer Incident Report/Instructions-----	2-21
Marine Pollution (MARPOL) Incident Report/Instructions-----	2-25
Vessel Information Form and Instructions -----	2-28
Photo Log Form and Instructions -----	2-31

SECTION 3 – BY-CATCH – DATA COLLECTION

By-Catch Data Collection -----	3-1
Collection of By-Catch Trip Report Information -----	3-4
Trip Report Pages 1, 2 and 3 and Instructions -----	3-5
By-Catch Data Forms -----	3-11
Gear Specification & TED BRD Form and Instructions -----	3-12
Try Net Tow Summary and Instructions -----	3-22
Station Sheet and Instructions -----	3-24
Condition and Fate Form and Instructions -----	3-29
Species Characterization Forms and Instructions -----	3-31
Length Frequency Form and Instructions -----	3-39
List of and Order of By-Catch Data Forms -----	3-41
Mandatory Skimmer Protocol -----	3-42

SECTION 4 – REEF FISH – DATA COLLECTION

Reef Fish Data Collection -----	4-1
Collection of Reef Fish Trip Report Information -----	4-3
Trip Report Pages 1, 2, and 3 and Instructions -----	4-4
Bandit Reel Data Forms -----	4-10
Gear Specification Form and Instructions (BR-GS) -----	4-11
Collection of Biological Data – Bandit Reel -----	4-15
Station Sheet and Instructions (BR-SS) -----	4-18

Length Frequency/Weight Form and Instructions (BR-LF)	4-22
Longline Data Forms -----	4-25
Gear Specification Form and Instructions (LL-GS) -----	4-26
Collection of Biological Data -----	4-29
Station Sheet and Instructions (LL-SS) -----	4-30
Length Frequency/Weight Form and Instructions (LL-LF)	4-34
Modified Buoy Forms -----	4-37
Gear Specification Form and Instructions (JUG-GS) -----	4-38
Collection of Biological Data -----	4-41
Station Sheet and Instructions (JUG-SS) -----	4-42
Length Frequency/Weight Form and Instructions (JUG-LF)	4-45
Spearfishing Data Forms -----	4-48
Gear Specification Form and Instructions (SF-GS) -----	4-49
Collection of Biological Data -----	4-51
Station Sheet and Instructions (SF-SS) -----	4-52
Length Frequency/Weight Forms and Instructions (SF-LF)	4-56
List of and Order of Reef Fish Data Forms -----	4-58

SECTION 5 – PROTECTED SPECIES & REPORTING FORMS

Protected Species & Reporting Forms -----	5-1
Sea Turtle Life History Form and Instructions -----	5-2
Hook Location Guide -----	5-12
Turtle Resuscitation Guidelines -----	5-20
Protected Resources Capture Report and Instruction -----	5-21
(sawfish, sturgeon, giant manta ray and bird)	
Observer sampling protocol for Sawfish -----	5-26
Observer sampling protocol for Atlantic & Gulf Sturgeon-	5-27
Fin Ray removal of Atlantic & Gulf Sturgeon -----	5-28
PIT Tag Scanning for Gulf Sturgeon -----	5-31
Observer sampling protocol for Giant Manta Ray ID -----	5-32
Marine Mammal Life History Form -----	5-34
Tag Reporting Form and Instructions (LL/BR/SF-TAG) -----	5-38
Specimen Collection Log -----	5-40
Teleost Sampling Request & Procedures (Gonad/Otolith Form) -	5-42

SECTION 6 – SPECIES LIST

Species List - By-catch and Reef Fish -----	6-1 to 6-22
---	-------------

SECTION 7 – APPENDICES

1 - United States Coast Guard Vessel Safety Decal -----	7-1
2 - NMFS Emergency Contacts -----	7-2
3 - Observer Status Codes -----	7-3
4 - Otter Trawl – Shrimp Boat with Four Nets -----	7-4
5 - Otter Trawl – Trawl Net Parts -----	7-5
6 - Otter Trawl – Trawl Net -----	7-6 to 7-7
7 - Key TED Measurements and How to Take Them -----	7-8
8 - BRD Type Illustrations -----	7-9 to 7-10
9 - BRD -----	7-11
10 - Otter Trawl Diagram -----	7-12
11 - Operation Codes -----	7-13
12 - NMFS Measurement, Bottom Type and Sea State Codes -----	7-14
13 - Statistical Zones Map -----	7-15
Statistical Zone 12 Map -----	7-16
14 - Conversion - Minutes to Seconds -----	7-17
15 - Hooks (actual size) -----	7-18
16 - Common Errors -----	7-19 to 7-21
17 - Gear Check-Off Sheet -----	7-22
Turtle Kit Gear Check-Off Sheet-----	7-23
18 - Fishing Vessel USCG Safety Requirements-----	7-24
19 - Reef Fish Bait Type List -----	7-25
20 - Reef Fish and Shrimp Observer issues-----	7-26

Updates and changes from previous version (September 2019)

- Updated Genus Species list based on data request by FSD (Fisheries Statistics Division Miami) (2/2020)
- Galveston Emergency Workbook – Updated (Appendix 2) – AIS added
- Gear Inventory Sheet – Updated (Appendix 17) (revised 2/26/20)
- NOCATCH discrepancy (NOCATCH should be written in both Common Name and Genus columns – Corrected (4-23, 4-46, and 7-20)
- Added Sampling Request and Procedures (revised 4/23/2019)
- Changes to text - Vessel (check one) - comment added to trolling to collect time out, ending depth and GPS (4-20 and 4/54)
- Changes to Turtle Protocol Regarding Resuscitation and Resuscitation Time Line (5-7)
- IAP - Observer Deployment Guidelines (Appendix 21) – removed
- Appendix 1 – Updated with new sticker
- Appendix 17 – Gear Check-off Sheet page 1 - Updated (prices added)
- Appendix 17 Cont. – Gear Check-off Sheet page 2 - Updated (prices added)

Updates and changes from previous version (June 2019)

- Collection permits Instructions – Added (1-27)
- Safety Check Off Form - Updated (new OMB Exp Date 12/31/21)
- Gear Specification Form Instructions - Updated (length of the EE [3-17])
- Space between TED bars measurement after capture - Added (3-20)
- Hook Measurement graphic - Updated (4-28, 4-40)
- # of Hook Set Instructions - Updated (4-32)
- # of Hooks Lost - Updated (4-32)
- Videos for Turtles - Added (5-5)
- Turtle Resuscitation Time Line - Added (5-8)
- Biopsy Samples Not Taken for Kemp's Ridley's - Added (5-16)
- Measurement of TED Bar Spacing After Capture - Added (5-17)
- Giant Manta Ray ID – Added (5-32)
- NMFS Galveston Emergency Contacts - Updated (7-2)

Updates and changes from previous version (September 2018)

- NMFS Galveston Emergency Contacts - Updated
- BRD/Bycatch and Reef Fish Program Receipt - Updated
- Genus Species List - Updated
- Reef Fish Bait Type List – Updated

- SEFSC Online Safety Training Information Removed
- Chapter 4 page 1 - Primary coordinator receiving mail changed to Matthew Duffy
- Updated Sea Turtle Life History Form (7_18) text updated for new form

Updates and changes from previous version (March 2018)

- Advice to Women at Sea - Removed
- Chapter 2 page 5 - Data collection, list of forms updated
- Chapter 2 page 9 - Trip Completion Form instructions added
- Chapter 2 page 10 - Observer Feedback Form updated - Missed work due to illness or injury
- Chapter 2 page 11 - Observer Feedback Form instructions added
- Chapter 2 page 12 - Safety Checkoff Form updated - first aid and ditch bag question updated
- Chapter 2 page 14 - Safety Checkoff Form instructions added
- Chapter 2 page 17 - Ovate Checkoff Form instructions added
- Chapter 2 page 31 - Photo Log Form added
- Chapter 2 page 32 - Photo Log Form instructions added
- Genus Species List - Updated
- Reef Fish Bait Type List - Updated
- Appendix 7 - Key TED Measurements and how to take them - Added
- Appendix 8 – BRD Type Illustration - Added

Updates and changes from previous version (July 2017)

- Chapter 4 page 7 – Following note removed (Note: If Bandit reels and Handline are used during the same trip check both.)
- Chapter 1 page 21 – Digital Selective Calling (DSC) - Added
- Chapter 1 page 22 – HF-SSB Radios – Updated – (USCG no longer monitor 2182 kHz for emergencies)
- Genus Species List – Updated
- Reef Fish Bait Type List – Updated
- Appendix 6 - Updated
- Appendix 14 – Added instructions regarding total shrimp weight concerning non-Penaeid shrimp (i.e. seabob shrimp and rock shrimp)

Updates and changes from previous version (December 2016)

- Genus Species List – Updated
- Reef Fish Bait Type List – Updated

- Appendix 2 - Updated
- Section 3 page 3 - 7 - All station sheets no longer need to be signed by Captain
- Section 3 page 10 - Tows not sampled p.2, paper work removed as a reason for not sampling a tow
- Chapter 4 page 1 - Primary coordinator receiving mail changed to Andrew Whatley

Updates and changes from previous version (December 2016)

- Genus Species List – Updated
- Reef Fish Bait Type List – Updated
- Appendix 2 - Updated
- Section 3 page 3 - 7 - All station sheets no longer need to be signed by Captain
- Section 3 page 10 - Tows not sampled p.2, paper work removed as a reason for not sampling a tow
- Chapter 4 page 1 - Primary coordinator receiving mail changed to Andrew Whatley

Updates and changes from previous version (May 2016)

- Acknowledgement of Data Collected (Signature page) – Added
- OMB # 0648-0345 removed from all shrimp form – Updated
- Reef Fish forms, all Station Sheets (signature lines removed), Bandit gear (braid & Fluoro Carbon added) – Updated
- Turtle form, Skimmer net and Whole Water Column – Added
- K - Shark Longline project code added
- NMFS Contact List – NOAA OLE 24 Number – Deleted
- Genus Species List – Updated
- Reef Fish Bait Type List – Updated

Updates and changes from previous version (December 2015)

- Safety Check-off Form/Station Bill (OMB#, EPIRB Registered to vessel) – Updated
- OVATEK Check Off Form -Added
- Genus Species List – Updated
- Reef Fish Bait Type List – Updated
- Characterization Forms (S. Atl. Penaeid Shrimp and Rock Shrimp) – Updated
- List of and Order of Reef Fish Forms – Added
- NMFS Contact List – IAP 24/7 Nurse Number – Added

Updates and changes from previous version (January 2015)

- Safety Check-off Form/Station Bill (Life Raft Type) - Updated
- Genus Species List – Updated
- Reef Fish Bait Type List – Updated
- Stat Zone map, zone 12 redrawn – Updated
- Length Frequency Form (Target Species), # of Broken (Unmeasurable) - Updated

Updates and changes from previous version (January 2014)

- Genus Species List - Updated
- Riverside Observer Deployment Guidelines 3/10/14 (appendix 20) - Added
- Appendix 2 (NMFS Galveston Contacts) - Updated
- Reef Fish Bait Type List - Updated
- Safety Check-off Form/Station Bill (Go No Go) - Updated

Updates and changes from previous version (Nov 2013)

- Introduction rewritten (Penaeid, Shrimp & Reef program overview) – Added
- Safety aboard Vessel - Revised
- General Safety Precautions – Added
- Regulations Applying to Observers – Added
- Standards of Observer Behavior – Added
- Observer Information – Added
- Photo and Videos – Added
- Data Submission - Added
- Personal Gain – Added
- Regulations and Compliance (By-catch Data Collection) – Added
- Collection of Biological Data (Reef Fish rewritten) – Added

Updates and changes from previous version (April 2013)

- Safety at-sea transfer (Updated)
- Southeast Fisheries Observer Incident Report/Instructions – Added
- Marine Pollution (MARPOL) Incident Report/Instructions – Added
- Bycatch Gear Form – TED measurements (Updated)
- Mandatory Skimmer Protocol – Added
- Station Sheet – Marine Mammal, Secchi disk (Bandit, Longline, Modified Buoy [JUG], Spearfishing) (Updated)
- Species List (Nov 2013)
- Reef Fish Bait List (Nov 2013)

- Reef Fish and Shrimp Observer Issues – Appendix 18, Added
- SEFSC Online Safety Training – Appendix 19, Added

Updates and changes from previous version (June 2012)

- Trip Completion Form
- Safety Check Off Form - page 2, wheel watch
- Reef Fish Forms – Trip # increased to accommodate trips 1000 and over
- Sea turtle life history form – PIT tag #'s, Trip #
- Tag Reporting Form – Trip # increased to accommodate trips 1000 and over
- Genus Species List – April 2013
- Emergency Contact list – April 2013
- Gear Check off – Jan 2013
- Bait Type list – April 2013

SECTION 1

INTRODUCTION

NATIONAL OVERVIEW

From: NMFS. 1999. Our Living Oceans. Report on the status of U.S. living marine resources, 1999. U.S. Dep. Commer., NOAA Tech. Memo. NMFS-F/SPO-41, on-line version, <http://spo.nwr.noaa.gov/olo99.htm>.

The conservation and management of living marine resources (LMR's) in the US is entrusted to the National Oceanic and Atmospheric Administration's National Marine Fisheries Service (NMFS), which carries out its charge under many laws, treaties, and legislative mandates from the US Congress. Most of the agency's stewardship responsibilities come from five statutes:

1. Magnuson-Steven's Fishery Conservation and Management Act (MSFCMA) regulates fisheries within the US Exclusive Economic Zone (EEZ);
2. Endangered Species Act (ESA) protects species that are in danger of extinction or likely to become endangered;
3. Marine Mammal Protection Act (MMPA) regulates the taking of marine mammals;
4. Fish and Wildlife Coordination Act (FWCA) authorizes collection of fisheries data and coordination with other agencies for environmental decisions affecting LMR's; and
5. Federal Power Act provides for concurrent responsibilities with the US Fish and Wildlife Service (USFW) in protecting aquatic habitat.

NMFS regulates fisheries from 3 to 200 nautical miles (Federal EEZ) off the 48 contiguous states, Alaska, Hawaii, and US affiliated islands. Within the 0-3 nautical miles or territorial seas, management jurisdiction belongs to coastal states and multi-state fisheries commissions. Territorial waters extend 9 nautical miles off Texas, Florida's west coast, and Puerto Rico. Applicable international laws and multilateral agreements among sovereign governments regulate international waters, outside the US EEZ, and the agency places an important role on behalf of the US in the implementation of international arrangements. Federal resource conservation laws require the best scientific information be used as the basis for management actions. NMFS scientists collect and analyze much of these data. From these data bases, the agency prepares reports and makes technical presentations to fishery managers, industry groups, and the public for use in formulating sound policies governing the long-term protection and sustainable use of the Nation's living marine resources.

The Secretary of Commerce has management responsibility for most marine life in US waters. Fishery resources are managed largely through fishery management plans (FMPs). These plans are generally developed by finfish management councils (Councils) through extensive consultations with state and Federal agencies, affected industry sectors, public interest groups, and, in pertinent cases, international science and management organizations.

FMPs for stocks within the EEZ originate through the MSFCMA, which established eight regional Councils. The Councils represent diverse interest through their members who are nominated by state governors in each region and appointed by the Secretary of Commerce. For most marine fishes and for federally protected marine mammals and sea turtles, FMPs and protected species recovery plans may be developed by NMFS with input from the public and by direction of the Councils.

The Southeast Region covers the Gulf of Mexico, the Southeast Atlantic, and the Caribbean Sea. The important resources are Atlantic sharks, Atlantic and Gulf of Mexico coastal migratory pelagics, Atlantic and Gulf of Mexico reef fish, drum and croaker, menhaden, invertebrates, highly migratory pelagic fishes, and nearshore resources. Menhaden rates first by weight. Penaeid shrimp rank first in terms of value.

National Observer Program FAQ

From: National Observer Program. Available at <http://www.st.nmfs.noaa.gov/st4/nop/>.

1. Why are fisheries monitored by fishery observer programs?

The authority to place observers on commercial fishing and processing vessels operating in particular fisheries is provided either by the Magnuson-Stevens Fishery Conservation and Management Act (MSFCMA) or the Marine Mammal Protection Act (MMPA). These two acts require the government to collect data on activities that affect marine resources. Many of the programs also satisfy requirements of the Endangered Species Act (ESA). The data collected by the observer's programs are often the best means to get current data on the status of many fisheries. Without observers and observer programs, there would not be sufficient data in many fisheries for effective management.

2. Where do fishery observers work?

Fishery observers work in U.S. waters. Observers collect data on the Georges Bank scallop and lobster fisheries, as well as the California drift gillnet fishery targeting swordfish and thresher shark. Observers monitor the vast Alaska fisheries in the North Pacific and Bering Sea. The Gulf of Mexico Otter trawl shrimp fishery and Mid Atlantic shark gill net fishery are other examples of fisheries that are monitored by observers. The size of vessel ranges from factory motherships several hundred feet long, to 18 ft. reef fish vessels. The length of a fishing trip varies with the fishery and the vessels involved. Some fisheries have trips that typically last a day such as Mid-Atlantic gillnets and Monterey Bay set net fisheries. Pelagic longliners targeting swordfish and tunas may stay out five or six weeks to fill their holds.

3. What type of work do fishery observers perform?

Fishery observers monitor and record catch data on commercial fishing activity from U.S. vessels and processing facilities. When observing, most observers are at sea. Processing facilities may be on shore, but many are large factory vessels. The data is used to supplement research and aid in the management of US living marine resources. The observers may collect data on species composition of the catch, weights of fish caught, disposition of landed species

and protected species interactions. Though most observer programs cover commercial fishing activities, not all do. Some observers in the Gulf of Mexico monitor the removal of oil drilling platforms and off Florida's East coast, observers monitor beach nourishment dredging.

Much of the data collected by observers are fish lengths, weights and aging structures. Observers working on processing vessels can often collect stomach content data that would be otherwise difficult to collect. Fishing positions and fishing effort are important data for managing fisheries. In some fisheries, observers provide valuable assistance to researchers with tagging projects involving sharks, tunas, sablefish, spiny lobsters, swordfish, and even some species of sea turtles. Observer programs often are responsible for collecting the largest part of fisheries management data.

The firsthand information supplied by observers to NOAA Fisheries on protected species interactions with fishing activities provides excellent information to help sustain and rebuild some populations of protected species.

4. How do I become an observer?

NOAA Fisheries contracts with or certifies private [observer provider companies](#) to recruit, hire, and deploy observers. Observer providers recruit for observer candidates that meet the following eligibility criteria:

Education: Observer candidates should have a bachelor's degree from an accredited college or university with a major in one of the natural sciences, or with a combination of marine science and fisheries course work with specialized experience. The specialized experience must have been in the field of fisheries and include functions such as participation in ocean fishing activities; observing ocean fishing activities; participation in fishery research cruises; recording data on marine mammal sightings and fishing activities; tallying incidental take of marine mammals, sea turtles, and sea birds from fishing platforms; collecting biological samples and specimens from postmortem animals; and entering data into a database using computers.

Penaeid Shrimp

From: NMFS. 1999. Our Living Oceans. Report on the status of U.S. living marine resources, 1999. U.S. Dep. Commer., NOAA Tech. Memo. NMFS-F/SPO-41, on-line version, <http://spo.nwr.noaa.gov/olo99.htm>.

Penaeid shrimp (brown, white and pink) account for 90% of the total Gulf of Mexico shrimp catch. In 1997 alone, these three species produced 84,967 tons valued at over \$437 million. They are found in all US Gulf waters inside 120 m depths. Most of the offshore brown shrimp are taken at 20-40 m depths; white shrimp are caught in 10 m or less; and pink shrimp are taken in 20-30 m. Brown shrimp are most abundant off the Texas-Louisiana coast, and the greatest concentration of pink shrimp is off southwestern Florida. In the South Atlantic, white shrimp landings are about 21% of their Gulf counter parts, while brown and pink shrimp are 6% of the Gulf yield.

Regulations in the Gulf of Mexico Shrimp FMP restrict shrimp by closing two shrimping grounds. There is a seasonal closure of fishing grounds off Texas for brown shrimp and a closure off Florida for pink shrimp. There are also size limits on white shrimp caught in Federal waters and landed in Louisiana.

Shrimp Observer Program Overview

From: Scott-Denton, E., P. Cryer, M. Duffy, J. Gocke, M. Harrelson, D. Kinsella, J. Nance, J. Pulver, R. Smith, and J. Williams. 2012. Characterization of the U.S. Gulf of Mexico and South Atlantic penaeid and rock shrimp fisheries based on observer data. *Marine Fisheries Review* 74(4): 1-27. *

Bycatch in shrimp trawls is a significant source of fishery induced mortality for several state and federally managed finfish species in the southeastern United States. Significant declines in landings of several species of southeastern finfish, notably red snapper, *Lutjanus campechanus*, resulted in the implementation of Federal management measures to identify reasons for these declines and to expedite the necessary steps required to rebuild affected stocks.

In response to Congressional directives, NOAA's National Marine Fisheries Service (NMFS), Southeast Fisheries Science Center (SEFSC), in cooperation with the Gulf and South Atlantic Fisheries Foundation, Inc. (Foundation), implemented a cooperative research plan in 1992 to identify, develop, and evaluate gear options to reduce bycatch in the Gulf of Mexico and South Atlantic shrimp fisheries. More than 150 bycatch reduction device (BRD) styles were developed by industry, scientists and gear specialists and evaluated through cooperative multi-year efforts.

The two primary objectives of these evaluations were to: 1) estimate catch operations for both target and nontarget species by area, season, and depth; and 2) evaluate BRD effectiveness at eliminating or significantly reducing the capture of nontargeted species, notably red snapper.

Since the early 1990's, much progress has been made in addressing the complex issues associated with finfish bycatch reduction in the southeastern shrimp fishery. BRD's have been required in Federal waters of the South Atlantic since 1997, the western Gulf of Mexico since 1998, and the eastern Gulf of Mexico since 2004 (50 CFR 622). BRD designs currently certified (or provisionally certified) for use in Federal waters of the Gulf of Mexico and South Atlantic include: composite panel, extended funnel, fisheye, Jones-Davis, and modified Jones-Davis. An additional design, the expanded mesh BRD, is certified for use in the South Atlantic only. Potential BRD designs are certified based on criteria set forth in the revised and consolidated BRD testing manuals and certification requirements for the Gulf and South Atlantic shrimp fisheries. Once certified, observer data are used periodically to reassess the continued effectiveness of BRD designs.

To improve the statistical validity of data from the voluntary observer program, including

bycatch, effort, and fishery performance estimates, the Gulf of Mexico Fishery Management Council (GMFMC) through Amendment 13 to the Shrimp Fishery Management Plan, mandated observer coverage of federally permitted vessels. In 2007, the SEFSC implemented a mandatory observer program for the commercial shrimp fishery operating in the U.S. Gulf of Mexico. In June 2008, observer coverage was expanded to include the South Atlantic penaeid and rock shrimp fisheries through Amendment 6 to the Shrimp Fishery Management Plan for the South Atlantic Region. A voluntary component of the observer program continues for the purposes of BRD development and evaluation.

Three commercially important penaeid shrimp species, brown shrimp, *Farfantepenaeus aztecus*; white shrimp, *Litopenaeus setiferus*; and pink shrimp, *Farfantepenaeus duorarum*, historically comprise the majority of shrimp landed in southeastern U.S. waters. In 2010, these three species accounted for 99.9 % of annual shrimp landed in the Gulf of Mexico. Landings were approximately 177.0 million lb. (80.3 million kg) (heads-on) valued at \$335.5 million. Penaeid shrimp landings in the South Atlantic were approximately 16.3 million lb. (7.4 million kg) (heads-on) valued at \$33 million. Rock shrimp, *Sicyonia* spp., primarily targeted in the South Atlantic, accounted for a smaller percentage of landings (1.8 million lb.; 816 thousand kg) valued at \$2.5 million.

The shrimp fishery operates year round in the Gulf of Mexico, with the highest effort occurring from May through December. The majority of brown shrimp catch from offshore waters occurs primarily off the coasts of Texas and Louisiana in depths between 20–40 fm. White shrimp are typically caught in waters of about 10 fm in the same areas. Pink shrimp are caught in waters of about 35 fm, predominately off southwestern Florida in the winter months. Rock shrimp are primarily targeted from waters off the east coast of Florida in depths between 10–40 fm.

Currently, there are 1,467 federally permitted vessels in the Gulf of Mexico, and 534 penaeid and 106 rock shrimp Federal permit holders in the South Atlantic. Observer coverage of the entire southeastern shrimp fishery is approximately 2% based on industry effort (nominal days at sea).

While finfish are the primary bycatch, several species listed under the Endangered Species Act of 1973 as amended (16 U.S.C. 1536 et seq.), or other regulatory mandates, have been encountered in the southeastern shrimp fishery. Five species of sea turtles (Kemp's ridley, *Lepidochelys kempii*; leatherback, *Dermochelys coriacea*; hawksbill, *Eretmochelys imbricata*; loggerhead, *Caretta*; and green, *Chelonia mydas*) occur in the Gulf of Mexico and South Atlantic and may be affected by shrimping activities. All of these species are currently listed as threatened or endangered under the Endangered Species Act (ESA).

Other species that may be encountered include smalltooth sawfish, *Pristis pectinata*, listed by NMFS as endangered under the ESA in April 2003 (50 CFR 224). Atlantic sturgeon, *Acipenser oxyrinchus*, and Gulf sturgeon, *Acipenser oxyrinchus desotoi*, were listed by NMFS as endangered species in February 2012. While delisted in November 2009 under ESA, the brown

pelican, *Pelecanus occidentalis*, remains protected under the Migratory Bird Treaty Act (16 U.S.C. §§ 703–712). Lastly, the Marine Mammal Protection Act (MMPA) enacted in 1972 (16 USC Chapter 31) affords protection for marine mammals. NMFS routinely prepares ESA section 7 consultations and other recommendations based on observer data to describe the effects of Federal activities, including federally permitted fisheries, on threatened or endangered species.

The continuing goals of the mandatory observer programs are to provide quantitative biological, vessel, and gear-selectivity information for the southeastern shrimp fishery. The primary objectives are to: 1) provide general fishery bycatch characterization and catch rates for finfish species by area and target species; and 2) provide catch rates that can be used to estimate protected species bycatch levels.

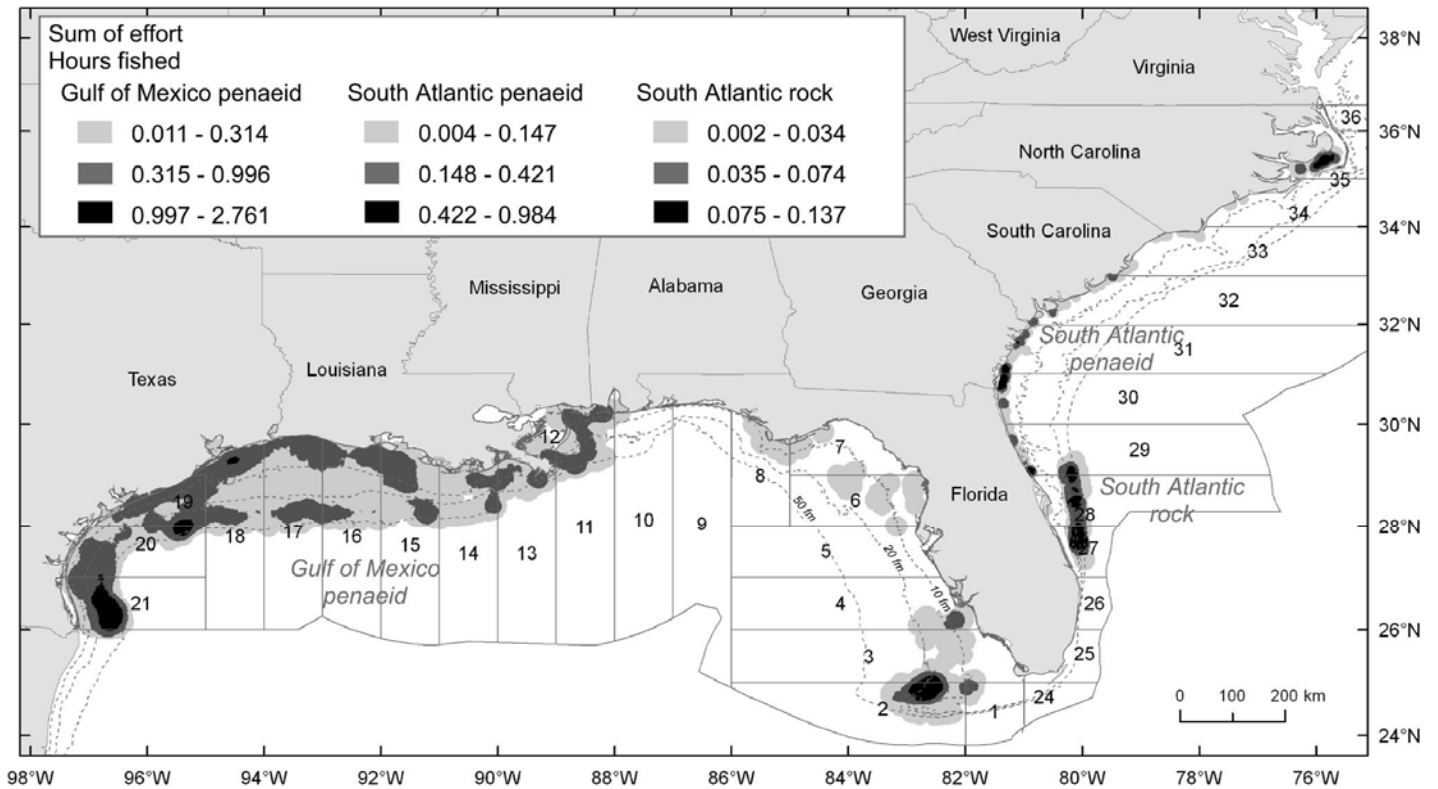

Density of sampling effort (sum of tow times), based on observer coverage of the U.S. southeastern shrimp fishery from July 2007 through December 2010.

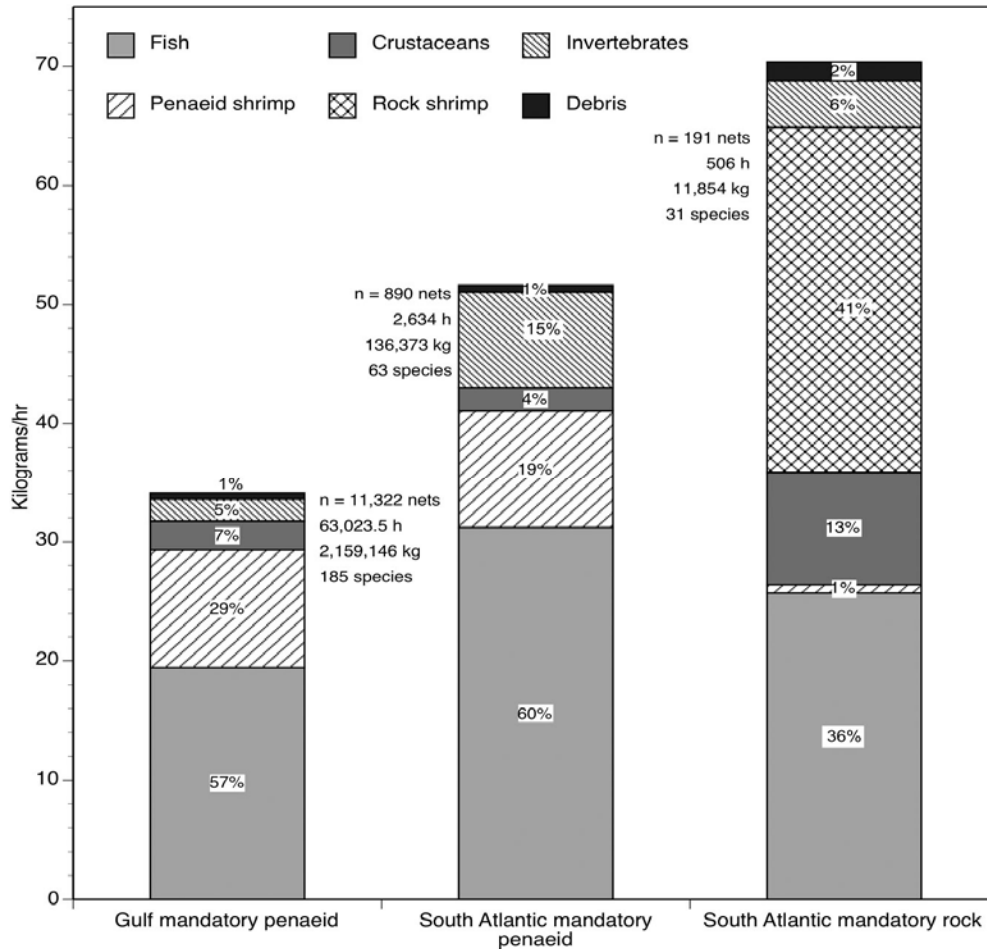

Major species categories grouped by area and target species, based on mandatory observer coverage of the U.S. southeastern shrimp fishery from July 2007 through December 2010.

* Best Publication - Marine Fisheries Review - 2012

Reef Fish Observer Program Overview

From: Scott-Denton, E., P. F. Cryer, J. P. Gocke, M. R. Harrelson, D. L. Kinsella, J. R. Pulver, R. C. Smith, and J. A. Williams. 2011. Descriptions of the U.S. Gulf of Mexico reef fish bottom longline and vertical line fisheries based on observer data. Marine Fisheries Review 73(2): 1-26.

Amendment 22 to the Gulf of Mexico Fishery Management Council’s (GMFMC) Reef Fish Fishery Management Plan dictates mandatory observer coverage. In July 2006, in collaboration with the commercial fishing industry and the GMFMC, the National Marine Fisheries Service’s (NMFS) Southeast Fisheries Science Center (SEFSC) implemented a mandatory observer program to characterize the commercial reef fishery operating in the U.S. Gulf of Mexico (Gulf).

This fishery consists of approximately 890 federally permitted vessels. Primary gears used include bottom longline, vertical line (bandit or handline), and more recently, modified buoy

gear. Although many reef fish species are retained, the predominant target species are groupers, *Epinephelus* spp., and snappers, *Lutjanus* spp. Longliners off the coast of Florida generally target red grouper, *Epinephelus morio*, in shallow waters, and in deeper waters yellowedge grouper, *E. flavolimbatus*, tilefish (Malacanthidae), and sharks (Carcharhinidae). Vertical line vessel operators target shallow-water grouper (e.g. red grouper), red snapper, *Lutjanus campechanus*, and may also seek yellowedge grouper and vermilion snapper, *Rhomboplites aurorubens*. From historical effort data, most commercial fishing effort for red snapper occurs in the western Gulf of Mexico.

In November 1984, the Reef Fish Fishery Management Plan was implemented to rebuild declining reef fish stocks. Since that time, Federal regulations have restricted size and landings of several reef fish species. Weight quotas regulate commercial landings for grouper, with 7.57 million lbs. for shallow-water grouper and 1.02 million lbs. for deepwater grouper. The current total allowable catch (TAC) for red snapper is 6.3 million lbs., divided between the commercial (51%) and recreational (49%) fishing sectors. An individual fishing quota (IFQ) program for the commercial red snapper fishery was implemented in 2007 and for the grouper and tilefish fisheries in 2010.

Certain areas for reef fish are closed or restricted based on gear type. Federal waters are closed in the Tortugas North and Tortugas South Ecological Reserves in the Florida Keys National Marine Sanctuary and the Madison and Swanson and Steamboat Lumps Marine Reserves off the west central Florida coast. Longline and other buoy gear are prohibited inside the 50-fm contour west and the 20-fm contour east of Cape San Blas, Fla.

In May 2009, an emergency rule to protect sea turtles (Cheloniidae and Dermochelyidae) went into effect prohibiting the use of bottom longline gear east of Cape San Blas, Fla., shoreward of the 50-fm contour. Modification through subsequent regulations prohibited bottom longline gear east of Cape San Blas, Fla., shoreward of the 35-fm contour from June through August, restricted the number of hooks onboard to 1,000, of which only 750 could be rigged for fishing, and reduced the number of vessels through an endorsement system based on documentation of an average annual landing of at least 40,000 lbs. during 1999 through 2007.

The effectiveness of quota systems, size limits, and area closures as management tools has been debated. Once a vessel's red snapper quota is reached, for example, the vessel often targets other reef fish, making red snapper a bycatch species. Currently, the minimum legal size for red snapper is 13 in total length (TL). The minimum size limit for red grouper was reduced from 20 in TL to 18 in TL, effective 18 May 2009. The mortality rates of both undersized target species and nontargeted species caught on the various gear types remains a pressing concern. Findings from mark-release mortality studies indicate variable rates of mortality based on depth and method of capture.

In December 1993, SEFSC's Galveston Laboratory implemented a voluntary observer program to characterize the fish trap, bottom longline, and bandit reel fisheries in the U.S. Gulf

of Mexico. Observer coverage of the commercial reef fish fishery operating primarily off the west coast of Florida and, to a lesser extent, off Louisiana, was conducted from 1993 through 1995. Data from 576 sets aboard fish trap vessels, 317 sets from bottom longline, and 580 sets from bandit reel vessels were analyzed. Findings from this study revealed a low proportion (<5% of total number caught) of fish discarded dead (immediate mortality) based on surface observations. However, due to the number of fish released in stressed state (air bladder expansion and/or eyes protruding), total predicted red snapper discards of 25% to 30% were used to estimate the number of discarded fish at age that died and thus contributed to fishing mortality.

The continuing goal of the current observer program is to provide quantitative biological, vessel, and gear-selectivity information relative to the directed reef fish fishery. The specific objectives are to: 1) provide general fishery bycatch characterization for finfish species taken by this fishery, 2) estimate managed finfish discard and release mortality levels, and 3) estimate protected species bycatch levels.

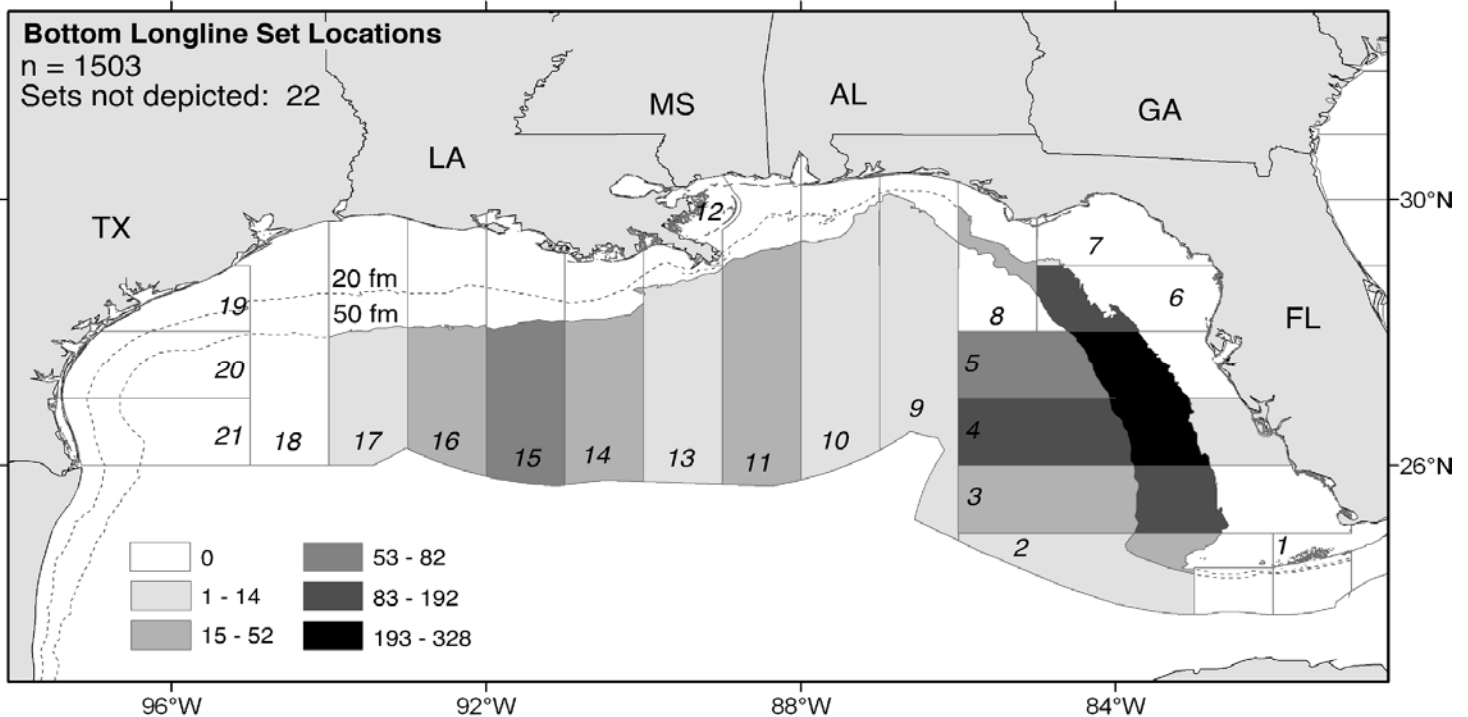

Distribution of sampling effort (sets) based on observer coverage of the U.S. Gulf of Mexico bottom longline reef fish fishery from August 2006 through November 2009.

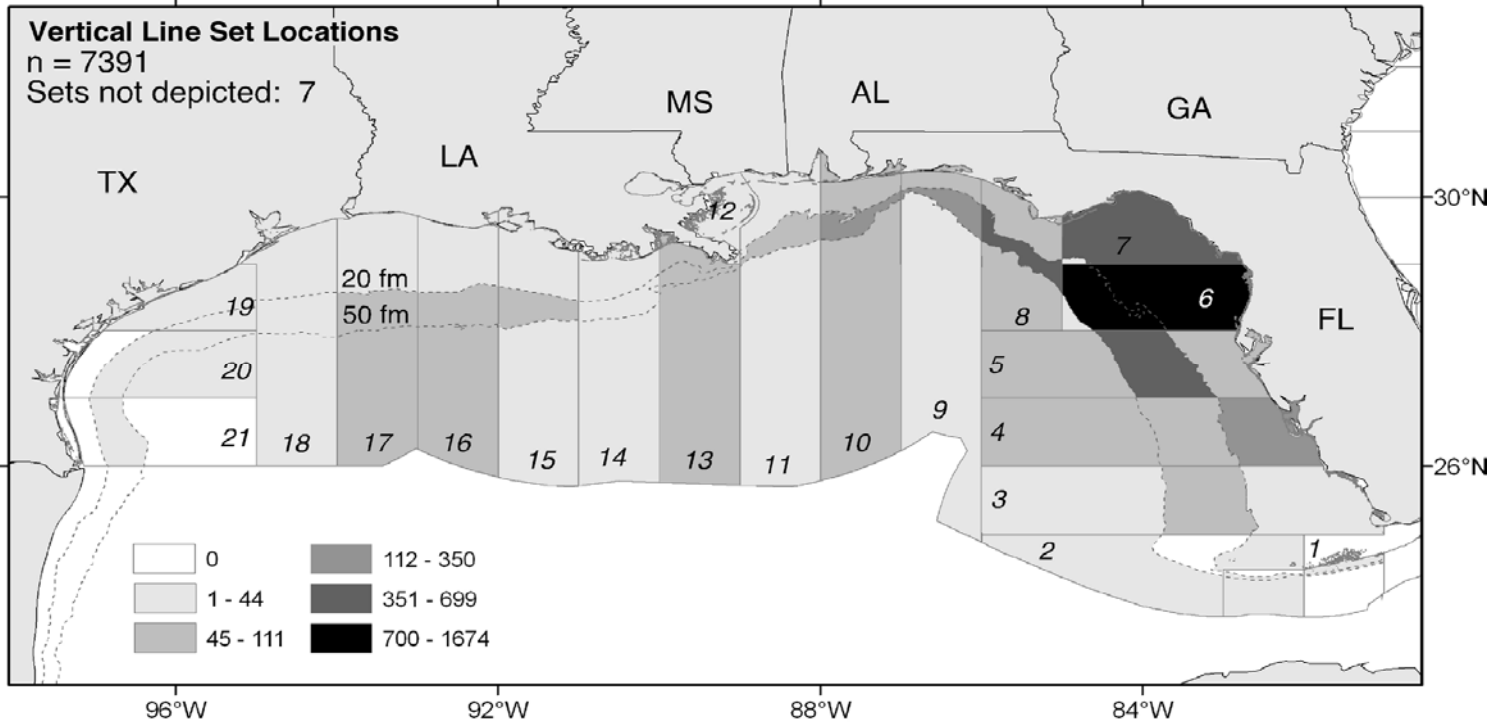

Distribution of sampling effort (sets) based on observer coverage of the U.S. Gulf of Mexico vertical line reef fish fishery from July 2006 through December 2009.

OBSERVER PROGRAM GUIDELINES AND SAFETY

Modified from: SEFSC Safety and Conduct Manual Fishery Observer Programs, May 1993 and includes revisions of 9/2/93 and 10/6/93. Safety sections from the North Pacific Fisheries Observer Training Center's Scallop Observer Training Manual (NPFOTC), 2000 have been duplicated or modified for use in this manual.

Observer Safety

Commercial fishing in the US Gulf of Mexico and southeastern Atlantic is a dangerous occupation. Inclement weather and the nature of the gear and equipment being used on a rolling deck make for a hazardous environment. You can greatly increase your chances of safety and survival by considering safety in all that you do and preparing for emergencies ahead of time. You must take responsibility for your own safety and learn as much as you can before an emergency threatens your life. Safety-minded captains who realize the danger of their occupation and consider safety in all that they do operate most fishing vessels. Use the knowledge and experience of the vessel's crew for guidance on safety on your vessel. They are certainly concerned about the safety of an Observer, a guest on their vessel, and will make sure that the dangers for you are minimized. No matter how cautious the crew is it is your responsibility to keep yourself safe and know how to react in an emergency situation (NPFOTC, 2000).

Medical Fitness for Sea

Individuals selected for employment with the Southeast Fisheries Science Center (SEFSC), Galveston Laboratory, as fishery observers--either as NMFS employees or contract--must be fully qualified to safely and efficiently perform the essential duties and responsibilities of their positions. You will be required to complete a Report of Medical History (Standard Form 93) to be held in a confidential file and reviewed only in the event of a medical emergency at sea. You must inform the Program Manager, in writing, of any medical condition or situation, including medications being taken, prior to departing on a vessel.

Training

Prior to your first assignment, you will receive training in safety and survival at sea. At a minimum, the training curriculum will include the following subjects:

1. Proper use of personal flotation devices and immersion suits.
2. Abandon vessel procedures and training in life raft deployment.
3. Use of emergency position indicating radio beacon (EPIRB).
4. Use of marine VHF radio, SSB radio, and satellite phone (including distress-calling procedures).
5. Basic first aid and cardio-pulmonary resuscitation (CPR).
6. At-sea and sea-air transfers.

Before Deployment on Vessel

The Commercial Industry Vessel Safety Act of 1988 required the U.S. Coast Guard (USCG) to issue regulations that require certain equipment, instructions and drills aboard vessels that operate beyond the boundary line (COLREGS) or carry more than sixteen individuals. Equipment, instructions and drills all increase your safety. Your assigned vessel almost certainly operates beyond the COLREGS line (an imaginary line drawn from points of lands, or closes passes, bays and inlets). These regulations are published in the Code of Federal Regulations (CFR), with most contained in 46 CRR. These safety regulations are outlined in the publication Federal Requirements for Commercial Fishing Industry Vessels. Specific regulations vary, depending on the type and length of vessel, location of fishing operations, seasonal conditions and other factors.

When you board a vessel, safety regulations mandate the captain to make sure you receive a safety orientation. This may be as simple as showing you around, but may include watching videos, or conducting drills. There are some important items that you need to be familiar with while on board any vessel. Check these things before you leave the dock. Aboard fishing vessels, a life-threatening emergency is possible at any time.

By law, vessels selected for participation in fishery evaluations projects that carry observers must have a current USCG safety inspection decal (appendix 1). The policy regarding vessel selection or rejection for participation in the observer program, whether the program is mandatory or voluntary, is as follows:

1. **You will not sail aboard a vessel, unless a current USCG safety decal** is displayed in the starboard window of the wheelhouse of the vessel. This is the law.

3. **Before** the vessel leaves the dock, you need to fill out the safety check off list to determine whether the minimum safety equipment is onboard. Do this before the vessel gets underway because you could find yourself the fifth person on a vessel with a four-man life raft.

If you determine that the vessel does not comply with the minimum safety equipment requirements, or for any other reason, consider the vessel unsafe in a pre-boarding survey, do not board, and immediately contact the Observer Program Manager (appendix 2).

Once you have completed your check off list, become familiar with other safety features. Somewhere, in a prominent, place you will find the station bill (NPFOTC, 2000). Below is an example of a typical station bill.

	Person Overboard Signal: 3 long blasts Repeated at least 4 times	Fire Signal: 1 long continuous blast not less than 10 seconds	Flooding Signal: 1 long continuous blast not less than 10 seconds	Abandon Ship Signal: at least 7 short blasts followed by 1 long blast
Position	Station/Duty/Bring	Station/Duty/Bring	Station/Duty/Bring	Station/Duty/Bring
Captain	Wheelhouse, radio, Maneuver vessel	Wheelhouse, radio, Maneuver vessel	Wheelhouse, radio, Maneuver vessel	Wheelhouse, radio, Maneuver vessel
1 st Mate	Throw ring, lookout	Fight fire	Plug hole, pump	Immersion suite, life raft
2 nd Mate	Don immersion suit, safety line	Assist in fire fighting	Assist plugging hole and pumping	Immersion suite, life raft
Deckhand	Communicate, assist where needed	Communicate, boundary person, remove hazards, get survival suit	Communicate, assist where needed, secure hatches	Communicate, EPIRB, count crew
Observer	Wheelhouse	Wheelhouse	Wheelhouse	Disembarkation station, immersion suit

There may be other placards posted that describe the procedures for specific emergencies. (i.e., survival craft embarkation stations, fire and emergency signal and the abandon ship signal, and detailed instructions on how to make distress calls (MAYDAY). Regulations require that instructions be available, but they may not be posted. Be sure to ask for these and review them. There should be instructions available for fires, person overboard, rough weather, and flooding.

ABANDON SHIP



SIGNAL

Seven short blasts followed by one long blast

1. Preparations should include the following as time and circumstances permit:
 - a. General **Alarm & Mayday**
 - b. All **personnel don immersion suits/PFD's**, warm clothing if time permits.
 - c. **Prepare to launch life raft**. Attach sea painter to vessel.
 - d. Assemble **signal devices** - EPIRB, flares, smokes, flashlights, handheld radios, etc.
 - e. **First Aid Kit**
 - f. **Water**
 - g. **Food**
2. Muster at embarkation station
3. When sinking is imminent or remaining onboard is inappropriate:
 - a. Launch & board life raft.
 - b. Keep sea painter attached to vessel. Be prepared to cut sea painter immediately if there is a risk or damage to life raft or vessel sinks.
 - c. Activate EPIRB & commence 7 Steps to Survival.

Drills and instructions must be conducted at least once a month. Each person onboard who has not participated in the drills and instructions must be given a safety orientation before the vessel is underway. You should take every opportunity to learn or review safety and survival procedures, and participate in any drills that are conducted (NPFOTC, 2000).

THE SEVEN STEPS TO SURVIVAL

(Modified from: AMSEA, Marine Safety Instructors Manual, 2001)

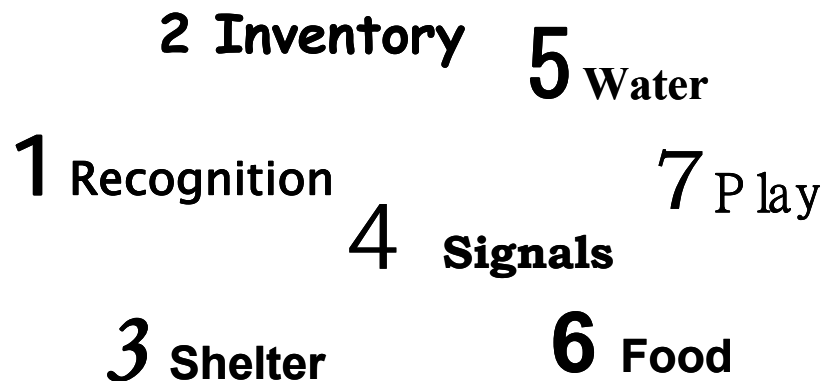

The Seven Steps to Survival were assembled by the USCG from personal experiences of those who survived emergency situations. Committing the seven steps to survival to memory should be one of your goals in learning how to survive at sea.

1. Recognition: You must quickly recognize the seriousness of the situation and that your life is in danger. Hesitation or denial may cost your life, especially in the harsh environment of Alaska.

2. Inventory: Stop and assess the situation. Decide what you have that will help you survive. Inventory your equipment, the weather, your skills, your injuries, and your mental condition. Doing so will help you make good decisions that will help you survive.

Survival Kits: A personal survival kit can take up very little space in an immersion suit, yet greatly enhance your ability to survive. Think of these seven steps and choose items that can help you with them. Items such as a knife, dental floss (a strong multi-purpose line), plastic garbage bags, matches, signal mirrors, a compass, hard candy, or bouillon cubes are small items that can save your life and fit in a zip-lock bag. Vessels may have an emergency bag stored and a person named in the station bill to bring it in case of an emergency.

3. Shelter: Your biggest enemy in Alaska is the cold. Shelter can be clothing, an immersion suit, a raft, or an overturned vessel anything that protects you against the loss of your body heat. Because water can take heat away from your body much quicker than air, shelter helps you keep as dry as possible. The high loss of heat areas such as the head and neck need to be protected the most. The added buoyancy of a PFD helps to keep the head and neck out of the water, therefore conserving heat. Once you are on shore, shelter is your first priority after you inventory the situation. It takes hours to construct adequate shelter on shore and you should do so as soon as possible

4. Signals: A signal is anything that attracts attention and conveys a message. Radios, EBIRBS, and flares are signals carried by vessels:

Radios: The emergency frequencies are Channel 16 VHF and 2182 KHz or 4125 KHz on single side band radios (SSB). VHF radios are short range and SSB radios are for long range communications. Near the radios, there will be a placard posted that describes MADAY calls. Be familiar with what constitutes a proper MAYDAY call. Vessels are required to monitor the emergency frequencies at all times. If you hear a MAYDAY call on the radio, listen carefully and take notes. Inform the person on watch and be ready to respond to the call if the Coast Guard does not.

Flares: The vessel will have flares and/or smoke signals stored in the life raft and other locations on the vessel (most likely the wheelhouse). Each type, handheld, rocket, smoke flares, etc., will have instructions for use printed on its canister. If you see a flare launched at sea, inform the person on watch immediately.

EPIRB (Emergency Position Indicating Radio Beacon): The vessel will have at least one EPIRB mounted in a float-free bracket that will be automatically activated in the event of sinking. The signal is received by satellite and, in new styles, will identify the sender. In the event of an abandon ship emergency it is an item you want to take with you. Someone will be assigned that duty on the station bill. If not shown by a crewmember, be sure to locate the EPIRB(s) on the vessel and read the directions on how to activate them.

Other Signals: Anything that makes you bigger and brighter is a signal. Immersion suits have lights attached. You may have a signal mirror in your personal survival kit. If abandoning ship, anything that can be tossed overboard may help in aircraft spot your position. In a shore survival situation, three of anything (fires, buoys, immersion suits on the beach) is an internationally recognized distress signal.

5. Water: It is recommended that humans drink two liters of water per day to stay healthy. You can live without water for days, but will suffer dehydration from the onset of any abandon ship emergency. Life rafts have limited rations of water, but it is advised to gather as much as possible before abandoning ship, if time permits. Have a strategy for gathering extra water in an emergency. Never drink seawater or urine.

6. Food: A person can go without food much longer than without water. Never eat food without water your body requires water to digest food. Life rafts are supplied with limited food rations. In a shore survival situation, many types of edibles can be found near shore. Almost any animals or green plants in the inter-tidal zones are edible, but avoid mussels or clams they may cause paralytic shellfish poisoning.

7. Play: Studies have shown that mental attitude makes a difference in a survival situation. Play can be anything that keeps you occupied and prevents your mind from dwelling on the difficulties you are facing. Play can be reading, telling jokes or stories, completing a task, or improving your shelter anything that keeps your mind active and focused.

DONNING an IMMERSION SUIT

(Modified from: AMSEA, Marine Safety Instructors Manual, 2001)

Sit on deck and work your legs into the suit. You may have to remove your boots to do so. (Putting plastic bags over them may help your legs slide in easier.)



Place your weak arm in first, and then pull the hood over your head (or hood first, then weak arm). If you have long hair, make sure that it is safely tucked in the hood. Then place your stronger arm in the sleeve.

Holding the zipper below the slide with one hand, lean back to straighten the zipper and pull the lanyard with the other hand. Secure the face flap. Do not inflate the air bladder until you are in the water.

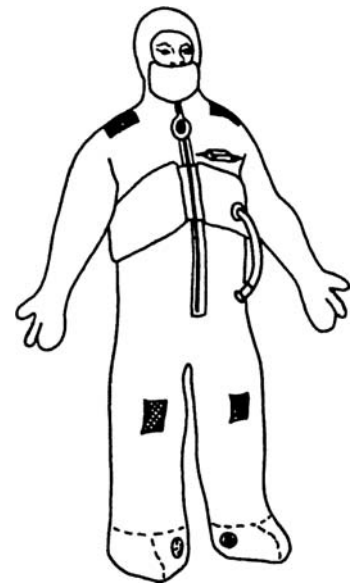

Jumping in the water is the last resort. Ease yourself into the water if possible. If jumping, protect your head and keep your feet together to protect from floating debris.

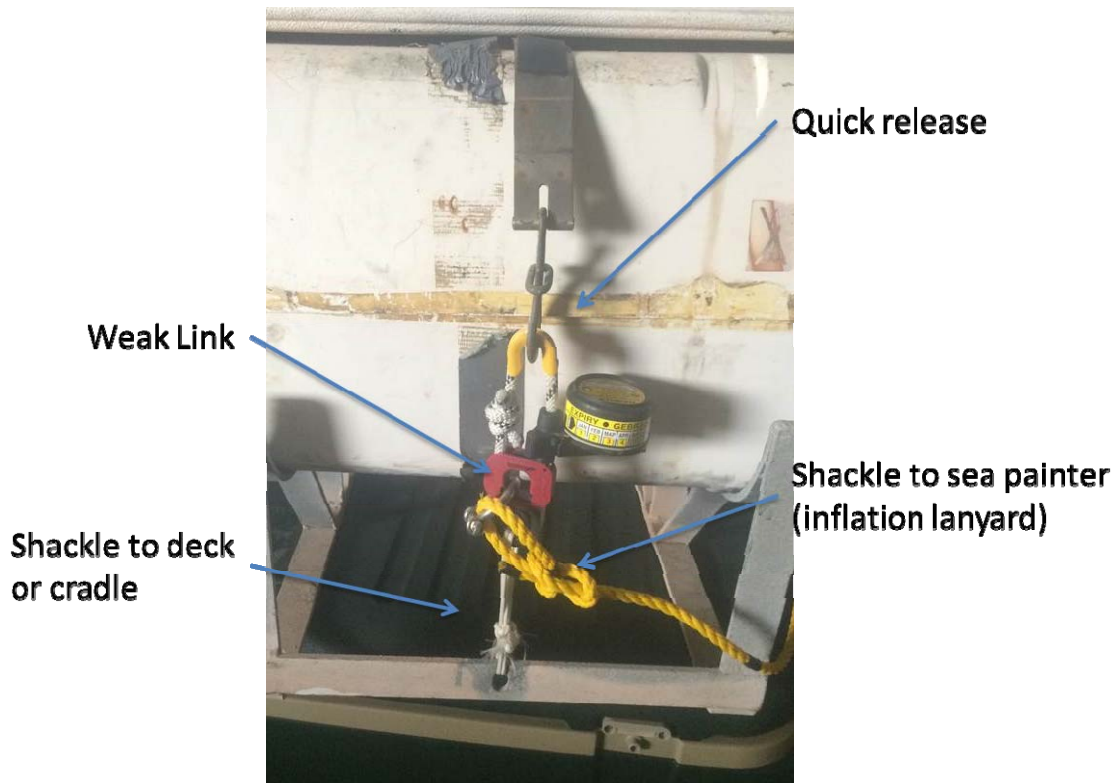
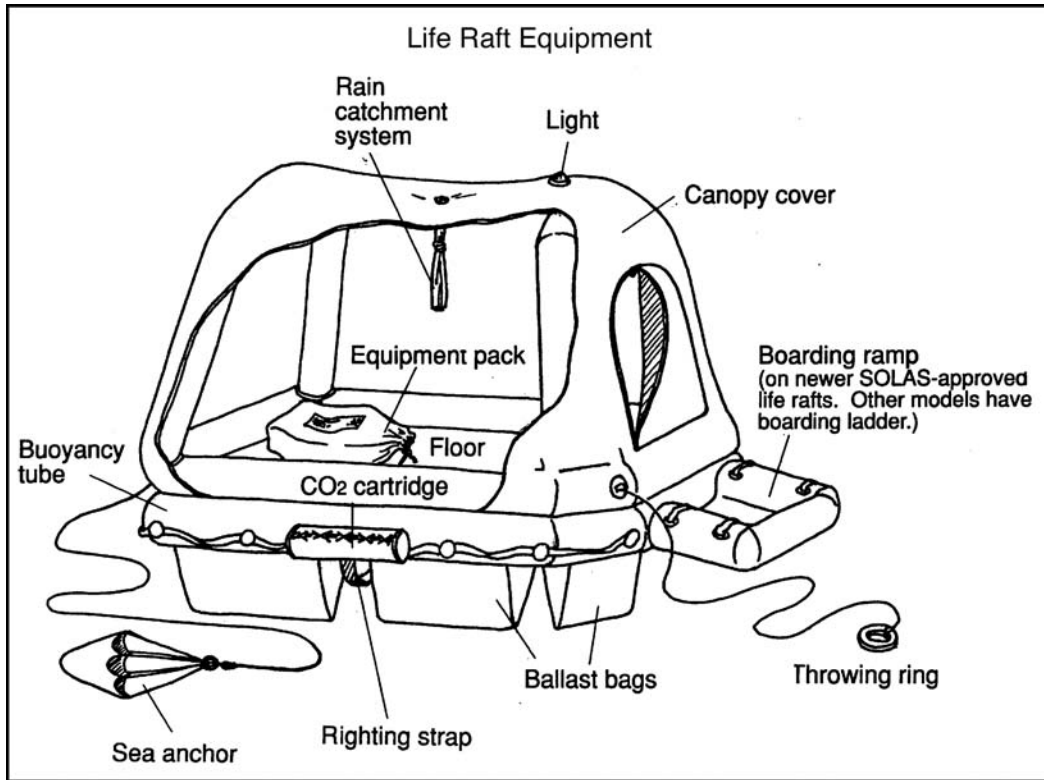

Clothing

Cotton, although very comfortable, offers little protection in a damp environment. Consider taking clothing to sea that has the ability to provide insulation when wet, like wool, polar fleece, or polypropylene. If your clothes are too warm to work in, keep them with your immersion suit. Polar fleece, polypropylene, and similar synthetics cost more than wool, but dry quickly.

Immersion suits

An immersion suit is a shelter that is required by safety regulations for everyone aboard a vessel that operates in cold water. There are different brands and styles, but all are made of neoprene, and are generally a universal size. Vessels are required by law to have an immersion suit for every person onboard. You should find where they are stored and try one on. Be sure that you can find your suit and put it on in less than a minute, even in the dark. The suits should have a working zipper (add some wax to lubricate) and a signal device, such as a strobe light attached. They should be stored in an easily accessible place.

Life rafts

Your assigned vessel will have enough life rafts or lifeboat capacity for all aboard. Life rafts are stored in canisters that allow them to float free and automatically inflate if the vessel sinks. It is much better to manually launch and inflate the raft if there is time. Know where the rafts are stored, how to remove them from the cradle, where to launch them, and how to inflate them.

SAFETY ABOARD VESSELS

The following points must be adhered to while on every vessel:

1. The first day aboard every vessel, note where the lifeboats, PFD's (Personal Floatation Devices), EPIRB (Emergency Position Indicating Radio Beacon), vessel radios, first aid equipment, and other safety devices are kept. Memorize the exit route from your cabin, the galley, and other locations where you may spend a fair amount of time.
2. It is the expectation of the observer program that you will wear a personal flotation device whenever you are working on deck, disembarking or boarding your vessel.
3. Never board or disembark a vessel alone! Always be sure someone is there to watch that you are safely on or off the vessel.
4. During your first talk with the captain, ask him to explain to you what to do in the event of a major emergency such as a fire aboard the ship, a collision with another vessel, or other conditions which might require abandoning the ship.
5. You are provided with the required protective equipment and are expected to follow the required safety policies of any vessel you are aboard.

6. Don't run aboard ships, particularly up or down stairwells. Slipping, tripping, and falling are the most common sources of observer injury. These accidents often happen when an observer is in a hurry. Specifically watch out for slick spots where the deck is wet or oily, step carefully over the half-foot combing rising from the bottom of metal latch doors and passageways, and look out for low overheads in vessel stairwells and watertight doors.
7. Lift correctly! When lifting, get as close as possible to the object, keep your back straight, and use your legs. On a moving vessel, this is critical because unexpected movements can strain your back. Don't be afraid to ask for assistance in moving heavy objects, such as full baskets.
8. When rough sea conditions severely limit the effectiveness of sampling, refrain from conducting observations and document the weather and sea conditions during these periods in your logbook. When outside make an attempt to remain in the view of others.
9. When conducting nighttime sampling, always let someone else know that you are going out on deck. Never conduct monitoring from an area that you consider unsafe.
10. Cables and lines that break under strain can be a serious hazard. Whenever a line or cable is subjected to tension, stand in a place where a backlash would not hit you.
11. Always wear gloves when handling fish. Be cautious whenever handling fish since fish spines (especially hardhead catfish) can penetrate boots and gloves and cause a painful wound. Treat all minor cuts, especially those on hands, with antiseptic to avoid infection. Poisoning from fish slime is called cellulitis and is a form of staph infection. Should a staph infection be left untreated and allowed to develop, your lymphatic system becomes involved and the threat to your health becomes serious. After handling fish, wash hands thoroughly with hot water and soap or an antiseptic such as betadine or providone iodine (1-2 oz. per qt. of water).

GENERAL SAFETY PRECAUTIONS

Staying safe aboard a vessel includes more than safety equipment.

- Avoid loose clothing or apparel with strings. Remove all jewelry prior to going out on deck. Long hair should be tied back. These items could be caught in moving equipment.

- Fatigue and sleep deprivation suffered by the crew and yourself are threats to your safety. Be aware of the physical state of those around you, whether the person is on watch or in control of the gear. Fatigued individuals make mistakes that could affect you. Follow the example of the crew and catch up on sleep when there are breaks in fishing.

- Eat well. Vegetarians (due to common meat-and potato menus) and diabetics (due to odd eating schedules) need to be especially concerned about getting a proper diet. Dietary supplements or vitamins may be helpful if this is a concern for you.

SAFETY AT-SEA TRANSFERS

At-sea transfers must be approved by the Observer Program Manager and are only to be performed in extreme cases. Transfers between vessels are potentially hazardous, especially in rough weather. You must assume responsibility for deciding whether or not to transfer based upon your evaluation of the transfer conditions. There are no hard and fast rules for allowable safety limits during transfers. Conditions such as mode of transfer, vessel size, swells versus waves, current and impending weather affect the decision to transfer. Observers must use their best judgment. Be cautious, not foolhardy. Do not be forced into transferring against your better judgment by an anxious or impatient captain. Usually the captain will determine conditions are too rough for transfer before an observer thinks it is too rough. In these cases, the observer must follow the recommendation of the captain who is responsible for the safety of the vessel and personnel aboard.

Several methods are available for transfers. Transfers between vessels may involve using a swing rope or a personnel basket. Given a choice, select the personnel basket for transfers. The swing rope can be potentially hazardous in anything but calm seas. Whenever possible, be preceded by an experienced crewman. Stepping, climbing, or jumping from one vessel to another must be executed with extreme caution and proper timing. The following general guidelines should be followed during all transfers:

1. Observers will wear PFD's, during all transfers.
2. Observers will not encumber themselves with baggage when transferring. Balance is critical and both hands must be free during transfers. Baggage should be handed across after the transfer is completed or sent across by basket or cargo net.
3. If a personnel basket is to be used, make sure a guide line is attached to the basket and manned for greater control and to reduce swinging when landing the basket on deck. Baggage should be securely stowed in the center of the personnel basket. The following procedures should be used during personnel basket transfers:
 - a. Stand with one foot on the outer ring of the basket, the other on the deck and both hands securely holding the netting.
 - b. As the basket lifts off the deck, bring your foot off the deck and place it on the outer ring of the basket net to your other foot (already on the basket ring).
 - c. Stand firmly on the outer ring with knees slightly bent as opposed to locking your knees to avoid leg or back injury in the event of a hard landing. Carefully step off the basket when it has landed firmly on the deck.

OFF-SHORE COMMUNICATIONS

Most communications from offshore locations are conducted with the use of cellular or satellite phone systems. **While offshore, observers are required to call the office every Monday, Wednesday and Friday to keep your observer coordinator up-dated on your safety status (Appendix 3), location, and progress.** If a cellular or satellite may not be available, use the vessel's radio to call the office using the marine radio operator (call collect).

You may also need to use the vessel radio to contact another vessel if your partner is aboard a different vessel monitoring at a different location. Vessel radios are also used to make a distress call during an emergency. Observers should familiarize themselves with the following information regarding vessel radios.

Radio Communications

The radios that you will encounter most often are VHF-FM (Very High Frequency Modulation), used for short range vessel to vessel and vessel to shore communication, and HF-SSB (High Frequency Single Side Band), used for communication when the stations are out of VHF range with each other. Both types offer certain advantages and each requires a specific operating procedure. The use of VHF-FM and HF-SSB radio equipment requires a station license and operator's license as well. Safety is the primary function for a radio aboard a vessel. Certain other uses are authorized but by law these are secondary to safety communications. If the vessel gives you permission to use the radio you must follow the Federal Communications Commission rules for calling and speaking. Always ask first for permission to use the radio and how to operate the radio. Use these pages as a guide for calling.

VHF-FM Radios

The VHF band is divided into 71 channels with a frequency range of 156.000 to 163.000 MHz, including 6 weather channels. By law all VHF stations are required to have at least three of these channels: channel 6, channel 16, and at least one other working channel. **Channel 16 is the International Distress Safety and Calling Channel** and is also monitored continuously by the USCG. Calls to vessels are normally initiated on this channel and then, except in an emergency, switched to a working channel once contact is established with the other vessel. Channel 6 is for ship-to-ship safety use only; it is not to be used for other than search and rescue and for the prevention of collision.

Digital Selective Calling (DSC)

VHF-FM radios have been implementing a new system since 1999, called Digital Selective Calling (DSC). DSC operates over the Rescue 21 system, the newest USCG monitoring system. DSC radios will come equipped with an "Emergency" or "Distress" button that, when pressed, will transmit a message of distress, current vessel latitude and longitude, vessel description and the POB capacity of the vessel. The DSC capable radio will then send this message in a digital burst signal of 1/3 of a second, and transmit it continuously until it is received. In order for this system to function properly, the vessel must register a Maritime Mobile Service Identity (MMSI)

and then enter it into the radio, and the radio must be either GPS capable or wired to the onboard GPS system.

HF-SSB Radios

Radio communications over distances beyond twenty miles, will require you to use a high frequency radio referred to as a Single Side Band (SSB) radio. The signal quality is inferior to VHF and susceptible to slight atmospheric shifts. Lower frequencies are used for medium distances and higher frequencies for greater distances. The USCG no longer actively monitors frequency 2182 kHz for emergencies. SSB radios should only be used for vessel-to-vessel communications.

General Calling Guidelines

Radios are different from telephones in that they cannot transmit and receive simultaneously. Keep in mind that people on other ships can also hear your conversations. Speak directly into the microphone; speaking loudly, slowly, and distinctly -- but not shouting-- can significantly improve the clarity of radio broadcasts. Upon completing a transmission, you must sign off by identifying your station and using the words "clear" or "out." If you expect to resume contact with the same station soon, you may sign off using the phrase "standing by."

Remember, in cases other than an emergency, when hailing another station on VHF channel 16 or SSB frequency 2182 you must switch to another working channel after initial contact is established. Finally, keep transmissions short and concise, giving the other station a chance to respond, ask questions, or reconfirm an unclear message. Radio transmissions should be limited to 3 minutes except for emergency calls.

General Calling Procedure

1. Make sure radio is on and appropriate channel is selected. Listen momentarily to make sure the channel is not in use.
2. Background static from the radio speaker can be reduced with the squelch control. However, too much squelch can drown out incoming transmissions. Adjust the squelch so that a small amount of static is barely audible or to the point where the static first stops.
3. If there is no traffic on that channel, begin by depressing the button on the microphone and calling the name of the vessel or other station (such as the Marine Radio Operator) you are trying to contact three times, followed by your vessel name and call sign and the channel you are broadcasting on since most ships and stations listen simultaneously to several channels. Example: CANDY WORLD, CANDY WORLD this is CRUSADER WM2418 on channel 16 over."
4. If there is no initial response to your call, wait two minutes before repeating the call. If there is no reply the hail may be repeated at two-minute intervals up to three times, after which you must sign off and wait at least 15 minutes before making another attempt.

5. If contact is established, you must switch to a working channel (VHF) or frequency (SSB) to continue your transmission.
6. When you have temporarily finished talking and are ready to listen, say "over," and release the button on the microphone. When the other party is ready to listen they will say "over."
7. After you have completed your message end with the vessel name, call sign, and the word "out" to signal the end of your transmission. Example: "... CRUSADER WM2418 out."

If you are placing a phone call through the marine radio operator, never use the government calling card number to bill the call. Instead, call the office collect. You should only call the office via radio when there is no cellular or satellite phone system available on the vessel and only for official business.

Distress Calling Procedures

Normally, the captain of the vessel will decide if and when a distress call is required. However, depending on the nature of the emergency you may be the only one able to get to the radio to make the call, therefore, you should be familiar with the procedure. A distress call is used only when a life or vessel is in immediate danger. The procedure is as follows:

1. Make sure radio is on and select channel 16 if using a VHF radio or frequency 2182 kHz if using a SSB radio.
2. Press the transmit button and speak slowly, clearly, and calmly and say, "**MAYDAY - MAYDAY - MAYDAY.**"
3. Say, "**This is (your vessel name and call sign)**" and repeat **3 times.**
4. Say, "**MAYDAY (your vessel name).**"
5. **Tell where you are. Give your present position if you know it, or describe any navigational aids or landmarks you are near.**
6. **State the nature of your distress.**
7. **Give the number of persons aboard and condition of any injured.**
8. **Estimate the present seaworthiness of the vessel.**
9. **Briefly describe your vessel providing length, type, hull, and colors.**
10. **"I will be listening on Channel 16/2182"** (use the appropriate channel).
11. End your message by saying, "**This is (vessel name and call sign) over.**"

12. Release the microphone and listen: Someone should answer. **If you do not receive an answer, repeat the above procedure. If there is still no answer, try another channel and begin again.**
13. If your situation permits, stand by your radio to provide information as requested (e.g., closest landmarks, water depth, emergency equipment onboard, etc.).

SUMMARY: WHAT YOU NEED TO KNOW ABOUT SEA SURVIVAL (NPFOTC, 2000)

It is true that you could learn much about sea safety and survival from the vessel personnel, who probably have many years of sea experience between them, but you must realize the ultimate responsibility is upon you to survive. It is easy to think “this will never happen to me” and the captain will know what to do,” but those thoughts may cost you your life. You must take the time to learn as much as you can, and consider what your actions will be in emergency situations.

The class time dedicated to these subjects serves only as an introduction to life at sea, and your life is worth far more than any data you could collect in the fishery. The following are some steps to you should take:

1. Pay close attention to all safety related materials presented.
2. Take the recommended clothing and safety equipment.
3. Before you leave the dock, completely tour your vessel, complete the check-off list and the vessel’s safety and survival equipment and procedures whether you are shown them or not.
4. Participate in any drills conducted by the vessel and discuss safety procedures with the crew.
5. Read materials and watch safety videos that are on the vessel.
6. Observe the vessel’s procedures and be familiar with the inherent dangers before you start sampling and working on deck.
7. **Take vessel safety very seriously.**

****IT IS THE POLICY OF THIS PROGRAM THAT THE OBSERVER HAS THE RIGHT TO REFUSE ANY TRIP FOR DOCUMENTED SAFETY OR HEALTH CONCERNS****

DEPLOYMENT ON VESSEL

Living Conditions

Cleanliness, upkeep, safety, comfort of quarters, quality of food, and general attitude of the vessel personnel vary from vessel to vessel. Observers must be flexible and function professionally under a wide variety of living conditions.

Guidelines developed from experience are: show respect to others and it will be returned to you. Clean up after yourself and make a conscious effort to maintain a professional

appearance. Adaptable observers with an easygoing attitude will likely receive more cooperation than those who criticize and make demands. Observers will inevitably encounter individuals who will take great pleasure in "ribbing" observers with talk of turtle soup recipes and "worthless" turtles. Don't let it bother you. The more attention you give these individuals, the longer they will continue.

Accidents and Illness Aboard

All Accidents and Illness Must Be Reported Within 24 Hours of Happening.

In the event of an emergency such as an injury or serious illness requiring hospitalization, the captain and the USCG should be contacted via radio and they will attempt a rescue and/or advise you on how to proceed. If it is you or another observer that is involved, have the USCG also notify the Galveston Laboratory, and keep them advised.

If you are injured, regardless of how minor you may perceive the injury to be you must document the incident in your log book and report it to your supervisor as soon as possible. If you become seriously injured or ill, notify the office immediately. All injuries should be reported to the vessel captain and the medic if one is aboard the vessel. Upon your return to port you must also fill out an accident report form even if no medical treatment was/is necessary. These measures are for your protection. Do not neglect your responsibilities to report injuries or illness.

Seasickness

Seasickness often hampers observers at the beginning of a trip, but most effects of seasickness disappear after a few days. Vessel motion, indigestible stomach contents, unpleasant fumes or cooking smells, and anticipatory fear will trigger seasickness. The symptoms are nausea, headache, drowsiness, and depression. This is normal; it's just difficult to live with. Typically, serious cases can cause severe dehydration and weakness. To prevent this make yourself drink water or some non-acidic juice and try to eat some mild food (soda crackers are often recommended).

Take some seasickness medication along even if you don't plan to use it. Scopolamine works very well for many people. Scopolamine is currently sold under two trade names, Transderm Scop (the "ear patches"), available only with a prescription, and Triptone, an oral, non-prescription form. Some people cannot tolerate scopolamine's side effects, which include drowsiness, dry mouth, and headache. Dramamine (the trade name of Meclizine), Bonine and Cyclizine (trade name is Marezine) are the usual over-the-counter drugs which will inhibit vomiting. The USCG formerly used Meclizine with moderate success. USCG research "found that a combination of two drugs, promethazine hydrochloride (an antihistamine, trade name Phenergan), and ephedrine sulfate (a decongestant), was by far the most effective treatment available. Similar tests on Navy and Air Force personnel corroborated the Coast Guard's results. The recommended dosage is 25 mg of each drug one to two hours prior to motion stress and at six-hour intervals as needed thereafter. This combination of Promethazine hydrochloride and ephedrine sulfate is also known as the "Coast Guard Cocktail". Promethazine hydrochloride is a prescription drug, may cause drowsiness, and ephedrine sulfate may aggravate existing cases of

hypertension. Neither drug can be taken within 12 hours after ingesting alcohol. None of the drugs mentioned here can be taken during pregnancy, and you should consult with your physician prior to taking any of these medications. It is recommended that you take one dose of a motion sickness medication as directed before you leave the dock since taking medication afterward will delay or nullify effectiveness. In addition, here are some guidelines for getting through a bout of seasickness. These actions will speed up the process of readapting:

- Try not to think about seasickness, put it out of your mind, and force yourself to think of other things.
- Take heart and build up your confidence.
- Practice releasing the tension in your muscles; as soon as you begin to feel apprehensive try and relax (desensitization).
- Avoid unpleasant smells (especially tobacco, damp clothing, fumes, and vomit). Stay away from the galley.
- Where possible, keep away from enclosed spaces, go up on deck.
- Below deck: lie down, keep your eyes closed.
- In the salon: fix your eyes on a freely suspended object.
- Seek out cool, fresh air and take calm, deep breaths.
- Reduce the amplitude of the motion stimuli: keep amid ship or astern.
- Try not to sit and let your self be rocked passively back and forth with the motion of the boat.
- When standing, avoid leaning against anything, stand erect and make active compensatory movements to keep your balance.
- Try to move your head as little as possible.
- Participate in your normal duties on board.
- At all events see a job through to the end; do not give up on it.

Determine that you will persevere through the mental and physical discomfort due to seasickness. Do not dwell on fear. It is simply a matter of adjustment. If severe discomfort persists for more than a few days let your supervisor know. ¹ Wayne Haack, Motion Sickness (Sea Kayaker magazine, Summer 1986)

OBSERVER CONDUCT

Regulations Applying to Observers

Federal fisheries observers are not exempt from laws or regulations. Observers who falsify data, accept bribes, harass other observers, or conspire with someone to do the same may face civil or criminal charges. Observers who violate Standards of Observer Behavior may face employer disciplinary action or termination from the program. Observers, who commit conflict of interest violations by having financial or employment ties to industry, may face agency administrative or civil action. The collection of reliable data is essential to the effective conservation, management, and scientific understanding of the fishery resources of the United States. As such, false data reports, conflict of interest and observer misconduct issues are dealt with very seriously.

Collection Permits

As a fisheries observer you are required to collect biological data and samples. To be legally authorized to work you are required to have **VALID** collection permits. **Valid Hard Copies of your Collection Permits** must be in your possession during each deployment. Penalties for not having valid permits (in applicable scenarios) include **heavy fines and/or imprisonment**. In addition to the Paper Copies, you are required to scan or photograph each permit and save on your phone as a digital file. This serves as a backup if something happens to your paper copies. You are responsible for replacing lost or damaged **Hard Copies As Soon As Possible**.

Authority	Permit Number
Texas Parks & Wildlife	SPR-0417-123
Louisiana Saltwater	SCP 66
Louisiana Turtle	WDP-19-076
Mississippi Collection	SRP-001-19
Mississippi Transport	SRP-002-19
Alabama Collection US DOC	None indicated.
Florida Turtle	Your name in authorized personnel, 3 possible permit #'s: MTP-19-156, MTP-19-198, MTP-19-182
Florida Saltwater	SAL-16-0128E-SR
Georgia Collection	Order #: 353892330
South Carolina Department of Natural Resources	Laminated card (includes your name only) and authorization letter.
North Carolina Endangered Species – Sea Turtle	19ST34
United States DOC NMFS Reef/Shrimp (fresh sea turtle carcass protocol change letter dated 2/7/2017)	19627
US Fish & Wildlife (**THIS EXPIRED PERMIT ONLY VALID WITH AMENDMENT LETTER**)	TE676379-5 Amendment Letter reads “United States Department of the Interior” at the top.

Standards of Observer Behavior

As an observer, you are placed in a unique situation of responsibility. The image you present and your integrity in the field affects the views of the industry towards you as an individual and towards the Observer Program in its entirety. The data you collect are critical to the effective management of the marine resources in the Southeast Fisheries. Therefore, you must adhere to the following guidelines:

1. You must perform your assigned duties as described in the Observer Manual or other written instructions from the Observer Program Office.
2. You must accurately record your sampling data, write complete reports, and report accurately any observations of suspected violations of regulations relevant to conservation of marine resources or their environment.
3. You must not disclose collected data and/or observations made on board the vessel to any person except the owner or operator of the observed vessel, an authorized officer, or NMFS.

It is the expectation of the Observer Program that you will conduct yourself in a professional manner and that you refrain from actions that could negatively affect your image as a professional and/or the image of the Observer Program. Any behavior contrary to these standards, or the intent of these standards, is grounds for decertification. You must follow your employer's conduct and behavior policy.

Your behavior when deployed as an observer not only affects you, but also the observers that follow you in the future and the image of the Observer Program as a whole.

Participation in Fishing/Vessel Operations

You are not a crewmember. You should not participate in fishing/vessel operations typically performed by crew. For instance, you should not operate fishing gear or deck equipment, stand watch in the wheelhouse, or serve as the vessel's regular cook. Observers may, however, assist crew members in catch sorting, clearing the catch from the deck, and hosing down the deck, as part of their normal duties of catch characterization, measuring of catch, and collection of biological samples. Observers may also participate in minimal housekeeping duties aboard the vessel, where housekeeping duties are shared among crew. Remember you are a guest aboard the vessel.

Discussions with the captain, prior to sailing, will clarify your role and the common sense level of assistance that is appropriate on the fishing trip, thus ensuring access to data and samples needed to complete the duties specific to your assignment. You should not be denied access to areas needed to perform sampling duties, or access to vessel instruments or readings as required for scientific logs. You should find out what areas of the vessel are off-limits to you and how best to minimize interference with fishing operations in performing your duties.

Observer Information

All observer information must be kept confidential; this includes proper handling and use of observer data. Observers must not post observer information on the internet, including but not limited to social networking sites and other file sharing sites. Observer information must not be used for personal research projects, publishing articles, or any other unofficial or unapproved purpose(s). Observer information is defined at 16 USC 1802 §3-Definitions (32): ...any information collected, observed, retrieved, or created by an observer or electronic monitoring system... including fish harvest or processing observations, fish sampling or weighing data, vessel logbook data, vessel or processor specific information (including any

safety, location, or operating condition observations), and video, audio, photographic, or written document.

Data Confidentiality and Access

Data collected by observers and recorded on data sheets and/or in scientific logs are classified as confidential. Only the vessel owner or operator, NMFS staff, and you are allowed to see the data you collect. The data will be submitted to your observer coordinator upon completion of the trip. Access to the data is strictly limited because of confidentiality rules. Therefore, the following must be strictly adhered to:

1. All program personnel working with the collection of fishery data will be required to read and sign the NOAA Administrative Order 216-100, Protection of Confidential Fisheries Statistics.
2. You will not release the data to persons other than the Observer Program Manager (or designee), or an authorized enforcement officer. You will not discuss the data with any other persons either during or after a trip, unless specifically authorized to do so by the Program Manager. This precaution is necessary to protect the integrity of the data and to fulfill assurances given on protecting the confidential nature of the data. *Never allow crew from one vessel to see any data from another vessel. Sharing another vessel's data, even inadvertently, can be grounds for termination.*
3. You must provide data sheets and/or scientific logs if so requested by an authorized enforcement officer. Data, which are collected under the authority of a mandatory data collection, are accessible to authorized enforcement personnel for the investigation of violations. Data, which are collected under a voluntary data collection program also, must be turned over to an authorized enforcement officer upon request. Use of voluntary data in enforcement actions is covered by regulations, which are presently under review.
4. Generally, the confidentiality rules do not allow data with individual identifiers to be released to the public. Only summarized data (which are pooled) are available for public release. Individual data, however, are available for agency use, including use by enforcement officials, when data are collected under mandatory programs. Also, if subpoenaed by a court of jurisdiction, confidential data must be released to other agencies, officials or individuals.
5. If requested by the captain, allow the captain to view the scientific logs, since he/she is the "supplier" of the data. Requests from crew to look at data should be referred to the captain for his/her permission.
6. If requested by other persons, you should state that the data are confidential, he/she is not authorized to release or discuss the data, and all requests for release of data should be made to the Observer Program Manager.
7. Requests for confidential data from all other persons should be made to the Observer Program Manager, who will refer the requests to the Laboratory Director who will forward the

request to the SEFSC Director and the Regional Data Base Administrator. If the SEFSC Director concurs with the request, he will recommend that the SEFSC Data Base Administrator approve access for the requesting individual. Such access may be on a one-time or more frequent basis as determined by the Data Base Administrator.

8. The Regional Data Base Administrator will implement procedures to ensure compliance with items 5 and 6.

9. Under no circumstances will individual vessel data be released to the general public, verbally or in publication. Pooled data that are not identifiable to individual vessels may be approved for release.

10. Failure of any individual to adhere to the above policy may result in disciplinary action being taken, or dismissal.

Photos and Videos

Any photos or videos taken by an observer while assigned to a vessel are the property of the National Marine Fisheries Service as defined by the Magnuson-Stevens Fishery Conservation and Management Act. This includes any photos or videos that are taken with a personal camera. Photos or videos that can be used to identify a vessel, crew, fishery, or any other potentially sensitive images are of special concern. You must protect the pictures that you take as if they were written data. For example, posting photos to the internet is not an authorized use of observer data. If you have concerns about your use of any photos taken during an assignment, contact the Galveston Observer Program. Additionally, some vessels may discourage the use of cameras on their vessels. On these vessels you do not have the right to take photos for any non-work related reasons. You should only take photos for the purposes of fish identification, turtle identification and other protected species.

Data Submission

Upon completion of your trip you have **1 week** to submit your data to the Galveston Lab. If you need more time to submit your data, the lab must be notified immediately. All observers are encouraged to contact the program staff regarding any questions about their trip prior to data submission. Once your data is received at the lab, a coordinator will check for errors in data collection, protocol, species identification, etc. An email will be generated with a list of questions, areas of concern, etc. regarding your data as well as a debriefing score. After that you will be contacted to schedule a debriefing appointment with the coordinator. Debriefing typically last less than one hour. You should have copies of all forms, logbooks, and photos available to reference during the appointment. **YOUR TRIP IS NOT OVER UNTIL YOU COMPLETE A DEBRIEFING WITH YOUR COORDINATOR.**

It is the programs policy that all new observers must be debriefed before being deployed on another vessel. This increases the quality of data collected by minimizing errors from being repeated. Observer trip data is processed for debriefing by the order received at the lab. During especially busy times of the year it may take up to 2 weeks upon arrival for debriefing,

however, data is typically processed in less than a week. When sending in your trip information the following needs to be included: all necessary forms, original logbooks, photos, photo logs, and protected species samples if applicable. Forgetting to send in all required trip information will delay the debriefing process. All trip information is to be shipped to the following address:

NOAA Fisheries
Attn: Coordinator Name
4700 Avenue U
Galveston, TX 77551

Being Subpoenaed to Testify in Court

If you are subpoenaed, bring this immediately to the attention of the Observer Program Manager. The Observer Program Manager will seek guidance through the Laboratory Director, SEFSC and SERO Administrators and from SERO and NOAA General Counsel.

Witnessing the Violations of Laws or Regulations

If you witness violations of the provisions or implementing regulations of the Endangered Species Act, Marine Mammal Protection Act, or Magnuson-Steven's Fishery Conservation and Management Act, record on data sheets or in a scientific log, the pertinent facts relative to the violation (when, what, where, etc.). The use of a code-type system is acceptable. After documenting the violation(s) you should report the violation as soon as safely possible, or on returning to port.

Boarding by USCG/NMFS Enforcement Personnel

If a vessel boarding occurs, you should introduce yourself to the boarding party and provide appropriate assistance (for example, species identification) if requested. It is not permissible for you to neither participate in discussions between the boarding party and vessel personnel nor interfere with the boarding. If you have strong objections to boarding party decisions, this should be discussed, in private, with the senior member of the boarding party or with the Observer Program Manager upon returning to port. You should not document in logbooks their objections to boarding party decisions.

If the boarding party requests to meet with you or vice versa, arrange to do so in private. To the maximum extent possible, you should avoid speaking with the boarding party in front of the captain and crew, particularly if it relates to incidents of threats, abuse or assault by the captain or crew as discussed above. If the boarding party is unwilling to discuss such matters in private, ask if they will accept a written statement instead. Whether verbal or written, the information provided should be factual, complete and accurate. Should an authorized enforcement agent request data sheets and/or scientific logs, you must turn over such records. If for any reason you feel in danger if they stay on the vessel, they should get off the vessel with the boarding party.

Threats, Abuse, or Assaults by Captain or Crew

The captain of a vessel is responsible for the conduct and actions of the crew. If you are threatened, physically or verbally abused, or assaulted by crew, the incident should be documented, in writing, and reported to the captain. Similar incidents by the captain will also be documented. All such incidents are to be reported to the Observer Program Manager immediately, both verbally and in writing.

For mandatory observer programs, the FBI and USCG will investigate such incidents. For voluntary observer programs, only incidents covered by civil law codes apply. Observers may request the USCG to remove them from the vessel if the circumstances warrant such action.

Personal Behavior

In the performance of your duties, you are official representatives of the U.S. Government and, as such, must act appropriately at all times. Observers are referred to the Standards of Ethical Conduct - for Employees of the Executive Branch. Our program policy prohibits:

1. Drinking alcohol while on duty and while off duty.
2. Using and/or distributing illegal drugs
3. Advocating personal views that are contrary to NOAA official policy.
4. Making threats.
5. Abusing power or authority.
6. Accepting gifts (this includes any part of the vessel's catch).
7. Granting interviews to the press or communications media, without prior approval.

Personal Gain

The limitations on conflict of interest and the confidentiality requirements restrict observers from using specimens or data collected while deployed as an Observer for personal gain. This includes, but is not limited to, conducting personal research projects, publishing articles, or the sale of jewelry made from fish or fish parts.

PAY ELIGIBILITY

Following is a detailed explanation of what is considered pay hours. This tends to be an area of some confusion particularly considering that you spend a great deal of time in travel status and offshore.

Work Period Policy

Employees participating in offshore bycatch research cruises are restricted to no more than 16-hour work periods per 24 hours (from 0001 to 2400). At least eight hours (consecutive or intermittent) must be taken for rest and meals. Total overtime per seven-day week cannot exceed 58 hours. This action is mainly necessary to ensure your safety aboard participating vessels. Budgetary constraints are also a factor in overtime limitations. We must ensure that funding allocated for overtime lasts for the project's duration. Again, the primary concern is for your safety.

When observers are on a vessel they are not considered totally indisposed and do not qualify to be paid 24 hours a day. This is a temporary duty station so one does not get paid unless one is working. For example, when on a vessel, the temporary duty station is the vessel. Riding vessels to the sampling site offshore does not qualify as pay status unless you are actually working. Observers get paid for working, which includes sampling catches, filling out data sheets, cleaning gear, assisting the crew, etc. No employee gets paid for eating meals. The government provides a minimum of 0.5 hours for each meal.

Example

An observer is on a vessel and cannot work for three days or is unable to work up to 8 hours per day due to inclement weather conditions. How much pay should be claimed? When at sea on a vessel you will receive a minimum of 8 hours per day. If you were finally able to work from 8 PM to midnight on a given day you get paid for 8 hours. You do not get paid 8 hours because you were unable to work normally from 8-4:30 and then an additional 4 hours for the time put in later. **During the down time period due to weather, you should be doing constructive work like filling in data sheets, proofing those already filled out, preparing trip reports, etc.**

You are not paid for:

1. Talking to crew other than directly related to work.
2. Eating or sleeping.
3. Making observations from inside the wheelhouse of a vessel, or from the porthole of your stateroom.

The time required eating, drinking, sleeping, and conversing casually with other offshore personnel does not constitute work time.

SECTION 2

DATA COLLECTION

ALL TRIPS

**NMFS GALVESTON LABORATORY
BRD/BYCATCH and REEF FISH PROGRAM**

RECEIPT

VESSEL NAME: _____ **DOC#:** _____ **LIC#:** _____

OBSERVER NAME: _____

\$ _____ **X** _____ **SEA DAYS = \$** _____

Captain's Signature _____ **Date** _____

By signature above, the vendor makes the statement they will not accept a government bank card or government purchase order as payment.

Trip Number _____

Sea Dates _____ **to** _____

Trip Number _____

Sea Dates _____ **to** _____

Trip Number _____

Sea Dates _____ **to** _____

Trip Number _____

Sea Dates _____ **to** _____

Trip Number _____

Sea Dates _____ **to** _____

**BRD/BYCATCH and REEF FISH PROGRAM
RECEIPT**

VESSEL NAME: Enter the full name of the vessel.

VESSEL DOC #: Enter the USCG documentation number or State Registration number as applicable.

LICENSE #: Enter the net license number as applicable.

OBSERVER NAME: Clearly print your full name.

To calculate the vessels total fee for each trip, complete the following:

\$ _____ X _____ SEADAYS = \$ _____

\$ _____: Vessels are paid **\$25 per day** for Mandatory Observer trips, per regulations this cannot exceed \$25 per day. For Experimental Observer trips the dollar amount varies based on the type of experiment, in this case contact your observer coordinator to determine the dollar amount per day.

X _____: Multiple the dollar amount (\$25 for Mandatory Observer trips) by the total number of days at sea. Sea days begin the day your Fishing Vessel departs from the dock and end the day the vessel returns to unload. Any part of a day spent at sea is considered a sea day.

Individual receipt cannot exceed \$2500. Generally, this does not occur for Mandatory Observer trips; however, on an Experimental Observer trip this can occur. If the total amount of the trip exceeds \$2500, you will need to generate two receipts for the trip splitting up the amount.

Captain's Signature: **The captain must sign all receipts; this is extremely important. Vessels WILL NOT BE PAID for a trip if the receipt is not signed by the captain.**

NOTE: Photo copies and/or faxes **will not be accepted**; **only** original forms with original signatures are accepted.

REMEMBER: THE CAPTAIN MUST SIGN ALL RECEIPTS. ONE RECEIPT CANNOT EXCEED \$2500. ONLY ORIGINAL FORMS ARE ACCEPTED.

**NMFS GALVESTON LABORATORY
BRD/BYCATCH and REEF FISH PROGRAM**

ACKNOWLEDGEMENT OF DATA COLLECTED

Vessel Name: _____

Observer Name: _____

Trip Number: _____ Sea Dates _____ to _____

Tow #'s: _____ to _____

Captain's Signature _____ Date _____

**BRD/BYCATCH and REEF FISH PROGRAM
ACKNOWLEDGEMENT OF DATA COLLECTED**

VESSEL NAME: Enter the full name of the vessel.

OBSERVER NAME: Clearly print your full name.

TRIP No.: Enter the Trip Number provided by Observer Coordinator.

SEA DATES: Enter the dates (departure-arrival) that you actually spent at sea.

TOW #'S: Enter the first tow number (this will always be 1) and the last tow number. Non-sampled tows are not included here.

CAPTAIN'S SIGNATURE: **THIS IS MANDATORY FOR ALL TRIPS.** At the Captain's convenience, have him sign this form. This is to verify that the data were collected.

DATA COLLECTION

The following forms are to be completed for all trip types (By-Catch and Reef Fish). They should be placed in the following order at the beginning of each trip.

1. Receipt
2. Cover Sheet
3. Trip Report pages 1, 2, and 3
4. Trip Completion Form
5. Observer Feedback Form
6. Southeast Fisheries Observer Incident Report
7. Marine Pollution (MARPOL) Incident Report
8. Safety Check off Form pages 1 and 2 (Station Bill)
9. Vessel Information Form
10. Acknowledgement of Data Collected Form
11. Photo Log (optional)

The Cover Sheet, Observer Feedback Form, Trip Completion Form, and the Southeast Fisheries Observer and Marine Pollution (MARPOL) incident reports are to be completed after the trip has been completed. The Safety Check off Form and Station Bill must be completed and e-mailed to the observer coordinators at the Galveston Laboratory prior to departure. If the vessel does not pass inspection, contact the Galveston Laboratory immediately and do not depart. If the information needed to complete the Vessel Information Form is not provided prior to the trip, you can acquire the information from the vessel's registration documents or the captain or owner.

COVER SHEET

TRIP NUMBER: _____

VESSEL NAME: _____

DATES OF TRIP: _____

OBSERVER NAME: _____

NUMBER OF TOWS/SETS SAMPLED: _____

OBSERVER SUBMITTING DATA: _____

DATE SUBMITTED TO LAB: _____ / _____ / _____

OBSERVER DATA PROOFS:

DATE 1ST COMPLETE PROOF WAS COMPLETED _____ / _____ / _____

DATE 2ND SCAN PROOF WAS COMPLETED _____ / _____ / _____

OBSERVER SIGNATURE: _____

COVER SHEETS

This form is to be placed on top of your (completed trip) data forms.

Trip No.: Enter the Trip Number provided by Observer Coordinator.

Vessel Name: Enter the full name of the vessel.

Dates of Trip: Enter the start and end date of the trip.

Observer Name: Enter your full name.

Number of Tows/Sets Sampled: Enter the number of tows/sets actually sampled.

Observer Submitting Data: Observer responsible for submitting data to NMFS/NOAA.

Date Submitted to Lab: Enter the date when data were submitted to observer coordinator.

Observer Data Proofs:

Date 1st Complete Proof was completed: Enter the date completed.

Date 2nd Scan Proof was Completed: Enter date scan proof was completed.

Observer Signature: The observer of the trip “signs off” to verify that the data are clean of errors and ready for proofing by observer coordinator.

All regional bycatch data (electronic and hard copies) are archived at the NMFS Galveston Laboratory.

TRIP COMPLETION FORM

Trip No.: Enter the Trip Number provided by Observer Coordinator.

Observer: Enter your full name.

Vessel: Enter the full name of the vessel

Trip Travel and Paperwork Summary: This section is to account all hours claimed while NOT offshore. Provide the date, amount of hours claimed, purpose of hours claimed and details of the work that was done. For travel, included cities travelled to and from along with the time of departure and arrival. Include date AND time the vessel leaves and returns to the dock. Include standby time at the dock when relevant. See example below for assistance.

Example:

Date(s) Hours Purpose (travel, paperwork, stand by) Details (locations traveled, etc.)

5/4	8	Travel 1000-1800	Galveston, TX to Bayou la Batre, AL
5/5	3	Safety Check, Standby	Safety Check 1 hr. Standby for crew 2 hrs
5/5		Left Dock	Left dock at 1100
6/1		Return to Dock	Arrive at dock 0800
6/1	9	Unload gear, Travel 0900-1700	Bayou la Batre, AL to Galveston, TX
6/3	7	Paperwork	Finished paperwork and two proofs

Coordinated With: If more than 8 hours are needed to complete paperwork onshore, authorization will need to be given by an Observer Program Coordinator. Send an email to ALL Observer Coordinators once 8 hours has been reached and request a range of time you believe it will take to complete the paperwork. Include trip number, amount of sets/tows and how much paperwork still needs to be completed. If approved, write the Observer Coordinator's name that gave approval for additional hours to complete the paperwork. See example below.

Example Email:

Coordinators,

I have reached 8 hours of paperwork on trip GB0001. There was 102 sets and multiple length frequency forms on a majority of sets. I am requesting 5-6 more hours to complete the length frequencies and to do two thorough proofs.

Observer Name

OBSERVER FEEDBACK FORM

2_18

Vessel Name: _____ Vessel I.D.#: _____ Trip # _____

Observer: _____ Date: _____

Sleeping Accommodations: _____

Shower: Yes No _____

Toilet: Yes No _____

Air Conditioning: Yes No _____

Food and Water: _____

Sampling Advice: _____

General Comments: _____

Missed Work Due to Illness or Injury: Yes No _____

Close Calls / Near misses / Hazards experienced: _____

OBSERVER FEEDBACK FORM

Vessel Name: Enter the full name of the vessel.

Vessel ID#: Enter the USCG documentation number or State Registration number as applicable.

Trip#: Enter the Trip Number provided by Observer Coordinator.

Observer: Enter your full name.

Date: Enter the date the document is filled out.

Sleeping Accommodations: Provide information about your sleeping arrangements.

Shower: Circle Yes or NO. Provide details about shower accommodations if applicable.

Toilet: Circle Yes or NO. Provide details if applicable.

Air Conditioning: Circle Yes or NO. Provide details if applicable.

Food and Water: Give general description of food and drink provided on trip.

Sampling Advice: Give sampling advice for future observers on trip. Examples include where to set up scale and/or measuring board, which side of vessel is easiest to work on, where to keep baskets, etc.

General Comments: Give comments about vessel and/or crew.

Missed Work Due to Illness or Injury: Circle Yes or NO. If yes, give detailed description of illness and/or injury and how much work was missed. Example: Seasick, missed 2 tows. Injured back, missed 3 tows.

Close Calls/Near Miss/Hazards Experienced: Give comments on any close calls, near misses or hazards experienced onboard the vessel.

SAFETY CHECKOFF FORM

Observer Name _____ Trip Number _____
Vessel Name _____ Vessel Doc Number _____

Safety Check list - ("NO GO" Deficiencies Highlighted)

USCG Safety Exam Decal # _____ Expiration Date: _____ / _____ Distance Rating: _____
(Month/Year)

Life Saving Equipment

Life Raft Type: SOLAS A, SOLAS B, Lifefloat, IBA, NONE, or Other:

(Circle One or if other reference in space provided)

Expiration Date: _____ / _____
(Month/Year)

Capacity? _____

Life Raft Hydrostatic Release Expiration Date: _____ / _____

(Month/Year)

Total # of People Onboard: _____

(This number is including the Observer, Can not exceed capacity)

Life Raft Hydro Setup Correct: Y or N

EPIRB Location: _____

EPIRB Battery Expiration Date: _____ / _____
(Month/Year)

EPIRB Hydrostatic Release Expiration Date: _____ / _____

(Month/Year)

EPIRB Registration: _____ / _____ / _____
(Month/Day/Year)

Is this EPIRB registered to this vessel? Y or N

Personal Flotation Device for each person on board (POB)? Y or N Location(s): _____

Immersion Suit for each POB? Y or N (only required above 32'00 N latitude)

Orange Ring Buoy(s) with Line attached? Y or N Location(s): _____

Distress Flares? Location(s): _____

Expiration Date for each distress flare.

Parachute _____
(Month/Year)

Hand _____
(Month/Year)

Hand _____
(Month/Year)

Smoke _____
(Month/Year)

Parachute _____
(Month/Year)

Hand _____
(Month/Year)

Hand _____
(Month/Year)

Smoke _____
(Month/Year)

Parachute _____
(Month/Year)

Hand _____
(Month/Year)

Hand _____
(Month/Year)

Smoke _____
(Month/Year)

Fire Fighting Equipment

Fire Extinguishers Charged? Y or N

Location 1: _____

Location 2: _____ Location 4: _____

Communication Equipment

Vessel Call Letters: _____

Single Side Band

VHF

Satellite Phone # (if applicable)

Vessel Cell Phone # (if applicable)

Other First Aid Kit? Y or N Location(s): _____

Ditch Bag? Y or N Location(s): _____

Vessel Safety Orientation? Y or N

General Alarm Tested? Y or N High Water Alarm Tested? Y or N

Engine on/off, steering, gear selection, etc.? Y or N Entrapment: exit routes? Y or N

Hazardous: hatched, winches, machinery, lines, slippery areas, stability concerns etc.? Y or N

SAFETY CHECK OFF FORM STATION BILL

Trip # _____

	Person Overboard Signal:	Fire Signal:	Flooding Signal:	Abandon Ship Signal:
Position	Station/Bring/Duty	Station/Bring/Duty	Station/Bring/Duty	Station/Bring/Duty
Captain				
Crew				
Crew				
Crew				
Observer				
Date Drill Performed				

Detailed Description of Vessel and Comments: _____

Fishing Vessel USCG Safety Requirements for the WARM WATERS of the Gulf of Mexico and South Atlantic

These safety requirements are determined by the fishing location

Fishing Location	Inside the Boundary Line Within 3 Nautical Miles	Within 12 NM of Coastline (Boundary Line)	12 to 20 miles of Coastline	Between 20 & 50 miles	Over 50 Nautical Miles
Survival Craft Equipment	No Survival Craft Required	No Survival Craft Required	Float free Life Float with light and line	Inflatable Life Raft with SOLAS B pack or Coastal Service Pack	Inflatable Life Raft with SOLAS A pack or Ocean Service Pack
EPIRBs	Not Required	Required	Required	Required	Required
Distress Signals	3 Red Flares OR 3 other flares with a night signal	3 - 6 - 3 (Parachute - Hand - Smoke)	3 - 6 - 3 (Parachute - Hand - Smoke)	3 - 6 - 3 (Parachute - Hand - Smoke)	3 - 6 - 3 (Parachute - Hand - Smoke)

*RED flares include parachute and hand flares which can be seen both day and night.

These safety requirements are determined by the vessel size

Vessel Size	Vessels < 26 feet long	Vessels 26 to 40 feet long	Vessels < 65 feet long	Vessels ≥ 65 feet long
Life Rings	1 Buoyant Cushion OR 1 Orange Life Ring	1 Orange Life Ring with 60 feet of line	1 Orange Life Ring with 60 feet of line	3 Orange Life Rings 1 with 90 feet of line
Fire Extinguishers	at least 1	1 to 2	2 to 3	2 in the Bridge, 1 in the Galley AND 2 in the Engine Room

* make sure fire extinguishers are charged and strategically placed around vessel (galley & engine room & near exits)

To be completed by captain:

Sampling protocol has been explained by observer and is understood. Yes ____ No ____

Wheel watch while underway requirement has been explained by observer and is understood. Yes ____ No ____

Observer Signature and Date: _____ / /

Captain Signature and Date: _____ / /

SAFETY CHECK OFF FORM

Observer Name: Enter your full name.

Trip Number: Enter the Trip Number provided by Observer Coordinator.

Vessel Name: Enter the full name of the vessel.

Vessel Doc Number: Enter the USCG documentation number or State Registration number as applicable.

USCG Safety Exam Decal #, Expiration date, Distance Rating: Enter the USCG Safety Decal number, expiration date and vessel distance rating found on the USCG decal. If the vessel is missing the decal, you **MUST** ask the captain for the USCG Safety Examination paperwork.

Life Raft Type, Expiration Date, Capacity: Circle the type of life raft found on the vessel. If the type of life raft is not listed on the for, write in the type next to Other. Enter the life raft expiration date and capacity found on the life raft.

Life Raft Hydrostatic Release Expiration Date: Enter the Month and Year the life raft hydro expires.

Total # of People Onboard: Enter the TOTAL number of people that will be onboard for the trip.

Life Raft Hydro Setup Correct: Check to see if the life raft hydro is set up correctly. If so circle Yes. If not circle No and call the lab.

EPIRB Location: Give a brief description of where the vessel EPIRB is located. Example, Port side on top of wheelhouse.

EPIRB Battery Expiration Date: Enter the Month and Year of the expiration date of the vessel's EPIRB battery.

EPIRB Hydrostatic Release Expiration Date: Enter the Month and Year the EPIRB hydro expires.

EPIRB Registration: Enter the Month, Day and Year the vessel EPIRB's registration expires.

Is this EPIRB registered to this vessel? Check the NOAA Registration sticker on the vessel's EPRIB to make sure it is registered to the vessel. If so, circle Yes. If not, circle No and call the lab.

Personal Flotation Device for each person on board (POB)?, Locations: Check the vessel to make sure there are enough PFDs for everyone onboard. If so, circle Yes and write the location they are found onboard. If not, circle No and call the lab.

Immersion Suit for each POB? This is only required on vessels North of 32 degrees. Circle Yes or No.

Orange Ring Bouy(s) with Line Attached?, Locations: Check the vessel for Orange ring bouy(s) with the vessel's name printed on it and line attached. If so, circle Yes and give the location(s) found on the vessel. If not, circle No and call the lab.

Distress Flares? Location(s): Enter the location the flares are stored onboard.

Expiration Date for each distress flare: Check each flare and write the Month and Year each flare expires.

Fire Fighting Equipment: Enter the location(s) fire extinguishers are found onboard.

Fire Extinguishers Charged?: Check each fire extinguisher to make sure they are charged to appropriate levels. If so, circle Yes. If not, circle No and call the lab.

Communication Equipment: Enter the number of working single side band and VHF radios found onboard on corresponding lines. If the vessel has a satellite phone or cell phone, enter the phone number on the corresponding line.

First Aid Kit?: Check the vessel for a first aid kit. If so, circle Yes and give its location found onboard. If not, circle No and call the lab.

Ditch Bag?: Ask the captain if the vessel has a ditch bag.. If so, circle Yes and give its location found onboard. If not, circle No.

Vessel Safety Orientation: If you were given a safety orientation, circle Yes. If not, circle No. If you were given a safety orientation, circle the appropriate answer to the questions regarding the safety orientation.

Station Bill: Ask the captain for the vessel's station bill. If the vessel does NOT have a station bill, ask the captain what everyone's duties are in the case of each emergency listed on the station bill.

Detailed Description of Vessel and Comments: Give a brief description of the vessel that would help identify it in the case of a search and rescue operation. Example, 69-foot shrimp trawler with a forward house. The wheelhouse is painted Blue and the hull is painted Red with Black trim.

Sampling Protocol: Explain to the captain what your sampling protocol is and what is expected of the captain and crew for reasonable assistance. Have the captain check Yes or No that you explained sampling protocol.

Wheel Watch: Explain to the captain that while the vessel is underway, someone needs to be alert on wheel watch. The observer is NOT allowed to be a wheel watch on a commercial vessel. Have the captain check Yes or No that you explained the policy on wheel watch.

Signatures: You and the captain must sign and date the safety check to indicate the safety check has been performed and valid.

OVATEK CHECKOFF FORM

Observer Name _____ Trip Number _____

Vessel Name _____ Vessel Doc Number _____

MINIMUM REQUIREMENTS

SOLAS A > 50 nm

Expiration Date for each item listed: Flares **MUST BE** SOLAS approved.

Parachute _____ Hand _____ Hand _____ Smoke _____
(Month/Year) (Month/Year) (Month/Year) (Month/Year)

Parachute _____ Hand _____ Hand _____ Smoke _____
(Month/Year) (Month/Year) (Month/Year) (Month/Year)

Parachute _____ Hand _____ Hand _____
(Month/Year) (Month/Year) (Month/Year)

Parachute _____
(Month/Year)

First AID Kit _____ Seasick Pills _____ Food Ration _____ Water _____
(Month/Year) (Month/Year) (Month/Year) (Month/Year)

SOLAS B < 50 nm

Expiration Date for each item listed:

Parachute _____ Hand _____ Smoke _____
(Month/Year) (Month/Year) (Month/Year)

Parachute _____ Hand _____
(Month/Year) (Month/Year)

Hand _____
(Month/Year)

First AID Kit _____ Seasick Pills _____
(Month/Year) (Month/Year)

Comments: _____

OVATEK CHECKOFF FORM

Observer Name: Enter your full name.

Trip Number: Enter the Trip Number provided by Observer Coordinator.

Vessel Name: Enter the full name of the vessel.

Vessel Doc Number: Enter the USCG documentation number or State Registration number as applicable.

Check the USCG safety decal for the distance rating for the vessel. If the distance is greater than 50nm, use the checklist for SOLAS A. If the distance is less than 50nm, use the checklist for SOLAS B.

SOLAS A: Check the survival pack contents to check the expiration dates. For the flares, first aid kit, seasick pills, food rations and water enter the Month and Year each expires. Make sure the water, food rations and seasick pills are unopened. Check the first aid kit to make sure it is fully stocked.

SOLAS B: Check the survival pack contents to check the expiration dates. For the flares, first aid kit and seasick pills enter the Month and Year each expires. Make sure the seasick pills are unopened. Check the first aid kit to make sure it is fully stocked.

REGULATIONS AND COMPLIANCE

The primary responsibility of National Marine Fisheries (NMFS) trained observers is to collect scientific data for management of the fishery. However, an important function of observers is to also collect information on potential violations that occur during observer deployments on vessels. These potential violations are reported by NMFS to Office of Law Enforcement (OLE), the United States Coast Guard (USCG), and, in some cases both. **Observers are not enforcement agents and thus are not authorized to issue citations, and must not advise the crew of regulations, interpret regulations, waive regulatory requirements, or enforce regulations.** This long-standing NMFS policy is designed to draw a clear distinction between the data collection and reporting requirements of observers and the enforcement of regulations by OLE. This separation of responsibilities serves to protect observers from harassment, intimidation, or assault that might occur if an observer were to attempt to enforce potential violations during an at-sea deployment (NOPAT, 2014).

Federal Regulations provide clear and unambiguous language prohibiting anyone from assaulting, harassing, opposing, impeding, intimidating, or interfering with a NMFS-approved observer (50 CFR §600.725(o), (t), and (u)). Not surprisingly then, all observer programs collect data on potential violations that are considered serious, affect observer safety, involve observer assault or harassment, or include other major violations. Furthermore, when cases of alleged assault, harassment, or interference are reported by an observer, the information is immediately relayed from the observer programs to OLE (NOPAT, 2014).

The NMFS Southeast Observer Programs and NOAA OLE Southeast Division have established guidelines for the referrals of potential violations (SEFSC, NOAA OLE, 2013). Recognizing that Southeast Observers are not trained in the enforcement of Federal fisheries laws or regulations, the information provided from the Southeast Observers will be considered as witness information. The safety of the Southeast Observers onboard is the individual's first priority.

Vessel owners and operators can access the full text of fishery regulations at <http://sero.nmfs.noaa.gov>. All questions regarding Observer Program policies and/or sampling procedures should be referred to a Galveston Observer Program staff member, see Appendix 2 "NMFS Galveston Contacts" on page 7-2. For a list of potential violations see Appendix 18 "Reef Fish and Shrimp Observer Issues" on page 7-19.

The International Convention for the Prevention of Pollution from Ships (MARPOL) and five annexes are international agreements designed to halt at-sea disposal of wastes. MARPOL Annex V specifically prohibits the at-sea disposal of all plastics. It also eliminates the discharge of other types of vessel-generated garbage to specific distances from land. At-sea disposal restrictions apply to commercial and publicly owned vessels of all sizes and classes. Vessels complying with MARPOL Annex V have three options for dealing with wastes: 1) non-plastics can be disposed of at sea within the legal restrictions, 2) they can incinerate wastes onboard the vessel, or 3) they can hold the wastes for shore side disposal at port (adapted from NPOP, 2014).

Documentation of Potential Violations

This section (adapted from NPOP, 2014) contains information that will assist you to fulfill your role in monitoring for and documenting compliance information and suspected potential violations. This includes how to handle potential violations, how to effectively document and communicate potential violations, and information to inform and support you during and following deployment.

Observers are required to report accurately any observations of potential violations relevant to the conservation of marine resources, the environment, and observer safety. Detailed and thorough documentation is essential to quality scientific data and compliance information. The observer's role in monitoring compliance is quite different from the role of a NOAA Fisheries Enforcement Officer. Observers are not enforcement and do not issue citations, or take enforcement action.

The Observer Logbook is frequently the primary document used by enforcement as evidence of fishing violations. Writing a statement is much easier if potential violations are documented in the logbook. Unauthorized release of observer information contained within an Observer Logbook is a violation of the Magnuson Stevens Act. **Special care must be taken to safeguard observer information as confidential and to protect it from tampering.**

What do I Document

Document factual information about each potential resource violation. Be thorough and objective. Objective documentation is critical to clearly conveying compliance information. Subjective comments, such as opinions and conclusions must be left out.

All logbook entries of suspected violations should contain the following basic elements:

Who: Identifying characteristics such as: Names (vessel or person), nicknames, tattoos, permit numbers, job title/position on the vessel, witnesses, and anyone involved in resolving the incident.

What: Describe the events and circumstances in narrative form. Include information leading up to the event and following, any resolution to the situation (if any), and the number of times the event occurred quantify where appropriate.

When: Identify the time and date of the suspected violation. If estimating a time, give other details that may help identify the time, such as tow or set number, trip number, where fishing occurred, etc.

Where: Identify the vessel's position as specifically as possible at the time of the suspected violation or where the event occurred on board the vessel.

Why and How: Document observations and any conversations with the crew members. Be as objective as possible and cite factors which may provide mitigating or aggravating information. Consider the following questions:

- Were there circumstances beyond the control of vessel such as severe weather, mechanical breakdowns, or injuries?

- Was the suspected violation intentional? If so, on whose orders, or with whose knowledge and why?

Describe any effect the potential violation had on your ability to perform your observer duties.

Documented potential violations will be discussed with your debriefer. You may be asked to clarify your notes or to complete a written statement describing the events, if not previously filled out.

SEFSC, OLE. 2013. Guidance for Referral of Potential Observer Violations to NOAA OLE Southeast Division.

NPOP, 2014. Observer Sampling Manual North Pacific Observer Program.

NOPAT, 2014. National Review of Observer Program Policies and Procedures with Recommendations (in revision).

SOUTHEAST FISHERIES OBSERVER INCIDENT REPORT

Trip Number: _____ Vessel Name/Doc #: _____

Observer: _____

Did you witness any drug and/or alcohol usage, or other unsafe operations that you feel affected your safety or impeded your duties while offshore? (Circle one) YES or NO. If YES, explain below and use attached sheets if needed.

Did you witness any fishery violations? (Circle one) YES or No. If YES, explain below and use attached sheets if needed.

I have read this statement consisting of _____ page(s) and have initialed all corrections. I fully understand its entire contents and declare under penalty of perjury under the laws of the United States of America that the forgoing is true and correct.

Signature

Date

Address and Phone

Page ____ of ____

SOUTHEAST FISHERIES OBSERVER INCIDENT REPORT INSTRUCTIONS

This form will be completed for each observed trip, regardless of if a violation was documented or not. Observers are expected to record anything they believe may be a violation. *Waiting until the vessel's return or debriefing to ask if something should have been reported as a violation is unacceptable.* If there is ANY question about if an action or activity was a violation, report it and your Program Staff will consult with OLE/USCG as applicable to determine if a violation has occurred. If during debriefing your Program Staff notices something in your data that indicates a violation has occurred, but this form does not indicate a violation has occurred, you will be required to resubmit a revised version of this form with the violation documented.

Trip Number: This will be the identification number assigned by your observer program for the trip you were deployed.

Vessel Name/ID: Provide the name of the vessel you were deployed, and the USCG documentation number or State Registration number as applicable.

Drug/Alcohol use: If you did not witness drug or alcohol use that you feel affected your safety, please circle "NO" and continue to the next question. If you did witness drug and/or alcohol use that you feel created an unsafe situation on board the vessel, please document it fully, using the back of the form or supplemental pages as needed. Documentation should be clear and specific, and should answer the following questions: WHO, WHAT, WHERE, WHEN, and HOW. Examples of unacceptable documentation and acceptable documentation are below:

Unacceptable: "Captain drank a lot this trip."

Acceptable: "I witnessed the vessel Captain, John Doe, apparently inebriated on at least two occasions during this trip. The first was on January 15th 2013 when between approximately 1300 and 1800 the Captain drank no less than eight 12 ounce beers while in the wheelhouse piloting the vessel to the next set location. When I went to the wheelhouse around 1800 to ask how much longer the trip would be lasting Captain Doe's speech was noticeably slurred. The second time was 2 days later (January 17th, 2013) when between 1400 and 1800 Captain Doe consumed 10 eight ounce beers. When I went to the wheelhouse for my daily discussion with the Captain around 1800, I noticed the wheelhouse smelled like marijuana smoke and Captain Doe was asleep with the vessel on autopilot and had not informed any of the other crew to stand watch. I noticed that on channel 16 on the VHF radio (which had the volume turned down a bit) that a vessel appeared to be hailing an unnamed vessel in our vicinity. Simultaneously I observed a freighter approximately 3 miles off our port bow on what appeared to be a collision course. I woke the Captain and informed him of the situation. He altered the course of our vessel but did not engage in any communication on the VHF radio. In our subsequent conversation his voice was again slurring."

Fishery violations: If you did not witness any suspected/potential fishery, please circle "NO" and continue to the next question. If you did witness such suspected or potential violations, please document it fully, using the back of the form or supplemental pages as needed. Documentation should be clear and specific, and should answer the following question: WHO,

WHAT, WHERE, WHEN, HOW. Examples of unacceptable documentation and acceptable documentation are below:

Unacceptable: "Captain tried to harass a dolphin."

Acceptable: "I witnessed the captain try to injure a dolphin on September 12/20/13 at approximately 0800. The captain noticed a dolphin was feeding on his catch and tried to scare the dolphin away. He then used a nearby gaff to try to get the dolphin away from the lines. Eventually the dolphin left the area and did not appear injured by the captain's attempts. We began to haul gear back about 10 minutes later, our position at that time was 28 degrees 48 minutes N Lat and 94 degrees 20 minutes W."

Affidavit Section: The observer must fill in their name, date, and sign the statement even if they are claiming they did not witness a violation.

MARINE POLLUTION (MARPOL) INCIDENT REPORT INSTRUCTIONS

This form will be completed for each observed trip, regardless of if a violation was documented or not. Observers are expected to record anything they believe may be a violation. *Waiting until the vessel's return or debriefing to ask if something should have been reported as a violation is unacceptable.* If there is ANY question about if an action or activity was a violation, report it and your Program Staff will consult with OLE/USCG as applicable to determine if a violation has occurred. If during debriefing your Program Staff notices something in your data that indicates a violation has occurred, but this form does not indicate a violation has occurred, you will be required to resubmit a revised version of this form with the violation documented.

Trip Number: This will be the identification number assigned by your observer program for the trip you were deployed.

Vessel Name/ID: Provide the name of the vessel you were deployed, and the USCG documentation number or State Registration number as applicable.

MARPOL violations: If you did not witness any suspected/potential MARPOL violations, please circle "NO" and continue to the next question. If you did witness such suspected or potential violations, please document it fully, using the back of the form or supplemental pages as needed. Documentation should be clear and specific, and should answer the following question: WHO, WHAT, WHERE, WHEN, HOW. Examples of unacceptable documentation and acceptable documentation are below:

Unacceptable: "Crew threw a lot of trash, including plastics, overboard."

Acceptable: "I witnessed virtually all crew members of this vessel throwing trash overboard during the entire trip. Specific examples include: on September 12/20/2013 at approximately 0800 I saw a deckhand (who was only referred to as "Timmy" during the trip) throw over the side and into the water two full plastic trash bags. In addition to the plastic trash bag there were numerous other plastic wastes in the bags including empty milk and soda containers, food packaging, etc. We began to haul gear about 10 minutes later, our position at that time was 28 degrees 48 minutes N Lat and 94 degrees 20 minutes W lon. The next day (the 21st) the vessel had a large tangle of monofilament gear which had to be cut away. There was at least 90-100 feet of mainline, gangion, and dropline monofilament that was thrown over the side at approximately 1050; the position was 27 degrees 18 minutes N Lat and 94 degrees 01 minutes W Lon. The individuals who threw the line over were the vessel Captain John Smith and Timmy".

Affidavit Section: The observer must fill in their name, date, and sign the statement even if they are claiming they did not witness a violation.

VESSEL INFORMATION FORM

ORG PRO
[] [] [] [] [] [] [] []

TRIP NO.

[] [] [] []

VESSEL CODE

[] [] [] []

OBSERVER

MO DY YR
[] [] [] [] [] [] [] []

DATE: START OF TRIP

MO DY YR
[] [] [] [] [] [] [] []

DATE: END OF TRIP

VESSEL NAME: _____

OBSERVER NAME: _____

VESSEL ID # _____ VESSEL LENGTH (ft): _____ YEAR VESSEL BUILT: _____

VESSEL TYPE (CIRCLE ONE): FREEZER or ICE BOAT

MATERIAL OF HULL CONSTRUCTION (CIRCLE ONE): STEEL WOOD FIBERGLASS FIBERGLASS/WOOD

GROSS TONNAGE: _____ HORSEPOWER OF ENGINE: _____

CREW SIZE (WITHOUT CAPTAIN): _____

This # does not include observers

OWNER NAME: _____

OWNER ADDRESS: _____

CAPTAIN'S NAME: _____

OWNER'S OR CAPTAIN'S SIGNATURE: _____

VESSEL INFORMATION FORM

Trip No.: The trip number will be assigned to you by the Observer Coordinator. The trip number consists of five or six characters: The first character refers to the organization conducting the project.

G = NMFS, Galveston Laboratory
F = Foundation, Gulf of Mexico
S = Foundation, South Atlantic

T = Texas Shrimp Association
D = Georgia DNR
N = North Carolina Sea Grant/
State Resource Agency

The second character refers to the project type.

By-Catch Project Types:

A = South Atlantic Mandatory Penaeid Shrimp
B = BRD Evaluation
C = Bycatch Characterization
D = Deep Water Royal Red
E = Effort
F = Flynet
G = BRD Certification, Gulf of Mexico
H = North Carolina Blue Crab
I = Skimmer Trawl (Mandatory)
L = Experimental Skimmer (TED evaluations)
M = Modified Bycatch Characterization
N = Naked Net (TED alternative)

P = Electronic Monitoring - Pink Shrimp
(Sawfish)
R = Red Snapper Initiative/
Gulf Mandatory Penaeid Shrimp
S = BRD Certification, South Atlantic
T = TED Evaluation
W = South Atlantic
Mandatory Rock Shrimp
X = Rock Shrimp Characterization
Y = Rock Shrimp BRD Evaluation
Z = Soft TED Evaluation

Reef Fish Project Types:

B = Bandit Reel
H = Handline
L = Longline
J = Modified Buoy (JUG)
K = Shark Longline

E = Electronic Monitoring - Longline
F = Hook Timer
C = Shareholders Alliance Project
S = Spear Fishing

The third through sixth characters identify the number of the trip.

Vessel Code: Enter the vessel number provided by observer coordinator. For repeat trips on the same vessel, use the same code. (Note: if code is not supplied, **leave it blank, do not make one up**. The Observer Coordinator will generate the code and fill in the information when the trip is received at the lab.).

Observer Code: Enter the Observer Code provided by observer coordinator (this code will never change).

Date: Start of Trip: Enter the starting date of the trip (mo/dy/yr).

Date: End of Trip: Enter the ending date of the trip (mo/dy/yr).

Vessel Name: Write the vessel's full name.

Observer Name: Print your full name.

Vessel ID #: Enter the State or Federal vessel registration number.

NOTE: The following information can be found on the vessel's registration paperwork. Ask the captain for the form.

Vessel Length (ft.): Enter the total or keel length in feet (make note if it's a keel length). Get this information from the Captain.

Year Vessel Built: Get this information from the Captain.

Vessel Type (circle one): Freezer or Ice Boat.

Material of Hull Construction (circle one): Steel, Wood, Fiberglass, or Fiberglass/Wood (fiberglass covering a wood boat).

Gross Tonnage: Get this information from the Captain.

Horsepower of Engine: Get this information from the Captain.

Crew Size (without captain): Enter the number of crew members minus the captain.

Owner Name: Enter the owners' full name.

Owner Address: Self-explanatory.

Captain's Name: Self-explanatory.

Owner's or Captain's Signature: Self-explanatory.

PHOTO LOG

Trip#:

Observer Name:

Vessel Name:

Trip Dates:

- 1.
- 2.
- 3.
- 4.
- 5.
- 6.
- 7.
- 8.
- 9.
- 10.
- 11.
- 12.
- 13.
- 14.
- 15.
- 16.
- 17.
- 18.
- 19.
- 20.
- 21.
- 22.
- 23.
- 24.
- 25.
- 26.
- 27.
- 28.
- 29.
- 30.
- 31.
- 32.
- 33.
- 34.
- 35.
- 36.
- 37.
- 38.

PHOTO LOG

Photo Requirements: You are required to take at least one photo of all species represented on your characterization/length frequency forms (for shrimp AND reef). For all new species encountered, as well as frequently misidentified species on reef vessels multiple pictures are requested. In addition, you are required to submit photos of all gear on shrimp vessels. For species you cannot positively identify and sharks, take at least 2 clear photos, at different angles, displaying characteristics useful in the identification of those species.

Photo Log: There are two acceptable ways to complete a photo log. The first way is to rename the picture files on the photo CD you MUST submit with every trip. The second way is to fill out a written photo log. Write the file name and then corresponding details of the phot next to it. Example, 1. DSC00825, red snapper.

See next page for proper layout of written photo log.

SECTION 3

BY-CATCH

DATA COLLECTION

BY-CATCH DATA COLLECTION

BRD Evaluation

Vessel length, hull construction material, gross tonnage, engine horsepower and crew size will be obtained for each vessel (Vessel Information Form). For each trawl haul (the location of gear placement at a defined time) the type, number and construction material of the fishing gear will be recorded (Gear Specification Form).

Latitude, longitude, and depth are recorded at the start of each tow (Station Sheet). The time the gear remains in the water (soak or fishing time) will also be calculated based on Time in (the time the nets are set) and Time Out (time at the start of haul back).

Bycatch Reduction Evaluation

Comparisons of catch data for nets equipped with BRD/TED gear combinations will be conducted. The total catch weight, total shrimp weights, and red snapper lengths and total weight will be obtained from the sampled experimental nets. A subsample of approximately 32 kg (one shrimp basket ~ 70 lbs.) from each sampled net will be processed for bycatch characterization. **NOTE: If an observer is placed on a vessel with control nets, it will be a special project and further protocol will be given at that time.**

Before the boat departs the dock, you will need to get with the captain and crew to discuss the sampling protocol and how to accomplish the objectives of the mission. The following guidelines will help you with some of the items that need to be addressed regarding these procedures.

1. **Gear Measurements:** Before departure, become familiar with the vessel's net gear and rigging. The trawl nets are referenced in the data forms by their "net" position on the vessel (Appendix 4 thru 8). The nets are numbered 1 through 4. Net position 1 denotes the outside port net and number 4 representing the outside starboard net on a 4 net-rigged vessel. On a two-net vessel, the nets are numbered 2 for port and 3 for starboard. On a 4-rig vessel, only sample the number 1 and number 4 positions to eliminate possible bias from the trynet and the engine wash. If the vessel has only two nets, sample the net not behind the try net for the duration of the trip. However, you need to fill out gear sheets for both nets 2 and 3. Complete a Gear and TED/BRD Specification form for each net used for testing or sampling. Tell the captain the information and measurements you need to complete the forms and discuss any safety issues concerning gear use (i.e., where to and not to stand when the nets are brought on board the boat).

2. **Mark Nets:** Next you need to mark the sample nets for easy recognition. Discuss this with the captain, but usually a brightly colored piece of twine tied to the middle of the sampled codends or tie off ropes will work.

3. **Electronic Scale Location:** Before you begin sampling you and the captain need to determine the best location for weighing your sample baskets. As a general rule, the best location to avoid

excessive boat motion is a position near the midpoint of the vessel. However, since on most vessels that location is occupied by the net winches, the only available option is to hang the scale from the "A-frame" or net rack on the stern of the boat. Once a location is located, determine the proper distance the scale needs to be hanging from the deck of the boat. To do this, hang the scale from a rope or hook with the shackle provided. Then take one of the orange shrimp baskets with the longest rope and hang it from the scale hook. The bottom of the basket should swing freely above the deck of the boat. (Remember that the rope is going to stretch some when the baskets are full). The lower the baskets are to the deck the easier it is to lift them onto the scale hook.

4. Net Separation Plan: When the nets are brought on board (decked) the catch from the sample nets need to be dumped independent and separate from the catch of the other nets. It is sometimes difficult to keep the catch separate if the seas are rough, there is an excessive quantity of jellyfish, or the total amount of catch in each net is just too much to prevent the total catch of all nets from piling together, but having a good separation plan will enhance the quality of the data and increase the number of successfully sampled tows during your trip.

Before the vessel begins trawling, discuss and devise a plan to accomplish this goal with the captain. **Keep in mind that before the bags (codends of the nets) are dumped they are often swinging freely over the deck of the boat and often contain stingrays, hardhead catfish or other hazardous marine life. Caution should be observed. In most cases the captain will want the observer to stand clear until the crew has dumped the catch.**

Sampling Procedure

1. Haul Back Time: At the time of haul back (net retrieval) get the following information and enter into your log book; time out, depth out, GPS out, sea state, and pick up direction. (Time in, Depth in and GPS in should have been obtained when the nets were dogged off at the winches at the start of the trawl).

2. Operation Codes and Predator Interactions: While the nets are being retrieved, note the following information for the Condition and Fate form: Predator types? Is anything escaping from BRD opening and if so, what quantity; and if catch is escaping from opening are the predators feeding on the catch and if so, which ones are feeding? During this time also observe for any operation code problems that may have affected the net's performance (i.e., tire blocking #3 net at the TED). Also check with the captain and crew as to any possible problems that could have affected trawl performance and note this information in your logbook.

3. Re-Deployment Time: If the vessel is planning to re-deploy the nets, remember to get "time in", "depth in", and "GPS in" for the next tow.

4. Total Weight of the Catch: Once the catch is dumped onto the deck and separated into piles, set up and "TARE" your scale using one of the orange shrimp baskets. Next, select one of the nets you are sampling and mix the catch of that net with the scoop shovel or by lining up

several baskets and putting a small amount of catch in each one until they are all full (this works better for large volumes of catch). If a characterization is to be performed, pick one basket, weigh it, set it aside, and then multiply that weight by the total number of baskets you shoveled to obtain a total weight for that net. Circle or specify the weight of the characterization basket in your logbook to identify it as the "sample weight". Once the total weight has been obtained and entered in your logbook, pour the baskets (except the characterization basket) back onto the deck and separate out any target species of fish (Red Snapper). After you have completed obtaining the total weight and removing target fish for this net, repeat these steps for the other net. Once both sides have been weighed, make sure to designate a separate basket to each pile to obtain the total shrimp weight.

5. Characterization: The first priorities of characterization are to remove the penaeid shrimp and target fish. Next, count and weigh ("head-on") the sample shrimp, and add them to the basket designated for total shrimp weight for that net. (If the crew is heading the shrimp, these shrimp must also be headed before adding to the basket). To accomplish these priorities, take the sample basket full of catch (approximately 30 kg) and place directly in front of you while sitting on the sampling stool. Next, place an empty basket on each side of the sample basket of catch and a small basket designated for target fish directly beside you. Pour out a little of the catch from the sample basket, separate out shrimp and put in one basket, place any target fish in the small basket and finally scoop up the remaining bycatch and put it in the other basket. Repeat until the sample basket is empty. Do this for both sides.

After the shrimp and target species have been removed, begin characterizing the remaining bycatch. Start by placing the basket of bycatch directly in front of you. Place several small baskets along each side of you and one large shrimp basket next to the bycatch basket. Use the large basket for the dominant species by volume. This is usually miscellaneous Pisces. Pour a little of the bycatch from the basket and begin sorting out the species and groups listed on the Species Characterization Form. It is typically easiest to separate out one species at a time beginning with the most dominant in the pile. Repeat until the contents of the basket are completely separated. Next, count individual species and get total weights, then obtain weights for grouped species. Finally, remember to subtract the weights of any target (red snapper) or select species found remaining in the sample bycatch basket from the original sample weight obtained.

6. Target Species and Shrimp Total Weight: Once total weights and characterizations for each sampled net have been obtained begin measuring target species (red snapper) and obtain a total red snapper weight for each net sampled. When the crew of the boat finishes separating the shrimp from the sample nets, obtain a total weight, denote species, and whether "head-on" or "head-off", and return them back to crew and captain for processing. (Remember to add in the weight of the shrimp from the sample characterization basket if applicable). If time permits, once you are finished with the target species, it makes for good relations and is good experience to help the crew sort through the remainder of the catch.

7. **Data Forms:** As time permits, complete data forms with the necessary information recorded in your logbooks. Remember to fill in all fields, and write legible. At the completion of a trip, the captain may request copies of data collected aboard the vessel. All copies of trips must be approved by the Program Manager. Trip copies will be made and sent only from the Galveston Laboratory to the person requesting data. Your trip data must be submitted to your coordinator with the forms in the following order.

COLLECTION of BY- CATCH TRIP REPORT INFORMATION

Complete the following forms for each By-Catch trip made:

1. Trip Report - Page 1
2. Trip Report - Page 2 (Tows not Sampled)
3. Trip Report - Page 3 (Sampled Tow Log)

This information is filled out when the trip is complete. These forms make up a compilation of facts that sum up the trip.

TRIP REPORT - SHRIMP BY-CATCH

TRIP # _____

VESSEL NAME _____ ID # _____ VSCODE _____ LTH _____
(CG DOCUMENTATION #) (LENGTH)

STATE _____ CITY _____

PORT OF DEPARTURE _____ / _____

OBSERVER NAME _____ ORGANIZATION _____

TRIP DATES _____ - _____ - _____ OBSERVER DAYS _____
(dates, total # of travel and sea days allotted for this trip)

DATES AT SEA _____ - _____ - _____ SEA DAYS _____
(dates, total # of days at sea from port to port)

24 HR. DAYS FISHED (including tows not sampled) _____ STARTING TOW # _____
 TOTAL TIME (hours towed) _____ / 24 = _____ ENDING TOW # _____
(DO NOT INCLUDE TOWS NOT SAMPLED)

AVERAGE TOW TIME

TOT. TIME HOURS TOWED [SAMPLED] (1) (1) (2) (3) (4)

TOT. TIME HOURS TOWED [UNSAMPLED] (2) (____ + ____)/(____ + ____) = ____

TOT. # TOWS SAMPLED (3)

TOT. # TOWS UNSAMPLED (4)

GEAR CONFIGURATION (MAIN NETS)

NET #1 TED _____	BRD _____	APPLICABLE
NET #2 TED _____	BRD _____	TOW #S
NET #3 TED _____	BRD _____	
NET #4 TED _____	BRD _____	
NET #1 TED _____	BRD _____	APPLICABLE
NET #2 TED _____	BRD _____	TOW #S
NET #3 TED _____	BRD _____	
NET #4 TED _____	BRD _____	

TRY NET

HRL _____ NET# _____ (Location)

FRL _____ APPLICABLE

TOW #S _____

CIRCLE TRY NET LOCATION ON DIAGRAM

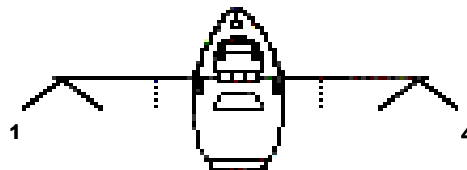

(ENTER N/A FOR NET #s 1 & 4 IF ONLY TWO NETS ARE PULLED BY YOUR BOAT)

AREAS FISHED

STAT. AREA #	INSHORE	NEARSHORE ≤ 60'	OFFSHORE > 60'			

(ENTER APPLICABLE STATISTICAL AREA # THEN THE # OF TOWS "SAMPLED" IN THE APPROPRIATE ZONE BLOCK)

TURTLES CAPTURED

SPECIES	NET #/TYPE *	LAT/LONG	DATE	TOW#
1	_____	_____	_____	_____
2	_____	_____	_____	_____
3	_____	_____	_____	_____
4	_____	_____	_____	_____
5	_____	_____	_____	_____
6	_____	_____	_____	_____
7	_____	_____	_____	_____

TURTLES SIGHTED

SPECIES	LAT/LONG	DATE
1	_____	_____
2	_____	_____
3	_____	_____
4	_____	_____
5	_____	_____
6	_____	_____
7	_____	_____

*(ST-STANDARD NET, TB-NET WITH TED AND BRD, T-NET WITH TED ONLY, B-NET WITH BRD ONLY, TR-TRY NET)

SIGNATURE _____

TRIP REPORT - SHRIMP BY-CATCH
TOWS NOT SAMPLED

VSCODE _____

TRIP DATES _____

TRIP # _____

(A TOW WITH AN OPERATION CODE SHOULD NOT BE LISTED AS UNSAMPLED)

NO.	DATE	LATITUDE	LONGITUDE	HOURS TOWED	DEPTH (FEET)	STAT ZONE	REASON NOT SAMPLED
1							
2							
3							
4							
5							
6							
7							
8							
9							
10							
11							
12							
13							
14							
15							
16							
17							
18							
19							
20							
21							
22							
23							
24							
25							
26							
27							
28							
29							
30							
31							
32							
33							
34							
35							
36							
37							
38							
39							
40							
41							
42							
43							
44							
45							

TRIP REPORT FORM

A trip ends when the vessel unloads the shrimp catch. This form is completed at the end of a trip. Upon completion of each trip:

Identify unknown fish or invertebrates and enter appropriate species information on data sheets.

Triple proof data sheets for:

- blank fields (enter 9's in the fields when data was not collected)
- legibility
- hours towed calculations
- proper data format (do not enter decimals when not required)

Trip No.: Enter Trip Number provided by Observer Coordinator.

Vessel Name: Enter the full name of the vessel.

ID #: (Vessel Documentation Number). Transcribe from Vessel Information Form.

Vessel Code (VSCODE): Enter Vessel Code provided by Observer Coordinator.

Length (LTH): Transcribe from Vessel Information Form.

Port of Departure: Enter the STATE and CITY from where the vessel departed.

Observer Name: Enter your full name.

Organization: Enter the organization conducting the survey (e.g., NOAA, Foundation, etc.).

Trip Dates: Enter month, day, and year that you left home and began traveling to the vessel. Enter the month and day that you returned home. This includes days spent in motels waiting for the vessel to depart and/or transportation and return to the laboratory or home (for example, 3/5-3/10/13).

Observer Days: Enter the total number of days of your trip. For the above example, enter 6. Any part of a day constitutes an observer day.

Dates at Sea: Enter the dates (departure-arrival) that you actually spent at sea (for example, 3/6-3/9/13).

Sea Days: Enter the total number of days spent at sea (for the above example, 4). Any part of a day spent at sea is considered a sea day. Please double check this value, and be sure you count the starting day.

24 Hr. Days Fished: Enter the total number of hours towed including tows sampled and tows not sampled. Divide this number by 24 to get the total number of 24 hr days fished. For example:

$$\begin{array}{cccccc} (4.4 \text{ hours} + 6.5 \text{ hours} + 3.2 \text{ hours} + 2.6 \text{ hours} + 4.6 \text{ hours}) / 24 = 0.9 \\ \text{sampled} \quad + \quad \text{sampled} \quad + \quad \text{sampled} \quad + \quad \text{unsampled} \quad + \quad \text{unsampled} \end{array}$$

Starting Tow No.: This will always be 001. **Tows not sampled are not numbered.**

Ending Tow No.: Enter the last tow number. **Tows not sampled are not numbered.**

Average Tow Time: Compute and enter value in spaces provided. Include tow times for tows not sampled in your calculation.

Gear Configuration (main nets only): Enter the appropriate TED and BRD codes for each net.

Applicable Tow #'s: Enter numbers that this gear configuration applies to (e.g., tow #'s 001-026).

If the gear configuration is changed during the trip, (i.e., different TED(s) or BRD(s)), Complete the second section and enter applicable tow numbers (e.g., tow numbers 027-092) for this new configuration. If more changes are made, use additional sheets as necessary and attach. Enter N/A for net positions 1 and 4 if only two nets are towed.

Try Net

HRL: Enter the headrope length (feet).

FRL: Enter the footrope length (feet).

Net NO.: Enter the net position that the try net is being towed in front of (typically net position 3).

Applicable Tow No(s): Enter tow numbers where try net was used (at this net position).

Areas Fished

Stat. Area No.: Enter the appropriate STAT ZONE (s) where sampled tows occurred (e.g., 18, 20, see appendix 11) these zones should correspond to what is listed on the Station Sheets.

Next, under the stat zone, enter the total number of tows completed **INSHORE** (areas inside the COLREG lines [line of demarcation that closes off bays and barrier islands]).

Enter the total number of tows completed **NEARSHORE** (water depth \leq 60 ft., all waters outside the inshore line outward into the Gulf of Mexico to the 10 fathom contour line). Enter the total number of tows completed **OFFSHORE** (water depth $>$ 60 ft.).

Turtles Captured

Species: Enter the species. If a positive identification could not be made enter unknown.

Net Position/Type: Enter the net position and net type that the turtle was captured in ("ST" for standard net, "TB" for a net with a TED and BRD, "T" for a net with only a TED, "B" for a net with only a BRD, and "TR" for a try net).

Lat/Long: Enter the starting latitude and longitude of the tow, or lat/long at the time the turtle is taken onboard (try net capture).

Date: Enter the date of capture.

Tow Number: Enter the tow number that the turtle was captured in. If the turtle was captured on a tow not sampled, list closest sampled tow number and note in comments.

Turtle Sighted

Species: Enter the species if positive identification is made, or unknown.

Lat/Long: Enter the latitude and longitude of the vessel at the time turtle was sighted.

Date: Enter the date of sighting.

Trip Report Form - Tows Not Sampled – Page 2

On page 2 of the trip report re-enter the vessel code, trip dates and trip no.

Enter the date, latitude, longitude, hours towed, depth, stat zone, and reason for not sampling (e.g., sleeping, sick, or processing previous tow). A tow with an operation code (i.e., vessel/trawl operational problem, or tows not sampled due to weather) should be listed as a tow Sampled, a numbered tow with a completed Station Sheet reflecting operational problem (i.e., op code).

Trip Report Form - Sampled Tow Log – Page 3

List, in order, all tows sampled during the trip. Completion of this form will provide a list of the following information: Date of Tow, Tow Number, Time in, Time Out, Hours Towed, Water Depth (feet), State Zone, Experimental net position (EXP NP), Control net position (CONT NP).

It can be utilized to add up tow times for completion of the trip report and is also utilized in office to calculate Sea Days. Use as many pages needed to list all "sampled" tows. If more than one page is needed, reference the numbers at the bottom of the page.

BY-CATCH DATA FORMS

Complete the following forms for all By-catch trips.

1. Gear Specification Form (page 1) and TED/BRD Specification Form (page 2)
2. Try Net Tow Summary
3. Station Sheet BRD Evaluation
4. Condition and Fate Form
5. Species Characterization Form (four versions of this form are provided, use the one that best fits your needs)
 - BRD Testing Protocol
 - Modified South Atlantic Penaeid Shrimp
 - Modified South Atlantic Rock Shrimp
 - Shrimp Characterization – can be used as page two for the above forms if species not listed on the form are present.
6. Length Frequency Form (Target Species)
7. Sea Turtle Life History Form (Complete only if a turtle is captured or sighted)
8. Specimen Collection Log (as required)

GEAR SPECIFICATION FORM

A Gear Specification Form must be completed for each net used during trawling operations. If any gear setting or configuration changes are made, then additional form(s) must be completed by the observer for the affected net(s). If either of the two samples nets are torn and repaired, then the repaired net must be re-measured for possible changes. All measurements should be recorded in feet and inches. Measurements should be converted to decimal form prior to data entry (10 feet and 6 inches = 10.5 feet, 3/4 inch = 0.75 inch). Detailed instructions for the Gear Specification Form are as follows:

Trip No.: Enter the Trip Number provided by the Observer Coordinator.

Vessel: Leave blank unless provided by Observer Coordinator.

Tow No.: Enter the starting tow number for a given vessel. If net or gear changes are made, enter the starting tow number when these changes occurred. For example: a net is hung up and lost on Tow 5 and a new net is put on. The next gear sheet will start on Tow 6.

Date: Enter the starting tow number date, or the date when the changes occurred.

Net Position: Enter 1 for outside port net; 2 for inside port net; 3 for inside starboard net; or 4 for outside starboard net (if only 2 nets are pulled then they will be designated 2 and 3).

Control-Experimental: Sampled nets will always be experimental "E" unless specifically told by a coordinator.

SECTION I – NET GEAR MEASUREMENTS (see Appendices 4 – 8 for picture referrals) Net Type and Head/Footrope Measurements

Net Type: semi-balloon, balloon, balloon w/bib, flat, mongoose, Jib, etc.

Headrope Length: Measure the length of the trawl headrope (feet and inches in decimal form) where webbing is attached.

Footrope Length: Measure the length of the trawl footrope (feet and inches in decimal form) where webbing is attached.

Comments: Enter comments relative to net type or rope measurements (e.g., changed net type, replaced headrope or footrope).

Leg Line

Top Legline Length on Door: Measure the length of the top legline (feet and inches in decimal form) on the trawl's standard door. Top legline length is measured from the point of cable attachment at the door to the point where the first mesh on the net is tied to the cable.

Bottom Legline Length on Door: Measure the length of the bottom legline (feet and inches in decimal form) on the trawl's standard door. Bottom legline length is measured from the point of cable attachment at the door to the point where the first mesh on the net is tied to the cable.

Top Legline Length on Dummy Door: Measure the top legline length (feet and inches in decimal form) on the trawl's dummy door.

Bottom Legline Length on Dummy Door: Measure the bottom legline length (feet and inches in decimal form) on the trawl's dummy door.

Trawl Body

Type: Select the appropriate answer: nylon, poly, sapphire, or spectra.

Mesh Size: Measure the stretched length to the nearest 1/8".

Comments: Enter comments relative to trawl body (e.g., changed net).

Trawl Extension

Type: Select the appropriate answer: nylon, poly, sapphire, spectra, or none.

Mesh Size: Measure the stretched length to the nearest 1/8".

Comments: Enter comments relative to trawl extension (e.g., none used).

Cod End

Type: Select the appropriate answer: nylon, poly, sapphire, or spectra.

Mesh Size: Measure the stretched length to the nearest 1/8".

Twine Size: Ask captain (if unknown enter 9's).

Comments: Enter comments relative to cod end (e.g., new cod end).

Chaffing Gear

Type: Select the appropriate answer: whiskers, mesh, metal, or none.

Comments: Enter comments relative to chaffing gear (e.g., none used).

Doors

Door Type: Select the appropriate answer, aluminum, wood, steel, other, or none. If other, identify in the comments section.

Door Length: Measure the length of door (feet and inches in decimal form).

Door Height: Measure the height of the door (feet and inches in decimal form).

Dummy Door Length: Enter the total length of dummy door (feet and inches in decimal form).

Comments: Enter comments relative to doors (e.g., fiberglass doors).

Tickler Chain

Chain Length: Measure the length of chain (feet and inches in decimal form) from door to door.

Chain Size: Measure the gauge (thickness) of the metal part of the link to the nearest 1/16-inch, in decimal form (do not measure the area where it is connected to another link or an area that has been welded).

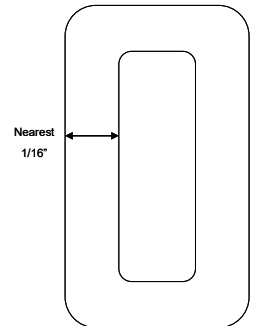

Comments: Enter comments relative to tickler chain (e.g., replaced).

Lazy Line

Rigging: Select one, Elephant Ears or Choke (rings).

Comments: Enter comments relative to lazy line.

SECTION II – Bycatch Reduction Device (BRD) Measurements

Type: Select BRD type. Fisheye, Jones-Davis, Modified Jones Davis, Extended Funnel, Composite, none, or other (specify in space provided).

BRD Position: Select location, top or offset, from top seam (leave blank if Jones-Davis BRD).

Spooker Cone: Check Yes or No

Codend length (# of meshes): Enter number of meshes.

Circumference of the codend (# of meshes): Enter number of meshes.

Distance of escape opening from elephant ear or choke rings: Measure in feet and inches.

Distance of escape opening from tie off rings: Measure in feet and inches.

Number of meshes the Fisheye (BRD) is offset from top center: self-explanatory.

Fisheye (BRD) escape opening: Measure the height and width in inches.

Shape of escape opening: Circle one: oval, diamond, square, halfmoon, rectangle, triangle, or specify if other.

BRD Position (select one): Looking from the mouth of the net towards the codend, is the BRD in front, centered (at), or behind the (attachment point of) elephant ears?

What is the length of the elephant ear, measure from the point of attachment to the tip of the ring: Record length in inches.

Distance from point of attachment of elephant ear to tie off rings (on codend): Enter in feet and inches.

Section III - TED Measurements

TED/BRD Specification Forms must be completed once for each net used in the control and experimental positions during trawling operations. If any gear setting or configuration changes are made, an additional form(s) must be completed by the observer for the affected net(s). Detailed instructions for the TED/BRD Specification Form are as follows:

Trip No.: Enter the Trip Number provided by the Observer Coordinator.

Vessel: Enter Vessel Code provided by Observer Coordinator.

Tow No.: Enter the starting tow number for a given vessel (001). If net or gear changes are made, enter the tow number when these changes occurred.

Date: Enter the starting tow number date, or the date when the changes occurred.

Net Position: Enter 1 for outside port net; 2 for inside port net; 3 for inside starboard net; or 4 for outside starboard net (if only 2 nets are pulled then they are designated 2 and 3).

TED Type: Check one. Soft (soft TED), Hard (hard TED) or None.

TED Design: Check one. Ask captain if unsure and take pictures if possible.

TED Opening: Check one. Top (top opening TED), Bottom (bottom opening TED) or None.

TED Used Inshore Only: Check one. Only check yes if ALL tows for trip are in inshore waters.

TED Funnel: Check Yes or No. The TED funnel is located forward of the TED and is used to accelerate the catch through the TED and toward the codend.

Stretched Measurement of Accelerator Funnel (Offshore $\geq 70''$, Inshore $\geq 44''$): Measure stretched horizontal opening of funnel if present in inches.

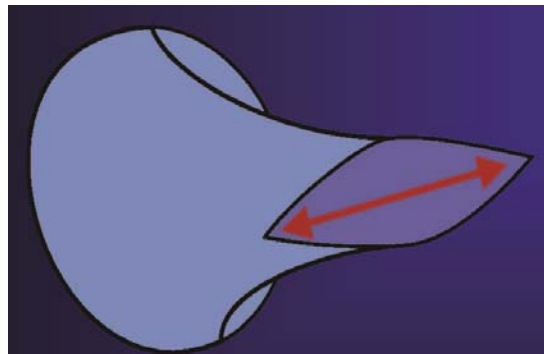

TED Flap: Check Yes or No. TED flap is extension of mesh behind farthest part of TED opening.

Cover Flap: Check one. Single or double (2 pieces) cover flap.

Length of Mesh (not stretched) Past Grid (All $\leq 24''$): Measure how far the flap extends past the bottom of the TED grid (not stretched) in inches.

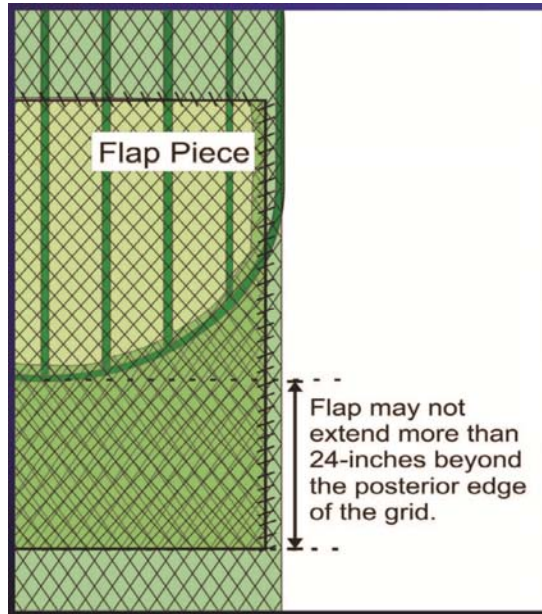

Leading Edge Measurement (Single $\geq 71''$, Double $\geq 56''$): Measure the stretched leading edge in inches.

Forward Cut Measurement (Single $\geq 26''$, Double $\geq 20''$): Measure the stretched forward cut in inches.

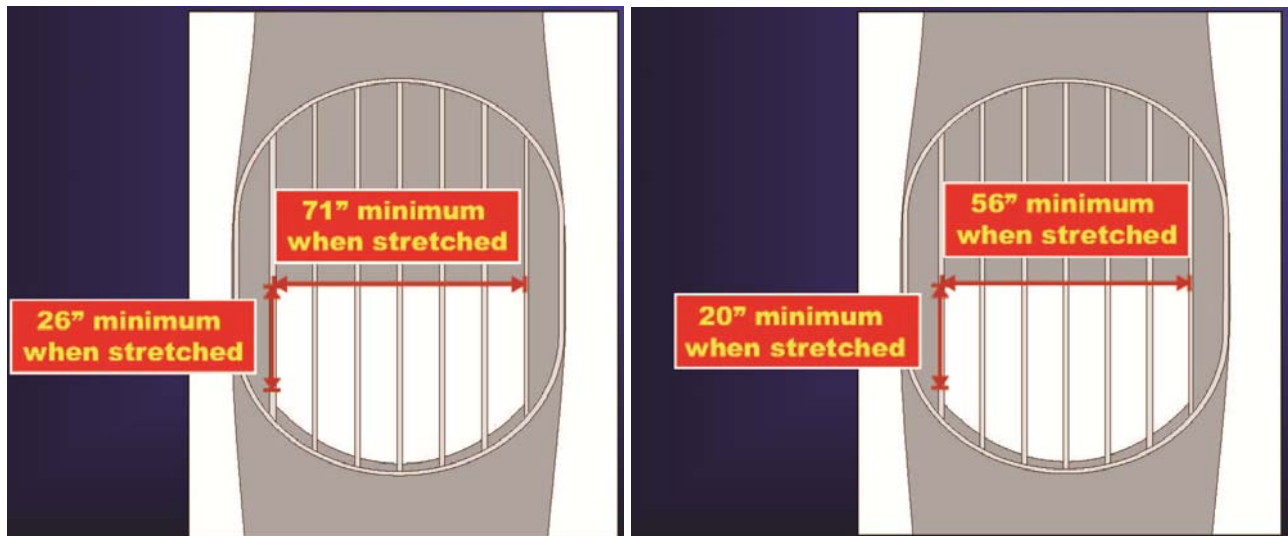

Length of Flap (not stretched) Sewn from Bottom of Grid (Single $\leq 6''$): Measure (not stretched) in inches.

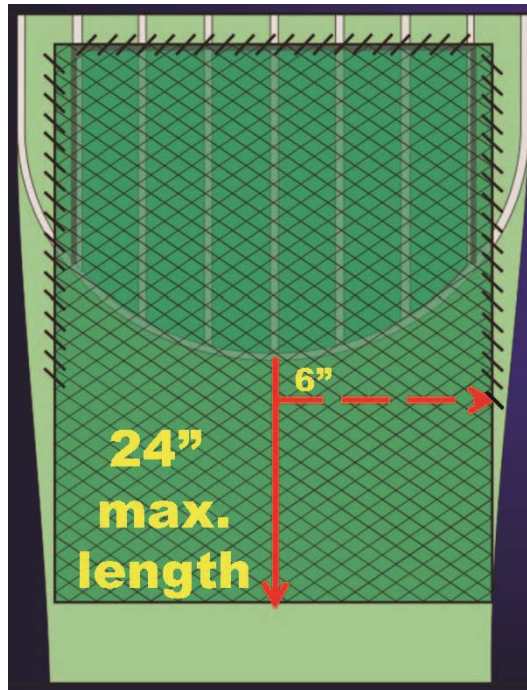

TED Angle (Degrees): Use a TED protractor (angle finder) to obtain the angle of the TED (with respect to the plane of the net) while the nets are hanging freely (use the non-magnetic side of the angle finder).

TED Dimensions (32" MIN): Enter the total length and width of the TED grid in inches.



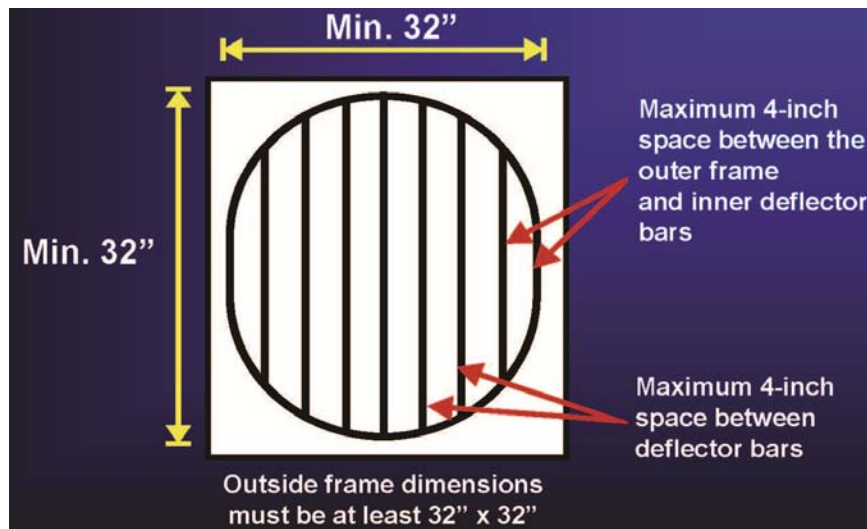

Space Between Bar: Measure maximum space between bars to nearest quarter of an inch. In the event that a turtle is captured, you are required to remeasure the Space Between Bar as soon as possible after the interaction with the turtle. This second measurement, and the date the measurement was taken, should be recorded in the comments section of the turtle form.



TED Material: Enter the material type used in TED construction (e.g., aluminum for hard TED or polypropylene mesh for a soft TED).

Number of TED Floats: Enter the total number of floats attached to TED.

Float Type: Choose the appropriate shape and construction material of the TED floats from the chart below and enter in the space provided.

SHAPES				CONSTRUCTION MATERIAL
				Sponge
Football	Bullet	Cylinder	Round	Foam
				Plastic
				Other

Gear Descriptions

BRD Description / Diagram: Give a written description of the BRD and below sketch a detailed diagram of the BRD and how it is positioned in the net. Provide all length and measurements. (If more space is needed, use additional pages and include trip and tow number). For fisheyes trace an outline of the opening size and shape on the back of this form or piece of cardboard (if possible).

Gear Description / Diagram: Give a written description of all net gear and sketch a detailed diagram of the net gear including TED and BRD positions, location of tie off rings, and elephant ears. Provide all lengths and measurements. (If more space is needed, use additional pages and include trip and tow number).

Photograph BRD and gear configurations and attach to the TED/BRD Form. Circle Yes or No on the bottom of the form to denote if pictures were taken.

TRY NET TOW SUMMARY BRD/CHARACTERIZATION

TRIP #

VESSEL CODE

TRYNET HEADROPE LENGTH (feet)

TRYNET FOOTROPE LENGTH (feet)

TRYNET TED TYPE (IF PRESENT)

STATION TOW # STAT. ZONE CHECK ONE: INSHORE NEARSHORE OFFSHORE

TRY NET TOW #	TIME IN	TIME OUT	TURTLE (X)	TRY NET TOW #	TIME IN	TIME OUT	TURTLE (X)
<input type="text"/>	<input type="text"/>	<input type="text"/>	<input type="text"/>	<input type="text"/>	<input type="text"/>	<input type="text"/>	<input type="text"/>
<input type="text"/>	<input type="text"/>	<input type="text"/>	<input type="text"/>	<input type="text"/>	<input type="text"/>	<input type="text"/>	<input type="text"/>
<input type="text"/>	<input type="text"/>	<input type="text"/>	<input type="text"/>	<input type="text"/>	<input type="text"/>	<input type="text"/>	<input type="text"/>
<input type="text"/>	<input type="text"/>	<input type="text"/>	<input type="text"/>	<input type="text"/>	<input type="text"/>	<input type="text"/>	<input type="text"/>
<input type="text"/>	<input type="text"/>	<input type="text"/>	<input type="text"/>	<input type="text"/>	<input type="text"/>	<input type="text"/>	<input type="text"/>
<input type="text"/>	<input type="text"/>	<input type="text"/>	<input type="text"/>	<input type="text"/>	<input type="text"/>	<input type="text"/>	<input type="text"/>
<input type="text"/>	<input type="text"/>	<input type="text"/>	<input type="text"/>	<input type="text"/>	<input type="text"/>	<input type="text"/>	<input type="text"/>
<input type="text"/>	<input type="text"/>	<input type="text"/>	<input type="text"/>	<input type="text"/>	<input type="text"/>	<input type="text"/>	<input type="text"/>
<input type="text"/>	<input type="text"/>	<input type="text"/>	<input type="text"/>	<input type="text"/>	<input type="text"/>	<input type="text"/>	<input type="text"/>
<input type="text"/>	<input type="text"/>	<input type="text"/>	<input type="text"/>	<input type="text"/>	<input type="text"/>	<input type="text"/>	<input type="text"/>

COMMENTS: _____

STATION TOW # STAT. ZONE CHECK ONE: INSHORE NEARSHORE OFFSHORE

TRY NET TOW #	TIME IN	TIME OUT	TURTLE (X)	TRY NET TOW #	TIME IN	TIME OUT	TURTLE (X)
<input type="text"/>	<input type="text"/>	<input type="text"/>	<input type="text"/>	<input type="text"/>	<input type="text"/>	<input type="text"/>	<input type="text"/>
<input type="text"/>	<input type="text"/>	<input type="text"/>	<input type="text"/>	<input type="text"/>	<input type="text"/>	<input type="text"/>	<input type="text"/>
<input type="text"/>	<input type="text"/>	<input type="text"/>	<input type="text"/>	<input type="text"/>	<input type="text"/>	<input type="text"/>	<input type="text"/>
<input type="text"/>	<input type="text"/>	<input type="text"/>	<input type="text"/>	<input type="text"/>	<input type="text"/>	<input type="text"/>	<input type="text"/>
<input type="text"/>	<input type="text"/>	<input type="text"/>	<input type="text"/>	<input type="text"/>	<input type="text"/>	<input type="text"/>	<input type="text"/>
<input type="text"/>	<input type="text"/>	<input type="text"/>	<input type="text"/>	<input type="text"/>	<input type="text"/>	<input type="text"/>	<input type="text"/>
<input type="text"/>	<input type="text"/>	<input type="text"/>	<input type="text"/>	<input type="text"/>	<input type="text"/>	<input type="text"/>	<input type="text"/>
<input type="text"/>	<input type="text"/>	<input type="text"/>	<input type="text"/>	<input type="text"/>	<input type="text"/>	<input type="text"/>	<input type="text"/>
<input type="text"/>	<input type="text"/>	<input type="text"/>	<input type="text"/>	<input type="text"/>	<input type="text"/>	<input type="text"/>	<input type="text"/>
<input type="text"/>	<input type="text"/>	<input type="text"/>	<input type="text"/>	<input type="text"/>	<input type="text"/>	<input type="text"/>	<input type="text"/>

COMMENTS: _____

STATION TOW # STAT. ZONE CHECK ONE: INSHORE NEARSHORE OFFSHORE

TRY NET TOW #	TIME IN	TIME OUT	TURTLE (X)	TRY NET TOW #	TIME IN	TIME OUT	TURTLE (X)
<input type="text"/>	<input type="text"/>	<input type="text"/>	<input type="text"/>	<input type="text"/>	<input type="text"/>	<input type="text"/>	<input type="text"/>
<input type="text"/>	<input type="text"/>	<input type="text"/>	<input type="text"/>	<input type="text"/>	<input type="text"/>	<input type="text"/>	<input type="text"/>
<input type="text"/>	<input type="text"/>	<input type="text"/>	<input type="text"/>	<input type="text"/>	<input type="text"/>	<input type="text"/>	<input type="text"/>
<input type="text"/>	<input type="text"/>	<input type="text"/>	<input type="text"/>	<input type="text"/>	<input type="text"/>	<input type="text"/>	<input type="text"/>
<input type="text"/>	<input type="text"/>	<input type="text"/>	<input type="text"/>	<input type="text"/>	<input type="text"/>	<input type="text"/>	<input type="text"/>
<input type="text"/>	<input type="text"/>	<input type="text"/>	<input type="text"/>	<input type="text"/>	<input type="text"/>	<input type="text"/>	<input type="text"/>
<input type="text"/>	<input type="text"/>	<input type="text"/>	<input type="text"/>	<input type="text"/>	<input type="text"/>	<input type="text"/>	<input type="text"/>
<input type="text"/>	<input type="text"/>	<input type="text"/>	<input type="text"/>	<input type="text"/>	<input type="text"/>	<input type="text"/>	<input type="text"/>
<input type="text"/>	<input type="text"/>	<input type="text"/>	<input type="text"/>	<input type="text"/>	<input type="text"/>	<input type="text"/>	<input type="text"/>
<input type="text"/>	<input type="text"/>	<input type="text"/>	<input type="text"/>	<input type="text"/>	<input type="text"/>	<input type="text"/>	<input type="text"/>

COMMENTS: _____

STATION TOW # STAT. ZONE CHECK ONE: INSHORE NEARSHORE OFFSHORE

TRY NET TOW #	TIME IN	TIME OUT	TURTLE (X)	TRY NET TOW #	TIME IN	TIME OUT	TURTLE (X)
<input type="text"/>	<input type="text"/>	<input type="text"/>	<input type="text"/>	<input type="text"/>	<input type="text"/>	<input type="text"/>	<input type="text"/>
<input type="text"/>	<input type="text"/>	<input type="text"/>	<input type="text"/>	<input type="text"/>	<input type="text"/>	<input type="text"/>	<input type="text"/>
<input type="text"/>	<input type="text"/>	<input type="text"/>	<input type="text"/>	<input type="text"/>	<input type="text"/>	<input type="text"/>	<input type="text"/>
<input type="text"/>	<input type="text"/>	<input type="text"/>	<input type="text"/>	<input type="text"/>	<input type="text"/>	<input type="text"/>	<input type="text"/>
<input type="text"/>	<input type="text"/>	<input type="text"/>	<input type="text"/>	<input type="text"/>	<input type="text"/>	<input type="text"/>	<input type="text"/>
<input type="text"/>	<input type="text"/>	<input type="text"/>	<input type="text"/>	<input type="text"/>	<input type="text"/>	<input type="text"/>	<input type="text"/>
<input type="text"/>	<input type="text"/>	<input type="text"/>	<input type="text"/>	<input type="text"/>	<input type="text"/>	<input type="text"/>	<input type="text"/>
<input type="text"/>	<input type="text"/>	<input type="text"/>	<input type="text"/>	<input type="text"/>	<input type="text"/>	<input type="text"/>	<input type="text"/>
<input type="text"/>	<input type="text"/>	<input type="text"/>	<input type="text"/>	<input type="text"/>	<input type="text"/>	<input type="text"/>	<input type="text"/>
<input type="text"/>	<input type="text"/>	<input type="text"/>	<input type="text"/>	<input type="text"/>	<input type="text"/>	<input type="text"/>	<input type="text"/>

COMMENTS: _____

TRY NET TOW SUMMARY FORM

Observers are required to complete a Try Net Tow Summary Form for each trip. With the existing work load and operation speed it's understandable that not all try net tows time can be recorded; however, you're required to record as many as possible during duty hours.

Trip No.: Enter the Trip Number provided by the Observer Coordinator.

Vessel Code: Leave blank unless provided by Observer Coordinator.

Try Net Headrope Length: Measure the length of the try net headrope (feet and inches in decimal form) where webbing is attached.

Try Net Footrope Length: Measure the length of the try net footrope (feet and inches in decimal form) where webbing is attached.

Try Net TED Type: If present, enter the type of Try net TED used (e.g., hard, curved, bottom =HCB) if none present write NONE.

Station Tow #: Enter try net tow number of sampled and unsampled tows (enter 9's).

Stat. Zone: Enter the appropriate statistical zone, **At Time In** (see appendices 11). This should match the Stat Zone on the corresponding Station Sheet.

Area Fished (check one): Enter the appropriate location **INSHORE** (areas inside the COLREG lines, **NEARSHORE** (water depth \leq 60 ft., all waters outside the inshore line outward into the Gulf of Mexico to the 10 fathom contour line), or **OFFSHORE** (water depth $>$ 60 ft.).

Try Net Tow #: Try net tow numbers should begin at one for each new **Station Tow Number**.

Time In: Enter the time that the try net was set.

Time Out: Enter the time at the start of haul back.

Turtle (X): Check space provided if turtle interaction occurred.

Comments: Enter any appropriate information to the try net tow.

STATION SHEET BRD EVALUATION

BRD TESTING PROTOCOL

ORG PRO <input type="text"/>					<input type="text"/>			<input type="text"/>			<input type="text"/>						
TRIP NO.					VESSEL			TOW NO.			OBSERVER						
MONTH		DAY		YEAR	DEGREE			MINUTE		SECONDS		DEGREE		MINUTE		SECONDS	
<input type="text"/>					<input type="text"/>			<input type="text"/>			<input type="text"/>			<input type="text"/>			
START DATE					TIME IN			LATITUDE IN			LONGITUDE IN			DEPTH IN (FEET)			
MONTH		DAY		YEAR	DEGREE			MINUTE		SECONDS		DEGREE		MINUTE		SECONDS	
<input type="text"/>					<input type="text"/>			<input type="text"/>			<input type="text"/>			<input type="text"/>			
STOP DATE					TIME OUT			LATITUDE OUT			LONGITUDE OUT			DEPTH OUT (FEET)			
<input type="text"/>		<input type="text"/>		<input type="text"/>	KNOTS			<input type="text"/>	<input type="text"/>	<input type="text"/>	<input type="text"/>	<input type="text"/>	<input type="text"/>	<input type="text"/>	<input type="text"/>	<input type="text"/>	<input type="text"/>
HOURS		TOWED		VESSEL	STAT			OPERATION	TOTAL	SEA	NET RETRIEVAL	SCALE	TYPE	DIRECTION	TYPE	DIRECTION	TYPE
														Up (U), Down (D), or Cross (C) Sea	Digital (D), Mechanical (M), Both (B) or Unknown (U)		

COORDINATOR COMMENTS

<input type="text"/>					Gear ID#			<input type="text"/>			BRD OPEN			<input type="text"/>			
<input type="text"/>					TOTAL CATCH WEIGHT (kg)			<input type="text"/>			SHRIMP TOTAL WEIGHT (kg)			<input type="text"/>			
<input type="text"/>					RED SNAPPER			<input type="text"/>			RED SNAPPER			NO. OF RED SNAPPER			
<input type="text"/>					TOTAL WEIGHT (kg)			TOTAL NUMBER			NO. OF RED SNAPPER			NO. OF RED SNAPPER			
<input type="text"/>											≤ 100 mm			> 100 mm			
Comments: _____																	

<input type="text"/>					Gear ID#			<input type="text"/>			BRD OPEN			<input type="text"/>			
<input type="text"/>					TOTAL CATCH WEIGHT (kg)			<input type="text"/>			SHRIMP TOTAL WEIGHT (kg)			<input type="text"/>			
<input type="text"/>					RED SNAPPER			<input type="text"/>			RED SNAPPER			NO. OF RED SNAPPER			
<input type="text"/>					TOTAL WEIGHT (kg)			TOTAL NUMBER			NO. OF RED SNAPPER			NO. OF RED SNAPPER			
<input type="text"/>											≤ 100 mm			> 100 mm			
Comments: _____																	

Characterization sample completed? YES (Attach species forms). NO

STATION SHEET

This form is split into two sections, the first part is for location information and the second part is for sample information. For both sections, 999's should be entered as a default code for all numeric fields where data are not available, with an explanation given in the comments section. The sample section is divided, half is for the first net being sampled, and the other half is for the second net sampled.

This form must be filled out for both sampled and unsampled sets. For tows not sampled (or unsampled tows) enter the following information: trip number, vessel code, 999's for tow number, start and stop dates, time in and time out, latitude in/out, longitude in/out, depth in/out, hours towed, and reason for not sampling. Remember unsampled tows are not given tow numbers. They are unsampled simply due to time constraints or observer choice (some reasons for not sampling are: observing crew operations, processing previous set, time constraints, sickness, sleep etc.).

SECTION 1

Trip No.: Enter the Trip Number provided by Observer Coordinator.

Vessel: Leave blank unless provided by Observer Coordinator.

Tow Number: Enter the appropriate tow number. The tow number starts at 001 for each trip.

Observer: Enter Observer Code provided by Observer Coordinator.

Start Date: Reference the date the tow started. Using two digits for month, day, and year (MO/DY/YR) enter the appropriate information (e.g., May 6, 2013 is 050613).

Time In: Enter the time that the nets are set (i.e., "dog off" time – dogged off refers to when winches are locked into place by the brake system). Use military time, midnight is 0001, 1 A.M. is 0100, and 1 P.M. is 1300. Military time uses a 24-hour clock for time keeping.

Latitude In: Enter the position occupied at set (time in) in degrees, minutes, and seconds. Ask the captain if the LORAN or GPS **unit reads in degrees, minutes, and seconds or in degrees, minutes, and hundredths of a minute**. If the unit reads in hundredths of minutes, multiply the last two digits (as a decimal figure) by 60 to obtain the seconds (e.g., .88 x 60 = 52.8 seconds, this is rounded up to 53 seconds [see appendix 12]). If coordinates are given in LORAN, the reading should be written above the space provided for GPS units (leaving GPS units blank). The units will be converted in the lab and filled in by the Observer Coordinator.

Longitude In: Enter the position of the vessel at start of tow time: degrees, minutes and seconds. Remember to correct the data if necessary.

Depth In (in feet): Enter the water depth at the start of the tow. Ask the captain if the transponder is mounted at the water line or on the keel. If the water depth is measured from anywhere other than the water line, then add the depth of the transponder to the depth reading.

Stop Date: Reference the date the tow stopped. Using two digits for month, day, and year (MO/DY/YR) enter the appropriate information (e.g., May 7, 2008 is 050708).

Time Out: Enter the time at the start of haul back (when winches are engaged and nets come off the bottom).

Latitude Out: Enter the position of the vessel at the start of haul back in degrees, minutes and seconds. Remember to correct the data if necessary.

Longitude Out: Enter the position of the vessel at the start of haul back: degrees, minutes and seconds. Remember to correct the data if necessary.

Depth Out (in feet): Enter the water depth at the end of the tow. Remember to correct the data for true depth if necessary.

Hours Towed: Compute the hours towed from Time In to the Time Out. Enter this information in hours and tenths of hours (e.g., one hour and thirty minutes is 1.5 hours). If time in is at 19:48 pm and time out is 02:30 am then hours towed is 6.7 hours towed.

Vessel Speed: Obtain average speed of tow information from Captain, record in KNOTS only.

Stat Zone: Enter the appropriate statistical zone, **At Time In** (see appendices 11). If vessel is trawling seaward of a statistical zone enter the closest zone and note "outside statistical zone" on comments section.

Operational Code: Select the appropriate operational code for each net (appendix 9). The try net code (Y) is used to designate the position of the try net (if used) and is normally pulled in front of either the #2 or #3 net. For example, ZZYZ represents a successful tow for all 4 nets and a try net was towed in the # 3 position. In situations where several problems affect a net, generally the most severe problem is recorded. If all nets were bogged down due to mud, the operational code would read BBBB. Note that the try net code is superseded by all codes except "Z". For unsuccessful tows please give further explanation in the comments section.

Total Nets: Enter the total number of nets trawled (e.g., 2 or 4). Do not include the try net.

Sea State: Enter the number that best describes the sea state (wave height):

1 = 0-2 feet 2 = 3-5 feet 3 = 6-8 feet 4 = 8+ feet

Net Retrieval Direction: Enter the direction (up sea "U" - against the wave direction, down sea "D" - with the wave direction, or cross sea "C" - perpendicular to wave direction) the vessel is heading while retrieving the nets. If the sea is flat, ask the captain the tide direction and use in place of wave direction.

Scale Type: Enter the type of scale use, Digital (D), Mechanical (M), Both (B) or Unknown (U).

SECTION 2

If two nets are sampled fill out the following information for each net in the space provided.

Net Position Sampled: Enter the net position number of the sample net. **Port and starboard are determined by facing the bow of the vessel, starboard is on the right and port is on the left.** (Net # 1 is the outside port net and is usually the first recorded on the form). If a vessel is using 4 nets, you will sample nets 1 and 4. If a vessel is using 2 nets, you will sample net 2 or 3 (sample the one that is opposite the try net). You will record 9's in the space provided for the net not being sampled (i.e. sample weight, total catch weight, shrimp total weigh, etc.).

BRD Open (E) or BRD Closed (C): Enter "E" if net is experimental or "C" if net is the "Control". Circle whether BRD is closed (typically "C") or open (typically "E"). If an observer is placed on a vessel with a control net, it will be a special project and further protocol will be given to the observer at that time.

Sample Weight: If a characterization is performed, after mixing the catch, obtain a one-basket sample (approximately 70 pounds) from each net. Weigh the basket in kilograms. If characterization is not performed, enter 99.9.

Total Catch Weight: Enter the weight of the total catch (in kilograms) from the sampled net. Remember to weigh and add any partial baskets. For example: You shovel 9 full baskets and one partial basket. You weigh 1 full basket at 29.73 kg (sample basket) and the partial basket at 14.33 kg. So the total catch weight is as follows: 29.73 kg (sample basket) X 9 (total number of full baskets) + 14.33 kg (partial basket) = 281.9 kg.

Shrimp Total Weight: Enter the weight of all kept penaeid (brown, white, pink) shrimp. Remember to add in the weight of penaeid shrimp from the characterization sample if you didn't already add it to your total shrimp weight basket. Note: Shrimp species discarded (culled) by the crew (referenced on the characterization form as Penaeus Discard [PENAEUSDISCAR]) are not included in the total shrimp weight; they are only represented in the sample weight. If on a Rock Shrimp trip, Rock Shrimp weights are to be entered on the Station Sheet for total shrimp weights.

Shrimp - Head On or Head Off: Enter "O" if the head is left on the shrimp, "X" if the head is removed, or a 9 if it is 9'd out. If the vessel is saving both head on and head off shrimp for a

particular tow, obtain both weights and enter in comments and the proper conversions will be made back at the laboratory (leave the total shrimp weight blank on the form).

Red Snapper Total Weight: Weigh all red snapper and enter their total weight in kilograms.

Red Snapper Total Number: Enter the total number of red snapper, if none enter zero.

No. of Red Snapper Less Than or Equal (\leq) to 100mm: Enter the total number of red snapper that have a fork length of less than or equal to 100mm (Attach the length frequency form for red snapper). If no red snapper are captured enter zeros and 9's if red snapper were not looked for. **Do Not Leave Blank.**

No. of Red Snapper Greater than ($>$) 100mm: Enter the total number of red snapper that have a fork length greater than 100mm. (Attach the length frequency form for red snapper). If no red snapper are captured enter zeros and 9's if red snapper were not looked for. **Do Not Leave Blank.**

Comments: Enter any appropriate information to the trawl (e.g., nets bogged down with mud, net torn, tire blocking TED). If operation codes other than Z or Y are used add a comment to explain why. **Do Not Write in the Coordinator Comment Section.**

Characterization (one basket) for Each Net: If a characterization was performed, check yes and attach species forms, if not, check no.

CONDITION & FATE FORM

BRD TESTING PROTOCOL

ORG PRO

--	--	--	--	--	--	--	--

TRIP NO.

--	--	--

VESSEL

--	--	--

TOW

NUMBER

CONTROL or EXPERIMENTAL NET POSITION <input style="width: 20px; height: 15px;" type="text"/> CIRCLE ONE	CONTROL or EXPERIMENTAL NET POSITION <input style="width: 20px; height: 15px;" type="text"/> CIRCLE ONE
---	---

CONDITION AND FATE OF BYCATCH PRIOR TO DISCARDING

Check the appropriate boxes.

FISH	FISH
<input type="checkbox"/> MORE THAN 50% OF CATCH ALIVE	<input type="checkbox"/> MORE THAN 50% OF CATCH ALIVE
<input type="checkbox"/> MORE THAN 50% OF CATCH DEAD	<input type="checkbox"/> MORE THAN 50% OF CATCH DEAD
<input type="checkbox"/> NOT DETERMINED (CATCH NOT DUMPED)	<input type="checkbox"/> NOT DETERMINED (CATCH NOT DUMPED)
<input type="checkbox"/> NOT OBSERVED	<input type="checkbox"/> NOT OBSERVED
COMMENTS: _____	COMMENTS: _____
INVERTEBRATES	INVERTEBRATES
<input type="checkbox"/> MORE THAN 50% OF CATCH ALIVE	<input type="checkbox"/> MORE THAN 50% OF CATCH ALIVE
<input type="checkbox"/> MORE THAN 50% OF CATCH DEAD	<input type="checkbox"/> MORE THAN 50% OF CATCH DEAD
<input type="checkbox"/> NOT DETERMINED (CATCH NOT DUMPED)	<input type="checkbox"/> NOT DETERMINED (CATCH NOT DUMPED)
<input type="checkbox"/> NOT OBSERVED	<input type="checkbox"/> NOT OBSERVED
COMMENTS: _____	COMMENTS: _____

PREDATORS OBSERVED

Refer to the table and choose the appropriate number code for each predator type.

PREDATORS OBSERVED	PREDATORS OBSERVED
<input type="checkbox"/> SHARKS	<input type="checkbox"/> SHARKS
<input type="checkbox"/> DOLPHINS	<input type="checkbox"/> DOLPHINS
<input type="checkbox"/> OTHER FISH	<input type="checkbox"/> OTHER FISH
<input type="checkbox"/> SEA BIRDS	<input type="checkbox"/> SEA BIRDS
COMMENTS: _____	COMMENTS: _____

- 0 = Predator not present in area.
- 1 = Predator observed but "not" feeding on organisms exiting BRD.
- 2 = Predator observed "feeding" on organisms exiting BRD.
- 3 = Predator observed but couldn't determine (or could not see) if they were feeding on organisms exiting BRD.
- 9 = Not determined (Observer was not able to check for predator).

ESTIMATED # OF ORGANISMS SEEN EXITING BRD DURING NET RETRIEVAL

Check the appropriate boxes.

ESTIMATED # OF ORGANISMS SEEN EXITING BRD DURING NET RETRIEVAL	ESTIMATED # OF ORGANISMS SEEN EXITING BRD DURING NET RETRIEVAL
<input type="checkbox"/> (1 - 10)	<input type="checkbox"/> (1 - 10)
<input type="checkbox"/> (10 - 50)	<input type="checkbox"/> (10 - 50)
<input type="checkbox"/> (50 - 100)	<input type="checkbox"/> (50 - 100)
<input type="checkbox"/> (100 OR MORE)	<input type="checkbox"/> (100 OR MORE)
<input type="checkbox"/> NONE	<input type="checkbox"/> NONE
<input type="checkbox"/> N/A (BRD Closed)	<input type="checkbox"/> N/A (BRD Closed)
<input type="checkbox"/> NOT OBSERVED <small>(or not able to see.)</small>	<input type="checkbox"/> NOT OBSERVED <small>(or not able to see.)</small>
COMMENTS: _____	COMMENTS: _____

CONDITION and FATE FORM

This form must be completed for each Sampled Tow

Trip No.: Enter Trip Number provided by Observer Coordinator.

Vessel: Leave blank unless provided by Observer Coordinator.

Tow Number: Transcribe from Station Sheet.

This form is used for all sampled tows. All nets should be experimental unless specifically told by on Observer Coordinator.

Experimental Net (BRD Typically Open)

Net Position: Circle experimental and enter the net position.

Condition and Fate of Bycatch Prior to Discarding

- 1. Fish:** Select and mark one of the four categories listed: more than 50% of catch alive, more than 50% of catch dead, not determined (catch not dumped), or not observed.
- 2. Invertebrates:** Select and mark one of the four categories listed: more than 50% of catch alive, more than 50% of catch dead, not determined (catch not dumped), or not observed.
- 3. Predators Observed:** Refer to the table on the form and select the appropriate number code for each predator species listed: sharks, dolphins, seabirds, or other fish. Note: if BRD is closed, predators cannot be observed feeding on organisms exiting BRD.
- 4. (Estimated # or Organisms) Seen Exiting BRD during Net Retrieval:** Select and mark one of the seven categories listed: 1 – 10, 10 – 50, 50 – 100, 100 or more, none, N/A (BRD closed), or not observed (or not able to see).

Note: If the vessel is only pulling two nets, even though you are only sampling one net (the net not behind the try net), you still need to fill out the condition/fate information for both nets 2 and 3.

SPECIES CHARACTERIZATION FORM

BRD TESTING PROTOCOL

ORG PRO

Control (C) or Experimental (E)

TRIP NO.

VESSEL

TOW NUMBER

NET POSITION

COMMON NAME	GENUS						SPECIES						NUMBER			SAMPLE WEIGHT (kg)			SELECT WEIGHT (kg)			
BROWN SHRIMP	F	A	R	F	A	N	T	A	Z	T	E	C	U									
WHITE SHRIMP	L	I	T	O	P	E	N	S	E	T	I	F	E									
PINK SHRIMP	F	A	R	F	A	N	T	D	U	O	R	A	R									
PENAEUS DISCARD	P	E	N	A	E	U	S	D	I	S	C	A	R									
CRABS, LOBSTERS, ETC.	C	R	U	S	T	A	C									1						
OTHER INVERTEBRATES	I	N	V	E	R	T	E									1						
BLACKNOSE SHARK	C	A	R	C	H	A	R	A	C	R	O	N	O									
SPINNER SHARK	C	A	R	C	H	A	R	B	R	E	V	I	P									
FINETOOTH SHARK	C	A	R	C	H	A	R	I	S	O	D	O	N									
BLACKTIP SHARK	C	A	R	C	H	A	R	L	I	M	B	A	T									
ATLANTIC SHARPNOSE SHARK	R	H	I	Z	O	P	R	T	E	R	R	A	E									
BONNETHEAD SHARK	S	P	H	Y	R	N	A	T	I	B	U	R	O									
SMOOTH DOGFISH SHARK	M	U	S	T	E	L	U	C	A	N	I	S										
FLORIDA SMOOTHOUND SHARK	M	U	S	T	E	L	U	N	O	R	R	I	S									
LEM ON SHARK	N	E	G	A	P	R	I	B	R	E	V	I	R									
OTHER SHARKS NOT LISTED	C	A	R	C	H	A	R															
TROUT	C	Y	N	O	S	C	I															
SNAPPER (OTHER)	L	U	T	J	A	N	U															
LANE SNAPPER	L	U	T	J	A	N	U	S	Y	N	A	G	R									
CROAKER	M	I	C	R	O	P	O	U	N	D	U	L	A									
SOUTHERN FLOUNDER	P	A	R	A	L	I	C	L	E	T	H	O	S									
BLACK DRUM	P	O	G	O	N	I	A	C	R	O	M	I	S									
COBIA	R	A	C	H	Y	C	E	C	A	N	A	D	U									
VERMILLION SNAPPER	R	H	O	M	B	O	P	A	U	R	O	R	U									
RED DRUM	S	C	I	A	E	N	O	O	C	E	L	L	A									
SPOTTED SEATROUT	C	Y	N	O	S	C	I	N	E	B	U	L	O									
KING MACKEREL	S	C	O	M	B	E	R	C	A	V	A	L	L									
SPANISH MACKEREL	S	C	O	M	B	E	R	M	A	C	U	L	A									
LONGSPINE PORGY	S	T	E	N	O	T	O	C	A	P	R	I	N									
OTHER FINFISH-GROUPED	P	I	S	C	E	S									1							
DEBRIS	D	E	B	R	I	S									1							
DOMINANTS / OTHER NOT LISTED																						

SPECIES CHARACTERIZATION FORM - MODIFIED SOUTH ATLANTIC PENAEID SHRIMP

ORG PRO TRIP NO.

VESSEL

TOW NUMBER

NET POSITION

Control (C) or Experimental (E)

COMMON NAME	GENUS	SPECIES	NUMBER	SAMPLE WEIGHT (kg)	SELECT WEIGHT (kg)
BROWN SHRIMP	F A R F A N T	A Z T E C U			
WHITE SHRIMP	L I T O P E N S	E T I F E			
PINK SHRIMP	F A R F A N T	D U O R A R			
PENAEUS DISCARD	P E N A E U S	D I S C A R			
BLUE CRAB	C A L L I N E S	A P I D U			
CRABS, LOBSTERS, ETC.	C R U S T A C		1		
CANNONBALL JELLYFISH	S T O M O L O M	E L E A G			
JELLYFISH FAMILY	C A R Y B D E		1		
OTHER INVERTEBRATES	I N V E R T E		1		
STAR DRUM	S T E L L I F L	A N C E O			
ATLANTIC MENHADEN	B R E V O O R T	Y R A N N			
SHAD	A L O S A				
SPINNER SHARK	C A R C H A R B	R E V I P			
SILKY SHARK	C A R C H A R F	A L C I F			
FINETOOTH SHARK	C A R C H A R I	S O D O N			
BLACKTIP SHARK	C A R C H A R L	I M B A T			
ATLANTIC SHARPNOSE SHARK	R H I Z O P R T	E R R A E			
BONNETHEAD SHARK	S P H Y R N A T	I B U R O			
SMOOTH DOGFISH SHARK	M U S T E L U C	A N I S			
SCALLOPED HAMMERHEAD SHARK	S P H Y R N A L	E W I N I			
OTHER SHARKS NOT LISTED	C A R C H A R				
SPOTTED SEATROUT	C Y N O S C I N	E B U L O			
SILVER SEATROUT	C Y N O S C I N	O T H U S			
WEAKFISH (GRAY TROUT)	C Y N O S C I R	E G A L I			
SEATROUT (GENUS)	C Y N O S C I				
SPOT	L E I O S T O X	A N T H U			
ATLANTIC CROAKER	M I C R O P O U	N D U L A			
SOUTHERN KINGFISH	M E N T I C I A	M E R I C			
NORTHERN KINGFISH	M E N T I C I S	A X A T I			
RED DRUM	S C I A E N O O	C E L L A			
BLACK DRUM	P O G O N I A C	R O M I S			
COBIA	R A C H Y C E C	A N A D U			
SOUTHERN FLOUNDER	P A R A L I C L	E T H O S			
SUMMER FLOUNDER	P A R A L I C D	E N T A T			
KING MACKEREL	S C O M B E R C	A V A L L			
SPANISH MACKEREL	S C O M B E R M	A C U L A			
SCUP	S T E N O T O C	H R Y S O			
GAG	M Y C T E R O M	I C R O L			
BLACK SEABASS	C E N T R O P S	T R I A T			
BANK SEABASS	C E N T R O P O	C Y U R U			
ROCK SEABASS	C E N T R O P P	H I L A D			
FLORIDA POM PANO	T R A C H I N C	A R O L I			
BLUEFISH	P O M A T O M S	A L T A T			
STURGEON	A C I P E N S				
OTHER FINFISH-GROUPED	P I S C E S		1		
DEBRIS	D E B R I S		1		

SPECIES CHARACTERIZATION FORM - MODIFIED SOUTH ATLANTIC ROCK SHRIMP

ORG PRO TRIP NO.

VESSEL

TOW NUMBER

NET POSITION

Control (C) or Experimental (E)

COMMON NAME	GENUS	SPECIES	NUMBER	SAMPLE WEIGHT (kg)	SELECT WEIGHT (kg)
ROCK SHRIMP	S I C Y O N I				
ROCK SHRIMP CULL	S I C Y O N I	D I S C A R			
BROWN SHRIMP	F A R F A N T	A Z T E C U			
WHITE SHRIMP	L I T O P E N S E T I F E				
PINK SHRIMP	F A R F A N T	D U O R A R			
PENAEUS DISCARD	P E N A E U S	D I S C A R			
IRIDESCENT SWIMMING CRAB	P O R T U N U	G I B B E S			
LONGSPINE SWIMMING CRAB	P O R T U N U	S P I N I C			
CRABS, LOBSTERS, ETC.	C R U S T A C		1		
OTHER INVERTEBRATES	I N V E R T E		1		
DUSKY FLOUNDER	S Y A C I U M	P A P I L L			
INSHORE LIZARDFISH	S Y N O D U S	F O E T E N			
SHAD	A L O S A				
SPINNER SHARK	C A R C H A R	B R E V I P			
SILKY SHARK	C A R C H A R	F A L C I F			
FINETOOTH SHARK	C A R C H A R	I S O D O N			
BLACKTIP SHARK	C A R C H A R	L I M B A T			
ATLANTIC SHARPNOSE SHARK	R H I Z O P I T E R	R A E			
BONNETHEAD SHARK	S P H Y R N A T I B U R O				
SM OOTH DOGFISH SHARK	M U S T E L U C A N I S				
SCALLOPED HAMMERHEAD SHARK	S P H Y R N A L E W I N I				
OTHER SHARKS NOT LISTED	C A R C H A R				
SPOTTED SEATROUT	C Y N O S C I N E B U L O				
SILVER SEATROUT	C Y N O S C I N O T H U S				
WEAKFISH (GRAY TROUT)	C Y N O S C I R E G A L I				
SEATROUT (GENUS)	C Y N O S C I				
SPOT	L E I O S T O X A N T H U				
ATLANTIC CROAKER	M I C R O P O U N D U L A				
SOUTHERN KINGFISH	M E N T I C I A M E R I C				
NORTHERN KINGFISH	M E N T I C I S A X A T I				
RED DRUM	S C I A E N O O C E L L A				
BLACK DRUM	P O G O N I A C R O M I S				
COBIA	R A C H Y C E C A N A D U				
SOUTHERN FLOUNDER	P A R A L I C L E T H O S				
SUMMER FLOUNDER	P A R A L I C D E N T A T				
KING MACKEREL	S C O M B E R C A V A L L				
SPANISH MACKEREL	S C O M B E R M A C U L A				
SCUP	S T E N O T O C H R Y S O				
GAG	M Y C T E R O M I C R O L				
BLACK SEABASS	C E N T R O P S T R I A T				
BANK SEABASS	C E N T R O P O C Y U R U				
ROCK SEABASS	C E N T R O P P H I L A D				
FLORIDA POM PANO	T R A C H I N C A R O L I				
BLUEFISH	P O M A T O M S A L T A T				
STURGEON	A C I P E N S				
OTHER FINFISH-GROUPED	P I S C E S		1		
DEBRIS	D E B R I S		1		

SPECIES CHARACTERIZATION FORM

SHRIMP CHARACTERIZATION

ORG PRO

--	--	--	--	--	--	--

TRIP NO.

--	--	--

VESSEL

--	--	--

TOW NUMBER

NET POSITION

Control (C) or Experimental (E)

	COMMON	GENUS			SPECIES			NUMBER			SAMPLE WEIGHT (kg)			SELECT WEIGHT (kg)		
1																
2																
3																
4																
5																
6																
7																
8																
9																
10																
11																
12																
13																
14																
15																
16																
17																
18																
19																
20																
21																
22																
23																
24																
25																
26																
27																
28																
29																
30																
31																
32																
33																
34																
35																
36																
37																
38																
39																
40																

SPECIES CHARACTERIZATION FORM

Trip No: Enter Trip Number provided by Observer Coordinator.

Vessel: Leave blank unless provided by Observer Coordinator.

Tow Number: Transcribe from Station Sheet.

Net Position: Enter the net position sample was taken from.

Control (C) or Experimental (E): Enter the appropriate code for the sample net.

Procedure

Obtain approximately one basket of catch from each sampled net for species characterization purposes. Weigh each basket and enter the weight on the Station Sheet. Target species (red snapper) and select species (a particular species generally of commercial importance or rare [prior to the trip you will be informed of what commercial species, if any, are select]) should not be included on the sample weight. Once the sample weight has been obtained, separate the penaeid shrimp by species (brown, white, pink), count, and weigh (**head on**). Now, add these shrimp weights to the rest of the nets catch to get total shrimp weight for the sampled net (recorded on Station Sheet). **VERY IMPORTANT:** If the vessel is heading the shrimp, remove the heads from the shrimp obtained from the characterization basket and re-weigh before adding in the shrimp weights.

Processing Remainder of Sample

Species Separation

Become familiar with the species listed on the species characterization form. These organisms will be separated by species, counted and weighed. Weight and length measurements are recorded to the hundredths place; if your value is 0.20 (for example) you are required to fill in the leading zero and the hundredth place zero.

COMMON NAME	GENUS	SPECIES	NUMBER	SAMPLE WEIGHT (kg)	SELECT WEIGHT (kg)
LANE SNAPPER	L U T J A N U	S Y N A G R	5	0 . 2 0	. 2
LANE SNAPPER	L U T J A N U	S Y N A G R	5	. 2	. 2

**CORRECT
INCORRECT**

If a weight or number cannot be obtained (i.e., accidentally discarded organisms overboard before counting or weighing) 999.99 or 99999 should be entered. Enter 888.88 for weights less than 0.01 kg.

COMMON NAME	GENUS	SPECIES	NUMBER	SAMPLE WEIGHT (kg)	SELECT WEIGHT (kg)	
LANE SNAPPER	L U T J A N U	S Y N A G R	9 9 9 9 9	9 9 9 . 9 9		Discarded Before Weighing and Measuring
LANE SNAPPER	L U T J A N U	S Y N A G R	9 9 9 9 9	5 . 0 3		Obtained Weight but not Total Number
PIN FISH	L A G O D O N	R H O M B O		1 8 8 8 . 8 8		One Specimen Weight less than 0.01 kg

If you catch a new species not listed on the Species List, (Section 6 in the manual) then the new species should be flagged for the Observer Coordinator so it can be added to the Data Base.

Gulf of Mexico Fish Species

Blacknose Shark; Spinner Shark; Finetooth Shark; Blacktip Shark; Atlantic Sharpnose Shark; Bonnethead Shark; Smooth Dogfish Shark; Florida Smoothhound Shark; Lemon Shark; Other Sharks not Listed - use these categories for all species of sharks not listed above;

Trout - this includes all species of sea trout except spotted (speckled) sea trout;

Snapper (Other) - is for "Lutjanus" species only (this does not include wenchman snappers);

Lane Snapper - commonly referred to as a "candy snapper";

Atlantic croaker - very common, sometimes confused with spot (which has a conspicuous spot just above the pectoral fin);

Southern Flounder – take care not to confuse this with other common flatfish;

Black Drum - juveniles sometimes confused with sheepshead;

Cobia - juveniles sometimes confused with shark suckers;

Vermilion Snapper - easily confused with wenchman snapper (which are usually more common in offshore trawls);

Red Drum (Redfish);

Spotted (Speckled) Seatrout;

King Mackerel - deep posterior downward slope to lateral line;

Spanish mackerel - shallow posterior slope to lateral line; and

Longspine Porgy - very common on offshore shrimp grounds.

East Coast Fish Species

Shad - all species of "Alosa" genus;

Spinner Shark; Silky Shark; Finetooth Shark; Blacktip Shark; Atlantic Sharpnose Shark; Bonnethead Shark; Smooth Dogfish Shark; Scalloped Hammerhead; Other Sharks not Listed - use these categories for all species of sharks not listed above;

Spotted (Speckled) Seatrout;

Silver Seatrout - easily confused with weakfish. Pigment on tongue not defined to tip but scattered more uniformly over surface, body silvery without noticeable spots and anal fin generally pale to slightly yellow in juveniles. Anal fin of weakfish typically exhibits a more noticeable yellow color than the silver seatrout;

Atlantic croaker - sometimes confused with spot (which has a conspicuous spot just above the pectoral fin);

Southern and Northern Kingfish (whiting) - easily confused especially as juveniles. Distinctive characteristics of the northern kingfish - typically has an extended second dorsal spine, a dark "v" shaped pattern extending from nape and apexing at pectoral fin followed posteriorly by a series of bars. The southern kingfish lacks an extended second dorsal spine and the two sides of the "v" do not come together to form an apex (the pigmentation of the "v" and subsequent bars is typically considerably lighter or almost faint);

Red Drum (Redfish);

Black Drum - juveniles sometimes confused with sheepshead;

Cobia - juveniles sometimes confused with shark suckers;

Southern and summer flounder - be careful not to confuse with other common flatfish trawls;

King Mackerel - deep posterior downward slope to lateral line;

Scup - this resembles the Gulf of Mexico longspine porgy;

Gag - often confused with black grouper;

Black Seabass;

Rock Seabass; Florida Pompano; Bluefish; and Sturgeon.

All remaining organisms will be separated into the following categories:

A group weight should be obtained for each of the four categories (listed below) and entered on the species characterization form. You do not have to count each organism within a category a default code of 1 has already been entered in the number column. 999.99 should be entered if a weight cannot be obtained (i.e., accidentally discarded organisms overboard before weighing). Enter 888.88 for weights less than 0.01 kg.

1. **Crabs, Lobster, etc. (Crustacea):** includes shrimp other than brown, white, and pink (mantis shrimp, sugar shrimp, and seabobs). Other crustaceans such as crabs, lobsters, etc. should be included in this group as well.
2. **Other Invertebrates:** includes organisms like squid, jellyfish, starfish, sea pansies, shells, etc.
3. **Other Finfish (Pisces):** includes all other fish, skates and rays not listed on the pre-printed Station Sheet. If the dominant fish species in your sample is not listed on the pre-printed station sheet enter the common and scientific name, count and weight for that species group on the pre-printed list under other species not listed.
4. **Debris:** Includes miscellaneous non-living debris such as mud, rocks, shells, sticks, etc.

Other Species Not Listed

Use this area to note other species of interest (unusual) or other important species that seem dominant but do not appear on species list. Shrimp species discarded (culled) by the crew are entered as Penaeus Discard (PENAEUSDISCAR) with the total number and weight.

Select Species

If a particular species is to be selected out of the total catch, and not just the sample, record the species group weight in the select weight column. Select species are not included in the sample weight. Generally, this occurs when the species is of commercial importance or rare. The project manager will inform you prior to the trip what commercial species (if any) are select. If a species is rare (i.e., not generally trawl caught) select that species out of the entire catch for the net selected for sampling (Note: If a species is selected out of the total catch you must select it out of both nets to prevent side bias). **If the catch was worked up in its entirety (less than one basket of catch), all entries will be in the select column.**

The blank Species Characterization Form (Shrimp Characterization) can be used as a page two for the other Species Characterization Forms if space is needed to list species not listed on the forms.

LENGTH FREQUENCY FORM

Length Frequency Form(s) should be completed for all target species present in the sample. Enter length measurements in millimeters. For the Gulf of Mexico, all red snapper in the net should be measured.

Trip No: Enter Trip Number provided by Observer Coordinator.

Vessel: Leave blank unless provided by Observer Coordinator

Tow No.: Transcribe from Station Sheet.

Net Position: Transcribe from Station Sheet.

Genus-Species: Enter the first seven characters of the genus and the first six characters of the species name. The highlighted last two squares are for the measurement code, which indicates the type of measurement that should be utilized (appendix 10). The measurement code is 01 (measure fork length) for red snapper. List the measurements in the columns. Use adjacent column(s) if more than 25 lengths are obtained, and use additional forms if needed. List the number of broken (unmeasurable) specimens in the blocks below the respective column.

GENUS							
L	U	T	J	A	N	U	
C	A	M	P	E	C	0	1
SPECIES						MEAS.CODE	

GENUS							
F	A	R	F	A	N	T	
A	Z	T	E	C	U	0	3
SPECIES						MEAS.CODE	

	LENGTH (MM)			
1			9	9
2			8	8
3			5	0

	LENGTH (MM)			
1		1	2	3
2		1	1	0
3		1	4	2

NUMBER OF BROKEN (UNMEASURABLE)			
≤100 mm	1	>100 mm	0

NUMBER OF BROKEN (UNMEASURABLE)			
≤100 mm	0	>100 mm	0

Length Frequency/Weight Form Continued: If you need additional space, continue on a new Length Frequency Form. Number the sheets in the space provided at the bottom of the form. (Page 1 of 3 , Page 2 of 3 , etc.)

LIST OF AND ORDER OF BY-CATCH DATA FORMS

Required for the completion of all By-Catch trips:

Cover Sheet

Acknowledgement of Data Collected

Trip Report – Page 1

Vessel Information Form

Trip Report – Page 2 (Tows Not Sampled)

Trip Report – Page 3 (Sampled Tow Log)

Safety Check-off Form – Page 1

Safety Check-off Form (Station Bill) – Page 2

Observer Feedback Form

Trip Completion Form

Southeast Fisheries Observer Incident Report

Marine Pollution (MARPOL) Incident Report

Try Net Tow Summary

Gear Specification Form – Page 1

TED/BRD Specification Form – Page 2

Station Sheet (tows not sampled)

Station Sheet (sampled tows)

Condition and Fate Form (sampled tows)

Species Characterization Forms (complete appropriate forms based on type of trip)

- BRD Testing Protocol
- Modified South Atlantic Penaeid Shrimp
- Modified South Atlantic Rock Shrimp
- Shrimp Characterization

Length Frequency Form (Target Species) / BRD Testing Protocol

Sea Turtle Life History Form – Pages 1 and 2 (as required)

Specimen Collection Log (as required)

MANDATORY SKIMMER PROTOCOL

All mandatory skimmer trip numbers begin with "GI". Forms are filled out the same as with a vessel pulling two nets (**nets #2 and #3, always experimental**). Before the vessel starts fishing, obtain gear measurements for both nets. It may be necessary to drop the skimmer frames to obtain these measurements. Net type will always be "Skimmer". For all other measurements use the same protocol as otter trawl. Skimmer vessels may not have a BRD installed depending on state regulations. If the vessel has a BRD installed, record that on the gear form and indicate whether it is open or closed on the station sheet for each tow. Once the initial gear measurements are made, no further measurements are necessary unless changes are made to the nets.

During the trip, you should attempt to sample every tow. For each tow, record latitudes, longitudes, depths, start times, and end times. For the entire duration of the trip, monitor both nets for protected species interactions. To sample finfish and shrimp; begin by randomly (e.g. coin flip) selecting a net to start sampling (port or starboard). Continue to sample that net until there is a break in fishing operations. At that point, start sampling the other net. Alternate back and forth until observer coverage is completed on the vessel. Be aware of mitigating factors such as vessel layout, captain's request, etc., that may alter this sampling protocol.

For the net being sampled, tow times are defined by when the codend (bag) is deployed in the water (time in) and when the codend is brought onboard (time out) the vessel (bag in - bag out). Codends may be periodically brought up to the surface without being brought onboard (surface observation codends remaining in the water) to determine the size of the catch and check for protected species interactions. **This does not constitute the end of a tow** (only record times in logbook/comments section, not operation code K). Remember, a tow time out is not recorded until the codend is brought all the way onboard the vessel. Record the surface observation times in the comments section of the station sheet and logbook. If the codends are brought **fully** onboard and redeployed without emptying, use operation code K followed by T for the subsequent tow (same as otter trawl).

Skimmer trawl operations allow nets to fish continuously while retrieving only the codend. When the codends are picked up and the frames remain in the water between tows, the following tow's start time is recorded as one minute after the previous tow's end time. This accounts for the effort when the frames remain in the water while dumping the catch and redeploying only the codend. If both the frames and codends are picked up, the following tow's start time is recorded when the frames and codends are redeployed, as both are deployed simultaneously.

Since you are only recording tow times for the net being sampled (2 or 3), you need to indicate if the tow time for the other net is known. This is done with operation codes. If the tow times are known for both nets (codends deployed and retrieved simultaneously) use 9ZZ9. If the codends are not being brought onboard the vessel at the same time, use operation code V for the net not being sampled. For example, you are sampling net #2 (thus recording tow

times for net #2). The #3 codend remains in the water while the #2 codend is retrieved, the operation codes would be 9ZV9. This indicates that the recorded tow time is only for net #2 and the net #3 tow time is unknown.

For each tow, you will attempt to sample one net for total catch and total shrimp weight. You will shovel or dump the catch into baskets to obtain a total weight for the sampled net. Remove all red snapper from the sampled net, then measure and weigh. If possible, obtain a total shrimp weight for the sampled net. If a brine tank is used to separate the bycatch, it may be more difficult to keep the shrimp separate, as it requires the crew to empty the tank of all catch from the unsampled net before adding the catch from the sampled net. Finally, if there is sufficient time and space aboard the vessel, perform a characterization on one basket from the sampled net using the standard Gulf of Mexico characterization form.

PRIORITY LIST DURING FISHING OPERATIONS

1	Document all protected species interactions for both nets on all tows
2	Obtain total catch weight for sampled net
3	Obtain all red snapper from sampled net
4	Obtain total shrimp weight from sampled net
5	Obtain a ~1 basket characterization sample from sampled net

Overhead view of a typical skimmer trawl vessel. Source: Hein, S., and P. Meier. 1995. Skimmers: Their development and use in coastal Louisiana. Marine Fisheries Review 57(1):17-24.

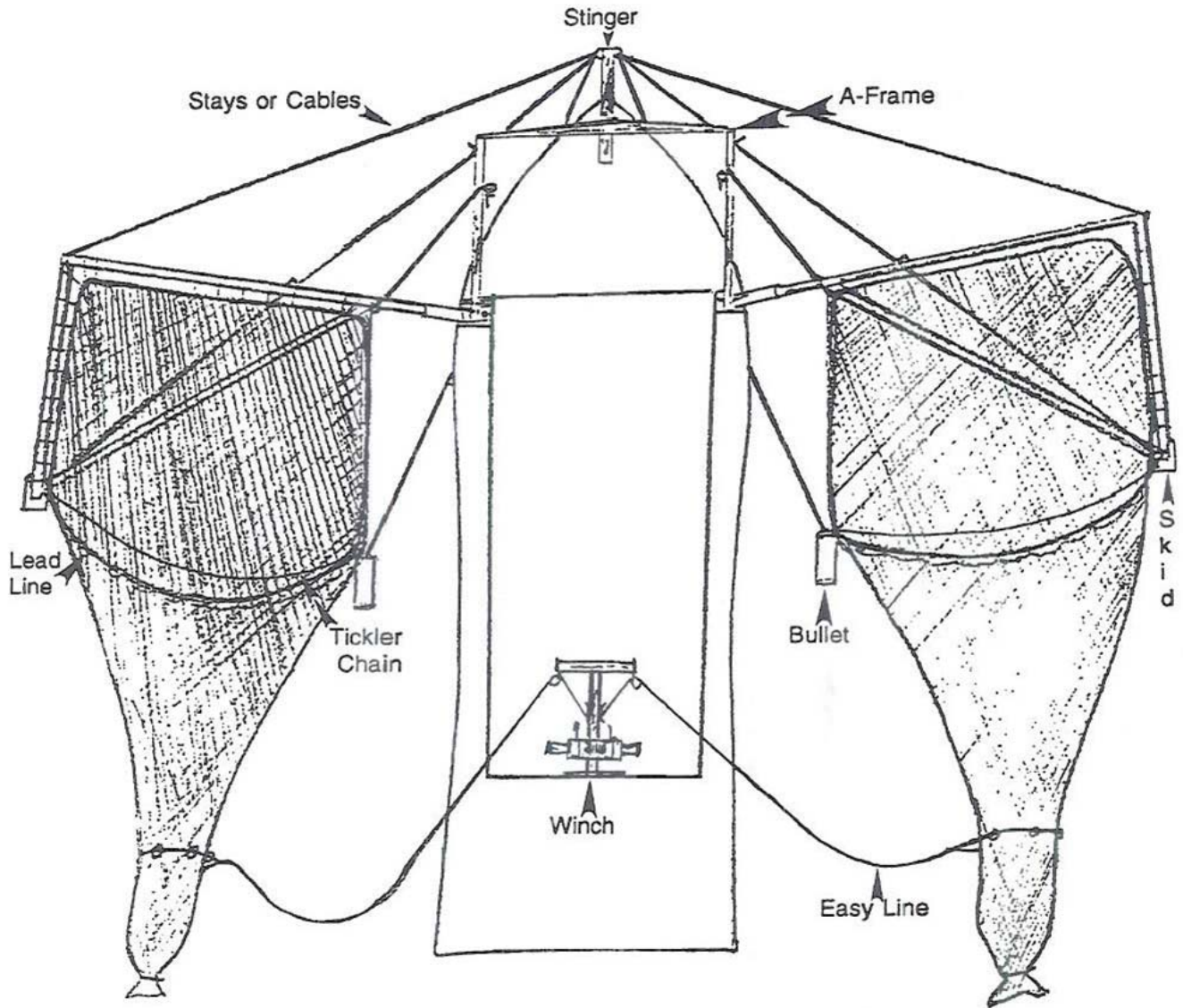

SECTION 4

REEF FISH

DATA COLLECTION

REEF FISH DATA COLLECTION

Onboard data collection for reef fish bycatch characterization will consist of sampling catches of commercial fishermen operating in the U.S. Gulf of Mexico. Observers will gather data on species composition and abundance from each set sampled. Personnel at NOAA Fisheries Service's Southeast Fisheries Science Center (SEFSC) Galveston Laboratory have prepared the procedures outlined below for sampling, which are consistent with the Southeast Area Monitoring and Assessment Program's (SEAMAP) data management system. We recommend this protocol for use in all regional reef fish bycatch assessment programs to facilitate the accessibility and analysis of integrated data sets.

Onboard observers will identify all fish to the species level from reef fish sets. An individual weight and length measurement for each specimen as well as fate or health condition of all fish, including discarded individuals, will be recorded. Selected species will be tagged and released. Sets will be randomly sub-sampled if warranted.

Data collected by observers aboard reef fish boats will be completed on the appropriate forms upon arrival at the dock. Captains may request photocopies of data, whereby the observer will make arrangements to fulfill this request through the proper channels. All copies of data given to Captains must be approved by the Program Manager. Upon returning to the dock, observers must thoroughly review all data sheets (i.e., triple-check all entries). Completed trip data sets must then be mailed promptly to: NOAA Fisheries, 4700 Avenue U, Galveston, Texas 77551 Attention: Matthew Duffy. Photocopies of all data, including logbooks, need to be retained in the event that the original data are not received. Observers will retain any and all photocopies until instructed by the Observer Coordinator to properly dispose of them.

A letter of intent explaining project objectives will be provided to the captain and/or owner of each vessel during the initial stages of a trip. The observer coordinators are responsible for talking to the captain/owner **at least once** prior to each trip to ensure clarification of data collection methods.

Each observer is required to read and understand the SEFSC Observer Safety and Conduct Manual (see page 15), as well as general information and safety requirements set forth in the Galveston Laboratory's Observer Program Guidelines.

COMPLETING and SUBMITTING DATA FORMS

Fishery observers will be placed year-round on reef fish vessels operating in the US Gulf of Mexico and southeastern Atlantic. Sampling effort allocation will be based on current effort trends for all areas. Reef fish fisheries are hand line, bandit reel, longline, modified buoy and spear fishing.

Vessel length, hull construction material, gross tonnage, engine horsepower and crew size will be obtained for each vessel. Economic data relative to fuel, oil, ice, bait and associated vessel costs may be collected on a per trip basis. For each set (the location of gear placement at a defined time) the type, number and construction material of the fishing gear will be recorded.

Latitude, longitude, depth, and environmental parameters including, sea state and bottom type will be recorded at the start of each set. Soak or fishing time, the time the gear remains in the water, will be calculated.

Fishery-specific data will be obtained from each set made aboard reef fish vessels (hand-line, bandit reel, longline, modified buoy [JUG] and spear fishing). If a set cannot be sampled due to time constraints or weather conditions, a minimum of location, depth and fishing time will be recorded. Non-target and undersized target species will be processed first, recording length, weight and fate prior to release (alive, dead, or unknown). Air bladder punctures by the captain and crew of live fish will be recorded. Retained species are then processed, recording length, weight and condition. Captures and sightings of sea turtles, marine mammals and any other protected species will be documented.

Data will be computerized, edited and archived on a per trip basis. The final analyses will include t-tests, ANOVA, linear and/or multiple regression and spatial statistics, ratio estimation, and Bayesian procedures.

In the following sections, copies of each of the data forms are included. It is imperative that you complete each form correctly. The first three forms listed below must be submitted, for each type of reef fish trip (hand line, bandit reel, longline and spear fishing):

1. **Trip Report Form Page 1**
2. **Trip Report Form Page 2 (Sets not Sampled)**
3. **Trip Report Form Page 3 (Sampled Set Log)**

Completion of the remaining 5 data forms is dependent on the type of reef fish trip (bandit reel [BR], hand line [BR], longline [LL], modified buoy [JUG] and spear fishing [SF]). Gear specification forms are required for each trip, however; completion of forms 2 through 5 is dependent on the collection of fishery specific data.

1. **Gear Specification Form (BR-GS) (LL-GS) (JUG-GS) (SF-GS)**
2. **Station Sheet (BR-SS) (LL-SS) (JUG-SS) (SF-SS)**
3. **Length Frequency/Weight Form (BR-LF) (LL-LF) (JUG-SS) (SF-LF)**
4. **Sea Turtle Life History Form** (only if applicable)
5. **Protected Resources Capture Report** (only if applicable)
6. **Marine Mammal Life History Form** (only if applicable)
7. **Tag Reporting Form** (only if applicable)
8. **Specimen Collection Form** (only if applicable)
9. **Gonad/Otolith Form** (only if applicable)

COLLECTION of REEF FISH TRIP REPORT INFORMATION

Complete the following forms for each reef fish trip made:

1. Trip Report (Reef Fish) Page 1
2. Trip Report (Reef Fish) Page 2 (Sets not Sampled)
3. Trip Report (Reef Fish) Page 3 (Sampled Set Log)

This information is filled out when the trip is complete. These forms make up a compilation of facts that sum up the trip.

TRIP REPORT - REEF FISH

TRIP # _____

VESSEL NAME _____ ID # _____ VSCODE _____ LTH _____
(CG DOCUMENTATION #) (LENGTH)

VESSEL RIGGING : **LONGLINE** _____ **HANDLINE** _____ **BANDIT** _____ **JUG** _____ **SPEAR** _____
(CHECK ONE) STATE CITY

PORT OF DEPARTURE _____ / _____

OBSERVER NAME _____

ORGANIZATION _____

TRIP DATES _____ MTH/DAY - _____ MTH/DAY _____ YEAR
(dates, total # of travel and sea days allotted for this trip)

OBSERVER DAYS _____

DATES AT SEA _____ MTH/DAY - _____ MTH/DAY _____ YEAR
(dates, total # of days at sea from port to port)

SEA DAYS _____

24 HR. DAYS. FISHED (including sets not sampled)
 TOTAL TIME (set hours) _____ / 24 = _____

STARTING SET # _____
 ENDING SET # _____
(UNSAMPLED SETS DO NOT GET NUMBERED)

AVERAGE SET TIME

TOT.TIME SET HOURS [SAMPLED] (1) (1) (2) (3) (4)
 TOT.TIME SET HOURS [UNSAMPLED] (2) (_____ + _____) / (_____ + _____) = _____
 TOT.# SETS SAMPLED (3)
 TOT.# SETS UNSAMPLED (4)

AREAS FISHED

STAT.AREA #						
INSHORE						
NEARSHORE ≤ 60'						
OFFSHORE > 60'						

(ENTER APPLICABLE STATISTICAL AREA # THEN THE # OF SETS "SAMPLED" IN THE APPROPRIATE ZONE BLOCK)

TURTLES CAPTURED

SPECIES	LAT/LONG	DATE	SET NO.
1 _____	_____	_____	_____
2 _____	_____	_____	_____
3 _____	_____	_____	_____
4 _____	_____	_____	_____
5 _____	_____	_____	_____
6 _____	_____	_____	_____
7 _____	_____	_____	_____

TURTLES SIGHTED

SPECIES	LAT/LONG	DATE	SET NO.
1 _____	_____	_____	_____
2 _____	_____	_____	_____
3 _____	_____	_____	_____
4 _____	_____	_____	_____
5 _____	_____	_____	_____
6 _____	_____	_____	_____
7 _____	_____	_____	_____

COMMENTS

SIGNATURE _____

TRIP REPORT - REEF FISH

SETS NOT SAMPLED

VSCODE _____

TRIP DATES _____

TRIP # _____

NO.	DATE	LATITUDE	LONGITUDE	HOURS SOAKED	DEPTH (FT)	STAT ZONE	REASON NOT SAMPLED
1							
2							
3							
4							
5							
6							
7							
8							
9							
10							
11							
12							
13							
14							
15							
16							
17							
18							
19							
20							
21							
22							
23							
24							
25							
26							
27							
28							
29							
30							
31							
32							
33							
34							
35							
36							
37							
38							
39							
40							
41							
42							
43							
44							
45							

TRIP REPORT FORMS

Trip No: Enter Trip Number provided by Observer Coordinator.

Vessel Name: Enter the full name of the vessel.

ID #: (Vessel Documentation Number). Enter the Coast Guard Documentation number.

Vessel Code (VSCODE): Enter Vessel Code provided by Observer Coordinator.

Length (LTH): Transcribe from Vessel Information Form.

Vessel Rigging (check one): Check the appropriate answer.

Port of Departure: Enter the STATE and CITY from where the vessel departed.

Observer Name: Print your full name.

Organization: Enter the organization conducting the survey (e.g., NOAA, Foundation, etc.).

Trip Dates: Enter month, day, and year that you left the laboratory (or home) and began traveling to the vessel. Enter the month and day that you returned to your final destination. This includes days spent in motels waiting for the vessel to depart and/or transportation and return to the laboratory or home (ex., 3/5 - 3/10/13).

Observer Days: Enter the total number of days of your trip. For the above example, enter 6. Any part of a day constitutes an observer day.

Dates at Sea: Enter the dates (departure-arrival) that you actually spent at sea (ex., departure at 3:30pm 3/6/13, arrival 2:00am 3/9/13).

Sea Days: Enter the total number of days spent at sea (for the above example, 4). Any part of a day spent at sea is considered a sea day. Please double check this value, and be sure you count the starting day.

24 Hr. Days Fished: Enter the total number of set hours, including sets sampled and sets not sampled. Divide this number by 24 to get the total number of 24 hr days fished. For example, (4.4 hours sampled + 6.5 hours unsampled) / 24 = 0.5

Starting Set No.: This will always be 001 (UNSAMPLED SET ARE NOT NUMBERED).

Ending Set No.: Enter the last set number (UNSAMPLED SET ARE NOT NUMBERED).

Average Set Time: Compute and enter value in spaces provided. Include set times for sets not sampled in your calculation.

Areas Fished

Stat. Area No.: Enter the appropriate STAT ZONE (s) where sampled sets occurred (e.g., 18, 20, see appendix 11) these zones should correspond to what is listed on the Station Sheets.

Next, under the stat zone, enter the total number of sets completed **INSHORE** (areas inside the COLREG lines [line of demarcation that closes off bays and barrier islands]). Enter the total number of sets completed.

Enter the total number of sets completed **NEARSHORE** (water depth \leq 60 ft., all waters outside the inshore line outward into the Gulf of Mexico to the 10 fathom contour line). Enter the total number of sets completed **OFFSHORE** (water depth $>$ 60 ft.).

Turtle Captured

Species: Enter the species (enter unknown if a positive identification could not be made).

Lat/Long: Enter the starting latitude and longitude of the set, or lat/long at the time the turtle is taken onboard.

Date: Enter the date of capture.

Set Number: Enter the set number that the turtle was captured in. If the turtle was captured on a set not sampled, list closest sampled set number and note in comments.

Turtle Sighted

Species: Enter the species if positive identification is made, or unknown.

Lat/Long: Enter the latitude and longitude of the vessel at the time turtle was sighted.

Date: Enter the date of sighting.

Sets Not Sampled – Trip Report Page 2

On page 2 of the trip report re-enter the vessel code, trip dates and trip no. Enter the following information for sets not sampled (or unsampled sets): date, latitude, longitude, hours soaked, depth (ft.), stat zone and reason for not sampling. Remember unsampled sets are not given set numbers. They are unsampled simply due to time constraints or observer choice

(some reasons for not sample are observing crew operations, processing previous set, time constraints, weather, sickness, sleep etc.).

SAMPLED SET LOG – Trip Report Page 3

List, in order, all sets sampled during the trip. The following information should accompany each set listed:

Date: Using two digits for month, day, and year (MO/DY/YR) enter the appropriate information.

Set No.: Enter the set number. The set number begins with "001" for each trip.

Time In: Enter in military time (0001-2359), when the gear was first deployed for this set.

Time Out: Enter in military time (0001-2359), when the gear was removed from the water.

Soak/Fishing Time: To calculate fishing time the procedure is as follows:

Subtract the TIME IN from TIME OUT. Be sure to convert minutes to tenths of an hour prior to entering on the station sheet. (i.e., if the TIME IN is 1331 and the TIME OUT is 1439 then the fishing time was one hour and eight minutes or 1.1 hours).

Depth (feet): Enter the Water Depth on the set in feet.

State Zone: Enter the statistical zone at set time in.

BANDIT REEL DATA FORMS

Complete the following forms for all Bandit Reel (GB) and Hand Line (GH) Trips.

1. Gear Specification Form (BR-GS)
2. Station Sheet (BR-SS)
3. Length Frequency/Weight Form (BR-LF)
4. Sea Turtle Life History Form (Complete only if a turtle is captured or sighted)
5. Protected Resources Capture Report (only if applicable)
6. Marine Mammal Life History Form (only if applicable)
7. Tag Reporting Form (only if applicable)
8. Specimen Collection Log (only if applicable)
9. Gonad/Otolith Form (only if applicable)

GEAR SPECIFICATION FORM - BANDIT REEL

ORG PRO

 TRIP NO.

MO DAY YR

 DATE

OBSERVER CODE

SET NO.

GEAR CODE

ROD MOUNT

Fixed Portable

REEL TYPE

Hand Electric Hydraulic Other

Comments: _____

HOOK TYPE # 1

Hook Type: J-Hook Circular Treble Lure Other

Hook Shape: Straight Offset Double Triple

/0 °

Hook Size Manufacturer/Style: Degrees Offset

Shaft Length in. Point to Shaft in.

Hook Material: Steel Stainless Steel Other Unknown

Comments: _____

MAIN LINE MATERIAL

Mono Braid Nylon Cable Other

Main Line Cable Test lbs

Comments: _____

HOOK TYPE # 2

Hook Type: J-Hook Circular Treble Lure Other

Hook Shape: Straight Offset Double Triple

/0 °

Hook Size Manufacturer/Style: Degrees Offset

Shaft Length in. Point to Shaft in.

Hook Material: Steel Stainless Steel Other Unknown

Comments: _____

LINES OFF MAIN LINE

Length 1: . Feet

Length 2: . Feet

Construction: Twisted Single

Mono Braid Nylon Fluoro Wire Other

Carbon

Test lbs

NO. of Lines

Comments: _____

HOOK TYPE # 3

Hook Type: J-Hook Circular Treble Lure Other

Hook Shape: Straight Offset Double Triple

/0 °

Hook Size Manufacturer/Style: Degrees Offset

Shaft Length in. Point to Shaft in.

Hook Material: Steel Stainless Steel Other Unknown

Comments: _____

NUMBER OF HOOKS

Total No. of Hooks

TRACE HOOK W / DIMENSIONS BELOW

SKETCH GEAR CONFIGURATION & PLACEMENT

GEAR SPECIFICATION FORM – BANDIT REEL

Complete one gear specification form for each gear type used during fishing operations. Changes to any gear setting or configuration require completion of additional forms for the affected sets.

Trip No: Enter Trip Number provided by observer coordinator.

Date: Enter the starting set number date, or the date when the gear was first used.

Observer: Enter your assigned observer code.

Set Number: Enter the starting set number. If gear changes are made, enter the set number when the gear was first used.

Gear Code: Gear codes are designated by the observer; they should always start with the letter "A" and progress through the alphabet, DO NOT SKIP LETTERS. For example, if reels 1, 2 and 3 have the same configuration and reel 4 is different, then 1, 2 and 3 are assigned gear code "A" and reel 4 is assigned gear code "B". Any changes in gear configuration result in a new gear code.

Rod Mount: Enter an "X" in the appropriate square that corresponds to the type of mount. A rod is only considered portable if it is fished by hand. If a portable rod is placed in a rod holder while it is fished, it is no longer considered portable and should be referenced as a fixed rod.

Reel Type: Enter an "X" in the appropriate square that corresponds to the reel type. If you mark "Other," then enter an explanation in the **Comments** section.

Main Line Material: Enter an "X" in the appropriate square that corresponds to the material of the line. If you mark "Other," then enter an explanation in the **Comments** section.

Main Line Cable Test: Enter the test or breaking strength of the main line in pounds. Ask the captain for this information. Enter any comments necessary to better describe entries.

Lines off Main Line: Measure the length (in feet) from the hook's eye (swivel or point of attachment) to the line's end (backbone), including snaps or clips, if any. An extra length field (length 2) has been added for additional lines off the main line. If there are more than two leader lengths add additional lengths in the comments section. If the main line is the leader enter 0.0 feet for length 1 and all characteristics of main line such as type of material and test pounds.

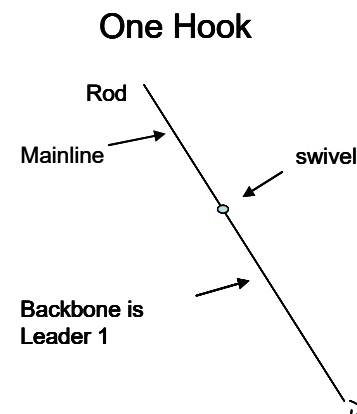

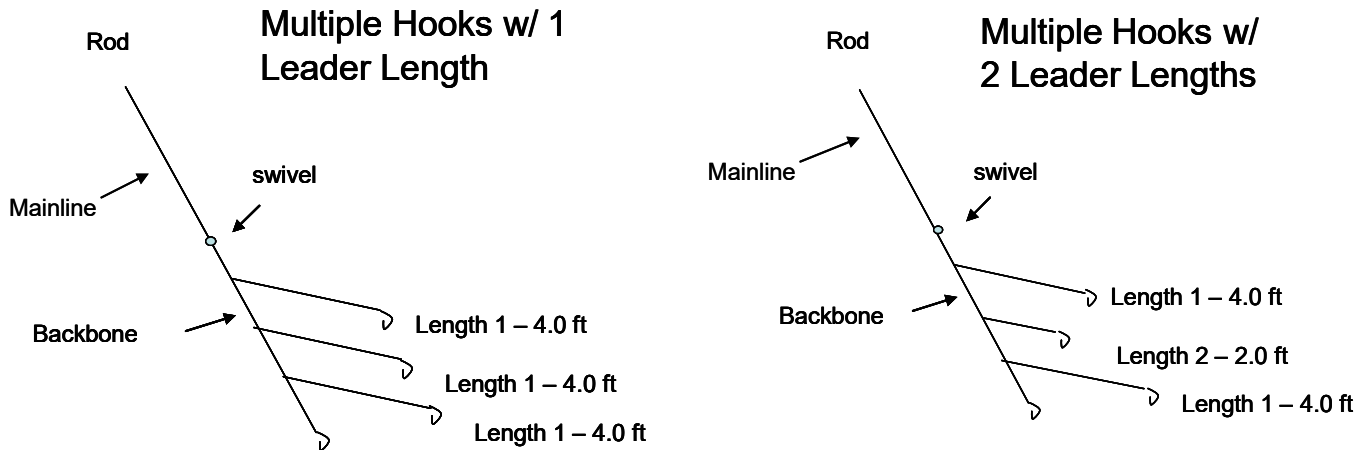

Construction: Enter an "X" in the square that corresponds to the construction of the line.

Material: Enter an "X" in the appropriate square that corresponds to the material of the line. If you mark "Other," then enter an explanation in the **Comments** section.

Test: Enter test or breaking strength of the line in pounds (ask captain for this information).

Number of Lines: Enter the number of lines off the main line (If no leader is used [i.e., mainline attached straight to the hook] then the number of lines is still one).

Lines off Main Line Comments: Enter comments necessary to better describe entries above.

Number of Hooks: Enter the total number of hooks associated with this gear configuration.

Sketch Gear Configuration and Placement: Sketch the gear configuration.

Hook Type: Enter an "X" in the square that best describes the hook shape (see appendix 13). If you mark "Other", then enter the hook types in the **Comments** section. If more than one hook or more than one type of hook is used with one piece of bait (with one hook being threaded through the eye hole of the next hook) you should check all hook types that apply and "Double" or "Triple". This is counted as one hook for "Total No. of Hooks". A hook is considered a **lure** if there is an object attached to the hook designed to create movement, vibration, and color to attract fish. For example, if you have a J-hook with a spoon attached to it. You should check both J-hook and Lure. Space is provided to record up to three different types of hooks.

Hook Shape: Enter an "X" in the appropriate square.

Hook Size: Enter hook size, for example 10/0.

Manufacturer/Style: Enter manufacturer/styles, for example MUSTAD/39960D.

Degrees Offset: Enter the Degrees Offset.

Hook Measurements: Record “Hook Shaft Length” and “Hook Point to Shaft” measurements. If it is a double or triple hook setup with more than one hook size, enter the second or third hook measurements in the comments section.

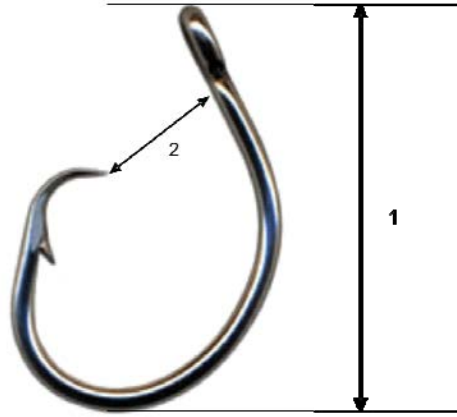

1. Hook Shaft Length: Measure the distance (in inches) from the hook eye to the point of maximum curvature on the bent portion of the hook. Shaft length is in effect the total length of the hook.

2. Hook Point to Shaft: Measure the shortest distance (in inches) from the point of the hook to the shaft of the hook.

Hook Material: Enter an "X" in the appropriate square that best describes the hook materials. If you mark "Other", then enter an explanation in the **Comments** section.

Hook Comments: Enter comments necessary to better describe entries above.

Trace Outline of Hook with Dimensions in Space Below: If possible, lay hook onto paper and trace. Include in diagram, hook shaft length and hook point to shaft measurements.

COLLECTION OF BIOLOGICAL DATA – BANDIT REEL

The First Sets - During the first one or two sets, take this time to observe and assist the crew. You should observe how the gear is being deployed, key out unknown fish, set up your sampling station, get a feel for the data sheets and **determine how many reels you would be able to sample**. The only information you need to record for these sets is: date, latitude, longitude, depth, hours soaked, and reason for not sampling. This information should be recorded in your logbook, the Trip Report, and the corresponding station sheet. Remember unsampled sets are not given set numbers. Some reasons for not sampling are observing crew operations, time constraints, weather, sickness, sleep, etc. At this time, you should also number the reels. **REEL NUMBERING MUST REMAIN CONSISTENT FOR THE ENTIRE TRIP**. For example, Reel #1 - starboard side nearest wheelhouse, Reel #2 - starboard side stern, etc. Keep the same numbering scheme throughout the trip.

Selecting a Reel for "Sampling" - You should always attempt to sample every reel if possible. Once a reel is chosen to sample for a set, all fish caught for that set need to be recorded. In the event that you are unable to sample every reel (due to time constraints, number of reels, or multiple hooks) subsampling of reels is acceptable. The first determination will be how many reels that you think you can acceptably sample without getting overwhelmed, i.e. 2 out of 4 reels, 1 out of 4, etc. Remember, you will need to accurately keep track of how many times **ALL** the reels are being fished (dropped with baited hooks) even if subsampling reels. Once you determine how many reels you think you can sample, randomly choose the reel(s) to start sampling. One easy way to do this is flip a coin, i.e. heads to start sampling reel #1 on port side or tails for reel #2 on the starboard side of vessel. Once you start sampling alternate between reels for every set. The reason for alternating the reels is to reduce bias relative to a particular reel or fisher position on the vessel (one fisher might fish better than another, or the starboard-side reels might fish better than the port-side reels).

A simplified example is that you start by numbering the reels #1, 2, 3, and 4 at the beginning of the trip. Remember those reel numbers will never change throughout the trip. The reels may alter their gear (change of gear code, i.e. reel/gear 1A to 1B), but the reel number will not change. After watching the first set you determine that you can sample 2 out of 4 reels without being overwhelmed. You will be able to accurately keep track of all fishing effort for that set (reels dropped) and process all fish caught on reels being sampled. For two reel groupings (1, 2 and 3, 4) you flip a coin (heads for reels #1 and 2, tails for reels #3 and 4). It comes up tails and you start sampling reels #3 and 4 for set#1. For the next set (set#2), you should sample reels 1 and 2. Alternate back and forth for the remainder of the trip.

Another way to determine which reel to start sampling is using the random number table below. Use the last two numbers of your trip number to find which reel(s) to start sampling. For example, the vessel typically uses 8 reels for each set. Once again, you determine that you can sample two reels acceptably. Use the last two digits from your trip number, i.e. GB1127, use column 2 row 7. Reel #5 was selected from the random number table below. If your trip

number generates a reel not being used (ex: trip number GB1117 generates reel #11), just follow the row to the right until a reel being fished is chosen. Due to the vessel layout, it is almost always necessary to sample reels in close proximity to one other for each set. Since you chose reel #5 to start with, typically a reel close by will be sampled in addition for that set, i.e. reel #6. Once the first reel(s) to be sampled are randomly determined, rotate reels being sampled for the remainder of the trip. For example, you start sampling reels #5 and 6, then the next set reels #7 and 8, then reels #1 and 2, then reels #3 and 4, and then back to reels #5 and 6. This rotation is to be followed for the remainder of the trip.

	0	1	2	3	4	5	6	7	8	9
0	4	3	12	4	3	11	2	8	10	6
1	9	2	9	11	10	3	12	2	1	3
2	10	4	4	3	6	8	11	11	8	4
3	3	2	1	5	2	11	1	5	10	9
4	6	10	10	4	10	12	12	12	9	8
5	9	3	5	11	2	11	3	12	2	6
6	2	1	7	9	2	2	12	12	4	2
7	10	11	5	2	9	11	7	4	9	6
8	2	5	4	12	2	12	5	3	4	9
9	5	9	1	9	10	9	10	12	8	12

Often due to vessel layout it can be difficult to process fish caught from some reels. Do your best to minimize any bias by including these reels in your sampling rotation. It is important that the reel sampling rotation remains consistent throughout the trip. It is often helpful to include diagrams of the vessel layout in your logbook explaining your methodology. If you have any questions, make sure to contact the coordinators before fishing operations begin.

Sets Not Sampled - If you are unable to sample every set due to observer choice or time constraints, record in your **logbook** the date, location, depth, set times, and reason you did not sample. This information should also be included on the Trip Report. Since you did not sample these, do not number them consecutively as sets. Station sheets still need to be filed out for unsampled sets.

Sampling Procedures

- 1. Fish Identification:** Identify the fish to species level. Record the common name, genus and species on the length frequency/weight form. Use common names located in the appendix.
- 2. Fish Length Measurement:** Record the length of the fish in **millimeters**. Care should be taken to use the proper length measurement code which is species specific (see appendix

- 10). Write the length measurement code used in the **LENGTH CODE** column on the length frequency/weight form.
- 3. Fish Weight Measurement:** Record the weight of the fish in **kilograms**. Indicate whether the fish was weighed "**whole**" code **1** or "**gutted**" code **2** in the **WEIGHT CODE** column on the length frequency/weight form.
- 4. Fish Fate:** Record the fate of the fish using the fate codes found at the bottom of the length frequency/weight form. Remember to use the sink or swim method. Use fate code "U" Unknown Discard if you are unable to determine if the fish sank or swam (dark or rough conditions). Use fate code "X" if it is unknown if fish was kept or discarded.
- 5. Tagging Undersized Select Species (only if instructed by Program Manager or coordinators):** Undersized select species in good health will be tagged and released. Only place an "X" on the length/frequency form in the **TAGGED** column if the fish is tagged by the observer. You will also be required to complete a **Tag Reporting Form**. If a previously tagged fish is captured reference the tag number and contact information in the comment section of the station sheet.
- 6. Air Bladders:** If the air bladder is punctured (in released fish), enter an "X" in the **AIR BLADDER** column. Puncture air bladders only if this is the traditional procedure of the captain and crew.
- 7. Length Frequency/Weight Form Continued:** If you need additional space, continue on a new Length Frequency Form. Number the sheets in the space provided at the bottom of the form.

STATION SHEET BANDIT REEL

ORG PRO
 TRIP NO.
 SET NO.
 OBSERVER
 MO DAY YR
 DATE
 Degree Minutes Seconds
 Degree Minutes Seconds
 TIME IN
 LATITUDE IN
 LONGITUDE IN
 STAT ZONE
 SEA STATE

TIME OUT
 TOTAL # of REELS

VESSEL(CHECK ONE):
 ON ANCHOR DRIFTING TROLLING UNKNOWN
 (ATTACHED to RIG)

LIST THE FOLLOWING FOR ALL REELS: REEL #, GEAR CODE, NUMBER OF TIMES A REEL WAS SET, NUMBER OF REELS SAMPLED

Reel #	Gear Code	# of Reels Set	# of Reels Sampled	Reel #	Gear Code	# of Reels Set	# of Reels Sampled	Reel #	Gear Code	# of Reels Set	# of Reels Sampled

FISHING TIME HRS
 AVG. HAUL IN TIME MIN

PREDATORS OBSERVED

<input type="checkbox"/> SHARKS <input type="checkbox"/> MARINE MAMMALS <input type="checkbox"/> SEA BIRDS <input type="checkbox"/> OTHER FISH	0 = PREDATOR NOT PRESENT IN AREA 1 = PREDATOR OBSERVED BUT NOT FEEDING 2 = PREDATOR OBSERVED FEEDING ON BAIT (ON HOOK) 3 = PREDATOR OBSERVED FEEDING ON CAPTURES (ON HOOK) 4 = PREDATOR OBSERVED FEEDING ON CAPTURES AND BAIT (ON HOOK)	5 = PREDATOR OBSERVED BUT COULD NOT DETERMINE IF FEEDING 6 = PREDATOR OBSERVED FEEDING ON DISCARDED CAPTURES 7 = PREDATOR OBSERVER FEEDING ON DISCARDED BAIT 8 = PREDATOR OBSERVER FEEDING ON DISCARDED CAPTURES AND BAIT 9 = NOT OBSERVED
---	---	--

BAIT (Check all that apply)

<input type="checkbox"/> Squid <input type="checkbox"/> Mackerel <input type="checkbox"/> Herring <input type="checkbox"/> Other _____ <input type="checkbox"/> Other _____ <input type="checkbox"/> Other _____ <input type="checkbox"/> Other _____ <input type="checkbox"/> Artificial	STATE OF BAIT (Check Whole or Cut then check all that apply for each type of bait used.) <table style="width: 100%; text-align: center;"> <tr> <td style="width: 12.5%;">Whole</td> <td style="width: 12.5%;">Cut</td> <td style="width: 12.5%;">Fresh</td> <td style="width: 12.5%;">Frozen</td> <td style="width: 12.5%;">Salted</td> <td style="width: 12.5%;">Live</td> </tr> <tr> <td><input type="checkbox"/></td><td><input type="checkbox"/></td><td><input type="checkbox"/></td><td><input type="checkbox"/></td><td><input type="checkbox"/></td><td><input type="checkbox"/></td> </tr> <tr> <td><input type="checkbox"/></td><td><input type="checkbox"/></td><td><input type="checkbox"/></td><td><input type="checkbox"/></td><td><input type="checkbox"/></td><td><input type="checkbox"/></td> </tr> <tr> <td><input type="checkbox"/></td><td><input type="checkbox"/></td><td><input type="checkbox"/></td><td><input type="checkbox"/></td><td><input type="checkbox"/></td><td><input type="checkbox"/></td> </tr> <tr> <td><input type="checkbox"/></td><td><input type="checkbox"/></td><td><input type="checkbox"/></td><td><input type="checkbox"/></td><td><input type="checkbox"/></td><td><input type="checkbox"/></td> </tr> <tr> <td><input type="checkbox"/></td><td><input type="checkbox"/></td><td><input type="checkbox"/></td><td><input type="checkbox"/></td><td><input type="checkbox"/></td><td><input type="checkbox"/></td> </tr> <tr> <td><input type="checkbox"/></td><td><input type="checkbox"/></td><td><input type="checkbox"/></td><td><input type="checkbox"/></td><td><input type="checkbox"/></td><td><input type="checkbox"/></td> </tr> <tr> <td><input type="checkbox"/></td><td><input type="checkbox"/></td><td><input type="checkbox"/></td><td><input type="checkbox"/></td><td><input type="checkbox"/></td><td><input type="checkbox"/></td> </tr> </table>	Whole	Cut	Fresh	Frozen	Salted	Live	<input type="checkbox"/>	<input type="checkbox"/>	<input type="checkbox"/>	<input type="checkbox"/>	<input type="checkbox"/>	<input type="checkbox"/>	<input type="checkbox"/>	<input type="checkbox"/>	<input type="checkbox"/>	<input type="checkbox"/>	<input type="checkbox"/>	<input type="checkbox"/>	<input type="checkbox"/>	<input type="checkbox"/>	<input type="checkbox"/>	<input type="checkbox"/>	<input type="checkbox"/>	<input type="checkbox"/>	<input type="checkbox"/>	<input type="checkbox"/>	<input type="checkbox"/>	<input type="checkbox"/>	<input type="checkbox"/>	<input type="checkbox"/>	<input type="checkbox"/>	<input type="checkbox"/>	<input type="checkbox"/>	<input type="checkbox"/>	<input type="checkbox"/>	<input type="checkbox"/>	<input type="checkbox"/>	<input type="checkbox"/>	<input type="checkbox"/>	<input type="checkbox"/>	<input type="checkbox"/>	<input type="checkbox"/>	<input type="checkbox"/>	<input type="checkbox"/>	<input type="checkbox"/>	<input type="checkbox"/>	<input type="checkbox"/>	<input type="checkbox"/>
Whole	Cut	Fresh	Frozen	Salted	Live																																												
<input type="checkbox"/>	<input type="checkbox"/>	<input type="checkbox"/>	<input type="checkbox"/>	<input type="checkbox"/>	<input type="checkbox"/>																																												
<input type="checkbox"/>	<input type="checkbox"/>	<input type="checkbox"/>	<input type="checkbox"/>	<input type="checkbox"/>	<input type="checkbox"/>																																												
<input type="checkbox"/>	<input type="checkbox"/>	<input type="checkbox"/>	<input type="checkbox"/>	<input type="checkbox"/>	<input type="checkbox"/>																																												
<input type="checkbox"/>	<input type="checkbox"/>	<input type="checkbox"/>	<input type="checkbox"/>	<input type="checkbox"/>	<input type="checkbox"/>																																												
<input type="checkbox"/>	<input type="checkbox"/>	<input type="checkbox"/>	<input type="checkbox"/>	<input type="checkbox"/>	<input type="checkbox"/>																																												
<input type="checkbox"/>	<input type="checkbox"/>	<input type="checkbox"/>	<input type="checkbox"/>	<input type="checkbox"/>	<input type="checkbox"/>																																												
<input type="checkbox"/>	<input type="checkbox"/>	<input type="checkbox"/>	<input type="checkbox"/>	<input type="checkbox"/>	<input type="checkbox"/>																																												

TARGET SPECIES: List all targeted species for this set using genus species format.

WATER DEPTH <input type="text"/> <input type="text"/> <input type="text"/> <input type="text"/> <input type="text"/> <input type="text"/> FEET	TOTAL NO. REELS SET <input type="text"/> <input type="text"/> <input type="text"/>	TOTAL NO. REELS SAMPLED <input type="text"/> <input type="text"/> <input type="text"/>	TOTAL NO. HOOKS SET <input type="text"/> <input type="text"/> <input type="text"/>	TOTAL NO. HOOKS SAMPLED <input type="text"/> <input type="text"/> <input type="text"/>
APPROX. FISHING DEPTH <input type="text"/> <input type="text"/> <input type="text"/> <input type="text"/> <input type="text"/> FEET	BOTTOM TYPE <input type="text"/> <input type="text"/>		SCALE TYPE DIGITAL (D), MECHANICAL (M) BOTH (B) or UNKNOWN (U)	

COORDINATOR COMMENTS:

OBSERVER COMMENTS:

STATION SHEET – BANDIT REEL

Complete one station sheet for each set. This form must be filled out for both sampled and unsampled sets. For sets not sampled (or unsampled sets) enter the following information: trip number, 999 for set number, observer code, date, time in and time out, latitude, longitude, statistical zone, sea state, fishing time, water depth and reason for not sampling.

Trip No: Enter Trip Number provided by Observer Coordinator.

Set No: Enter the set number. The set number begins with "001" for each trip. Sets are based on fishing location; any change in location is considered a new set. Remember unsampled sets are not given set numbers and are not sampled (due to: observing crew operations, processing previous set, time constraints, weather, sickness, sleep etc.).

Observer: Enter your assigned observer code.

Date: Enter the date the Set started (use two digits for month, day, and year (MO/DY/YR)).

Time In: Enter in military time (0001 - 2359) the time when the first hook enters the water.

Latitude In: Enter the position occupied at set (time in) in degrees, minutes, and seconds. Ask the captain if the LORAN or GPS **unit reads in degrees, minutes, and seconds or in degrees, minutes, and hundredths of a minute**. If the unit reads in hundredths of minutes, multiply the last two digits (as a decimal figure) by 60 to obtain the seconds (e.g., .88 x 60 = 52.8 seconds, this is rounded up to 53 seconds [see appendix 12]). If coordinates are given in LORAN, the reading should be written above the space provided for GPS units (leaving GPS units blank). The units will be converted in the lab and filled in by the Observer Coordinator.

Longitude In: Enter the position occupied at set (time in) in degrees, minutes, and seconds.

Stat Zone: Enter the statistical zone at set (time in) (appendix 11). Leave blank if using LORAN.

Sea State: Enter the number that best describes the sea state (wave height):

1 = 0-2 feet, 2 = 3-5 feet, 3 = 6-8 feet, 4 = 8+ feet.

Time Out: Enter in military time (0001 - 2359) the time when the last hook leaves the water. (If vessel is trolling, include the GPS and depth out data in the Station Sheet Comments.)

Total # of Reels: Enter the total number of reels used during this set (remember to include reels sampled and reels not sampled). For example, there are a total of 10 reels on your vessel. For this set the vessel is fishing with 6 reels, you decide you can sample 4 reels the 2 others you cannot sample due to deck space. The total number of reels used would be 6.

Vessel (check one): While fishing was the vessel On Anchor (if vessel is tied to a rig, this is still on anchor), Drifting (if vessel is motor fishing, this is still drifting), Trolling (include time out data with ending depth and GPS position in the Station Sheet comments), or Unknown?

Gear Configurations - List the following for all sampled and unsampled reels: Reel #, Gear Code, number of times reel was set (# of Reels Set), and number of times set reel was sampled (# of Reels Sampled). For example, for gear configuration 1A the reel was set (dropped) 3 times but only 2 drops were sampled, you would reference 3 of 2 in the spaces provided.

Fishing Time: To calculate fishing time the procedure is as follows: Subtract the TIME IN from TIME OUT. Be sure to convert minutes to tenths of an hour prior to entering on the station sheet. (i.e., if the TIME OUT is 1439 and the TIME IN is 1331 then the fishing time was one hour and eight minutes or 1.1 hours (see appendix 12)).

Avg. Haul in Time: Enter the amount of time it takes to bring fish up from fishing depth to surface. This is an average of all reels for this set. There is no calculation necessary and generally changes with fishing depth.

Predators Observed: Select and mark one of the 10 categories listed for each of the 4 predator types. If the predator observed is marine mammals, other than a dolphin, specify the species of marine mammal in the observer comments section and circle marine mammal on the data form.

Bait: Check all bait types used for this set, if a bait type other than the ones listed are used reference it in the space labeled other (see appendix 17). For each type of bait listed you must also reference the **State of Bait**. Check if the bait is whole or cut then check if the bait is fresh, frozen, salted or live. Check all that apply. Whole is only used if the bait is a whole fish. If an artificial lure is used check the box next to artificial.

Target Species: List all species being targeted for the set in genus species format (i.e. LUTJANUCAMPEC, EPINEPHMORIO, and EPINEPHFLAVOL). Enter the first seven characters of the genus name and the first 6 characters of the species name (refer to Reef Fish Species List) **DO NOT reference common names.**

Water Depth: Enter the bottom depth in feet. If depth is in fathoms, multiply it by 6 to convert the depth to feet.

Total Number of Reels Set: Enter total number of reels (DROPS) set at this location. Reel set refers to how many times an individual reel is dropped down to fish. For example, if the vessel fished with 4 reels and each reel was set (dropped) 3 times at this same location, enter 12 (**REELS SET= ALL DROPS**). To double check the total number of reels set, add up all the values from “# of reels set” from the gear configuration at the top of the station sheet, the total number should be equal to the total number of reels set.

Total Number of Reels Sampled: Enter total number of reels (DROPS) sampled at this location (**REELS SAMPLED = DROPS SAMPLED**). To double check the total number of reels sampled, add up all the values from “# of reels sampled” from the gear configuration, the total number should be equal to the total number of reels sampled.

Total Number of Hooks Set: Enter the total number of hooks set at this location. If each reel had two hooks and the vessel set 10 reels, enter 20.

Total Number of Hooks Sampled: Enter the total number of hooks sampled at this location. You will always "sample" all hooks on a reel, even if they have no catch.

Approx. Fishing Depth: Enter the approximate fishing depth in feet. If there is more than one approx. fishing depth, enter the average of all fishing depths and reference the individual fishing depths in the comments section.

Bottom Type: Enter the bottom type (refer to captain and appendix 10 for codes).

Scale Type: Enter the type of scale use, Digital (D), Mechanical (M), Both (B) or Unknown (U).

Coordinator Comments: Leave blank.

Observer’s Comments: Enter your comments or observations.

LENGTH-FREQUENCY/WEIGHT FORM BANDIT REEL

ORG PRO

--	--	--	--	--	--	--

TRIP NO.

SET NO.

--	--	--

REEL NUMBER	GEAR CODE	COMMON NAME	GENUS	SPECIES	LENGTH (mm)	LENGTH CODE	WEIGHT (kg)	WEIGHT CODE	CONDITION CODE	FATE RELEASSE	TAGGED	AIR BLADDER	SPECIMEN #	O / G
1														
2														
3														
4														
5														
6														
7														
8														
9														
10														
11														
12														
13														
14														
15														
16														
17														
18														
19														
20														
21														
22														
23														
24														
25														
LENGTH CODES		WEIGHT CODES		CONDITION CODES (AS BROUGHT ONBOARD)					FATE CODE					
01- FORK		1- WHOLE		1- LIVE: NORMAL APPEARANCE					K - FISH KEPT					
02 - STANDARD		2 - DRESSED/CLEANED		2 - LIVE AIR BLADDER/STOMACH PROTRUDING					D - DISCARD DEAD					
18 - TOTAL		8 - NOT MEASURABLE		3 - LIVE: EYES PROTRUDING					A - DISCARD ALIVE					
22 - DISC		9 - NO DATA		4 - LIVE: COMBINATION 2 AND 3					B - KEPT FOR BAIT					
23 - ANAL				5 - DEAD ON ARRIVAL					U - UNKNOWN DISCARD					
88 - NOT MEASURABLE				9 - NO DATA OR UNKNOWN					X - UNKNOWN IF KEPT					
99 - NO DATA or UNKNOWN									OR DISCARDED					

LENGTH FREQUENCY / WEIGHT FORM – BANDIT REEL

Record all fish caught on sampled reels. If all the reels deployed are retrieved empty (i.e., all hooks empty) you are still required to fill out a Frequency/Weight form. You should reference the sampled reel number and gear and write "NOCATCH" in the space provided for both the Common name and the Genus Columns. For example, there are 2 reels being sampled 1A and 2B, 1A catches fish and 2B does not, you would reference NOCATCH for reel 2B. If both reels sampled do not catch fish, NOCATCH should be referenced for both reels 1A and 2B. Remember unsampled sets are not given set numbers, and are not sampled (due to: observing crew operations, processing previous set, time constraints, weather, sickness, sleep etc.).

Trip No: Enter Trip Number provided by Observer Coordinator.

Set No: Enter set number that corresponds to Station Sheet set number.

Sampling Procedures

- 1. Reel Number Sampled:** Enter the reel number(s) the fish was caught on.
- 2. Gear Code:** Enter the gear code the fish was caught on.
- 3. Fish Identification:** Identify the fish to species level, record common name, genus and species. Enter the first seven characters of the genus name and the first 6 characters of the species name (refer to Reef Fish Species List). If more than one of the same species is caught, instead of writing the common name, genus and species repeatedly, it can be written once with a line drawn vertically down through the fields until a new species is noted.
- 4. Fish Length Measurement:** Record the length of fish in **millimeters**. Be sure to measure the fish using the appropriate species specific length measurement code (see appendix 10 and Species List). If the fish is unmeasurable (e.g. mutilated, tail missing from shark attack) enter 888.88 in the **LENGTH** column and 88 for the **LENGTH CODE**. If no measurement was taken (e.g., thrown overboard) enter 999.99 in the **LENGTH** column to denote unknown and/or not measured and 99 for the **LENGTH CODE**.
- 5. Fish Weight Measurement:** Record the weight of fish in **kilograms**. Indicate whether the fish was weighed "**whole**" code **1** or "**gutted**" code **2** in the **WEIGHT CODE** column on the length frequency/weight form. If the fish is too light to obtain a reading on your scale or damaged, enter 888.88 in the **WEIGHT** column and 8 for the **WEIGHT CODE**. If the weight was not measured or the weight is unknown, enter 999.99 in the **WEIGHT** column and 9 for the **WEIGHT CODE**.

6. **Condition Code:** Use the most appropriate condition code (see the bottom of the form) to describe the condition of the fish when brought on deck.
7. **Fish Fate:** Use the most appropriate fate code (see bottom of form) to describe fate of the fish. In determining the fate of a **discarded fish** note if it is alive or dead; do not attempt to establish poor health conditions (i.e., it probably would die). Remember to use the sink or swim method. If the fish floats and does not attempt to swim towards the bottom, it is considered discarded dead. If the fish attempts to swim down but floats back up and then tries to get back down it is considered discarded alive. Also, please remember that we do not want to become the source of fish mortality. Process the fish to be discarded first and quickly.
8. **Tagging Undersized Select Species (only if instructed by program manager or coordinator):** Undersized select species in good health will be tagged and released. Only place an "X" on the length/frequency form in the **TAGGED** column if the fish is tagged by the observer. You will also be required to complete a **Tag Reporting Form**. If a previously tagged fish is captured reference the tag number and contact information in the comment section of the station sheet.
9. **Air Bladders:** If the air bladder is punctured (in released fish), enter an "X" in the **AIR BLADDER** column. Puncture air bladders only if this is the traditional procedure of the captain and crew.
10. **Specimen # O/G:** If a specimen is sampled for Otolith/Gonads it is given specimen #. These numbers are assigned by the observer and are consecutive from the start of the trip to the end. The number, as well as the recorded information, should coincide with the numbers referenced on the Gonad/Otolith sample log.
11. **Length Frequency/Weight Form Continued:** If you need additional space, continue on a new Length Frequency Form. Number the sheets in the space provided at the bottom of the form.

LONGLINE DATA FORMS

Complete the following forms for all Longline (GL) Trips.

1. Gear Specification Form (LL-GS)
2. Station Sheet (LL-SS)
3. Length Frequency/Weight Form (LL-LF)
4. Sea Turtle Life History Form (Complete only if a turtle is captured or sighted)
5. Protected Resources Capture Report (only if applicable)
6. Marine Mammal Life History Form (only if applicable)
7. Tag Reporting Form (only if applicable)
8. Specimen Collection Log (only if applicable)
9. Gonad/Otolith Form (only if applicable)

GEAR SPECIFICATION FORM - LONGLINE

Complete one gear specification form for each gear type used during fishing operations. Changes to any gear setting or configuration require completion of additional forms for the affected sets (consult the captain for unknown Main Line, Gangion and Hook information).

Trip No: Enter Trip Number provided by Observer Coordinator.

Date: Enter the date the set number started, or the date changes occurred to the gear.

Observer: Enter your assigned observer code.

Set number: Enter the starting set number 001 for the first gear used. If gear changes are made, enter the set number when these changes occurred.

Gear Code: Gear codes are designated by the observer; they should always start with the letter "A" and progress through the alphabet, DO NOT SKIP LETTERS. Any changes in gear configuration (i.e. gangion length or length of main line) will result in a new gear code.

Main Line Length: Enter the length of the main line and enter an "X" in the appropriate square for units of measurement. Make sure to ask the captain if it is nautical miles or regular miles.

Main Line Material: Enter an "X" in the appropriate square that corresponds to the material of the line. If you mark "Other", then enter an explanation in the **Comments** section.

Main Line Diameter: Enter the diameter of the main line in inches. Measure it yourself!!

Main Line Test: Enter the test, or breaking strength, of the main line in pounds.

Main Line Material Comments: Enter comments necessary to better describe the entries above.

Gangion Length: Measure length from hook's eye to gangion's end, including snaps, if any.

Gangion Length Comments: Enter comments necessary to better describe the entries above.

Gangion Material: Enter an "X" in the appropriate square which corresponds to the material of the gangion. If you mark "Other", then enter an explanation in the **Comments** section.

Gangion Test: Enter the test, or breaking strength, of the gangion material in pounds.

Gangion Color: Enter the color of the gangion.

Construction: Enter an "X" in the square that corresponds to the construction of the line.

Gangion Material Comments: Enter comments necessary to better describe the entries above.

Number of Hooks on Board (per Captain): At the start of the trip, ask the captain, for the total number of hooks on board.

Approximate Distance between Hooks: Enter approximate distance in feet.

Number of Hooks Comments: Enter comments necessary to better describe the entries above.

Hook Type: Enter an "X" in the square that best describes the hook shape (see appendix 13). If you mark "Other", then enter the hook types in the **Comments** section. Space is provided to record up to three different types of hooks.

Hook Shape: Enter an "X" in the appropriate square.

Hook Size: Enter hook size, for example 10/0.

Manufacturer/Style: Enter manufacturer/styles, for example MUSTAD/39960D.

Degrees Offset: Enter the Degrees Offset. Typically, 10° or 25°.

Hook Measurements: Record "Hook Shaft Length" and "Hook Point to Shaft" measurements. If it is a double or triple hook setup with more than one hook size, enter the second or third hook measurements in the comments section.

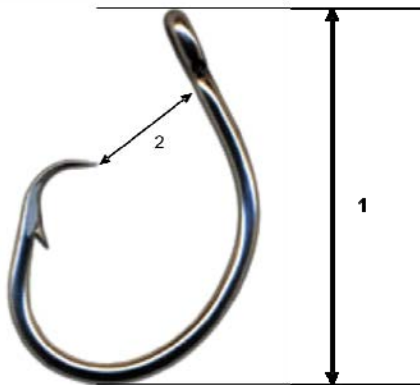

1. Hook Shaft Length: Measure the distance (in inches) from the hook eye to the point of maximum curvature on the bent portion of the hook. Shaft length is in effect the total length of the hook.

2. Hook Point to Shaft: Measure the shortest distance (in inches) from the point of the hook to the shaft of the hook.

Hook Material: Enter an "X" in the appropriate square that best describes the hook materials. If you mark "Other", then enter an explanation in the **Comments** section.

Hook Comments: Enter comments necessary to better describe entries above.

Trace Outline of Hook with Dimensions in Space Below: If possible, lay hook onto paper and trace. Include in diagram, hook shaft length and hook point to shaft measurements.

COLLECTION OF BIOLOGICAL DATA - LONGLINE

Sets Not Sampled - If you are unable to sample every set due to observer choice or time constraints, record in your **log book** and later on the **Trip Report**, the date, location, depth, hours soaked, and reason for not sampling. Since you did not sample these, do not number them consecutively as sets.

Sampling Procedures

- 1. Fish Identification:** Identify the fish to species level. Record the common name, genus and species on the length frequency/weight form.
- 2. Fish Length Measurement:** Record the length of the fish in **millimeters**. Care should be taken to use the proper length measurement code which is species specific (see appendix 10 and Species List). Write the length measurement code used in the **LENGTH CODE** column on the length frequency/weight form.
- 3. Fish Weight Measurement:** Record the weight of the fish in **kilograms**. Indicate whether the fish was weighed "**whole**" code **01** or "**gutted**" code **02** in the **WEIGHT CODE** column on the length frequency/weight form.
- 4. Fish Fate:** Record the fate of the fish using the fate codes found at the bottom of the length frequency/weight form. Remember to use the sink or swim method. Use fate code "U" Unknown Discard if you are unable to determine if the fish sank or swam (dark or rough conditions). Use fate code "X" if it is unknown if fish was kept or discarded.
- 5. Tagging Undersized Select Species (only if instructed by program manager or coordinator):** Undersized select species in good health will be tagged and released. Only place an "X" on the length/frequency form in the **TAGGED** column if the fish is tagged by the observer. You will also be required to complete a **Tag Reporting Form**. If a previously tagged fish is captured reference the tag number and contact information in the comment section of the station sheet.
- 6. Air Bladders:** If air bladder is punctured (in released fish), enter an "X" in **AIR BLADDER** column. The air bladder should only be punctured if this is the traditional procedure of the captain and crew.

STATION SHEET LONGLINE

ORG PRO

 TRIP NO.

SET NO.

OBSERVER

MO DAY YR

 DATE

GEAR CODE

SET TIME

 START

SET TIME

 END

Degree Minutes Seconds

 LATITUDE IN

Degree Minutes Seconds

 LONGITUDE IN

HAUL TIME

 START

HAUL TIME

 END

STAT ZONE

SEA STATE

PREDATORS OBSERVED

- | | | |
|---|--|--|
| <input type="checkbox"/> SHARKS | 0 = PREDATOR NOT PRESENT IN AREA | 5 = PREDATOR OBSERVED BUT COULD NOT DETERMINE IF FEEDING |
| <input type="checkbox"/> MARINE MAMMALS | 1 = PREDATOR OBSERVED BUT NOT FEEDING | 6 = PREDATOR OBSERVED FEEDING ON DISCARDED CAPTURES |
| <input type="checkbox"/> SEA BIRDS | 2 = PREDATOR OBSERVED FEEDING ON BAIT (ON HOOK) | 7 = PREDATOR OBSERVER FEEDING ON DISCARDED BAIT |
| <input type="checkbox"/> OTHER FISH | 3 = PREDATOR OBSERVED FEEDING ON CAPTURES (ON HOOK) | 8 = PREDATOR OBSERVER FEEDING ON DISCARDED CAPTURES AND BAIT |
| | 4 = PREDATOR OBSERVED FEEDING ON CAPTURES AND BAIT (ON HOOK) | 9 = NOT OBSERVED |

BAIT (Check all that apply)

- Squid
- Mackerel
- Herring
- Other _____
- Other _____
- Other _____
- Other _____

STATE OF BAIT (Check Whole or Cut then check all that apply for each type of bait used.)

Whole	Cut	Fresh	Frozen	Salted	Live
<input type="checkbox"/>	<input type="checkbox"/>	<input type="checkbox"/>	<input type="checkbox"/>	<input type="checkbox"/>	<input type="checkbox"/>
<input type="checkbox"/>	<input type="checkbox"/>	<input type="checkbox"/>	<input type="checkbox"/>	<input type="checkbox"/>	<input type="checkbox"/>
<input type="checkbox"/>	<input type="checkbox"/>	<input type="checkbox"/>	<input type="checkbox"/>	<input type="checkbox"/>	<input type="checkbox"/>
<input type="checkbox"/>	<input type="checkbox"/>	<input type="checkbox"/>	<input type="checkbox"/>	<input type="checkbox"/>	<input type="checkbox"/>
<input type="checkbox"/>	<input type="checkbox"/>	<input type="checkbox"/>	<input type="checkbox"/>	<input type="checkbox"/>	<input type="checkbox"/>
<input type="checkbox"/>	<input type="checkbox"/>	<input type="checkbox"/>	<input type="checkbox"/>	<input type="checkbox"/>	<input type="checkbox"/>
<input type="checkbox"/>	<input type="checkbox"/>	<input type="checkbox"/>	<input type="checkbox"/>	<input type="checkbox"/>	<input type="checkbox"/>
<input type="checkbox"/>	<input type="checkbox"/>	<input type="checkbox"/>	<input type="checkbox"/>	<input type="checkbox"/>	<input type="checkbox"/>
<input type="checkbox"/>	<input type="checkbox"/>	<input type="checkbox"/>	<input type="checkbox"/>	<input type="checkbox"/>	<input type="checkbox"/>

TARGET SPECIES: List all targeted species for this set using genus species format.

SOAK TIME HRS

of HOOKS SET

of HOOKS LOST

WATER DEPTH FEET

BOTTOM TYPE

YES NO
 OR
 REVERSE HAUL

YES NO
 OR
 MAINLINE PARTED

SCALE TYPE
 DIGITAL (D), MECHANICAL (M)
 BOTH (B) or UNKNOWN (U)

COORDINATOR COMMENTS: _____

OBSERVER COMMENTS: _____

STATION SHEET – LONGLINE

Complete one station sheet for each set. This form must be filled out for both sampled and unsampled sets. For sets not sampled (or unsampled sets) enter the following information: trip number, 999 for set number, observer code, date, time in and time out, latitude, longitude, statistical zone, sea state, and reason for not sampling.

Record all fish caught on sampled gear. Remember unsampled sets are not given set numbers, and are not sampled (due to: observing crew operations, processing previous set, time constraints, weather, sickness, sleep etc.).

Trip No: Enter Trip Number provided by Observer Coordinator.

Set No: Enter the set number. The set number begins with "001" for each trip. Remember unsampled sets are not given set numbers, and are not sampled (due to: time constraints, weather, sickness, sleep etc.).

Observer: Enter Observer Code provided by Observer Coordinator.

Date: Enter the date the Set started (use two digits for month, day, and year (MO/DY/YR)).

Gear Code: Enter the gear code that corresponds to the gear configuration used for this station.

Set Time Start: Enter in military time (0001-2359), time when **first** hook is set (First Hook In).

Set Time End: Enter in military time (0001–2359), time when **last** hook is set (Last Hook In).

Latitude In: Enter the position occupied at set (set time start) in degrees, minutes, and seconds. Ask the captain if the LORAN or GPS **unit reads in degrees, minutes, and seconds or in degrees, minutes, and hundredths of a minute**. If the unit reads in hundredths of minutes, multiply the last two digits (as a decimal figure) by 60 to obtain the seconds (e.g., .88 x 60 = 52.8 seconds, this is rounded up to 53 seconds [see appendix 12]). If coordinates are given in LORAN, the reading should be written above the space provided for GPS units (leaving GPS units blank). The units will be converted in the lab and filled in by the Observer Coordinator.

Longitude In: Enter the position occupied at set (time in) in degrees, minutes, and seconds.

Haul Time Start: Enter in military time (0001–2359), time when **first** hook is retrieved.

Haul Time End: Enter in military time (0001-2359), time when **last** hook is retrieved.

Stat Zone: Enter the statistical zone at set (time in) (appendix 11). Leave blank if using LORAN.

Sea State: Enter the number that best describes the sea state (wave height):

1 = 0-2 feet, 2 = 3-5 feet, 3 = 6-8 feet, 4 = 8+ feet.

Predators Observed: Select and mark one of the 10 categories listed for each of the 4 predator types. If predator observed is a marine mammal **other than a dolphin**, specify the species of marine mammal, in the observer comments section and circle marine mammal on the data form.

Bait: Check all bait types used for this set, if a bait type other than the ones listed are used reference it in the space labeled other (see appendix 17). For each type of bait listed you must also reference the **State of Bait**. Check if the bait is whole or cut then check if the bait is fresh, frozen, salted or live. Check all that apply. Whole is only used if the bait is a whole fish.

Target Species: List all species being targeted for the set in genus species format (i.e. LUTJANUCAMPEC, EPINEPHMORIO, and EPINEPHFLAVOL). Enter the first seven characters of the genus name and the first 6 characters of the species name (refer to Reef Fish Species List), **DO NOT reference common names.**

Soak Time: Subtract “Set Time Start” from “Haul Time End”. Be sure to convert minutes to tenths of an hour prior to entering on the station sheet (see appendix 12).

14:30 (Haul Time End) – 12:03 (Set Time Start) = 2:27 or 2.5 hrs. (Soak Time)

of Hooks Set: Enter the exact number of hooks set. To help keep track of the total number of hooks set without having to count each time; count the exact number of hooks for the first set, then keep track of the number of hooks as it changes. This includes the lost ones and the ones left in the barrel after the set time ends. You can use this information to determine the number of hooks used for the next set. For example, the starting set of the day had 750 hooks set and no hooks remained in the barrel, 5 hooks were lost during the set giving you a count of 745. The second set of the day had 10 hooks remaining in the barrel after set up, so the second set will have 735 hooks. The hooks lost from the first set plus the hooks not set out. This only applies if lost hooks were not replaced, if hooks are replaced you will have to add that value to the total. Once every 24-hour period you should physically recount the exact number of hooks set. This should also recount if any change is made in fishing operations, i.e. half set.

of Hooks Lost: Enter total number of hooks lost during each set due to predation (bite-offs), hangs, cut-offs etc. This includes any and all hooks that entered the water during a set that do not come back out of the water after the set.

Water Depth: Enter the bottom depth in feet. If depth is in fathoms, multiply it by 6 to convert depth to feet.

Bottom Type: Enter the bottom type (refer to captain and appendix 10).

Reverse Haul: Was gear hauled back in reverse, i.e. started haul back from the last buoy set. Check “Yes”, if the last buoy/hook set was the first buoy/hook hauled. Check “No”, if the first buoy/hook set was the first buoy/hook hauled.

Mainline Parted: Check “Yes”, if mainline parted during set and they were forced to haul from the opposite end, otherwise check no. Add a comment for haul time lost and if any gear was lost, i.e. gear parted at 0852, resumed haul back at 0925, all gear recovered. This does not include the crew tying off the gear and fixing splices.

Scale Type: Enter the type of scale use, Digital (D), Mechanical (M), Both (B) or Unknown (U).

Coordinator Comments: Leave blank.

Observer’s Comments: Enter your comments or observations.

LENGTH FREQUENCY / WEIGHT FORM – LONGLINE

Trip No: Enter Trip Number provided by Observer Coordinator.

Set No: Enter the set number. The set number begins with “001” for each trip.

Sampling Procedures

- 1. Fish Identification:** Identify the fish to species level, record common name, genus and species. Enter the first seven characters of the genus name and the first 6 characters of the species name (refer to Species List).
- 2. Fish Length Measurement:** Record the length of fish in **millimeters**. Be sure to measure the fish using the appropriate species specific length measurement code (see appendix 10 and Species List). If the fish is not measurable (mutilated, e.g., tail missing from shark attack) enter 888.88 in the **LENGTH** column and 88 for the **LENGTH CODE**. If no measurement was taken (e.g., thrown overboard) 999.99 in the **LENGTH** column to denote unknown and/or not measured and 99 for the **LENGTH CODE**.
- 3. Fish Weight Measurement:** Record the weight of fish in **kilograms**. Indicate whether the fish was weighed "**whole**" code **1** or "**gutted**" code **2** in the **WEIGHT CODE** column on the length frequency/weight form. If the fish is damaged or too light to obtain a reading on your scale, enter 888.88 in the **WEIGHT** column and 8 for the **WEIGHT CODE**. If the weight was not measured or the weight is unknown, enter 999.99 in the **WEIGHT** column and 9 for the **WEIGHT CODE**.
- 4. Condition Code:** Use most appropriate condition code (see bottom of form) to describe condition of the fish when brought on deck.
- 5. Fish Fate:** Record the fate of the fish using the fate codes found at the bottom of the length frequency/weight form. Remember to use the sink or swim method. Use fate code “U” Unknown Discard if you are unable to determine if the fish sank or swam (dark or rough condition). Use fate code “X” if it is unknown if fish was kept or discarded.
- 6. Tagging Undersized Select Species (only if instructed by program manager or coordinator):** Undersized select species in good health will be tagged and released. Only place an “X” on the length/frequency form in the **TAGGED** column if the fish is tagged by the observer. You will also be required to complete a **Tag Reporting Form**. If a previously tagged fish is captured reference the tag number and contact information in the comment section of the station sheet.
- 7. Air Bladders:** If air bladder is punctured, enter an "X" in the **AIR BLADDER** column. Puncture air bladders only if this is the traditional procedure of the captain and crew.

8. Specimen # O/G: If a specimen is sampled for Otolith/Gonads it is given specimen #. These numbers are assigned by the observer and are consecutive from the start of the trip to the end. The number, as well as the recorded information, should coincide with the numbers referenced on the Gonad/Otolith sample log.

9. Length Frequency/Weight Form Continued: If you need additional space, continue on a new Length Frequency Form. Number the sheets in the space provided at the bottom of the form.

MODIFIED BUOY DATA FORMS

Complete the following forms for all Spear Fishing Trips.

1. Gear Specification Form (JUG-GS)
2. Station Sheet (JUG-SS)
3. Length Frequency/Weight Form (JUG-LF)
4. Sea Turtle Life History Form (Complete only if a turtle is captured or sighted)
5. Protected Resources Capture Report (only if applicable)
6. Marine Mammal Life History Form (only if applicable)
7. Tag Reporting Form (only if applicable)
8. Specimen Collection Log (only if applicable)
9. Gonad/Otolith Form (only if applicable)

GEAR SPECIFICATION FORM - MODIFIED BUOY

ORG PRO

MO DAY YR

TRIP NO.

DATE

OBSERVER CODE

GEAR CODE

MAIN LINE LENGTH

MILES NAUTICAL FEET
MILES

MAIN LINE MATERIAL

Mono Poly Nylon Cable Rope Other

Main Line Diameter: In.

Main Line Test: lbs

Comments:

GANGION LENGTH

Length 1 : Feet

Length 2 : Feet

Comments:

Comments:

GANGION MATERIAL

Mono Cable Nylon Wire Other

Gangion Test: lbs

Gangion Color:

Construction: Twisted Single

Comments:

Comments:

NUMBER OF HOOKS

No. of Hooks on Board (per Captain):

Approx. Dist. between Hooks: Feet

Comments:

HOOK TYPE # 1

Hook Type: J-Hook Circular Treble Lure Other

Hook Shape: Straight Offset Double Triple

/0 _____ _____

Hook Size Manufacturer/Style: Degrees Offset

Shaft Length in. Point to Shaft in.

Hook Material: Steel Stainless Steel Other Unknown

Comments:

HOOK TYPE # 2

Hook Type: J-Hook Circular Treble Lure Other

Hook Shape: Straight Offset Double Triple

/0 _____ _____

Hook Size Manufacturer/Style: Degrees Offset

Shaft Length in. Point to Shaft in.

Hook Material: Steel Stainless Steel Other Unknown

Comments:

HOOK TYPE # 3

Hook Type: J-Hook Circular Treble Lure Other

Hook Shape: Straight Offset Double Triple

/0 _____ _____

Hook Size Manufacturer/Style: Degrees Offset

Shaft Length in. in.

Hook Material: Steel Stainless Steel Other Unknown

Comments:

TRACE HOOK W / DIMENSIONS BELOW

Comments:

GEAR SPECIFICATION FORM – MODIFIED BUOY

Complete one gear specification form for each gear type used during fishing operations. Changes to any gear setting or configuration require completion of additional forms for the affected sets (consult the captain for unknown Main Line, Gangion and Hook information).

Trip No: Enter Trip Number provided by Observer Coordinator.

Date: Enter the date the set number started, or the date changes occurred to the gear.

Observer: Enter your assigned observer code.

Gear Code: Gear codes are designated by the observer; they should always start with the letter “A” and progress through the alphabet, DO NOT SKIP LETTERS. Any changes in gear configuration (i.e. gangion length or length of main line) will result in a new gear code.

Main Line Length: Enter the length of the main line and enter an “X” in the appropriate square for units of measurement.

Main Line Material: Enter an “X” in the appropriate square that corresponds to the material of the line. If you mark “Other”, then enter an explanation in the **Comments** section.

Main Line Diameter: Enter the diameter of the main line in inches.

Main Line Test: Enter the test, or breaking strength, of the main line in pounds.

Main Line Material Comments: Enter comments necessary to better describe the main line.

Gangion Length: Measure length from hook’s eye to gangion’s end, including snaps, if any.

Gangion Length Comments: Enter comments necessary to better describe the entries above.

Gangion Material: Enter an “X” in the appropriate square which corresponds to the material of the gangion. If you mark “Other”, then enter an explanation in the **Comments** section.

Gangion Test: Enter the test, or breaking strength, of the gangion material in pounds.

Gangion Color: Enter the color of the gangion.

Construction: Enter an “X” in the square that corresponds to the construction of the line.

Gangion Material Comments: Enter comments necessary to better describe the entries above.

Number of Hooks on Board (per Captain): At the start of the trip, ask the captain, for the total number of hooks on board. This value will be the same on all gear sheets.

Approximate Distance between Hooks: Enter approximate distance in feet.

Number of Hooks Comments: Enter comments necessary to better describe the entries above.

Hook Type: Enter an "X" in the square that best describes the hook shape (see appendix 13). If you mark "Other", then enter the hook types in the **Comments** section. Space is provided to record up to three different types of hooks.

Hook Shape: Enter an "X" in the appropriate square.

Hook Size: Enter hook size, for example 10/0.

Manufacturer/Style: Enter manufacturer/styles, for example MUSTAD/39960D.

Degrees Offset: Enter the Degrees Offset.

Hook Measurements: Record "Hook Shaft Length" and "Hook Point to Shaft" measurements. If it is a double or triple hook setup with more than one hook size, enter the second or third hook measurements in the comments section.

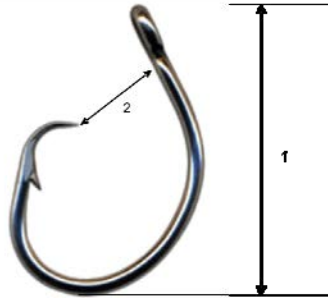

1. Hook Shaft Length: Measure the distance (in inches) from the hook eye to the point of maximum curvature on the bent portion of the hook. Shaft length is in effect the total length of the hook.

2. Hook Point to Shaft: Measure the shortest distance (in inches) from the point of the hook to the shaft of the hook.

Hook Material: Enter an "X" in the appropriate square that best describes the hook materials. If you mark "Other", then enter an explanation in the **Comments** section.

Hook Comments: Enter comments necessary to better describe entries above.

Trace Outline of Hook with Dimensions in Space Below: If possible, lay hook onto paper and trace. Include in diagram, hook shaft length and hook point to shaft measurements.

COLLECTION OF BIOLOGICAL DATA – MODIFIED BUOY

Sets Not Sampled - If you are unable to sample every set due to observer choice or time constraints, record in your **log book** and later on the **Trip Report**, the date, location, depth, hours soaked, and reason for not sampling. Since you did not sample these, do not number them consecutively as sets.

Sampling Procedures

- 1. Fish Identification:** Identify the fish to species level. Record the common name, genus and species on the length frequency/weight form.
- 2. Fish Length Measurement:** Record the length of the fish in **millimeters**. Care should be taken to use the proper length measurement code which is species specific (see appendix 10 and Species List). Write the length measurement code used in the **LENGTH CODE** column on the length frequency/weight form.
- 3. Fish Weight Measurement:** Record the weight of the fish in **kilograms**. Indicate whether the fish was weighed "**whole**" code **01** or "**gutted**" code **02** in the **WEIGHT CODE** column on the length frequency/weight form.
- 4. Fish Fate:** Record the fate of the fish using the fate codes found at the bottom of the length frequency/weight form. Remember to use the sink or swim method. Use fate code "U" Unknown Discard if you are unable to determine if the fish sank or swam (dark or rough conditions). Use fate code "X" if it is unknown if fish was kept or discarded.
- 5. Tagging Undersized Select Species (only if instructed by program manager or coordinator):** Undersized select species in good health will be tagged and released. Only place an "X" on the length/frequency form in the **TAGGED** column if the fish is tagged by the observer. You will also be required to complete a **Tag Reporting Form**. If a previously tagged fish is captured reference the tag number and contact information in the comment section of the station sheet.
- 6. Air Bladders:** If air bladder is punctured (in released fish), enter an "X" in **AIR BLADDER** column. The air bladder should only be punctured if this is the traditional procedure of the captain and crew.

STATION SHEET MODIFIED BUOY

ORG PRO <input type="text"/> <input type="text"/> <input type="text"/> <input type="text"/> <input type="text"/> <input type="text"/> <input type="text"/> <input type="text"/> TRIP NO.	<input type="text"/> <input type="text"/> <input type="text"/> SET NO.	<input type="text"/> <input type="text"/> <input type="text"/> OBSERVER	MO DAY YR <input type="text"/> <input type="text"/> <input type="text"/> <input type="text"/> <input type="text"/> <input type="text"/> DATE	GEAR CODE <input type="text"/> <input type="text"/> <input type="text"/> <input type="text"/>	# OF JUGS SET <input type="text"/> <input type="text"/> <input type="text"/> <input type="text"/> <input type="text"/> <input type="text"/> <input type="text"/> <input type="text"/>
SET TIME <input type="text"/> <input type="text"/> <input type="text"/> <input type="text"/> START	SET TIME <input type="text"/> <input type="text"/> <input type="text"/> <input type="text"/> END	Degree Minutes Seconds <input type="text"/> <input type="text"/> <input type="text"/> <input type="text"/> <input type="text"/> <input type="text"/> LATITUDE IN	Degree Minutes Seconds <input type="text"/> <input type="text"/> <input type="text"/> <input type="text"/> <input type="text"/> <input type="text"/> LONGITUDE IN		
HAUL TIME <input type="text"/> <input type="text"/> <input type="text"/> <input type="text"/> START	HAUL TIME <input type="text"/> <input type="text"/> <input type="text"/> <input type="text"/> END	<input type="text"/> <input type="text"/> STAT ZONE	<input type="text"/> SEA STATE		

PREDATORS OBSERVED

<input type="checkbox"/> SHARKS	0 = PREDATOR NOT PRESENT IN AREA	5 = PREDATOR OBSERVED BUT COULD NOT DETERMINE IF FEEDING
<input type="checkbox"/> MARINE MAMMALS	1 = PREDATOR OBSERVED BUT NOT FEEDING	6 = PREDATOR OBSERVED FEEDING ON DISCARDED CAPTURES
<input type="checkbox"/> SEA BIRDS	2 = PREDATOR OBSERVED FEEDING ON BAIT (ON HOOK)	7 = PREDATOR OBSERVER FEEDING ON DISCARDED BAIT
<input type="checkbox"/> OTHER FISH	3 = PREDATOR OBSERVED FEEDING ON CAPTURES (ON HOOK)	8 = PREDATOR OBSERVER FEEDING ON DISCARDED CAPTURES AND BAIT
	4 = PREDATOR OBSERVED FEEDING ON CAPTURES AND BAIT (ON HOOK)	9 = NOT OBSERVED

BAIT (Check all that apply) <input type="checkbox"/> Squid <input type="checkbox"/> Mackerel <input type="checkbox"/> Herring <input type="checkbox"/> Other _____ <input type="checkbox"/> Other _____ <input type="checkbox"/> Other _____ <input type="checkbox"/> Other _____	STATE OF BAIT (Check Whole or Cut then check all that apply for each type of bait used.) <table border="1" style="width: 100%; text-align: center; border-collapse: collapse;"> <tr> <th style="width: 12.5%;">Whole</th> <th style="width: 12.5%;">Cut</th> <th style="width: 12.5%;">Fresh</th> <th style="width: 12.5%;">Frozen</th> <th style="width: 12.5%;">Salted</th> <th style="width: 12.5%;">Live</th> </tr> <tr> <td><input type="checkbox"/></td><td><input type="checkbox"/></td><td><input type="checkbox"/></td><td><input type="checkbox"/></td><td><input type="checkbox"/></td><td><input type="checkbox"/></td> </tr> <tr> <td><input type="checkbox"/></td><td><input type="checkbox"/></td><td><input type="checkbox"/></td><td><input type="checkbox"/></td><td><input type="checkbox"/></td><td><input type="checkbox"/></td> </tr> <tr> <td><input type="checkbox"/></td><td><input type="checkbox"/></td><td><input type="checkbox"/></td><td><input type="checkbox"/></td><td><input type="checkbox"/></td><td><input type="checkbox"/></td> </tr> <tr> <td><input type="checkbox"/></td><td><input type="checkbox"/></td><td><input type="checkbox"/></td><td><input type="checkbox"/></td><td><input type="checkbox"/></td><td><input type="checkbox"/></td> </tr> <tr> <td><input type="checkbox"/></td><td><input type="checkbox"/></td><td><input type="checkbox"/></td><td><input type="checkbox"/></td><td><input type="checkbox"/></td><td><input type="checkbox"/></td> </tr> <tr> <td><input type="checkbox"/></td><td><input type="checkbox"/></td><td><input type="checkbox"/></td><td><input type="checkbox"/></td><td><input type="checkbox"/></td><td><input type="checkbox"/></td> </tr> <tr> <td><input type="checkbox"/></td><td><input type="checkbox"/></td><td><input type="checkbox"/></td><td><input type="checkbox"/></td><td><input type="checkbox"/></td><td><input type="checkbox"/></td> </tr> </table>	Whole	Cut	Fresh	Frozen	Salted	Live	<input type="checkbox"/>	<input type="checkbox"/>	<input type="checkbox"/>	<input type="checkbox"/>	<input type="checkbox"/>	<input type="checkbox"/>	<input type="checkbox"/>	<input type="checkbox"/>	<input type="checkbox"/>	<input type="checkbox"/>	<input type="checkbox"/>	<input type="checkbox"/>	<input type="checkbox"/>	<input type="checkbox"/>	<input type="checkbox"/>	<input type="checkbox"/>	<input type="checkbox"/>	<input type="checkbox"/>	<input type="checkbox"/>	<input type="checkbox"/>	<input type="checkbox"/>	<input type="checkbox"/>	<input type="checkbox"/>	<input type="checkbox"/>	<input type="checkbox"/>	<input type="checkbox"/>	<input type="checkbox"/>	<input type="checkbox"/>	<input type="checkbox"/>	<input type="checkbox"/>	<input type="checkbox"/>	<input type="checkbox"/>	<input type="checkbox"/>	<input type="checkbox"/>	<input type="checkbox"/>	<input type="checkbox"/>	<input type="checkbox"/>	<input type="checkbox"/>	<input type="checkbox"/>	<input type="checkbox"/>	<input type="checkbox"/>	<input type="checkbox"/>
Whole	Cut	Fresh	Frozen	Salted	Live																																												
<input type="checkbox"/>	<input type="checkbox"/>	<input type="checkbox"/>	<input type="checkbox"/>	<input type="checkbox"/>	<input type="checkbox"/>																																												
<input type="checkbox"/>	<input type="checkbox"/>	<input type="checkbox"/>	<input type="checkbox"/>	<input type="checkbox"/>	<input type="checkbox"/>																																												
<input type="checkbox"/>	<input type="checkbox"/>	<input type="checkbox"/>	<input type="checkbox"/>	<input type="checkbox"/>	<input type="checkbox"/>																																												
<input type="checkbox"/>	<input type="checkbox"/>	<input type="checkbox"/>	<input type="checkbox"/>	<input type="checkbox"/>	<input type="checkbox"/>																																												
<input type="checkbox"/>	<input type="checkbox"/>	<input type="checkbox"/>	<input type="checkbox"/>	<input type="checkbox"/>	<input type="checkbox"/>																																												
<input type="checkbox"/>	<input type="checkbox"/>	<input type="checkbox"/>	<input type="checkbox"/>	<input type="checkbox"/>	<input type="checkbox"/>																																												
<input type="checkbox"/>	<input type="checkbox"/>	<input type="checkbox"/>	<input type="checkbox"/>	<input type="checkbox"/>	<input type="checkbox"/>																																												

TARGET SPECIES: List all targeted species for this set using genus species format.

<input type="text"/> <input type="text"/> <input type="text"/> <input type="text"/> <input type="text"/>	<input type="text"/> <input type="text"/> <input type="text"/> <input type="text"/>	<input type="text"/> <input type="text"/> <input type="text"/> <input type="text"/>	<input type="text"/> <input type="text"/> <input type="text"/> <input type="text"/>	<input type="text"/> <input type="text"/> <input type="text"/> <input type="text"/>
<input type="text"/> <input type="text"/> <input type="text"/> <input type="text"/> <input type="text"/> <input type="text"/> WATER DEPTH	<input type="text"/> <input type="text"/> BOTTOM TYPE	<input type="text"/> SCALE TYPE DIGITAL (D), MECHANICAL (M) BOTH (B) or UNKNOWN (U)		
COORDINATOR COMMENTS: _____ _____				
OBSERVER COMMENTS: _____ _____				

STATION SHEET – MODIFIED BUOY

Complete one station sheet for each set. This form must be filled out for both sampled and unsampled sets. For sets not sampled (or unsampled sets) enter the following information: trip number, 999 for set number, observer code, date, set time start and end, haul time start and end, latitude, longitude, statistical zone, sea state, and reason for not sampling.

Trip No: Enter Trip Number provided by Observer Coordinator.

Set No: Enter the set number. The set number begins with "001" for each trip. Remember unsampled sets are not given set numbers, and are not sampled (due to: time constraints, weather, sickness, sleep etc.).

Observer: Enter Observer Code provided by Observer Coordinator.

Date: Enter the date the Set started (use two digits for month, day, and year (MO/DY/YR)).

Gear Code: Enter the gear codes that corresponds to the gear configuration used for this station and the number of jugs set for each gear code.

Set Time Start: Enter in military time (0001-2359), time when **first** buoy is set (First Buoy In).

Set Time End: Enter in military time (0001–2359), time when **last** buoy is set (Last Buoy In).

Latitude In: Enter the position occupied at set (set time start) in degrees, minutes, and seconds. Ask the captain if the LORAN or GPS **unit reads in degrees, minutes, and seconds or in degrees, minutes, and hundredths of a minute**. If the unit reads in hundredths of minutes, multiply the last two digits (as a decimal figure) by 60 to obtain the seconds (e.g., .88 x 60 = 52.8 seconds, this is rounded up to 53 seconds [see appendix 12]). If coordinates are given in LORAN, the reading should be written above the space provided for GPS units (leaving GPS units blank). The units will be converted in the lab and filled in by the Observer Coordinator.

Longitude In: Enter the position occupied at set (time in) in degrees, minutes, and seconds.

Haul Time Start: Enter in military time (0001–2359), time when **first** buoy is retrieved.

Haul Time End: Enter in military time (0001-2359), time when **last** buoy is retrieved.

Stat Zone: Enter the statistical zone at set (time in) (appendix 11). Leave blank if using LORAN.

Sea State: Enter the number that best describes the sea state (wave height):

1 = 0-2 feet, 2 = 3-5 feet, 3 = 6-8 feet, 4 = 8+ feet.

Predators Observed: Select and mark one of the 10 categories listed for each of the 4 predator types. If predator observed is a marine mammal other than a dolphin, specify the species of marine mammal, in the observer comments section and circle marine mammal on the data form.

Bait: Check all bait types used for this set, if a bait type other than the ones listed are used reference it in the space labeled other (see appendix 17). For each type of bait listed you must also reference the **State of Bait**. Check if the bait is whole or cut then check if the bait is fresh, frozen, salted or live. Check all that apply. Whole is only used if the bait is a whole fish.

Target Species: List all species being targeted for the set in genus species format (i.e. LUTJANUCAMPEC, EPINEPHMORIO, and EPINEPHFLAVOL). Enter the first seven characters of the genus name and the first 6 characters of the species name (refer to Reef Fish Species List), **DO NOT reference common names.**

Soak Time: Subtract “Set Time Start” from “Haul Time End”. Be sure to convert minutes to tenths of an hour prior to entering on the station sheet (see appendix 12).

14:30 (Haul Time End) – 12:03 (Set Time Start) = 2:27 or 2.5 hrs. (Soak Time)

of Jugs Set: Enter the total number of jugs set.

of Jugs Sampled: Enter the total number of jugs sampled. If a jug is lost it is considered unsampled and should not be included in the total for number of jug sampled.

of Hooks Set: Enter the exact number of hooks set.

of Hooks Lost: Enter total number of hooks lost during each set due to predation, hangs, etc.

Water Depth: Enter the bottom depth in feet. If depth is in fathoms, multiply it by 6 to convert the depth to feet.

Bottom Type: Enter the bottom type (refer to captain and appendix 10).

Scale Type: Enter the type of scale use, Digital (D), Mechanical (M), Both (B) or Unknown (U).

Coordinator Comments: Leave blank.

Observer’s Comments: Enter your comments or observations.

LENGTH-FREQUENCY/WEIGHT FORM MODIFIED BUOY

ORG PRO

--	--	--	--	--	--

--	--	--

TRIP NO.

SET NO.

G E A R C O D E	COMMON NAME	GENUS	SPECIES	LENGTH (mm)	L E N G T H C O D E	W E I G H T C O D E	W E I G H T C O D E	C O N D I T I O N C O D E	F A T E R E L E A S E	T A G G E D	A I R B L A D D E R	S P E C I M E N #	O / G
1													
2													
3													
4													
5													
6													
7													
8													
9													
10													
11													
12													
13													
14													
15													
16													
17													
18													
19													
20													
21													
22													
23													
24													
25													
LENGTH CODES		WEIGHT CODES		CONDITION CODES (AS BROUGHT ONBOARD)				FATE CODE					
01 - FORK		1 - WHOLE		1 - LIVE: NORMAL APPEARANCE				K - FISH KEPT					
02 - STANDARD		2 - DRESSED/CLEANED		2 - LIVE AIR BLADDER/STOMACH PROTRUDING				D - DISCARD DEAD					
18 - TOTAL		8 - NOT MEASURABLE		3 - LIVE: EYES PROTRUDING				A - DISCARD ALIVE					
22 - DISC		9 - NO DATA		4 - LIVE: COMBINATION 2 AND 3				B - KEPT FOR BAIT					
23 - ANAL				5 - DEAD ON ARRIVAL				U - UNKNOWN DISCARD					
88 - NOT MEASURABLE				9 - NO DATA OR UNKNOWN				X - UNKNOWN IF KEPT OR DISCARDED					
99 - NO DATA or UNKNOWN													

LENGTH FREQUENCY / WEIGHT FORM – MODIFIED BUOY

Record all fish caught on sampled hooks. If all the buoys deployed are retrieved empty (i.e., all hooks empty) enter “No Fish Caught” in the observer comments section on the station sheet. You are also required to reference no fish caught on the Length Frequency / Weight form. You should reference the sampled gear code and write “NOCATCH” in the space provided for both the Common name and the Genus Columns. For example, there are 2 types of gear sampled, A and B. A catches fish and B does not, you would reference NOCATCH for gear B. If both gears sampled do not catch fish, NOCATCH should be referenced for both gears A and B. Remember unsampled sets are not given set numbers, and are not sampled (due to: observing crew operations, processing previous set, time constraints, weather, sickness, sleep etc.).

Trip No: Enter Trip Number provided by Observer Coordinator.

Set No: Enter set number that corresponds to Station Sheet set number.

Sampling Procedures

- 1. Gear Code:** Enter the gear code the fish was caught on.
- 2. Fish Identification:** Identify the fish to species level, record common name, genus and species. Enter the first seven characters of the genus name and the first 6 characters of the species name (refer to Species List).
- 3. Fish Length Measurement:** Record the length of fish in **millimeters**. Be sure to measure the fish using the appropriate species specific length measurement code (see appendix 10 and Species List). If the fish is not measurable (mutilated, e.g., tail missing from shark attack) enter 888.88 in the **LENGTH** column and 88 for the **LENGTH CODE**. If no measurement was taken (e.g., thrown overboard) 999.99 in the **LENGTH** column to denote unknown and/or not measured and 99 for the **LENGTH CODE**.
- 4. Fish Weight Measurement:** Record the weight of fish in **kilograms**. Indicate whether the fish was weighed "**whole**" code **1** or "**gutted**" code **2** in the **WEIGHT CODE** column on the length frequency/weight form. If the fish is damaged or too light to obtain a reading on your scale, enter 888.88 in the **WEIGHT** column and 8 for the **WEIGHT CODE**. If the weight was not measured or the weight is unknown, enter 999.99 in the **WEIGHT** column and 9 for the **WEIGHT CODE**.
- 5. Condition Code:** Use most appropriate condition code (see bottom of form) to describe condition of the fish when brought on deck.

- 6. Fish Fate:** Record the fate of the fish using the fate codes found at the bottom of the length frequency/weight form. Remember to use the sink or swim method. Use fate code "U" Unknown Discard if you are unable to determine if the fish sank or swam (dark or rough conditions). Use fate code "X" if it is unknown if fish was kept or discarded.

- 7. Tagging Undersized Select Species (only if instructed by program manager or coordinator):** Undersized select species in good health will be tagged and released. Only place an "X" on the length/frequency form in the **TAGGED** column if the fish is tagged by the observer. You will also be required to complete a **Tag Reporting Form**. If a previously tagged fish is captured reference the tag number and contact information in the comment section of the station sheet.

- 8. Air Bladders:** If air bladder is punctured, enter an "X" in the **AIR BLADDER** column. Puncture air bladders only if this is the traditional procedure of the captain and crew.

- 9. Specimen # O/G:** If a specimen is sampled for Otolith/Gonads it is given specimen #. These numbers are assigned by the observer and are consecutive from the start of the trip to the end. The number, as well as the recorded information, should coincide with the numbers referenced on the Gonad/Otolith sample log.

- 10. Length Frequency/Weight Form Continued:** If you need additional space, continue on a new Length Frequency Form. Number the sheets in the space provided at the bottom of the form.

SPEARFISHING DATA FORMS

Complete the following forms for all Spear Fishing Trips.

1. Gear Specification Form (SF-GS)
2. Station Sheet (SF-SS)
3. Length Frequency/Weight Form (SF-LF)
4. Sea Turtle Life History Form (Complete only if a turtle is captured or sighted)
5. Protected Resources Capture Report (only if applicable)
6. Marine Mammal Life History Form (only if applicable)
7. Tag Reporting Form (only if applicable)
8. Specimen Collection Log (only if applicable)
9. Gonad/Otolith Form (only if applicable)

GEAR SPECIFICATION FORM - SPEARFISHING

ORG PRO

--	--	--	--	--	--	--	--

TRIP NO.

MO DAY YR

--	--	--	--	--	--

DATE

--	--	--

OBSERVER

--	--	--

SET NO.

--

GEAR CODE

BRAND OF SPEAR GUN _____ MODEL # _____

SHAFT LENGTH

		.	
--	--	---	--

 inches

SHAFT DIAMETER

	.		
--	---	--	--

 inches

NUMBER SHAFTS USED

--	--

FIRING MECHANISM

EXPLOSIVE (POWER HEAD) _____

RUBBER or ELASTIC _____

PNEUMATIC or GAS POWERED _____

OTHER _____

GEAR DESCRIPTION

GEAR DIAGRAM

GEAR SPECIFICATION FORM – SPEARFISHING

Complete a gear specification form for each gear type used. A change of spear gun or configuration of existing spear gun requires additional forms for the affected sets.

Trip No: Enter the trip number provided by Observer Coordinator.

Date: Enter the date the set number started, or the date changes occurred to the gear.

Set Number: Enter the starting set number 001 for the first gear used. If gear changes are made, enter the set number when these changes occurred on a new gear sheet.

Gear Code: Gear codes are designated by the observer; they should always start with the letter “A” and progress through the alphabet. Any changes in gear configuration (i.e. shaft length, shaft diameter or number of shafts used) result in a new gear code.

Brand of Spear Gun: Reference the brand of spear gun that applies to a particular gear code.

Model #: Model numbers are normally referenced on the shaft of the gun, if not; try to acquire the information from the user or leave blank.

Shaft Length: Measure the shaft length in inches.

Shaft Diameter: Measure the shaft diameter in inches.

Number Shafts used: Enter the total number of shafts used during fishing. If the number of shafts is changed between dives you will need to fill out a new gear form to reflect the changes.

Firing Mechanism: Enter an “X” in the appropriate space. **Explosive (Power Head)** - An explosive cartridge launches the spear when the trigger is pulled. **Rubber or Elastic-** bands are stretched to slot into a notch on the spear shaft and launch the spear when the trigger is pulled. **Pneumatic or Gas Powered** – pneumatic, where after firing the expanded gas or air is kept and can be re-compressed by the user underwater or gas-powered (usually carbon dioxide) where the gas escapes after firing. If a type other than the three mentioned is used, mark “**Other**” and describe the firing mechanism in the description section.

Gear Description: Write a detailed description of the gear.

Gear Diagram: Provide a diagram of the gear used.

COLLECTION OF BIOLOGICAL DATA – SPEARFISHING

Sets Not Sampled - If you are unable to sample every set due to weather or time constraints, record in your **log book** and on the **Trip Report**: the date, location, depth, set times, and reason for not sampling. Do not number these as sets.

Sampling Procedures

- 1. Fish Identification:** Identify the fish to species level. Record the common name, genus and species on the length frequency/weight form.
- 2. Fish Length Measurement:** Record the length of the fish in **millimeters**. Care should be taken to use the proper length measurement code which is species specific (see appendix 10 and Species List). Write the length measurement code used in the **LENGTH CODE** column on the length frequency/weight form.
- 3. Fish Weight Measurement:** Record the weight of the fish in **kilograms**. Indicate whether the fish was weighed "**whole**" code **1** or "**gutted**" code **2** in the **WEIGHT CODE** column on the length frequency/weight form.
- 4. Fish Fate:** Record the fate of the fish using the fate codes found at the bottom of the length frequency/weight form. Remember to use the sink or swim method. Use fate code "U" Unknown Discard if you are unable to determine if the fish sank or swam (dark or rough conditions). Use fate code "X" if it is unknown if fish was kept or discarded.
- 6. Tagged:** If a tagged fish is captured, place an "X" on the length frequency/weight form in the **TAGGED** column and reference the tag number in the comment section of the station sheet. You will also be required to complete a Tag Reporting Form.
- 7. Air Bladders:** If air bladder is punctured, enter an "X" in the **AIR BLADDER** column. Puncture air bladders only if this is the traditional procedure of the captain and crew.
- 8. Length Frequency/Weight Form Continued:** If you need additional space, continue on a new Length Frequency Form. Number the sheets in the space provided at the bottom of the form.

STATION SHEET SPEARFISHING

ORG PRO

TRIP NO.

SET NO.

OBSERVER

MO DAY YR

DATE

Degree Minutes Seconds

LATITUDE IN

Degree Minutes Seconds

LONGITUDE IN

STAT ZONE

SEA STATE

DIVE 1

TIME IN

TIME OUT

DIVE TIME

HRS

DIVE 5

TIME IN

TIME OUT

DIVE TIME

HRS

DIVE 2

TIME IN

TIME OUT

DIVE TIME

HRS

DIVE 6

TIME IN

TIME OUT

DIVE TIME

DIVE 3

TIME IN

TIME OUT

DIVE TIME

HRS

DIVE 7

TIME IN

TIME OUT

DIVE TIME

DIVE 4

TIME IN

TIME OUT

DIVE TIME

HRS

DIVE 8

TIME IN

TIME OUT

DIVE TIME

HRS

LIST ALL GEAR CONFIGURATIONS THAT APPLY TO EACH DIVER IF DIVER UNUSED, LEAVE BLANK
 1 _____ 2 _____ 3 _____ 4 _____ 5 _____ 6 _____ 7 _____ 8 _____

VESSEL(CHECK ONE): ON ANCHOR _____ DRIFTING _____ TROLLING _____ UNKNOWN _____
(ATTACHED TO RIG)

PREDATORS OBSERVED

<input type="checkbox"/>	SHARKS	0 = PREDATOR NOT PRESENT IN AREA
<input type="checkbox"/>	MARINE MAMMAL	1 = PREDATOR OBSERVED BUT NOT FEEDING
<input type="checkbox"/>	SEA BIRDS	5 = PREDATOR OBSERVED BUT COULD NOT DETERMINE IF FEEDING
<input type="checkbox"/>	OTHER FISH	6 = PREDATOR OBSERVED FEEDING ON DISCARDED CAPTURES
		9 = NOT OBSERVED

TARGET SPECIES: List all targeted species for this set

TOTAL DIVING TIME <input type="text"/> <input type="text"/> <input type="text"/> <input type="text"/> <input type="text"/> <input type="text"/> <input type="text"/> <input type="text"/> <input type="text"/> HRS	WATER DEPTH <input type="text"/> <input type="text"/> <input type="text"/> <input type="text"/> <input type="text"/> <input type="text"/> <input type="text"/> <input type="text"/> <input type="text"/> FEET	TOTAL NO. <input type="text"/> <input type="text"/> <input type="text"/> <input type="text"/> DIVES	TOTAL NO. <input type="text"/> <input type="text"/> <input type="text"/> <input type="text"/> DIVES SAMPLED
APPROX. <input type="text"/> <input type="text"/> <input type="text"/> <input type="text"/> <input type="text"/> <input type="text"/> <input type="text"/> <input type="text"/> <input type="text"/> DIVING DEPTH	BOTTOM <input type="text"/> <input type="text"/> TYPE	SCALE TYPE DIGITAL (D), MECHANICAL (M) BOTH (B) or UNKNOWN (U)	

COORDINATOR COMMENTS:

OBSERVER COMMENTS:

STATION SHEET – SPEARFISHING

Complete one station sheet for each set. This form must be filed out for both sampled and unsampled sets. For sets not sampled (or unsampled sets) enter the following information: trip number, 999 for set number, observer code, date, latitude, longitude, statistical zone, sea state, dive time in and time out, and reason for not sampling.

Trip No: Enter Trip Number provided by Observer Coordinator.

Set No: Enter the set number. The set number begins with "001" for each trip. A set is based on fishing location. Remember unsampled sets are not given set numbers, and are not sampled (due to: time constraints, weather, sickness, sleep etc.).

Observer: Enter Observer Code provided by Observer Coordinator.

Date: Enter the date the Set started (use two digits for month, day, and year (MO/DY/YR)).

Latitude In: Enter the position occupied at set (time in) in degrees, minutes, and seconds. Ask the captain if the LORAN or GPS **unit reads in degrees, minutes, and seconds or in degrees, minutes, and hundredths of a minute**. If the unit reads in hundredths of minutes, multiply the last two digits (as a decimal figure) by 60 to obtain the seconds (e.g., .88 x 60 = 52.8 seconds, this is rounded up to 53 seconds [see appendix 12]). If coordinates are given in LORAN, the reading should be written above the space provided for GPS units (leaving GPS units blank). The units will be converted in the lab and filled in by the Observer Coordinator.

Longitude In: Enter the position occupied at set (time in) in degrees, minutes, and seconds.

Stat Zone: Enter the statistical zone at set (time in) (appendix 11). Leave blank if using LORAN.

Sea State: Enter the number that best describes the sea state (wave height):

1 = 0-2 feet, 2 = 3-5 feet, 3 = 6-8 feet, 4 = 8+ feet.

Dive Times: All dive times are recorded in military time (0001 - 2359). The station sheet allows space for up to 8 dives per set; they are labeled as **Dive 1 – 8**. A dive is defined as one diver diving down and returning to the boat (with or without catch) once. Record the Time In (start time) and Time Out (stop time) for each dive separately. For example, if one diver makes a total of 3 dives the dive times (Time In and Time Out) for each dive are recorded separately as **Dive 1 – 3**. If the boat has multiple divers aboard the dive times are still recorded separately. For consistency list dives in the order of occurrence. If both divers go down at the same time, then their Time In will be the same.

For Example:

Diver 1			Diver 2		
Time In	Time Out		Time In	Time Out	
Dive 1 = 12:55	13:25	= 30 min	Dive 2 = 12:55	13:20	= 25 min
Dive 3 = 14:40	15:20	= 20 min	Dive 4 = 14:40	15:08	= 28 min

<p>DIVE 1</p> <table border="1"> <tr><td>1</td><td>2</td><td>5</td><td>5</td></tr> </table> <p>TIME IN</p>	1	2	5	5	<table border="1"> <tr><td>1</td><td>3</td><td>2</td><td>5</td></tr> </table> <p>TIME OUT</p>	1	3	2	5	<table border="1"> <tr><td>0</td><td></td><td>5</td><td>0</td></tr> </table> <p>DIVE TIME</p>	0		5	0	<p>DIVE 5</p> <table border="1"> <tr><td></td><td></td><td></td><td></td></tr> </table> <p>TIME IN</p>					<table border="1"> <tr><td></td><td></td><td></td><td></td></tr> </table> <p>TIME OUT</p>					<table border="1"> <tr><td></td><td></td><td></td><td></td></tr> </table> <p>DIVE TIME</p>				
1	2	5	5																										
1	3	2	5																										
0		5	0																										
<p>DIVE 2</p> <table border="1"> <tr><td>1</td><td>2</td><td>5</td><td>5</td></tr> </table> <p>TIME IN</p>	1	2	5	5	<table border="1"> <tr><td>1</td><td>3</td><td>2</td><td>0</td></tr> </table> <p>TIME OUT</p>	1	3	2	0	<table border="1"> <tr><td>0</td><td></td><td>4</td><td>2</td></tr> </table> <p>DIVE TIME</p>	0		4	2	<p>DIVE 6</p> <table border="1"> <tr><td></td><td></td><td></td><td></td></tr> </table> <p>TIME IN</p>					<table border="1"> <tr><td></td><td></td><td></td><td></td></tr> </table> <p>TIME OUT</p>					<table border="1"> <tr><td></td><td></td><td></td><td></td></tr> </table> <p>DIVE TIME</p>				
1	2	5	5																										
1	3	2	0																										
0		4	2																										
<p>DIVE 3</p> <table border="1"> <tr><td>1</td><td>4</td><td>4</td><td>0</td></tr> </table> <p>TIME IN</p>	1	4	4	0	<table border="1"> <tr><td>1</td><td>5</td><td>2</td><td>0</td></tr> </table> <p>TIME OUT</p>	1	5	2	0	<table border="1"> <tr><td>0</td><td></td><td>6</td><td>7</td></tr> </table> <p>DIVE TIME</p>	0		6	7	<p>DIVE 7</p> <table border="1"> <tr><td></td><td></td><td></td><td></td></tr> </table> <p>TIME IN</p>					<table border="1"> <tr><td></td><td></td><td></td><td></td></tr> </table> <p>TIME OUT</p>					<table border="1"> <tr><td></td><td></td><td></td><td></td></tr> </table> <p>DIVE TIME</p>				
1	4	4	0																										
1	5	2	0																										
0		6	7																										
<p>DIVE 4</p> <table border="1"> <tr><td>1</td><td>4</td><td>4</td><td>0</td></tr> </table> <p>TIME IN</p>	1	4	4	0	<table border="1"> <tr><td>1</td><td>5</td><td>0</td><td>8</td></tr> </table> <p>TIME OUT</p>	1	5	0	8	<table border="1"> <tr><td>0</td><td></td><td>4</td><td>7</td></tr> </table> <p>DIVE TIME</p>	0		4	7	<p>DIVE 8</p> <table border="1"> <tr><td></td><td></td><td></td><td></td></tr> </table> <p>TIME IN</p>					<table border="1"> <tr><td></td><td></td><td></td><td></td></tr> </table> <p>TIME OUT</p>					<table border="1"> <tr><td></td><td></td><td></td><td></td></tr> </table> <p>DIVE TIME</p>				
1	4	4	0																										
1	5	0	8																										
0		4	7																										

List all Gear Configurations used by each Diver: List all gear code(s) that correspond to the gear used by each diver.

Vessel (Check One): While fishing was the vessel On Anchor (if vessel is tied to a rig, this is still on anchor), Drifting (if vessel is motor fishing, this is still drifting), Trolling (include time out data with ending depth and GPS position in the Station Sheet comments), or Unknown?

Predators Observed: Select and mark one of the 5 categories listed for each of the 4 predator types. If predator observed is a marine mammal other than a dolphin, specify the species of marine mammal, in the observer comments section and circle marine mammal on the data form.

Target Species: List all species being targeted for the set (LUTJANUCAMPEC, EPINEPHMORIO, and EPINEPHFLAVOL). Enter the first seven characters of the genus name and the first 6 characters of the species name (refer to Reef Fish Species List), do not reference common names.

Total Dive Time: Add up all Dive Times (1-8). Round to the nearest tenth of an hour after adding.

Water Depth: Enter the bottom depth in feet for the set. If depth is in fathoms, multiply it by 6 to convert depth to feet.

Total Number of Dives: Enter total number dives during the set.

Total Number of Dives Sampled: Enter total number of sampled dives. If a dive is made and no catch is brought up, it is still a sampled dive.

Approximate Diving Depth: Enter the average depth of the dives in feet.

Bottom Type: Enter the bottom type (refer to captain and appendix 10).

Scale Type: Enter the type of scale use, Digital (D), Mechanical (M), Both (B) or Unknown (U).

Coordinator Comments: Leave blank.

Observer's Comments: Enter your comments or observations.

LENGTH-FREQUENCY/WEIGHT FORM SPEARFISHING

ORG PRO

--	--	--	--	--	--	--

TRIP NO.

--	--	--

SET NO.

D I V E R N U M B E R	S A M P L E D	G E A R C O D E	COMMON NAME	G E N U S	S P E C I E S	L E N G T H C O D E	W E I G H T C O D E	W E I G H T	C O N D I T I O N	F A T E	R E L E A S E	T A G G E D	A I R	B L A D D E R	S P E C I M E N
															#
						LENGTH (mm)	WEIGHT (kg)								O / G
1															
2															
3															
4															
5															
6															
7															
8															
9															
10															
11															
12															
13															
14															
15															
16															
17															
18															
19															
20															
21															
22															
23															
24															
25															

LENGTH CODES	WEIGHT CODES	CONDITION CODES (AS BROUGHT ONBOARD)	FATE CODE
01- FORK	1- WHOLE	1- LIVE: NORMAL APPEARANCE	K - FISH KEPT
02 - STANDARD	2 - DRESSED/CLEANED	2 - LIVE AIR BLADDER/STOMACH PROTRUDING	D - DISCARD DEAD
18 - TOTAL	8 - NOT MEASURABLE	3 - LIVE: EYES PROTRUDING	A - DISCARD ALIVE
22 - DISC	9 - NO DATA	4 - LIVE: COMBINATION 2 AND 3	B - KEPT FOR BAIT
23 - ANAL		5 - DEAD ON ARRIVAL	U - UNKNOWN DISCARD
88 - NOT MEASURABLE		9 - NO DATA OR UNKNOWN	X - UNKNOWN IF KEPT OR DISCARDED
99 - NO DATA or UNKNOWN			

LENGTH FREQUENCY / WEIGHT FORM – SPEARFISHING

Trip No: Enter Trip Number provided by Observer Coordinator.

Set No: Enter the set number. The set number begins with “001” for each trip.

Sampling Procedures

- 1. Diver Number Sampled:** Enter the diver number sampled. You may sample one diver more than one time during a set.
- 2. Gear Code:** Enter the gear code that corresponds to the diver sampled.
- 3. Fish Identification:** Identify the fish to species level, record common name, genus and species. Enter the first seven characters of the genus name and the first 6 characters of the species name (refer to Species List). Record all fish caught while spear fishing.
- 4. Fish Length Measurement:** Record the length of fish in **millimeters**. Be sure to measure the fish using the appropriate species specific length measurement code (see appendix 10 and Species List). If the fish is not measurable (mutilated, e.g., tail missing from shark attack) enter 888.88 in the **LENGTH** column and 88 for the **LENGTH CODE**. If no measurement was taken (e.g., thrown overboard) 999.99 in the **LENGTH** column to denote unknown and/or not measured and 99 for the **LENGTH CODE**.
- 5. Fish Weight Measurement:** Record the weight of fish in **kilograms**. Indicate whether the fish was weighed "**whole**" code **1** or "**gutted**" code **2** in the **WEIGHT CODE** column on the length frequency/weight form. If the fish is damaged or too light to obtain a reading on your scale, enter 888.88 in the **WEIGHT** column and 8 for the **WEIGHT CODE**. If the weight was not measured or the weight is unknown, enter 999.99 in the **WEIGHT** column and 9 for the **WEIGHT CODE**.
- 6. Condition Code:** Use most appropriate condition code (see bottom of form) to describe condition of the fish when brought on deck.
- 7. Fish Fate:** Use most appropriate fate code (see bottom of form) to describe fate of the fish.
- 8. Tagging Undersized Select Species (only if instructed by program manager or coordinator):** Undersized select species in good health will be tagged and released. Only place an “X” on the length/frequency form in the **TAGGED** column if the fish is tagged by the observer. You will also be required to complete a **Tag Reporting Form**. If a previously tagged fish is captured reference the tag number and contact information in the comment section of the station sheet.
- 9. Air Bladders:** If air bladder is punctured, enter an "X" in the **AIR BLADDER** column. Puncture air bladders only if this is the traditional procedure of the captain and crew.
- 10. Length Frequency/Weight Form Continued:** Continue on a new Length Frequency Form.

LIST OF AND ORDER OF REEF FISH FORMS

Required for the completion of all Reef Fish Trips:

Receipt

Acknowledgement of Data Collected

Cover Sheet

Trip Report – Page 1

Trip Report – Page 2 (Un-sampled set)

Trip Report – Page 3 (Sampled set)

Trip Completion Form

Observer Feedback Form

Southeast Fisheries Observer Incident Report

Marine Pollution (MARPOL) Incident Report

Safety Check-off Form – Page 1

Safety Check-off Form (Station Bill) – Page 2

Vessel Information Form

All Gear Specification Forms

Protected Species (sampled and un-sampled) – Sea turtle, Marine Mammal, Bird, Sawfish, Sturgeon)

Specimen Collection Log

Station Sheet (un-sampled sets)

Group sampled Station Sheet and Length-Frequency/Weight Forms by consecutive set #'s

Station Sheet (sampled sets)

Length-Frequency/Weight Form

Gonad/Otolith

SECTION 5

PROTECTED SPECIES

**(SEA TURTLES, SAWFISH, STURGEON, GIANT MANTA RAY,
BIRDS, & MARINE MAMMALS)**

TAG REPORTING

SPECIMEN COLLECTION LOG

GONAD/OTOLITH

PROTECTED SPECIES and REPORTING FORMS

The following forms are to be used for all types of trips and only completed when appropriate.

- 1. Sea Turtle Life History**
- 2. Protected Resources Capture Report (sawfish, sturgeon, giant manta ray, birds)**
- 3. Marine Mammal Life History**
- 4. Tag reporting Form (LL/BR/JUG/SF-TAG)**
- 5. Specimen Collection Log**
- 6. Gonad/Otolith**

BIOLOGICAL INFORMATION

Trip # _____ Set/Tow _____ Specimen # _____

Estimated carapace length (notch-to-tip straight line): ft. (needed only if turtle is not boated & measured)

DIMENSIONS (cm):

	Curved (measuring tape) Standard Measurements	Straight Line (calipers) Standard Measurements	Straight Line (calipers)
Carapace Length	<input type="text"/> <input type="text"/> <input type="text"/> <input type="text"/> Notch-to-Tip	<input type="text"/> <input type="text"/> <input type="text"/> <input type="text"/> Notch-to-Tip	<input type="text"/> <input type="text"/> <input type="text"/> <input type="text"/> Notch-to-Notch
Carapace Width	<input type="text"/> <input type="text"/> <input type="text"/> <input type="text"/>	<input type="text"/> <input type="text"/> <input type="text"/> <input type="text"/>	

TAGS (Identify address on each tag in the comments section):

Flipper Tag Number	Metal (1) or Plastic (2)	Position (Flipper) LF, RF, LR, RR	Already Present (1) or Applied by Observer (2)	Were Tags Removed?
<input type="text"/>	<input type="text"/>	<input type="text"/>	<input type="text"/>	Y / N
<input type="text"/>	<input type="text"/>	<input type="text"/>	<input type="text"/>	Y / N
<input type="text"/>	<input type="text"/>	<input type="text"/>	<input type="text"/>	Y / N
<input type="text"/>	<input type="text"/>	<input type="text"/>	<input type="text"/>	Y / N

PIT Tag # Type: Old (alphanumeric) Decimal Hexadecimal (Put PIT tag label here)

If you have the option of Decimal or Hexadecimal sequence, choose **DECIMAL**

Living Tag Yes/No (describe) _____ Other Tags (describe) _____

BIOPSY SAMPLES TAKEN? Y (itemized below) / N / Unsuccessful (if yes, USFWS 3-177 form may be needed)

Y / N Did observer assist in dehooking, resuscitation, etc. (other than standard measurements, etc.). Address in Comments.

RELEASE INFORMATION: TIME (24hr) : DATE / /

LATITUDE deg min sec LONGITUDE deg min sec

FINAL DISPOSITION: Discarded Marked Dead/Unresponsive Carcass Discarded Unmarked Dead/Unresponsive Carcass

Salvaged Carcass/Part (explain) Released Alive Taken to Holding Facility Unknown (explain)

ADDITIONAL COMMENTS: (list all biological samples collected; describe or sketch any anomalies):

SECTION 4 - BOTH

IDENTIFICATION CRITERIA:

- Number of:
- Left Lateral Scutes
 - Right Lateral Scutes
 - Vertebral Scutes
 - L. Inframarginal Scutes
 - R. Inframarginal Scutes
- Overlapping Scutes? Y / N / U
- Inframarginal Pores? Y / N / U
- 1 Pair Prefrontal Scales? Y / N / U
- Lacks Bony Shell? Y / N
- Nuchal Touch 1st Lateral? Y / N / U
- Rigor Mortis Y / N / U
- Rotting Flesh Y / N / U
- Foul Smell Y / N / U

INJURIES: Mark Location of Injuries on Diagram and BEHAVIOR:

- Fractures of shell Y / N / U
- % width of scute _____
- Skull or mandibular fracture Y / N / U
- Injuries to eye(s) Y / N / U
- Bleeding from: (check all that apply) unknown
- cloaca nares eyes oral cavity

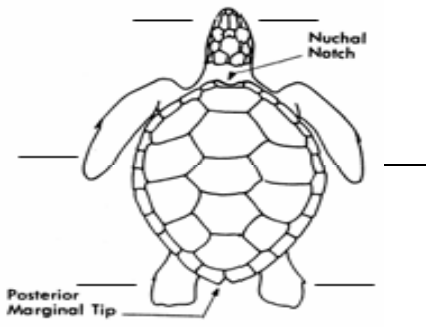

- Vigorously crawls
- Actively responds if handled
- No movement/response if handled
- Lifting head to breathe
- Moving all flippers
- Eyes open
- Tilting head
- Moving sluggish/slow/lethargic/weak
- Head/flippers hang limp
- Circling
- Water/froth discharge from mouth/nares
- Immediately swims/dives (<1 min)
- Listing/rolling in water
- Inability to right self in water
- Stays at surface/no diving _____ min.
- Sinks without swimming
- Not observed (explain): _____

AT CAPTURE	<input type="text"/>
AT RELEASE/IN WATER	<input type="text"/>

DORSAL COLORATION:

- Black
- Orange/Red-Brown
- Brown
- Gray-Green
- Other _____

CONDITION EVALUATION FOR TURTLES NOT CODED "ALIVE"

Place a "Y" on the lines of the diagram to indicate positive reflex/response or a "N" for no response.

SEA TURTLE LIFE HISTORY FORM

Write legibly in both the log book and on the forms themselves. For Captured turtles, **COPIES** of turtle forms, photos, videos, and biopsies are to be mailed to the Galveston Laboratory as soon as possible after the vessel reaches port (Original Forms are to be kept with the trip at all times!!!). **DO NOT MAIL FORMS, PHOTOS, VIDEOS, AND BIOPSIES DIRECTLY TO THE MIAMI LABORATORY.**

It is pertinent that all information collected on the Sea Turtle Life History Form is as **accurate** and **detailed** as possible. **Detailed information should also be logged in your log books.** We are unable to verify questionable information on the forms if we have nothing to compare it to.

The sea turtle life history form is used for both the By-catch and Reef Fish Programs; however, the information utilized by the individual programs varies. The form has been separated into four sections: Section 1 – All, Section 2 – Shrimp, Section 3 – Reef Fish and Section 4 – All. Sections 1 and 4 are to be completed for every turtle sighted or captured. The completion of sections 2 and 3 is program dependent. If the information does not apply to your trip, for example hook size on a shrimp trip, the section should be left blank. It is very important to complete the form in its entirety.

Complete a Sea Turtle Life History Form for every turtle, sighted or captured (brought aboard or released alongside a vessel). Photographs and videos should be taken of all turtles if possible, if you are unable to identify the species record it on the data sheet as “Unknown” or “Unknown Hardshell” (if the turtle can be positively identified as a hardshell turtle). Record tag data if tags are present. Take biological samples (biopsy), if possible, of all boated turtles (biopsies of Kemp’s Ridley are not required unless there is a question regarding identification).

While turtles should be worked up and returned to the water as soon as possible (unless resuscitated), in order to continue your other observer duties, you may need to put the turtle safely aside and work it up later. If the animal has gear attached, the gear should be photographed then removed as soon as possible, as the severity of the injury can increase with prolonged exposure to the gear.

SECTION 1 - All

Trip No.: Enter Trip Number provided by Observer Coordinator.

Date: Enter month day and year turtle was captured or sighted.

Set/Tow: Record the set or tow number during the trip when interaction or sighting occurred. If the turtle was not associated (non-station) with a set or tow, then enter 999.

Station/Non-Station: A turtle is considered a station turtle if it is captured or sighted during a sampled set or tow. All others should be considered non-station turtles. This is an important distinction, as they are entered in the database differently.

Captured/Sighted: Record if the animal was captured or sighted. For sighted turtles you are required to complete as much information as possible. All of Section 1, minus the condition of turtle at capture, should be completed. Estimated carapace length in section 4 should be completed if possible. **“Sighting only, no interaction with vessel or gear”** should be written in the comments section.

Specimen Number: Record a three-digit consecutive number for captured turtles only. Turtle specimen numbers begin with 001 and continue sequentially throughout the trip.

Experimental Y/ N? Enter “Y” for yes if it is an “Experimental Trip” and reference the project name in the comments section. Your observer coordinator will provide this information.

Does vessel have Sea Turtle Release Equipment Y / N? Enter “Y” for yes if the vessel has standard release equipment, such as de-hookers, line cutters, mouth openers, tire etc. Reference specific gear types in the comments section.

Vessel Code: Enter Vessel Code provided by Observer Coordinator.

Observer: Enter Observer Code provided by Observer Coordinator.

State: Enter the state that you were closest to when sea turtle was sighted or captured.

Time: Enter in military time (0001-2359) when turtle was sighted or captured.

Water Depth (ft.): Record the water depth in feet.

Air Temp (°F): Record the ambient air temperature in °F.

Photographed (circle one): Y or N. **Number of Photos Taken?** Record the number of photos taken. Always photograph the turtle if possible. Take at least one picture to document gear interaction (prior to gear removal). This should never be left blank; it is asking for quantity, if no photos were taken you should place a zero in the boxes provided.

Videos (circle one): Y or N. **Number of Videos Taken?** Record the number of videos taken. This should never be left blank; it is asking for quantity, if no videos are taken you should place a zero in the boxes provided.

When possible video every turtle, and record the number of videos taken. The purpose of the videos is to document behavior and reflex/response to stimuli in addition to the information

gained from a photograph. Take a short video clip (30 seconds – 1 minute unless you need to document something specific) for each of the following events:

- At capture or while it is in gear if not brought on board
- Behavior while on deck
- During reflex tests if possible
- Leading up to and during release
- Behavior in water after release.

Latitude: Record the degrees, minutes and seconds of latitude at the time of capture or sighting.

Longitude: Record the degrees, minutes and seconds of longitude at the time of capture or sighting.

Species Identification: Check the appropriate box which corresponds to the species of turtle. Enter Unknown or Unknown Hardshell if a positive identification cannot be made.

Condition of Turtle at Capture: Check the appropriate box that best corresponds to the turtle's condition when it was recovered.

Previously Dead: The turtle died prior to and not as a result of the observed fishing interaction. Note: A **previously dead** turtle will usually have rotting tissue around the eyes and vents, and it may be bloated and foul smelling. It also may have sloughing scutes and scales. However, it may not smell, but will have rigor mortis.

Alive: A turtle should be coded as alive if it makes directed movements, such as attempting to crawl or bite, and while breathing the carapace raises and lowers. If the turtle is brought onboard responsive, but lethargic, you should check "Alive".

Unknown: The turtle was not closely observed and the condition is unknown. Explain in comments.

Other: The condition does not fit any category described above. Explain in comments.

Fresh Dead/Comatose/Unresponsive: At times it is difficult to make the distinction whether a turtle is dead or comatose/unresponsive. The two groups have been combined to allow for maximum flexibility, as well as separated out to allow for a more detailed response. If you are unsure if a turtle is fresh dead or comatose/unresponsive you should check the "Fresh dead/comatose/unresponsive". If can determine if the turtle is "fresh dead" or "comatose/unresponsive" circle specific category as well as checking the combined category. For example:

CONDITION OF TURTLE AT CAPTURE:			Complete condition evaluation on p. 2 for any not coded "alive"
<input type="checkbox"/> Previously Dead	<input type="checkbox"/> Unknown (describe)	<input type="checkbox"/> Other (describe in comments)	
<input type="checkbox"/> Alive	<input checked="" type="checkbox"/> Fresh dead, <u>Comatose/Unresponsive</u>		

Fresh Dead: The turtle died as a result of the current (observed) fishing operation. The carcass may show signs that it has been alive during the interaction (e.g., multiple wrap entanglement in line or netting, or internal hooking). The carcass may or may not have rigor mortis and may begin to smell. Extended soak times, over several days may influence the condition; the carcass may exhibit moderate to severe decomposition when retrieved. Selecting this field indicates that the turtle was assuredly alive when captured in the gear; regardless of the time elapsed before being observed.

Comatose/Unresponsive: Select this category if there is an indication of life but no obvious direct movement or breaths. A comatose/unresponsive turtle should be coded as uninjured unless it was hooked or shows obvious signs of fresh cuts or lesions. If the turtle appears to be comatose/unresponsive you should check for bilateral responses as described by the Sea Turtle resuscitation guidelines on Page 5-22 of the manual. This should be done periodically prior to the animal being returned to the water. A fully conscious turtle has bilateral reflexes and central (e.g., brain) recognition of the stimulus. An unresponsive turtle will not have full bilateral responses, or central recognition of a stimulus. A comatose turtle will have lost all reflexes. To test eye reflexes, check for a blink response by gently touching the corner of the eye or eyelid. Pinch both front and rear flippers and the tail to check for responses. A lack of bilateral response is an indication that resuscitation may be needed.

VERY IMPORTANT: TURTLE PROTOCOL REGARDING RESUSCITATION

Please inform the Captain and Crew that they are responsible (as per regulations) for the safety and care of captured/boarded sea turtles. This includes resuscitation and removal of fishing gear (dehooking). The observer can instruct the Captain and Crew regarding resuscitation (refer to Sea Turtle Resuscitation Guidelines) and gear removal techniques. You do not have the authority to force them to perform these tasks.

Instructions to the Captain and Crew in these techniques does not constitute “assisting in resuscitation and/or dehooking”. Record the resuscitation timeline as well as video and photograph the turtle during resuscitation and gear removal.

If it is clear that the Captain and Crew will not resuscitate or dehook the turtle, at this point you are allowed to perform the resuscitation or dehooking. Be sure to indicate this on the Sea Turtle Life History Form by circling yes to “Did observer assist in dehooking, resuscitation, etc.”. Once you have completed working up the turtle (collect biological information to complete the Sea Turtle Life History Form, apply necessary tags and collect biopsy samples),

request that the captain and/or crew release the turtle overboard. Release of the sea turtle should be done while the vessel is idle and away from other vessels and/or fishing gear.

Attempted Resuscitation? For turtle classified as Fresh Dead or Comatose/Unresponsive this should never be left blank. This indicates if the vessel crew attempted resuscitation. To be coded as Yes, it must be an active resuscitation attempt, per the Sea Turtle Resuscitation Guidelines on page 20 (66 FR 67495, Dec 21, 2001).

ATTEMPTED RESUSCITATION:			
Hindquarters Elevated? Y / N	Rocked? Y / N	Resuscitation Duration	<input type="text"/> <input type="text"/> . <input type="text"/> <input type="text"/> hrs
Time on Deck before release	<input type="text"/> <input type="text"/> . <input type="text"/> <input type="text"/> hrs	If Successful, Time it took turtle to respond	<input type="text"/> <input type="text"/> . <input type="text"/> <input type="text"/> hrs

Hindquarters Elevated? Y / N: The turtle’s hindquarters must be elevated at least six inches (15 – 30 degrees) for a period of 4 up to 24 hours while the turtle is kept moist and in the shade at a temperature similar to water temperature at capture.

Rocked? Y / N: Periodically, rock the turtle gently left to right and right to left by holding the outer edge of the carapace and lifting one side about 3 inches, then alternate to the other side.

If a turtle is simply placed on a tire or on deck without elevation, this is not an active resuscitation attempt and should be coded as No. Please describe the circumstances in the comments section. ****Note in the comments section the time it took for the turtle to respond and how long you were able to keep the animal on deck before release.**

Resuscitation Duration: This is the total amount of time turtle was resuscitated. Duration starts when resuscitation begins (to include both hindquarters elevated and rocking) and stops when resuscitation ends. This duration can be longer than **“If Successfully Resuscitated, Time it took turtle to respond”**. Record in decimal hours.

If Successfully Resuscitated, Time it took turtle to respond: This is the time it took to show signs of improvement (positive changes to reflex tests). Duration starts when resuscitation begins and ends when turtle shows signs of being successfully resuscitated. Record in decimal hours.

Time on Deck before release: Time the turtle was on deck after successful resuscitation. Duration starts when turtle is successfully resuscitated (shows signs of positive changes to reflex test) and ends when the turtle is released into the water. Record in decimal hours.

Injury Status: Specify the turtle’s injury status as **Injured, Uninjured, or Unknown**. Injury status is considered independently and refers only to whether a turtle is hooked or otherwise injured (scrapes to flesh, cracks to carapace, etc.) as a result of the observed fishing operation. ****Note:** A captured turtle (previously dead, fresh dead or comatose/unresponsive) should be

coded **Uninjured** if it was not hooked and did not sustain fresh cuts or lesions from the current fishing operations.

Injured: The turtle is injured as a result of the observed fishing operation. The turtle should be considered injured if it was hooked, or sustained fresh cuts or lesions from the current fishing operations. Describe in detail how the turtle was injured.

Uninjured: The turtle was not hooked or injured (e.g., net captures or entangled), and there are no fresh lesions.

Unknown: The observer cannot determine if the turtle is injured. This may happen when an animal is not boarded, and the observer did not get a good view of the animal.

Gear Type: Indicate which gear is being fished. If gear is something other than the listed types, write the gear type in the comments section.

Gear Depth: Indicate whether the gear was being fished at the surface, mid-water, on the bottom, or other. If other, reference the depth in the comment section.

The following two questions are yes or no responses, which should never be left unanswered. Answers to these two questions are considered extremely important when evaluating turtle interaction.

Did turtle slide out/escape from gear? Circle **Y** or **N**. If the turtle had to be cut loose from the gear, then the correct answer is **N**. If the turtle is a sighted turtle leave blank.

Was turtle brought on board? Circle **Y** or **N**

SECTION 2 - SHRIMP

This section should always be filled out completely for shrimp trips.

Net Position: Enter net position at time of turtles capture or sighting. For turtle captured in a trawl net or non-station turtles enter 9 (default code).

Net Type Turtle Captured In: Check the appropriate answer to describe the type of net turtle had interaction with.

Net Modifications: Check the appropriate answer to explain all net modifications present in net.

Check one to describe turtle interaction with TED: Check the appropriate answer. You have four options: Turtle caught before TED, Turtle went through TED grid, Not Applicable (No TED or not caught in net) and Unknown (you do not know).

Tow Time (check one): First check, Try net or Standard net to denote the type of tow time being referenced. If the turtle is captured in/or passed through the Try net reference the Try net tow time (if time permits the collection of the try net tow time). If the Try net tow time was not collected or if there was no interaction with the Try net, then reference the Standard net tow time. Reference the date the tow started, the time the nets are set, the date the tow stopped, and the time at the start of haul back. Then calculate hours towed.

SECTION 3 – REEF FISH

This section should always be filled out completely for Reef Fish trips.

Hook Type: Check “J” or Circle. If hook type is neither, select Other (describe).

Hook Size: Write in size of hook, (e.g., 9/0, 18/0).

Manufacturer/Style No.: Write in the manufacturer and style number (e.g., Mustad #39968D).

Degree Offset: Write in the degree offset of hook (e.g., 0°, 5°, 10°).

Bait: Check all that apply: Squid, Mackerel, Sardine, Unknown or Other (describe). Enter the size of bait used.

Hook Location (see guide on pages 5-12 to 5-15): For hooked turtles, circle the specific location if it can be determined. If specific location cannot be determined, note the general location of the hook by checking the appropriate code box. Describe the hook and its location in the comments section. Note if there is more than one hook involved.

This section is divided into several parts. First, was the turtle hooked and do you know where. Check the most appropriate box to answer the question: **Not Hooked; Not Known if Hooked; Hooked, but location is totally unknown; or Holding bait/hook.** If you know where the turtle was hooked, then leave this part blank and complete the appropriate section (**Internal or External**). **Note: For Shrimp By-catch trips please check “Not Hooked”. This acts as a red flag to other agencies that the animal was not hooked.

Internal Hook Location - Check general location and circle the specific location, if known.

Unknown, internal: The animal has been hooked internally, but the location cannot be determined. This may be the case when an animal cannot be observed closely.

Swallowed (esophagus): Indicates the turtle “swallowed” the hook. The barb of the hook is lodged in the esophagus, as indicated by the presence of papillae, or the hook may be deeper. Part of the eye or shank may be visible in the open mouth. If “Swallowed” is selected, you must also answer “**Hook Visible?**”

Hook Visible: Check the extent to which the hook is visible, choose from: **visible to insertion point, partially visible or not visible.**

Beak/Mouth: Indicates the turtle was internally hooked in the beak or the mouth. Circle whether hook is in the **beak** (the hard, keratinized parts of the upper or lower jaw in hardshell turtles) or **mouth** (soft tissue parts). Hook is usually easily visible, except those lodged in the back of the mouth. Describe hook location in the comments section.

Jaw location: Specify the location of the hook in the jaw: **upper, lower, or side** (mouth only) by checking the appropriate box. If a turtle is hooked in the mouth you are required to check specific location (**tongue, glottis, soft palate, jaw joint** or **other**). Check **other**, if the specific locations listed do not apply. For example, if a turtle was hooked in the lower jaw but was not hooked in the tongue or glottis you should check the following:

Internal: Unknown, internal
 Swallowed (Esophagus) Hook visible? Visible to insertion point Partial hook Not visible
 Beak Mouth Jaw Location (check one): upper lower side (mouth only)
 Check one for mouth: tongue glottis soft palate jaw joint other (describe)

beak/mouth, mouth, lower jaw and other.

External: Turtle is hooked “Externally”, but the specific location cannot be determined. This may be the case when an animal cannot be observed closely.

Beak/Head/Neck: The turtle is hooked in the neck or head, including the external beak area. Describe location in the comments section.

Carapace/Plastron: The turtle is hooked in the carapace or plastron. Describe location in the comments section.

Front Flipper/Shoulder/Armpit: The turtle is hooked in the front limbs, armpits (trailing edge or ventral), or shoulders (leading edge). Describe which side (right or left) in the comments section.

Rear Flipper/Groin/Tail: The turtle is hooked in the rear limbs, groin or tail. Describe which side (right or left) in the comments section.

Was hook recovered from this animal: Circle Yes, No, Unknown, or Not Applicable. If turtle was ‘Not Hooked’, or ‘Not known if hooked’ then mark ‘Not Applicable’. This question should also be answered, for shrimp trips please circle “Not Applicable” (another red flag).

Was animal entangled in gear at capture? These should always be answered. Circle Yes, No, or Unknown. **At release?** Circle Yes, No, or Unknown.

How much gear (linear feet) was left on turtle when released? Estimate or measure the amount of gear line left on turtle when released. Record a zero if all line is removed.

HOOK LOCATION GUIDE

Internal:

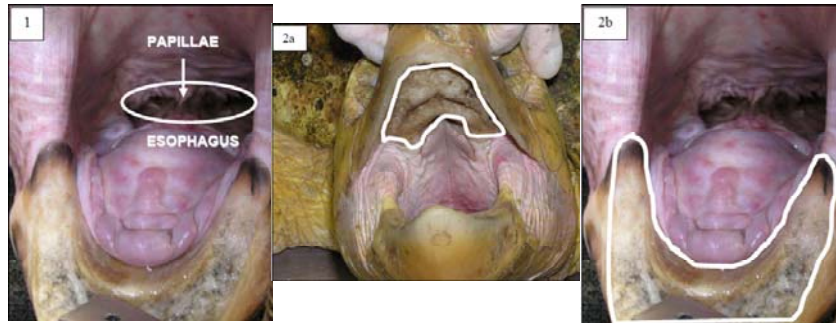

1) Swallowed = inside the esophagus, the entrance marked by the presence of papillae. Indicate whether hook is visible to insertion point, partially visible, or not visible.

2) Internal Beak - hard keratinized rhamphotheca – hardshell turtles only. a) Upper or b) Lower

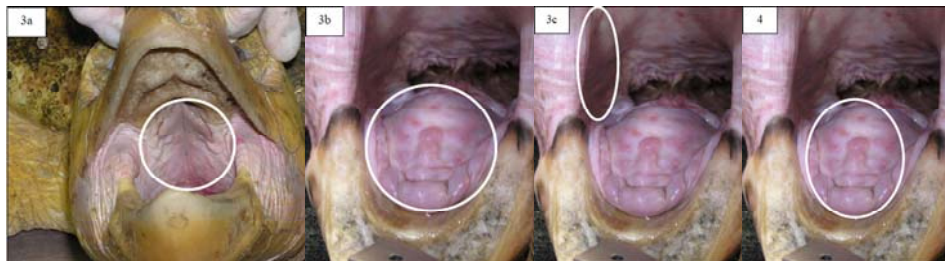

3) Mouth, a) Upper - should generally be coded as roof of mouth, b) Lower - may be tongue, glottis, or other if under or beside the tongue, c) Side - could be jaw joint or other. 4) Tongue

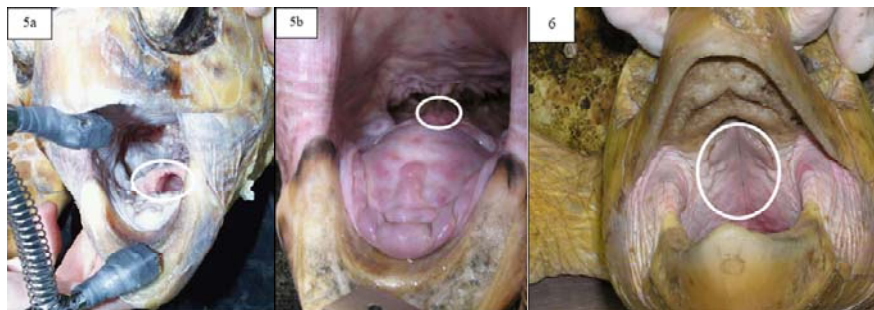

5) Glottis a) Open b) Closed, 6) Roof of Mouth

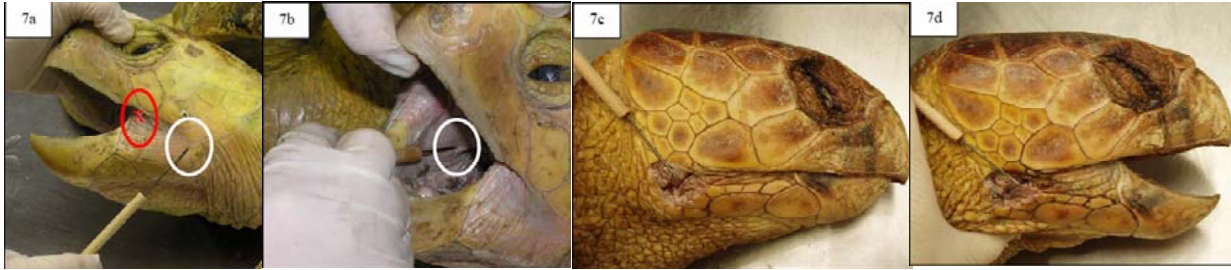

7) Jaw Joint a) external, b) internal, c) dissection depicting jaw joint with jaw closed, and d) dissection with jaw open. Note: this is **not** the corner of the mouth, depicted in Figure 7a by the **red** circle (which shows the “corner of the mouth”). To understand the difference, locate your own jaw joint (just in front of the ear) and notice its position relative to the corner of your mouth (where upper and lower lips meet).

8) Other = any area not otherwise described here. For example, “mouth, lower, other” might be below the tongue in the soft tissue. “Mouth, side, other” could be the “corner of the mouth” in the soft tissue connecting the jaws in front of the jaw joint. Describe in further detail in comments if possible.

External Hardshell: 1) Beak, 2) Head, 3) Neck, 4) Carapace, 5) Front Flipper, 6) Shoulder, 7) Rear Flipper

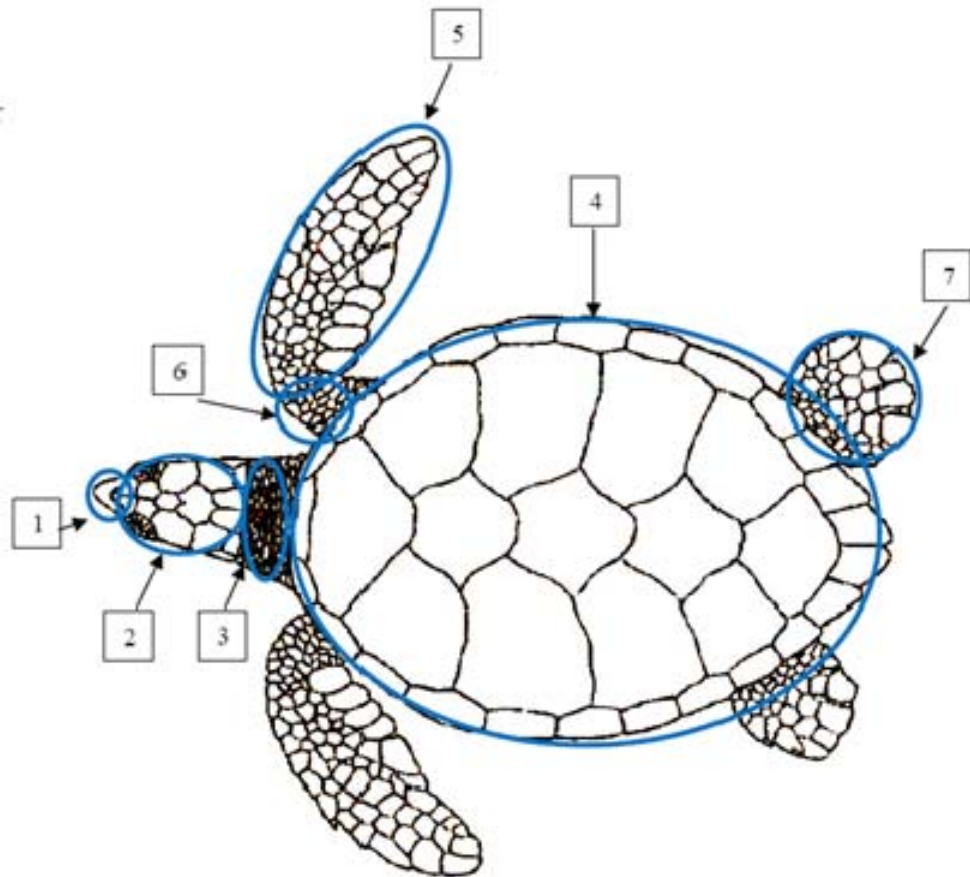

External Hardshell:

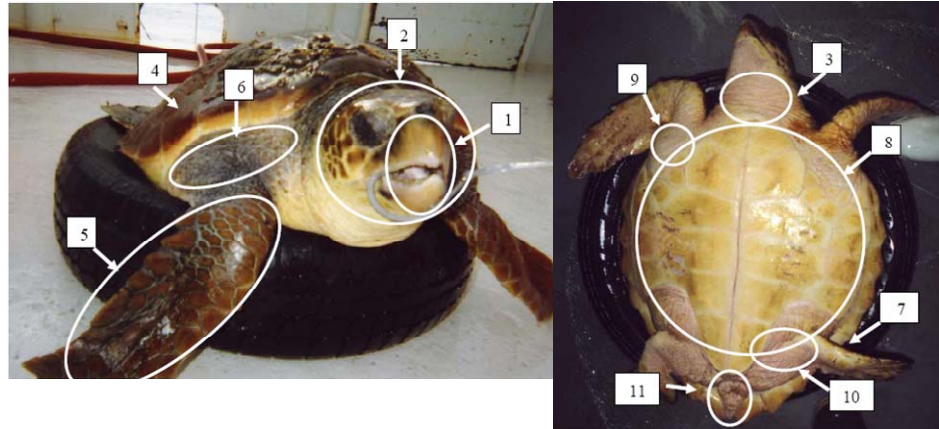

1) Beak (hard keratinized rhamphotheca, either upper or lower, never side), 2) Head, 3) Neck (dorsal and ventral surface), 4) Carapace, 5) Front Flipper, 6) Shoulder, 7) Rear Flipper, 8) Plastron, 9) armpit (ventral side and trailing edge of front flipper), 10) Groin, 11) Tail

External Leatherback:

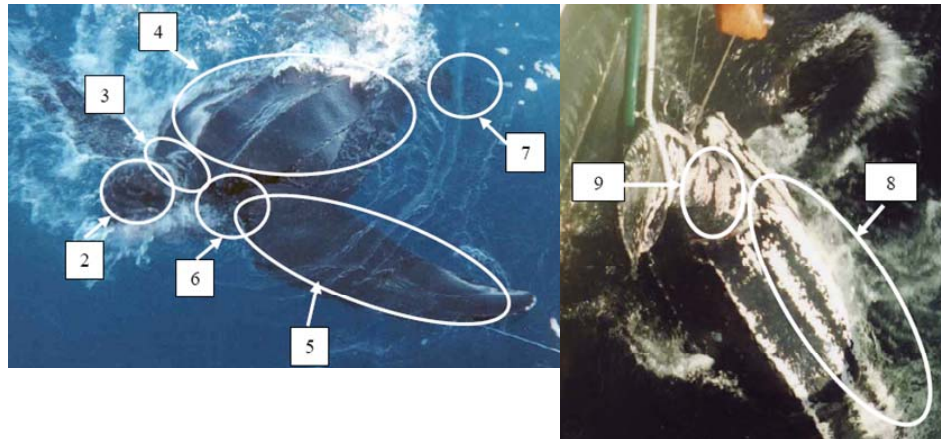

1) Beak (Leatherbacks do not have rhamphotheca and should never be coded as hooked in the beak), 2) Head, 3) Neck (dorsal and ventral), 4) Carapace, 5) Front Flipper, 6) Shoulder (dorsal surface and leading edge between front flipper and neck), 7) Rear Flipper, 8) Plastron, 9) Armpit (ventral surface and trailing edge between front flipper and plastron) and trailing edge of front flipper), 10) Groin.

SECTION 4 - Biological Information

Be as detailed as possible, take measurements whenever possible, apply tags, scan for existing tags and take biopsies whenever possible. This is vital for possible recapture studies in the future.

Trip No.: Enter Trip Number provided by Observer Coordinator.

Set/Tow: Record the set or tow number of the trip.

Specimen Number: Reference specimen number given on pervious page.

Estimated Carapace Length (ft): Measurement must be estimated if turtle is not boarded or is a sighted turtle. **Note the unit of measurement is feet.

DIMENSIONS: Record carapace measurements in centimeters (cm), use a tape measure for curved and calipers for straight. Measurements over-the-curve, follow the curvature of the carapace. If barnacles affect these measurements, record the details in the comment section. Only curved measurements are taken on leatherbacks.

Carapace Length, curved, notch-to-tip (standard): The distance between the center of the nuchal scute and the end of the longest postcentral scute, following the curvature of the dorsal center line. On leatherbacks the measurement is taken alongside (not over the top) of the vertebral (center) ridge.

Carapace Length, straight, notch-to-tip (standard): The distance between the center of the nuchal scute and the end of the longest postcentral scute.

Carapace Width, curved: The distance between the lateral edges of the carapace, measured over the curvature of the shell, perpendicular to the centerline of the carapace, at the widest point. On leatherbacks the width is measured from side ridge to side ridge at the widest point.

Carapace Width, straight: The maximum distance between the lateral edges of the carapace.

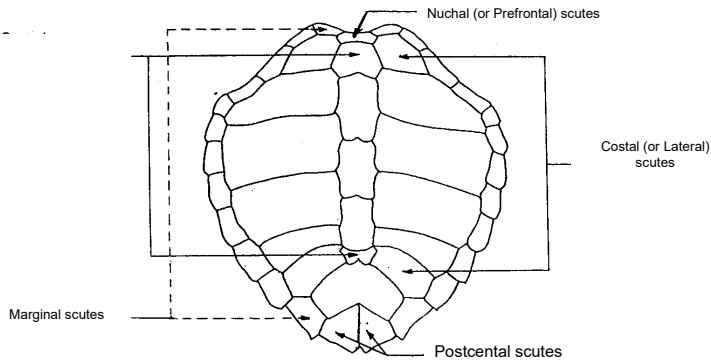

Carapace of an olive ridley turtle (*Lepidochelys olivacea*) (Surinam specimen, scaled drawing by S. Handigman)

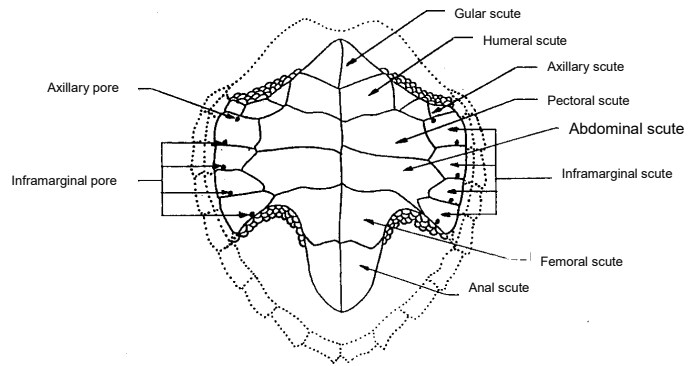

Plastron of an olive ridley turtle (*Lepidochelys olivacea*) (Surinam specimen, scaled drawing by S. Handigman)

TAGS

Look for existing tags. Metal or plastic tags may be found externally on any of the four flippers. If no rear metal flipper tags are present, apply 2 inconel tags, one to each rear flipper. Living tags, created by surgically removing a small piece of the plastron and implanting it in the carapace, may appear in any of the lateral scutes, mainly on Kemp's Ridley turtles. In addition, there may be two types of internal tags (wire and PIT) placed in the shoulders or front flippers. You will apply a PIT (Passive Integrated Transponder) tag if one is not present (location varies by species). Generally, all turtles over 30 cm straight carapace length (SCL) should be flipper and

PIT tagged if not already carrying tags. Turtles less than 20cm SCL should only get PIT tagged. If the turtle measures between 20 and 30cm SCL then it is up to the observer to use their best judgment to determine if flipper tagging is appropriate.

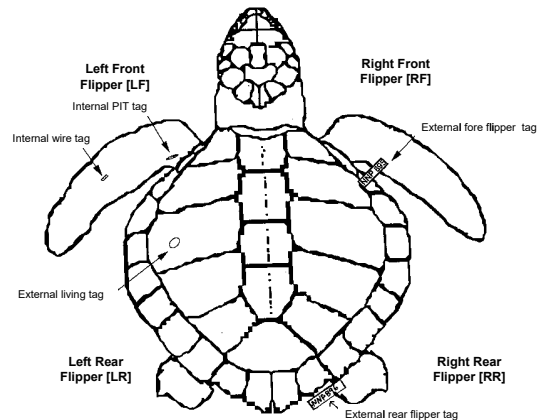

Flipper Tag Number: Record the number of the tag already present or which is being applied. If the tag is already present record the return address of the tag in the comments section. If no tags are on the turtle and none are being applied, leave blank.

Tag Type: Metal [1] or Plastic [2]: Identify the type of tag appearing on or to be applied to the turtle. If no tags are on the turtle and none are being applied, leave blank.

Position: The tag may be on any of the four flippers. Observers should apply two tags, one to each rear flipper, if none already are present at that location. Record the location of the tag. If no tags are on the turtle and none are being applied, leave blank.

Already Present [1] or Applied by Observer [2]: Indicate whether the tag was already present or whether it is being applied by the observer. If no tags are on the turtle and none are being applied, leave blank.

Were Tags Removed: Circle Yes or No. Preexisting tags that are hard to read or about to fall off should be removed. If the tag is removed from the rear flippers it should be replaced with a new one. The old tags should be collected and given to the Observer Coordinator with the trip. If the existing tags are in good condition, then leave them in place. If no tags are on the turtle, leave blank.

PIT Tag: Scan the flippers, shoulders and arm pit area with the PIT tag scanner. If the turtle has a preexisting tag record the tag number and "Position", then mark the form "Already present (1)" and circle "Yes" for scanned. If there is no PIT tag present in either of the front flippers, inject a PIT tag into the left front flipper, record the PIT tag number and attach the PIT tag sticker to the data sheet. Then mark the form as follows: "position" LF, applied by Observer (2) and circle "Yes" for scanned. If no PIT tags are on the turtle and none are applied, leave blank.

Scanned: Circle Yes or No, indicating if you scanned the flipper, shoulder and armpit area prior to and after application.

Living Tag: Indicate if living tags are present. Record details, including position, in the comments section. Photograph the mark.

Other Tags: Indicate whether any other types of tags, such as satellite tags, were present or were attached. Record the tag number here if it has one. Record details, including position, in the comments section. Photograph the tag.

Biopsy Samples Taken? Circle Yes, No, or Unsuccessful. Biopsy samples for genetic analysis should be taken from all turtles, with the exception of Kemp's Rيدleys. Biopsy samples are not required for Kemp's Ridley turtle unless there is a question regarding identification. List all samples taken in the comments section. **If you are importing biopsy samples from the high seas (outside the U.S. EEZ), you must have a copy of the CITES permit and complete a USFWS 3-177 form listing all samples imported for that trip.**

Did Observer assist in dehooking, resuscitation, etc.: Circle Yes or No to indicate the observer assisted, then circle dehooking or resuscitation to indicate what the observer assisted with (dehooking, resuscitation or both). ****Note:** Providing instructional advice is not considered assisting.

RELEASE INFORMATION

Latitude/Longitude, Time and Date is **NOT** always the same information referenced for time of capture. Be as detailed as possible.

Latitude: Record the degrees, minutes and seconds of latitude at the time of release.

Longitude: Record the degrees, minutes and seconds of longitude at the time of release.

Time: Enter in military time (0001-2359) when turtle was released.

Date: Enter month, day and year when turtle was released.

Final Disposition: Record the final disposition (fate) of the turtle at time of release by checking the appropriate box.

Discarded Marked Dead/Unresponsive Carcass: All carcasses returned to sea should be spray painted or otherwise marked.

Discarded Unmarked Dead/Unresponsive Carcass: Carcass returned to sea unmarked.

Salvaged Carcass/Parts (explain): Indicate whether the carcass or parts of the carcass were salvaged (note: this does not include biopsy samples from live turtle), record in the

comments section what was salvaged and where it was taken. **A current CITES permit is required with animals or parts taken in the high seas (outside the U.S. EEZ).**

Released Alive

Taken to Holding Facility

Unknown (explain)

Additional Comments: Use this area to record any and all comments. Annotate the drawing to indicate any anomalies, location of living tags, etc. Be sure to list all biological samples collected. If resuscitation was attempted, record details (length of time resuscitation was attempted, method(s) used, etc.). Describe the interaction with as much detail as possible. For shrimp trips, after a turtle capture, re-measure the space between the TED bars and record the measurement and date in the comments section.

IDENTIFICATION CRITERIA

Left Lateral Scutes: Record number of lateral (costal) scutes on left side of carapace.

Right Lateral Scutes: Record number of lateral (costal) scutes on right side of carapace.

Vertebral Scutes: Record number of vertebral scutes on midline of carapace.

Left Inframarginal Scutes: Record number of scutes on left side of plastron.

Right Inframarginal Scutes: Record number of scutes on right side of the plastron.

Overlapping Scutes: Are there overlapping scutes on dorsal surface? Circle Y, N, or Unknown.

Inframarginal Pores: Are there pores on ventral inframarginal scutes? Circle Y, N, or Unknown.

1 Pair Prefrontal Scales: Does turtle have one pair of prefrontal scales? Circle Y, N, or Unknown.

Lacks Bony Shell: Does turtle lack a bony shell? Circle Y or N.

Nuchal scute: Does first nuchal scute touch first lateral scute? Circle Y, N, or Unknown.

Rigor Mortis: Yes, No or Unknown

Rotting Flesh: Yes, No or Unknown

Foul Smell: Yes, No or Unknown

Dorsal Coloration: Check the most appropriate box to describe coloration of turtle or check other and describe.

INJURIES: Mark location of injuries on Diagram and Describe:

Fractures of Shell: Yes, No or Unknown

% width of scute: Reference % value

Skull or mandibular fracture: Yes, No or Unknown

Injuries to eye(s): Yes, No or Unknown

Bleeding from (check all that apply): Unknown, Cloaca, Nares, Eyes, and/or Oral Cavity.

Behavior (check all that apply, check for Yes blank for No): Questions should be answered at capture (describes behavior at time of capture) as well as at release/in water (describes behavior after turtle is returned to the water).

Vigorously crawls

Actively responds if handled

No movement/response if handled

Lifting head to breathe

Moving all flippers

Eyes open

Tilting head

Moving sluggish/slow/lethargic/weak

Head/flippers hang limp

Circling

Water/froth discharge from mouth/nares

Immediately swims/dives (<1 min)

Listing rolling in water

Inability to right self in water

Stays at surface/no diving _____ min.

Sinks without swimming

Not Observed (explain)

Condition Evaluation for Turtles Not Coded "Alive": Mark each line on the turtle diagram with a "Y" to indicate positive reflex/responsiveness for all turtles coded fresh dead/comatose/unresponsive. Where there is no response, mark the line with an "N". Mark all seven lines.

To check for a response, stimulate each of the general areas marked with lines on the diagram. To test eye reflexes, check for a blink response by gently touching the skin around each eye. Position yourself so that you can see both eyes at the same time. Stimulate the front and rear flippers and the tail with a firm pinch. If there is a positive response, note whether or not it was limited to the stimulated area or if it evoked a larger response. If reflex tests are performed more than once, record all results (example: N/Y).

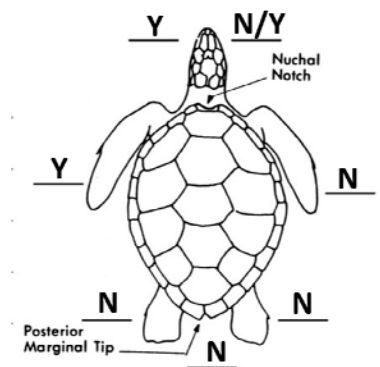

Sea Turtle Resuscitation Guidelines

If a turtle appears to be unconscious or comatose, attempt to revive it before release. Turtles can withstand lengthy periods without breathing; a living comatose sea turtle may not move, breathe voluntarily, or show reflex responses or other signs of life. In other cases, a lightly comatose turtle may show shallow breathing or reflexes such as eyelid or tail movement when touched. Use the following method of resuscitation in the field if veterinary attention is not immediately available:

- Place the turtle on its plastron (lower shell) and elevate the hindquarters approximately 15 - 30 degrees to permit the lungs to drain off water for a period of 4 up to 24 hours. A board, tire or boat cushion, etc. can be used for elevation.
- Periodically, rock the turtle gently left to right and right to left by holding the outer edge of the carapace and lifting one side about 3 inches, then alternate to the other side.
- Keep the turtle in the shade, at a temperature similar to water temperature at capture. Keep the skin (especially the eyes) moist while the turtle is on deck by covering the animal's body with a wet towel, periodically spraying it with water, or by applying petroleum jelly to its skin and carapace. Do not put the turtle into a container with water.
- Do not put the turtle on its carapace (top shell) and pump the plastron (breastplate) or try to compress the turtle to force water out, as this is dangerous to the turtle and may do more harm than good.
- Periodically, gently touch the corner of the eye or eyelid and pinch the tail near the vent (reflex tests) to monitor consciousness.
- Sea turtles may take some time to revive; do not give up too quickly. Turtles that are successfully resuscitated benefit from being held on deck as long as possible (up to 24 hours) to fully recover from the stress of accidental forced submergence.
- Release successfully resuscitated turtles over the stern of the boat, when fishing or scientific collection gear is not in use, the engine is in neutral, and in areas where they are unlikely to be recaptured or injured by vessels. A turtle that has shown no sign of life after 24 hours on deck may be considered dead and returned to the water in the same manner.



NMFS/SEFSC Photos



References:

Federal Register, December 31, 2001. Government Printing Office, Washington DC 66 (250), pp. 67495-67496.

July 2009

PROTECTED RESOURCES CAPTURE REPORT - SAWFISH, STURGEON GIANT MANTA RAY and BIRDS

Write legibly in both the log book and on the forms themselves. **COPIES** of the protected resources capture report and photos are to be mailed to the Galveston Laboratory as soon as possible after the vessel reaches port (Original Forms are to be kept with the trip at all times!!!). **DO NOT MAIL FORMS, PHOTOS, AND BIOPSIES DIRECTLY TO THE MIAMI LABORATORY.**

It is pertinent that all information collected on the protected resources capture report is as **accurate** and **detailed** as possible. **Detailed information should also be logged in your log books.** We are unable to verify questionable information on the forms if we have nothing to compare it to.

The protected resources capture form is to be used to log the capture and sighting of **SAWFISH, STURGEON GIANT MANTA RAY and BIRDS.** Photographs should be taken of all captures if possible. If the information does not apply to your trip, for example hook information on a shrimp trip, the section should be left blank. It is very important to complete the form in its entirety.

Trip No.: Enter Trip Number provided by Observer Coordinator.

Date: Enter month day and year when captured occurred.

Set/Tow: Record the set or tow number during the trip when capture occurred. If the capture was not associated (non-station) with a set or tow, then enter 999.

Station/Non-Station: Check station if the specimen was captured during a sampled set or tow. All others should be considered non-station.

Captured/Sighted: Captured should always be checked as information is only collected for captures.

Specimen Number: Record a three-digit consecutive number for captured specimens. Specimen numbers begin with 001 and continue sequentially throughout the trip.

Species Identification: Place a check in the appropriate box next to the specimen captured and reference the species (if known) in the space provided. If you are unable to identify the species record it on the data sheet as "Unknown".

Vessel Code: Enter Vessel Code provided by Observer Coordinator.

Observer: Enter Observer Code provided by Observer Coordinator.

State: Enter the state that you were closest to when capture occurred.

Time: Enter in military time (0001-2359) when capture occurred.

Water Depth: Record the water depth in feet.

Photographed (circle one): Y or N. **Number of Photos Taken?** Record the number of photos taken. Always photograph the specimen if possible. Take at least one picture illustrating the location of gear attachment. This should never be left blank; it is asking for quantity. So if no photos were taken you should place a zero in the boxes provided.

Latitude: Record the degrees, minutes and seconds of latitude at the time of capture.

Longitude: Record the degrees, minutes and seconds of longitude at the time of capture.

Target Species: List all species being targeted for the set in genus species format. Enter the first seven characters of the genus name and the first 6 characters of the species name (refer to the Species List), **do not reference common names.**

Gear Type: Indicate which gear is being fished. If gear is something other than the listed types, write the gear type in the comments section.

Gear Depth: Indicate whether the gear was being fished at the surface, mid-water, on the bottom, whole water column, or other. If other, reference the depth in the comment section.

Net Position: Enter net position at time of capture. For captures in a try net or non-station captures enter 9 (default code).

Net Type Animal Captured In: Check the appropriate answer to describe the type of net specimen was captured in.

Net Modifications: Check the appropriate answer to explain all net modifications present.

Gillnet Net Material: Reference in the comments section. Monofilament or multifilament gillnet gear.

Stretched Mesh size: Record in inches.

Twine size: Record the twine size used in the net. This information can be obtained from the Captain.

Net Length: Record the gillnet length in feet.

Net Depth: Record the gillnet depth in feet.

Hook Type: Check "J" or Circle. If hook type is neither, select Other (describe).

Hook Size: Write in size of hook, (e.g., 9/0, 18/0).

Manufacturer/Style No.: Write in the manufacturer and style number (e.g., Mustad #39968D).

Degree Offset: Write in the degree offset of hook (e.g., 0°, 5°, 10°).

Bait: Check all that apply: Squid, Mackerel, Sardine, Unknown or Other (describe). Enter the size of bait used.

Was hook removed from this animal? Circle Yes, No, Unknown, or Not Applicable. If specimen was 'Not Hooked', or 'Not known if hooked' then mark 'Not Applicable'. This question should also be answered, for shrimp trips please circle "Not Applicable".

Was animal entangled in gear at capture? These should always be answered. Circle Yes, No, or Unknown. **At release?** Circle Yes, No, or Unknown.

How much gear (linear feet) was left on the animal when released? Estimate or measure the amount of gear line left on specimen when released. Record a zero if all line is removed.

BIOLOGICAL INFORMATION

Estimated total length: Record in Feet.

Estimated length of rostrum (saw): Record length of saw in Feet (for sawfish only).

If the animal is boated:

Sex: Circle Male, Female or Unknown

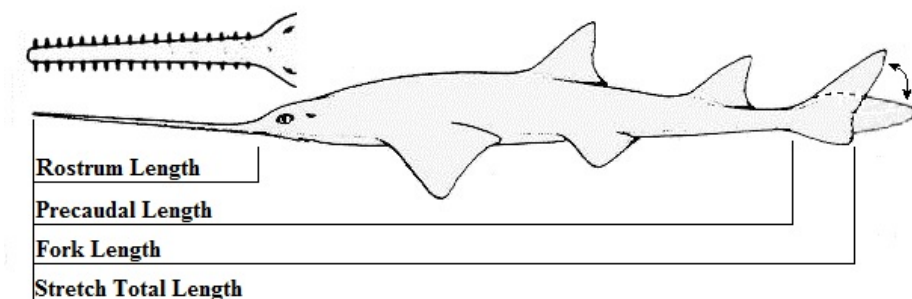

Precaudal Length: Record straight line measurement in cm.

Fork Length: Record straight line measurement in cm.

Stretch Total Length: Stretching the caudal fin down to the vertical (see diagram), record straight line measurement in cm. **For birds,** record total wingspan (fully spread).

Rostrum Length: Record straight line measurement in cm (for sawfish only).

Rostral teeth: Count and record the number of teeth on either side of the saw (for sawfish only).

Estimated Disc Width (ft.): Giant Manta Ray Only. Record estimated disc width in feet.

TAG ID NUMBERS

Was this animal PIT scanned? Circle Yes or No and if a PIT tag is found, record the number in the boxes provided. **Note:** PIT tags in sawfish and sturgeon are usually inserted at the base of the first dorsal fin. Sturgeon may actually have two PIT tags.

There is space provided for 2 tags. Record the tag number and color. Note the location of the tag. If there is a tag in both fins record both numbers and colors. Additional information can be added below in the comments section. **Do not reference any tags that you have applied to the animal in this section.**

RELEASE INFORMATION

Latitude/Longitude, Time and Date is **NOT** always the same information referenced for time of capture. Be as detailed as possible.

Time: Enter in military time (0001-2359) when specimen was released.

Date: Enter month, day and year when specimen was released.

Latitude: Record the degrees, minutes and seconds of latitude at the time of release.

Longitude: Record the degrees, minutes and seconds of longitude at the time of release.

Final Disposition: Record the final disposition (fate) of the specimen at time of release by checking the appropriate box.

Discarded Dead/Unresponsive Carcass

Released Alive

Unknown (explain)

Biological Samples: Check the appropriate boxes for any samples that you take from the animal.

Additional Comments: Use this area to record any and all comments. Describe the interaction with as much detail as possible. Record information on any tags that you apply to the animal (you may be issued spaghetti or PAT (satellite) tags). **DO NOT PIT TAG STURGEON OR SAWFISH, JUST SCAN FOR EXISTING TAGS!!!!**

OBSERVER SAMPLING PROTOCOL FOR SAWFISH

IF BOATED ALIVE:

1. Secure the rostrum with help from the crew. Live sawfish are **DANGEROUS**
2. Scan for PIT tags
 - Around the base of the dorsal fins
3. Check for external tags
 - Around the base of the dorsal fins
4. Take a precaudal length, a fork length, stretched total length and rostrum length measurement in cm
 - Straight line measurements
5. Count the rostral teeth on either side of the saw
6. Check the sex of the sawfish
7. Remove small (0.5 cm) portion of caudal or anal fin for genetic sample
 - Store in a plastic bag, on ice or frozen if possible
 - Can be stored in ethanol
8. Tag with spaghetti and PAT (satellite) tags when available
9. Release sawfish with vessel out of gear

IF BOATED DEAD:

1. Scan for PIT tags
 - Around the base of the dorsal fins
2. Check for external tags
 - Around the base of the dorsal fins
3. Take a precaudal length, a fork length, stretched total length and rostrum length measurement in cm
 - Straight line measurements
4. Count the rostral teeth on either side of the saw
5. Check the sex of the sawfish
6. Remove small (0.5 cm) portion of caudal or anal fin for genetic sample
 - Store in a plastic bag, on ice or frozen if possible
 - Can be stored in ethanol
7. Remove gonads, stomach, vertebrae (about 6-10 inches), the rostrum and all fins
 - Store in plastic bag, on ice or frozen
8. Discard the remaining carcass

SEND ALL SAMPLES TO:

John Carlson
NMFS SEFSC Panama City Laboratory
3500 Delwood Beach Dr.
Panama City, FL 32408

OBSERVER SAMPLING PROTOCOL FOR ATLANTIC AND GULF STURGEON

IF CAPTURED ALIVE:

1. Scan for PIT tags
 - Under dorsal fin, both sides
2. Check for external tags
 - Under side of pectoral fins
3. Take a fork length (FL) measurement in cm
 - Indicate whether measurement is straight line or curved
4. Remove small (0.5 cm) portion of caudal or anal fin for genetic sample
 - Store in a plastic bag, on ice or frozen if possible
 - Can be stored in ethanol
5. Remove 2 cm portion of 2nd marginal fin ray from left pectoral fin (see protocol)
 - Store dry in plastic bag or envelope

IF CAPTURED DEAD:

1. Scan for PIT tags
 - Under dorsal fin, both sides
2. Check for external tags
 - Under side of pectoral fins
3. Take a fork length (FL) measurement in cm
 - Indicate whether measurement is straight line or curved
4. Remove pectoral fin
 - Store dry in plastic bag or envelope
5. Remove gonads
 - Store in plastic bag, on ice or frozen

SEND ALL SAMPLES TO:

Ivy Baremore
NMFS SEFSC Panama City Laboratory
3500 Delwood Beach Dr.
Panama City, FL 32408

Removal of the second marginal fin ray from the pectoral fin of Atlantic and Gulf sturgeon:

Tools:

Scalpel w/ size 10 blade

Wire Cutters

Forceps

Protocol for LIVE sturgeon:



With ventral side up, make a 2 cm incision (parallel to the fin ray) between the 2nd marginal fin ray and the “spine” or 1st marginal fin ray of the pectoral fin. This should be done approximately 2 cm from the base of the pectoral fin.

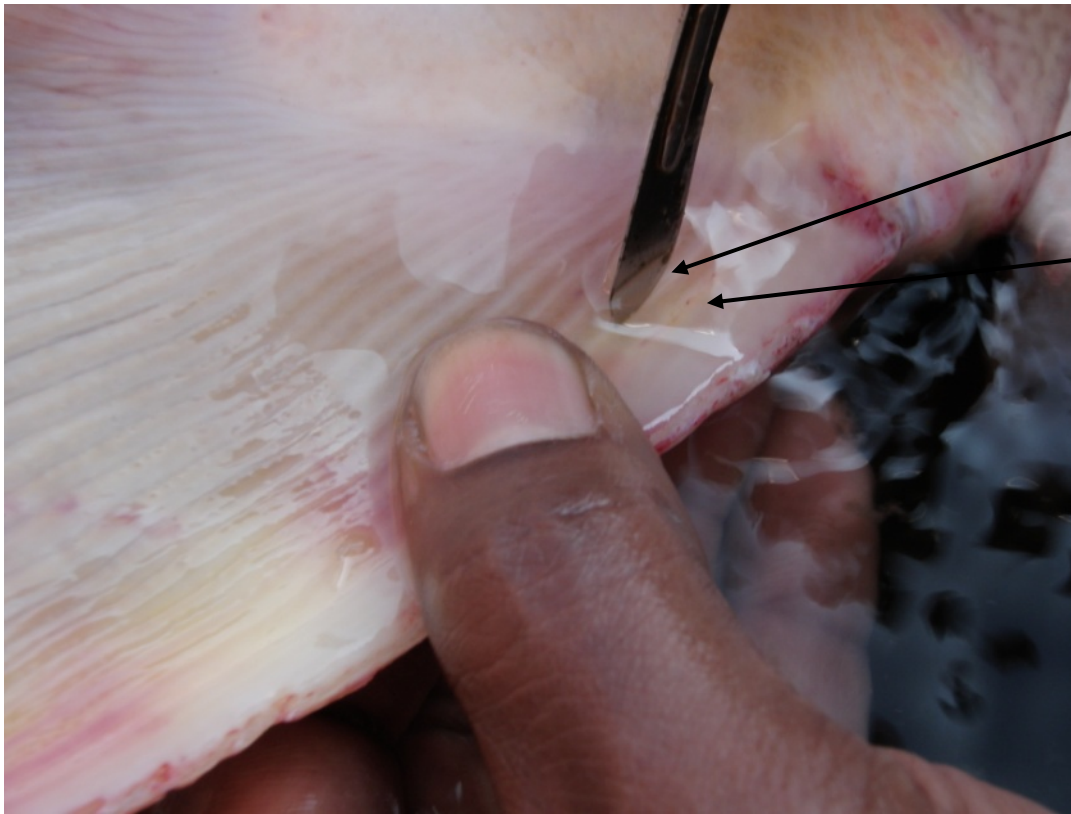

2nd
marginal
fin ray
Spine

Make similar incision between the 2nd and 3rd marginal fin rays.



Use forceps to hold the now separated fin ray, then use wire cutters to snip each end of the cut.



Use forceps to completely remove fin ray. Place in labeled plastic bag and store on ice.



The finished product should look like this, or with even a smaller removal.

PIT Tag Scan for Gulf Sturgeon

DO NOT PIT TAG GULF STURGEON, JUST SCAN FOR EXISTING TAGS!!!!

For the Gulf sturgeon the PIT tags (134 kHz PIT tags) are inserted at the base of the dorsal fin. Note: the standardization to the 134 kHz tag is a recent effort; previously sturgeons were tagged with PIT tags of several different frequencies. In 2011 groups have started inserting 134 kHz PIT tags into all captures and so as a result some fish may be carrying two PIT tags: one will be the new 134 kHz and the other may be an older 125 kHz. Researchers are implementing the new tag on the opposite side of the fish if an existing PIT tag is found. Therefore, you should scan both sides of the base of the dorsal fin.

Also, many fish have spaghetti tags in their pectoral fins. If you come across a spaghetti tag, record the tag number and color. Note which pectoral the spaghetti tag is in, if there is a tag in both fins record both numbers and colors. **Do not remove the tag.**



Mobula Ray Identification Guide For Fisheries Observers

Purpose: This guide is intended to assist fishery observers in the visual identification of the giant manta ray and several devil ray species that occur in the Southeast and Mid-Atlantic.

General Observations: The size, coloring patterns, and a few morphological differences can be used to distinguish between species.

- Giant manta rays are larger than devil rays. Measurements should be taken by estimating the distance over their wingspan [“Disc Width” (DW)].
- Giant manta rays have a terminal mouth (i.e., mouth points straight forward, in front of the head); Devil rays have a sub-terminal mouth (i.e., mouth beneath the head).

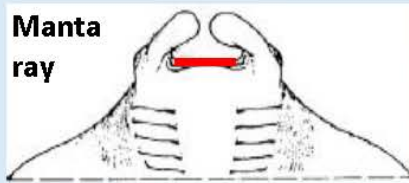
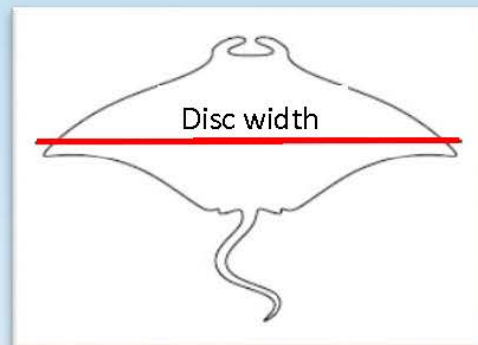

Terminal mouth

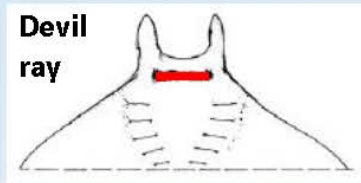

Sub-terminal mouth

Manta birostris

Common Names: Giant Manta Ray, Oceanic Manta Ray

Status: U.S.: Listed as *Threatened* under Endangered Species Act.

Size: Up to 700 cm DW; appx. 200 cm DW at birth.

Dorsal Coloration: Black with distinct white patches creating a T-shaped shoulder pattern.

Ventral Coloration: White with dark spots; spots rarely found between gill slits. Dark shading along the posterior edges of the pectoral fins.



Photo credit: Joshua Stewart

Mobula mobular

Common Names: Giant Devil Ray, Spinetail Devil Ray

Status: U.S.: Not listed. International Union for Conservation of Nature (IUCN): *Endangered*

Size: Up to 520 cm DW

Dorsal Coloration: Predominantly dark gray; with a black (crescent shape) stripe that runs from side to side on upper shoulders. White tip on the dorsal fin.

Ventral Coloration: White.



Mobula tarapacana

Common Names: Chilean Devil Ray, Sicklefin Devil Ray, Box Ray

Status: U.S.: Not listed. IUCN: *Vulnerable*

Size: Up to 340 cm DW

Dorsal Coloration: Golden brown to olive green.

Ventral Coloration: Predominately white with gray shading along the posterior margin of pectoral fins.



Mobula hypostoma

Common Names: Atlantic Devil Ray, Lesser Devil Ray

Status: U.S.: Not listed. IUCN: *Data Deficient*

Size: Up to 120 cm DW

Dorsal Coloration: Variable, brown, gray to black. Sometimes have a dark gray/black stripe that runs from side to side on the "neck" right behind the eyes.

Ventral Coloration: White.



MARINE MAMMAL LIFE HISTORY FORM

Write legibly in both the log book and on the forms themselves. **COPIES** of the marine mammal life history form and photos are to be mailed to the Galveston Laboratory as soon as possible after the vessel reaches port (Original Forms are to be kept with the trip at all times!!!). **DO NOT MAIL FORMS and PHOTOS DIRECTLY TO THE MIAMI LABORATORY.**

It is pertinent that all information collected on the marine mammal life history form is as **accurate** and **detailed** as possible. **Detailed information should also be logged in your log books.** We are unable to verify questionable information on the forms if we have nothing to compare it to.

The marine mammal life history form is to be used to log the capture of all marine mammal species. Photographs should be taken of all captures if possible. If the information does not apply to your trip, for example hook information on a shrimp trip, the section should be left blank. It is very important to complete the form in its entirety.

Trip No.: Enter Trip Number provided by Observer Coordinator.

Date: Enter month day and year when captured occurred.

Set/Tow: Record the set or tow number during the trip when capture occurred. If the capture was not associated (non-station) with a set or tow, then enter 999.

Station/Non-Station: Check station if the specimen was captured during a sampled set or tow. All others should be considered non-station.

Captured/Sighted: Captured should always be checked as information is only collected for captures.

Specimen Number: Record a three-digit consecutive number for captured specimens. Specimen numbers begin with 001 and continue sequentially throughout the trip.

Time: Enter in military time (0001-2359) when capture occurred.

Water Depth (Ft.): Record the depth in feet.

Gear Type: Indicate which gear is being fished. If gear is something other than the listed types, write the gear type in the comments section.

Gear Depth: Indicate whether the gear was being fished at the surface, mid-water, on the bottom, or other. If other, reference the depth in the comment section.

Latitude: Record the degrees, minutes and seconds of latitude at the time of capture.

Longitude: Record the degrees, minutes and seconds of longitude at the time of capture.

Species Identification: Place a check in the appropriate box next to the specimen captured and reference the species (if known) in the space provided. If you are unable to identify the species record it on the data sheet as “Unknown”.

Photographed (circle one): Y or N. **Number of Photos Taken?** Record the number of photos taken. Always photograph the specimen if possible. Take at least one picture illustrating the location of gear attachment. This should never be left blank; it is asking for quantity. So if no photos were taken you should place a zero in the boxes provided.

Diagnostic feature: List all diagnostic features.

Confidence level of species ID: Check the most appropriate Good, Fair, or Poor.

Hook Type: Check “J” or Circle. If hook type is neither, select other (describe).

Hook Size: Write in size of hook, (e.g., 9/0, 18/0).

Manufacturer/Style No.: Write in the manufacturer and style number (e.g., Mustad #39968D).

Degree Offset: Write in the degree offset of hook (e.g., 0°, 5°, 10°).

Bait: Check all that apply: Squid, Mackerel, Sardine, Unknown or Other (describe). Enter the size of bait used.

HOOKING OF MARINE MAMMAL

Was animal hooked? Check yes, no or unknown. If no, skip to next section. If yes, answer the following.

Hook Location

Internal Hook Location: Check general location and circle the specific location, if known.

External: Check general location and circle the specific location, if known.

Was hook removed from this animal: Circle Yes, No, or Unknown. If no, was line cut? Check yes or no. If yes, how much line was left trailing (reference length in feet)?

ENTANGLEMENT OF MARINE MAMMAL

Was animal entangled? Check yes, no or unknown.

Entanglement Location: Check all that apply.

Gear Involved: Check all that apply.

Amount of gear left on animal? Reference the amount in feet.

Were loops cut? Check yes, no, or unknown.

Write a description of the release procedures in space provided.

CONDITION OF MARINE MAMMAL UPON RELEASE

Check the most appropriate option and describe animals' behavior upon release.

PRESENCE OF OTHER MARINE MAMMALS AT TIME OF CAPTURE

Were other marine mammals present at time of capture? Check yes, didn't look, or looked but did not see.

Number of other marine mammals present (record all three): Reference the MIN, MAX and BEST GUESS.

Same species as animal captured? Check yes or no, to reference if the other marine mammal present in the area were the same species as the one captured. If different, reference the other species present.

Approximate distance from vessel (in yards): Reference the approximate distance of the other species in the area.

Describe any actions taken by the other mammals in the area.

NOTE: At this time observer is not required to take biopsies or actively tag marine mammals. This may change in the future; if it does you will receive extra training. **You are required to record existing tags.**

BIOPSY

Were biopsy samples taken? Check yes, no, or unsuccessful. If yes, itemize the samples taken.

TAGS

Tagged before release? Check yes or no. Reference the following: tag number, tag type and the position of the tag.

TAG REPORTING FORM

ORG PRO

MO DY YR

MO DY YR

TRIP NO.

DATE-START TRIP

DATE - END TRIP

LONGLINE

BANDIT

JUG

SPEAR

STARTING TAG NUMBER

ENDING TAG NUMBER

TAG TYPE: _____

GENUS: _____ SPECIES: _____

COMMON NAME: _____

SET NO.	DATE RELEASED			FISH TAG NO.	LAT. RELEASED			LONG. RELEASED			DEPTH (FEET)	FISH LENG. (mm)
	MO.	DAY	YR		DEG	MIN	SEC	DEG	MIN	SEC		
1												
2												
3												
4												
5												
6												
7												
8												
9												
10												
11												
12												
13												
14												
15												
16												
17												
18												
19												
20												
21												
22												
23												
24												
25												
26												
27												
28												
29												
30												

LL/BR/JUG/SF-TAG

TAG REPORTING FORM

Upon completion of a reef fish trip complete the following information relevant to the fish tags used. This information should be obtained from your Station Sheets and Length Frequency/Weight Forms. This form should only to be completed if the fish were tagged by the observer.

Trip No.: Enter Trip Number provided by Observer Coordinator.

Date–Start Trip: Enter the starting date of the trip, month/day/year.

Date–End Trip: Enter the ending date of the trip, month/day/year.

Type of Trip: Check the most appropriate box: Longline, Bandit, Spear fishing

Starting Tag Number: Enter the first tag used during this trip.

Ending Tag Number: Enter the last tag used during this trip.

Tag Type: List the type of tag used.

Genus: List the first 7 letters for the genus.

Species: List the first 6 letters for the species.

Common Name: List the full common name.

Set Number: Enter the set number when tagging occurred.

Date Released: Enter the date that you released the tagged fish.

Fish Tag Number: Enter the tag number used.

Latitude Released: Enter the latitude (deg, min, and sec) where the tagged fish was released.

Longitude Released: Enter the longitude (deg, min, and sec) where the tagged fish was released.

Depth: Enter the bottom depth (ft) at release.

Fish Length: Enter the length of the fish (mm).

SPECIMEN COLLECTION LOG

The Specimen Collection Log is to be completed when specimen(s) are collected for identification purpose or when instructed by a coordinator to do so.

Trip No.: Enter Trip Number provided by Observer Coordinator.

Observer Name: Self-explanatory.

Vessel Name: Self-explanatory.

State Fish & Wildlife Notified: Circle Yes or No.

Official Notified: Reference which official was notified.

Phone #: Reference the phone number of the official notified.

Date Notified: Reference the date notification was made.

Landing Date: Reference the date vessel landed on.

Landing State: Reference the state vessel landed in.

Reason Collected: Reference why specimen(s) were collected.

For each type of specimen collected reference the following information: date, location, the state, common name and total number.

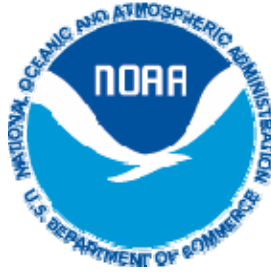

NOAA Fisheries Service Observer Training

Teleost Sampling Request and Procedures

NOAA Fisheries Service
3500 Delwood Beach Road
Panama City, FL 32408

For questions contact:
Galveston Observer Program
Kayla Chapman
Phone: 409-766-3451
Email: kayla.chapman@noaa.gov

Shark Bottom Longline Observer Program
Beth Deacy or Alyssa Mathers
Phone: 850-234-6541 ext. 260, 226
Email: bethany.deacy@noaa.gov or alyssa.mathers@noaa.gov

written by Linda Lombardi and revised April 23, 2019

Common Species List

Includes common, scientific name, IFQ group, abbreviated Genus Species, species abbreviation and NMFS standard numeric species code.

Common Name	Scientific Name	IFQ group	GenSp	Sp. Abbr	Code
GAG GROUPER	<i>Mycteroperca microlepis</i>	GAG	MYCTEROMICROL	GAG	1423
RED GROUPER	<i>Epinephelus morio</i>	RED GROUPER	EPINEPHMORIO	RGR	1416
BLACK GROUPER	<i>Mycteroperca bonaci</i>	SWG	MYCTEROBONACI	BLG	1422
SCAMP GROUPER	<i>Mycteroperca phenax</i>	SWG	MYCTEROPHENAX	CGR	1424
YELLOWEDGE GROUPER	<i>Epinephelus flavolimbatus</i>	DWG	EPINEPHFLAVOL	YEG	1415
GRAY SNAPPER	<i>Lutjanus griseus</i>		LUTJANUGRISEU	SNG	3762
LANE SNAPPER	<i>Lutjanus synagris</i>		LUTJANUSYNAGR	LUL	3761
MUTTON SNAPPER	<i>Lutjanus analis</i>		LUTJANUANALIS	MSN	3763
RED SNAPPER	<i>Lutjanus campechanus</i>	RED SNAPPER	LUTJANUCAMPEC	RSN	3764
VERMILION SNAPPER	<i>Rhomboplites aurorubens</i>		RHOMBOPAUORU	SNV	3765
YELLOWTAIL SNAPPER	<i>Ocyurus chrysurus</i>		OCYURUSCHRYSU	YTS	3767
TILEFISH (Golden)	<i>Lopholatilus chamaeleonticeps</i>	TILEFISH	LOPHOLACHAMAE	TIL	4470
GREATER AMBERJACK	<i>Seriola dumerili</i>		SERIODADUMERI	GAJ	1812
RED PORGY	<i>Pagrus</i>		PAGRUSPAGRUS	PRD	3300
GRAY TRIGGERFISH	<i>Balistes capriscus</i>		BALISTECAPRIS	TRG	0106
KING MACKEREL	<i>Scomberomorus cavalla</i>		SCOMBERCAVALL	KGM	1940
SPANISH MACKEREL	<i>Scomberomorus maculatus</i>		SCOMBERMACULA	SMK	3840

In order to collect complete information for each fish, please collect the otolith (or dorsal spine for Gray Triggerfish) and a gonad sample. (IFQ – Individual Fishing Quota, SWG – shallow-water grouper, DWG – deep-water grouper)

Lesser Known Species List

Includes common, scientific name, IFQ group, abbreviated Genus Species, species abbreviation and NMFS standard numeric species code.

Common Name	Scientific Name	IFQ group	GenSp	Sp. Abbr	NMFS Code
YELLOWFIN GROUPER	<i>Mycteroperca venenosa</i>	SWG	MYCTEROVENENO	YFG	1426
YELLOWMOUTH GROUPER	<i>Mycteroperca interstitialis</i>	SWG	MYCTEROINTERS	YMG	1425
ROCK HIND	<i>Epinephelus adscensionis</i>	SWG	EPINEPHADSCEN	RHI	1412
RED HIND	<i>Epinephelus guttatus</i>	SWG	EPINEPHGUTTAT	REH	1423
SNOWY GROUPER	<i>Epinephelus niveatus</i>	DWG	EPINEPHNIVEAT	OGR	1414
WARSAW GROUPER	<i>Epinephelus nigritus</i>	DWG	EPINEPHNIGRIT	WGR	4740
SPECKLED HIND	<i>Epinephelus drummondhayi</i>	DWG	EPINEPHDRUMMO	SHI	1411
MISTY GROUPER	<i>Epinephelus mystacinus</i>	DWG	EPINEPHMYSTAC	MSG	1420
BLUELINE TILEFISH	<i>Caulolatilus microps</i>	TILEFISH	CAULOLAMICROP	BLT	4474
BLACKLINE TILEFISH	<i>Caulolatilus cyanops</i>	TILEFISH	CAULOLACYANOP	BKT	4476
ANCHOR TILEFISH	<i>Caulolatilus intermedius</i>	TILEFISH	CAULOLAINTERM	ANT	4479
GOLDFACE TILEFISH	<i>Caulolatilus chrysops</i>	TILEFISH	CAULOLACHRYSO	GFT	4472

In order to collect complete information for each fish, please collect both of the sagittal otoliths (except for Speckled Hind) and a gonad sample. (IFQ – Individual Fishing Quota, SWG – shallow-water grouper, DWG – deep-water grouper)

Common and Lesser Known Species Sampling Protocol:

Target a minimum of 5 samples per species per day of the vessel’s targeted reef fish species and a minimum of 5 samples per species per day of the vessel’s non-targeted reef fish species. Both an otolith and a gonad are sampled from the targeted and non-targeted species. Fin Clips do not need to be sampled for each fish.

Trip Length (day)	Targeted species per day	Non-Targeted species per day	Total # Otoliths & Gonads
1	5	5	10
2	5	5	20
3	5	5	30

Scenario 1. Vessel targeting red grouper in February and also catches non-target species of speckled hind, red hind, red porgy and gag but on day 2, only 3 red grouper are caught.

Trip Length (day)	Targeted species per day	Non-Targeted species per day	Total # Otoliths & Gonads	# Fin Clips	
				Target	Non-Target
1	5 red grouper	1 speckled hind, 4 red porgy	10	2 RGR	1 SHI 1 PRD
2	3 red grouper	4 red porgy, 1 red hind, 1 speckled hind, 1 gag	20	2 RGR	1 PRD 1 REH 1 SHI 1 GAG

Scenario 2. Vessel targeting red snapper in August and also catches non-target species of vermilion snapper, lane snapper, and gray triggerfish

Trip Length (day)	Targeted species per day	Non-Targeted species per day	Total # Otoliths & Gonads	# Fin Clips	
				Target	Non-Target
1	5 red snapper	5 vermilion snapper	10	1 RSN	1 SNV
2	5 red snapper	3 gray triggerfish, 2 vermilion snapper	20	1 RSN	3 TRG 1 SNV
3	5 red snapper	4 lane snapper, 1 gray triggerfish	30	1 RSN	2 LUL 1 TRG

Scenario 3. Vessel targeting red snapper in April locates a school of greater amberjack and switches the target species; non-target catch includes lane snapper and Spanish mackerel. On day 3, 7 greater amberjack are caught and no non-targeted species are caught.

Trip Length (day)	Targeted species per day	Non-Targeted species per day	Total # Otoliths & Gonads	# Fin Clips	
				Target	Non-Target
1	5 red snapper	5 lane snapper	10	2 RSN	2 LUL
2	5 greater amberjack	5 Spanish mackerel	20	3 GAJ	3 SMK
3	5 greater amberjack		25	3 GAJ	

Scenario 4. Vessel targeting one species, non-target common species and lesser known species caught.

Trip Length (day)	Targeted species per day	Non-Targeted species per day	Total # Otoliths & Gonads	# Fin Clips	
				Target	Non-Target
1	5 golden tilefish	5 yellowedge grouper	10	1 TIL	1 YEG
2	5 golden tilefish	5 yellowedge grouper	20	1 TIL	1 YEG
3	5 golden tilefish	5 snowy grouper 1 speckled hind 2 warsaw grouper	33	1 TIL	3 OGR 1 SHI 2 WGR

Notes on Sampling

- Maximum of 15 fish per common species sampled for both otoliths and gonads per trip.
- Maximum of 3 fish per species sampled for fin clips per trip.

SPECIES LIST AND REQUESTED SAMPLES

Common Name	Sp Abbr	GenSp	OTOLITHS	GONADS	FIN
GAG GROUPER	GAG	MYCTEROMICROL	Left	Yes	Yes
RED GROUPER	RGR	EPINEPHMORIO	Left	Yes	Yes
BLACK GROUPER	BLG	MYCTEROBONACI	Left	Yes	Yes
YELLOWFIN GROUPER	YFG	MYCTEROVENENO	Both	Yes	Yes
YELLOWMOUTH GROUPER	YMG	MYCTEROINTERS	Both	Yes	Yes
SCAMP GROUPER	CGR	MYCTEROPHENAX	Left	Yes	Yes
ROCK HIND	RHI	EPINEPHADSCEN	Both	Yes	Yes
RED HIND	REH	EPINEPHGUTTAT	Both	Yes	Yes
SNOWY GROUPER	OGR	EPINEPHNIVEAT	Both	Yes	Yes
WARSAW GROUPER	WGR	EPINEPHNIGRIT	Both	Yes	Yes
YELLOWEDGE GROUPER	YEG	EPINEPHFLAVOL	Left	Yes	Yes
SPECKLED HIND	SHI	EPINEPHDRUMMO	Left	Yes	Yes
MISTY GROUPER	MSG	EPINEPHMYSTAC	Both	Yes	Yes
GRAY SNAPPER	SNG	LUTJANUGRISEU	Left	Yes	Yes
LANE SNAPPER	LUL	LUTJANUSYNAGR	Left	Yes	Yes
MUTTON SNAPPER	MSN	LUTJANUANALIS	Left	Yes	Yes
RED SNAPPER	RSN	LUTJANUCAMPEC	Left	Yes	Yes
VERMILION SNAPPER	SNV	RHOMBOPAURORU	Left	Yes	Yes
YELLOWTAIL SNAPPER	YTS	OCYURUSCHRYSU	Left	Yes	Yes
TILEFISH (Golden)	TIL	LOPHOLACHAMAE	Left	Yes	Yes
BLUELINE TILEFISH	BLT	CAULOLAMICROP	Both	Yes	Yes
BLACKLINE TILEFISH	BKT	CAULOLACYANOP	Both	Yes	Yes
ANCHOR TILEFISH	ATL	CAULOLAINTERM	Both	Yes	Yes
GOLDFACE TILEFISH	GFT	CAULOLACHRYSO	Both	Yes	Yes
GREATER AMBERJACK	GAJ	SERIOADUMERI	Left	Yes	Yes
RED PORGY	PRD	PAGRUSPAGRUS	Left	Yes	Yes
GRAY TRIGGERFISH	TRG	BALISTECAPRIS	Doral Spine	Yes	Yes
KING MACKEREL	KGM	SCOMBERCAVALL	Left	Yes	Yes
SPANISH MACKEREL	SMK	SCOMBERMACULA	Left	Yes	Yes

Otoliths (both- left and right sagittal for lesser known species) and gonads should be collected from species. Anal fin clip are collected for genetic tissue.

Note: Maximum of 15 fish per common species sampled for both otoliths and gonads per trip and maximum of 3 fish per species sampled for fin clips per trip.

The species list contains 17 of the most common species and 12 of the lesser known species managed in the Gulf of Mexico. Additionally, there are additional rare species (e.g. graysby grouper, *Epinephelus cruentatus*, cubera snapper, *Lutjanus cyanopterus*) and any samples collected from these species would be highly valuable, since very little is known about their life history.

List of Supplies for Fish Tissue Sampling for Observers

Otolith Collection

- 35 Pre-Stamped Otolith Envelopes
- 10 freezer proof quart Ziploc bags

BUCKET # _____
TOPPER # _____

Gonad Collection

- 1 3.5-gallon Bucket
- 1 100-gram spring scale (rinse with fresh water & lubricate with 3 in 1, daily)
- 35 labeled vials pre-filled with 10% buffered formalin
Grouped in quart sized Ziploc: 5 pre-filled vials with gonad labels Please label Ziplocs with Trip # and Set/Haul #
- Safety Supplies – 5 pairs nitrile gloves, 1 pair safety glasses

Use to group otolith envelopes per set/haul.
Label with OBS/TRIP ID and Set/Haul #.

Fin-clip Collection

- 30 vials pre-filled with DMSO (2 vials per bag, replicate samples per fish)
- Field scissors
- 15 disposable bleach wipes

General Supplies:

- 2 Chisels different sizes – small (1/4"), medium (1/2")
- Small bait knife
- 2 Forceps – pointed, curved
- Species List and Requested Samples laminated page
- 2 – Black Sharpies and 2 – Pencils
- 3 in 1 lubricant
- 1 laminated MSDS sheet and 2 absorbent pads
- 210 barcodes (35 unique numbers, 6 replicates)

Sagittal Otolith Removal Procedures

1. Cut the operculum to fold forward and open it wide towards the anterior end of the fish.

2. Cut away the gill arches at their insertion.

3. Use a chisel to scrape away tissue from the otolith capsule, the capsule will feel like a large knob or protrusion.

4. Open the capsule with a chisel, the large sagittal otoliths can be easily removed with forceps.

5. Rub off any attached membranes from the otolith, rinse with fresh water and pat dry.

6. Place otolith in the provided coin envelope.

7. Gray triggerfish only – do not remove otolith, remove the 1st dorsal spine. Insert a knife at the base of the spine and cut out the whole spine above the knuckle, but close to the knuckle. Rinse, pat dry & store in otolith envelope.

8. Please write the following information on the provided pre-stamped envelopes and place **barcode** on the envelope.

OBS/TRIP ID:

Set/Haul #:

Species Abbreviation: (see attached list)

9. Please store all otoliths in the provided quart Ziploc bags, labeled with:

OBS/TRIP ID

Set/Haul #

10. Assigning specimen numbers.

Galveston Observer Program - Consecutively number all fish from the same trip

SBLOP – each haul Specimen Number starts at #101

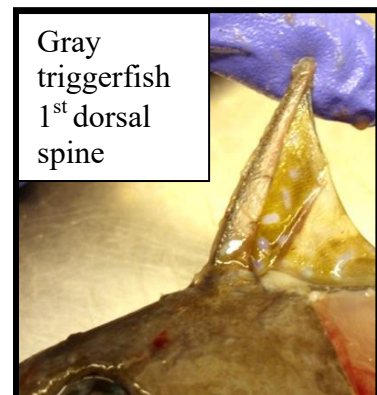
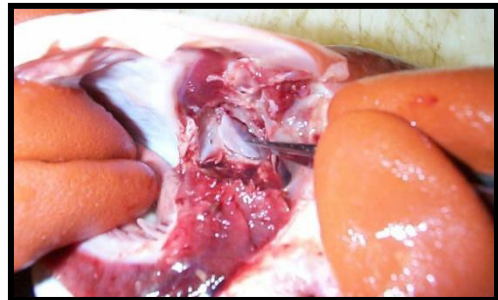
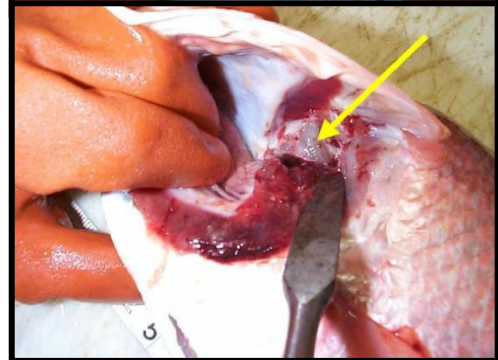

Gonad Removal & Subsampling Procedures

1. Use a sharp knife and insert its tip just inside the anus.

2. Make a shallow cut through the ventral abdomen up to the base of the pelvic fin.

3. The gonad will be the only bi-lobed organ in the abdominal cavity dorsal to the anus, and will be attached to the upper-rear abdominal wall.

4. Grab the two lobes and carefully pull them away from the abdominal wall.

5. Cut the posterior end from the abdominal wall without cutting any of the lobes.

6. If the gonad is small enough to fit in the provided vial, then make a small incision in the gonad and submerge the entire gonad in the prefilled vial.

7. If the gonad is too large (greater than 10g) to fit in the provided vial, weigh the entire gonad. Then use a knife to remove **cross-section** of gonad tissue, with **tunica albuginea intact (casing/wall)**, about the size of a fingertip from the **posterior** part of the gonad. Vials are filled with 10% neutral buffered formalin.

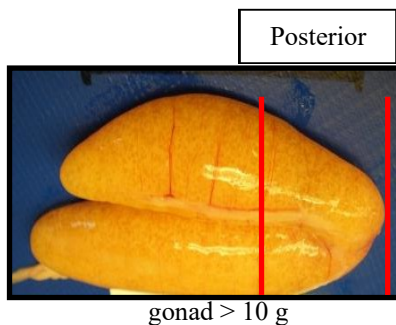
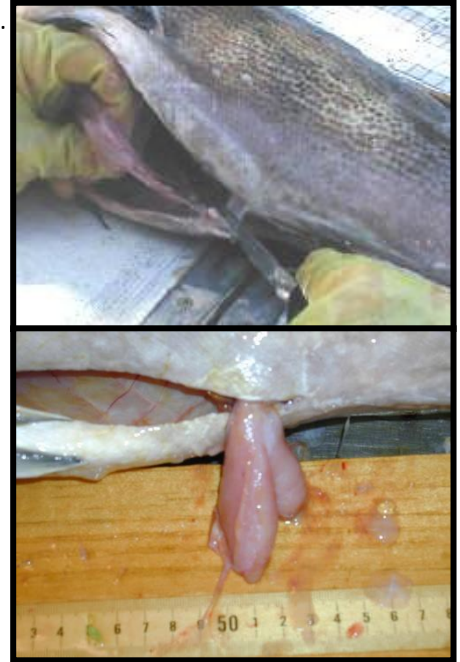

8. Please place the **barcode** on the outside of the vial.

9. Place all gonads samples from a single haul in a Ziploc bag. Write the following information on the Ziploc (use **SHARPIE**):

OBS/TRIP ID: _____

Set/Haul #: _____

Fin-Clip Collection

1. Use scissors to remove about 2cm^2 ($\sim 3/4$ inch²) in size of anal fin or chose a fin that is light in color (not bright yellow, orange or red).
 - a. Please take replicate samples (two vials).
2. Place one fin clip in each vial (pre-filled with DMSO*). Please do not use larger (or more) pieces of tissue as fixation often will be incomplete and the DNA degraded.
3. Cutting equipment needs to be wiped with disposable bleach wipe, followed by water to minimize chances of cross-contamination.
4. Please place the **barcode** on the inside of the small ziplock.

*DMSO solution is saturated with salt. It is non-flammable and non-toxic.

Also, the goal of collection genetic material is to collect samples throughout the Gulf of Mexico. Please only collect genetic material from a maximum of 3 fish of one species, per trip.

Identifying Sex

Both male and female gonads go through morphological changes depending on the stage of reproduction. Male gonads are thin, normally white to pinkish in color and taper to a point whereas, female gonads are oval in shape, appear pink to red in color, and during the peak of spawning small, fully developed oocytes can be seen with the naked eye.

Male

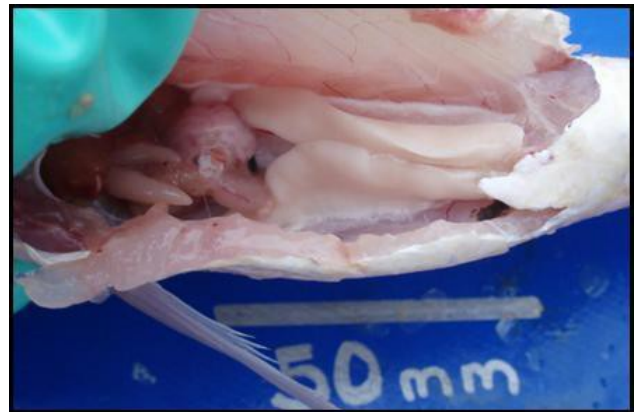

Female



Unknown

For those gonads that you have sampled but cannot distinguish as a male or female.

Barcodes (starting in 2019)

Assist with:

Identify samples per specimen. Reduce transcription errors.

There are 6 barcodes (with the same last 5 digits) for each fish.

Place a barcode on each of the following for the same fish:





1. Gonad/Otolith Form or Samples Taken Form (necessary to revise or use additional form)
2. Otolith Envelope
3. Gonad Vial
4. Fin Clip sample bag (may not be taken for all fish)
5. Extra
6. Extra

Barcodes: Observer Program Initials Year 5 digit sequential number

Galveston Observer Program

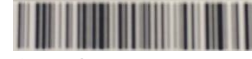
Form	Otolith Envelope	Gonad Vial	Fin Clip
 GOP201900001	 GOP201900001	 GOP201900001	 GOP201900001
 GOP201900002	 GOP201900002	 GOP201900002	 GOP201900002

Shark Bottom Longline Observer Program

Form	Otolith Envelope	Gonad Vial	Fin Clip
 SPAG201900001	 SPAG201900001	 SPAG201900001	 SPAG201900001
 SPAG201900001	 SPAG201900001	 SPAG201900001	 SPAG201900001

The above barcodes are for example only.

GONAD / OTOLITH FORM

NOAA Fisheries Panama City Laboratory - Galveston Observer Program (GOP)

Trip #: _____ Observer Name: _____

Returning Port: _____ State: _____

Trip Comments: _____

Set #	Specimen #	Genus				Species				Length (mm)	Length Code	Gonad Weight (g)	Sex (M-Male, F-Female, U-Unknown)	Target Species (Check for Yes)			Place Sticker Here
		Otolith	Gonad	Fin Clip	Samples Taken (Check for Yes)												
1																	
2																	
3																	
4																	
5																	
6																	
7																	
8																	
9																	
10																	
11																	
12																	
13																	
14																	
15																	

Length Codes 01- Fork 02- Standard 8- Total 88- Not Measured 99- No Data or Unknown

GONAD / OTOLITH FORM

The Gonad/Otolith form is to be completed for catch share trips when you are instructed by a coordinator to do so.

Trip No.: Enter Trip Number provided by Observer Coordinator.

Observer Name: Self-explanatory.

Returning Port: Self-explanatory.

State: Self-explanatory.

Trip Comments: Enter as necessary.

Set Number: Enter the set number the fish was sampled from.

Specimen Number: Specimen number should start at one and go sequentially throughout the trip. A specimen number should never be repeated for a trip.

Genus: List the first 7 letters for the genus.

Species: List the first 6 letters for the species.

Length (mm)/ Length Code: Record the length of fish in **millimeters**. Be sure to measure the fish using the appropriate species specific length measurement code (see appendix 10 and Species List). If the fish is not measurable (mutilated, e.g., tail missing from shark attack) enter 888.88 in the **LENGTH** column and 88 for the **LENGTH CODE**. If no measurement was taken (e.g., thrown overboard) 999.99 in the **LENGTH** column to denote unknown and/or not measured and 99 for the **LENGTH CODE**.

Gonad Weight (g): Enter the weight of the Gonad in grams. Be sure to properly tare your scale.

Sex: Enter M for male, F for Female or U for Unknown.

Target Species: Put a check mark in the space provided if the sampled fish is a target species. If the spot is left blank it will be assumed that the answer is no.

Samples Taken: Put a check mark in the spaces provided if Otolith, Gonad, and or Fin Clip samples were collected. If the spot is left blank it will be assumed that sample was not collected.

Place Sticker Here: Corresponding barcode (all samples from the same fish will have the same barcode number).

SECTION 6

SPECIES LIST

BYCATCH & REEF FISH

GenSp	Scientific	Common	MeasCode	Fishery	
ACANTHOPOLYGO	<i>Acanthostracion polygonius</i>	Cowfish, Honeycomb	18	SH	RF
ACANTHOQUADRI	<i>Acanthostracion quadricornis</i>	Cowfish, Scrawled	18	SH	RF
ACANTHOSOLAND	<i>Acanthocybium solandri</i>	Wahoo	1		RF
ACANTHUCHIRUR	<i>Acanthurus chirurgus</i>	Doctorfish	18		RF
ACHIRUSLINEAT	<i>Achirus lineatus</i>	Sole, Lined	18	SH	RF
ACIPENS	<i>Acipenser</i>	Sturgeon (Genus)	18	SH	RF
ACIPENSXYRHY	<i>Acipenser oxyrhynchus</i>	Sturgeon, Atlantic	18	SH	RF
ACTINIARIA	Actiniaria	Sea Anemone (Order)	10	SH	RF
AETOBATNARINA	<i>Aetobatus narinari</i>	Ray, Spotted Eagle	22	SH	RF
AHLIA EGMONT	<i>Ahlia egmontis</i>	Key Worm Eel	18	SH	RF
ALBULA VULPES	<i>Albula vulpes</i>	Bonefish	1	SH	
ALBUNEAGIBBES	<i>Albunea gibbesii</i>	Purple Surf Crab	6	SH	RF
ALBUNEI	Albuneidae	Mole Crab (Family)	6	SH	
ALCYONIHAUFFI	<i>Alcyonidium hauffi</i>	Rubbery Bryozoan	20	SH	RF
ALECTISCILIAR	<i>Alectis ciliaris</i>	Pompano, African	1	SH	RF
ALOPIASVULPIN	<i>Alopias vulpinus</i>	Shark, Common Thresher	18		RF
ALOSA	<i>Alosa</i>	Herring (Genus)	1	SH	RF
ALOSA AESTIV	<i>Alosa aestivalis</i>	Herring, Blueback	1	SH	RF
ALOSA CHRYSO	<i>Alosa chrysochloris</i>	Herring, Skipjack	1	SH	RF
ALOSA MEDIOC	<i>Alosa mediocris</i>	Shad, Hickory	1	SH	RF
ALUTERUHEUDEL	<i>Aluterus heudeloti</i>	Filefish, Dotterel	18	SH	RF
ALUTERUMONOCE	<i>Aluterus monoceros</i>	Filefish, Unicorn	18	SH	RF
ALUTERUSCHOEP	<i>Aluterus schoepfi</i>	Filefish, Orange	18	SH	RF
ALUTERUSSCRIPT	<i>Aluterus scriptus</i>	Filefish, Scrawled	18	SH	RF
AMUSIUMPAPYRA	<i>Amusium papyraceus</i>	Scallop, Paper	12	SH	
ANACANTFOLIRO	<i>Anacanthobatis folirostris</i>	Skate, Leaf-nose Leg	22	SH	
ANADARAFLORID	<i>Anadara floridana</i>	Ark, Cut-Ribbed	11	SH	
ANADARANOTABI	<i>Anadara notabilis</i>	Ark, Eared	11	SH	
ANADARAOVALIS	<i>Anadara ovalis</i>	Blood Ark Shell	11	SH	RF
ANADARATRANSV	<i>Anadara transversa</i>	Ark, Transverse	11	SH	
ANASIMULATUS	<i>Anasimus latus</i>	Crab, Stilt Spider	6	SH	
ANCHOA	<i>Anchoa sp</i>	Anchovy	1	SH	RF
ANCHOA HEPSET	<i>Anchoa hepsetus</i>	Anchovy, Striped	1	SH	RF
ANCHOA LYOLEP	<i>Anchoa lyolepis</i>	Anchovy, Dusky	1	SH	RF
ANCHOA MITCHI	<i>Anchoa mitchilli</i>	Anchovy, Bay	1	SH	RF
ANCYLOPDILECT	<i>Ancylopsetta dilecta</i>	Flounder, Three eyed	18		RF
ANCYLOPQUADRO	<i>Ancylopsetta quadrocellata</i>	Flounder, Ocellated	18	SH	
ANCYLOPQUADRO	<i>Ancylopsetta quadrocellata</i>	Flounder, Ocellated	18		RF
ANGUILLROSTRA	<i>Anguilla rostrata</i>	Eel, American	18		RF
ANISOTRSURINA	<i>Anisotremus surinamensis</i>	Margate, Black	1		RF
ANISOTRVIRGIN	<i>Anisotremus virginicus</i>	Porkfish	1		RF
ANOTOPT	<i>Anotopterus</i>	Daggertooth (Genus)	18	SH	
ANTENNAMULTIO	<i>Antennarius multiocellatus</i>	Frogfish, Longlure	18	SH	RF
ANTENNAOCELLA	<i>Antennarius ocellatus</i>	Frogfish, Ocellated	18	SH	RF
ANTENNARADIOS	<i>Antennarius radiosus</i>	Frogfish, Singlespot	18	SH	RF
ANTENNASCABER	<i>Antennarius scaber</i>	Frogfish, Splitlure	18	SH	RF
ANTENNASTRIAT	<i>Antennarius striatus</i>	Frogfish, Splitlure (Striated)	18	SH	RF
ANTHOZO	Anthozoa	Sea Anemone (Class)	10	SH	

GenSp	Scientific	Common	MeasCode	Fishery
ANTIGON	Antigonia	Boarfish (Genus)	18	RF
APLYSIA	Aplysia sp	Sea Hare	20	SH
APLYSIABRASIL	Aplysia brasilliana	Mottled Seahare	20	SH
APOGON	Apogon	Cardinalfish (Genus)	1	SH RF
APOGON AUROLI	Apogon aurolineatus	Cardinalfish, Bridle	1	SH RF
APOGON MACULA	Apogon maculatus	Flamefish	1	RF
APOGON PSEUDO	Apogon pseudomaculatus	Cardinalfish, Two Spot	1	SH RF
APSILUSDENTAT	Apsilus dentatus	Snapper, Black	1	RF
ARBACIA	Arbacia	Sea Urchin (Genus)	20	SH
ARBACIAPUNCTU	Arbacia punctulata	Atlantic Purple Sea Urchin	20	SH
ARCHITENOBILI	Architectonic nobilia	Common Sundial	17	SH
ARCHOSAPROBAT	Archosargus probatocephalus	Sheepshead	1	SH RF
ARCHOSARHOMBO	Archosargus rhomboidalis	Seabream	1	SH RF
ARCIDAE	Arcidae	Ark Shell (Family)	11	SH
ARCINELCORNUT	Arcinella cornuta	Jewelbox, Spiny	17	SH
ARENAEUCRIBRA	Arenaeus cribrarius	Crab, Speckled Swimming	5	SH
ARGENTISTRIAT	Argentina striata	Argentine, Striated	18	SH
ARGOPEC	Argopecten sp.	Scallop	12	SH
ARGOPECGIBBUS	Argopecten gibbus	Scallop, Calico	12	SH
ARGOPECIRRADI	Argopecten irradians	Scallop, Bay	12	SH
ARIIDAE	Ariidae	Sea Catfish (Family)	1	SH RF
ARIOMMAMELANU	Ariomma melanum	Brown driftfish	1	SH
ARIOMMAREGULU	Ariomma regulus	Driftfish, Spotted	1	SH RF
ARIOPSIFELIS	Ariopsis felis	Catfish, Hardhead	1	SH RF
ASCIDIA	Asciacea	Sea Squirt (Class)	20	SH
ASTERIAFORBES	Asterias forbesi	Sea Star, Forbes Asterias	15	SH
ASTERIIDAE	Asteriidae	Starfish (Family)	14	SH
ASTERINFOLIUM	Asterina folium	Sea Star, Common Blunt Armed	14	SH
ASTEROI	Asteroidea	Starfish (Subclass)	14	SH
ASTRAPOALUTUS	Astrapogon alutus	Cardinalfish, Bronze	1	RF
ASTRAPOPUNCTI	Astrapogon puncticulatus	Cardinalfish, Blackfin	1	SH RF
ASTRONE	Astronesthes sp.	Stareater (Genus)	18	SH
ASTROPE	Astropectinidae	Starfish (Family)	15	RF
ASTROPEARTICU	Astropecten articulatus	Sea Star, Beaded	14	SH
ASTROPECTEN	Astropecten	Sea Star (Genus)	14	SH
ASTROPECTINID	Astropectinidea	Sea Star (Family)	14	SH
ASTROPEDUPLIC	Astropecten duplicatus	Sea Star, Spiny Beaded	14	SH
ASTROSCY-GRAE	Astroscopus y-graecum	Stargazer, Southern	18	SH RF
ATHERINIDAE	Atherinidae	Silverside (Family)	1	SH RF
ATRACOSPATUL	Atractosteus spatula	Gar, Alligator	18	SH
ATRINA	Atrina sp	Pen Shell	11	SH
ATRINA RIGIDA	Atrina rigida	Pen Shell, Stiff	11	SH
ATRINA SERRAT	Atrina serrata	Pen Shell, Saw-tooth	11	SH
AULOPUSFILAME	Aulopus filamentosus	Yellowfin Aulopus	1	RF
AURELIAAURITA	Aurelia aurita	Jellyfish, Moon	99	SH
AVES	Aves	Birds	99	SH
BAGRE MARINU	Bagre marinus	Catfish, Gafftopsail	1	SH RF
BAIRDIEBATABA	Bairdiella batabana	Croaker, Blue	18	SH RF

GenSp	Scientific	Common	MeasCode	Fishery	
BAIRDIECHRYSO	Bairdiella chrysoura	Perch, Silver	1	SH	RF
BALISTECAPRIS	Balistes capriscus	Triggerfish, Gray	1	SH	RF
BALISTEVETULA	Balistes vetula	Triggerfish, Queen	1		RF
BALISTI	Balistidae	Triggerfish/Filefish (Family)	18	SH	RF
BARBATICANCEL	Barbatia cancellaria	Ark, Red Brown	11	SH	
BATHYANMEXICA	Bathyanthias mexicanus	Bass, Yellowtail	99		RF
BATHYCLARGENT	Bathyclupea argentea	Deepsea Herring	1	SH	
BATHYGAMELANO	Bathygadus melanobranchus	Vaillant's Grenadier	18	SH	
BATOIDEA	Batoidea	Skates and Rays (Superorder)	22	SH	RF
BELLATOBACHY	Bellator brachychir	Searobin, Shortfin	18	SH	RF
BELLATOEGRETT	Bellator egretta	Searobin, Streamer	18	SH	RF
BELLATOMILITA	Bellator militaris	Searobin, Horned	18	SH	RF
BELONID	Belonidae	Needlefish (Genus)	1	SH	RF
BEMBROPANATIR	Bembrops anatiostris	Flathead, Duckbill	18	SH	
BENTHODTENUIS	Benthodesmus tenuis	Frostfish, Slender	18	SH	
BITEOFF	Bite Off	Bite Off	99		RF
BIVALVI	Bivalvia	Bivalve (Class)	11	SH	
BLENNII	Blenniidae	Blenny (Family)	18		RF
BODIANUPULCHE	Bodianus pulchellus	Hogfish, Spotfin	18	SH	RF
BODIANURUFUS	Bodianus rufus	Hogfish, Spanish	18		RF
BOLLMAN	Bollmannia	Goby (Genus)	18		RF
BOLLMANBOQUER	Bollmannia boqueronensis	Goby, White eyed	18		RF
BOLLMANCOMMUN	Bollmannia communis	Goby, Ragged	18		RF
BOTHIDA	Bothidae	Flounder (Family)	18	SH	RF
BOTHUS	Bothus	Flounder (Genus)	18	SH	RF
BOTHUS LUNATU	Bothus lunatus	Flounder, Peacock	18	SH	RF
BOTHUS OCELLA	Bothus ocellatus	Flounder, Eyed	18	SH	RF
BOTHUS ROBINS	Bothus robinsi	Flounder, Twospot	18	SH	RF
BRACTECANTILL	Bractechlamys antillarum	Scallop, Antillean	12	SH	
BREGMAC	Bregmacerotidae	Codlet (Family)	18		RF
BREGMACATLANT	Bregmaceros atlanticus	Codlet, Antenna	18		RF
BREGMACHOUDEI	Bregmaceros houdei	Codlet, Stellate	18		RF
BREVIRACOLESI	Breviraja colesi	Skate, Lightnose	22	SH	
BREVOOR	Brevoortia	Menhaden (Genus)	1		RF
BREVOORGUNTER	Brevoortia gunteri	Menhaden, Finescale	1	SH	RF
BREVOORPATRON	Brevoortia patronus	Menhaden, Gulf	1	SH	RF
BREVOORSMITHI	Brevoortia smithi	Menhaden, Yellowfin	1	SH	RF
BREVOORTYRANN	Brevoortia tyrannus	Menhaden, Atlantic	1	SH	RF
BROTULABARBAT	Brotula barbata	Brotula, Bearded	18	SH	RF
BUSYCON	Busycon	Whelk (Genus)	17	SH	
BUSYCONCARICA	Busycon carica	Whelk, Knobbed	17	SH	
BUSYCONEGGCAS	Busycon Eggcase	Eggcase, Whelk (Genus)	20	SH	
BUSYCONSINIST	Busycon sinistrum	Whelk, Lightning	17	SH	
BUSYCONSPIRAT	Busycon spiratum	Whelk, Pear	17	SH	
BUSYCOTCANALI	Busycotypus canaliculatus	Whelk, Channeled	17	SH	
CAELORICAELOS	Caelorinchus caelorrhincus	Grenadier, Saddled	18		RF
CAELORICARIBB	Caelorinchus caribbaeus	Grenadier, Blackfin	18	SH	RF
CALAMUS	Calamus	Porgy (Genus)	1	SH	RF

GenSp	Scientific	Common	MeasCode	Fishery	
CALAMUSARCTIF	Calamus arctifrons	Porgy, Grass	1	SH	RF
CALAMUSBAJONA	Calamus bajonado	Porgy, Jolthead	1	SH	RF
CALAMUSCALAMU	Calamus calamus	Porgy, Saucereye	1	SH	RF
CALAMUSLEUCOS	Calamus leucosteus	Porgy, Whitebone	1	SH	RF
CALAMUSNODOSU	Calamus nodosus	Porgy, Knobbed	1	SH	RF
CALAMUSPENNA	Calamus penna	Porgy, Sheepshead	1	SH	RF
CALAMUSPRORID	Calamus proridens	Porgy, Littlehead	1	SH	RF
CALAPPA	Calappa	Crab, Box (Genus)	5	SH	
CALAPPAFLAMME	Calappa flammea	Crab, Flame Box	5	SH	
CALAPPASULCAT	Calappa sulcata	Crab, Yellow Box	5	SH	
CALAPPIDAE	Calappidae	Box Crab (Family)	5	SH	
CALLECHGUINIE	Callechelys guiniensis	Eel, Short Tail Snake	18		RF
CALLINE	Callinectes	Crab (Genus)	5	SH	
CALLINEDANAE	Callinectes danae	Dana's Blue Crab	5	SH	RF
CALLINEDISCAR	Callinectes Discard	Crab, Blue (Discards)	5	SH	
CALLINELARVAT	Callinectes larvatus	Crab, Masked Swimming	5	SH	
CALLINEORNATU	Callinectes ornatus	Crab, Shelligs	5	SH	
CALLINESAPIDU	Callinectes sapidus	Crab, Blue	5	SH	
CALLINESIMILI	Callinectes similis	Crab, Lesser Blue	5	SH	
CALLYSPVAGINA	Callyspongia vaginalis	Sponge, Tube	20	SH	
CANCER BOREAL	Cancer borealis	Crab, Jonah	5	SH	
CANCER IRRORA	Cancer irroratus	Crab, Atlantic Rock	5	SH	
CANTHERMACROC	Cantherhines macrocerus	Filefish, Whitespotted	18	SH	RF
CANTHERPULLUS	Cantherhines pullus	Filefish, Orangespotted	18	SH	RF
CANTHIDSUFFLA	Canthidermis sufflamen	Triggerfish, Ocean	18	SH	RF
CARANGI	Carangidae	Jack (Family)	1	SH	RF
CARANGOBARTHO	Carangoides bartholomaei	Jack, Yellow	1	SH	RF
CARANX	Caranx	Jack (Genus)	1		RF
CARANX CRYCOS	Caranx crysos	Runner, Blue	1	SH	RF
CARANX HIPPOS	Caranx hippos	Jack, Common Crevalle	1	SH	RF
CARANX LATUS	Caranx latus	Jack, Horse-eye	1	SH	RF
CARANX RUBER	Caranx ruber	Jack, Bar	1		RF
CARANXLUGUBR	Caranx lugubris	Jack, Black	1		RF
CARAPUSBERMUD	Carapus bermudensis	Pearlfish	18	SH	RF
CARCHAR	General Sharks	Sharks Grouped	18	SH	RF
CARCHARACRONO	Carcharhinus acronotus	Shark, Blacknose	18	SH	RF
CARCHARALTIMU	Carcharhinus altimus	Shark, Bignose	18		RF
CARCHARBREVIP	Carcharhinus brevipinna	Shark, Spinner	18	SH	RF
CARCHARFALCIF	Carcharhinus falciformis	Shark, Silky	18	SH	RF
CARCHARINIFOR	Carcharhiniformes	Sharks, Ground (Order)	18	SH	RF
CARCHARISODON	Carcharhinus isodon	Shark, Finetooth	18	SH	RF
CARCHARLEUCAS	Carcharhinus leucas	Shark, Bull	18	SH	RF
CARCHARLIMBAT	Carcharhinus limbatus	Shark, Blacktip	18	SH	RF
CARCHAROBSCUR	Carcharhinus obscurus	Shark, Dusky	18	SH	RF
CARCHARPLUMBE	Carcharhinus plumbeus	Shark, Sandbar	18	SH	RF
CARCHARPOROSU	Carcharhinus porosus	Shark, Smalltail	18	SH	RF
CARCHARPOST08	Carcharpost08	Sharks, Grouped	18	SH	RF
CARCHARSIGNAT	Carcharhinus signatus	Shark, Night	18		RF

GenSp	Scientific	Common	MeasCode	Fishery
CARCHARSP	Carcharhinus sp	Shark, Requiem (Genus)	18	RF
CARCHARTAURUS	Carcharias taurus	Shark, Sand tiger	18	RF
CARYBDE	Carybdeidae	Jellyfish (Family)	99	SH
CAULOLA	Caulolatilus sp	Tilefish (Genus)	1	RF
CAULOLACHRYSO	Caulolatilus chrysops	Tilefish, Goldface	18	SH RF
CAULOLACYANOP	Caulolatilus cyanops	Tilefish, Blackline	1	RF
CAULOLAINTERM	Caulolatilus intermedius	Tilefish, Gulf Bar-Eyed	1	SH RF
CAULOLAMICROP	Caulolatilus microps	Tilefish, Blueline	1	SH RF
CENTROPGRANUL	Centrophorus granulosus	Shark, Gulper	18	SH RF
CENTROPOCYURU	Centropristis ocyurus	Seabass, Bank	2	SH RF
CENTROPOMUS	Centropomus	Snook (Genus)	1	SH RF
CENTROPPHILAD	Centropristis philadelphica	Seabass, Rock	2	SH RF
CENTROPRISTIS	Centropristis	Seabass (Genus)	2	SH RF
CENTROPSTRIAT	Centropristis striata	Seabass, Black	2	SH RF
CEPHALOCRUENT	Cephalopholis cruentata	Graysby	18	RF
CEPHALOFULVA	Cephalopholis fulva	Coney	18	RF
CEPHALOPODA	Cephalopoda	Squid and Octopus (Class)	13	SH
CHAETODCAPIST	Chaetodon capistratus	Butterflyfish, Foureye	18	SH RF
CHAETODFABER	Chaetodipterus faber	Spadefish, Atlantic	1	SH RF
CHAETODOCELLA	Chaetodon ocellatus	Butterflyfish, Spotfin	18	RF
CHAETODSEMENT	Chaetodon sedentarius	Butterflyfish, Reef	18	SH RF
CHASCANLUGUBR	Chascanopsetta lugubris	Flounder, Pelican	18	SH
CHASMODSABURR	Chasmodes saburrae	Blenny, Florida	18	RF
CHAULIOSLOANI	Chauliodus sloani	Viperfish, Sloane's	18	SH
CHAUNAXSTIGMA	Chaunax stigmaeus	Gaper, Redeye	18	SH
CHAUNAXSUTTKU	Chaunax suttkusi	Frogmouth, Pink	18	SH
CHILOMYANTILL	Chilomycterus antillarum	Burrfish, Web	18	SH RF
CHILOMYSCHOEP	Chilomycterus schoepfi	Burrfish, Striped	18	SH RF
CHIONE LATILI	Chione latilirata	Venus, Imperial	11	SH
CHLOROPAGASSI	Chlorophthalmus agassizi	Greeneye, Shortnose	1	SH RF
CHLOROSCHRYSU	Chloroscombrus chrysurus	Bumper, Atlantic	1	SH RF
CHRYSAOQUINQU	Chrysaora quinquecirrha	Sea Nettle	99	SH
CIRRHIGASPER	Cirrhigaleus asper	Dogfish, Roughskin	18	SH RF
CITHARI	Citharichthys sp	Whiff (Genus)	18	RF
CITHARIARENAC	Citharichthys arenaceus	Whiff, Sand	18	SH RF
CITHARICORNUT	Citharichthys cornutus	Whiff, Horned	18	RF
CITHARIMACROP	Citharichthys macrops	Whiff, Spotted	18	SH RF
CITHARISPILOP	Citharichthys spilopterus	Whiff, Bay	18	SH RF
CLIBANAVITTAT	Clibanarius vittatus	Crab, Striped Hermit	6	SH
CLUPEIDAE	Clupeidae	Herrings (Family)	1	SH RF
CLYPEASSUBDEP	Clypeas subdepressus	Sea Biscuit, Flat	20	SH
CLYPEASTEROID	Cylpeasteroida	Sand Dollar (Order)	20	SH
CNIDARIA	Cnidaria	Polyps and Medusae (Phylum)	20	SH
COELOCESPINOS	Coelocerus spinosus	Crab, Channelnose Spider	5	SH
CONGER OCEANI	Conger oceanicus	Eel, Conger	18	SH RF
CONGER TRIPOR	Conger triporiceps	Conger, Manytooth	18	SH RF
CONGRID	Congridae	Eel, Conger (Family)	18	SH RF
CONODONNOBILI	Conodon nobilis	Grunt, Barred	99	RF

GenSp	Scientific	Common	MeasCode	Fishery	
CONUS DELESS	Conus delessertii	Cone, Sozon's	17	SH	
COOKEOLJAPONI	Cookeolus japonicus	Bulleye	18	SH	RF
CORNIGESPINOS	Corniger spinosus	Soldierfish, Spinycheek	1		RF
CORYPHEAEQUISE	Coryphaena equisetis	Dolphin, Pompano	1		RF
CORYPHAHIPPUR	Coryphaena hippurus	Dolphin	1		RF
CRUSTAC	Crustacean	Crustacean	99	SH	RF
CTENODICRISPA	Ctenodiscus crispatus	Mud Star	14	SH	
CTENOPH	Ctenophora	Jellyfish, Comb	99	SH	
CYCLOPS	Cyclopsetta sp	Flounder (Genus)	18	SH	RF
CYCLOPSCHITTE	Cyclopsetta chittendeni	Flounder, Mexican	18	SH	RF
CYCLOPSFIMBRI	Cyclopsetta fimbriata	Flounder, Spotfin	18	SH	RF
CYNOSCI	Cynoscion sp	Seatrout (Genus)	18	SH	RF
CYNOSCIARENAR	Cynoscion arenarius	Seatrout, Sand	18	SH	RF
CYNOSCINEBULO	Cynoscion nebulosus	Seatrout, Spotted	18	SH	RF
CYNOSCINOTHUS	Cynoscion nothus	Seatrout, Silver	18	SH	RF
CYNOSCIREGALI	Cynoscion regalis	Weakfish	18	SH	RF
CYSELUMELANU	Cypselurus melanurus	Flyingfish, Atlantic	1	SH	RF
CYRTIPLCOSTAT	Cyrtopleura costata	Angel Wing	11	SH	
CYTTOPSROSEA	Cyttopsis rosea	Dory, Red	18	SH	RF
DACTYLOCLARKI	Dactylobatus clarkii	Clark's Finger Skate	22	SH	
DACTYLOTRIDIG	Dactyloscopus tridigitatus	Stargazer, Sand	18	SH	RF
DACTYLOVOLITA	Dactylopterus volitans	Gurnard, Flying	1	SH	RF
DALATIALICHA	Dalatias licha	Kitefin Shark	18	SH	
DASYATI	Dasyatis sp.	Stingray (Genus)	22	SH	RF
DASYATIAMERIC	Dasyatis americana	Stingray, Southern	22	SH	RF
DASYATICENTRO	Dasyatis centroura	Stingray, Roughtail	22	SH	RF
DASYATIDAE	Dasyatidae	Stingray (Family)	22	SH	RF
DASYATISABINA	Dasyatis sabina	Stingray, Atlantic	22	SH	RF
DASYATISAY	Dasyatis say	Stingray, Bluntnose	22	SH	RF
DEANIA	Deania	Long-snout dogfish (genus)	18	SH	
DEBRIS	Debris	Debris (rocks,logs,etc.)	20	SH	
DECAPOD	DECAPODA	Decapod Crustacean	99	SH	
DECAPODA	Decapoda	Decapod (Order)	20		RF
DECAPTE	Decapterus	Scad (Genus)	1		RF
DECAPTEMACARE	Decapterus macarellus	Scad Mackerel	18	SH	RF
DECAPTEPUNCTA	Decapterus punctatus	Scad, Round	1	SH	RF
DECAPTETABL	Decapterus tabl	Redtail Scad	1		RF
DECODONPUELLA	Decodon puellaris	Hogfish, Red	1	SH	RF
DEMOSPO	Demospongiae	Sponge (Class)	20	SH	
DERMATOINERMI	Dermatolepis inermis	Grouper, Marbled	1		RF
DIAPTERAURATU	Diapterus auratus	Pompano, Irish	1	SH	RF
DIAPTERPLUMIE	Diapterus plumieri	Mojarra, Striped	1		RF
DIBRANCATLANT	Dibranchus atlanticus	Batfish, Atlantic	18	SH	RF
DINOCARDIUM	Dinocardium	Cockle, (Genus)	99	SH	
DINOCARROBUST	Dinocardium robustum	Cockle, Giant Atlantic	99	SH	
DIODON HOLOCA	Diodon holocanthus	Balloonfish	18	SH	RF
DIODON HYSTRI	Diodon hystrix	Porcupinefish	18		RF
DIPLECTBIVITT	Diplectrum bivittatum	Perch, Dwarf Sand	2	SH	RF

GenSp	Scientific	Common	MeasCode	Fishery	
DIPLECTFORMOS	Diplectrum formosum	Perch, Sand	2	SH	RF
DIPLECTRUM	Diplectrum	Seabass (Genus)	2	SH	RF
DIPLODUARGENT	Diplodus argenteus	Porgy, Silver	1	SH	RF
DIPLODUHOLBRO	Diplodus holbrooki	Pinfish, Spottail	1	SH	RF
DIPTURUGARRIC	Dipturus garricki	Skate, San Blas	22		RF
DIPTURULAEVIS	Dipturus laevis	Skate, Barndoor	22	SH	RF
DIPTURUOLSENI	Dipturus olseni	Skate, Spreadfin	22	SH	RF
DIPTURUOREGON	Dipturus oregoni	Skate, Hooktail	22		RF
DIPTURUTEEVAN	Dipturus teevani	Ray, Prickly Brown	22	SH	RF
DIRETMOPAUCIR	Directmoides pauciradiatus	Longwing Spinyfin	18	SH	
DIRETMU	Directmus	Spinyfin (Genus)	18	SH	
DISTORSMACGIN	Distorsio macgintyi	Distorsio, McGinty's	17	SH	
DORMITAMACULA	Dormitator maculatus	Sleeper, Fat	18	SH	RF
DOROSOMCEPEDI	Dorosoma cepedianum	Shad, Gizzard	1	SH	RF
DOROSOMPETENE	Dorosoma petenense	Shad, Threadfin	1	SH	RF
DROMIA ERYTHR	Dromia erythropus	Crab, Sponge	6	SH	
DROMIDI	Dromidia sp	Crab, Sponge	5	SH	
DROMIDIANTILL	Dromidia antillensis	Crab, Hairy Sponge	5	SH	
DROMIIDAE	Dromiidae	Sponge Crab (Family)	5	SH	
ECHENEIDAE	Echeneidae	Sharksucker (family)	18		RF
ECHENEIDIDAE	Echeneididae	Remora (Family)	18		RF
ECHENEINAUCRA	Echeneis naucrates	Sharksucker	18	SH	RF
ECHENEINEUCRA	Echeneis neucratoides	Sharksucker, White Fin	18	SH	RF
ECHINARPARMA	Echinarachnius parma	Sand Dollar, Common	14	SH	
ECHINASSPINUL	Echinaster spinulosus	Sea Star, Brown Spiny	14	SH	
ECHINOI	Echinoidea	Echinoderm (Class)	14	SH	
ECHIOPH	Echiophis sp	Eel, Snake (Genus)	18		RF
ECHIOPHINTERT	Echiophis intertinctus	Eel, Spotted Spoonnose	18	SH	RF
ECHIOPHPUNCTI	Echiophis punctifer	Eel, Snapper	18	SH	RF
ELAGATIBIPINN	Elagatis bipinnulata	Rainbow Runner	1		RF
ELASMOBEGGPOU	Elasmobranchiomorphi eggpouch	Eggpouch, Cartilaginous Fish (Class)	20	SH	
ELASMOBRANCHI	Elasmobranchiomorphi	Cartilaginous fish (Class)	99	SH	RF
ELEOTRIPISONI	Eleotris pisonis	Spineycheek Sleeper	18	SH	RF
ELOPS SAURUS	Elops saurus	Ladyfish	1	SH	RF
EMERITATALPOI	Emerita talpoida	Crab, Mole	6	SH	
ENCOPE	Encope	Sand Dollar (Genus)	20	SH	
ENCOPE EMARGI	Encope emarginata	Sand Dollar, Notched	20	SH	
ENCOPE MICHEL	Encope michelini	Sand Dollar, Michelin's	20	SH	
ENGYOPHSENTA	Engyophrys senta	Flounder, Spiny	18		RF
EPINEPH	Epinephelus	Grouper (Genus)	1		RF
EPINEPHADSCEN	Epinephelus adscensionis	Hind, Rock	1		RF
EPINEPHDRUMMO	Epinephelus drummondhayi	Hind, Speckled	1	SH	RF
EPINEPHFLAVOL	Epinephelus flavolimbatus	Grouper, Yellowedge	1	SH	RF
EPINEPHGUTTAT	Epinephelus guttatus	Hind, Red (Strawberry Grouper)	1		RF
EPINEPHITAJAR	Epinephelus itajara	Grouper, Goliath (Jewfish)	1		RF
EPINEPHMORIO	Epinephelus morio	Grouper, Red	1	SH	RF
EPINEPHMYSTAC	Epinephelus mystacinus	Grouper, Misty	18		RF
EPINEPHNIGRIT	Epinephelus nigritus	Grouper, Warsaw	1	SH	RF

GenSp	Scientific	Common	MeasCode	Fishery	
EPINEPHNIVEAT	Epinephelus niveatus	Grouper, Snowy	1	SH	RF
EPTATRESFRING	Eptatretus springer	Hagfish, Gulf	18	SH	RF
EQUETUS	Equetus sp	Drum, Cubbyu (Genus)	18		RF
EQUETUSIWAMOT	Equetus iwamotoi	Drum, Blackbar	18	SH	RF
EQUETUSLANCEO	Equetus lanceolatus	Jackknife - fish	18	SH	RF
EQUETUSPUNCTA	Equetus punctatus	Drum, Spotted	18	SH	RF
ERYTHROMONODI	Erythrocles monodi	Rubyfish, Atlantic	1		RF
ETELIS OCULAT	Etelis oculatus	Snapper, Queen	1	SH	RF
ETMOPTERUS	Etmopterus	Shark, Lantern (Genus)	18	SH	
ETROPUS	Etropus sp	Flounder (Genus)	18	SH	RF
ETROPUSCROSSO	Etropus crossotus	Flounder, Fringed	18	SH	RF
ETROPUSMICROS	Etropus microstomus	Flounder, Smallmouth	18	SH	RF
ETROPUSRIMOSU	Etropus rimosus	Flounder, Gray	18	SH	RF
ETRUMEUTERES	Etrumeus teres	Herring, Round	1	SH	RF
EUCIDARTRIBUL	Eucidaris tribuloides	Urchin, Pencil	14	SH	
EUCINOS	Eucinostomus sp	Mojarra (Genus)	1	SH	RF
EUCINOSARGENT	Eucinostomus argenteus	Mojarra, Spotfin	1	SH	RF
EUCINOSGULA	Eucinostomus gula	Jenny, Silver	1	SH	RF
EUCINOSHARENG	Eucinostomus harengulus	Mojarra, Tidewater	1		RF
EUCINOSHAVANA	Eucinostomus havana	Mojarra, Big Eye	18	SH	RF
EUCINOSJONESI	Eucinostomus jonesi	Mojarra, Slender	1	SH	RF
EUCINOSLEFROY	Eucinostomus lefroyi	Mojarra, Mottled	1	SH	RF
EUCINOSMELANO	Eucinostomus melanopterus	Mojarra, Flagfin	1		RF
EUECHINOIDEA	Euechinoidea	Sea Urchin (Subclass)	20	SH	
EUTHYNNALLETT	Euthynnus alletteratus	Bonito	1	SH	RF
EUVOLA ZICZAC	Euvola ziczac	Scallop, Zigzag	12	SH	
EVOXYMETAENIA	Evoxymetopon taeniatus	Channel Scabbardfish	18	SH	
FARFANTAZTECU	Farfantepenaeus aztecus	Shrimp, Brown	3	SH	
FARFANTDUORAR	Farfantepenaeus duorarum	Shrimp, Pink	3	SH	
FARFANTEPENAE	Farfantepenaeus sp.	Shrimp (Genus)	3	SH	
FASCIOLHUNTER	Fasciolaria hunteria	Shell, Hunter's Banded Tulip	16	SH	
FASCIOLLILIUM	Fasciolaria lillium	Shell, Banded Tulip	16	SH	
FASCIOLTULIPA	Fasciolaria tulipa	Snail, Tulip	16	SH	
FENESTR	Fenestraja	Skate (Genus)	22	SH	RF
FENESTRISHIYA	Fenestraja ishiyamai	Plain pygmy skate	22	SH	
FICUS COMMUN	Ficus communis	Figsnail, Atlantic	17	SH	
FISTULAPETIMB	Fistularia petimba	Cornetfish, Red	18	SH	RF
FISTULATABACA	Fistularia tabacaria	Coronetfish, Blue Spotted	18	SH	RF
FOETOREAGASSI	Foetorepus agassizii	Dragonet, Spotfin	18	SH	
FUNDULUGRANDI	Fundulus grandis	Killifish, Gulf	18		RF
FUSININAE	Fusininae	Shell, Spindle (Sub-Family)	17	SH	
GADELLAIMBERB	Gadella imberbis	Beardless codling	18	SH	
GADIDAE	Gadidae	Hake (Family)	18	SH	
GALEOCECUVIER	Galeocerdo cuvier	Shark, Tiger	18	SH	RF
GALEUS ARAE	Galeus arae	Catshark, Marbled	18	SH	
GASTROP	Gastropoda	Snail (Class)	17	SH	
GASTROPEGGCAS	Gastropoda Eggcase	Gastropoda (Class) Eggcase	20	SH	
GASTROPFRONTA	Gastropsetta frontalis	Flounder, Shrimp	18	SH	RF

GenSp	Scientific	Common	MeasCode	Fishery	
GEPHYRODARWIN	Gephyroberyx darwinii	Slimehead, Darwin's	18		RF
GERREIDAE	Gerreidae	Mojarra (Family)	1	SH	RF
GERRES CINERE	Gerres cinereus	Mojarra, Yellowfin	1	SH	RF
GINGLYMCIRRAT	Ginglymostoma cirratum	Shark, Nurse	18	SH	RF
GNATHAGEGREGI	Gnathagnus egregius	Stargazer, Freckled	18	SH	
GOBIESOSTRUMO	Gobiesox strumosus	Skilletfish	18	SH	RF
GOBIIDA	Gobiidae	Goby (Family)	18	SH	RF
GOBIOIDBROUSS	Gobioides broussoneti	Goby, Violet	18		RF
GOBIONECEANI	Gobionellus oceanicus	Goby, Highfin	18	SH	RF
GOBIOSOMACROD	Gobiosoma macrodon	Goby, Tiger	18	SH	RF
GONIOPLHISPAN	Gonioplectrus hispanus	Flag, Spanish	18		RF
GORGONOCEPHAL	Gorgonocephalidae	Basket Star (Family)	14	SH	
GYMNACHMELAS	Gymnachirus melas	Sole, Naked	18	SH	RF
GYMNACHTEXAE	Gymnachirus texae	Sole, Fringed	18	SH	RF
GYMNOTHFUNEBR	Gymnothorax funebris	Moray, Green	18		RF
GYMNOTHKOLPOS	Gymnothorax kolpos	Moray, Blacktail	18		RF
GYMNOTHMORING	Gymnothorax moringa	Moray, Spotted	18	SH	RF
GYMNOTHNIGROM	Gymnothorax nigromarginatus	Moray, Blackedge	18	SH	RF
GYMNOTHORAX	Gymnothorax sp.	Moray (Genus)	18	SH	RF
GYMNOTHSAXICO	Gymnothorax saxicola	Moray, Honeycomb	18	SH	RF
GYMNOTHVICINU	Gymnothorax vicinus	Moray, Purplemouth	18		RF
GYMNURA	Gymnura sp	Ray, Butterfly	22	SH	RF
GYMNURAALTAVE	Gymnura altavela	Ray, Spiny Butterfly	22	SH	RF
GYMNURAMICRUR	Gymnura micrura	Ray, Smooth Butterfly	22	SH	RF
HAEMULIDAE	Haemulidae	Grunt (Family)	1	SH	RF
HAEMULOALBUM	Haemulon album	Margate	1	SH	RF
HAEMULOAUROLI	Haemulon aurolineatum	Tomtate	1	SH	RF
HAEMULOMELANU	Haemulon melanurum	Cottonwick	1		RF
HAEMULON	Haemulon	Grunt (Genus)	1	SH	RF
HAEMULOPARRA	Haemulon parra	Sailor's Choice	1	SH	RF
HAEMULOPLUMIE	Haemulon plumieri	Grunt, White	1	SH	RF
HAEMULOSCIURU	Haemulon sciurus	Grunt, Bluestriped	1	SH	RF
HAEMULOSTRIAT	Haemulon striatum	Grunt, Striped	1		RF
HALICHO	Halichoeres sp	Wrasse (Genus)	18	SH	RF
HALICHOBATHYP	Halichoeres bathyphilus	Wrasse, Greenband	18	SH	RF
HALICHOBIVITT	Halichoeres bivittatus	Slippery dick	18		RF
HALICHOCAUDAL	Halichoeres caudalis	Wrasse, Painted	18	SH	RF
HALICHORADIAT	Halichoeres radiatus	Puddingwife	1	SH	RF
HALICLOOCULAT	Haliclona oculata	Sponge, Finger	20	SH	
HALIEUTACULEA	Halieutichthys aculeatus	Batfish, Pancake	18	SH	RF
HARENGU	Harengula sp	Herring (Genus)	1		RF
HARENGUCLUPEO	Harengula clupeola	Pilchard, False	1	SH	RF
HARENGUHUMERA	Harengula humeralis	Sardine, Redear	1	SH	RF
HARENGUJAGUAN	Harengula jaguana	Sardine, Scaled	1	SH	RF
HELICOLDACTYL	Helicolenus dactylopterus	Rosefish, Blackbelly	18	SH	RF
HEMANTHLEPTUS	Hemanthias leptus	Bass, Longtail	1	SH	RF
HEMICARAMBLYR	Hemicaranx amblyrhynchus	Jack, Bluntnose	1	SH	RF
HEMIPTEMARTIN	Hemipteronotus martinicensis	Razorfish, Rosy	18		RF

GenSp	Scientific	Common	MeasCode	Fishery	
HEMIRAMBRASIL	Hemiramphus brasiliensis	Ballyhoo	1		RF
HEPATUSEPHELI	Hepatus epheliticus	Crab, Calico Box	5	SH	
HEPTRANPERLO	Heptranchias perlo	Shark, Sevengill	18	SH	RF
HETEROGRANUL	Heterocrypta granulata	Crab, Chip	5	SH	
HETEROPCRUEMENT	Heteropriacanthus cruentatus	Snapper, Glasseye	18		RF
HEXANCH	Hexanchus sp	Shark, Sixgill (Genus)	18		RF
HEXANCHGRISEU	Hexanchus griseus	Shark, Six Gill	18		RF
HEXANCHIDAE	Hexanchidae	Shark, Cow (family)	18	SH	RF
HEXANCHNAKAMU	Hexanchus nakamurai	Shark, Bigeye Sixgill	18		RF
HILDEBRFLAVA	Hildebrandia flava	Conger, Yellow	18	SH	RF
HIMANTOGROENL	Himantolophus groenlandicus	Footballfish, Atlantic	2	SH	RF
HIPPOCA	Hippocampus sp	Seahorse (Genus)	18	SH	RF
HIPPOCAERECTU	Hippocampus erectus	Seahorse, Lined	18	SH	RF
HIPPOCAREIDI	Hippocampus reidi	Seahorse, Longsnout	18	SH	RF
HOLACANBERMUD	Holacanthus bermudensis	Angelfish, Blue	18	SH	RF
HOLACANCILIAR	Holacanthus ciliaris	Angelfish, Queen	18		RF
HOLANTHMARTIN	Holanthias martinicensis	Bass, Roughtongue	1		RF
HOLOCENADSCEN	Holocentrus adscensionis	Squirrelfish	1	SH	RF
HOLOCENRUFUS	Holocentrus rufus	Squirrelfish, Longspine	1		RF
HOLOCENTRIDAE	Holocentridae	Squirrelfishes (Family)	1		RF
HOLOCENVEXILL	Holocentrus vexillarius	Squirrelfish, Dusky	1		RF
HOLOTHU	Holothuroidea	Sea Cucumber (Class)	20	SH	
HOPLOSTOCCIDE	Hoplostethus occidentalis	Western Roughy	1	SH	
HOPLUNN	Hoplunnis sp	Eel, Pike-Conger	18	SH	RF
HOPLUNNMACRUR	Hoplunnis macrurus	Conger, Silver	18	SH	RF
HOPLUNNTENUIS	Hoplunnis tenuis	Spotted Pike-conger	18	SH	RF
HYDROLA	Hydrolagus	Ratfish genus	18	SH	
HYDROLAALBERT	Hydrolagus alberti	Shortnose Ratfish	18	SH	
HYDROLAMIRABI	Hydrolagus mirabilis	Rabbitfish, Large-eyed	18	SH	
HYDROZOA	Hydrozoa	Hydrozoan (Class)	20	SH	RF
HYPEROGBYTHIT	Hyperoglyphe bythites	Driftfish, Black	1		RF
HYPEROGERCIF	Hyperoglyphe perciformis	Barrelfish	1		RF
HYPLEURAEQUIP	Hypleurochilus aequipinnis	Blenny, Oyster	18		RF
HYPLEURGEMINA	Hypleurochilus geminatus	Blenny, Crested	18		RF
HYPOPLEUNICOL	Hypoplectrus unicolor	Hamlet, Butter	2	SH	RF
ICTALURFURCAT	Ictalurus furcatus	Catfish, Blue	1	SH	RF
IJIMAIA	Ijimaia sp.	Jellynose (Genus)	18	SH	
ILIACANLIODAC	Iliacantha liodactylus	Crab, Purse	6	SH	
ILIACANTHA	Iliacantha	Purse Crab (Genus)	6	SH	
ILLEX ILLECE	Illex illecebrosus	Squid, Northern Shortfin	13	SH	
INVERTE	Invertebrate	Invertebrate	99	SH	RF
INVERTECRUSTA	NONE	Inverts & Non-Penaeid Crustaceans	99	SH	
IRCINIACAMPAN	Ircinia campana	Sponge, Vase	20	SH	
IRCINIASTROBI	Ircinia strobilina	Sponge, Cake	20	SH	
ISODICT	Isodictya sp.	Sponge, Palmate (Genus)	20	SH	
ISOPODA	Isopoda	Isopoda (Order)	99	SH	
ISTIOPHPLATYP	Istiophorus platypterus	Sailfish	24		RF
ISURUS OXYRIN	Isurus oxyrinchus	Shark, Shortfin Mako	18		RF

GenSp	Scientific	Common	MeasCode	Fishery	
KATHETOALBIGU	Kathetostoma albigutta	Stargazer, Lancer	18	SH	RF
KATSUWOPELAMI	Katsuwonus pelamis	Skipjack Tuna	1		RF
KYPHOSUSECTAT	Kyphosus sectatrix	Chub, Bermuda	1		RF
LABRIDAE	Labridae	Wrasses (Family)	18	SH	RF
LACHNOLMAXIMU	Lachnolaimus maximus	Hogfish	1	SH	RF
LACTOPHBICAUD	Lactophrys bicaudalis	Trunkfish, Spotted	18		RF
LACTOPHTRIGON	Lactophrys trigonus	Trunkfish	18	SH	RF
LAEVICALAEVIG	Laevicardium laevigatum	Eggcockle	11	SH	
LAGOCEPLAEVIG	Lagocephalus laevigatus	Pufferfish, Smooth	18	SH	RF
LAGOCEPLAGOCE	Lagocephalus lagocephalus	Pufferfish, Oceanic	18		RF
LAGODONRHOMBO	Lagodon rhomboides	Pinfish	1	SH	RF
LARIMUSFASCIA	Larimus fasciatus	Drum, Banded	18	SH	RF
LEATHESDIFFOR	Leathesia difformis	Sea Potato	20	SH	
LEIOLAMNITIDU	Leiolambrus nitidus	Crab, White Elbow	5	SH	
LEIOSTOXANTHU	Leiostomus xanthurus	Spot (Flat Croaker)	18	SH	RF
LEPISOSOSSEUS	Lepisososteus osseus	Gar, Longnose	18	SH	
LEPISOSPLATOS	Lepisosteus platostomus	Gar, Shortnose	18	SH	
LEPOPHI	Lepophidium	Cusk-eel (Genus)	18	SH	RF
LEPOPHIBREVIB	Lepophidium brevibarbe	Cusk-eel, Blackedge	18	SH	RF
LEPOPHICERVIN	Lepophidium cervinum	Eel, Fawn Cusk	18	SH	
LEPOPHIJEANNA	Lepophidium jeannae	Cusk-eel, Mottled	18	SH	RF
LEPOPHISTAURO	Lepophidium staurophor	Cusk-eel, Barred	18	SH	RF
LEPTOGO	Leptogorgia sp	Soft Coral (Genus)	20	SH	
LEPTOGOVIRGUL	Leptogorgia virgulata	Sea Whip	20	SH	
LEPTONI	Leptonidae	Bivalve (Family)	99	SH	
LESTIDIATLANT	lestidium atlanticum	Atlantic barracudina	1	SH	
LEUCORAGARMAN	Leucoraja garmani	Rosette skate	22		RF
LEUCORALENTIG	Leucoraja lentiginosa	Skate, Speckled	22	SH	
LIBINIA	Libinia sp	Crab, Spider (Genus)	6	SH	RF
LIBINIADUBIA	Libinia dubia	Crab, Longnose Spider	6	SH	
LIBINIAEMARGI	Libinia emarginata	Crab, Portly Spider	6	SH	
LIMULUSPOLYPH	Limulus polyphemus	Crab, Horseshoe	5	SH	
LINDAPEMUSCOS	Lindapecten muscosus	Rough Scallop	12	SH	
LITOPENSETIFE	Litopenaeus setiferus	Shrimp, White	3	SH	
LOBOTESURINA	Lobotes surinamensis	Tripletail	18	SH	RF
LOLIGINIDAE	Loliginidae	Squid (Family)	13	SH	
LOLIGO	Loligo sp	Squid (Genus)	13	SH	
LOLIGO PEALEI	Loligo pealeii	Squid, Longfin	13	SH	
LOLIGO PLEII	Loligo pleii	Squid, Slender Inshore	13	SH	
LOLLIGUBREVIS	Lolliguncula brevis	Squid, Atlantic Brief	13	SH	
LONCHOPMICROG	Lonchopisthus micrognathus	Jawfish, Swordtail	18	SH	RF
LOPHIOD	Lophiodes sp	Goosefish (Genus)	18	SH	RF
LOPHIODRETICU	Lophiodes reticulatus	Goosefish, Reticulated	18	SH	RF
LOPHIUSAMERIC	Lophius americanus	Goosefish	18	SH	
LOPHIUSGASTRO	Lophius gastrophysus	Goosefish, Blackfin	18	SH	
LOPHOLACHAMAE	Lopholatilus chamaeleonticeps	Tilefish	1		RF
LUCINIDAE	Lucinidae	Lucinid Shell (Family)	11	SH	
LUIDIA ALTERN	Luidia alternata	Seastar, Limp or Weak	99	SH	

GenSp	Scientific	Common	MeasCode	Fishery
LUIDIA CLATHR	Luidia clathrata	Seastar, Slender	14	SH
LUIDIA SENEGA	Luidia senegalensis	Seastar, 9-armed	15	SH
LUTJANIDAE	Lutjanidae	Snapper (Family)	1	SH RF
LUTJANU	Lutjanus sp	Snapper (Genus)	1	SH RF
LUTJANUANALIS	Lutjanus analis	Snapper, Mutton	1	SH RF
LUTJANUAPODUS	Lutjanus apodus	Schoolmaster	1	RF
LUTJANUBUCCAN	Lutjanus buccanella	Snapper, Blackfin	1	RF
LUTJANUCAMPEC	Lutjanus campechanus	Snapper, Red	1	SH RF
LUTJANUCYANOP	Lutjanus cyanopterus	Snapper, Cubera	1	SH RF
LUTJANUGRISEU	Lutjanus griseus	Snapper, Gray	1	SH RF
LUTJANUJOCU	Lutjanus jocu	Snapper, Dog	1	SH RF
LUTJANUSYNAGR	Lutjanus synagris	Snapper, Lane	1	SH RF
LUTJANUVIVANU	Lutjanus vivanus	Snapper, Silk	1	RF
LYSIOSQSCABRI	Lysiosquilla scabricauda	Spring Tailed Mantis Shrimp	3	SH
LYSMATAWURDEM	Lysmata wurdemanni	Shrimp, Peppermint	3	SH
LYTECHIVARIEG	Lytechinus variegatus	Urchin, Variable	20	SH
MACOMA	Macoma	Bivalve (Genus)	11	SH
MACROCAMACULA	Macrocallista maculata	Clam, Calico	11	SH
MACROCOSUBPAR	Macrocoeloma subparallelum	Crab, Sponge Spider	6	SH
MACROCOTRISPI	Macrocoeloma trispinosum	Crab, Spongy Decorator	6	SH
MACROUR	Macrouridae	Grenadier (Family)	18	SH
MAJIDAE	Majidae	Crab, Spider (Family)	6	SH
MALACANPLUMIE	Malacanthus plumieri	Tilefish, Sand	1	RF
MALACANTHIDAE	Malacanthidae	Tilefish (Family)	1	SH RF
MALACLETERRAP	Malaclemys terrapin	Terrapin, Diamondback	99	SH
MALACOCCLAEVIS	Malacocephalus laevis	Softhead Grenadier	18	SH
MALACORASENTA	Malacoraja senta	Skate, Smooth	22	RF
MALACORSENTA	Malacoraja senta	Skate, Smooth	22	SH
MANTA BIROST	Manta birostris	Ray, Giant Manta	22	SH RF
MEGALOPATLANT	Megalops atlanticus	Tarpon	18	SH RF
MELANOSTOMIID	Melanostomiidae	Scaless dragonfish (Family)	18	SH
MELLITAQUINQU	Mellita quinquiesperforata	Urchin, Keyhole (Sand Dollar)	20	SH
MEMBRASMARTIN	Membras martinica	Silverside, Rough	1	SH RF
MENIDIA	Menidia	Silverside (Genus)	1	SH RF
MENIDIABERYLL	Menidia beryllina	Inland Silverside	1	SH RF
MENIDIAMENIDI	Menidia menidia	Silverside, Atlantic	1	SH RF
MENIDIAPENINS	Menidia peninsulae	Silverside, Tidewater	1	SH RF
MENIPPEMERCEN	Menippe mercenaria	Crab, Florida Stone	5	SH
MENTICI	Menticirrhus sp	Drum, Kingfish (Genus)	18	SH RF
MENTICIAMERIC	Menticirrhus americanus	Kingfish, Southern	18	SH RF
MENTICILITTOR	Menticirrhus littoralis	Kingfish, Gulf	18	SH RF
MENTICISAXATI	Menticirrhus saxatilis	Kingfish, Northern	18	SH RF
MEOMA VENTRI	Meoma ventricosa	Urchin, Cake	20	SH
MERCENA	Mercenaria sp	Clam (Genus)	11	SH
MERCENACAMPEC	Mercenaria campechiensis	Quahog, Southern	11	SH
MERLUCCALBIDU	Merluccius albidus	Hake, Offshore	18	SH RF
METOPORCALCAR	Metoporphapis calcarata	Crab, False Arrow	6	SH
MICROPASCULPT	Micropanope sculptipes	Crab, Sculptured Mud	5	SH

GenSp	Scientific	Common	MeasCode	Fishery
MICROPHBICORN	<i>Microphrys bicornutus</i>	Crab, Decorator	6	SH
MICROPHBRACHY	<i>Microphis brachyurus</i>	Pipefish, Opossum	18	SH RF
MICROPOUNDULA	<i>Micropogonias undulatus</i>	Croaker, Atlantic	18	SH RF
MITHRAX	<i>Mithrax</i>	Crab, Spider (Genus)	6	SH
MITHRAXFORCEP	<i>Mithrax forceps</i>	Crab, Red-Ridged Clinging	6	SH
MITHRAXSPINOS	<i>Mithrax spinosissimus</i>	Crab, Spiny Spider	6	SH
MOBULA HYPOST	<i>Mobula hypostoma</i>	Ray, Lesser Devil	22	SH
MOBULA MOBULA	<i>Mobula mobular</i>	Ray, Giant Devil	22	SH
MOBULA TARAPA	<i>Mobula tarapacana</i>	Ray, Chilean Devil	22	SH
MOIRA ATROPO	<i>Moira atropos</i>	Urchin, Heart	20	SH
MOLA MOLA	<i>Mola mola</i>	Sunfish, Ocean	18	RF
MOLLUSC	Mollusca	Mollusk (Phylum)	99	SH
MONACAN	<i>Monacanthus sp</i>	Filefish (Genus)	18	SH RF
MONACANCILIAT	<i>Monacanthus ciliatus</i>	Filefish, Fringed	18	SH RF
MONACANSETIFE	<i>Monacanthus setifer</i>	Filefish, Pigmy	18	SH RF
MONACANTUCKER	<i>Monacanthus tuckeri</i>	Filefish, Slender	18	SH RF
MONOLENSESSIL	<i>Monolene sessilicauda</i>	Flounder, Deepwater	18	SH
MORONE AMERIC	<i>Morone americana</i>	Perch, White	1	RF
MUGIL	<i>Mugil sp</i>	Mullet (Genus)	1	RF
MUGIL CEPHAL	<i>Mugil cephalus</i>	Mullet, Striped	1	SH RF
MUGIL CUREMA	<i>Mugil curema</i>	Mullet, White	1	SH RF
MULLIDAE	Mullidae	Goatfish (Family)	1	SH RF
MULLOIDMARTIN	<i>Mulloidichthys martinicus</i>	Goatfish, Yellow	1	SH RF
MULLUS AURATU	<i>Mullus auratus</i>	Goatfish, Red	1	SH RF
MURAENARETIFE	<i>Muraena retifera</i>	Moray, Reticulate	18	RF
MUREX	<i>Murex sp</i>	Shell, Rock (Genus)	17	SH
MUSTELU	<i>Mustelus</i>	Shark, Dogfish	18	SH RF
MUSTELUCANIS	<i>Mustelus canis</i>	Shark, Smooth Dogfish	18	SH RF
MUSTELUNORRIS	<i>Mustelus norrisi</i>	Shark, Florida Smoothhound	18	SH RF
MYCTERO	<i>Mycteroperca</i>	Grouper, (Genus)	1	SH RF
MYCTEROBONACI	<i>Mycteroperca bonaci</i>	Grouper, Black	1	SH RF
MYCTEROINTERS	<i>Mycteroperca interstitialis</i>	Grouper, Yellowmouth	1	RF
MYCTEROMICROL	<i>Mycteroperca microlepis</i>	Gag	1	SH RF
MYCTEROPHENAX	<i>Mycteroperca phenax</i>	Scamp	18	SH RF
MYCTEROVENENO	<i>Mycteroperca venenosa</i>	Grouper, Yellowfin	1	RF
MYCTOPHIDAE	Myctophidae	Lanternfish (Family)	18	SH
MYLIOBAFREMIN	<i>Myliobatis freminvillei</i>	Ray, Bullnose	22	SH RF
MYLIOBAGOODEI	<i>Myliobatis goodei</i>	Ray, Southern Eagle	22	SH RF
MYRIPRIJACOBUS	<i>Myripristis jacobus</i>	Soldierfish, Blackbar	1	SH RF
MYROPHIPUNCTA	<i>Myrophis punctatus</i>	Eel, Speckled Worm	18	RF
MYROPSIQUINQU	<i>Myropsis quinquespinosa</i>	Crab, Fivespine Purse	6	SH
NARCINEBRASIL	<i>Narcine brasiliensis</i>	Ray, Lesser Electric	22	SH RF
NATICID	Naticidae	Shell, Moon (Family)	11	SH
NAUCRATDUCTOR	<i>Naucrates ductor</i>	Pilotfish	1	SH RF
NEGAPRIBREVIR	<i>Negaprion brevirostris</i>	Shark, Lemon	18	SH RF
NEMICHTSCOLOP	<i>Nemichthys scolopaceus</i>	Slender Snipe Eel	18	SH
NEOEPINAMERIC	<i>Neoepinnula americana</i>	Sackfish, American	18	SH
NEOMERIHEMING	<i>Neomerinthe hemingwayi</i>	Scorpionfish, Spinycheek	18	SH RF

GenSp	Scientific	Common	MeasCode	Fishery
NEOSCOPMICROC	Neoscopelus microchir	Shortfin neoscopelid	18	SH
NEOTIA PONDER	Neotia ponderosa	Shell, Ponderosa Ark	11	SH
NETTASTOMATID	Nettastomatidae	Eel, Duckbill (family)	18	SH
NEZUMIABAIRDI	Nezumia bairdii	Marlin-Spike	18	SH RF
NICHOLSUSTA	Nicholsina usta	Parrotfish, Emerald	18	SH RF
NOCATCH	NOCATCH	NOCATCH	99	RF
NUDIBRANCHIA	Nudibranchia	Nudibranch (Order)	99	SH
OCTOCORALLIA	Octocorallia	Coral, Soft (Subclass)	20	SH
OCTOPODA	Octopoda	Octopus (Order)	13	RF
OCTOPUS	Octopus sp	Octopus (Genus)	13	SH RF
OCTOPUSBRIARE	Octopus briareus	Octopus, Caribbean Reef	13	SH
OCTOPUSJUBIN	Octopus joubin	Octopus, Atlantic Pigmy	13	SH
OCTOPUSVULGAR	Octopus vulgaris	Octopus, Common	13	SH RF
OCYURUSCHRYSU	Ocyurus chrysurus	Snapper, Yellowtail	1	SH RF
ODONTOSDENTEX	Odontoscion dentex	Croaker, Reef	18	SH RF
OGCOCEP	Ogcocephalus sp	Batfish (Genus)	18	SH RF
OGCOCEPCORNIG	Ogcocephalus corniger	Batfish, Longnose	18	SH RF
OGCOCEPDECLIV	Ogcocephalus declivirostris	Batfish, Slantbrow	18	SH RF
OGCOCEPNASUTU	Ogcocephalus nasutus	Batfish, Shortnose	18	SH RF
OGCOCEPPANTOS	Ogcocephalus pantostictus	Batfish, Spotted	18	SH RF
OGCOCEPPARVUS	Ogcocephalus parvus	Batfish, Roughback	18	SH RF
OGCOCEPRADIAT	Ogcocephalus radiatus	Batfish, Polkadot	18	SH RF
OLIGOPLSAURUS	Oligoplites saurus	Leatherjacket	1	SH RF
OLIVA RETICU	Oliva reticularis	Olive, Netted	17	SH
OLIVIDA	Olividae	Olive Shell (Family)	17	SH
OPHICH	Ophichthidae	Eel, Snake (Family)	18	SH RF
OPHICHT	Ophichthus sp	Eel, Banded Shrimp	18	RF
OPHICHTGOMESI	Ophichthus gomesi	Eel, Shrimp	18	SH RF
OPHICHTMELANO	Ophichthus melanoporus	Eel, Blackpored	18	RF
OPHICHTOPHIS	Ophichthus ophis	Eel, Spotted Snake	18	SH RF
OPHICHTPUNCTI	Ophichthus puncticeps	Eel, Pale Spotted	18	SH RF
OPHICHTREX	Ophichthus rex	Eel, King Snake	18	SH RF
OPHIDII	Ophidiidae	Cusk-eel (Family)	18	SH RF
OPHIDIOGRAYI	Ophidion grayi	Cusk-eel, Blotched	18	SH RF
OPHIDIOHOLBRO	Ophidion holbrookii	Cusk-eel, Bank	18	SH RF
OPHIDIOJOSEPH	Ophidion josephi	Cusk-eel, Crested	18	SH RF
OPHIDIOMARGIN	Ophidion marginatum	Cusk-eel, Striped	18	RF
OPHIDIOSELENO	Ophidion selenops	Cusk-eel, Mooneye	18	SH RF
OPHIOPHACULEA	Ophiopholis aculeata	Star, Daisy Brittle	14	SH
OPHIURO	Ophiuroidea	Brittle Star (Subclass)	14	SH
OPISTHOGLINU	Opisthonema oglinum	Herring, Atlantic Thread	1	SH RF
OPISTOG	Opistognathus sp	Jawfish, Spotfin	18	SH RF
OPSANUS	Opsanus sp	Toadfish (Genus)	18	RF
OPSANUSBETA	Opsanus beta	Toadfish, Gulf	18	SH RF
OPSANUSPARDUS	Opsanus pardus	Toadfish, Leopard	18	SH RF
OPSANUSTAU	Opsanus tau	Toadfish, Oyster	18	SH RF
OREASTERETICU	Oreaster reticulatus	Starfish, Cushion (Reticulated)	15	SH
ORTHOPRCHRYSO	Orthopristis chrysoptera	Pigfish	1	SH RF

GenSp	Scientific	Common	MeasCode	Fishery	
OSTICHTTRACHY	Ostichthys trachypoma	Soldierfish, Bigeye	1		RF
OTOPHIDOMOSTI	Otophidium omostigma	Cusk-eel, Polka-dot	18	SH	RF
OVALIPE	Ovalipes sp	Crab, Lady (Genus)	5	SH	
OVALIPEFLORID	Ovalipes floridanus	Crab, Florida Lady	5	SH	
OVALIPEGUADUL	Ovalipes guadulpensis	Crab, Lady (w/o spots)	5	SH	
OVALIPEOCELLA	Ovalipes ocellatus	Crab, Lady (w/specks)	5	SH	
PACHYGRGRACIL	Pachygrapsus gracilis	Crab, Wharf	5	SH	
PAGRUS	Pagrus sp	Porgy (Genus)	1	SH	RF
PAGRUS PAGRUS	Pagrus pagrus	Porgy, Red	1	SH	RF
PAGURID	Paguridae	Crab, Right-Handed Hermit (Family)	6	SH	
PAGUROIDEA	Paguroidea	Crab, Hermit (Superfamily)	6	SH	
PAGURUS	Pagurus	Crab, Right-Handed Hermit (Genus)	6	SH	
PAGURUSACADIA	Pagurus acadianus	Crab, Acadian Hermit	6	SH	
PAGURUSPOLLIC	Pagurus pollicaris	Crab, Flat Claw Hermit	6	SH	
PANOPEU	Panopeus sp	Crab, Mud	5	SH	
PANULIRARGUS	Panulirus argus	Lobster, Caribbean Spiny	8	SH	RF
PARACONCAUDIL	Paraconger caudilimbatus	Conger, Margintail	18	SH	RF
PARALEPIDIDAE	Paralepididae	Barracudina (family)	18	SH	
PARALIC	Paralichthys sp	Flounder, Lefteye (Genus)	18	SH	RF
PARALICALBIGU	Paralichthys albigutta	Flounder, Gulf	18	SH	RF
PARALICDENTAT	Paralichthys dentatus	Flounder, Summer	18	SH	RF
PARALICLETHOS	Paralichthys lethostigma	Flounder, Southern	18	SH	RF
PARALICOBLONG	Paralichthys oblongus	Flounder, Fourspot	18		RF
PARALICSQUAMI	Paralichthys squamilentus	Flounder, Broad	18	SH	RF
PARANTHFURCIF	Paranthias furcifer	Creole-Fish	1		RF
PARANTHRAPIFO	Paranthus rapiformis	Onion Anemone	10	SH	RF
PARASUDTRUCUL	Parasudis truculenta	Greeneye, Longnose	18	SH	
PAREQUEUMBROS	Pareques umbrosus	Drum, Cubbyu	18	SH	RF
PARRIBAANTARC	Parribacus antarcticus	Lobster, Sculptured Slipper	8	SH	
PARTHEN	Parthenopidae	Crab, Elbow (Family)	5	SH	
PARTHENPOURTA	Parthenope pourtalesii	Crab, Spinous Elbow	5	SH	
PARTHENSERRAT	Parthenope serrata	Crab, Sawtoothed Elbow	5	SH	
PECTEN RAVENE	Pecten raveneli	Scallop, Ravenel	11	SH	
PECTINI	Pectinidae	Scallop (Family)	12	SH	
PENAEIDAE	Penaeidae	Shrimp, Penaeid (Family)	3	SH	
PENAEUS	Penaeus sp	Shrimp, Penaeid (brown,white, pink)	3	SH	
PENAEUSDISCAR	Penaeus Discard	Shrimp, Discard (brown,white, pink)	99	SH	
PENAEUSMONODO	Penaeus monodon	Shrimp, Tiger	3	SH	
PEPRILU	Peprilus sp	Butterfish (Genus)	1	SH	RF
PEPRILUBURTI	Peprilus burti	Butterfish, Gulf	1	SH	RF
PEPRILUPARU	Peprilus paru	Harvestfish	1	SH	RF
PEPRILUTRIACA	Peprilus triacanthus	Butterfish, Atlantic	1	SH	RF
PERCOPHIDAE	Percophidae	Flathead (Family)	18	SH	
PERISTEBREVIR	Peristedion brevirostre	Searobin, Flathead	18	SH	
PERISTEGRACIL	Peristedion gracile	Searobin, Slender	18	SH	RF
PERISTEMINIAT	Peristedion miniatum	Searobin, Armored	18	SH	RF
PERISTETHOMPS	Peristedion thompsoni	Searobin, Rimspine	18	SH	RF
PERSEPHMEDITE	Persephona mediterranea	Crab, Mottled Purse	6	SH	

GenSp	Scientific	Common	MeasCode	Fishery
PERSEHPUNCTA	Persephona punctata	Crab, Purse	6	SH
PETROCH	Petrochirus	Crab, Left-Handed Hermit (Genus)	6	SH
PETROCHDIOGEN	Petrochirus diogenes	Crab, Giant Hermit	6	SH
PHAEOPTPIGMEN	Phaeoptyx pigmentaria	Cardinalfish, Dusky	1	RF
PHAEOPTXENUS	Phaeoptyx xenus	Cardinalfish, Sponge	1	SH RF
PHALIUMGRANUL	Phalium granulatum	Bonnet, Scotch	17	SH
PHOSICHTHYIDA	Phosichthyidae	Lightfishes (family)	1	SH
PHYCIDAE	Phycidae	Hake (Family)	18	RF
PILUMNU SAYI	Pilumnus sayi	Crab, Spineback Hairy	5	SH
PILUMNUDASYPO	Pilumnus dasypodus	Crab, Brown Hairy Wharf	6	SH
PILUMNUFLORID	Pilumnus floridanus	Crab, Plumed Hairy	5	SH
PINNOTH	Pinnotheres sp	Crab, Pea (Genus)	6	SH
PISCES	Pisces	Fish (Superclass)	99	SH RF
PISCES BAIT	Pisces - Bait Fish	Fish, Miscellaneous Bait	99	RF
PLACOPEMAGELL	Placopecten magellanicus	Scallop, Deep Sea	12	SH
PLECTRYRETROS	Plectrypops retrospinis	Soldierfish, Cardinal	1	RF
PLEOTICDISCAR	Pleoticus discard	Shrimp, Royal Red (Discard)	99	SH
PLEOTICROBUST	Pleoticus robustus	Shrimp, Royal Red	3	SH
PLEURONECTIFO	Pleuronectiformes	Flatfish (Order)	18	SH RF
PODOCHESIDNEY	Podochela sidneyi	Crab, Shortfinger Neck	5	SH
POECILOBEANII	Poecilopsetta beanii	Deepwater dab	18	SH
POGONIACROMIS	Pogonias cromis	Drum, Black	18	SH RF
POLINICDUPLIC	Polinices duplicatus	Shell, Lobed Moon	20	SH
POLYDACOCTONE	Polydactylus octonemus	Threadfin, Atlantic	1	SH RF
POLYMETCORYTH	Polymetme corythaeola	Rendezvous Fish	18	SH
POLYMIX	Polymixiidae	Beardfish (Family)	18	SH
POLYMIXIIDAE	Polymixiidae	Beardfish (Family)	18	RF
POLYMIXNOBILI	Polymixia nobilis	Beardfish, Stout	1	SH RF
POLYODOSPATHU	Polyodon spathula	Paddlefish	1	SH
POMACANARCUAT	Pomacanthus arcuatus	Angelfish, Gray	18	SH RF
POMACANPARU	Pomacanthus paru	Angelfish, French	18	SH RF
POMATOMSALTAT	Pomatomus saltatrix	Bluefish	1	SH RF
PONTINULONGIS	Pontinus longispinis	Scorpionfish, Longspine	18	SH RF
PONTINUS	Pontinus	Scorpionfish (Genus)	18	RF
PORICHT	Porichthys sp	Midshipman/Toadfish (Genus)	18	RF
PORICHTPLECTR	Porichthys plectrodon	Midshipman, Atlantic	18	SH RF
PORIFER	Porifera	Sponge (Phylum)	20	SH
PORTUNI	Portunidae	Crab, Swimming (Family)	5	SH
PORTUNU	Portunus sp	Crab, Swimming (Genus)	5	SH
PORTUNUDEPRES	Portunus depressifrons	Crab, Flatface Swimming	5	SH
PORTUNUGIBBES	Portunus gibbesii	Crab, Iridescent Swimming	5	SH
PORTUNUSAYI	Portunus sayi	Crab, Sargassum	5	SH
PORTUNUSPINIC	Portunus spinicarpus	Crab, Longspine Swimming	5	SH
PORTUNUSPINIM	Portunus spinimanus	Crab, Blotched Swimming	5	SH
PRIACANARENAT	Priacanthus arenatus	Bigeye	1	SH RF
PRIONOT	Prionotus sp	Searobin (Genus)	18	SH RF
PRIONOTALATUS	Prionotus alatus	Searobin, Spiny	18	SH RF
PRIONOTCAROLI	Prionotus carolinus	Searobin, Northern	18	SH RF

GenSp	Scientific	Common	MeasCode	Fishery	
PRIONOTEVOLAN	Prionotus evolans	Searobin, Striped	18	SH	RF
PRIONOTLONGIS	Prionotus longispinosus	Searobin, Bigeye (Blackfin)	18	SH	RF
PRIONOTMARTIS	Prionotus martis	Searobin, Barred	18	SH	RF
PRIONOTOPHRYA	Prionotus ophryas	Searobin, Bandtail	18	SH	RF
PRIONOTPARALA	Prionotus paralatus	Searobin, Mexican	18	SH	RF
PRIONOTROSEUS	Prionotus roseus	Searobin, Bluespotted	18	SH	RF
PRIONOTRUBIO	Prionotus rubio	Searobin, Blackwing	18	SH	RF
PRIONOTSCITUL	Prionotus scitulus	Searobin, Leopard	18	SH	RF
PRIONOTSTEARNS	Prionotus stearnsi	Searobin, Shortwing	18	SH	RF
PRIONOTTRIBUL	Prionotus tribulus	Searobin, Bighead	18	SH	RF
PRISTIGALTA	Pristigenys alta	Bigeye, Short	1	SH	RF
PRISTIPAQUILO	Pristipomoides aquilonaris	Wenchman	1	SH	RF
PRISTIPMACROP	Pristipomoides macrophthalmus	Snapper, Cardinal	1		RF
PROGNICGIBBIF	Prognichthys gibbifrons	Flyingfish, Bluntnose	1		RF
PROMETHPROMET	Promethichthys prometheus	Roudi escolar	1	SH	
PSEUDOMNIMIUS	Pseudomyrophis nimius	Eel, Elongate Worm	18	SH	
PSEUDUPMACULA	Pseudupeneus maculatus	Goatfish, Spotted	1	SH	RF
PTEROIS	PTEROIS	Lionfish Genus	18	SH	RF
PTEROISANTENN	Pterois antennata	Lionfish, Banded	18		RF
PTEROISVOLITA	Pterois volitans	Lionfish, Red	18	SH	RF
PTEROPLVIOLAC	Pteroplatytrygon violacea	Stingray, Pelagic	22	SH	RF
PYCNOGONIDA	Pycnogonida	Seaspiders (Class)	99	SH	
RACHYCECANADU	Rachycentron canadum	Cobia, Ling	1	SH	RF
RAJA	Raja	Skate (Genus)	22	SH	RF
RAJA EGLANT	Raja eglanteria	Skate, Clearnose	22	SH	RF
RAJA TEXANA	Raja texana	Skate, Roundel	22	SH	RF
RAJIDAE	Rajidae	Skate (Family)	22	SH	RF
RAJIFORMES	Rajiformes	Skate and Ray (Order)	99	SH	RF
RANINOILOUISI	Raninoides louisianensis	Crab, Gulf Frog	5	SH	
REMORA REMORA	Remora remora	Remora	18	SH	RF
RENILLA	Renilla	Sea Pansy	20	SH	
RHINOBALENTIG	Rhinobatos lentiginosus	Guitarfish, Atlantic	18	SH	RF
RHINOPTBONASU	Rhinoptera bonasus	Ray, Cownose	22	SH	RF
RHIZOPRTERRAE	Rhizoprionodon terraenovae	Shark, Atlantic Sharpnose	18	SH	RF
RHOMBOPAURORU	Rhomboplites aurorubens	Snapper, Vermillion (B-liner)	1	SH	RF
RUVETTUPRETIO	Ruvettus pretiosus	Oilfish	1	SH	RF
RYPTICUMACULA	Rypticus maculatus	Soapfish, Whitespotted	18	SH	RF
RYPTICUSAPONA	Rypticus saponaceus	Soapfish, Greater	18		RF
RYPTICUSUBBIF	Rypticus subbifrenatus	Soapfish, Spotted	18		RF
SARDA SARDA	Sarda sarda	Atlantic bonito	1		RF
SARDINE	Sardinella sp	Herring (Genus)	1	SH	RF
SARDINEAURITA	Sardinella aurita	Sardine, Spanish	1	SH	RF
SARDINEBRASIL	Sardinella brasiliensis	Sardine, Orange Spot	1	SH	RF
SARGOCEBULLIS	Sargocentron bullisi	Squirrelfish, Deepwater	1		RF
SAURENCCOGNIT	Saurenchelys cognita	Eel, Longface	18	SH	
SAURIDABRASIL	Saurida brasiliensis	Lizardfish, Largescale	1	SH	RF
SAURIDACARIBB	Saurida caribbaea	Lizardfish, Smallscale	1	SH	RF
SAURIDANORMAN	Saurida normani	Lizardfish, Shortjaw	1	SH	RF

GenSp	Scientific	Common	MeasCode	Fishery	
SCARIDAE	Scaridae	Parrotfish (Family)	1	SH	RF
SCARTELCRISTA	Scartella cristata	Miller, Molly	18		RF
SCARUS VETULA	Scarus vetula	Parrotfish, Queen	1	SH	RF
SCHIZOPORELLA	Schizoporella	Bryosoan (Genus)	20	SH	
SCHIZOPPUNGEN	Schizoporella pungens	Bryozoan, Gulf Staghorn	20	SH	
SCHULTZBETA	Schultzea beta	Bass, School	1	SH	RF
SCIAENI	Sciaenidae	Drum (Family)	99	SH	RF
SCIAENOOCELLA	Sciaenops ocellatus	Drum, Red	18	SH	RF
SCLERODBRIARE	Sclerodactyla briareus	Hairy Sea Cucumber	20	SH	RF
SCOMBER	Scomberomorus	Mackerel (genus)	1	SH	RF
SCOMBERCAVALL	Scomberomorus cavalla	Mackerel, King	1	SH	RF
SCOMBERJAPONI	Scomber japonicus	Mackerel, Chub	1	SH	RF
SCOMBERMACULA	Scomberomorus maculatus	Mackerel, Spanish	1	SH	RF
SCOMBERMACULA	Scomberomorus maculatus	Mackerel, Spanish	1		
SCOMBERSCOMBR	Scomber scombrus	Mackeral, Atlantic	1	SH	RF
SCOMBRIDAE	Scombridae	Mackerel (Family)	1	SH	RF
SCOMBROOCULAT	Scombrops oculatus	Atlantic Scombrops	1	SH	
SCOPHTHAQUOSU	Scophthalmus aquosus	Windowpane	18	SH	RF
SCORPAE	Scorpaena sp	Scorpionfish	18	SH	RF
SCORPAEAGASSI	Scorpaena agassizi	Scorpionfish, Longfin	18	SH	RF
SCORPAEBERGII	Scorpaena bergii	Scorpionfish, Goosehead	18		RF
SCORPAEBRACHY	Scorpaena brachyptera	Scorpionfish, Shortfin	18	SH	RF
SCORPAEBRASIL	Scorpaena brasiliensis	Barbfish	18	SH	RF
SCORPAECALCAR	Scorpaena calcarata	Scorpionfish, Smoothead	18	SH	RF
SCORPAECARIBB	Scorpaenodes caribbaeus	Scorpionfish, Reef	18	SH	RF
SCORPAEDISPAR	Scorpaena dispar	Scorpionfish, Hunchback	18	SH	RF
SCORPAEGRANDI	Scorpaena grandicornis	Scorpionfish, Plumed	18	SH	RF
SCORPAEISTHME	Scorpaena isthmensis	Scorpionfish, Smoothcheek	18	SH	RF
SCORPAEPLUMIE	Scorpaena plumieri	Scorpionfish, Spotted	18	SH	RF
SCYLIIORRETIFE	Scyliorhinus retifer	Dogfish, Chain	18	SH	RF
SCYLLAR	Scyllarides	Lobster, Slipper (Genus)	8	SH	
SCYLLARAEQUIN	Scyllarides aequinoctialis	Lobster, Spanish Slipper	8	SH	
SCYLLARCHACEI	Scyllarus chacei	Lobster, Slipper	8	SH	
SCYLLARIDAE	Scyllaridae	Lobster, Slipper (Family)	8	SH	
SCYLLARNODIFE	Scyllarides nodifer	Lobster, Ridged Slipper	8	SH	
SCYPHOZ	Scyphozoa	Jellyfish (Class)	99	SH	
SELAR CRUMEN	Selar crumenophthalmus	Scad, Bigeye	1	SH	RF
SELENE SETAPI	Selene setapinnis	Moonfish, Atlantic	1	SH	RF
SELENE VOMER	Selene vomer	Lookdown	1	SH	RF
SEPIOLIDAE	Sepiolidae	Bobtail Squid (Family)	13	SH	
SERIOLA	Seriola sp	Jack (Genus)	1		RF
SERIOLADUMERI	Seriola dumerili	Amberjack, Greater	1	SH	RF
SERIOLAFASCIA	Seriola fasciata	Amberjack, Lesser	1	SH	RF
SERIOLARIVOLI	Seriola rivoliana	Jack, Almaco	1		RF
SERIOLAZONATA	Seriola zonata	Rudderfish, Banded	1	SH	RF
SERRANIDAE	Serranidae	Sea Bass (Family)	2	SH	RF
SERRANIPUMILI	Serraniculus pumilio	Seabass, Pygmy	2	SH	RF
SERRANU	Serranus	Sea Bass (Genus)	2	SH	RF

GenSp	Scientific	Common	MeasCode	Fishery	
SERRANUATROBR	<i>Serranus atrobranchus</i>	Seabass, Blackear	2	SH	RF
SERRANUNOTOSP	<i>Serranus notospilus</i>	Bass, Saddle	2		RF
SERRANUPHOEBE	<i>Serranus phoebe</i>	Tattler	1		RF
SETARCHGUENTH	<i>Setarches guentheri</i>	Rockfish, Channeled	18	SH	
SICYONI	<i>Sicyonia</i> sp	Shrimp, Rock (Genus)	3	SH	
SICYONIBREVIR	<i>Sicyonia brevirostris</i>	Shrimp, Brown Rock	3	SH	
SICYONIDISCAR	<i>Sicyonia</i> Discards	Shrimp, Rock (Discards)	3	SH	
SICYONITYPICA	<i>Sicyonia typica</i>	Shrimp, Kinglet Rock	3	SH	
SINUM PERSPE	<i>Sinum perspectivum</i>	Common Baby's Ear	17	SH	
SOLENOCERIDAE	Solenoceridae	Shrimp, Solenocetid (Family)	3	SH	
SPARIDA	Sparidae	Porgie (Family)	99	SH	RF
SPARISOAUROFR	<i>Sparisoma aurofrenatum</i>	Parrotfish, Redband	99		RF
SPARISORADIAN	<i>Sparisoma radians</i>	Parrotfish, Bucktooth	18		RF
SPARISORUBRIP	<i>Sparisoma rubripinne</i>	Parrotfish, Redfin	18	SH	RF
SPATANGOIDA	Spatangoida	Heart Urchin (Order)	20	SH	
SPHAEROQUADRI	<i>Sphaeroma quadridentatum</i>	Sea Pill Bug	20	SH	
SPHOERO	<i>Sphoeroides</i> sp	Pufferfish (Genus)	18	SH	RF
SPHOERODORSAL	<i>Sphoeroides dorsalis</i>	Pufferfish, Marbled	18	SH	RF
SPHOEROMACULA	<i>Sphoeroides maculatus</i>	Pufferfish, Northern	18	SH	RF
SPHOERONEPHEL	<i>Sphoeroides nephelus</i>	Pufferfish, Southern	18	SH	RF
SPHOEROPACHYG	<i>Sphoeroides pachygaster</i>	Pufferfish, Blunthead	18	SH	RF
SPHOEROPARVUS	<i>Sphoeroides parvus</i>	Pufferfish, Least	18	SH	RF
SPHOEROSPENGL	<i>Sphoeroides spengleri</i>	Pufferfish, Bandtail	18	SH	RF
SPHOEROTESTUD	<i>Sphoeroides testudineus</i>	Pufferfish, Checkered	18	SH	RF
SPHYRAE	<i>Sphyaena</i> sp	Barracuda (Genus)	1	SH	RF
SPHYRAEBARRAC	<i>Sphyaena barracuda</i>	Barracuda, Great	1	SH	RF
SPHYRAEBOREAL	<i>Sphyaena borealis</i>	Sennet, Northern	1	SH	RF
SPHYRAEGUACHA	<i>Sphyaena guachancho</i>	Guaguanche	1	SH	RF
SPHYRAEPICUDI	<i>Sphyaena picudilla</i>	Sennet, Southern	1	SH	RF
SPHYRNA	<i>Sphyrna</i> sp	Shark, Hammerhead (Genus)	18	SH	RF
SPHYRNALEWINI	<i>Sphyrna lewini</i>	Shark, Hammerhead Scalloped	18	SH	RF
SPHYRNAMOKARR	<i>Sphyrna mokarran</i>	Shark, Great Hammerhead	18	SH	RF
SPHYRNATIBURO	<i>Sphyrna tiburo</i>	Shark, Bonnethead	18	SH	RF
SQUALIDAE	Squalidae	Dogfish (Family)	18	SH	RF
SQUALIFORMES	Squaliformes	Shark, Dogfish (Order)	18	SH	RF
SQUALUS	<i>Squalus</i>	Dogfish (Genus)	18		RF
SQUALUSACANTH	<i>Squalus acanthias</i>	Dogfish, Spiny	18	SH	RF
SQUALUSCUBENS	<i>Squalus cubensis</i>	Dogfish, Cuban	18	SH	RF
SQUALUSMITSUK	<i>Squalus mitsukurii</i>	Dogfish, Shortspine	18	SH	RF
SQUATINDUMERI	<i>Squatina dumeril</i>	Shark, Angel	18	SH	RF
SQUILLA	<i>Squilla</i> sp	Shrimp, Mantis (Genus)	3	SH	RF
SQUILLAEMPUSA	<i>Squilla empusa</i>	Shrimp, Mantis (empusa species)	3	SH	
SQUILLANEGLEC	<i>Squilla neglecta</i>	Shrimp, Mantis (neglecta species)	3	SH	
STEINDAARGENT	<i>Steindachneria argentea</i>	Hake, Luminous	18	SH	RF
STELLEROIDEA	Stelleroidea	Starfish (Class)	15	SH	
STELLIFLANCEO	<i>Stellifer lanceolatus</i>	Drum, Star	18	SH	RF
STENOCIFURCAT	<i>Stenocionops furcatus</i>	Crab, Furcate Spider	6	SH	
STENOCISPINOS	<i>Stenocionops spinosissimus</i>	Crab, Tenspine Spider	6	SH	

GenSp	Scientific	Common	MeasCode	Fishery	
STENORHSETICO	<i>Stenorhynchus seticornis</i>	Crab, Yellowline Arrow	6	SH	
STENOTOCAPRIN	<i>Stenotomus caprinus</i>	Porgy, Longspine	1	SH	RF
STENOTOCHRYSO	<i>Stenotomus chrysops</i>	Scup	1	SH	RF
STEPHANHISPID	<i>Stephanolepis hispidus</i>	Filefish, Planehead	18	SH	RF
STERNOPTYCHID	Sternoptychidae	Hatchetfish (Family)	18	SH	
STOMATOPODA	Stomatopoda	Shrimp, Mantis (Order)	3	SH	
STOMIAS	Stomias	Dragonfish genus	1	SH	
STOMOLOMELEAG	<i>Stomolophus meleagris</i>	Jellyfish, Cannonball	99	SH	
STRAMONHAEMAS	<i>Stramonita haemastoma</i>	Shell, Rock	17	SH	
STROMBU	<i>Strombus</i> sp	Conch (Genus)	17	SH	
STROMBUALATUS	<i>Strombus alatus</i>	Conch, Florida Fighting	99	SH	
STRONGYMARINA	<i>Strongylura marina</i>	Needlefish, Atlantic	1	SH	RF
STYGNOBLATEBR	<i>Stygnobrotula latebricola</i>	Brotula, Black	18	SH	RF
SYACIUM	<i>Syacium</i> sp	Flounder, Left-eye (Genus)	18	SH	RF
SYACIUMGUNTER	<i>Syacium gunteri</i>	Flounder, Shoal	18	SH	RF
SYACIUMPAPILL	<i>Syacium papillosum</i>	Flounder, Dusky	18	SH	RF
SYMPHUR	<i>Symphurus</i> sp	Tonguefish (Genus)	18	SH	RF
SYMPHURARAWAK	<i>Symphurus arawak</i>	Tonguefish, Caribbean	18	SH	RF
SYMPHURCIVITA	<i>Symphurus civitatum</i>	Tonguefish, Offshore	18	SH	RF
SYMPHURDIOMED	<i>Symphurus diomedeanus</i>	Tonguefish, Spottedfin	18	SH	RF
SYMPHURMINOR	<i>Symphurus minor</i>	Tonguefish, Largescale	18	SH	
SYMPHURNEBULO	<i>Symphurus nebulosus</i>	Tonguefish, Freckled	18	SH	RF
SYMPHURPARVUS	<i>Symphurus parvus</i>	Tonguefish, Pygmy	18	SH	RF
SYMPHURPELICA	<i>Symphurus pelicanus</i>	Tonguefish, Longtail	18	SH	RF
SYMPHURPIGER	<i>Symphurus piger</i>	Tonguefish, Deepwater	18	SH	RF
SYMPHURPLAGIU	<i>Symphurus plagiosa</i>	Tonguefish, Blackcheek	18	SH	RF
SYMPHURUROSPI	<i>Symphurus urospilus</i>	Tonguefish, Spottail	18	SH	RF
SYNAGROBELLUS	<i>Synagrops bellus</i>	Bass, Blackmouth	1	SH	
SYNGNAT	Syngnathidae	Pipefish (Family)	18	SH	RF
SYNGNATFUSCUS	<i>Syngnathus fuscus</i>	Pipefish, Northern	18	SH	RF
SYNGNATLOUISI	<i>Syngnathus louisianae</i>	Pipefish, Chain	18	SH	RF
SYNGNATSCOVEL	<i>Syngnathus scovelli</i>	Pipefish, Gulf	18		RF
SYNODON	Synodontidae	Lizardfish (Family)	1	SH	RF
SYNODUSFOETEN	<i>Synodus foetens</i>	Lizardfish, Inshore	1	SH	RF
SYNODUSINTERM	<i>Synodus intermedius</i>	Sand Diver	1	SH	RF
SYNODUSPOEYI	<i>Synodus poeyi</i>	Lizardfish, Offshore	1	SH	RF
SYNODUSSYNODU	<i>Synodus synodus</i>	Lizardfish, Red	1	SH	RF
TAGELUSPLEBEI	<i>Tagelus plebeius</i>	Tagel, Stout	11	SH	
TARACTILONGIP	<i>Taractichthys longipinnis</i>	Pomfret, Big Scale	1		RF
TETRAODONTIDA	Tetraodontidae	Puffer (Family)	18	SH	RF
TEUTHOIDEA	Teuthoidea	Squid (Order)	13	SH	
THUNNUS	<i>Thunnus</i> sp	Tuna (Genus)	1		RF
THUNNUSALBACA	<i>Thunnus albacares</i>	Tuna, Yellowfin	1		RF
THUNNUSATLANT	<i>Thunnus atlanticus</i>	Tuna, Blackfin	1		RF
THUNNUSOBESUS	<i>Thunnus obesus</i>	Big Eye Tuna	1		RF
THYONELGEMMAT	<i>Thyonella gemmata</i>	Sea Cucumber, Stripped	20	SH	
TONNA GALEA	<i>Tonna galea</i>	Tun, Giant	17	SH	
TONNA MACULO	<i>Tonna maculosa</i>	Tun, Atlantic Partridge	17	SH	

GenSp	Scientific	Common	MeasCode	Fishery	
TORPEDONOBILI	<i>Torpedo nobiliana</i>	Torpedo, Atlantic	22	SH	RF
TRACHIN	<i>Trachinotus</i> sp	Jack (Genus)	1		RF
TRACHINCAROLI	<i>Trachinotus carolinus</i>	Pompano, Florida	1	SH	RF
TRACHINFALCAT	<i>Trachinotus falcatus</i>	Permit	1	SH	RF
TRACHINMYOPS	<i>Trachinocephalus myops</i>	Snakefish	1	SH	RF
TRACHURLATHAM	<i>Trachurus lathami</i>	Scad, Rough	1	SH	RF
TRACHYP	<i>Trachypenaeus</i> sp	Shrimp, Sugar/Blood	3	SH	
TRICHIULEPTUR	<i>Trichiurus lepturus</i>	Cutlassfish, Atlantic	23	SH	RF
TRICHOPVENTRA	<i>Trichopsetta ventralis</i>	Flounder, Sash	18	SH	RF
TRIGLIDAE	Triglidae	Searobin (Family)	18	SH	RF
TRINECTINSCRI	<i>Trinectes inscriptus</i>	Sole, Scrawled	18	SH	RF
TRINECTMACULA	<i>Trinectes maculatus</i>	Hogchoker	18	SH	RF
TRIPNEUVENTRI	<i>Tripneustes ventricosus</i>	Sea Egg (Urchin)	20	SH	
TYLOSURCROCOD	<i>Tylosurus crocodilus</i>	Houndfish	1		RF
UMBRINACOROID	<i>Umbrina coroides</i>	Drum, Sand	18	SH	RF
UNKNOWC	Unknowc	Unknown Crustacean	99	SH	
UNKNOWF	Unknowf	Unknown Fish	99	SH	RF
UNKNOWI	Unknowi	Unknown Invertebrate	99	SH	
UNKNOWN	Unknown	Unknown Matter	99	SH	
UPENEUSPARVUS	<i>Upeneus parvus</i>	Goatfish, Dwarf	1	SH	RF
URANOSCOPIDAE	Uranoscopidae	Stargazer (Family)	18	SH	RF
URASPISSECUND	<i>Uraspis secunda</i>	Jack, Cottonmouth	1		RF
UROCHOR	Urochordata	Tunicate (Phylum)	20	SH	
UROCONGSYRING	<i>Uroconger syringinus</i>	Conger, Threadtail	18		RF
UROLOPHJAMAIC	<i>Urolophus jamaicensis</i>	Stingray, Yellow	22	SH	RF
UROPHYC	<i>Urophycis</i> sp	Hake (Genus)	18	SH	RF
UROPHYCCIRRAT	<i>Urophycis cirrata</i>	Hake, Gulf	18	SH	RF
UROPHYCEARLLI	<i>Urophycis earlli</i>	Hake, Carolina	18		RF
UROPHYCFLORID	<i>Urophycis floridana</i>	Hake, Southern	18	SH	RF
UROPHYCREGIA	<i>Urophycis regia</i>	Hake, Spotted	18	SH	RF
USEATURTLE	Unidentified Sea Turtle	Unidentified Sea Turtle	20	SH	
VENERID	Veneridae	Clam, Hardshell (Family)	11	SH	
XANTHICRINGEN	<i>Xanthichthys ringens</i>	Triggerfish, Sargassum	18	SH	RF
XANTHID	Xanthidae	Crab, Xanthid (Family)	5	SH	
XENODERCOPEI	<i>Xenodermichthys copei</i>	Bluntsnouth smooth-head	18	SH	
XENOLEPDALGLE	<i>Xenolepidichthys dalgleishi</i>	Tinselfish, Spotted	18	SH	
XIPHIASGLADIU	<i>Xiphias gladius</i>	Swordfish	24		RF
XIPHOPENKROYER	<i>Xiphopenaeus kroyeri</i>	Shrimp, Sea Bob	3	SH	
XYRICHTNOVACU	<i>Xyrichtys novacula</i>	Razorfish, Pearly	18	SH	RF
ZALIEUTMCGINT	<i>Zalieutes mcgintyi</i>	Batfish, Tricorn	99	SH	RF
ZENION HOLOLE	<i>Zenion hololepis</i>	Dory, Dwarf	18	SH	
ZENOPSISCONCHI	<i>Zenopsis conchifer</i>	Silvery John dory	18	SH	

SECTION 7

APPENDICES

APPENDIX 1

United States Coast Guard Vessel Safety Decal

Commercial Fishing Vessel Safety EXAMINATION

VESSEL

Documented

Undocumented

OPERATIONS

Cold Waters

Warm Waters

Inside Boundary Line

Beyond Boundary Line

FROM COASTLINE

< 3 NM

< 12 NM

< 20 NM

< 50 NM

> 50 NM

> 100 NM



EXPIRES

2009

2010

2011

2012

JAN	JUL
FEB	AUG
MAR	SEP
APR	OCT
MAY	NOV
JUN	DEC

THIS VESSEL MEETS ALL
USCG COMMERCIAL
FISHING INDUSTRY
VESSEL REGULATIONS
FOR OPERATING
AREAS AS MARKED

NO.

CG-5587A
(Rev. 6/08)

U.S. Department of Homeland Security

This decal is mandatory on all vessels carrying NMFS observers.

APPENDIX 2

UPDATED 1/2020

NMFS Galveston Contacts

Elizabeth Scott-Denton - Program manager

Office: 409-766-3571 Cell (Winston): 713-248-4883
Cell: 409-771-5954 Elizabeth.Scott-Denton@noaa.gov

Pat Cryer

Office: 409-766-3525 * ** answering machine location*
Govt Cell: 409-682-2447 Pat.Cryer@noaa.gov

Mike Harrelson

Office: 409-766-3450 Mike.Harrelson@noaa.gov
Personal Cell: 409-789-5976

Kayla Chapman

Office: 409-766-3451 Kayla.Chapman@noaa.gov
Govt Cell: 774-836-4948

Ellen Sikes

Office: 409-766-3527 Ellen.Sikes@noaa.gov
Govt Cell: 409-682-3187

Jason Williams

Office: 409-766-3451 Jason.Williams@noaa.gov
Govt Cell: 409-692-3937

Lab Fax#

Main # for Obs: 409-766-3489
Alternate #: 409-766-3508

Farron Wallace - Laboratory Director

Office: 409-766-3500
Sat Phone: 8816-325-33513
Cell: 409-682-1834

Deputy Director

Office: 305-361-4284
Cell: 786-239-0309

Clay Porch - Center Director

Office: 305-361-4264
Cell: 305-389-2395

VMS Contacts (After Hours Call NOAA Enforcement)

Southeast Division VMS
1-800-758-4833

Note: VMS Emails are charged to vessel owner

Federal Enforcement and Re NOAA/NMFS Enforcement (OLE)

24/7 NOAA Fisheries Enforcement Hotline: 800-853-1964
OLE Mainline: 727-824-5344
Special Agent Kelly Kalamus
Office: 727-824-5344
Cell: 727-423-5797
Matt Walia (Enforcement Technician/Observer Program Liaison)
Office: 727-824-5334

A.I.S. Inc**Rebecca Hailey - Project Manager**

Work Cell: 774-392-3434
email: rebecaha@aisobservers.com

Jason Dean - Assistant Project Manager

Work Cell: 774-392-2267
email: Jasond@aisobservers.com

Michael Bradley - Logistics Coordinator

Work Cell: 774-392-6393
email: michaelb@aisobservers.com

Mailing address:

A.I.S. Inc.
540 Hawthorn St.
North Dartmouth, MA 02747
Office: 508-990-9054
Fax: 508-990-9055

State Fish & Wildlife Enforcement Dept

Texas: 512-389-4848 Dispatch 24 hrs
Louisiana: 985-447-0821 7:00 am - 3:00 am
Mississippi: 800-237-6278
Alabama: 800-272-4263 Enforcement (M-F)
Ryan Bennett, Lieutenant
Florida: 888-404-3922 Dispatch 24 hrs
Georgia: 770-918-6408 Enforcement (M-F)
770-918-6406 GA Fisheries Management
S Carolina: 800-922-5431 Enforcement 24 hrs
N Carolina: 800-662-7137 Dispatch 24 hrs
Check state permit for collected specimen report numbers

US Coast Guard

Houston/Galveston Area: 713-678-9057 Dispatch 24 hrs
Galveston Officer of the Day: 409-682-0142

District 8 Commander (W. GOM to Apalachicola, FL)

New Orleans: 504-589-6225 Command Center 24 hrs

District 7 Commander (Rest of Florida and SE Coast)

Miami: 305-415-6800 Command Center 24 hrs

APPENDIX 3

Chapter 2 Observer Status Codes

All observers are required to report in to their coordinators on a regular basis while offshore. The call-in dates will be determined during the observer-training workshop. The main reason for these call-ins is to ensure the safety and well-being of the observer. When your coordinator answers the phone, he or she will ask for the observer status code. The codes allow the observer to report his or her status without alerting anyone on the vessel about what you are reporting. These codes and descriptions are listed below:

001 All is ok (Self-explanatory).

666 Alert to a bad situation (This code should be used to alert the lab that a situation exist that could lead to possible removal of the observer, but at present not "life threatening" (i. e. illegal gear operation, observer sick and could get worse, or harassment from the crew or captain).

999 Get observer off the boat "NOW" (Use this code to inform the coordinator of a situation where the observer feels his or her life is endangered).

APPENDIX 4

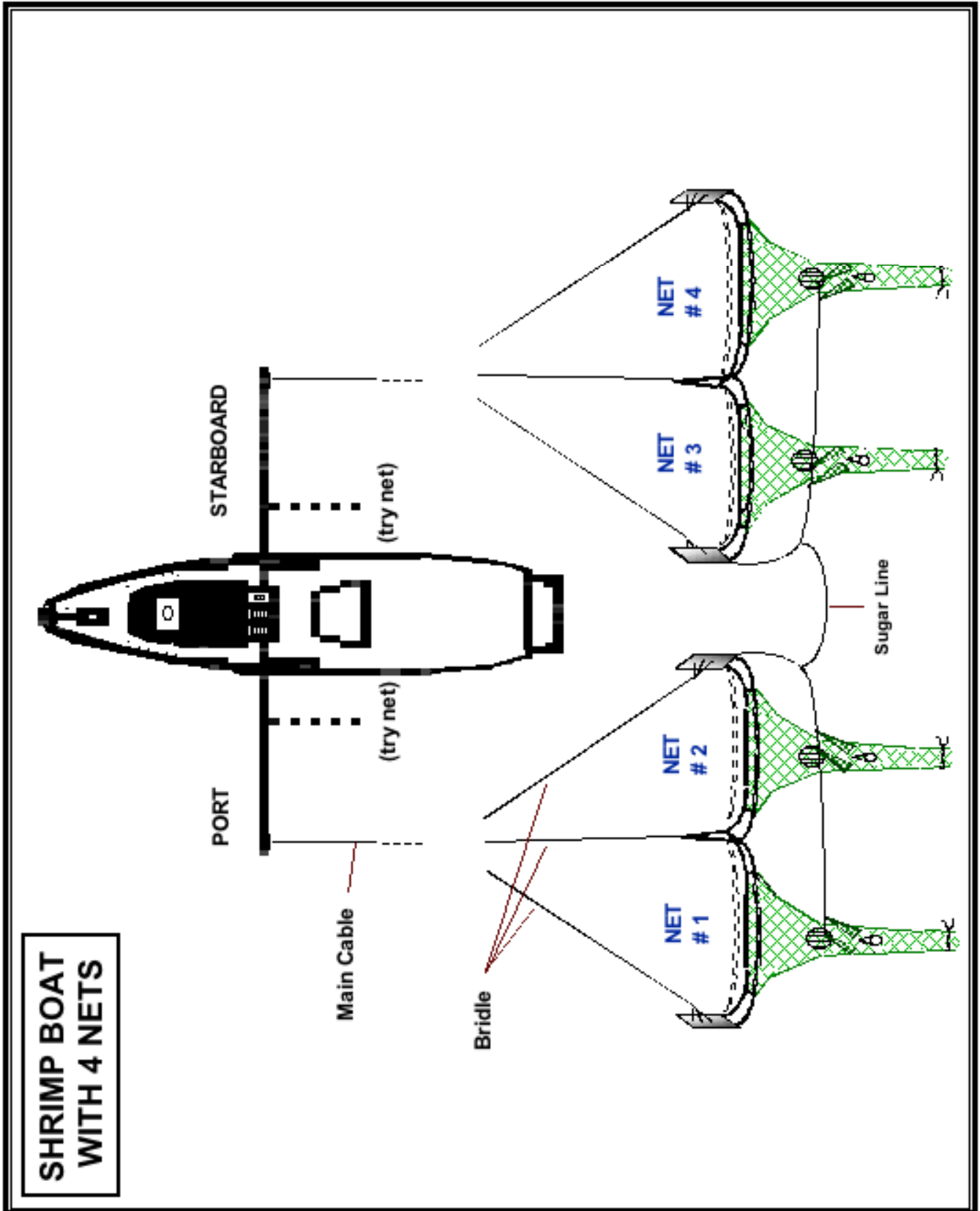

**SHRIMP BOAT
WITH 4 NETS**

APPENDIX 5

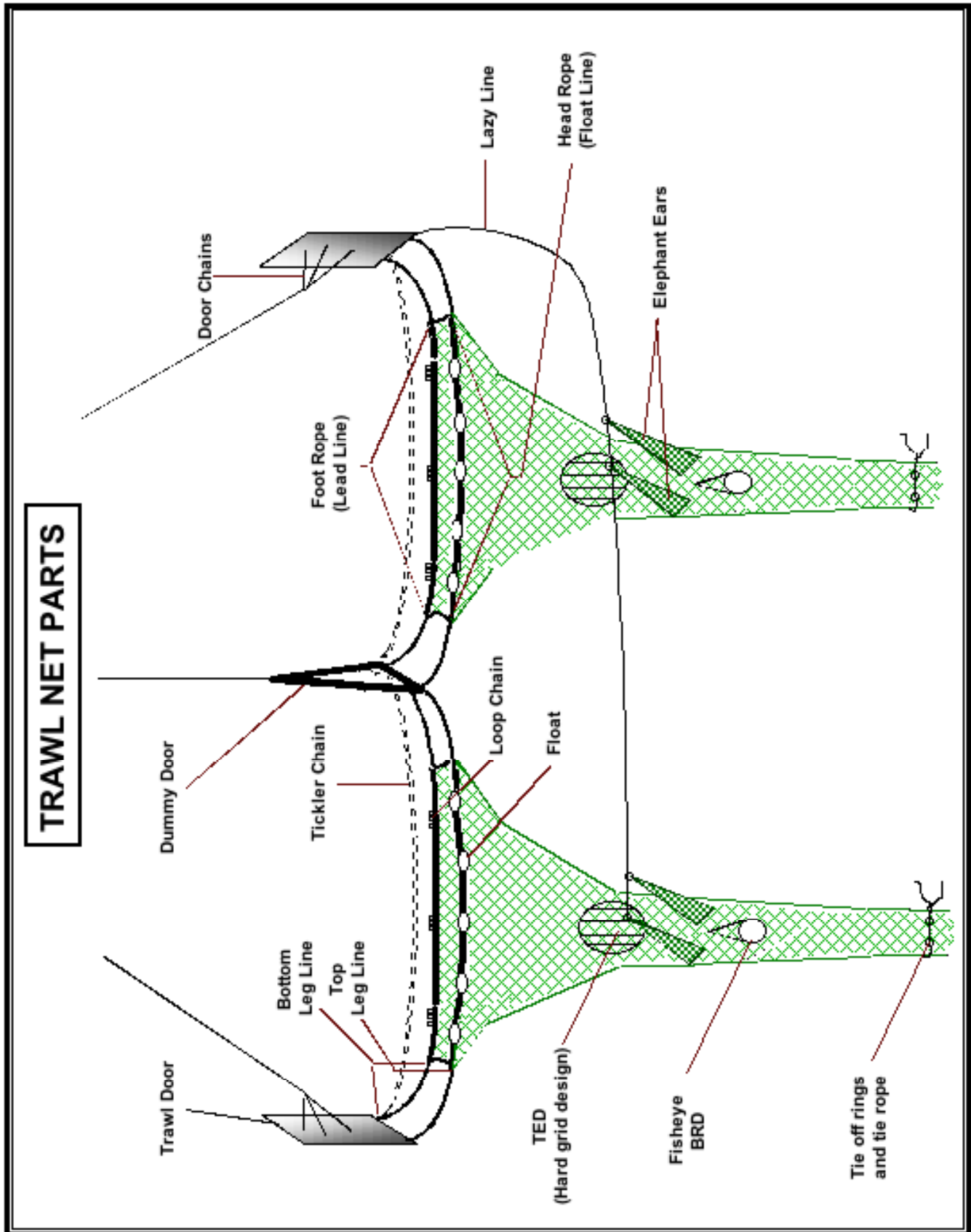

APPENDIX 6

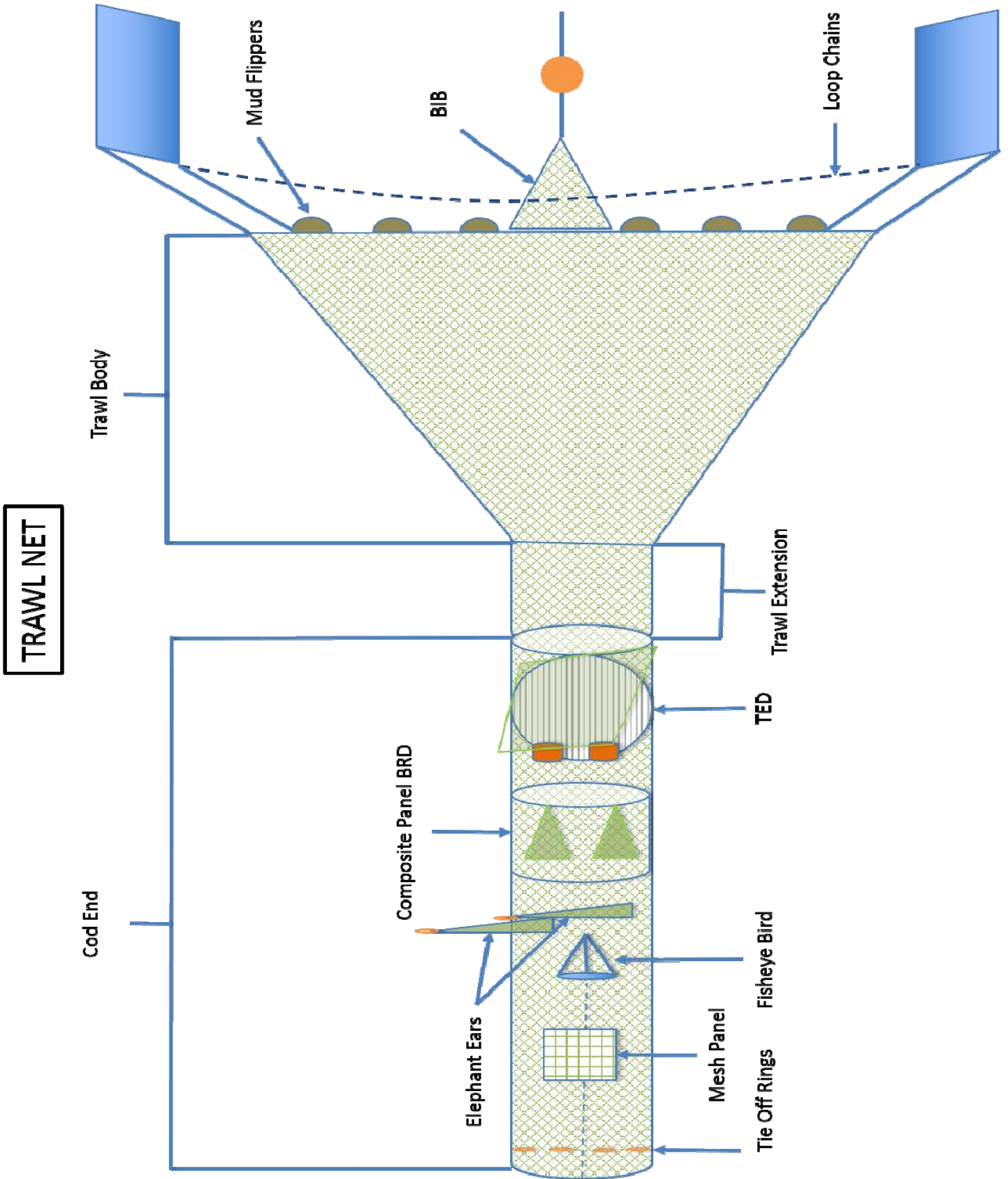

APPENDIX 6 – Cont.

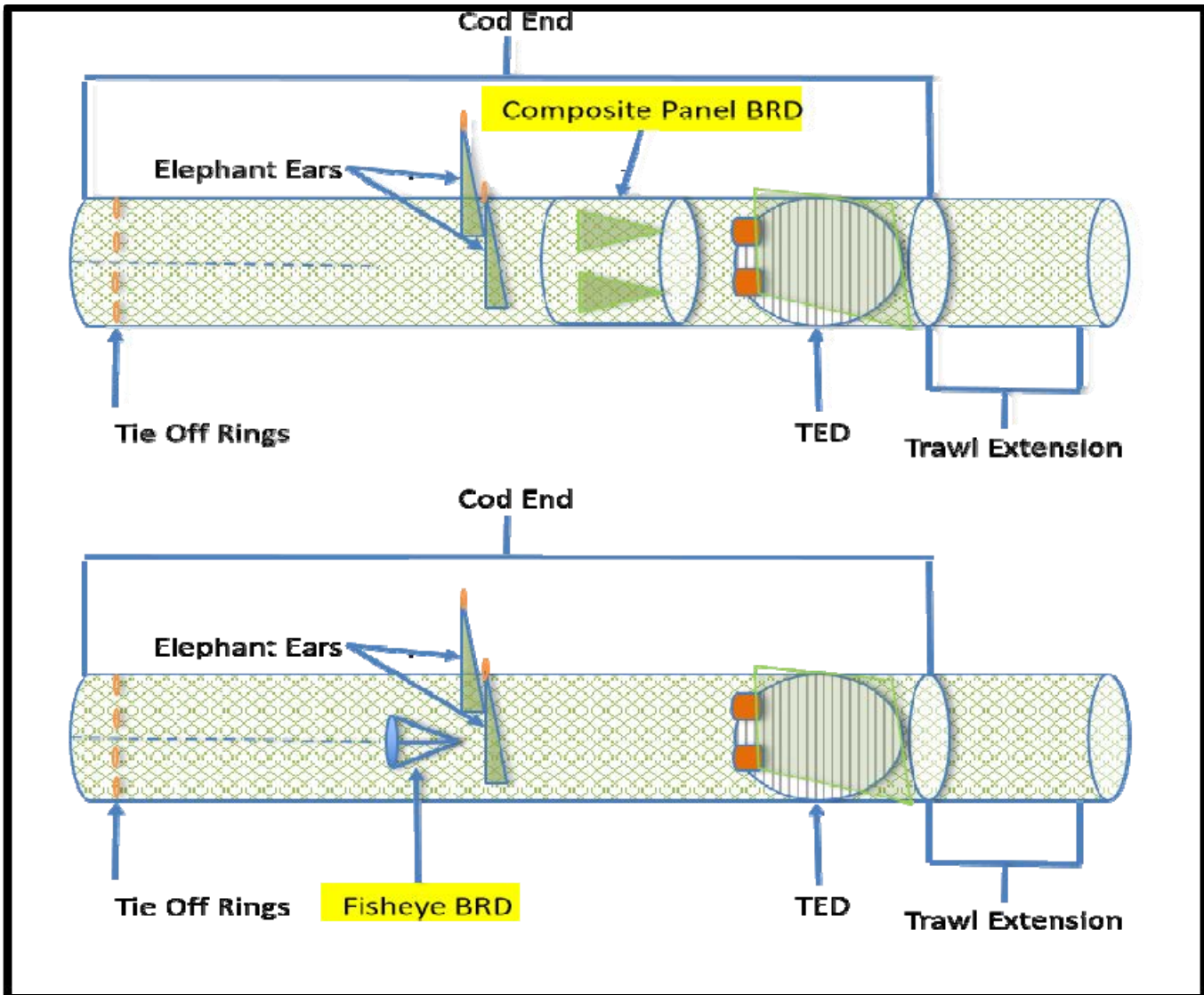

Approved BRD's

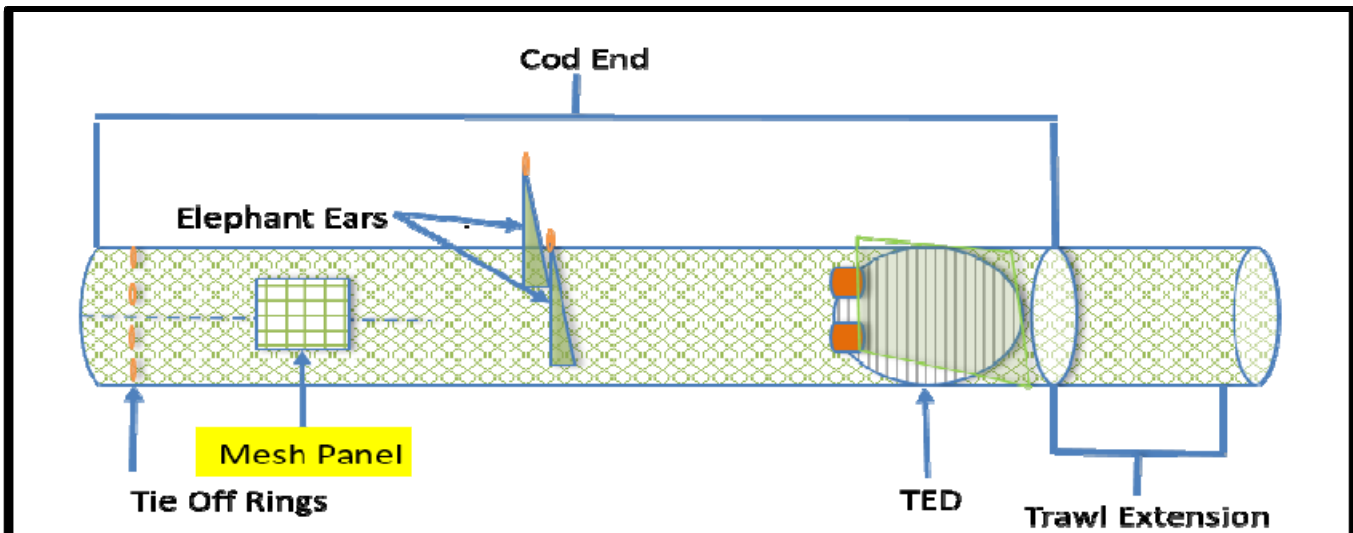

Mesh Panel

APPENDIX 7

Key TED Measurements and How to Take Them

How to find angle

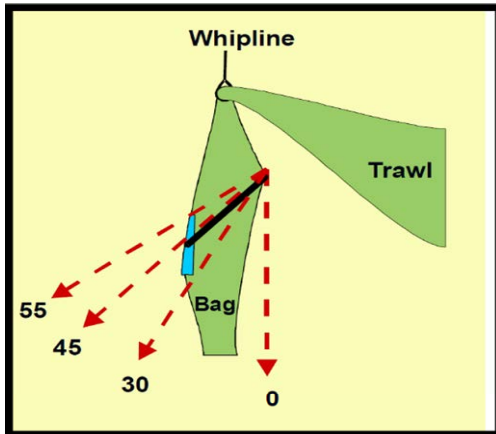

Grid Measurements

Angle (55° max)
Bar Spacing (4" max)
Grid length and width (32" min)
Top shooter (TS) or bottom shooter (BS)
SFSTCA Complaint (50 CFR 223.207 (a)(3)(ii))
Do all bottom shooters have proper flotation? (If no explain in comment section)

Single cover (71")TED

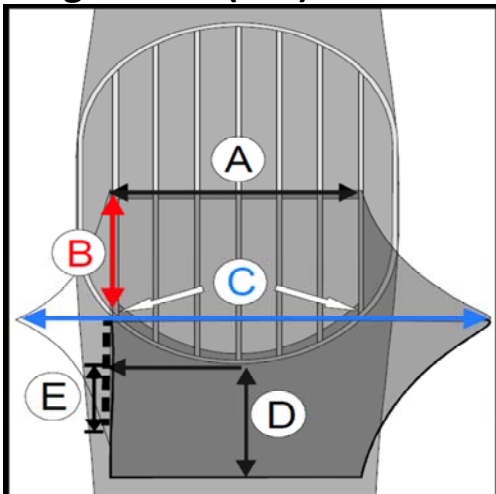

Double Cover (DC) TED

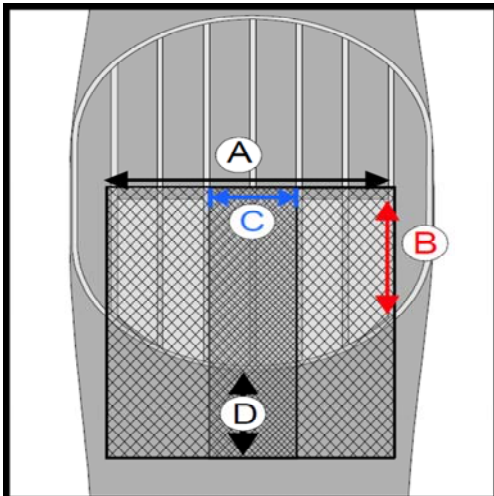

Opening and Flap Measurements (all stretched except D)

Identify each TED as Inshore, 71" or DC	
A	Leading edge of 71" must be $\geq 71"$.
A	Leading edge of DC" must be $\geq 56"$.
B	Forward cut of 71" must be $\geq 26"$.
B	Forward cut of DC must be $\geq 20"$.
C	The 71" opening must be $\geq 71"$ of stretched flap between the 2 points where flap is sewn to grid.
C	The DC overlap must be $\leq 15"$.
D	Length of flap not stretched below grid $\leq 24"$.
E	The 71"/44" flap can be sewn down the side no more than 6" from bottom of grid.

Adapted from NMFS TED Enforcement Boarding Form

APPENDIX 8

Composite Panel BRD

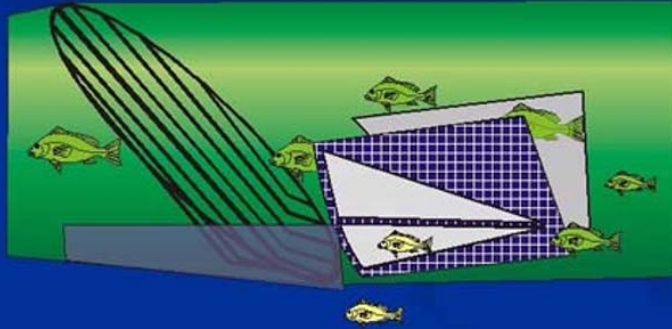

***Provisional Certification**

Extended Funnel



***Provisional Certification**



Fisheye

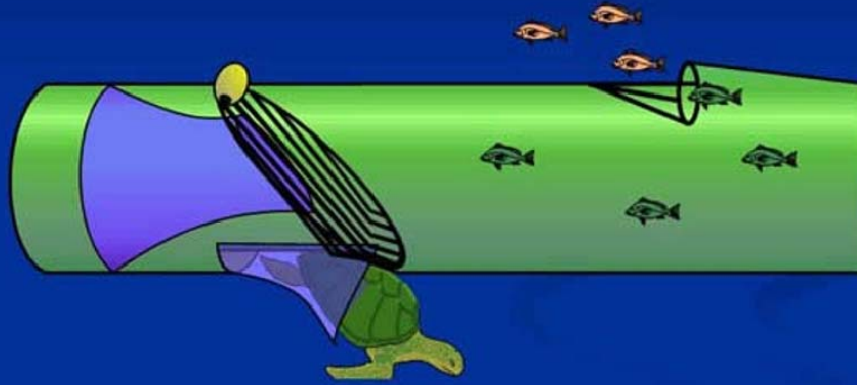

Jones-Davis

Turtle Excluder Device (TED)

Jones/Davis BRD with Cone Stimulator

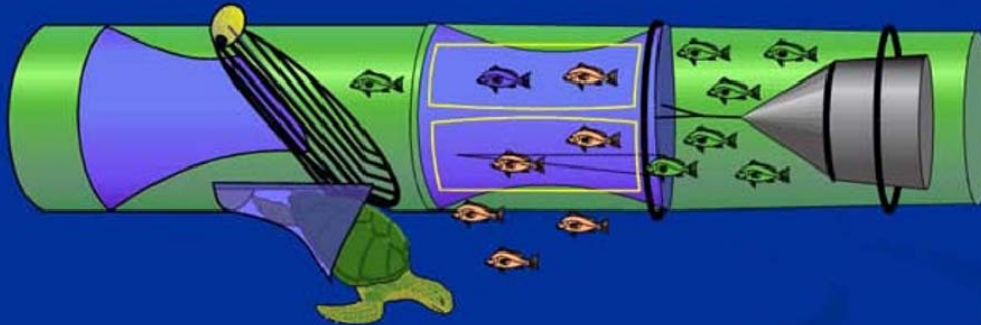

Modified Jones Davis

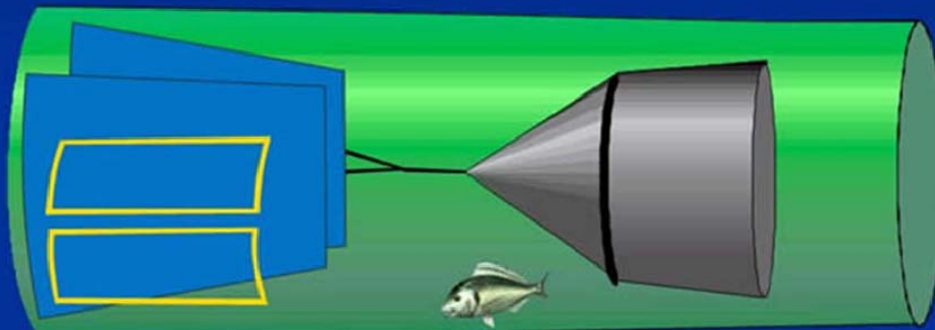

APPENDIX 9

Gulf Fisheye Installation (Cont.)

The Gulf fisheye must be installed so that the center apex bar is against the codend webbing and the exit hole is facing the mouth of the trawl.

The center apex bar must be no more than 15 inches to either side of the top center of the codend.

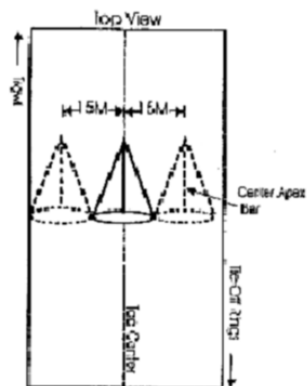

Recommendation: Test data indicates that maximum shrimp retention was achieved with the Gulf fisheye in the forward-most top center position (12.5 ft.). Optimum placement of the Gulf fisheye, however, may be affected by different fishing conditions and catch rates.

Jones Davis BRD

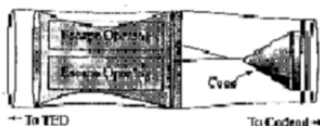

The Jones Davis is a funnel type BRD. It uses a webbing funnel, placed in an extension of webbing, to separate fish and shrimp. Four windows cut in the extension webbing, around the funnel, allow fish to escape. A cone constructed of webbing is placed behind the funnel to enhance finfish reduction.

For information on the construction and installation of the Jones Davis BRD, contact the National Marine Fisheries Service, Harvesting Systems and Engineering Branch at (228) 762-4591.

At this time, the Gulf fisheye and Jones Davis BRDs have not been approved. We anticipate approval prior to May 14, 1998. Please refer to the federal regulations, 50 CFR part 622 and the Federal Register for specific and controlling BRD requirements.

For additional information:
 Technical: (228) 762-4591
 Fisheries Operations: (813) 570-5305
 Enforcement: (813) 570-5344
 Enforcement Hotline: (800) 851-1964



Information

Shrimp Trawl Bycatch Reduction Devices (BRDs)

Gulf of Mexico, 1998

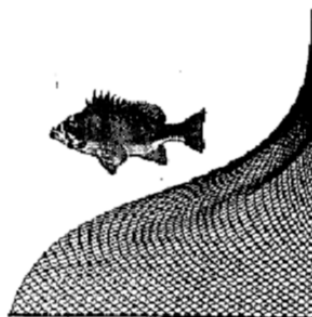

National Marine Fisheries Service

Bycatch Reduction Devices (BRDs)

BRDs are devices that are installed in shrimp trawls to reduce the take of juvenile red snapper as well as other finfish bycatch.

Who is Required To use BRDs?

Effective May 14, 1998 all shrimp trawlers fishing in the EEZ (federal waters) in the Gulf of Mexico seaward of the 100 fm (183 m) depth contour west of 83° 30' W, long. (West of Cape San Blas, Florida)

Are BRDs be Required in Try-nets?

BRDs are required in try nets with a headrope length greater than 16 ft (4.9 m).

What will be Exempt From Using BRDs?

(See Federal Register for definitions)

- ♦ Royal Red Shrimp Trawlers
- ♦ Try nets with a 16 ft. headrope length or smaller
- ♦ Rigid-Frame Roller Trawls

What Types of BRDs are Allowed?

- ♦ The Gulf fisheye BRD*
- ♦ The Jones Davis BRD*
- ♦ Fisheye BRD

* Approval expected through October 1998 with potential extension through April 1999.

Gulf Fisheye BRD

Approved Gulf fisheyes (includes fisheye) are cone-shaped rigid frames constructed from aluminum or steel rod of at least 1/4 in diameter. They are inserted into the top of the codend to form an escape opening.

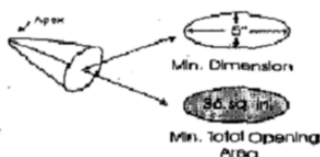

The escape opening can vary in shape, but cannot have a diameter any smaller than 5 inches or total escape opening area smaller than 26 square inches. Below are the minimum height and width dimensions needed to achieve 26 square inches for oval and diamond shaped Gulf fisheyes.

Example: If the height of a diamond shaped Gulf fisheye is 6 inches the width has to be at least 12 inches.

Oval		Diamond	
Height	Width	Height	Width
5"	8.12"	5"	14.5"
6"	7.61"	6"	12"
6.75"	6.75"	7"	10.25"
		8"	9"
		8.5"	8.5"

Gulf Fisheye Installation

The Gulf fisheye frame must be installed in the top of the codend (tailbag) with the apex of the frame pointing forward.

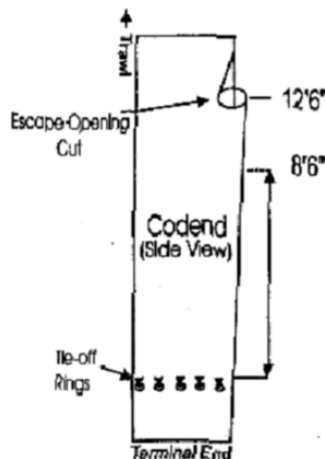

The escape opening cut must be no farther than 12 ft 6 inches and no less than 8 ft 6 inches from the bag drawstring (tie-off rings)

OTTER TRAWL COMPONENTS

APPENDIX 10

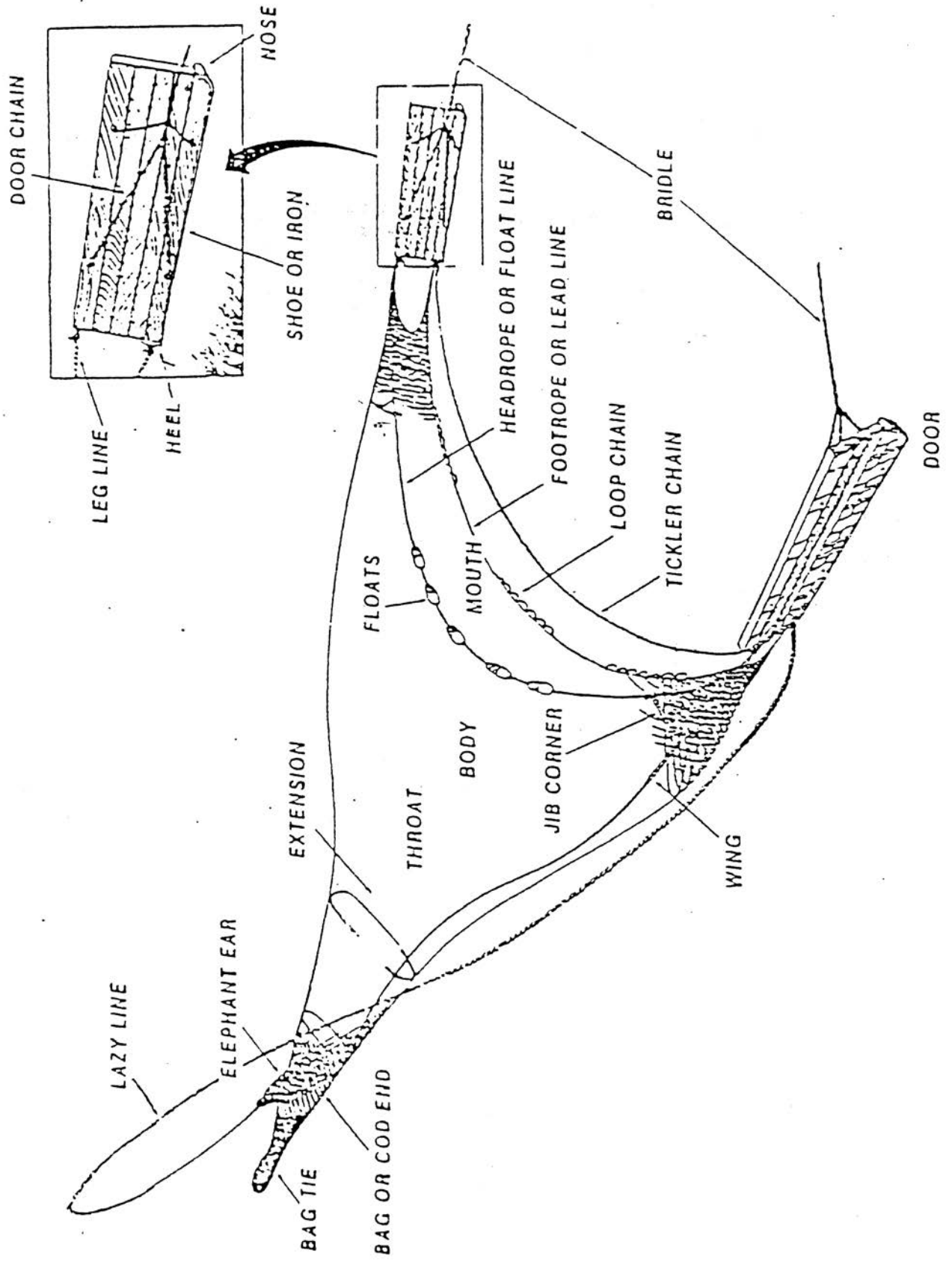

APPENDIX 11 OPERATION CODES

- A - Nets not spread; typically, doors are flipped or doors hung together so net could not spread.
- B - Gear bogged; the net has picked up a large quantity of sand, clay, mud, or debris in the tail bag possibly affecting trawl performance.
- C - Bag obstructed; the catch in the net is prevented from getting into the bag by something (i.e. grass, sticks, turtle, tires, metal/plastic containers etc.) or constriction of net (i.e. twisting of the lazy-line around net).
- D - Gear not digging; the net is fishing off the bottom due to insufficient weight or not enough cable let out (etc.).
- E - Twisted warp or line; the cables composing the bridle get twisted (from passing over blocks which occasionally must be removed before continuing to fish). Use this code if catch was affected.
- F - Gear fouled; the gear has become entangled in itself or with another net. Typically, this involves the webbing and some object like a float or chains or lazy line (etc.).
- G - Bag untied; bag of net not tied when dragging net.
- H - Rough weather. Bags mixed due to rough seas (too dangerous to separate); if the weather is so bad fishing is stopped, then the previous tow should receive this code if the rough conditions affected the catch.
- I - Torn, damaged, or lost net; usually results from hanging the net and tearing it loose. The net comes back with large tears etc. if at all. Do not use this code if there are only a few broken meshes. Continue using this code until net is repaired or replaced
- J - Dumped catch; tow was made but catch was discarded, perhaps because of too mud. Give reason in comments.
- K - Catch not emptied on deck; nets brought to surface, boat changes location, nets redeployed. (explain in comments)
- L - Hung up; untimely termination of a tow by a hang. Specify trawl(s) which were hung and caused lost time in Comments.
- M - Bags dumped together, catches could not be kept separate.
- N - Net did not fish; no apparent cause. Describe reasoning in comments.
- O - Gear fouled on submerged object but tow was not terminated. Performance of tow could be affected. Give specifics in Comments.
- P - No measurement taken of shrimp and/or total catch.
- Q - Main cable breaks and entire rigging lost. Describe in Comments.
- R - Net caught in wheel.
- S - Tickler chain heavily fouled, tangled, or broken.
- T - Other problems. Describe in comments.
- U - Turtle excluder gear intentionally disabled.
- V - Unknown operation code.
- W - Damaged (i.e., bent or broken) excluder gear.
- X - BRD intentionally disabled or non-functional. (Damaged) Describe in comments.
- Y - Net trailing behind try net.
- Z - Successful tow.

APPENDIX 12
NMFS MEASUREMENT CODES

01	Fish, fork length
02	Fish, standard length
03	Shrimp, total length
04	Shrimp, carapace length
05	Crab, carapace width (lateral measurement)
06	Crab, carapace length (anterior-posterior measurement)
07	Lobster carapace length (from rostral tip)
08	Lobster, total length
09	Lobster, tail length
10	Anemone and Coral Polyps, disc width
11	Bivalve, total length (parallel to hinge joint)
12	Scallop, total length (hinge to bill edge)
13	Squid, mantle length
14	Starfish, disc width (between arm bases)
15	Starfish, total radial diameter (arms, tip to tip)
16	Sea Pansy and Other Colonial Invertebrates, maximum disc width
17	Univalve Snail, total length (longitudinal axis of spire)
18	Fish, total length
19	Shrimp, tail length
20	Other, specify
22	Skates and Rays, disc width
23	Fish, snout, anal length
24	Billfish, curved lower jaw fork length

BOTTOM TYPE CODES

BD	=	Boulders	CL	=	Clay	CO	=	Coral
G	=	Gravel	GR	=	Grass	M	=	Mud
OZ	=	Ooze	RK	=	Rock	S	=	Sand
SH	=	Shell	SP	=	Sponge	W	=	Wreck
UN	=	Undetermined						

SEA STATE CODES

- 1 = 0 - 2 Feet
- 2 = 3 - 5 Feet
- 3 = 6 - 8 Feet
- 4 = 8 + Feet

APPENDIX 13

NMFS Statistical Zones of the Southeast Region

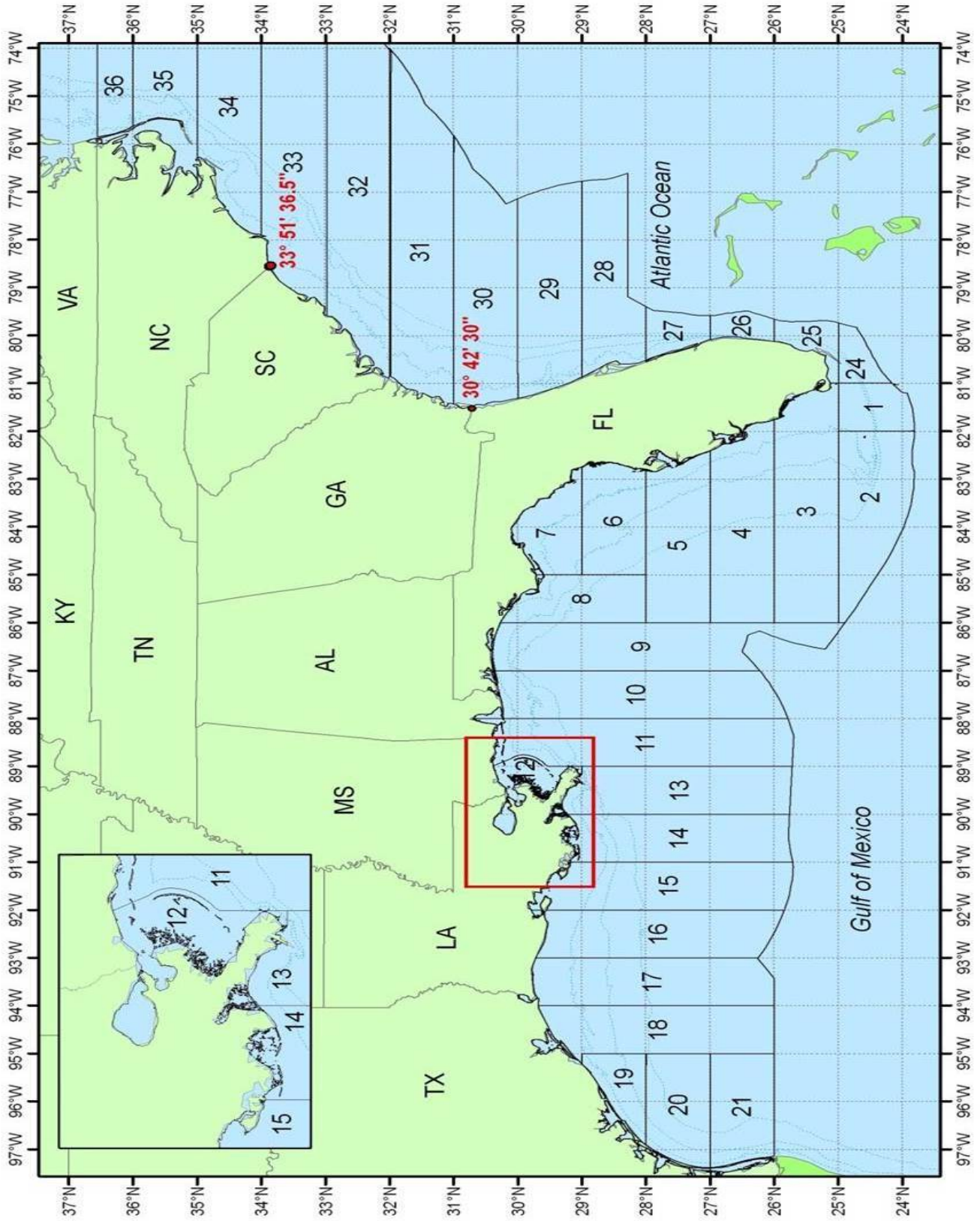

Note: Stat zone 12 expands east to include Chandeleur Islands (see inset)

APPENDIX 13 – Cont.

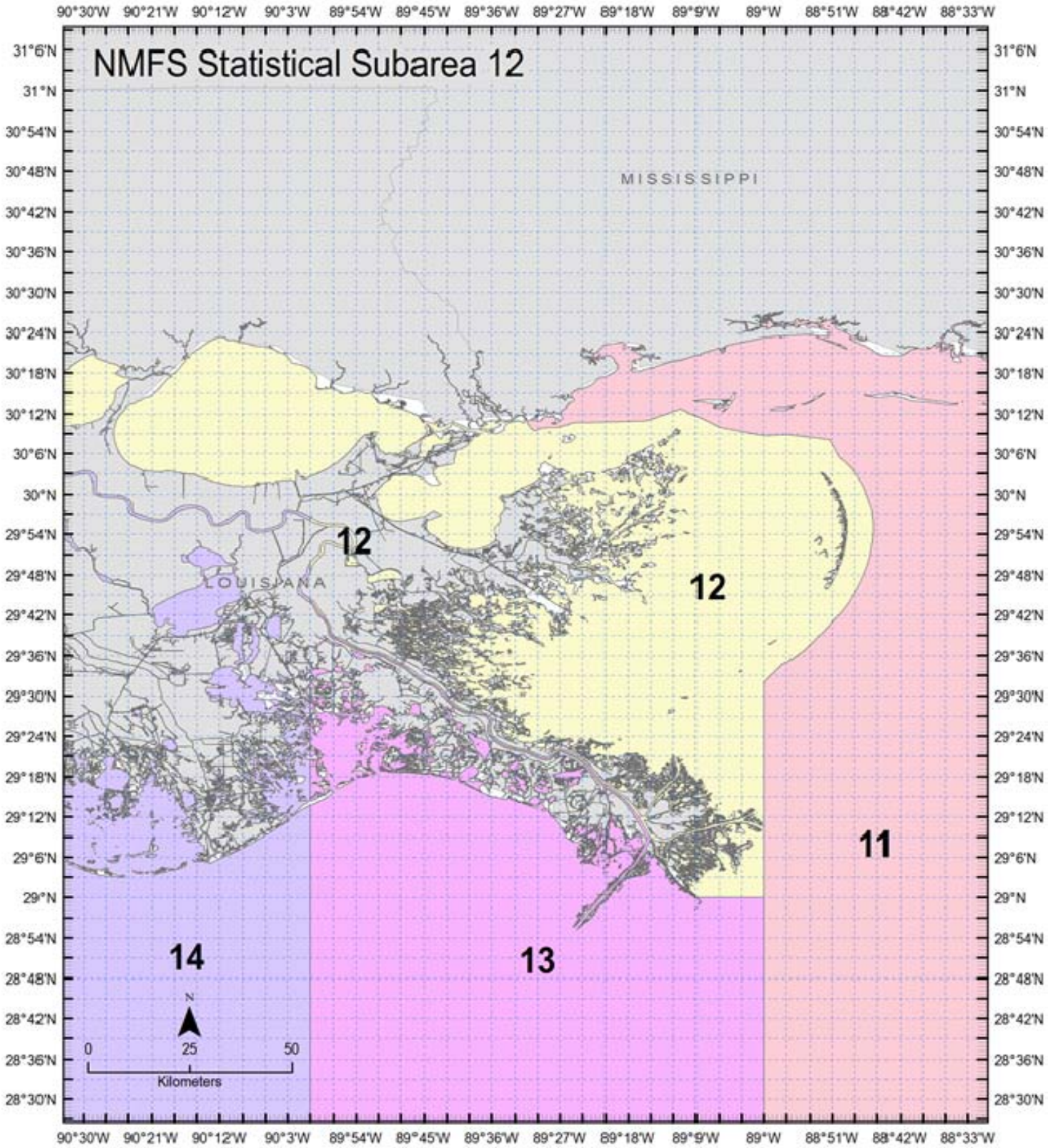

APPENDIX 14

Table to convert decimal minutes to seconds.

Example - A location reading of 2932.89 is actually 29 degrees, 32 minutes, and 53 seconds.

Decimal Minutes	Seconds	Decimal Minutes	Seconds	Decimal Minutes	Seconds	Decimal Minutes	Seconds
.01	1	.31	19	.61	37	.91	55
.02	1	.32	19	.62	37	.92	55
.03	2	.33	20	.63	38	.93	56
.04	2	.34	20	.64	38	.94	56
.05	3	.35	21	.65	39	.95	57
.06	4	.36	22	.66	40	.96	58
.07	4	.37	22	.67	40	.97	58
.08	5	.38	23	.68	41	.98	59
.09	5	.39	23	.69	41	.99	59
.10	6	.40	24	.70	42		
.11	7	.41	25	.71	43		
.12	7	.42	25	.72	43		
.13	8	.43	26	.73	44		
.14	8	.44	26	.74	44		
.15	9	.45	27	.75	45		
.16	10	.46	28	.76	46		
.17	10	.47	28	.77	46		
.18	11	.48	29	.78	47		
.19	11	.49	29	.79	47		
.20	12	.50	30	.80	48		
.21	13	.51	31	.81	49		
.22	13	.52	31	.82	49		
.23	14	.53	32	.83	50		
.24	14	.54	32	.84	50		
.25	15	.55	33	.85	51		
.26	16	.56	34	.86	52		
.27	16	.57	34	.87	52		
.28	17	.58	35	.88	53		
.29	17	.59	35	.89	53		
.30	18	.60	36	.90	54		

APPENDIX 15
Mustad #39965 series Actual Size

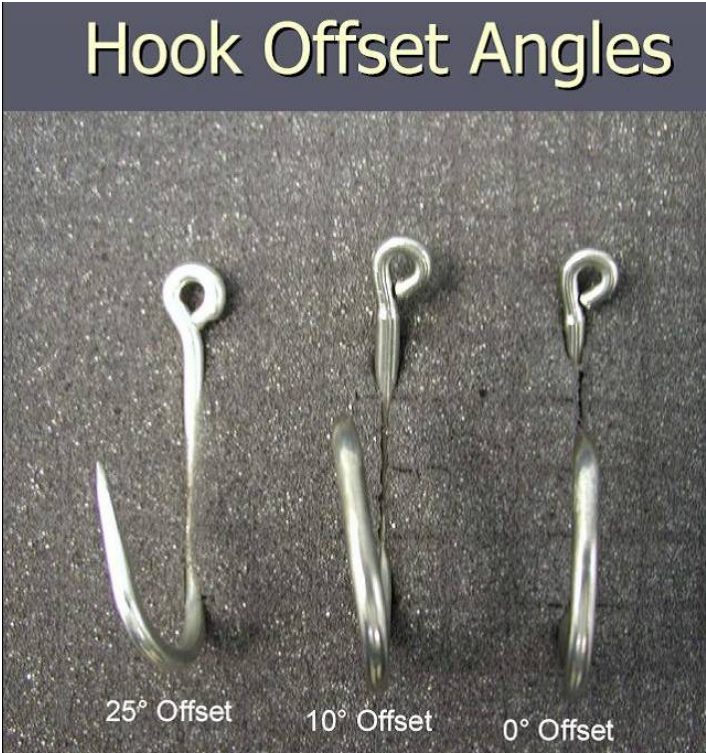
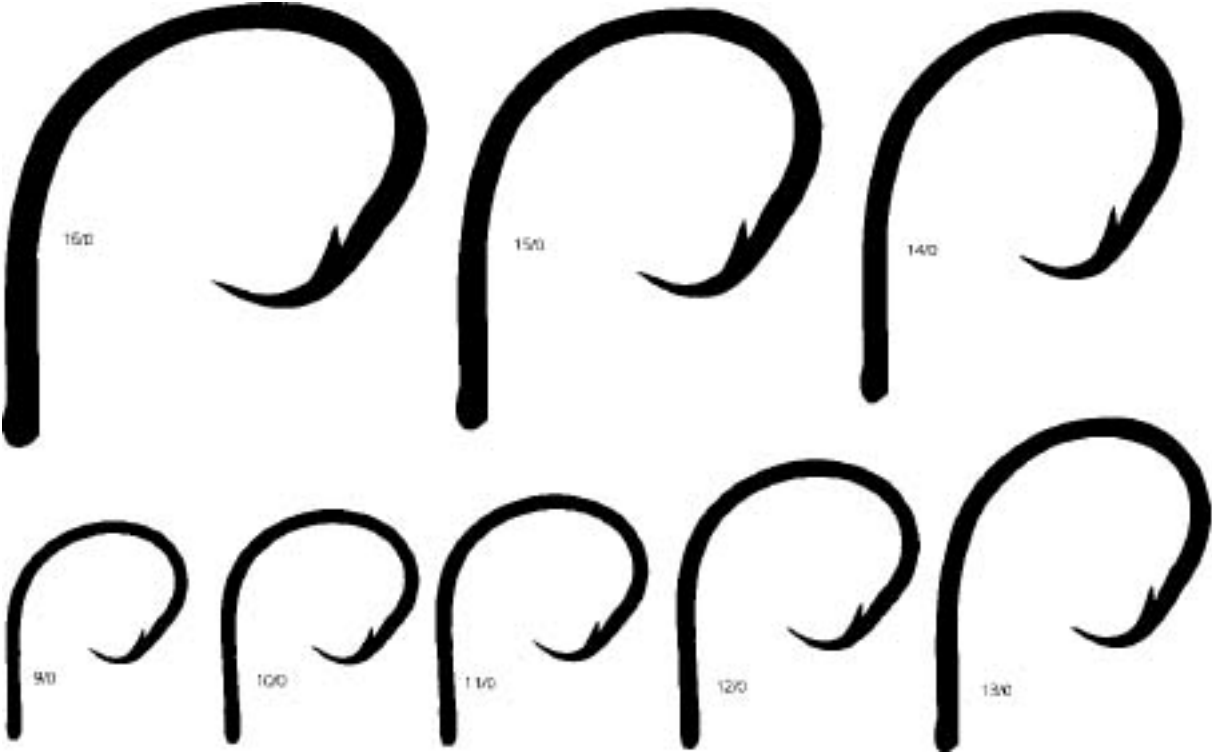

APPENDIX 16 COMMON ERRORS

General

- Put ALL information you collect in your logbook
- If you have a question or are confused ask us, use satellite phone if offshore. Do not assume anything
- Get photos for any protected species interaction and fill out forms thoroughly. Notify the lab within 24 hours, no exceptions. They are a BIG DEAL!
- Get ALL necessary forms signed by captain
- Do the safety check before leaving the dock, departing with expired/missing safety equipment is a cause for termination
- Make sure you pay attention to Coast Guard safety decal distance rating. The vessel is not allowed to exceed this, if they do contact the lab immediately
- If no turtles are captured / sighted put none in respective area on trip report
- Use trip dates, not sea dates, where applicable, i.e. cover sheet, trip report page 2, vessel information form
- Turtle sightings need a sea turtle life history form filled out
- Double check time flow between tows/sets, i.e. no overlapping times (except longline)
- Double check location flow between tows/sets, i.e. dragging 70 miles in 2 hours is not possible
- Unsampled tows/sets need a station sheet filled out for shrimp and reef
- Proof your trip thoroughly before submitting, we can tell the difference if you do not
- Take photos for species ID and gear for ALL trips
- If the vessel is using LORAN instead of GPS, leave GPS blank on station sheet and write LORAN in area above it, also leave statistical zones blank if unsure

Shrimp

- Call and ask if you have any questions
- All gear information goes in the logbook, be thorough
- Do not multiply out baskets for shrimp total weight, each basket must be weighed
- Do not confuse 8's and 9's, 8's is too light to weigh, 9's is unknown
- Sample weight is 9's on station sheet if no characterization is done
- Ask if confused about sampled vs. unsampled tows
- Use your digital scale if you have one, it is much more accurate
- Red snapper found in your sample basket gets subtracted from the sample weight
- Add comments to station sheet when using operation codes besides Z or Y
- Add comments in logbook if you take a night/day off due to weather, repairs, etc.
- PENAUS DISCARD represents white; brown or pink shrimp not being retained by the vessel. All other shrimp species (seabobs, rock, etc.) go in CRUSTACEAN
- Sample shrimp weights (white, brown, pink) are always head on
- Time in is when the winched are dogged off, time out is when the winches are engaged

- If the crew is keeping head on and head off shrimp, just leave the total shrimp area blank and write the respective weight in the comments section and we will calculate on our end
- Make sure your BRD measurements in the codend make sense, i.e. the distances between elephant ears and tie off rings to the BRD
- The correct calculation is Footrope + both bottom leglines = Tickler + setback
- Fill out the BRD and gear description thoroughly and include diagrams
- On the trip report nearshore is ≤ 60 feet depth (not miles), offshore is > 60 feet
- Broken red snapper should be identified as $<$ or > 100 mm
- If your sample weight is the entire catch all characterization weights are select
- Make sure to mix the piles well before obtaining your sample basket
- Total shrimp weight on the station sheet refers only to white, brown and pink shrimp. If other shrimp species (i.e. seabob shrimp and rock shrimp) are mixed with the total shrimp retained by the vessel, record the total shrimp weight value including seabob shrimp and rock shrimp in the observer comment section. Along with a comment stating, which non-Penaeid shrimp are included in the total shrimp weight. You are also required to include seabob shrimp and/or rock shrimp counts and weights on the characterization form.
- It helps to be consistent if your sample shrimp need to be added to total shrimp or you are reweighing, either is acceptable just find out what works best for you
- Make sure you are doing a full basket for characterization ~ 30 kgs.
- Get a new trip number when your vessel offloads the catch
- On a vessel with 2 nets only sample the net not behind the try net all trip, but fill out gear sheets for both nets and fill out the station sheet for both nets 2 and 3 and just fill the net not sampled with 9's for total weight, total shrimp, red snapper, etc.
- On vessel utilizing only 2 nets put a 9 in for operation code for nets 1 and 4, i.e. with a try net in #3 position and #2 successful would be 9ZY9 for operation codes
- On the east coast characterization threadfin shad is not Shad ALOSA genus, also do not confuse lesser blue crabs with blue crabs
- If you cannot see if organisms are exiting the BRD, the predators cannot be feeding on them since you do not know if any are exiting. Same if nothing is exiting the BRD, they cannot be feeding
- Select species indicates all of that species from the entire net
- If you are selecting species from one net you need to make sure you are doing it for the other net as well, also make sure the select species weight is included in total weight

Reef

- Call and ask if you have any questions
- Keep track of ALL reels and sample as many as possible
- Species ID is YOUR job, do not rely on the fisherman for ID
- Make sure you are using sink or swim when determining discard fate
- Transcribe in order from logbook to length frequency form, do not skip around to group species together when transcribing, however you can record in the log in any order
- If no fish are caught for a reel and gear configuration you need to reference that reel/gear with NOCATCH common name and genus on length frequency form
- You need to put hook calculations in logbook for sets with multiple reels and multiple gears

- The first time a gear code is used, use that set# and date on the gear form
- Fish must be measured to the nearest mm, not every 5th mm
- The # of fish caught on a reel cannot be greater than the # of hooks set for that reel, something is seriously wrong if this is happening
- Use the correct measurement for each species listed in the appendix. Some common errors are sharks, scamp, seabass, sand perch, and sharksuckers
- When you have reel with 2 different gears you need to specify what reel and gear the fish is caught on, i.e. use reel# 2A or #2B instead of just reel#2
- Use the correct full common name listed in the appendix; “amberjack” is not acceptable use “greater amberjack”, “beeliner” is not acceptable use vermilion snapper”, etc.
- Average haul in time is just average amount of time it takes to bring the reels up from fishing depth with fish on them, no calculation needed
- For longline, you need to sample all fish caught for a set, if for some reason you are unable to (weather, sick, etc.) you need to record a time when you stopped sampling and the number of hooks sampled out of the entire set
- Hard bottom usually means rock (limestone)

APPENDIX 17 GEAR CHECK-OFF SHEET

Name _____ Date: _____ OUT _____ Date: _____ IN _____

SAFETY GEAR		qty	unit price	total price	Out	In	SAMPLING GEAR		qty	unit price	total price	Out	In
Immersion Suit	Size _____	1	\$300.00	\$300.00	<input type="checkbox"/>	<input type="checkbox"/>	10kg Salter Mechanical Scale	1	\$75.00	\$75.00	<input type="checkbox"/>	<input type="checkbox"/>	
	Serial # _____				<input type="checkbox"/>	<input type="checkbox"/>	50kg Salter Mechanical Scale	1	\$75.00	\$75.00	<input type="checkbox"/>	<input type="checkbox"/>	
Hemilight		1	\$22.00	\$22.00	<input type="checkbox"/>	<input type="checkbox"/>	Measuring Board Large	1	\$50.00	\$50.00	<input type="checkbox"/>	<input type="checkbox"/>	
Suit Hanger		1	\$5.00	\$5.00	<input type="checkbox"/>	<input type="checkbox"/>	Measuring Board Small	1	\$25.00	\$25.00	<input type="checkbox"/>	<input type="checkbox"/>	
Personal Marker Light		2	\$7.00	\$14.00	<input type="checkbox"/>	<input type="checkbox"/>	Meter Stick	1	\$100	\$100	<input type="checkbox"/>	<input type="checkbox"/>	
Firefly Strobe Light		1	\$70.00	\$70.00	<input type="checkbox"/>	<input type="checkbox"/>	Measuring Tape	1	\$2.00	\$2.00	<input type="checkbox"/>	<input type="checkbox"/>	
C-Strobe/Light		1	\$19.00	\$19.00	<input type="checkbox"/>	<input type="checkbox"/>	Angle Protractor	1	\$17.00	\$17.00	<input type="checkbox"/>	<input type="checkbox"/>	
Signal Mirror & Whistle		1	\$20.00	\$20.00	<input type="checkbox"/>	<input type="checkbox"/>	Large Baskets	8	\$18.00	\$144.00	<input type="checkbox"/>	<input type="checkbox"/>	
Flotation Coat	Size _____	1	\$250.00	\$250.00	<input type="checkbox"/>	<input type="checkbox"/>	Small Baskets	20	\$4.00	\$80.00	<input type="checkbox"/>	<input type="checkbox"/>	
Horsecollar		1	\$210.00	\$210.00	<input type="checkbox"/>	<input type="checkbox"/>	Ice Chest (72 quart)	1	\$125.00	\$125.00	<input type="checkbox"/>	<input type="checkbox"/>	
Horsecollar Hydro	Experation _____	1	\$50.00	\$50.00	<input type="checkbox"/>	<input type="checkbox"/>	Sampling stool	1	\$50.00	\$50.00	<input type="checkbox"/>	<input type="checkbox"/>	
Fanny pack		1	\$85.00	\$85.00	<input type="checkbox"/>	<input type="checkbox"/>	Shovel	1	\$55.00	\$55.00	<input type="checkbox"/>	<input type="checkbox"/>	
Fanny pack rearm kit	Experation _____	1	\$20.00	\$20.00	<input type="checkbox"/>	<input type="checkbox"/>	Culling Rake	1	\$9.00	\$9.00	<input type="checkbox"/>	<input type="checkbox"/>	
Type 1		1	\$65.00	\$65.00	<input type="checkbox"/>	<input type="checkbox"/>	Hook Counter Plastic	1	\$5.00	\$5.00	<input type="checkbox"/>	<input type="checkbox"/>	

ELECTRONIC GEAR		qty	unit price	total price	Out	In	MISCELLANEOUS GEAR		qty	unit price	total price	Out	In
microSD Cards		5	\$14.00	\$70.00	<input type="checkbox"/>	<input type="checkbox"/>	Hard Hat	1	\$9.00	\$9.00	<input type="checkbox"/>	<input type="checkbox"/>	
microSD to SD Card Adapter		1	\$2.00	\$2.00	<input type="checkbox"/>	<input type="checkbox"/>	Scrub Brush	1	\$3.00	\$3.00	<input type="checkbox"/>	<input type="checkbox"/>	
SD to USB Adapter		1	\$4.00	\$4.00	<input type="checkbox"/>	<input type="checkbox"/>	Duct Tape	1	\$5.00	\$5.00	<input type="checkbox"/>	<input type="checkbox"/>	
Electronic Scale	Serial # _____	1	\$1300.00	\$1300.00	<input type="checkbox"/>	<input type="checkbox"/>	Twine & Rope	1	\$2.00	\$2.00	<input type="checkbox"/>	<input type="checkbox"/>	
GPS Unit	Serial # _____	1	\$200.00	\$200.00	<input type="checkbox"/>	<input type="checkbox"/>	Flashlight	1	\$9.00	\$9.00	<input type="checkbox"/>	<input type="checkbox"/>	
	CD # _____				<input type="checkbox"/>	<input type="checkbox"/>	Calculator	1	\$3.00	\$3.00	<input type="checkbox"/>	<input type="checkbox"/>	
PLB	Reg # _____	1	\$350.00	\$350.00	<input type="checkbox"/>	<input type="checkbox"/>	Clipboard	1	\$4.00	\$4.00	<input type="checkbox"/>	<input type="checkbox"/>	
	CD # _____				<input type="checkbox"/>	<input type="checkbox"/>	File Box	1	\$20.00	\$20.00	<input type="checkbox"/>	<input type="checkbox"/>	
Satellite Phone	ID # _____	1	\$1200.00	\$1200.00	<input type="checkbox"/>	<input type="checkbox"/>	Dry Bag (40L)	1	\$40.00	\$40.00	<input type="checkbox"/>	<input type="checkbox"/>	
	CD # _____				<input type="checkbox"/>	<input type="checkbox"/>	Duffel Bag	1	\$60.00	\$60.00	<input type="checkbox"/>	<input type="checkbox"/>	
Digital Camera	Kit # _____	1	\$200.00	\$200.00	<input type="checkbox"/>	<input type="checkbox"/>	Deck Boots	Size _____	1	\$30.00	\$30.00	<input type="checkbox"/>	<input type="checkbox"/>
	CD # _____				<input type="checkbox"/>	<input type="checkbox"/>	Foul Weather Gear	Size _____	1	\$125.00	\$125.00	<input type="checkbox"/>	<input type="checkbox"/>
Go Pro	Kit # _____	1	\$300.00	\$300.00	<input type="checkbox"/>	<input type="checkbox"/>	Reef Sampling Gloves	Size _____	6	\$7.00	\$42.00	<input type="checkbox"/>	<input type="checkbox"/>
	CD # _____				<input type="checkbox"/>	<input type="checkbox"/>	Shrimp Sampling gloves	Size _____	12	\$4.00	\$48.00	<input type="checkbox"/>	<input type="checkbox"/>
					<input type="checkbox"/>	<input type="checkbox"/>	Log Books Orange	12	\$9.00	\$108.00	<input type="checkbox"/>	<input type="checkbox"/>	
					<input type="checkbox"/>	<input type="checkbox"/>	Log Books Yellow	12	\$6.00	\$72.00	<input type="checkbox"/>	<input type="checkbox"/>	
					<input type="checkbox"/>	<input type="checkbox"/>	First Aid Kit	1	\$12.00	\$12.00	<input type="checkbox"/>	<input type="checkbox"/>	
					<input type="checkbox"/>	<input type="checkbox"/>	Hibiclens w/Optional Spray Bottle	1	\$14.00	\$14.00	<input type="checkbox"/>	<input type="checkbox"/>	
					<input type="checkbox"/>	<input type="checkbox"/>	Germ-X Hand Sanitizer	1	\$5.00	\$5.00	<input type="checkbox"/>	<input type="checkbox"/>	
					<input type="checkbox"/>	<input type="checkbox"/>	RelyOn Antiseptic Hand Wipes	1	\$7.00	\$7.00	<input type="checkbox"/>	<input type="checkbox"/>	
					<input type="checkbox"/>	<input type="checkbox"/>	Protective Eyeware	1	\$4.00	\$0.00	<input type="checkbox"/>	<input type="checkbox"/>	
					<input type="checkbox"/>	<input type="checkbox"/>	Carbon Monoxide Detector	1	\$20.00	\$20.00	<input type="checkbox"/>	<input type="checkbox"/>	

Sensitive Property

APPENDIX 17 – Cont.

GEAR CHECK-OFF SHEET

LITERATURE

	qty	unit price	total price	Out	In
Observer Manual	1	in house	\$0.00		
Data Forms (master copies)	1	in house	\$0.00		
Collecting Permits	1	in house	\$0.00		
Guide Books	A Field Guide to Coastal Fishes	1	\$23.00	\$23.00	
	Fishes of the Gulf	1	\$20.00	\$20.00	
	Marine Mammals & Turtles	1	\$25.00	\$25.00	
	Reef Identification Guide	1	in house	\$0.00	
	Shark Qck Ref (Laminated 2 sheets)	1	in house	\$0.00	
	Sharks of US (Laminated 2 sheets)	1	in house	\$0.00	
	Sharks of North American Waters	1	\$20.00	\$20.00	
	USCG Training Video	1	USCG	\$0.00	
	Beating the Odds	1	\$15.00	\$15.00	
CG Exam Guide Book	1	USCG	\$0.00		

TURTLE GEAR

Turtle Calipers	1	\$200.00	\$200.00		
Soft Sided Cooler	#	Miami	\$0.00		
Turtle Kit	Turtle Kit Box	1	\$15.00	\$15.00	
	Tag Applicator	1	\$25.00	\$25.00	
	Pit Tag Reader w/ aquapac	1	\$425.00	\$425.00	
	Pit Tag Applicator	1	\$0.00	\$0.00	
	Dive Slate	1	\$5.00	\$5.00	
	Turtle ID Card	1	in house	\$0.00	
	Cloth Measuring Tape	1	\$3.00	\$3.00	
	Flipper Tags	10	\$1.00	\$10.00	
	Pit Tags	5	\$8.00	\$40.00	
	Biopsy Punches	5	\$2.00	\$10.00	
	NaCl Solution Vials	5	\$1.00	\$5.00	
	AAA Batteries	4	\$0.50	\$2.00	
	Cable Ties	5	\$0.25	\$1.25	
	Orange Paint	1	\$5.00	\$5.00	
	Disposable Gloves	5	\$0.25	\$1.25	
	Antibiotic Ointment	1	\$1.00	\$1.00	
	Alcohol Prep Pads	20	\$0.20	\$4.00	
	Betadine Swabs	10	\$0.30	\$3.00	
	Waterproof Labels	20	\$0.10	\$2.00	
	Para film Squares	20	\$0.15	\$3.00	
	Whirl Packs	20	\$0.50	\$10.00	
	Mechanical Pencils	3	\$0.75	\$2.25	
	Extra Fine Sharpie	3	\$0.75	\$2.25	
Large Paperclips	3	\$0.05	\$0.15		
Scotch Tape Dispenser	1	\$1.00	\$1.00		
Stick-On labels	10	\$0.10	\$1.00		
Grand Total:			\$6,987.15		

Observer Signature _____ (Acknowledges RECEIPT of gear)

Coordinator Initials _____

Observer Signature _____ (Acknowledges RETURN of gear)

Coordinator Initials _____

Fishing Vessel USCG Safety Requirements for the WARM WATERS of the Gulf of Mexico and South Atlantic

APPENDIX 18

These safety requirements are determined by the fishing location

Fishing Location	Inside the Boundary Line Within 3 Nautical Miles	Within 12 NM of Coastline (Boundary Line)	12 to 20 miles of Coastline	Between 20 & 50 miles	Over 50 Nautical Miles
Survival Craft Equipment	No Survival Craft Required	No Survival Craft Required	Life Float with light and line	Inflatable Life Raft with SOLAS B pack or Coastal Service Pack	Inflatable Life Raft with SOLAS A pack
EPIRBs	Not Required	Required	Required	Required	Required
Distress Signals	3 Red Flares OR 3 other flares with a night signal	3 - 6 - 3 Parachute - Hand - Smoke	3 - 6 - 3 Parachute - Hand - Smoke	3 - 6 - 3 Parachute - Hand - Smoke	3 - 6 - 3 Parachute - Hand - Smoke

*RED flares include parachute and hand flares which can be seen both day and night.

These safety requirements are determined by the vessel size

Vessel Size	Vessels < 26 feet long	Vessels 26 to 40 feet long	Vessels < 65 feet long	Vessels ≥ 65 feet long
Life Rings	1 Buoyant Cushion OR 1 Orange Life Ring	1 Orange Life Ring with 60 feet of line	1 Orange Life Ring with 60 feet of line	3 Orange Life Rings 1 with 90 feet of line
Fire Extinguishers	at least 1	1 to 2	2 to 3	2 in the Bridge, 1 in the Galley AND 2 in the Engine Room

* make sure fire extinguishers are charged and strategically placed around vessel (galley & engine room & near exits)

A *cheat sheet* to use when you are conducting your Fishing Vessel Safety Checks.

Keep this copy for your reference.

APPENDIX 19

BaitType			
Almaco Jack	Dolphin	Pale Spotted Eel	Skate Stomach
Anchovy	Dusky Flounder	Pig Feet	Sm Scale Lizard fish
Artificial	Eel	Pig Skin	Smooth Dogfish
Asian Carp	Fish Stomach	Pig Stomach	Smooth Pufferfish
Atl Sharpnose Shark	Fish Trim	Pigfish	Snakefish
Atlantic Bumper	Flounder	Pinfish	Snapper Stomach
Atlantic Stingray	Flying Fish	Porgy	Snapper Trim
Ballyhoo	Fried Chicken Bones	Pork	Southern Hake
Banded Rudderfish	Gag Grouper Stomach	Pufferfish	Southern Puffer
Bank Seabass	Gizzards	Purplemouth Moray	Spanish Flag
Barracuda	Goggle Eye	Rainbow Runner	Spanish Mackerel
Bearded Brotula	Grass Porgy	Ray	Spanish Sardine
Bermuda Chub	Gray Triggerfish	Red Drum	Spinycheek Scorpionfish
Bigeye	Greater Amberjack	Red Grouper	Spotfin Hogfish
Bigeye Scad	Green Moray	Red Grouper Stomach	Spotted Hake
Black Seabass	Grouper Stomach	Red Hogfish	Spotted Moray
Blackbelly Rosefish	Grunt	Red Porgy	Squid
Blackedge moray	Gulf Hake	Red Snapper	Squirrelfish
Blackfin Snapper	Hake	Red Snapper Skin	Stingray
Blackfin tuna	Herring	Red Snapper Stomach	Stomach
Blacknose Shark	Hotdog	Reticulate Moray	Striped Mojarra
Blacktail Moray	Inshore Lizardfish	Rock Seabass	Striped Mullet
Blue Crab	Jack	Round Scad	Swordfish
Blue Runner	Jack Crevalle	Saddle Bass	Swordfish Trim
Bluefin tuna	Jolthead Porgy	Sand Diver	Tattler
Bluefish	King Mackerel	Sand Perch	Tilefish
Blueline Tilefish	King Snake Eel	Sand Tilefish	Tilefish Stomach
Boneless beef ribs	Knobbed Porgy	Sardine	Toadfish
Bonito	Ladyfish	Scad	Tomtate
Butterfishes	Ladyfish Head	Scamp Grouper	Trim
Catfish	Lane Snapper	Sea Bass	Trim(swordfish/tuna)
Chicken Fat	Leopard Toadfish	Shark	Trout
Chicken Guts	Lesser Amberjack	Shark Stomach	Tuna
Chub Mackerel	Littlehead Porgy	Shark Trim	Tuna Trim
Chum Oat Balls	Lizardfish	Sharksucker	Unk Dead
Clearnose Skate	Longtail Bass	Sheepshead	Unk Fish
Cobia Stomach	Lookdown	Shrimp	Unk Live
Conger Eel	Mackerel	Shrimp Trash	Vermilion Snapper
Cownose Ray	Mantis Shrimp	Silk Snapper	Wenchman
Crab	Menhaden	Silky Shark	White Grunt
Creole-fish	Minnow	Silver Mullet	Whiting
Croaker	Moray Eel	Silver Perch	Yellowtail Snapper
Cuban Dogfish	Mullet	Silverside	
Cutlassfish	Octopus	Skate	

APPENDIX 20
REEF FISH AND SHRIMP OBSERVER ISSUE

Violation Observed	Violation	OLE Comments
Handling prohibitions	Smalltooth sawfish	Medium -> High (i.e. take or negligent handling)
Gear violations	Required fishing gear (non-stainless steel circle hooks)	Low -> Medium (i.e. using majority illegal hooks)
Gear violations	BRD requirements	High (uninstalled, sewn shut, dysfunctional, etc.)
Gear violations	TED violations (angles, openings, etc.)	High (angle, bent bar, undersized opening, etc.)
Gear violations	Reef fish as bait/filleted at seas	Medium to High level (unless filleted for consumption at sea). Fact specific
Gear violations	Use of illegal gear (reef fish longline, buoy gear, fish traps)	High (Fish traps) Longline/buoy gear dependent on location
Gear violations	Not in possession of required turtle handling devices	Low; Fix-It, SS, VW, WW, etc.
Gear violations	Marking of all floats with vessel name and number	Low; Fix-It, SS, VW, WW, etc. unless blatant disregard
Handling prohibitions	Harassing marine mammals, turtles, seabirds	High
Handling prohibitions	Attempting to purposefully injure marine mammals, turtles, seabirds	High
Observer compliance	Failure to take an observer when selected due to no communication, inadequate/unsafe conditions, etc.	High
Observer compliance	Harass, intimidate, obstruct an observer	High
Observer compliance	Assault an observer	High
Retention Limits	Retain a marketable species under the size limit	Low -> Medium (Species specific, significant disregard)
Retention Limits	Retain a marketable catch in an amount greater than allowed	Low level; Depends on species and if catch limit is certain amount of fish or significant disregard for regulations.
Retention Limits	Retain a marketable catch during a closed season	High (Species and/or Quantity specific)
Retention Limits	Retain a prohibited species	High (Species and/or Quantity specific)
Retention Limits	Offload of IFQ species prior to allowable times	Medium -> High
Retention Limits	Offload of IFQ species at non-approved landing location	Medium -> High
Spatial violation	Fish in a closed area	High