

High School and Beyond 2022 (HS&B:22)
Base-Year Full-Scale Study Recruitment and Data
Collection

OMB# 1850-0944 v.8

Appendix A – Communication Materials

Submitted by
National Center for Education Statistics
U.S. Department of Education

March 2019
revised November 2020

Contents

****Materials in this appendix have been marked as previously approved (as compared to OMB# 1850-0944 v.7) to facilitate review. Materials changed only due to study name and date due to the one-year delay of data collection are marked “previously approved” as opposed to “modified”. Each item’s approval status is noted next to its title in the Table of Contents****

Appendix A1.	Endorsement Request Letter (previously approved).....	2
Appendix A1a.	Endorsement Delay Letter (new).....	3
Appendix A2.	State Letter and Sample Endorsement Letter (previously approved).....	4
Appendix A2a.	State 2 nd Delay Notification Letter (new).....	6
Appendix A3.	District Notification and Recruitment Letter (previously approved).....	7
Appendix A3a.	HS&B:22 District Notification Letter – District Post-Delay Recontact Letter (previously approved).....	9
Appendix A3a1.	District 2 nd Delay Notification Letter (new).....	11
Appendix A4a.	School Recruitment Letter (previously approved).....	12
Appendix A4a1.	HS&B:22 School Notification Letter – School Post-Delay Recontact Letter (previously approved).....	13
Appendix A4a2.	School 2 nd Delay Notification Letter Final Agreement Schools (new).....	15
Appendix A4a3.	School 2 nd Delay Notification Letter in Progress and Pending Refusals (new).....	16
Appendix A4b.	School Coordinator Role Overview (previously approved).....	17
Appendix A4b1.	School Coordinator Letter Accompanying Permission Materials (previously approved).....	20
Appendix A4b2.	School Coordinator Role Overview Virtual School (previously approved).....	21
Appendix A4c.	School Thank You Letter (previously approved).....	23
Appendix A4d.	School Participation Reminder Emails (previously approved).....	24
Appendix A5a.	Parent Notification Letter (modified).....	29
Appendix A5b.	Parent Notification Letter – Spanish (modified).....	30
Appendix A5c.	Parent Permission Letter – Implicit (modified).....	31
Appendix A5d.	Parent Permission Letter - Implicit – Spanish (modified).....	32
Appendix A5e.	Parent Permission Letter – Explicit (modified).....	33
Appendix A5f.	Parent Permission Letter – Explicit – Spanish (modified).....	34
Appendix A5g.	Student Assent Form (previously approved).....	35
Appendix A5h.	Student Script (previously approved).....	36
Appendix A6a.	Study Information Sheet (previously approved).....	37
Appendix A6b.	Frequently Asked Questions (previously approved).....	38
Appendix A6c.	Brochure Text (previously approved).....	42
Appendix A6d.	HS&B:22 Newsletter (previously approved).....	43
Appendix A6e.	Video Script (previously approved).....	47
Appendix A7a.	Recruitment Website Text (modified).....	49
Appendix A8a.	Out-of-School Data Collection – Parent Letter (previously approved).....	59
Appendix A8a.1	Out-of-School Data Collection – Parent Letter Reminder (previously approved).....	61
Appendix A8a.2	Out-of-School Data Collection – Parent Email Initial (previously approved).....	62
Appendix A8a.3	Out-of-School Data Collection – Parent Email Reminder (previously approved).....	63
Appendix A8b.	Out-of-school Data Collection – Student Letter (previously approved).....	64

Appendix A8b.1	Out-of-school Data Collection – Student Letter Reminder (previously approved).....	65
Appendix A8b.2	Out-of-School Data Collection – Student Email Initial (previously approved).....	66
Appendix A8b.3	Out-of-School Data Collection – Student Email Reminder (previously approved).....	67
Appendix A8b.4	Out-of-School Data Collection – Student Postcard (previously approved).....	68
Appendix A8b.4	Out-of-School Data Collection: Sorry I Missed You Card (previously approved).....	69
Appendix A8c.	Hybrid Out-of-School Data Collection – Student Postcard (previously approved).....	70
Appendix A8d.	Hybrid Out-of-School Data Collection – Parent Letter (previously approved).....	71
Appendix A8d.1	Hybrid Out-of-School Data Collection – Parent Letter Reminder (previously approved).....	72
Appendix A8d.2	Hybrid Out-of-School Data Collection – Parent Email Initial (previously approved).....	73
Appendix A8d.3	Hybrid Out-of-School Data Collection – Parent Email Reminder (previously approved).....	74
Appendix A8e.	Hybrid Out-of-school Data Collection – Student Letter (previously approved).....	75
Appendix A8e.1	Hybrid Out-of-school Data Collection – Student Letter Reminder (previously approved).....	76
Appendix A8e.2	Hybrid Out-of-School Data Collection – Student Email Initial (previously approved).....	77
Appendix A8e.3	Hybrid Out-of-School Data Collection – Student Email Reminder (previously approved).....	78
Appendix A9a.	Summary of Mathematics Questions (previously approved).....	79
Appendix A9b.	Summary of Reading Questions (previously approved).....	80
Appendix A9c.	Summary of Student Survey (previously approved).....	81
Appendix A9d.	Summary of Parent Survey (previously approved).....	82
Appendix A9e.	Summary of Mathematics Teacher Survey (previously approved).....	83
Appendix A9f.	Summary of School Counselor Survey (previously approved).....	84
Appendix A9g.	Summary of School Administrator Survey (previously approved).....	85
Appendix A10.	Student Rostering Materials (previously approved).....	86
Appendix A11.	Parent Data Collection Letter (previously approved).....	89
Appendix A11.1	Parent Data Collection Letter Reminder (previously approved).....	90
Appendix A11.1a	Parent Data Collection Reminder Postcard (previously approved).....	91
Appendix A11.1b	Parent Data Collection Abbreviated Survey Postcard (previously approved).....	92
Appendix A11.2	Parent Data Collection Email (previously approved).....	93
Appendix A11.3a	Parent Data Collection Email Reminder (previously approved).....	94
Appendix A11.3b	Parent Data Collection Email Reminder (previously approved).....	95
Appendix A11.4a	Parent Data Collection Reinterview Email – Web (previously approved).....	96
Appendix A11.4b	Parent Data Collection Reinterview Email – CATI (previously approved).....	97
Appendix A12a.	Staff Data Collection Letters – Math Teacher Letter (previously approved).....	98
Appendix A12a.1	Staff Data Collection Letters – Math Teacher Reminder (previously approved).....	99
Appendix A12a.2	Staff Data Collection Letters – Math Teacher Email (previously approved).....	100
Appendix A12a.3	Staff Data Collection Letters – Math Teacher Email Reminder (previously approved).....	101
Appendix A12b.	Staff Data Collection Letters – Guidance Counselor (previously approved).....	102
Appendix A12b.1.	Staff Data Collection Letters Reminder – Guidance Counselor (previously approved).....	103
Appendix A12b.2.	Staff Data Collection Email– Guidance Counselor (previously approved).....	104
Appendix A12b.3.	Staff Data Collection Email Reminder – Guidance Counselor (previously approved).....	105
Appendix A12c.	Staff Data Collection Letters – School Administrator (previously approved).....	106
Appendix A12c.1.	Staff Data Collection Letters Reminder– School Administrator (previously approved).....	107
Appendix A12c.2.	Staff Data Collection Email – School Administrator (previously approved).....	108
Appendix A12c.3.	Staff Data Collection Email Reminder– School Administrator (previously approved).....	109

Appendix A13a. School Staff Participation Certificate (previously approved)..... 110
Appendix A13b. Parent/Student Incentive Receipt Form (previously approved)..... 111
Appendix A14a. Lead Postcards (previously approved)..... 112
Appendix A14b. Informational Materials (modified)..... 115
Appendix A14c. Virtual Session PowerPoint (previously approved)..... 119

<Title First Name Last Name>

<Date>

<National Education Organization Official's Title>

<National Education Organization>

<Address>

<City, State Zip>

Dear <Name>:

We are writing to request support from your organization for the U.S. Department of Education's **High School & Beyond Longitudinal Study of 2022 (HS&B:22)**.

Educational success is crucial to individual and societal outcomes. Understanding what factors propel some students to successful completion of high school and entry into work or college while leaving others behind is a critical function of this National Center for Education Statistics' (NCES) research study.

How a student does in 9th grade is more predictive of their odds of graduating high school than all other factors, including race, gender, socioeconomic status, and prior academic achievement, combined.

HS&B:22 will give policymakers and educators information they need to improve the high-school experience and outcomes for ALL students. It will offer the opportunity to explore students transitions into and out of high-school and create a big picture view of K-12 education and trends as it follows the elementary and middle grades longitudinal studies.

We are hoping you will partner with us by learning more about HS&B:22 and encouraging participation of schools that are selected to represent the U.S. Educational experience in this study. Your support and a letter of endorsement can show how important this study is and increase participation and success of the study. Without school participation, the validity of national estimates is at risk.

If the 1.3 million dropouts from the Class of 2010 had graduated, the nation would have seen \$337 billion more in earnings over the course of the students' lifetimes.²

Next steps: Support HS&B:22 by lending your logo and name, providing a letter of endorsement, and sharing information about the study with your members and partners.

You may contact Jen Krause at RTI International with questions at (919) 541-1287 or HSB22@rti.org. You may also contact HS&B:22 Project Officer Elise Christopher at NCES at (202) 245-7098. We are confident that you will see the value and importance of this research and will want to partner with us to advance the quality of education for high school students.

Sincerely,

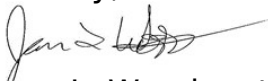

James L. Woodworth
NCES Commissioner

NCES is authorized to conduct the High School and Beyond Longitudinal Study of 2022 (HS&B:22) by the Education Sciences Reform Act of 2002 (ESRA 2002, 20 U.S.C. §9543) and to collect students' education records from education agencies or institutions for the purposes of evaluating federally supported education programs under the Family Educational Rights and Privacy Act (FERPA, 34 CFR §§ 99.31(a)(3)(iii) and 99.35). The data are being collected for NCES by RTI International, a U.S.-based nonprofit research organization. All of the information students, parents, and staff provide may be used only for statistical purposes and may not be disclosed, or used, in identifiable form for any other purpose except as required by law (20 U.S.C. §9573 and 6 U.S.C. §151). The collected information will be combined across respondents to produce statistical reports.

Allensworth, E., & Easton, J.Q. (2007). *What matters for staying on-track and graduating in Chicago public high schools: A close look at course grades, failures, and attendance in the freshman year*. University of Chicago Consortium on School Research.

² Campaign for CHSE High School Equity. "Plan for Success: Communities of Color Define Policy Priorities for High School Reform." Campaign for CHSE High School Equity. Accessed February 18, 2015.



Dear [ORGANIZATION]:

I am grateful for your support and endorsement of the **High School and Beyond Longitudinal Study of 2021 (HS&B:21)** and would like to share **important information** about the study with you. As the coronavirus pandemic has evolved, we have continued to maintain close contact with our educational partners so we can best understand the impact on schools. We understand that districts and schools may be facing challenges in adjusting plans to deliver meaningful learning experiences to students during the current school year. We also know that schools and families across the U.S. continue to feel significant disruptions as a result of the pandemic.

We need to conduct the study safely and without additional stresses to students or school personnel while schools and the families that send their children to them are working through how best to respond to the pandemic. We feel it is in the best interest of schools, educators, and students to delay the first data collection cycle by an additional year. This delay will result in the **first cycle occurring in the fall of 2022** and the follow-up occurring in the spring of 2026. As such, the study will now be known as **HS&B:22**.

Thank you for any communications that you may already have had with your partners and members regarding HS&B:22. **We will contact you next year** to further discuss your letter of support and path forward.

Your support in this endeavor is crucial to advance the quality of education for our country's high school students. For additional study details, please visit the study website: <https://surveys.nces.ed.gov/hsb22>. Please contact us with questions at (855) 500-1439 or HSB22@rti.org. You may also contact Project Officer Elise Christopher, PhD at NCES at Elise.Christopher@ed.gov. We are confident that you will continue to see the significance of this research to advance the quality of education for our country's high school students.

We are grateful for your support to make the High School and Beyond Longitudinal Study of 2022 a success.

Sincerely,

James L. Woodworth, PhD
Commissioner
National Center for Education Statistics
PCP, 550 12th St., SW, 4th floor, Room 3532
Washington, DC 20202

Dear <Name>:

Understanding what factors propel some students to successful completion of high school and entry into work or college while leaving others behind is a critical function of the National Center for Education Statistics' (NCES) High School and Beyond Longitudinal Study of 2022 (HS&B:22).

How a student does in 9th grade is more predictive of their odds of graduating high school than all other factors, including race, gender, socioeconomic status, and prior academic achievement, combined.

<Thank you for partnering> <We are hoping you will partner> with us by learning more about HS&B:22 and encouraging participation of schools that are selected to represent the U.S.

Educational experience in this study. Your support and a letter of endorsement can show how important this study is and increase participation and success of the study.

High School has changed immensely over the last decade and even more so in recent months. HS&B:22 will give policymakers and educators important information they need to improve the high school experience and outcomes for ALL students. It will offer the opportunity to explore students transitions into and out of high school, equity in education, family factors, and student attitudes. HS&B:22 will create a big picture view of K-12 education and trends, rounding out the elementary and middle grades longitudinal studies.

If the 1.3 million dropouts from the Class of 2010 had graduated, the nation would have seen \$337 billion more in earnings over the course of the students' lifetimes.²

Next steps: <Continue to encourage Superintendents and Principals to participate if they are selected. You can also provide a letter of support if you have not done so already.>

<Support your state's participation in this research by providing a letter of endorsement. A representative of RTI International will contact you to discuss the possibility of receiving such a letter.>

You may contact RTI International with questions at (855) 500-1439 or HSB22@rti.org. You may also contact HS&B:22 Project Officer Elise Christopher at NCES at (202) 245-7098. We are confident that you will see the value and importance of this research and will want to partner with us to advance the quality of education for our country's high school students.

Sincerely,

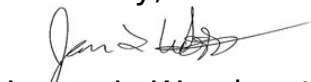

James L. Woodworth
NCES Commissioner

information students, parents, and staff provide may be used only for statistical purposes and may not be disclosed, or used, in identifiable form for any other purpose except as required by law (20 U.S.C. §9573 and 6 U.S.C. §151). The collected information will be combined across respondents to produce statistical reports.

Allensworth, E., & Easton, J.Q. (2007). What matters for staying on-track and graduating in Chicago public high schools: A close look at course grades, failures, and attendance in the freshman year. University of Chicago Consortium on School Research.

² Campaign for CHSE High School Equity. "Plan for Success: Communities of Color Define Policy Priorities for High School Reform." Campaign for CHSE High School Equity. Accessed February 18, 2015.

<Title First Name Last Name> <Date>
<State Department of Education Official’s Title>
<State Department of Education>
<Address>
<City, State Zip>

Sample Letter of Support

<Date>
<Superintendent or Principal’s Name>
<Title>
<School>
<Address>
<City, State Zip>

Dear School District and School Administrators:

The <INSERT STATE EDUCATION AGENCY NAME> is pleased to support the **High School and Beyond** Longitudinal Study of 2022 (HS&B:22), conducted by the National Center for Education Statistics (NCES) within the U.S. Department of Education. The study complements our <vision/mission/goal; *here an SEA administrator enters district- or school-specific visions, missions, or goals to which HS&B:22 contributes*>

The data your school, students, staff, and parents provide to NCES and its contractor, RTI International, will help policymakers and educators understand the factors associated with successful transitions to high school and allow for examination of trends over time. These data are critical for making decisions related to policy and practice and the collection of these data is not possible without the participation of selected school districts and schools. By participating in the study, you are providing much needed information to help understand what factors propel some students to successful completion of high school and entry into work or postsecondary education and identify key risk factors during this critical stage of education.

We strongly encourage your participation in HS&B:22. **We are confident that <schools in our state /our members and partners, along with state and local education leadership> will understand the importance of this national study and will accept the invitation to participate.**

Should you have any questions, please call the HS&B:22 information number, (855) 500-1439, or send an email to HSB22@rti.org. You may also contact Project Officer Elise Christopher, PhD at NCES at (202) 245-7098 for more information.

Thank you for dedication to education research and your help in making HS&B:22 a success.

Sincerely,

<Name>
Chief State School Officer

Dear Colleague:

I am writing today to share **important information** about the **High School and Beyond Longitudinal Study of 2021 (HS&B:21)**. As the coronavirus pandemic has evolved, we have continued to maintain close contact with our educational partners so we can best understand the impact on schools. We understand that your districts and schools may be facing challenges in adjusting plans to deliver meaningful learning experiences to students during the current school year. We also know that schools and families across the U.S. continue to feel significant disruptions as a result of the pandemic.

We need to conduct the study safely and without additional stresses to students or school personnel while you are working through how best to respond to the pandemic. We feel it is in the best interest of schools, educators, and students to delay the first data collection cycle by an additional year. This delay will result in the **first cycle occurring in the fall of 2022** and the follow-up occurring in the spring of 2026. As such, the study will now be known as **HS&B:22**.

Thank you for any communications that you may already have had with schools in your state regarding HS&B:22. **We will contact you next year** to further discuss how your office can best support your state's selected schools.

Your support in this endeavor is crucial to advance the quality of education for our country's high school students. For additional study details, please visit the study website: <https://surveys.nces.ed.gov/hsb22>. Please contact us with questions at (855) 500-1439 or HSB22@rti.org. You may also contact Project Officer Elise Christopher, PhD at NCES at Elise.Christopher@ed.gov. We are confident that you will continue to see the significance of this research to advance the quality of education for our country's high school students.

We look forward to working with schools in your state in the 2022-23 school year to help make the study a success.

Sincerely,

James L. Woodworth, PhD
Commissioner
National Center for Education Statistics
PCP, 550 12th St., SW, 4th floor, Room 3532
Washington, DC 20202

[DATE]

[DistrictName]

[Address]

[CitySTZip]

Dear <Superintendent>,

Education in the United States is at a pivotal juncture – rapidly changing, as district and school leaders forge new and innovative ways to manage an evolving situation and to ensure continuous learning and support for our nation’s youth. Now more than ever, it is vital that we capture a national picture of the high school experience, so we can learn from these efforts and help shape policy, practice, programs, and funding priorities going forward.

One or more schools (please see enclosure for list) in your district have been selected for the High School and Beyond Longitudinal Study of 2022 (HS&B:22). Your support and partnership are vital to advancing the quality of education for our country’s high school students.

Benefits of HS&B:22 include:

- Schools may select from a menu of incentive options for schools, school coordinators, teachers, and students.
- Eligible district and school staff may register for a no-cost interactive, interactive webinar on timely topics such as social and emotional learning, project-based learning, or STEM.
- Receive school-level reports to compare school-level measures to the national averages and similar schools.
- Participating students and staff also receive a service certificate from the U.S. Department of Education.

Within a few days study materials will be sent to selected schools in your district, and our contractor RTI International will contact them to participate. Please contact us with questions at: 855-500-1439 or HSB22@rti.org

While it may never be the best time for research, we feel it is always the right time for important research that will improve education and support successful outcomes for all students. We look forward to working with your school in the 2022-23 school year to make the study a success.

Sincerely,
James L. Woodworth
NCES Commissioner

Enclosures: HS&B:22 Brochure, Study Snapshot, State Letter of Endorsement (if provided)

HS&B:22 is sponsored by the National Center for Education Statistics (NCES). NCES is a division within the Institute of Education Sciences (IES), a part of the U.S. Department of Education. IES is the nation's leading source for rigorous, independent education research, evaluation and statistics. School and student participation are voluntary. Learn more about HS&B:22 by visiting: <https://surveys.nces.ed.gov/hsb22>. Please contact us with questions at (855) 500-1439 or HSB22@rti.org.

NCES is authorized to conduct the High School and Beyond Longitudinal Study of 2022 (HS&B:22) by the Education Sciences Reform Act of 2002 (ESRA 2002, 20 U.S.C. §9543) and to collect students' education records from education agencies or institutions for the purposes of evaluating federally supported education programs under the Family Educational Rights and Privacy Act (FERPA, 34 CFR §§ 99.31(a)(3)(iii) and 99.35). The data are being collected for NCES by RTI International, a U.S.-based nonprofit research organization. All of the information students, parents, and staff provide may be used only for statistical purposes and may not be disclosed, or used, in identifiable form for any other purpose except as required by law (20 U.S.C. §9573 and 6 U.S.C. §151). The collected information will be combined across respondents to produce statistical reports.

HS&B:22 SNAPSHOT

Occurs in the fall of the 2022-23 school year

Only a small group of 9th graders at each school will be selected, an average of 35!

Student session is 90 minutes or less

Monetary donation and resources provided to participating schools

The schools listed below have been selected for the study. We would appreciate it if you would notify these schools that they will be contacted in the next few weeks by the study team. Thank you for your support.

<School 1>	<School 2>
<School 3>	<School 4>

list of selected schools as enclosure

[DATE]

[DistSuptName]

[DistrictName]

[Address]

[CitySTZip]

Dear Superintendent,

Education in the United States is at a pivotal juncture – rapidly changing, as district and school leaders forge new and innovative ways to manage an evolving situation and to ensure continuous learning and support for our nation’s youth. Now more than ever, it is vital that we capture a national picture of the high school experience and student outcomes, so we can learn from these efforts and help shape policy, practice, programs, and funding priorities going forward.

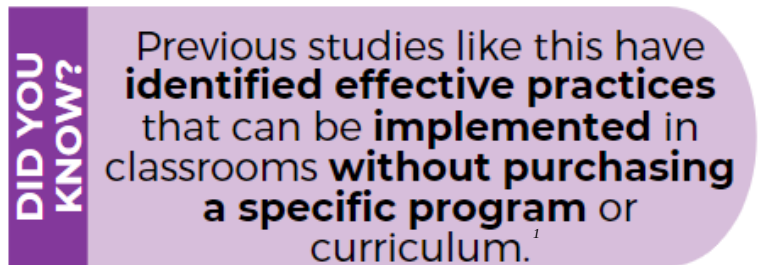

We previously contacted you requesting your support for the **High School and Beyond Longitudinal Study of 2022 (HS&B:22)**. As you may recall, the study was delayed by two years, to be sensitive to disruptions faced by many school systems in response to the COVID-19 pandemic. I am writing to inform you that we are proceeding with the study, now planned for the 2022-23 school year.

Please refer to the enclosed list of schools in your district that were selected for HS&B:22. We will contact all selected schools this school year to begin planning and preparing for data collection Fall 2022. The study’s follow-up data collection will occur Spring 2026.

This is not just a research study. HS&B:22 presents an opportunity for your students, parents, and school staff to share their experiences and opinions and help improve education today and in the future. It is extremely important to have the participation of all schools selected for the study. Participation is voluntary yet needed to represent the broad diversity of schools and students across the nation. **Your support and partnership are vital to advancing the quality of education for our country’s high school students.**

You can learn more about HS&B:22 by reviewing the enclosures and visiting our website <https://surveys.nces.ed.gov/hsb22>.

Please contact us with questions at 855-500-1439 or HSB22@rti.org.

While it may never be the best time for research, we feel it is always the right time for important research that will improve education and support successful outcomes for all students. We look forward to working with your school(s) in the 2022-2023 school year to make the study a success.

Sincerely,

James L. Woodworth
NCES Commissioner

Enclosures: HS&B:22 Brochure, Study Snapshot, State Letter of Endorsement (if provided)

HS&B:22 is sponsored by the National Center for Education Statistics (NCES). NCES is a division within the Institute of Education Sciences (IES), a part of the U.S. Department of Education. IES is the nation's leading source for rigorous, independent education

research, evaluation and statistics. School and student participation are voluntary. Learn more about HS&B:22 by visiting: <https://surveys.nces.ed.gov/hsb22>. Please contact us with questions at (855) 500-1439 or HSB22@rti.org.

NCES is authorized to conduct the High School and Beyond Longitudinal Study of 2022 (HS&B:22) by the Education Sciences Reform Act of 2002 (ESRA 2002, 20 U.S.C. §9543) and to collect students' education records from education agencies or institutions for the purposes of evaluating federally supported education programs under the Family Educational Rights and Privacy Act (FERPA, 34 CFR §§ 99.31(a)(3)(iii) and 99.35). The data are being collected for NCES by RTI International, a U.S.-based nonprofit research organization. All of the information students, parents, and staff provide may be used only for statistical purposes and may not be disclosed, or used, in identifiable form for any other purpose except as required by law (20 U.S.C. §9573 and 6 U.S.C. §151). The collected information will be combined across respondents to produce statistical reports.

1. <https://www.brookings.edu/research/federally-supported-education-research-doesnt-need-a-do-over/>



Dear Superintendent:

I am writing today to share **important information** about the **High School and Beyond Longitudinal Study of 2021 (HS&B:21)**. As the coronavirus pandemic has evolved, we have continued to maintain close contact with our educational partners so we can best understand the impact on schools. We understand that your schools may be facing challenges in adjusting plans to deliver meaningful learning experiences to students during the current school year. We also know that schools and families across the U.S. continue to feel significant disruptions as a result of the pandemic.

We need to conduct the study safely and without additional stresses to students or school personnel while you are working through how best to respond to the pandemic. We feel it is in the best interest of schools, educators, and students to delay the first data collection cycle by an additional year. This delay will result in the **first cycle occurring in the fall of 2022** and the follow-up occurring in the spring of 2026. As such, the study will now be known as **HS&B:22**.

U.S. Department of Education has posted information and resources for schools and school personnel about the coronavirus pandemic at:

We will contact you next school year to provide additional information and discuss how we can partner to ensure students in your district have the opportunity to participate with others from across the U.S.

The Department's Institute of Education Sciences offers coronavirus pandemic resources from the Regional Education Laboratories:
<https://ies.ed.gov/ncee/edlabs/projects>

In the meantime, please visit the links provided in the call-out boxes for some resources your district and schools may find helpful in navigating these uncharted waters. For additional study details, please visit the study website: <https://surveys.nces.ed.gov/hsb22>. Please contact us with questions at (855) 500-1439 or HSB22@rti.org. You may also contact Project Officer Elise Christopher, PhD at NCES at Elise.Christopher@ed.gov. We are confident that you will continue to

see the significance of this research to advance the quality of education for our country's high school students.

Please know that we value what you, your schools, and staff are doing to keep students engaged in learning, and your district's commitment to supporting students and their families as the COVID-19 situation continues to evolve.

Keeping you, your staff, students, and families in our thoughts.

Sincerely,

James L. Woodworth, PhD
Commissioner
National Center for Education Statistics

<<date>

<Principal name>

<school name>

<address>

<city> <state> <zip>

Dear <Principal Name>:

Education in the United States is at a pivotal juncture – rapidly changing, as district and school leaders forge new and innovative ways to manage an evolving situation and to ensure continuous learning and support for our nation’s youth. Now more than ever, it is vital that we capture a national picture of the high school experience, so we can learn from these efforts and help shape policy, practice, programs, and funding priorities going forward.

Your school has been selected to participate in the High School and Beyond Longitudinal Study of 2022 (HS&B:22). Your support and partnership are vital to advancing the quality of education for our country’s high school students.

To meet the rigorous standard of HS&B:22 data, each selected school needs to do their part and participate. To ensure participation is feasible for your school, NCES has developed a highly flexible study design so schools are excited to contribute. We will reach out to you in the next few days to answer any questions and obtain the name of your school coordinator who will serve as the study liaison.

Next Steps:

- Review the enclosed materials
- Write down the name and email address of your school coordinator (SC) on the purple paper
- You will receive a call in the next few days to discuss the study and provide the name of your SC.
- If you prefer to contact us first, we can be reached at 855-500-1439 OR HSB22@rti.org

While it may never be the best time for research, we feel it is always the right time for important research that will improve education and support successful outcomes for all students. We look forward to working with your school in the 2022-23 school year to make the study a success.

Sincerely,

James L. Woodworth
NCES Commissioner

Enclosures: HS&B:22 Brochure, Study Snapshot, State Letter of Endorsement (if provided)

HS&B:22 is sponsored by the National Center for Education Statistics (NCES). NCES is a division within the Institute of Education Sciences (IES), a part of the U.S. Department of Education. IES is the nation's leading source for rigorous, independent education research, evaluation and statistics. School and student participation are voluntary.

NCES is authorized to conduct the High School and Beyond Longitudinal Study of 2022 (HS&B:22) by the Education Sciences Reform Act of 2002 (ESRA 2002, 20 U.S.C. §9543) and to collect students' education records from education agencies or institutions for the purposes of evaluating federally supported education programs under the Family Educational Rights and Privacy Act (FERPA, 34 CFR §§ 99.31(a)(3)(iii) and 99.35). The data are being collected for NCES by RTI International, a U.S.-based nonprofit research organization. All of the information students, parents, and staff provide may be used only for statistical purposes and may not be disclosed, or used, in identifiable form for any other purpose except as required by law (20 U.S.C. §9573 and 6 U.S.C. §151). The collected information will be combined across respondents to produce statistical reports.

HS&B:22 SNAPSHOT

Occurs in the fall of the 2022-23 school year

Only a small group of 9th graders at each school will be selected, an average of 35!

Student session is 90 minutes or less

\$200 incentive for schools plus professional development for staff

Appendix A4a1. HS&B:22 School Notification Letter – School Post-Delay Recontact Letter (previously approved)

<date>

<Principal name>

<school name>

<address>

<city> <state> <zip>

Dear <Principal Name>:

Education in the United States is at a pivotal juncture – rapidly changing, as district and school leaders forge new and innovative ways to manage an evolving situation and to ensure continuous learning and support for our nation’s youth. Now more than ever, it is vital that we capture a national picture of the high school experience and student outcomes, so we can learn from these efforts and help shape policy, practice, programs, and funding priorities going forward.

In the 2017-2018 school year, only 21% of public schools offered at least one course entirely online.¹ The High School & Beyond Longitudinal Study of 2021 will help us learn

HOW THE SHIFT TO ONLINE EDUCATION HAS IMPACTED OUR STUDENTS AND NATION.

We previously contacted you requesting your participation in the High School and Beyond Longitudinal Study of 2022 (HS&B:22). The study was delayed by two years, to be sensitive to disruptions faced by many schools responding to the COVID-19 pandemic. I am writing to <FOR SCHOOLS THAT PREVIOUSLY APPROVED: thank you for your partnership and to> inform you that we are proceeding with the study, now known as **High School and Beyond Longitudinal Study of 2022 (HS&B:22)** and planned for the 2022-23 school year.

We are contacting all selected schools in the 2021-22 school year begin planning and preparing for data collection Fall 2022. The study’s follow-up data collection will occur Spring 2026. **Our contractor, RTI International, will contact you soon to discuss the details of your school’s participation.**

This is not just a research study. HS&B:22 presents an opportunity for your students, parents, and school staff to share their experiences and opinions and help improve education today and in the future. It is extremely important to have the participation of all schools selected for the study. Participation is voluntary yet needed to represent the broad diversity of schools and students across the nation. Your support and partnership are vital to advancing the quality of education for our country’s high school students.

The research is clear -

FRESHMAN YEAR IS WHERE WE'RE LOSING STUDENTS.

That also means that we know where to start to ensure that more students succeed.²

Learn more about HS&B:22, including the benefits of participation, by reviewing the enclosures. You can also get more information by watching a short video on our website <https://surveys.nces.ed.gov/hsb22>. Reserve your school’s participation NOW by contacting HS&B:22 at (855) 500-1439 or

HSB22@rti.org.> **Our contractor, RTI International, will contact you soon to confirm your School Coordinator (primary contact for the study) and discuss the details of participation.**

While it may never be the best time for research, we feel it is always the right time for important research that will improve education and support successful outcomes for all students. We look forward to working with your school in the 2022-23 school year to make the study a success.

Sincerely,

James L. Woodworth
NCES Commissioner

Enclosures: HS&B:22 Brochure, Study Snapshot, State Letter of Endorsement (if provided)

HS&B:22 is sponsored by the National Center for Education Statistics (NCES). NCES is a division within the Institute of Education Sciences (IES), a part of the U.S. Department of Education. IES is the nation's leading source for rigorous, independent education research, evaluation and statistics. School and student participation are voluntary. Learn more about HS&B:22 by visiting: <https://surveys.nces.ed.gov/hsb22>. Please contact us with questions at (855) 500-1439 or HSB22@rti.org.

NCES is authorized to conduct the High School and Beyond Longitudinal Study of 2022 (HS&B:22) by the Education Sciences Reform Act of 2002 (ESRA 2002, 20 U.S.C. §9543) and to collect students' education records from education agencies or institutions for the purposes of evaluating federally supported education programs under the Family Educational Rights and Privacy Act (FERPA, 34 CFR §§ 99.31(a)(3)(iii) and 99.35). The data are being collected for NCES by RTI International, a U.S.-based nonprofit research organization. All of the information students, parents, and staff provide may be used only for statistical purposes and may not be disclosed, or used, in identifiable form for any other purpose except as required by law (20 U.S.C. §9573 and 6 U.S.C. §151). The collected information will be combined across respondents to produce statistical reports.

1. https://nces.ed.gov/surveys/ntps/tables/ntps1718_2019082303_s12n.asp
2. <http://stand.org/washington/blog/does-freshman-year-matter>



550 12th Street SW
Washington, DC 20202

Dear Principal:

I am writing today to share **important information** about the **High School and Beyond Longitudinal Study of 2021 (HS&B:21)**. As the coronavirus pandemic has evolved, we have continued to maintain close contact with our educational partners so we can best understand the impact on schools. We understand that your school may be facing challenges in adjusting plans to deliver meaningful learning experiences to students during the current school year. We also know that schools and families across the U.S. continue to feel significant disruptions as a result of the pandemic.

We need to conduct the study safely and without additional stresses to students or school personnel while you are working through how best to respond to the pandemic. We feel it is in the best interest of schools, educators, and students to delay the first data collection cycle by an additional year. This delay will result in the **first cycle occurring in the fall of 2022** and the follow-up occurring in the spring of 2026. As such, the study will now be known as **HS&B:22**.

Thank you for your continued support of this significant study. **We will contact you again next school year** to provide additional information and discuss how we can partner to ensure students in your school have the opportunity to participate with others from across the U.S.

posted information and resources for schools and school personnel about the coronavirus pandemic at: <https://www.ed.gov/coronavirus>

The Department's Institute of Education Sciences offers coronavirus pandemic resources from the Regional Education Laboratories: <https://ies.ed.gov/ncee/edlabs/projects/covid-19/>

In the meantime, please visit the links provided in the call-out boxes for resources your school may find helpful in navigating these uncharted waters. For additional study details, please visit the study website: <https://surveys.nces.ed.gov/hsb22>. Please contact us with questions at (855) 500-1439 or HSB22@rti.org. You may also contact Project Officer Elise Christopher, PhD at NCES at Elise.Christopher@ed.gov. We are confident that you will continue to see the significance of this research

to advance the quality of education for our country's high school students.

Please know that we value what you, your school, and staff are doing to keep students engaged in learning, and your commitment to supporting students and their families as the COVID-19 situation continues to evolve.

Keeping you, your staff, students, and families in our thoughts.

Sincerely,

James L. Woodworth, PhD
Commissioner
National Center for Education Statistics
PCP, 550 12th St., SW, 4th floor, Room 3532
Washington, DC 20202

CC: School Coordinator

Dear Principal:

I am writing today to share **important information** about the **High School and Beyond Longitudinal Study of 2021 (HS&B:21)**. As the coronavirus pandemic has evolved, we have continued to maintain close contact with our educational partners so we can best understand the impact on schools. We understand that your school may be facing challenges in adjusting plans to deliver meaningful learning experiences to students during the current school year. We also know that schools and families across the U.S. continue to feel significant disruptions as a result of the pandemic.

We need to conduct the study safely and without additional stresses to students or school personnel while you are working through how best to respond to the pandemic. We feel it is in the best interest of schools, educators, and students to delay the first data collection cycle by an additional year. This delay will result in the **first cycle occurring in the fall of 2022** and the follow-up occurring in the spring of 2026. As such, the study will now be known as **HS&B:22**.

U.S. Department of Education has posted information and resources for schools and school personnel about the coronavirus pandemic at:

We will contact you again next year to provide additional information and discuss how we can partner to ensure students in your school have the opportunity to participate with others from across the U.S.

The Department's Institute of Education Sciences offers coronavirus pandemic resources from the Regional Education Laboratories:
<https://ies.ed.gov/ncee/edlabs/projects/covid-19/>

In the meantime, please visit the links provided in the call-out boxes for some resources your school may find helpful in navigating these uncharted waters. For additional study details, please visit the study website: <https://surveys.nces.ed.gov/hsb22>. Please contact us with questions at (855) 500-1439 or HSB22@rti.org. You may also contact Project Officer Elise Christopher, PhD at NCES at Elise.Christopher@ed.gov. We are confident that you will continue to

see the significance of this research to advance the quality of education for our country's high school students.

Please know that we value what you, your school, and staff are doing to keep students engaged in learning, and your commitment to supporting students and their families as the COVID-19 situation continues to evolve.

Keeping you, your staff, students, and families in our thoughts.

Sincerely,

James L. Woodworth, PhD
Commissioner
National Center for Education Statistics
PCP, 550 12th St., SW, 4th floor, Room 3532
Washington, DC 20202

Welcome, colleague, to the exciting role of School Coordinator (SC) for the **High School and Beyond Longitudinal Study of 2022 (HS&B:22)** study conducted by the National Center for Education Statistics (NCES). By helping with HS&B:22, you are contributing to the success of a study that will help educators, parents, and researchers learn how to best support student socioemotional and academic growth and learning during these extremely important years. We need your help and we thank you in advance.

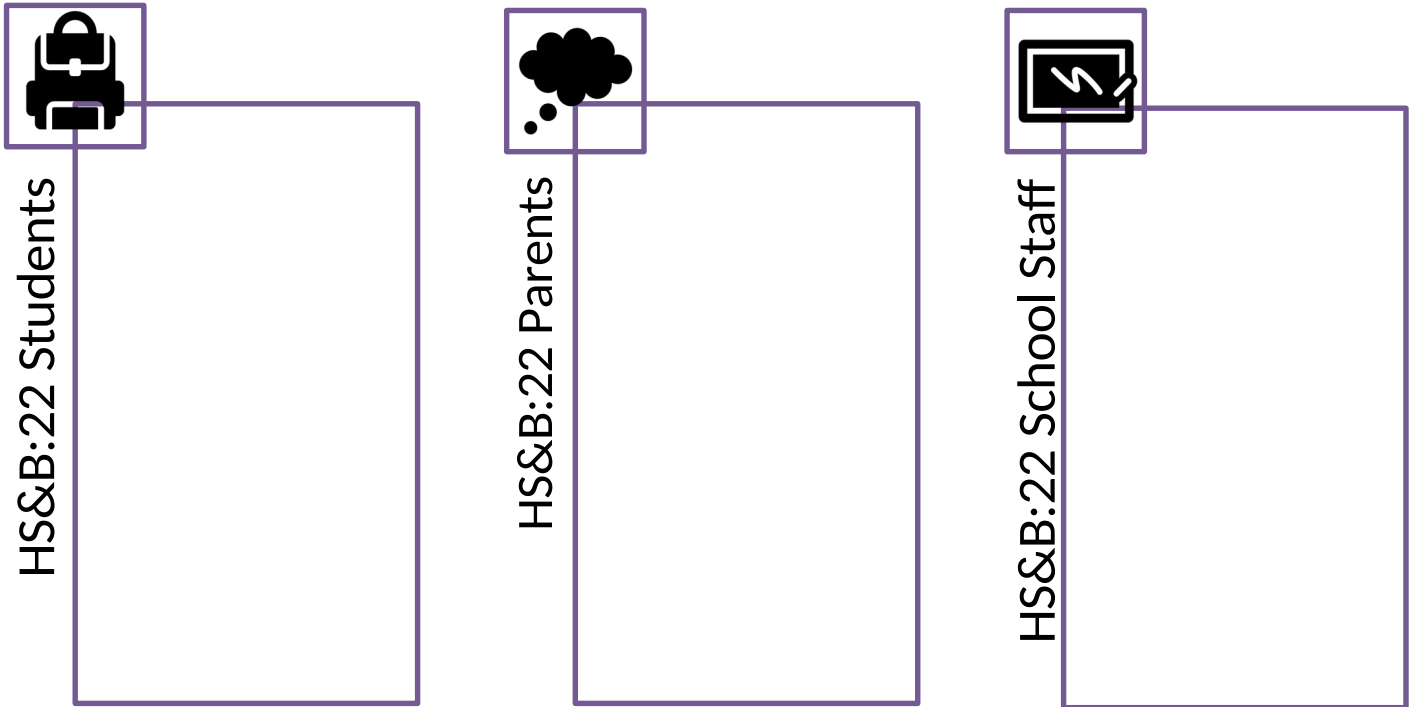

Study Activities

Student Session- About 35 students in grade 9 will be invited to participate in an online survey about their life in high school: class selections, grades, and social topics. It will be conducted at your school and HS&B:22 session facilitators (SFs) will set up a mobile Chromebook lab including internet connectivity.

Students will also complete a vision and hearing evaluation as part of the student in-school session. Parents will receive follow-up information based on the results. Student participants will receive an incentive selected by the school and receive a service certificate from the U.S. Department of Education.

Counselor and Administrator Survey- The principal and one counselor will complete surveys about school characteristics, staffing, the student population, and the academic environment. The surveys are completed

online, and login credentials will be sent to each participant. If allowed, counselors and administrators may receive <incentive> and a U.S. Department of Education certificate of service for their participation.

Math Teacher Survey- Math teachers of selected students in grade 9 will complete a survey about their professional background. Teachers will also respond to questions about students participating in HS&B:22. If allowed, teachers will receive <incentive> for their time.

Parent Survey- The parent survey will ask about students' education experiences, parents' involvement in and expectations for their children's academic attainment, and family characteristics. Their survey is online or via telephone interview.

HS&B:22 School Coordinator Responsibilities

We have enclosed a checklist for you to use to help you with organizing these tasks.

- Provide roster
- Finalize logistics
- Communicate to teachers, parents, and teachers
- Permission forms
- Meet your session facilitator (SF) in person
- The day before the session, receive shipment of Chromebooks and store in a secure location.
- Session day

Permission Forms: Determine which type of form to use for your school. RTI will mail forms to you several weeks before the session. Please send these forms home with the students selected for the study when they arrive.

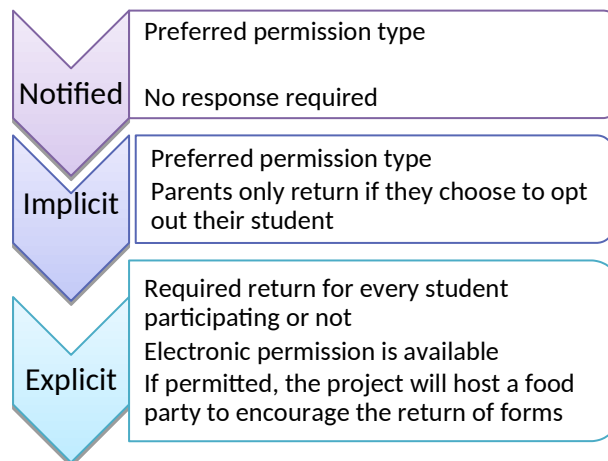

Roster- Provide a roster of your entire 9th grade enrollment so that we can select the students. If your school is small, we may select all your 9th students to participate.

1. Upload the 9th grade student roster to the secure HS&B:22 website.
2. Receive list of selected students and submit parent and teacher information for each student.

Logistics-

- Select date, time, and location for the student session.
- Send home the permission forms and reminders if needed. You may be asked to call parents for outstanding forms.
- Work with your **Session Facilitator (SF)** to identify any students with special needs who may need accommodations.
- Notify teachers, parents, and students and explain activities coming up.

Session Day- Session facilitators will arrive about 1.5 hours before the session to set up the mobile Chromebook lab including internet connectivity. Please be available before the session to locate and bring any students that did not arrive on time. If you are unable to be there, designate another staff member to fill in for you that day.

Token of Appreciation-If allowed: As a token of our appreciation for your time and effort with HS&B:22, you will be mailed a \$100 check once the student session is completed. The person who completes the upload of the 9th grade roster, will receive \$50. Your school will receive \$200; students receive a 2-hour service certificate from the U.S. Department of Education plus a token of appreciation selected by your school. Staff will also receive <incentive> and service certificate.

THANK YOU for doing your part to improve the excellence of high school education for this generation and beyond!

School Coordinator Checklist

Task	Activity	Timeline	Completed
1	Upload 9th grade roster to <insert URL>	Within 2 weeks of receiving upload instructions	
2	After students are selected, log back into <insert URL> and provide teacher and parent info	Within 1 week of receiving sample list	
3	Select day and time for student session	During logistics call	
4	Reserve the media center or empty classroom for the student session	During logistics call	
5	Determine parental consent type (notified, implicit, explicit)	During logistics call	
6	Communicate to parents, teachers, and students about upcoming activities	4-6 weeks prior to student session	
7	Send home parental permission forms	As soon as they arrive from RTI	
8	Remind parents to sign and return forms as needed	Weekly after forms are sent home	
9	Communicate to your HS&B:22 SF when permission forms are returned and be willing to call parents to encourage participation	Weekly after forms are sent home	
10	Determine if any students need accommodations	1-2 weeks prior to student session	
11	Meet in person with your SF for a pre-session visit	1 week prior to student session	
12	Receive Chromebook Shipment	1-2 days prior to student session	
13	Meet the SF at school	1.5 hours before the session begins	
14	Assist as needed to set-up and locate any students who did not arrive for the session	During the session day	
15	Return all permission forms to the SF and allow them to use the school fax machine	During the session day	
16	If needed, schedule a make-up session for students unable to attend	After the session day	

Dear <SC name>:

Thank you for your school's participation in the **High School and Beyond Longitudinal Study of 2022 (HS&B:22)** and for all you have done to prepare for the data collection thus far. We look forward to coming to your school on <session date> to conduct the student session(s).

In this mailing, we have provided the student tracking form (STF) which lists the 9th grade students selected to participate at your school and parental permission materials for each selected student. In anticipation of the in-school session, we ask that you:

- distribute the parental <notification letters/permission forms> to the students listed on the STF<s>; and
- work with RTI's session facilitator (SF) to finalize the logistics of the session(s), determine the eligibility of the students listed on the STF<s> to participate in the study, and discuss any accommodations that may be needed for students.

<IF INCENTIVE ALLOWED: As a token of our appreciation for your time and effort with HS&B:22, a check for \$100 will be mailed to you after all student sessions have been completed at the school. Your school will also receive <incentive>.>

RTI's session facilitator (SF) will contact you in the next few days to confirm the session logistics and to assist you in completing the activities listed above. Should you have questions in the meantime, you may contact us at 1-855-500-1439 or HSB22@rti.org.

Thank you again for serving as the school coordinator and for your help to make HS&B:22 successful at your school.

Sincerely,



Dan Pratt
Project Director, HS&B:22

Welcome colleague to the exciting role of School Coordinator (SC) for the **High School and Beyond Longitudinal Study of 2022 (HS&B:22)** study conducted by the National Center for Education Statistics (NCES). By helping with HS&B:22, you are contributing to the success of a study that will help educators, parents, and researchers learn how to best support student socioemotional and academic growth and learning during these extremely important years. We need your help and we thank you in advance.

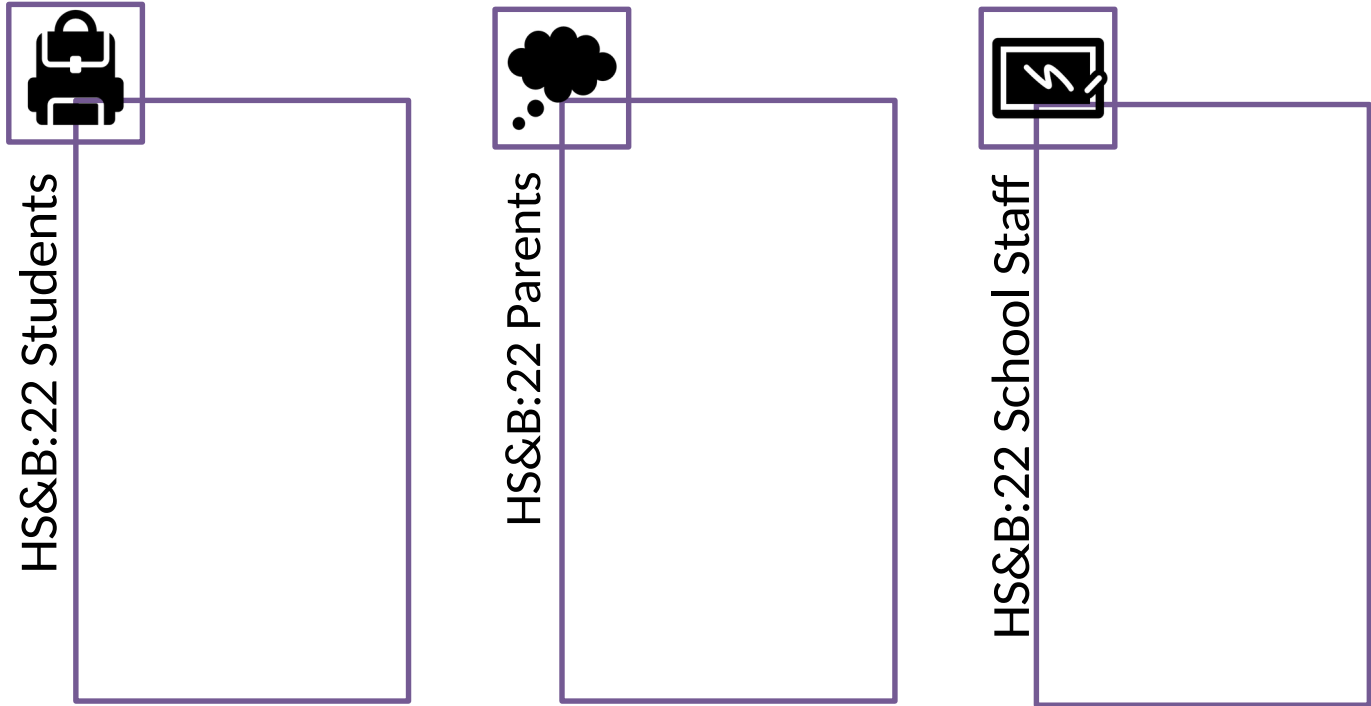

Study Activities

Student Session- About 35 students in grade 9 will be invited to participate in an online survey about their life in high school: class selections, grades, and social topics. Students will participate virtually using a home computer.

Student participants will receive <incentive> and a service certificate from the U.S. Department of Education.

Counselor and Administrator Survey- The principal and one counselor will complete surveys about school characteristics, staffing, the student population, and the academic environment. The surveys are completed online, and login credentials will be sent to each participant. If allowed, counselors and administrators

may receive <incentive> and a U.S. Department of Education certificate of service for their participation.

Teacher Survey- Teachers of students in grade 9 will complete a survey about their professional background. Teachers will also respond to questions about students participating in HS&B:22. If allowed, teachers will receive <incentive> for their time.

Parent Survey- The parent survey will ask about students' education experiences, parents' involvement in and expectations for their children's academic attainment, and family characteristics. Their survey is online or via telephone interview.

HS&B:22 School Coordinator Responsibilities

Provide roster of 9th grade students, their math teachers, and parent contact information

Math teacher/parent contacting information can be added after student selection is complete

Identify the 9th grade counselor or lead counselor

Encourage participation by showing the power point presentation to the selected 9th grade students

Send reminders as needed to families, students, and teachers



Power Point Presentation: We will email you a power point slide deck for students. To maximize participation, we encourage you to hold a virtual meeting with the selected students. At the end of the presentation, students can click on the link and participate

Roster- Provide a roster of your entire 9th grade enrollment so that we can select the students. If your school is small, we may select all your 9th students to participate.

1. Upload the 9th grade student roster to the secure HS&B:22 website.
2. Receive list of selected students and submit parent and teacher information for each student.

Login Credentials: An envelope will be sent home to each family with a selected 9th grade student. Inside the envelope will contain the student and parent login credentials. If the envelope is lost or misplaced, the family may email HSB22Survey@rti.org or call 855-500-1439 to request the login credentials.

Token of Appreciation- If allowed: As a token of our appreciation for your time and effort with HS&B:22, **the person who completes the upload of the 9th grade roster**, will receive \$50 plus a 2-hour service certificate from the U.S. Department of Education.

THANK YOU for doing your part to improve the excellence of high school education for this generation and beyond!

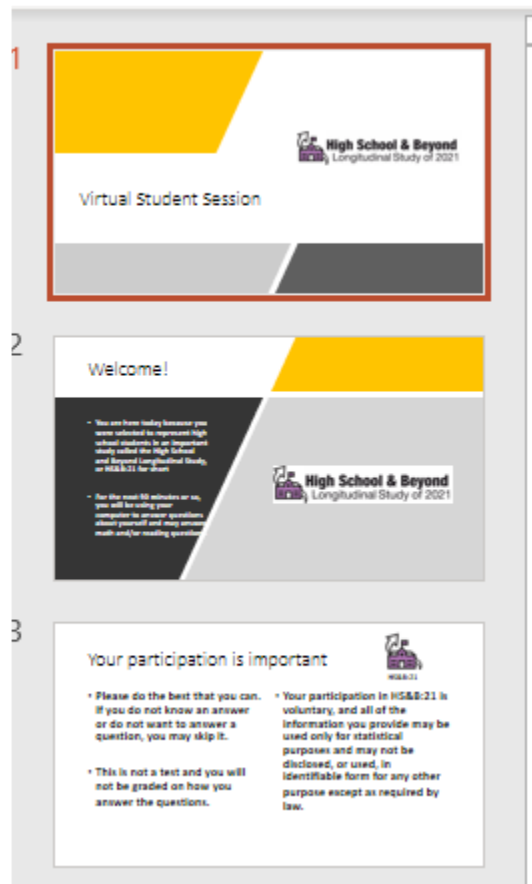

<DATE>

<School name>

<Address 1>

<Address 2>

<City, state, zip>

We are writing to thank you for your school's participation in the **High School and Beyond Longitudinal Study of 2022 (HS&B:22)** this fall. The contributions of schools like yours provides invaluable feedback on the current high school experience, and we are grateful for your partnership. We would like to extend a special thank you to <School Coordinator name> <IF LP DIFFERENT FROM SC: and <List provider name>> for working with us to coordinate the student session(s) and ensure the study's success at your school. <if applicable: We have enclosed <incentive> as a token of our appreciation for the school's participation.>

We will contact you again in the summer or fall of <2025/2026> to plan for the study's follow-up round, which will be conducted spring semester <2025/2026>. If you have any questions, please call us at (855) 500-1439 or email us at HSB22@rti.org.

Thank you for helping to make HS&B:22 a success!

Sincerely,

Dan Pratt
Project Director, HS&B:22

Templates 1-4 will be sent to schools at times throughout the recruitment period. Template 5 will be sent once to states and districts after allowing contact with their districts and schools.

-----“THANK YOU” EMAIL TEMPLATE 1-----

We are writing to say, “Thank you!” By participating in research studies like the **High School & Beyond Longitudinal Study of 2022 (HS&B:22)** you are contributing information that will help us make important decisions about what works best for our students. This knowledge will inform policymakers, researchers, and educators at all levels to improve outcomes for youth today and for years to come.

Here are some helpful education tools we thought you might be interested in: **NCES DataLab** includes user-friendly analysis tools, training, and access to over 30 federal datasets offering a wealth of information on American education: <https://nces.ed.gov/datalab/index.aspx>



NCES strives to bridge the research to practice gap and make the data available, useable, and meaningful for educators at all levels. Online training is available to learn how to use the NCES datasets in relation to local interests and contexts.

We look forward to working with you in the fall of 2022 and will be contacting you soon!

The HS&B:22 Team

High School & Beyond Longitudinal Study of 2022 (HS&B:22)

855-500-1439

Email: HSB22@rti.org



The High School & Beyond Longitudinal Study of 2022 (HS&B:22) is sponsored by the National Center for Education Statistics (NCES). NCES is a division within The Institute of Education Sciences (IES). IES, a part of the U.S. Department of Education, is the nation's leading source for rigorous, independent education research, evaluation and statistics.

We are writing to say **THANK YOU!** By participating in research studies like the **High School & Beyond Longitudinal Study of 2022 (HS&B:22)** you are contributing information that will help us make important decisions about what works best for our students. This knowledge will inform policymakers, researchers, and educators at all levels to improve outcomes for youth today and for years to come.



Did you know...

School climate is key to improving student outcomes. “By promoting a positive climate, schools can facilitate greater equality in educational opportunities, decrease socioeconomic inequalities, and enable more social mobility.”¹

Here are some School Climate Improvement Resources you may be interested in.

Check out: <https://safesupportivelearning.ed.gov/edscls> and

<https://safesupportivelearning.ed.gov/SCIRP/Quick-Guide>



We look forward to partnering with you in the fall of 2022 and will be contacting you soon!

The HS&B:22 Team

High School & Beyond Longitudinal Study of 2022 (HS&B:22)

855-500-1439

Email: HSB22@rti.org



The High School & Beyond Longitudinal Study of 2022 (HS&B:22) is sponsored by the National Center for Education Statistics (NCES). NCES is a division within The Institute of Education Sciences (IES). IES, a part of the U.S. Department of Education, is the nation's leading source for rigorous, independent education research, evaluation and statistics.

¹ Berkowitz, R., Moore, H,m and Astor, R. A., November 1, 2016. ,A Research Synthesis of the Associations Between Socioeconomic Background, Inequality, School Climate, and Academic Achievement.

-----“THANK YOU” EMAIL TEMPLATE 3-----

This is just a quick email to say **THANK YOU!** By participating in research studies like the **High School & Beyond Longitudinal Study of 2022 (HS&B:22)** in the fall of 2022, you are helping to improve the condition of education for high school students today and for years to come. To learn more about the current condition of education, check out the link below.

Here is “The Condition of Education” 2022 report:

<https://nces.ed.gov/programs/coe/>



We look forward to talking to you again soon!

The HS&B:22 Team

High School & Beyond Longitudinal Study of 2022 (HS&B:22)

855-500-1439

Email: HSB22@rti.org



The High School & Beyond Longitudinal Study of 2022 (HS&B:22) is sponsored by the National Center for Education Statistics (NCES). NCES is a division within The Institute of Education Sciences (IES). IES, a part of the U.S. Department of Education, is the nation's leading source for rigorous, independent education research, evaluation and statistics.

-----“THANK YOU” EMAIL TEMPLATE 4-----

We are writing to say **THANK YOU!** By participating in research studies like the **High School & Beyond Longitudinal Study of 2022 (HS&B:22)** you are contributing information that will help us make important decisions about what works best for our students. This knowledge will inform policymakers, researchers, and educators at all levels to improve outcomes for youth today and for years to come.

We thought you might be interested in some recent articles using data from NCES’s longitudinal studies series:

- [Reasons High School Students Change Their Education Setting, 11/18, From HSLS:09](#)
- [Factors that Influence Student College Choice, 11/18, From HSLS:09](#)
- [Public School Principals’ Three Most Important Education Goals, by Community Type and School Level, 4/20, 2015-16 NTPS](#)
- [Participation in High School Career and Technical Education and Postsecondary Enrollment, 11/17, ELS:2002](#)

NCES strives to bridge the research to practice gap and make the data available, useable, and meaningful for educators at all levels. Online training is available to learn how to use the NCES datasets in relation to local interests and contexts.

Thank you for your time and contribution.

The HS&B:22 Team

High School & Beyond Longitudinal Study of 2022 (HS&B:22)

855-500-1439

Email: HSB22@rti.org



The High School & Beyond Longitudinal Study of 2022 (HS&B:22) is sponsored by the National Center for Education Statistics (NCES). NCES is a division within The Institute of Education Sciences (IES). IES, a part of the U.S. Department of Education, is the nation's leading source for rigorous, independent education research, evaluation and statistics.

Thank you for your support of the High School & Beyond Longitudinal Study of 2022 (HS&B:22)! Data collected from HS&B:22 will be compiled into a public data set and used to improve policy and practice in high schools across the United States.

NCES strives to bridge the research to practice gap and make the data available, useable, and meaningful for educators at all levels. Here is a helpful resource we thought you might be interested in:

The Distance Learning Dataset Training (DLDT) system is an online, interactive tool that allows you to learn about the National Center for Education Statistics (NCES) data products across the education spectrum and evaluate them for your particular purposes. The DLDT modules are designed to introduce you to many NCES datasets, their design, and special considerations for analysis to facilitate effective use. <https://nces.ed.gov/training/datauser/#/>



Thank you for your time and contribution.

The HS&B:22 Team

High School & Beyond Longitudinal Study of 2022 (HS&B:22)

855-500-1439

Email: HSB22@rti.org



The High School & Beyond Longitudinal Study of 2022 (HS&B:22) is sponsored by the National Center for Education Statistics (NCES). NCES is a division within The Institute of Education Sciences (IES). IES, a part of the U.S. Department of Education, is the nation's leading source for rigorous, independent education research, evaluation and statistics.

WHO: About 35 ninth grade students from your child's school. Your child will represent other ninth graders like them. About 920 schools across the country will be participating.

WHAT: Students will complete a survey and do some math and reading questions on a Chromebook. A hearing and vision evaluation will also be completed and you will receive the results. Participation is voluntary.

WHEN: In the fall, at a convenient time chosen by your school, students will spend <FILL> minutes in school. <If 45-minutes: Students will be asked to complete another <FILL> minutes outside of school and will receive **\$15** when the out-of-school session is finished.> Students will participate again in winter/spring 2026, and then high school transcripts will be collected in the fall of 2027. If your child attends a different school for the follow-up, the study will request information from both the previous and newly enrolled school.



Your child's school is participating in the **High School and Beyond Longitudinal Study of 2022 (HS&B:22)**!

Your child will receive a certificate for **2 hours of community service** from the U.S. Department of Education, and a **small gift** as a "thank you" for participating. Schools and staff may also receive an incentive for participating.

IMPORTANT: *This is not a test, and it is not graded. We follow very strict laws to protect personal information and any data collected. All information collected is securely maintained. All reports will use aggregate information for all students who participate; no names will be published in the data files or reports.*

HS&B:22 is conducted by the National Center for Education Statistics in the U.S. Department of Education. HS&B:22 gives you and your student the opportunity to share your experiences and opinions to help improve education for your student and students

WHERE: The school will choose the best location for the session, typically a classroom or media center.

WHY: The study will help us learn more about students' academic and social growth during high school and ways we can support them. Together, this information helps us learn how to give all high schoolers the experience and skills they need to thrive in high school, and beyond.

To learn more: Watch a short video to see what participation will look like by visiting the study website at <https://surveys.nces.ed.gov/hsb22/>.

If you have questions, please call us at (855) 500-1439 or send an email to HSB22Survey@rti.org.

¿QUIÉNES?: Se les pedirá a aproximadamente 35 estudiantes de noveno grado de la escuela de su estudiante que participen. Más o menos entre 920 escuelas de todo el país participarán.

¿QUÉ?: Los estudiantes completarán una encuesta sobre sí mismos y sus experiencias y contestarán algunas preguntas de matemáticas y de lectura. Esto se hará usando una computadora portátil *Chromebook*. También se les hará una evaluación de audición y visión y usted recibirá los resultados. La participación es voluntaria.

¿CUÁNDO?: La escuela de su estudiante elegirá un día y hora que considere convenientes en el otoño, para que los estudiantes puedan dedicar tan solo [FILL] minutos en la sesión para estudiantes del proyecto HS&B:22. <If 45-minutes:> Se les pedirá a los estudiantes que completen otros <FILL> minutos fuera de la escuela y ellos recibirán **\$15** cuando hayan terminado la sesión de fuera de la escuela. Los estudiantes participarán nuevamente en la primavera del 2026 y obtendremos los certificados finales de calificaciones en el otoño del 2027. Si su hijo(a) atiende una escuela diferente para el seguimiento, el estudio solicitará información tanto de la escuela anterior como de la escuela de recién matriculación.



La escuela de su estudiante está participando en el estudio **Durante y Después de High School 2022 (HS&B:22)!**

Su estudiante recibirá un certificado de parte del Departamento de Educación de los Estados Unidos que lo/la acredita por 2 horas de servicio comunitario, así como también un pequeño regalo como muestra de agradecimiento



HS&B:22 que está llevando a cabo el Centro Nacional para Estadísticas de Educación del Departamento de Educación de los Estados Unidos. HS&B:22 les brinda a usted y a su estudiante la oportunidad única de compartir sus experiencias y opiniones para ayudar a mejorar la educación de su estudiante y la de otros

to por su participación. Las escuelas y el personal también pueden recibir un incentivo por participar.

¿DÓNDE?: La escuela elegirá el lugar más adecuado para llevar a cabo la sesión. Generalmente, ese hace en un salón de clases o la biblioteca.

¿POR QUÉ?: El estudio nos ayudará a conocer más sobre el crecimiento académico y social de los estudiantes durante *high school*, así como sobre las diferentes maneras en que podemos darles apoyo. Esta información, de manera conjunta, nos ayuda a conocer la forma en que debemos darles a todos los estudiantes de *high school* la experiencia y las habilidades necesarias para florecer en *high school* y en el futuro.

Para conocer más sobre el estudio: Por favor, mire un

INFORMACIÓN IMPORTANTE: Esto no es un examen y tampoco se califica. Seguimos leyes muy estrictas para proteger la información personal de los participantes y cualquier información que se obtenga. Toda la información se mantendrá de manera segura y el nombre de su estudiante nunca se guardará junto con sus respuestas. Todos los reportes usarán información agregada de todos los estudiantes que participen

video breve en el que se muestra cómo sería la participación de su estudiante visite la página de Internet <https://surveys.nces.ed.gov/hsb22/>. Si usted tiene alguna pregunta, por favor llámenos al (855) 500-1439 o envíenos un correo electrónico a la dirección HSB22Survey@rti.org.

WHO: About 35 ninth grade students from your child’s school. Your child will represent other ninth graders like them. About 920 schools across the country will be participating.

WHAT: Students will complete a survey and do some math and reading questions on a Chromebook. A hearing and vision evaluation will also be completed and you will receive the results. Participation is voluntary.

WHEN: In the fall, at a convenient time chosen by your school, students will spend <FILL> minutes in school. <If 45-minutes: Students will be asked to complete another <FILL> minutes outside of school and will receive **\$15** when the out-of-school session is finished.> Students will participate again in winter/spring 2026, and then high school transcripts will be collected in the fall of 2027. If your child attends a different school for the follow-up, the study will request information from both the previous and newly enrolled school.



Your child’s school is participating in the **High School and Beyond Longitudinal Study of 2022 (HS&B:22)**!

Your child will receive a certificate for **2 hours of community service** from the U.S. Department of Education, and a **small gift** as a “thank you” for participating. Schools and staff may also receive an incentive for participating.

HS&B:22 is conducted by the National Center for Education Statistics in the U.S. Department of Education. HS&B:22 gives you and your student the opportunity to share your experiences and opinions to help improve education for your student and

WHERE: The school will choose the best location for the session, typically a classroom or media center.

WHY: The study will help us learn more about students’ academic and social growth during high school and ways we can support them. Together, this information helps us learn how to give all high schoolers the experience and skills they need to thrive in high school, and beyond.

To learn more: Watch a short video to see what participation will look like by visiting the study website at <https://surveys.nces.ed.gov/hsb22/>. If you have questions, please call us at (855) 500-1439 or send an email to HSB22Survey@rti.org.

Thank you for taking the time to learn about this important study and how you can help.

You only need to return the attached form if you

IMPORTANT: *This is not a test, and it is not graded. We follow very strict laws to protect the privacy of the data collected. All information collected is securely maintained. All reports will use aggregate information for all students who participate; no names will be published in the data files or reports.*

**do not want your
student to participate.**

¿QUIÉNES?: Se les pedirá a aproximadamente 35

estudiantes de noveno grado de la escuela de su estudiante que participen. Mas o menos los reportes usarán información, agregada de todos los estudiantes que participarán

NCES está autorizado a hacer el estudio HS&B:22 por el Acta de la Reforma de Educación de 2002 (ESRA 2)

escolares de los estudiantes, de agencias o instituciones educativas con el propósito de evaluar programas

educativos y Privacidad Familiar (FERPA, 34 CFR § 99.31 (a) (3) (iii) y 99.31 (a) (3) (iv))

La información que se obtenga se combinará con la de otros participantes para producir reportes estadísticos.

completarán una encuesta sobre sí mismos y sus experiencias y contestarán algunas preguntas de matemáticas y de lectura.

Esto se hará usando una computadora portátil

Chromebook. También se les hará una evaluación de

audición y visión y usted recibirá los resultados. La

participación es voluntaria.

¿CUÁNDO?: La escuela de su

estudiante elegirá un día y hora que considere

convenientes en el otoño, para que los estudiantes puedan

dedicar tan solo [FILL] minutos en la sesión para estudiantes

del proyecto HS&B:22. <If 45-minutes:> Se les pedirá a los

estudiantes que completen otros <FILL> minutos fuera de

la escuela y ellos recibirán \$15 cuando hayan terminado

la sesión de fuera de la escuela. Los estudiantes

participarán nuevamente en la primavera del 2026 y

obtendremos los certificados finales de calificaciones en el

otoño del 2027. Si su hijo(a) atiende una escuela

diferente para el seguimiento, el estudio

solicitará información tanto de la escuela anterior como

de la escuela de recién matriculación.

La escuela de su estudiante está participando en el estudio Durante y Después de High School 2022 (HS&B:22)!

Su estudiante recibirá un certificado de parte del Departamento de Educación de los Estados Unidos que lo/la acredita por 2 horas de servicio comunitario, así como también un pequeño regalo como muestra de agradecimiento por su participación. Las escuelas y el personal

HS&B:22 que está llevando a cabo el Centro Nacional para Estadísticas de Educación del Departamento de Educación de los Estados Unidos. HS&B:22 les brinda a usted y a su estudiante la oportunidad única de compartir sus experiencias y opiniones para ayudar a mejorar la educación de su estudiante y la de otros

¿DÓNDE?: La escuela elegirá el lugar más adecuado para llevar a cabo la sesión. Generalmente, ese hace en un salón de clases o la biblioteca.

¿POR QUÉ?: El estudio nos ayudará a conocer más sobre el crecimiento académico y social de los estudiantes durante *high school*, así como sobre las diferentes maneras en que podemos darles apoyo. Esta información, de manera conjunta, nos ayuda a conocer la forma en que debemos darles a todos los estudiantes de *high school* la experiencia y las habilidades necesarias para florecer en *high school* y en el futuro.

Para conocer más sobre el estudio: Por favor, mire un video breve en el que se muestra cómo sería la participación de su estudiante visite la página de Internet <https://surveys.nces.ed.gov/hsb22/>. Si usted tiene alguna pregunta, por favor llámenos al (855) 500-1439 o envíenos un correo electrónico a la



dirección
HSB22Survey@rti.org.

Gracias por dedicar tiempo a conocer sobre este estudio tan importante y la manera en que usted puede contribuir.

Si usted no desea que su estudiante participe, lo único que tiene que hacer es devolver el formulario incluido.



WHO: About 35 ninth grade students from your child's school. Your child will represent other ninth graders like them. About 920 schools across the country will be participating.

IMPORTANT: This is not a test, and it is not graded. We follow very strict laws regarding data collection. All information collected is securely maintained. All reports will be published in the data files or reports.

WHAT: Students will complete a survey and do some math and reading questions on a Chromebook. A hearing and vision evaluation will also be completed and you will receive the results. Participation is voluntary.

WHEN: In the fall, at a convenient time chosen by your school, students will spend <FILL> minutes in school. <If 45-minutes: Students will be asked to complete another <FILL> minutes outside of school and will receive \$15 when the out-of-school session is finished.> Students will participate again in winter/spring 2026, and then high school transcripts will be collected in the fall of 2027. If your child attends a different school for the follow-up, the study will request information from both the previous and newly enrolled school.

HS&B:22 is conducted by the National Center for Education Statistics in the U.S. Department of Education. HS&B:22 gives you and your student the opportunity to share your experiences and opinions to help improve education for your student and

Your child's school is participating in the High School and Beyond Longitudinal Study of 2022 (HS&B:22)!

Your child will receive a certificate for **2 hours of community service** from the U.S. Department of

Education, and a **small gift** as a "thank you" for participating.

WHERE: The school will choose the best location for the session, typically a classroom or media center.

WHY: The study will help us learn more about students' academic and social growth during high school and ways we can support them. Together, this information helps us learn how to give all high schoolers the experience and skills they need to thrive in high school, and beyond.

To learn more: Watch a short video to see what participation will look like by visiting the study website at <https://surveys.nces.ed.gov/hs>



[b22/](#). If you have questions, please call us at (855) 500-1439 or send an email to HSB22Survey@rti.org.

Thank you for taking the time to learn about this important study and how you can help.

Please sign and return the attached form <OR submit an online signature> for your student to participate <by visiting the study website>.

¿QUIÉNES?: Se les pedirá a aproximadamente 35 estudiantes de noveno grado de la escuela de su estudiante que participen. Más o menos entre 920 escuelas de todo el país participarán.

¿QUÉ?: Los estudiantes completarán una encuesta sobre sí mismos y sus experiencias y contestarán algunas preguntas de matemáticas y de lectura. Esto se hará usando una computadora portátil *Chromebook*. También se les hará una evaluación de audición y visión y usted recibirá los resultados. La participación es voluntaria.

¿CUÁNDO?: La escuela de su estudiante elegirá un día y hora que considere convenientes en el otoño, para que los estudiantes puedan dedicar tan solo [FILL] minutos en la sesión para estudiantes del proyecto HS&B:22. <If 45-minutes:> Se les pedirá a los estudiantes que completen otros <FILL> minutos fuera de la escuela y ellos recibirán **\$15** cuando hayan terminado la sesión de fuera de la escuela. Los estudiantes participarán nuevamente en la primavera del 2026 y obtendremos los certificados finales de calificaciones en el otoño del 2027. Si su hijo(a) atiende una escuela diferente para el seguimiento, el estudio solicitará información tanto de la escuela anterior como de la escuela de recién matriculación.



La escuela de su estudiante está participando en el estudio Durante y Después de *High School* 2022 (HS&B:22)!

Su estudiante recibirá un certificado de parte del Departamento de Educación de los Estados Unidos que lo/la acredita por 2 horas de servicio comunitario, así como también un pequeño regalo como muestra de agradecimiento por su participación. Las escuelas y el

HS&B:22 que está llevando a cabo el Centro Nacional para Estadísticas de Educación del Departamento de Educación de los Estados Unidos. HS&B:22 les brinda a usted y a su estudiante la oportunidad única de compartir sus experiencias y opiniones para ayudar a mejorar la educación de su estudiante y la de otros.

¿DÓNDE?: La escuela elegirá el lugar más adecuado para llevar a cabo la sesión. Generalmente, ese hace en un salón de clases o la biblioteca.

¿POR QUÉ?: El estudio nos ayudará a conocer más sobre el crecimiento académico y social de los estudiantes durante *high school*, así como sobre las diferentes maneras en que podemos darles apoyo. Esta información, de manera conjunta, nos ayuda a conocer la forma en que debemos darles a todos los estudiantes de *high school* la experiencia y las habilidades necesarias para florecer en *high school* y en el futuro.

Para conocer más sobre el estudio: Por favor, mire un video breve en el que se muestra cómo sería la participación de su estudiante visite la página de Internet <https://surveys.nces.ed.gov/hsb22/>. Si usted tiene alguna pregunta, por favor llámenos al (855) 500-1439 o envíenos un correo electrónico a la



INFORMACIÓN IMPORTANTE: Esto no es un examen y tampoco se califica. Seguimos leyes muy estrictas para proteger la información personal de los participantes y cualquier información que se obtenga. Toda la información se mantendrá de manera segura y el nombre de su estudiante nunca se guardará junto con sus respuestas. Todos los reportes usarán información agregada de todos los estudiantes que participen.

dirección
HSB22Survey@rti.org.

Gracias por dedicar tiempo a conocer sobre este estudio tan importante y la manera en que usted puede contribuir.

Por favor firme y devuelva el formulario incluido. <O, visite la página del estudio en Internet para enviar su firma electrónica.>



**High School and Beyond Longitudinal Study of 2022 (HS&B:22)
Student Assent Form (used only when required by the school)**

You are being asked to participate in a national study called the High School and Beyond Longitudinal Study of 2022 (HS&B:22). This study is conducted by the National Center for Education Statistics (NCES) within the U.S. Department of Education.

Your participation in HS&B:22 is voluntary. The information you provide will be combined with the information received from thousands of other students, parents, and school staff. No names of schools or individuals will be published in study reports. Each student who participates will receive a certificate of community service [if allowed by district: and a token of appreciation valued at \$10].

Please check only one option below to indicate your decision to participate in the study.

Yes, I will participate in HS&B:22.

No, I will not participate in HS&B:22.

PRINT your name here:

SIGN your name here:

Date: ____/____/____

FOR OFFICE USE ONLY:

Student ID: _____

School name: _____

INSTRUCTION TO SF: READ THE FOLLOWING SCRIPT VERBATIM TO THE STUDENTS PRIOR TO STARTING THE STUDENT SESSION.

Welcome, my name is [SF1 name] and this is [SF2 name]. You are here today because you were selected to represent high school students in an important study called the High School and Beyond Study of 2022, or HS&B:22 for short. We are very excited that you are able to join us today. For the next [45/90] minutes or so, you will be using a Chromebook to answer questions about yourself and may answer math and/or reading questions. Please do the best that you can. If you do not know an answer or do not want to answer a question, you may skip it. This is not a test and you will not be graded on how you answer the questions. You can touch the screen or use the touchpad to answer the questions. You can also have the questions read aloud to you if you like by clicking on the “read aloud” button.

[If hearing and vision: You will have your hearing and vision measured, so when you see the screen that says you should log out and have your hearing and vision measured, *please go to the hearing and vision station [point out where students should go]*. After you are done with hearing and vision, you will return to your Chromebook. Make sure to log back in and finish up your session on the Chromebook.]

Your participation in HS&B:22 is voluntary, and all of the information you provide will be combined with all of the other information we collect. No names of schools or individuals will be included in any study reports.

When you are all done you will see a screen that says “Congratulations.” When you see that screen, raise your hand, and I will come over and log you out and collect your student login card. You may keep the earbuds and the pencil. And you will receive a certification of community service [if allowed: and a token of appreciation valued at \$10]. Please meet me here [point out where student should go] to check out. Next, [please sit quietly until the end of the session/please go back to your class after you get a hall pass]. Any questions?

When you are all done you will see a screen that says “Congratulations.” When you see that screen, raise your hand, and I will come over and log you out and collect your student login card. You may keep the earbuds and the pencil. Please meet me here [point out where student should go] to check out. Next, [please sit quietly until the end of the session/please go back to your class after you get a hall pass]. Any questions?

[If students are part of 45-minute session: Don’t forget to finish up the remainder of the session on your own. Remember, you’ll receive \$15 once you complete the rest!]

Okay, let’s get started. Go ahead and enter the username and password on the card at your desk. Then click “start” on the screen and follow the instructions.

[If hardcopy student assent is required, distribute student assent forms and say: If you agree to participate in HS&B:22, please check “Yes, I will participate in HS&B:22” if you would like to participate, or “No, I will not participate in HS&B:22” if you decide you do not want to participate. If you check “no” please raise your hand.]

HS&B:22 Study Information Sheet

HS&B:22 data collection takes place between September 15, 2022 – January 31, 2023

STUDY INFO SHEET

FALL 2022 & SPRING 2026



High School & Beyond Longitudinal Study of 2022

STUDENTS

- Approximately 35 9th grade students will complete a computer-based questionnaire with math and reading questions and a brief hearing and vision evaluation
- Student session is 90 minutes and can be modified to fit school schedules
- Student session facilitated by study staff, all equipment and materials are provided
- Participation is voluntary and confidential
- Students will receive a small token of appreciation and a certificate for 2 hours of community service from the U.S. Department of Education

TEACHERS

- Two to four math teachers will be invited to participate in an online survey about background, classroom practices, and answer questions about students in the study
- Teachers will receive an honorarium and a Certificate of Participation from the U.S. Department of Education for their time

ADMINISTRATOR/COUNSELOR

- One administrator and one counselor will be asked to complete an online questionnaire about the school environment, policies, and services for students
- Participating staff will receive an honorarium and a Certificate of Participation from the U.S. Department of Education for their time

SCHOOL COORDINATOR

- School Coordinator will serve as a liaison between school and research staff to:
 - ✓ Facilitate upload of student rosters and parent/math teacher info
 - ✓ Coordinate session day logistics and be available that day
 - ✓ Distribute parent permission forms and reminders
- School Coordinators will receive an honorarium for their time and assistance
- Schools will receive a monetary donation or the equivalent in goods and services
- Eligible staff can register for interactive webinars on timely topics, such as social and emotional learning, project-based learning, or STEM.

855-500-1439

HSB22@rti.org

<https://surveys.nces.ed.gov/hsb22>

FREQUENTLY ASKED QUESTIONS

<p>What is HS&B:22 and why is it important?</p>	<p>The High School and Beyond Longitudinal Study of 2022 (HS&B:22) is sponsored by the National Center of Education (NCES) within the U.S. Department of Education. Studies like this occur once a decade. <u>HS&B:22 will take place next school year (Fall 2022)</u>, and one follow-up will occur Spring 2026.</p> <p>Selected students, their families, and school staff all have an important role in helping us learn more about the high school experience, students’ academic and social growth, and ways we can support students in gaining the knowledge and skills they need to thrive in high school and beyond.</p>
<p>Why did my school get selected?</p>	<p>Study schools were randomly selected by geographic region, locale, and type: public and private, including charter, magnet, and virtual schools.</p> <p>Approximately 920 schools and 26,000 students will be invited to participate. Your school represents schools like yours across the country and cannot be replaced!</p>
<p>Why should my school participate?</p>	<p>High school is rapidly changing. What worked in schools 10 years ago may not be relevant today. Educators at all levels rely on scientific data from studies such as HS&B:22 to make decisions about policies, funding, programs, and practices.</p> <p>HS&B:22 needs the participation of all selected schools to capture an accurate picture of high school students and their environment. If you have been selected, your participation is crucial.</p>
<p>How will this study benefit my school?</p>	<p>Schools will receive \$200 as a thank you. Eligible staff may also register for a no-cost, interactive webinar on timely topics, such as social and emotional learning, project-based learning, or STEM.</p> <p>You will receive a report with results comparing your school to schools like yours nationwide. Based on survey results, you will also receive relevant resources and action items aligned with district priorities and specific school needs.</p> <p>All schools ultimately benefit from research findings that will inform policies and practices that will advance education at the high school level for generations.</p>
<p>How is privacy and confidentiality protected?</p>	<p>As a federal study, HS&B:22 complies with all laws and regulations and we have a rigorous set of standards and procedures to safeguard the privacy of participants and the confidentiality of data.</p> <p>Results are never reported for individual respondents. No schools, staff, students, or families will ever be identified.</p>
<p>How many students and how are they selected?</p>	<p>We will request a list of all 9th grade students and randomly select about 35 per school. All students will have a chance to be selected</p>

	regardless of race, gender, disability, or ELL status. Accommodations will be made for those students with special needs.
What is involved for students?	Students will complete a survey and answer some math and reading questions. They will also participate in a hearing and vision evaluation, with feedback provided to parents. The student session will take 90 minutes or less, on a date selected by the school. If allowed, students will receive a \$10 gift card and 2 hours of community service credit from the U.S. Department of Education.
Who conducts the student session?	RTI International, a not-for-profit research organization in North Carolina, is conducting HS&B:22 for NCEs. RTI staff will facilitate the student session at your school. We will provide Chromebooks and a mobile computer lab. Your school's internet is not needed.
What is involved for school staff?	A school administrator, one counselor, and the math teacher of each selected student (average 2-4 teachers) will be asked to complete a questionnaire. School staff input is <i>voluntary</i> but also critical! Staff can complete the online survey at their convenience, at once or in increments. They will be offered <incentive> for their time.
Are parents involved in HS&B:22?	Parents provide information on the home environment and family involvement in their student's education. The parent/guardian of selected students will be invited to complete a web-based (or telephone) questionnaire at a convenient time. Their input is extremely important and an essential part of this study!
What should my school do now?	Please select a staff member to serve as a School Coordinator (SC)—a primary contact to help with scheduling, providing the list of students, and distributing parent permission forms. If permitted, the SC receives \$50 for the student roster and an additional \$100 at the end of data collection.
Is HS&B:22 mandatory?	All participation is <i>voluntary</i> , and participants can skip any question they do not wish to answer. There will be no penalties for not participating.
How will the information HS&B:22 collects be used?	HS&B:22 data will allow us to examine student, school, and family factors that impact successful outcomes. The study will capture unique experiences in high school and can provide insight to: <ul style="list-style-type: none"> • Student transitions into high school and preparations for postsecondary education and/or work plans; • Academic achievement, reducing achievement gaps, and equal access to educational opportunities; • Career and technical education opportunities available to students; and • Use of technology for innovations such as online learning and effects on student outcomes. <p>Many education policies, programs, and practices currently in use are based on research that used NCEs's longitudinal data.</p>

**I am ready to get started,
how do I contact the HS&B:22
team?**

Phone: 855-500-1439
Email: HSB22@rti.org
Website: <INSERT URL>

Appendix A6b. Frequently Asked Questions Virtual Schools (previously approved)

FREQUENTLY ASKED QUESTIONS VIRTUAL SCHOOLS

<p>What is HS&B:22 and why is it important?</p>	<p>The High School and Beyond Longitudinal Study of 2022 (HS&B:22) is sponsored by the National Center of Education (NCES) within the U.S. Department of Education. Studies like this occur once a decade. <u>HS&B:22 will take place next school year (Fall 2022)</u>, and one follow-up will occur Spring 2026.</p> <p>Selected students, their families, and school staff all have an important role in helping us learn more about the high school experience, students’ academic and social growth, and ways we can support students in gaining the knowledge and skills they need to thrive in high school and beyond.</p>
<p>Why did my school get selected?</p>	<p>Study schools were randomly selected by geographic region, locale, and type: public and private, including charter, magnet, and virtual schools.</p> <p>Approximately 920 schools and 26,000 students will be invited to participate. Your school represents schools like yours across the country and cannot be replaced!</p>
<p>Why should my school participate?</p>	<p>High school is rapidly changing. What worked in schools 10 years ago may not be relevant today. Educators at all levels rely on scientific data from studies such as HS&B:22 to make decisions about policies, funding, programs, and practices.</p> <p>HS&B:22 needs the participation of all selected schools to capture an accurate picture of high school students and their environment. If you have been selected, your participation is crucial.</p>
<p>How will this study benefit my school?</p>	<p>Schools will receive \$200 as a thank you. Eligible staff may also register for a no-cost, interactive webinar on timely topics, such as social and emotional learning, project-based learning, or STEM.</p> <p>You will receive a report with results comparing your school to schools like yours nationwide. Based on survey results, you will also receive relevant resources and action items aligned with district priorities and specific school needs.</p> <p>All schools ultimately benefit from research findings that will inform policies and practices that will advance education at the high school level for generations.</p>
<p>How is privacy and confidentiality protected?</p>	<p>As a federal study, HS&B:22 complies with all laws and regulations and we have a rigorous set of standards and procedures to safeguard the privacy of participants and the confidentiality of data.</p> <p>Responses are always kept confidential. Results are never reported for individual respondents. No schools, staff, students, or families will ever be identified.</p>
<p>How many students and how are they selected?</p>	<p>We will request a list of all 9th grade students and randomly select about 35 per school. All students will have a chance to be selected regardless of race, gender, disability, or ELL status. Accommodations</p>

	will be made for those students with special needs.
What is involved for students?	<p>Students will complete a survey and answer some math and reading questions. The student session will take 90 minutes or less and students will participate virtually.</p> <p>If allowed, students will receive a \$10 gift card and 2 hours of community service credit from the U.S. Department of Education.</p>
Who conducts the study?	RTI International, a not-for-profit research organization in North Carolina, is conducting HS&B:22 for NCES.
What is involved for school staff?	<p>A school administrator, one counselor, and the math teacher of each selected student (average 2-4 teachers) will be asked to complete a questionnaire. School staff input is <i>voluntary</i> but also critical!</p> <p>Staff can complete the online survey at their convenience, at once or in increments. They will be offered <incentive> for their time.</p>
Are parents involved in HS&B:22?	Parents provide information on the home environment and family involvement in their student’s education. The parent/guardian of selected students will be invited to complete a web-based (or telephone) questionnaire at a convenient time. Their input is extremely important and an essential part of this study!
What should my school do now?	<p>Please select a staff member to serve as a School Coordinator (SC)—a primary contact to help with providing the list of 9th grade students and can send reminders as needed to encourage participation.</p> <p>If permitted, the SC receives \$50 for their assistance.</p>
Is HS&B:22 mandatory?	All participation is <i>voluntary</i> , and participants can skip any question they do not wish to answer. There will be no penalties for not participating.
How will the information HS&B:22 collects be used?	<p>HS&B:22 data will allow us to examine student, school, and family factors that impact successful outcomes. The study will capture unique experiences in high school and can provide insight to:</p> <ul style="list-style-type: none"> • Student transitions into high school and preparations for postsecondary education and/or work plans; • Academic achievement, reducing achievement gaps, and equal access to educational opportunities; • Career and technical education opportunities available to students; and • Use of technology for innovations such as online learning and effects on student outcomes. <p>Many education policies, programs, and practices currently in use are based on research that used NCES’s longitudinal data.</p>
I am ready to get started, how do I contact the HS&B:22 team?	<p>Phone: 855-500-1439</p> <p>Email: HSB22@rti.org</p> <p>Website: https://surveys.nces.ed.gov/hsb22</p>

What is HS&B:22?

The **High School and Beyond** Longitudinal Study of 2022 (HS&B:22) is a research study that will build on decades of research (since 1972) to understand what makes students successful as they enter high school and progress to postsecondary education, the military, or early careers.

Why participate in HS&B:22?

You have been given an opportunity to share your experiences and opinions. While your name will never be used in any reports, your input will be used to improve education now and in the future. We want to hear from you!

What does participation involve?

Students will respond to a survey, answer math and reading questions, and complete a brief hearing and vision evaluation. Questionnaires will be completed by school administrators about the school and its environment; math teachers on their background, teaching approaches, and student engagement in class; counselors on counseling practices at the school; and parents about the home environment and their experiences with their child's school.

Who is conducting the study?

HS&B:22 is conducted by the National Center for Education Statistics (NCES) part of the U.S. Department of Education. NCES collects, analyzes, and reports statistics on the condition of education in the United States. Our mission is to provide scientific evidence on which to ground education practice and policy and to share this information in formats that are useful and accessible to educators, parents, policymakers, researchers, and the public. NCES has contracted RTI International, an independent, not-for-profit research institute, to collect the data for HS&B:22.

Did you know?

- How a student does in 9th grade has more influence on graduating from high school than all other factors, including race/ethnicity, gender, socioeconomic status, and prior academic achievement, combined.
<https://tinyurl.com/y773hksf>
- Attendance contributes more than any other factor to course failure and low grades.
<https://tinyurl.com/ybn22dew>
- Nearly half of students who begin college do not graduate within six years.
<https://tinyurl.com/y74xz2zu>
- If the 1.3 million dropouts from the Class of 2010 had graduated, the nation would have seen \$337 billion more in earnings over the course of the students' lifetimes.
<https://tinyurl.com/jgesdzb>

Contact Us

Schools & school staff: (855) 500-1439 or HSB22@rti.org

Parents: (855) 500-1439 or hsbsurvey@rti.org

<https://surveys.nces.ed.gov/hsb22>

HIGH SCHOOL & BEYOND LONGITUDINAL STUDY OF 2022

A STUDY OF THE AMERICAN HIGH SCHOOL EXPERIENCE



LEARN MORE

WHAT IS THE HIGH SCHOOL
& BEYOND LONGITUDINAL
STUDY OF 2022?

WHY IS HS&B:22
IMPORTANT?

HOW CAN I SUPPORT THIS
RESEARCH?

HOW DO WE BEST SUPPORT STUDENT GROWTH AND SUCCESS?

We all want every child to succeed in school, work, and life. But only some do. There are big gaps when we look at who does well in school, who graduates on time, who goes to college and finishes, and who becomes gainfully employed. While these gaps are well documented, the factors that impact success need to be researched so that we know what needs to be done to bridge gaps and improve outcomes for ALL students.

The High School and Beyond Longitudinal Study of 2022 (HS&B:22) aims to identify those factors that impact student growth and outcomes through and beyond High School. Only with this information can we promote change and make a difference.

WHY IS HS&B:22 IMPORTANT?

We need to know, when a student struggles, what are their barriers, and when a student does well, what contributes to their success. We want every student to be successful. Without exception. To do this, we need to know the factors that propel some students to completion of high school and entry into work or postsecondary education while leaving others behind. We need to know how wonderful or how challenging high school experiences are for today's adolescents. When schools participate in HS&B:22, these stories and experiences can be shared and used to inform policy and practice. High School & Beyond Longitudinal Study of 2022 is important because we all care about the future of our kids.

HOW CAN I SUPPORT THIS RESEARCH?

Support: Learn about the study and how it will impact national, state, and local education systems and students. Encourage schools and students to participate.

Participate: Your participation is critical. If you are selected to participate, do. Research can only be useful when target response rates are met, and without this research, we cannot make informed, positive change.

Advocate: Talk about High School & Beyond 2022 and what it means to you and your schools or students.

"I wish I knew before I went to college, that GPA is not everything."

*-Rebecca F.,
University of
Notre Dame*



Districts and schools across the nation participate in the [High School & Beyond Longitudinal Study of 2022](#) so that they know they did everything they could to contribute to improved outcomes for their students and students nationwide.

National Center for Education Statistics

The National Center for Education Statistics (NCES) collects, analyzes, and reports statistics on the condition of American education. Our mission is to provide scientific evidence on which to ground education practice and policy and to share this information in formats that are useful and accessible to educators, parent, policymakers, researchers, and the public.

NCES has contracted with RTI International to conduct the High School & Beyond Longitudinal Study of 2022. RTI is an independent, nonprofit institute that provides research, development, and technical services to government and commercial clients nationwide. RTI's mission is to improve the human condition by turning knowledge into practice.

MORE ABOUT HS&B:22

Website <https://surveys.nces.ed.gov/hsb22/>
Phone 855.500.1439
Email HSB22@rti.org



High School & Beyond Longitudinal Study of 2022

NATIONALLY ENDORSING ORGANIZATIONS

Below are a some of the organizations partnering with NCES to support the High School & Beyond Longitudinal Study of 2022:

- Council for American Private Education
- Council of Chief State School Officers
- Council of Islamic Schools in North America
- National Indian Education Association
- National Catholic Education Association
- National Charter Schools Institute
- National Education Association
- National Parent-Teacher Association
- National School Boards Association
- The Institute for Excellence in Education

^{i, ii} Allensworth, E., & Easton, J.Q. (2007). *What matters for staying on-track and graduating in Chicago public high schools: A close look at course grades, failures, and attendance in the freshman year.* University of Chicago Consortium on School Research.

^{iii, iv} <https://www.dosomething.org/us/facts/11-facts-about-education-america>

^v <https://www.ed.gov/news/press-releases/fact-sheet-focusing-higher-education-student-success>

NCES High School and Beyond Study Video Script

Voiceover: Imagine being part of something bigger than yourself.



You can. But we all have to work together to make our voices heard.
(images of students populate screen)



The National Center for Education Statistics wants to hear from everyone involved with the high school experience.
(Scan of classroom)



We need schools to participate in our High School and Beyond Study.
(Shot of students walking through hallway)



We're gathering data from students, along with their parents, teachers, counselors, and principals, too.
(Multiple shots of students walking, talking with school staff, Administrators in a school setting)



We want to know what people think about high school.
What works? What doesn't? *(Image of student participating in HS&B on Chromebook)*

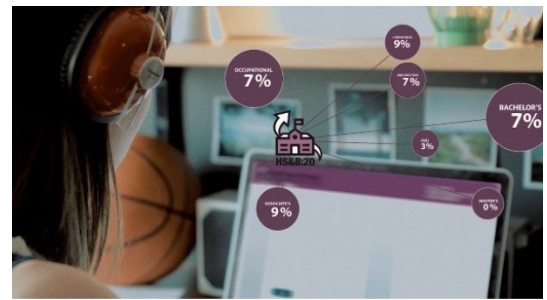

How can we improve education today, and in the future?
(Image of science class)



We all have an integral part to play. *(image of volunteering community service, Habitat for Humanity)*



Now is the time to make your voice heard.
(video of Malala speaking)



ON-SCREEN TEXT: We're listening

ON-SCREEN TEXT: When you are contacted, please participate in the High School and Beyond study
<https://surveys.nces.ed.gov/hsb22>

ON-SCREEN LOGOS: U.S. Department of Education, HS&B:22

The recruitment website is used to provide information to school staff and parents about the study. The website also serves as a portal to securely upload student list information and complete the parent and school staff questionnaires.

HS&B:22 Website Content

Landing Page

- Sign-In
- Welcome to HS&B:22! High School and Beyond Longitudinal Study of 2022 (HS&B:22) is a national study of 9th-graders as they progress through high school and beyond. This site is for school staff, parents, and students who are participating in HS&B:22. Log in to begin.



About | Contact Us | Phone: 855-500-1439 [Log in](#)

[Home](#) [About HS&B:21](#) [Endorsements](#) [Why Should I Participate?](#) [FAQs](#) [Study Content](#) [Resources](#) [Findings](#) [Contact Us](#)



Welcome to HS&B:21!

High School and Beyond Longitudinal Study of 2021 (HS&B:21) is a national study of 9th-graders as they progress through high school and beyond.

Data collection for participating schools, students, and parents will begin in fall 2021.

If you are not participating in the study but would like to learn more, [click here](#).



[Learn More About HS&B:21](#)



[Click to watch a video to see why you should participate.](#)



[Questions? Contact Us](#)

NCES is authorized to conduct the High School and Beyond Longitudinal Study of 2022 (HS&B:21) by the Education Sciences Reform Act of 2002 (ESRA 2002, 20 U.S.C. §9543). The data are being collected for NCES by RTI International, a U.S.-based nonprofit research organization. All of the information you provide may be used only for statistical purposes and may not be disclosed, or used, in identifiable form for any other purpose except as required by law (20 U.S.C. §9573 and 6 U.S.C. §151).

According to the Paperwork Reduction Act of 1995, no persons are required to respond to a collection of information unless it displays a valid OMB control number. The valid OMB control number for this voluntary information collection is 1850-0944. Approval expires 10/31/2023. The time required to complete this information collection is estimated to average approximately 35 minutes per response for school administrators, 25 minutes per response for parents, 25 minutes per response for school counselors, 20 minutes per response for math teachers, and 25 minutes per response for student surveys, including the time to review instructions, gather the data needed, and complete and review the information collection. If you have any comments concerning the accuracy of the time estimate, suggestions for improving this survey, or any comments or concerns regarding the status of your individual submission of this survey, please write directly to: High

School and Beyond Longitudinal Study of 2022 (HS&B:22), National Center for Education Statistics, Potomac Center Plaza, 550 12th St, SW, Room 3505, Washington, DC 20202.

Contact info: *website, phone, email*

About HS&B:22

- *High School and Beyond Longitudinal Study of 2022(HS&B:22) is a national longitudinal study conducted by the National Center for Education Statistics (NCES) within the U.S. Department of Education. Study participants include 9th-grade students and their families, teachers, school administrators, and guidance counselors. HS&B:22 will help educators, parents, researchers, and policymakers better understand the factors that contribute to student success. Information collected through the study also can be used to improve high school educational experiences for this generation and beyond.*
- *NCES Info: The National Center for Education Statistics (NCES) collects, analyzes, and report statistics on the condition of education in the United States. Our mission is to provide scientific evidence on which to ground education practice and policy and to share this information in formats that are useful and accessible to educators, parents, policymakers, researchers, and the public.*
 - o *Longitudinal Series info: Have timeline with links to information about each study*
- *RTI Info: RTI is an independent, nonprofit institute that provides research, development, and technical services to government and commercial clients worldwide. Our mission is to improve the human condition by turning knowledge into practice.*

/ About

About HS&B:21

High School and Beyond Longitudinal Study of 2021 (HS&B:21) is a national longitudinal study conducted by the National Center for Education Statistics (NCES) within the U.S. Department of Education. Study participants include 9th-grade students and their families, teachers, school administrators, and guidance counselors. HS&B:21 will help educators, parents, researchers, and policymakers better understand the factors that contribute to student success. Information collected through the study also can be used to improve high school educational experiences for this generation and beyond.

HS&B:21 is conducted by the National Center for Education Statistics (NCES)



NCES collects, analyzes, and reports statistics on the condition of education in the United States. Our mission is to provide scientific evidence on which to ground education practice and policy and to share this information in formats that are useful and accessible to educators, parents, policymakers, researchers, and the general public.

HS&B:21 is the sixth in NCES' secondary longitudinal studies program

- National Longitudinal Study of 1972 (NLS-72)
- High School and Beyond 1980 (HS&B)
- National Education Longitudinal Study of 1988 (NELS:88)
- Education Longitudinal Study of 2002 (ELS:2002)
- High School Longitudinal Study of 2009 (HSL:09)

Data Collection Timepoints for the NCES High School Cohort Studies

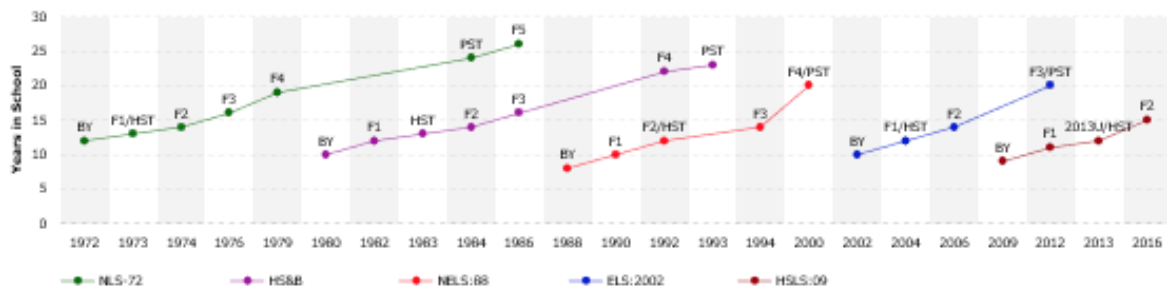

NLS-72: National Longitudinal Study of the High School Class of 1972
 HS&B: High School and Beyond
 NELS:88: National Education Longitudinal Study of 1988
 ELS:2002: Education Longitudinal Study of 2002
 HSL:09: High School Longitudinal Study of 2009

BY: Base Year
 F1: First follow-up data collection
 F2: Second follow-up data collection
 F3: Third follow-up data collection
 F4: Fourth follow-up data collection
 F5: Fifth follow-up data collection

2013 U: 2013 update
 HST: High School Transcript
 PST: Post-secondary Transcript

The data are being collected for NCES by RTI International

RTI is an independent, nonprofit institute that provides research, development, and technical services to government and commercial clients worldwide. Our mission is to improve the human condition by turning knowledge into practice.



NCES is authorized to conduct the High School and Beyond Longitudinal Study of 2021 (HS&B:21) by the Education Sciences Reform Act of 2002 (ESRA 2002, 20 U.S.C. 99543). The data are being collected for NCES by RTI International, a U.S.-based nonprofit research organization. All of the information you provide may be used only for statistical purposes and may not be disclosed, or used, in identifiable form for any other purpose except as required by law (20 U.S.C. 99573 and 6 U.S.C. 9151).
 According to the Paperwork Reduction Act of 1995, no persons are required to respond to a collection of information unless it displays a valid OMB control number. The valid OMB control number for this voluntary information collection is 1850-0944. Approval expires 08/31/2022. The time required to complete this information collection is estimated to average approximately 40 minutes per response for school administrators, 25 minutes per response for parents, 25 minutes per response for school counselors, 20 minutes per response for math teachers, and 25 minutes per response for student surveys, including the time to review instructions, gather the data needed, and complete and review the information collection. If you have any comments concerning the accuracy of the time estimate, a deadline for improving this estimate, or any comments or concerns regarding the ethics of our institution's collection of this survey, please write directly to High School and Beyond

Endorsements

The following organizations have endorsed HS&B:22:

Council of Chief State School Officers
National School Boards Association
National Parent Teacher Association
National Indian Education Association
National Education Association
National Charter Schools Institute
National Catholic Educational Association
The Institute for Excellence in Education
Council of Islamic Schools in North America
Council for American Private Education

Why Should I Participate?

- You have been given an opportunity to share your experiences and opinions. While your name will never be used in any reports, your input will be used to improve education for our children and those in the future. We want to hear from you!
- What can you contribute by participating in HS&B:22?
 - o **Districts** can learn about HS&B:22 and how the collected data can be used to improve policies that support student success. They can support participation among peers and educators.
 - o **Counselors** can share information about supports they offer to students in their schools.
 - o **Teachers** can share information about their unique learning environments, background, and individual students' classroom experiences.
 - o **Principals** can provide valuable information about their school's unique structure and environment.
 - o **Parents** can encourage their children to participate and to tell researchers about their transition to high school, their social and academic experiences, and how their school environment and culture impact their growth.
 - o **Students** can join with peers across the U.S. to participate in student sessions where they will have the opportunity to share information about their high school experiences.

- How will my school benefit?
 - o This is a unique opportunity for schools and educators to contribute in a way that will impact student outcomes for generations to come. Schools that participate in the High School and Beyond Longitudinal Study of 2022 will join national research that will be used to improve the high school experience for all students. Schools may receive a report that shows how their students compare with students nationwide and to schools like theirs. Schools will also receive \$200 for participating. HS&B:22 will give \$150 to the school coordinator. Students will receive a token of appreciation if allowed by the school.
- Why is this study important?
 - o Providing national-level information that is needed to better understand what factors lead students to successful completion of high school and entry into work or postsecondary education, as well as those factors that are barriers to success, is a critical function of high school longitudinal studies such as HS&B:22. Research has long shown that increases in education attainment are associated with a wide range of important civic and life outcomes, including stronger employment prospects and earning potential, lower incarceration rates, higher voting rates, and better health and life expectancy (Cutler & Lleras-Muney, 2006; Julian & Kominski, 2011; Milligan, Moretti, & Oreopoulos, 2004; Oreopoulos & Petronijevic, 2013; Sum, Khatiwada, & McLaughlin, 2009).
 - o Data from HS&B:22 can also contribute to improved educational experiences by documenting opportunity and achievement gaps and how well schools address inequity. Finally, HS&B:22 and its predecessor studies offer an extraordinary opportunity to study trends in students' high school experiences and education outcomes. By maintaining linkages with NCES's previous high school longitudinal studies, HS&B:22 data can be used to examine changes over time and shed light on the effects of various policies, demographic shifts, and school practices on student achievement, growth, and education attainment.

Frequently Asked Questions

Click on a question to learn more

Study Content

Student	Parent	Administrator	Counselor	Teacher
Background Information	Background Information	School characteristics	Counseling program characteristics	Teacher characteristics
Family structure	Family Structure	School calendar	Discipline and safety	Teacher communication
Neighborhood	Neighborhood	Coursework	School characteristics	Class-level characteristics
Native Language	Native Language	Graduation requirements	Transitions	Coursework
Academic Expectations	Parental Academic Expectations	School performance	Coursework	Student-level characteristics
Parental Academic Expectations	Guidance	Parent engagement	Graduation requirements	Programs and services
Guidance	Attendance Information	Programs and services	Evaluation of staff	School climate
Attendance Information	Academic Experiences	Special education services	Programs and services - offered	School policies
Academic Experiences	Math and Science Experiences	Technology	Programs and services - participation	Teacher attitudes
Math and Science Experiences	School Safety and Climate	Transition to high school	School performance	Evaluation of staff
School Library	Parent Attitudes	Student characteristics	Counselor-level characteristics	Technology usage
School Safety and Climate	Student Behavior	Personnel		
Student Attitudes about School	Out-of-School Activities	Interdisciplinary teaching		
Student Attitudes about Self	Home life	School climate		
Student Behavior	Student Health	Discipline and safety		
Student Employment	Student's Peers	Admissions		
Out-of-school Activities	Technology Usage	Principal characteristics		
Home life	Postsecondary			
Student Health	Parent Employment			
Student's Peers	Parent Education			
Technology Usage	Parent Income/wealth			
Postsecondary	Parental Involvement			
Parent Employment	High school educational expenses			
Parent Education	Locating Information			
Parental Involvement				
Hearing/Vision				

Locating Information				

Resources

Links to Resources

- HS&B:22 School Brochure
- HS&B:22 Student Video

Resources



Links to Resources

- HS&B:21 School Brochure
- HS&B:21 Student Video

Findings

HS&B:22 is the 6th in a series of high school longitudinal studies. Here we provide a subset of the results from the predecessor study – the High School Longitudinal Study of 2009 (HSL:09). Similar reports, tables, infographics, etc. will be prepared as a result of the HS&B:22 data collection(s).

Infographics

College Readiness: Math Coursetaking in Public High Schools and College Remediation

Reports

- Education, Employment, and Earnings: Expectations of 2009 Ninth-Graders in 2016.
- STEM Occupational Intentions: Stability and Change Through High School
- Male and Female High School Students' Expectations for Working In a Health-Related Field
- Postsecondary Occupational Education Among Students Who Took Career and Technical Education in High School
- Labor Market Outcomes for High School Career and Technical Education Participants: 2016
- Parent and Student Expectations of Highest Education Level

Tables

Findings

HS&B:21 is the 6th in a series of high school longitudinal studies. Here we provide a subset of the results from the predecessor study – the High School Longitudinal Study of 2009 (HSLs:09). Similar reports, tables, infographics, etc. will be prepared as a result of the HS&B:21 data collection(s).

Infographics

College Readiness: Math Coursetaking in Public High Schools and College Remediation

Reports

- Education, Employment, and Earnings: Expectations of 2009 Ninth-Graders in 2016.
- STEM Occupational Intentions: Stability and Change Through High School
- Male and Female High School Students' Expectations for Working In a Health-Related Field
- Postsecondary Occupational Education Among Students Who Took Career and Technical Education in High School
- Labor Market Outcomes for High School Career and Technical Education Participants: 2016
- Parent and Student Expectations of Highest Education Level

Tables

HSLs:09 Table Library



NCES is authorized to conduct the High School and Beyond Longitudinal Study of 2021 (HS&B:21) by the Education Sciences Reform Act of 2002 (ESRA 2002, 20 U.S.C. §9543). The data are being collected for NCES by RTI International, a U.S.-based nonprofit research organization. All of the information you provide may be used only for statistical purposes and may not be disclosed, or used, in identifiable form for any other purpose except as required by law (20 U.S.C. §9573 and 6 U.S.C. §151).

According to the Paperwork Reduction Act of 1995, no persons are required to respond to a collection of information unless it displays a valid OMB control number. The valid OMB control number for this voluntary information collection is 1850-0944. Approval expires 08/31/2022. The time required to complete this information collection is estimated to average approximately 40 minutes per response for school administrators, 25 minutes per response for parents, 25 minutes per response for school counselors, 20 minutes per response for math teachers, and 25 minutes per response for student surveys, including the time to review instructions, gather the data needed, and complete and review the information collection. If you have any comments concerning the accuracy of the time estimate, suggestions for improving this survey, or any comments or concerns regarding the status of your individual submission of this survey, please write directly to: High School and Beyond Longitudinal Study of 2021 (HS&B:21), National Center for Education Statistics, Potomac Center Plaza, 550 12th St, SW, Room 4005, Washington, DC 20202.

HS&B:22 Student Roster Instructions

Not all students in your school will be asked to participate. We will be selecting a sample. In order to select the sample, we are requesting a complete roster of all students currently enrolled in ninth <and twelfth grade> at your school.

The roster should include key characteristics about each student for sampling purposes. The HS&B:22 roster data request conforms fully to the requirements of the Family Educational Rights and Privacy Act of 1974 (FERPA) (20 U.S.C. §1232g; 34 CFR Part 99). For the purposes of this collection of data, FERPA permits education agencies and institutions to disclose personally identifiable information from students' education records, without consent, to authorized representatives of the Secretary of Education in connection with an evaluation of federally supported education programs (34 CFR §§ 99.31(a)(3)(iii) and 99.35). Student data are subject to strict protections that are adhered to by NCES and its contractor organizations. Roster information will be securely destroyed when no longer needed for the purposes specified in 34 CFR §99.35.

Below are instructions for preparing and uploading your student roster. The upload process is similar to attaching a file to an e-mail.

Website Upload Instructions

1. Go to <https://surveys.nces.ed.gov/hsb22>
2. Enter the study ID and Password provided in the cover letter.
3. If this is your first time entering your login credentials, you will be prompted to change your Password to something that you can remember.
4. Click "Provide Your Student Roster."
5. Fill out the required contact information.
6. Prepare your document containing the requested information. You have two options for preparing a data file:
 - a. Click on the link provided (Download Student Roster Template) to download an Excel spreadsheet or;
 - b. Upload a pre-prepared file from your data system.
7. If you used our excel file template, once you have filled in the requested data fields, please save this file to your desktop, or some other location on your computer.
8. If you have a file already prepared, please save your file to your desktop, or some other location on your computer.
9. Go back to the HS&B:22 website (<https://surveys.nces.ed.gov/hsb22>) and click the "Upload" button.
10. Click the "Browse" button and navigate to the completed data file stored on your computer and select that file.
11. Click the "Upload" button. You will receive a message alerting you to the status of your upload.

NCES is authorized to conduct the High School and Beyond Longitudinal Study of 2022 (HS&B:22) by the Education Sciences Reform Act of 2002 (ESRA 2002, 20 U.S.C. §9543). The data are being collected for NCES by RTI International, a U.S.-based nonprofit research organization. All of the information you provide may be used only for statistical purposes and may not be disclosed, or used, in identifiable form for any other purpose except as required by law (20 U.S.C. §9573 and 6 U.S.C. §151).

According to the Paperwork Reduction Act of 1995, no persons are required to respond to a collection of information unless it displays a valid OMB control number. The valid OMB control number for this voluntary information collection is 1850-0944. Approval expires 8/31/2023. The time required to complete this information collection is estimated to average approximately <x> minutes per response, including the time to review instructions, gather the data needed, and complete and review the information collection. If you have any comments concerning the accuracy of the time estimate, suggestions for improving this information collection, or any comments or concerns regarding the status of your individual submission, please write directly to: The High School and Beyond Longitudinal Study of 2022 (HS&B:22), National Center for Education Statistics, PCP, 550 12th St., SW, 4th floor, Washington, DC 20222.

Data Files Requested

Please note that just the student information can be submitted initially. Once the sample is drawn, you can submit the parent and teacher information for those sampled students separately.

Data Elements Requested (*denotes element required for sampling)

- Name
- District/School Student identification number
- Date of birth*
- Grade level * (9<, 12,> or U=ungraded)
- Sex
- Race/ethnicity*
- ELL status
- Parent contact information
 - Name (last, first)
 - Parent Street address, City, State, Zip
 - Home phone number
 - Cell phone number
 - E-mail address
- Student's Math Teacher Name (last, first)
- Student's Math Teacher Email Address
- Student's Math Course Name
- Student's Math Course Period/Section

If you need assistance, please call the HS&B:22 Help Desk at (855) 500-1439.

Endorsements

- Blurb about Endorsements page: *The following organizations have partnered with NCES to support High School and Beyond 2022. When you see the following symbol, you can view their letter of support and endorsement.*
- Include symbol to show when there is a letter of support to view: 
- Support letters from universities/colleges
- Include regional endorsement letters (maybe map of U.S. and links to letters?)



Resources

- Link to video
- Materials
 - Brochure, FAQ, Survey Information Sheet, newsletter
- Link to usable data from ED (ECLS-K, ECLS-K:2011, HSLs:09, etc.)
- Parent Permission Forms
- Publications related to study

Appendix A8a. Out-of-School Data Collection – Parent Letter (previously approved)

<PARENT NAME>
<ADDR1>
<ADDR2>
<CITY STATE ZIP>

<DATE>

Dear <Parent or Guardian Name>:

<If child only: Your child can share his/her high school experiences and opinions and help improve education for them and other students in the future.> <If parent already participated, add: You have already provided valuable information for this study and we thank you for your participation.> <If parent and child needed: You and your child can share your high school experiences and opinions and help improve education for your child and other students in the future.>. <If we've already reached out to the parent and are adding the child to the out-of-school data collection: You were recently contacted to share your experiences and opinions about the high school experience, and we would also like to ask [child name] to share his/her experience.>

How a student does in 9th grade is more predictive of their odds of graduating high school than all other factors, including race, gender, socioeconomic status, and prior academic achievement, combined.
<https://toandthrough.uchicago.edu/mythbusters>

The U.S. Department of Education's National Center for Education Statistics (NCES) is conducting **the High School and Beyond Longitudinal Study of 2022 (HS&B:22)** study. We want to hear from you <both> about what works for you with the high school experience and what doesn't work. We are listening!

Students will be asked to spend about <FILL> minutes taking a survey and answering math and reading questions on the computer. In return, we will send them a certificate for 2 hours of community service from the U.S. Department of Education and <incentive>. We will then ask them to participate again in Spring 2026 to see how things change during high school and then we will collect their high school transcripts in Fall 2025.

Participation is easy! Please give your child the enclosed envelope so that he/she can participate. The envelope contains the information that needs to be entered into the computer to log in and complete the session.

If the 1.3 million dropouts from the Class of 2010 had graduated, the nation would have seen \$337 billion more in earnings over the course of the students' lifetimes.
<https://www.dosomething.org/us/facts/11-facts-about-education-america>

<If parent has not already participated: You will also be asked to complete a survey and will receive a separate letter about your participation.>

The enclosed brochure provides more information about the study. If you have questions, please call (855) 500-1439 or email us at HSB22Survey@rti.org. You can also get more information by watching a short video on our website <https://surveys.nces.ed.gov/hsb22..>

We thank you in advance for your cooperation in this important research.

Sincerely,

James L. Woodworth
NCES Commissioner



IMPORTANT: This is not a test, and it is not graded. We follow very strict laws to protect personal information and any data collected. All information collected is securely maintained. All reports will use aggregate information for all students who participate; no names will be published in the data files or reports.

NCES is authorized to conduct the High School and Beyond Longitudinal Study of 2022 (HS&B:22) by the Education Sciences Reform Act of 2002 (ESRA 2002, 20 U.S.C. §9543) and to collect students' education records from education agencies or institutions for the purposes of evaluating federally supported education programs under the Family Educational Rights and Privacy Act (FERPA, 34 CFR §§ 99.31(a)(3)(iii) and 99.35). The data are being collected for NCES by RTI International, a U.S.-based nonprofit research organization. All of the information students, parents, and staff provide may be used only for statistical purposes and may not be disclosed, or used, in identifiable form for any other purpose except as required by law (20 U.S.C. §9573 and 6 U.S.C. §151). The collected information will be combined across respondents to produce statistical reports.

Appendix A8a.1 Out-of-School Data Collection – Parent Letter Reminder (previously approved)

<PARENT NAME>
<ADDR1>
<ADDR2>
<CITY STATE ZIP>

<DATE>

Dear <Parent or Guardian Name>:

We recently sent you information about The U.S. Department of Education's National Center for Education Statistics (NCES) **High School and Beyond Longitudinal Study of 2022 (HS&B:22)** study. If your child has already submitted responses, we thank you both.

If your child has not participated yet, please give them a reminder. <CHILD_NAME> is asked to spend about <FILL> minutes taking a survey and answering math and reading questions on the computer. In return, we will send them <incentive> and a certificate for 2 hours of community service from the U.S. Department of Education. We will then ask <him/her> to participate again in Spring 2026 to see how things change during high school and then we will collect their high school transcripts in Fall 2025.

Please give your child the enclosed envelope so that he/she can participate. The envelope contains the information that needs to be entered into the computer to log in and complete the session.

You will also be asked to complete a survey and will receive a separate letter about your participation.

If you have questions, please call (855) 500-1439 or email us at HSB22Survey@rti.org. You can also get more information by watching a short video on our website <https://surveys.nces.ed.gov/hsb22>.

We thank you in advance for your cooperation in this important research.

Sincerely,

James L. Woodworth
NCES Commissioner



IMPORTANT: *This is not a test, and it is not graded. We follow very strict laws to protect personal information and any data collected. All information collected is securely maintained. All reports will use aggregate information for all students who participate; no names will be published in the data files or reports.*

NCES is authorized to conduct the High School and Beyond Longitudinal Study of 2022 (HS&B:22) by the Education Sciences Reform Act of 2002 (ESRA 2002, 20 U.S.C. §9543) and to collect students' education records from education agencies or institutions for the purposes of evaluating federally supported education programs under the Family Educational Rights and Privacy Act (FERPA, 34 CFR §§ 99.31(a)(3)(iii) and 99.35). The data are being collected for NCES by RTI International, a U.S.-based nonprofit research organization. All of the information students, parents, and staff provide may be used only for statistical purposes and may not be disclosed, or used, in identifiable form for any other purpose except as required by law (20 U.S.C. §9573 and 6 U.S.C. §151). The collected information will be combined across respondents to produce statistical reports.

Appendix A8a.2 Out-of-School Data Collection – Parent Email Initial (previously approved)

Dear <Parent or Guardian Name>:

<CHILD’S NAME> was selected to take part in the High School and Beyond Longitudinal Study of 2022 (HS&B:22) study. Your child has an opportunity to help improve education for themselves and other students in the future.

We are asking <CHILD_NAME> to spend about <FILL> minutes taking a survey and answering math and reading questions on the computer.

Once we have received <CHILD’S_NAME> response, we will send <him/her> a certificate for 2 hours of community service from the U.S. Department of Education and <incentive>.

Please give your child the login information below that needs to be entered into the computer to log in and complete the session.

Web Address: <https://surveys.nces.ed.gov/hsb22>

Student Study ID: <XXXXXXXX>

Parent Password: <XXXXXXXX><PW_ind>

You will also be asked to complete a survey and will receive a separate email about your participation. We will ask <CHILD’S NAME> to participate again in Spring 2026 to see how things change during high school and then we will collect their high school transcripts in Fall 2025.

If you have questions, please call (855) 500-1439 or email us at HSB22Survey@rti.org. You can also get more information by watching a short video on our website <https://surveys.nces.ed.gov/hsb22>.

We thank you in advance for your cooperation in this important research.

Sincerely,

James L. Woodworth
NCES Commissioner

Appendix A8a.3 Out-of-School Data Collection – Parent Email Reminder (previously approved)

Dear <Parent or Guardian Name>:

We noticed that we have not received <CHILD'S_NAME> response to the HS&B:22 study, and we wanted to make sure your child had the opportunity to receive <incentive> and 2 hours of community service from the U.S. Department of Education. All <CHILD_NAME> has to do is spend about <FILL> minutes on the computer completing a survey and answering math and reading questions.

Participation is easy! Please give your child the login information below that needs to be entered into the computer to log in and complete the session.

Web Address: <https://surveys.nces.ed.gov/hsb22>
Student Study ID: <XXXXXXXX>
Parent Password: <XXXXXXXX><PW_ind>

You will also be asked to complete a survey and will receive a separate email about your participation.

If you have questions, please call or email us at HSB22Survey@rti.org. You can also get more information by watching a short video on our website <https://surveys.nces.ed.gov/hsb22>.

We thank you in advance for your cooperation in this important research.

Sincerely,

James L. Woodworth
NCES Commissioner

<DATE>

<STUDENT NAME>
<ADDR1>
<CITY STATE ZIP>

Web Address: https://surveys.nces.ed.gov/hsb22
Student Study ID: <XXXXXXXX>
Student Password: <XXXXXXXX><PW_ind>

Dear <Student Name>:

Congratulations! You have been selected to share about your high school experiences and opinions. Your input will help to improve education for students now and in the future.

YOU can make a difference!

The **High School and Beyond** Longitudinal Study of 2022 (HS&B:22) is conducted by the National Center for Education Statistics (NCES) in the U.S. Department of Education. We will ask for your input now, and then we will contact you again in the first half of 2025 to see how things went in high school and to see what may have changed.

This is your chance to provide information that could lead to important changes in education.

Your participation is voluntary, but we can't do this without you. The study will take about <45-90> minutes and will include a short survey and math and reading questions. Your answers will never be shared with your parents, teachers, or school staff.

We will send you a certificate for **two hours of volunteer service** from the U.S. Department of Education and **<incentive>** after you have completed the session. To participate, please use the web link and the unique student study ID and Password provided above.

'Believe you can and you're halfway there'
-Theodore Roosevelt-

RTI International will collect the data for HS&B:22 on behalf of NCES. We hope that you will take part in this important research. Participation is easy and we really value your responses! The enclosed brochure provides more information about the study. If you have questions, please call (855) 500-1439 or email us at HSB22Survey@rti.org.

We thank you in advance for your cooperation in this important research.

Sincerely,

James L. Woodworth
NCES Commissioner



IMPORTANT: This is not a test, and it is not graded. We follow very strict laws to protect personal information and any data collected. All information collected is securely maintained. All reports will use aggregate information for all students who participate; no names will be published in the data files or reports.

NCES is authorized to conduct the High School and Beyond Longitudinal Study of 2022 (HS&B:22) by the Education Sciences Reform Act of 2002 (ESRA 2002, 20 U.S.C. §9543) and to collect students' education records from education agencies or institutions for the purposes of evaluating federally supported education programs under the Family Educational Rights and Privacy Act (FERPA, 34 CFR §§ 99.31(a)(3)(iii) and 99.35). The data are being collected for NCES by RTI International, a U.S.-based nonprofit research organization. All of the information students, parents, and staff provide may be used only for statistical purposes and may not be disclosed, or used, in identifiable form for any other purpose except as required by law (20 U.S.C. §9573 and 6 U.S.C. §151). The collected information will be combined across respondents to produce statistical reports.

Appendix A8b.1 Out-of-school Data Collection – Student Letter Reminder (previously approved)

<DATE>

<STUDENT NAME> Web Address: <https://surveys.nces.ed.gov/hsb22>
<ADDR1> Student Study ID: <XXXXXXXX>
<CITY STATE ZIP> Student Password: <XXXXXXXX><PW_ind>

Dear <Student Name>:

We recently sent you information about your selection in an exciting new study, the **High School and Beyond Longitudinal Study 2022** or HS&B:22 and we didn't want you to miss out on an opportunity to earn two hours of volunteer service from the U.S. Department of Education and <incentive>. All you have to do is spend about <45-90> minutes answering a short survey, and math and reading questions. We would really appreciate it if you would share your high school experiences and opinions to help improve education for you and other students now and in the future.

HS&B:22 is conducted by the National Center for Education Statistics (NCES) in the U.S. Department of Education, and RTI International is collecting the data for HS&B:22. We will contact you again in the first half of 2025 to see how things went in high school and to see what may have changed.

It is your decision to participate or not, but we hope that you will decide to join fellow students taking part in this important research. We will never share your responses with your parents, teachers, or school staff. Participation is easy! Just use the web link and the unique student study ID and Password provided above.

If you have any questions, please call (855) 500-1439 or email us at HSB22Survey@rti.org. You can also get more information by watching a short video on our website <https://surveys.nces.ed.gov/hsb22>.

Thank you so much for your cooperation in this important research.

Sincerely,

James L. Woodworth
NCES Commissioner



IMPORTANT: This is not a test, and it is not graded. We follow very strict laws to protect personal information and any data collected. All information collected is securely maintained. All reports will use aggregate information for all students who participate; no names will be published in the data files or reports.

NCES is authorized to conduct the High School and Beyond Longitudinal Study of 2022 (HS&B:22) by the Education Sciences Reform Act of 2002 (ESRA 2002, 20 U.S.C. §9543) and to collect students' education records from education agencies or institutions for the purposes of evaluating federally supported education programs under the Family Educational Rights and Privacy Act (FERPA, 34 CFR §§ 99.31(a)(3)(iii) and 99.35). The data are being collected for NCES by RTI International, a U.S.-based nonprofit research organization. All of the information students, parents, and staff provide may be used only for statistical purposes and may not be disclosed, or used, in identifiable form for any other purpose except as required by law (20 U.S.C. §9573 and 6 U.S.C. §151). The collected information will be combined across respondents to produce statistical reports.

Appendix A8b.2 Out-of-School Data Collection – Student Email Initial (previously approved)

Dear <Student Name>:

Congratulations! You have been selected to participate in the High School and Beyond Longitudinal Study of 2022 (HS&B:22). This is your chance to not only improve education for yourself and other students, but you will also earn <incentive> and 2 hours of volunteer service from the U.S. Department of Education.

All we are asking you to do is to take about <45-90> minutes to complete a short survey and answer some reading and math questions.

Here's the information you need to participate:

Web Address: <https://surveys.nces.ed.gov/hsb22>
Student Study ID: <XXXXXXXX>
Student Password: <XXXXXXXX><PW_ind>

If you have questions, please call (855) 500-1439 or email us at HSB22@rti.org. You can also get more information on our website by watching a short video on our website <https://surveys.nces.ed.gov/hsb22>.

We thank you in advance for your cooperation in this important research.

Sincerely,

James L. Woodworth
NCES Commissioner

Appendix A8b.3 Out-of-School Data Collection – Student Email Reminder (previously approved)

Dear <Student Name>:

We wanted to remind you that it's not too late to earn <incentive> and 2 hours of volunteer service from the U.S. Department of Education! All you have to do is spend about <45-90> minutes completing a short survey and math and reading questions. Students nationwide are participating in the High School and Beyond Longitudinal Study of 2022 (HS&B:22), and we need your input too!

This is your chance to provide information that could lead to important changes in education.

Your participation is voluntary, but we can't do this without you. Your answers will never be shared with your parents, teachers, or school staff. To participate, please use the web link and the unique student study ID and Password provided below.

Web Address: <https://surveys.nces.ed.gov/hsb22>
Student Study ID: <XXXXXXXX>
Student Password: <XXXXXXXX><PW_ind>

If you have questions, please call (855) 500-1439 or email us at HSB22@rti.org. You can also get more information on our website by watching this short video at <https://surveys.nces.ed.gov/hsb22>.

We thank you in advance for your cooperation in this important research.

Sincerely,

James L. Woodworth
NCES Commissioner

Appendix A8b.4 Out-of-School Data Collection – Student Postcard (previously approved)

We're sorry we missed you at the HS&B:22 student session at your school! We would still like for you to participate at home. Please complete the session on your computer. You can log in at:

Web Address: surveys.nces.ed.gov/hsb22

Student Study ID: <XXXXXXXXXX>

Student Password: <XXXXXXXXXX><PW_ind>

When you have finished, we will send you a **certificate for 2 hours of community service** and **<incentive>**.

**Sorry I Missed
You...**

Appendix A8c. Hybrid Out-of-School Data Collection – Student Postcard (previously approved)

Thank you for your participation today. Please complete the rest of the session on your computer. You can log in at:

Web Address: surveys.nces.ed.gov/hsb22
Student Study ID: <XXXXXXXXX>
Student Password: <XXXXXXXXX><PW_ind>

When you have finished, we will send you a **certificate for 2 hours of community service** and <incentive>.

<DATE>

<PARENT NAME>
<ADDR1>
<ADDR2>
<CITY STATE ZIP>

Dear <Parent or Guardian Name>:

Your child recently participated in the High School & Beyond Longitudinal study of 2022 (HS&B:22) in school. We would like him/her to complete the rest at home.

By participating in HS&B:22, <student name> can share his/her experiences and opinions to help improve education for them and other students in the future.

The remaining portion of the session should take about {XX} minutes and will consist of <a survey and answering math and reading questions> on the computer. In return, we will send your child a **certificate for 2 hours of community service from the U.S. Department of Education and <incentive>**.

We will then ask your child to participate again in the Spring of 2026 to see how things change during high school and then we will collect their high school transcript in Fall 2027.

Please give your child the enclosed envelope so that he/she can participate. The envelope contains the information that needs to be entered into the computer to log in and complete the session.

You will also be asked to complete a survey and will receive a separate letter about your participation.

The enclosed brochure provides more information about the study. If you have questions, please call (855) 500-1439 or email us at HSB22Survey@rti.org. You can also get more information on our website by watching a short video at <https://surveys.nces.ed.gov/hsb22>.

We thank you in advance for your cooperation in this important research.

Sincerely,

James L. Woodworth
NCES Commissioner



IMPORTANT: This is not a test, and it is not graded. We follow very strict laws to protect personal information and any data collected. All information collected is securely maintained. All reports will use aggregate information for all students who participate; no names will be published in the data files or reports.

NCES is authorized to conduct the High School and Beyond Longitudinal Study of 2022 (HS&B:22) by the Education Sciences Reform Act of 2002 (ESRA 2002, 20 U.S.C. §9543) and to collect students' education records from education agencies or institutions for the purposes of evaluating federally supported education programs under the Family Educational Rights and Privacy Act (FERPA, 34 CFR §§ 99.31(a)(3)(iii) and 99.35). The data are being collected for NCES by RTI International, a U.S.-based nonprofit research organization. All of the information students, parents, and staff provide may be used only for statistical purposes and may not be disclosed, or used, in identifiable form for any other purpose except as required by law (20 U.S.C. §9573 and 6 U.S.C. §151). The collected information

will be combined across respondents to produce statistical reports.

Appendix A8d.1 Hybrid Out-of-School Data Collection – Parent Letter Reminder (previously approved)

<DATE>

<PARENT NAME>
<ADDR1>
<ADDR2>
<CITY STATE ZIP>

Dear <Parent or Guardian Name>:

<Child_name> recently participated in the High School & Beyond Longitudinal Study of 2022 (HS&B:22) at school, and only has to complete about {XX} minutes of the < survey and math and reading questions> on the computer to receive a **certificate for 2 hours of community service from the U.S. Department of Education and <incentive>**.

Participating is easy! The enclosed envelope contains the information <CHILD_NAME> needs to log in to the computer and complete the session.

You will also be asked to complete a survey and will receive a separate letter about your participation.

The enclosed brochure provides more information about the study. If you have questions, please call (855) 500-1439 or email us at HSB22Survey@rti.org. You can also get more information on our website by watching a short video at <https://surveys.nces.ed.gov/hsb22>.

We thank you in advance for your cooperation in this important research.

Sincerely,

James L. Woodworth
NCES Commissioner



IMPORTANT: This is not a test, and it is not graded. We follow very strict laws to protect personal information and any data collected. All information collected is securely maintained. All reports will use aggregate information for all students who participate; no names will be published in the data files or reports.

NCES is authorized to conduct the High School and Beyond Longitudinal Study of 2022 (HS&B:22) by the Education Sciences Reform Act of 2002 (ESRA 2002, 20 U.S.C. §9543) and to collect students' education records from education agencies or institutions for the purposes of evaluating federally supported education programs under the Family Educational Rights and Privacy Act (FERPA, 34 CFR §§ 99.31(a)(3)(iii) and 99.35). The data are being collected for NCES by RTI International, a U.S.-based nonprofit research organization. All of the information students, parents, and staff provide may be used only for statistical purposes and may not be disclosed, or used, in identifiable form for any other purpose except as required by law (20 U.S.C. §9573 and 6 U.S.C. §151). The collected information will be combined across respondents to produce statistical reports.

Dear <Parent or Guardian Name>:

<CHILD_NAME> recently participated in the High School & Beyond Longitudinal study of 2022 (HS&B:22) in school and has about {XX} minutes left to complete <the survey and math and reading questions>. We wanted to be sure your child gets credit for participating and receives <his/her> **certificate for 2 hours of community service from the U.S. Department of Education and <incentive>**.

Please give your child the login information below to complete the session.

Web Address: surveys.nces.ed.gov/hsb22
Student Study ID: <XXXXXXXXX>
Student Password: <XXXXXXXXX><PW_ind>

You will also be asked to complete a survey and will receive a separate email about your participation.

We will ask your child to participate again in the Spring of 2026 to see how things change during high school and then we will collect their high school transcript in Fall 2027.

If you have questions, please call (855) 500-1439 or email us at HSB22Survey@rti.org. You can also get more information by watching a short video on our website at <https://surveys.nces.ed.gov/hsb22>.

We thank you in advance for your cooperation in this important research.

Sincerely,

James L. Woodworth
NCES Commissioner

Dear <Parent or Guardian Name>:

There is still time for <CHILD_NAME> to login and complete the remaining portion of the High School and Beyond Longitudinal Study of 2022 (HS&B:22) session at home. It should take about {XX} minutes and will consist of <a survey and answering math and reading questions> on the computer. In return, we will send <CHILD_NAME> a **certificate for 2 hours of community service from the U.S. Department of Education and <incentive>**.

Please give your child the login information below that needs to be entered into the computer to log in and complete the session.

Web Address: surveys.nces.ed.gov/hsb22
Student Study ID: <XXXXXXXXX>
Student Password: <XXXXXXXXX><PW_ind>

We will then ask your child to participate again in the Spring of 2026 to see how things change during high school and then we will collect their high school transcript in Fall 2027.

You will also be asked to complete a survey and will receive a separate email about your participation.

If you have questions, please call (855) 500-1439 or email us at HSB22Survey@rti.org. You can also get more information on our website by watching a short video at <https://surveys.nces.ed.gov/hsb22>.

We thank you in advance for your cooperation in this important research.

Sincerely,

James L. Woodworth
NCES Commissioner

Appendix A8e. Hybrid Out-of-school Data Collection – Student Letter (previously approved)

<DATE>

<STUDENT NAME> Web Address: surveys.nces.ed.gov/hsb22
<ADDR1> Student Study ID: <XXXXXXXX>
<CITY STATE ZIP> Student Password: <XXXXXXXX><PW_ind>

Dear <Student Name>:

Thank you for participating in the first part of the High School and Beyond Longitudinal Study of 2022 (HS&B:22) at your school. By sharing your school experiences and opinions, you can help to improve education for students now and in the future.

Please take <##> minutes to complete the rest of the session. Your participation is voluntary, but we can't do this without you. Your answers will never be shared with your parents, teachers, or school staff. We will send you a certificate for **two hours of volunteer service** from the U.S. Department of Education and **<incentive>** after you have completed the session. To participate, please use the web link and the unique student study ID and Password provided above.

NCES has asked RTI International, a not-for-profit research organization, to collect the data for HS&B:22. We hope that you will participate in this important research. We value and appreciate your input! The enclosed brochure provides more information about the study. If you have questions, please call (855) 500-1439 or email us at HSB22Survey@rti.org.

We thank you in advance for your cooperation in this important research.

Sincerely,

James L. Woodworth
NCES Commissioner



IMPORTANT: *This is not a test, and it is not graded. We follow very strict laws to protect personal information and any data collected. All information collected is securely maintained. All reports will use aggregate information for all students who participate; no names will be published in the data files or reports.*

NCES is authorized to conduct the High School and Beyond Longitudinal Study of 2022 (HS&B:22) by the Education Sciences Reform Act of 2002 (ESRA 2002, 20 U.S.C. §9543) and to collect students' education records from education agencies or institutions for the purposes of evaluating federally supported education programs under the Family Educational Rights and Privacy Act (FERPA, 34 CFR §§ 99.31(a)(3)(iii) and 99.35). The data are being collected for NCES by RTI International, a U.S.-based nonprofit research organization. All of the information students, parents, and staff provide may be used only for statistical purposes and may not be disclosed, or used, in identifiable form for any other purpose except as required by law (20 U.S.C. §9573 and 6 U.S.C. §151). The collected information will be combined across respondents to produce statistical reports.

Appendix A8e.1 Hybrid Out-of-school Data Collection – Student Letter Reminder (previously approved)

<DATE>

<STUDENT NAME>
<ADDR1>
<CITY STATE ZIP>

Web Address: surveys.nces.ed.gov/hsb22
Student Study ID: <XXXXXXXX>
Student Password: <XXXXXXXX><PW_ind>

Dear <Student Name>:

Thank you again for completing the first part of the High School and Beyond Longitudinal Study of 2022 (HS&B:22) at your school! As a reminder, we would still like you to log in and complete the rest of the session, which should take about <###> minutes. Participating is easy and will earn you <incentive> and two hours of volunteer service from the U.S. Department of Education.

The information you need to login in is provided above.

NCES has asked RTI International, a not-for-profit research organization, to collect the data for HS&B:22. We hope that you will participate in this important research. We value and appreciate your input! The enclosed brochure provides more information about the study. If you have questions, please call (855) 500-1439 or email us at HSB22Survey@rti.org.

We thank you in advance for your cooperation in this important research.

Sincerely,

James L. Woodworth
NCES Commissioner



IMPORTANT: *This is not a test, and it is not graded. We follow very strict laws to protect personal information and any data collected. All information collected is securely maintained. All reports will use aggregate information for all students who participate; no names will be published in the data files or reports.*

NCES is authorized to conduct the High School and Beyond Longitudinal Study of 2022 (HS&B:22) by the Education Sciences Reform Act of 2002 (ESRA 2002, 20 U.S.C. §9543) and to collect students' education records from education agencies or institutions for the purposes of evaluating federally supported education programs under the Family Educational Rights and Privacy Act (FERPA, 34 CFR §§ 99.31(a)(3)(iii) and 99.35). The data are being collected for NCES by RTI International, a U.S.-based nonprofit research organization. All of the information students, parents, and staff provide may be used only for statistical purposes and may not be disclosed, or used, in identifiable form for any other purpose except as required by law (20 U.S.C. §9573 and 6 U.S.C. §151). The collected information will be combined across respondents to produce statistical reports.

Dear <Student Name>:

Thank you for participating in the first part of the High School and Beyond Longitudinal Study of 2022 (HS&B:22) at your school.

We want to make sure you get credit for participating, and the <incentive> and two hours of volunteer service from the U.S. Department of Education. Please take <##> minutes to complete the rest of the session. To participate, please use the web link and the unique student study ID and Password provided below.

Web Address: surveys.nces.ed.gov/hsb22

Student Study ID: <XXXXXXXX>

Student Password: <XXXXXXXX><PW_ind>

If you have questions, please call (855) 500-1439 or email us at HSB22Survey@rti.org. You can also get more information by watching a short video on our website at surveys.nces.ed.gov/hsb22.

Thank you so much for your cooperation in this important research.

Sincerely,

James L. Woodworth
NCES Commissioner

Dear <Student Name>:

It's not too late to log in and complete the HS&B:22 session, which should take about <###> minutes.

Once you complete the session, we will send you a certificate for **two hours of volunteer service** from the U.S. Department of Education and **<incentive>**. Participating is easy! Just use the web link and the unique student study ID and Password provided below.

Web Address: surveys.nces.ed.gov/hsb22

Student Study ID: <XXXXXXXX>

Student Password: <XXXXXXXX><PW_ind>

If you have questions, please call (855) 500-1439 or email us at HSB22Survey@rti.org. You can also get more information by watching a short video on our website at surveys.nces.ed.gov/hsb22.

We thank you in advance for your cooperation in this important research.

Sincerely,

James L. Woodworth
NCES Commissioner

Appendix A9a. Summary of Mathematics Questions (previously approved)

Approximate length Goal for Main Study	30 minutes (part of a 45 min or 90 min session including math, reading, and a student survey)
Mode of administration	<p>In school computerized administration using Chromebooks, tablet-like computers with touchscreen capability and an attached keyboard, that will be brought in to the school by the study</p> <p>Out of school computerized administration using students' personal computers with or without touchscreen capability</p>
Key constructs	<p>Number Systems and Arithmetic</p> <ul style="list-style-type: none">• Number sense• applying basic operations with fractions and integers to word problems• representing and understanding rational numbers in multiple forms• understanding the relative size of irrational numbers• understanding basic concepts of ratio, rate, and proportional relationships• using rational numbers to solve problems and understand slope and functions <p>Algebra and Functions</p> <ul style="list-style-type: none">• understanding the use of expressions beginning with letter representations of a single number• solving and representing linear equations and inequalities• understanding functions• comparing functions represented in different ways• distinguishing between linear and nonlinear functions• comparing and creating representations of different functions <p>Geometry and Measurement</p> <ul style="list-style-type: none">• analyzing geometric figures in one, two, or three dimensions• measuring physical attributes• systems of measurement• understanding transformations <p>Data, Probability, and Statistics</p> <ul style="list-style-type: none">• understanding how to represent and interpret data• calculating and interpreting descriptive statistics• demonstrating a general conceptual understanding of data distribution shapes and properties• using basic probability rules and counting techniques

Approximate length Goal for Main Study	25 minutes (part of a 45 min or 90 min session including math, reading, and a student survey)
Mode of administration	Two-stage, in school computerized session using Chromebooks, tablet-like computers with touchscreen capability and an attached keyboard, that will be brought in to the school by the study Out of school computerized administration using students' personal computers with or without touchscreen capability
Key constructs	<p>Word Recognition & Decoding Students read words (e.g., elect), pronounceable nonwords (e.g., clort) and pseudohomophones (e.g., brane) and decide whether the stimulus is a word, not a real word, or sounds exactly like a real word.</p> <p>Vocabulary A single target word is presented and the student decides which of provided three words goes with the target word. Correct answers are either synonyms (e.g., data - information) or meaning associates (e.g., thermal - heat).</p> <p>Morphological Awareness The student completes a sentence by choosing from three words derived from the same root word (e.g., She is good at many sports, but her _____ is basketball: specialty, specialize, specialist). The target words vary in difficulty based on the frequency of the derived forms (i.e., lower frequency derivations are more difficult).</p> <p>Sentence Processing The student completes sentences of increasing length and syntactic complexity by choosing from three choices (e.g., Shouting in a voice louder than her friend Cindy's, Tonya asked Joe to unlock the door, but _____ didn't respond: he, she, they). In this task, frequent words used in everyday language are used in the sentences to decrease the influence of vocabulary knowledge in this task. Consequently, the focus is on understanding of sentence syntax and meaning (rather than word meaning).</p> <p>Efficiency of Basic Reading Comprehension (MAZE task) Students read short passages containing sentences that are completed using a forced-choice cloze task (e.g., Agriculture meant that people stayed in one place to grow their baskets / crops / rings.). These passages are between 250-300 words in length and have Flesch-Kinkaid Grade Level estimates of grades 6 and 7. Students in this block will read approximately 3 paragraphs in this way. This task is timed such that students are given 3 minutes to complete a passage and its corresponding items, making it a measure of efficiency as well as basic comprehension.</p> <p>Reading Comprehension Students answer questions about the passage they read while doing the MAZE task. The passage presented in the MAZE task will be presented again with the correct completions for the items presented in the MAZE task. The passage will appear on the same screen as the questions. Easier questions will be selected for this skill-based block.</p>

Student Survey

Approximate length Goal for Main Study	25 minutes (part of a 45 min or 90 min session including math, reading, and a student survey)
Mode of administration	<p>In school computerized administration using Chromebooks, tablet-like computers with touchscreen capability and an attached keyboard, that will be brought into the school by the study.</p> <p>Out of school computerized administration using students' personal computers with or without touchscreen capability.</p>
Key constructs	<p>Student Background</p> <ul style="list-style-type: none"> • Demographics (i.e., sex, race/ethnicity, date of birth) • Language characteristics (e.g., first language, how often speaks non-English language at home and with friends, preferred language, English fluency) <p>School Experiences</p> <ul style="list-style-type: none"> • School and grade level attended last year • Ever repeated a grade • Math coursework (i.e., 8th-grade and current math course(s), most advanced math course expects to take) • Confidence in math abilities • Participation in ELL program • Preparedness for class • School climate (e.g., safety, supportive teachers/staff, sense of belonging, and bullying) • School activities • Frequency of and difficulty with internet usage for homework <p>Family</p> <ul style="list-style-type: none"> • Family structure (e.g., number/types of parents or guardians) • Parent(s)/guardian(s) employment status and educational attainment • Relationship between parent/guardian and student (e.g., autonomy, monitoring, school-related discussions) <p>Guidance and Future Plans</p> <ul style="list-style-type: none"> • Academic guidance received (e.g., academic courses, going to college) • Educational attainment expectations and confidence • College affordability and financial literacy <p>Attitudes, Behavior, and Wellness</p> <ul style="list-style-type: none"> • Growth mindset (e.g., general and math-specific) • Sleep (e.g., time student wakes up and goes to sleep, sleep issues) and exercise patterns • Hearing (e.g., use of hearing device, hearing issues, noise exposure) • Vision (e.g., use of glasses or contact lenses, vision issues) • Recreational technology usage • Conscientious behavior, persistence, and optimism • Racial/ethnic inclusion • Peers (e.g., social support, school-related values) • Participation in activities outside of school including employment <p>Locating Information for Future Follow-Up</p>

Parent Survey

Approximate length	25 minutes
Mode of administration	Web-based administration accessible by individualized link, with a telephone-based interview option available.
Key constructs	<p>School Experiences</p> <ul style="list-style-type: none"> • School assigned or chosen, number of times changed schools • Grades student repeated or skipped • Ever participated in gifted and talented program • Special education services (e.g., 504 plan and IEP/ISP) • Participation in ELL program • Suspension or expulsion (e.g., number of times and length, type, reason) • Ever dropped out • Availability of place to do homework, digital devices and internet at home <p>Family</p> <ul style="list-style-type: none"> • Family composition (e.g., number/types of parents or guardians and marital status, number of people in household, and number of siblings) • Student's amount of time spent living with parent/guardian • Student's contact with nonresident parent • Siblings' educational experience (e.g., number in high school, graduated from high school, and continued education after high school) <p>Background Information</p> <ul style="list-style-type: none"> • Student's demographics (i.e., sex, race/ethnicity, date of birth) • Parent/guardian demographics (i.e., race/ethnicity, birth year) • Language characteristics (e.g., language(s) spoken at home, parent's language as a barrier to school involvement) <p>Guidance and Future Plans</p> <ul style="list-style-type: none"> • Educational guidance received (e.g., influence on course selection, participation by nonresident parent, parents'/guardians' educational and occupational advice, talk with counselor or teacher about postsecondary admission) • Educational expectations (e.g., desired and expected) • Family's plans for financing postsecondary education and savings <p>Parental Education, Employment and Socioeconomic Status</p> <ul style="list-style-type: none"> • Parental educational attainment • Parental employment status and job characteristics (e.g., number of jobs, hours worked, job stability, and occupation) • Parental active duty status • Economic status (e.g., household income, number of dependents, home ownership, student receives free or reduced-price lunch) <p>Home Life and Wellness</p> <ul style="list-style-type: none"> • Residential stability (e.g., time at current residence and number of residences) • Relationship between parent and student (e.g., frequency eating meals together, number of student's friends known, and communication with parents of student's friends, regulation of technology use) • Student's activities outside of school, tutoring and summer school • Student's wellness (e.g., last dental and health care visit, overall health, number of sick days, experience of asthma, ADD/ADHD medication, evaluation/formal diagnosis, hearing issues, use of hearing device, noise exposure) <p>Locating Information for Future Follow-up</p>

Mathematics Teacher Survey

Approximate length	15 minutes for teacher background and classroom characteristics; 3 minutes per student report
Mode of administration	Web-based administration accessible by individualized link.
Key constructs	<p>Teacher background and classroom characteristics</p> <p>Classroom Characteristics</p> <ul style="list-style-type: none">• Math course subject• Class size (number of students)• Class rigor• Classroom behavior• Achievement level of class <p>Classroom Mathematics Instruction</p> <ul style="list-style-type: none">• Taught course before or first time• Source of course curriculum used (e.g., local, state, national)• Mathematics teaching objectives• Sources of teaching materials (e.g., textbook, open educational resources) <p>Teacher Experience and Background</p> <ul style="list-style-type: none">• Highest degree and major field(s) of study• Type of certification• Years and grades of math and other teaching experience• Employment status in school (e.g., full-time, part-time, long-term substitute)• Professional development in math• Demographic information (i.e., sex, race/ethnicity, year born) <p>School Climate and Teaching Practices</p> <ul style="list-style-type: none">• School climate• Teaching climate• Growth mindset• Availability and use of classroom technology <p>Teacher provided information on individual students</p> <p>Mathematical Thinking</p> <ul style="list-style-type: none">• Appropriate level for student• Demonstrated mathematics abilities <p>Observations/Impressions</p> <ul style="list-style-type: none">• Positive behavior• Attendance/tardiness• Preparedness• Future expectations for college attendance <p>Student Characteristics</p> <ul style="list-style-type: none">• Taught student since beginning of school year• IEP/ISP status

School Counselor Survey

Approximate length	25 minutes
Mode of administration	Web-based administration accessible by individualized link.
Key constructs	<p>School and Counseling Program Characteristics</p> <ul style="list-style-type: none">• Enrollment practices• Number of counselors by full-time and part-time status• Number of counselors certified• Caseload by full-time and part-time status• Practices for assigning students to counselors• Counseling program priorities• Counseling services offered to students• Assisting students with transitions from middle grades to high school <p>School Courses and Academic Programs</p> <ul style="list-style-type: none">• Course placement practices• Course offerings (e.g., Advanced Placement, International Baccalaureate, dual enrollment, CTE)• Instructional modalities (e.g., distance learning, online, blended learning, work-based)• TRiO program offerings <p>Counseling and Support Services</p> <ul style="list-style-type: none">• School extended learning opportunities• Academic assistance, enrichment, and remediation opportunities• Credit recovery program• Supports for disadvantaged students• General Education Development (GED) offerings• Use of early warning systems <p>School Graduation Requirements and Transitions after High School</p> <ul style="list-style-type: none">• Graduation requirements (e.g., credits required by subject, proficiency test, math coursetaking requirements)• Career and education plan requirements• Assistance with graduation, postsecondary, and workforce preparation• School's network with employers• Tracking of students' pathways after high school

School Administrator Survey

Approximate length	35 minutes
Goal for Main Study	
Mode of administration	Web-based administration accessible by individualized link.
Key constructs	<p>School Characteristics</p> <ul style="list-style-type: none"> • School characteristics (e.g., public/private, grades served, special type/focus, enrollment, average daily attendance) • School calendar, start time, and number of hours of instruction • Availability of technology for use during lessons • Admission criteria, acceptance rate, tuition, and financial assistance • Student population (e.g., racial/ethnic composition, percent free- and reduced-price lunch, percent ELL, special education, repeating 9th grade) • Student attrition, transfers to alternative program or school • Pathways of students after high school <p>Teaching Staff</p> <ul style="list-style-type: none"> • Number of teachers by full-time and part-time status • Teaching faculty's racial/ethnic composition • Teachers' certification status (e.g., number certified, type of certification, certified in subject teaches) • Number of new teachers • Teacher absenteeism and attrition • Teaching staff salary information • Math teaching staff preparedness <p>School Programs and Coursework</p> <ul style="list-style-type: none"> • Advanced Placement (AP) offering and enrollment • Vocational/technical/business program offering and enrollment • Competency-based advancement • Common academic curriculum • Cooperative learning • Assistance for parents • Extracurricular activities • Special education offerings (e.g., IEP/ISP) • English Language Learner (ELL) offerings <p>Discipline and Safety</p> <ul style="list-style-type: none"> • Safety and school-level security practices (e.g., visitor sign-ins, metal detector checks) • Types of disciplinary actions and emphasis on discipline • Parental engagement in disciplinary actions <p>School Administrator Background</p> <ul style="list-style-type: none"> • Highest degree and major field of study • Certification • Years of school administrator experience overall and at current school • Years, grades, and main subject of teaching experience • Factors affecting school administrator's evaluation • Demographic information (e.g., sex, race/ethnicity) <p>School Climate</p> <ul style="list-style-type: none"> • Student and teaching staff attitudes (e.g., morale, school press, attitudes towards learning) • Problems at school (e.g., student misconduct) <p>School relationships with stakeholders</p>

Appendix A10. Student Rostering Materials (previously approved)

Request for Student Roster Information from Schools

<<date>>

«listprovidername»
«schoolname»
«schooladdress»
«schoolcitystzip»

Study ID: «username»
Password: «passwd»
HS&B:22 website:
<https://surveys.nces.ed.gov/HSB21/>

Dear «listprovidername»:

We are looking forward to working with your students on the High School and Beyond Longitudinal Study of 2022 (HS&B:22). Your school's participation is important to the success of the study and we appreciate it! To select the student sample, we are asking you to provide information about each student enrolled in your school in grade 9. About 35 students, on average will be selected. If your school is small, we may invite all of your students in grades 9 to participate.

Please go to the HS&B:22 website (URL provided above) to provide your roster once your enrollment is stable for the 2022-2023 school year. Instructions are included with this letter. You will receive \$50 after student, parent, and teacher data are provided. We appreciate your timely response to this request.

This information request conforms to the requirements of the Family Educational Rights and Privacy Act of 1974 (FERPA) (20 U.S.C. §1232g; 34 CFR Part 99). For the purposes of this collection of data, FERPA permits education agencies and institutions to disclose personally identifiable information from students' education records, without consent, to authorized representatives of the Secretary of Education in connection with an evaluation of federally supported education programs (34 CFR §§ 99.31(a)(3)(iii) and 99.35). Student data are subject to strict protections that are adhered to by NCES and its contractor organizations. Roster information will be securely destroyed when no longer needed for the purposes specified in 34 CFR §99.35.

If you have any questions, please contact us toll-free: 855-500-1439 or via email HSB22@rti.org

Sincerely,



Dan Pratt, Project Director

NCES is authorized to conduct the High School and Beyond Longitudinal Study of 2022 (HS&B:22) by the Education Sciences Reform Act of 2002 (ESRA 2002, 20 U.S.C. §9543). The data are being collected for NCES by RTI International, a U.S.-based nonprofit research organization. All of the information you provide may be used only for statistical purposes and may not be disclosed, or used, in identifiable form for any other purpose except as required by law (20 U.S.C. §9573 and 6 U.S.C. §151).

Below are instructions for preparing and uploading **your 9th grade student roster**.

Website Upload Instructions

1. Go to <https://surveys.nces.ed.gov/hsb22>
2. Enter the study ID and password provided in the cover letter.
3. If this is your first time entering your login credentials, you will be prompted to change your password to something that you can remember.
4. Click "Provide Your Student Roster."
5. Fill out the required contact information.
6. Prepare your document containing the requested information. You have two options for preparing a data file:
 - a. Click on the link provided (Download Student Roster Template) to download an Excel spreadsheet or;
 - b. Upload a pre-prepared file from your data system.
7. If you use our excel file template, once you have filled in the requested data fields, please save this file to your desktop, or some other location on your computer.
8. If you have a file already prepared, please save your file to your desktop, or some other location on your computer.
9. Go back to the HS&B:22 website (<https://surveys.nces.ed.gov/hsb22>) and click the "Upload" button.
10. Click the "Browse" button and navigate to the completed data file stored on your computer and select that file.
11. Click the "Upload" button. You will receive a message alerting you to the status of your upload.

Data Elements Requested

You may submit ALL information for the entire 9th grade population or, only the 9th grade student data elements can be submitted initially. Once the sample is drawn, if you prefer, you can submit the parent and teacher information and IEP/504 status for only those sampled students._

The data elements needed for student sampling include:

- Student Name (First, Middle, Last) and/or,
- District/School Student Identification Number
- Date of Birth mm/dd/year
- Grade Level = 9th
- Sex
- Race/Ethnicity
- ELL Status (yes or no)

If not provided on initial roster, once we notify you of the list of sampled students, please return to the website to provide the following for those students:

- **STUDENT IEP/504 STATUS- YES OR NO** Once the students have been selected, we will ask for an indicator if students have an IEP/504 plan (yes/no). This will ensure the data collection staff can provide any accommodations needed during the student session.
- **Parent Contact Information for Sampled Students**
 - Parent Name (last, first)
 - Parent Street address, City, State, Zip
 - Home phone number
 - Cell phone number
 - E-mail address
- **Math Teacher Information- FOR SAMPLED 9TH GRADE STUDENTS** *If no math class taken by 9TH grade student during fall 2022 semester, please indicate by NA (not applicable) in Math Course Name Column. PLEASE DO NOT LEAVE BLANK.*
- 9th grade Student's Math Teacher Name (last, first) *** (if math class taken during fall semester)*
- 9th grade Student's Math Teacher Email Address

- 9th grade Student's Math Course Name
- 9th grade Student's Math Course Period/Section

Instructions: Please provide the information below for each student currently enrolled in the ninth <and twelfth> grade<s> at your school. This information will be used to select an average of 35 ninth grade <and 35 twelfth grade> students from your school for the study.

General Student information						Race (Y/N all that apply)				Ethnicity (Y/N)	ELL	IEP/504 (Yes or No) sampled students only	Parent Contact information						Student's 9 th grd. Math Teacher/Class information **if math class taken Fall 2022										
StudentID	FirstName	LastName	Suffix	Grade 9	Date of birth MM/DD/YY	Sex(M/F)	White	Black or African American	Asian	Native Hawaiian or Pacific	American Indian or Alaska Native	Hispanic	Yes/No	Yes/No	Parent's First Name	Parent's Last Name	Parent's Address	Parent City	Parent State	Parent Zip	Parent's Email	Parent's Home Phone	Parent's Cell Phone	MathTeacherFirstName	MathTeacherLastName	MathTeacherEmail	Math Course Name	Math Course Period/Section	

NCES is authorized to conduct the High School and Beyond Longitudinal Study of 2022 (HS&B:22) by the Education Sciences Reform Act of 2002 (ESRA 2002, 20 U.S.C. §9543) and to collect students' education records from education agencies or institutions for the purposes of evaluating federally supported education programs under the Family Educational Rights and Privacy Act (FERPA, 34 CFR §§ 99.31(a)(3)(iii) and 99.35). The data are being collected for NCES by RTI International, a U.S.-based nonprofit research organization. All of the information students, parents, and staff provide may be used only for statistical purposes and may not be disclosed, or used, in identifiable form for any other purpose except as required by law (20 U.S.C. §9573 and 6 U.S.C. §151). The collected information will be combined across respondents to produce statistical reports.

According to the Paperwork Reduction Act of 1995, no persons are required to respond to a collection of information unless it displays a valid OMB control number. The valid OMB control number for this voluntary information collection is 1850-0944. Approval expires 10/31/2023. The time required to complete this information collection is estimated to average approximately 5 minutes per row, including the time to review instructions, gather the data needed, and complete and review the information collection. If you have any comments concerning the accuracy of the time estimate, suggestions for improving this information collection, or any comments or concerns regarding the status of your individual submission, please write directly to: The High School and Beyond Longitudinal Study of 2022 (HS&B:22), National Center for Education Statistics, PCP, 550 12th St., SW, 4th floor, Washington, DC 20222.

Appendix A11. Parent Data Collection Letter (previously approved)

Dear Parent or Guardian,

We are thrilled that your child's school is participating in the **High School and Beyond** Longitudinal Study of 2022 (HS&B:22). Here at the National Center for Education Statistics (NCES) in the U.S. Department of Education, we are reaching out to schools, students, parents, school counselors, math teachers, and school administrators to understand the high school experience. The information that is provided will contribute to improving education for students now and in the future.

We would greatly appreciate it if the person most knowledgeable about <student_firstname>'s school and home life would complete a <##>-minute online survey for the study. We have enclosed \$5 to thank you in advance for your participation. As a token of our appreciation for being a part of the study, when you finish the survey either online or over the phone, you will receive <incentive>. You may have already received a letter inviting your child to participate in HS&B:22, or that letter will be coming to you in the next few weeks.

American students are outperforming one group: their grandparents. In fact, Millennials are on track to be the most educated generation in history compared with older generations when they were the same age. <http://www.pewresearch.org/fact-tank/2015/08/10/5-facts-about-americas-students/>

To access the parent survey, please log into:
surveys.nces.ed.gov/hsb22
Study ID: xxxxxxxx
Password: xxxxxxxx.

Your participation will directly benefit your child's school. Teachers will earn incentives and continuing education credits during this research, and we need everyone to do their part. Please log in today and complete your survey!

To learn more, watch a short video at the study website at <https://surveys.nces.ed.gov/hsb22/>. If you have questions, please call us at (855) 500-1439 or send email to HSB22Survey@rti.org. Thank you for supporting education by participating in this important study!

Sincerely,

James L. Woodworth
NCES Commissioner

Enclosures: Study Information Sheet, Brochure and Flyer

The study is conducted by the National Center for Education Statistics (NCES), part of the U.S. Department of Education. All of the information collected is protected, as required by law. NCES is authorized to conduct HS&B:22 by the Education Sciences Reform Act of 2002 (ESRA 2002, 20 U.S.C. §9543) and to collect students' education records from education agencies or institutions for the purposes of evaluating federally supported education programs under the Family Educational Rights and Privacy Act (FERPA, 34 CFR §§ 99.31(a)(3)(iii) and 99.35). The data are being collected for NCES by RTI International, a U.S.-based nonprofit research organization. All of the information you and your child provide may be used only for statistical purposes and may not be disclosed, or used, in identifiable form for any other purpose except as required by law (20 U.S.C. §9573 and 6 U.S.C. §151). The collected information will be combined across respondents to produce statistical reports. Completing the survey is voluntary for you and your child and there are no penalties for not participating. You may also skip any question you do not want to answer if you choose to participate.

Appendix A11.1 Parent Data Collection Letter Reminder (previously approved)

Dear <Parent or Guardian>,

We recently sent you information about the **High School and Beyond** Longitudinal study of 2022 (HS&B:22). It is not too late to participate in this exciting study that schools, students, parents, school counselors, math teachers, and school administrators are participating in nationwide. Your contributions will help improve education for students now and in the future.

Participating is easy and should only take about <###> minutes. Your participation will directly benefit your child's school. As a token of our appreciation, you will receive <incentive> when you finish the survey. You may have already received a letter inviting your child to participate in HS&B:22, or that letter will be coming to you in the next few weeks.

American students are outperforming one group: their grandparents. In fact, Millennials are on track to be the most educated generation in history compared with older generations when they were the same age.
<http://www.pewresearch.org/fact-tank/2015/08/10/5-facts-about-americas-students/>

To access the parent survey, please log into:
surveys.nces.ed.gov/hsb22
Study ID: xxxxxxxx
Password: xxxxxxxx.

To learn more, watch a short video at the study website at <https://surveys.nces.ed.gov/hsb22/>. If you have questions, please call us at (855) 500-1439 or send email to HSB22Survey@rti.org. Thank you for supporting education by participating in this important study.

Sincerely,

James L. Woodworth
NCES Commissioner

Enclosures: Study Information Sheet, Brochure and Flyer

The study is conducted by the National Center for Education Statistics (NCES), part of the U.S. Department of Education. All of the information collected is protected, as required by law. NCES is authorized to conduct HS&B:22 by the Education Sciences Reform Act of 2002 (ESRA 2002, 20 U.S.C. §9543) and to collect students' education records from education agencies or institutions for the purposes of evaluating federally supported education programs under the Family Educational Rights and Privacy Act (FERPA, 34 CFR §§ 99.31(a)(3)(iii) and 99.35). The data are being collected for NCES by RTI International, a U.S.-based nonprofit research organization. All of the information you and your child provide may be used only for statistical purposes and may not be disclosed, or used, in identifiable form for any other purpose except as required by law (20 U.S.C. §9573 and 6 U.S.C. §151). The collected information will be combined across respondents to produce statistical reports. Completing the survey is voluntary for you and your child and there are no penalties for not participating. You may also skip any question you do not want to answer if you choose to participate.

Appendix A11.1a Parent Data Collection Reminder Postcard (previously approved)

<FirstName>,

The **High School and Beyond** Longitudinal Study of 2022 (HS&B:22) is happening now! Nationwide, schools, students, parents, school counselors, math teachers, and school administrators are participating in this study!

The information you provide will help improve education for students now and in the future.

It only takes <xx> minutes, and we'll send you <incentive>.

Go to <https://surveys.nces.ed.gov/hsb21>

Study ID: <xxxxxxxx>

Password: <xxxxxxxx>

Or call the HS&B:22 Help Desk at (855) 500-1439 or send email to HSB22Survey@rti.org.

Thank you for supporting education by participating in this important study.

The High School and Beyond Longitudinal Study of 2022 (HS&B:22) is being conducted by the National Center for Education Statistics (NCES) with the U.S. Department of Education. RTI International is carrying out the HS&B:22 data collection on behalf of NCES.

Appendix A11.1b Parent Data Collection Abbreviated Survey Postcard (previously approved)

Why participate in HS&B:22?

We need YOUR input so the study can represent the experiences of all high school students across the U.S.

<FNAME>, your participation will now take only <xx> minutes of your time.

Complete online: <https://surveys.nces.ed.gov/hsb21>

Study ID: <xxxxxxxx>
Password: <xxxxxxxx>

Complete by phone: (855) 500-1439

Complete the HS&B:22 survey today and **receive \$<incentive>** as our thanks to you.

The High School and Beyond Longitudinal Study of 2022 (HS&B:22) is being conducted by the National Center for Education Statistics (NCES) with the U.S. Department of Education. RTI International is carrying out the HS&B:22 data collection on behalf of NCES.

Dear <Parent or Guardian>,

We are thrilled that your child's school is participating in the **High School and Beyond** Longitudinal Study of 2022 (HS&B:22), and we are hoping that the person most knowledgeable about <student_firstname>'s school and home life would complete a <##>-minute online survey for the study.

Your participation will directly benefit your child's school. Teachers will earn incentives and continuing education credits during this research, and we need everyone to do their part. Please log in today and complete your survey!

As a token of our appreciation for being a part of the study, when you finish the survey either online or over the phone, you will receive <incentive>. You may have already received a letter inviting your child to participate in HS&B:22, or that letter will be coming to you in the next few weeks. To access the parent survey, please use the login information below:

Study website: <https://surveys.nces.ed.gov/hsb22>

Study ID: <xxxxxxxx>

Password: <xxxxxxxx>

NCES has been conducting studies like this since 1970. This is your opportunity to contribute information that may lead to change.

For more information please watch this brief video about the study at <https://surveys.nces.ed.gov/hsb22>. You may also call the study hotline at (855) 500-1439 or send email to HSB22Survey@rti.org. Thank you for supporting education by participating in this important study.

Sincerely,

James L. Woodworth
NCES Commissioner

Appendix A11.3a Parent Data Collection Email Reminder (previously approved)

Dear Parent or Guardian,

Did you know that it's not too late to participate in the **High School and Beyond** Longitudinal Study of 2022 (HS&B:22) a study that schools, students, parents, school counselors, math teachers, and school administrators are participating in around the nation? The information you provide will help improve education for students now and in the future.

Please complete the <##>-minute online survey for the study. As a token of our appreciation for being a part of the study, when you finish the survey either online or over the phone, you will receive <incentive>. To access the parent survey, please use the login information below:

Study website: surveys.nces.ed.gov/hsb21

Study ID: <xxxxxxxx>

Password: <xxxxxxxx>

NCES has been conducting studies like this since 1970. This is your opportunity to contribute information that may lead to change.

For more information, please watch this brief video about the study at <https://surveys.nces.ed.gov/hsb22>. You may also call the study hotline at (855) 500-1439 or send email to HSB22Survey@rti.org. Thank you for supporting education by participating in this important study.

Sincerely,

James L. Woodworth
NCES Commissioner

Appendix A11.3b Parent Data Collection Email Reminder (previously approved)

Dear <<fname>>,

My name is Elise Christopher and I am the Project Officer for the High School and Beyond Longitudinal Study of 2022 (HS&B:22), from the National Center for Education Statistics (NCES). I hope that you will take a bit of time out of your busy schedule to complete the HS&B:22 survey today. This survey is part of a nationwide study of students' education and life experiences as they move through high school and transition into postsecondary education and/or the workforce. Your views and those of your child are important to this study. Decisions about what high school courses to take, whether to pursue further education after high school, and which future career paths to follow are important for policymakers and researchers to understand.

On average, the survey takes only about <##> minutes and you will receive <<inc_amount>> as a token of appreciation for filling it out.

To complete the survey online, go to our secure website:

<https://surveys.nces.ed.gov/hsb22>

Study ID: <<StudyID>>

Password: <<password>>

If you have questions or prefer to complete the survey over the phone, please call us at 855-500-1439. You may also contact HSB22Survey@rti.org. Our data collection contractor, RTI International, is available to assist you with any questions you may have.

Thank you for helping to make HS&B:22 a success.

Elise Christopher, PhD
HS&B:22 Project Officer
National Center for Education Statistics (NCES)
U.S. Department of Education
Elise.Christopher@ed.gov

Appendix A11.4a Parent Data Collection Reinterview Email – Web (previously approved)

Dear «fname»:

You may recall recently completing the High School and Beyond Longitudinal Study of 2022 (HS&B:22) web survey. Thank you for your participation!

At the end of your survey, you were randomly selected for and agreed to participate in a quality control web survey. This second survey will take only about 10 minutes to complete, and will determine how well our questions collected reliable information.

To complete the quality control survey, please log in to our secure website at <https://surveys.nces.ed.gov/hsb22/> using the Study ID and password provided below:

Study ID = «caseid»

Password = «password»

If you have any questions or need assistance, you can call us toll-free at 1-855-500-1439, or you can e-mail us at HSB22Survey@rti.org.

If you have already completed this quality control survey, please disregard this message.

Again, thank you for your time and willingness to participate.

Sincerely,

Dan Pratt
HS&B:22 Project Director
RTI International

Appendix A11.4b Parent Data Collection Reinterview Email – CATI (previously approved)

Dear «fname»:

You may recall recently completing the High School and Beyond Longitudinal Study of 2022 (HS&B:22) survey with a telephone interviewer. Thank you for your participation!

At the end of your survey, you were randomly selected for and agreed to participate in a quality control survey. This second survey will take only about 10 minutes to complete and will determine how well our questions collected reliable information.

Please call **1-855-500-1439**, provide our interviewer with the Study ID number listed below, and inform them that you are calling in reference to the quality control survey.

Study ID = «caseid»

If you have already received a telephone call and have completed this quality control survey, please disregard this message. Again, thank you for your time and willingness to participate.

Sincerely,

Dan Pratt
HS&B:22 Project Director
RTI International

Appendix A12a. Staff Data Collection Letters – Math Teacher Letter (previously approved)

<DATE>
<TEACHER NAME>
<SCHOOL NAME>
<ADDR1>
<ADDR2>
<CITY STATE ZIP>

Your login information:
Website: <insert URL>
Study ID: <ID>
Password: <Password>

Dear <TEACHER NAME>,

<SCHOOL NAME> is participating in the **High School and Beyond Longitudinal Study of 2022 (HS&B:22)**, conducted by the National Center for Education Statistics (NCES), part of the U.S. Department of Education's Institute of Education Sciences. You are receiving this invitation to participate because one or more of your 9th grade students has been selected. <As a token of our appreciation, you will receive [incentive] for answering questions about your background and selected students.> You will also receive a Certificate of Service from the U.S. Department of Education for your survey.

FACTS FROM NCES RESEARCH

Students who took **Algebra 1 before 9th grade** were more likely to **enroll in college** than their counterparts

Source: <https://nces.ed.gov/pubs2019/2019154.pdf>

HS&B:22 focuses on factors that lead to positive outcomes for high school students. This is data that educators, policymakers, and researchers need to inform practices, knowledge funding, and to support student success. This is your opportunity to provide information about your experiences and opinions as a teacher, providing essential information about academic policies and curriculum in the classroom. The survey will include several general questions about your background and experiences at school and in the classroom (about 15 minutes), as well as questions about students in the study (about 3 minutes per student). Your

FACTS LEARNED FROM NCES LONGITUDINAL HIGH SCHOOL STUDIES

Students are **more likely** to have a **positive perception with the challenge of math classes** when teachers convey an **expectation of success**

Source: Kelly, S., & Zhang, Y. (2016). *Teacher Support and Engagement in Math and Science: Evidence from the High School Longitudinal Study*. *The High School Journal* 99(2), 141-165.

participation is voluntary and very important to the success of this study.

To access the online questionnaire, use the web address and unique study ID and password provided at the top of this letter.

Should you have any questions, please call (855) 500-1439 or email HSB22StaffSurvey@rti.org. You can also learn more about the study in the enclosed materials, or by watching a short video on our website <https://surveys.nces.ed.gov/hsb22>.

We thank you in advance for your cooperation in making this important research study a success.

Sincerely,

James L. Woodworth
NCES Commissioner

NCES is authorized to conduct the High School and Beyond Longitudinal Study of 2022 (HS&B:22) by the Education Sciences Reform Act of 2002 (ESRA 2002, 20 U.S.C. §9543) and to collect students' education records from education agencies or institutions for the purposes of evaluating federally supported education programs under the Family Educational Rights and Privacy Act (FERPA, 34 CFR §§ 99.31(a)(3)(iii) and 99.35). The data are being collected for NCES by RTI International, a U.S.-based nonprofit research organization. All of the information students, parents, and staff provide may be used only for statistical purposes and may not be disclosed, or used, in identifiable form for any other purpose except as required by law (20 U.S.C. §9573 and 6 U.S.C. §151). The collected information will be combined across respondents to produce statistical reports.

Enclosures: HS&B:22 Brochure, Study Snapshot

Appendix A12a.1 Staff Data Collection Letters – Math Teacher Reminder (previously approved)

<DATE>
<TEACHER NAME>
<SCHOOL NAME>
<ADDR1>
<ADDR2>
<CITY STATE ZIP>

Your login information:

Website: <insert URL>
Study ID: <ID>
Password: <Password>

Dear <TEACHER NAME>,

We are following up on survey information recently sent to you about the **U.S. Department of Education’s High School and Beyond Longitudinal Study of 2022** (HS&B:22), which <SCHOOL NAME> is participating in. You are invited to complete a survey because one or more of your students are in the study. <As a reminder, you will receive [incentive] for answering questions about your background and selected students. You will also receive a Certificate of Service from the U.S. Department of Education for your survey.> <As a reminder, you will receive a Certificate of Service from the U.S. Department of Education for your survey.>

**FACTS FROM
NCES RESEARCH**

Students who took **Algebra 1 before 9th grade** were more likely to **enroll in college** than their counterparts

Source: <https://nces.ed.gov/pubs2019/2019154.pdf>

This is your opportunity to provide information about your experiences and opinions as a teacher, providing essential information about academic policies and curriculum in the classroom. The survey will include general questions about your background and experiences at school and in the classroom (about 15 minutes), and questions about students who are part of the study (about 3 minutes per student). Your participation is voluntary and very important to the success of this study.

**FACTS LEARNED FROM
NCES LONGITUDINAL
HIGH SCHOOL STUDIES**

Students are **more likely** to have a **positive perception with the challenge of math classes** when teachers convey an **expectation of success**

Source: Kelly, S., & Zhang, Y. (2016). *Teacher Support and Engagement in Math and Science: Evidence from the High School Longitudinal Study*. *The High School Journal* 99(2), 141-165.

To access the online questionnaire, use the web address and unique study ID and password provided at the top of this letter.

Should you have any questions, please call (855) 500-1439 or email HSB22StaffSurvey@rti.org. You can also learn more about the study in the enclosed materials.

We thank you in advance for your cooperation in making this important research study a success.

Sincerely,

James L. Woodworth
NCES Commissioner

NCES is authorized to conduct the High School and Beyond Longitudinal Study of 2022 (HS&B:22) by the Education Sciences Reform Act of 2002 (ESRA 2002, 20 U.S.C. §9543) and to collect students' education records from education agencies or institutions for the purposes of evaluating federally supported education programs under the Family Educational Rights and Privacy Act (FERPA, 34 CFR §§ 99.31(a)(3)(iii) and 99.35). The data are being collected for NCES by RTI International, a U.S.-based nonprofit research organization. All of the information students, parents, and staff provide may be used only for statistical purposes and may not be disclosed, or used, in identifiable form for any other purpose except as required by law (20 U.S.C. §9573 and 6 U.S.C. §151). The collected information will be combined across respondents to produce statistical reports.

Enclosures: HS&B:22 Brochure, Study Snapshot

Appendix A12a.2 Staff Data Collection Letters – Math Teacher Email (previously approved)

SUBJECT LINE: Share your voice! Inform education practices nationwide



U.S. DEPARTMENT OF EDUCATION
INSTITUTE OF EDUCATION SCIENCES

NATIONAL CENTER FOR EDUCATION STATISTICS



Dear <TEACHER NAME>,

This email is to follow up on an invitation you should have received from the U.S. Department of Education about <SCHOOL NAME>'s participation in the [High School and Beyond Longitudinal Study of 2022 \(HS&B:22\)](#). **You are receiving this invitation because one or more of your students are in the study.** This is an opportunity for your voice and the voices of your students to be heard by providing information about your experiences and opinions as a teacher. The survey will include general questions about your background and experiences teaching (about 15 minutes), as well as questions about students who are part of the study (about 3 minutes per student). Your participation is voluntary and very important to the success of this study.

As a token of our appreciation, you will receive a Certificate of Service from the U.S. Department of Education for your time. <You will also receive [**incentive**] for answering the questions about your background and selected students.> To access the online questionnaire, please use the web address and unique study ID and password provided below.

Website: surveys.nces.ed.gov/hsb22

Study ID: <ID>

Password: <Password>

Should you have any questions, please call (855) 500-1439 or email HSB22StaffSurvey@rti.org. You can also get more information by watching a short video on our website <https://surveys.nces.ed.gov/hsb22>.

We thank you in advance for your cooperation in making this important research study a success.

Sincerely,

James L. Woodworth
NCES Commissioner

HS&B:22 is conducted by the National Center for Education Statistics (NCES) in the U.S. Department of Education's Institute for Education Sciences. NCES is authorized to conduct the High School and Beyond Longitudinal Study of 2022 (HS&B:22) by the Education Sciences Reform Act of 2002 (ESRA 2002, 20 U.S.C. §9543) and to collect students' education records from education agencies or institutions for the purposes of evaluating federally supported education programs under the Family Educational Rights and Privacy Act (FERPA, 34 CFR §§ 99.31(a)(3)(iii) and 99.35). The data are being collected for NCES by RTI International, a U.S.-based nonprofit research organization. All of the information students, parents, and staff provide may be used only for statistical purposes and may not be disclosed, or used, in identifiable form for any other purpose except as required by law (20 U.S.C. §9573 and 6 U.S.C. §151). The collected information will be combined across respondents to produce statistical reports.

Study Conducted by:  Institute of
Education Sciences by: Data Collected



Appendix A12a.3 Staff Data Collection Letters – Math Teacher Email Reminder (previously approved)

SUBJECT LINE: SHARE your voice! It is not too late!



U.S. DEPARTMENT OF EDUCATION
INSTITUTE OF EDUCATION SCIENCES

NATIONAL CENTER FOR EDUCATION STATISTICS



Dear <TEACHER NAME>,

It is not too late to participate in the [High School and Beyond Longitudinal Study of 2022 \(HS&B:22\)](#). **This is an opportunity to support your student's and <SCHOOL>'s participation and for your voice to be heard by providing information about your experiences and opinions as a teacher.** The survey will include general questions about your background and experiences teaching (about 15 minutes), as well as questions about students who are part of the study (about 3 minutes per student). Your participation is voluntary and very important to the success of this study.

As a token of our appreciation, you will receive a Certificate of Service from the U.S. Department of Education for your time. <You will also receive **[incentive]** for answering the questions about your background and selected students.> To access the online questionnaire, please use the web address and unique study ID and password provided below.

Website: surveys.nces.ed.gov/hsb22

Study ID: <ID>

Password: <Password>

Should you have any questions, please call (855) 500-1439 or email HSB22StaffSurvey@rti.org. You can also get more information by watching a short video on our website <https://surveys.nces.ed.gov/hsb22>.

We thank you in advance for your cooperation in making this important research study a success.

Sincerely,

James L. Woodworth
NCES Commissioner

HS&B:22 is conducted by the National Center for Education Statistics (NCES) in the U.S. Department of Education's Institute for Education Sciences. NCES is authorized to conduct the High School and Beyond Longitudinal Study of 2022 (HS&B:22) by the Education Sciences Reform Act of 2002 (ESRA 2002, 20 U.S.C. §9543) and to collect students' education records from education agencies or institutions for the purposes of evaluating federally supported education programs under the Family Educational Rights and Privacy Act (FERPA, 34 CFR §§ 99.31(a)(3)(iii) and 99.35). The data are being collected for NCES by RTI International, a U.S.-based nonprofit research organization. All of the information students, parents, and staff provide may be used only for statistical purposes and may not be disclosed, or used, in identifiable form for any other purpose except as required by law (20 U.S.C. §9573 and 6 U.S.C. §151). The collected information will be combined across respondents to produce statistical reports.

Appendix A12b. Staff Data Collection Letters – Guidance Counselor (previously approved)

<DATE>
<COUNSELOR NAME>
<SCHOOL NAME>
<ADDR1>
<ADDR2>
<CITY STATE ZIP>

Your web browser information URL:
Study ID: <ID>
Website Username/Password:
Study ID: <ID>
Password: <Password>

Dear <COUNSELOR NAME>,

<SCHOOL NAME> is participating in the **High School and Beyond Longitudinal Study of 2022 (HS&B:22)**, conducted by the National Center for Education Statistics (NCES), part of the U.S. Department of Education’s Institute of Education Sciences. To gain a wholistic view of the high school education experience, we are asking you to complete an online school counselor questionnaire on behalf of your school. Your participation will provide essential information about student services, activities and programs in the school, and other school related experiences that impact student learning.



Source: <https://toandthrough.uchicago.edu/mythbusters>

This is an opportunity for your voice to be heard by providing information about your

experiences and opinions as a counselor. Your participation is voluntary and very important to the success of this study and you will receive a Certificate of Service from the U.S. Department of Education **<and [incentive]>** for your time.

To access the questionnaire online, please use the web address and unique study ID and Password provided at the top of this letter. **It should take no longer than 25 minutes to complete.** We recommend gathering the following information in advance of completing the survey:

- Student services and programs offered at school
- Participation rates in programs and services
- Graduation requirements
- Student population (e.g., percent IEP, percent ELL/LEP)

Should you have any questions, please call (855) 500-1439 or email to HSB22StaffSurvey@rti.org. You can also learn more about the study and education research focused on students in the enclosed materials, or by watching a short video on our website <https://surveys.nces.ed.gov/hsb22>.

We thank you in advance for your cooperation in making this important research study a success.

Sincerely,

James L. Woodworth
NCES Commissioner

NCES is authorized to conduct the High School and Beyond Longitudinal Study of 2022 (HS&B:22) by the Education Sciences Reform Act of 2002 (ESRA 2002, 20 U.S.C. §9543) and to collect students’ education records from education agencies or institutions for the purposes of evaluating federally supported education programs under the Family Educational Rights and Privacy Act (FERPA, 34 CFR §§ 99.31(a)(3)(iii) and 99.35). The data are being collected for NCES by RTI International, a U.S.-based nonprofit research organization. All of the information students,

parents, and staff provide may be used only for statistical purposes and may not be disclosed, or used, in identifiable form for any other purpose except as required by law (20 U.S.C. §9573 and 6 U.S.C. §151). The collected information will be combined across respondents to produce statistical reports.

Enclosures: HS&B:22 Brochure, Study Snapshot

Appendix A12b.1. Staff Data Collection Letters Reminder – Guidance Counselor (previously approved)

<DATE>
<COUNSELOR NAME>
<SCHOOL NAME>
<ADDR1>
<ADDR2>
<CITY STATE ZIP>

Web registration information:
Study ID: <ID>
Web ID: <ID>
Password: <Password>

Dear <COUNSELOR NAME>,

We are following up on information recently sent to you about the **U.S. Department of Education's High School and Beyond Longitudinal Study of 2022 (HS&B:22)**, which <SCHOOL NAME> is participating in. To gain a wholistic view of the high school education experience, we are asking you to complete an online school counselor questionnaire to provide essential information about student services, activities and programs in the school, and other school related experiences that impact student learning.

This is an opportunity to support not only your students, but students nation-wide by providing information about your experiences and opinions as a counselor. Your participation is voluntary and very important to the success of this study. You will receive a Certificate of Service from the U.S. Department of Education **<and [incentive]>** for your time.

STUDENT PERFORMANCE IN
9th grade predicts student graduation better
than race, gender, socioeconomic status, and
prior academic performance, combined!

Source: <https://toandthrough.uchicago.edu/mythbusters>

To access the questionnaire online, please use the web address and unique study ID and Password provided at the top of this letter. It should take no longer than 25 minutes to complete. We recommend gathering the following information in advance of completing the survey:

- Student services and programs offered at school
- Participation rates in programs and services
- Graduation requirements
- Student population (e.g. percent IEP, percent ELL/LEP).

Should you have any questions, please call (855) 500-1439 or email to HSB22StaffSurvey@rti.org. You can also learn more about the study and education research focused on students in the enclosed materials, or by watching a short video on our website <https://surveys.nces.ed.gov/hsb22>.

We thank you in advance for your cooperation in making this important research study a success.

Sincerely,

James L. Woodworth
NCES Commissioner

NCES is authorized to conduct the High School and Beyond Longitudinal Study of 2022 (HS&B:22) by the Education Sciences Reform Act of 2002 (ESRA 2002, 20 U.S.C. §9543) and to collect students' education records from education agencies or institutions for the purposes of evaluating federally supported education programs under the Family Educational Rights and Privacy Act (FERPA, 34 CFR §§ 99.31(a)(3)(iii) and 99.35). The data are being collected for NCES by RTI International, a U.S.-based nonprofit research organization. All of the information students, parents, and staff provide may be used only for statistical purposes and may not be disclosed, or used, in identifiable form for any other purpose except as required by law (20 U.S.C. §9573 and 6 U.S.C. §151). The collected information will be combined across respondents to produce statistical reports.

Enclosures: HS&B:22 Brochure, Study Snapshot

Appendix A12b.2. Staff Data Collection Email– Guidance Counselor (previously approved)

SUBJECT LINE: Share your voice! Inform education practices and student supports nationwide



U.S. DEPARTMENT OF EDUCATION
INSTITUTE OF EDUCATION SCIENCES

NATIONAL CENTER FOR EDUCATION STATISTICS



Dear <COUNSELOR NAME>,

This email is to follow up on an invitation you should have received from the U.S. Department of Education about <SCHOOL NAME>'s participation in the [High School and Beyond Longitudinal Study of 2022 \(HS&B:22\)](#). This is an opportunity for you to share your experiences and opinions as a school counselor at <SCHOOL>. **This information will be combined with data from counselors across the nation to inform high school policy and practice. You will receive a Certificate of Service from the U.S. Department of Education <and [incentive]> for your time.** Participation is voluntary and very important to the success of this study.

Please use the web address and unique study ID and password provided below to complete an online questionnaire. The survey should take no longer than 25 minutes. We recommend gathering the following information in advance of completing the survey:

- Student services programs offered at school
- Participation rates in programs and services offered
- Graduation requirements
- Student population (e.g., percent IEP, percent ELL/LEP)

Website: surveys.nces.ed.gov/hsb22

Study ID: <ID>

Password: <Password>

If you have questions, please call the HS&B:22 information number, (855) 500-1439 or send an email to HSB22StaffSurvey@rti.org. Learn more about the study and education research focused on students in high school by watching a short video on our website surveys.nces.ed.gov/hsb22.

We thank you in advance for your cooperation in making this important research study a success.

Sincerely,

James L. Woodworth
NCES Commissioner

HS&B:22 is conducted by the National Center for Education Statistics (NCES) in the U.S. Department of Education's Institute for Education Sciences. NCES is authorized to conduct the High School and Beyond Longitudinal Study of 2022 (HS&B:22) by the Education Sciences Reform Act of 2002 (ESRA 2002, 20 U.S.C. §9543) and to collect students' education records from education agencies or institutions for the purposes of evaluating federally supported education programs under the Family Educational Rights and Privacy Act (FERPA, 34 CFR §§ 99.31(a)(3) (iii) and 99.35). The data are being collected for NCES by RTI International, a U.S.-based nonprofit research organization. All of the information students, parents, and staff provide may be used only for statistical purposes and may not be disclosed, or used, in identifiable form for any other purpose except as required by law (20 U.S.C. §9573 and 6 U.S.C. §151). The collected information will be combined across respondents to produce statistical reports.

Appendix A12b.3. Staff Data Collection Email Reminder – Guidance Counselor (previously approved)

SUBJECT LINE: Share your voice! It is not too late!



U.S. DEPARTMENT OF EDUCATION
INSTITUTE OF EDUCATION SCIENCES

NATIONAL CENTER FOR EDUCATION STATISTICS



Dear <COUNSELOR NAME>,

It is not too late to participate in the [High School and Beyond Longitudinal Study of 2022 \(HS&B:22\)](#). **This is an opportunity to support <SCHOOL>'s participation and for your voice to be heard by providing information about your experiences as a school counselor.** You will receive a Certificate of Service from the U.S. Department of Education <and [incentive]> for your time. Participation is voluntary and very important to the success of this study.

Please use the web address and unique study ID and password provided below to complete an online questionnaire. The survey should take no longer than 25 minutes. We recommend gathering the following information in advance of completing the survey:

- Student services programs offered at school
- Participation rates in programs and services offered
- Graduation requirements
- Student population (e.g., percent IEP, percent ELL/LEP)

Website: surveys.nces.ed.gov/hsb22

Study ID: <ID>

Password: <Password>

If you have questions, please call the HS&B:22 information number, (855) 500-1439 or send an email to HSB22StaffSurvey@rti.org. Learn more about the study and education research focused on students in high school by watching a short video on our website surveys.nces.ed.gov/hsb22.

We thank you in advance for your cooperation in making this important research study a success.

Sincerely,

James L. Woodworth
NCES Commissioner

HS&B:22 is conducted by the National Center for Education Statistics (NCES) in the U.S. Department of Education's Institute for Education Sciences. NCES is authorized to conduct the High School and Beyond Longitudinal Study of 2022 (HS&B:22) by the Education Sciences Reform Act of 2002 (ESRA 2002, 20 U.S.C. §9543) and to collect students' education records from education agencies or institutions for the purposes of evaluating federally supported education programs under the Family Educational Rights and Privacy Act (FERPA, 34 CFR §§ 99.31(a)(3)(iii) and 99.35). The data are being collected for NCES by RTI International, a U.S.-based nonprofit research organization. All of the information students, parents, and staff provide may be used only for statistical purposes and may not be disclosed, or used, in identifiable form for any other purpose except as required by law (20 U.S.C. §9573 and 6 U.S.C. §151). The collected information will be combined across respondents to produce statistical reports.



U.S. DEPARTMENT OF EDUCATION
INSTITUTE OF EDUCATION SCIENCES

NATIONAL CENTER FOR EDUCATION STATISTICS

<DATE>
<ADMIN NAME>
<SCHOOL NAME>
<ADDR1>
<ADDR2>
<CITY STATE ZIP>

Your login information:
Website: <insert URL>
Study ID: <ID>
Password: <Password>

Dear <ADMIN NAME>,

Thank you for your school’s participation in the **High School and Beyond Longitudinal Study of 2022 (HS&B:22)**. To provide a wholistic view of the high school education experience, we are asking you to participate in an online administrator questionnaire about academic policies and programs, activities and curriculum in the school, and other school related experiences that impact student learning. **This is an opportunity for you to provide information about your experiences and opinions as a school administrator.** Your participation is voluntary and very important to the success of this study.

IN 2015 THE U.S. GRADUATION RATE WAS 83.2%. IF IT WERE 90%, THOSE ADDITIONAL GRADUATES WOULD EARN
\$3.1 BILLION MORE ANNUALLY
LEADING TO AN ANNUAL INCREASE OF \$5.7 BILLION IN GDP

Source: <http://impact.all4ed.org/>

You will receive a Certificate of Service from the U.S. Department of Education <and [incentive]> for your time. To access the questionnaire online, please use the web address and unique study ID and Password provided at the top of this letter. The survey should take no longer than 35 minutes to complete. We recommend gathering the following information in advance of completing the survey:

- Student body demographics
- Math curriculum information
- Student attendance and matriculation information
- School personnel counts
- State assessment scores
- Programs, services, and supports available for students with IEPs, and the percentage of students who use them

If there is someone at your school who you would like to respond on your behalf, please contact us at (855) 500-1439, or HSB22StaffSurvey@rti.org to provide your designee’s name and email address. Learn more about the study and education research focused on students in high school in the enclosed information or by watching a short video on our website <https://surveys.nces.ed.gov/hsb22>.

We thank you in advance for your cooperation in making this important research study a success.

Sincerely,

James L. Woodworth
NCES Commissioner

HS&B:22 is conducted by the National Center for Education Statistics (NCES) in the U.S. Department of Education’s Institute for Education Science. NCES is authorized to conduct the High School and Beyond Longitudinal Study of 2022 (HS&B:22) by the Education Sciences Reform Act of 2002 (ESRA 2002, 20 U.S.C. §9543) and to collect students’ education records from education agencies or institutions for the purposes of evaluating federally supported education programs under the Family Educational Rights and Privacy Act (FERPA, 34 CFR §§ 99.31(a)(3) (iii) and 99.35). The data are being collected for NCES by RTI International, a U.S.-based nonprofit research organization. All of the information students, parents, and staff provide may be

Appendix A12c.1. Staff Data Collection Letters Reminder– School Administrator (previously approved)



U.S. DEPARTMENT OF EDUCATION
INSTITUTE OF EDUCATION SCIENCES

NATIONAL CENTER FOR EDUCATION STATISTICS

<DATE>
<ADMIN NAME>
<SCHOOL NAME>
<ADDR1>
<ADDR2>
<CITY STATE ZIP>

Your login information:
Website: <insert URL>
Study ID: <ID>
Password: <Password>

Dear <ADMIN NAME>,

Thank you for <SCHOOL>'s participation in the **High School and Beyond Longitudinal Study of 2022 (HS&B:22)**. Please take time to participate in your online administrator questionnaire to provide essential information about academic policies and programs, activities and curriculum in the school, and other school related experiences that impact student learning. Your participation is voluntary and very important to the success of this study.

You will receive a Certificate of Service from the U.S. Department of Education <and [incentive]> for your time. To access the questionnaire online, **please use the web address and unique study ID and Password provided at the top of this letter.** The survey should take no longer than 35 minutes to complete.

IN 2015 THE U.S. GRADUATION RATE WAS 83.2%. IF IT WERE 90%, THOSE ADDITIONAL GRADUATES WOULD EARN \$3.1 BILLION MORE ANNUALLY LEADING TO AN ANNUAL INCREASE OF \$5.7 BILLION IN GDP

Source: <http://impact.all4ed.org/>

We recommend gathering the following information in advance of completing the survey:

- Student body demographics
- Math curriculum information
- Student attendance and matriculation information
- School personnel counts
- State assessment scores
- Programs, services, and supports available for students with IEPs, and the percentage of students who use them

If there is someone at your school who you would like to respond on your behalf, please contact us at (855) 500-1439, or HSB22StaffSurvey@rti.org to provide your designee's name and email address. Learn more about the study and education research focused on students in high school in the enclosed information or by watching a short video on our website <https://surveys.nces.ed.gov/hsb22>.

We thank you in advance for your cooperation in making this important research study a success.

Sincerely,

James L. Woodworth
NCES Commissioner

HS&B:22 is conducted by the National Center for Education Statistics (NCES) in the U.S. Department of Education's Institute for Education Science. NCES is authorized to conduct the High School and Beyond Longitudinal Study of 2022 (HS&B:22) by the Education Sciences Reform Act of 2002 (ESRA 2002, 20 U.S.C. §9543) and to collect students' education records from education agencies or institutions for the purposes of evaluating federally supported education programs under the Family Educational Rights and Privacy Act (FERPA, 34 CFR §§ 99.31(a)(3) (iii) and 99.35). The data are being collected for NCES by RTI International, a U.S.-based nonprofit research organization. All of the information students, parents, and staff provide may be used only for statistical purposes and may not be disclosed, or used, in identifiable form for any other purpose except as required by law (20 U.S.C. §9573 and 6 U.S.C. §151). The collected information will be combined across respondents to produce statistical reports.

Enclosures: HS&B:22 Brochure, Study Snapshot

Appendix A12c.2. Staff Data Collection Email – School Administrator (previously approved)

SUBJECT LINE: Share your voice! Inform education practices and student supports nationwide



U.S. DEPARTMENT OF EDUCATION
INSTITUTE OF EDUCATION SCIENCES

NATIONAL CENTER FOR EDUCATION STATISTICS



Website: surveys.nces.ed.gov/hsb22

Study ID: <ID>

Password: <Password>

Dear <ADMIN NAME>,

We are grateful for your schools participation in the [High School and Beyond Longitudinal Study of 2022 \(HS&B:22\)](#). Please complete your online administrator questionnaire to provide essential information about academic policies, programs, activities, and curriculum in the school. Your participation is voluntary and very important to the success of this study. You will receive a Certificate of Service from the U.S. Department of Education <and **[incentive]**> for your time.

To access the questionnaire online, please use the web address and unique study ID and password provided above. The survey should take no longer than 35 minutes and does not have to be completed at one sitting. We recommend gathering the following information in advance of completing the survey:

- Student attendance and matriculation information
- Student body demographics
- Math curriculum information
- School personnel counts
- State assessment scores
- Programs, services, and supports available for students with IEPs, and the percentage of students who use them

If there is someone at your school who you would like to respond on your behalf, please contact us at (855) 500-1439, or HSB22StaffSurvey@rti.org to provide their name and email address.

Learn more about the study by watching a short video on our website <https://surveys.nces.ed.gov/hsb22>.

We thank you in advance for your cooperation in making this important research study a success.

Sincerely,

James L. Woodworth
NCES Commissioner

HS&B:22 is conducted by the National Center for Education Statistics (NCES) in the U.S. Department of Education's Institute for Education Sciences. NCES is authorized to conduct the High School and Beyond Longitudinal Study of 2022 (HS&B:22) by the Education Sciences Reform Act of 2002 (ESRA 2002, 20 U.S.C. §9543) and to collect students' education records from education agencies or institutions for the purposes of evaluating federally supported education programs under the Family Educational Rights and Privacy Act (FERPA, 34 CFR §§ 99.31(a)(3) (iii) and 99.35). The data are being collected for NCES by RTI International, a U.S.-based nonprofit research organization. All of the information students, parents, and staff provide may be used only for statistical purposes and may not be disclosed, or used, in identifiable form for any other purpose except as required by law (20 U.S.C. §9573 and 6 U.S.C. §151). The collected information will be combined across respondents to produce statistical reports.

Appendix A12c.3. Staff Data Collection Email Reminder– School Administrator (previously approved)

SUBJECT LINE: Share your voice! It is not too late!



U.S. DEPARTMENT OF EDUCATION
INSTITUTE OF EDUCATION SCIENCES

NATIONAL CENTER FOR EDUCATION STATISTICS



Website: surveys.nces.ed.gov/hsb22

Study ID: <ID>

Password: <Password>

Dear <ADMIN NAME>,

We are grateful for your schools participation in the [High School and Beyond Longitudinal Study of 2022 \(HS&B:22\)](#). Please complete your online questionnaire to provide essential information about academic policies, programs, activities, and curriculum in the school. Your survey will help complete your school's participation. Your administrator survey is voluntary yet very important to the success of this study. You will receive a Certificate of Service from the U.S. Department of Education <and [incentive]> for your time.

To access the questionnaire online, please use the web address and unique study ID and password provided above. The survey should take no longer than 35 minutes and does not have to be completed at one sitting. We recommend gathering the following information in advance of completing the survey:

- Student attendance and matriculation information
- Student body demographics
- Math curriculum information
- School personnel counts
- State assessment scores
- Programs, services, and supports available for students with IEPs, and the percentage of students who use them

If there is someone at your school who you would like to respond on your behalf, please contact us at (855) 500-1439, or HSB22StaffSurvey@rti.org to provide their name and email address.

Learn more about the study by watching a short video on our website <https://surveys.nces.ed.gov/hsb22>.

We thank you in advance for your cooperation in making this important research study a success.

Sincerely,

James L. Woodworth
NCES Commissioner

HS&B:22 is conducted by the National Center for Education Statistics (NCES) in the U.S. Department of Education's Institute for Education Sciences. NCES is authorized to conduct the High School and Beyond Longitudinal Study of 2022 (HS&B:22) by the Education Sciences Reform Act of 2002 (ESRA 2002, 20 U.S.C. §9543) and to collect students' education records from education agencies or institutions for the purposes of evaluating federally supported education programs under the Family Educational Rights and Privacy Act (FERPA, 34 CFR §§ 99.31(a)(3)(iii) and 99.35). The data are being collected for NCES by RTI International, a U.S.-based nonprofit research organization. All of the information students, parents, and staff provide may be used only for statistical purposes and may not be disclosed, or used, in identifiable form for any other purpose except as required by law (20 U.S.C. §9573 and 6 U.S.C. §151). The collected information will be combined across respondents to produce statistical reports.

CERTIFICATE *of* PARTICIPATION

THE U.S. DEPARTMENT OF EDUCATION ACKNOWLEDGES THAT

[Recipient Name]

PARTICIPATED IN

**MISSION CRITICAL EDUCATION
RESEARCH ACTIVITIES**

Month & Date, Year

James L. Woodworth
Commissioner
National Center for Education Statistics
U.S. Department of Education

nces.info@rti.org



Did you know...

The National Center for Education Statistics (NCES) surveys offer an opportunity for school systems, educators, parents, and students to report and share data on the state of education in their communities with policymakers, researchers, and the media. Below are a few examples of survey and assessment results appearing in national news and journals.

Based on data collected from the Early Childhood Longitudinal Study, Kindergarten Class of 2010-11:

“ Kids arrive at school with large achievement gaps between rich and poor, and the achievement gaps grow over the summer. ”

U.S. News and World Report, 05/28/2018

Based on data collected from the Trends in International Mathematics and Science Study:

“ U.S. curriculum is a mile wide and an inch deep. ”

U.S. Dept. of Education, Mathematics and Science Initiative

Based on data collected from the 2018 Indicators of School Crime and Safety Report:

“ Despite perceptions that schools are less safe, data show that bullying, violence and crime have decreased.”

U.S. News and World Report, 04/17/2019

<<ADDRESS>>

By participating in our surveys and assessments, you help deepen the understanding of the U.S. education system. Each respondent provides invaluable data that informs policy, research, and practices.

Contribute to the national dialogue on education statistics by completing High School and Beyond 2022 (HS&B:22).
<https://surveys.nces.ed.gov/hsb20>

NATIONAL
 CENTER FOR
 EDUCATION
 STATISTICS

Did you know...

The National Center for Education Statistics (NCES) surveys offer an opportunity for school systems, educators, parents, and students to report and share data on the state of education in their communities with policymakers, researchers, and the media. Below are a few examples of survey and assessment results appearing in national news.



Based on data collected from teachers through the 2018 Teaching and Learning International Survey:

“U.S. teachers work longer hours and spend more time during the school day teaching than teachers in other parts of the world.”

U.S. News and World Report, 06/19/2019



Based on data collected from teachers through the 2015-16 National Teacher and Principal Survey:

“94 percent of U.S. teachers spend their own money on school supplies.”

The New York Times, 05/16/2018

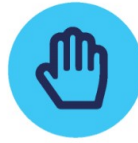

Based on data collected from teachers through the 2018 Teaching and Learning International Survey:

“While majority of teachers are satisfied with their jobs, only a fraction believes American society values their profession.”

U.S. News and World Report, 06/19/2019

How can you contribute?



By participating in our surveys and assessments, you help deepen the understanding of the U.S. education system. Each respondent provides invaluable data that informs policy, research, and practices.

Contribute to the national dialogue on education statistics by completing High School and Beyond 2022 (HS&B:22). <https://surveys.nces.ed.gov/hsb20/>

NATIONAL
CENTER FOR
EDUCATION
STATISTICS

Did you know...

The National Center for Education Statistics (NCES) surveys offer an opportunity for school systems, educators, parents, and students to report and share data on the state of education in their communities with policymakers, researchers, and the media. Below are a few examples of survey and assessment results appearing in national news and journals.



Based on data collected from the Early Childhood Longitudinal Study, Kindergarten Class of 2010-11:

“Kids arrive at school with large achievement gaps between rich and poor, and the achievement gaps grow over the summer.”

U.S. News and World Report, 05/28/2018



Based on data collected from the Trends in International Mathematics and Science Study:

“U.S. curriculum is a mile wide and an inch deep.”

U.S. Dept. of Education, Mathematics and Science Initiative

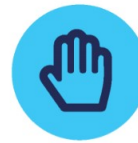

Based on data collected from the 2018 Indicators of School Crime and Safety Report:

“Despite perceptions that schools are less safe, data show that bullying, violence and crime have decreased.”

U.S. News and World Report, 04/17/2019

How can you contribute?



By participating in our surveys and assessments, you help deepen the understanding of the U.S. education system. Each respondent provides invaluable data that informs policy, research, and practices.

Contribute to the national dialogue on education statistics by completing High School and Beyond 2022 (HS&B:22). <https://surveys.nces.ed.gov/hsb20/>

NATIONAL
CENTER FOR
EDUCATION
STATISTICS

Did you know...



The National Center for Education Statistics (NCES) surveys offer an opportunity for school systems, educators, parents, and students to report and share data on the state of education in their communities with policymakers, researchers, and the media. Below are a few examples of survey and assessment results appearing in national news.

Based on data collected from teachers through the 2018 Teaching and Learning International Survey:

“U.S. teachers work longer hours and spend more time during the school day teaching than teachers in other parts of the world.”

U.S. News and World Report, 06/19/2019

Based on data collected from teachers through the 2015-16 National Teacher and Principal Survey:

“94 percent of U.S. teachers spend their own money on school supplies.”

The New York Times, 05/16/2018

Based on data collected from teachers through the 2018 Teaching and Learning International Survey:

“While majority of teachers are satisfied with their jobs, only a fraction believes American society values their profession.”

U.S. News and World Report, 06/19/2019

How can you contribute?



Survey/Assessments



Data Collection



Analysis



Reporting and Dissemination

By participating in our surveys and assessments, you help deepen the understanding of the U.S. education system. Each respondent provides invaluable data that informs policy, research, and practices.

Contribute to the national dialogue on education statistics by completing High School and Beyond 2022 (HS&B:22). <https://surveys.nces.ed.gov/hsb20/>

NATIONAL
CENTER FOR
EDUCATION
STATISTICS

Did you know...



The National Center for Education Statistics (NCES) surveys offer an opportunity for school systems, educators, parents, and students to report and share data on the state of education in their communities with policymakers, researchers, and the media. Below are a few examples of survey and assessment results appearing in national news.

Based on data collected from the Early Childhood Longitudinal Study, Kindergarten Class of 2010-11:

“Kids arrive at school with large achievement gaps between rich and poor, and the achievement gaps grow over the summer.”

U.S. News and World Report, 05/28/2018

Based on data collected from the Trends in International Mathematics and Science Study:

“U.S. curriculum is a mile wide and inch deep.”

U.S. Dept. of Education, Mathematics and Science Initiative

Based on data collected from the 2018 Indicators of School Crime and Safety Report:

“Despite perceptions that schools are less safe, data show that bullying, violence and crime have decreased.”

U.S. News and World Report, 04/17/2019

How can you contribute?



Survey/Assessments



Data Collection



Analysis



Reporting and Dissemination

By participating in our surveys and assessments, you help deepen the understanding of the U.S. education system. Each respondent provides invaluable data that informs policy, research, and practices.

Contribute to the national dialogue on education statistics by completing High School and Beyond 2022 (HS&B:22). <https://surveys.nces.ed.gov/hsb20/>

NATIONAL
CENTER FOR
EDUCATION
STATISTICS

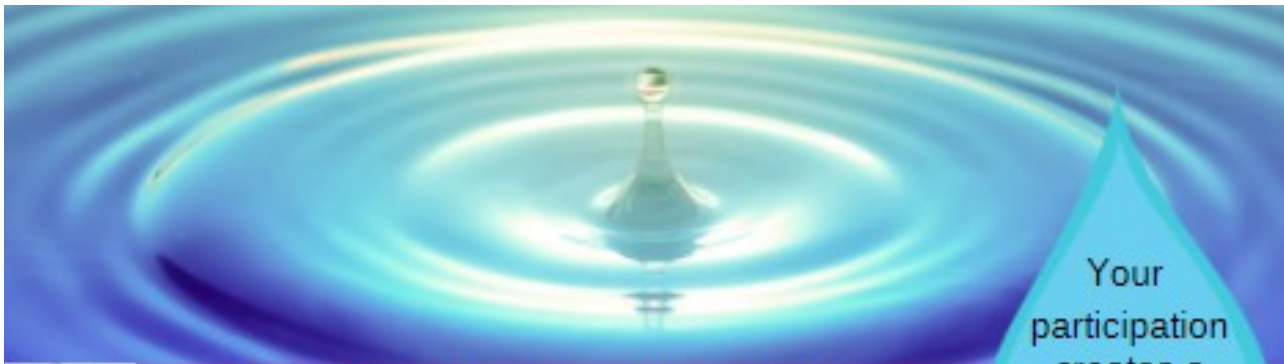

HIGH SCHOOL & BEYOND LONGITUDINAL STUDY OF 2022

Your participation creates a ripple in the field of education

YOUR PARTICIPATION

1 Day

Students have approximately 1,195 classroom hours per year. The student session is only 90 minutes, that's less than .13% of school time!

35 Students

About 35 grade 9 students are randomly selected to participate, on a date & time of greatest convenience to you!

5-7 Staff

1 school coordinator for logistics plan, 1 Administrator, 1 Counselor, & Math teacher's of students complete voluntary online survey.

THE IMPACT



POLICY

The California Dropout Research Project used previous longitudinal data to examine predictors of high school graduation in the state. Recommendations from this research were incorporated into six California State Senate bills to address the state's dropout problem

http://cdprpsb.org/pubs_reports.htm



FUNDING

Studies funded by IES have identified effective practices that can be implemented in classrooms without purchasing a specific program or curriculum.

<https://www.brookings.edu/research/federally-supported-education-research-doesnt-need-a-do-over/>



PRACTICE

The U.S. DOE's Office of Planning, Evaluation and Policy Development relied on similar longitudinal data to report to Congress about the benefits of career and technical education. The report illustrated how high school CTE course taking related to later postsecondary education outcomes.

<https://www2.ed.gov/scholars/eval/sectech/articles/career-technical-education/first-report.pdf>



Institute of Education Sciences



High School & Beyond

Longitudinal Study of 2022

Your participation is important and may help shape the future of education.

Flexible scheduling and incentives are available.

See reverse side for details.



Step One: School Selection

Your school is one of 920 selected to represent all schools across the country.



Step Two: Student Selection

Approximately 35 ninth-grade students in your school will be invited to participate.



Step Three: Date Selection

The school picks a convenient date and time in Fall 2022 for the student session.



Step Four: Student Participation

Students will participate in a 90-minute computer-based activity including a survey, reading and math questions, and a hearing and vision evaluation—facilitated by HS&B:22 staff.



Step Five: Staff Participation

One administrator, one counselor, and math teachers of selected students will complete an online survey.



Step Six: Impact

Data collected will generate research to advance education practices that lead to successful academic and life outcomes for all students.

Contact us or visit our website for more information

Phone: 855-500-1439 | **Email:** hsb22@rti.org | **Web:** surveys.noes.ed.gov/hsb22

Study Snapshot Page 2



Phone: 855-500-1439
Email: hsb22@rti.org
Web: surveys.nces.ed.gov/hsb22

Flexible Scheduling & Incentives

We want to encourage participation in this study while making it easy for schools, students, and staff. Scheduling can be flexible according to school or district needs. Incentives are offered as a thank you for your time. Participation provides a great opportunity for student civic engagement!



School Incentives

- \$200 value incentive
- Interactive webinars and school reports with supporting resources
- Parents receive results from their child's hearing and vision evaluation



Student Incentives

- \$10 gift card or equivalent
- Two-hour certificate of community service
- Food party available to encourage participation



Staff Incentives

All participating staff:
Two-hour U.S. Department of Education Certificate of Service

Monetary Incentives (If allowed):

- Math Teacher: \$20 + \$7 per student
- Administrator: \$25
- Counselor: \$25
- School Coordinator: \$150



Simple and Customized

- Small sample of students (about 35 ninth graders)
- School can choose any day and time in Fall 2022 for the student session
- Additional customizations are available if needed, contact us now for more details!

High School and Beyond Longitudinal Study of 2022 (HS&B:22) is a national longitudinal study conducted by the National Center for Education Statistics (NCES) within the U.S. Department of Education. Data collected by RTI International.



How is HS&B:22 Different From State, Local & Other Research?

- ✓ HS&B:22 is a unique opportunity for all involved in the education experience—students, educators, and parents—to contribute meaningful information that will impact student outcomes for generations to come.
- ✓ This is not just another test or survey; rather HS&B:22 will capture a wholistic view of student learning, growth, and social and interpersonal development during the critical high school years.
- ✓ While NAEP and state assessments measure student performance and progress, NCES longitudinal series are the only studies that collect data on school and family experiences that allow us to examine associations between contextual factors and student outcomes.
- ✓ HS&B:22 is not high stakes – the study does not affect student grades or school accountability ratings.
- ✓ HS&B:22 was designed with input from educators and recognizes that a “one size fits all” approach does not work. Within an overarching framework, we partner with districts and schools to customize a data collection plan that complies with district policies and minimizes disruption to the school day.
- ✓ Many educational programs and practices currently in use are based on research that used NCES’s longitudinal data. School participation today is essential for producing research-based practices for tomorrow.
- ✓ Findings generated from HS&B:22 will not only advance teaching and learning, but will also inform federal, state, and local policy, programming, and funding decisions.
- ✓ With limited resources available, it is imperative for districts and schools to join together in research that will benefit all of our nation’s youth.

- ✓ What we learn from HS&B:22 will be invaluable to better understanding student achievement and what factors lead students to successfully complete high school and enter postsecondary education or the workforce.



Virtual Student Session

Welcome!

- You are here today because you were selected to represent high school students in an important study called the High School and Beyond Longitudinal Study, or HS&B:22 for short
- For the next 90 minutes or so, you will be using your computer to answer questions about yourself and may answer math and/or reading questions



Incentives



YOU WILL RECEIVE A 2-HOUR SERVICE CERTIFICATE



YOU WILL ALSO RECEIVE AN INCENTIVE FOR YOUR TIME

Your participation is important



HS&B:22

- **Please do the best that you can. If you do not know an answer or do not want to answer a question, you may skip it.**
- **This is not a test and you will not be graded on how you answer the questions.**
- **Your participation in HS&B:22 is voluntary, and all of the information you provide may be used only for statistical purposes and may not be disclosed, or used, in identifiable form for any other purpose except as required by law.**

Your login credentials were sent home via mail.

Please ask your parent for the HS&B:22 envelope with your name on it.

To participate, go to:

<https://surveys.nces.ed.gov/hsbstudent/>

Welcome to HS&B:20!

High School and Beyond Longitudinal Study of 2020 (HS&B:20) is a national study of 9th-graders as they progress through high school and beyond.

This site is for school staff, parents, and students who are participating in HS&B:20. Log in to begin. [If you are a student, click here to login in.](#)

<input type="text" value="Study ID"/>	<input type="password" value="Password"/>
Forgot your Study ID or Password?	Show Password

Need help?

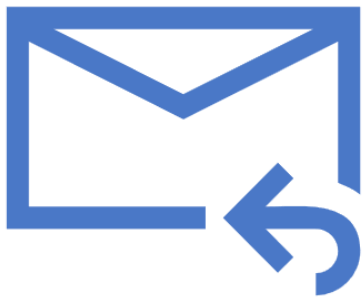

- If students have any login issues, they can contact our team directly at hsb22survey@rti.org.

