

Generic Environmental Impact Statement for License Renewal of Nuclear Plants

Main Report

Chapters 1–8

Draft Report for Comment

AVAILABILITY OF REFERENCE MATERIALS IN NRC PUBLICATIONS

NRC Reference Material

As of November 1999, you may electronically access NUREG-series publications and other NRC records at the NRC's Library at www.nrc.gov/reading-rm.html. Publicly released records include, to name a few, NUREG-series publications; *Federal Register* notices; applicant, licensee, and vendor documents and correspondence; NRC correspondence and internal memoranda; bulletins and information notices; inspection and investigative reports; licensee event reports; and Commission papers and their attachments.

NRC publications in the NUREG series, NRC regulations, and Title 10, "Energy," in the *Code of Federal Regulations* may also be purchased from one of these two sources:

1. The Superintendent of Documents

U.S. Government Publishing Office
Washington, DC 20402-0001
Internet: <https://bookstore.gpo.gov/>
Telephone: (202) 512-1800
Fax: (202) 512-2104

2. The National Technical Information Service

5301 Shawnee Road
Alexandria, VA 22312-0002
Internet: <https://www.ntis.gov/>
1-800-553-6847 or, locally, (703) 605-6000

A single copy of each NRC draft report for comment is available free, to the extent of supply, upon written request as follows:

Address: **U.S. Nuclear Regulatory Commission**
Office of Administration
Digital Communications and Administrative
Services Branch
Washington, DC 20555-0001
E-mail: Reproduction.Resource@nrc.gov
Facsimile: (301) 415-2289

Some publications in the NUREG series that are posted at the NRC's Web site address www.nrc.gov/reading-rm/doc-collections/nuregs are updated periodically and may differ from the last printed version. Although references to material found on a Web site bear the date the material was accessed, the material available on the date cited may subsequently be removed from the site.

Non-NRC Reference Material

Documents available from public and special technical libraries include all open literature items, such as books, journal articles, transactions, *Federal Register* notices, Federal and State legislation, and congressional reports. Such documents as theses, dissertations, foreign reports and translations, and non-NRC conference proceedings may be purchased from their sponsoring organization.

Copies of industry codes and standards used in a substantive manner in the NRC regulatory process are maintained at—

The NRC Technical Library

Two White Flint North
11545 Rockville Pike
Rockville, MD 20852-2738

These standards are available in the library for reference use by the public. Codes and standards are usually copyrighted and may be purchased from the originating organization or, if they are American National Standards, from—

American National Standards Institute

11 West 42nd Street
New York, NY 10036-8002
Internet: www.ansi.org
(212) 642-4900

Legally binding regulatory requirements are stated only in laws; NRC regulations; licenses, including technical specifications; or orders, not in NUREG-series publications. The views expressed in contractor prepared publications in this series are not necessarily those of the NRC.

The NUREG series comprises (1) technical and administrative reports and books prepared by the staff (NUREG-XXXX) or agency contractors (NUREG/CR-XXXX), (2) proceedings of conferences (NUREG/CP-XXXX), (3) reports resulting from international agreements (NUREG/IA-XXXX), (4) brochures (NUREG/BR-XXXX), and (5) compilations of legal decisions and orders of the Commission and the Atomic and Safety Licensing Boards and of Directors' decisions under Section 2.206 of the NRC's regulations (NUREG-0750), (6) Knowledge Management prepared by NRC staff or agency contractors (NUREG/KM-XXXX).

DISCLAIMER: This report was prepared as an account of work sponsored by an agency of the U.S. Government. Neither the U.S. Government nor any agency thereof, nor any employee, makes any warranty, expressed or implied, or assumes any legal liability or responsibility for any third party's use, or the results of such use, of any information, apparatus, product, or process disclosed in this publication, or represents that its use by such third party would not infringe privately owned rights.

Generic Environmental Impact Statement for License Renewal of Nuclear Plants

Main Report

Chapters 1–8

Draft Report for Comment

Manuscript Completed: February 2023
Date Published: February 2023

COMMENTS ON DRAFT REPORT

Any interested party may submit comments on this report for consideration by the NRC staff. Comments may be accompanied by additional relevant information or supporting data. Please specify the report number **NUREG-1437**, Revision 2 in your comments, and send them by the end of the comment period specified in the *Federal Register* notice announcing the availability of this report.

Addresses: You may submit comments by any one of the following methods. Please include Docket ID **NRC-2018-0296** in the subject line of your comments. Comments submitted in writing or in electronic form will be posted on the NRC website and on the Federal rulemaking website <http://www.regulations.gov>.

Federal Rulemaking Website: Go to <http://www.regulations.gov> and search for documents filed under Docket ID **NRC-2018-0296**.

Email comments to: Rulemaking.Comments@nrc.gov. If you do not receive an automatic email reply confirming receipt, then contact us at 301-415-1677.

Mail comments to: Secretary, U.S. Nuclear Regulatory Commission, Washington, DC 20555-0001, ATTN: Rulemakings and Adjudications Staff.

For any questions about the material in this report, please contact: Jennifer Davis, Senior Environmental Project Manager, or Kevin Folk, Senior Environmental Project Manager, at 1-800-368-5642, extension 3835 or 6944 (respectively), or by e-mail at Jennifer.Davis@nrc.gov or Kevin.Folk@nrc.gov.

Please be aware that any comments that you submit to the NRC will be considered a public record and entered into the Agencywide Documents Access and Management System (ADAMS). Do not provide information you would not want to be publicly available.

1

COVER SHEET

2 **Responsible Agency:** U.S. Nuclear Regulatory Commission, Office of Nuclear Material Safety
3 and Safeguards

4 **Title:** Draft *Generic Environmental Impact Statement for License Renewal of Nuclear Plants*
5 (NUREG-1437) Volumes 1 and 2, Revision 2

6 For additional information or copies of this Draft *Generic Environmental Impact Statement for*
7 *License Renewal of Nuclear Plants*, contact:

8 Jennifer A. Davis, Senior Environmental Project Manager
9 Kevin T. Folk, Senior Environmental Project Manager
10 U.S. Nuclear Regulatory Commission
11 Office of Nuclear Material Safety and Safeguards
12 Mail Stop T-4B72
13 11545 Rockville Pike
14 Rockville, Maryland 20852
15 Phone: 1-800-368-5642, extension 3835 or 6944
16 Email: Jennifer.Davis@nrc.gov or Kevin.Folk@nrc.gov

17

ABSTRACT

18 U.S. Nuclear Regulatory Commission (NRC) regulations allow for the renewal of commercial
19 nuclear power plant operating licenses. There are no specific limitations in the Atomic Energy
20 Act or the NRC’s regulations restricting the number of times a license may be renewed. To
21 support license renewal environmental reviews, the NRC published the first *Generic*
22 *Environmental Impact Statement for License Renewal of Nuclear Plants* (LR GEIS) in 1996.
23 Per NRC regulations, a review and update of the LR GEIS is conducted every 10 years, if
24 necessary. The proposed action is the renewal of nuclear power plant operating licenses.

25 Since publication of the 1996 LR GEIS, 59 nuclear power plants (96 reactor units) have
26 undergone license renewal environmental reviews and have received renewed licenses, the
27 results of which were published as supplements to the LR GEIS. This revision evaluates the
28 issues and findings of the 2013 LR GEIS (Revision 1). Lessons learned and knowledge gained
29 from initial license renewal (initial LR) and subsequent license renewal (SLR) environmental
30 reviews provide major sources of new information for this assessment. In addition, new
31 research, findings, public comments, changes in applicable laws and regulations, and other
32 information were considered in evaluating the environmental impacts associated with license
33 renewal. Additionally, this revision fully considers and evaluates the environmental impacts of
34 one term of SLR as well as initial LR.

35 The purpose of the LR GEIS is to identify and evaluate environmental issues that could result in
36 the same or similar impact at all nuclear power plants (or a distinct subset of plants) (i.e.,
37 generic issues) and determine which issues could result in different levels of impact, thus
38 requiring nuclear power plant-specific environmental analyses for impact determination. The
39 NRC has identified a total of 80 environmental issues for consideration in license renewal
40 reviews, 59 of which have been evaluated in the LR GEIS and their impacts determined to be

1 applicable to license renewal for all nuclear power plants or a subset of plants. The LR GEIS
2 also discusses a range of reasonable alternatives to the proposed action (initial LR or SLR),
3 which would be analyzed in detail in plant-specific supplements to the LR GEIS.

4

5

6

7

8

9

10

11

12

13

14

15

16

17

18

19 **Paperwork Reduction Act Statement**

20 This NUREG provides voluntary guidance for implementing the mandatory information
21 collections in 10 CFR Part 51 that are subject to the Paperwork Reduction Act of 1995
22 (44 U.S.C. 3501 et seq.). These information collections were approved by the Office of
23 Management and Budget (OMB) under control number 3150-0021. Send comments regarding
24 these information collections to the FOIA, Library, and Information Collections Branch
25 (T6A10M), U.S. Nuclear Regulatory Commission, Washington, D.C. 20555-0001, or by email to
26 Infocollects.Resource@nrc.gov, and to the OMB reviewer at: OMB Office of Information and
27 Regulatory Affairs (3150-0021). Attn: Desk Officer for the Nuclear Regulatory Commission,
28 725 17th Street NW, Washington, DC 20503; email: oira_submission@omb.eop.gov.

29 **Public Protection Notification**

30 The NRC may not conduct or sponsor, and a person is not required to respond to, a request for
31 information or an information collection requirement unless the requesting document displays a
32 currently valid Office of Management and Budget control number.

CONTENTS

1		
2	ABSTRACT	iii
3	LIST OF FIGURES	xi
4	LIST OF TABLES	xiii
5	ACRONYMS, ABBREVIATIONS, AND CHEMICAL NOMENCLATURE	xxi
6	SHORTENED NUCLEAR POWER PLANT NAMES USED IN THIS REPORT.....	xxvii
7	CONVERSION TABLE	xxix
8	EXECUTIVE SUMMARY	xxx
9	S.1 Purpose and Need for the Proposed Action	xxxiii
10	S.2 Development of the Revised Generic Environmental Impact Statement	xxxiv
11	S.3 Impact Definitions and Categories	xxxv
12	S.4 Affected Environment.....	xxxvi
13	S.5 Impacts from Continued Operations and Refurbishment Activities Associated with License Renewal (Initial or Subsequent)	xxxvii
14	S.6 Comparison of Alternatives.....	xlvii
15		
16	1.0 INTRODUCTION	1-1
17	1.1 Purpose of the LR GEIS	1-2
18	1.2 Description of the Proposed Action.....	1-3
19	1.3 Purpose and Need for the Proposed Action	1-3
20	1.4 Alternatives to the Proposed Action.....	1-4
21	1.5 Analytical Approach Used in the LR GEIS.....	1-4
22	1.5.1 Objectives	1-4
23	1.5.2 Methodology.....	1-4
24	1.6 Scope of the LR GEIS Revision.....	1-6
25	1.7 Decisions to Be Supported by the LR GEIS	1-8
26	1.7.1 Changes to Nuclear Power Plant Cooling Systems	1-9
27	1.7.2 Disposition of Spent Nuclear Fuel.....	1-10
28	1.7.3 Emergency Preparedness.....	1-12
29	1.7.4 Safeguards and Security	1-14
30	1.7.5 Need for Power	1-14
31	1.7.6 Seismicity, Flooding, and Other Natural Hazards	1-15
32	1.8 Implementation of the Rule (10 CFR Part 51).....	1-15
33	1.8.1 General Requirements	1-15
34	1.8.2 Applicant's Environmental Report	1-15
35	1.8.3 Supplemental Environmental Impact Statement	1-16
36	1.8.4 Public Scoping and Public Comments	1-16
37	1.8.5 Draft Supplemental Environmental Impact Statement	1-16
38	1.8.6 Final Supplemental Environmental Impact Statement	1-16

Contents

1	1.9	Public Scoping Comments on the LR GEIS Update	1-17
2	1.10	Lessons Learned	1-18
3	1.11	Organization of the LR GEIS	1-19
4	2.0	ALTERNATIVES INCLUDING THE PROPOSED ACTION	2-1
5	2.1	Proposed Action.....	2-2
6	2.1.1	Nuclear Plant Operations during the License Renewal Term	2-2
7	2.1.2	Refurbishment and Other Activities Associated with License	
8		Renewal	2-3
9	2.1.3	Termination of Nuclear Plant Operations and Decommissioning	
10		after License Renewal.....	2-4
11	2.1.4	Impacts of the Proposed Action	2-5
12	2.2	No Action Alternative	2-16
13	2.3	Alternative Energy Sources	2-16
14	2.3.1	Fossil Fuel Energy Technologies	2-18
15	2.3.2	New Nuclear Energy Technologies.....	2-21
16	2.3.3	Renewable Energy Technologies	2-23
17	2.3.4	Non-Power Generating Alternatives.....	2-33
18	2.4	Comparison of Alternatives.....	2-36
19	3.0	AFFECTED ENVIRONMENT	3-1
20	3.1	Description of Nuclear Power Plant Facilities and Operations.....	3-1
21	3.1.1	External Appearance and Settings.....	3-1
22	3.1.2	Nuclear Reactor Systems	3-4
23	3.1.3	Cooling Water Systems.....	3-13
24	3.1.4	Radioactive Waste Management Systems	3-17
25	3.1.5	Nonradioactive Waste Management Systems	3-21
26	3.1.6	Utility and Transportation Infrastructure	3-22
27	3.1.7	Nuclear Power Plant Operations and Maintenance	3-24
28	3.2	Land Use and Visual Resources.....	3-25
29	3.2.1	Land Use.....	3-25
30	3.2.2	Visual Resources	3-26
31	3.3	Meteorology, Air Quality, and Noise	3-27
32	3.3.1	Meteorology and Climatology.....	3-27
33	3.3.2	Air Quality.....	3-28
34	3.3.3	Noise	3-33
35	3.4	Geologic Environment.....	3-34
36	3.5	Water Resources	3-38
37	3.5.1	Surface Water Resources	3-40
38	3.5.2	Groundwater Resources	3-47
39	3.6	Ecological Resources	3-50
40	3.6.1	Terrestrial Resources	3-50
41	3.6.2	Aquatic Resources	3-54
42	3.6.3	Federally Protected Ecological Resources	3-59
43	3.7	Historic and Cultural Resources	3-84
44	3.7.1	Scope of Review	3-84

1	3.7.2	NEPA and NHPA	3-85
2	3.7.3	Historic and Cultural Resources at Nuclear Power Plant Sites.....	3-85
3	3.8	Socioeconomics.....	3-87
4	3.8.1	Power Plant Employment and Expenditures.....	3-87
5	3.8.2	Regional Economic Characteristics	3-88
6	3.8.3	Demographic Characteristics	3-89
7	3.8.4	Housing and Community Services	3-90
8	3.8.5	Tax Revenue.....	3-91
9	3.8.6	Local Transportation	3-92
10	3.9	Human Health.....	3-92
11	3.9.1	Radiological Exposure and Risk	3-92
12	3.9.2	Nonradiological Hazards	3-125
13	3.10	Environmental Justice.....	3-134
14	3.11	Waste Management and Pollution Prevention.....	3-137
15	3.11.1	Radioactive Waste	3-137
16	3.11.2	Hazardous Waste.....	3-144
17	3.11.3	Mixed Waste	3-144
18	3.11.4	Nonhazardous Waste.....	3-145
19	3.11.5	Pollution Prevention and Waste Minimization	3-145
20	3.12	Greenhouse Gas Emissions and Climate Change	3-145
21	3.12.1	Greenhouse Gas Emissions	3-145
22	3.12.2	Observed Changes in Climate	3-150
23	4.0	ENVIRONMENTAL CONSEQUENCES AND MITIGATING ACTIONS.....	4-1
24	4.1	Environmental Consequences and Mitigating Actions.....	4-2
25	4.1.1	Introduction	4-2
26	4.1.2	Environmental Consequences of the Proposed Action.....	4-2
27	4.1.3	Environmental Consequences of Continued Operations and	
28		Refurbishment Activities During the License Renewal Term	
29		(Initial or Subsequent).....	4-3
30	4.1.4	Environmental Consequences of the No Action Alternative.....	4-4
31	4.1.5	Environmental Consequences of Alternative Energy Sources.....	4-5
32	4.1.6	Environmental Consequences of Terminating Nuclear Power Plant	
33		Operations and Decommissioning	4-5
34	4.2	Land Use and Visual Resources.....	4-6
35	4.2.1	Environmental Consequences of the Proposed Action –	
36		Continued Operations and Refurbishment Activities.....	4-6
37	4.2.2	Environmental Consequences of Alternatives to the Proposed	
38		Action	4-8
39	4.3	Air Quality and Noise	4-10
40	4.3.1	Environmental Consequences of the Proposed Action –	
41		Continued Operations and Refurbishment Activities.....	4-10
42	4.3.2	Environmental Consequences of Alternatives to the Proposed	
43		Action	4-17
44	4.4	Geologic Environment.....	4-20

Contents

1	4.4.1	Environmental Consequences of the Proposed Action –	
2		Continued Operations and Refurbishment Activities.....	4-20
3	4.4.2	Environmental Consequences of Alternatives to the Proposed	
4		Action	4-21
5	4.5	Water Resources	4-22
6	4.5.1	Environmental Consequences of the Proposed Action –	
7		Continued Operations and Refurbishment Activities.....	4-23
8	4.5.2	Environmental Consequences of Alternatives to the Proposed	
9		Action	4-50
10	4.6	Ecological Resources	4-53
11	4.6.1	Environmental Consequences of the Proposed Action –	
12		Continued Operations and Refurbishment Activities.....	4-53
13	4.6.2	Environmental Consequences of Alternatives to the Proposed	
14		Action	4-122
15	4.7	Historic and Cultural Resources	4-126
16	4.7.1	Environmental Consequences of the Proposed Action –	
17		Continued Operations and Refurbishment Activities.....	4-126
18	4.7.2	Environmental Consequences of Alternatives to the Proposed	
19		Action	4-127
20	4.8	Socioeconomics.....	4-128
21	4.8.1	Environmental Consequences of the Proposed Action –	
22		Continued Operations and Refurbishment Activities.....	4-128
23	4.8.2	Environmental Consequences of Alternatives to the Proposed	
24		Action	4-132
25	4.9	Human Health.....	4-134
26	4.9.1	Environmental Consequences of the Proposed Action –	
27		Continued Operations and Refurbishment Activities.....	4-134
28	4.9.2	Environmental Consequences of Alternatives to the Proposed	
29		Action	4-148
30	4.10	Environmental Justice.....	4-149
31	4.10.1	Environmental Consequences of the Proposed Action –	
32		Continued Operations and Refurbishment Activities.....	4-149
33	4.10.2	Environmental Consequences of Alternatives to the Proposed	
34		Action	4-151
35	4.11	Waste Management and Pollution Prevention.....	4-151
36	4.11.1	Environmental Consequences of the Proposed Action –	
37		Continued Operations and Refurbishment Activities.....	4-151
38	4.11.2	Environmental Consequences of Alternatives to the Proposed	
39		Action	4-160
40	4.12	Greenhouse Gas Emissions and Climate Change	4-161
41	4.12.1	Greenhouse Gas Impacts on Climate Change	4-162
42	4.12.2	Environmental Consequences of Alternatives to the Proposed	
43		Action	4-163
44	4.12.3	Climate Change Impacts on Environmental Resources.....	4-164
45	4.13	Cumulative Effects of the Proposed Action.....	4-166
46	4.13.1	Air Quality.....	4-168

1 4.13.2 Surface Water Resources 4-168

2 4.13.3 Groundwater Resources 4-168

3 4.13.4 Ecological Resources 4-169

4 4.13.5 Historic and Cultural Resources 4-169

5 4.13.6 Socioeconomics 4-169

6 4.13.7 Human Health 4-170

7 4.13.8 Environmental Justice 4-170

8 4.13.9 Waste Management and Pollution Prevention 4-170

9 4.13.10 Climate Change 4-170

10 4.14 Impacts Common to All Alternatives 4-171

11 4.14.1 Environmental Consequences of Fuel Cycles 4-171

12 4.14.2 Replacement Energy Alternative Fuel Cycles 4-184

13 4.14.3 Environmental Consequences of Terminating Operations and

14 Decommissioning 4-187

15 4.15 Resource Commitments Associated with the Proposed Action 4-197

16 4.15.1 Unavoidable Adverse Environmental Impacts 4-197

17 4.15.2 Relationship between Short-Term Use of the Environment and

18 Long-Term Productivity 4-198

19 4.15.3 Irreversible and Irretrievable Commitment of Resources 4-199

20 **5.0 REFERENCES 5-1**

21 **6.0 LIST OF PREPARERS 6-1**

22 **7.0 DISTRIBUTION LIST 7-1**

23 **8.0 GLOSSARY 8-1**

24 **APPENDIX A COMMENTS RECEIVED ON THE ENVIRONMENTAL REVIEW A-1**

25 **APPENDIX B COMPARISON OF ENVIRONMENTAL ISSUES AND FINDINGS IN THIS**

26 **LR GEIS REVISION TO THE ISSUES AND FINDINGS IN TABLE B-1 OF**

27 **10 CFR PART 51 B-1**

28 **APPENDIX C GENERAL CHARACTERISTICS AND ENVIRONMENTAL SETTINGS**

29 **OF OPERATING DOMESTIC NUCLEAR POWER PLANTS C-1**

30 **APPENDIX D TECHNICAL SUPPORT FOR LR GEIS ANALYSES D-1**

31 **APPENDIX E ENVIRONMENTAL IMPACT OF POSTULATED ACCIDENTS E-1**

32 **APPENDIX F LAWS, REGULATIONS, AND OTHER REQUIREMENTS F-1**

33

34

LIST OF FIGURES

2	Figure 2.3-1	Schematic of a Natural Gas-Fired Plant	2-19
3	Figure 2.3-2	Schematic of a Coal-Fired Power Plant.....	2-20
4	Figure 2.3-3	Schematic of an Advanced Light Water Reactor.....	2-22
5	Figure 2.3-4	Schematic of a Light Water Small Modular Nuclear Reactor	2-23
6	Figure 2.3-5	Schematic of Solar Photovoltaic Power Plant	2-25
7	Figure 2.3-6	Schematic of Concentrated Solar Power Plant	2-26
8	Figure 2.3-7	Components of a Modern Horizontal-Axis Wind Turbine	2-27
9	Figure 2.3-8	Major Offshore Wind Power Plant and Transmission Elements	2-28
10	Figure 2.3-9	Cross Section of a Large Hydroelectric Plant.....	2-29
11	Figure 2.3-10	Schematic of a Biomass/Waste-to-Energy Plant.....	2-30
12	Figure 2.3-11	Schematic of a Hydrothermal Binary Power Plant.....	2-31
13	Figure 2.3-12	Primary Types of Wave Energy Devices	2-32
14	Figure 2.3-13	Components of a Hydrogen Fuel Cell	2-33
15	Figure 3.1-1	Operating Commercial Nuclear Power Plants in the United States.....	3-5
16	Figure 3.1-2	Pressurized Water Reactor	3-12
17	Figure 3.1-3	Boiling Water Reactor.....	3-13
18	Figure 3.1-4	Schematic Diagrams of Nuclear Power Plant Cooling Systems.....	3-18
19	Figure 3.3-1	Locations of Operating Nuclear Plants Relative to EPA-Nonattainment	
20		Areas, as of August 30, 2011	3-30
21	Figure 3.4-1	Occurrence of Prime Farmland and Other Farmland of Importance,	
22		with Nuclear Power Plant Locations Shown	3-36
23	Figure 3.4-2	2018 National Seismic Hazard Model Peak Horizontal Acceleration	
24		with a 2 Percent Probability of Exceedance in 50 Years with Nuclear	
25		Power Plant Locations Shown.....	3-37
26	Figure 3.6-1	National Marine Sanctuaries and Marine National Monuments	3-82
27	Figure 3.9-1	Average, Median, and Extreme Values of the Collective Dose per	
28		Boiling Water Reactors Reactor from 1994 to 2018	3-101
29	Figure 3.9-2	Average, Median, and Extreme Values of the Collective Dose per	
30		Pressurized Water Reactor from 1994 to 2018	3-102
31	Figure 3.9-3	Dose Distribution for All Commercial U.S. Reactors by Dose Range,	
32		2014 through 2018	3-115
33	Figure 3.11-1	Typical Dry Cask Storage Systems	3-141
34	Figure 3.11-2	Locations of Independent Spent Fuel Storage Installations Licensed	
35		by the NRC	3-143
36	Figure 3.12-1	Locations of Operating Nuclear Power Plants Relative to National	
37		Climate Assessment Geographic Regions	3-152
38	Figure D.2-1	Average Annual Maximum Temperatures across the Continental	
39		United States	D-3
40	Figure D.2-2	Average Annual Minimum Temperatures across the Continental	
41		United States	D-4
42	Figure D.2-3	Average Annual Precipitation across the Continental United States.....	D-5
43	Figure D.5-1	Level I Ecoregions of the United States	D-12

Figures

1	Figure E.3-1	Iodine Release to the Environment for SOARCA Unmitigated	
2		Scenarios and the 1982 Siting Study SST1 Case	E-39
3	Figure E.3-2	Cesium Release to the Environment for SOARCA Unmitigated	
4		Scenarios and the 1982 Siting Study SST1 Case	E-39
5	Figure E.3-3	Percentages of Cesium and Iodine Released to the Environment for	
6		SOARCA Unmitigated Scenarios, the 1982 Siting Study SST1 Case,	
7		and Historical Accidents	E-40
8	Figure E.3-4	Comparison of Population-Weighted Average Individual Latent	
9		Cancer Fatality Risk Results from NUREG-2161 to the NRC Safety	
10		Goal	E-60
11	Figure E.3-5	Uncertainty in Average Individual Latent Cancer Fatality Risk in the	
12		2015 Containment Protection and Release Reduction Regulatory	
13		Analysis	E-67
14	Figure E.3-6	Complementary Cumulative Distribution Functions of Conditional	
15		Individual Latent Cancer Fatality Risk within Five Annular Areas	
16		Centered on the Sequoyah Plant	E-77
17	Figure E.3-7	Complementary Cumulative Distribution Functions of Conditional	
18		Individual Latent Cancer Fatality Risk within Five Annular Areas	
19		Centered on the Surry Plant	E-78
20			

LIST OF TABLES

2	Table 2.1-1	Summary of Findings on Environmental Issues under the Proposed Action	2-5
3	Table 2.3-1	Net Generation at Utility-Scale Facilities	2-18
4	Table 2.4-1	Construction under the Proposed Action and Alternatives – Assessment Basis and Nature of Impacts.....	2-37
5	Table 2.4-2	Operations under the Proposed Action and Alternatives – Assessment Basis and Nature of Impacts	2-38
6	Table 2.4-3	Postulated Accidents under the Proposed Action and Alternatives – Assessment Basis and Impact Magnitude.....	2-39
7	Table 2.4-4	Termination of Nuclear Power Plant Operations and Decommissioning under the Proposed Action and Alternatives – Assessment Basis and Nature of Impacts	2-40
8	Table 2.4-5	Fuel Cycle under the Proposed Action and Alternatives – Assessment Basis and Nature of Impacts	2-41
9	Table 3.1-1	Characteristics of Operating U.S. Commercial Nuclear Power Plants	3-6
10	Table 3.1-2	Cooling Water System Source – Coastal or Estuarine Environment.....	3-14
11	Table 3.1-3	Cooling Water System Source – Great Lakes Environment.....	3-14
12	Table 3.1-4	Cooling Water System Source – Freshwater Riverine or Impoundment Environment	3-15
13	Table 3.2-1	Percent of Land Cover Types within a 5-Mile Radius of Nuclear Power Plants.....	3-26
14	Table 3.3-1	Fujita Tornado Intensity Scale	3-28
15	Table 3.3-2	National Ambient Air Quality Standards for Six Criteria Pollutants.....	3-29
16	Table 3.5-1	Comparison of Cooling Water System Attributes for Operating Commercial Nuclear Power Plants.....	3-41
17	Table 3.6-1	Factors That Influence the Impacts of Nuclear Power Plant Operation on Aquatic Organisms	3-58
18	Table 3.6-2	Critical Habitats Evaluated in License Renewal Reviews, 2013–Present	3-62
19	Table 3.6-3	NMFS-Issued Biological Opinions for Nuclear Power Plant Operation	3-63
20	Table 3.6-4	FWS-Issued Biological Opinions for Nuclear Power Plant Operation	3-64
21	Table 3.6-5	ESA Listed Species Evaluated in License Renewal Reviews, 2013–Present	3-69
22	Table 3.6-6	EFH Evaluated in License Renewal Reviews, 2013–Present	3-80
23	Table 3.6-7	National Marine Sanctuaries Near Operating Nuclear Power Plants	3-83
24	Table 3.8-1	Local Employment and Tax Revenues at 15 Nuclear Plants from 2014 through 2020	3-88
25	Table 3.8-2	Population Classification of Regions around Selected Nuclear Power Plants.....	3-90
26	Table 3.9-1	Occupational Dose Limits for Adults Established by 10 CFR Part 20	3-93
27	Table 3.9-2	Design Objectives and Annual Standards on Doses to the General Public from Nuclear Power Plants from Appendix I to 10 CFR 50	3-94

Tables

1	Table 3.9-3	Design Objectives and Annual Standards on Doses to the General Public from Nuclear Power Plants from 40 CFR 190, Subpart B3-95	3-95
2			
3	Table 3.9-4	Occupational Whole-Body Dose Data at U.S. Commercial Nuclear Power Plants3-96	3-96
4			
5	Table 3.9-5	Annual Average Measurable Occupational Dose per Individual for U.S. Commercial Nuclear Power Plants in rem.....3-97	3-97
6			
7	Table 3.9-6	Annual Average Collective Occupational Dose for U.S. Commercial Nuclear Power Plants in person-rem.....3-97	3-97
8			
9	Table 3.9-7	Collective and Individual Worker Doses at Boiling Water Reactors from 2016 to 20183-98	3-98
10			
11	Table 3.9-8	Collective and Individual Worker Doses at Pressurized Water Reactors from 2016 through 2018.....3-99	3-99
12			
13	Table 3.9-9	Annual Collective Dose and Annual Occupational Dose for Pressurized Water Reactor Nuclear Power Plants from 2006 through 2018.....3-103	3-103
14			
15			
16	Table 3.9-10	Annual Collective Dose and Annual Occupational Dose for Boiling Water Reactor Nuclear Power Plants from 2006 through 20183-104	3-104
17			
18	Table 3.9-11	Annual Collective Dose for Pressurized Water Reactor Nuclear Power Plants from 2006 through 20183-106	3-106
19			
20	Table 3.9-12	Annual Collective Dose for Boiling Water Reactor Nuclear Power Plants from 2006 through 20183-107	3-107
21			
22	Table 3.9-13	Annual Average Measurable Occupational Doses at Pressurized Water Reactor Commercial Nuclear Power Plant Sites from 2006 through 20183-109	3-109
23			
24			
25	Table 3.9-14	Annual Average Measurable Occupational Doses at Boiling Water Reactor Commercial Nuclear Power Plant Sites from 2006 through 20183-112	3-112
26			
27			
28	Table 3.9-15	Average, Maximum, and Minimum Annual Collective Occupational Dose per Plant for Pressurized Water Reactor Nuclear Power Plants in person-rem3-113	3-113
29			
30			
31	Table 3.9-16	Average, Maximum, and Minimum Annual Collective Occupational Dose per Plant for Boiling Water Reactor Nuclear Power Plants in person-rem3-113	3-113
32			
33			
34	Table 3.9-17	Average, Maximum, and Minimum Annual Individual Occupational Whole-Body Dose for Pressurized Water Reactor Nuclear Power Plants in rem3-113	3-113
35			
36			
37	Table 3.9-18	Average, Maximum, and Minimum Annual Individual Occupational Whole-Body Dose for Boiling Water Reactor Nuclear Power Plants in rem3-114	3-114
38			
39			
40	Table 3.9-19	Number of Workers at Boiling Water Reactors and Pressurized Water Reactors Who Received Whole-Body Doses within Specified Ranges during 2018.....3-114	3-114
41			
42			
43	Table 3.9-20	Collective and Average Committed Effective Dose Equivalent for Commercial U.S. Nuclear Power Plant Sites in 2018.....3-115	3-115
44			
45	Table 3.9-21	Doses from Gaseous Effluent Releases by Select Pressurized Water Reactors from 2018 through 2020.....3-119	3-119
46			

1	Table 3.9-22	Doses from Gaseous Effluent Releases by Select Boiling Water Reactors from 2018 through 2020.....	3-120
2			
3	Table 3.9-23	Dose from Liquid Effluent Releases by Select Pressurized Water Reactor Nuclear Power Plants for 2018 through 2020	3-121
4			
5	Table 3.9-24	Dose from Liquid Effluent Releases from Select Boiling Water Reactor Nuclear Power Plants for 2018 through 2020.....	3-121
6			
7	Table 3.9-25	Average Annual Effective Dose Equivalent of Ionizing Radiation to a Member of the U.S. Population for 2016	3-123
8			
9	Table 3.9-26	Nominal Probability Coefficients Used in ICRP (1991).....	3-124
10	Table 3.9-27	Number and Rate of Fatal Occupational Injuries by Industry Sector in 2020.....	3-132
11			
12	Table 3.9-28	Incidence Rate of Nonfatal Occupational Injuries and Illnesses in Different Utilities in 2020.....	3-132
13			
14	Table 3.9-29	Number and Rate of Fatal Occupational Injuries for Selected Occupations in 2020.....	3-133
15			
16	Table 3.11-1	Solid Low-Level Radioactive Waste Shipped Offsite per Reactor from Select Pressurized Water Reactor Power Plant Sites in 2020	3-139
17			
18	Table 3.11-2	Solid Low-Level Radioactive Waste Shipped Offsite per Reactor from Select Boiling Water Reactor Power Plant Sites in 2020	3-140
19			
20	Table 3.12-1	Greenhouse Gas Emissions by State, 2020.....	3-146
21	Table 3.12-2	Estimated Greenhouse Gas Emissions from Operations at Nuclear Power Plants	3-149
22			
23	Table 4.3-1	Emission Factors of Representative Fossil Fuel Plants	4-18
24	Table 4.5-1	Water Withdrawal and Consumptive Use Factors for Select Electric Power Technologies	4-51
25			
26	Table 4.6-1	Estimated Radiation Dose Rates to Terrestrial Ecological Receptors from Radionuclides in Water, Sediment, and Soils at U.S. Nuclear Power Plants	4-60
27			
28			
29	Table 4.6-2	Estimated Annual Bird Collision Mortality in the United States	4-66
30	Table 4.6-3	Commonly Impinged and Entrained Taxa at Nuclear Power Plants by Ecosystem Type	4-76
31			
32	Table 4.6-4	Results of NRC Impingement and Entrainment Analyses at Nuclear Power Plants, 2013–Present	4-81
33			
34	Table 4.6-5	Results of NRC Thermal Analyses at Nuclear Power Plants, 2013–Present	4-86
35			
36	Table 4.6-6	Possible ESA Effect Determinations	4-113
37	Table 4.6-7	Appropriate Type of Consultation by ESA Effect Determination	4-114
38	Table 4.6-8	Possible EFH Effect Determinations	4-118
39	Table 4.6-9	Appropriate Type of Consultation by Type of Proposed Action and EFH Effect Determination.....	4-118
40			
41	Table 4.6-10	Types of Sanctuary Resources	4-120
42	Table 4.6-11	Possible NMSA Effect Determinations	4-121
43	Table 4.9-1	Additional Collective Occupational Dose for Different Actions under Typical and Conservative Scenarios during the License Renewal Term	4-135
44			
45			

Tables

1	Table 4.12-1	Carbon Dioxide Emission Factors for Representative Fossil Fuel	
2		Plants.....	4-164
3	Table 4.14-1	Table S-3 Taken from 10 CFR 51.51 on Uranium Fuel Cycle	
4		Environmental Data	4-175
5	Table 4.14-2	Table S-4 Taken from 10 CFR 51.52 on the Environmental Impact of	
6		Transporting Fuel and Waste to and from One Light-Water-Cooled	
7		Nuclear Power Reactor	4-179
8	Table 4.14-3	Population Doses from Uranium Fuel Cycle Facilities Normalized to	
9		One Reference Reactor Year	4-183
10	Table 6-1	U.S. Nuclear Regulatory Commission Preparers	6-1
11	Table 6-2	Pacific Northwest National Laboratory Preparers.....	6-3
12	Table B.1-1	Comparison of Land Use-Related Environmental Issues and Findings	
13		in This LR GEIS Revision to Prior Versions of Table B-1 of	
14		10 CFR Part 51.....	B-2
15	Table B.1-2	Comparison of Visual Resource-Related Environmental Issues and	
16		Findings in This LR GEIS Revision to Prior Versions of Table B-1 of	
17		10 CFR Part 51.....	B-4
18	Table B.1-3	Comparison of Air Quality-Related Environmental Issues and Findings	
19		in This LR GEIS Revision to Prior Versions of Table B-1 of	
20		10 CFR Part 51.....	B-5
21	Table B.1-4	Comparison of Noise-Related Environmental Issues and Findings in	
22		This LR GEIS Revision to Prior Versions of Table B-1 of	
23		10 CFR Part 51.....	B-7
24	Table B.1-5	Comparison of Geologic-Related Environmental Issues and Findings	
25		in This LR GEIS Revision to Prior Versions of Table B-1 of	
26		10 CFR Part 51.....	B-8
27	Table B.1-6	Comparison of Surface Water Resources-Related Environmental	
28		Issues and Findings in This LR GEIS Revision to Prior Versions of	
29		Table B-1 of 10 CFR Part 51	B-9
30	Table B.1-7	Comparison of Groundwater Resources-Related Environmental	
31		Issues and Findings in This LR GEIS Revision to Prior Versions of	
32		Table B-1 of 10 CFR Part 51	B-14
33	Table B.1-8	Comparison of Terrestrial Resources-Related Environmental Issues	
34		and Findings in This LR GEIS Revision to Prior Versions of Table B-1	
35		of 10 CFR Part 51.....	B-19
36	Table B.1-9	Comparison of Aquatic Resources-Related Environmental Issues and	
37		Findings in This LR GEIS Revision to Prior Versions of Table B-1 of	
38		10 CFR Part 51.....	B-25
39	Table B.1-10	Comparison of Federally Protected Ecological Resources-Related	
40		Environmental Issues and Findings in This LR GEIS Revision to Prior	
41		Versions of Table B-1 of 10 CFR Part 51	B-37
42	Table B.1-11	Comparison of Historic and Cultural Resources-Related	
43		Environmental Issues and Findings in This LR GEIS Revision to Prior	
44		Versions of Table B-1 of 10 CFR Part 51	B-40

1	Table B.1-12	Comparison of Socioeconomics-Related Environmental Issues and Findings in This LR GEIS Revision to Prior Versions of Table B-1 of 10 CFR Part 51.....	B-41
2			
3			
4	Table B.1-13	Comparison of Human Health-Related Environmental Issues and Findings in This LR GEIS Revision to Prior Versions of Table B-1 of 10 CFR Part 51.....	B-45
5			
6			
7	Table B.1-14	Comparison of Postulated Accidents-Related Environmental Issues and Findings in This LR GEIS Revision to Prior Versions of Table B-1 of 10 CFR Part 51.....	B-50
8			
9			
10	Table B.1-15	Comparison of Environmental Justice-Related Environmental Issues and Findings in This LR GEIS Revision to Prior Versions of Table B-1 of 10 CFR Part 51.....	B-52
11			
12			
13	Table B.1-16	Comparison of Waste Management-Related Environmental Issues and Findings in This LR GEIS Revision to Prior Versions of Table B-1 of 10 CFR Part 51.....	B-53
14			
15			
16	Table B.1-17	Comparison of Greenhouse Gas Emissions and Climate Change-Related Environmental Issues and Findings in This LR GEIS Revision to Prior Versions of Table B-1 of 10 CFR Part 51	B-59
17			
18			
19	Table B.1-18	Comparison of Cumulative Effects-Related Environmental Issues and Findings in This LR GEIS Revision to Prior Versions of Table B-1 of 10 CFR Part 51.....	B-61
20			
21			
22	Table B.1-19	Comparison of Uranium Fuel Cycle-Related Environmental Issues and Findings in This LR GEIS Revision to Prior Versions of Table B-1 of 10 CFR Part 51.....	B-62
23			
24			
25	Table B.1-20	Comparison of Termination of Nuclear Power Plant Operations and Decommissioning-Related Environmental Issues and Findings in This LR GEIS Revision to Prior Versions of Table B-1 of 10 CFR Part 51	B-66
26			
27			
28	Table D.2-1	Common Sources of Noise and Decibels Levels	D-6
29	Table D.5-1	Level I Ecoregions and Corresponding Level III Ecoregions That Occur in the Vicinity of Operating U.S. Commercial Nuclear Power Plants.....	D-10
30			
31			
32	Table D.5-2	Ecoregions in the Vicinity of Operating U.S. Commercial Nuclear Power Plants	D-13
33			
34	Table D.5-3	Percent of Area Occupied by Wetland and Deepwater Habitats Within 5 Miles of Operating Nuclear Power Plants.....	D-17
35			
36	Table D.7-1	Definition of Regions of Influence at 12 Nuclear Plants	D-23
37	Table E.3-1	Comparison of 1996 LR GEIS Predicted Risks to License Renewal Estimated Risks.....	E-6
38			
39	Table E.3-2	Pressurized Water Reactor Internal Event Core Damage Frequency Comparison	E-16
40			
41	Table E.3-3	Boiling Water Reactor Internal Event Core Damage Frequency Comparison	E-17
42			
43	Table E.3-4	Pressurized Water Reactor Internal Event Population Dose Risk Comparison	E-18
44			
45	Table E.3-5	Boiling Water Reactor Internal Event Population Dose Risk Comparison	E-19
46			

Tables

1	Table E.3-6	Pressurized Water Reactor All Hazards Core Damage Frequency Comparison	E-22
2			
3	Table E.3-7	Boiling Water Reactor All Hazards Core Damage Frequency Comparison	E-23
4			
5	Table E.3-8	Pressurized Water Reactor All Hazards Population Dose Risk Comparison	E-24
6			
7	Table E.3-9	Boiling Water Reactors All Hazards Population Dose Risk Comparison	E-25
8			
9	Table E.3-10	Fire Core Damage Frequency Comparison.....	E-26
10	Table E.3-11	Seismic Core Damage Frequency Comparison	E-30
11	Table E.3-12	Pressurized Water Reactor and Boiling Water Reactor All Hazards Core Damage Frequency Comparison.....	E-33
12			
13	Table E.3-13	Brief Source Term Description for Unmitigated Peach Bottom Accident Scenarios and the SST1 Source Term from the 1982 Siting Study	E-37
14			
15			
16	Table E.3-14	Brief Source Term Description for Unmitigated Surry Accident Scenarios and the SST1 Source Term from the 1982 Siting Study	E-38
17			
18	Table E.3-15	SOARCA Results: Long-Term Cancer Fatality Risk.....	E-41
19	Table E.3-16	Changes in Large Early Release Frequencies for Extended Power Uprates.....	E-45
20			
21	Table E.3-17	Loss-of-Coolant Accident Consequences as a Function of Fuel Burnup.....	E-49
22			
23	Table E.3-18	Airborne Impacts of Low Power and Shutdown Accidents	E-53
24	Table E.3-19	Impacts of Accidents at Spent Fuel Pools from NUREG-1738.....	E-57
25	Table E.3-20	Uncertainty Analysis Inputs	E-68
26	Table E.3-21	Ratio of Consequence Results for Population Density Sensitivity Cases in the 2015 Containment Protection and Release Reduction Regulatory Analysis.....	E-70
27			
28			
29	Table E.3-22	Uncertain MELCOR Parameters Chosen for the SOARCA Unmitigated Station Blackout Uncertainty Analyses.....	E-74
30			
31	Table E.3-23	Uncertain MACCS Parameter Groups Used in the SOARCA Unmitigated Station Blackout Uncertainty Analyses.....	E-75
32			
33	Table E.3-24	Population-weighted Individual Latent Cancer Fatality Risk Statistics that Are Conditional on the Occurrence of an Long-Term Station Blackout for Five Circular Areas Centered on the Peach Bottom Plant	E-76
34			
35			
36	Table E.3-25	Individual Early Fatality Risk Statistics that Are Conditional on the Occurrence of a Long-Term Station Blackout for Five Circular Areas with Specified Radii Centered on the Peach Bottom Plant.....	E-79
37			
38			
39	Table E.5-1	Summary of Conclusions.....	E-90
40	Table F.5-1	State Environmental Requirements for Air Quality Protection.....	F-13
41	Table F.5-2	State Environmental Requirements for Water Resources Protection.....	F-14
42	Table F.5-3	State Environmental Requirements for Waste Management and Pollution Prevention.....	F-15
43			
44	Table F.5-4	State Environmental Requirements for Emergency Planning and Response	F-15
45			

1 Table F.5-5 State Environmental Requirements for Ecological Resources
 2 ProtectionF-16
 3 Table F.5-6 State Environmental Requirements for Historic and Cultural
 4 Resources ProtectionF-16
 5 Table F.6-1 Federal, State, and Local Permits and Other Requirements for Air
 6 Quality ProtectionF-17
 7 Table F.6-2 Federal, State, and Local Permits and Other Requirements for Water
 8 Resource ProtectionF-17
 9 Table F.6-3 Federal, State, and Local Permits and Other Requirements for Waste
 10 Management and Pollution Prevention.....F-18
 11 Table F.6-4 Federal, State, and Local Permits and Other Requirements for
 12 Emergency Planning and ResponseF-19
 13 Table F.6-5 Federal, State, and Local Permits and Other Requirements for
 14 Ecological Resource Protection.....F-20
 15 Table F.6-6 Federal, State, and Local Permits and Other Requirements for
 16 Historic and Cultural Resource Protection.....F-21
 17

1 **ACRONYMS, ABBREVIATIONS, AND CHEMICAL NOMENCLATURE**

2	°C	degree(s) Celsius
3	°F	degree(s) Fahrenheit
4		
5	ac	acre(s)
6	ADAMS	Agencywide Documents Access and Management System
7	AEA	Atomic Energy Act
8	AEC	U.S. Atomic Energy Commission
9	ALARA	as low as is reasonably achievable
10	APE	area of potential effect
11		
12	BCG	Biota Concentration Guide
13	BEIR	Biological Effects of Ionizing Radiation (National Research Council Committee)
14		
15	BMP	best management practice
16	BTA	best technology available
17	Btu	British thermal unit(s)
18	BWR	boiling water reactor
19		
20	CAA	Clean Air Act
21	CCS	cooling canal system
22	CDC	Centers for Disease Control and Prevention
23	CDF	core damage frequency
24	CEQ	Council on Environmental Quality
25	CFR	<i>Code of Federal Regulations</i>
26	CH ₄	methane
27	cm	centimeter(s)
28	CO	carbon monoxide
29	CO ₂	carbon dioxide
30	CO _{2e}	carbon dioxide equivalent
31	CWA	Clean Water Act
32		
33	dB	decibel(s)
34	dBA	A-weighted decibel(s)
35	DOE	U.S. Department of Energy
36	DPS	distinct population segment
37		
38	EFH	essential fish habitat
39	EI	exposure index
40	EIA	Energy Information Administration
41	EIS	environmental impact statement
42	EMF	electromagnetic field
43	EPA	U.S. Environmental Protection Agency
44	ESA	Endangered Species Act

Acronyms, Abbreviations, and Chemical Nomenclature

1	ESP	early site permit
2	Exelon	Exelon Generating Company LLC
3		
4	F	Fujita (scale)
5	FCDF	fire core damage frequency
6	FES	final environmental statement
7	FLEX	flexible coping
8	FPRA	fire probabilistic risk assessment
9	FR	<i>Federal Register</i>
10	ft	foot (feet)
11	ft ²	square foot (feet)
12	ft ³	cubic foot (feet)
13	FWS	U.S. Fish and Wildlife Service
14		
15	gal	gallon(s)
16	GEIS	generic environmental impact statement
17	GHG	greenhouse gas
18	gpm	gallon(s) per minute
19	GWd	gigawatt day(s)
20	GWd/MT	Gigawatt-days (units of energy) per metric tonne
21	Gy	gray(s)
22		
23	H ₂ O	water; water vapor
24	ha	hectare(s)
25	hr	hour(s)
26	Hz	hertz
27		
28	IAEA	International Atomic Energy Agency
29	ICRP	International Commission on Radiological Protection
30		
31	IM&E	impingement mortality and entrainment
32	in.	inch(es)
33	IPE	Individual Plant Examination
34	IPEEE	Individual Plant Examination of External Events
35	ISFSI	independent spent fuel storage installation
36	ITS	incidental take statement
37		
38	Kd	partition coefficient
39	kg	kilogram(s)
40	km	kilometer(s)
41	kV	kilovolt(s)
42	kW	kilowatt(s)
43	kWh	kilowatt-hour(s)
44		
45	L	liter(s)
46	LAR	license amendment request

Acronyms, Abbreviations, and Chemical Nomenclature

1	lb	pound(s)
2	LCF	latent cancer fatality
3	LERF	large early release frequency
4	LLW	low-level (radioactive) waste
5	Ln	statistical sound level
6	LNT	linear no-threshold
7	LOA	letter of authorization
8	LOCA	loss-of-coolant accident
9	LOEL	lowest observed effects level
10	lpm	liter(s) per minute
11	LR GEIS	<i>Generic Environmental Impact Statement for License Renewal of Nuclear</i>
12		<i>Plants</i>
13	LWR	light water reactor
14		
15	m	meter(s)
16	m ²	square meter(s)
17	m ³	cubic meter(s)
18	m ³ /s	cubic meter(s) per second
19	mA	milliampere(s)
20	MACCS	MELCOR Accident Consequence Code System
21	MCR	main cooling reservoir
22	MEI	maximally exposed individual
23	mG	milligauss
24	mg	milligram(s)
25	mg/L	milligram(s) per liter
26	Mgd	million gallons per day
27	mGy	milligray(s)
28	MHz	megahertz
29	mi	mile(s)
30	min	minute(s)
31	mL	milliliter(s)
32	MLd	million liters per day
33	MMBtu	million Btu
34	MPa	megapascal(s)
35	mph	mile(s) per hour
36	mrad	milliard(s)
37	mrem	millirem(s)
38	MSA	Magnuson-Stevens Fishery Conservation and Management Act
39	mSv	millisievert(s)
40	MT	metric tonne(s)
41	mT	millitesla(s)
42	MTHM	metric tonne(s) of heavy metal
43	MTU	metric tonne(s) of uranium
44	MW	megawatt(s)
45	MW(e)	megawatt(s) electric
46	MW(t)	megawatt(s) thermal

Acronyms, Abbreviations, and Chemical Nomenclature

1	MWh	megawatt-hour(s)
2	NAAQS	National Ambient Air Quality Standards
3	NEPA	National Environmental Policy Act of 1969
4	NGCC	natural gas combined cycle
5	NHPA	National Historic Preservation Act of 1966
6	NMFS	National Marine Fisheries Service
7	NMSA	National Marine Sanctuaries Act
8	NO	nitrogen oxide
9	NO ₂	nitrogen dioxide
10	NOAA	National Oceanic and Atmospheric Administration
11	NO _x	nitrogen oxides
12	NPDES	National Pollutant Discharge Elimination System
13	NRC	U.S. Nuclear Regulatory Commission
14	NREL	National Renewable Energy Laboratory
15	NRHP	National Register of Historic Places
16	NTTF	Near-Term Task Force
17		
18	ODCM	Offsite Dose Calculation Manual
19	ONMS	Office of National Marine Sanctuaries
20	OSHA	Occupational Safety and Health Administration
21		
22	pCi	picocurie(s)
23	pCi/L	picocuries per liter
24	PDR	Population dose risk
25	PM	particulate matter
26	PM ₁₀	particulate matter with a mean aerodynamic diameter of 10 µm or less
27	PM _{2.5}	particulate matter with a mean aerodynamic diameter of 2.5 µm or less
28	ppm	part(s) per million
29	ppmv	parts per million by volume
30	ppt	part(s) per thousand
31	PRA	probabilistic risk assessment
32	PSD	prevention of significant deterioration
33	psi	pound(s) per square inch
34	PWR	pressurized water reactor
35		
36	QHO	quantitative health objective
37		
38	RCRA	Resource Conservation and Recovery Act of 1976
39	rem	roentgen-equivalent-man
40	REMP	Radiological Environmental Monitoring Program
41	ROW	right-of-way
42		
43	s	second(s)
44	SAMA	severe accident mitigation alternative
45	SAMG	severe accident management guideline
46	SCDF	seismic core damage frequency

Acronyms, Abbreviations, and Chemical Nomenclature

1	scf	standard cubic foot (feet)
2	SEIS	supplemental environmental impact statement
3	SFP	spent fuel pool
4	SGTR	steam generator tube rupture
5	SHPO	State Historic Preservation Office or Officer
6	SLR	subsequent license renewal
7	SO ₂	sulfur dioxide
8	SOARCA	state-of-the-art reactor consequence analysis
9	SPRA	seismic probabilistic risk assessment
10	SRM	Staff Requirements Memorandum
11	Sv	sievert(s)
12		
13	TEDE	total effective dose equivalent
14	T/yr	ton (s) per year
15		
16	UA	uncertainty analysis
17	UCB	upper confidence bound
18	UF ₆	uranium hexafluoride
19	USACE	U.S. Army Corps of Engineers
20	USGCRP	U.S. Global Change Research Program
21		
22	VOC	volatile organic compound
23		
24	yr	year(s)
25		
26	μCi	microcurie(s)
27	μGy	microgray(s)

1 **SHORTENED NUCLEAR POWER PLANT NAMES**
2 **USED IN THIS REPORT**

3	Arkansas	Arkansas Nuclear One
4	Beaver Valley	Beaver Valley Power Station
5	Braidwood	Braidwood Station
6	Browns Ferry	Browns Ferry Nuclear Plant
7	Brunswick	Brunswick Steam Electric Plant
8	Byron	Byron Station
9	Callaway	Callaway Plant
10	Calvert Cliffs	Calvert Cliffs Nuclear Power Plant
11	Catawba	Catawba Nuclear Station
12	Clinton	Clinton Power Station
13	Columbia	Columbia Generating Station
14	Comanche Peak	Comanche Peak Steam Electric Station
15	Cooper	Cooper Nuclear Station
16	Crystal River	Crystal River Nuclear Power Plant
17	Davis-Besse	Davis-Besse Nuclear Power Station
18	Diablo Canyon	Diablo Canyon Power Plant
19	D.C. Cook	Donald C. Cook Nuclear Plant
20	Dresden	Dresden Nuclear Power Station
21	Duane Arnold	Duane Arnold Energy Center
22	Farley	Joseph M. Farley Nuclear Plant
23	Fermi	Enrico Fermi Atomic Power Plant
24	FitzPatrick	James A. FitzPatrick Nuclear Power Plant
25	Fort Calhoun	Fort Calhoun Station
26	Ginna	R.E. Ginna Nuclear Power Plant
27	Grand Gulf	Grand Gulf Nuclear Station
28	Harris	Shearon Harris Nuclear Power Plant
29	Hatch	Edwin I. Hatch Nuclear Plant
30	Hope Creek	Hope Creek Generating Station
31	Indian Point	Indian Point Energy Center
32	Kewaunee	Kewaunee Power Station
33	LaSalle	LaSalle County Station
34	Limerick	Limerick Generating Station
35	McGuire	McGuire Nuclear Station
36	Millstone	Millstone Power Station
37	Monticello	Monticello Nuclear Generating Plant
38	Nine Mile Point	Nine Mile Point Nuclear Station
39	North Anna	North Anna Power Station
40	Oconee	Oconee Nuclear Station
41	Oyster Creek	Oyster Creek Nuclear Generating Station
42	Palisades	Palisades Nuclear Plant
43	Palo Verde	Palo Verde Nuclear Generating Station
44	Peach Bottom	Peach Bottom Atomic Power Station

Shortened Nuclear Power Plant Names Used in This Report

1	Perry	Perry Nuclear Power Plant
2	Pilgrim	Pilgrim Nuclear Power Station
3	Point Beach	Point Beach Nuclear Plant
4	Prairie Island	Prairie Island Nuclear Generating Plant
5	Quad Cities	Quad Cities Nuclear Power Station
6	River Bend	River Bend Station
7	Robinson	H.B. Robinson Steam Electric Plant
8	St. Lucie	St. Lucie Nuclear Plant
9	Salem	Salem Nuclear Generating Station
10	San Onofre	San Onofre Nuclear Generating Station
11	Seabrook	Seabrook Station
12	Sequoyah	Sequoyah Nuclear Plant
13	South Texas	South Texas Project Electric Generating Station
14	Summer	Virgil C. Summer Nuclear Station
15	Surry	Surry Power Station
16	Susquehanna	Susquehanna Steam Electric Station
17	Three Mile Island	Three Mile Island, Unit 1
18	Turkey Point	Turkey Point Nuclear Plant
19	Vermont Yankee	Vermont Yankee Nuclear Power Station
20	Vogtle	Vogtle Electric Generating Plant
21	Waterford	Waterford Steam Electric Station
22	Watts Bar	Watts Bar Nuclear Plant
23	Wolf Creek	Wolf Creek Generating Station

CONVERSION TABLE

Multiply	By	To Obtain
<i>To Convert English to Metric Equivalents</i>		
acres	0.4047	hectares (ha)
cubic feet (ft ³)	0.02832	cubic meters (m ³)
cubic yards (yd ³)	0.7646	cubic meters (m ³)
curies (Ci)	3.7×10^{10}	becquerels (Bq)
degrees Fahrenheit (°F) -32	0.5555	degrees Celsius (°C)
feet (ft)	0.3048	meters (m)
gallons (gal)	3.785	liters (L)
gallons (gal)	0.003785	cubic meters (m ³)
inches (in.)	2.540	centimeters (cm)
miles (mi)	1.609	kilometers (km)
pounds (lb)	0.4536	kilograms (kg)
rads	0.01	grays (Gy)
rems	0.01	sieverts (Sv)
short tons (tons)	907.2	kilograms (kg)
short tons (tons)	0.9072	metric tons (t)
square feet (ft ²)	0.09290	square meters (m ²)
square yards (yd ²)	0.8361	square meters (m ²)
square miles (mi ²)	2.590	square kilometers (km ²)
yards (yd)	0.9144	meters (m)
<i>To Convert Metric to English Equivalents</i>		
becquerels (Bq)	2.7×10^{-11}	curies (Ci)
centimeters (cm)	0.3937	inches (in.)
cubic meters (m ³)	35.31	cubic feet (ft ³)
cubic meters (m ³)	1.308	cubic yards (yd ³)
cubic meters (m ³)	264.2	gallons (gal)
degrees Celsius (°C) +17.78	1.8	degrees Fahrenheit (°F)
grays (Gy)	100	rads
hectares (ha)	2.471	acres
kilograms (kg)	2.205	pounds (lb)
kilograms (kg)	0.001102	short tons (tons)
kilometers (km)	0.6214	miles (mi)
liters (L)	0.2642	gallons (gal)
meters (m)	3.281	feet (ft)
meters (m)	1.094	yards (yd)
metric tons (t)	1.102	short tons (tons)
sieverts (Sv)	100	rems
square kilometers (km ²)	0.3861	square miles (mi ²)
square meters (m ²)	10.76	square feet (ft ²)
square meters (m ²)	1.196	square yards (yd ²)

1

EXECUTIVE SUMMARY

2 The Atomic Energy Act of 1954 authorizes the U.S. Nuclear Regulatory Commission (NRC) to
3 issue licenses to operate commercial nuclear power plants for up to 40 years and permits the
4 renewal of these licenses. By regulation, the NRC is allowed to renew these licenses for up to
5 an additional 20 years, depending on the outcome of the safety and environmental reviews.
6 There are no specific limitations in the Atomic Energy Act or the NRC's regulations restricting
7 the number of times a license may be renewed.

8 NRC regulations in Title 10 of the *Code of Federal Regulations* Section 54.17(c) (10 CFR
9 54.17(c)) allow a license renewal application to be submitted within 20 years of license
10 expiration, and NRC regulations at 10 CFR 54.31(b) specify that a renewed license will be for a
11 term of up to 20 years plus the length of time remaining on the current license. As a result,
12 renewed licenses may be for a term of up to 40 years.

13 The license renewal process is designed to ensure safe operation of the nuclear power plant
14 and protection of the environment during the license renewal term. Under the NRC's
15 environmental protection regulations in 10 CFR Part 51, which implements Section 102(2) of the
16 National Environmental Policy Act (NEPA), the renewal of a nuclear power plant operating
17 license requires an analysis of the environmental effects of the action and the preparation of an
18 environmental impact statement (EIS).

19 To support the preparation of license renewal EISs, the NRC conducted a comprehensive
20 review to identify the environmental effects of license renewal. The review determined which
21 environmental effects could result in the same or similar (generic) impact at all nuclear power
22 plants or a subset of plants and which effects could result in different levels of impact, requiring
23 nuclear power plant-specific analyses for an impact determination. The review culminated in
24 the issuance of the *Generic Environmental Impact Statement for License Renewal of Nuclear
25 Plants* (LR GEIS), NUREG-1437, in May 1996, followed by the publication of the final rule that
26 codified the LR GEIS findings on June 5, 1996 (61 *Federal Register* [FR] 28467).¹

27 The 1996 LR GEIS² improved the efficiency of the license renewal environmental review
28 process by (1) identifying and evaluating all of the environmental effects that may occur when
29 renewing commercial nuclear power plant operating licenses, (2) identifying and evaluating the
30 environmental effects that are expected to be generic (the same or similar) at all nuclear plants
31 or a subset of plants, and (3) defining the number and scope of the environmental effects that
32 need to be addressed in nuclear power plant-specific EISs. For the issues that cannot be
33 evaluated generically, the NRC conducts nuclear power plant-specific (hereafter called plant-
34 specific) environmental reviews and prepares plant-specific supplemental EISs (SEISs) to the
35 LR GEIS. The generic environmental findings in the LR GEIS are applicable to the 20-year
36 license renewal increment, either an initial license renewal (initial LR) term or the first
37 subsequent license renewal (SLR) term, plus the number of years remaining on the current
38 license, up to a maximum of 40 years.

¹ Final rules were also issued in December 18, 1996 (61 FR 66537), and September 3, 1999 (64 FR 48496).

² Any reference to the 1996 LR GEIS includes the two-volume set published in May 1996 and Addendum 1 to the LR GEIS published in August 1999.

Executive Summary

1 The 1996 final rule codified the findings of the 1996 LR GEIS into regulations at 10 CFR
2 Part 51, Appendix B to Subpart A, “Environmental Effect of Renewing the Operating License of
3 a Nuclear Power Plant,” and Table B-1, “Summary of Findings on NEPA Issues for License
4 Renewal of Nuclear Power Plants” (61 FR 28467, June 5, 1996). As stated in the final rule, the
5 Commission recognized that environmental issues might change over time and that additional
6 issues may need to be considered. Based on this recognition, and as further stated in the rule
7 and in the introductory paragraph to Appendix B to Subpart A in Part 51 of the regulations, the
8 Commission intends to review the material in Appendix B, including Table B-1 and the
9 underlying LR GEIS, on a 10-year basis, and update it if necessary.

10 Subsequently, the NRC completed its first 10-year review of the 1996 LR GEIS and Table B-1
11 on June 20, 2013. That review of the LR GEIS considered lessons learned and knowledge
12 gained from completed license renewal environmental reviews since 1996. The updated LR
13 GEIS, Revision 1, and final rule (78 FR 37282), including Table B-1, redefined the number and
14 scope of the NEPA issues that must be addressed in license renewal environmental reviews.

15 The NRC began the second 10-year review on August 4, 2020, by publishing a notice of intent
16 to review and potentially update the LR GEIS (85 FR 47252), which contained the staff’s
17 preliminary analysis, including for SLR. The notice invited public comments and proposals for
18 specific environmental areas that should be updated. Pursuant to 10 CFR 51.29, the NRC
19 conducted scoping and held a series of public meetings (see 85 FR 47252 for more details).
20 The scoping period concluded on November 2, 2020.

21 In July 2021, the NRC staff submitted a rulemaking plan via SECY-21-0066 requesting
22 Commission approval to initiate a rulemaking to amend Table B-1 and update the LR GEIS and
23 associated guidance. In February 2022, the Commission issued Staff Requirements
24 Memorandum (SRM)-SECY-21-0066, disapproving the staff’s recommendation and directing
25 the staff to develop a rulemaking plan that aligned with the Commission’s adjudicatory Order
26 CLI-22-03, and recent decisions in Orders CLI-22-02 and CLI-22-04, which concluded that the
27 2013 GEIS did not apply to SLR applications. The SRM also directed the NRC staff to include
28 in the rulemaking plan a proposal to revise the LR GEIS, Table B-1, other regulations, and
29 associated guidance, to fully account for one term of SLR.

30 The NRC staff submitted a revised rulemaking plan via SECY-22-0024 in March 2022 that
31 requested Commission approval to initiate a rulemaking that aligned with the Commission’s
32 Order CLI-22-03 and recent decisions in Orders CLI-22-02 and CLI-22-04 regarding the NEPA
33 analysis of SLR applications by updating NRC regulations and revising the LR GEIS, Table B-1,
34 and associated guidance to fully account for one term of SLR. In April 2022, the Commission
35 issued SRM-SECY-22-0024 approving the staff’s recommendation to proceed with the
36 rulemaking.

37 In April 2022, pursuant to SRM-SECY-21-0066, the staff also submitted a second paper to the
38 Commission, SECY-22-0036, which concluded that no further updates to the LR GEIS were
39 needed beyond those identified in SECY-22-0024 and that the rulemaking effort identified in
40 SECY-22-0024 should constitute the agency’s 10-year update to the LR GEIS. In June 2022,
41 the Commission approved these recommendations in SRM-SECY-22-0036.

42 The proposed revisions to the LR GEIS are based on the consideration of (1) comments
43 received from the public during the public scoping period, (2) a review of comments received on
44 plant-specific SEISs, and (3) lessons learned and knowledge gained from previously completed
45 and ongoing initial LR and SLR environmental reviews, (4) and Commission direction in SRM-

1 SECY-22-0024. In addition, new scientific research, public comments, changes in
2 environmental regulations and impacts methodology, and other new information were
3 considered in evaluating the potential impacts associated with nuclear power plant continued
4 operations and refurbishment during the license renewal term (initial LR or SLR).

5 Since development of the 2013 LR GEIS, 15 nuclear power plants have undergone initial LR
6 environmental reviews. For the purposes of this review, the NRC also considered five SLR
7 environmental reviews, including two environmental reviews (i.e., for North Anna and Point
8 Beach plants) for which the NRC has issued a draft SEIS, but not a final SEIS. The purpose of
9 the review for this LR GEIS is to determine if the findings presented in the 2013 LR GEIS
10 remain valid for initial LR and support the scope of license renewal, consider whether those
11 findings also apply to SLR, and to update or revise those findings as appropriate. When
12 conducting a thorough update to the LR GEIS that reflects the “hard look” that is required for a
13 NEPA document, the NRC considered changes in applicable laws and regulations, new data,
14 collective experience, and lessons learned and knowledge gained from conducting initial LR and
15 SLR environmental reviews since development of the 2013 LR GEIS. These developments and
16 practical insights informed this LR GEIS revision. In doing so, the NRC considered the need to
17 modify, add to, group, subdivide, or delete any of the 78 environmental issues evaluated in the
18 2013 LR GEIS.

19 **S.1 Purpose and Need for the Proposed Action**

20 The proposed action is the renewal of commercial nuclear power plant operating licenses. A
21 renewed license is just one of a number of conditions that licensees must meet to be allowed to
22 continue to operate the nuclear power plant during the renewal term.

23 The purpose and need for the proposed action (license renewal) is to provide an option for the
24 continued operation of the nuclear power plant beyond the current licensing term to meet future
25 system power-generation needs, as such needs may be determined by State, utility, system,
26 and, where authorized, Federal (other than NRC) decisionmakers. Unless there are findings in
27 the safety review required by the Atomic Energy Act or in the NEPA environmental review that
28 would lead the NRC to not renew the operating license, the NRC has no role in the energy-
29 planning decisions of power plant owners, State regulators, system operators, and, in some
30 cases, other Federal agencies as to whether the nuclear power plant should continue to
31 operate.

32 In addition, the NRC has no authority or regulatory control over the ultimate selection of
33 replacement energy alternatives. The NRC also cannot ensure the selection of environmentally
34 preferable replacement power alternatives. While a range of reasonable replacement energy
35 alternatives are discussed in the LR GEIS, and evaluated in detail in plant-specific supplements
36 to the LR GEIS, the only alternative to license renewal within NRC’s decisionmaking authority is
37 to not renew the operating license. The environmental impacts of not renewing the operating
38 license are addressed under the no action alternative.

39 At some point, all nuclear power plants will terminate reactor operations and begin the
40 decommissioning process. Under the no action alternative, reactor operations would be
41 terminated at or before the end of the current operating license. The no action alternative,
42 unlike the other alternatives, does not expressly meet the purpose and need of the proposed
43 action (license renewal), because it does not provide an option for energy-planning
44 decisionmakers in meeting future electric power system needs. No action, on its own, would
45 likely create a need for replacement power, energy conservation and efficiency (demand-side

1 management), purchasing power from outside the region, or some combination of these
2 options. Thus, a range of reasonable replacement energy alternatives is described in the LR
3 GEIS, including fossil fuel, new nuclear, and renewable energy sources. Conservation and
4 power purchasing are also considered as replacement energy alternatives to license renewal
5 because they represent other options for electric power system planners.

6 **S.2 Development of the Revised Generic Environmental Impact Statement**

7 This LR GEIS documents the results of the systematic approach the NRC used to evaluate the
8 environmental impacts of renewing the operating licenses of commercial nuclear power plants
9 for an additional 20 years beyond the current license term, plus the number of years remaining
10 on the current license, up to a maximum of 40 years. The environmental consequences of both
11 initial LR and SLR include (1) impacts associated with continued operations and any
12 refurbishment activities similar to those that have occurred during the current license term;
13 (2) impacts of various alternatives to the proposed action; (3) impacts from the termination of
14 nuclear power plant operations and decommissioning after the license renewal term (with
15 emphasis on the incremental effect caused by an additional 20 years of operation); (4) impacts
16 associated with the uranium fuel cycle; (5) impacts of postulated accidents (design-basis
17 accidents and severe accidents); (6) cumulative effects of the proposed action; and (7) resource
18 commitments associated with the proposed action, including unavoidable adverse impacts,
19 relationship between short-term use and long-term productivity, and irreversible and irretrievable
20 commitment of resources. The LR GEIS also discusses the impacts of various reasonable
21 alternatives to the proposed action (initial LR or SLR). The environmental consequences of
22 these activities are discussed in the LR GEIS.

23 For this revision, the NRC staff reviewed and evaluated the 78 environmental issues and impact
24 findings from the 2013 LR GEIS. Experience gained from license renewal reviews conducted
25 since development of the 2013 LR GEIS provides a source of new information for the evaluation
26 presented in this LR GEIS revision. In addition, new research, findings, and other information
27 were considered in evaluating the significance of impacts associated with initial LR and SLR.
28 The purpose of the evaluation was to determine if the 2013 LR GEIS findings remain valid and
29 apply to SLR. In doing so, the NRC considered the need to modify, add to, group, subdivide, or
30 delete any of the 78 issues evaluated in the 2013 LR GEIS.

31 In a notice of intent published in the *Federal Register* on August 4, 2020 (85 FR 47252), the
32 NRC notified the public of its preliminary analysis and plan to review and potentially revise the
33 LR GEIS, including to address SLR, and to provide an opportunity to participate in the
34 environmental scoping process. This step was the initial opportunity for public participation in
35 the LR GEIS revision. The NRC held four public webinars in August 2020 (August 19, 2020 and
36 August 27, 2020, from 1:30 p.m. to 4:00 p.m. Eastern Daylight Time and 6:30 p.m. to 9:00 p.m.
37 Eastern Daylight Time).

38 Participation in the scoping process by members of the public and local, State, Tribal, and
39 Federal government agencies was encouraged and used to (1) determine whether to update the
40 2013 LR GEIS; (2) define the proposed action; (3) determine the scope of the update and
41 identify whether there are any significant new issues to be analyzed in depth; (4) identify and
42 eliminate from detailed study issues that are peripheral, are not significant, or have been
43 covered by prior environmental review; (5) identify environmental assessments and other EISs
44 under development or consideration related to the scope of the LR GEIS update; (6) identify
45 other review and consultation requirements related to the proposed action; and (7) describe how

1 the LR GEIS revision will be prepared. In addition, the NRC proposed to address SLRs in the
2 LR GEIS revision.

3 The scoping period for this LR GEIS revision was from August 4, 2020 to November 2, 2020.
4 The NRC staff reviewed the transcripts from the public meetings and all written material
5 received during the scoping period and identified individual comments. All comments and
6 suggestions received orally during the scoping meetings or in writing were considered. The
7 NRC staff issued a scoping summary report in June 2021.

8 In evaluating the impacts of the proposed action (license renewal) and considering comments
9 received during the scoping period, as well as the Commission's direction in SRM-SECY-22-
10 0024, the NRC identified 80 environmental issues: 72 environmental issues were associated
11 with continued operations, refurbishment, and other supporting activities; 2 with postulated
12 accidents; 1 with termination of plant operations and decommissioning; 4 with the uranium fuel
13 cycle; and 1 with cumulative effects (impacts). For all of these issues, the incremental effect of
14 license renewal was the focus of the evaluation.

15 For each potential environmental issue, the revised LR GEIS (1) describes the nuclear power
16 plant activity during the initial LR or SLR term that could affect the resource; (2) identifies the
17 resource that is affected, (3) evaluates past license renewal reviews and other available
18 information, including information related to impacts during a SLR term; (4) assesses the nature
19 and magnitude of the environmental impact on the affected resource during initial LR or SLR;
20 (5) characterizes the significance of the effect; (6) determines whether the results of the analysis
21 apply to all nuclear power plants (whether the environmental issue is Category 1, Category 2, or
22 uncategorized); and (7) considers additional mitigation measures for adverse impacts.

23 The scope of the revised LR GEIS also discusses a range of alternatives to license renewal,
24 including replacement power generation (using fossil fuels, nuclear, and renewables), energy
25 conservation and efficiency (demand-side management), and purchased power. It also
26 evaluates the impacts from the no action alternative (not renewing the operating license). This
27 LR GEIS includes the NRC's evaluation of construction, operation, postulated accidents,
28 decommissioning, and fuel cycles for replacement energy alternatives.

29 **S.3 Impact Definitions and Categories**

30 The NRC's environmental impact standard considers Council on Environmental Quality (CEQ)
31 terminology, including CEQ revisions in Part 1501—NEPA and Agency Planning
32 (40 CFR 1501).

33 In considering whether the effects of the proposed action are significant, the NRC analyzes the
34 potentially affected environment and degree of the effects of the proposed action (initial LR or
35 SLR). The potentially affected environment consists of the affected area and its resources,
36 such as listed species and designated critical habitat under the Endangered Species Act (ESA).
37 For nuclear power plant-specific environmental issues, significance would depend on the effects
38 in the local area—including (1) both short- and long-term effects; (2) both beneficial and adverse
39 effects; (3) effects on public health and safety; and (4) effects that would violate Federal, State,
40 Tribal, or local law protecting the environment (40 CFR 1501.3(b)).

41 Based on this, the NRC has established three significance levels for potential impacts: SMALL,
42 MODERATE, and LARGE. The three significance levels, presented in a footnote to Table B-1
43 of 10 CFR Part 51, Appendix B to Subpart A, are defined as follows:

Executive Summary

- 1 • **SMALL:** Environmental effects are not detectable or are so minor that they will neither
2 destabilize nor noticeably alter any important attribute of the resource. For the purposes of
3 assessing radiological impacts, the Commission has concluded that those impacts that do
4 not exceed permissible levels in the Commission's regulations are considered **SMALL**.
- 5 • **MODERATE:** Environmental effects are sufficient to alter noticeably, but not to destabilize,
6 important attributes of the resource.
- 7 • **LARGE:** Environmental effects are clearly noticeable and are sufficient to destabilize
8 important attributes of the resource.

9 In addition to determining the impacts for each environmental issue, the NRC also determined
10 whether the analysis in the LR GEIS could be applied to all nuclear power plants (or plants with
11 specified design or site characteristics). Issues were assigned Category 1 or Category 2 as
12 follows:

13 Category 1 issues are those that meet all of the following criteria:

- 14 – The environmental impacts associated with the issue have been determined to
15 apply either to all plants or, for some issues, to plants having a specific type of
16 cooling system or other specified plant or site characteristics;
- 17 – A single significance level (i.e., **SMALL**, **MODERATE**, or **LARGE**) has been
18 assigned to the impacts (except for offsite radiological impacts of spent nuclear fuel
19 and high-level waste disposal and offsite radiological impacts—collective impacts
20 from other than the disposal of spent fuel and high-level waste); and
- 21 – Mitigation of adverse impacts associated with the issue has been considered in the
22 analysis, and it has been determined that additional plant-specific mitigation
23 measures are not likely to be sufficiently beneficial to warrant implementation.

24 For issues that meet the three Category 1 criteria, no additional plant-specific analysis is
25 required in future SEISs unless new and significant information is identified.

26 Category 2 issues are those that do not meet one or more of the criteria of Category 1, and
27 therefore, require additional plant-specific review.

28 **S.4 Affected Environment**

29 For purposes of the evaluation in this LR GEIS revision, the “affected environment” is the
30 environment currently existing around operating commercial nuclear power plants. Current
31 conditions in the affected environment are the result of past construction and operations at the
32 plants. The NRC has considered the effects of these past and ongoing impacts and how they
33 have shaped the environment. The NRC evaluated impacts of license renewal that are
34 incremental to existing conditions. These existing conditions serve as the baseline for the
35 evaluation and include the effects of past and present actions at the nuclear power plant sites
36 and vicinity. This existing affected environment comprises the environmental baseline against
37 which potential environmental impacts of license renewal are evaluated.

38 In the LR GEIS, the NRC describes the affected environment in terms of the following resource
39 areas or subject matter areas: (1) description of nuclear power plant facilities and operations;
40 (2) land use and visual resources; (3) meteorology, air quality, and noise; (4) geologic
41 environment; (5) water resources (surface water and groundwater resources); (6) ecological

1 resources (terrestrial resources, aquatic resources, and federally protected ecological
 2 resources); (7) historic and cultural resources; (8) socioeconomics; (9) human health
 3 (radiological and nonradiological hazards and postulated accidents); (10) environmental justice;
 4 (11) waste management and pollution prevention (radioactive and nonradioactive waste); and
 5 (12) greenhouse gas (GHG) emissions and climate change. The affected environments of the
 6 operating plant sites represent diverse environmental conditions.

7 **S.5 Impacts from Continued Operations and Refurbishment Activities Associated** 8 **with License Renewal (Initial or Subsequent)**

9 The NRC identified 80 environmental issues related to continued operations and refurbishment
 10 associated with both initial LR or SLR. Twenty of the issues were identified as Category 2
 11 issues and would require plant-specific evaluations in future SEISs. Fifty-nine issues have been
 12 evaluated and determined to be generic to all nuclear power plants or to a subset of plants, and
 13 one issue is uncategorized. The conclusions for each issue are listed below by resource area.

14 **Land Use**

- 15 • The impacts of continued operations and refurbishment on onsite land use would be
 16 SMALL. Changes in onsite land use from continued operations and refurbishment
 17 associated with license renewal would be a small fraction of the nuclear power plant site and
 18 would only involve land that is controlled by the licensee. This is a Category 1 issue.
- 19 • The impacts of continued operations and refurbishment on offsite land use would be
 20 SMALL. Offsite land use would not be affected by continued operations and refurbishment
 21 associated with license renewal. This is a Category 1 issue.
- 22 • The impacts of continued operations and refurbishment on offsite land use in transmission
 23 line right-of-ways (ROWs) would be SMALL. Use of transmission line ROWs would continue
 24 with no change in offsite land use restrictions. This is a Category 1 issue.

25 **Visual Resources**

- 26 • The impacts of continued operations and refurbishment on the visual appearance
 27 (aesthetics) of plant structures or transmission lines from continued operations and
 28 refurbishment would be SMALL. No important changes to the aesthetics are expected from
 29 continued operations and refurbishment. This is a Category 1 issue.

30 **Air Quality**

- 31 • Air quality impacts from continued operations and refurbishment activities would be SMALL
 32 at all plants. Emissions from emergency diesel generators and fire pumps and routine
 33 operations of boilers used for space heating are minor. Impacts from cooling tower
 34 particulate emissions even under the worst-case situations have been small. Emissions
 35 resulting from refurbishment activities at locations in or near air quality nonattainment or
 36 maintenance areas would be short-lived and would cease after these activities are
 37 completed. Operating experience has shown that the scale of refurbishment activities has
 38 not resulted in exceedance of the *de minimis* thresholds for criteria pollutants, and best
 39 management practices (BMPs), including fugitive dust controls and the imposition of permit
 40 conditions in State and local air emissions permits, would ensure conformance with
 41 applicable State or Tribal implementation plans. This is a Category 1 issue.

Executive Summary

- 1 • The impacts on air quality from continued operations of transmission lines would be SMALL.
2 Production of ozone and oxides of nitrogen from transmission lines is insignificant and does
3 not contribute measurably to ambient levels of these gases. This is a Category 1 issue.

4 **Noise**

- 5 • The impacts of continued operations and refurbishment on offsite noise levels would be
6 SMALL. Noise levels would remain below regulatory guidelines for offsite receptors. This is
7 a Category 1 issue.

8 **Geologic Environment**

- 9 • The impacts of continued operations and refurbishment activities on geology and soils would
10 be SMALL for all nuclear plants and would not change appreciably during the license
11 renewal term. This is a Category 1 issue.

12 **Surface Water Resources**

- 13 • The non-cooling system impacts of continued operations and refurbishment on surface
14 water use and quality would be SMALL if BMPs are employed to control soil erosion and
15 spills. Surface water use would not increase significantly or would be reduced if
16 refurbishment occurs during a plant outage. This is a Category 1 issue.
- 17 • Altered current patterns would be limited to the area in the vicinity of the intake and
18 discharge structures. These impacts have been SMALL at operating nuclear power plants.
19 This is a Category 1 issue.
- 20 • Effects on salinity gradients would be limited to the area in the vicinity of the intake and
21 discharge structures. These impacts have been SMALL at operating nuclear power plants.
22 This is a Category 1 issue.
- 23 • Effects on thermal stratification in lakes would be limited to the area in the vicinity of the
24 intake and discharge structures. These impacts have been SMALL at operating nuclear
25 power plants. This is a Category 1 issue.
- 26 • Scouring effects would be limited to the area in the vicinity of the intake and discharge
27 structures. These impacts have been SMALL at operating nuclear power plants. This is a
28 Category 1 issue.
- 29 • The impacts from discharges of metals during continued operations and refurbishment
30 would be SMALL. Discharges of metals in cooling system effluent have not been found to
31 be a problem at operating nuclear power plants that have cooling-tower-based heat
32 dissipation systems and have been mitigated at other plants. Discharges are monitored as
33 part of the National Pollutant Discharge Elimination System (NPDES) permit process. This
34 is a Category 1 issue.
- 35 • The discharge and effects of biocides, sanitary wastes, and minor chemical spills are
36 regulated by State and Federal environmental agencies. Discharges are monitored and
37 controlled as part of the NPDES permit process. These impacts have been SMALL at
38 operating nuclear power plants. This is a Category 1 issue.
- 39 • Surface water use conflicts at plants with once-through cooling systems have not been
40 found to be a problem at operating nuclear power plants that have once-through heat
41 dissipation systems and the impacts would be SMALL. This is a Category 1 issue.

- 1 • Surface water use conflicts could occur at nuclear power plants that rely on cooling ponds or
2 cooling towers using makeup water from a river. Impacts could be SMALL or MODERATE,
3 depending on makeup water requirements, water availability, and competing water
4 demands. This is a Category 2 issue.
- 5 • The effects of dredging on surface water quality would be SMALL. Dredging to remove
6 accumulated sediments in the vicinity of intake and discharge structures and to maintain
7 barge shipping has not been found to be a problem for surface water quality. Dredging is
8 performed under permit from the U.S. Army Corps of Engineers, and possibly, from State or
9 local agencies. This is a Category 1 issue.
- 10 • The impacts of temperature effects on sediment transport capacity would be SMALL.
11 Temperature effects on sediment capacity have not been found to be a problem at operating
12 nuclear power plants and are not expected to be a problem during the license renewal term.
13 This is a Category 1 issue.

14 **Groundwater Resources**

- 15 • The non-cooling system impacts of continued operations and refurbishment on groundwater
16 would be SMALL. Extensive dewatering is not anticipated during continued operations and
17 refurbishment associated with license renewal. Industrial practices involving the use of
18 solvents, hydrocarbons, heavy metals, or other chemicals and/or the use of wastewater
19 ponds or lagoons have the potential to contaminate site groundwater, soil, and subsoil.
20 Contamination is subject to State or U.S. Environmental Protection Agency (EPA)-regulated
21 cleanup and monitoring programs. The application of BMPs for handling any materials
22 produced or used during these activities would reduce impacts. This is a Category 1 issue.
- 23 • Groundwater use conflicts are not anticipated for nuclear power plants that withdraw less
24 than 100 gallons per minute and the impacts would be SMALL. This is a Category 1 issue.
- 25 • Groundwater use conflicts with nearby groundwater users could occur at nuclear power
26 plants that withdraw more than 100 gallons per minute. Impacts could be SMALL,
27 MODERATE, or LARGE. This is a Category 2 issue.
- 28 • For plants that have closed-cycle cooling systems that withdraw makeup water from a river,
29 groundwater use conflicts could result from water withdrawals from rivers during low-flow
30 conditions, which may affect aquifer recharge. The significance of impacts would depend on
31 makeup water requirements, water availability, and competing water demands. The impacts
32 on groundwater quality could be SMALL, MODERATE, or LARGE. This is a Category 2
33 issue.
- 34 • The impacts of continued operations and refurbishment activities on groundwater quality
35 resulting from water withdrawals would be SMALL. Groundwater withdrawals at operating
36 nuclear power plants would not significantly degrade groundwater quality. This is a
37 Category 1 issue.
- 38 • For plants that have cooling ponds, the impacts on groundwater quality could be SMALL or
39 MODERATE. The significance of the impact would depend on cooling pond operation;
40 water quality; site hydrogeologic conditions (including the interaction of surface water and
41 groundwater); and the location, depth, and pump rate of water wells. This is a Category 2
42 issue.
- 43 • Radionuclides released to groundwater, particularly tritium, due to inadvertent leaks of
44 radioactive liquids from plant components and pipes could result in SMALL or MODERATE
45 groundwater quality impacts. Such leaks have occurred at numerous plants. Groundwater

Executive Summary

1 protection programs have been established at all operating nuclear power plants to minimize
2 the potential impact from any inadvertent releases. This is a Category 2 issue.

3 **Terrestrial Resources**

- 4 • Non-cooling system impacts on terrestrial resources may be SMALL, MODERATE, or
5 LARGE. The magnitude of the effects of continued nuclear power plant operation and
6 refurbishment, unrelated to operation of the cooling system, would depend on numerous
7 site-specific factors, including ecological setting, planned activities during the license
8 renewal term, and characteristics of the plants and animals present in the area. Application
9 of BMPs and other conservation initiatives would reduce the potential for impacts. This is a
10 Category 2 issue.
- 11 • Exposure of terrestrial organisms to radionuclides would be SMALL. Doses to terrestrial
12 organisms from continued nuclear power plant operation and refurbishment during the
13 license renewal term would be expected to remain well below U.S. Department of Energy
14 exposure guidelines developed to protect these organisms. This is a Category 1 issue.
- 15 • Cooling system impacts on terrestrial resources for plants that have once-through cooling
16 systems or cooling ponds would be SMALL. Continued operation of nuclear power plant
17 cooling systems during license renewal could cause thermal effluent additions to receiving
18 water bodies, chemical effluent additions to surface water or groundwater, impingement of
19 waterfowl, disturbance of terrestrial plants and wetlands by maintenance dredging, and
20 erosion of shoreline habitat. However, plants where these impacts have occurred
21 successfully mitigated the impact, and it is no longer of concern. These impacts are not
22 expected to be significant issues during the license renewal term. This is a Category 1
23 issue.
- 24 • Cooling tower impacts on terrestrial plants would be SMALL. Continued operation of
25 nuclear power plant cooling towers could deposit particulates and water droplets or ice on
26 vegetation and lead to structural damage or changes in terrestrial plant communities.
27 However, plants where these impacts occurred successfully mitigated the impact. These
28 impacts are not expected to be significant issues during the license renewal term. This is a
29 Category 1 issue.
- 30 • The impacts of bird collisions with plant structures and transmission lines would be SMALL.
31 Bird mortalities from collisions with nuclear power plant structures and in-scope transmission
32 lines would be negligible for any species and are unlikely to threaten the stability of local or
33 migratory bird populations or result in noticeable impairment of the function of a species
34 within the ecosystem. These impacts are not expected to be significant issues during the
35 license renewal term. This is a Category 1 issue.
- 36 • Nuclear power plants could consume water at rates that cause occasional or intermittent
37 water use conflicts with nearby and downstream terrestrial and riparian communities. Such
38 impacts could noticeably affect riparian or wetland species or alter characteristics of the
39 ecological environment. The one plant where impacts have occurred successfully mitigated
40 the impact. Impacts are expected to be SMALL at most nuclear power plants but could be
41 MODERATE at some. This is a Category 2 issue.
- 42 • Transmission line ROW management impacts on terrestrial resources would be SMALL. In-
43 scope transmission lines tend to occupy only industrial-use or other developed portions of
44 nuclear power plant sites and, therefore, the effects of ROW maintenance on terrestrial
45 plants and animals during the license renewal term would be negligible. Application of
46 BMPs would reduce the potential for impacts. This is a Category 1 issue.

- 1 • Electromagnetic field (EMF) effects on terrestrial plants and animals would be SMALL. In-
2 scope transmission lines tend to occupy only industrial-use or other developed portions of
3 nuclear power plant sites and, therefore, the effects of EMFs on terrestrial plants and
4 animals would be negligible. This is a Category 1 issue.

5 **Aquatic Resources**

- 6 • The impacts of impingement mortality and entrainment (IM&E) of aquatic organisms at
7 nuclear power plants that have once-through cooling systems or cooling ponds may be
8 SMALL, MODERATE, or LARGE. Impacts would generally be SMALL at nuclear power
9 plants that have implemented best technology requirements for existing facilities under
10 Clean Water Act (CWA) Section 316(b). For all other nuclear power plants that have once-
11 through cooling systems or cooling ponds, impacts could be SMALL, MODERATE, or
12 LARGE depending on characteristics of the cooling water intake system, results of
13 impingement and entrainment studies performed at the plant, trends in local fish and
14 shellfish populations, and implementation of mitigation measures. This is a Category 2
15 issue.
- 16 • The impacts of IM&E of aquatic organisms at nuclear power plants that have cooling towers
17 would be SMALL. No significant impacts on aquatic populations associated with IM&E at
18 nuclear power plants that have cooling towers have been reported, including effects on fish
19 and shellfish from direct mortality, injury, or other sublethal effects. Impacts during the
20 license renewal term would be similar and small. Further, the effects of these cooling water
21 intake systems would be mitigated through adherence to NPDES permit conditions
22 established pursuant to CWA Section 316(b). This is a Category 1 issue.
- 23 • Entrainment of phytoplankton and zooplankton would be SMALL at all nuclear power plants.
24 Entrainment has not resulted in noticeable impacts on phytoplankton or zooplankton
25 populations near operating nuclear power plants. Impacts during the license renewal term
26 would be similar and small. Further, the effects would be mitigated through adherence to
27 NPDES permit conditions established pursuant to CWA Section 316(b). This is a
28 Category 1 issue.
- 29 • The effects of thermal effluents on aquatic organisms at nuclear power plants that have
30 once-through cooling systems or cooling ponds may be SMALL, MODERATE, or LARGE.
31 Effects would generally be SMALL at nuclear power plants that adhere to State water quality
32 criteria or that have and maintain a valid CWA Section 316(a) variance. For all other nuclear
33 power plants that have once-through cooling systems or cooling ponds, impacts could be
34 SMALL, MODERATE, or LARGE depending on site-specific factors, including the ecological
35 setting of the plant, characteristics of the cooling system and effluent discharges, and
36 characteristics of the fish, shellfish, and other aquatic organisms present in the area. This is
37 a Category 2 issue.
- 38 • The effects of thermal effluents on aquatic organisms at nuclear power plants that have
39 cooling towers would be SMALL. Thermal effluents have not resulted in noticeable impacts
40 on aquatic communities at nuclear power plants that have cooling towers. Impacts during
41 the license renewal term would be similar and small. Further, effects would be mitigated
42 through adherence to State water quality criteria or CWA Section 316(a) variances. This is
43 a Category 1 issue.
- 44 • Infrequently reported effects of thermal effluents would be SMALL at all nuclear power
45 plants. Continued operation of nuclear power plant cooling systems could result in certain
46 infrequently reported thermal impacts, including cold shock, thermal migration barriers,

Executive Summary

- 1 accelerated maturation of aquatic insects, proliferation of aquatic nuisance organisms,
2 depletion of dissolved oxygen, gas supersaturation, eutrophication, and increased
3 susceptibility of exposed fish and shellfish to predation, parasitism, and disease. Most of
4 these effects have not been reported at operating nuclear power plants. Plants that have
5 experienced these impacts successfully mitigated the impact, and it is no longer of concern.
6 Infrequently reported thermal impacts are not expected to be significant issues during the
7 license renewal term. This is a Category 1 issue.
- 8 • The effects of nonradiological contaminants on aquatic organisms would be SMALL. Heavy
9 metal leaching from condenser tubes was an issue at several operating nuclear power
10 plants. These plants successfully mitigated the issue, and it is no longer of concern.
11 Cooling system effluents would be the primary source of nonradiological contaminants
12 during the license renewal term. Implementation of BMPs and adherence to NPDES permit
13 limitations would minimize the effects of these contaminants on the aquatic environment.
14 This is a Category 1 issue.
 - 15 • Exposure of aquatic organisms to radionuclides would be SMALL. Doses to aquatic
16 organisms from continued nuclear power plant operation and refurbishment during license
17 renewal would be expected to remain well below U.S. Department of Energy exposure
18 guidelines developed to protect these organisms. This is a Category 1 issue.
 - 19 • The effects of dredging on aquatic resources would be SMALL. Dredging at nuclear power
20 plants is expected to occur infrequently, would be of relatively short duration, and would
21 affect relatively small areas. Continued operation of many plants may not require any
22 dredging. Adherence to BMPs and CWA Section 404 permit conditions would mitigate
23 potential impacts at plants where dredging is necessary to maintain the function or reliability
24 of cooling systems. Dredging is not expected to be a significant issue during the license
25 renewal term. This is a Category 1 issue.
 - 26 • Water use conflicts with aquatic resources at nuclear power plants that have cooling ponds
27 or cooling towers using makeup water from a river may be SMALL or MODERATE. Nuclear
28 power plants could consume water at rates that cause occasional or intermittent water use
29 conflicts with nearby and downstream aquatic communities. Such impacts could noticeably
30 affect aquatic plants or animals or alter characteristics of the ecological environment during
31 the license renewal term. The one plant where impacts have occurred successfully
32 mitigated the impact. Impacts are expected to be SMALL at most nuclear power plants but
33 could be MODERATE at some. This is a Category 2 issue.
 - 34 • Non-cooling system impacts on aquatic resources would be SMALL. No significant impacts
35 on aquatic resources associated with landscape and grounds maintenance, stormwater
36 management, or ground-disturbing activities at operating nuclear power plants have been
37 reported. Impacts from continued operation and refurbishment during the license renewal
38 term would be similar and small. Application of BMPs and other conservation initiatives
39 would reduce the potential for impacts. This is a Category 1 issue.
 - 40 • Impacts of transmission line ROW management on aquatic resources would be SMALL. In-
41 scope transmission lines tend to occupy only industrial-use or other developed portions of
42 nuclear power plant sites and, therefore, the effects of ROW maintenance on aquatic plants
43 and animals during the license renewal term would be negligible. Application of BMPs
44 would reduce the potential for impacts. This is a Category 1 issue.

1 **Federally Protected Ecological Resources**

- 2 • The potential effects of continued nuclear power plant operation and refurbishment on
3 federally listed species and critical habitats under U.S. Fish and Wildlife Service jurisdiction
4 would depend on numerous site-specific factors, including the ecological setting; listed
5 species and critical habitats present in the action area; and plant-specific factors related to
6 operations, including water withdrawal, effluent discharges, and other ground-disturbing
7 activities. Consultation with the U.S. Fish and Wildlife Service under ESA Section 7(a)(2)
8 would be required if license renewal may affect listed species or critical habitats under this
9 agency's jurisdiction. This is a Category 2 issue.
- 10 • The potential effects of continued nuclear power plant operation and refurbishment on
11 federally listed species and critical habitats under National Marine Fisheries Service
12 jurisdiction would depend on numerous site-specific factors, including the ecological setting;
13 listed species and critical habitats present in the action area; and plant-specific factors
14 related to operations, including water withdrawal, effluent discharges, and other ground-
15 disturbing activities. Consultation with the National Marine Fisheries Service under ESA
16 Section 7(a)(2) would be required if license renewal may affect listed species or critical
17 habitats under this agency's jurisdiction. This is a Category 2 issue.
- 18 • The potential effects of continued nuclear power plant operation and refurbishment on
19 essential fish habitat (EFH) would depend on numerous site-specific factors, including the
20 ecological setting; EFH present in the area, including habitats of particular concern; and
21 plant-specific factors related to operations, including water withdrawal, effluent discharges,
22 and other activities that may affect aquatic habitats. Consultation with the National Marine
23 Fisheries Service under Magnuson-Stevens Act Section 305(b) would be required if license
24 renewal could result in adverse effects to EFH. This is a Category 2 issue.
- 25 • The potential effects of continued nuclear power plant operation and refurbishment on
26 sanctuary resources would depend on numerous site-specific factors, including the
27 ecological setting; national marine sanctuaries present in the area; and plant-specific factors
28 related to operations, including water withdrawal, effluent discharges, and other activities
29 that may affect aquatic habitats. Consultation with the Office of National Marine Sanctuaries
30 under National Marine Sanctuaries Act Section 304(d) would be required if license renewal
31 could destroy, cause the loss of, or injure sanctuary resources. This is a Category 2 issue.

32 **Historic and Cultural Resources**

- 33 • Impacts from continued operations and refurbishment on historic and cultural resources
34 located onsite and in the transmission line ROW are analyzed on a plant-specific basis. The
35 NRC will perform a NEPA and National Historic Preservation Act (NHPA) Section 106
36 analysis, in accordance with 36 CFR Part 800, in its preparation of the SEIS. The NHPA
37 Section 106 analysis includes consultation with the State and Tribal Historic Preservation
38 Officers, Indian Tribes, and other interested parties. This is a Category 2 issue.

39 **Socioeconomics**

- 40 • Although most nuclear power plants have large numbers of employees with higher than
41 average wages and salaries, employment, income, recreation, and tourism, impacts from
42 continued operations and refurbishment associated with license renewal are expected to be
43 SMALL. This is a Category 1 issue.
- 44 • Impacts on tax revenue would be SMALL. Nuclear plants provide tax revenue to local
45 jurisdictions in the form of property tax payments, payments in lieu of tax (PILOT) payments,

Executive Summary

1 or tax payments on energy production. The amount of tax revenue paid during the license
2 renewal term as a result of continued operations and refurbishment associated with license
3 renewal is not expected to change. This is a Category 1 issue.

4 • Changes to community services and education resulting from continued operations and
5 refurbishment associated with license renewal would be SMALL. With little or no change in
6 (1) employment at the licensee's plant, (2) value of the power plant, (3) payments on energy
7 production, and (4) PILOT payments expected during the renewal term, community and
8 educational services would not be affected by continued power plant operations. This is a
9 Category 1 issue.

10 • Population and housing impacts would be SMALL because changes resulting from
11 continued operations and refurbishment associated with license renewal to regional
12 population and housing availability and value would be small. With little or no change in
13 employment at the licensee's plant expected during the license renewal term, population
14 and housing availability and values would not be affected by continued power plant
15 operations. This is a Category 1 issue.

16 • Transportation impacts would be SMALL because changes resulting from continued
17 operations and refurbishment associated with license renewal to traffic volumes would be
18 small. This is a Category 1 issue.

19 **Human Health**

20 • Radiation doses to plant workers from continued operations and refurbishment associated
21 with license renewal are expected to be within the range of doses experienced during the
22 current license term and would continue to be well below regulatory limits. The impacts from
23 radiation doses to plant workers would be SMALL. This is a Category 1 issue.

24 • Radiation doses to the public from continued operations and refurbishment associated with
25 the license renewal term are expected to continue at current levels and would be well below
26 regulatory limits. The impacts from radiation doses to the public would be SMALL. This is a
27 Category 1 issue.

28 • Chemical hazards to plant workers resulting from continued operations and refurbishment
29 associated with license renewal are expected to be minimized by the licensee implementing
30 good industrial hygiene practices as required by permits and Federal and State regulations.
31 Chemical releases to the environment and the potential for impacts on the public are
32 expected to be minimized by adherence to discharge limitations of NPDES and other
33 permits. The impacts from chemical hazards to plant workers would be SMALL. This is a
34 Category 1 issue.

35 • Microbiological hazards to plant workers would be SMALL. Occupational health impacts are
36 expected to be controlled by continued application of accepted industrial hygiene practices
37 to minimize worker exposures as required by permits and Federal and State regulations.
38 This is a Category 1 issue.

39 • Microbiological hazards to the public are not expected to be a problem at most operating
40 plants but could result in SMALL, MODERATE, or LARGE impacts at plants that have
41 cooling ponds, lakes, canals, or that discharge to waters of the United States accessible to
42 the public. Impacts would depend on site-specific characteristics. This is a Category 2
43 issue.

44 • The effects of EMFs associated with nuclear plants and associated transmission lines on
45 human health are uncertain. Studies of 60-hertz (Hz) EMFs have not uncovered consistent

1 evidence linking harmful effects with field exposures. EMFs are unlike other agents that
 2 have a toxic effect (e.g., toxic chemicals and ionizing radiation) in that dramatic acute effects
 3 cannot be forced and longer-term effects, if real, are subtle. Because the state of the
 4 science is currently inadequate, no generic conclusion on human health impacts is possible.
 5 This issue has not been categorized.

- 6 • Impacts from continued operations and refurbishment on worker safety would be SMALL.
 7 Physical occupational safety and health hazards are generic to all types of electrical
 8 generating stations, including nuclear power plants, and are of small significance if the
 9 workers adhere to safety standards and use personal protective equipment as required by
 10 Federal and State regulations. This is a Category 1 issue.
- 11 • Electric shock hazards could result in SMALL, MODERATE, or LARGE impacts. Electrical
 12 shock potential is of small significance for transmission lines that are operated in adherence
 13 with the National Electrical Safety Code (NESC). Without a review of conformance with
 14 NESC criteria of each nuclear power plant's in-scope transmission lines, it is not possible to
 15 determine the generic significance of the electrical shock potential. This is a Category 2
 16 issue.

17 **Postulated Accidents**

- 18 • The environmental impacts of design-basis accidents are SMALL for all nuclear plants. Due
 19 to the requirements for nuclear plants to maintain their licensing basis and implement aging
 20 management programs during the license renewal term, the environmental impacts from
 21 design-basis accident risk during an initial license renewal or SLR term should not differ
 22 significantly from those calculated for the design-basis accident assessments conducted as
 23 part of the initial plant licensing process. This is a Category 1 issue.
- 24 • For severe accidents, the probability-weighted consequences of atmospheric releases,
 25 fallout onto open bodies of water, releases to groundwater, and societal and economic
 26 impacts from severe accidents are SMALL for all plants. Severe accident mitigation
 27 alternatives do not warrant further plant-specific analysis because the demonstrated
 28 reductions in population dose risk and continued severe accident regulatory improvements
 29 substantially reduce the likelihood of finding cost-effective significant plant improvements.
 30 Additionally, all license renewal applicants expected to reference this LR GEIS have already
 31 considered severe accident mitigation and therefore would not need to do so again under
 32 Commission policy. This is a Category 1 issue.

33 **Environmental Justice**

- 34 • Impacts on minority populations, low-income populations, Indian Tribes, and subsistence
 35 consumption resulting from continued operations and refurbishment associated with license
 36 renewal will be addressed in nuclear plant-specific reviews. This is a Category 2 issue.

37 **Waste Management**

- 38 • The impacts from low-level waste (LLW) storage and disposal would be SMALL. The
 39 comprehensive regulatory controls that are in place and the low public doses being
 40 achieved at reactors ensure that the radiological impacts on the environment would remain
 41 SMALL during the license renewal term. This is a Category 1 issue.
- 42 • The impacts from onsite storage of spent nuclear fuel would be SMALL during the license
 43 renewal term, as defined as the licensed life for operation of a reactor evaluated in NUREG-
 44 2157. The expected increase in the volume of spent fuel from an additional 20 years of

Executive Summary

1 operation can be safely accommodated onsite during the license renewal term with small
2 environmental effects through dry or pool storage at all plants. This is a Category 1 issue.
3 For the period after the licensed life for reactor operations, the impacts of onsite storage of
4 spent nuclear fuel during the continued storage period are discussed in NUREG-2157 and
5 as stated in [10 CFR] § 51.23(b), shall be deemed incorporated into this issue.

- 6 • For the impacts from offsite radiological impacts of spent nuclear fuel and high-level waste
7 disposal, the Commission has not assigned a single significance level. The EPA dose limits
8 established for the proposed repository at Yucca Mountain, Nevada apply. The Commission
9 concludes that the impacts would not be sufficiently large to require the NEPA conclusion,
10 for any plant, that the option of extended operation under 10 CFR Part 54 should be
11 eliminated. Accordingly, while the Commission has not assigned a single level of
12 significance for the impacts of spent fuel and high-level waste disposal, this issue is
13 considered Category 1.
- 14 • The radiological and nonradiological environmental impacts of storage and long-term
15 disposal of mixed waste from any individual plant at licensed sites are SMALL. The
16 comprehensive regulatory controls and the facilities and procedures that are in place ensure
17 proper handling and storage, as well as negligible doses and exposure to toxic materials for
18 the public and the environment at all plants. License renewal would not increase the small
19 continuing risk to human health and the environment posed by mixed waste at all plants.
20 This is a Category 1 issue.
- 21 • The impacts from nonradioactive waste storage and disposal would be SMALL. No
22 changes to systems that generate nonradioactive waste are anticipated during the license
23 renewal term. Facilities and procedures are in place to ensure continued proper handling,
24 storage, and disposal, as well as negligible exposure to toxic materials for the public and the
25 environment at all plants. This is a Category 1 issue.

26 **Greenhouse Gas Emissions and Climate Change**

- 27 • GHG impacts on climate change from continued operation and refurbishment associated
28 with license renewal are expected to be SMALL. GHG emissions from routine operations at
29 nuclear power plants are typically very minor because such plants, by their very nature, do
30 not normally combust fossil fuel to generate electricity. GHG emissions from construction
31 vehicles and other motorized equipment for refurbishment activities would be intermittent
32 and temporary, restricted to the refurbishment period. Worker vehicle GHG emissions for
33 refurbishment would be similar to worker vehicle emissions from normal nuclear power plant
34 operations. This is a Category 1 issue.
- 35 • Climate change can have additive effects on environmental resource conditions that may
36 also be directly impacted by continued operations and refurbishment during the license
37 renewal term. The effects of climate change can vary regionally and climate change
38 information at the regional and local scale is necessary to assess trends and the impacts on
39 the human environment for a specific location. The impacts of climate change on
40 environmental resources are location-specific and cannot be evaluated generically. This is
41 a Category 2 issue.

42 **Cumulative Effects**

- 43 • Cumulative effects or impacts are those effects that result from the incremental effects of the
44 proposed license renewal action when added to the effects of other past, present, and
45 reasonably foreseeable actions, regardless of what agency (Federal or non-Federal) or
46 person undertakes such actions. The cumulative effects of continued operations and

1 refurbishment associated with license renewal must be considered on a nuclear plant-
 2 specific basis. The effects depend on regional resource characteristics, the incremental
 3 resource-specific effects of license renewal, and the cumulative significance of other factors
 4 affecting the environmental resource. This is a Category 2 issue.

5 Uranium Fuel Cycle

- 6 • The individual offsite radiological impacts resulting from portions of the uranium fuel cycle,
 7 other than the disposal of spent fuel and high-level waste, would be SMALL. The impacts
 8 on individuals from radioactive gaseous and liquid releases during the license renewal term
 9 would remain at or below the NRC's regulatory limits. This is a Category 1 issue.
- 10 • For the collective offsite radiological impacts from the uranium fuel cycle other than the
 11 disposal of spent fuel and high-level waste, there are no regulatory limits applicable to
 12 collective doses to the general public from fuel-cycle facilities. The practice of estimating
 13 health effects based on collective doses may not be meaningful. All fuel-cycle facilities are
 14 designed and operated to meet the applicable regulatory dose limits and standards.
 15 Accordingly, the Commission concludes that the collective impacts are acceptable. This is a
 16 Category 1 issue.
- 17 • The nonradiological impacts of the uranium fuel cycle resulting from the renewal of an
 18 operating license for any plant would be SMALL. This is a Category 1 issue.
- 19 • The impacts of transporting materials to and from uranium-fuel-cycle facilities on workers,
 20 the public, and the environment are expected to be SMALL. This is a Category 1 issue.

21 Termination of Nuclear Power Plant Operations and Decommissioning

- 22 • Termination of plant operations and decommissioning would occur eventually regardless of
 23 license renewal. The additional 20-year period of operation under the license renewal term
 24 would not affect the impacts of shutdown and decommissioning on any resource or at any
 25 plant. This is a Category 1 issue.

26 S.6 Comparison of Alternatives

27 This LR GEIS also evaluates the impacts of the proposed action (license renewal) and
 28 describes a range of alternatives to license renewal, including the no action alternative (not
 29 renewing the operating license). It also evaluates the impacts of replacement energy
 30 alternatives (fossil fuel, nuclear, and renewables), energy conservation and efficiency (demand-
 31 side management), and purchased power. The impacts of renewing the operating license of a
 32 nuclear power plant are comparable to the impacts of replacement energy alternatives.
 33 Replacement energy alternatives could require the construction of a new power plant and/or
 34 modification of the electric transmission grid. New power plants would also have operational
 35 impacts. Conversely, license renewal does not require new construction and operational
 36 impacts beyond what is already being experienced. Other alternatives not requiring
 37 construction or causing operational impacts include energy conservation and efficiency
 38 (demand-side management), delayed retirement, repowering, and purchased power.

39 The operational impacts of license renewal are comparable to the operational impacts of
 40 replacement energy alternatives in some resource areas (socioeconomics) but are different in
 41 other resource areas (air emissions, fuel cycles, land use, and water consumption). Renewable
 42 energy alternatives (wind, ocean wave, and current power generation) have very few
 43 operational impacts, while others (biomass combustion and conventional hydropower) can have

Executive Summary

1 considerable impacts. In addition, some renewable energy alternatives (wind and solar) have
2 relatively low but regionally variable capacity factors.

3 License renewal and replacement energy alternatives differ in other respects, including accident
4 consequences and fuel-cycle impacts. A severe accident under the license renewal and the
5 new nuclear alternative may have a low probability but potentially high consequence, and,
6 compared to renewables, fossil fuel power generation may require large amounts of land for fuel
7 extraction and storage.

8 In addition, impacts from terminating power plant operations and decommissioning also differ.
9 License renewal delays the date of terminating reactor operations and decommissioning but
10 generally does not alter the level of impact. In comparison, impacts from terminating operations
11 and decommissioning of some replacement energy alternatives could be greater than those
12 from license renewal.

13 Under NEPA, the NRC has an obligation to consider reasonable alternatives to the proposed
14 action (license renewal). The LR GEIS facilitates that analysis by providing NRC review teams
15 with environmental information related to the range of reasonable replacement energy
16 alternatives as of the time this LR GEIS was prepared. A plant-specific analysis of replacement
17 energy alternatives will be performed for each SEIS, taking into account changes in technology
18 and science since the preparation of this LR GEIS.

1

1.0 INTRODUCTION

2 The Atomic Energy Act (AEA) of 1954 (42 U.S.C. § 2011 et seq.) authorizes the U.S. Nuclear
 3 Regulatory Commission (NRC) to issue licenses to operate commercial nuclear power plants for
 4 up to 40 years. The 40-year length of the original license period was imposed for economic and
 5 antitrust reasons rather than the technical limitations of the nuclear power plant. NRC
 6 regulations allow for the renewal of these licenses for up to an additional 20 years, depending
 7 on the outcome of an assessment determining whether the nuclear power plant can continue to
 8 operate safely and protect the environment during the 20-year period of extended operation.
 9 There are no specific limitations in the AEA or the NRC’s regulations restricting the number of
 10 times a license may be renewed.

11 The NRC’s regulations in Title 10 of the *Code of Federal Regulations* (10 CFR) Section 54.17(c)
 12 allow a license renewal application to be submitted within 20 years of license expiration, and the
 13 NRC’s regulations at 10 CFR 54.31(b) specify that a renewed license will be for a term of up to
 14 20 years plus the length of time remaining on the current license. As a result, renewed licenses
 15 may be for a term of up to 40 years.

<p>Contents of Chapter 1.0</p> <ul style="list-style-type: none"> • Purpose of the LR GEIS (Section 1.1) • Description of the Proposed Action (Section 1.2) • Purpose and Need for the Proposed Action (Section 1.3) • Alternatives to the Proposed Action (Section 1.4) • Analytical Approach Used in the LR GEIS (Section 1.5) • Scope of the LR GEIS Revision (Section 1.6) • Decisions to Be Supported by the LR GEIS (Section 1.7) • Implementation of the Rule (Section 1.8) • Public Scoping Comments on the LR GEIS Update (Section 1.9) • Lessons Learned (Section 1.10) • Organization of the LR GEIS (Section 1.11)
--

- Purpose of the LR GEIS (Section 1.1)
- Description of the Proposed Action (Section 1.2)
- Purpose and Need for the Proposed Action (Section 1.3)
- Alternatives to the Proposed Action (Section 1.4)
- Analytical Approach Used in the LR GEIS (Section 1.5)
- Scope of the LR GEIS Revision (Section 1.6)
- Decisions to Be Supported by the LR GEIS (Section 1.7)
- Implementation of the Rule (Section 1.8)
- Public Scoping Comments on the LR GEIS Update (Section 1.9)
- Lessons Learned (Section 1.10)
- Organization of the LR GEIS (Section 1.11)

16 The license renewal process is designed to ensure the safe operation of the nuclear power plant
 17 and protection of the environment during the license renewal term. Under the NRC’s
 18 regulations in 10 CFR Part 51, “Environmental Protection Regulations for Domestic Licensing
 19 and Related Regulatory Functions”, which implement Section 102(2) of the National
 20 Environmental Policy Act (NEPA; 42 U.S.C. § 4321 et seq.), the renewal of a nuclear power
 21 plant operating license requires an analysis of the environmental effects of the proposed action
 22 and the preparation of an environmental impact statement (EIS).

23 To support the preparation of license renewal EISs, the NRC conducted a comprehensive
 24 review to identify the environmental effects of license renewal. The review determined which
 25 environmental effects could result in the same or similar (generic) impact at all nuclear power
 26 plants or a subset of plants and which effects could result in different levels of impact, requiring

Introduction

1 nuclear plant-specific analyses for an impact determination. The review culminated in the
2 issuance of NUREG-1437, *Generic Environmental Impact Statement for License Renewal of*
3 *Nuclear Plants* (LR GEIS), in May 1996, followed by the publication of the final rule that codified
4 the LR GEIS findings on June 5, 1996 (61 *Federal Register* [FR] 28467¹; NRC 1996, NRC
5 1999b).

6 The 1996 LR GEIS² improved the efficiency of the license renewal environmental review
7 process by (1) identifying and evaluating all of the environmental effects that may occur when
8 renewing commercial nuclear power plant operating licenses, (2) identifying and evaluating the
9 environmental effects that are expected to be generic (the same or similar) at all nuclear power
10 plants or a subset of plants, and (3) defining the number and scope of the environmental effects
11 that need to be addressed in nuclear power plant-specific EISs. For the issues that could not be
12 evaluated generically, the NRC would conduct nuclear power plant-specific (hereafter called
13 plant-specific) environmental reviews and prepare plant-specific supplemental EISs (SEISs) to
14 the LR GEIS. The generic environmental findings in this LR GEIS are applicable to the 20-year
15 license renewal increment, either an initial license renewal (initial LR) term or the first
16 subsequent license renewal (SLR) term, plus the number of years remaining on the current
17 license, up to a maximum of 40 years.

Generic Environmental Impact Statement

A GEIS is an EIS that assesses the scope and impact of the environmental effects that would be associated with an action (such as license renewal) at numerous sites.

18 **1.1 Purpose of the LR GEIS**

19 This LR GEIS documents the results of the systematic approach the NRC used to evaluate the
20 incremental environmental impacts of renewing the operating licenses of commercial nuclear
21 power plants for an additional 20 years beyond the current license term, plus the number of
22 years remaining on the current license, up to a maximum of 40 years. The LR GEIS also
23 provides the technical basis for the Commission's license renewal regulations in 10 CFR Part
24 51. In the 1996 LR GEIS and related rulemaking, the Commission determined that certain
25 impacts associated with the renewal of a nuclear power plant operating license were the same
26 or similar for all plants or subset of plants and could be treated on a generic basis. In this way,
27 repetitive reviews of these impacts could be avoided. The Commission based its generic
28 assessment of certain environmental impacts on the following factors:

- 29 • License renewal will involve nuclear power plants for which the environmental impacts of
30 operation are well understood as a result of lessons learned and knowledge gained from
31 operating experience and completed license renewals.
- 32 • Activities associated with license renewal are expected to be within this range of operating
33 experience; thus, environmental impacts can be reasonably predicted.
- 34 • Changes in the environment around nuclear power plants are gradual and predictable.

¹ Final rules were also issued on December 18, 1996 (61 FR 66537) and September 3, 1999 (64 FR 48496).

² Any reference in this document to the 1996 LR GEIS includes the two-volume set published in May 1996 (NRC 1996) and Addendum 1 to the LR GEIS published in August 1999 (NRC 1999b).

1 The LR GEIS is intended to improve the efficiency of the license renewal environmental review
2 process by (1) providing an evaluation of the types of environmental impacts that may occur by
3 an initial LR of commercial nuclear power plant operating licenses or SLR (specifically limited to
4 one term of SLR), (2) identifying and assessing impacts that are expected to be generic
5 (the same or similar) at all nuclear plants (or plants with specified plant or site characteristics),
6 and (3) defining the number and scope of environmental issues that need to be addressed in
7 plant-specific SEISs. The LR GEIS also provides information that aids in the preparation of
8 plant-specific EISs.

9 **1.2 Description of the Proposed Action**

10 The NRC's environmental regulations in 10 CFR 51.20, require the preparation of an EIS to
11 address the impacts of renewing a plant's operating license. The EIS requirements for a plant-
12 specific license renewal review are specified in 10 CFR 51.71 and 51.95. The NRC's public
13 health and safety and other technical requirements for the renewal of operating licenses are
14 found in 10 CFR Part 54. Part 54 requires applicants to perform safety evaluations and
15 assessments of nuclear power plants and provide the NRC with sufficient information to analyze
16 the impacts of continued operation for the requested license renewal term. Applicants are
17 required to assess the effects of aging on passive and long-lived systems, structures, and
18 components.

The Proposed Action

To renew commercial nuclear power plant operating licenses.

Purpose and Need for the Proposed Action

To provide an option to continue nuclear power plant operations beyond the current licensing term to meet future system generating needs.

19 Most nuclear power plant licensees (either a public utility or non-utility plant owner) are
20 expected to begin preparation for license renewal about 10 to 20 years before expiration of their
21 current operating licenses. Inspection, surveillance, testing, and maintenance programs to
22 support continued nuclear power plant operations during the license renewal term would be
23 integrated gradually over a period of years. Any refurbishment-type activities undertaken for the
24 purposes of license renewal have generally been completed during normal plant refueling or
25 maintenance outages before the original license expires. Activities associated with license
26 renewal and operation of a nuclear power plant for an additional 20 years are discussed in
27 Chapter 2.0.

28 **1.3 Purpose and Need for the Proposed Action**

29 The Commission acts on each application submitted by a licensee for the renewal of
30 commercial nuclear power plant operating licenses per Section 103 of the AEA. A renewed
31 license is just one of several conditions that each licensee must meet to operate its nuclear
32 power plant during the license renewal term. State regulators, system operators, and in some
33 cases, other Federal agencies, ultimately decide whether the nuclear power plant will continue
34 to operate based on factors such as need for power or other factors within the State's
35 jurisdiction or owner's control. Economic considerations play a primary role in this decision.

Introduction

1 The purpose and need for the proposed action (issuance of a renewed license) is to provide an
2 option that allows for baseload power generation capability beyond the term of the current
3 nuclear power plant operating license to meet future system generating needs. Such needs
4 may be determined by other energy-planning decisionmakers, such as State, utility, and, where
5 authorized, Federal agencies (other than the NRC). Unless there are findings in the safety
6 review required by the AEA or the NEPA environmental review that would lead the NRC to
7 reject a license renewal application, the NRC does not have a role in the energy-planning
8 decisions about whether a particular nuclear power plant should continue to operate.

9 From the perspective of the licensee and the State regulatory authority, the purpose of renewing
10 an operating license is to maintain the availability of the nuclear power plant to meet system
11 energy requirements beyond the term of the plant's current license. In cases of interstate
12 generation or other special circumstances, Federal agencies such as the Federal Energy
13 Regulatory Commission or the Tennessee Valley Authority may be involved in making these
14 decisions.

15 **1.4 Alternatives to the Proposed Action**

16 In plant-specific license renewal environmental reviews, the NRC considers the environmental
17 consequences of the proposed action, the no action alternative (i.e., not renewing the operating
18 license), and the environmental consequences of various alternatives for replacing or offsetting
19 the nuclear power plant's generating capacity. No conclusions are made in the LR GEIS about
20 the relative environmental consequences of license renewal, the no action alternative, and the
21 construction and operation of alternative facilities for generating electric energy. However,
22 information presented in the LR GEIS can be used by the NRC and applicants in performing the
23 plant-specific analysis of alternatives.

24 In plant-specific environmental reviews, the NRC compares the environmental impacts of
25 license renewal with those of the no action alternative and replacement energy alternatives to
26 determine whether or not the adverse environmental impacts of license renewal are so great
27 that preserving the option of license renewal for energy planning decisionmakers would be
28 unreasonable (10 CFR 51.95(c)(4)).

29 **1.5 Analytical Approach Used in the LR GEIS**

30 **1.5.1 Objectives**

31 The LR GEIS serves to facilitate the NRC's environmental review process by identifying and
32 evaluating environmental impacts that are considered generic and common to all, or a subset
33 of, nuclear power plants. Plant-specific environmental issues will be addressed in separate
34 SEISs to the LR GEIS. Generic impacts will be reconsidered in plant-specific SEISs only if
35 there is new and potentially significant information with respect to the conclusions in this LR
36 GEIS.

37 **1.5.2 Methodology**

38 Environmental impacts of license renewal and the resources that could be affected by continued
39 operation and any refurbishment undertaken for the purposes of license renewal were identified.
40 The general analytical approach for identifying environmental impacts was to (1) describe the
41 nuclear power plant activity that could affect the resource, (2) identify the resource that is
42 affected, (3) evaluate past license renewal reviews and other available information, (4) assess

1 the nature and magnitude of the environmental impact from initial LR or SLR on the affected
2 resource, (5) characterize the significance of the effects, and (6) determine whether the results
3 of the analysis apply to all, or a subset of, nuclear power plants (whether the environmental
4 issue is Category 1 or Category 2, as described below). Identifying environmental impacts
5 (or issues) was done in an iterative rather than a stepwise manner. For example, after
6 information was collected and levels of significance were reviewed, impacts were reexamined to
7 determine if any should be removed, added, consolidated, or divided.

8 *1.5.2.1 Defining Environmental Issues*

9 The NRC updated the LR GEIS in 2013. The 2013 LR GEIS presents the findings of a
10 systematic inquiry into the environmental impacts of license renewal resulting in the
11 identification of 78 environmental issues (or impacts). Public and stakeholder comments on
12 previous plant-specific license renewal reviews were analyzed in an effort to reevaluate the
13 existing environmental issues and identify new issues. As a result, the NRC considered the
14 need to modify, add to, group, subdivide, or delete any of the 78 environmental issues
15 evaluated in the 2013 LR GEIS. In this revised LR GEIS, the NRC has evaluated 80
16 environmental issues.

17 *1.5.2.2 Collecting Information*

18 Information from license renewal environmental reviews performed since development of the
19 2013 LR GEIS was collected and reviewed. Searches of the open scientific literature,
20 databases, and websites were conducted for each resource area. This information was
21 collected and evaluated to determine if the environmental issues and findings in the 2013 LR
22 GEIS needed to be revised for initial LR and to update those findings to apply to SLR.

23 *1.5.2.3 Impact Definitions and Categories*

24 The NRC's environmental impact standard considers Council on Environmental Quality (CEQ)
25 terminology, including CEQ revisions in Part 1501—NEPA and Agency Planning
26 (40 CFR 1501).

27 In considering whether the effects of the proposed action are significant, the NRC analyzes the
28 potentially affected environment and degree of the effects of the proposed action (license
29 renewal – either initial LR or SLR). The potentially affected environment consists of the affected
30 area and its resources, such as listed species and designated critical habitat under the
31 Endangered Species Act of 1973 (16 U.S.C. § 1531 et seq.). For plant-specific environmental
32 issues, significance would depend on the effects in the local area, including (1) short- and long-
33 term effects, (2) beneficial and adverse effects, (3) effects on public health and safety, and
34 (4) effects that would violate Federal, State, Tribal, or local law protecting the environment
35 (40 CFR 1501.3(b)).

36 Based on this, the NRC has established three significance levels for potential impacts: SMALL,
37 MODERATE, and LARGE. The three significance levels, presented in a footnote to Table B–1
38 in Appendix B to Subpart A of 10 CFR Part 51, are defined as follows:

- 39 • SMALL – environmental effects are not detectable or are so minor that they will neither
40 destabilize nor noticeably alter any important attribute of the resource. For the purposes of
41 assessing radiological impacts, the Commission has concluded that those impacts that do
42 not exceed permissible levels in the Commission's regulations are considered SMALL.

Introduction

- 1 • MODERATE – environmental effects are sufficient to alter noticeably, but not to destabilize,
2 important attributes of the resource.
- 3 • LARGE – environmental effects are clearly noticeable and are sufficient to destabilize
4 important attributes of the resource.

5 These levels are used for describing the environmental impacts of the proposed action as well
6 as the impacts of a range of reasonable alternatives to the proposed action. Resource-specific
7 effects or impact definitions from applicable environmental laws and executive orders, other
8 than SMALL, MODERATE, and LARGE, are provided where appropriate.

9 For issues in which the probability of occurrence is a key consideration (i.e., postulated
10 accidents), the probability of occurrence has been factored into the impact determination.
11 Mitigation measures that could be used to avoid, minimize, rectify, reduce, eliminate, or
12 compensate for adverse impacts are discussed where appropriate.

13 In addition to determining the impacts for each environmental issue, a determination is also
14 made for each issue about whether the environmental analysis in the LR GEIS could be applied
15 to all nuclear power plants (or plants with specified design or site characteristics). Based on the
16 applicability of the impact analysis, each issue is assigned either Category 1 or Category 2.
17 These categories are defined below.

- 18 • **Category 1** – the analysis reported in the LR GEIS has shown the following:
 - 19 – The environmental impacts associated with the issue have been determined to
20 apply either to all plants or, for some issues, to plants having a specific type of
21 cooling system or other specified plant or site characteristics;
 - 22 – A single significance level (i.e., SMALL, MODERATE, or LARGE) has been
23 assigned to the impacts (except for offsite radiological impacts of spent nuclear fuel
24 and high-level waste disposal and offsite radiological impacts – collective impacts
25 from other than the disposal of spent fuel and high-level waste); and
 - 26 – Mitigation of adverse impacts associated with the issue has been considered in the
27 analysis, and it has been determined that additional plant-specific mitigation
28 measures are not likely to be sufficiently beneficial to warrant implementation.
- 29 • **Category 2** – the analysis reported in the LR GEIS has shown that one or more of the
30 criteria of Category 1 cannot be met and therefore, additional plant-specific review is
31 required.

32 If all three Category 1 criteria apply to an issue, the NRC relies on the generic finding and
33 analysis in this LR GEIS when conducting license renewal environmental reviews as
34 documented in plant-specific SEISs, provided no new and significant information is identified
35 requiring additional analysis. For issues that do not meet all three Category 1 criteria, the issue
36 is considered Category 2, and a plant-specific impact analysis is required for that issue in the
37 SEIS.

38 **1.6 Scope of the LR GEIS Revision**

39 The introduction in Appendix B to Subpart A of 10 CFR Part 51 states that, on a 10-year cycle,
40 the Commission intends to review the material in Appendix B, including Table B-1, and update
41 it, if necessary (61 FR 28467). Therefore, the NRC began the latest review in April 2020,
42 approximately 7 years after the completion of the previous revision cycle in June 2013.

1 Subsequently, the NRC published a notice of intent in the *Federal Register* on August 4, 2020
2 (85 FR 47252), that notified the public of the NRC’s intent to review and potentially update Table
3 B-1 and the 2013 LR GEIS; indicated the results of the NRC staff’s preliminary review, including
4 consideration of SLR; and invited public comments and proposals for other areas that should be
5 updated.

6 At the conclusion of the scoping period, the staff began drafting a rulemaking plan. In July
7 2021, the NRC staff submitted SECY-21-0066, “Rulemaking Plan for Renewing Nuclear Power
8 Plant Operating Licenses – Environmental Review (RIN 3150-AK32; NRC-2018-0296)” (NRC
9 2021I), to request Commission approval to initiate a rulemaking to amend Table B-1 and update
10 the LR GEIS and associated guidance. The rulemaking plan also proposed to remove the word
11 “initial” from 10 CFR 51.53(c)(3), which details when license renewal applicants may rely on the
12 LR GEIS’s findings for Category 1 issues in preparing environmental reports in support of those
13 applications. These changes would have enabled SLR applicants to also rely on the LR GEIS
14 for Category 1 issues. The rulemaking plan would also have made corresponding changes to
15 the LR GEIS and the associated guidance, to indicate their applicability to SLRs.

16 In February 2022, the Commission issued Staff Requirements Memorandum (SRM)-SECY-21-
17 0066, “Rulemaking Plan for Renewing Nuclear Power Plant Operating Licenses –
18 Environmental Review (RIN 3150-AK32; NRC-2018-0296)” (NRC 2022c), disapproving the
19 staff’s recommendation and directing the staff to develop a rulemaking plan that aligned with the
20 Commission’s adjudicatory orders in CLI-22-03, CLI-22-02, and CLI-22-04, which concluded
21 that the 2013 LR GEIS did not apply to SLR applications. The SRM also directed the NRC staff
22 to include in the rulemaking plan a proposal to remove the word “initial” from 10 CFR 51.53(c)(3)
23 and to revise the LR GEIS, Table B-1, and associated guidance, to fully account for one term of
24 SLR.

25 The NRC staff submitted SECY-22-0024, “Rulemaking Plan for Renewing Nuclear Power Plant
26 Operating Licenses – Environmental Review (RIN 3150-AK32; NRC-2018-0296)” (NRC 2022b),
27 in March 2022 requesting Commission approval to initiate a rulemaking that would align with the
28 Commission’s orders CLI-22-02, CLI-22-03, and CLI-22-04 regarding the NEPA analysis of SLR
29 applications by removing the word “initial” from 10 CFR 51.53(c)(3) and revising the LR GEIS,
30 Table B-1 and associated guidance to fully account for one term of SLR. In April 2022, the
31 Commission issued SRM-SECY-22-0024, “Rulemaking Plan for Renewing Nuclear Power Plant
32 Operating Licenses – Environmental Review (RIN 3150-AK32; NRC-2018-0296)” (NRC 2022d),
33 approving the staff’s recommendation to proceed with the rulemaking.

34 In April 2022, pursuant to SRM-SECY-21-0066, the staff also submitted a second paper to the
35 Commission, SECY-22-0036, which concluded that no further updates to the LR GEIS were
36 needed beyond those identified in SECY-22-0024 and that the rulemaking effort identified in
37 SECY-22-0024 should constitute the agency’s 10-year update to the LR GEIS. In June 2022,
38 the Commission approved these recommendations in SRM-SECY-22-0036.

39 To support this review, the NRC staff reviewed and evaluated the environmental issues and
40 impact findings in the 2013 LR GEIS for both initial LR and SLR. Lessons learned and
41 knowledge gained during previous license renewal environmental reviews provided a major
42 source of new information for this review. Public comments received during license renewal
43 environmental reviews were reexamined to validate existing environmental issues and identify
44 new ones. Since 2013, 15 commercial nuclear power plants have undergone an initial LR
45 environmental review. For the purposes of this review, the NRC also considered five SLR
46 environmental reviews including two reviews (i.e., North Anna and Point Beach) where the NRC

1 has issued a draft SEIS, but not a final SEIS. The purpose of the review for this LR GEIS was
2 to determine if the findings presented in the 2013 LR GEIS support the scope of license renewal
3 including initial LR and SLR. In doing so, the NRC considered the need to modify, add to,
4 group, subdivide, or delete any of the 78 environmental issues evaluated in the 2013 LR GEIS.
5 In summary, new research, findings, public comments, changes in applicable laws and
6 regulations, and other information were considered in evaluating the environmental impacts
7 associated with license renewal. As a result of this review, the NRC proposes 80 environmental
8 issues for detailed consideration in this LR GEIS.

9 **1.7 Decisions to Be Supported by the LR GEIS**

10 The decisions to be supported by the LR GEIS are whether or not to renew the operating
11 licenses of individual commercial nuclear power plants for an additional 20 years. The LR GEIS
12 was developed to support these decisions and to serve as a basis from which future NEPA
13 analyses for the license renewal of individual nuclear power plants would tier. According to
14 CEQ guidelines (CEQ 2022), tiering refers to "... the coverage of general matters in broader
15 environmental impact statements or environmental assessments (such as national program or
16 policy statements) with subsequent narrower statements or environmental analyses (such as
17 regional or basin-wide program statements or ultimately site-specific statements) incorporating
18 by reference the general discussions and concentrating solely on the issues specific to the
19 statement subsequently prepared." CEQ also states that, "Tiering in such cases is appropriate
20 when it helps the lead agency focus on the issues [that] are ripe for decision and exclude from
21 consideration issues already decided or not yet ripe." The LR GEIS provides the NRC
22 decisionmaker with important environmental information considered common to all (or a subset
23 of) nuclear power plants and allows greater focus to be placed on plant-specific (i.e.,
24 Category 2) issues.

25 The scope of the environmental review for license renewal consists of the range of actions,
26 alternatives, and impacts to be considered in an EIS. The purpose of scoping is to identify
27 significant issues related to the proposed action. Scoping also identifies and eliminates from
28 detailed study issues that are not significant or have been covered by a prior environmental
29 review. Having a defined scope for the environmental review allows the NRC to concentrate on
30 the essential issues resulting from the actions being considered rather than on issues that may
31 have been or are being evaluated in different regulatory review processes, such as the license
32 renewal safety review (NRC 2006a).

Environmental Impact Statements

10 CFR 51.70(b): The draft environmental impact statement ... will state how alternatives considered in it and decisions based on it will or will not achieve the requirements of Sections 101 and 102(1) of NEPA. (See also the Council on Environmental Quality (CEQ) Regulations for Implementing NEPA, 40 CFR 1502.2(d))

33 The NEPA process for license renewal under 10 CFR Part 51 focuses on environmental
34 impacts rather than on issues related to safety. Safety issues become important to the
35 environmental review when they could result in environmental impacts, which is why the
36 environmental effects of postulated accidents are considered in the LR GEIS and in plant-
37 specific supplements to the LR GEIS. Under 10 CFR Part 54, the staff safety review considers
38 nuclear power plant aging management of systems, structures, and components. The
39 environmental issues are not considered as part of the safety review. Nuclear power plant

1 safety issues are considered under 10 CFR Part 50. Safety issues that are raised during the
2 environmental review are forwarded to the appropriate NRC organization for consideration and
3 appropriate action (NRC 2006a).

4 The Commission determined that the NRC's regular ongoing oversight activities are sufficient to
5 ensure the safety of active components during the period of extended operation, therefore the
6 Commission determined to only consider aging for passive, long-lived components in license
7 renewal reviews. Actions subject to NRC approval for license renewal are limited to the
8 performance of specific activities and programs necessary to manage the effects of aging on the
9 passive, long-lived structures and components identified in accordance with 10 CFR Part 54.
10 Accordingly, the LR GEIS does not serve as the NEPA review for other activities or programs
11 outside the scope of the NRC's 10 CFR Part 54 license renewal review.

12 For other actions, separate NEPA reviews must be conducted regardless of whether the action
13 is necessary as a consequence of receiving a renewed license, even if the activity was
14 specifically addressed in the LR GEIS. For example, the environmental impacts of spent fuel
15 pool expansion are addressed in the LR GEIS in the context of the environmental
16 consequences of approving a renewed operating license. However, any plant-specific
17 application submitted to the NRC to expand spent fuel pool capacity at a given facility would still
18 require its own separate NEPA review. These separate NEPA reviews may reference and
19 otherwise use applicable environmental information contained in the LR GEIS. For example, an
20 environmental assessment prepared for a separate spent fuel pool expansion request may use
21 the information in the LR GEIS to support a finding of no significant impact (see June 5, 1996
22 final rule [61 FR 28467]).

23 There are many factors that the NRC takes into consideration when deciding whether to renew
24 the operating license of a nuclear power plant. The analyses of environmental impacts
25 evaluated in this LR GEIS will provide the NRC's decisionmaker with important environmental
26 information for use in the overall decisionmaking process. There are also decisions outside the
27 regulatory scope of license renewal that cannot be made on the basis of the final LR GEIS
28 analysis. These decisions include the issues addressed in the following sections.

29 **1.7.1 Changes to Nuclear Power Plant Cooling Systems**

30 The NRC will not make a decision or any recommendations on the basis of information
31 presented in this LR GEIS regarding changes to nuclear power plant cooling systems, other
32 than those involving safety-related issues, to mitigate adverse impacts under the jurisdiction of
33 State or other Federal agencies. Implementation of the provisions of the Clean Water Act
34 (CWA; 33 U.S.C. § 1251 et seq.), including those regarding cooling system operations and
35 design specifications, is the responsibility of the U.S. Environmental Protection Agency (EPA).
36 In many cases, the EPA delegates such authority to the individual States. To operate a nuclear
37 power plant, licensees must comply with the CWA, including associated requirements imposed
38 by the EPA or the State, as part of the National Pollutant Discharge Elimination System
39 (NPDES) permitting system under CWA Section 402 and State water quality certification
40 requirements under CWA Section 401. The EPA or the State, not the NRC, sets the limits for
41 effluents and operational parameters in plant-specific NPDES permits. Nuclear power plants
42 cannot operate without a valid³ NPDES permit and a Section 401 Water Quality Certification.

³ A valid NPDES permit is considered to be one that is either current (i.e., within its current effective date) or one that has expired but has been "administratively continued" by the permitting authority upon the timely submission of an application for renewal pursuant to the provisions of 40 CFR 122.6.

1 **1.7.2 Disposition of Spent Nuclear Fuel**

2 The NRC will not make a decision or any recommendations on the basis of the information
3 presented in this LR GEIS regarding the disposition of spent nuclear fuel at nuclear power plant
4 sites. The scope of this LR GEIS with regard to the management and ultimate disposition of
5 spent nuclear fuel for the timeframe after the period of extended operation is limited to the
6 findings codified at 10 CFR 51.23 of the September 19, 2014 Continued Storage of Spent
7 Nuclear Fuel, Final Rule (79 FR 56238) and associated NUREG-2157, *Generic Environmental*
8 *Impact Statement for Continued Storage of Spent Nuclear Fuel* (Continued Storage GEIS; NRC
9 2014c; 79 FR 56263).

10 In 1982, the Congress enacted the Nuclear Waste Policy Act (42 U.S.C. § 10101 et seq.), and
11 on January 7, 1983, the President signed it into law. The Nuclear Waste Policy Act defined the
12 Federal Government’s responsibility to provide permanent disposal in a deep geologic
13 repository for spent fuel and high-level radioactive waste from commercial and defense
14 activities. Under amended provisions (1987) of this Act, the U.S. Department of Energy (DOE)
15 has the responsibility to locate, build, and operate a repository for such wastes. The NRC has
16 the responsibility to establish regulations governing the construction, operation, and closure of
17 the repository, consistent with environmental standards established by the EPA.

18 The 1987 amendments required DOE to evaluate only the suitability of the site at Yucca
19 Mountain, Nevada, for a geologic disposal facility. In addition, the amendments outlined a
20 detailed approach for the disposal of high-level radioactive waste involving review by the
21 President, Congress, State and Tribal governments, NRC, and other Federal agencies. In
22 February 2002, after many years of studying the suitability of the site, DOE recommended to the
23 President that the Yucca Mountain site be developed as a long-term geologic repository for
24 high-level waste. In April 2002, the Governor of Nevada notified Congress of his State’s
25 objection to the proposed repository. Subsequently, Congress voted to override the objection of
26 the State.

27 DOE submitted a license application to the NRC for construction authorization for a repository at
28 Yucca Mountain in June 2008. Upon acceptance of the application, the NRC started its
29 technical evaluation. However, on March 3, 2010, DOE filed a motion with the Atomic Safety
30 and Licensing Board (Board) seeking permission to withdraw its application for authorization to
31 construct a high-level waste geological repository at Yucca Mountain, Nevada. The Board
32 denied that request on June 29, 2010, in LBP-10-11 (NRC 2010d), and the parties filed petitions
33 asking the Commission to uphold or reverse this decision. On October 1, 2010, the
34 Commission directed the staff to perform an orderly closure of its Yucca Mountain activities. As
35 part of the orderly closure, the NRC staff prepared three technical evaluation reports
36 documenting its work.

37 On September 9, 2011, the Commission issued Memorandum and Order CLI-11-07, stating that
38 it found itself evenly divided about whether to take the affirmative action of overturning or
39 upholding the Board’s June 29, 2010 decision. Exercising its inherent supervisory authority, the
40 Commission directed the Board to complete all necessary and appropriate case management
41 activities by September 30, 2011. On September 30, 2011, the Board issued a Memorandum
42 and Order suspending the proceeding (NRC 2011c).

43 In August 2013, the U.S. Court of Appeals for the District of Columbia Circuit issued a decision
44 directing the NRC to resume its review of the DOE’s license application (On Petition for Writ of
45 Mandamus 2013). In November 2013, the Commission directed the NRC staff to complete the

1 safety evaluation report and requested that DOE prepare the EIS supplement that the NRC staff
2 had determined to be necessary. DOE informed the NRC that it would update a 2009 technical
3 analysis it provided to the NRC, but that it would not prepare a supplement to its EISs. In
4 January 2015, the NRC staff completed the five-volume safety evaluation report. In February
5 2015, the Commission directed the NRC staff to prepare the EIS supplement, which was
6 completed in May 2016 as NUREG-2184 (NRC 2016a). Although the adjudicatory proceeding
7 remains suspended, these materials along with other NRC nonsensitive Yucca Mountain-related
8 documents are available to the public as part of the NRC staff's activities to retain the
9 accumulated knowledge and experience gained as a result of its Yucca Mountain-related
10 activities. These documents can be viewed on the NRC's public website
11 (<https://www.nrc.gov/waste/hlw-disposal.html>).

12 Historically, the NRC's Waste Confidence Decision and Rule represented the Commission's
13 determination that spent fuel could continue to be stored safely and without significant
14 environmental impacts at reactor sites for a period of time after the end of the licensed life for
15 operation. The Commission incorporated the generic determinations in a previous version of
16 10 CFR 51.23, which satisfied the NRC's obligations under NEPA for specific licensing actions
17 that would foreseeably generate spent fuel and high-level waste. Because the Waste
18 Confidence Rule was originally developed in 1984, the NRC updated the Rule; the last update
19 was completed in 2010.

20 On December 23, 2010, the Commission published in the *Federal Register* a revision of the
21 Waste Confidence Decision and Rule to reflect information gained from experience in the
22 storage of spent nuclear fuel and the increased uncertainty in the siting and construction of a
23 permanent geologic repository for the disposal of spent nuclear fuel and high-level waste
24 (75 FR 81032 and 75 FR 81037). In response to the 2010 Waste Confidence Decision and
25 Rule, the States of New York, New Jersey, Connecticut, and Vermont, along with several other
26 parties challenged the Commission's NEPA analysis in the decision, which provided the
27 regulatory basis for the rule. On June 8, 2012, the U.S. Court of Appeals, District of Columbia
28 Circuit, in *New York v. NRC*, 681 F.3d 471 (*New York v. NRC* 2012), vacated the NRC's Waste
29 Confidence Decision and Rule, after finding that it did not comply with NEPA.

30 In response to the court's ruling, the Commission issued CLI-12-16 (NRC 2012e) on August 7,
31 2012, in which the Commission determined that it would not issue licenses that rely upon the
32 Waste Confidence Decision and Rule until the issues identified in the court's decision are
33 appropriately addressed by the Commission. In SRM-COMSECY-12-0016 (dated September 6,
34 2012 [NRC 2012g]), the Commission directed the NRC staff to proceed with a rulemaking that
35 included the development of a generic EIS to support a revised Waste Confidence Decision and
36 Rule and to publish both the EIS and the revised decision and rule in the *Federal Register* within
37 24 months (by September 6, 2014).

38 Two LR GEIS issues in Table B-1 were affected by the court's decision. These issues which
39 relied, wholly or in part, on the Waste Confidence Decision and Rule, were the "onsite storage
40 of spent nuclear fuel" and "offsite radiological impacts of spent nuclear fuel and high-level waste
41 disposal." Both of these issues were classified as Category 1 in the 1996 rule; the 2009
42 proposed rule continued the Category 1 classification for both of these issues. As part of its
43 response to the *New York v. NRC* decision, the NRC revised these two issues accordingly in
44 the 2013 LR GEIS and in the June 2013 Revisions to Environmental Review for Renewal of
45 Nuclear Power Plant Operating License, Final Rule (78 FR 37282). Specifically, the NRC
46 revised the Category 1 "onsite storage of spent nuclear fuel" issue to limit the period of time
47 covered by the issue to only the license renewal term with an impact level of SMALL. Similarly,

1 the NRC revised the Category 1 issue, “offsite radiological impacts of spent nuclear fuel and
2 high-level waste disposal” by reclassifying the issue from Category 1 having an impact level of
3 SMALL to uncategorized having an impact level of uncertain.

4 The Commission’s direction in SRM-COMSECY-12-0016 led to the 2014 Continued Storage
5 Final Rule (79 FR 56238), which replaced the Waste Confidence Decision and Rule with a new
6 regulation at 10 CFR 51.23 that codified the discussion of environmental impacts in NUREG-
7 2157. In addition, the 2014 Continued Storage Final Rule made conforming changes to the two
8 environmental issues in Table B-1 that were affected by the vacated 2010 Waste Confidence
9 Rule: “onsite storage of spent nuclear fuel” and “offsite radiological impacts of spent nuclear
10 fuel and high-level waste disposal.” The Commission revised the Table B-1 finding for “onsite
11 storage of spent nuclear fuel” to add the phrase “during the license renewal term” to make clear
12 that the SMALL impact is for the license renewal term only. In addition, a new paragraph was
13 added for this issue in Table B-1 to address the impacts of onsite storage of spent fuel during
14 the continued storage period. The second paragraph of the column entry was revised to read,
15 “For the period after the licensed life for reactor operations, the impacts of onsite storage of
16 spent nuclear fuel during the continued storage period are discussed in NUREG-2157 and as
17 stated in § 51.23(b), shall be deemed incorporated into this issue.” As defined in the Continued
18 Storage Final Rule, the phrase “licensed life for reactor operations” refers to the term of the
19 license to operate a reactor and assumes an original licensed life of 40 years and up to two
20 20-year license extensions for each reactor. The changes reflect that the Category 1 findings
21 for the issue of “onsite storage of spent nuclear fuel” cover the environmental impacts
22 associated with the storage of spent nuclear fuel during the license renewal term as well as the
23 period after the licensed life for reactor operations.

24 For the issue “offsite radiological impacts of spent nuclear fuel and high-level waste disposal,”
25 the Continued Storage Final Rule revised the finding to reclassify the impact determination as a
26 Category 1 issue with no impact level assigned. The finding column entry for this issue was
27 also revised to reference EPA’s radiation protection standards for the high-level waste and
28 spent nuclear fuel disposal components of the fuel cycle. As stated in the Continued Storage
29 Final Rule (79 FR 56238), while the status of a geologic repository including a repository at
30 Yucca Mountain, remains uncertain, the NRC believes that the current radiation standards for
31 Yucca Mountain are protective of public health and safety and the environment. Further, the
32 Continued Storage GEIS (NRC 2014c) concludes that deep geologic disposal remains
33 technically feasible.

34 Lessons learned and knowledge gained from operating experience and license renewal
35 environmental reviews completed since development of the 2013 LR GEIS regarding these
36 issues are discussed in Section 4.11.1 of this LR GEIS.

37 **1.7.3 Emergency Preparedness**

38 The NRC will not make a decision or any recommendations on the basis of information
39 presented in this LR GEIS regarding emergency preparedness at nuclear power plants.
40 Nuclear power plant owners, government agencies, and State and local officials work together
41 to create a system for emergency preparedness and response that will serve the public in the
42 unlikely event of an emergency. The emergency plans for nuclear power plants cover
43 preparations for evacuation, sheltering, and other actions to protect residents near plants in the
44 event of a serious incident.

1 In the United States, 92 commercial nuclear power reactors are licensed to operate at 54 sites
2 in 28 States. Each site has onsite and offsite emergency plans to assure that adequate
3 protective measures can be taken to protect the public in the event of a radiological emergency.
4 Federal oversight of emergency preparedness for licensed nuclear power plants is shared by
5 the NRC and Federal Emergency Management Agency (FEMA). The NRC and FEMA have a
6 Memorandum of Understanding (44 CFR Part 353 Appendix A), under which FEMA has the
7 lead in overseeing offsite planning and response, and the NRC assists FEMA in carrying out
8 this role. The NRC has statutory responsibility for the radiological health and safety of the
9 public and retains the lead for oversight of onsite preparedness.

10 Before a nuclear power plant is licensed to operate, the NRC must have reasonable assurance
11 that adequate protective measures can and will be taken in the event of a radiological
12 emergency. The NRC's decision of reasonable assurance is based on licensees complying with
13 NRC regulations and guidance. In addition, licensees and area response organizations must
14 demonstrate that they can effectively implement emergency plans and procedures during
15 periodic evaluated exercises. As part of the reactor oversight process, the NRC reviews
16 licensees' emergency planning procedures and training. These reviews include regular drills
17 and exercises that assist licensees in identifying areas for improvement, such as the interface of
18 security operations and emergency preparedness. Each nuclear power plant owner is required
19 to exercise its emergency plan with the NRC, FEMA, and offsite authorities at least once every
20 2 years to ensure that State and local officials remain proficient in implementing their
21 emergency plans. Licensees also self-test their emergency plans regularly by conducting drills.

22 FEMA findings and determinations about the adequacy and capability of implementing offsite
23 plans are communicated to the NRC. The NRC reviews the FEMA findings and determinations
24 as well as the onsite findings. The NRC then makes a determination about the overall state of
25 emergency preparedness. The NRC uses the overall findings and determinations to make
26 radiological health and safety decisions before issuing licenses and in its continuing oversight of
27 operating reactors. The NRC has the authority to take action, including shutting down any
28 reactor deemed not to provide reasonable assurance of the protection of public health and
29 safety.

30 The Commission considered the need for a review of emergency planning issues in the context
31 of license renewal during its rulemaking proceedings on 10 CFR Part 54, which included public
32 notice and comment. As discussed in the statement of consideration for rulemaking
33 (56 FR 64966), the programs for emergency preparedness at nuclear power facilities apply to all
34 nuclear power facility licensees and require the specified levels of protection from each licensee
35 regardless of nuclear power plant design, construction, or license date. Requirements related to
36 emergency planning are in the regulations at 10 CFR 50.47 and Appendix E to 10 CFR Part 50.
37 These requirements apply to all operating licenses and will continue to apply to facilities with
38 renewed licenses. Through its standards and required exercises, the Commission reviews
39 existing emergency preparedness plans throughout the life of any facility, keeping up with
40 changing demographics and other site-related factors.

41 Therefore, the Commission has determined that there is no need for a special review of
42 emergency planning issues in the context of an environmental review for license renewal
43 (NRC 2006a). Thus, decisions and recommendations concerning emergency preparedness at
44 nuclear power plants are ongoing and outside the regulatory scope of license renewal.

1 **1.7.4 Safeguards and Security**

2 The NRC requires that nuclear power plants be both safe and secure. Safety refers to
3 operating the nuclear power plant in a manner that protects the public and the environment.
4 Security refers to protecting the nuclear power plant (using people, equipment, and
5 fortifications) from intruders who wish to damage or destroy it in order to harm people and the
6 environment.

7 Security issues such as safeguards planning are not tied to a license renewal action but are
8 considered to be issues that need to be dealt with continuously as a part of a nuclear power
9 plant's current (and renewed) operating license. Security issues are periodically reviewed and
10 updated at every operating nuclear power plant. These reviews continue throughout the period
11 of an operating license, whether it is the original or renewed license. If issues related to security
12 are discovered at a nuclear power plant, they are addressed immediately, and any necessary
13 changes are reviewed and incorporated under the operating license (NRC 2006a). As such,
14 decisions and recommendations concerning safeguards and security at nuclear power plants
15 are ongoing and outside the regulatory scope of this LR GEIS.

16 **1.7.5 Need for Power**

17 The NRC will not make a decision or any recommendations on the basis of information
18 presented in this LR GEIS regarding the need for power provided by nuclear power plants.
19 The regulatory authority over licensee economics (including the need for power) falls within the
20 jurisdiction of the States and, to some extent, within the jurisdiction of the Federal Energy
21 Regulatory Commission. The proposed rule for license renewal published on September 17,
22 1991 (56 FR 47016), had originally included a cost-benefit analysis and consideration of
23 licensee economics as part of the NEPA review. However, during the comment period, State,
24 Federal, and licensee representatives expressed concern about the use of economic costs and
25 cost-benefit balancing in the proposed rule and the 1996 LR GEIS. They noted that CEQ
26 regulations interpret NEPA as requiring only an assessment of the cumulative effects of a
27 proposed Federal action on the natural and human-made environment and that the
28 determination of the need for generating capacity has always been a State responsibility. For
29 this reason, the purpose and need for license renewal was defined by the Commission in the
30 June 5, 1996 final rule as follows (61 FR 28467):

31 The purpose and need for the proposed action (renewal of an operating license) is to
32 provide an option that allows for power generation capability beyond the term of a
33 current nuclear power plant operating license to meet future system generating needs,
34 as such needs may be determined by State, utility, and, where authorized, Federal
35 (other than NRC) decisionmakers.

36 10 CFR 51.95(c)(2) states, in part:

37 The supplemental environmental impact statement for license renewal is not required to
38 include discussion of need for power or the economic costs and economic benefits of the
39 proposed action or of alternatives to the proposed action except insofar as such benefits
40 and costs are either essential for a determination regarding the inclusion of an
41 alternative in the range of alternatives considered or relevant to mitigation.

1 **1.7.6 Seismicity, Flooding, and Other Natural Hazards**

2 The NRC will not make a decision or any recommendations on the basis of information
3 presented in this LR GEIS regarding seismic risk and flooding at nuclear power plants. The
4 NRC's assessment of seismic and flood hazards for existing nuclear power plants is a separate
5 and distinct process from license renewal reviews. Seismic and flood hazard issues are
6 appropriately addressed by the NRC on an ongoing basis at all licensed nuclear facilities as part
7 of its regulatory oversight activities. As such, decisions and recommendations concerning
8 seismic risk and flooding at nuclear power plants are outside the regulatory scope of this LR
9 GEIS. Following the accident at the Fukushima Dai-ichi nuclear power plant resulting from the
10 March 11, 2011, Great Tohoku Earthquake and subsequent tsunami, the NRC established the
11 Near-Term Task Force as directed by the Commission on March 23, 2011, in COMGBJ-11-
12 0002 (NRC 2011e). In consideration of the lessons learned following the Fukushima Dai-ichi
13 accident, the NRC staff developed an enhanced process to make sure that there is an ongoing
14 assessment of information on a range of natural hazards that could potentially pose a threat to
15 nuclear power plants. The framework developed as part of this process provides a graded
16 approach that allows the NRC to proactively, routinely, and systematically seek, evaluate, and
17 respond to new hazard information (NRC 2016f). In 2017, the Commission approved the staff's
18 process enhancements for an ongoing assessment of natural hazard information (NRC 2017).

19 **1.8 Implementation of the Rule (10 CFR Part 51)**

20 **1.8.1 General Requirements**

21 The regulatory requirements for conducting a NEPA review for license renewal are similar to the
22 NEPA review requirements for other major nuclear plant licensing actions. Consistent with the
23 current NEPA practice for nuclear plant licensing actions, an applicant is required to submit an
24 environmental report that assesses the environmental impacts associated with the proposed
25 action, considers alternatives to the proposed action, and evaluates any alternatives for
26 reducing adverse environmental effects. For license renewal, the NRC prepares a draft SEIS to
27 the LR GEIS for public comment and issues a final SEIS after considering public comments on
28 the draft.

29 **1.8.2 Applicant's Environmental Report**

30 The applicant's environmental report must contain an assessment of the environmental impacts
31 of renewing a license, the environmental impacts of alternatives, and mitigation alternatives. In
32 assessing the environmental impacts of license renewal for the environmental report, the
33 applicant should refer to the summary of findings on environmental issues for license renewal in
34 Table B-1 of 10 CFR Part 51. The license renewal applicant is not required to assess the
35 environmental impacts of Category 1 issues listed in Table B-1 unless the applicant is aware of
36 new and significant information that would change the conclusions in the LR GEIS. For
37 Category 2 issues listed in Table B-1, the applicant must provide a plant-specific assessment of
38 the impacts. The NRC's regulation in 10 CFR 51.53(c)(3)(ii) specifies the areas that must be
39 analyzed for the Category 2 issues in the environmental report.

40 The NRC's regulations in 10 CFR 51.45(c) and 10 CFR 51.53(c)(2) require license renewal
41 applicants to consider alternatives for reducing or avoiding adverse environmental effects
42 associated with the proposed action. Typically, this consideration is limited to the Category 2
43 NEPA issues listed in Table B-1. Pursuant to 10 CFR 51.45(d), the environmental report must
44 also include a discussion of the status of compliance with applicable Federal, State, and local

1 environmental standards. In addition, the NRC's regulation in 10 CFR 51.53(c)(2) specifically
2 excludes the consideration of need for power, the economic costs and benefits of the proposed
3 action, or alternatives to the proposed action in the environmental report for license renewal,
4 except when such consideration is essential for determining whether to include an alternative in
5 the range of alternatives or is relevant to mitigation. Other issues excluded from consideration
6 in the environmental report include issues not related to the environmental effects of the
7 proposed action (license renewal) and associated alternatives. The applicant should also
8 demonstrate the consideration of a range (set) of reasonable alternatives to license renewal in
9 the environmental report and is not limited to the alternatives and energy technologies
10 presented in this LR GEIS. Information provided in the applicant's environmental report will be
11 used in preparing the NRC's SEIS.

12 **1.8.3 Supplemental Environmental Impact Statement**

13 As required by 10 CFR 51.20(b)(2), the NRC is required to prepare a SEIS to the LR GEIS for
14 each license renewal environmental review. The SEIS serves as the NRC's analysis of the
15 environmental impacts of license renewal as well as a comparison of the impacts of alternatives.
16 This document also presents the NRC's recommendation about the environmental impact of
17 license renewal. SEISs for license renewal do not need to include a discussion of the need for
18 power or the economic costs and economic benefits of the proposed action or of alternatives to
19 the proposed action (10 CFR 51.95(c)(2)).

20 **1.8.4 Public Scoping and Public Comments**

21 The NRC conducts public scoping meetings to inform the public about the license renewal
22 process and receive comments on the scope of the NRC's plant-specific environmental review.
23 At the conclusion of the scoping period, NRC reviews and considers public comments in a
24 scoping summary report. In addition, the draft SEIS is issued for public comment (see
25 10 CFR 51.73). In reviewing public scoping comments on the proposed action and comments
26 on the draft SEIS, the NRC determines whether each comment provides any new and
27 significant information compared to the information and conclusions presented in the LR GEIS
28 (for Category 1 issues) as well as the information it provides on Category 2 issues considered in
29 the SEIS. If comments are determined to provide new and significant information that could
30 change the conclusions in the LR GEIS, these comments will be addressed in the SEIS.

31 **1.8.5 Draft Supplemental Environmental Impact Statement**

32 The NRC's draft SEIS presents an analysis of the environmental impacts of the proposed
33 license renewal action and the environmental impacts of the alternatives to the proposed action.
34 The NRC considers (1) the summary of findings on environmental issues for license renewal of
35 nuclear power plants in Table B-1 of 10 CFR Part 51 for Category 1 issues, (2) plant-specific
36 environmental impact analyses of Category 2 issues, and (3) any new and significant
37 information from the applicant's environmental report or identified through public scoping and
38 comment to reach a conclusion regarding the environmental impacts of license renewal. These
39 impacts are then compared to the environmental impacts of replacement energy alternatives.

40 **1.8.6 Final Supplemental Environmental Impact Statement**

41 The NRC issues a final SEIS in accordance with 10 CFR 51.91 and 51.93 after considering
42 (1) public comments, (2) the plant-specific environmental impact analysis of Category 2 issues,
43 and (3) new and significant information involving Category 1 issues summarized in Table B-1.

1 The NRC provides a record of its decision regarding the environmental impacts of the proposed
2 license renewal action (see 10 CFR 51.102 and 51.103). All comments on the draft SEIS are
3 addressed by the NRC in the final SEIS in accordance with 10 CFR 51.91(a)(1). Comments
4 regarding Category 1 issues are addressed in the following manner:

- 5 • The NRC's response to a comment regarding the applicability of the analysis of an impact
6 codified in the rule (i.e., 10 CFR Part 51) to the plant in question may be a statement and
7 explanation of its view that the analysis is adequate including, if applicable, consideration of
8 the significance of any new information. A commenter dissatisfied with such a response
9 may file a petition for rulemaking under 10 CFR 2.802. Procedures for the submission of
10 petitions for rulemaking are explained in 10 CFR Part 2. If a commenter is successful in
11 persuading the Commission that the new information does indicate that the analysis of an
12 impact codified in the rule is incorrect in significant respects (either in general or with respect
13 to the particular plant), then a rulemaking proceeding will be initiated.
- 14 • If a commenter provides new information that is relevant to the plant and is also relevant to
15 other plants (i.e., generic information) and that information demonstrates that the analysis of
16 an impact codified in the rule is incorrect, the NRC will seek Commission approval either to
17 suspend the application of the rule on a generic basis with respect to the analysis or to delay
18 granting the renewal application (and possibly other renewal applications) until the rule can
19 be amended. This LR GEIS would reflect the corrected analysis and any additional
20 consideration of alternatives as appropriate.
- 21 • If a commenter provides new, plant-specific information that demonstrates that the analysis
22 of an impact codified in the rule is incorrect with respect to the particular plant, then the NRC
23 staff will seek Commission approval to waive the application of the rule with respect to that
24 analysis in that specific renewal proceeding. The SEIS would reflect the corrected analysis
25 as appropriate.

26 The NRC will also consider comments on Category 2 issues and make any necessary changes
27 to the SEIS or explain why no changes were needed.

28 **1.9 Public Scoping Comments on the LR GEIS Update**

29 In support of the proposed review and update of the LR GEIS, the NRC staff conducted a
30 thorough environmental scoping process in 2020. The scoping process was conducted in
31 accordance with Commission direction and the NRC's regulations in Appendix B,
32 "Environmental Effect of Renewing the Operating License of a Nuclear Power Plant," to
33 Subpart A, "National Environmental Policy Act – Regulations Implementing Section 102(2)," of
34 10 CFR Part 51, "Environmental Protection Regulations for Domestic Licensing and Related
35 Regulatory Functions". The introduction in Appendix B to Subpart A of 10 CFR Part 51 states
36 that, on a 10-year cycle, the Commission intends to review the material in Appendix B, including
37 Table B-1, and update it, if necessary (61 FR 28467). Thus, the NRC began the latest review in
38 April 2020, approximately 7 years after the completion of the previous revision cycle in
39 June 2013.

40 On August 4, 2020, the NRC staff issued a *Federal Register* notice (85 FR 47252) initiating the
41 scoping process to solicit public input to support the review to determine whether to update the
42 LR GEIS, including updates to address SLR. It provided the public and other governmental
43 entities with an opportunity to comment on the review and propose areas for updating, in
44 accordance with 10 CFR 51.29. The NRC staff also directly contacted other Federal agencies,
45 States, and Tribes to invite their participation.

Introduction

1 The scoping process consisted of a 90-day public comment period and included four webinar
2 meetings conducted on August 19, 2020, and August 27, 2020, from 1:30 p.m. to 4:00 p.m. and
3 from 6:30 p.m. to 9:00 p.m. to receive comments from the public. Because of the COVID-19
4 public health emergency, no in-person meetings were held. The contents of each webinar
5 meeting were transcribed by a court reporter. On August 19, approximately 40 people attended
6 the two public webinar meetings, including representatives from the nuclear industry and
7 Federal and State agencies. On August 27, approximately 20 people collectively attended the
8 two webinar meetings, including representatives from the nuclear industry and Federal and
9 State agencies. The official transcripts are available in NRC's Agencywide Documents Access
10 and Management System (ADAMS) (NRC 2020j). The public scoping period ended on
11 November 2, 2020.

12 At the conclusion of the scoping period, the NRC staff issued *Environmental Impact Statement*
13 *Scoping Process Summary Report, Review and Update of the Generic Environmental Impact*
14 *Statement for License Renewal of Nuclear Plants (NUREG-1437)*, dated June 2021 (NRC
15 2021e). The report contains (1) comments received during the public meeting, via email, and
16 through Regulations.gov; (2) public comments grouped by subject area; and (3) NRC staff
17 responses to those comments.

18 All comments received were considered as part of the staff's review and update and are
19 referenced in Appendix A.

20 **1.10 Lessons Learned**

21 As previously discussed, the NRC reviewed and evaluated the impacts of license renewal. In
22 conducting a thorough update to the LR GEIS that reflects the "hard look" that is required for a
23 NEPA document, the NRC considered changes in applicable laws and regulations, new data in
24 its possession, collective experience, and lessons learned and knowledge gained from
25 conducting environmental reviews for initial LR and SLR since 2013. These developments and
26 practical insights provided a significant source of new information for this LR GEIS revision.

27 The purpose of this review and evaluation was to determine if the findings presented in the 2013
28 LR GEIS support the scope of license renewal, including for initial LR and SLR. In doing so, the
29 NRC considered the need to modify, add, group, subdivide, or delete any of the 78 issues in the
30 2013 LR GEIS. After this review and evaluation, the NRC identified 80 environmental issues for
31 detailed consideration in this LR GEIS revision. The following summarizes the types of
32 proposed changes to Table B-1. These changes are listed by order of appearance in Table B-1,
33 not by order of significance:

- 34 • One Category 2 issue, "Groundwater quality degradation (cooling ponds at inland sites),"
35 and a related Category 1 issue, "Groundwater quality degradation (cooling ponds in salt
36 marshes)," were consolidated into a single Category 2 issue, "Groundwater quality
37 degradation (plants with cooling ponds)."
- 38 • Two related Category 1 issues, "Infrequently reported thermal impacts (all plants)," and
39 "Effects of cooling water discharge on dissolved oxygen, gas supersaturation, and
40 eutrophication," and the thermal effluent component of the Category 1 issue, "Losses from
41 predation, parasitism, and disease among organisms exposed to sublethal stresses," were
42 consolidated into a single Category 1 issue, "Infrequently reported effects of thermal
43 effluents."
- 44 • One Category 2 issue, "Impingement and entrainment of aquatic organisms (plants with
45 once-through cooling systems or cooling ponds)," and the impingement component of a

- 1 Category 1 issue, “Losses from predation, parasitism, and disease among organisms
2 exposed to sublethal stresses,” were consolidated into a single Category 2 issue,
3 “Impingement mortality and entrainment of aquatic organisms (plants with once-through
4 cooling systems or cooling ponds).”
- 5 • One Category 1 issue, “Impingement and entrainment of aquatic organisms (plants with
6 cooling towers),” and the impingement component of the Category 1 issue, “Losses from
7 predation, parasitism, and disease among organisms exposed to sublethal stresses,” were
8 consolidated into a single Category 1 issue, “Impingement mortality and entrainment of
9 aquatic organisms (plants with cooling towers).”
 - 10 • One Category 2 issue, “Threatened, endangered, and protected species and essential fish
11 habitat,” was divided into three Category 2 issues: (1) “Endangered Species Act: federally
12 listed species and critical habitats under U.S. Fish and Wildlife jurisdiction,” (2) “Endangered
13 Species Act: federally listed species and critical habitats under National Marine Fisheries
14 Service jurisdiction,” and (3) “Magnuson-Stevens Act: essential fish habitat.”
 - 15 • Two new Category 2 issues, “National Marine Sanctuaries Act: sanctuary resources” and
16 “Climate change impacts on environmental resources,” were added.
 - 17 • One Category 2 issue, “Severe accidents,” was changed to a Category 1 issue.
 - 18 • One new Category 1 issue, “Greenhouse gas impacts on climate change,” was added.
 - 19 • Several issue titles and findings were revised for clarity.

20 Historically, the issues identified in the LR GEIS have served to accurately categorize most
21 environmental impacts associated with license renewal. While there have been a number of
22 instances where new (but not significant) information was discovered during a license renewal
23 environmental review for Category 1 issues since publication of the 2013 LR GEIS, the number
24 of instances where information was determined to be both new and significant has been limited.
25 Most notably, in the SEIS for second renewal of Turkey Point, the NRC found that new
26 information for the Category 1 (generic) issue “Groundwater Quality Degradation (Plants with
27 Cooling Ponds in Salt Marshes)” was both new and significant for the initial LR term (NRC
28 2019c). As noted above, that issue was consolidated with a Category 2 issue, “Groundwater
29 quality degradation (cooling ponds at inland sites),” into a new Category 2 issue, “Groundwater
30 quality degradation (plants with cooling ponds).”

31 **1.11 Organization of the LR GEIS**

32 Consistent with the 2013 LR GEIS, this LR GEIS revision adopts the NRC’s standard format for
33 EISs as established in 10 CFR Part 51, Subpart A, Appendix A. This LR GEIS is organized
34 according to a more typical NEPA resource-based approach to presenting impacts where all
35 components of the proposed action and alternatives are presented for each resource area. The
36 following list describes the contents of each chapter of the LR GEIS:

- 37 • **Chapter 2** presents brief descriptions of the proposed action (including nuclear plant
38 operations, refurbishment, and termination of operations and decommissioning) during the
39 license renewal term and a summary of impacts, the no action alternative, and energy
40 alternatives.
- 41 • **Chapter 3** presents a general description of the affected environment in the vicinity of
42 operating commercial nuclear power plants in the United States. Included are descriptions
43 of nuclear power plant facilities and operations followed by general descriptions of existing
44 conditions in the following topical areas: (1) land use and visual resources; (2) meteorology,

Introduction

- 1 air quality, and noise; (3) geologic environment; (4) water resources (surface water
2 resources and groundwater resources); (5) ecological resources (terrestrial resources,
3 aquatic resources, and federally protected ecological resources); (6) historic and cultural
4 resources; (7) socioeconomics; (8) human health (radiological and nonradiological hazards);
5 (9) environmental justice; (10) waste management and pollution prevention; and
6 (11) greenhouse gas emissions and climate change.
- 7 • **Chapter 4** presents the environmental consequences associated with the proposed action
8 (license renewal) and energy alternatives (including the incremental effects of continued
9 operations and refurbishment) on each of the topical areas presented in Chapter 3. Impacts
10 common to all alternatives (including the environmental consequences of fuel cycles and
11 terminating power plant operations), cumulative effects (impacts), and resource
12 commitments associated with the proposed action are also discussed.
- 13 • **Chapter 5** presents the references for Chapters 1 through 4.
- 14 • **Chapter 6** presents a list of the preparers of this LR GEIS, their affiliations, authorship
15 responsibilities, and qualifications.
- 16 • **Chapter 7** provides a list of the agencies, organizations, and persons receiving copies of the
17 LR GEIS.
- 18 • **Chapter 8** provides for a glossary of terms used in the LR GEIS.
- 19
20

2.0 ALTERNATIVES INCLUDING THE PROPOSED ACTION

The proposed action is the renewal of a commercial nuclear power plant's operating license. The U.S. Nuclear Regulatory Commission's (NRC's) regulations in Title 10 of the *Code of Federal Regulations* (10 CFR) Part 51, implementing Section 102(2) of the National Environmental Policy Act (NEPA; 42 U.S.C. § 4321 et seq.), requires the consideration of alternatives to renewing the nuclear power plant's operating license and the comparison of the impacts of renewing the operating license to the environmental impacts of reasonable alternatives. This allows the NRC to determine whether the environmental impacts of license renewal are so great that preserving the option of license renewal for energy-planning decisionmakers would be unreasonable. If the NRC decides not to renew the operating license of a nuclear power plant, energy-planning decisionmakers will then have to find alternative means of addressing energy needs. Alternatives to license renewal include other means of generating electricity, as well as offsetting demand using conservation and energy efficiency measures (demand-side management), delaying planned retirements of other existing plants, or purchasing sufficient power to replace the capacity supplied by the existing nuclear power plant.

Contents of Chapter 2.0

- Proposed Action (Section 2.1)
- No Action Alternative (Section 2.2)
- Alternative Energy Sources (Section 2.3)
- Comparison of Alternatives (Section 2.4)

If the NRC renews the operating license, the decision about whether or not to continue nuclear power plant operations will be made by the licensee and State or other Federal (non-NRC) decisionmakers. This decision may be based on economic, reliability, operational, policy, and environmental objectives.

Section 2.1 below in this revision of NUREG-1437, *Generic Environmental Impact Statement for License Renewal of Nuclear Plants* (LR GEIS) describes the proposed action, including nuclear plant operations during the license renewal term (initial license renewal (initial LR) or subsequent license renewal (SLR)), refurbishment, and other activities associated with license renewal. Most of these activities would be the same as or similar to those already occurring at the nuclear plant. Termination of nuclear plant operations would occur at or before the end of the license renewal term, and decommissioning activities would commence after reactor operations have ceased.

The impacts of the proposed action and any refurbishment activities that may be undertaken in support of license renewal are summarized in Section 2.1.4, including each of the identified 80 environmental issues, their significance (SMALL, MODERATE, or LARGE, as defined in Section 1.5), and whether the impact designation would apply to all or a subset of nuclear plants. Section 2.2 describes the no action alternative (not renewing the operating license), and Section 2.3 presents alternatives for replacing existing nuclear generating capacity using other energy sources, including fossil fuel, new nuclear, renewable energy, and offsetting existing nuclear generating capacity, including demand-side management, delayed retirement, and

Alternatives Including the Proposed Action

1 purchased power. The potential environmental consequences (impacts) of the proposed action
2 and alternatives to the proposed action are presented in Chapter 4.0.

3 The NRC does not reach a generic conclusion regarding the impacts of alternatives to license
4 renewal and will consider these impacts in nuclear power plant-specific (hereafter called plant-
5 specific) supplemental environmental impact statements (SEISs). However, Section 2.4
6 presents a summary comparison of the impacts of the proposed action to these alternatives.

Alternatives to the Proposed Action Considered in the LR GEIS

- Not renewing the operating licenses of commercial nuclear power plants (no action alternative).
- Replacing existing nuclear generating capacity using other energy sources (including fossil fuel, new nuclear, and renewable energy).
- Offsetting existing nuclear generation capacity using conservation and energy efficiency (demand-side management), delayed retirement, or purchased power.

7 **2.1 Proposed Action**

8 As stated in Section 1.2, the proposed action is the renewal of commercial nuclear power plant
9 operating licenses. For the NRC to determine whether the license should be renewed, an
10 applicant is required to perform certain safety analyses to demonstrate that the nuclear power
11 plant and the licensee can effectively manage the effects of aging and continue safe reactor
12 operations during the renewal term. These safety analyses include an assessment of the
13 effects of potential age-related degradation of certain long-lived, passive systems, structures,
14 and components (SSCs). This requires applicants to describe the conditions under which the
15 plant would operate during the license renewal term. A description of nuclear plant operations
16 during the license renewal term is provided in Section 2.1.1.

17 Applicants may also conduct refurbishment activities (replacement of major components and
18 systems) necessary to continue reactor operation during the renewal term. These are
19 described in Section 2.1.2. Section 2.1.3 presents an overview of the termination of nuclear
20 plant operations and decommissioning process. Termination of operations and
21 decommissioning impacts are addressed in Section 4.14.3.

22 **2.1.1 Nuclear Plant Operations during the License Renewal Term**

23 This section describes nuclear plant operations, maintenance, and refueling activities, including
24 aging management reviews, required for license renewal. During the license renewal term,
25 nuclear plants would continue to operate in the same manner as they do now. All nuclear
26 reactors currently operating in the United States are light water reactors, of which there are two
27 basic types—pressurized water reactors (PWRs) and boiling water reactors (BWRs). A brief
28 description of these reactors and baseline conditions during their operation are presented in
29 Chapter 3.0.

30 Activities conducted at nuclear plants include:

- 31 • reactor operations;
- 32 • waste management (processing, storage, packaging, and offsite shipment of wastes);

- 1 • security (includes site security personnel);
- 2 • office and clerical work (management, public relations, and support staff);
- 3 • laboratory analysis;
- 4 • surveillance, monitoring, and maintenance (e.g., equipment testing and inspections); and
- 5 • refueling and other outages (additional workers during outage).

6 These activities are expected to continue during the license renewal term. Certain SSCs such
 7 as the reactor pressure vessel, reactor containment building, and piping would continue to
 8 operate into the license renewal term. The regulations in 10 CFR Part 54 place certain
 9 requirements on licensees to make sure that such SSCs continue to operate safely.
 10 Incremental aging management activities implemented to allow operation of a nuclear power
 11 plant beyond the original 40-year license term are assumed to fall under one of two broad
 12 categories: (1) surveillance, monitoring, inspection, testing, trending, and recordkeeping
 13 actions, most of which are repeated at regular intervals, and (2) major refurbishment actions,
 14 which usually occur infrequently and possibly only once in the life of the plant for any given item.
 15 Refurbishment activities are discussed in Section 2.1.2.

16 The NRC finds that the approaches to environmental impacts from refurbishment activities
 17 contained in the previous LR GEISs are valid and conservative. The approaches yield
 18 environmental impacts that are likely greater than—or at least equal to—the actual impacts
 19 during the license renewal term.

20 **2.1.2 Refurbishment and Other Activities Associated with License Renewal**

21 The NRC assumes that licensees may need to conduct refurbishment activities to ensure the
 22 safe and economic operation of nuclear plants during the license renewal term. Refurbishment
 23 activities include replacement and repair of SSCs. Replacement activities include replacing
 24 steam generators and pressurizers for PWRs and recirculation piping systems for BWRs. It is
 25 assumed that some applicants may undertake construction projects to replace or improve power
 26 plant infrastructure. Such projects could include construction of new parking lots, roads, storage
 27 facilities, office buildings, structures, and other facilities.

28 The number of SSCs involved in refurbishment and the frequency and duration of each activity
 29 would vary. In many circumstances, refurbishment activities (e.g., steam generator and reactor
 30 vessel head replacement) have already taken place at a number of nuclear plants. These
 31 refurbishment-type activities were conducted for economic, reliability, or efficiency reasons
 32 during refueling or maintenance outages (i.e., not for license renewal). In addition, very few
 33 applications have identified any refurbishment activities associated with license renewal.

34 Impacts from refurbishment activities outside of license renewal are assumed to have been
 35 considered in annual site evaluation reports, environmental operating reports, and Radiological
 36 Environmental Monitoring Program reports. Detailed analyses of environmental impacts have
 37 not been performed for refurbishment actions in this LR GEIS revision because these actions
 38 would vary at each nuclear plant. Refurbishment activities proposed by license renewal
 39 applicants in their environmental report will be addressed in plant-specific environmental
 40 reviews. Chapter 4.0 of this LR GEIS considers the impacts of representative or bounding
 41 refurbishment activities in a number of resource areas.

1 **2.1.3 Termination of Nuclear Plant Operations and Decommissioning after License**
2 **Renewal**

3 Environmental impacts caused by the licensee's decision to permanently cease nuclear plant
4 operations and enter into decommissioning are outside the scope of the LR GEIS. This
5 includes impacts from terminating reactor operations and the removal of fuel from the reactor
6 vessel, regardless of when or why the decision is made. Decommissioning impacts are
7 addressed in NUREG-0586, *Generic Environmental Impact Statement on Decommissioning of*
8 *Nuclear Facilities, Supplement 1: Regarding the Decommissioning of Nuclear Power Reactors,*
9 *(Decommissioning GEIS) (NRC 2002c).*

10 Most nuclear plant activities and systems dedicated to reactor operations would cease after
11 reactor shutdown. Some activities (e.g., security and spent nuclear fuel management) would
12 continue, while other activities (administration, laboratory analysis, and reactor surveillance,
13 monitoring, and maintenance) may be reduced or eliminated. Shared systems at a nuclear
14 power plant that have multiple units would continue to operate but at reduced capacity until all
15 units cease operation. The cessation of activities needed to maintain and operate the reactor
16 would reduce the need for workers at the nuclear power plant, but it would not lead to the
17 immediate dismantlement of the reactor or its infrastructure.

18 The decommissioning process begins when the licensee informs the NRC that it has
19 permanently ceased reactor operations, defueled, and intends to decommission the nuclear
20 plant. Regulations in 10 CFR 50.82(a)(4)(i) and 10 CFR 52.110(d)(1) require licensees to
21 submit a post-shutdown decommissioning activity report (PSDAR) to the NRC, and forward a
22 copy to the affected State(s), no later than 2 years after the cessation of reactor operations.

23 The licensee must describe all planned activities in the PSDAR, including the schedule and
24 estimated costs for radiological decommissioning (excluding site restoration and spent fuel
25 management costs). The licensee also documents the evaluation of the environmental impacts
26 of planned decommissioning activities at the nuclear plant and provides a basis for why impacts
27 are bounded by previously issued environmental review documents (e.g., Decommissioning
28 GEIS, NRC 2002c). The licensee must also describe any decommissioning activities whose
29 impacts are not bounded and how the impacts will be addressed prior to conducting these
30 activities at the nuclear plant (e.g., through regulatory exemption or license amendment
31 requests). The licensee is required to update the PSDAR if there are any significant changes in
32 decommissioning activity, costs, schedule, or environmental impact.

33 Once the NRC receives the PSDAR, the report is docketed and a notice of receipt is published
34 in the *Federal Register* to solicit public comments. The NRC conducts a public meeting near
35 the nuclear plant to discuss the licensee's decommissioning plans and schedule, answer
36 questions, and solicit comments.

37 The licensee submits a License Termination Plan with final status survey strategy to the NRC
38 near the end of decommissioning, at least 2 years before the operating license can be
39 terminated. Prior to completing decommissioning, the licensee must conduct a survey
40 demonstrating compliance with site release criteria established in the License Termination Plan.
41 The NRC verifies the survey results by one or more of the following methods: a quality
42 assurance/quality control review, side-by-side or split sampling of radiological surveys of
43 selected areas, or independent confirmatory surveys. When the NRC confirms that the criteria
44 in the License Termination Plan and all other NRC regulatory requirements have been met, the
45 NRC either terminates or amends the operating license, depending on the licensee's decision

1 on use of the licensed area. The former nuclear plant area and any remaining structures on the
 2 site can then be released for restricted or unrestricted use, as appropriate. The criteria for
 3 restricted use conditions and alternate criteria that the NRC may approve under certain
 4 conditions are listed in 10 CFR 20.1403 and 10 CFR 20.1404, respectively. The radiological
 5 criteria for releasing sites for unrestricted use are given in 10 CFR 20.1402.

6 **2.1.4 Impacts of the Proposed Action**

7 When evaluating the impacts of the proposed action, 80 environmental issues were identified:
 8 72 issues associated with continued operations and any refurbishment during the initial LR and
 9 SLR terms; 2 with postulated accidents; 1 with the termination of nuclear power plant operations
 10 and decommissioning; 4 with the uranium fuel cycle; and 1 with cumulative effects. For all
 11 issues, the focus of the evaluation was on the incremental effects of license renewal (for the
 12 initial LR or SLR term) relative to the no action alternative. Impact significance levels and
 13 categories are defined in Section 1.5.

14 A summary of the environmental impacts of the proposed action is presented in Table 2.1-1.
 15 The technical basis for the impact determinations presented in this table is found in Chapter 4.0
 16 of this LR GEIS in Sections 4.2 through 4.14.

17 **Table 2.1-1 Summary of Findings on Environmental Issues under the Proposed Action**
 18 **(Initial and One Term of Subsequent License Renewal)**

Environmental Issue	Impact Finding ^{(a)(b)}
Land Use	
Onsite land use	SMALL (Category 1). Changes in onsite land use from continued operations and refurbishment associated with license renewal would be a small fraction of the nuclear power plant site and would involve only land that is controlled by the licensee.
Offsite land use	SMALL (Category 1). Offsite land use would not be affected by continued operations and refurbishment associated with license renewal.
Offsite land use in transmission line right-of-ways (ROWs) ^(c)	SMALL (Category 1). Use of transmission line ROWs from continued operations and refurbishment associated with license renewal would continue with no change in land use restrictions.
Visual Resources	
Aesthetic impacts	SMALL (Category 1). No important changes to the visual appearance of plant structures or transmission lines are expected from continued operations and refurbishment associated with license renewal.

Alternatives Including the Proposed Action

Environmental Issue	Impact Finding ^{(a)(b)}
Air Quality	
Air quality impacts	<p>SMALL (Category 1). Air quality impacts from continued operations and refurbishment associated with license renewal are expected to be small at all plants. Emissions from emergency diesel generators and fire pumps and routine operations of boilers used for space heating are minor. Impacts from cooling tower particulate emissions have been small.</p> <p>Emissions resulting from refurbishment activities at locations in or near air quality nonattainment or maintenance areas would be short-lived and would cease after these activities are completed. Operating experience has shown that the scale of refurbishment activities has not resulted in exceedance of the <i>de minimis</i> thresholds for criteria pollutants, and best management practices, including fugitive dust controls and the imposition of permit conditions in State and local air emissions permits, would ensure conformance with applicable State or Tribal implementation plans.</p>
Air quality effects of transmission lines ^(c)	<p>SMALL (Category 1). Production of ozone and oxides of nitrogen from transmission lines is insignificant and does not contribute measurably to ambient levels of these gases.</p>
Noise	
Noise impacts	<p>SMALL (Category 1). Noise levels would remain below regulatory guidelines for offsite receptors during continued operations and refurbishment associated with license renewal.</p>
Geologic Environment	
Geology and soils	<p>SMALL (Category 1). The impact of continued operations and refurbishment activities on geology and soils would be small for all nuclear power plants and would not change appreciably during the license renewal term.</p>
Surface Water Resources	
Surface water use and quality (non-cooling system impacts)	<p>SMALL (Category 1). Impacts are expected to be small if best management practices are employed to control soil erosion and spills. Surface water use associated with continued operations and refurbishment associated with license renewal would not increase significantly or would be reduced if refurbishment occurs during a plant outage.</p>
Altered current patterns at intake and discharge structures	<p>SMALL (Category 1). Altered current patterns would be limited to the area in the vicinity of the intake and discharge structures. These impacts have been small at operating nuclear power plants.</p>
Altered salinity gradients	<p>SMALL (Category 1). Effects on salinity gradients would be limited to the area in the vicinity of the intake and discharge structures. These impacts have been small at operating nuclear power plants.</p>
Altered thermal stratification of lakes	<p>SMALL (Category 1). Effects on thermal stratification would be limited to the area in the vicinity of the intake and discharge structures. These impacts have been small at operating nuclear power plants.</p>
Scouring caused by discharged cooling water	<p>SMALL (Category 1). Scouring effects would be limited to the area in the vicinity of the intake and discharge structures. These impacts have been small at operating nuclear power plants.</p>

Environmental Issue	Impact Finding ^{(a)(b)}
Discharge of metals in cooling system effluent	SMALL (Category 1). Discharges of metals have not been found to be a problem at operating nuclear power plants with cooling-tower-based heat dissipation systems and have been satisfactorily mitigated at other plants. Discharges are monitored and controlled as part of the National Pollutant Discharge Elimination System (NPDES) permit process.
Discharge of biocides, sanitary wastes, and minor chemical spills	SMALL (Category 1). The effects of these discharges are regulated by Federal and State environmental agencies. Discharges are monitored and controlled as part of the NPDES permit process. These impacts have been small at operating nuclear power plants.
Surface water use conflicts (plants with once-through cooling systems)	SMALL (Category 1). These conflicts have not been found to be a problem at operating nuclear power plants with once-through heat dissipation systems.
Surface water use conflicts (plants with cooling ponds or cooling towers using makeup water from a river)	SMALL or MODERATE (Category 2). Impacts could be of small or moderate significance, depending on makeup water requirements, water availability, and competing water demands.
Effects of dredging on surface water quality	SMALL (Category 1). Dredging to remove accumulated sediments in the vicinity of intake and discharge structures and to maintain barge shipping has not been found to be a problem for surface water quality. Dredging is performed under permit from the U.S. Army Corps of Engineers, and possibly, from other State or local agencies.
Temperature effects on sediment transport capacity	SMALL (Category 1). These effects have not been found to be a problem at operating nuclear power plants and are not expected to be a problem during the license renewal term.
Groundwater Resources	
Groundwater contamination and use (non-cooling system impacts)	SMALL (Category 1). Extensive dewatering is not anticipated from continued operations and refurbishment associated with license renewal. Industrial practices involving the use of solvents, hydrocarbons, heavy metals, or other chemicals, and/or the use of wastewater ponds or lagoons have the potential to contaminate site groundwater, soil, and subsoil. Contamination is subject to State or U.S. Environmental Protection Agency (EPA) regulated cleanup and monitoring programs. The application of best management practices for handling any materials produced or used during these activities would reduce impacts.
Groundwater use conflicts (plants that withdraw less than 100 gallons per minute [gpm])	SMALL (Category 1). Plants that withdraw less than 100 gpm are not expected to cause any groundwater use conflicts.
Groundwater use conflicts (plants that withdraw more than 100 gallons per minute [gpm])	SMALL, MODERATE, or LARGE (Category 2). Plants that withdraw more than 100 gpm could cause groundwater use conflicts with nearby groundwater users.

Alternatives Including the Proposed Action

Environmental Issue	Impact Finding ^{(a)(b)}
Groundwater use conflicts (plants with closed-cycle cooling systems that withdraw makeup water from a river)	SMALL, MODERATE, or LARGE (Category 2). Water use conflicts could result from water withdrawals from rivers during low-flow conditions, which may affect aquifer recharge. The significance of impacts would depend on makeup water requirements, water availability, and competing water demands.
Groundwater quality degradation resulting from water withdrawals	SMALL (Category 1). Groundwater withdrawals at operating nuclear power plants would not contribute significantly to groundwater quality degradation.
Groundwater quality degradation (plants with cooling ponds)	SMALL or MODERATE (Category 2). Sites with cooling ponds could degrade groundwater quality. The significance of the impact would depend on site-specific conditions including cooling pond water quality, site hydrogeologic conditions (including the interaction of surface water and groundwater), and the location, depth, and pump rate of water wells.
Radionuclides released to groundwater	SMALL or MODERATE (Category 2). Leaks of radioactive liquids from plant components and pipes have occurred at numerous plants. Groundwater protection programs have been established at all operating nuclear power plants to minimize the potential impact from any inadvertent releases. The magnitude of impacts would depend on site-specific characteristics.
Terrestrial Resources	
Non-cooling system impacts on terrestrial resources	SMALL, MODERATE, or LARGE (Category 2). The magnitude of effects of continued nuclear power plant operation and refurbishment, unrelated to operation of the cooling system, would depend on numerous site-specific factors, including ecological setting, planned activities during the license renewal term, and characteristics of the plants and animals present in the area. Application of best management practices and other conservation initiatives would reduce the potential for impacts.
Exposure of terrestrial organisms to radionuclides	SMALL (Category 1). Doses to terrestrial organisms from continued nuclear power plant operation and refurbishment during the license renewal term would be expected to remain well below U.S. Department of Energy exposure guidelines developed to protect these organisms.
Cooling system impacts on terrestrial resources (plants with once-through cooling systems or cooling ponds)	SMALL (Category 1). Continued operation of nuclear power plant cooling systems during license renewal could cause thermal effluent additions to receiving water bodies, chemical effluent additions to surface water or groundwater, impingement of waterfowl, disturbance of terrestrial plants and wetlands from maintenance dredging, and erosion of shoreline habitat. However, plants where these impacts have occurred successfully mitigated the impact, and it is no longer of concern. These impacts are not expected to be significant issues during the license renewal term.
Cooling tower impacts on terrestrial plants	SMALL (Category 1). Continued operation of nuclear power plant cooling towers could deposit particulates and water droplets or ice on vegetation and lead to structural damage or changes in terrestrial plant communities. However, nuclear power plants where these impacts occurred have successfully mitigated the impact. These impacts are not expected to be significant issues during the license renewal term.

Environmental Issue	Impact Finding ^{(a)(b)}
Bird collisions with plant structures and transmission lines ^(c)	SMALL (Category 1). Bird mortalities from collisions with nuclear power plant structures and in-scope transmission lines would be negligible for any species and are unlikely to threaten the stability of local or migratory bird populations or result in noticeable impairment of the function of a species within the ecosystem. These impacts are not expected to be significant issues during the license renewal term.
Water use conflicts with terrestrial resources (plants with cooling ponds or cooling towers using makeup water from a river)	SMALL or MODERATE (Category 2). Nuclear power plants could consume water at rates that cause occasional or intermittent water use conflicts with nearby and downstream terrestrial and riparian communities. Such impacts could noticeably affect riparian or wetland species or alter characteristics of the ecological environment during the license renewal term. The one plant where impacts have occurred successfully mitigated the impact. Impacts are expected to be small at most nuclear power plants but could be moderate at some.
Transmission line right-of-way (ROW) management impacts on terrestrial resources ^(c)	SMALL (Category 1). In-scope transmission lines tend to occupy only industrial-use or other developed portions of nuclear power plant sites and, therefore, effects of ROW maintenance on terrestrial plants and animals during the license renewal term would be negligible. Application of best management practices would reduce the potential for impacts.
Electromagnetic field effects on terrestrial plants and animals ^(c)	SMALL (Category 1). In-scope transmission lines tend to occupy only industrial-use or other developed portions of nuclear power plant sites and, therefore, the effects of electromagnetic fields on terrestrial plants and animals during the license renewal term would be negligible.
Aquatic Resources	
Impingement mortality and entrainment of aquatic organisms (plants with once-through cooling systems or cooling ponds)	SMALL, MODERATE, or LARGE (Category 2). The impacts of impingement mortality and entrainment would generally be small at nuclear power plants with once-through cooling systems or cooling ponds that have implemented best technology requirements for existing facilities under Clean Water Act (CWA) Section 316(b). For all other plants, impacts could be small, moderate, or large depending on characteristics of the cooling water intake system, results of impingement and entrainment studies performed at the plant, trends in local fish and shellfish populations, and implementation of mitigation measures.
Impingement mortality and entrainment of aquatic organisms (plants with cooling towers)	SMALL (Category 1). No significant impacts on aquatic populations associated with impingement mortality and entrainment at nuclear power plants with cooling towers have been reported, including effects on fish and shellfish from direct mortality, injury, or other sublethal effects. Impacts during the license renewal term would be similar and small. Further, the effects of these cooling water intake systems would be mitigated through adherence to NPDES permit conditions established pursuant to CWA Section 316(b).
Entrainment of phytoplankton and zooplankton	SMALL (Category 1). Entrainment has not resulted in noticeable impacts on phytoplankton or zooplankton populations near operating nuclear power plants. Impacts during the license renewal term would be similar and small. Further, effects would be mitigated through adherence to NPDES permit conditions established pursuant to CWA Section 316(b).
Effects of thermal effluents on aquatic organisms (plants with once-through)	SMALL, MODERATE, or LARGE (Category 2). Acute, sublethal, and community-level effects of thermal effluents on aquatic organisms would generally be small at nuclear power plants with once-through cooling systems or cooling ponds that adhere to State water quality criteria or that

Alternatives Including the Proposed Action

Environmental Issue	Impact Finding ^{(a)(b)}
cooling systems or cooling ponds)	have and maintain a valid CWA Section 316(a) variance. For all other plants, impacts could be small, moderate, or large depending on site-specific factors, including ecological setting of the plant; characteristics of the cooling system and effluent discharges; and characteristics of the fish, shellfish, and other aquatic organisms present in the area.
Effects of thermal effluents on aquatic organisms (plants with cooling towers)	SMALL (Category 1). Acute, sublethal, and community-level effects of thermal effluents have not resulted in noticeable impacts on aquatic communities at nuclear power plants with cooling towers. Impacts during the license renewal term would be similar and small. Further, effects would be mitigated through adherence to State water quality criteria or CWA Section 316(a) variances.
Infrequently reported effects of thermal effluents	SMALL (Category 1). Continued operation of nuclear power plant cooling systems could result in certain infrequently reported thermal impacts, including cold shock, thermal migration barriers, accelerated maturation of aquatic insects, proliferation of aquatic nuisance organisms, depletion of dissolved oxygen, gas supersaturation, eutrophication, and increased susceptibility of exposed fish and shellfish to predation, parasitism, and disease. Most of these effects have not been reported at operating nuclear power plants. Plants that have experienced these impacts successfully mitigated the impact, and it is no longer of concern. Infrequently reported thermal impacts are not expected to be significant issues during the license renewal term.
Effects of nonradiological contaminants on aquatic organisms	SMALL (Category 1). Heavy metal leaching from condenser tubes was an issue at several operating nuclear power plants. These plants successfully mitigated the issue, and it is no longer of concern. Cooling system effluents would be the primary source of nonradiological contaminants during the license renewal term. Implementation of best management practices and adherence to NPDES permit limitations would minimize the effects of these contaminants on the aquatic environment.
Exposure of aquatic organisms to radionuclides	SMALL (Category 1). Doses to aquatic organisms from continued nuclear power plant operation and refurbishment during the license renewal term would be expected to remain well below U.S. Department of Energy exposure guidelines developed to protect these organisms.
Effects of dredging on aquatic resources	SMALL (Category 1). Dredging at nuclear power plants is expected to occur infrequently, would be of relatively short duration, and would affect relatively small areas. Continued operation of many plants may not require any dredging. Adherence to best management practices and CWA Section 404 permit conditions would mitigate potential impacts at plants where dredging is necessary to maintain function or reliability of cooling systems. Dredging is not expected to be a significant issue during the license renewal term.
Water use conflicts with aquatic resources (plants with cooling ponds or cooling towers using makeup water from a river)	SMALL or MODERATE (Category 2). Nuclear power plants could consume water at rates that cause occasional or intermittent water use conflicts with nearby and downstream aquatic communities. Such impacts could noticeably affect aquatic plants or animals or alter characteristics of the ecological environment during the license renewal term. The one plant where impacts have occurred successfully mitigated the impact. Impacts are expected to be small at most nuclear power plants but could be moderate at some.

Environmental Issue	Impact Finding ^{(a)(b)}
Non-cooling system impacts on aquatic resources	SMALL (Category 1). No significant impacts on aquatic resources associated with landscape and grounds maintenance, stormwater management, or ground-disturbing activities at operating nuclear power plants have been reported. Impacts from continued operation and refurbishment during the license renewal term would be similar and small. Application of best management practices and other conservation initiatives would reduce the potential for impacts.
Impacts of transmission line right-of-way (ROW) management on aquatic resources ^(c)	SMALL (Category 1). In-scope transmission lines tend to occupy only industrial-use or other developed portions of nuclear power plant sites and, therefore, the effects of ROW maintenance on aquatic plants and animals during the license renewal term would be negligible. Application of best management practices would reduce the potential for impacts.
Federally Protected Ecological Resources	
Endangered Species Act: federally listed species and critical habitats under U.S. Fish and Wildlife jurisdiction	(Category 2). The potential effects of continued nuclear power plant operation and refurbishment on federally listed species and critical habitats would depend on numerous site-specific factors, including the ecological setting; listed species and critical habitats present in the action area; and plant-specific factors related to operations, including water withdrawal, effluent discharges, and other ground-disturbing activities. Consultation with the U.S. Fish and Wildlife Service under Endangered Species Act Section 7(a)(2) would be required if license renewal may affect listed species or critical habitats under this agency's jurisdiction.
Endangered Species Act: federally listed species and critical habitats under National Marine Fisheries Service jurisdiction	(Category 2). The potential effects of continued nuclear power plant operation and refurbishment on federally listed species and critical habitats would depend on numerous site-specific factors, including the ecological setting; listed species and critical habitats present in the action area; and plant-specific factors related to operations, including water withdrawal, effluent discharges, and other ground-disturbing activities. Consultation with the National Marine Fisheries Service under Endangered Species Act Section 7(a)(2) would be required if license renewal may affect listed species or critical habitats under this agency's jurisdiction.
Magnuson-Stevens Act: essential fish habitat	(Category 2). The potential effects of continued nuclear power plant operation and refurbishment on essential fish habitat would depend on numerous site-specific factors, including the ecological setting; essential fish habitat present in the area, including habitats of particular concern; and plant-specific factors related to operations, including water withdrawal, effluent discharges, and other activities that may affect aquatic habitats. Consultation with the National Marine Fisheries Service under Magnuson-Stevens Act Section 305(b) would be required if license renewal could result in adverse effects to essential fish habitat.
National Marine Sanctuaries Act: sanctuary resources	(Category 2). The potential effects of continued nuclear power plant operation and refurbishment on sanctuary resources would depend on numerous site-specific factors, including the ecological setting; national marine sanctuaries present in the area; and plant-specific factors related to operations, including water withdrawal, effluent discharges, and other activities that may affect aquatic habitats. Consultation with the Office of National Marine Sanctuaries under National Marine Sanctuaries Act Section 304(d) would be required if license renewal could destroy, cause the loss of, or injure sanctuary resources.

Environmental Issue	Impact Finding ^{(a)(b)}
Historic and Cultural Resources	
Historic and cultural resources ^(c)	(Category 2). Impacts from continued operations and refurbishment on historic and cultural resources located onsite and in the transmission line ROW are analyzed on a plant-specific basis. The NRC will perform a National Historic Preservation Act (NHPA) Section 106 review, in accordance with 36 CFR Part 800 which includes consultation with the State and Tribal Historic Preservation Officers, Indian Tribes, and other interested parties.
Socioeconomics	
Employment and income, recreation and tourism	SMALL (Category 1). Although most nuclear plants have large numbers of employees with higher than average wages and salaries, employment, income, recreation, and tourism impacts from continued operations and refurbishment associated with license renewal are expected to be small.
Tax revenue	SMALL (Category 1). Nuclear plants provide tax revenue to local jurisdictions in the form of property tax payments, payments in lieu of tax (PILOT), or tax payments on energy production. The amount of tax revenue paid during the license renewal term as a result of continued operations and refurbishment associated with license renewal is not expected to change.
Community services and education	SMALL (Category 1). Changes resulting from continued operations and refurbishment associated with license renewal to local community and educational services would be small. With little or no change in employment at the licensee's plant, value of the power plant, payments on energy production, and PILOT payments expected during the license renewal term, community and educational services would not be affected by continued power plant operations.
Population and housing	SMALL (Category 1). Changes resulting from continued operations and refurbishment associated with license renewal to regional population and housing availability and value would be small. With little or no change in employment at the licensee's plant expected during the license renewal term, population and housing availability and values would not be affected by continued power plant operations.
Transportation	SMALL (Category 1). Changes resulting from continued operations and refurbishment associated with license renewal to traffic volumes would be small.
Human Health	
Radiation exposures to plant workers	SMALL (Category 1). Occupational doses from continued operations and refurbishment associated with license renewal are expected to be within the range of doses experienced during the current license term, and would continue to be well below regulatory limits.
Radiation exposures to the public	SMALL (Category 1). Radiation doses to the public from continued operations and refurbishment associated with license renewal are expected to continue at current levels, and would be well below regulatory limits.
Chemical hazards	SMALL (Category 1). Chemical hazards to plant workers resulting from continued operations and refurbishment associated with license renewal are expected to be minimized by the licensee implementing good industrial hygiene practices as required by permits and Federal and State

Environmental Issue	Impact Finding ^{(a)(b)}
Microbiological hazards to plant workers	<p>regulations. Chemical releases to the environment and the potential for impacts to the public are expected to be minimized by adherence to discharge limitations of NPDES and other permits.</p> <p>SMALL (Category 1). Occupational health impacts are expected to be controlled by continued application of accepted industrial hygiene practices to minimize worker exposures as required by permits and Federal and State regulations.</p>
Microbiological hazards to the public	<p>SMALL, MODERATE, or LARGE (Category 2). These microorganisms are not expected to be a problem at most operating plants except possibly at plants using cooling ponds, lakes, canals, or that discharge to waters of the United States accessible to the public. Impacts would depend on site-specific characteristics.</p>
Electromagnetic fields (EMFs) ^(c)	<p>Uncategorized (Uncertain impact). Studies of 60-Hz EMFs have not uncovered consistent evidence linking harmful effects with field exposures. EMFs are unlike other agents that have a toxic effect (e.g., toxic chemicals and ionizing radiation) in that dramatic acute effects cannot be forced and longer-term effects, if real, are subtle. Because the state of the science is currently inadequate, no generic conclusion on human health impacts is possible.</p>
Physical occupational hazards	<p>SMALL (Category 1). Occupational safety and health hazards are generic to all types of electrical generating stations, including nuclear power plants, and are of small significance if the workers adhere to safety standards and use protective equipment as required by Federal and State regulations.</p>
Electric shock hazards ^(c)	<p>SMALL, MODERATE, or LARGE (Category 2). Electrical shock potential is of small significance for transmission lines that are operated in adherence with the National Electrical Safety Code (NESC). Without a review of conformance with NESC criteria of each nuclear power plant's in-scope transmission lines, it is not possible to determine the significance of the electrical shock potential.</p>
Postulated Accidents	
Design-basis accidents	<p>SMALL (Category 1). The NRC staff has concluded that the environmental impacts of design-basis accidents are of small significance for all plants.</p>
Severe accidents ^(d)	<p>SMALL (Category 1). The probability-weighted consequences of atmospheric releases, fallout onto open bodies of water, releases to groundwater, and societal and economic impacts from severe accidents are small for all plants. Severe accident mitigation alternatives do not warrant further plant-specific analysis because the demonstrated reductions in population dose risk and continued severe accident regulatory improvements substantially reduce the likelihood of finding cost-effective significant plant improvements.</p>
Environmental Justice	
Impacts on minority populations, low-income populations, and Indian Tribes	<p>(Category 2). Impacts on minority populations, low-income populations, Indian Tribes, and subsistence consumption resulting from continued operations and refurbishment associated with license renewal will be addressed in nuclear plant-specific reviews.</p>

Environmental Issue	Impact Finding ^{(a)(b)}
Waste Management	
Low-level waste storage and disposal	SMALL (Category 1). The comprehensive regulatory controls that are in place and the low public doses being achieved at reactors ensure that the radiological impacts on the environment would remain small during the license renewal term.
Onsite storage of spent nuclear fuel	<p>During the license renewal term, Small (Category 1). The expected increase in the volume of spent fuel from an additional 20 years of operation can be safely accommodated onsite during the license renewal term with small environmental impacts through dry or pool storage at all plants.</p> <p>For the period after the licensed life for reactor operations, the impacts of onsite storage of spent nuclear fuel during the continued storage period are discussed in NUREG-2157 and as stated in § 51.23(b), shall be deemed incorporated into this issue.</p>
Offsite radiological impacts of spent nuclear fuel and high-level waste disposal	<p>(Category 1). For the high-level waste and spent fuel disposal component of the fuel cycle, the EPA established a dose limit of 0.15 mSv (15 millirem) per year for the first 10,000 years and 1.0 mSv (100 millirem) per year between 10,000 years and 1 million years for offsite releases of radionuclides at the proposed repository at Yucca Mountain, Nevada.</p> <p>The Commission concludes that the impacts would not be sufficiently large to require the NEPA conclusion, for any plant, that the option of extended operation under 10 CFR part 54 should be eliminated. Accordingly, while the Commission has not assigned a single level of significance for the impacts of spent fuel and high level waste disposal, this issue is considered Category 1.</p>
Mixed-waste storage and disposal	SMALL (Category 1). The comprehensive regulatory controls and the facilities and procedures that are in place ensure proper handling and storage, as well as negligible doses and exposure to toxic materials for the public and the environment at all plants. License renewal would not increase the small, continuing risk to human health and the environment posed by mixed waste at all plants. The radiological and nonradiological environmental impacts of long-term disposal of mixed waste from any individual plant at licensed sites are small.
Nonradioactive waste storage and disposal	SMALL (Category 1). No changes to systems that generate nonradioactive waste are anticipated during the license renewal term. Facilities and procedures are in place to ensure continued proper handling, storage, and disposal, as well as negligible exposure to toxic materials for the public and the environment at all plants.
Greenhouse Gas Emissions and Climate Change	
Greenhouse gas impacts on climate change	<p>SMALL (Category 1). Greenhouse gas impacts on climate change from continued operations and refurbishment associated with license renewal are expected to be small at all plants. Greenhouse gas emissions from routine operations of nuclear power plants are typically very minor, because such plants, by their very nature, do not normally combust fossil fuels to generate electricity.</p> <p>Greenhouse gas emissions from construction vehicles and other motorized equipment for refurbishment activities would be intermittent and temporary,</p>

Environmental Issue	Impact Finding ^{(a)(b)}
<p>Climate change impacts on environmental resources</p>	<p>restricted to the refurbishment period. Worker vehicle greenhouse gas emissions for refurbishment would be similar to worker vehicle emissions from normal nuclear power plant operations.</p> <p>(Category 2). Climate change can have additive effects on environmental resource conditions that may also be directly impacted by continued operations and refurbishment during the license renewal term. The effects of climate change can vary regionally and climate change information at the regional and local scale is necessary to assess trends and the impacts on the human environment for a specific location. The impacts of climate change on environmental resources during the license renewal term are location-specific and cannot be evaluated generically.</p>
<p>Cumulative Effects</p> <p>Cumulative effects</p>	<p>(Category 2). Cumulative effects or impacts of continued operations and refurbishment associated with license renewal must be considered on a plant-specific basis. The effects depend on regional resource characteristics, the incremental resource-specific effects of license renewal, and the cumulative significance of other factors affecting the environmental resource.</p>
<p>Uranium Fuel Cycle</p> <p>Offsite radiological impacts—individual impacts from other than the disposal of spent fuel and high-level waste</p> <p>Offsite radiological impacts—collective impacts from other than the disposal of spent fuel and high-level waste</p> <p>Nonradiological impacts of the uranium fuel cycle</p> <p>Transportation</p>	<p>SMALL (Category 1). The impacts to the public from radiological exposures have been considered by the Commission in Table S-3 of this part. Based on information in the GEIS, impacts to individuals from radioactive gaseous and liquid releases, including radon-222 and technetium-99, would remain at or below the NRC’s regulatory limits.</p> <p>(Category 1). There are no regulatory limits applicable to collective doses to the general public from fuel-cycle facilities. The practice of estimating health effects on the basis of collective doses may not be meaningful. All fuel-cycle facilities are designed and operated to meet the applicable regulatory limits and standards. The Commission concludes that the collective impacts are acceptable.</p> <p>The Commission concludes that the impacts would not be sufficiently large to require the NEPA conclusion, for any plant, that the option of extended operation under 10 CFR Part 54 should be eliminated. Accordingly, while the Commission has not assigned a single level of significance for the collective impacts of the uranium fuel cycle, this issue is considered Category 1.</p> <p>SMALL (Category 1). The nonradiological impacts of the uranium fuel cycle resulting from the renewal of an operating license for any plant would be small.</p> <p>SMALL (Category 1). The impacts of transporting materials to and from uranium-fuel-cycle facilities on workers, the public, and the environment are expected to be small.</p>

Environmental Issue	Impact Finding ^{(a)(b)}
<p>Termination of Nuclear Power Plant Operations and Decommissioning</p> <p>Termination of plant operations and decommissioning</p>	<p>SMALL (Category 1). License renewal is expected to have a negligible effect on the impacts of terminating operations and decommissioning on all resources.</p>
<p>1 (a) Supports the finding codified in Table B-1 of Appendix B to Subpart A of 10 CFR Part 51. Where appropriate, a 2 single significance level (i.e., SMALL, MODERATE, or LARGE) has been assigned to the impacts. 3 (b) The technical bases for these issues and findings in the LR GEIS have been revised to fully account for the 4 impacts of initial LR and SLR. 5 (c) This issue applies only to the in-scope portion of electric power transmission lines, which are defined as 6 transmission lines that connect the nuclear power plant to the substation where electricity is fed into the regional 7 power distribution system and transmission lines that supply power to the nuclear plant from the grid. 8 (d) Although the NRC does not anticipate any license renewal applications for nuclear power plants for which a 9 previous severe accident mitigation design alternative (SAMDA) or severe accident mitigation alternative (SAMA) 10 analysis has not been performed, alternatives to mitigate severe accidents must be considered for all plants that 11 have not considered such alternatives and would be the functional equivalent of a Category 2 issue requiring 12 site-specific analysis.</p>	

13 **2.2 No Action Alternative**

14 The no action alternative represents a decision by the NRC not to renew the operating license
15 of a nuclear power plant beyond the current operating license term. At some point, all nuclear
16 plants will terminate operations and undergo decommissioning. Under the no action alternative,
17 plant operations would terminate at or before the end of the current license term.

18 Not renewing the license and ceasing operation under the no action alternative may lead to a
19 variety of potential outcomes, but these would be essentially the same regardless of whether
20 operations cease at the expiration of the original operating license or at the expiration of a
21 renewed license. Expiration of a license will require the reactor to ultimately undergo
22 decommissioning, whether it be more immediate (as under DECON), or deferred (as under
23 SAFSTOR). Termination of nuclear power plant operations would result in the total cessation of
24 electrical power production. The no action alternative, unlike the other alternatives, does not
25 expressly meet the purpose and need of the proposed action, because it does not provide a
26 means of delivering baseload power to meet future electric system needs. No action on its own
27 would likely create a need for replacement energy; that need could be met by installation of
28 additional generating capacity, adoption or expansion of energy conservation and energy
29 efficiency programs (including demand-side management), delayed retirements, purchased
30 power, or some combination of these options.

31 **2.3 Alternative Energy Sources**

32 The following sections describe alternative energy sources identified by the NRC as being
33 potentially capable of meeting the purpose and need of the proposed action (license renewal).
34 Accordingly, these alternative energy sources could provide additional options that allow for
35 baseload power-generation capability beyond the term of the current nuclear power plant
36 operating license to meet future system power-generating needs, as such needs may be
37 determined by State, utility, and, where authorized, Federal (other than NRC) decisionmakers.
38 A reasonable alternative must be commercially viable on a utility scale and operational prior to
39 the expiration of the reactor’s operating license, or expected to become commercially viable on

1 a utility scale and operational prior to the expiration of the reactor’s operating license. The NRC
 2 has updated this LR GEIS to incorporate the latest information on alternative energy sources,
 3 but it is inevitable that rapidly evolving technologies will outpace the information presented. As
 4 technologies improve, the NRC expects that some alternative energy sources not currently
 5 viable for replacing or offsetting the power generated by a nuclear power plant may become
 6 viable at some time in the future. The NRC will make that determination during plant-specific
 7 license renewal reviews, as documented in plant-specific SEISs to this LR GEIS. The amount
 8 of replacement power generated or offset must equal the baseload capacity previously supplied
 9 by the nuclear plant and reliably operate at or near the nuclear plant’s demonstrated capacity
 10 factor.¹

11 If the need arises to replace or offset the generating capacity of a nuclear reactor, power could
 12 be provided by a suite of individual alternative energy sources. Power could also be provided
 13 using combinations of alternative energy sources, as well as by instituting demand-side
 14 management measures, delaying the scheduled retirement of one or more existing power
 15 plants, or purchasing an equivalent amount of power. The number of possible combinations of
 16 alternative energy sources that could replace or offset the generating capacity of a nuclear
 17 power plant is potentially unlimited. Based on this, the NRC has only evaluated individual
 18 energy sources rather than combinations of energy sources in this LR GEIS. However,
 19 combinations of energy sources may be considered during plant-specific license renewal
 20 reviews.

21 The following sections describe alternative means of generating electricity or otherwise
 22 addressing electrical loads that could serve to replace or offset the power produced by an
 23 existing nuclear power plant. As discussed in Chapter 1.0, the NRC does not engage in energy-
 24 planning decisions and makes no judgment about which alternative energy source(s) evaluated
 25 would be chosen in any given case.

26 The NRC relies on many sources of information to determine which alternatives are available
 27 and commercially viable. The U.S. Department of Energy’s (DOE’s) Energy Information
 28 Administration (EIA) maintains the official energy statistics of the Federal government. Along
 29 with information from other sources, the NRC commonly uses information from EIA reports,
 30 including the Electric Power Annual, Monthly Energy Review, Annual Energy Outlook, and
 31 Assumptions to the Annual Energy Outlook to identify energy trends and inform the staff’s
 32 analysis of alternatives to the proposed action (initial LR or SLR). The NRC often considers the
 33 existing portfolio of electric generating technologies in the State or utility service area in which a
 34 nuclear plant is located, along with State and Federal policies that may promote or oppose
 35 certain alternatives. The NRC may also use the EIA’s State Energy Profiles as well as State,
 36 regional, and, in some cases, utility- or system-level assessments of energy resources and
 37 projections (such as integrated resource plans) to identify alternatives for consideration.

38 The United States relies on a variety of energy sources and technologies to provide electrical
 39 power. Annual electric power generation has decreased from 4,125 million megawatt-hours
 40 (MMWh) in 2010 to 4,007 MMWh in 2020. Coal and petroleum (oil) generation decreased
 41 substantially between 2010 and 2020, while natural gas, wind, and solar increased. Table 2.3-1
 42 includes the changes in values of net generation at utility-scale facilities between 2010 and
 43 2020 (DOE/EIA 2022d).

¹ The capacity factor is the ratio of the amount of electric energy produced by an electric generator over a given period of time to the amount of electric energy the same generator would have produced had it operated at its full, rated capacity over the same period of time.

1 **Table 2.3-1 Net Generation at Utility-Scale Facilities (million megawatt-hours [MMWh])**

Utility-Scale Facility	Net Generation (in MMWh) in Year 2010	Net Generation (in MMWh) in Year 2020
Nuclear	807	790
Coal	1,847	773
Natural Gas	988	1,624
Oil	37	17
Hydroelectric	260	285
Geothermal	15	16
Wind	95	338
Biomass	56	55
Solar	1	89
Other ^(a)	19	19
Total	4,125	4,007

2 MMWh = million megawatt-hours.

3 (a) Other includes blast furnace gas and other manufactured and waste gases derived from fossil fuels, non-
4 biogenic municipal solid waste, batteries, hydrogen, purchased steam, sulfur, tire-derived fuel, and other
5 miscellaneous energy sources, offset by savings associated with hydroelectric pumped storage.

6 In the EIA's *Annual Energy Outlook 2022 with Projections to 2050* (DOE/EIA 2022b), the EIA
7 projects an increase in energy consumption and generating capacity throughout the 2050
8 forecast period because population and economic growth is expected to outweigh efficiency
9 gains. Electricity demand is expected to grow slowly over the projection period, with renewable
10 energy generation increasing more rapidly than overall electricity demand. Battery storage is
11 expected to reduce natural gas- and oil-fired generation during peak hours. As coal and nuclear
12 generating capacity retires, new capacity additions are likely to come largely from wind and
13 solar generation (DOE/EIA 2022a).

14 In Sections 2.3.1 through 2.3.3 of this LR GEIS, the NRC presents a variety of energy sources
15 (including fossil fuel, nuclear, and renewable energy technologies) that might be considered as
16 alternatives for replacing the power generated by nuclear power plants being considered for
17 initial LR or SLR. In Chapter 4.0, the NRC compares the environmental impacts of these
18 alternatives to the environmental impacts of license renewal. In addition, Section 2.3.4
19 discusses non-power generating approaches that could also be considered for offsetting a
20 nuclear power plant's existing capacity.

21 **2.3.1 Fossil Fuel Energy Technologies**

22 Fossil fuel energy technologies burn fuel derived from ancient organic matter such as natural
23 gas, coal, or crude oil and as such are a source of greenhouse gases, including carbon dioxide
24 (CO₂) (NRC 2013a). While the EIA indicates that renewable energy will be the fastest-growing
25 category of U.S. energy source through 2050, fossil fuels such as natural gas will maintain a
26 large market share, while coal and oil are likely to continue to decline.

27 **2.3.1.1 Natural Gas**

28 The most common types of natural gas-fired plants are combustion turbine and combined-cycle
29 plants. A schematic of a representative gas-fired power plant is provided in Figure 2.3-1.
30 Combustion turbines use hot gases that drive a generator and are then used to run a

1 compressor. In contrast, a combined-cycle power system typically uses a gas turbine to drive
 2 an electrical generator, recovering waste heat from the turbine exhaust to generate steam that
 3 drives a steam turbine generator. This two-cycle process has a high rate of efficiency because
 4 the natural gas combined-cycle system captures the exhaust heat that otherwise would be lost
 5 and reuses it. Baseload natural gas combined-cycle power plants have proven their reliability
 6 and can have capacity factors as high as 87 percent (DOE/EIA 2015a). Since 2016, 31 percent
 7 of new natural gas-powered plants constructed use advanced natural gas-fired combined-cycle
 8 units, increasing efficiency and decreasing capital construction costs (DOE/EIA 2019a).

9 As of 2021, natural gas technologies represented 37 percent of electricity generation, outpacing
 10 coal (23%), nuclear (19%), and renewables (21%). Based on reference case projections,
 11 natural gas generation as a proportion of U.S. electricity generation is expected to remain
 12 relatively constant (34% in 2050), with decreases in coal and nuclear generation being replaced
 13 by increases in renewables (DOE/EIA 2022h).

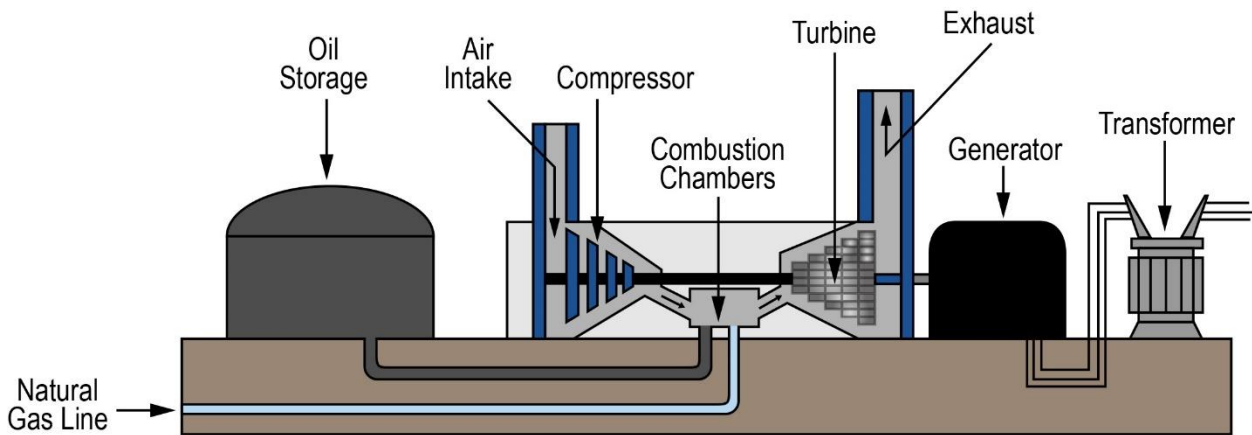

14
 15 **Figure 2.3-1 Schematic of a Natural Gas-Fired Plant**

16 **2.3.1.2 Coal**

17 Although coal has historically been the largest source of electricity generation in the United
 18 States, both natural gas and nuclear energy generation surpassed coal at the national level in
 19 2020, before coal-fired generation rebounded after 2020. Overall, coal-fired electricity
 20 generation in the United States has continued to decrease as coal-fired generating units have
 21 been retired or converted to use other fuels and as the remaining coal-fired generating units
 22 have been used less often (DOE/EIA 2021c). Projections for the amount of electricity produced
 23 from coal in the future vary widely across planning scenarios, primarily due to cost uncertainties
 24 associated with anticipated future environmental regulations such as cap-and-trade regulations
 25 for nitrogen dioxide, sulfur dioxide and the regulation of greenhouse gases emissions, primarily
 26 carbon dioxide. The EIA projects that between 2021 and 2050, coal-fired generation will
 27 decrease from 23 percent to 10 percent of total U.S. electricity generation (DOE/EIA 2022h).

28 Baseload coal units have proven their reliability and can routinely sustain capacity factors as
 29 high as 85 percent. Among the technologies available, pulverized coal boilers producing
 30 supercritical steam (supercritical pulverized coal boilers) have become increasingly common at
 31 newer coal-fired plants given their generally high thermal efficiencies and overall reliability. A
 32 schematic of a representative coal-fired power plant is provided in Figure 2.3-2.

Alternatives Including the Proposed Action

1 Supercritical pulverized coal facilities are more expensive than subcritical coal-fired plants to
2 construct, but they consume less fuel per unit output, reducing environmental impacts.
3 Integrated gasification combined cycle (IGCC) is another technology that generates electricity
4 from coal. It combines modern coal gasification technology with both gas turbine and steam
5 turbine power generation. The technology is cleaner than conventional pulverized coal plants
6 because some of the major pollutants are removed from the gas stream before combustion.
7 Although several smaller, IGCC power plants have been in operation since the mid-1990s, more
8 recent large-scale projects using this technology have experienced setbacks and opposition that
9 have hindered the technology from being fully integrated into the energy market.

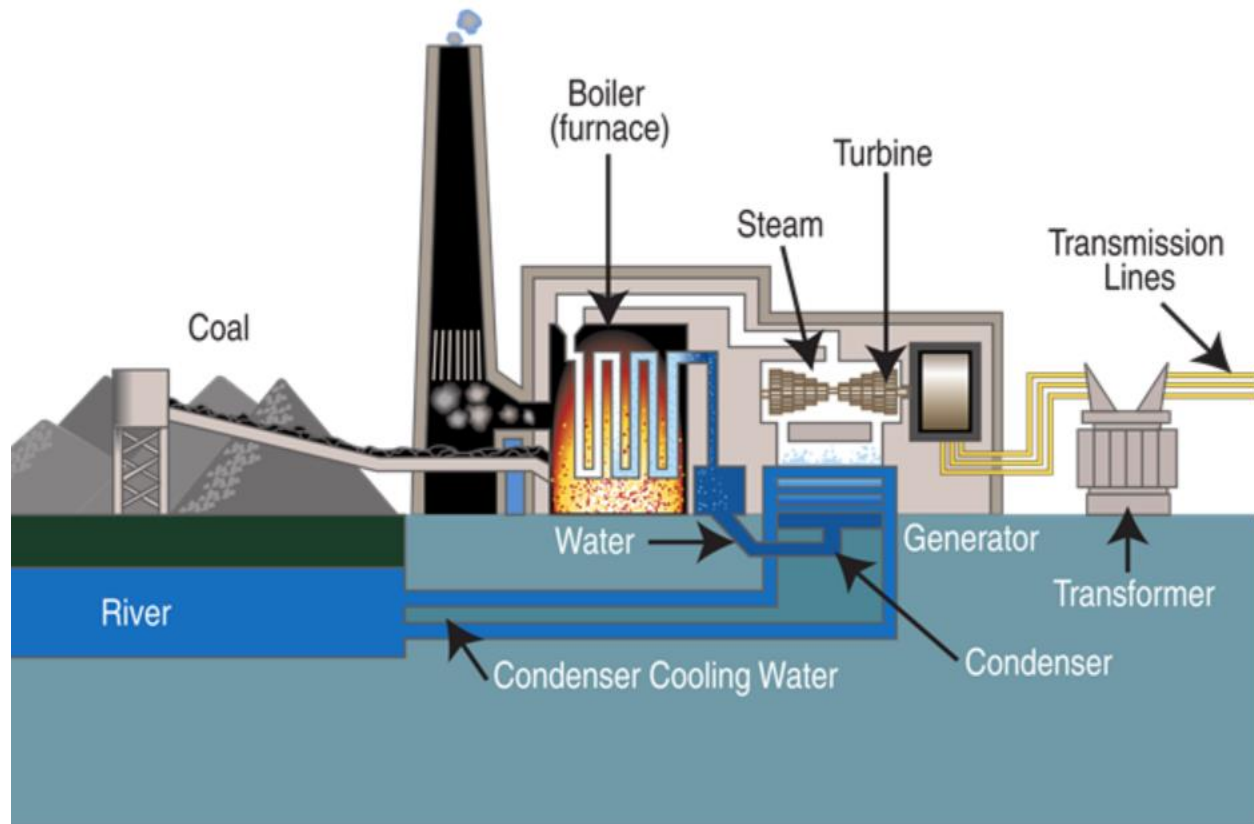

10

11 **Figure 2.3-2 Schematic of a Coal-Fired Power Plant. Source: NETL Undated.**

12 Advanced coal technologies will likely become increasingly important as regulations on power
13 plant emissions evolve, including under the Clean Air Act (42 U.S.C. § 701 et seq.) and the
14 CWA (33 U.S. C. § 1251 et seq.). Technologies often referred to as “clean coal technologies,”
15 which include coal cleaning processes, coal gasification technologies, improved combustion
16 technologies, and enhanced devices for capturing pollutants, may reduce impacts associated
17 with a coal-fired plant (NRC 2013a). The EIA assumes that by 2025, coal plants are expected
18 to either invest in heat rate improvement technologies or be retired. Additionally, low natural
19 gas prices are expected to contribute to the retirement of existing coal-fired plants (DOE/EIA
20 2020a).

21 2.3.1.3 Oil

22 Oil-fired energy technologies are conceptually similar to gas-fired technologies but use crude oil
23 rather than natural gas fuel. According to the EIA, in 2016, only 3 percent of utility-scale

1 generators used petroleum as a primary fuel and produced less than 1 percent of total electricity
 2 generation in the United States. In general, oil plants are located in coastal States where
 3 marine modes of oil transportation are competitive with transportation of coal by rail. These
 4 plants are on average nearly 40 years old, with roughly 70 percent of the capacity constructed
 5 prior to 1980. Since that time, oil-fired generation has become more expensive than other fossil
 6 fuel generation options. Accordingly, this high cost has contributed to the overall decline in the
 7 use of oil for electricity generation (DOE/EIA 2017).

8 **2.3.2 New Nuclear Energy Technologies**

9 Commercial nuclear power plants use fission to heat water and produce steam, which is then
 10 used to spin turbines that generate electricity. The newest nuclear power plant to enter service
 11 in the United States is Tennessee’s Watts Bar Unit 2, which began operation in June 2016.
 12 Prior to then, the last new nuclear power reactor to come online was Watts Bar Unit 1 in 1996
 13 (DOE/EIA 2022g). The EIA projects that nuclear power’s contribution to total U.S. electrical
 14 generation will decrease from 19 percent in 2021 to 12 percent by 2050 (DOE/EIA 2022h).
 15 Currently, six light water nuclear reactor designs have been certified by the NRC. Certified
 16 designs include the 1,300 megawatt-electric (MWe) U.S. Advanced Boiling Water Reactor
 17 (10 CFR Part 52, Appendix A), the 1,300 MWe System 80+ Design (10 CFR Part 52,
 18 Appendix B), the 600 MWe AP600 Design (10 CFR Part 52 Appendix C), the 1,100 MWe
 19 AP1000 Design (10 CFR Part 52, Appendix D), the 1,500 MWe GE-Hitachi Economic Simplified
 20 Boiling Water Reactor (10 CFR Part 52 Appendix E), and the 1,400 MWe Korean Electric Power
 21 Corporation APR 1400 (10 CFR Part 52 Appendix F) (NRC 2020c).

22 Several companies are considering other advanced, non-light water reactor designs and
 23 technologies and are conducting preapplication activities with the NRC. These reactors may be
 24 cooled by liquid metals, molten salt mixtures, or inert gases. Advanced reactors can also
 25 consider fuel materials and designs that differ radically from standard uranium dioxide fuel types
 26 currently in use (NRC 2021c). Given the uncertainties associated with their technical viability
 27 and deployment timeframes, these emerging technologies are not evaluated further in this LR
 28 GEIS. Furthermore, the NRC is currently in the process of developing a Generic Environmental
 29 Impact Statement for Advanced Nuclear Reactors (ANR GEIS) to analyze the environmental
 30 impacts associated with the licensing of these reactors (85 FR 24040). In this LR GEIS, the
 31 NRC staff has evaluated the construction and operation of two types of new nuclear
 32 technologies as reasonable alternatives to license renewal: (1) large, advanced light water
 33 reactor (ALWR) plants and (2) small modular reactor (SMR) plants.

34 *2.3.2.1 Advanced Light Water Reactors*

35 ALWR designs feature advanced safety systems and evolutionary operating improvements over
 36 existing power reactors. The first large ALWR units to be built in the United States are expected
 37 to go into operation in 2023. When completed, Vogtle Units 3 and 4, in Waynesboro, Georgia,
 38 will become the first U.S. deployment of the Westinghouse AP1000 reactor, which was
 39 designed as a next-generation nuclear reactor that could provide a standardized design for the
 40 U.S. utilities market. In addition, the AP1000 has a smaller footprint, simpler design, and uses
 41 less piping, fewer valves, and fewer pumps than older designs (DOE/EIA 2022i, DOE Undated-
 42 d). A schematic of a large ALWR is depicted in Figure 2.3-3.

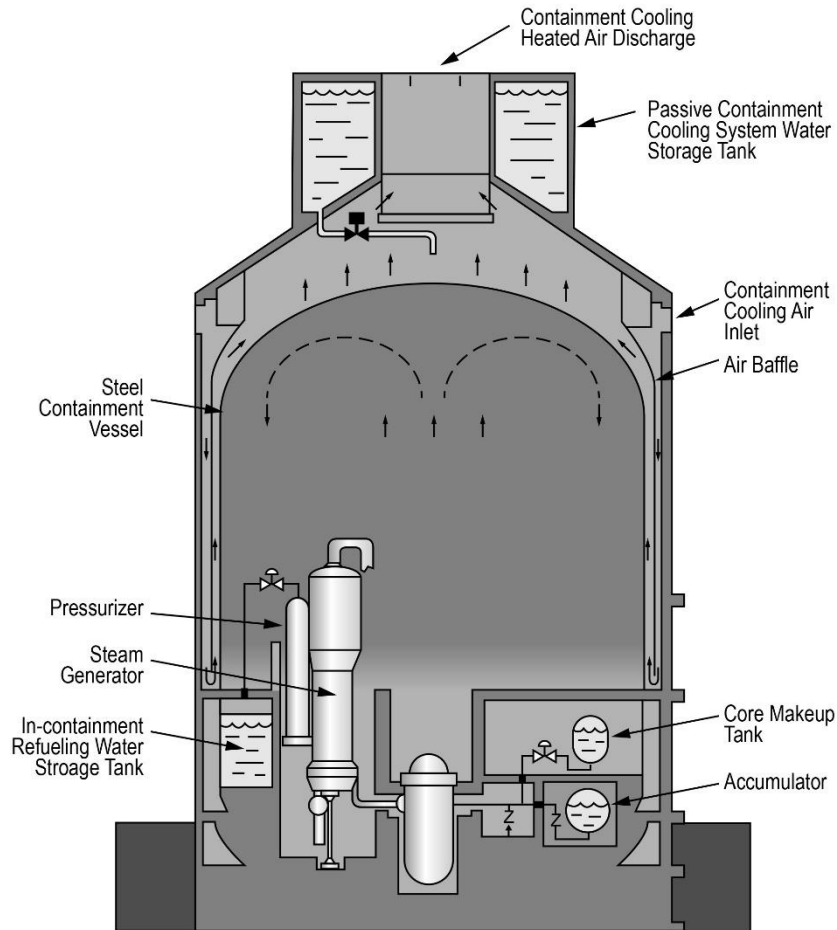

1
 2 **Figure 2.3-3 Schematic of an Advanced Light Water Reactor. Adapted from: NRC**
 3 **2004a.**

4 **2.3.2.2 Small Modular Reactors**

5 SMRs, in general, are light-water reactors that use water for cooling and enriched uranium for
 6 fuel in the same manner as the conventional, large light-water reactors currently operating in the
 7 United States. SMR modules typically generate 300 MWe or less, compared to today’s larger
 8 nuclear reactor designs, which can generate 1,000 MWe or more per reactor. However, their
 9 smaller size means that several SMRs can be bundled together in a single containment.
 10 Smaller size also means greater siting flexibility because they can fit in locations not large
 11 enough to accommodate a conventional nuclear reactor (NRC 2018b, NRC 2020a, DOE
 12 2022a). SMR design features can include below grade containment and inherent safe
 13 shutdown features, longer station blackout coping time without external intervention, and core
 14 and spent fuel pool cooling without the need for active heat removal. A representative SMR is
 15 illustrated in Figure 2.3-4. SMR power-generating facilities are also designed to be deployed in
 16 an incremental fashion to meet the power-generation needs of a service area, in which
 17 generating capacity can be added in increments to match load growth projections (NRC 2018b).
 18 Overall, the NRC staff assumes that the resource requirements, key characteristics, and
 19 impacts associated with constructing and operating SMRs would be bounded by the impacts of
 20 constructing and operating the large light-water reactor units that have been evaluated in NRC
 21 EISs since the 1970s. The NRC received the first design certification application for an SMR in

1 December 2016 (NRC 2022a). Following NRC certification, this design could potentially
 2 achieve operation on a commercial scale by 2027 (NuScale Power LLC 2022). Therefore,
 3 SMRs could be constructed and operational by the time many existing nuclear power plant
 4 licenses expire.

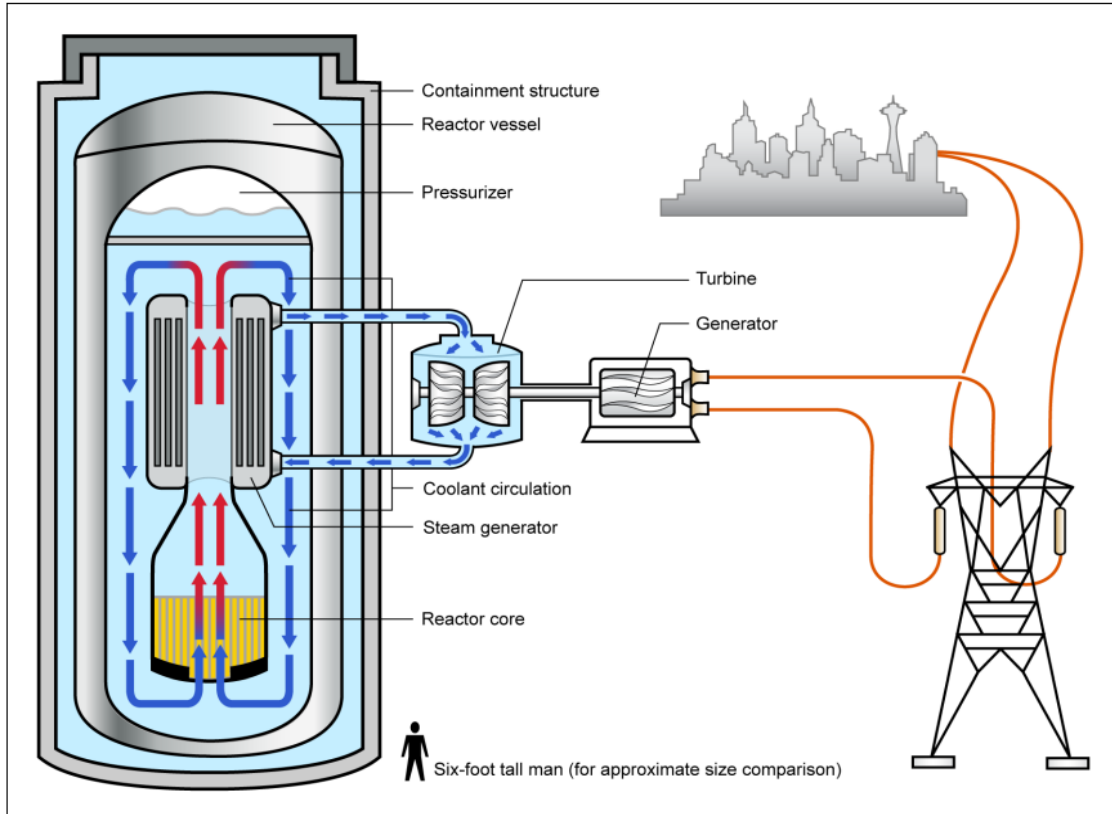

5 Source: GAO, based on Department of Energy documentation. | GAO-15-652

6 **Figure 2.3-4 Schematic of a Light Water Small Modular Nuclear Reactor. Source: GAO**
 7 **2015.**

8 **2.3.3 Renewable Energy Technologies**

9 The NRC considers the following renewable energy technology alternatives for possible
 10 replacement power: solar (both photovoltaic and thermal), wind (both land-based and offshore),
 11 hydroelectric, biomass, geothermal, ocean wave and current, and fuel cells. Combinations of
 12 renewable energy alternatives may be considered during plant-specific license reviews.

13 Renewable energy sources accounted for approximately 20 percent of total U.S. electricity
 14 generation in 2020, and are projected to account for nearly 60 percent of cumulative generating
 15 capacity additions through 2050 (DOE/EIA 2021b, DOE/EIA 2022a). The past two decades
 16 have seen a dramatic increase in the commercial use of renewable energy alternatives, allowing
 17 for the increased likelihood that some of these technologies could individually or in combination
 18 provide total replacement power for a nuclear power plant. One of the major reasons for this is
 19 that energy storage technologies are rapidly gaining in importance. As the amounts of power
 20 from variable renewable energy sources such as wind and solar increase, energy storage
 21 capability has become an essential tool for temporally decoupling generation and demand
 22 (DOE/EIA 2021e).

Alternatives Including the Proposed Action

1 Energy storage can enhance the overall efficiency and value of intermittent renewable energy
2 technologies as sources of reliable baseload power. Some energy storage options can also
3 help maintain grid stability through improved frequency management, and some may improve
4 the use and integration of smart grid technologies. Energy storage technologies are not
5 generation sources but rather complementary technologies that can take many forms, among
6 them, electrochemical energy of batteries and capacitors, pumped storage hydropower, and
7 compressed air.

8 Battery energy storage systems are increasingly being used to provide electric power-
9 generation and backup capacity for times when nondispatchable renewable energy sources,
10 such as wind and solar, are unavailable. These batteries can be used in a standalone manner
11 or as components of a hybrid system coupled with intermittent generation sources. U.S. battery
12 power capacity grew by 35 percent in 2020 and tripled over the last 5 years, and EIA expects
13 this rapid growth to continue (DOE/EIA 2021e).

14 Pumped storage hydropower generates energy during peak load periods by using water
15 previously pumped into an elevated storage reservoir and then released to turn a turbine-
16 generator during off-peak periods, and in 2020 accounted for 93 percent of grid storage in the
17 United States. In contrast, compressed air energy storage (CAES) systems use motor-driven
18 air compressors to compress air into a suitable geological repository such as an underground
19 salt cavern, a mine, or a porous rock formation. CAES systems have been limited, with only
20 one such system developed in the United States in the 1990s (NPCC 2010).

21 The environmental impacts of the construction and operation of renewable energy alternatives
22 are quite different from those of nonrenewable alternatives. The NRC presents these impacts in
23 Chapter 4.0. In general, however, resource areas that have the greatest range of impacts
24 include air quality, hydrology, and land use. Air quality impacts from hydroelectric, wind, solar,
25 and ocean wave and ocean current generation methods would be negligible; however, biomass-
26 fueled energy, for example, would emit air pollutants, some of them hazardous. Some
27 geothermal technologies may also be sources of hazardous air pollutants. All renewable energy
28 alternatives would rely on modest amounts of water, but those that would rely on conventional
29 steam cycles to power turbine generators (biomass, geothermal, solar thermal) would have
30 higher water demands, some of which are comparable to those of nonrenewable alternatives.
31 All renewable energy alternatives would require land, although land requirements would be
32 negligible for offshore wind and ocean wave and ocean current alternatives. Solar and
33 conventional hydroelectric generators, for example, would require significant amounts of land.

34 The NRC has elected not to evaluate energy storage technologies as discrete alternatives to a
35 nuclear reactor because they do not directly generate electricity. The NRC intends to consider
36 the influence that energy storage technologies can have on its evaluations of the environmental
37 impacts of alternative generating technologies in future license renewal reviews.

38 Brief overviews of renewable energy alternatives are provided in the following sections.

39 2.3.3.1 *Solar Energy*

40 Solar energy technologies generate power from sunlight. Solar technologies that are
41 commercially viable for the production of electricity include solar photovoltaic (PV) and solar
42 thermal, also referred to as concentrating solar power (CSP) (see Figure 2.3-5 and
43 Figure 2.3-6).

1 Solar PV components convert sunlight directly into electricity using solar cells. Solar cells have
 2 been developed using silicon (single crystal, polycrystalline, and amorphous silicon) and a
 3 variety of compounds such as cadmium telluride, copper-indium-gallium-selenide, and gallium
 4 arsenide. Among the silicon-based solar cells, single crystals exhibit the highest efficiency, but
 5 polycrystalline cells now represent the majority of the PV market. Although more expensive to
 6 produce, high-performance, multi-junction cells offer greater energy-conversion efficiencies and
 7 are currently the subject of most research into utility-scale applications. Many solar cell
 8 materials are now being manufactured as thin films, which have lower efficiencies than other
 9 types of PV technologies but typically can be made at a lower cost. Unlike CSP technologies,
 10 PV systems do not require cooling water, although they may have substantial land
 11 requirements.

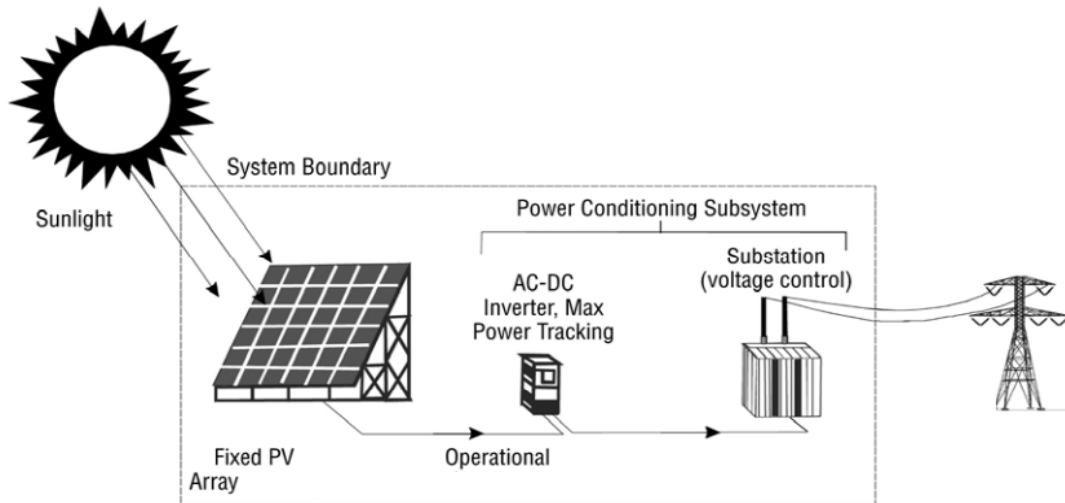

12
 13 **Figure 2.3-5 Schematic of Solar Photovoltaic Power Plant. Adapted from: NRC 2013a.**

14 CSP systems use heat from the sun to boil water and produce steam. The steam then drives a
 15 turbine connected to a generator to ultimately produce electricity (NREL Undated). CSP
 16 facilities can use molten salt to store heat for steam production at night and during cloudy
 17 periods, but to do so and still maintain their nameplate capacities, such CSP facilities must
 18 increase the size of the solar field. CSP facilities use conventional steam cycles and thus have
 19 cooling demands similar to fossil fuel power plants of equivalent capacities and overall thermal
 20 efficiencies.

21 Solar generators are considered an intermittent resource because their availability depends on
 22 ambient exposure to the sun, also known as solar insolation. The highest-value solar resources
 23 in the United States exist in the desert regions of the Southwest. However, solar resources of
 24 adequate quality to support utility-scale solar energy facilities, particularly PV, are located—to
 25 varying extents—throughout the country.

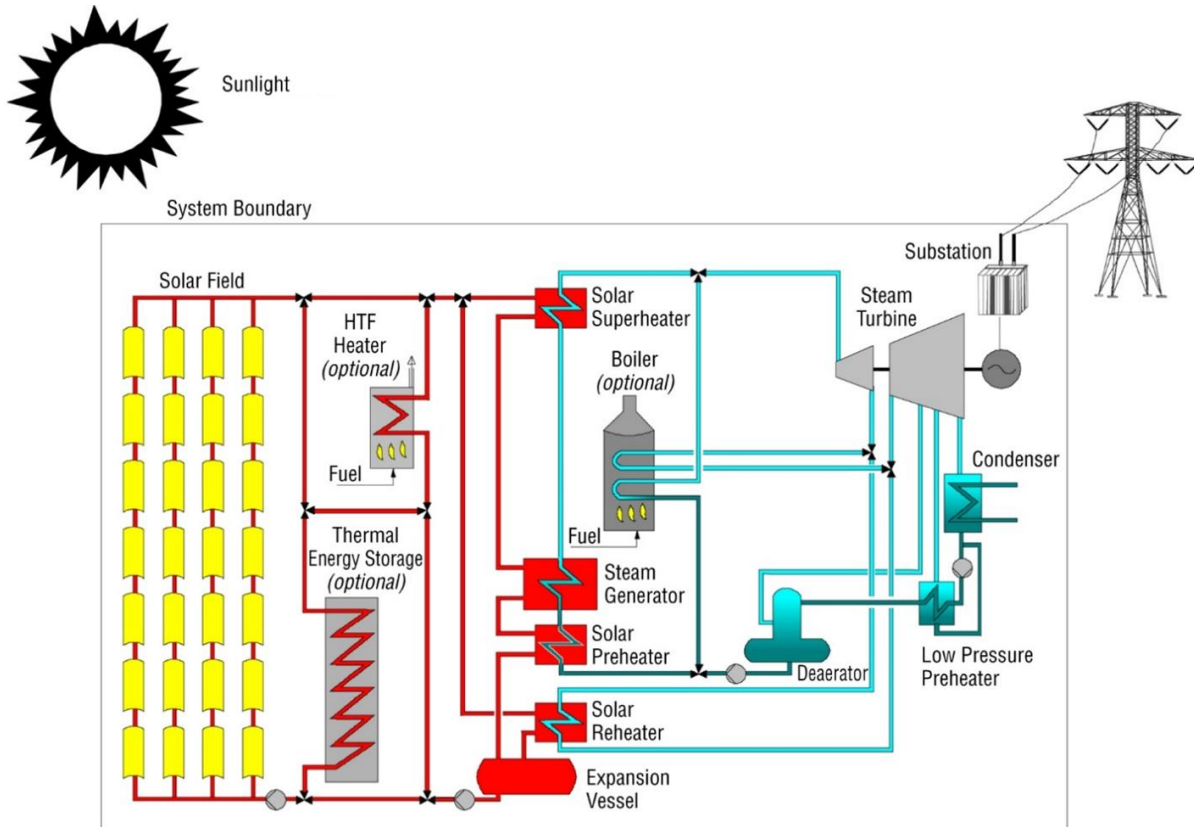

1
2 **Figure 2.3-6 Schematic of Concentrated Solar Power Plant. Adapted from: NRC 2013a.**

3 Solar energy technologies produced approximately 2.8 percent of total U.S. electricity
4 generation in 2021, representing approximately 13.5 percent of total renewable generation
5 (DOE/EIA 2022e). Nationwide, growth in utility-scale solar PV facilities (greater than 1 MW) has
6 resulted in an increase from 145 MW in 2009 to over 35,000 MW of installed capacity in 2019
7 (DOE/EIA Undated-a). EIA projects that solar energy's contribution to total U.S. electrical
8 generation will continue to increase and account for 20 percent by 2050 (DOE/EIA 2021d). EIA
9 further projects that solar energy's share of total U.S. capacity will increase from 7 percent in
10 2020 to 29 percent in 2050. About 70 percent of these solar additions are anticipated to be from
11 utility-scale PV power plants, and 30 percent from end-use PV such as residential and
12 commercial rooftop solar installations (DOE/EIA 2022b).

13 **2.3.3.2 Wind Energy**

14 Onshore and offshore wind resources exist throughout the United States. The dominant
15 technology for utility-scale applications is the horizontal-axis wind turbine. A typical wind turbine
16 consists of rotor blades attached to a nacelle, which is mounted on a tower. Within the nacelle,
17 a drive train connects to an electrical generator to produce electricity, which is then conveyed by
18 cables to electronic conversion equipment situated at ground level within the tower (see
19 Figure 2.3-7). As is the case with other renewable energy sources, the feasibility of wind energy
20 serving as an alternative baseload power depends on the location (relative to expected
21 electricity users), value, accessibility, and constancy of the resource. Wind energy must be
22 converted to electricity at or near the point where it is extracted, and backup power sources or
23 energy storage capabilities often need to be paired to overcome the intermittency and variability
24 of wind resources.

1 The American Clean Power Association reports a total of more than 122,000 MW of installed
 2 wind energy capacity nationwide as of December 31, 2020 (DOE Undated-e). The average
 3 rated (nameplate) capacity of newly installed land-based wind turbines in the United States in
 4 2018 was 2.4 MW (Wiser and Bolinger 2019).

5 Increasing attention has recently been focused on developing U.S. offshore wind resources,
 6 particularly along the Atlantic coast. In 2016, a 30 MWe project off the coast of Rhode Island
 7 became the first operating offshore wind farm in the United States (Orsted Undated). This was
 8 followed in 2020 with the construction and operation of the Mid-Atlantic's first offshore wind
 9 demonstration project in Federal waters, a 12 MWe demonstration project supporting the
 10 planned operation of a 2,600 MWe utility-scale wind farm off the coast of Virginia (BOEM 2021).

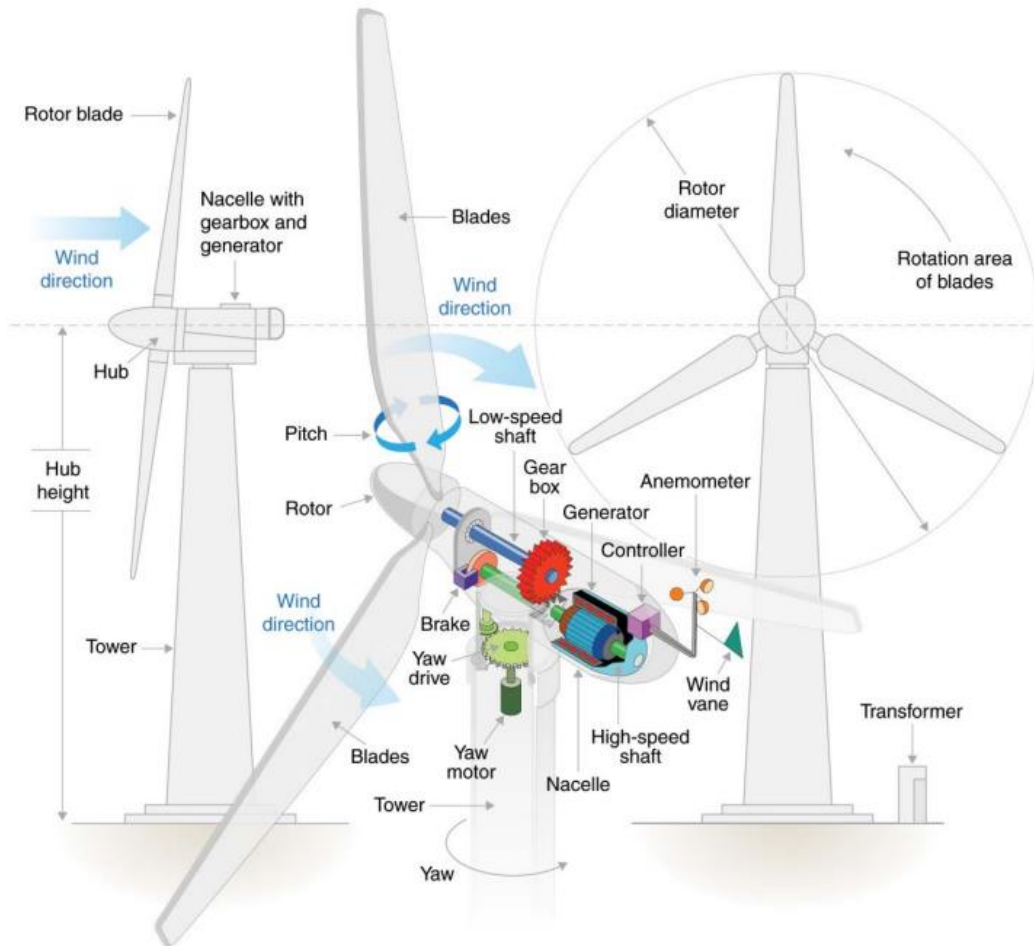

11
 12 **Figure 2.3-7 Components of a Modern Horizontal-Axis Wind Turbine. Source: NREL**
 13 **2012.**

14 Modern offshore wind turbines are substantially larger than those constructed and operated on
 15 land. From 2000 to 2020, offshore wind turbine sizes have grown from an installed average of
 16 2 MW per turbine to recent designs capable of generating 14 MW per turbine (BOEM 2020a).
 17 Offshore wind energy development activities have the potential to also affect onshore land use
 18 and coastal infrastructure, particularly due to onshore construction activities, port modifications,
 19 and cable landing facilities needed to connect the wind turbines to onshore electricity

Alternatives Including the Proposed Action

1 transmission infrastructure (BOEM 2019). A schematic of a representative offshore wind
2 generating facility is illustrated in Figure 2.3-8.

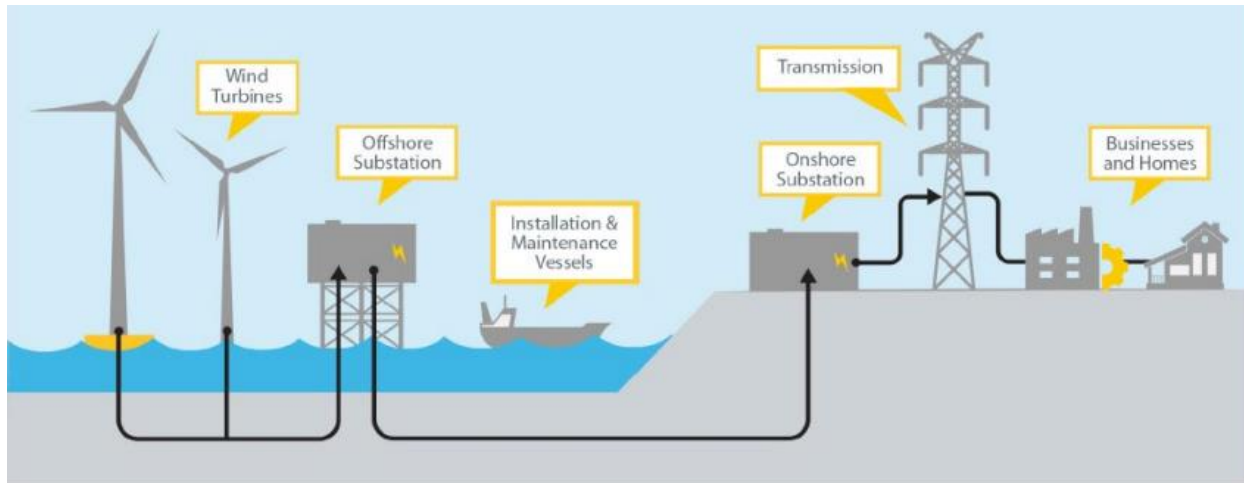

3
4 **Figure 2.3-8 Major Offshore Wind Power Plant and Transmission Elements. Source:**
5 **DOE 2022b.**

6 The amount of wind electricity generation has grown significantly in the past 30 years. Wind
7 energy was the source of approximately 9.2 percent of total U.S. electricity generation and
8 about 46 percent of all renewable energy produced in 2021 (DOE/EIA 2022e). EIA forecasts
9 that wind energy will account for approximately 10 percent of new U.S. generating capacity
10 additions through 2050, exceeded only by solar and natural gas (DOE/EIA 2022b).

11 2.3.3.3 *Hydroelectric Energy*

12 Hydropower, which uses the flow of moving water to generate electricity, is one of the oldest
13 and largest sources of renewable energy. As of 2020, there were approximately 2,300
14 operating hydroelectric facilities in the United States (DOE Undated-c). Hydroelectric
15 technology operates by capturing the energy of flowing water and directing it to a turbine and
16 generator to produce electricity. There are two fundamental hydropower facility designs: “run-
17 of-the-river” facilities that simply redirect the natural flow of a river, stream, or canal through a
18 hydroelectric facility and “store-and-release” facilities that block the flow of the river by using
19 dams that cause the water to accumulate in an upstream reservoir (see Figure 2.3-9) (NRC
20 2013a).

21 Hydropower facilities generally have between a 40–50 percent capacity factor, higher than
22 those of solar or wind, but lower than power plants operated for baseload power generation
23 (DOE/EIA 2021a).

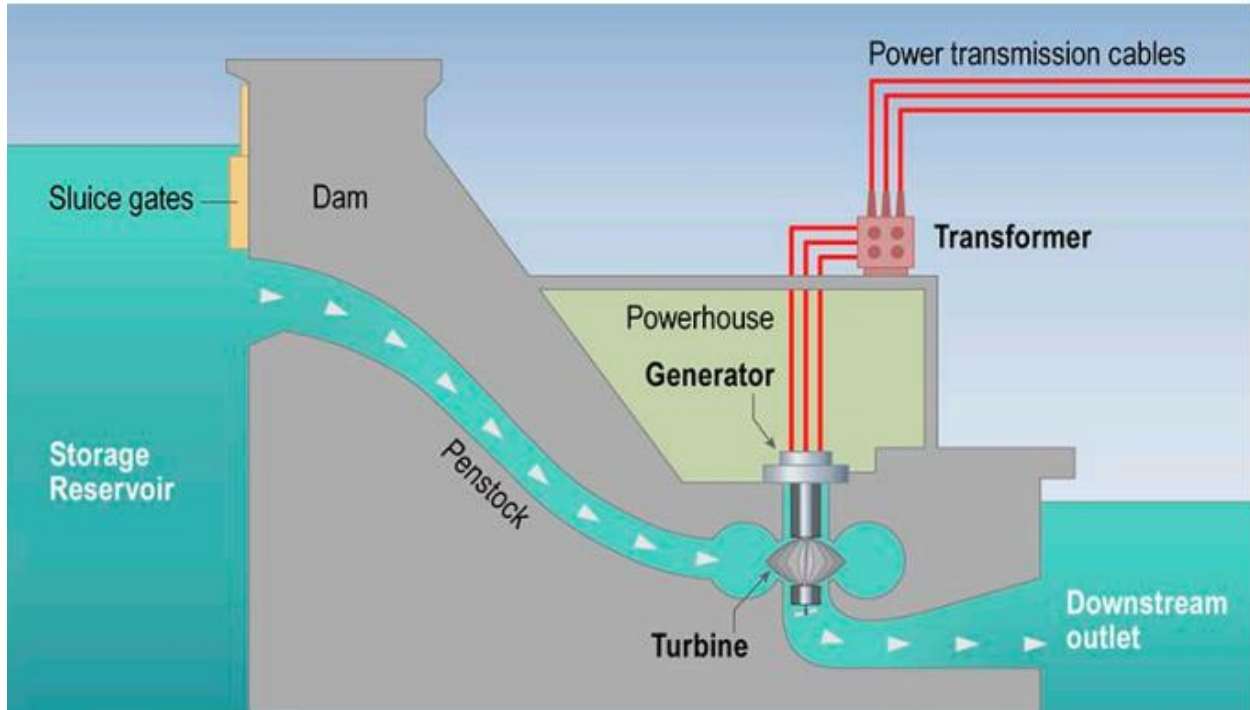

1

2

Figure 2.3-9 Cross Section of a Large Hydroelectric Plant. Source: NREL 2012.

3

4

5

6

7

8

9

10

11

12

13

14

15

Large hydroelectric facilities constructed on major rivers can have peak power capacities as high as 10,000 MW(e). However, river flow conditions and other circumstances and factors (e.g., spawning periods of anadromous fish) often require dam operators to divert river flow around power-generating turbines over various periods of time, thereby reducing the amount of power generated (NRC 2013a). In addition, hydroelectricity generation ultimately depends on precipitation levels that can vary seasonally and annually. As recently as 2019, hydroelectric energy was the leading source of U.S. renewable energy generation. In 2021, hydroelectricity accounted for approximately 6.3 percent of total U.S. utility-scale electricity generation and more than 31 percent of the total utility-scale renewable electricity generation (DOE/EIA 2022e). EIA projects that this level of generation will remain relatively steady through 2050 (DOE/EIA 2022b). However, the potential for future construction of large dams has diminished due to increased public concerns about flooding, habitat alteration and loss, and destruction of natural river courses. Additional demands for river water have also reduced water flow.

16

2.3.3.4 Biomass Energy

17

18

19

20

Biomass energy can be generated from a wide variety of fuels, including municipal solid waste (MSW), refuse-derived fuel, landfill gas, urban wood wastes, forest residues, agricultural crop residues and wastes, and energy crops. Definitions of materials that qualify as biomass may vary by State or region depending on regulatory schemes or renewable portfolio standards.

21

22

23

24

25

26

Biomass energy conversion is accomplished using a wide variety of technologies, some of which are similar in appearance and operation to fossil fuel plants, and include directly combusting biomass in a boiler or incinerator to produce steam, co-firing biomass along with fossil fuels (primarily coal) in boilers to produce steam, producing synthetic liquid fuels that are subsequently combusted, gasifying biomass to produce gaseous fuels that are subsequently combusted, and anaerobically digesting biomass to produce biogas. Accordingly, biomass

Alternatives Including the Proposed Action

1 generation is generally considered a carbon-emitting technology. Historically, wood has been
2 the most widely used biomass fuel for electricity generation, while coal-biomass co-firing and
3 MSW combustion are also commercially feasible. An example of a biomass-fired power plant is
4 illustrated in Figure 2.3-10 (NRC 2013a).

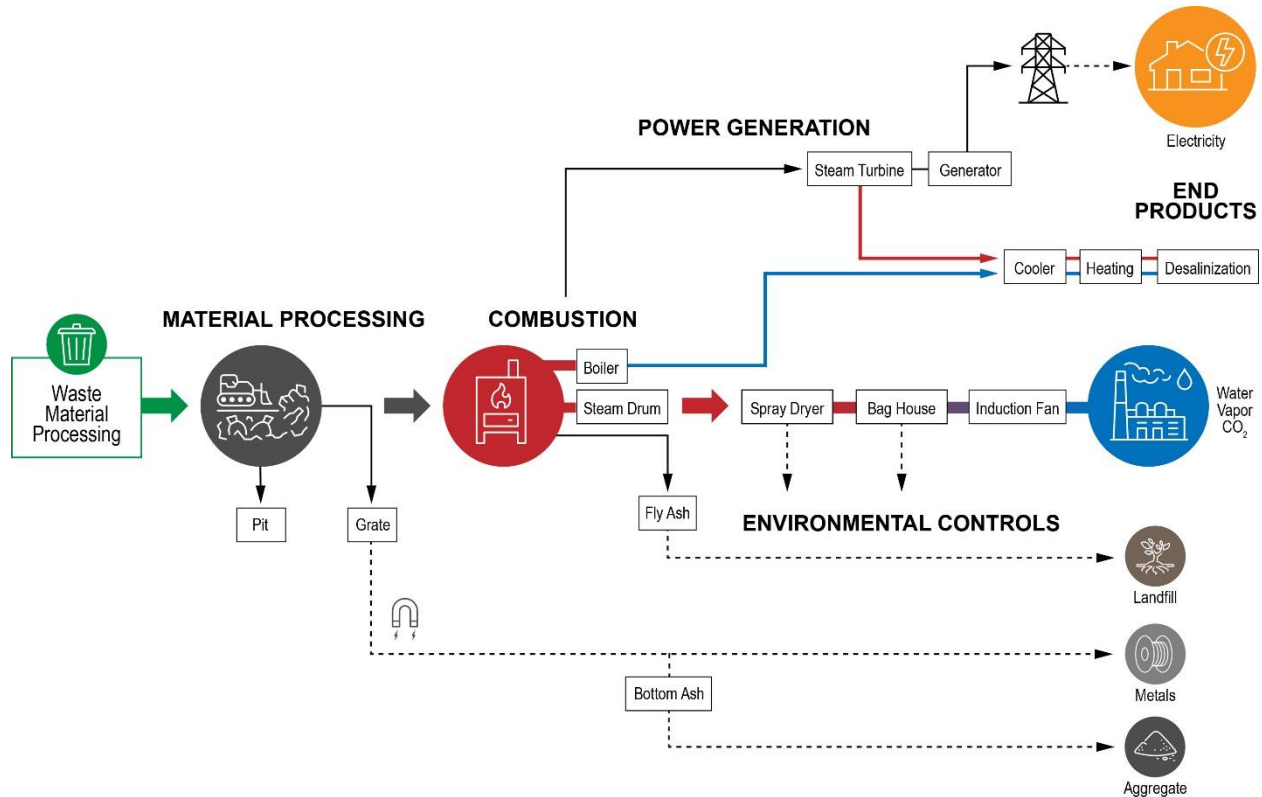

5
6 **Figure 2.3-10 Schematic of a Biomass/Waste-to-Energy Plant**

7 MSW combustors use one of three types of technologies: mass burn, modular, or refuse-
8 derived fuel. Mass burning is currently the method used most frequently in the United States
9 and involves no (or little) sorting, shredding, or separation. Consequently, toxic or hazardous
10 components present in the waste stream are combusted, and toxic constituents are exhausted
11 to the air or become part of the resulting solid wastes. As of 2019, the United States had 75
12 operational waste-to-energy plants in 21 States, processing approximately 29 million tons of
13 waste per year. These waste-to-energy plants have an aggregate capacity of 2,725 MWe
14 (Michaels and Krishnan 2019). Although some plants have expanded to handle additional
15 waste and to produce more energy, only one new plant has been built in the United States since
16 1995 (Maize 2019).

17 Landfill gas is another potential source of biomass energy for electric power production.
18 Landfills in which organic materials are disposed represent the largest source of methane in the
19 United States. Landfill gas composition varies depending on the type of waste.

20 In 2021, biomass energy was the source of approximately 1.3 percent of total U.S. electrical
21 generation and approximately 6.7 percent of the total generation derived from renewable energy
22 sources (DOE/EIA 2022e). This contribution from biomass energy sources is projected to
23 remain largely unchanged through 2050 (DOE/EIA 2022h).

1 2.3.3.5 *Geothermal Energy*

2 Geothermal energy is energy in the form of heat contained below the Earth’s surface in
 3 hydrothermal zones (hot water or steam trapped in an aquifer), hot and dry geologic formations
 4 (referred to as hot dry rock or engineered geothermal systems [EGSs]), or in geopressurized
 5 resources (hot brine aquifers existing under pressure). The technical approaches to extracting
 6 geothermal energy resources involve drilling wells down into the heated resources to raise hot
 7 water or steam to the surface where the heat energy can be used to generate electricity. EGSs
 8 differ in that crews must first fracture a hot, dry rock formation and then inject a heat transfer
 9 fluid (typically water). They then recover the heated fluid from the formation through the well
 10 and then use the heated fluid to produce steam—and subsequently electricity—in a
 11 conventional steam turbine generator (NRC 2013a). A schematic of a representative
 12 geothermal generating facility is provided in Figure 2.3-11.

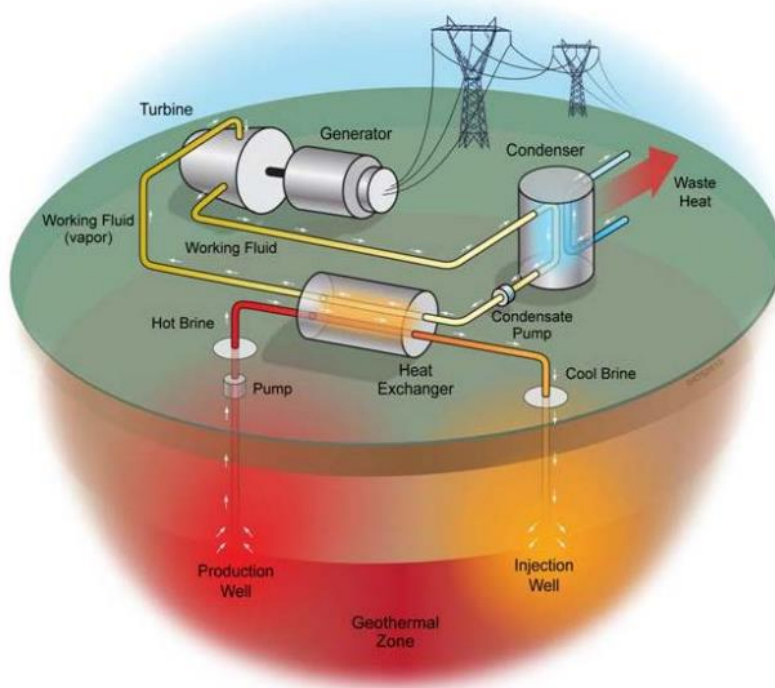

13
 14 **Figure 2.3-11 Schematic of a Hydrothermal Binary Power Plant. Source: NREL 2012.**

15 Utility-scale geothermal energy generation requires geothermal reservoirs with a temperature
 16 above 200 degrees Fahrenheit (°F) (93 degrees Celsius [°C]). Known utility-scale geothermal
 17 resources are concentrated in the western United States, specifically Alaska, Arizona,
 18 California, Colorado, Hawaii, Idaho, Montana, Nevada, New Mexico, Oregon, Utah,
 19 Washington, and Wyoming. In general, most assessments of geothermal resources have
 20 concentrated on these Western States (DOE Undated-b, USGS 2008). In 2021, geothermal
 21 power plants produced approximately 1.3 percent of total U.S. electrical generation, equivalent
 22 to approximately 2.0 percent of total U.S. renewable electricity generation (DOE/EIA 2022e).
 23 This contribution from geothermal energy sources is projected to remain largely unchanged
 24 through 2050 (DOE/EIA 2022h).

1 2.3.3.6 Ocean Wave and Current Energy

2 Waves, currents, and tides are often predictable and reliable, making them attractive candidates
 3 for potential renewable energy generation. Four major technologies may be suitable to harness
 4 wave energy: (1) point absorbers, (2) attenuators, (3) water column terminator devices, and
 5 (4) overtopping devices (see Figure 2.3-12) (BOEM Undated). Point absorbers and attenuators
 6 use floating buoys to convert wave motion into mechanical energy, driving a generator to
 7 produce electricity. Overtopping devices trap some portion of an incident wave at a higher
 8 elevation than the average height of the surrounding sea surface, while terminators allow waves
 9 to enter a tube, compressing air that is then used to drive a generator that produces electricity
 10 (2013 LR GEIS). Some of these technologies are undergoing demonstration testing at
 11 commercial scales, but none is currently used to provide baseload power (BOEM Undated).

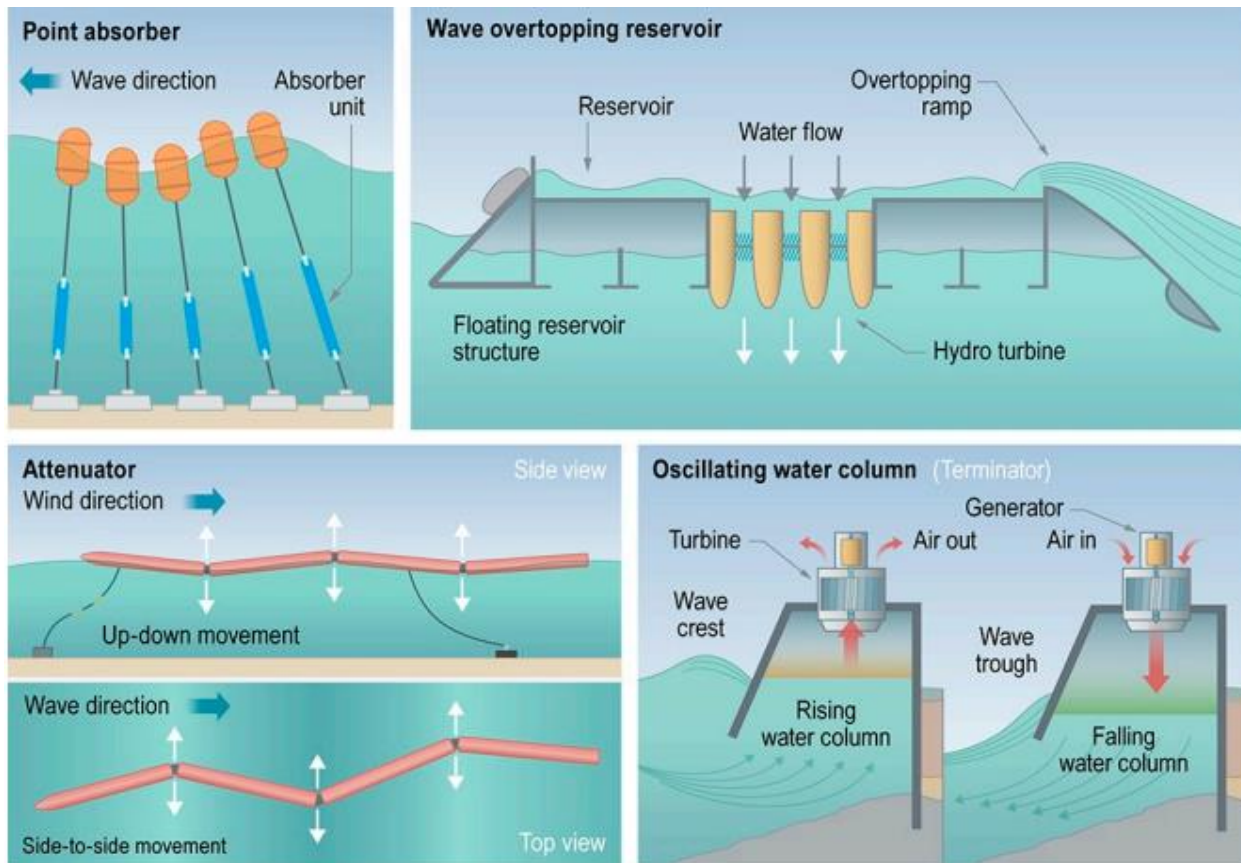

12
 13 **Figure 2.3-12 Primary Types of Wave Energy Devices. Source: NREL 2012. Illustrations**
 14 **not to scale.**

15 In general, technologies that harness the energy of ocean waves are in their infancy and have
 16 not been used at utility scale. Feasibility studies and prototype tests for wave energy capture
 17 devices have been conducted for locations off the coasts of Hawaii, Oregon, California,
 18 Massachusetts, and Maine. Similarly, ocean current energy technology is also in its infancy.
 19 Existing prototypes capture ocean current energy with submerged turbines that are similar to
 20 wind turbines. Although the functions of ocean turbines and wind turbines are similar (both
 21 derive power from moving fluids), ocean turbines have substantially greater power-generating
 22 capacity because the energy contained in moving water is approximately 800 times greater than
 23 that contained in air (MMS 2007).

1 2.3.3.7 *Fuel Cells*

2 Fuel cells work without combustion and its associated environmental side effects. Power is
 3 produced electrochemically by passing a hydrogen-rich fuel over an anode, air over a cathode,
 4 and then separating the two by an electrolyte. The only byproducts are heat, water, and CO₂
 5 (see Figure 2.3-13). Hydrogen fuel can come from a variety of hydrocarbon resources by
 6 subjecting them to steam under pressure. Natural gas is typically used as the source of
 7 hydrogen (DOE Undated-a). As of October 2020, the United States had a total of 250 MW of
 8 fuel cell generation capacity (DOE/EIA Undated-a).

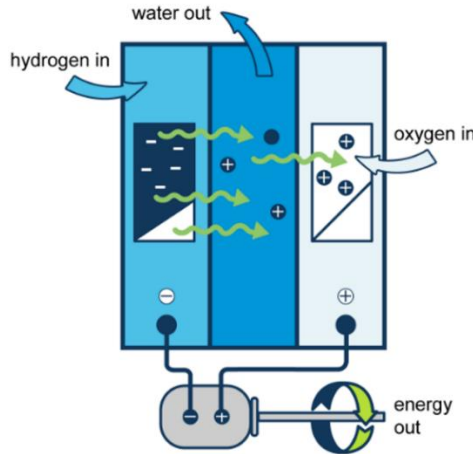

9

10 **Figure 2.3-13 Components of a Hydrogen Fuel Cell. Adapted from: DOE/EIA 2022f.**

11 Currently, fuel cells are not economically or technologically competitive with other alternatives
 12 for electricity generation. The EIA estimates that fuel cells may cost \$6,866 per installed
 13 kilowatt (total overnight capital costs in 2020 dollars), which is high compared to other
 14 alternative technologies analyzed in this section (DOE/EIA 2022c). In 2021, the DOE launched
 15 an initiative to reduce the cost of hydrogen production to spur fuel cell and energy storage
 16 development over the next decade (DOE 2021b). However, it is unclear to what degree this
 17 initiative will lead to increased future development and deployment of fuel cell technologies.

18 **2.3.4 Non-Power Generating Alternatives**

19 As discussed in Section 2.3, various electric power-generating technologies can be employed to
 20 replace the power provided by a nuclear power plant in a particular region of the country. The
 21 preceding sections have identified the technologies that the NRC considers to be viable
 22 candidates as alternatives. However, in addition to these power-generating options, alternatives
 23 that offset power needs and do not include the introduction of new electricity-generating
 24 capacity also exist. Three such alternatives are energy efficiency and demand response
 25 measures (collectively, part of a range of demand-side management measures), delayed
 26 retirement of existing non-nuclear plants, and purchased power from other electricity generators
 27 within or outside of a region.

28 **2.3.4.1 Demand-Side Management Programs**

29 The need for alternative or replacement power can precipitate or invigorate conservation and
 30 energy efficiency efforts designed to either reduce electricity demand at the retail level or alter
 31 the shape of the electricity load. All such efforts are broadly categorized as demand-side

Alternatives Including the Proposed Action

1 management (DSM), although DSM can also include other measures to influence energy
2 consumer practices. Utility companies use DSM to reduce consumer energy usage, either
3 through conservation and energy efficiency measures or through demand response (DOE/EIA
4 2019b). Energy efficiency measures consist of installations of more efficient devices or
5 implementing more efficient processes that exceed current standards. Examples are replacing
6 light bulbs with more efficient technology or replacing older heating, ventilation, and air
7 conditioning systems with high-efficiency systems that exceed current codes and standards.
8 Demand response programs are procedures that encourage a temporary reduction in demand
9 for electricity at certain times in response to a signal from the grid operator or market conditions
10 (DOE/EIA Undated-b). DSM measures may be championed by the same company that
11 operates a nuclear power plant when that company also serves retail customers. In other
12 cases, the measures may be offered by other load-serving entities, State-based programs, third-
13 party service providers and aggregators, or even transmission operators. Programs include, but
14 are not limited to, incentives for equipment upgrades, improved codes and standards, rebates or
15 rate reductions in exchange for allowing a utility to control or curtail the use of high-consumption
16 appliances (like air conditioners) or equipment, training in efficient operation of building heating
17 and lighting systems, direct payments in consideration for avoided consumption, or use of price
18 signals to shift consumption away from peak times.

19 Data contained in the latest EIA Electric Power Annual report showed that peak demand
20 savings from energy efficiency and demand response activities totaled 16,674 MW in 2020
21 (DOE/EIA 2022d).

22 EIA data show that historically, residential electricity consumers have been responsible for the
23 majority of peak load reductions achieved by conservation and energy efficiency programs.
24 However, participation in most conservation programs is voluntary, and the existence of a
25 program does not guarantee that reductions in electricity demand would occur. Nevertheless,
26 energy conservation programs in general can result in significant reductions in demand. Recent
27 legislative actions in some States requiring the establishment of programs such as “net
28 metering” and technological advances in the electric transmission network (the “smart grid”)
29 have facilitated greater degrees of participation in energy conservation programs, especially
30 among residential customers.

31 Conservation and energy efficiency programs may reduce overall environmental impacts
32 associated with energy production.

33 However, while the energy conservation or energy efficiency potential in the United States is
34 substantial, the NRC staff is not aware of any cases where a DSM program has been
35 implemented expressly to replace or offset a large, baseload generation station. While the
36 potential to replace a large baseload generator may exist in some locations, it is more likely that
37 DSM programs will not be evaluated in plant-specific license renewal environmental reviews as
38 standalone alternatives but may play an important role in the evaluation of a combination of
39 alternatives.

40 2.3.4.2 *Delayed Retirement of Other Generating Facilities*

41 Delayed retirement of other power-generating plants is another potential alternative to license
42 renewal. Delaying the retirement of one or more power-generating facilities in a region could
43 enable them to continue supplying sufficient electricity to offset that which a nuclear plant
44 currently provides to its service area. Repowering existing facilities using new or different
45 technologies could also provide a means for delaying their retirement.

1 Power plants retire for several reasons. Because generators are required to adhere to
 2 additional regulations that will require significant reductions in plant emissions, some power
 3 plant owners may opt for early retirement of older units (which often generate more pollutants
 4 and are less efficient) rather than incur the cost for compliance. Additional retirements may be
 5 driven by low competing commodity prices (such as low natural gas prices), slow growth in
 6 electricity demand, and the requirements of the EPA's Mercury and Air Toxics Standards
 7 (DOE/EIA 2015b). Impacts would occur in areas where delayed retirements of existing non-
 8 nuclear power plants occur, and the magnitude of these impacts would be reflective of the type
 9 of generating technology employed and the amount of power required.

10 *2.3.4.3 Purchased Power*

11 Bulk electricity purchases currently take place within geographic regions established by the
 12 North American Electric Reliability Corporation (NERC), the authorized Electric Reliability
 13 Organization for the United States. NERC is a regulatory organization that develops and
 14 enforces reliability standards; monitors the bulk power system; assesses future adequacy;
 15 audits owners, operators, and users for preparedness; and educates and trains industry
 16 personnel. NERC is composed of eight Regional Reliability Councils, each responsible for a
 17 specific geographic area. These entities account for virtually all bulk electricity (i.e., electricity
 18 provided at 100 kV or higher) supplied in the United States, Canada, and a portion of Baja
 19 California Norte, Mexico. Interconnections exist between NERC regions that allow for power
 20 exchanges between the regions when necessary to satisfy short-term demand. The NRC
 21 recognizes the possibility that replacement power may be imported from outside a nuclear
 22 power plant's service area, which may or may not require importing power from another region.
 23 In most instances, importing power from distant generating sources would have little or no
 24 measurable environmental impact in the vicinity of the nuclear power plant, but it could cause
 25 environmental impacts where the power is generated or anywhere along the transmission route.
 26 Similar to other approaches, the magnitude of these impacts would be reflective of the type of
 27 generating technology employed and the amount of power required.

28 Many factors influence power purchasing decisions, with respect to both technical feasibility and
 29 cost. The existing transmission grid may not support every possible power transfer agreement.
 30 Incremental power transfer capacities have been established between grid segments both
 31 within and across NERC regions, and modest amounts of power routinely transfer across those
 32 points. Such capabilities were established to make sure that overall grid stability and reliability
 33 under both routine and nonroutine conditions are maintained. In contrast, long-term transfers of
 34 utility-scale power from outside of a given power plant's region may require modification of one
 35 or more existing transmission grid segments (as well as modifications of substations and power
 36 synchronization equipment) and could require construction of new transmission line segments.
 37 New transmission lines may be required for long-term purchased power from within the same
 38 NERC region, but the need for new transmission lines is highly situation-dependent. Further,
 39 efforts by transmission operators to provide a price signal for transmission congestion through
 40 locational-marginal pricing would, over the long run, provide an incentive for power purchases
 41 closer to the existing power plant or construction of new capacity nearer the existing power
 42 plant. In general, the more geographically distant the exporting source, the greater the
 43 likelihood that new or modified interconnecting transmission line segments would be necessary.

1 **2.4 Comparison of Alternatives**

2 This section provides a summary comparison of the environmental impacts of the proposed
3 action and alternatives. Table 2.4-1 through Table 2.4-5 provide an overview of the general
4 findings of the impact analyses (presented in Chapter 4) for the proposed action and
5 alternatives, including the no action alternative, and replacement energy alternatives (fossil fuel
6 energy, nuclear energy, and renewable energy). Impacts related to construction (Table 2.4-1),
7 operations (Table 2.4-2), postulated accidents (Table 2.4-3), termination of nuclear power plant
8 operations and decommissioning (Table 2.4-4), and the fuel cycle (Table 2.4-5) are provided.
9 In each of these tables, important aspects of each alternative that serve as the basis of the
10 assessment are identified as well as the magnitude of the anticipated impact in each resource
11 area. These tables also provide a summary of anticipated impacts from potential non-power
12 generating approaches for offsetting a nuclear power plant's generating capacity (DSM, delayed
13 retirement, and purchased power). Such non-power generating approaches are most likely to
14 be considered only as components of plant-specific combination alternatives in plant-specific
15 SEISs prepared to evaluate the environmental impacts of renewing a nuclear power plant's
16 operating license. The non-power generating approaches would generally have impacts that
17 will depend on the source used to compensate for the lost energy generation. Accordingly,
18 these nongenerating approaches are not evaluated further in Chapter 4.0 of this LR GEIS.
19 More detailed analyses incorporating relevant site-specific factors (as well as the future state of
20 technology and, possibly, other reasonable alternatives) will be provided in each plant-specific
21 SEIS.

22 Further, each plant-specific SEIS must analyze the impacts of the proposed action (license
23 renewal) as well as a range of reasonable alternatives to provide replacement energy.
24 According to the White House Council on Environmental Quality, reasonable alternatives
25 comprise "those that are practical or feasible from the technical and economic standpoint and
26 using common sense" (46 FR 18026). Replacement energy alternatives may require the
27 construction of a new power plant and possibly the modification of the electric transmission grid.
28 New power plants would also have operational impacts that may or may not be equivalent in
29 nature and/or extent to the operational impacts of the nuclear plant. License renewal would not
30 require major construction and operational impacts would not change beyond what is currently
31 being experienced at the nuclear plant. Other alternatives that would not have construction or
32 operational impacts include conservation and energy efficiency, delayed retirement, and
33 purchased power.

34 The operational impacts of license renewal are comparable to replacement power alternatives
35 and some renewable energy alternatives in some resource areas (e.g., socioeconomics), but
36 quite different in other resource areas (e.g., air emissions, fuel cycle, land use, and water
37 consumption). Some renewable energy alternatives (wind, ocean wave, and ocean current
38 alternatives) have very few operational impacts, while others (biomass combustion and
39 conventional hydropower) can have considerable operational impacts. Some renewable energy
40 alternatives (wind and solar) have relatively low but regionally variable capacity factors while
41 others (e.g., conventional hydropower and geothermal) can exhibit capacity factors at or near
42 those of a nuclear power plant.

43 The proposed action and alternatives differ in other respects, including the consequences of
44 accidents. The proposed action and new nuclear energy alternatives all may have low
45 probability but potentially high-consequence accidents in comparison to non-nuclear
46 alternatives.
47

1

Table 2.4-1 Construction under the Proposed Action and Alternatives – Assessment Basis and Nature of Impacts

Proposed Action^(a)	No Action Alternative	Fossil, New Nuclear, and Renewable Energy Alternatives	Demand-Side Management	Purchased Power and Delayed Retirement
Minor construction projects (refurbishment) associated with the proposed action. Original nuclear plant construction is not part of the proposed action.	No construction at nuclear plant sites if license renewal is denied.	Major construction projects would be required to build replacement fossil fuel, nuclear, or renewable energy generation capacity. Impacts would vary according to the specific alternative technology selected and site-specific resource conditions that would be reviewed under separate environmental review processes, depending on the activity's location and proponent. Impacts at brownfield sites would be smaller than at greenfield sites. Power may also be replaced by a portfolio of alternative technologies; in such cases, impacts would be additive among portfolio components, occurring at each facility commensurate with the technology and the amount of replacement power it provides.	Little or no construction would be associated with DSM programs implemented to offset lost generation capacity.	No construction would occur from purchased power or delayed retirements of existing non-nuclear plants if available excess capacity is sufficient to offset losses. Construction could occur in instances where expansions of the capacity of the alternative generation source to meet power purchase agreements or modifications to the transmission grid were required to bring the imported power to the load centers affected by reactor retirement.

2

DSM = demand-side management.

3

(a) Refer to Table 2.1-1 for a more detailed presentation of the impacts of construction (likely refurbishments) under the proposed action. These impacts are discussed in detail in Chapter 4.0.

4

5

1

Table 2.4-2 Operations under the Proposed Action and Alternatives – Assessment Basis and Nature of Impacts

Proposed Action^(a)	No Action Alternative	Fossil, New Nuclear, and Renewable Energy Alternatives	Demand-Side Management	Purchased Power and Delayed Retirement
Continued operations under the proposed action would be comparable to what is already occurring at the nuclear plant.	Termination of reactor operations would occur sooner than under the proposed action. After reactor shutdown, some systems would continue operating but at reduced levels.	<p>Operation of a new fossil fuel energy, nuclear, or renewable energy facility would introduce new impacts to the facility site and vicinity. Impacts would vary according to site-specific resource conditions that would be reviewed under separate NEPA assessments. If lost power capacity is replaced with a portfolio of alternatives, impacts would be additive, occurring at each of the facilities within the portfolio based on the nature of the technology employed and commensurate with the amount of power produced. Impacts at brownfield sites may be less than at greenfield sites.</p> <p>Fossil fuel energy alternatives would have similar operational impacts as the proposed action, nuclear, and some renewable alternatives (e.g., biomass), but would produce more air emissions. New nuclear energy alternatives would have operational impacts similar to those of fossil fuel and some renewable technologies but would produce fewer air emissions than fossil fuel and biomass technologies. Renewable technologies differ greatly in terms of operational impacts.</p>	No new operational impacts are likely to result from DSM programs implemented to offset lost generation capacity. Existing operational impacts from current generation sources may be lessened if greater load reductions result.	Impacts would occur in areas where purchased power is produced or where delayed retirements of existing non-nuclear plants occur. Impact magnitude would be reflective of the type of generating technology employed and the amount of power required.

DSM = demand-side management.

(a) Refer to Table 2.1-1 for a more detailed presentation of the impacts of operations under the proposed action. These impacts are discussed in detail in Chapter 4.0.

2

3

4

5

1 **Table 2.4-3 Postulated Accidents under the Proposed Action and Alternatives – Assessment Basis and Impact Magnitude**

Proposed Action^(a)	No Action Alternative	Fossil, New Nuclear, and Renewable Energy Alternatives	Demand-Side Management	Purchased Power and Delayed Retirement
<p>Postulated accidents associated with continued operations under the license renewal term include design-basis accidents and severe accidents. The impacts take into consideration the low probability of an accident occurring. Design-basis accidents would have a small impact. Severe accidents would likely have larger consequences than design-basis accidents, but the probability-weighted consequences (i.e., the probability of occurrence of the accident multiplied by the consequence if the accident occurred) would be SMALL for all plants.</p>	<p>Plant shutdown would occur sooner than under the proposed action. A reduction in accident risk would occur sooner.</p>	<p>Accidents associated with fossil fuel energy facilities would have short-term, localized effects. Accidents associated with nuclear energy would be similar to those of the proposed action. Accidents associated with biomass facilities would be comparable to those of fossil fuel energy facilities. Accidents associated with hydropower (e.g., dam collapse) could have large, far-reaching effects. Accidents associated with coal combustion residue handling and storage could also have large, far-reaching effects. Impacts from accidents associated with other renewable energy technologies would be localized and generally inconsequential.</p>	<p>No accidents are associated with DSM measures aside from occupational hazards for those who install or implement them.</p>	<p>Impacts would occur in areas where purchased power is produced or where delayed retirements of existing non-nuclear plants occur. The nature and magnitude of the impact would depend on the technology used to produce the power and characteristics of the plant site. If power is purchased from existing generating facilities with excess capacity, little change in impact would be expected. Additional impacts may result from required expansions or modifications of transmission infrastructures.</p>

2 DSM = demand-side management.

3 (a) Refer to Table 2.1-1 for a more detailed presentation of the impacts of accidents under the proposed action. These impacts are discussed in detail in
 4 Section 4.9.1.2.
 5

1
2

3
4
5

Table 2.4-4 Termination of Nuclear Power Plant Operations and Decommissioning under the Proposed Action and Alternatives – Assessment Basis and Nature of Impacts

Proposed Action^(a)	No Action Alternative	Fossil, New Nuclear, and Renewable Energy Alternatives	Demand-Side Management	Purchased Power and Delayed Retirement
Termination of reactor operations and decommissioning would occur regardless of the proposed action. The proposed action would not contribute substantially to the impacts from the termination of reactor operations and decommissioning.	The no action alternative would not contribute to the impacts of terminating reactor operations and decommissioning.	Termination of power plant operations and decommissioning of a fossil fuel, nuclear, or renewable energy facility would result in short-term impacts during facility dismantlement and longer-term waste management impacts. Impacts would vary according to site-specific resource conditions. The NRC staff's analysis assumes that dams would remain in place for flood control after hydroelectric power generation ceases. Impacts at brownfield sites may be less than at greenfield sites.	No termination of operations and decommissioning impacts are anticipated to result from energy conservation programs implemented to offset lost generation capacity. Delaying retirements of existing non-nuclear plants would similarly delay impacts associated with termination of operations and decommissioning.	Because existing facilities would be used to produce purchased power, no termination of operations and decommissioning impacts would be associated with this alternative.
(a) Refer to Table 2.1-1 for a more detailed presentation of the impacts of decommissioning under the proposed action. These impacts are discussed in detail in Section 4.14.3.				

Table 2.4-5 Fuel Cycle under the Proposed Action and Alternatives – Assessment Basis and Nature of Impacts

Proposed Action ^(a)	No Action Alternative	Fossil, Nuclear, and Renewable Energy Alternatives	Demand-Side Management	Purchased Power and Delayed Retirement
During the license renewal term, the proposed action would result in the need for continued mining and milling of uranium; fuel fabrication; and storage, transport, and disposal of radioactive and other wastes.	The no action alternative would reduce the need for nuclear fuel and reduce the environmental impacts associated with the uranium fuel cycle.	The fuel cycle of fossil fuel energy alternatives includes the extraction of coal (mining) or natural gas (drilling and fracking); fuel cleanup; transport of extracted fuel; and storage, transport, and disposal of combustion waste. Impacts would depend on characteristics of extraction sites and fuels. The new nuclear energy alternatives would have impacts similar to those of the proposed action. Of renewables, only certain biomass technologies (e.g., crop residues, forest products) have a well-defined fuel cycle. Biomass projects that involve growing, harvesting, and processing of plant materials would have impacts associated with producing and transporting biomass fuel and storage and disposal of combustion waste. Impacts would depend on the nature of the biomass being produced, the characteristics of areas used to produce fuel, and the technology used to convert the biomass to energy.	There is no fuel cycle associated with energy conservation. The fuel-cycle impacts associated with delayed retirement would depend on the specific fuel type associated with the existing non-nuclear plant.	The fuel-cycle impacts associated with power purchases would depend on the mix of generating sources that are used to produce purchased power.
(a) Refer to Table 2.1-1 for a more detailed presentation of the impacts of operations under the proposed action. These impacts are discussed in detail in Section 4.14.1.				

Alternatives Including the Proposed Action

- 1 The termination of nuclear power plant operations and decommissioning impacts at nuclear
2 plant sites would eventually occur regardless of a decision to renew their licenses. Thus, in this
3 analysis, those impacts are not attributed to the proposed action, and the effects of the
4 proposed action on the impacts from the termination of nuclear power plant operations and
5 decommissioning would be SMALL in all resource areas. Impacts from the decommissioning of
6 a new nuclear power reactor would be similar to that of the existing reactor.
- 7 Fuel-cycle impacts have been evaluated for license renewal and were found to be SMALL for all
8 resource areas, except for offsite radiological impacts—collective impacts from other than the
9 disposal of spent fuel and high-level waste, which are acceptable (see Section 4.14.1.1,
10 “Uranium Fuel Cycle” for information about this issue). Fossil-fueled alternatives may have
11 larger fuel-cycle impacts (mostly associated with land disturbance at fuel extraction sites), while
12 other alternatives have no fuel-cycle impacts (renewable alternatives such as wind, wave,
13 current, or solar alternatives do not require fuel).

1

3.0 AFFECTED ENVIRONMENT

2 For purposes of the evaluation in this revision of NUREG-1437, *Generic Environmental Impact*
 3 *Statement for License Renewal of Nuclear Plants* (LR GEIS), the “affected environment” is the
 4 environment that currently exists at and around operating U.S. commercial nuclear power
 5 plants. Because existing conditions are at least partially the result of past construction and
 6 operations at the nuclear plants, the impacts of these past and ongoing activities and how they
 7 have shaped the environment are summarized here. Thus, it is this existing environment that
 8 composes the environmental baseline against which potential environmental impacts of license
 9 renewal are evaluated. The impacts of continued operations and any refurbishment during the
 10 license renewal (initial license renewal [initial LR] or subsequent license renewal [SLR]) term
 11 that are presented in Chapter 4.0 are incremental to these baseline conditions, which include
 12 the effects of past and present actions at the plants.

<p>Contents of Chapter 3.0</p> <ul style="list-style-type: none"> • Description of Nuclear Power Plant Facilities and Operations (Section 3.1) • Land Use and Visual Resources (Section 3.2) • Meteorology, Air Quality, and Noise (Section 3.3) • Geologic Environment (Section 3.4) • Water Resources (Section 3.5) • Ecological Resources (Section 3.6) • Historic and Cultural Resources (Section 3.7) • Socioeconomics (Section 3.8) • Human Health (Section 3.9) • Environmental Justice (Section 3.10) • Waste Management and Pollution Prevention (Section 3.11) • Greenhouse Gas Emissions and Climate Change (Section 3.12)
--

- Description of Nuclear Power Plant Facilities and Operations (Section 3.1)
- Land Use and Visual Resources (Section 3.2)
- Meteorology, Air Quality, and Noise (Section 3.3)
- Geologic Environment (Section 3.4)
- Water Resources (Section 3.5)
- Ecological Resources (Section 3.6)
- Historic and Cultural Resources (Section 3.7)
- Socioeconomics (Section 3.8)
- Human Health (Section 3.9)
- Environmental Justice (Section 3.10)
- Waste Management and Pollution Prevention (Section 3.11)
- Greenhouse Gas Emissions and Climate Change (Section 3.12)

13 **3.1 Description of Nuclear Power Plant Facilities and Operations**

14 **3.1.1 External Appearance and Settings**

15 Nuclear power plants contain a number of buildings or structures. Among them are containment
 16 or reactor buildings, turbine buildings, auxiliary buildings, vent stacks, meteorological towers,
 17 and cooling systems, particularly cooling towers. A plant site layout also includes large parking
 18 areas, security fencing, switchyards, water intake and discharge facilities, and transmission
 19 lines (see Section 3.1.6.5). While reactor, turbine, and auxiliary buildings are often clad or
 20 painted in colors that are intended to reduce or mitigate their visual presence, the heights of
 21 many of the structures, coupled with red and/or white safety lights, make nuclear plants visible
 22 from many directions. Typical heights of nuclear plant facilities are as follows: reactor buildings
 23 are 300 ft (90 m), turbine buildings are 100 ft (30 m), stacks are 300 ft (90 m), meteorological

Affected Environment

1 towers are 200 ft (60 m), natural draft cooling towers are higher than 500 ft (150 m), and
2 mechanical draft cooling towers are 100 ft (30 m) tall. In addition, condensation from cooling
3 towers is generally visible for many miles. Transmission line towers are between 70 ft (20 m)
4 and 170 ft (50 m) in height, depending on the voltage being carried.

5 There are two types of power reactors currently operating in the United States—boiling water
6 reactors (BWRs) and pressurized water reactors (PWRs). All nuclear power plant sites are
7 generally similar in terms of the types of facilities they contain. All plant sites contain a nuclear
8 steam supply system. In addition, there are a number of common structures necessary for plant
9 operation. However, the layout of buildings and structures varies considerably among the sites.
10 For example, control rooms may be located in the auxiliary building, in a separate control
11 building, or in a radwaste and control building. The following list describes typical structures
12 located on most sites.

13 • **Containment or reactor building.** The containment or reactor building in a PWR is a
14 massive concrete or steel structure that houses the reactor vessel, reactor coolant piping
15 and pumps, steam generators, pressurizer, pumps, and associated piping. The reactor
16 building structure of a BWR generally includes a containment structure and a shield building.
17 The reactor containment building is a very large concrete or steel structure that houses the
18 reactor vessel, the reactor coolant piping and pumps, and the suppression pool. It is located
19 inside another structure called the shield building. The shield building for a BWR also
20 generally contains the spent fuel pool and the new fuel pool.

21 The reactor containment building for both PWRs and BWRs is designed to withstand natural
22 disasters, such as tornados, hurricanes, and earthquakes. The containment building's
23 ability to withstand such events and to contain the effects of accidents initiated by system
24 failures constitutes a principal protection against releasing radioactive material to the
25 environment.

26 • **Fuel building.** For PWRs, the fuel building has a fuel pool that is used to store and service
27 spent fuel and prepare new fuel for insertion into the reactor. This building is connected to
28 the reactor containment building by a transfer tube or channel that is used to move new fuel
29 into the reactor and move spent fuel out of the reactor for storage.

30 • **Turbine building.** The turbine building houses the turbines, generators, condenser,
31 feedwater heaters, condensate and feedwater pumps, waste-heat rejection system, pumps,
32 and equipment that support those systems. In BWRs, primary coolant circulates through
33 these systems, thereby causing them to become slightly contaminated. In PWRs, primary
34 coolant is not circulated through the turbine building systems. However, it is not unusual for
35 portions of the turbine building to become mildly contaminated because of leaks from the
36 primary system into the secondary side during power generation at PWRs.

37 • **Auxiliary buildings.** Auxiliary buildings house support systems, such as the ventilation
38 systems, emergency core cooling systems, laundry facilities, water treatment systems, and
39 waste treatment systems. An auxiliary building may also contain the emergency diesel
40 generators and, in some PWRs, the diesel fuel storage facility. The facility's control room is
41 often located in the auxiliary building.

42 • **Diesel generator building.** Often a separate building houses the emergency diesel
43 generators if they are not located in the auxiliary building. The emergency diesel generators
44 do not become contaminated or activated.

45 • **Pump houses.** Various pump houses for circulating water, standby service water, diesel
46 fuel, or makeup water may be onsite.

- 1 • **Cooling towers.** Cooling towers are structures designed to remove excess heat from the
 2 condenser without dumping the heat directly into water bodies, such as lakes or rivers.
 3 There are two principal types of cooling towers: mechanical draft towers and natural draft
 4 towers. Most nuclear power plants that have once-through cooling do not have cooling
 5 towers associated with them. However, several operating nuclear power plants with once-
 6 through cooling also have cooling towers that are used to reduce the temperature of the
 7 water before it is released to the environment.
- 8 • **Radioactive waste (radwaste) facilities.** Radioactive waste facilities may be contained in
 9 an auxiliary building or located in a separate solid radwaste building. For example, the
 10 radioactive waste storage facility may be a separate building.
- 11 • **Ventilation stack.** Many older nuclear power plants, particularly BWRs, have ventilation
 12 stacks to discharge gaseous waste effluents and ventilation air directly to the outside.
 13 These stacks can be 300 ft (90 m) tall or higher and contain monitoring systems to ensure
 14 that radioactive gaseous discharges are below fixed release limits. Radioactive gaseous
 15 effluents are treated and processed before being discharged out the stack.
- 16 • **Switchyard and transmission lines.** Plant sites also typically contain a large switchyard,
 17 where the electric voltage is stepped up and fed into the regional power distribution system.
 18 Electricity generated at the plant is carried offsite by transmission lines. Only those
 19 transmission lines that connect the plant to the switchyard where electricity is fed into the
 20 regional power distribution system (encompassing those lines that connect the plant to the
 21 first substation of the regional electric power grid) and power lines that feed the plant from
 22 the grid during outages are considered within the regulatory scope of license renewal
 23 environmental review and this LR GEIS. The transmission lines that comprise the regional
 24 power distribution system, and beyond the scope of the environmental review, would be
 25 expected to remain energized regardless of nuclear power plant license renewal.
- 26 • **Administrative, training, and security buildings.** Normally, the administrative, training,
 27 and security buildings are located outside the radiation protection zones; no radiological
 28 contamination is present; and radiation exposures are at general background levels.
- 29 • **Independent spent fuel storage installations (ISFSIs).** An ISFSI is designed and
 30 constructed for the interim storage of spent nuclear fuel and other radioactive materials
 31 associated with spent fuel storage. ISFSIs may be located at the site of a nuclear power
 32 plant or at another location. The most common design for an ISFSI, at this time, is a
 33 concrete pad with dry casks containing spent fuel bundles. ISFSIs are used by operating
 34 plants that require increased spent fuel storage capability because their spent fuel pools
 35 have reached capacity (see Section 3.11.1).

36 Nuclear power plant site areas range from 391 acres (ac) (158 hectares [ha]) to 14,000 ac
 37 (5,700 ha), with most sites encompassing 700 to 2,500 ac (283 to 1,000 ha). Larger land use
 38 areas are associated with plant cooling systems that include reservoirs, artificial lakes, and
 39 buffer areas.

40 Nuclear power plant sites are located in a range of political jurisdictions, including towns,
 41 townships, service districts, counties, parishes, and States. At 50 percent of the sites, the
 42 population density within a 50 mi (80 km) radius is fewer than 150 persons/mi²
 43 (58 persons/km²), and for 75 percent of the sites, the density within 50 mi (80 km) is fewer than
 44 325 persons/mi² (127 persons/km²). Within the 50 mi (80 km) radius, Federal, State, and Tribal
 45 lands are present to various extents. Typically, inland nuclear power plant sites and their
 46 surrounding areas consist of flat to rolling countryside in wooded or agricultural areas. Coastal

Affected Environment

1 and Great Lakes nuclear power plant sites include riparian, wetland, beach, and other shoreline
2 habitats. See Appendix C for summary descriptions of the characteristics of nuclear power
3 plant sites and their surroundings.

4 **3.1.2 Nuclear Reactor Systems**

5 In the United States, all of the currently operating reactors used for commercial power
6 generation are conventional (thermal) light water reactors (LWRs) that use water as a
7 moderator and coolant. The two types of LWRs are PWRs and BWRs. Of the 92 operating
8 LWRs, 61 are PWRs and 31 are BWRs (Figure 3.1-1 and Table 3.1-1). They are located at
9 54 sites in 28 States. Some of the reactors have sought and received power uprates, which
10 allow these plants to operate at a higher licensed power level. Power uprates are a separate
11 licensing action from license renewal and require separate U.S. Nuclear Regulatory
12 Commission (NRC) review and approval. For the reactors that have been authorized to
13 increase their power level, power uprate information is incorporated into Table 3.1-1. Additional
14 reactors may seek power uprates in the future.
15



Figure 3.1-1 Operating Commercial Nuclear Power Plants in the United States

Table 3.1-1 Characteristics of Operating U.S. Commercial Nuclear Power Plants^(a)

Nuclear Power Plant	Unit	Year Operating License Granted	Year License Expires	Net Capacity (MWe)	Reactor Type	Design Condenser Flow Rate (10³ gpm)	Total Site Area (acres)	Nearest City	2020 Population within 50 mi
Arkansas Nuclear One	1	1974	2034	833	PWR	762	1,164	Little Rock, AR	312,591
Arkansas Nuclear One	2	1978	2038	985	PWR	422	-	-	-
Beaver Valley Power Station	1	1976	2036	892	PWR	480	453	Pittsburgh, PA	3,146,489
Beaver Valley Power Station	2	1987	2047	901	PWR	480	-	-	-
Braidwood Station	1	1987	2046	1,183	PWR	730	4,457	Joliet, IL	5,033,013
Braidwood Station	2	1988	2047	1,154	PWR	730	-	-	-
Browns Ferry Nuclear Plant	1	1973	2033	1,256	BWR	734	840	Huntsville, AL	1,081,319
Browns Ferry Nuclear Plant	2	1974	2034	1,259	BWR	734	-	-	-
Browns Ferry Nuclear Plant	3	1976	2036	1,260	BWR	734	-	-	-
Brunswick Steam Electric Plant	1	1976	2036	938	BWR	675	1,200	Wilmington, NC	548,758
Brunswick Steam Electric Plant	2	1974	2034	932	BWR	675	-	-	-
Byron Station	1	1985	2044	1,182	PWR	632	1,398	Rockford, IL	1,284,960
Byron Station	2	1987	2046	1,154	PWR	632	-	-	-
Callaway Plant	1	1984	2044	1,190	PWR	530	5,228	Columbia, MO	585,372
Calvert Cliffs Nuclear Power Plant	1	1974	2034	866	PWR	1,200	2,108	Washington, D.C.	3,962,475
Calvert Cliffs Nuclear Power Plant	2	1976	2036	842	PWR	1,200	-	-	-
Catawba Nuclear Station	1	1985	2043	1,160	PWR	660	391	Charlotte, NC	3,034,933
Catawba Nuclear Station	2	1986	2043	1,150	PWR	660	-	-	-
Clinton Power Station	1	1987	2027	1,065	BWR	569	14,000	Decatur, IL	815,617
Columbia Generating Station	1	1984	2043	1,163	BWR	550	1,089	Spokane, WA	517,245
Comanche Peak Steam Electric Station	1	1989	2030	1,205	PWR	1,030	7,669	Fort Worth, TX	2,077,599
Comanche Peak Steam Electric Station	2	1993	2033	1,195	PWR	1,030	-	-	-

Nuclear Power Plant	Unit	Year Operating License Granted	Year License Expires	Net Capacity (MWe)	Reactor Type	Design Condenser Flow Rate (10³ gpm)	Total Site Area (acres)	Nearest City	2020 Population within 50 mi
Cooper Nuclear Station	1	1974	2034	770	BWR	631	1,251	Lincoln, NE	153,581
Donald C. Cook Nuclear Plant	1	1974	2034	1,009	PWR	800	650	South Bend, IN	1,265,894
Donald C. Cook Nuclear Plant	2	1977	2037	1,060	PWR	800	-	-	-
Davis-Besse Nuclear Power Station	1	1977	2037	894	PWR	480	733	Toledo, OH	1,812,385
Diablo Canyon Power Plant	1	1984	2024	1,122	PWR	863	750	Santa Barbara, CA	499,952
Diablo Canyon Power Plant	2	1985	2025	1,118	PWR	863	-	-	-
Dresden Nuclear Power Station	2	1969	2029	902	BWR	940	2,500	Joliet, IL	7,525,651
Dresden Nuclear Power Station	3	1971	2031	895	BWR	940	-	-	-
Joseph M. Farley Nuclear Plant	1	1977	2037	874	PWR	635	1,850	Columbus, GA	425,394
Joseph M. Farley Nuclear Plant	2	1981	2041	877	PWR	635	-	-	-
Enrico Fermi Atomic Power Plant	2	1985	2045	1,141	BWR	836	1,120	Detroit, MI	4,908,826
James A. FitzPatrick Nuclear Power Plant	1	1974	2034	848	BWR	353	702	Syracuse, NY	932,913
R.E. Ginna Nuclear Power Plant	1	1969	2029	581	PWR	340	488	Rochester, NY	1,299,149
Grand Gulf Nuclear Station	1	1984	2044	1,401	BWR	572	2,100	Jackson, MS	323,744
Shearon Harris Nuclear Power Plant	1	1987	2046	964	PWR	483	10,744	Raleigh, NC	3,041,733
Edwin I. Hatch Nuclear Plant	1	1974	2034	876	BWR	556	2,240	Savannah, GA	464,024
Edwin I. Hatch Nuclear Plant	2	1978	2038	883	BWR	556	-	-	-
Hope Creek Generating Station	1	1986	2046	1,172	BWR	552	740	Wilmington, DE	5,946,917
LaSalle County Station	1	1982	2042	1,131	BWR	645	3,060	Joliet, IL	1,948,438

Nuclear Power Plant	Unit	Year Operating License Granted	Year License Expires	Net Capacity (MWe)	Reactor Type	Design Condenser Flow Rate (10³ gpm)	Total Site Area (acres)	Nearest City	2020 Population within 50 mi
LaSalle County Station	2	1984	2043	1,134	BWR	645	-	-	-
Limerick Generating Station	1	1985	2049	1,120	BWR	450	595	Reading, PA	8,594,665
Limerick Generating Station	2	1990	2049	1,122	BWR	450	-	-	-
McGuire Nuclear Station	1	1981	2041	1,159	PWR	675	577	Charlotte, NC	3,351,808
McGuire Nuclear Station	2	1983	2043	1,158	PWR	675	-	-	-
Millstone Power Station	2	1975	2035	853	PWR	523	500	New Haven, CT	3,071,351
Millstone Power Station	3	1986	2045	1,220	PWR	907	-	-	-
Monticello Nuclear Generating Plant	1	1970	2030	617	BWR	292	1,250	Minneapolis, MN	3,347,158
Nine Mile Point Nuclear Station	1	1968	2029	621	BWR	290	900	Syracuse, NY	927,862
Nine Mile Point Nuclear Station	2	1987	2046	1,292	BWR	580	-	-	-
North Anna Power Station	1	1978	2038	948	PWR	950	1,043	Richmond, VA	2,237,934
North Anna Power Station	2	1980	2040	944	PWR	950	-	-	-
Oconee Nuclear Station	1	1973	2033	847	PWR	680	510	Greenville, SC	1,577,801
Oconee Nuclear Station	2	1973	2033	848	PWR	680	-	-	-
Oconee Nuclear Station	3	1974	2034	859	PWR	680	-	-	-
Palisades Nuclear Plant ^(b)	1	1972	2031	769	PWR	98	432	Kalamazoo, MI	1,441,106
Palo Verde Nuclear Generating Station	1	1985	2045	1,211	PWR	560	4,050	Phoenix, AZ	2,350,442
Palo Verde Nuclear Generating Station	2	1986	2046	1,314	PWR	560	-	-	-
Palo Verde Nuclear Generating Station	3	1987	2047	1,312	PWR	560	-	-	-
Peach Bottom Atomic Power Station	2	1973	2053	1,265	BWR	750	620	Lancaster, PA	6,005,101
Peach Bottom Atomic Power Station	3	1974	2054	1,285	BWR	750	-	-	-
Perry Nuclear Power Plant	1	1986	2026	1,261	BWR	545	1,100	Euclid, OH	2,299,476
Point Beach Nuclear Plant	1	1970	2030	598	PWR	350	1,260	Green Bay, WI	826,680

Nuclear Power Plant	Unit	Year Operating License Granted	Year License Expires	Net Capacity (MWe)	Reactor Type	Design Condenser Flow Rate (10³ gpm)	Total Site Area (acres)	Nearest City	2020 Population within 50 mi
Point Beach Nuclear Plant	2	1972	2033	603	PWR	350	-	-	-
Prairie Island Nuclear Generating Plant	1	1973	2033	521	PWR	294	560	Minneapolis, MN	3,309,059
Prairie Island Nuclear Generating Plant	2	1974	2034	519	PWR	294	-	-	-
Quad Cities Nuclear Power Station	1	1972	2032	908	BWR	485	817	Davenport, IA	655,699
Quad Cities Nuclear Power Station	2	1972	2032	911	BWR	485	-	-	-
River Bend Station	1	1985	2045	968	BWR	508	3,300	Baton Rouge, LA	1,037,151
H.B. Robinson Steam Electric Plant	2	1970	2030	759	PWR	454	6,020	Columbia, SC	922,132
St. Lucie Nuclear Plant	1	1976	2036	981	PWR	484	1,130	West Palm Beach, FL	1,456,749
St. Lucie Nuclear Plant	2	1983	2043	987	PWR	484	-	-	-
Salem Nuclear Generating Station	1	1976	2036	1,174	PWR	1,100	700	Wilmington, DE	5,873,042
Salem Nuclear Generating Station	2	1981	2040	1,130	PWR	1,100	-	-	-
Seabrook Station	1	1990	2050	1,295	PWR	399	889	Lawrence, MA	4,693,723
Sequoyah Nuclear Plant	1	1980	2040	1,152	PWR	522	525	Chattanooga, TN	1,172,704
Sequoyah Nuclear Plant	2	1981	2041	1,126	PWR	522	-	-	-
South Texas Project Electric Generating Station	1	1988	2047	1,280	PWR	907	12,350	Galveston, TX	268,364
South Texas Project Electric Generating Station	2	1989	2048	1,280	PWR	907	-	-	-
Virgil C. Summer Nuclear Station	1	1982	2042	971	PWR	507	2,245	Columbia, SC	1,289,146
Surry Power Station	1	1972	2052	838	PWR	840	840	Newport News, VA	2,462,820
Surry Power Station	2	1973	2053	838	PWR	840	840	-	-

Nuclear Power Plant	Unit	Year Operating License Granted	Year License Expires	Net Capacity (MWe)	Reactor Type	Design Condenser Flow Rate (10 ³ gpm)	Total Site Area (acres)	Nearest City	2020 Population within 50 mi
Susquehanna Steam Electric Station	1	1982	2042	1,247	BWR	484	1,173	Wilkes-Barre, PA	1,829,035
Susquehanna Steam Electric Station	2	1984	2044	1,247	BWR	484	-	-	-
Turkey Point Nuclear Plant	3	1972	2052	837	PWR	650	2,400	Miami, FL	3,813,589
Turkey Point Nuclear Plant	4	1973	2053	861	PWR	650	-	-	-
Vogtle Electric Generating Plant	1	1987	2047	1,150	PWR	510	3,169	Augusta, GA	789,654
Vogtle Electric Generating Plant	2	1989	2049	1,152p	PWR	510	-	-	-
Waterford Steam Electric Station	3	1985	2044	1,250	PWR	975	3,000	New Orleans, LA	2,171,180
Watts Bar Nuclear Plant	1	1996	2035	1,123	PWR	410	1,170	Chattanooga, TN	1,312,700
Watts Bar Nuclear Plant	2	2015	2055	1,122	PWR	410	-	-	-
Wolf Creek Generating Station	1	1985	2045	1,166	PWR	500	9,818	Topeka, KS	173,018

BWR = boiling water reactor, gpm = gallon(s) per minute; MWe = megawatts-electric; PWR = pressurized water reactor.

(a) The 2013 LR GEIS (NRC 2013a) included a number of nuclear power plants that are not being considered for license renewal and are not included in this table. They include the following plants:

- Bellefonte: Construction permits issued in 1974. Units 1 & 2 were never finished and mothballed in 1988. Currently under the NRC's Deferred Policy.
- Big Rock: Shutdown in 1997; decommissioning completed in August 2006. Stored spent fuel is still onsite.
- Crystal River Nuclear Power Plant (Crystal River) Unit 3: Shutdown in 2013. Decommissioning completion scheduled for 2026-2030.
- Duane Arnold Energy Center (Duane Arnold): Shutdown in 2020. Decommissioning completion scheduled for 2080.
- Fort Calhoun Station (Fort Calhoun): Shutdown in 2016. Decommissioning completion scheduled for 2026.
- Haddam (Connecticut Yankee): Shutdown in 1996; decommissioned in 2004. Stored spent fuel is still onsite.
- Indian Point Energy Center (Indian Point) Unit 2: Shutdown in 2020; Unit 3: Shutdown in 2021. Decommissioning completion scheduled for 2026 to 2033.
- Kewanee: Shutdown in 2013. Decommissioning completion scheduled for 2073.
- Maine Yankee: Closed in 1997; decommissioned completed in 2005. Stored spent fuel is still onsite.
- Millstone Power Station (Millstone), Unit 1: Shutdown in 1995; Decommissioning completion scheduled for 2056.
- Oyster Creek Nuclear Generating Station (Oyster Creek): Shutdown in 2018. Decommissioning completion scheduled for 2025.
- Pilgrim Nuclear Power Station (Pilgrim): Shutdown in 2019. Decommissioning completion scheduled for 2027.
- Rancho Seco: Shutdown in 1989; decommissioning completed and licensed terminated in 2018. Stored spent fuel is still onsite.
- San Onofre Nuclear Generating Station (San Onofre): Unit 1: Shutdown in 1992; Units 2 & 3: Shutdown in 2013. Decommissioning completion scheduled for 2030-2031.

- Shoreham: Fully decommissioned in 1994; it never produced power.
 - Three Mile Island Unit 1: Shutdown in 2019. Decommissioning completion scheduled for 2079. Unit 2: Shutdown in 1979. Decommissioning completion scheduled for 2037.
 - Trojan: Closed in 1992; decommissioning completed in 2006. Stored spent fuel is still onsite.
 - Vermont Yankee Nuclear Power Station (Vermont Yankee): Shutdown in 2014. Decommissioning completion scheduled for 2026-2030.
 - Yankee Rowe: Shutdown in 1992; decommissioning completed in 2006. Stored spent fuel is still onsite.
 - Zion: Shutdown in 1998, decontamination and dismantlement began in 2011 and is scheduled to be completed by the end of 2022.
- (b) Palisades Nuclear Plant (Palisades): Shutdown in May 2022. Status to be determined. The plant has been retained in this table for the purposes of this LR GEIS update.

No entry has been denoted by “-”.

Sources: Appendix C; NRC 2018f; NRC 2021r; Pacific Northwest National Laboratory calculations based on 2020 decennial census data.

Affected Environment

1 The nuclear fuel used in all LWRs is uranium enriched to 2 to 5 percent in the uranium-235
2 isotope. The fuel is in the form of cylindrical uranium dioxide (UO_2) pellets, which are
3 approximately 0.4 in. (1 centimeter [cm]) in diameter and 0.4 to 0.6 in. (1 to 1.5 cm) in height.
4 The fuel pellets are stacked and sealed inside a hollow cylindrical zirconium alloy fuel rod. The
5 fuel rods, also called fuel pins or fuel elements, are approximately 12 ft (3.6 m) long. They are
6 bundled into fuel assemblies that generally consist of 15×15 or 17×17 rods for PWRs and
7 8×8 or 10×10 rods for BWRs. When new fuel is loaded into the reactors or spent fuel is
8 removed from reactors, the fuel is handled as intact assemblies. Similarly, when spent fuel is
9 stored onsite awaiting shipment offsite, the fuel assemblies remain intact.

10 Fission reactions that occur inside the fuel, primarily by the uranium-235 isotope, are the source
11 of thermal energy in a nuclear reactor. This energy is transferred to the coolant, which is
12 ordinary water, circulating in the primary coolant system in LWRs. The vessel, which encloses
13 the reactor, is part of the primary coolant system.

14 In PWRs, water is heated to a high temperature under pressure inside the reactor vessel
15 (Figure 3.1-2). The water flows in the primary circulation loop to the steam generator. Within
16 the steam generator, water in the secondary circulation loop is converted to steam that drives
17 the turbines. The turbines turn the generator to produce electricity. The steam leaving the
18 turbines is condensed by water in the tertiary loop and returned to the steam generator. The
19 tertiary loop water flows to cooling towers where it is cooled by evaporation, or it is discharged
20 directly to a body of water, such as a river, lake, or other heat sink (see Section 3.1.3). The
21 tertiary loop is open to the atmosphere, but the primary and secondary cooling loops are not.

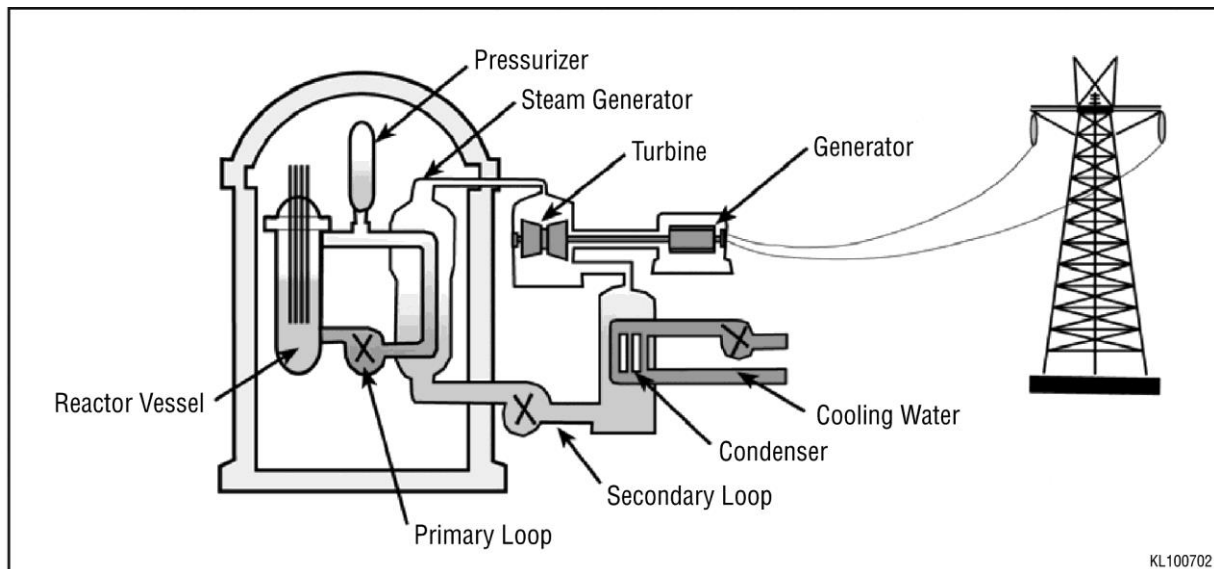

22
23 **Figure 3.1-2 Pressurized Water Reactor. Adapted from NRC 2002c.**

24 BWRs generate steam directly within the reactor vessel (Figure 3.1-3). The steam passes
25 through moisture separators and steam dryers and then flows to the turbines. Because it
26 generates steam directly in the reactor vessel, the power generation system contains only two
27 heat transfer loops. The primary loop transports the steam from the reactor vessel directly to
28 the turbines, which generate electricity. The secondary coolant loop removes excess heat from
29 the primary loop in the condenser. From the condenser, the primary condensate proceeds into
30 the feedwater stage, and the secondary coolant loop removes the excess heat and discharges it

1 to the receiving water body. As is the case for PWRs, the coolant water from the condenser is
 2 pumped to cooling towers or it is discharged directly to a water body.

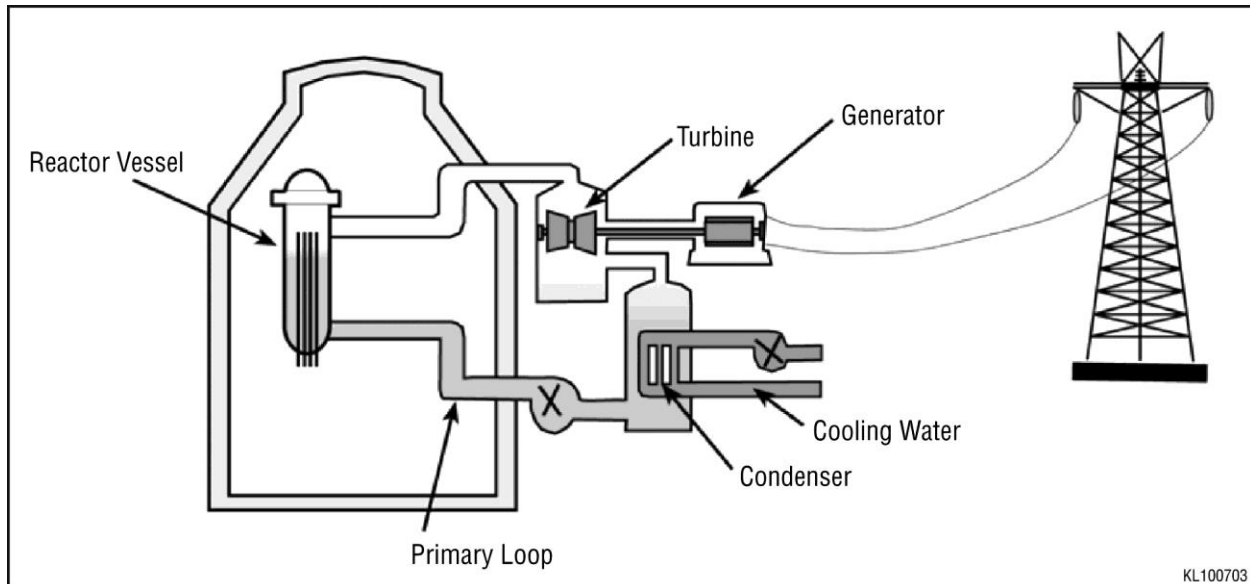

3
 4 **Figure 3.1-3 Boiling Water Reactor. Adapted from NRC 2002c.**

5 **3.1.3 Cooling Water Systems**

6 In LWR designs, water is used to remove excess heat generated in reactor systems. The
 7 volume of water required and rate of flow is a function of several factors, including the licensed
 8 thermal power level of the reactor and the increase in cooling water temperature from the intake
 9 to the discharge. In general, larger nuclear power plants (i.e., more reactor units and/or higher
 10 licensed power levels) generate more waste heat and require more water for cooling.

11 Table 3.1-2 through Table 3.1-4 describe the configurations of the cooling systems used at
 12 existing nuclear power plant sites. There are two major types of cooling systems: once-through
 13 and closed-cycle. Once-through cooling systems withdraw water for condenser cooling from a
 14 nearby water body, such as a lake or river, circulate it through the condenser tubes, and return
 15 that water as heated effluent to the same water body (Figure 3.1-4a).

16 Average water withdrawal for nuclear power plants using once-through cooling is about
 17 39,000 gal/MWh (148 m³/MWh) of electricity generated (USGS 2019b). For comparison, using
 18 the dataset described by Marston et al. (2018) for operating nuclear power plants, most plants
 19 using once-through cooling withdraw between 28,000 and 52,000 gal/MWh (106 to
 20 197 m³/MWh) of water. In a once-through cooling system, waste heat is dissipated to the
 21 atmosphere mainly through evaporation, mixing with ambient water from the source water body,
 22 and, to a much smaller extent, by conduction, convection, and thermal radiation loss. Average
 23 consumptive water use for nuclear power plants using once-through cooling is about
 24 400 gal/MWh (1.51 m³/MWh) (USGS 2019b), with most plants estimated to consume between
 25 290 and 570 gal/MWh (1.1 to 2.2 m³/MWh) of water during electricity generation (based on the
 26 dataset described by Marston et al. [2018]).

1 **Table 3.1-2 Cooling Water System Source – Coastal or Estuarine Environment**

Nuclear Power Plant	State	Cooling System	Cooling Water Source
Diablo Canyon	California	Once-through	Pacific Ocean
Millstone	Connecticut	Once-through	Long Island Sound
St. Lucie	Florida	Once-through	Atlantic Ocean
Turkey Point	Florida	Cooling canal	Biscayne Bay; Upper Floridan Aquifer (supplemental source)
Calvert Cliffs	Maryland	Once-through	Chesapeake Bay
Seabrook	New Hampshire	Once-through	Gulf of Maine
Hope Creek	New Jersey	Natural draft cooling towers	Delaware River
Salem	New Jersey	Once-through	Delaware River
Brunswick	North Carolina	Once-through	Cape Fear River
South Texas	Texas	Cooling pond	Colorado River
Surry	Virginia	Once-through	James River

2 **Table 3.1-3 Cooling Water System Source – Great Lakes Environment**

Nuclear Power Plant	State	Cooling System	Cooling Water Source
D.C. Cook	Michigan	Once-through	Lake Michigan
Fermi	Michigan	Natural draft cooling towers	Lake Erie
Palisades ^(a)	Michigan	Mechanical draft cooling towers	Lake Michigan
FitzPatrick	New York	Once-through	Lake Ontario
Ginna	New York	Once-through	Lake Ontario
Nine Mile Point	New York	Unit 1: Once-through Unit 2: Natural draft cooling towers	Lake Ontario
Davis-Besse	Ohio	Natural draft cooling towers	Lake Erie
Perry	Ohio	Natural draft cooling towers	Lake Erie
Point Beach	Wisconsin	Once-through	Lake Michigan

3 (a) Palisades shutdown in May 2022 but has been retained in this LR GEIS update.

1 **Table 3.1-4 Cooling Water System Source – Freshwater Riverine or Impoundment**
 2 **Environment**

Nuclear Power Plant	State	Cooling System	Cooling Water Source
Browns Ferry	Alabama	Once-through (helper towers)	Wheeler Reservoir
Farley	Alabama	Mechanical draft cooling towers	Chattahoochee River
Palo Verde	Arizona	Mechanical draft cooling towers	Phoenix Wastewater Treatment Plant Effluent
Arkansas	Arkansas	Unit 1: once-through Unit 2: natural draft cooling towers	Lake Dardanelle
Hatch	Georgia	Mechanical draft cooling towers	Altamaha River
Vogtle	Georgia	Natural draft cooling towers	Savannah River
Braidwood	Illinois	Cooling pond	Kankakee River
Byron	Illinois	Natural draft cooling towers	Rock River
Clinton	Illinois	Once-through (cooling pond)	Salt Creek
Dresden	Illinois	Cooling pond and optional mechanical draft cooling tower or once-through including residence time in pond and optional cooling towers	Kankakee River
LaSalle	Illinois	Cooling pond	Illinois River
Quad Cities	Illinois	Once-through	Mississippi River
Wolf Creek	Kansas	Cooling pond	Coffey County Lake
River Bend	Louisiana	Mechanical draft cooling towers	Mississippi River
Waterford	Louisiana	Once-through	Mississippi River
Monticello	Minnesota	Once-through and mechanical draft cooling towers	Mississippi River
Prairie Island	Minnesota	Once-through and mechanical draft cooling towers	Mississippi River
Grand Gulf	Mississippi	Natural draft cooling towers	Mississippi River
Callaway	Missouri	Natural draft cooling towers	Missouri River
Cooper	Nebraska	Once-through	Missouri River
Harris	North Carolina	Natural draft cooling towers	Harris Reservoir
McGuire	North Carolina	Once-through	Lake Norman
Beaver Valley	Pennsylvania	Natural draft cooling towers	Ohio River
Limerick	Pennsylvania	Natural draft cooling towers	Schuylkill River
Peach Bottom	Pennsylvania	Unit 2: Once-through Unit 3: Once-through (mechanical draft cooling towers)	Conowingo Pond
Susquehanna	Pennsylvania	Natural draft cooling towers	Susquehanna River

Nuclear Power Plant	State	Cooling System	Cooling Water Source
Catawba	South Carolina	Mechanical draft cooling towers	Lake Wylie
Oconee	South Carolina	Once-through	Lake Keowee
H.B. Robinson	South Carolina	Once-through (Cooling pond)	Lake Robinson
Summer	South Carolina	Cooling pond	Monticello Reservoir
Sequoyah	Tennessee	Once-through and natural draft cooling towers	Chickamauga Lake
Watts Bar	Tennessee	Natural draft cooling towers	Chickamauga Lake
Comanche Peak	Texas	Once-through	Squaw Creek Reservoir
North Anna	Virginia	Once-through	Lake Anna
Columbia	Washington	Mechanical draft cooling towers	Columbia River

1 Closed-cycle cooling systems typically use recirculated water from cooling towers to cool the
 2 condenser. Some nuclear power plants use cooling ponds, lakes, reservoirs, or canals
 3 (Figure 3.1-4b) that often function as closed-cycle systems. The average water withdrawal for
 4 nuclear power plants using closed-cycle cooling is 480 gal/MWh (1.82 m³/MWh) for cooling
 5 ponds or lakes and 700 gal/MWh (2.65 m³/MWh) for cooling towers (USGS 2019b). Because
 6 the predominant cooling mechanism associated with closed-cycle systems is evaporation, much
 7 of the water used for cooling is consumed and is not returned to the water source. The average
 8 consumptive water use for nuclear power plants using cooling towers is 500 gal/MWh (1.9
 9 m³/MWh) (USGS 2019b). Based on the dataset described by Marston et al. (2018),
 10 consumptive water use for most nuclear power plants using closed-cycle cooling ranges
 11 between 450 and 750 gal/MWh (1.7 to 2.8 m³/MWh). Makeup water to account for these
 12 losses, as well as blowdown (water that is periodically rinsed from the cooling system to remove
 13 impurities and sediment that may degrade performance) is typically withdrawn from and
 14 released to a surface water body near the site.

15 Several nuclear plants use hybrid cooling systems that may be used in different configurations
 16 at different times of the year (Figure 3.1-4c). For instance, some once-through cooling system
 17 plants also operate cooling towers (sometimes referred to as “helper towers”) seasonally to
 18 reduce thermal load to the receiving water body, reduce entrainment during peak spawning
 19 periods, or reduce consumptive water use during periods of low river flow. The Peach Bottom
 20 Atomic Power Station (Peach Bottom) (NRC 2003b, NRC 2020g) has helper mechanical draft
 21 cooling towers that can process up to 60 percent of the plant’s heated effluent, while the
 22 remaining effluent is discharged as part of the once-through system. The Monticello Nuclear
 23 Generating Plant (Monticello) (NRC 2006c) uses once-through cooling in the winter but has
 24 mechanical draft cooling towers for closed-cycle cooling in the summer. The Dresden Nuclear
 25 Power Station (Dresden) (NRC 2004c) is similar in that it relies on a cooling pond system in the
 26 fall, winter, and spring, but in the summer, the plant operates as a once-through system that
 27 uses the cooling pond and helper mechanical draft cooling towers to reduce effluent
 28 temperatures before releasing the water to the Kankakee River (see Table 3.1-4). The Browns
 29 Ferry Nuclear Plant (Browns Ferry) (NRC 2005b) uses mechanical draft cooling towers in helper
 30 mode in accordance with conditions in its National Pollutant Discharge Elimination System
 31 (NPDES) permit to limit thermal impacts on Wheeler Reservoir.

1 All existing sites with two or three reactor units use the same cooling system for all units, except
2 for two sites: the Arkansas Nuclear One (Arkansas) plant in Arkansas and Nine Mile Point
3 Nuclear Station (Nine Mile Point) in New York. These two sites use once-through cooling for
4 one unit and closed-cycle cooling for the other. The configuration of each nuclear power plant
5 intake and discharge structure varies to accommodate the source water body and to minimize
6 impacts on the hydrologic environment and aquatic ecosystem. Intake structures generally are
7 located along the shoreline of the source water body. Most are equipped with devices that
8 reduce impingement and entrainment of fish and other aquatic organisms. Some include fish
9 return systems that return impinged organisms to the source water body. Discharge structures
10 usually consist of pipes or canals that terminate in discharge jets or diffusers that promote rapid
11 mixing of the effluent with the receiving body of water. Discharge of condenser cooling water
12 (once-through systems) and blowdown water (closed-cycle systems) containing biocides and
13 other chemicals used for corrosion control and other water treatment purposes are authorized
14 by the Environmental Protection Agency (EPA), or authorized States and Tribes, under NPDES
15 permits, which establish limits, as necessary, based on flow rates, chemical concentrations, and
16 thermal criteria.

17 In addition to heat removal, nuclear power plants require cooling water for service water and
18 auxiliary cooling water systems. Service water is special-purpose water that may not be treated
19 for use. The auxiliary cooling water system typically includes the emergency core cooling
20 system, the containment spray and cooling system, the emergency feedwater system, the
21 component cooling water system, and the spent fuel pool water system. The volume of water
22 required for these systems is usually less than 15 percent of the volume required for condenser
23 cooling in once-through cooling systems. In closed-cycle cooling systems, the additional water
24 needed for service water and auxiliary purposes is usually less than 5 percent of that needed for
25 condenser cooling (NRC 1996).

26 In addition to surface water sources, some nuclear power plants use groundwater as a source
27 for service, makeup, or potable water. The Grand Gulf Nuclear Station (Grand Gulf) uses
28 groundwater as a source of makeup water to the condenser cooling system. This plant employs
29 a radial collector well system (i.e., also known as Ranney[®] wells) to draw groundwater from the
30 Mississippi River Alluvial aquifer (NRC 2014e). The Turkey Point Nuclear Plant (Turkey Point)
31 also draws groundwater from the Upper Floridan Aquifer as a supplemental source of makeup
32 water to the cooling canal system (CCS). These withdrawals primarily address salinity levels in
33 the system and are part of a State-mandated mitigation program to restore salinity to a level
34 similar to that of nearby surface waters (i.e., Biscayne Bay) (NRC 2019c).

35 **3.1.4 Radioactive Waste Management Systems**

36 During the fission process, a large inventory of radioactive fission products builds up within the
37 fuel. Virtually all of the fission products are contained within the fuel pellets. The fuel pellets are
38 enclosed in hollow metal rods (cladding), which are hermetically sealed to further prevent the
39 release of fission products. However, a small fraction of the fission products escape from the
40 fuel rods and contaminate the reactor coolant. The primary system coolant also has radioactive
41 contaminants as a result of neutron activation. The radioactivity in the reactor coolant is the
42 source of liquid, gaseous, and most of the solid radioactive wastes at LWRs. The following
43 sections describe the basic design and operation of PWR and BWR radioactive waste treatment
44 systems.

1 3.1.4.1 *Liquid Radioactive Waste*

2 Radionuclide contaminants in the primary coolant are the source of liquid radioactive waste in
 3 LWRs. The specific sources of these wastes, their associated modes of collection and
 4 treatment, and the types and quantities of liquid radioactive wastes released to the environment
 5 are similar in many respects in BWRs and PWRs. Accordingly, the following discussion applies
 6 to both BWRs and PWRs; distinctions are made only when important differences exist.

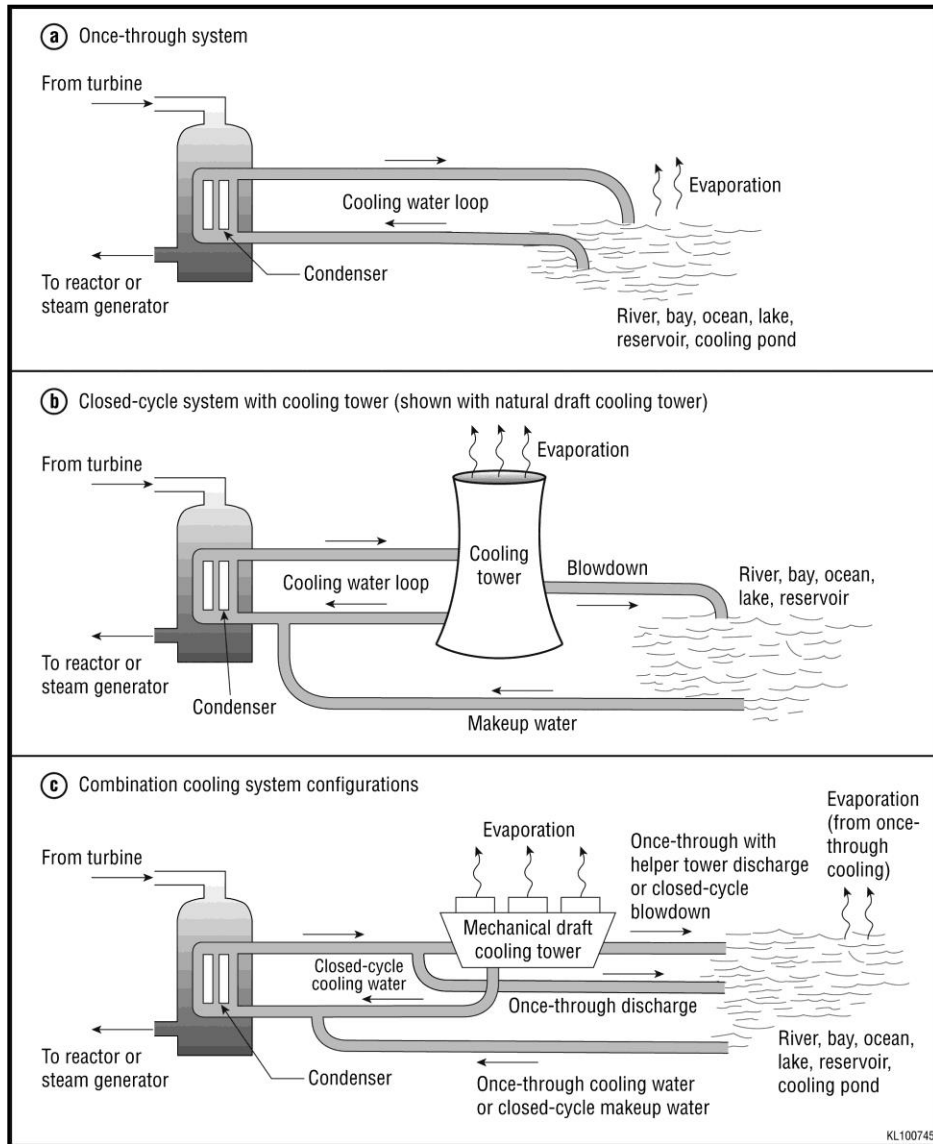

7
 8 **Figure 3.1-4 Schematic Diagrams of Nuclear Power Plant Cooling Systems. Source:**
 9 **NRC 2013a.**

10 Liquid wastes resulting from LWR operation may be placed into the following categories: clean
 11 wastes, dirty wastes, detergent wastes, turbine building floor-drain water, and steam generator
 12 blowdown (PWRs only). Clean wastes include all liquid wastes with normally low conductivity
 13 and variable radioactivity. They consist of reactor-grade water, which is amenable to
 14 processing for reuse as reactor coolant makeup water. Clean wastes are collected from

1 equipment leaks and drains, certain valve and pump seal leaks, and other aerated leakage
2 sources. Dirty wastes include all liquid wastes with moderate chemical (ionic) conductivity and
3 variable radioactivity that, after processing, may be used as reactor coolant makeup water.
4 Dirty wastes consist of liquid wastes collected in the containment building sump, auxiliary
5 building sumps and drains, laboratory drains, sample station drains, and other floor drains.
6 Detergent wastes consist principally of laundry wastes and personnel and equipment
7 decontamination wastes and normally have low radioactivity. Turbine building floor-drain
8 wastes usually have high conductivity and a low radionuclide content. In PWRs, steam
9 generator blowdown can have relatively high concentrations of radionuclides, depending on the
10 amount of primary-to-secondary leakage. After processing, the water may be reused or
11 discharged.

12 Each of these sources of liquid wastes receives varying degrees and types of treatment before
13 being stored for reuse or discharged to the environment in accordance with applicable
14 regulatory requirements and permit provisions (e.g., NPDES permit). The extent and types of
15 treatment depend on the chemical content of the waste; to increase the efficiency of waste
16 processing, wastes with similar characteristics are batched before treatment.

17 Controls for limiting the release of radiological liquid effluents at each nuclear power plant are
18 described in the facility's Offsite Dose Calculation Manual (ODCM). Controls are based on
19 (1) concentrations of radioactive materials in liquid effluents and (2) dose to a member of the
20 public. Concentrations of radioactive material that are allowed to be released in liquid effluents
21 to unrestricted areas are limited to the concentration specified in 10 *Code of Federal*
22 *Regulations* (CFR) Part 20, Appendix B, Table 2.

23 The degree and effectiveness of processing, storing, and recycling of liquid radioactive waste
24 has steadily increased among operating plants. For example, extensive recycling of steam
25 generator blowdown in PWRs is now the typical mode of operation, and secondary side
26 wastewater is routinely treated. In addition, the plant systems that process wastes are often
27 augmented by commercial mobile processing systems. As a result, radionuclide releases in
28 liquid effluent from LWRs have generally declined for most plants or remained the same over
29 time.

30 3.1.4.2 Gaseous Radioactive Waste

31 The gaseous waste management system collects fission products, mainly noble gases, which
32 accumulate in the primary coolant. A small portion of the primary coolant flow is continually
33 diverted to the primary coolant purification, volume, and chemical control system to remove
34 contaminants and adjust the coolant chemistry and volume. During this process,
35 noncondensable gases are stripped and routed to the gaseous waste management system,
36 which consists of a series of gas storage tanks. The storage tanks allow the short-half-life
37 radioactive gases to decay, leaving only relatively small quantities of long-half-life radionuclides
38 to be released to the atmosphere. Some LWRs may use charcoal delay systems rather than
39 gas storage tanks.

40 For BWRs, the sources of routine radioactive gaseous emissions to the atmosphere are the air
41 ejector, which removes noncondensable gases from the coolant to improve power conversion
42 efficiency, and gaseous and vapor leakages, which, after monitoring and filtering, are
43 discharged to the atmosphere via the building ventilation systems.

Affected Environment

1 PWRs have three primary sources of gaseous radioactive emissions: (1) discharges from the
2 gaseous waste management system; (2) discharges associated with the exhaust of
3 noncondensable gases at the main condenser if a primary-to-secondary system leak exists; and
4 (3) radioactive gaseous discharges from the building ventilation exhaust, including the reactor
5 building, reactor auxiliary building, and fuel-handling building.

6 The quantities of gaseous effluents released from operating plants are controlled by the
7 administrative limits that are defined in the ODCM, which is specific for each nuclear power
8 plant. Controls are based on (1) the rate at which the gaseous effluent is released and (2) dose
9 to a member of the public. The limits in the ODCM are designed to provide reasonable
10 assurance that radioactive materials discharged in gaseous effluents are not in excess of the
11 limits specified in 10 CFR Part 20, Appendix B, thereby limiting the exposure of a member of the
12 public in an unrestricted area.

13 3.1.4.3 *Solid Radioactive Waste*

14 Solid low-level radioactive waste (LLW) from nuclear power plants is generated from the
15 removal of radionuclides from liquid waste streams, filtration of airborne gaseous emissions,
16 and removal of contaminated material from various reactor areas. Liquid contaminated with
17 radionuclides comes from primary and secondary coolant systems, spent fuel pools,
18 decontaminated wastewater, and laboratory operations.

19 Solid waste is packaged in containers to meet the applicable requirements of 49 CFR Parts 171
20 through 177. Disposal and transportation are performed in accordance with the applicable
21 requirements of 10 CFR Part 61 and 10 CFR Part 71, respectively.

22 Solid radioactive waste generated during operations is shipped to a LLW processor or directly to
23 a LLW disposal site. Volume reduction may occur both onsite and offsite. The most common
24 onsite volume reduction techniques are high-pressure compacting in waste drums, dewatering
25 and evaporating wet wastes, monitoring waste streams to segregate wastes, and sorting.
26 Offsite waste management vendors compact wastes at ultra-high pressures, incinerate dry
27 active waste, separate and incinerate oily and organic wastes, and concrete-solidify resins and
28 sludges before the waste is sent to a LLW disposal site.

29 Spent fuel contains fission products and actinides produced when nuclear fuel is irradiated in
30 reactors, as well as any unburned, unfissioned nuclear fuel remaining after the fuel rods have
31 been removed from the reactor core. In the United States, the spent fuel is considered waste
32 and is being stored at the reactor sites, either in spent fuel pools or dry storage facilities, called
33 ISFSIs (see Section 3.11.1.2). While all spent fuel is currently stored at nuclear power plant
34 sites, the NRC has licensed a consolidated interim storage facility ISFSI in Andrews, Texas
35 (NRC 2021h), and has another application under review. Consolidated interim storage facilities
36 are licensed under 10 CFR Part 72 and provide an option for away-from-reactor spent fuel
37 storage.

38 Mixed wastes, which contain both radioactive and hazardous components, are generally
39 accumulated in designated areas onsite and then shipped offsite for treatment and disposal.
40 Mixed wastes are regulated both by the EPA or the State under authority granted by the
41 Resource Conservation and Recovery Act (RCRA; 42 U.S.C. § 6901) and by the NRC or the
42 State under authority granted by the Atomic Energy Act (AEA; 42 U.S.C. § 2011 et seq.) (see
43 Section 3.11.3).

1 3.1.5 Nonradioactive Waste Management Systems

2 Nonradioactive wastes from nuclear power plants include both hazardous and nonhazardous
3 wastes. Hazardous wastes, as defined by RCRA Subtitle C, may include organic materials,
4 heavy metals, solvents, paints, cutting fluids, and lubricating oils that have been used at a
5 nuclear power plant and, after use, have been declared to be waste. These wastes are
6 generally accumulated in designated areas onsite and then shipped offsite for treatment and
7 disposal. Certain hazardous waste streams may receive treatment at some sites. For example,
8 waste oil is incinerated at some sites. Common treatment methods for these nonradioactive
9 wastes include incineration, neutralization, biological treatment, and removal and recovery. All
10 activities related to hazardous wastes—including storage, treatment, shipment, and disposal—
11 are conducted pursuant to the regulations issued by the EPA or the State, if authorized, under
12 RCRA (see Section 3.11.2).

13 There are also some routine or nonroutine releases from nuclear power plants that may have
14 hazardous components, including boiler blowdown (continual or periodic purging of impurities
15 from plant boilers), water treatment wastes (sludges and high-saline streams whose residues
16 are disposed of as solid waste and biocides), boiler metal cleaning wastes, floor and yard
17 drains, and stormwater runoff. With the exception of solid water treatment wastes, these
18 releases would be regulated in accordance with each plant's NPDES permit. Principal chemical
19 and biocide waste sources include the following:

- 20 • Boric acid used to control reactor power and lithium hydroxide used to control pH in the
21 coolant. These chemicals could be inadvertently released because of pipe or steam
22 generator leakage.
- 23 • Sulfuric acid, which is added to the circulating water system to control scale.
- 24 • Hydrazine, which is used for corrosion control. It is released in steam generator blowdown.
- 25 • Sodium hydroxide and sulfuric acid, which are used to regenerate resins. These are
26 discharged after neutralization.
- 27 • Phosphate in cleaning solutions.
- 28 • Biocides (e.g., chlorine and bromine compounds) used for condenser defouling.

29 Other small volumes of wastewater are released from other plant systems depending on the
30 design of each plant. These volumes are discharged from sources such as the service water
31 and auxiliary cooling systems, laboratory and sampling wastes, and metal treatment wastes.
32 These waste streams are regulated and discharged in accordance with each plant's NPDES
33 permit as separate point sources or are combined with the cooling water discharges.

34 Nonradioactive and nonhazardous wastes such as office trash are picked up by a local waste
35 hauler and sent to a local landfill without any treatment. Sanitary wastes are treated at a
36 sewage treatment plant that is located either onsite or offsite. If the treatment plant is offsite,
37 the sanitary waste is either collected in septic tanks, tested for radioactivity as necessary, and
38 sent offsite periodically, or the sanitary waste may be tested for radioactivity and discharged
39 directly to a publicly owned treatment works. Any effluent releases to surface water from onsite
40 sewage plants are subject to NPDES permit limits.

1 **3.1.6 Utility and Transportation Infrastructure**

2 The utility and transportation infrastructure at nuclear power plants typically interfaces with
3 public infrastructure systems available in the region. This infrastructure includes utilities, such
4 as suppliers of electricity, fuel, and water, as well as roads and railroads used to gain access to
5 the sites.

6 *3.1.6.1 Electricity*

7 Nuclear power plants generate electricity for other users and they also use electricity to operate.
8 The amount of electrical power needed to run a 1,000 MWe nuclear power plant is relatively
9 small compared to the amount it generates. Nuclear power plants must have at least two
10 connections to the electrical distribution system to receive power from offsite sources. One
11 serves as a primary source for power and a separate one serves as a backup to run the
12 engineered safety features and emergency equipment in case of a loss of the first source. Each
13 power plant has backup sources (e.g., diesel generators) to supply power if the power plant
14 loses both offsite sources. The backup generators are tested periodically and power the
15 emergency systems automatically in case external sources of electrical power are interrupted.

16 *3.1.6.2 Fuel*

17 An operating 1,000 MWe PWR contains approximately 220,000 lb (100 metric tons [MT]) of
18 nuclear fuel in the form of uranium dioxide (UO₂) at any one time. Only about one-third of that
19 fuel is replaced during every refueling. Assuming that the reactor is refueled once every
20 18 months, the amount of nuclear fuel needed (and spent fuel generated) would be roughly
21 44,000 lb (20 MT) per year. Fresh fuel is brought to the site and stored at the site until it is
22 needed.

23 In addition to nuclear fuel, a nuclear power plant needs a certain amount of diesel fuel to
24 operate the emergency diesel power generators. To meet emergency demands, a certain
25 quantity of diesel fuel is stored onsite in fuel storage tanks. Fuel is also needed for space
26 heating, ventilation, and air conditioning (i.e., HVAC) purposes. Plants use a variety of energy
27 sources for heating, ventilation, and air conditioning, including electricity, natural gas, or fuel oil.
28 Some plants have waste oil incinerators onsite to burn their used oil. The heat generated by
29 such an incinerator is used to heat buildings during winter.

30 *3.1.6.3 Water*

31 Systems designed to provide cooling water at nuclear power plants are described in
32 Section 3.1.3. In addition to needing water for cooling, plants need water for sanitary reasons
33 and for everyday use by the personnel (e.g., drinking, showering, cleaning, laundry, toilets, and
34 eye washes). Because most nuclear power plants are located in more rural areas away from
35 population centers, they are typically not connected to community (public) water systems and
36 need to be self-sufficient in meeting their water needs. Many plants continue to rely on onsite
37 groundwater (e.g., the Palo Verde Nuclear Generating Station [Palo Verde], Limerick
38 Generating Station [Limerick], South Texas Project Electric Generating Station [South Texas],
39 Byron Station [Byron], Braidwood Station [Braidwood], LaSalle County Station [LaSalle], Surry
40 Power Station [Surry], North Anna Power Station [North Anna], and Point Beach Nuclear Plant
41 [Point Beach]) and some on surface water bodies (e.g., nearby rivers and lakes) (e.g., the
42 Columbia Generating Station [Columbia] and Peach Bottom plant) to obtain potable water. An
43 increasing number of plants obtain potable water from public water systems (e.g., the Seabrook

1 Station [Seabrook], Enrico Fermi Atomic Power Plant [Fermi], Sequoyah Nuclear Plant
2 [Sequoyah], Waterford Steam Electric Station [Waterford], River Bend Station [River Bend], and
3 Turkey Point plants).

4 The quantity of water needed for cooling purposes was discussed in Section 3.1.3. The amount
5 of water needed for sanitary reasons is generally much smaller than the amount needed for
6 cooling. After use, the potable water is processed as part of the sanitary wastewater treatment
7 system. As described in Section 3.11.4, sanitary waste is either treated onsite, collected in
8 septic tanks and then shipped offsite to be treated at a local sewage treatment plant, or
9 discharged directly to a publicly owned treatment system.

10 3.1.6.4 *Transportation Systems*

11 All nuclear power plants are served by controlled access roads. In addition to the roads, many
12 of the plants also have railroad connections for moving heavy equipment and other materials.
13 Some of the plants that are located on navigable waters, such as rivers, the Great Lakes, or
14 oceans, have facilities to receive and ship loads on barges.

15 Trucks are the most common mode of transportation for delivering materials to and from the
16 sites. Deliveries are accepted at and shipments are made from designated areas on the sites
17 under controlled conditions and by following established procedures. Workers generally use
18 their personal vehicles to commute to work. Visitors use passenger cars or light pickup trucks
19 to get to and from the sites. Parking areas are available on every site for workers and visitors.
20 There is also a network of roads and sidewalks for vehicles and pedestrians on each site.

21 3.1.6.5 *Power Transmission Systems*

22 Each nuclear power plant is connected to an independent regional electrical power distribution
23 grid. Power transmission systems consist of switching stations (or substations) and the
24 transmission lines that transfer electricity from the nuclear power plant to the regional grid (see
25 Section 3.1.1). Switching stations transfer electrical power from generating sources to
26 transmission lines and regulate the operation of the power system. Transformers in switching
27 stations convert the generated voltage to levels appropriate for the transmission lines based on
28 the rating of the lines. Equipment for regulating system operation includes switches, power
29 circuit breakers, meters, relays, microwave communication equipment, capacitors, and a variety
30 of other electrical equipment. This equipment meters and controls power flow; improves the
31 performance characteristics of the generated power; and protects generating equipment from
32 short circuits, lightning strikes, and switching surges that may occur along the transmission
33 lines. At nuclear power plant sites, switching stations generally occupy areas two to four times
34 as large as areas occupied by the reactor and generator buildings, but they are typically not as
35 visible as other plant structures.

36 Only those transmission lines that connect the nuclear power plant to the first substation where
37 electricity is fed into the regional electric distribution system and power lines that provide power
38 to the plant from the grid are considered within the regulatory scope of initial LR or SLR.

39 The original final environmental statements for the construction and operation of nuclear power
40 plants also evaluated the impacts of constructing and operating transmission lines needed to
41 connect nuclear power plants to the regional electric grid. Since construction, many of these
42 transmission lines have been incorporated into the regional grid. In many cases, these
43 transmission lines are no longer owned or managed by NRC licensees and would remain

1 energized regardless of nuclear power plant license renewal. These transmission lines are
2 outside of the scope of this LR GEIS.

3 **3.1.7 Nuclear Power Plant Operations and Maintenance**

4 Nuclear power reactors are capable of generating electricity continuously for long periods of
5 time. However, they do not operate at maximum capacity or continuously for the entire term of
6 their license. Plants can typically operate continuously for periods of time ranging from 1 year to
7 2 years on a single fuel load.

8 Maintenance activities are routinely performed on systems and components to help ensure the
9 safe and reliable operation of the plant. In addition, inspection, testing, and surveillance
10 activities are conducted throughout the operational life of a nuclear power plant to maintain the
11 current licensing basis of the plant and ensure compliance with Federal, State, and local
12 requirements regarding the environment and public safety.

13 Nuclear power plants must periodically discontinue the production of electricity for refueling,
14 periodic in-service inspection (ISI), and scheduled maintenance. Refueling cycles occur
15 approximately every 12 to 24 months. The duration of a refueling outage is typically about 1 to
16 2 months. These enhanced inspections are performed to comply with NRC and/or industry
17 standards or requirements, such as the American Society of Mechanical Engineers Boiler and
18 Pressure Vessel Code. ISIs are generally scheduled and performed during 10-year intervals as
19 follows: the initial period of operation (the first 40 years) includes the 1st through 4th intervals,
20 an initial period of extended operation (years 40 through 60) would include the 5th and 6th
21 intervals, and a subsequent period of extended operation (years 60 through 80) would include
22 the 7th and 8th intervals, and are subject to the requirements of 10 CFR 50.55(a), "Codes and
23 Standards." For economic reasons and component accessibility, many of these activities are
24 conducted simultaneously (e.g., refueling activities typically coincide with the ISI and
25 maintenance activities).

26 Many plants also undertake various major refurbishment activities during their operational lives.
27 These activities are performed to ensure both that the plant can be operated safely and that the
28 capacity and reliability of the plant remain at acceptable levels. Typical major refurbishments
29 that have occurred in the past include replacing PWR steam generators, reactor vessel heads,
30 BWR recirculation piping, and rebuilding main steam turbine stages. The need to perform major
31 refurbishments is plant-specific and depends on factors such as design features, operational
32 history, and construction and fabrication details. The plants may remain out of service for
33 extended periods of time (e.g., several months) while these major refurbishments are made.
34 Outage durations vary considerably, depending on factors such as the scope of the repairs or
35 modifications undertaken, the effectiveness of the outage planning, and the availability of
36 replacement parts and components.

37 Each nuclear power plant may be part of a regulated utility system that may own several nuclear
38 power plants, fossil fuel-fired plants, or other means of generating electricity for sale in a
39 regulated market. Other nuclear power plants may be non-utility or independent power
40 generators operating to produce and sell electricity at competitive wholesale power rates.
41 An onsite staff is responsible for the actual operation of each plant, and an offsite staff may be
42 headquartered at the plant site or some other location. Typically, 800 to 2,300 people are
43 employed at nuclear power plant sites during periods of normal operation, depending on the
44 number of operating reactors located at a particular site. The permanent onsite workforce is
45 usually in the range of 600 to 800 people per reactor unit. However, during outage periods, the

1 onsite workforce typically increases by 200 to 900 additional workers. The additional workers
2 include engineering support staff, technicians, specialty crafts persons, and laborers called in
3 both to perform specialized repairs, maintenance, tests, and inspections, and to assist the
4 permanent staff with the more routine activities carried out during plant outages.

5 **3.2 Land Use and Visual Resources**

6 **3.2.1 Land Use**

7 Nuclear power plants are located on land zoned for industrial use in large complexes and land
8 area requirements generally are 100 to 125 ac (40 to 50 ha) for the reactor containment
9 building, auxiliary buildings, cooling system structures, administration and training offices, and
10 other facilities (e.g., switchyards, security facilities, and parking lots). Land areas disturbed
11 during construction of the power plant generally have been returned to prior uses or were
12 ecologically restored when construction ended. Land area ranges from 391 ac (158 ha) for the
13 Catawba Nuclear Station (Catawba) in North Carolina to 14,000 ac (5,700 ha) for the Clinton
14 Power Station (Clinton) in Illinois (Table 3.1-1). Almost 58 percent of nuclear power plants
15 encompass 500 to 2,000 ac (200 to 800 ha); 18 nuclear plants range from 500 to 1,000 ac
16 (200 to 400 ha); and an additional 14 encompass 1,000 to 2,000 ac (400 to 800 ha). Larger
17 land areas are often associated with human-made closed-cycle cooling systems that include
18 cooling lagoons, spray canals, reservoirs, artificial lakes, and buffer areas.

19 In addition to generating electricity, other land uses can be found. Some nuclear plant licensees
20 lease land for agricultural and forestry production, nature centers and conservation areas,
21 recreational use, and cemetery and historic site access. Nuclear plants also have land set
22 aside for onsite spent fuel storage facilities.

23 Land cover and land use percentages at each nuclear power plant depend on the total area and
24 amount of land required for electric power generation. Land cover is generally designated
25 within the land use "resource-oriented" classification system, which includes urban or built-up
26 land, agricultural land (e.g., cropland, pasture, orchards, nurseries, fields, and fallow lands),
27 rangeland, forest land, water, wetland (e.g., marshes and swamps), and barren land
28 (e.g., beaches and gravel pits). Land cover designations can also use visually descriptive
29 categories that include open areas (e.g., fields, cemeteries), forested areas, scrub forest,
30 deciduous forest, hardwood forest, beach, wetlands, open water (e.g., ponds, streams, lakes,
31 and canals), natural lands, recreational lands, and parking areas.

32 Land use within transmission line right-of-ways (ROWs) is restricted under easement rights
33 acquired from private landowners or from Federal, State, Tribal, and local governments. Land
34 use within ROWs may differ from adjacent land use. Land within the ROW is managed through
35 a variety of oversight and maintenance procedures so that vegetation growth and building
36 construction do not interfere with power line operation, maintenance, and access. Land use
37 within ROWs is limited to activities that do not endanger line operation and may include
38 recreation, off-road vehicle use, grazing, agricultural cultivation, irrigation, recreation, roads,
39 environmental conservation, and wildlife areas.

40 Land cover within a 5 mi (8 km) radius of operating U.S. nuclear power plants, using the
41 National Land Cover Database (USGS 2019a) classifications, is presented in Table 3.2-1. Land
42 cover types near each nuclear plant site are also presented in Appendix C.

Affected Environment

1 Section 307(c)(3)(A) of the Coastal Zone Management Act of 1972 (16 U.S.C. § 1456 et seq.)
2 requires that license renewal applicants certify that the proposed Federal license renewal in a
3 coastal zone or coastal watershed boundary, as defined by each State participating in the
4 National Coastal Zone Management Program, is consistent with the enforceable policies of that
5 State's Coastal Zone Management Program. States define their coastal zone boundaries by
6 using a variety of parameters, such as the entire State, county or county-equivalent boundaries,
7 political features (e.g., town boundaries), and geographic features (adjacency to tidal waters).
8 Applicants must coordinate with the State agency that manages the State Coastal Zone
9 Management Program to obtain a determination that the proposed nuclear plant license renewal
10 is consistent with their program.

11 **Table 3.2-1 Percent of Land Cover Types within a 5-Mile Radius of Nuclear Power**
12 **Plants**

Land Cover Classes	Overall (%)
Open water (total)	23.5
Undeveloped land (total)	43.1
Barren land	0.3
Forest (deciduous, evergreen, and mixed)	23.5
Wetlands	10.9
Herbaceous	4.2
Shrub/scrub	4.2
Developed land (total)	33.4
Agriculture (cultivated crops and hay/pasture)	22.2
Developed open space	4.5
Low to high intensity developed land	6.7
Total	100

13 Sources: USGS 2019a; Pacific Northwest National Laboratory calculations.

14 3.2.2 Visual Resources

15 Nuclear power plants—particularly those with tall natural draft cooling towers—stand out from
16 the natural background. Power plant structures can be seen from a distance and across a wide
17 area. Cooling towers can also draw attention because of their vapor plumes. These plumes,
18 seen under certain meteorological and seasonal conditions, can extend the viewshed
19 considerably beyond that of the cooling tower and power plant alone. After cooling towers and
20 the containment building, transmission line towers are probably the most frequently observed
21 power plant structure. However, nuclear plant transmission lines are generally indistinguishable
22 from those from other power plants. In addition, nuclear power plant structures are often
23 obscured by topography, other buildings, and vegetation.

24 Most nuclear plants have employed a variety of mitigation measures to decrease the visual
25 intrusion, including cladding and paint colors used to blend in with the surroundings,
26 nonreflective surfaces, and the placement of trees and other landscaping. Federal regulations
27 require that tall structures, including the reactor containment building, cooling towers, stacks,
28 and meteorological towers, be fitted with lights to alert aircraft of their presence. Often these
29 structures can be visible at night from miles away.

30 Because nuclear power plants are frequently located near water bodies, views of the industrial
31 facility and transmission lines intrude into recreational, historic, or scenic areas. Most of the

1 visual impacts from transmission lines are associated with river crossings, wetlands, wildlife
2 sanctuaries, open parks and athletic fields, roads, lakes, cemeteries, and historic battlefields.

3 **3.3 Meteorology, Air Quality, and Noise**

4 **3.3.1 Meteorology and Climatology**

5 The NRC requires that basic meteorological information be available for use in assessing (1) the
6 environmental effects of radiological and nonradiological emissions and effluents resulting from
7 the construction or operation of a nuclear power plant and (2) the benefits of design alternatives.
8 All nuclear power plants in the United States have a required onsite meteorological monitoring
9 program to provide the data needed to determine dispersion conditions in the vicinity of the
10 plant for assessment of safety and environmental factors. These data are used with air
11 dispersion models to assess and protect public health, safety, and property during plant
12 operations (NRC 2007e).

13 The most recent update to NRC Regulatory Guide 1.23, *Meteorological Monitoring Programs for*
14 *Nuclear Power Plants, Revision 1* (NRC 2007e), which covers meteorological monitoring
15 programs for nuclear power plants, provides guidance for onsite meteorological measurements
16 at licensed power reactors. The guidance covers the siting of instruments to provide
17 representative measures at plant sites, the accuracy and range of specified measured
18 parameters, and special considerations for plants located near influences of complex terrain
19 (e.g., coastal areas, hills of significant grade or valleys), among other criteria and specifications.

20 Onsite meteorological conditions at commercial nuclear power plants are monitored at primary
21 fixed meteorological towers with instrumentation at two levels (e.g., 10 and 60 m) and, if
22 necessary, one additional higher level on the tower to better represent dispersion of elevated
23 releases from stacks. A secondary onsite tower is typical at many installations as a backup if
24 primary tower measures fail. Basic meteorological measurements from tower instruments
25 typically include the following: (1) wind speed and direction from at least two levels;
26 (2) temperature for an ambient reading at 33 ft (10 m) and to determine deltas or changes with
27 height; and (3) precipitation, which is typically measured near ground level by the tower base.
28 Supplemental measurements can include moisture at 33 ft (10 m) and, if applicable, incoming
29 solar and net radiation, barometric pressure, soil temperature, and moisture at the top of the
30 cooling tower. Atmospheric stability is determined from temperature differences at the two
31 lowest levels on the tower. If a backup tower is present, measurements include wind speed and
32 direction and horizontal wind direction variation, usually taken at one level.

33 Weather conditions at each of the plants can be quite variable depending on the year, season,
34 time of day, and site-specific conditions, such as whether the site is near coastal zones or
35 located in or near terrain with complex features (e.g., steep slopes, ravines, valleys). These
36 conditions can be generally described by climate zones according to average temperatures.
37 On the basis of temperature alone, there are three major climate zones: polar, temperate, and
38 tropical. Within each of the three major climate zones, there are marine and continental
39 climates. Areas near an ocean or other large body of water have a marine climate. Areas
40 located within a large landmass have a continental climate. Typically, areas with a marine
41 climate receive more precipitation and have a more moderate climate. A continental climate
42 has less precipitation and a greater range in climate. Regional or localized refinements in
43 climate descriptions and assessments can be made by considering other important climate
44 variables and climate-influencing geographic variables, such as precipitation, humidity, surface
45 roughness, proximity to oceans or large lakes, soil moisture, albedo, snow cover, and

Affected Environment

1 associated linkages and feedback mechanisms. Localized microclimates can be defined by
2 considering factors such as urban latent and sensible heat flux and building-generated
3 turbulence. Both national and regional maximum and minimum average annual temperature
4 and precipitation climatologies over the 30 years from 1991 through 2020 are summarized in
5 Section D.2 in Appendix D.

6 The National Climatic Data Center records and archives the occurrence of storms and weather
7 phenomena. The National Climatic Data Center documents this information in a database that
8 dates back to January 1950 (NOAA 2022b). Severe weather events recorded include floods,
9 thunderstorms, hurricanes, and tornadoes. Table 3.3-1 provides the current enhanced Fujita
10 (EF) scale next to the original Fujita (F) scale, adjusted to represent peak winds averaged over
11 3 seconds, which are used to identify a tornado event's intensity. The EF scale (WSEC 2006) is
12 based on the highest wind speed estimated in the tornado path with maximum 3-second
13 average wind gusts within the range specified for each EF intensity level. The range in damage
14 to structures in the EF2 through EF5 range is described as considerable to incredible, and the
15 damage depends highly on the building's structural design.

16 **Table 3.3-1 Fujita Tornado Intensity Scale**

Intensity	Description of Damage	Original Fujita Scale (3-s gust) (mph)	Operational Enhanced Fujita Scale (3-s gust) (mph)
F0/EF0	Light	45 to 78	65 to 85
F1/EF1	Moderate	79 to 117	86 to 110
F2/EF2	Considerable	118 to 161	111 to 135
F3/EF3	Severe	162 to 209	136 to 165
F4/EF4	Devastating	210 to 261	166 to 200
F5/EF5	Incredible	262 to 317	>200

17 F = Fujita scale; EF = enhanced Fujita scale; mph = miles per hour; s = second.
18 Source: WSEC 2006.

19 **3.3.2 Air Quality**

20 Air emissions related to criteria air pollutants and volatile organic compounds (VOCs) (a
21 precursor of ozone) are released to the atmosphere from ancillary non-nuclear facilities at
22 nuclear power plants. These emissions include criteria air pollutants such as particulate matter
23 (PM) with a mean aerodynamic diameter of 10 μm or less (PM_{10}), PM with a mean aerodynamic
24 diameter of 2.5 μm or less ($\text{PM}_{2.5}$), sulfur dioxide (SO_2), nitrogen oxides (NO_x),¹ carbon
25 monoxide (CO), and lead, and VOCs.

26 The EPA has set National Ambient Air Quality Standards (NAAQS) for six criteria pollutants,
27 including SO_2 , nitrogen dioxide (NO_2), CO, ozone, PM_{10} , $\text{PM}_{2.5}$, and lead, as shown in
28 Table 3.3-2. Primary NAAQS specify maximum ambient (outdoor air) concentration levels of
29 the criteria pollutants with the aim of protecting public health. Secondary NAAQS specify
30 maximum concentration levels with the aim of protecting public welfare. The NAAQS specify
31 different averaging times as well as maximum concentrations. Some of the NAAQS for

¹ NO_x is not a criteria pollutant, but emissions are typically reported in terms of NO_x . Nitrogen dioxide (NO_2) is the component of NO_x that is a criteria pollutant, but emissions of NO_2 are not typically reported.

1 averaging times of 24 hours or less allow the standard values to be exceeded a limited number
 2 of times per year, and others specify other procedures for determining compliance. States can
 3 have their own State Ambient Air Quality Standards. State Ambient Air Quality Standards must
 4 be at least as stringent as the NAAQS and can include standards for additional pollutants. If a
 5 State has no standard corresponding to one of the NAAQS, the NAAQS apply.

6 An area where criteria air pollutants exceed NAAQS levels is called a nonattainment area.
 7 Previous nonattainment areas where air quality has improved to meet the NAAQS are
 8 redesignated maintenance areas and are subject to an air quality maintenance plan.

9 The currently designated nonattainment areas (as of February 2020)² for each criteria air
 10 pollutant (8-hour ozone, PM₁₀, PM_{2.5}, SO₂, NO₂, CO, and lead) and their relative locations with
 11 respect to operating nuclear power plants are shown on the map in Figure 3.3-1. There are
 12 currently more than 30 operating plants located within or adjacent to counties with designated
 13 nonattainment areas. There are no nonattainment areas designated for CO or NO₂.

14 **Table 3.3-2 National Ambient Air Quality Standards for Six Criteria Pollutants^(a)**

Pollutant	Averaging Time	NAAQS Value ^(b)	NAAQS Type ^(c)
SO ₂	1-hour	75 ppb	P
SO ₂	3-hour	0.5 ppm	S
NO ₂	1-hour	100 ppb	P
NO ₂	Annual	0.053 ppm (53 ppb)	P, S
CO	1-hour	35 ppm	P
CO	8-hour	9 ppm	P
O ₃	8-hour	0.070 ppm	P, S
PM ₁₀	24-hour	150 µg/m ³	P, S
PM _{2.5}	24-hour	35 µg/m ³	P, S
PM _{2.5}	Annual	15 µg/m ³	S
PM _{2.5}	Annual	12 µg/m ³	P
Pb	Rolling 3-month	0.15 µg/m ³	P, S

15 (a) CO = carbon monoxide; NAAQS = National Ambient Air Quality Standards; NO₂ = nitrogen dioxide; O₃ = ozone;
 16 Pb =lead; PM_{2.5} = particulate matter ≤ 2.5 µm; PM₁₀ = particulate matter ≤ 10 µm; and SO₂ = sulfur dioxide.

17 (b) Refer to 40 CFR Part 50 or EPA 2022f for detailed information about attainment determination and reference
 18 method for monitoring.

19 (c) P = Primary standard whose limits were set to protect public health; S = secondary standard whose limits were
 20 set to protect public welfare.

21 Source: EPA 2022f.

22

² Nonattainment area designations are ever-changing and redesignations may occur due to EPA's revisions for PM₁₀ and PM_{2.5} (effective March 18, 2013), 8-hour ozone (effective October 26, 2015), Pb (effective January 12, 2009), 1-hour SO₂ (effective August 23, 2010), and 1-hour NO₂ (effective April 12, 2010). Please refer to the latest EPA Green Book for the most updated nonattainment and maintenance area designations (Available URL: <http://www.epa.gov/green-book/>).

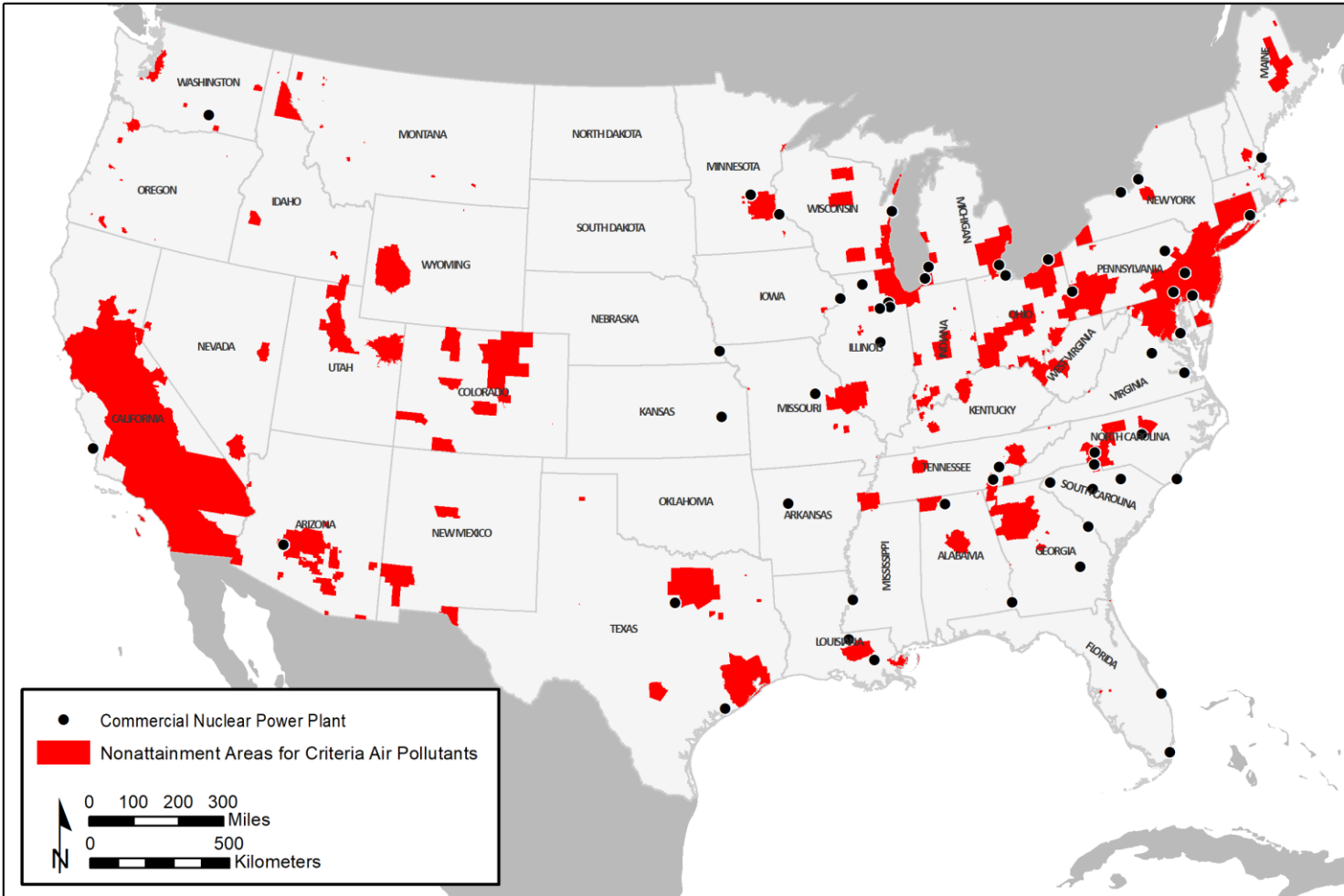

Figure 3.3-1 Locations of Operating Nuclear Plants Relative to EPA-Nonattainment Areas, as of August 30, 2011. Adapted from EPA 2022e. Revoked 1-hour (1979) and 8-hour (1997) ozone are excluded.

1 Sources at nuclear power plants that contribute to criteria air pollutants include backup diesel
2 generators, boilers, fire pump engines, and cooling towers. The emissions from these sources
3 (and, if applicable, emissions from the incineration of any waste products) must comply with
4 State and local regulatory air quality permitting requirements. Because nuclear power plant
5 ancillary facilities are generally low emitters of criteria air pollutants and VOCs, the impact on
6 potential ambient air quality is minimal. However, special permit conditions may be applicable
7 under various regulatory jurisdictions for facilities located in EPA designated nonattainment
8 areas.

9 The operation of wet cooling towers results in the emission of salt and other inorganic and/or
10 organic particles to the air. These releases are called drift emissions. Salt is the dominant drift
11 component—being typically greater than 70 percent of the total suspended PM released—for
12 coastal nuclear plants with wet towers that use seawater as the coolant. Drift emissions from
13 cooling towers are also associated with deposits on downwind surfaces (e.g., vegetation,
14 automobiles, and structures), known as drift deposition, and a resulting increase in downwind
15 PM concentrations. The magnitude and pattern of these impacts could include both near-field
16 and far-field receptors. The degree of impacts would depend on a number of factors, such as
17 the size of the particles, the steam condenser flow rate or throughput, and the type and height of
18 the cooling tower.

19 Cooling tower particulate emissions are formed entirely as secondary particles from evaporation
20 of wet tower drift droplet releases to the atmosphere. Because the drift droplets generally
21 contain the same chemical impurities (primarily dissolved solids) as those in the cooling water
22 circulating through the tower, these impurities wind up in the drift that escapes the tower. Large
23 drift droplets settle out of the tower's exhaust air stream and are deposited on surfaces near the
24 tower. This process can lead to wetting, icing, and salt deposition and can cause related
25 problems, such as damage to equipment or vegetation. Other drift droplets may evaporate and
26 form mixed chemical particles from water-soluble materials (total dissolved solids or TDS), such
27 as sea salt, and water-insoluble (total suspended solids) droplet-encapsulated particles
28 (Pruppacher and Klett 1980) that are transported in the air as suspended PM before being
29 deposited on surfaces downwind. Both PM₁₀ and PM_{2.5} are generated when the drift droplets
30 evaporate and leave fine PM formed by the crystallization of dissolved solids. Dissolved solids
31 found in cooling tower drift can consist of salt compounds (e.g., sodium chloride, sodium nitrate,
32 ammonium sulfate [(NH₄)₂SO₄] and other mineral matter, corrosion inhibitors, and biocides.

33 The magnitude of drift-related PM₁₀ and PM_{2.5} emissions from wet towers depends on several
34 conditions and parameters, such as the makeup water composition, concentrations of TDS
35 (organic matter, biocides, corrosion inhibitors, sodium chloride), steam condenser flow rate, drift
36 eliminator efficiency, number of cooling towers/cells, and annual hours of operation. In
37 comparison, drift emissions from cooling tower systems using seawater are over 7 times greater
38 than those from systems supplied with freshwater makeup feeds, if everything else is held
39 constant. The Palo Verde plant in Arizona uses makeup water derived from the Phoenix City
40 Sewage Treatment Plant. The associated drift emissions from the six mechanical draft cooling
41 towers at the Palo Verde plant in 2017 were less than 32 and 20 tons for PM₁₀ and PM_{2.5},
42 respectively (MCAQD 2019). These emissions are relatively small and typical for a well-
43 controlled cooling tower using a water supply with low TDS concentration levels. Palo Verde's
44 air permit issued by the Maricopa County Air Quality Department requires that TDS
45 concentration for each cooling tower be limited to 30,000 ppm (MCAQD 2010).

46 There is only one plant, Hope Creek Generating Station (Hope Creek) in New Jersey, that uses
47 high-salinity water (from the Delaware River Estuary) as the reactor coolant in a natural draft

Affected Environment

1 cooling tower. An analysis of drift emissions and air impacts from Hope Creek's natural draft
2 cooling tower was assessed with air quality modeling conducted in support of an extended
3 power uprate from about 3,300 to about 3,800 megawatts-thermal (MWt) (NRC 2008b). The
4 analysis showed that the uprate would increase the particulate cooling tower drift emissions
5 from the current rate of 29.4 lb/hr (13.3 kg/hr) to an average rate of 35.6 lb/hr (16.1 kg/hr, with a
6 maximum of 42.0 lb/hr [19.1 kg/hr]). Particulates (primarily salts) from the cooling tower are
7 primarily PM₁₀. Although smaller suspended drift particles would also likely be generated from
8 evaporation of cooling tower plume droplets, estimates of the size distribution of generated drift
9 particles to determine the PM_{2.5} fraction were not made. The NRC staff determined that the
10 estimated increase in particulate emissions would exceed the New Jersey Department of
11 Environmental Protection's (NJDEP's) regulatory maximum hourly emission limit of 30 lb/hr
12 (13.6 kg/hr) for particulates (NJ Admin. Code 7:27-6). However, the NJDEP's Bureau of
13 Technical Services reviewed the air quality modeling conducted in support of the proposed
14 power uprate and determined that the cooling tower emissions would not exceed the NAAQS for
15 PM₁₀ or New Jersey's Ambient Air Quality Standards for PM₁₀. On the basis of this
16 determination, the NRC staff concluded that there would be no significant particulate emission
17 impacts associated with the Hope Creek plant's cooling tower at the associated higher makeup
18 water throughput necessary to sustain the higher requested plant operating loads (NRC 2008b).
19 On June 13, 2007, NJDEP issued its final Title V air permit for the Hope Creek cooling tower,
20 authorizing a variance to the plant's air operating permit with an hourly emission rate of 42 lb/hr
21 (19.1 kg/hr) (State of New Jersey 2021). In addition, a prevention of significant deterioration
22 (i.e., PSD) applicability determination by the EPA concluded that the requested power uprate
23 would not result in a significant increase in emissions and would not be subject to prevention of
24 significant deterioration review (State of New Jersey 2021). Further regulatory review was not
25 required since the Hope Creek plant is located in an attainment area for PM₁₀.

26 Transmission lines have been associated with the production of minute amounts of ozone and
27 NO_x. These pollutants are associated with corona—the breakdown of air that is very near high-
28 voltage conductors. Corona is a phenomenon associated with all energized transmission lines.
29 Under certain conditions, the localized electric field near an energized conductor can be
30 sufficiently concentrated to produce a tiny electric discharge that can ionize air close to the
31 conductors (EPRI 1982). This partial discharge of electrical energy is called corona discharge,
32 or corona. Corona is most noticeable for higher-voltage lines during rain or fog conditions. In
33 addition to the small quantities of ozone and NO_x that form, other manifestations of corona
34 events include energy loss, interference with radio or television transmission, and ambient noise
35 (see Section 3.3.3). Typically, corona interference with radio and television reception is not a
36 design problem. Interference levels in both fair and rainy weather are extremely low at the
37 ROW edge for 230-kV and lower transmission lines, and they usually meet or exceed the
38 reception guidelines of the Federal Communications Commission. As discussed in the 2013 LR
39 GEIS, through the years, line designs that greatly reduce corona effects have been developed.
40 Because transmission line emissions associated with corona discharge are so small when
41 compared with emissions from other sources of air pollution (e.g., ozone precursors from
42 automobiles, power plants, and large industrial boilers), these emissions are not a regulated
43 source of air pollution in the United States.

44 Airborne radiological releases during normal plant operation and associated doses to downwind
45 populations are discussed in Section 3.9.

1 3.3.3 Noise

2 Noise is unwanted sound that can be generated by many sources. Sound intensity is measured
3 in logarithmic units called decibels (dB). A dB is the ratio of the measured sound pressure level
4 to a reference level equal to a normal person's threshold of hearing. Another characteristic of
5 sound is frequency or pitch. Noise may be comprised of many frequencies, but the human ear
6 does not hear very low or very high frequencies. To represent noise as closely as possible to
7 the noise levels people experience, sounds are measured using a frequency-weighting scheme
8 known as the A-scale. Sound levels measured on this A-scale are given in units of A-weighted
9 decibels (dBA). Levels can become very annoying at 85 dBA. To the human ear, an increase
10 of 3 dBA is barely noticeable and an increase of 10 dBA sounds twice as loud (EPA 1981).

11 Several different terms are commonly used to describe sounds that vary in intensity over time.
12 The equivalent sound intensity level represents the average sound intensity level over a
13 specified interval, often 1 hour. The day-night sound intensity level is a single value calculated
14 from hourly equivalent sound intensity level over a 24-hour period, with the addition of 10 dBA to
15 sound levels from 10 p.m. to 7 a.m. This addition accounts for the greater sensitivity of most
16 people to nighttime noise. Statistical sound level (Ln) is the sound level that is exceeded 'n'
17 percent of the time during a given period. For example, L90, is the sound level exceeded
18 90 percent of the time and is considered the background level.

19 The principal sources of noise from nuclear power plant operations are natural draft and
20 mechanical draft cooling towers, transmission lines, and transformers. Other occasional and
21 intermittent noise sources may include auxiliary equipment (such as pumps to supply cooling
22 water), mainsteam safety valves, corona discharge, firing range, and loudspeakers. In most
23 cases, the sources of noise are far enough away from sensitive receptors outside plant
24 boundaries that the noise is attenuated to nearly ambient levels and is scarcely noticeable.

25 There are no Federal regulations for public exposures to noise. When noise levels are below
26 the levels that result in hearing loss, impacts have been judged primarily in terms of adverse
27 public reactions to noise. The Department of Housing and Urban Development
28 (24 CFR 51.101(a)(8)) uses day-night average sound levels of 55 dBA, recommended by EPA
29 as guidelines or goals for outdoors in residential areas (EPA 1974). However, noise levels are
30 considered acceptable if the day-night average sound level outside a residence is less
31 than 65 dBA.

32 Natural draft and mechanical draft cooling towers emit noise of a broadband nature. Cooling
33 tower noise is generated by fan equipment or falling water. At 164 ft (50 m) distance, noise
34 level for a mechanical draft cooling tower can reach 60 dBA and at 230 ft (70 m) distance the
35 noise level for a natural draft cooling tower can reach 66 dBA (Tetra Tech 2010; Neller and
36 Snow 2003).

37 Transformers emit a humming noise of a specific tonal nature at twice the normal voltage or
38 current cycle (core expansion and contraction twice its 60 hertz [Hz] cycle) with a vibration or
39 noise harmonic of 120 Hz. This is called the fundamental noise frequency. Transformer noise
40 originates almost entirely in the core as a result of the restrictive effects of steel on the
41 generated magnetic field, a phenomenon called magnetostriction, which causes the core and its
42 clamps to vibrate (Ellingson 1979). Since the core is not symmetrical and the magnetic effects
43 do not behave in a simple way, the resultant noise is not pure in tone. This is the noise or
44 vibration produced. The noise radiated by transformers is primarily composed of discrete tones
45 at even harmonics of line frequency (e.g., 120, 240, 360 Hz) when the line frequency is 60 Hz

Affected Environment

1 (Vér and Beranek 2005). Transformer noise is distinct because of its specific low frequencies.
2 The low frequencies are not attenuated with distance and intervening materials as much as
3 higher frequencies are; thus, low frequencies are more noticeable and obtrusive. However, at
4 most sites employing cooling towers, transformer noise is masked by the broadband cooling
5 tower noise. Sound levels from transformers varies depending on the capacity rating.

6 Transmission lines can generate a small amount of sound energy during corona activity. During
7 corona events (see Section 3.3.2), the ionization of the air that surrounds conductors of the
8 high-voltage transmission lines, which is caused by electrostatic fields in these lines, generates
9 impulse corona currents. When the voltage on a particular phase is high enough, a corona
10 burst occurs, and a noise is generated. This noise occurs primarily on the positive power line
11 voltage wave and is referred to as positive corona noise (Maruvada 2000).

12 Although conductors are designed to minimize corona discharges, surface irregularities caused
13 by damage, insects, raindrops, or contamination may locally enhance the electric field strength
14 enough for corona discharges to occur (Cristina et al. 1985). This audible noise from the line
15 can barely be heard in fair weather on higher-voltage lines. During wet weather, water drops
16 collect on the conductor and increase corona activity so that a crackling or humming sound may
17 be heard near the line. This noise is caused by small electrical discharges from the water
18 drops. Measurements from a 765 kV transmission line during rain events found that the
19 average sound levels at 50 ft (15 m) from the transmission line were 54.6 dBA, with sound
20 levels as high as 64 dBA measured (Popeck and Knapp 1981).

21 Cooling tower and transformer noise from existing equipment does not change appreciably
22 during the time when the plant is operating, nor does the crackling sound of transmission lines
23 during storms. Increases or decreases in site noise levels can occur when equipment is
24 upgraded or modified to meet life-cycle maintenance requirements or when the power level is
25 updated.

26 **3.4 Geologic Environment**

27 The geologic environment of a nuclear power plant site encompasses the physiographic or
28 physical setting in which the plant has been constructed and the associated geologic strata and
29 soils that comprise the site. Large-scale geologic hazards are a condition of the geologic
30 environment and include geologic faulting and earthquakes that comprise a site's seismic
31 setting.

32 Nuclear power plants are located in a variety of physiographic provinces, though most nuclear
33 plants are located in the Atlantic Coastal Plain and Central Lowlands provinces. Each
34 physiographic province consists of a regional geologic terrain with a broadly similar structure
35 and character. However, within each province, the local geology may differ significantly from
36 the regional conditions. The geologic setting of each nuclear plant is therefore more a reflection
37 of the local geology rather than the physiographic province in which it is located. Nuclear power
38 plants are located in a wide variety of settings, including uplands along rivers, glaciated till
39 plains, Great Lakes shorelines, and coastal sites. As a result, the geologic strata on which
40 plants have been sited and constructed range from variably textured, interbedded,
41 unconsolidated to semi-consolidated sediments of relatively recent age (i.e., less than
42 11,700 years before present), to thick sequences of sedimentary rock (e.g., sandstone, shale,
43 siltstone) of varying age, to massive crystalline igneous and metamorphic rocks (e.g., granitic
44 and gneissic rocks) as old as Precambrian (i.e., greater than 540 million years before present).
45 All safety-related structures (e.g., seismic Category 1 structures) at nuclear power plants are

1 founded either on competent bedrock, engineered compacted strata, concrete fill, and/or
2 structural backfill in order to make sure that no safety-related facilities are constructed in
3 potentially unstable materials.

4 Soils across a plant site come from the disintegration of parent materials (i.e., bedrock or
5 sediments) and interaction with the atmosphere and biological action, and can develop distinct
6 horizons or layers with varying properties and uses. Soils and subsoils at nuclear plant sites
7 vary in terms of the geotechnical properties relevant to site construction (e.g., shear-strength,
8 shrink-swell potential, cut-slope stability, and erodibility) and the hydraulic properties related to
9 the infiltration of water at the soil surface, the occurrence of groundwater, and the movement of
10 contaminants. Depending on the nuclear plant's location and design, riverbanks or coastlines
11 may need to be protected to prevent erosion, especially at water intake or discharge structures.

12 The soil resources available at each nuclear power plant are site-specific in terms of their
13 potential erodibility and their potential use for agricultural activities and vary spatially on the
14 basis of the distribution of different soil types on the site. Many of the nuclear plants in the
15 Midwest, Great Plains, East, and Southeast (with the exception of plants in Florida) are located
16 in areas with soils that are designated as prime farmland (see Figure 3.4-1). Prime farmland
17 soil has the best combination of physical and chemical characteristics for growing crops and is
18 potentially subject to the Farmland Protection Policy Act of 1981 (FPPA; 7 U.S.C. § 4201
19 et seq.) and its implementing regulations (7 CFR Part 657, 7 CFR Part 658). Other important
20 farmland soils potentially subject to the FPPA include unique farmlands as well as farmlands
21 designated as having statewide or local importance. Farmland subject to FPPA regulation does
22 not have to be currently used for cropland. It can be forest land, pastureland, cropland, or other
23 land, but not water or urban built-up land. Nuclear plants in Florida and in Western States are
24 generally not located near prime or other important farmland. At some nuclear plant sites
25 (e.g., Cooper Nuclear Station [Cooper] and Shearon Harris Nuclear Power Plant [Harris]),
26 undeveloped or restored portions of the nuclear plant site have been leased for agricultural use
27 including timber production. However, some land areas on plant sites may not be available for
28 leasing if they are within a nuclear plant's security zone. Soil survey maps and data are
29 available for most locations in the United States from the U.S. Department of Agriculture Natural
30 Resources Conservation Service (USDA 2019).

31 The geologic resources in the vicinity of each nuclear plant, including rock, mineral, or energy
32 rights and assets, vary with the location and may support extraction industries. These industries
33 may include sand and gravel pit operations or quarrying for crushed stone. In general, there is
34 little if any interaction between plant operations and local extraction industries, although some
35 nuclear plants may purchase materials for landscaping and site construction from local sources.
36 Commercial mining, quarrying, or drilling operations are not allowed within nuclear power plant
37 site boundaries.

38 Another aspect of the geologic environment is the seismic setting. The NRC has well
39 established design criteria and standards that are used as the basis for the construction of all
40 commercial nuclear power plants in the United States. These include ensuring the ability to
41 withstand environmental hazards, such as earthquakes and flooding, without loss of capacity to
42 perform their safety functions. Specifically, the NRC requires that safety-related structures,
43 systems, and components be designed to take into account the most severe natural
44 phenomena historically reported for the site and surrounding area. With regard to earthquakes
45 in particular, existing U.S. nuclear power plants were designed and built to withstand the
46 ground-shaking level considered appropriate for the location, given the possible earthquake
47 sources that may affect the site.

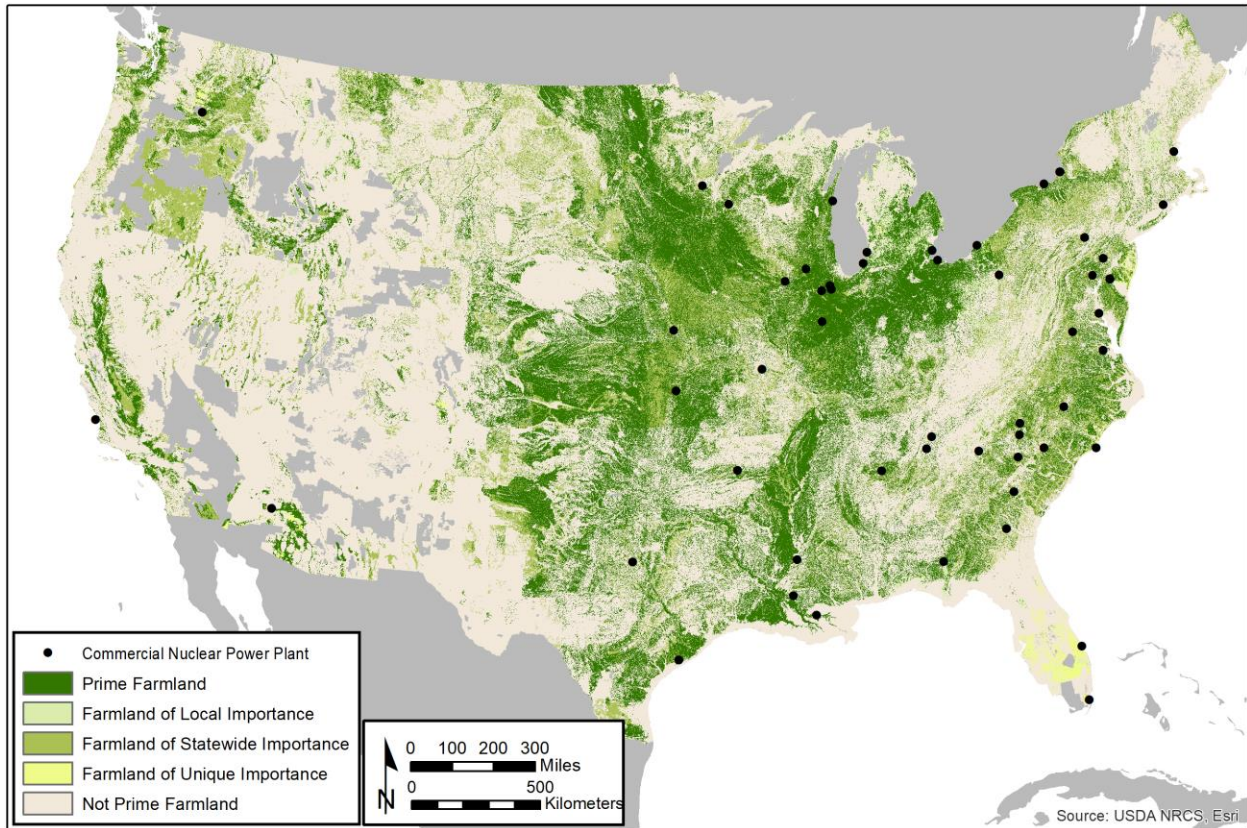

1
2 **Figure 3.4-1 Occurrence of Prime Farmland and Other Farmland of Importance, with**
3 **Nuclear Power Plant Locations Shown. Source: USDA 2021.**

4 U.S. nuclear power plants were originally sited using geologic and seismic criteria set forth in
5 10 CFR 100.10(c)(1) and 10 CFR Part 100, Appendix A and, where applicable, designed and
6 constructed in accordance with 10 CFR Part 50, Appendix A. The regulations require that plant
7 structures, systems, and components important to safety be designed to withstand the effects of
8 natural phenomena, including earthquakes and other natural phenomena, without loss of
9 capability to perform safety functions. Plant-specific design bases for seismic protection are
10 prescribed by a nuclear power plant’s final safety analysis report/updated final safety analysis
11 report and by applicable technical specifications. Detailed investigations of the proposed site
12 and regional geologic environment are required to include an analysis of all historic earthquakes
13 with the potential to affect the nuclear power plant site and power plant operations. Locations
14 for nuclear power plants are also evaluated and characterized for the presence of geologic
15 faults including those considered to be capable of generating earthquakes, predicted
16 earthquake ground motions in order to establish the plant’s safe shutdown earthquake, the
17 potential for the nuclear plant to be exposed to seismically induced floods and water waves, and
18 for the nature and behavior of the surficial geologic materials and subsurface materials and their
19 engineering properties. In addition, spent fuel pools are designed with reinforced concrete so
20 that they may remain operable through the largest historic earthquake that has or is expected to
21 occur in the area.

22 The U.S. Geological Survey regularly updates its seismic hazard mapping products for the
23 United States (see, for example, Rukstales and Petersen 2019; Petersen et al. 2020). Based
24 on the 2018 seismic hazard maps, and as measured in terms of predicted earthquake-produced

1 peak horizontal ground accelerations with a 2 percent probability of exceedance in 50 years
 2 (i.e., corresponding to a return time of about 2,500 years), most nuclear power plants are
 3 located in areas with peak horizontal acceleration less than 30 percent of gravity (0.3 g) (see
 4 Figure 3.4-2). Peak horizontal accelerations are related to earthquake intensity and the
 5 magnitude of shaking (Worden et al. 2020). Plants subject to a peak horizontal acceleration of
 6 0.3 g could experience very strong shaking equivalent to Modified Mercalli Intensity VI, which
 7 indicates damage to buildings of good design would be expected to be negligible (Petersen et
 8 al. 2020; USGS 2021). In California, one operating nuclear power plant, Diablo Canyon Power
 9 Plant (Diablo Canyon), and one plant undergoing decommissioning (San Onofre, shut down in
 10 2012) are in locations with predicted peak ground accelerations greater than 40 percent of
 11 gravity based on the 2018 seismic hazard map. Nuclear power plants, including Diablo Canyon,
 12 were designed to safely withstand the seismic hazards associated with earthquakes with
 13 epicenters at various locations and at various depths, magnitudes, and ground accelerations
 14 (AEC 1973; NRC 2020d).

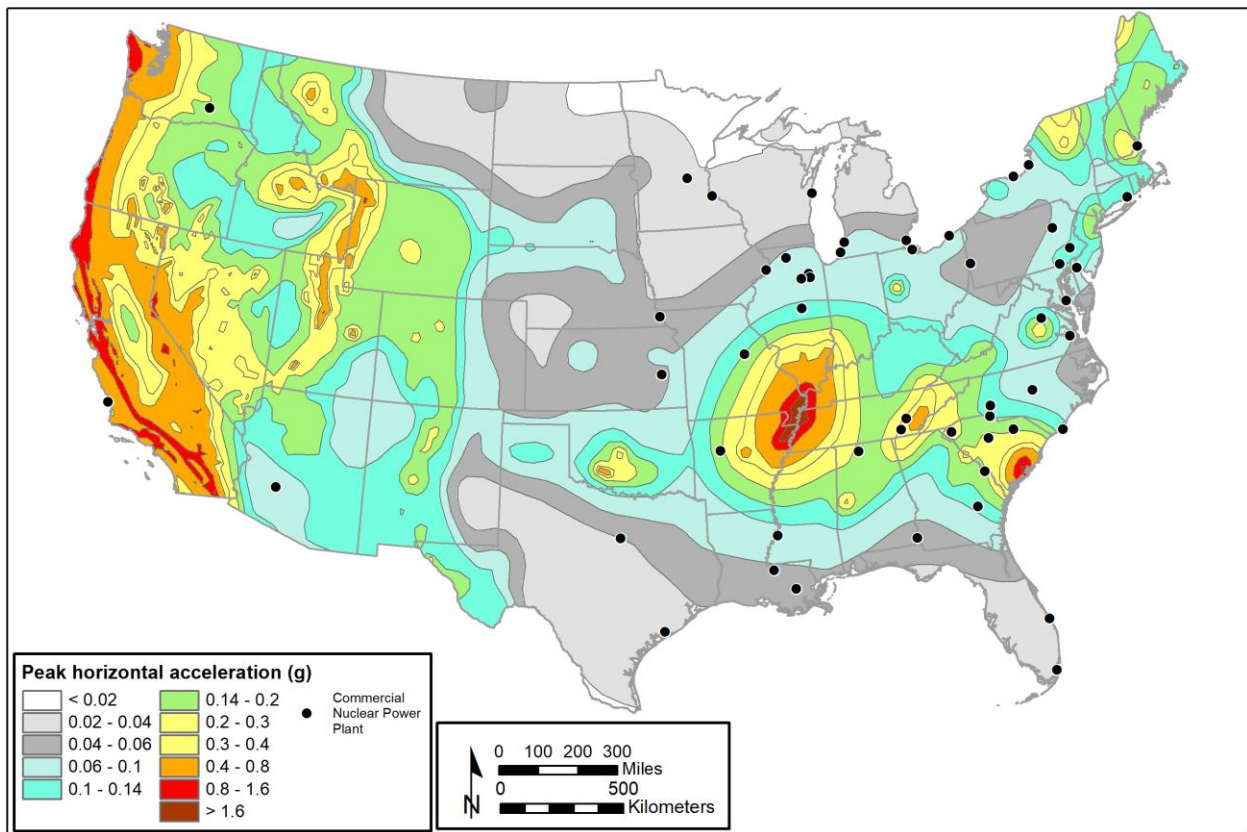

15
 16 **Figure 3.4-2 2018 National Seismic Hazard Model Peak Horizontal Acceleration with a**
 17 **2 Percent Probability of Exceedance in 50 Years (Site Class B/C) with**
 18 **Nuclear Power Plant Locations Shown. Seismic map source: Rukstales**
 19 **and Petersen 2019.**

1 The state of knowledge regarding geologic conditions and seismology and seismic hazards at a
2 specific nuclear power plant site may have changed since construction. Although such
3 discoveries are expected to be rare, new seismological conditions include the identification of
4 previously unknown geologic faults. For example, a strike-slip fault was discovered
5 approximately 1 km (0.6 mi) offshore of the Diablo Canyon Power Plant in 2009 (NRC 2009f).
6 Moreover, the 2011 Tohoku earthquake and the resulting accident at the Fukushima Dai-ichi
7 Nuclear Power Plant in Japan prompted a reevaluation of seismic hazards at U.S. nuclear
8 power plants using present-day NRC requirements and guidance (NRC 2021q).

9 Changes in potential seismic hazards are not within the scope of the NRC's license renewal
10 environmental review, except, where appropriate, during the analysis of severe accident
11 mitigation alternatives, because any such changes would not be the result of continued
12 operation of the nuclear power plant. Seismic design issues are considered during plant-
13 specific safety reviews and, more specifically, are addressed on an ongoing basis through the
14 reactor oversight process and other NRC safety programs, such as the Generic Issues
15 Program, which are separate from the license renewal process. When new seismic hazard
16 information becomes available, the NRC evaluates the new information, through the appropriate
17 program, to determine if any changes are needed at one or more existing nuclear plants.

18 **3.5 Water Resources**

19 Water resources comprise all forms of surface water and groundwater occurring in the vicinity of
20 nuclear power plants. Surface water encompasses all water bodies that occur above the
21 ground surface, including rivers, streams, lakes, ponds, and other features, such as human-
22 made reservoirs or other impoundments. Groundwater is water that is below the ground surface
23 within a zone of saturation, with the uppermost groundwater surface comprising the water table.
24 Groundwater comprises water that originated naturally as recharge from precipitation (e.g., rain
25 or the melting of snow, sleet, or hail) or artificially as recharge from activities such as irrigation,
26 industrial processing, and wastewater disposal. Groundwater returns to the surface through
27 discharge to springs and baseflow into rivers and streams, evaporation from shallow water table
28 areas, or human activity involving wells or excavations. Aquifers are subsurface formations
29 capable of yielding a significant amount of groundwater to wells or springs. Lesser amounts of
30 groundwater may also occur in areas above the saturated zone in the form of relatively small
31 and isolated lenses of groundwater known as "perched" groundwater.

32 Potential water uses, from either surface water or groundwater sources, include uses for
33 drinking and sanitary purposes, irrigation, maintenance of terrestrial and aquatic resources,
34 recreation, and, of critical importance to all nuclear plants, industrial cooling and other
35 applications. Demands for water are not restricted to freshwater (i.e., generally water with a
36 TDS level of less than 1,000 mg/L), but can also be met, for certain uses, by brackish (i.e., TDS
37 level of about 1,000 to 35,000 mg/L) and saltwater (saline) sources, including for industrial
38 cooling applications. As such, nuclear power plants are located in a range of settings with
39 respect to water resources availability. Specifically, 11 of the 55 currently licensed nuclear
40 power plants are located in estuarine or coastal areas, 9 plants are located on or near the Great
41 Lakes, and 35 plants are located on rivers and/or with associated impoundments
42 (e.g., reservoirs) (see also Table 3.1-2 through Table 3.1-4 and Section 3.5.1.1).

43 Earth's water is always in movement, and the natural water cycle, also known as the hydrologic
44 cycle, describes the continuous movement of water on, above, and below the surface of the
45 Earth. It is the movement of water from surface water, groundwater, and vegetation to the
46 atmosphere and back to the Earth in the form of precipitation. Natural waters are normally

1 replenished by precipitation. However, the availability of water resources is being reduced and
2 their distribution is changing due to human activity and natural forces. This is further
3 aggravated by global climate change and variations in natural conditions. Impacts within the
4 hydrologic cycle can be observed in precipitation patterns, infiltration to groundwater, surface
5 runoff, stream flow, and other natural features.

6 The water quality of surface water bodies and groundwater in the vicinity of and within the
7 watersheds where nuclear power plant sites are located is influenced by a wide range of
8 activities that are often unrelated to and far removed from plant operations. Urbanization and
9 development increase the amount of impervious surface coverage, such as roads and
10 sidewalks, and reduce the natural terrain and pervious surfaces, including woodlands, meadow,
11 and prairie lands. These alterations result in higher runoff velocities while reducing or
12 eliminating the ability for infiltration, which also reduces groundwater recharge. Pervious areas
13 associated with urbanization and development, such as landscape and recreational areas,
14 contribute to increased surface runoff because they are typically uniformly graded and sparsely
15 vegetated. Increased runoff is also thermally warmer than precipitation falling on natural terrain,
16 and can carry pollutants entrained from sources of contamination on the land surface and that
17 may have otherwise been filtered through natural processes. As a result, changes in surface
18 runoff velocities and volumes have the potential to result in surface water quality impacts,
19 including changes in the chemical and thermal characteristics of the receiving waters.
20 Additionally, increases in runoff lead to streamside erosion, loss of topsoil, and other hydrologic
21 changes leading to increased flooding potential of downstream areas. These changes can
22 occur in some watersheds despite design guidelines and regulations implemented by local,
23 State, and Federal agencies to manage runoff rates associated with development.

24 Typical pollutants carried in stormwater runoff include sediment, nutrients, debris, bacteria, and
25 common hazardous substances (e.g., fertilizers, pesticides, and petroleum products). Nutrient
26 additions, whether from fertilizer additions to landscaped lawns in urban and suburban areas or
27 from croplands in agricultural areas, add to the pollutant loading and can have negative effects
28 on water quality, terrestrial communities, and aquatic life (see Section 3.6). Atmospheric
29 deposition of pollutants is also a substantial contributor to water quality degradation in
30 “downwind” regions and particularly in urbanized areas. Nuclear power plant operations can
31 contribute to water quality and hydrologic changes by increasing stormwater runoff, adding to
32 nutrient discharges from sewage treatment, and through effluent discharges from industrial
33 cooling systems. The additional runoff volume results in a total increase in deposited pollutants
34 from impervious surfaces and industrial yards. Cooling system discharges typically contain
35 cooling water treatment chemicals (e.g., corrosion inhibitors and biocides) (see also
36 Section 3.5.1.2). Such chemical constituents, when released to receiving water bodies, have
37 the potential to affect aquatic organisms. Thermal pollution is an additional pollutant that warms
38 a receiving water body through both stormwater runoff and industrial cooling discharges. Within
39 a watershed, these conditions are exacerbated by basinwide deforestation and stripping of
40 streamside vegetation in urban, suburban, and even in agricultural areas.

41 The collection of these pollutants from all sources in receiving waters can result in waters that
42 are unable to meet the water quality standards and desired uses set by States, territories, or
43 authorized Indian Tribes. The water bodies that do not meet the standard are included in the
44 Clean Water Act (CWA) 303(d) list as impaired water bodies and require additional monitoring
45 and more stringent effluent limits being imposed on industrial and other dischargers under
46 Section 303(d). Each State is required to submit their impaired and threatened waters list (i.e.,
47 303(d) list) for EPA approval every 2 years (EPA 2021c). For each water on the list, the State
48 identifies the pollutant causing the impairment, when known. Based on the NRC’s license

1 renewal environmental reviews performed since 2013, the range of pollutants identified as
2 contributing to impairment of adjoining surface waters have included pathogens (e.g., coliform
3 bacteria), sediment, various nutrients (e.g., phosphorus), polychlorinated biphenyls, and
4 mercury contamination, none of which were attributable to nuclear power plant operations.

5 Finally, groundwater quality, whether in shallow, unconfined aquifers comprised of
6 unconsolidated sediments or bedrock aquifers, may be affected by many of the sources
7 previously described. Fertilizers, chemicals, and petroleum products can degrade groundwater
8 quality by infiltration into soil, subsoils, and the water table. Subsurface sources of pollution
9 may be from broken sewage pipelines, stormwater and/or combined sanitary sewers, as well as
10 cracks in or failures of underground storage tanks. At nuclear power plant sites, groundwater
11 quality has been affected by inadvertent releases of radionuclides, predominately tritium, from
12 plant systems. Spills and leaks of petroleum products from industrial facilities (including nuclear
13 facilities) also affect groundwater.

14 Within the context of the information discussed above, the following sections discuss the effects
15 of past and current nuclear power plant operations on water resources, including relevant
16 regulatory considerations.

17 **3.5.1 Surface Water Resources**

18 The dominant water requirement at most nuclear power plants is cooling water, which, in most
19 cases, is obtained from surface water bodies. For this reason, most plants are located near
20 suitable supplies of surface water, such as rivers, reservoirs, lakes, the Great Lakes, oceans,
21 bays, or human-made impoundments, as described above. An exception is the Palo Verde
22 plant in Arizona, which relies on treated municipal wastewater for cooling. Because of the
23 interaction between power plants and surface water, issues arise in terms of both usage and
24 quality. These are discussed in separate sections below.

25 *3.5.1.1 Surface Water Use*

26 Nuclear power plants withdraw large amounts of surface water to meet a variety of plant needs,
27 especially for condenser cooling (see Section 3.1.3 for detailed analysis). The operating
28 commercial nuclear power plants considered in this LR GEIS are compared in Table 3.5-1 in
29 terms of their condenser flow rates, when normalized to energy production. Although nuclear
30 plants in warmer geographical locations might be expected to have higher water requirements
31 for cooling, a comparison of the locations of the plants and the normalized water use by their
32 cooling systems suggests there is no correlation between high water use and warmer climate.
33 Design factors are likely responsible for the overlapping ranges in condenser flow rates.

34 For closed-cycle cooling systems featuring cooling towers, the amount of water consumed
35 equates approximately to the amount of water lost through evaporation and drift. In this type of
36 cooling system, the condenser flow rate is much larger than the withdrawal rate from a surface
37 water body, and this withdrawal rate is essentially the water consumption rate of the system.
38 For once-through cooling systems, the condenser flow rate is nearly equal to the surface water
39 withdrawal rate, and the consumption rate is much less because water is returned directly to the
40 surface water body and undergoes less evaporative loss than in a cooling tower.

41 Cooling towers used at operating nuclear power plants consume water at a rate of about 9,400
42 to 10,000 gpm (0.59 to 0.63 m³/s), normalized to 1,000 MWe, as a result of evaporation and drift
43 (Table 3.5-1) (Marston et al. 2018). According to the National Renewable Energy Laboratory

1 (NREL 2011), the operational water consumption of nuclear plant cooling towers ranges from
 2 9,700 to 14,000 gpm (0.61 to 0.88 m³/s), normalized to 1,000 MWe. Additional water
 3 requirements offset the blowdown returned to the surface water body. Water withdrawal for
 4 plants with closed-cycle cooling systems is 5 to 10 percent of the withdrawal for plants with
 5 once-through cooling systems, with much of this water being used for makeup of water lost to
 6 evaporation (NRC 1996). An estimate of typical makeup water needs for nuclear plants having
 7 closed-cycle cooling, normalized to a 1,000 MWe reactor, is about 14,000 to 18,000 gpm (0.9 to
 8 1.1 m³/s) for all makeup needs (NRC 1996). This range of required makeup water includes not
 9 only the consumed water but also the offset of blowdown, which is returned to the surface water
 10 body. Variation in water use among plants results from the design of the cooling tower,
 11 concentration factor of recirculated water, climate at the site, plant operating conditions, and
 12 other plant-specific factors.

13 Once-through cooling systems are somewhat more common than closed-cycle systems
 14 (Table 3.5-1). For once-through systems used at operating nuclear plants, the water withdrawn
 15 is returned to the surface water body with less consumptive loss (about 6,600-6,700 gpm or
 16 0.42 m³/s) per 1,000 MWe because there is less evaporation than that associated with cooling
 17 towers (Marston et al. 2018). As indicated by National Renewable Energy Laboratory (NREL
 18 2011), the operational water consumption of nuclear plant once-through cooling systems ranges
 19 between 2,000 to 7,000 gpm (0.13 to 0.44 m³/s), normalized to 1,000 MWe. Marston et al. 2018
 20 reports water consumption of once-through cooling systems at operating nuclear plants as
 21 ranging from 5,200 to 8,700 gpm (0.33 to 0.55 m³/s) per 1,000 MWe. In all, the withdrawal rate
 22 from the surface water body, however, is much higher in a once-through cooling system than in
 23 a closed-cycle system. For example, in Table 3.5-1, compare the condenser flow rates needed
 24 for once-through systems, which correspond to their surface water withdrawals, with the
 25 consumptive losses of closed-cycle systems (e.g., cooling tower systems), which correspond to
 26 their surface water withdrawal or makeup water requirements. The thermal discharge from
 27 once-through cooling systems is generally higher than that from cooling towers, as discussed in
 28 Section 3.5.1.2 below.

29 **Table 3.5-1 Comparison of Cooling Water System Attributes for Operating Commercial**
 30 **Nuclear Power Plants**

Cooling System ^(a)	Number of Sites ^(a)	Condenser Cooling Water Flow per Unit in gpm ^(b)	Average Reported Consumptive Water Loss per 1,000 MWe in gpm
Pond and/or canal	9	454,000 to 907,000	10,200 ^(c)
Mechanical draft cooling tower	7	98,000 to 660,000	10,000 ^(d)
Natural draft cooling tower	13	410,000 to 836,000	9,400 ^(d)
Once-through cooling (only)	24	340,000 to 1,200,000	6,700 ^(d)
Once-through cooling with tower	4	292,000 to 750,000	6,600 ^(d)

31 gpm = gallons per minute.

32 (a) There are 54 operating commercial power reactor sites (2022) encompassing 92 nuclear generating units. For
 33 cases of multiple reactors per site, reactors using the same type of cooling system were counted only once. If
 34 multiple reactors at a site used different cooling systems (i.e., Nine Mile Point plant and Arkansas plant), they
 35 were tallied separately.

36 (b) Source: Appendix C of this LR GEIS.

37 (c) Source: National Renewable Energy Laboratory 2011 (NREL 2011).

38 (d) Source: Marston et al. 2018. Data for some plants were not reported by Marston et al. 2018.

39 Note: To convert gallons per minute (gpm) to liters per minute, multiply by 3.784. To convert gpm to cubic meters
 40 per second (m³/s), multiply by 0.000063.

Affected Environment

1 Additional operational surface-water-related needs at power plants include service water,
2 auxiliary system supplies, and radioactive waste systems. These needs combined are small
3 relative to the flow needed for condenser cooling (NRC 1996).

4 Nuclear plant water usage must comply with State, local, and regional regulations regarding
5 water supply. Most States require permits regulating surface water usage.

6 For nuclear plants relying on river water, consumptive water losses reduce surface water
7 supplies for other users downstream. In areas experiencing water availability problems, nuclear
8 power plant consumption could conflict with other existing or potential uses (e.g., municipal and
9 agricultural water withdrawals) and instream uses (e.g., adequate instream flows to protect
10 aquatic biota, recreation, and riparian communities). Water availability issues have not been
11 generally noted in past license renewal environmental reviews and are most likely to occur
12 during times of extended drought.

13 Both water availability and water temperature are important factors in maintaining operations at
14 power plants. As was previously described in the 2013 LR GEIS, in August 2007, a heat wave
15 resulted in high river water temperatures at the Browns Ferry plant in Alabama. Because of the
16 reduced capability of the river water to cool the condensers, one of the plant's three reactors
17 was shut down, while operations at its other two reactors were cut by 25 percent. In summer
18 2006, the Quad Cities Nuclear Power Station (Quad Cities) in Illinois had to reduce operations
19 because the Mississippi River was warm, and other plants in Illinois and Minnesota had to cut
20 back as a result of drought effects.

21 More recently, a number of nuclear power plants have been affected by reduced water
22 availability due to high temperatures. As relevant examples, in July 2012, Byron Units 1 and 2
23 had to reduce power due to degraded cooling tower performance during hot weather (NRC
24 2021o). In August 2014, Turkey Point Units 3 and 4 had to operate at reduced power due to
25 excessive ultimate heat sink (CCS) temperature (NRC 2021m). In July 2016, the Perry Nuclear
26 Power Plant (Perry) had to reduce power due to high ambient water temperature (NRC 2021p).
27 In August 2018, the Clinton plant was forced to reduce power due to discharge temperature
28 limitations (NRC 2021n).

29 In the report, *Water-Related Power Plant Curtailments: An Overview of Incidents and*
30 *Contributing Factors*, National Renewable Energy Laboratory (NREL 2016) identifies 25
31 incidents at nuclear power plants between 2000 and 2015 where high water temperatures or
32 water availability affected power generation. The operating nuclear power plants cited included
33 Duane Arnold, Prairie Island Nuclear Generating Plant (Prairie Island), LaSalle, Dresden, Perry,
34 Donald C. Cook Nuclear Plant (D.C. Cook), Quad Cities, Braidwood, Limerick, Vermont Yankee,
35 Pilgrim Nuclear Power Station (Pilgrim), Millstone, Oyster Creek, Hope Creek, Riverbend,
36 Browns Ferry, Turkey Point, and Monticello.

37 3.5.1.2 Surface Water Quality

38 Discharges from the circulating cooling water system account for the largest volumes of water
39 and usually the greatest potential impacts on water quality and aquatic systems, although other
40 systems may also contribute heat and chemical contaminants to the effluent. Provisions of the
41 CWA regulate the discharge of pollutants into waters of the United States.

42 To operate a nuclear power plant, NRC licensees must comply with the CWA, including
43 associated requirements imposed by EPA or the State. Specifically, Section 402 of the CWA

1 requires that all facilities that discharge pollutants from any point source into waters of the
2 United States obtain a NPDES permit. A NPDES permit is developed with two levels of
3 controls: technology-based limits and water quality-based limits. NPDES permit terms may not
4 exceed 5 years, and the applicant must reapply at least 180 days prior to the permit expiration
5 date (EPA 2022g). Expired NPDES permits may be administratively extended and remain valid
6 and in-force if the permit holder submits a complete NPDES renewal application as required.
7 The EPA is authorized under the CWA to directly implement the NPDES program; however, the
8 EPA has authorized most States and Tribes to implement all or parts of the national program.
9 Conditions of discharge for each nuclear power plant are specified in its NPDES permit issued
10 by the State or EPA.

11 CWA Section 401 requires an applicant for a Federal license whose activities may cause a
12 discharge of regulated pollutants into navigable waters to provide the licensing agency with
13 water quality certification from the State. This certification implies that discharges from the
14 project to be licensed will comply with CWA requirements, as applicable, including that the
15 project will not cause or contribute to a violation of State water quality standards. If the
16 applicant has not received Section 401 certification, the NRC cannot issue a license unless that
17 State has waived the requirement.

18 In July 2020, the EPA published a final rule revising the procedural requirements for CWA
19 Section 401 certifications at 40 CFR 121 (85 FR 42210). The final rule became effective on
20 September 11, 2020.³ The revised regulations at 40 CFR 121.6 require that the Federal
21 licensing agency establish the “reasonable period of time” and communicate that deadline to the
22 appropriate certifying authority within 15 days of receiving notice of the applicant’s certification
23 request. Under the revised regulations, under no circumstances can the certifying authority take
24 more than 1 year to issue the requested certification, deny certification, or waive its right to
25 certify. The certifying authority’s failure or refusal to act on a certification request within the
26 reasonable period of time is considered a waiver. The NRC further recognizes that some
27 NPDES-delegated States explicitly integrate their 401 certification process with NPDES permit
28 renewal and issuance.

29 Separate from permitting and associated regulatory requirements imposed on operating nuclear
30 plants, the NRC considers new information and aspects of plant operations that could interact
31 with the environment in a manner not previously recognized during the course of license
32 renewal environmental reviews conducted for initial LR and SLRs. For example, nuclear
33 power plants with cooling ponds located in coastal areas have the potential to affect the water
34 quality of adjacent water bodies via the groundwater pathway. This new, plant-specific aspect
35 of continued operations was discovered during review of the second license renewal of Turkey
36 Point Units 3 and 4 (NRC 2019c).

³ In 2021, the EPA initiated a process to reconsider and revise the 2020 CWA Section 401 Certification Rule (86 FR 29541).

Clean Water Act

- Section 402 authorizes the NPDES permit program that controls water pollution by regulating point sources, including cooling water discharge from all facilities including thermoelectric power plants that discharge pollutants into waters of the United States.
- Section 401 requires applicants for Federal licenses or permits whose activities may cause a discharge of regulated pollutants into navigable waters of the United States to obtain a certification that their activities will not violate State water quality standards.
- Section 316(a) addresses the adverse environmental impacts associated with thermal discharges into waters of the United States. Under 316(b), the NPDES permitting authority can impose alternative, less-stringent, facility-specific effluent limits (called “variances”) on the thermal component of individual point source discharges as long as the variances will assure the protection and propagation of a balanced, indigenous population of shellfish, fish, and wildlife in and on the receiving body of water. Variances are good for the term of the NPDES permit (5 years), and the facility licensee must reapply for the variance each permit renewal term.
- Section 316(b) requires that the location, design, construction, and capacity of cooling water intake structures reflect the best technology available (BTA) for minimizing impingement mortality and entrainment of aquatic organisms. Impingement mortality BTA compliance options are prescribed in regulations, while entrainment BTA is site-specific.

1 3.5.1.2.1 *Thermal Effluents and Withdrawal of Cooling Water from Surface Water Bodies*

2 NPDES permits for nuclear power plants impose temperature limits for effluents (which may
3 vary by season) and/or a maximum temperature increase above the ambient water temperature
4 (referred to as “delta-T,” which also may vary by season). Other aspects of the permit may
5 include the compliance measuring location and restrictions against plant shutdowns during
6 winter to avoid drastic temperature changes in surface water bodies. Some NPDES permits
7 also require nuclear power plants that operate a once-through cooling system with helper
8 cooling towers to use the cooling towers seasonally to reduce thermal load to the receiving
9 waterbody.

10 The area affected by heated releases to surface water bodies (the thermal plume) varies with
11 site-specific conditions (e.g., discharge temperature, discharge rate, discharge structure location
12 and design, flow of the surface water body, and temperature of the surface water body).
13 Thermal plumes may be assessed in the field through computer modeling using thermal field
14 data. Generally, the use of cooling towers decreases the thermal effluent discharged by a
15 nuclear power plant (e.g., NRC 2006d).

16 Sections 316(a) and 316(b) of the CWA address thermal effects and impingement mortality and
17 entrainment of aquatic organisms caused by operation of nuclear power plant cooling systems
18 that withdraw and discharge to regulated waterbodies. The EPA, or authorized States and
19 Tribes, impose the requirements of these CWA sections through NPDES permitting programs.
20 Under CWA Section 316(a), nuclear power plants may apply for a thermal variance from State
21 thermal surface water quality criteria. To do so, the facility must demonstrate that the requested
22 variance is more stringent than necessary to assure the protection and propagation of a
23 balanced, indigenous population of shellfish, fish, and wildlife in and on the receiving body of
24 water (40 CFR Part 125 Subpart H). Variances are good for the NPDES permit term (5 years),
25 and the licensee must reapply for the variance each permit renewal term. CWA Section 316(b)

1 requires that the location, design, construction, and capacity of cooling water intake structures
2 reflect the BTA for minimizing impingement mortality and entrainment of aquatic organisms.
3 Impingement mortality BTA compliance options are prescribed in regulations, while entrainment
4 BTA is plant-specific. Section 4.6.1.2 describes these sections of the CWA in detail, including
5 the regulatory requirements relevant to nuclear power plants.

6 3.5.1.2.2 Other Effluents

7 Liquids containing chemicals and other constituents are discharged to surface water from
8 nuclear power plants, as discussed in Section 3.1.4.1. The concentrations and flow rates of the
9 liquids vary with activities involving the systems associated with floor drains, blowdown,
10 laundries, decontamination, and other facilities. The liquids may also undergo treatment before
11 reuse or discharge. These effluents are regulated under the plant's NPDES permit. As part of
12 the permitting process, concentration limits are established, and monitoring takes place at
13 specific outfalls or other monitoring locations. The frequency of sampling is also covered by the
14 plant's NPDES permit. The EPA or authorized State or Tribal agencies also provide the
15 reporting requirements, and they may post results on a publicly accessible website.
16 Noncompliance issues may range from administrative matters to exceedances of concentration,
17 temperature, or flow limits. The exceedance of a parameter limit will trigger the permitting
18 agency to review the history and magnitude of exceedance recurrences. Actions may include
19 reviewing the permit for appropriate parameter levels, setting a compliance schedule for the
20 applicant, assessing fines, and, in a worst-case scenario, withdrawing a permit and disallowing
21 the legal ability to discharge.

22 Sanitary sewage wastes are treated before their release to the environment to minimize
23 environmental impacts. The treatment may be through discharge to a municipal wastewater
24 treatment system, an onsite wastewater treatment plant, or an onsite septic system. In cases
25 where nonradioactive sanitary or other wastes cannot be processed by onsite wastewater
26 treatment systems, the wastes are collected by independent contractors and trucked to offsite
27 treatment facilities. Waste collection and offsite disposal can occur during a planned outage,
28 when portable toilets may be required to accommodate the additional workforce. Water quality
29 issues related to sanitary waste treatment include the adequacy of the wastewater treatment
30 system capacity for handling the increased flow and loading associated with operational
31 changes to the plant, emission of phosphates from onsite laundries, suspended solids, coliform
32 bacteria from sewage treatment discharges, and other effluents that cause excessive
33 biochemical oxygen demand. State regulators are typically involved in site inspections, review
34 of monitoring reports, and the handling of any violations.

35 The control of biological pests is critical to maintaining optimum system performance and
36 minimizing operating costs. Consequently, many nuclear power plant cooling systems are
37 periodically treated with molluscides to control the Asiatic clam (*Corbicula fluminea*) and the
38 zebra mussel (*Dreissena polymorpha*), which are generally found in the portions of the cooling
39 system where water temperatures are ambient rather than heated.

40 Biocides also are commonly used in cooling towers, although they may also be used in once-
41 through systems or cooling ponds (DOE 1997a). Discharge of these chemicals to the receiving
42 body of water can have toxic effects on aquatic organisms. Chlorine is commonly used as a
43 biocide at nuclear power plants and represents the largest potential source of chemically toxic
44 release to the aquatic environment. It may be injected at the intake or targeted at various points
45 (such as the condensers) on an intermittent or continuous basis. Chlorine gas, which was
46 commonly used in the past, has been replaced by many users with other forms, such as bleach

Affected Environment

1 (sodium hypochlorite) (DOE 1997a). At some plants, chemical biocides may be augmented with
2 a non-chemical cleaning system that involves the injection of small spheres to control biofouling
3 and buildup in condenser tubing. The spheres are injected into the water system and then
4 collected upon discharge for reuse.

5 Bromide compounds have been used increasingly in recent years, either in place of or in
6 addition to chlorine treatments. Dechlorination may occur prior to discharge. Non-oxidizing
7 biocides used to control zebra mussels and other organisms include quaternary ammonia salts,
8 triazine, glutaraldehyde, and other organic compounds.

9 Most nuclear power plants have a stormwater pollution prevention plan, with the parameter
10 limits of the stormwater outfalls included in either an NPDES general permit or individual
11 NPDES permit. Plants may also have a spill prevention, control, and countermeasures plan that
12 contains information about potential liquid spill hazards and the appropriate absorbent materials
13 to use if a spill occurs.

14 3.5.1.3 *Hydrologic Changes and Flooding*

15 As described in Section 3.5, urbanization of watersheds in which nuclear power plants operate
16 increases the amount of impervious surface coverage resulting in water quality impacts and
17 changes in the hydrologic characteristics of the watershed. Urbanization has a direct correlation
18 to the degradation of natural receiving streams. The higher the percentage of the impervious
19 surface coverage in a watershed, the higher the flow velocity and volume in receiving water
20 bodies. Increases in stream flow erode natural stream banks and scour natural vegetation from
21 littoral zones, while also adding to higher flow volume and increased potential for flooding. A
22 flood is the occurrence when, under high water level and/or flow conditions, water overflows the
23 natural or artificial bank of the water body. The floodplain or zone defines the extent of the land
24 areas covered by the overflowing water. Floods can occur at any time, but weather patterns,
25 terrain, land use coverage, and other factors influence when and where floods happen, as well
26 as their frequency and severity. For example, the western United States can experience
27 flooding due to cyclones in the winter and early spring; the streams in the southwest United
28 States can experience flash flooding due to thunderstorms in late summer and fall; frontal
29 storms in the northern and eastern United States can cause floods during the winter and spring;
30 and the southeastern United States experiences flooding due to tropical storms, such as
31 hurricanes, during the late summer and fall.

32 Flood zone boundaries are determined based on the predicted recurrence interval of flooding
33 and the extent of the land area inundated through the use of analytical modeling and field
34 observations. The recurrence interval is the average number of years between floods of a
35 certain size. For instance, the 100-year flood, on average, is expected to occur once every
36 100 years. However, statistically there is a 1 in 100 chance that the 100-year flood will occur in
37 any given year.

38 Flood zones are dynamic and change over time due to natural forces. Further, changes in
39 urbanization increase runoff and changes in weather patterns increase the intensity of
40 precipitation events. In some instances, land areas that were not previously within a flood zone
41 have been reclassified as being in one after nearby river elevations and flood potential were
42 reanalyzed. On large rivers, dams have been shown to reduce flooding. Flood-control dams,
43 such as on multiuse reservoirs, are designed to release water flow at a controlled rate and allow
44 water to back up in a reservoir when, typically under storm events, the inflows exceed the

1 predetermined outflow rate. This prevents high flows from reaching streams that would
2 otherwise flood and allows water flow to bypass communities without flooding them.

3 Currently operating nuclear power plants were originally sited in consideration of the hydrologic
4 siting criteria set forth in 10 CFR Part 100 and designed and constructed in accordance with
5 10 CFR Part 50, Appendix A. The regulations require that plant structures, systems, and
6 components important to safety be designed to withstand the effects of natural phenomena,
7 including flooding, without loss of capability to perform safety functions. Plant-specific design
8 bases for flood protection are prescribed by a nuclear power plant's updated safety analysis
9 report and by applicable technical specifications. Acceptable protection for floods includes
10 levees, seawalls, floodwalls, or breakwaters. If new information or plant operating experience
11 related to flooding become available, the NRC evaluates the new information or plant data to
12 determine whether any changes are needed at existing plants. Flood protection issues are
13 considered during plant-specific safety reviews and, more specifically, are addressed on an
14 ongoing basis through the reactor oversight process and other NRC safety programs, which are
15 separate from the license renewal process.

16 **3.5.2 Groundwater Resources**

17 Some nuclear power plants also use groundwater as a source of water for some of their
18 operational needs. The rate of usage varies greatly among the plants. Many plants use
19 groundwater only for the potable water system and require less than 100 gpm (378 liters per
20 minute or 0.006 m³/s). At some plants, the original construction required dewatering of a
21 shallow aquifer by using pumping wells or a drain system. Some plants operate dewatering
22 systems to lower the water table near buildings. This is accomplished either by pumping or by
23 having footing drains along foundations. Groundwater may also be used for sanitary uses or
24 landscaping, and it may undergo processing to be used for makeup or service water systems.
25 Groundwater usage regulations vary considerably from State to State, and State allocation
26 permits are typically required.

27 At the Grand Gulf plant in Mississippi, large-diameter wells with radial collector arms (i.e.,
28 Ranney wells) are used to withdraw groundwater along the Mississippi River at relatively high
29 rates. Radial collector wells are installed in alluvial aquifers along rivers to obtain a mixture of
30 groundwater and surface water through induced infiltration. At Grand Gulf, the average
31 groundwater pumping rate by their well systems is approximately 27,900 gpm (1.76 m³/s) (NRC
32 2014e). Groundwater withdrawn at Grand Gulf is used for cooling, makeup, service, potable,
33 sanitary, landscaping, and fire protection uses.

34 The quality of groundwater may be affected by operations at nuclear power plants. Water from
35 cooling ponds may seep into the underlying surficial aquifer. Activities at power plants typically
36 include general industrial practices, such as the storage and use of hydrocarbon fuels (diesel
37 and/or gasoline), solvents, and other chemicals. These practices have the potential to
38 contaminate soil and groundwater, and, at some plants, such contamination has occurred.
39 Examples from plant-specific supplemental environmental impact statements (SEISs) include
40 leakages or spills of gasoline (with methyl tertiary butyl ether or MTBE) at fuel tank storage
41 areas, spills of fuel at transfer or filling stations, solvent leakages from storage area drums,
42 spilled or sprayed solvents, and underground line leaks of hydraulic oil or diesel fuel (e.g., NRC
43 2006d, NRC 2007b, NRC 2016c). These incidents involved regulatory oversight under State
44 regulations for hydrocarbons and under RCRA (42 U.S.C. § 6901 et seq.) for other chemicals,
45 and offsite groundwater users were not affected.

Affected Environment

1 Radionuclide releases from nuclear power plants have been identified as the source of
2 radioactive materials in groundwater (or below-ground moisture) at many plant sites. These
3 releases have been attributed to system leaks (e.g., from pipes, valves, or tanks), evaporation
4 of liquids, condensation of vapors, and normal operations (routine, approved releases) (NRC
5 2021k). Detection of tritium has generally been the initial indicator of a release because it
6 travels readily in groundwater. The issue of tritium (and other radionuclide) releases to
7 groundwater rose to prominence as groundwater contamination was observed at an increasing
8 number of plants, including the exceedance of drinking water standards in onsite groundwater at
9 some plants.

10 The NRC formed a task force in 2006 in response to incidents at the Braidwood, Indian Point,
11 Byron, and Dresden plants to examine the matter of liquid radionuclide releases from power
12 plants (NRC 2006e). The task force report noted that the leaks were generally not observable
13 because they occurred underground and because plants were not required to have onsite
14 groundwater monitoring wells unless an onsite well was used for drinking water or irrigation
15 water. The task force concluded that the available data on radionuclide releases did not identify
16 any public health impacts, but the level of public concern warranted recommendations for
17 enhanced regulations or regulatory guidance for unplanned, unmonitored releases; additional
18 decommissioning funding and license renewal reviews; and enhanced public communications
19 (NRC 2006e).

20 In response to the discoveries of underground radionuclide releases at nuclear power plants,
21 the Nuclear Energy Institute, which represents the nuclear industry on policy issues, developed
22 the Groundwater Protection Initiative, originally published in 2007 and revised most recently in
23 2019 (NEI 2019). Each Nuclear Energy Institute member company voluntarily committed to
24 develop and implement a plant-specific groundwater protection program for operating or
25 decommissioning nuclear power plants by July 31, 2006. These programs cover the
26 assessment of plant systems and components, site hydrogeology, and implementation of
27 groundwater monitoring programs. To monitor the actions of the nuclear industry, the NRC
28 updated its inspection procedure to include this issue as part of its routine radiological
29 inspection at all nuclear power plants.

30 In March 2010, the NRC formed a Groundwater Task Force to determine whether additional
31 actions were needed to strengthen the NRC's response to incidents of radionuclide releases to
32 groundwater at nuclear power plant sites (NRC 2010e). This new task force was comprised of
33 NRC management and technical staff charged with reevaluating the recommendations made in
34 the 2006 lessons learned report and to consider more recent tritium releases to groundwater
35 from nuclear power plants. On June 11, 2010, the task force issued its report that identified 16
36 conclusions and 4 recommendations (NRC 2010b).

37 Subsequently, the NRC's Executive Director for Operations appointed a senior management
38 review group to consider the Groundwater Task Force's final report, identify the policy issues
39 associated with the NRC's groundwater protection regulatory framework, develop options for
40 addressing the policy issues, and present options to the Commission (NRC 2010c). The
41 outcome of the appointed senior management group's review of the Groundwater Task Force
42 Final Report was issued in February 2011 via SECY-11-0019 (NRC 2011f) along with a
43 separate memorandum to the NRC Chairman. In summary, the group supported several
44 ongoing staff actions, including evaluations of the long-term effectiveness of industry
45 groundwater protection initiatives through onsite inspections, review of licensees' root cause
46 analyses, tracking of the frequency of leakage, and evaluation of industry performance metrics
47 related to leakage and potential groundwater contamination.

1 In SRM-SECY-11-0019, dated August 15, 2011 (NRC 2011d), the Commission approved the
2 senior management review group's recommendation to not incorporate the industry's voluntary
3 initiative on groundwater protection into the NRC's regulatory framework and that the staff
4 continue to monitor the effectiveness of the industry initiatives. The Commission also requested
5 that the staff provide options for revising the agency's approach to groundwater protection.

6 On March 29, 2012, the staff submitted an options paper regarding the NRC's approach to
7 groundwater protection (SECY-12-0046) to the Commission (NRC 2012h). The staff
8 recommended an option that included continuing the agency's established regulatory approach
9 under which the staff would continue inspecting and enforcing existing regulations using the
10 system of dose limits and as low as is reasonably achievable (ALARA) principles. The staff
11 would also implement the new regulatory requirements in 10 CFR 20.1406 for minimizing the
12 introduction of residual radioactivity into the plant site and in 10 CFR 20.1501 for performing
13 subsurface (i.e., soil and groundwater) monitoring.

14 The Commission in its SRM-SECY-12-0046, approved the staff's recommended option to
15 continue the current regulatory approach to groundwater protection, including the additional
16 requirements contained in the decommissioning planning rule. The Commission also directed
17 the staff to provide a notation vote paper based on the result of comments solicited on the
18 technical basis including the pros and cons of moving forward with a proposed prompt
19 remediation rulemaking under consideration by the staff (NRC 2012f).

20 The NRC staff conducted a public meeting and webinar on June 4, 2013, to obtain stakeholder
21 comments on the ongoing prompt remediation issue. In SECY-13-0108, dated October 7, 2013,
22 the staff reported the results of its evaluation of stakeholder comments to the Commission (NRC
23 2013d). In SRM-SECY-13-0108, the Commission approved the NRC staff's recommendation to
24 collect 2 years of additional data from the implementation of the decommissioning planning rule.
25 Based on the staff's completion and evaluation of the data and stakeholder engagement, the
26 Commission directed that the staff provide a paper with recommendations for addressing
27 remediation of residual radioactivity at licensed facilities during facility operations (NRC 2013c).

28 In SECY-16-0121, dated October 16, 2016, the staff provided the Commission with its
29 evaluation of options including the consideration of rulemaking to address the remediation of
30 residual radioactivity at licensed facilities during operations (i.e., prompt remediation). The staff
31 recommended no rulemaking, and cited existing NRC regulatory requirements and voluntary
32 industry initiatives as providing adequate protection for public health and safety (NRC 2016g).
33 In December 2016 (SRM-SECY-16-0121), the Commission approved the staff's recommended
34 option (NRC 2016e).

35 The NRC has repeatedly determined that inadvertent releases at nuclear power plant sites
36 either remain on power plant property or involve such low offsite levels of tritium that they do not
37 affect public health and safety. The NRC has continued to review incidents of inadvertent
38 releases to ensure that nuclear power plant operators take appropriate action.

39 Additionally, the NRC maintains an updated list of operating reactor sites that have experienced
40 a leak or spill of liquids containing radioactive material to the onsite licensee (owner)-controlled
41 area. The list includes plant sites where the concentration of tritium in the leak source, or in a
42 groundwater sample, exceeded the EPA drinking water standard (20,000 pCi/L) at some time
43 since initial startup (NRC 2021j). To date, tritium in excess of the drinking water standard has
44 been observed in groundwater at 38 nuclear power plant sites as a result of leaks or spills, with
45 7 plants continuing to have tritium in groundwater above the drinking water standard as of

1 October 2021 (NRC 2021j). No site has reported tritium above the drinking water standard in
2 offsite groundwater (NRC 2021j).

3 The NRC provides public access to all radioactive effluent and environmental monitoring data,
4 including industry groundwater protection initiative monitoring results, reported to the NRC by
5 nuclear power plant licensees at [https://www.nrc.gov/reactors/operating/ops-
6 experience/tritium/plant-info.html](https://www.nrc.gov/reactors/operating/ops-experience/tritium/plant-info.html).

7 In summary, to protect groundwater quality during the period of operations and to minimize
8 contamination during decommissioning, NRC licensees are required to conduct operations to
9 minimize the introduction of residual radioactivity into the site, including the subsurface. NRC
10 licensees are also required to survey, evaluate, document, and report the hazard of known spills
11 or leaks of radioactive material. The NRC has reporting requirements based on the amount of
12 radioactivity released, thus any large spills or leaks will be reported.

13 **3.6 Ecological Resources**

14 A variety of ecological resources exist at and in the vicinity of operating nuclear power plants
15 across the United States. This section presents an overview of those resources.
16 Sections 3.6.1, 3.6.2, and 3.6.3, discuss terrestrial resources, aquatic resources, and federally
17 protected ecological resources, respectively. Wetlands and floodplains, which are transitional
18 areas between terrestrial and aquatic systems, are described with terrestrial resources. This
19 section summarizes the effects of past activities, including construction and current operations,
20 at operating commercial nuclear power plant sites.

21 **3.6.1 Terrestrial Resources**

22 Operating commercial nuclear power plants are located in a variety of terrestrial habitat types.
23 For the purposes of this analysis, terrestrial ecological resources in the vicinity of nuclear power
24 plants are described in terms of upland vegetation and habitats, floodplain and wetland
25 vegetation and habitats, and wildlife. Section 3.6.3.1 discusses federally protected terrestrial
26 resources.

27 *3.6.1.1 Upland Vegetation and Habitats*

28 Terrestrial vegetation and habitats include forests, grasslands, and shrublands. These habitats
29 have been affected by the initial construction of nuclear power plants, operation of those plants,
30 and natural successional changes occurring within vegetation communities. In general, the
31 level of land management varies by land use type at a nuclear power plant. See Section 3.2.1
32 for a general description of land use at a nuclear power plant.

33 Impacts on terrestrial vegetation and habitats can result from several activities or processes
34 during normal operations at a nuclear power plant. Since startup of operations, industrial-use
35 portions of nuclear power plant sites have typically been maintained as modified landscapes.
36 These areas may also include disturbed early successional habitats or areas of relatively
37 undisturbed habitat. Site maintenance, such as mowing and herbicide or pesticide application,
38 generally keeps the diversity of plant species at a reduced level in these areas. Native plant
39 species are often replaced by cultivated varieties or weedy species tolerant of disturbance.
40 Non-industrial use portions of nuclear power plant sites may include natural areas, such as
41 forest or shrubland, in various degrees of disturbance.

1 Terrestrial habitats near nuclear power plants can be subject to radiological releases under
2 normal plant operations. These habitats are exposed to small amounts of radionuclides that
3 result from the deposition of particulates released from nuclear power plant vents during normal
4 operations. Releases typically include noble gases (which are not deposited), tritium, isotopes
5 of iodine, and cesium, and they may also include carbon-14, strontium, cobalt, and chromium.
6 Exposure to these radionuclides results in a dose rate to terrestrial plants of much less than
7 1.0 rad/d (0.1 Gy/d), which is the U.S. Department of Energy (DOE) guideline for adequate
8 protection of terrestrial plant populations from the effects of ionizing radiation (DOE 2019) (see
9 Section 4.6.1.1.2). Radionuclides, such as tritium, and other constituents in cooling water
10 systems, such as biocides, that enter shallow groundwater from cooling ponds can be taken up
11 by terrestrial plants.

12 Terrestrial habitats near nuclear power plants that have cooling towers are subject to the
13 deposition of cooling tower drift particulates (including salt); the deposition of water droplets on
14 vegetation from drift; structural damage from freezing vapor plumes; and increased humidity.
15 Small amounts of particulates from cooling towers are dispersed over a wide area. Particulates
16 from natural draft towers are typically dispersed over a larger area and at a lower deposition
17 rate than those from mechanical draft towers (Roffman and Van Vleck 1974). However, most of
18 the deposition from cooling towers occurs in relatively close proximity to the towers. Generally,
19 deposition rates are below those that are known to result in measurable adverse effects on
20 plants, and no deposition effects on agricultural crops or natural vegetative communities have
21 been observed at most nuclear power plants. Some exceptions were observed at nuclear
22 power plants in studies conducted in the 1980s (e.g., Palisades in Michigan and Prairie Island in
23 Minnesota; NRC 1996); however, the NRC staff's review of recent license renewals did not
24 identify any new issues. Impacts from icing, when they have occurred, have been minor and
25 localized near cooling towers.

26 Effects of nuclear power plant operations on terrestrial habitats also include the effects of
27 transmission line ROWs and their maintenance. ROW management typically includes the
28 periodic cutting and removal of tall woody vegetation and the application of herbicides. Use of
29 mechanized equipment can crush vegetation or injure or disturb insects and small animals.
30 However, transmission lines and associated structures within the scope of license renewal
31 reviews are expected to occur primarily on developed portions of sites and would include only
32 the short lengths of transmission lines that run from the plant to the nearest substation (see
33 Section 3.1.6.5).

34 3.6.1.2 *Floodplain and Wetland Vegetation and Habitats*

35 Floodplains are areas where the land is susceptible to flooding from any source and tend to
36 occur along rivers and coastlines near many nuclear power plants (FEMA 2021). These areas
37 attenuate the extent of flooding and often include wetlands, marshes, and riparian habitat. One-
38 hundred year floodplains typically have at least a 1 percent chance of flooding in any given year.
39 Many nuclear power plant cooling water intake systems and outfalls lie within floodplains. Some
40 transmission lines may also cross through floodplains. Executive Order 11988, "Floodplain
41 Management" (42 FR 26951), requires Federal agencies to restore and preserve the natural
42 and beneficial values served by floodplains for activities undertaken in such areas.

43 Many wetland types occur near nuclear power plants. These include riverine, palustrine,
44 lacustrine, estuarine, and marine wetlands, as described by the U.S. Fish and Wildlife Service
45 (FWS) Cowardin classification for the National Wetlands Inventory (Cowardin et al. 1979). Most
46 nuclear power plants have wetlands nearby (within a radius of 5 mi [8 km]), and wetlands cover

1 an average of 9.3 percent of the land area near operating nuclear power plants, as mapped by
2 the National Wetlands Inventory (FWS 2022b). The definition of wetlands traditionally excludes
3 deep-water habitats, which are permanently flooded areas (Cowardin et al. 1979; FGDC 2013)
4 and which occupy, on average, 21.2 percent of the area within 5 mi of operating nuclear power
5 plants. The percentage of wetlands and deep-water habitats within 5 mi (8 km) of nuclear
6 power plants is presented in Table D.5-3 in Appendix D.

Wetland Types That Occur near Nuclear Power Plants

- **Riverine wetlands** are contained within a channel that has moving water, at least periodically, and lack persistent vegetation.
- **Palustrine wetlands** are freshwater habitats that primarily support trees, shrubs, or persistent emergent plants, or they can be small (generally under 20 ac or 8 ha), shallow wetlands lacking such plant communities.
- **Lacustrine wetlands** are large or deep bodies of water that lack persistent vegetation.
- **Estuarine wetlands** occur near land with access to the ocean, are influenced by tides, and are diluted to a variable extent by freshwater.
- **Marine wetlands** are exposed to open ocean waves and currents and may be slightly diluted by freshwater.

Source: Cowardin et al. 1979.

7 At many nuclear power plant sites, initial plant construction and various aspects of plant
8 operation have affected wetlands. These effects include those associated with facility
9 construction, transmission line construction and maintenance, construction and operation of
10 cooling systems, and stormwater management. Effects on wetlands from construction activities
11 and stormwater runoff often include changes in vegetative plant community characteristics,
12 altered hydrology, decreased water quality, and sedimentation (Wright et al. 2006; EPA 1996).
13 Forested wetlands in ROWs are converted to scrub/shrub or emergent wetland types when
14 trees are removed, and ROW management programs maintain ROWs in these habitat types.
15 The operation of heavy equipment in wetlands during ROW maintenance or transmission line
16 repairs can damage or compact wetland soils and vegetation and may promote the
17 establishment of invasive species (DOE 2000). Executive Order 13112, "Invasive Species" (64
18 FR 6183), directs Federal agencies to prevent introduction of or to monitor and control invasive
19 species.

20 Wetland losses or alterations occurred during the construction of many nuclear power plants.
21 For example, during construction of the Oyster Creek plant (no longer operating) in New Jersey,
22 the South Branch of Forked River and Oyster Creek were dredged and widened to
23 accommodate operation of the cooling water system. As a result, most of the natural aquatic
24 habitats that occurred within these portions of the river and creek were destroyed (NRC 2007b).
25 Construction resulted in the loss of 200 ac of several types of wetlands (AEC 1974), and the
26 resulting ecology of the river and creek is that they now function similar to Barnegat Bay.
27 However, at nuclear power plants using cooling ponds, new wetland habitats may form along
28 the margins of those ponds.

29 The operation of cooling water systems can expose wetland habitats to thermal impacts and
30 contaminants in effluent discharged from the plant. Intake or discharge structure maintenance,
31 periodic dredging, and the disposal of dredged sediments may also affect wetlands. Chemical
32 or fuel spills on nuclear power plant sites can allow contaminants to enter nearby surface or

1 groundwater, which could affect wetlands that interface with those water sources. Executive
2 Order 11990, "Protection of Wetlands" (42 FR 26961), requires Federal agencies to not only
3 minimize the destruction, loss, or degradation of wetlands while they are conducting their
4 activities but also to preserve and enhance the natural and beneficial values of wetlands. Many
5 activities that occur in wetlands are regulated under Section 404 of the CWA (Federal Water
6 Pollution Control Act of 1972). Actions that result in the discharge of dredge or fill material into
7 wetlands that are covered by the CWA require a permit from the U.S. Army Corps of Engineers.
8 Additional permits may be required dependent upon the State and local jurisdictions.

9 3.6.1.3 *Wildlife*

10 Wildlife near nuclear power plants has also been affected by construction and operations. The
11 initial construction of a nuclear power plant and transmission lines reduced the available
12 terrestrial habitat at the site; habitat losses in many cases totaled hundreds of acres. Site
13 maintenance of developed areas generally results in reduced wildlife diversity in these areas
14 compared to surrounding habitats. Wildlife species occurring on industrial-use portions of
15 nuclear power plant sites are typically limited by the low quality of the habitat and generally
16 include common species adapted to industrial developments.

17 Because habitats along transmission line ROWs are maintained in a modified condition, the
18 wildlife communities they support are different from those found in undisturbed habitats. Some
19 predator species, such as skunks and raccoons, more readily use ROW habitats, and ROWs
20 may therefore provide a means for new or easier access to some areas, thereby affecting
21 populations of prey species (Evans and Gates 1997; Crooks and Soule 1999). Wildlife species
22 in the vicinity of transformers or cooling towers are exposed to elevated noise levels that can
23 disrupt behavior patterns. Wildlife near transmission lines are exposed to electromagnetic fields
24 (EMFs). However, to date, there is no evidence that ecological resources are affected by
25 EMFs. Atmospheric or surface water releases can result in the exposure of wildlife to
26 contaminants. Wildlife is exposed to small amounts of radionuclides from the deposition of
27 particulates released from nuclear power plant vents during normal operations. Exposure to
28 these radionuclides results in a dose rate to terrestrial and riparian animals of much less than
29 0.1 rad/d (0.001 Gy/d), which is the DOE guideline for adequate protection from the effects of
30 ionizing radiation (DOE 2019) (see Section 4.6.1.1.2).

31 Nuclear power plant structures, such as cooling towers, meteorological towers, and
32 transmission lines, create collision hazards for birds. Some bird collisions could be considered
33 unlawful take if the bird species are protected under the Endangered Species Act (ESA) of
34 1973, as amended (16 U.S.C. § 1531 et seq.), the Bald and Golden Eagle Protection Act of
35 1940, as amended (16 U.S.C. §§ 668–668d), or the Migratory Bird Treaty Act of 1918, as
36 amended (16 U.S.C. § 703 et seq.). Several nuclear power plants with natural draft cooling
37 towers have conducted studies to investigate the risk of bird collision hazard related to cooling
38 towers and other site structures. The results of those monitoring efforts indicate that cooling
39 towers at nuclear power plants do cause some collision mortality for migrating songbirds;
40 however, these deaths represent only a fraction of the total annual bird collision mortality from
41 all human-made sources. There are no reports of relatively high collision mortality, such as
42 from electrocution, occurring from transmission lines associated with nuclear power plants in the
43 United States. The length of these lines is considerably less than the total of transmission lines
44 within the United States (Manville 2005). Although the data are not available, transmission lines
45 associated with nuclear power plants are likely responsible for only a small fraction of total bird
46 collision mortality associated with transmission lines nationwide. See Section 4.6.1.1 for a
47 detailed description of bird collision mortality at nuclear power plants.

1 Cooling water systems can have both positive and negative impacts on prey of birds and other
2 wildlife. Potential fish prey can be impinged or entrained by the cooling water intake system,
3 while the fish return system, if present, or heated effluent discharge can provide areas of
4 concentrated prey availability. Cooling system intakes can also create an impingement hazard
5 for waterfowl, and water demands for cooling can create water use conflicts with wildlife. At the
6 Nine Mile Point plant in New York, for example, approximately 100 greater scaup (*Aythya*
7 *marila*) and lesser scaup (*Aythya affinis*) ducks were impinged at the cooling water intake
8 structure in 2000 while feeding on zebra mussels (*Dreissena polymorpha*) during reverse flow
9 conditions for de-icing of the structure (NRC 2006b). As a result of this incident, the licensee
10 now cleans the Nine Mile Point intake structures annually to remove zebra mussels, and
11 reverse flow conditions are scheduled during periods when diving duck feeding is limited (NRC
12 2006b). Water use conflicts at the Wolf Creek Generating Station (Wolf Creek) in Kansas can
13 occur during drought conditions because makeup water for the cooling lake is withdrawn from
14 the Neosho River, resulting in reduced flows (NRC 2008a). During such times, riparian
15 communities along the Neosho River can be degraded or lost because of reduced flows, and
16 wildlife can experience reduced habitat quantity or quality. For some nuclear power plants,
17 State permits restrict water withdrawal to limit the adverse impacts of water withdrawals (e.g.,
18 the Byron [NRC 2015c] and River Bend plants [NRC 2018c]).

19 **3.6.2 Aquatic Resources**

20 Nuclear power plants are usually located near relatively large water bodies, such as major rivers
21 and reservoirs, the Great Lakes, and estuarine and marine coastal areas, which provide a
22 source of water to meet cooling system demands (Table 3.1-2, Table 3.1-3, Table 3.1-4). In the
23 few cases where an operating nuclear power plant is located near only small streams (e.g., the
24 Virgil C. Summer Nuclear Station [Summer] in South Carolina and Clinton plant in Illinois), the
25 streams have been impounded to create cooling lakes. Aquatic resources associated with
26 these water bodies may be affected by nuclear power plant operation. This discussion
27 emphasizes the major ecosystem types (i.e., freshwater rivers, reservoirs, and lakes and
28 coastal estuarine and marine systems) and major groups of aquatic biota (i.e., fish, other
29 aquatic vertebrates, macroinvertebrates, zooplankton, phytoplankton, and macrophytes).
30 Section 3.6.3.1 discusses federally protected aquatic resources.

31 **3.6.2.1 Aquatic Habitats**

32 The aquatic ecological communities that occur in the vicinity of operating nuclear power plants
33 are diverse because of the differences in their geographies and habitat types and in the physical
34 and chemical conditions of the water bodies located near them. The geographical setting,
35 physical conditions (e.g., substrate type, temperature, turbidity, and light penetration), chemical
36 factors (e.g., dissolved oxygen levels and nutrient concentrations), biological interactions
37 (e.g., competition and predation), seasonal influences, and anthropogenic factors all interact to
38 influence the types of species present and the nature of the aquatic community in a particular
39 aquatic ecosystem. Nuclear power plants use freshwater, estuarine, and marine water bodies
40 as sources of cooling water, except for the Palo Verde plant, which uses Phoenix City sewage
41 effluent (Table 3.1-4).

42 Freshwater systems can be broadly categorized as lentic or lotic, depending on the degree of
43 water movement. Lentic systems refer to water bodies that have standing or slow-flowing
44 water, such as that found in ponds, lakes, reservoirs, and some canals. Lotic habitats generally
45 have a measurable velocity and include natural rivers and streams and also some artificial
46 waterways. Although some freshwater aquatic species occur in both lentic and lotic habitats,

1 many species are adapted to the physical, chemical, and ecological characteristics of one
 2 system or the other, and the overall ecological communities present within these aquatic
 3 ecosystem types will differ for a given region of the country.

4 Species composition and ecological conditions within riverine environments are largely
 5 determined by the geographic area, gradient of the riverbed, velocity of the current, and source
 6 of nutrients and organic matter at the base of the food chain. Thus, ecological communities in
 7 rivers become altered if the river is impounded, with the degree of alteration depending on the
 8 degree to which various physical and chemical conditions are affected. These systems are
 9 sensitive to flow depletion or alteration, changes in temperature characteristics, blockages to the
 10 upstream or downstream movement of aquatic organisms, chemical pollution, and the
 11 introduction of non-native species.

Aquatic Ecosystem Types

- **Freshwater:** Waters with a salinity of 0.5 ppt or less.
 - **Lentic:** Standing or slow-flowing fresh water (e.g., lakes and ponds).
 - **Lotic:** Flowing freshwater with a measurable velocity (e.g., rivers and streams).
- **Marine:** Waters with a salinity of about 35–37 ppt (e.g., ocean overlying the continental shelf and associated shores).
- **Estuarine:** Coastal bodies of water, often semi-enclosed, that have a free connection with marine ecosystems (e.g., bays, inlets, lagoons, and ocean-flooded river valleys). In these areas, freshwater merges with marine waters; salinity concentrations vary spatially and temporally due to location and tidal activity.

12 Major rivers that serve as cooling water sources for operating nuclear power plants include the
 13 Mississippi River, Tennessee River, Missouri River, Susquehanna River, Delaware River, and
 14 Columbia River (see Table 3.1-4). Some nuclear power plants that use rivers for cooling are
 15 located on sections of rivers that have been impounded to slow the rate of flow and create
 16 pooled areas in the vicinity of cooling water withdrawal or discharge structures. These sections
 17 are not as clearly lentic in nature as the reservoirs.

18 The ecological communities that inhabit the aquatic environment differ, reflecting the
 19 preferences and tolerances of aquatic species at various life stages for the physical and
 20 chemical conditions that exist. A list of cooling water sources by operating nuclear power plant
 21 can be found in Table 3.1-3. Within the United States, nine operating nuclear power plants use
 22 water from natural lakes for cooling. These lakes are Lake Erie, Lake Michigan, and Lake
 23 Ontario.

24 Reservoirs differ from natural lakes and refer to areas of rivers or streams that are impounded
 25 by a dam or water control structure such that they have become physically, chemically, and
 26 ecologically more similar to lakes instead of the lotic system from which they are formed
 27 (Armantrout 1998). In the United States, 14 nuclear power plants use water from reservoirs for
 28 cooling. Fish species that thrive in the habitat conditions that exist within a given reservoir are
 29 often stocked and managed to support recreational fisheries (see Table 3.1-4).

30 Brackish to saltwater estuarine and marine ecosystems occur along the coastlines of the
 31 United States. General habitat types found within these ecosystems include the mouths of

Affected Environment

1 rivers, tidal streams, shorelines, salt marshes, beaches, mangroves, submerged aquatic
2 vegetation, coral reefs, and open water. Estuaries are particularly important as staging points
3 during the migration of certain fish species (e.g., salmon and eels) because these waterbodies
4 give fish time to form schools and to physiologically adjust to changes in salinity. Many marine
5 fish and invertebrate species use estuaries for spawning or as places where young fish can feed
6 and grow before moving to other marine habitats. Estuarine and marine habitats support
7 important commercial or recreational finfish and shellfish species. In the United States,
8 11 nuclear power plants use water from estuarine or marine environments (see Table 3.1-2).

9 3.6.2.2 Aquatic Organisms

10 Major groups of aquatic organisms include fish, other macroinvertebrates, aquatic
11 macroinvertebrates, zooplankton, phytoplankton and aquatic macrophytes.

12 Fish can be characterized as freshwater, estuarine, marine, or diadromous (e.g., anadromous
13 and catadromous) species. The first three categories are based on salinity regimes, whereas
14 the diadromous category is composed of reproductively specialized fish that migrate between
15 freshwater and saltwater to reproduce. Murdy et al. (1997) defined freshwater fish as those that
16 usually inhabit waters with a salinity of less than 0.5 ppt; estuarine fish as those that inhabit tidal
17 waters with salinities that range between 0 and 30 ppt; and marine fish as those that typically
18 live and reproduce in coastal and oceanic waters with salinities that are 35 to 37 ppt.
19 Anadromous species migrate from marine waters to freshwater to spawn, while catadromous
20 species migrate from freshwater to marine waters to spawn. Anadromous species include
21 sturgeons, clupeids, salmonids, smelts, striped bass (*Morone saxatilis*), and sea lamprey
22 (*Petromyzon marinus*). Within the United States, the only catadromous species is the American
23 eel (*Anguilla rostrata*). For some species, migratory movements may be confined within a
24 freshwater system (e.g., species tend to move to upstream areas for spawning) or within the
25 ocean (e.g., species tend to move northward as waters warm and southward as they cool).
26 Many of the fish species that occur in the vicinity of the nuclear power plants are of commercial
27 or recreational importance, while others serve as forage for those species.

28 Fish have various mechanisms to maintain health and fitness during large diurnal or seasonal
29 changes in water temperature. The swimming performance of fish is influenced by temperature.
30 A given species' swimming speed and endurance peak within a certain optimal temperature
31 range but are reduced at lower or higher temperatures (Claireaux et al. 2006). Many marine
32 fish have buoyant eggs while most stream fish have demersal eggs that are heavy and sink to
33 the bottom of the water column. Most demersal eggs are also, at least temporarily, adhesive
34 (Lagler et al. 1962). Newly hatched larvae undergo natural mortality rates of 5 to 30 percent per
35 day as a result of predation, starvation, disease, pollution, and other causes (Batty and Blaxter
36 1992).

37 In addition to fish, other vertebrate species can be present in the aquatic ecosystems near
38 nuclear power plants. These include marine reptiles, such as sea turtles, and marine mammals,
39 such as whales, seals, and the West Indian manatee (*Trichechus manatus*).

40 Aquatic macroinvertebrates include a diverse range of taxa, including immature and adult
41 insects, crustaceans, mollusks, and worms. These can occur on a variety of stable surfaces
42 such as substrates, plants, debris, etc., and within the water. Macroinvertebrates control key
43 ecosystem processes, such as primary production, decomposition, nutrient regeneration, water
44 chemistry, and water clarity.

1 Nuisance or invasive species can be present in cooling water sources. For example, Asiatic
2 clams (*Corbicula fluminea*) and zebra mussels can alter the trophic and nutrient dynamics of
3 aquatic ecosystems and displace native mussels. Executive Order 13112, "Invasive Species"
4 (64 FR 6183), directs Federal agencies to prevent introduction of or to monitor and control
5 invasive species. Many nuclear power plants monitor for these species and periodically use
6 physical or chemical methods to control biofouling of cooling system structures and
7 components.

8 Zooplankton include protozoans, crustaceans, and the drifting larvae of fish and
9 macroinvertebrates. Rotifers, cladocerans, and copepods are primary components of the
10 zooplankton community in freshwater ecosystems. The zooplankton of estuarine and marine
11 ecosystems include eggs, larvae, juveniles, and adults of anemones, jellyfish, bristleworms, sea
12 urchins, starfish, copepods, isopods, amphipods, shrimp, crabs, lobsters, bryozoans, and
13 mollusks. Ichthyoplankton, which are fish eggs and larvae, are a seasonal component of the
14 zooplankton in all aquatic ecosystems. Zooplankton are an important link between
15 phytoplankton and fish or other secondary consumers.

16 Phytoplankton are an important food source for some invertebrate and fish species and are
17 important for converting carbon dioxide (CO₂) to organic materials via photosynthesis.
18 Periphyton are algae attached to solid submerged objects and include species of diatoms and
19 other algae that grow on natural or artificial substrates. These species can become planktonic
20 as a result of scouring or other actions that separate individuals from their substrate.
21 Components of phytoplankton include green algae (Chlorophyta), blue-green algae
22 (Cyanophyta), and golden brown algae (Chrysophyta). Brown algae and kelp (Phaeophyta) and
23 red algae (Rhodophyta) also occur in marine waters. Diatoms (Bacillariophyta) are a major
24 component of the phytoplankton in many aquatic systems. Macrophytes can stabilize
25 sediments, act as important links in nutrient cycling, provide shelter and protection for animal
26 communities, and provide important nursery areas (Hall et al. 1978). Factors that affect the
27 distribution and condition of submersed aquatic vascular plants include weather and hydrology,
28 sedimentation, suspended solids and water clarity, and consumption and disturbance by fish
29 and wildlife (USGS 1999).

30 3.6.2.3 *Effects of Existing Nuclear Plant Operations on Aquatic Resources*

31 The effects of nuclear power plant operations on aquatic resources include impingement and
32 entrainment of aquatic organisms into the cooling water intake system, effects associated with
33 thermal discharges, and chemical and radiological contamination.

34 Impingement occurs when organisms are trapped against the outer part of an intake structure's
35 screening device (79 FR 48300). The force of the intake water traps the organisms against the
36 screen, and individuals are unable to escape. Impingement can kill organisms immediately or
37 cause exhaustion, suffocation, injury, and other physical stresses that contribute to later
38 mortality. The potential for injury or death is generally related to the amount of time an
39 organism is impinged, its fragility (susceptibility to injury), and the physical characteristics of the
40 screen wash and fish return systems of the intake structure. Entrainment occurs when
41 organisms pass through the screening device and travel through the entire cooling system,
42 including the pumps, condenser or heat exchanger tubes, and discharge pipes (79 FR 48300).
43 Organisms susceptible to entrainment are of smaller size, such as ichthyoplankton,
44 meriplankton, zooplankton, and phytoplankton. Impingement and entrainment occurs at all
45 nuclear power plants that withdraw water from a natural water body. The magnitude of impact
46 that impingement and entrainment creates on the aquatic environment depends on the plant-

Affected Environment

1 specific characteristics of the cooling system as well as the characteristics of the local aquatic
2 community.

3 Temperature can influence most biochemical, physiological, and life history activities of aquatic
4 organisms (Beitinger et al. 2000). Thermal effects on aquatic biota can be lethal, sub-lethal, or
5 community-level. These effects include heat shock; cold shock; interference with fish migration;
6 accelerated maturation of aquatic insects; and proliferated growth of aquatic nuisance species.

7 Nuclear power plants also affect aquatic organisms through radiological and nonradiological
8 chemical releases. Chemical effects on aquatic biota can occur from exposure to biocides and
9 other contaminants (e.g., heavy metals such as copper, zinc, and chromium that may be
10 leached from condenser tubing and other heat exchangers). Blowdown from closed-cycle
11 cooling systems can contain concentrated levels of constituents present in the makeup water,
12 residual biocides, process contaminants, and other chemicals added for controlling corrosion or
13 deposits (DOE 1997a). Radionuclides are released to aquatic systems at or below permitted
14 levels at nuclear power plants (10 CFR Part 20, Appendix B). Radionuclides can be
15 environmentally significant because they have a strong tendency to adsorb onto particles
16 (e.g., suspended and settled solids), can accumulate in biological organisms, or can be
17 concentrated through trophic transfers (MDNR 2019). However, exposure to radionuclides
18 results in a dose rate to aquatic organisms of much less than 1.0 rad/d (0.1 Gy/d), which is the
19 DOE guideline for adequate protection from the effects of ionizing radiation (DOE 2019) (see
20 Section 4.6.1.2.9). Radionuclides, such as tritium, and other constituents in cooling water
21 systems, such as biocides, can enter aquatic systems and be taken up by aquatic plants and
22 animals.

23 The impact of any type of nuclear power plant on aquatic resources can be difficult to determine
24 because individual organisms and populations also respond to changes in environmental
25 conditions (EPA 2002). Table 3.6-1 lists factors that influence the impacts of nuclear power
26 plant operation on aquatic organisms, including characteristics of the nuclear power plant itself,
27 as well as physical and biological ecosystem factors.

28 **Table 3.6-1 Factors That Influence the Impacts of Nuclear Power Plant Operation on**
29 **Aquatic Organisms**

Nuclear Power Plant Factors

- Volume of water withdrawn from source waterbody, which generally relates to type of cooling system (e.g., once-through, cooling tower, cooling pond, or hybrid)
 - Cooling water intake velocity
 - Intake and discharge location (e.g., distance from shoreline, depth of intake, biological richness of area, proximity to spawning and rearing habitat)
 - Exclusion technologies (e.g., traveling screens and mesh size, screen wash characteristics, fish return system, capture and release programs)
 - Thermal effluent temperature when entering receiving waterbody
 - Thermal plume characteristics (e.g., surface area, depth, isotherm contours)
 - Mitigation strategies (e.g., helper cooling tower operation, seasonal water withdrawal reductions, timing of outages, multiport or jet diffusers that promote rapid mixing of effluent)
 - Radiological effluents
 - Nonradiological chemical contaminants (e.g., chlorine, heavy metals, biocides)
 - Dredging to improve intake flow and keep intake and discharge areas clear of sediment
-

Nuclear Power Plant Factors

- Water use conflicts with aquatic resources
-

Physical Ecosystem Factors

- Waterbody type (e.g., riverine, lacustrine, estuarine, marine)
 - Ambient water temperatures and seasonal regimes
 - Ambient water quality (e.g., salinity, dissolved oxygen, pollutant levels)
 - Stream flow and tidal influence
 - Other human-induced stressors (e.g., dams, agricultural runoff, other industrial water users)
-

Biological Ecosystem Factors

- Spatial and temporal distribution of aquatic organisms and populations
 - Species richness and evenness
 - Population abundances and trends
 - Habitat and sediment types present
 - Seasonality of habitat use and migratory patterns of species
 - Developmental stage of organism (e.g., egg, larvae, juvenile, adult)
 - Body size of organism
 - Condition and health of organism
 - Ability of organism to detect or avoid flow of water into cooling water intake system
 - Swimming capability of organism (e.g., burst, prolonged, and sustained swimming speeds)
 - Physiological tolerance to abiotic factors (e.g., temperature, salinity, dissolved oxygen)
 - Reproductive strategy and characteristics (e.g., location of spawning, mode of egg and larval dispersal)
 - Predation pressures
-

1 **3.6.3 Federally Protected Ecological Resources**

2 The NRC must consider the effects of its actions on ecological resources protected under
 3 several Federal statutes and must consult with the FWS or the National Oceanic and
 4 Atmospheric Administration (NOAA) prior to taking action in cases where an agency action may
 5 affect those resources. These statutes include the following:

- 6 • Endangered Species Act of 1973, as amended (ESA) (16 U.S.C. § 1531 et seq.)
- 7 • Magnuson-Stevens Fishery Conservation and Management Act (MSA), as amended by the
 8 Sustainable Fisheries Act of 1996 (16 U.S.C. § 1801 et seq.)
- 9 • National Marine Sanctuaries Act (NMSA) (16 U.S.C. § 1431 et seq.).
- 10 • The FWS and the NOAA's National Marine Fisheries Service (NMFS) (collectively, "the
 11 Services") promulgated regulations on interagency consultation under the ESA in 1986 (51
 12 FR 19926). Depending on when a nuclear power plant was constructed and began
 13 operating, the NRC staff may have consulted with one or both Services under the ESA
 14 during initial permitting and licensing. NMFS promulgated regulations on interagency
 15 consultation under the MSA in 2002 (67 FR 2343). Congress amended the NMSA to
 16 require interagency coordination with NOAA's Office of National Marine Sanctuaries
 17 (ONMS) in 1992 (National Marine Sanctuaries Program Amendments Act of 1992). The
 18 NRC staff did not conduct essential fish habitat (EFH) and NMSA consultations during initial
 19 permitting and licensing of any current nuclear power plants, including those that have been

Affected Environment

1 decommissioned or are in decommissioning, because these statutes had either not been
2 passed or had not been amended to require consultation; however, rare species and unique
3 ecological habitats were often considered in project planning. The NRC staff did not
4 conduct EFH consultation for the first several initial LR reviews because these reviews were
5 also conducted prior to the establishment of consultation requirements.

6 The sections below discuss species and habitats protected under each of the three statutes and
7 how nuclear power plant operation during an initial LR or SLR term may affect these protected
8 resources.

9 3.6.3.1 *Endangered Species Act*

10 Congress enacted the ESA in 1973 to protect and recover imperiled species and the
11 ecosystems upon which they depend. The ESA provides a program for the conservation of
12 endangered and threatened plants and animals (collectively, “listed species”) and the habitats in
13 which they are found. The FWS and NMFS are the lead Federal agencies for implementing the
14 ESA, and these agencies are charged with determining species that warrant listing.

15 Section 7 of the ESA establishes interagency consultation requirements for actions by Federal
16 agencies. Section 7(a)(1) of the ESA charges Federal agencies to aid in the conservation of
17 listed species. Section 7(a)(2) of the ESA requires that Federal agencies consult with the
18 Services for actions that “may affect” federally listed species and critical habitats and to ensure
19 that their actions do not jeopardize the continued existence of those species or destroy or
20 adversely modify those habitats. Private actions with a Federal nexus, such as construction and
21 operation of facilities that involve Federal licensing or approval, are also subject to consultation.
22 Therefore, the NRC’s issuance of initial or subsequent renewed licenses may trigger
23 consultation requirements. Consultation pursuant to ESA Section 7(a)(2) is commonly referred
24 to as “Section 7 consultation.”

25 Section 9 of the ESA prohibits any action that causes a “take” of any listed species of
26 endangered fish or wildlife by any person or entity. Take, as defined under the ESA, means to
27 harass, harm, pursue, hunt, shoot, wound, kill, trap, capture, or collect, or to attempt to engage
28 in any such conduct. Likewise, import, export, interstate, and foreign commerce of listed
29 species are all generally prohibited.

30 Species listings and critical habitat designations require rulemakings and are codified at
31 50 CFR Part 17, “Endangered and Threatened Wildlife and Plants.” As of 2022, over
32 700 animals and 900 plants are listed as endangered or threatened, and the Services have
33 designated critical habitat for many of these species. Given this large number, listed species
34 are likely to occur near all operating nuclear power plants. However, the potential for a given
35 species to occur in the action area of a specific nuclear power plant depends on the life history,
36 habitat requirements, and distribution of that species and the ecological environment present on
37 or near the power plant site. The “action area” is a regulatory term. It includes all areas to be
38 affected directly or indirectly by the Federal action and not merely the immediate area involved
39 in the action (50 CFR 402.02). The action area is not limited to the footprint of the action nor is
40 it limited by the Federal action agency’s authority; rather, it is a biological determination of the
41 reach of the proposed action on the listed species.

42 In general, estuarine or marine listed species may occur in the action area of plants that draw
43 directly from estuaries or the ocean. Examples of such species include listed species of
44 sturgeon, sea turtles, whales, and salmon. Freshwater listed species, such as mussels and

1 pallid sturgeon (*Scaphirhynchus albus*), may occur in the action area of plants that draw directly
2 from freshwater sources, such as rivers or Great Lakes. Listed aquatic species are generally
3 less likely to be present in constructed habitats, such as cooling ponds or canals, that do not
4 hydrologically connect to natural surface waters from which colonization or immigration could
5 occur. The presence of terrestrial listed species is highly dependent upon habitat availability
6 and quality on or near the nuclear power plant site. Northern long-eared bats (*Myotis*
7 *septentrionalis*) and Indiana bats (*M. sodalis*) are widely distributed across the eastern and
8 north central United States and may be present at any site within their ranges whose habitat
9 provides sufficient forage, roosting, or hibernating opportunities. Likewise, listed migratory birds
10 may seasonally inhabit the action area of a nuclear power plant whose site provides even
11 marginal stopover habitat, especially if that site is within one of the four major North American
12 flyways.

13 Table 3.6-2 and Table 3.6-5 identify critical habitats and listed species that the NRC staff, in
14 consultation with the Services, evaluated during initial LR or SLR environmental reviews
15 conducted since development of the 2013 LR GEIS. As part of the 19 environmental reviews
16 identified in the tables below, the NRC staff evaluated 107 listed species and designated critical
17 habitat of 7 listed species. Many of the same species were present in the action area of multiple
18 nuclear power plants. The most commonly evaluated terrestrial species were northern long-
19 eared bats (11 license renewal reviews), Indiana bat (9 reviews), piping plover (*Charadrius*
20 *melodus*) (6 reviews), eastern prairie fringed orchid (*Platanthera leucophaea*) (5 reviews), and
21 rufa red knot (*Calidris canutus rufa*) (4 reviews). The most commonly evaluated aquatic species
22 were Atlantic sturgeon (*Acipenser oxyrinchus*) (5 reviews), shortnose sturgeon (*A. brevirostrum*)
23 (5 reviews), and pallid sturgeon (*Scaphirhynchus albus*) (4 reviews). Notably, the NRC staff
24 evaluated the effects of nuclear power plant license renewal on all five of the listed Atlantic
25 sturgeon distinct population segments (DPSs) among the five evaluations of this species. All
26 other species listed in Table 3.6-5 were evaluated in three license renewal reviews or less.

27 Critical habitat represents the habitat that contains the physical or biological features essential
28 to conservation of the listed species and that may require special management considerations
29 or protection (78 FR 53058). Critical habitat may also include areas outside the geographical
30 area occupied by the species if the Services determine that the area itself is essential for
31 conservation. The NRC staff evaluated the critical habitat of seven listed species among six
32 license renewal reviews since publication of the 2013 LR GEIS. Notably, the FWS has
33 designated much of the Turkey Point site in Florida, including the plant's artificial cooling canal
34 system (i.e., CCS), as critical habitat for the American crocodile (*Crocodylus acutus*). At the
35 Surry plant in Virginia, the entirety of the James River in the action area of the plant is
36 designated as critical habitat for the Chesapeake Bay DPS of Atlantic sturgeon. The Hudson
37 River within the action area of the Indian Point plant (no longer operating) in New York is
38 designated critical habitat for the New York Bight DPS of Atlantic sturgeon. At the Point Beach
39 plant in Wisconsin, the FWS has designated critical habitat for the Great Lakes population of
40 piping plover approximately 3 mi (5 km) south of the plant site along the shoreline of Lake
41 Michigan.

42 As the Services continue to evaluate species for listing and delisting, new species may be
43 relevant to license renewal reviews and additional critical habitat designations may occur near
44 operating nuclear power plants. This means that for a given plant, the staff may be required to
45 evaluate different or additional listed species and critical habitats during an SLR review than the
46 staff evaluated during the initial LR review for that same plant.

1 **Table 3.6-2 Critical Habitats Evaluated in License Renewal Reviews, 2013–Present**

Nuclear Power Plant	FWS Critical Habitat	Final Effect Determination^(c)	NMFS Critical Habitat	Final Effect Determination^(c)
Grand Gulf	Louisiana black bear	NE	-	-
Grand Gulf	rabbitsfoot mussel ^(d)	NE	-	-
LaSalle	Indiana bat	NE	-	-
Indian Point ^(a)	-	-	Atlantic sturgeon, New York Bight DPS	NLDM
Turkey Point ^(b)	American crocodile	LDM	-	-
Turkey Point ^(b)	West Indian manatee	NLDM	-	-
Surry ^(b)	Atlantic sturgeon, Chesapeake Bay DPS	NLDM	Atlantic sturgeon, Chesapeake Bay DPS	NLDM
Point Beach ^(b)	piping plover	NE	-	-

2 FWS = U.S. Fish and Wildlife Service; NMFS = U.S. National Marine Fishery Services; NE = no effect; NLDM = may
 3 affect but is not likely to destroy or adversely modify; and LDM = likely to destroy or adversely modify; DPS = distinct
 4 population segment.

5 (a) The evaluation of this species was a part of a review that supplemented the NRC's Final Supplemental
 6 Environmental Impact Statement (final SEIS).

7 (b) This review evaluated an SLR term.

8 (c) The effect determinations provided here are the final determinations concerning each species that resulted from
 9 consultation with the Services. In some cases, the Service's letter of concurrence revised or amended the NRC
 10 staff's original effect determinations for a given species.

11 (d) At the time the NRC staff performed its review, critical habitat for this species was proposed for Federal listing.
 12 The Services have now issued a final rule designating this critical habitat.

13 No entry has been denoted by "-".

14 Sources: NRC 2014e, NRC 2016d, NRC 2018e, NRC 2019c, NRC 2020f, NRC 2021f.

15 Listed species and critical habitats can be adversely affected by the same factors described in
 16 Sections 3.6.1 and 3.6.2 relevant to terrestrial and aquatic resources. However, the magnitude
 17 and significance of such impacts can be greater for listed species because—by virtue of being
 18 eligible for Federal listing—these species are significantly more sensitive to environmental
 19 stressors as their populations are already in decline. Similarly, critical habitats are afforded
 20 special protections because they are critical to the preservation of the listed species.

21 In cases where adverse effects on listed species or critical habitats are possible, the NRC staff
 22 has engaged the Services in formal ESA Section 7 consultation as part of the license renewal
 23 review and obtained a biological opinion. A biological opinion evaluates the nature and extent
 24 of effects of the action on listed species and critical habitats. It is prepared by the FWS or
 25 NMFS and documents the Service's assessment of effects on listed species and critical habitat
 26 and whether the Federal action is likely to jeopardize the continued existence of those species
 27 or result in destruction or adverse modification of critical habitat. Biological opinions may
 28 include an incidental take statement (ITS) consisting of the level of anticipated take, reasonable
 29 and prudent measures, and terms and conditions. Any take that is subject to and in compliance
 30 with an ITS is not prohibited under the ESA. Biological opinions may also include discretionary
 31 conservation recommendations.

32 For consultations resulting in the Service's issuance of a biological opinion, the NRC requires its
 33 licensees to comply with the ITS of the biological opinion by incorporating environmental

1 conditions into the relevant NRC facility license(s). As conditions of NRC-issued licenses, the
 2 NRC has a continuing duty to monitor compliance at facilities with valid biological opinions. This
 3 role is performed by the NRC’s Interagency Consultation Coordinator. The NRC may exclude
 4 specific ITS requirements from its license(s) if another Federal agency will require those actions
 5 be taken.

6 Since the publication of the 2013 LR GEIS, the Services have issued six biological opinions in
 7 connection with continued operation of nuclear power plants during an initial LR or SLR term.
 8 These biological opinions are for the Indian Point (no longer operating), Salem Nuclear
 9 Generating Station (Salem) and Hope Creek, St. Lucie Nuclear Plant (St. Lucie), Columbia,
 10 Turkey Point, and Oyster Creek (no longer operating) plants. Each biological opinion includes
 11 an ITS that allows for a specified amount of take of these species that is incidental to, and not
 12 the purpose of, carrying out the Federal action of license renewal, as well as reasonable and
 13 prudent measures and terms and conditions to minimize such take. In accordance with these
 14 requirements, these plants monitor and report the effects of continued operation under the
 15 license renewal terms to the Services and the NRC. In total, NMFS has issued biological
 16 opinions to address take of listed fish and sea turtles resulting from impingement, entrainment,
 17 or entrapment at 10 nuclear power plants. Table 3.6-3 lists the nuclear plants and relevant
 18 species to which these opinions apply. The FWS has issued one biological opinion to address
 19 the effects of operation of the Turkey Point plant. Table 3.6-4 lists the species to which this
 20 opinion applies.

21 **Table 3.6-3 NMFS-Issued Biological Opinions for Nuclear Power Plant Operation**

Nuclear Power Plant	Issue Date	Species Addressed in ITS	Opinion Reference
Brunswick	January 1, 2000	green sea turtle hawksbill sea turtle Kemp’s ridley sea turtle leatherback sea turtle loggerhead sea turtle	NRC 2000
Columbia	March 10, 2017	chinook salmon, Upper Columbia River spring run steelhead, Upper Columbia River	NMFS 2017
Crystal River ^(a)	August 8, 2002	green sea turtle hawksbill sea turtle Kemp’s ridley sea turtle leatherback sea turtle loggerhead sea turtle	NMFS 2002
Diablo Canyon	September 18, 2006	green sea turtle leatherback sea turtle loggerhead sea turtle olive ridley sea turtle	NMFS 2006
Hope Creek ^(b)	July 17, 2014, as clarified on November 23, 2018	none ^(c)	NMFS 2014c NMFS 2018c
Indian Point ^(d)	January 30, 2013, as amended on April 10, 2018, and October 5, 2020	Atlantic sturgeon shortnose sturgeon	NMFS 2013 NMFS 2018a NMFS 2020a
Oyster Creek ^(e)	May 29, 2020	green sea turtle Kemp’s ridley sea turtle loggerhead sea turtle	NRC 2020b

Affected Environment

Nuclear Power Plant	Issue Date	Species Addressed in ITS	Opinion Reference
Salem ^(b)	July 17, 2014, as clarified on November 23, 2018	Atlantic sturgeon shortnose sturgeon green sea turtle Kemp's ridley sea turtle loggerhead sea turtle	NMFS 2014c NMFS 2018c
San Onofre ^(f)	September 18, 2006	green sea turtle leatherback sea turtle loggerhead sea turtle olive ridley sea turtle	NMFS 2006
St. Lucie ^(g)	March 24, 2016	green sea turtle hawksbill sea turtle Kemp's ridley sea turtle leatherback sea turtle loggerhead sea turtle smalltooth sawfish	NMFS 2016

- 1 ITS = incidental take statement.
2 (a) Crystal River plant shut down in February 2013. In a letter dated January 24, 2022, NMFS (2022) confirmed that
3 the 2002 biological opinion is no longer applicable because the plant's cooling water intake system has been
4 repurposed and modified for the Duke Energy Citrus Combined Cycle Station and is currently compliant with the
5 2014 programmatic biological opinion on the EPA's final regulations implementing Section 316(b) of the CWA
6 (FWS/NMFS 2014).
7 (b) As of mid-2022, the NRC is in reinitiated consultation with NMFS to address incidental take of Atlantic sturgeon
8 and Kemp's ridley sea turtles at Salem in excess of the levels established in the ITS. At the conclusion of this
9 consultation, NMFS will issue a new biological opinion for continued operation of Salem and Hope Creek plants
10 under the terms of the renewed operating licenses.
11 (c) In its biological opinion, NMFS evaluates the potential effects of Hope Creek operations on Atlantic and
12 shortnose sturgeon and sea turtles but does not exempt incidental take at this plant because none is anticipated.
13 (d) Indian Point 2 ceased power operations in April 2020, and Indian Point 3 ceased in April 2021. Certain terms
14 and conditions of the biological opinion continue to impose requirements during the decommissioning period.
15 (e) Oyster Creek plant ceased power operations in September 2018. The 2020 biological opinion addresses the
16 effects of the last several years of operation as well as decommissioning. Although NMFS's prior biological
17 opinion, issued on November 21, 2011, allowed for incidental take of sea turtles in the form of impingement into
18 the cooling system intake system, the 2020 biological opinion does not exempt any additional take and does not
19 include an ITS.
20 (f) San Onofre plant ceased power operations in June 2013. As of mid-2022, the NRC is in reinitiated consultation
21 with NMFS to address the potential impacts of decommissioning on federally listed species. At the conclusion of
22 consultation, NMFS may issue a new biological opinion if it determines that take is anticipated during the
23 decommissioning period, or NMFS may not issue a new biological opinion and conclude consultation informally if
24 take is not anticipated.
25 (g) As of mid-2022, the NRC is in reinitiated consultation with NMFS to address incidental take of smalltooth
26 sawfish, green sea turtles, and Kemp's ridley sea turtles in excess of the levels established in the ITS.
27 Additionally, the plant collected two giant manta rays in the intake canal in 2020. At the conclusion of this
28 consultation, NMFS will issue a new biological opinion for continued operation of St. Lucie plant under the terms
29 of the renewed operating licenses. The new biological opinion will also address scalloped hammerhead sharks,
30 which were listed under the ESA in 2014 and have been historically captured at St. Lucie.

31 **Table 3.6-4 FWS-Issued Biological Opinions for Nuclear Power Plant Operation**

Nuclear Power Plant	Issue Date	Species Addressed in ITS	Opinion Reference
Turkey Point	July 25, 2019, as amended on March 21, 2022	American crocodile eastern indigo snake	FWS 2019a FWS 2022a

32 ITS = incidental take statement.

1 The primary concern for listed aquatic species at operating nuclear power plants is the effects
2 associated with operation of the cooling system. Listed fish, shellfish, and sea turtles are
3 vulnerable to impingement, entrainment, and entrapment at plants that withdraw cooling water
4 from natural water bodies, such as rivers, estuaries, and the ocean. Open-cycle cooling
5 systems withdraw more water, and at a typically higher velocity, than cooling-tower-based
6 closed-cycle systems. Therefore, risk of impingement, entrainment, and entrapment is greater
7 at these facilities.

8 Sea turtles are susceptible to impingement or entrapment at numerous once-through oceanic
9 plants. For instance, at the St. Lucie plant in Florida, marine organisms can enter one of three
10 intake pipes located in the Atlantic Ocean and be drawn into the intake canal where they
11 become entrapped. Since operations began in the late 1970s, St. Lucie plant has collected
12 seven listed species in its intake canal: five species of sea turtles,⁴ smalltooth sawfish (*Pristis*
13 *pectinata*), and giant manta rays (*Mobula birostris*). Additionally, the plant collected two
14 scalloped hammerhead sharks (*Sphyrna lewini*) prior to the NMFS's listing of this species in
15 2014. The NRC (2019a) most recently evaluated the impacts of St. Lucie plant operations on
16 federally listed species in a 2019 biological assessment prepared to support reinitiated ESA
17 Section 7 consultation. In that assessment, the NRC found that sea turtles could become
18 injured or die from travel through the intake pipes or from entanglement in barrier nets within the
19 intake canal. Turtles could suffer additional stress associated with capture and release. The
20 NRC found that smalltooth sawfish may experience minor to moderate injury because of St.
21 Lucie's cooling water intake system. As of mid-2022, the NRC and NMFS remain in reinitiated
22 consultation, and NMFS has not yet made a final determination of effects. Sea turtle
23 impingement or entrapment has also occurred at six other nuclear power plants: (1) Oyster
24 Creek in New Jersey (no longer operating); (2) Salem in New Jersey; (3) Brunswick Steam
25 Electric Plant (Brunswick) in North Carolina; (4) Crystal River Nuclear Power Plant (Crystal
26 River) in Florida (no longer operating); (5) Diablo Canyon in California; and (6) San Onofre (no
27 longer operating) in California. NMFS has issued biological opinions for each of these plants to
28 address these effects (see Table 3.6-3).

29 At coastal northeast plants, Atlantic and shortnose sturgeon can become impinged or entrained
30 on trash racks, traveling screens, or other components of the cooling water intake system.
31 NMFS has issued biological opinions for both the Salem and Indian Point (no longer operating)
32 plants to address these effects (Table 3.6-3). At other plants, although sturgeon are in the
33 action area, the NRC and NMFS have determined that impingement and entrainment are not
34 likely. For instance, at the Surry plant, the NRC (2020f) found that impingement of shortnose
35 and Atlantic sturgeon is extremely unlikely to occur during the SLR term because the life stages
36 of sturgeon in the action area would be of sufficient size and swimming capability to resist the
37 flow of water into Surry's low-level intake structure. The NRC (2020f) found that entrainment
38 does not pose a risk to sturgeon because entrainable life stages do not occur in the action area.
39 NMFS (2020b) concurred with this determination and did not issue a biological opinion for this
40 plant.

41 At the Columbia plant in Washington, Upper Columbia River spring run Chinook salmon
42 (*Oncorhynchus tshawytscha*) and Upper Columbia River steelhead (*O. mykiss*) are susceptible
43 to impingement on the intake screens or entrainment into the intake system because these
44 species migrate past the plant seasonally as fry, which are only a few centimeters in length at
45 this life stage. Notably, following the license renewal review, the licensee conducted fish

⁴ The species of sea turtles are green (*Chelonia mydas*), hawksbill (*Eretmochelys imbricata*), leatherback (*Dermochelys coriacea*), loggerhead (*Caretta caretta*), and Kemp's ridley (*Lepidochelys kempii*).

Affected Environment

1 entrainment characterization studies that showed that very few fish of any species are entrained
2 into Columbia's cooling water intake system due to its design, which hydraulically deflects fish
3 from becoming trapped on or passing through the intake screens. Neither of the two listed
4 salmon species were collected during the study. Nonetheless, because Chinook salmon fry are
5 small and seasonally abundant in the Hanford Reach of the Columbia River, researchers
6 estimated that one to two Chinook salmon fry could have been entrained during the two-year
7 study period (Anchor QEA, LLC 2020). Such take, if it occurred, is allowable under the NMFS's
8 2017 biological opinion (see Table 3.6-3).

9 Effects associated with thermal effluent discharge are another primary concern for aquatic listed
10 species and their critical habitats. Cooling water discharges are regulated by the EPA, or
11 authorized States or Tribes, under Section 316(a) of the CWA. Thermal effluent criteria and
12 limitations are imposed on many plants through special conditions in the site NPDES permit.
13 Under CWA Section 316(a), EPA or the States must establish thermal effluent limitations that
14 assure the protection and propagation of the water body's balanced, indigenous population of
15 shellfish, fish, and wildlife. Nonetheless, thermal discharges can affect habitat availability and
16 fish behavior or migration. For instance, if a thermal plume extends across a river, it can affect
17 fish migration by causing individuals to exert additional energy to avoid heated water, or it can
18 block passage altogether. In general, the NRC has found thermal effects on listed species to be
19 insignificant or discountable, and the NMFS has concurred on these findings during
20 consultation.

21 Listed terrestrial species, including bats, birds, mammals, reptiles, amphibians, and
22 invertebrates, can be affected by habitat loss, degradation, disturbance, or fragmentation
23 resulting from construction, refurbishment, or other site activities, including site maintenance
24 and infrastructure repairs, during the license renewal term. In general, the NRC staff has not
25 found habitat alternation to be of concern in past NRC license renewal reviews. Nuclear power
26 plant sites are already fully developed to support power operations, and neither initial LR nor
27 SLRs generally require additional development that would affect natural habitats on or
28 surrounding the site.

29 Noise and vibration and general human disturbance are stressors that can disrupt normal
30 feeding, sheltering, and breeding activities. At low noise levels or farther distances, animals
31 initially may be startled but would likely habituate to the low background noise levels. At louder
32 noise levels and closer range, animals would likely be startled to the point of fleeing from the
33 area. Fleeing individuals would expend increased levels of energy and would forgo the
34 foraging, resting, or breeding opportunities that the action area may have otherwise provided.
35 However, listed species that use the action area of operating nuclear power plants have likely
36 become habituated to such disturbance because these plants have been consistently operating
37 for several decades. For instance, the NRC (2021f) found that continued disturbances during
38 the SLR term of the Point Beach plant in Wisconsin would not cause behavioral changes in
39 piping plovers to a degree that would be able to be meaningfully measured, detected, or
40 evaluated or that would reach the scale where a take might occur. The FWS (2021) concurred
41 with this determination.

42 Listed bats can be vulnerable to mortality or injury from collisions with plant structures and
43 vehicles. Bat collisions with human-made structures at nuclear power plants are not well
44 documented but are likely rare based on the available information. In an assessment of the
45 potential effects of operation of the Davis-Besse Nuclear Power Station (Davis-Besse) plant in
46 Ohio, the NRC (2014a) noted that four dead bats were collected at the plant during bird
47 mortality studies conducted from 1972 through 1979. Two red bats (*Lasiurus borealis*) were

1 collected at the cooling tower, and one big brown bat (*Eptesicus fuscus*) and one tri-colored bat
2 (*Perimyotis subflavus*) were collected near other plant structures. During the initial LR review,
3 the NRC (2014a) found that future collisions of bats would be extremely unlikely and, therefore,
4 discountable given the small number of bats collected during the study and the marginal
5 suitable habitat that the plant site provides. The FWS (FWS 2014) concurred with this
6 determination. In a 2015 assessment associated with the Indian Point plant in New York, the
7 NRC (2015a) determined that bat collisions were less likely to occur at the Indian Point plant
8 than at the Davis-Besse plant because Indian Point does not have cooling towers or similarly
9 large obstructions. The tallest structures on the Indian Point site are 134 ft (40.8 m) tall turbine
10 buildings and 250 ft (76.2 m) tall reactor containment structures. The NRC (2015a) concluded
11 that the likelihood of bats colliding with these and other plant structures on the Indian Point site
12 during the license renewal period was extremely unlikely and, therefore, discountable. The
13 FWS (2015b) concurred with this determination. In 2018, the NRC (2018a) determined that the
14 likelihood of bats colliding with site buildings or structures on the Seabrook site in New
15 Hampshire would be extremely unlikely. The tallest structures on that site are a 199 ft (61 m)
16 tall containment structure and 103 ft (31 m) tall turbine and heater bay building. The FWS
17 (2018) concurred with the NRC's determination. In 2020, the NRC (2020f) determined that the
18 likelihood of bats colliding with site buildings or structures on the Surry site in Virginia would be
19 extremely unlikely. The FWS (2019b) again concurred with the NRC staff's determination on
20 the basis that activities associated with the Surry plant SLR would be consistent with the
21 activities analyzed in the FWS's January 5, 2016, programmatic biological opinion (FWS 2016).
22 Most recently, the NRC (2021f) determined that the likelihood of bats colliding with site buildings
23 or structures at the Point Beach plant in Wisconsin would be extremely unlikely based on
24 structure height and operating experience. The FWS (2021) also concurred with this
25 determination on the basis of the FWS's 2016 programmatic biological opinion (FWS 2016).

26 Unlike bat collision risk, the risk of bird collisions is more species-specific and depends on the
27 particular life history, behaviors, and flight patterns of a species. For example, in 2014, the
28 FWS (2014) used mortality data for blackpoll warbler (*Setophaga striata*), an unlisted species, to
29 estimate future mortality of the Kirtland's warbler (*S. kirtlandii*)⁵ at the Davis-Besse site during
30 the license renewal term because the two species are similar. Because blackpoll warblers had
31 been collected during past bird and bat mortality studies, the FWS determined that Kirtland's
32 warbler mortality from collisions with the site's cooling tower or meteorological tower was
33 possible. However, the FWS estimated the total Kirtland's warbler mortality during the seasonal
34 migratory periods over the license renewal period to be less than 0.01 birds. Therefore, the
35 FWS determined that no take was ultimately expected, and the FWS concurred with the NRC's
36 (2014a) determination that the likelihood of this bird colliding with nuclear power plant buildings
37 and structures is discountable or extremely unlikely to occur. In the same review, the FWS
38 (2014) determined that red knot collisions were also a discountable effect due to the specific
39 habitat needs of this species and the limited number that have been observed in Ohio, and the
40 FWS did not calculate mortality for this species.

41 In 2016, the NRC (NRC 2016c) found that the risk of both red knots and piping plovers colliding
42 with plant buildings or structures at the Fermi site in Michigan would be extremely unlikely to
43 occur. The NRC made these determinations based on species-specific factors. For red knots,
44 the NRC made this determination because this species is rare in the action area; the last red
45 knot observed at the Fermi site was in 1973. For piping plovers, the NRC made this
46 determination because individuals are not likely to inhabit inland developed portions of the site

⁵ At the time of this review, the Kirtland's warbler was listed as endangered. The FWS has since delisted this species due to recovery (84 FR 54436).

Affected Environment

1 that contain collision hazards. Factors relevant to both species included seasonal migration
2 periods and the absence of the two species in bird mortality surveys conducted on the site. The
3 FWS (2015a) concurred with the NRC's determination that Fermi license renewal was not likely
4 to adversely affect these species.

5 In 2021, the NRC (2021f) evaluated the risk of piping plovers colliding with nuclear power plant
6 buildings and structures as part of the Point Beach SLR review. The staff found that tall
7 structures are unlikely to represent a unique collision hazard for this species based on its typical
8 flight behavior. For instance, Stantial and Cohen (2015) assessed flight heights of piping
9 plovers in New Jersey and Massachusetts during the 2012 and 2013 breeding seasons. The
10 researchers found that flight heights ranged from 2.3 to 34.5 ft (0.7 to 10.5 m) with a mean of
11 8.5 ft (2.6 m). Visually estimated flight heights ranged from 0.25 to 131 ft (0.25 to 40 m).
12 Because piping plovers fly relatively low to the ground, they are acclimated to navigating various
13 natural and human-made flight hazards, and tall structures on nuclear power plant sites are
14 unlikely to create an additional risk. Even in the case of wind turbines, which have moving
15 components, researchers found that collision hazards at five wind facilities in New England
16 during the piping plover breeding season—assuming constant turbine operation—ranged from
17 0.06 to 2.27 collisions per year for a single large turbine (41 m radius), 0.03 to 0.99 for a single
18 medium turbine (22.5 m radius), and 0.01 to 0.29 for a single small turbine (9.6 m radius)
19 (Stantial 2014). With respect to vehicle collision hazards, Stantial and Cohen (2015)
20 determined the average calculated flight speed of piping plovers to be 30.5 fps (9.3 m/s). The
21 high speed at which piping plovers can fly makes them unlikely to collide with nuclear power
22 plant site vehicles, especially given that posted speed limits are generally low throughout these
23 sites. The FWS (2021) concurred with these findings for Point Beach SLR.

1 **Table 3.6-5 ESA Listed Species Evaluated in License Renewal Reviews, 2013–Present**

Nuclear Power Plant	FWS Species ^(c)	Final Effect Determination ^(d)	NMFS Species ^(c)	Final Effect Determination ^(d)
Seabrook	piping plover (<i>Charadrius melodus</i>)	NLAA	Atlantic sturgeon (<i>Acipenser oxyrinchus oxyrinchus</i>), Gulf of Maine DPS ^(g)	NLAA
Seabrook	roseate tern (<i>Sterna dougallii</i>)	NLAA	fin whale (<i>Balaenoptera physalus</i>)	NLAA
Seabrook	-		humpback whale (<i>Megaptera novaeangliae</i>)	NLAA
Seabrook	-		Kemp's ridley sea turtle (<i>Lepidochelys kempii</i>)	NLAA
Seabrook	-		leatherback sea turtle (<i>Dermochelys coriacea</i>)	NLAA
Seabrook	-		loggerhead sea turtle (<i>Caretta caretta</i>)	NLAA
Seabrook	-		North Atlantic right whale (<i>Eubalaena glacialis</i>)	NLAA
Seabrook	-		Shortnose sturgeon (<i>Acipenser brevirostrum</i>)	NLAA
South Texas	American alligator (<i>Alligator mississippiensis</i>)	N/A	green sea turtle (<i>Chelonia mydas</i>) ^(e)	NE
South Texas	Eskimo curlew (<i>Numenius borealis</i>)	NE	hawksbill sea turtle (<i>Eretmochelys imbricata</i>)	NE
South Texas	Louisiana black bear (<i>Ursus americanus luteolus</i>)	NE	Kemp's ridley sea turtle	NE
South Texas	northern aplomado falcon (<i>Falco femoralis septentrionalis</i>)	NLAA	leatherback sea turtle	NE
South Texas	ocelot (<i>Leopardus pardalis</i>)	NE	loggerhead sea turtle ^(e)	NE
South Texas	piping plover	NE	smalltooth sawfish (<i>Pristis pectinata</i>), U.S. DPS	NE
South Texas	Red wolf (<i>Canis rufus</i>)	NE	-	-
South Texas	smooth pimpleback (<i>Quadrula houstonensis</i>) ^(f)	NE	-	-
South Texas	Texas fawnsfoot (<i>Truncilla macrodon</i>) ^(f)	NE	-	-
South Texas	West Indian manatee (<i>Trichechus manatus</i>)	NE	-	-

Nuclear Power Plant	FWS Species ^(c)	Final Effect Determination ^(d)	NMFS Species ^(c)	Final Effect Determination ^(d)
South Texas	whooping crane (<i>Grus americana</i>)	NE	-	-
Limerick	bog turtle (<i>Clemmys muhlenbergii</i>)	NE	Atlantic sturgeon, New York Bight DPS	NE
Limerick	Dwarf wedgemussel (<i>Alasmidonta heterodon</i>)	NE	shortnose sturgeon	NE
Limerick	Indiana bat	NE	-	-
Limerick	small whorled pogonia (<i>Isotria medeoloides</i>)	NE	-	-
Grand Gulf	American black bear (<i>Ursus americanus</i>)	NLAA	none	-
Grand Gulf	bayou darter (<i>Etheostoma rubrum</i>)	NLAA	-	-
Grand Gulf	fat pocketbook mussel (<i>Potamilus capax</i>)	NE	-	-
Grand Gulf	least tern (<i>Sterna antillarum</i>), Interior population	NE	-	-
Grand Gulf	Louisiana black bear	NLAA	-	-
Grand Gulf	pallid sturgeon (<i>Scaphirhynchus albus</i>)	NLAA	-	-
Grand Gulf	rabbitsfoot mussel (<i>Quadrula cylindrica cylindrica</i>) ⁽⁹⁾	NE	-	-
Grand Gulf	red-cockaded woodpecker (<i>Picoides borealis</i>)	NE	-	-
Grand Gulf	wood stork (<i>Mycteria americana</i>)	NE	-	-
Callaway	gray bat (<i>Myotis grisescens</i>)	NE	none	-
Callaway	Indiana bat (<i>Myotis sodalis</i>)	NLAA	-	-
Callaway	Niangua darter (<i>Etheostoma nianguae</i>)	NE	-	-
Callaway	pallid sturgeon	NLAA	-	-
Callaway	pink mucket (<i>Lampsilis abrupta</i>)	NLAA	-	-
Callaway	running buffalo clover (<i>Trifolium stoloniferum</i>)	NE	-	-
Callaway	scaleshell (<i>Leptodea leptodon</i>)	NLAA	-	-
Callaway	spectaclecase (<i>Cumberlandia monodonta</i>)	NLAA	-	-
Callaway	Topeka shiner (<i>Notropis topeka</i>)	NE	-	-

February 2023

3-71

Draft NUREG-1437, Revision 2

Nuclear Power Plant	FWS Species ^(c)	Final Effect Determination ^(d)	NMFS Species ^(c)	Final Effect Determination ^(d)
Davis-Besse	eastern prairie fringed orchid (<i>Platanthera leucophaea</i>)	NE	none	-
Davis-Besse	Indiana bat	NLAA	-	-
Davis-Besse	Kirtland's warbler (<i>Setophaga kirtlandii</i>) ^(h)	NLAA	-	-
Davis-Besse	lakeside daisy (<i>Hymenopsis herbacea</i>)	NE	-	-
Davis-Besse	northern long-eared bat (<i>Myotis septentrionalis</i>)	NLAA	-	-
Davis-Besse	piping plover, Great Lakes watershed population	NLAA	-	-
Davis-Besse	rufa red knot (<i>Calidris canutus rufa</i>) ^(g)	NLAA	-	-
Sequoyah	dromedary pearlymussel (<i>Dromus dromas</i>)	NE	none	-
Sequoyah	gray bat	NE	-	-
Sequoyah	Indiana bat	NE	-	-
Sequoyah	large-flowered skullcap (<i>Scutellaria montana</i>)	NE	-	-
Sequoyah	northern long-eared bat	NE	-	-
Sequoyah	orangefoot pimpleback (<i>Plethobasus cooperianus</i>)	NE	-	-
Sequoyah	pink mucket	NE	-	-
Sequoyah	rough pigtoe (<i>Pleurobema plenum</i>)	NE	-	-
Sequoyah	small whorled pogonia	NE	-	-
Sequoyah	snail darter (<i>Percuba tanasi</i>)	NE	-	-
Sequoyah	Virginia spirarea (<i>Spiraea virginiana</i>)	NE	-	-
Byron	eastern prairie fringed orchid	NE	none	-
Byron	Indiana bat	NE	-	-
Byron	leafy prairie clover (<i>Dalea foliosa</i>)	NE	-	-
Byron	northern long-eared bat	NE	-	-
Byron	prairie bush clover (<i>Lespedeza leptostachya</i>)	NE	-	-

Affected Environment

Nuclear Power Plant	FWS Species ^(c)	Final Effect Determination ^(d)	NMFS Species ^(c)	Final Effect Determination ^(d)
Braidwood	eastern massasauga (<i>Sistrurus catenatus</i>) ^(g)	NE	none	-
Braidwood	eastern prairie fringed orchid	NE	-	-
Braidwood	Hine's emerald dragonfly (<i>Somatochlora hineana</i>)	NE	-	-
Braidwood	lakeside daisy	NE	-	-
Braidwood	leafy prairie clover	NE	-	-
Braidwood	Mead's milkweed (<i>Asclepias meadii</i>)	NE	-	-
Braidwood	northern long-eared bat	NE	-	-
Braidwood	sheepnose mussel (<i>Plethobasus cyphus</i>)	NLAA	-	-
Braidwood	snuffbox (<i>Epioblasma triquetra</i>)	NE	-	-
Fermi	eastern massasauga ^(g)	NE	none	-
Fermi	eastern prairie fringed orchid	NLAA	-	-
Fermi	Indiana bat	NLAA	-	-
Fermi	Karner blue butterfly (<i>Lycaeides melissa samuelis</i>)	NE	-	-
Fermi	northern long-eared bat	NLAA	-	-
Fermi	northern riffleshell (<i>Epioblasma torulosa rangiana</i>)	NE	-	-
Fermi	piping plover	NLAA	-	-
Fermi	rayed bean (<i>Villosa fabalis</i>)	NE	-	-
Fermi	rufa red knot	NLAA	-	-
Fermi	Snuffbox	NE	-	-
LaSalle	decurrent false aster (<i>Boltonia decurrens</i>)	NE	none	-
LaSalle	eastern prairie fringed orchid	NE	-	-
LaSalle	Indiana bat	NE	-	-
LaSalle	leafy prairie clover	NE	-	-
LaSalle	northern long-eared bat	NE	-	-
LaSalle	sheepnose mussel	NE	-	-

Nuclear Power Plant	FWS Species ^(c)	Final Effect Determination ^(d)	NMFS Species ^(c)	Final Effect Determination ^(d)
Indian Point ^(a)	bog turtle	NE	Atlantic sturgeon, New York Bight, Gulf of Maine, and Chesapeake Bay DPSs	LAA
Indian Point ^(a)	Indiana bat	NLAA	shortnose sturgeon	LAA
Indian Point ^(a)	northern long-eared bat	NLAA	-	
River Bend	pallid sturgeon	NLAA	none	
Waterford	gulf sturgeon (<i>Acipenser oxyrinchus desotoi</i>)	NE	none	-
Waterford	pallid sturgeon	NLAA	-	-
Waterford	West Indian manatee	NE	-	-
Turkey Point ^(b)	American alligator	N/A	green sea turtle, North Atlantic and South Atlantic DPSs	NLAA
Turkey Point ^(b)	American crocodile (<i>Crocodylus acutus</i>)	LAA	hawksbill sea turtle	NLAA
Turkey Point ^(b)	Bachman's warbler (<i>Vermivora bachmani</i>)	NE*	leatherback sea turtle	NLAA
Turkey Point ^(b)	Bartram's hairstreak butterfly (<i>Strymon acis bartrami</i>)	NE*	loggerhead sea turtle ^(e)	NLAA
Turkey Point ^(b)	beach jacquemontia (<i>Jacquemontia reclinata</i>)	NE*	smalltooth sawfish, U.S. DPS	NLAA
Turkey Point ^(b)	Blodgett's silverbush (<i>Argythamnia blodgettii</i>)	NLAA	-	-
Turkey Point ^(b)	Cape Sable seaside sparrow (<i>Ammodramus maritimus mirabilis</i>)	NE*	-	-
Turkey Point ^(b)	Cape Sable thoroughwort (<i>Chromolaena frustrata</i>)	NLAA	-	-
Turkey Point ^(b)	Carter's mustard (<i>Warea carteri</i>)	NE*	-	-
Turkey Point ^(b)	Carter's small-flowered flax (<i>Linum carteri carteri</i>)	NE*	-	-
Turkey Point ^(b)	crenulate lead-plant (<i>Amorpha crenulata</i>)	NE*	-	-
Turkey Point ^(b)	deltoid spurge (<i>Chamaesyce deltoidea deltoidea</i>)	NE*	-	-
Turkey Point ^(b)	eastern indigo snake (<i>Drymarchon corais couperi</i>)	LAA	-	-

Nuclear Power Plant	FWS Species ^(c)	Final Effect Determination ^(d)	NMFS Species ^(c)	Final Effect Determination ^(d)
Turkey Point ^(b)	Everglades bully (<i>Sideroxylon reclinatum austrofloridense</i>)	NE*	-	-
Turkey Point ^(b)	Everglades snail kite (<i>Rostrhamus sociabilis</i>)	NLAA	-	-
Turkey Point ^(b)	Florida bonneted bat (<i>Eumops floridanus</i>)	NLAA	-	-
Turkey Point ^(b)	Florida brickell-bush (<i>Brickellia mosieri</i>)	NE*	-	-
Turkey Point ^(b)	Florida bristle fern (<i>Trichomanes punctatum floridanum</i>)	NLAA	-	-
Turkey Point ^(b)	Florida grasshopper sparrow (<i>Ammodramus savannarum</i>)	NE*	-	-
Turkey Point ^(b)	Florida leafwing butterfly (<i>Anaea troglodyta floridalis</i>)	NE*	-	-
Turkey Point ^(b)	Florida panther (<i>Puma concolor coryi</i>)	NLAA	-	-
Turkey Point ^(b)	Florida pinelands crabgrass (<i>Digitaria pauciflora</i>)	NE*	-	-
Turkey Point ^(b)	Florida prairie-clover (<i>Dalea carthagenensis floridana</i>)	NE*	-	-
Turkey Point ^(b)	Florida scrub-jay (<i>Aphelocoma coerulescens</i>)	NE*	-	-
Turkey Point ^(b)	Florida semaphore cactus (<i>Consolea corallicola</i>)	NLAA	-	-
Turkey Point ^(b)	Garber's spurge (<i>Chamaesyce garberi</i>)	NE*	-	-
Turkey Point ^(b)	ivory-billed woodpecker (<i>Campephilus principalis</i>)	NE*	-	-
Turkey Point ^(b)	Kirtland's warbler ^(h)	NLAA	-	-
Turkey Point ^(b)	Miami blue butterfly (<i>Cyclargus thomasi bethunebakeri</i>)	NE*	-	-
Turkey Point ^(b)	Okeechobee gourd (<i>Cucurbita okeechobeensis okeechobeensis</i>)	NE*	-	-
Turkey Point ^(b)	pineland sandmat (<i>Chamaesyce deltoidea pinetorum</i>)	NE*	-	-
Turkey Point ^(b)	piping plover	NLAA	-	-

February 2023

3-75

Draft NUREG-1437, Revision 2

Nuclear Power Plant	FWS Species ^(c)	Final Effect Determination ^(d)	NMFS Species ^(c)	Final Effect Determination ^(d)
Turkey Point ^(b)	puma (<i>Puma concolor</i>), all subspecies except <i>coryi</i>	N/A	-	-
Turkey Point ^(b)	red-cockaded woodpecker	NE*	-	-
Turkey Point ^(b)	rufa red knot	NLAA	-	-
Turkey Point ^(b)	sand flax (<i>Linum arenicola</i>)	NLAA	-	-
Turkey Point ^(b)	Schaus swallowtail butterfly (<i>Heraclides aristodemus ponceanus</i>)	NE*	-	-
Turkey Point ^(b)	Small's milkpea (<i>Galactia smallii</i>)	NE*	-	-
Turkey Point ^(b)	Stock Island tree snail (<i>Orthalicus reses</i>)	NE*	-	-
Turkey Point ^(b)	tiny polygala (<i>Polygala smallii</i>)	NE*	-	-
Turkey Point ^(b)	West Indian manatee	NLAA	-	-
Turkey Point ^(b)	wood stork	NLAA	-	-
Surry ^(b)	northern long-eared bat	NLAA	Atlantic sturgeon, Chesapeake Bay DPS	NLAA
Surry ^(b)			shortnose sturgeon	NLAA
Peach Bottom ^(b)	Atlantic sturgeon, Chesapeake Bay DPS	NE	<i>none</i>	-
Peach Bottom ^(b)	bog turtle	NE	-	-
Peach Bottom ^(b)	Chesapeake logperch (<i>Percina bimaculata</i>) ⁽ⁱ⁾	LAA	-	-
Peach Bottom ^(b)	Indiana bat	NLAA	-	-
Peach Bottom ^(b)	northern long-eared bat	NLAA	-	-
Peach Bottom ^(b)	rufa red knot	NE	-	-
Peach Bottom ^(b)	shortnose sturgeon	NE	-	-
North Anna ^(b)	Atlantic pigtoe (<i>Fusconaia masoni</i>)	NE*	none	-
North Anna ^(b)	dwarf wedgemussel	NE*	-	-
North Anna ^(b)	green floater (<i>Lasmigona subviridis</i>)	NE*	-	-

Affected Environment

Nuclear Power Plant	FWS Species ^(c)	Final Effect Determination ^(d)	NMFS Species ^(c)	Final Effect Determination ^(d)
North Anna ^(b)	James spineymussel (<i>Pleurobema collina</i>)	NE*	-	-
North Anna ^(b)	northern long-eared bat	NLAA	-	-
North Anna ^(b)	small whorled pogonia	NE*	-	-
Point Beach ^(b)	dwarf lake iris (<i>Iris lacustris</i>)	NE*	none	-
Point Beach ^(b)	Hine's emerald dragonfly	NE*	-	-
Point Beach ^(b)	northern long-eared bat	NLAA	-	-
Point Beach ^(b)	piping plover	NLAA	-	-
Point Beach ^(b)	Pitcher's thistle (<i>Cirsium pitcheri</i>)	NE*	-	-
Point Beach ^(b)	rusty patched bumblebee (<i>Bombus affinis</i>)	NE*	-	-

FWS = U.S. Fish and Wildlife Service; NMFS = U.S. National Marine Fisheries Service; NE = no effect; NLAA = may affect but is not likely to adversely affect; and LAA = likely to adversely affect; DPS = distinct population segments.

(a) The evaluation of this species was a part of a review that supplemented the NRC's final SEIS.

(b) This review evaluated an SLR term.

(c) This table omits species that were candidates or proposed for Federal listing at the time of the NRC staff's review but for which the Services later determined that listing was not warranted.

(d) The effect determinations provided here are the final determinations concerning each species that resulted from consultation with the Services. In some cases, the Service's letter of concurrence revised or amended the NRC staff's original effect determinations for a given species. For certain species, the NRC staff determined that the species was not present in the action area. Accordingly, potential effects to these species were not evaluated in detail because there would be none. Effect determinations for these species are designated in this table as NE*.

(e) At the time the NRC staff performed its review, NMFS had not yet designated DPSs for this species.

(f) At the time the NRC staff performed its review, this species was a candidate for Federal listing. The Services have now issued a proposed rule to list the species.

(g) At the time the NRC staff performed its review, this species was a candidate species or was proposed for Federal listing. The Services have now issued a final rule listing the species.

(h) This species has been delisted since the NRC staff performed its review.

(i) At the time the NRC staff performed its review, this species was under review for Federal listing. It remains under review at this time.

No entry has been denoted by "-".

Sources: NRC 2015b, NRC 2013b, NRC 2014d, NRC 2014e, NRC 2014f, NRC 2015e, NRC 2015f, NRC 2015c, NRC 2015d, NRC 2016c, NRC 2016d, NRC 2018e, NRC 2018c, NRC 2018d, NRC 2019c, NRC 2020f, NRC 2020g, NRC 2021g, NRC 2021f

1 3.6.3.2 *Magnuson-Stevens Fishery Conservation and Management Act*

2 Congress enacted the MSA in 1976 to foster long-term biological and economic sustainability of
3 the Nation's marine fisheries. The MSA is a comprehensive, multi-purpose statute. Its key
4 objectives include preventing overfishing, rebuilding overfished stocks, increasing long-term
5 economic and social benefits, and ensuring a safe and sustainable supply of seafood. NOAA,
6 together with eight regional Fishery Management Councils established under the act, implement
7 the provisions of the MSA.

8 The MSA directs the Fishery Management Councils, in conjunction with NMFS, to designate
9 areas of EFH and to manage marine resources within those areas. EFH is defined as the
10 coastal and marine waters and substrate necessary for fish to spawn, breed, feed, or grow to
11 maturity (50 CFR 600.10). The NMFS further defines "waters," "substrate," and "necessary" at
12 50 CFR 600.10. EFH applies to federally managed finfish and shellfish (herein referred to as
13 "EFH species"). As of 2022, the Councils and NMFS have designated EFH for nearly
14 1,000 species at multiple life stages.

15 The Fishery Management Councils may also designate some EFH as habitat areas of particular
16 concern (HAPC) if that habitat exhibits one or more of the following traits: rare, stressed by
17 development, possessing important ecological functions for EFH species, or especially
18 vulnerable to anthropogenic degradation. HAPCs can cover a specific location (e.g., an estuary
19 bank or a single spawning location) or cover habitat type that is found at many locations (e.g.,
20 coral, nearshore nursery areas, or pupping grounds). HAPC designation does not convey
21 additional restrictions or protections on an area. The designation simply focuses on increased
22 scrutiny, study, or mitigation planning compared to surrounding areas because HAPCs
23 represent high-priority areas for conservation, management, or research and are necessary for
24 healthy ecosystems and sustainable fisheries. The Fishery Management Councils may,
25 however, restrict the use or possession of fishing gear types within HAPCs. The geographic
26 boundaries of HAPCs are subject to refinement through amendments, as research better
27 informs management decisions (NOAA 2020).

28 Section 305(b) of the MSA contains interagency consultation requirements pertaining to Federal
29 agencies and their actions. Under MSA Section 305(b)(2), Federal agencies must consult with
30 NMFS for actions that may adversely affect EFH. Private actions with a Federal nexus, such as
31 construction and operation of facilities that involve Federal licensing or approval, are also
32 subject to consultation. Therefore, the NRC's issuance of initial or subsequent renewed
33 licenses may trigger consultation requirements. Consultation pursuant to MSA Section 305(b) is
34 commonly referred to as "EFH consultation."

35 EFH includes the substrate and benthic resources (e.g., submerged aquatic vegetation, shellfish
36 beds, salt marsh wetlands, etc.), as well as the water column and prey species. NMFS defines
37 "adverse effects" under the MSA as (50 CFR 600.810):

38 ...any impact that reduces quality and/or quantity of EFH. Adverse effects may
39 include direct or indirect physical, chemical, or biological alterations of the waters
40 or substrate and loss of, or injury to, benthic organisms, prey species and their
41 habitat, and other ecosystem components, if such modifications reduce the quality
42 and/or quantity of EFH. Adverse effects to EFH may result from actions occurring
43 within EFH or outside of EFH and may include site-specific or habitat-wide impacts,
44 including individual, cumulative, or synergistic consequences of actions.

Affected Environment

1 Further, in 50 CFR 600.815(a)(7), adverse effects on EFH resulting from prey loss are
2 described as follows:

3 Loss of prey may be an adverse effect on EFH and managed species because the
4 presence of prey makes waters and substrate function as feeding habitat, and the
5 definition of EFH includes waters and substrate necessary to fish for feeding.
6 Therefore, actions that reduce the availability of a major prey species, either
7 through direct harm or capture, or through adverse impacts to the prey species'
8 habitat that are known to cause a reduction in the population of the prey species,
9 may be considered adverse effects on EFH if such actions reduce the quality of
10 EFH.

11 Notably, EFH is assessed in terms of impacts on the habitat of the EFH species rather than on
12 the species itself. Therefore, the physical removal of habitat through cooling water withdrawals
13 is an impact on EFH, whereas impingement and entrainment are not. Continued operation of a
14 nuclear power plant during an initial LR or SLR term may cause the following adverse effects in
15 the area:

- 16 • physical removal of habitat through cooling water withdrawals,
- 17 • physical alteration of habitat through heated effluent discharges,
- 18 • chemical alteration of habitat through radionuclides and other contaminants in heated
19 effluent discharges,
- 20 • physical removal of habitat through maintenance dredging, and
- 21 • reduction in the prey base of the habitat.

22 EFH may occur at nuclear power plants located on or near estuaries, coastal inlets and bays,
23 and the ocean. The MSA applies to marine and diadromous species. Therefore, EFH is
24 generally not relevant for license renewal reviews of plants located on rivers well above the
25 saltwater interface or confluence with marine waters; plants located on freshwater lakes,
26 including the Great Lakes; or at plants that draw cooling water from human-made cooling ponds
27 or canals that do not hydrologically connect to natural surface waters. One exception is in
28 cases where a plant draws cooling water from the freshwater portion of a river that is inhabited
29 by diadromous prey of EFH species with designated EFH downstream of the plant. By
30 definition, adverse effects may occur outside of EFH, and loss of prey may be an adverse effect
31 (see regulatory definitions above).

32 The Limerick plant in Pennsylvania is an example where prey loss was relevant to the license
33 renewal review although the plant itself is not located near designated EFH. Limerick withdraws
34 cooling water from the Schuylkill River and Perkiomen Creek and discharges heated effluent to
35 the Schuylkill River. In cases where the natural flow of Perkiomen Creek is not adequate to
36 supply cooling water to Limerick, the plant augments flow from the Delaware River to Perkiomen
37 Creek. Although these waterways do not contain designated EFH, they provide habitat for
38 anadromous fish consumed by several EFH species (bluefish [*Pomatomus saltatrix*],
39 windowpane flounder [*Scophthalmus aquosus*], summer flounder [*Paralichthys dentatus*], and
40 winter skate [*Leucoraja ocellata*]). These four species have designated EFH in the mixing zone
41 of the Delaware River downstream from the Limerick plant. Prey of these species, such as
42 *Alosa* species (e.g., American shad and river herring), spawn in freshwater and migrate to
43 marine waters as juveniles. During migration, individuals pass through areas of designated
44 EFH. Therefore, loss of *Alosa* individuals through impingement and entrainment at the Limerick

1 plant has the potential to affect the abundance of prey downstream in the mixing zone, which
2 could affect the quality of this EFH as feeding habitat. Based on this reasoning, NMFS
3 recommended that the NRC engage in EFH consultation during the license renewal review.
4 The NRC (2014b) prepared an EFH assessment that addressed these and other relevant
5 effects. The NRC staff concluded that the Limerick license renewal would have minimal
6 adverse effects on EFH for juveniles and adults of the four EFH species. Subsequently, NMFS
7 (2014b) provided the NRC with EFH conservation recommendations, and the NRC (2014g)
8 responded to these recommendations, which concluded EFH consultation.

9 The NRC staff also assessed prey loss for SLR of the Peach Bottom plant in Pennsylvania.
10 During that review, the NRC (NRC 2020g) found that SLR would have no direct effects on the
11 EFH of any species because no designated EFH is present in Conowingo Pond. All potential
12 adverse impacts on EFH would be limited to loss of prey for those EFH species that consume
13 anadromous prey species that migrate through Conowingo Pond. Anadromous prey fish, such
14 as *Alosa* species, have been rare in collections associated with Conowingo Pond aquatic
15 studies. None of the available studies or other information indicate that impingement,
16 entrainment, thermal effects, or indirect impacts on the habitat of prey species would be
17 noticeably affected as a result of SLR. Accordingly, no adverse effects on EFH would result
18 from loss of prey, and the NRC staff concluded that the proposed action would have no adverse
19 effects on the designated EFH for little skate, windowpane flounder, or winter skate.

20 Table 3.6-6 identifies EFH species and life stages whose EFH the NRC staff, in consultation
21 with NMFS, evaluated during initial LR and SLR environmental reviews conducted since
22 publication of the 2013 LR GEIS.⁶ During this period, EFH was relevant to six reviews, and the
23 NRC staff evaluated the EFH of 37 species among these reviews. Atlantic herring (*Clupea*
24 *harengus*), Atlantic butterfish (*Peprilus triacanthus*), summer flounder, winter flounder
25 (*Pleuronectes americanus*), and winter skate were the most prevalently evaluated EFH species.

26 In most cases, the NRC staff concluded that license renewal would result in no adverse effects
27 or minimal adverse effects on EFH. For two EFH species, silver hake (*Merluccius bilinearis*)
28 and winter flounder, the NRC concluded that license renewal would result in more than minimal
29 but less than substantial adverse effects. The NRC (2015b) made this determination for all life
30 stages of silver hake and larvae, juveniles, and adults of winter flounder as a result of the
31 Seabrook plant license renewal. This was based on the effects of impingement, entrainment,
32 and thermal effluents on these species' habitat.

⁶ Prior to the 2013 LR GEIS, the NRC assessed EFH as part of seven license renewal environmental reviews: Oyster Creek (no longer operating); (2) Brunswick; (3) Pilgrim in Massachusetts (no longer operating); (4) Vermont Yankee in New York (no longer operating); (5) Indian Point (no longer operating); (6) Salem and Hope Creek; and (7) Crystal River in Florida (no longer operating). These are not described in detail in the 2013 LR GEIS. See the plant-specific SEISs for more information about these EFH consultations. The NRC has also prepared EFH assessments and conducted EFH consultation with NMFS for extended power uprates at the Hope Creek (NRC 2007a) and St. Lucie (NRC 2012c) plants.

1

Table 3.6-6 EFH Evaluated in License Renewal Reviews, 2013–Present

Nuclear Power Plant	Species	Life Stage(s)^(b)	Final Effect Determination^(c)
Seabrook	American angler fish (<i>Lophius americanus</i>)	E, L, J	MAE
Seabrook	American angler fish	A	NAE
Seabrook	American plaice (<i>Hippoglossoides platessoides</i>)	J, A	NAE
Seabrook	Atlantic butterfish (<i>Peprilus triacanthus</i>)	E, L, J, A	NAE
Seabrook	Atlantic cod (<i>Gadus morhua</i>)	E	NAE
Seabrook	Atlantic cod	L, J, A	MAE
Seabrook	Atlantic halibut (<i>Hippoglossus hippoglossus</i>)	E, L	NAE
Seabrook	Atlantic halibut	J, A	MAE
Seabrook	Atlantic herring (<i>Clupea harengus</i>)	J, A	MAE
Seabrook	Atlantic mackerel (<i>Scomber scombrus</i>)	E, A	MAE
Seabrook	Atlantic mackerel	L, J	NAE
Seabrook	Atlantic sea scallop (<i>Placopecten magellanicus</i>)	E, L, A	NAE
Seabrook	Atlantic sea scallop	J	MAE
Seabrook	Atlantic surf clam (<i>Spisula solidissima</i>)	J, A	NAE
Seabrook	bluefin tuna (<i>Thunnus thynnus</i>)	A	NAE
Seabrook	haddock (<i>Melanogrammus aeglefinus</i>)	J	NAE
Seabrook	longfin inshore squid (<i>Loligo pealei</i>)	J, A	NAE
Seabrook	northern shortfin squid (<i>Illex illecebrosus</i>)	J, A	NAE
Seabrook	ocean pout (<i>Macrozoarces americanus</i>)	E, L, A	NAE
Seabrook	ocean pout	J	MAE
Seabrook	pollock (<i>Pollachius virens</i>)	J	MAE
Seabrook	red hake (<i>Urophycis chuss</i>)	E, L, J, A	MAE
Seabrook	redfish (<i>Sebastes fasciatus</i>)	L	NAE
Seabrook	Redfish	J, A	MAE
Seabrook	scup (<i>Stenotomus chrysops</i>)	J, A	NAE
Seabrook	silver hake (<i>Merluccius bilinearis</i>)	E, L, J, A	LSA
Seabrook	summer flounder (<i>Paralichthys dentatus</i>)	A	MAE
Seabrook	windowpane flounder (<i>Scopthalmus aquosus</i>)	J, A	MAE
Seabrook	winter flounder (<i>Pleuronectes americanus</i>)	E	NAE
Seabrook	winter flounder	L, J, A	LSA
Seabrook	yellowtail flounder (<i>Pleuronectes ferruginea</i>)	J, A	MAE
Columbia	coho salmon (<i>Oncorhynchus kisutch</i>)	-	MAE
Columbia	Upper Columbia River Chinook salmon (<i>Oncorhynchus tshawytscha</i>)	-	MAE
Limerick	American plaice	J	NAE
Limerick	Atlantic butterfish	J	NAE
Limerick	Atlantic herring	J	NAE
Limerick	black sea bass (<i>Centropristus striata</i>)	J	NAE

Nuclear Power Plant	Species	Life Stage(s) ^(b)	Final Effect Determination ^(c)
Limerick	bluefish (<i>Pomatomus saltatrix</i>)	J, A	MAE
Limerick	Scup	J	NAE
Limerick	summer flounder	J, A	MAE
Limerick	windowpane flounder	J, A	MAE
Limerick	winter flounder	J, A	MAE
Limerick	winter skate (<i>Leucoraja ocellata</i>)	J, A	MAE
Turkey Point ^(a)	gray snapper (<i>Lutjanus griseus</i>)	J, A	NE
Turkey Point ^(a)	mutton snapper (<i>Lutianus analis</i>)	J	NE
Turkey Point ^(a)	pink shrimp (<i>Farfantepenaeus duorarum</i>)	-	NE
Turkey Point ^(a)	spiny lobster (<i>Panulirus argus</i>)	-	NE
Turkey Point ^(a)	white grunt (<i>Haemulon plumieri</i>)	A	NE
Surry ^(a)	Atlantic butterfish	J, A	MAE
Surry ^(a)	Atlantic herring	-	NAE
Surry ^(a)	black sea bass	-	NAE
Surry ^(a)	Bluefish	J	MAE
Surry ^(a)	clearnose skate (<i>Raja eglanteria</i>)	-	NAE
Surry ^(a)	little skate (<i>Urophycis chuss</i>)	(P)	MAE
Surry ^(a)	red hake	-	NAE
Surry ^(a)	summer flounder	L, J, A	MAE
Surry ^(a)	windowpane flounder	J, A	MAE
Surry ^(a)	winter skate	(P)	MAE
Peach Bottom ^(a)	Atlantic herring	J, A	NE
Peach Bottom ^(a)	clearnose skate	J, A	NE
Peach Bottom ^(a)	little skate	E, L, J, A	NAE
Peach Bottom ^(a)	red hake	A	NE
Peach Bottom ^(a)	windowpane flounder	A	NAE
Peach Bottom ^(a)	winter skate	J, A	NAE

1 (a) This review evaluated an SLR term.
2 (b) EFH is designated by life stage. E = eggs; L = larvae; J = juveniles; A = adults; (P) = prey of EFH species.
3 (c) The effect determinations provided here are the final determinations concerning each species that resulted from
4 consultation with NMFS. NE = no effect; NAE = no adverse effects; MAE = minimal adverse effects; LSA = more
5 than minimal but less than substantial adverse effects; and SAA = substantial adverse effects.
6 No entry has been denoted by “-”.
7 Sources: NRC 2015b, NRC 2012a, NRC 2014b, NRC 2019c, NRC 2020f, NRC 2020g.

8 3.6.3.3 National Marine Sanctuaries Act

9 Congress enacted the NMSA in 1972 to protect areas of the marine environment that have
10 special national significance. The NMSA authorizes the Secretary of Commerce to establish the
11 National Marine Sanctuary System and designate sanctuaries within that system. ONMS is
12 charged with comprehensively managing this system, which includes 15 sanctuaries and the
13 Papahānaumokuākea and Rose Atoll marine national monuments, encompassing more than
14 600,000 square miles of marine and Great Lakes waters from Washington State to the Florida

Affected Environment

1 Keys, and from Lake Huron to American Samoa. Within these areas, sanctuary resources
2 include any living or nonliving resource of a national marine sanctuary that contributes to the
3 conservation, recreational, ecological, historical, educational, cultural, archaeological, scientific,
4 or aesthetic value of the sanctuary. As of 2022, four additional sanctuaries are proposed for
5 designation. Figure 3.6-1 depicts the locations of designated and proposed marine sanctuaries
6 and marine national monuments. Maps of designated and proposed sanctuaries are available
7 at: <https://sanctuaries.noaa.gov/about/maps.html>.



8
9 **Figure 3.6-1 National Marine Sanctuaries and Marine National Monuments. Source:**
10 **NOAA 2022a.**

11 In 1992, Congress amended the NMSA to require interagency coordination. Pursuant to
12 Section 304(d) of the NMSA, Federal agencies must consult with ONMS when their proposed
13 actions are likely to destroy, cause the loss of, or injure a sanctuary resource. Private actions
14 with a Federal nexus, such as construction and operation of facilities that involve Federal
15 licensing or approval, are also subject to consultation. Therefore, the NRC's issuance of initial
16 or subsequent renewed licenses may trigger consultation requirements. Consultation pursuant
17 to NMSA Section 304(d) is commonly referred to as "NMSA consultation."

18 Currently, five operating nuclear power plants are located near designated or proposed national
19 marine sanctuaries (see Table 3.6-7). Notably, this is a snapshot; the geographic extent of
20 existing sanctuaries may change or expand in the future, and NOAA is likely to designate new
21 sanctuaries as additional areas of conservation need are identified and assessed. National
22 marine sanctuary advisory councils, which are community-based advisory groups, actively help
23 ONMS determine whether additional areas warrant statutory protection. For instance, the
24 advisory council for the Flower Garden Banks National Marine Sanctuary coordinated with
25 ONMS to recommend expanding this sanctuary to include certain sensitive underwater features
26 and marine biodiversity hotspots in the northwestern Gulf of Mexico. In 2021, NOAA published
27 a final rule that added 14 additional shelf-edge reefs and banks off the coasts of Texas and
28 Louisiana to this sanctuary (86 FR 4937). The Wisconsin Shipwreck Coast National Marine
29 Sanctuary in western Lake Michigan is also a recent designation. NOAA designated this
30 sanctuary in 2021 (86 FR 45860). As described further below, the Point Beach plant is located
31 near this sanctuary.

1 **Table 3.6-7 National Marine Sanctuaries Near Operating Nuclear Power Plants**

Sanctuary Name	Location	Nearby Nuclear Power Plants
Lake Ontario ^(a)	Eastern Lake Ontario and a segment of the Thousand Islands region of the St. Lawrence River	Ginna, Nine Mile Point, FitzPatrick
Wisconsin Shipwreck Coast	Western Lake Michigan bordering Wisconsin	Point Beach
Florida Keys	Florida Keys from south of Miami westward to encompass the Dry Tortugas, excluding Dry Tortugas National Park	Turkey Point

2 (a) This sanctuary is currently proposed for designation.

3 The NRC staff has evaluated the potential impacts of license renewal on national marine
 4 sanctuaries in two environmental reviews conducted since publication of the 2013 LR GEIS: the
 5 Turkey Point and Point Beach plants, both of which were SLRs. These reviews are summarized
 6 below; neither ultimately required NMSA consultation with ONMS.

7 The Florida Keys National Marine Sanctuary encompasses 2,900 nautical mi² (5,370 nautical
 8 km²) of coastal and ocean waters and submerged land surrounding the Florida Keys from south
 9 of Miami westward and encompassing the Dry Tortugas. The sanctuary includes several
 10 unique habitats, including the Nation’s only coral reef that lies adjacent to the continent and one
 11 of the largest seagrass communities in the hemisphere. Card Sound, which lies adjacent and
 12 east of the Turkey Point site, is within the boundaries of the sanctuary. In 2019, the NRC staff
 13 determined that the Turkey Point SLR would not affect the resources of this sanctuary (NRC
 14 2019c). Available monitoring data indicated no discernable impact of Turkey Point plant’s CCS
 15 on the ecology of surrounding marsh and mangrove areas, Biscayne Bay, Card Sound, or any
 16 other nearby surface waters. The staff found that any potential future impacts would be
 17 addressed and mitigated through State and county requirements concerning the CCS and
 18 groundwater quality. Accordingly, the NRC staff concluded that SLR was not likely to destroy,
 19 cause the loss of, or injure any sanctuary resources and that consultation under the NMSA was
 20 not required.

21 The Wisconsin Shipwreck Coast National Marine Sanctuary encompasses a 962 mi²
 22 (1,550 km²) area of western Lake Michigan along the Wisconsin coast. The sanctuary protects
 23 shipwrecks that possess exceptional historic, archaeological, and recreational value. Rock
 24 reefs and the structures of the shipwrecks provide shelter and foraging habitat for many species
 25 of commercially and recreationally important fish. The sanctuary also includes the State-
 26 managed Southern Refuge and the largest spawning population of lake trout (*Salvelinus*
 27 *namaycush*). The Point Beach plant lies on the coast of Lake Michigan within the region
 28 designated for this sanctuary. In 2021, the NRC staff determined that the Point Beach SLR
 29 would not affect the resources of this sanctuary (NRC 2021f). The NRC staff found that the
 30 sanctuary resources of concern (a nationally significant collection of maritime cultural heritage
 31 resources, including 36 known shipwrecks) are located at least 2 mi (3.2 km) from the Point
 32 Beach site and beyond the influence of either Point Beach’s cooling water intake structure or the
 33 area affected by thermal effluent discharges and, thus, continued operation of Point Beach plant
 34 would not affect these resources. The licensee did not plan to conduct any shoreline
 35 stabilization or other in-water work during the proposed SLR term. Accordingly, the NRC staff
 36 concluded that subsequent license renewal was not likely to destroy, cause the loss of, or injure
 37 any sanctuary resources and that consultation under the NMSA was not required.

1 **3.7 Historic and Cultural Resources**

2 **3.7.1 Scope of Review**

3 Historic and cultural resources vary widely from site to site; there is no generic way of
4 determining their existence or significance. Historic and cultural resource impacts must be
5 analyzed on a plant-specific basis, and the NRC is required to complete a NEPA (42 U.S.C.
6 § 4321 et seq.) and National Historic Preservation Act (NHPA) Section 106 review (54 U.S.C. §
7 300101 et seq.) prior to issuing a renewed license. This section presents an overview of these
8 resources and the NEPA and NHPA Section 106 review and consultation processes. Historic
9 and cultural resources are the remains of past human activities and include precontact (i.e.,
10 prehistoric) and historic era archaeological sites, districts, buildings, structures, and objects.
11 Precontact era archaeological sites pre-date the arrival of Europeans in North America and may
12 include small temporary camps, larger seasonal camps, large village sites, or specialized-use
13 areas associated with fishing or hunting or with tool and pottery manufacture. Historic era
14 archaeological sites post-date European contact with Indian Tribes⁷ and may include
15 farmsteads, mills, forts, residences, industrial sites, and shipwrecks. Architectural resources
16 include buildings and structures. Historic and cultural resources also include elements of the
17 cultural environment such as landscapes, sacred sites, and other resources that are of religious
18 and cultural importance to Indian Tribes, such as traditional cultural properties (TCPs) important
19 to a living community of people for maintaining its culture.⁸

20 A historic or a cultural resource is deemed to be historically significant, and thus, a “historic
21 property” within the scope of the NHPA if it has been determined to be eligible for listing or is
22 listed on the National Register of Historic Places (NRHP).⁹ The NRHP is maintained by the
23 U.S. National Park Service in accordance with its regulations in 36 CFR Part 60. The NRHP
24 criteria to evaluate the eligibility of a property are set forth in 36 CFR 60.4.¹⁰ In this regard, a
25 historic property is at least 50 years old, although exceptions can be made for properties
26 determined to be of “exceptional significance.”¹¹

⁷ Per 36 CFR 800.2(c)(2)(ii), the agency official will consult with any Indian Tribe or Native Hawaiian organization that attaches religious and cultural significance to historic properties that may be affected by an undertaking.

⁸ According to U.S. National Park Service guidance, a “traditional cultural property” is associated “with the cultural practices or beliefs of a living community that (a) are rooted in that community’s history and (b) are important in maintaining the continuing cultural identity of the community” (Parker and King 1998).

⁹ Historic property is defined in 36 CFR 800.16(l)(1) as “... any prehistoric or historic district, site, building, structure, or object included in, or eligible for inclusion in, the [NRHP] maintained by the Secretary of Interior. This term includes artifacts, records, and remains that are related to and located within such properties.” As defined in 36 CFR 800.16(l)(2), “The term eligible for inclusion in the National Register includes both properties formally determined as such in accordance with regulations of the Secretary of the Interior and all other properties that meet National Register listing criteria.”

¹⁰ The eligibility of a resource for listing in the NRHP is evaluated based on four criteria and is articulated in 36 CFR 60.4, as follows: Criterion a: Associated with events that have made a significant contribution to broad patterns of our history; Criterion b: Associated with the lives of persons significant in our past; or Criterion c: Embodies the distinctive characteristics of a type, period, or method of construction, or represents the work of a master, or that possesses high artistic values, or that represents a significant and distinguishable entity whose components may lack individual distinction; and Criterion d: Has yielded, or is likely to yield, information important to prehistory and history.

¹¹ 36 CFR 60.4(g).

1 **3.7.2 NEPA and NHPA**

2 NEPA requires Federal agencies to consider the potential effects of their actions on the affected
 3 human environment, which includes “aesthetic, historic, and cultural resources as these terms
 4 are commonly understood, including such resources as sacred sites” (CEQ and ACHP 2013).
 5 For NEPA compliance, impacts on cultural resources that are not eligible for or listed in the
 6 NRHP would also need to be considered (CEQ and ACHP 2013). The Advisory Council on
 7 Historic Preservation (ACHP) is an independent Federal agency that oversees the NHPA
 8 Section 106 review process in accordance with its implementing regulations in 36 CFR Part
 9 800, “Protection of Historic Properties” (36 CFR Part 800). Section 106 of the NHPA requires
 10 Federal agencies to take into account the effects of their undertakings¹² on historic properties
 11 and consult with the appropriate parties as defined in 36 CFR 800.2. Consulting parties include
 12 the State Historic Preservation Officer (SHPO), ACHP, Tribal Historic Preservation Officer, and
 13 Indian Tribes that attach cultural and religious significance to historic properties on a
 14 government-to-government basis and other parties that have a demonstrated interest in the
 15 effects of the undertaking, including local governments and the public, as applicable. Issuing a
 16 renewed license (initial LR or SLR) is a Federal undertaking that requires compliance with the
 17 NHPA Section 106.

18 When preparing plant-specific supplements to this LR GEIS (see 36 CFR 800.8(c)), the NRC’s
 19 practice is to fulfill the requirements of NHPA Section 106 through the NEPA review process.
 20 For each application, the NRC would identify consulting parties and determine the scope of
 21 potential effects from the undertaking by defining the area of potential effect (APE). The license
 22 renewal (initial LR or SLR) APE includes lands within the nuclear power plant site boundary and
 23 the transmission lines up to the first substation that may be directly (e.g., physically) affected by
 24 land-disturbing or other operational activities associated with continued plant operations and
 25 maintenance and/or refurbishment activities. The APE may extend beyond the nuclear plant
 26 site when these activities may indirectly (e.g., visual and auditory) affect historic properties.
 27 This determination is made irrespective of land ownership or control.

28 The NRC will rely on historic and cultural resource investigations completed by qualified
 29 professionals, who meet the Secretary of Interior’s standards at 36 CFR Part 61, to identify
 30 historic and cultural resources located within the APE and complete NRHP eligibility
 31 determinations in consultation with the SHPO and other consulting parties to determine whether
 32 historic properties are present in the APE. The NHPA requires that information about the
 33 locations of some historic and cultural resources, as well as sensitive sacred and religious
 34 information, be withheld from the public to protect the resources (36 CFR 800.11(c)(1)). Other
 35 legal authorities regarding protection of information from public release may also apply.

36 Additional historic and cultural resource laws could apply if a proposed project is located on
 37 Federal lands (see Appendix F).

38 **3.7.3 Historic and Cultural Resources at Nuclear Power Plant Sites**

39 Nuclear power plant sites tend to be located in areas of focused past human activities (along
 40 waterways) and, as such, there is a potential for historic and cultural resources to be present

¹² An undertaking is “a project, activity, or program funded in whole or in part under the direct or indirect jurisdiction of a Federal agency, including those carried out by or on behalf of a Federal agency; those carried out with Federal financial assistance; and those requiring a Federal permit, license or approval” (see 36 CFR 800.16(y)).

Affected Environment

1 within existing nuclear power plant site boundaries. A review of historic and cultural resources
2 at various nuclear power plants that have undergone initial LR or SLR since 2013 indicates that
3 there are a variety of historic and cultural resources (mainly archaeological resources) that have
4 been identified that reflect land use throughout precontact and historic time periods. For
5 example, at one nuclear power plant site there were 129 historic and cultural resources
6 identified within the site boundaries. There are other examples of nuclear power plant sites that
7 contain fewer or no historic and cultural resources identified. The number and diversity of
8 resource types is dependent upon geographic location and prior site land use.

9 Based on experience from initial LR and SLR environmental reviews, ground-disturbing
10 activities occurred during nuclear power plant construction resulting in extensive disturbance of
11 much of the land in and immediately surrounding the power block. The term “power block”
12 refers to the buildings and components directly involved in generating electricity at a power
13 plant. At a nuclear power plant, the components of the power block vary with the reactor
14 design, but always include the reactor and turbine building, and usually include several other
15 buildings that include access, reactor auxiliary, safeguards, waste processing, or other nuclear
16 generation support functions. Buildings within the power block require significant excavation of
17 existing material, followed by placement of structural fill for a safe and stable base. Building
18 excavations are extensive, and the area of excavation is larger than the as-built power block
19 and reactor containment. There are also less-developed and undeveloped areas at nuclear
20 power plant sites, including areas that were not extensively disturbed (e.g., construction
21 laydown areas). Laydown areas are lands that were cleared, graded, and used to support
22 fabrication and installation activities during initial power plant construction. Intact archaeological
23 resources are unlikely to be present in heavily disturbed areas and do not require field
24 investigation, whereas less disturbed areas could still contain unrecorded archaeological
25 resources and should be investigated for the presence of historic and cultural resources.

26 Many nuclear power plant facilities were constructed prior to the implementation of NHPA
27 Section 106 regulations located at 36 CFR Part 800; therefore, there were no formal standards
28 for archaeological field investigations or requirements to identify and consult with Indian Tribes.
29 A review of historic and cultural resources at various nuclear power plants that have undergone
30 license renewal (initial LR or SLR) since 2013 indicates that most existing nuclear power plants
31 in the United States were not investigated prior to initial construction for the presence of
32 archaeological, architectural or TCP resources, nor have Indian Tribes been consulted
33 regarding historic and cultural resources that may have significance to a Tribe’s history, culture,
34 or religion. In some cases, archaeological and architectural resource investigations were
35 completed prior to construction, but the methods used then are unlikely to meet the current
36 Secretary of Interior’s standards for archaeological and architectural resource investigation.
37 Historic and cultural resource field investigations may be necessary at the time of initial LR and
38 SLR if none were completed previously or may need to be updated to meet current standards.
39 In addition, identification of and consultation with Indian Tribes that have cultural and religious
40 ties to nuclear power plant sites are required to identify all historic and cultural resources that
41 may be located within the APE. Identification and consultation with Indian Tribes is the
42 responsibility of the NRC.

43 For example during the license renewal review of the Sequoyah Nuclear Plant, Units 1 and 2,
44 during the environmental audit, the NRC determined that a mound site that was thought to have
45 been destroyed by initial facility construction was partially intact. The mound site was originally
46 recorded in 1913 and excavated in 1936 and 1973. In 2010, Tennessee Valley Authority (TVA)
47 conducted a cultural resources survey in preparation for its license renewal application. The
48 survey was unable to locate the mound site and presumed that the site no longer existed.

1 TVA's environmental report stated that the mound was destroyed during the construction of
2 Sequoyah Units 1 and 2. As a result of the NRC environmental audit and after further
3 discussions, TVA reopened its NHPA Section 106 consultation with the Tennessee SHPO and
4 submitted revisions to its previous cultural resource surveys and prepared an updated site form
5 for the mound site. Additionally, TVA also reinitiated NHPA Section 106 consultation with Indian
6 Tribes. There was no formal eligibility determination of the site for listing in the NRHP, although
7 TVA believes the site is eligible (NRC 2015f).

8 Most license renewals are granted for a period of 20 years, so it is possible for historic and
9 cultural resources, including the nuclear power plant facility itself, to fall within the 50-year
10 threshold for inclusion in the NRHP and to have achieved historic significance during the license
11 renewal period. For example, Fermi plant Unit 1, the Nation's first commercial-size nuclear
12 power plant was determined eligible for listing in the NRHP in 2012 (NRC 2016c). Due to the
13 passage of time since initial licensing, documentation and NRHP eligibility evaluation of all
14 historic and cultural resources that fall within the 50-year threshold should be completed for
15 initial LR and SLR.

16 **3.8 Socioeconomics**

17 This section describes socioeconomic factors that have the potential to be directly or indirectly
18 affected by changes in nuclear power plant operations. The nuclear plant and the communities
19 that support it can be described as a dynamic socioeconomic system. The communities provide
20 the people, goods, and services needed to operate the nuclear power plant. Power plant
21 operations, in turn, provide employment and income and pay for goods and services from the
22 communities. The measure of a community's ability to support power plant operations depends
23 on the ability of the community to respond to changing economic conditions.

24 The socioeconomic region of influence (ROI) is defined by the counties where nuclear power
25 plant employees and their families reside, spend their income, and use their benefits, thereby
26 affecting economic conditions in the region. Changes in power plant operation affects
27 socioeconomic conditions in the ROI, including employment and income, recreation and
28 tourism, tax revenue, community services and education, population and housing, and
29 transportation.

30 **3.8.1 Power Plant Employment and Expenditures**

31 Nuclear power plants generate employment and income in the local economy. Wages, salaries,
32 and expenditures generated by nuclear plant operation create demand for goods and services
33 in the local economy, while wage and salary spending by workers creates additional demand for
34 services and housing. Nuclear power plants also provide tax revenue for education, public
35 safety, government services, and transportation.

36 Employment at nuclear power plants varies based on a number of factors, including the number
37 of reactor units, energy production, and the type and age of the nuclear plant. The review of
38 annual economic data on 15 nuclear power plants shows employment at these nuclear plants
39 averaged about 800 workers, ranging from 506 workers at Point Beach to 941 workers at the
40 Surry plant (Table 3.8-1).

1 **Table 3.8-1 Local Employment and Tax Revenues at 15 Nuclear Plants from 2014**
 2 **through 2020**

Nuclear Power Plant	Data Year	Employment	Percent of Local Employment	Tax Revenues (\$ million)	Percent of Local Tax Revenue
Byron	2013	867	0.50	33.0	28.3
Braidwood	2014	885	0.22	24.5	1.4
Comanche Peak	2014	889	N/A	70.0	N/A
Fermi	2014	889	0.12	19.6	43.7
Ginna	2014	889	N/A	10.0	N/A
South Texas	2014	680	N/A	70.0	N/A
LaSalle	2015	889	0.22	22.5	31.1
Cooper	2016	641	N/A	N/A	N/A
Waterford	2016	641	0.27	22.4	15.2
River Bend	2017	680	0.31	14.2	63.1
Turkey Point	2018	679	0.05	36.6	0.4
Surry	2018	941	4.60	13.3	61.3
Peach Bottom	2019	919	0.19	1.4	0.8
North Anna	2020	903	2.69	11.6	4.8
Point Beach	2020	506	0.30	10.2	2.8

3 N/A = Not available.

4 Sources: NRC 2015c, NRC 2016d, NRC 2016c, NRC 2018c, NRC 2018d, NRC 2019c, NRC 2020g, NRC 2020f,
 5 NRC 2021f, NRC 2021g, NEI 2015b, NEI 2015c, NEI 2018, NEI 2015a.

6 Nuclear power plants provide tax revenue to State and local governments, and the 15 nuclear
 7 plants evaluated have tax characteristics similar to those in the 2013 LR GEIS. State and local
 8 tax payments ranged from \$1.4 million at the Peach Bottom plant to \$70.0 million at both the
 9 South Texas plant and Comanche Peak Steam Electric Station (Comanche Peak), averaging
 10 \$25.3 million. Differences in tax revenue generated by the nuclear power plants are due to
 11 differences in State and local tax laws, electricity output, plant size, and plant employment.

12 Additional employment and expenditures occur during refueling and maintenance outages at
 13 each nuclear power plant, when additional workers and services are required for a 1- to 2-month
 14 period. Refueling outages generally occur on a 18- to 24-month cycle.

15 **3.8.2 Regional Economic Characteristics**

16 Regional economic characteristics can vary depending on the location of the nuclear power
 17 plant. Socioeconomic conditions in the county where the nuclear plant is located are directly
 18 affected by power plant operations as are the counties where the majority of power plant
 19 workers reside.

20 Many areas have changed since the nuclear power plant was constructed. Residential and
 21 commercial development and the diversification of economic activity in these areas have also
 22 changed the local and regional economic profile. Outdoor recreational activities have changed
 23 the focus of local and regional economic activity and the growth of retirement communities, in
 24 some instances, rivals the importance of traditional economic activities in the vicinity of a
 25 nuclear power plant.

1 As previously discussed, nuclear power plant operations generate employment, income, and
2 expenditures in the local economy. These expenditures—payments for goods and services—
3 create additional opportunities for employment and income in the regional economy. Nuclear
4 plants are located in one of two regional economic settings: rural or urban.

5 3.8.2.1 *Rural Economies*

6 Most nuclear power plants are located in rural areas, where agriculture is the primary economic
7 activity. Rural areas are considered to have relatively simple economies, without industries that
8 provide the equipment and services needed to support nuclear plant operations, and with
9 smaller, less diversified labor markets. A range of other industrial activities, including those
10 associated with resource extraction, manufacturing, and transportation, provide employment
11 and income.

12 Nuclear power plants located in rural economies include the Byron, River Bend, Waterford,
13 Surry, North Anna, Point Beach, R.E. Ginna Nuclear Power Plant (Ginna), Comanche Peak,
14 South Texas, and Cooper plants. Only 2 of the 10 nuclear plants, Surry and North Anna,
15 provided 1 percent or more to regional employment.

16 3.8.2.2 *Urban Economies*

17 Some nuclear power plants are located in or near urban areas that have more complex
18 economic activities, a wider range of industries, and larger and more diverse labor markets.
19 Urban areas may also serve more specialized economic functions, including maritime shipping,
20 fishing, and boatbuilding; recreation; and tourism. Many also have residential areas with
21 second homes and retirement communities.

22 Nuclear power plants located in urban economies include the Braidwood, Fermi, LaSalle,
23 Turkey Point, and Peach Bottom plants. None of the nuclear plants provided 1 percent or more
24 to regional employment.

25 **3.8.3 Demographic Characteristics**

26 Although most nuclear power plants are situated in rural areas, population densities within 20 mi
27 (50 km) of most nuclear plant sites are generally high, and most are within 50 mi (80 km) of a
28 city with a population of at least 100,000 (see Appendix C). Demographics vary around each
29 nuclear power plant and many are affected by the remoteness of the nuclear plant to regional
30 population centers.

31 Two measures of remoteness were developed for the LR GEIS—“sparseness” and “proximity”—
32 which combine demographic data on population density and the distance to larger cities to place
33 nuclear plants into three population classes (1996 LR GEIS). Population classifications of
34 15 representative nuclear power plant sites are presented in Table 3.8-2.

1 **Table 3.8-2 Population Classification of Regions around Selected Nuclear Power Plants**

Population	Nuclear Power Plant	Population Density Within 20 miles	Sparseness Measure	Population Density Within 50 miles	Proximity Measure
Low	Cooper	12.9	1	19.7	1
Low	South Texas	40.1	2	42.8	1
Low	River Bend	105.7	3	137.0	3
Moderate	Comanche Peak	70.5	3	269.4	4
Moderate	Byron	220.1	4	165.3	3
High	North Anna	149.1	4	296.3	4
High	Point Beach	226.9	4	298.0	4
High	LaSalle	253.2	4	250.9	4
High	Waterford	438.8	4	353.2	4
High	Braidwood	486.8	4	655.8	4
High	Surry	531.3	4	427.2	4
High	Turkey Point	937.3	4	685.4	4
High	Peach Bottom	1,268.5	4	874.8	4
High	Fermi	1,486.7	4	788.2	4
High	Ginna	3,339.3	4	335.7	4

2 Source: Pacific Northwest National Laboratory calculations based on 2020 decennial census data.

3 Many communities near a nuclear power plant have transient populations attracted to tourism
 4 and recreational activities, weekend and summer homes, and students attending full-time
 5 colleges and other educational institutions. Nuclear power plants located in coastal regions,
 6 notably D.C. Cook and Palisades plants on Lake Michigan and Brunswick plant on the North
 7 Carolina coast between Wilmington, North Carolina, and Myrtle Beach, South Carolina, have
 8 weekend, summer, and retirement populations and a range of recreational amenities that attract
 9 visitors from nearby metropolitan areas.

10 In addition to transient populations, farms and factories in rural communities often employ
 11 migrant workers on a seasonal basis. For example, berry production near the D.C. Cook and
 12 Palisades plants is a local agricultural activity that employs a sizable migrant labor force in the
 13 summer.

14 **3.8.4 Housing and Community Services**

15 Housing in the vicinity of nuclear power plants ranges in the number of housing units and the
 16 type and quality of available housing. Much of the difference is due to the local economy,
 17 population, and income; proximity to metropolitan areas; and recreation, tourism, second
 18 homes, and retirement communities. Although housing demand can be affected by changes in
 19 the number of workers at a nuclear power plant, demand for temporary rental housing increases
 20 during refueling and maintenance outages. This demand affects the availability and cost of
 21 housing. Some workers may occupy motel rooms and other temporary accommodations during
 22 refueling outages which include onsite temporary housing at some nuclear power plants.

- 1 Rural communities have smaller housing markets, stable prices for most types of housing, lower
- 2 median house values, and stable vacancy rates. Housing markets in urban areas are generally
- 3 less stable and feature more turnover, higher prices, and lower vacancy rates. Controls on
- 4 housing development are more likely in urban areas, particularly where there is a transient
- 5 seasonal population.

Sparseness and Proximity Measures	
Sparseness	
Most Sparse	
1.	There are fewer than 40 people/mi ² (15 people/km ²) and there is no community with 25,000 or more people within 20 mi (32 km) of the plant.
2.	There are 40 to 60 people/mi ² (15 to 23 people/km ²) and there is no community with 25,000 or more people within 20 mi (32 km) of the plant.
3.	There are 60 to 120 people/mi ² (23 to 46 people/km ²) and there is at least one community with more than 25,000 people/mi ² (10,000 people/km ²) within 20 mi (32 km) of the plant.
Least Sparse	
4.	There are more than 120 people/mi ² (46 people/km ²) within 20 mi (32 km) of the plant.
Proximity	
Not in Close Proximity	
1.	There are fewer than 50 people/mi ² (19 people/km ²) and there is no city with more than 100,000 people within 50 mi (80 km) of the plant.
2.	There are 50 to 190 people/mi ² (19 to 73 people/km ²) and there is no city with 100,000 people within 50 mi (80 km) of the plant.
3.	There are fewer than 190 people/mi ² (73 people/km ²) and there are one or more cities with more than 100,000 people within 50 mi (80 km) of the plant.
In Close Proximity	
4.	There are more than 190 people/mi ² (73 people/km ²) within 50 mi (80 km) of the plant.
Source: Adapted from NUREG/CR-2239.	

6 **3.8.5 Tax Revenue**

- 7 Nuclear power plants provide tax revenue to State and local governments. Although property
- 8 taxes are the most important source of revenue for most communities, other sources of revenue
- 9 include taxes on energy production and direct funding from Federal and State governments for
- 10 educational facilities and programs. Between 2014 and 2020, State and local taxes paid by the
- 11 15 nuclear power plants listed in Table 3.8-1 ranged from \$1.4 million at the Peach Bottom plant
- 12 to \$70 million at the South Texas and Comanche Peak plants, averaging \$24.1 million.
- 13 Differences in tax revenue are due to variations in State and local tax laws, energy production,
- 14 power plant size, and employment. Tax revenue is also used by State, regional, and local
- 15 governments to fund education, public safety, services, and transportation networks. Property
- 16 taxes paid by nuclear power plant owners contribute more than 50 percent of total property tax

1 revenue in some rural communities (e.g., at the River Bend plant in Louisiana and the Surry
2 plant in Virginia). Loss of tax revenue can affect the quality and availability of public services.

3 The deregulation of electricity markets in some States has led to changes in the methods used
4 to estimate property values at some nuclear power plants. Any changes in tax revenues after
5 utility deregulation would not occur as a direct result of license renewal (initial LR or SLR).

6 **3.8.6 Local Transportation**

7 Local and regional transportation networks in the vicinity of a nuclear power plant vary
8 considerably depending on population density, the location and size of communities, economic
9 development patterns, the power plant's location relative to interregional transportation
10 corridors, and land surface features, such as mountains, rivers, and lakes. Commuting patterns
11 in the vicinity of a nuclear power plant depend on the extent to which these factors limit or
12 facilitate traffic movement and on the size of the workforce that uses the transportation network
13 at any given time. Traffic volumes near a nuclear power plant depend on road network
14 capacity, local traffic patterns, and the availability of alternate routes. Because most nuclear
15 power plants have only one access road, congestion on this road may occur during shift
16 changes.

17 **3.9 Human Health**

18 **3.9.1 Radiological Exposure and Risk**

19 Radiological exposures from nuclear power plants include offsite doses to members of the
20 public and onsite doses to the workforce. Each of these impacts is common to all commercial
21 U.S. reactors. The AEA requires the NRC to promulgate, inspect, and enforce standards that
22 provide an adequate level of protection for public health and safety and the environment. The
23 NRC continuously evaluates the latest radiation protection recommendations from international
24 and national scientific bodies to establish the requirements for nuclear power plant licensees.
25 The NRC has established multiple layers of radiation protection limits to protect the public
26 against potential health risks from exposure to effluent discharges from nuclear power plant
27 operations. If the licensees exceed a certain fraction of these dose levels in a calendar quarter,
28 they are required to notify the NRC, investigate the cause, and initiate corrective actions within
29 the specified time frame. Section 3.9.1.1 discusses regulatory requirements at nuclear power
30 plants. Sections 3.9.1.2 and 3.9.1.3 discuss occupational and public exposure, respectively.
31 These sections evaluate the performance of licensees in implementing these requirements, and
32 they compare the doses and releases with permissible levels. Risk estimates are provided in
33 Section 3.9.1.4.

34 *3.9.1.1 Regulatory Requirements*

35 Nuclear power reactors in the United States must be licensed by the NRC and must comply with
36 NRC regulations and conditions specified in the license in order to operate. The licensees are
37 required to comply with 10 CFR Part 20, Subpart C, "Occupational Dose Limits for Adults," and
38 10 CFR Part 20, Subpart D, "Radiation Dose Limits for Individual Members of the Public."

39 *3.9.1.1.1 Regulatory Requirements for Occupational Exposure*

40 10 CFR 20.1201 establishes occupational dose limits (see Table 3.9-1).

1 **Table 3.9-1 Occupational Dose Limits for Adults Established by 10 CFR Part 20**

Tissue	Dose Limit ^(a)
Whole-body or any individual organ or tissue other than the lens of the eye	More limiting of 5 rem/yr TEDE to whole-body or 50 rem/yr sum of the deep dose equivalent and the committed dose equivalent to any individual organ or tissue other than the lens of the eye
Lens of the eye	15 rem/yr dose equivalent
Extremities, including skin	50 rem/yr shallow dose equivalent

2 rem/yr = rem per year; TEDE = total effective dose equivalent.

3 (a) See table below for definitions.

4 Note: To convert rem to sievert, multiply by 0.01.

5 Source: 10 CFR Part 20

Definitions of Dosimetry Terms

- **Total effective dose equivalent (TEDE):** Sum of the dose equivalent (for external exposure) and the committed effective dose equivalent (for internal exposure).
- **Committed effective dose equivalent (CEDE):** Sum of the products of the weighting factors for body organs or tissues that are irradiated and the committed dose equivalent to these organs or tissues.
- **Deep dose equivalent:** Applies to external whole-body exposure and is the dose equivalent at a tissue depth of 1 cm.
- **Committed dose equivalent:** Dose equivalent to organs or tissues from an intake of radioactive material for the 50-year period following the intake.
- **Dose equivalent:** Product of the absorbed dose in the tissue, quality factor, and all other necessary modifying factors at the location of interest.
- **Shallow dose equivalent:** Applies to the external exposure of the skin, as the dose equivalent at a tissue depth of 0.007 cm averaged over an area of 1 cm².
- **Organ dose:** Dose received as a result of radiation energy absorbed in a specific organ.
- **Total body dose or whole-body dose:** Sum of the dose received from external exposure to the total body, gonads, active blood-forming organs, head and trunk, or lens of the eye and the dose due to the intake of radionuclides by inhalation and ingestion, where a radioisotope is uniformly distributed throughout the body tissues rather than being concentrated in certain parts.

6 Under 10 CFR 20.2206, the NRC requires licensees to submit an annual report of the results of
 7 individual monitoring carried out by the licensee for each individual for whom monitoring was
 8 required by 10 CFR 20.1502 during that year.

9 Under 10 CFR 20.2202 and 10 CFR 20.2203, the NRC requires all licensees to submit reports
 10 of all occurrences involving personnel radiation exposures that exceed certain control levels.
 11 The control levels are used to investigate occurrences and to take corrective actions as
 12 necessary. Depending on the magnitude of the exposure, the occurrence reporting is required
 13 immediately, within 24 hours, or within 30 days. On the basis of the reporting requirement, the
 14 control levels can be placed in one of three categories (A, B, or C), as follows (NRC 2020i):

Affected Environment

- 1 • Category A, immediate notification. A TEDE of 25 rem or more to any individual, an eye
2 dose equivalent of 75 rem or more, or a shallow dose equivalent to the skin or extremities of
3 250 rad or more (10 CFR 20.2202(a)(1)).
- 4 • Category B, notification within 24 hours. A TEDE of 5 rem or more to any individual, an eye
5 dose equivalent of 15 rem or more, or a shallow dose equivalent to the skin or extremities of
6 50 rem or more (10 CFR 20.2202(b)(1)).
- 7 • Category C, written report within 30 days. Any incident for which notification was required
8 and doses or releases that exceed the limits in the license set by the NRC or EPA
9 (10 CFR 20.2203).

10 3.9.1.1.2 Regulatory Requirements for Public Exposure

11 NRC regulations in 10 CFR Part 20 identify maximum allowable concentrations of radionuclides
12 that can be released from a licensed facility into the air and water above background levels at
13 the boundary of unrestricted areas to control radiation exposures of the public and releases of
14 radioactivity. These concentrations are derived on the basis of an annual TEDE of 0.1 rem to
15 individual members of the public. In addition, pursuant to 10 CFR 50.36a, nuclear power
16 reactors have special license conditions called technical specifications for radioactive gaseous
17 and liquid releases from the plant that are required to minimize the radiological impacts
18 associated with plant operations to levels that are ALARA.

19 Appendix I to 10 CFR Part 50 provides numerical values on dose-design objectives for
20 operation of LWRs to meet the ALARA requirement. The design objective doses for Appendix I
21 are summarized here in Table 3.9-2.

22 In addition to keeping within NRC requirements, nuclear power plant releases to the
23 environment must comply with EPA standards in 40 CFR Part 190, "Environmental Radiation
24 Protection Standards for Nuclear Power Operations." These standards specify limits on the
25 annual dose equivalent from normal operations of uranium fuel-cycle facilities (except mining,
26 waste disposal operations, transportation, and reuse of recovered non-uranium special nuclear
27 and by-product materials). The standards are given in Table 3.9-3. Radon and its daughters
28 are covered by Subpart D of 40 CFR Part 192 (the conforming NRC regulations are in
29 Appendix A of 10 CFR Part 40).

30 **Table 3.9-2 Design Objectives and Annual Standards on Doses to the General Public**
31 **from Nuclear Power Plants^(a) from Appendix I to 10 CFR 50**

Tissue	Gaseous Effluents	Liquid Effluents
Total body, mrem	5 ^(b)	3
Any organ (all pathways), mrem	N/A	10
Ground-level air dose, ^(b) mrad	10 (gamma) and 20 (beta)	N/A
Any organ ^(c) (all pathways), mrem	15	N/A
Skin, mrem	15	N/A

32 mrem = millirem; mrad = millirad; N/A = not applicable.

33 (a) Calculated doses.

34 (b) The ground-level air dose has always been limiting because an occupancy factor cannot be used. The 5-mrem
35 total body objective could be limiting only in the case of high occupancy near the restricted area boundary.

36 (c) Particulates, radioiodines.

37 Source: 10 CFR Part 50.

1 **Table 3.9-3 Design Objectives and Annual Standards on Doses to the General Public**
 2 **from Nuclear Power Plants^(a) from 40 CFR 190, Subpart B**

Tissue	Gaseous Effluents	Liquid Effluents
Whole-body, ^(b) mrem	25	N/A
Thyroid, ^(b) mrem	75	N/A
Any other organ, ^(b) mrem	25	N/A

3 mrem = millirem; N/A = not applicable.
 4 (a) Calculated doses.
 5 (b) All effluents and direct radiation except radon and its daughters.
 6 Source: 40 CFR Part 190.

7 EPA standards in 40 CFR Part 61, “National Emission Standards for Hazardous Air Pollutants,”
 8 apply only to airborne releases. The EPA specified an annual effective dose equivalent limit of
 9 10 mrem for airborne releases from nuclear power plants; however, no more than 3 mrem can
 10 be caused by any isotope of iodine. However, the EPA later rescinded Subpart I of 40 CFR Part
 11 61 as it applies to nuclear reactors based on the EPA’s determination that the NRC’s
 12 regulations provide an ‘ample margin of safety’ (60 FR 46206 1995).

13 Experience with the design, construction, and operation of nuclear power reactors indicates that
 14 compliance with the design objectives of Appendix I to 10 CFR Part 50 will keep average annual
 15 releases of radioactive material in effluents at small percentages of the limits specified in
 16 10 CFR Part 20 and 40 CFR Part 190. At the same time, the licensee is given the flexibility in
 17 operations, compatible with considerations of health and safety, to ensure that the public is
 18 provided with a dependable source of power, even under unusual operating conditions that
 19 might temporarily result in releases that were higher than such small percentages but still well
 20 within the regulatory limits.

21 Another 10 CFR Part 20 requirement is that the sum of the external and internal doses (i.e., in
 22 TEDE) for a member of the public shall not exceed 100 mrem/yr. This value is an annual limit
 23 and is not intended to be applied as a long-term average goal. The dose limits in 10 CFR
 24 Part 20 are based on the methodology described in International Commission on Radiological
 25 Protection (ICRP) Publication 26 (ICRP 1977). The radiation levels at any unrestricted area
 26 should not exceed 2 mrem in any one hour. As stated in 10 CFR 20.1302(b), licensees comply
 27 with the 100-mrem limit for individual members of the public by (1) demonstrating by
 28 measurement or calculation that the dose to the individual likely to receive the highest dose
 29 from sources under the licensee’s control does not exceed the annual dose limit or (2) that the
 30 annual average concentrations of radioactive material released in gaseous and liquid effluents
 31 at the boundary of the unrestricted area do not exceed the levels specified in Table 2 of 10 CFR
 32 Part 20, Appendix B; and at the unrestricted area boundary, the dose from external sources
 33 would not exceed 2 mrem in any given hour and 50 mrem in a single year. The concentration
 34 values given in Table 2 of Appendix B to 10 CFR Part 20 are equivalent to the radionuclide
 35 concentrations that, if inhaled or ingested continuously in a year, would produce a TEDE of
 36 50 mrem. Nuclear power reactors, as discussed earlier in this section, are subject to additional
 37 regulatory controls which maintain doses to members of the public to the ALARA dose-design
 38 objectives in Appendix I to 10 CFR Part 50.

1 3.9.1.2 Occupational Radiological Exposures

2 This section provides an evaluation of the radiological impacts on nuclear power plant workers.
 3 This evaluation extends to all nuclear power reactors. The data in this section are generally
 4 sourced from NUREG-0713 Volume 40 (NRC 2020i), which provides data through 2018. In
 5 2018, there were 98 operating reactors in the United States, and all were LWRs; among them
 6 33 are BWRs and 65 are PWRs. Currently (as of 2022), there are 92 operating reactors in the
 7 United States, and all are LWRs. Among them, 31 are BWRs and 61 are PWRs (NRC 2021c).

8 Plant workers conducting activities involving radioactively contaminated systems or working in
 9 radiation areas can be exposed to radiation. Individual occupational doses are measured by
 10 NRC licensees as required by the basic NRC radiation protection standard, 10 CFR Part 20
 11 (see Section 3.9.1.1). Most of the occupational radiation dose to nuclear plant workers results
 12 from external radiation exposure rather than from internal exposure from inhaled or ingested
 13 radioactive materials. Workers also receive radiation exposure during the storage and handling
 14 of radioactive waste and during the inspection of stored radioactive waste. However, this
 15 source of exposure is small compared with other sources of exposure at operating nuclear
 16 plants.

17 Table 3.9-4 shows the radiation exposure data from all commercial U.S. nuclear power plants
 18 for the years 2006 through 2018. The year 2006 was chosen as a starting date because the
 19 dose data for years before 2006 were presented in the 2013 LR GEIS and the 1996 LR GEIS.
 20 For each year, the number of reactors, the number of workers receiving measurable exposures,
 21 the collective dose¹³ for all reactors combined, and the number of individuals receiving a dose in
 22 the range of 4 to 5 rem are given. Data indicate that no worker received a dose in the range of
 23 4 to 5 rem from 2006 to 2018. The collective dose has been about 11,000 person-rem or less
 24 since 2006 and shows a decreasing trend.

25 **Table 3.9-4 Occupational Whole-Body Dose Data at U.S. Commercial Nuclear Power**
 26 **Plants**

Calendar Year	Number of Workers with Measurable Dose	Collective Dose (person-rem)	Number of Licensees	Number of Workers in the Range of 4 to 5
2006	80,265	11,021	104	0
2007	79,530	10,120	104	0
2008	79,450	9,196	104	0
2009	81,754	10,025	104	0
2010	75,010	8,631	104	0
2011	81,321	8,771	104	0
2012	79,549	8,035	104	0
2013	67,236	6,760	100	0
2014	70,847	7,125	100	0
2015	70,798	7,019	99	0
2016	59,353	5,366	99	0
2017	64,761	6,417	99	0

¹³ The collective dose is the sum of all personal doses and is expressed as person-rem.

Calendar Year	Number of Workers with Measurable Dose	Collective Dose (person-rem)	Number of Licensees	Number of Workers in the Range of 4 to 5
2018	61,014	5,829	98	0

Note: To convert rem to sievert (Sv), multiply by 0.01.
 Source: NRC 2020i

Table 3.9-5 and Table 3.9-6 show the occupational dose history (2006 to 2018) for all commercial U.S. reactors. Average measurable occupational dose and annual collective occupational dose information are presented for plants that operated between 2006 and 2018. For the period from 2006 to 2018, the annual average measurable dose per plant worker has shown decreasing trends for both PWRs and BWRs. During 2018, at all operating nuclear power plants, the annual average individual dose was 0.1 rem compared with an exposure limit of 5 rem. The average collective occupational exposure for the year 2018 was roughly 1.11 person-Sv (111 person-rem) per plant at BWRs and about 0.34 person-Sv (34 person-rem) per plant at PWRs. For the years 2016 to 2018, the average collective occupational exposure for the BWRs was 1.09 person-Sv (109 person-rem) per plant, and for the PWRs, it was 0.34 person-Sv (34 person-rem) (Table 3.9-6).

Table 3.9-7 and Table 3.9-8 show the 3-year collective dose per reactor, number of workers with measurable doses, and average dose per worker for BWRs and PWRs, respectively, for the years 2016 to 2018.

Table 3.9-5 Annual Average Measurable Occupational Dose per Individual for U.S. Commercial Nuclear Power Plants in rem

Year	BWR	PWR	LWR
2006	0.15	0.13	0.14
2007	0.14	0.11	0.13
2008	0.13	0.10	0.12
2009	0.15	0.10	0.12
2010	0.13	0.10	0.12
2011	0.13	0.09	0.11
2012	0.11	0.09	0.10
2013	0.12	0.07	0.10
2014	0.11	0.09	0.10
2015	0.12	0.08	0.10
2016	0.11	0.07	0.09
2017	0.12	0.07	0.10
2018	0.12	0.07	0.10

BWR = boiling water reactor; PWR = pressurized water reactor; LWR = light water reactor.
 Source: NRC 2020i

Table 3.9-6 Annual Average Collective Occupational Dose for U.S. Commercial Nuclear Power Plants in person-rem

Year	BWR	PWR	LWR
2006	143	87	106
2007	154	69	97
2008	129	68	88

Affected Environment

Year	BWR	PWR	LWR
2009	151	69	96
2010	137	55	83
2011	142	55	84
2012	120	56	77
2013	127	35	68
2014	109	51	71
2015	122	44	71
2016	98	31	54
2017	118	37	65
2018	111	34	59

1 BWR = boiling water reactor; PWR = pressurized water reactor; LWR = light water reactor.
 2 Source: NRC 2020i

3 Deviations higher than these averages in the table are routinely experienced, depending largely
 4 on whether a plant had an outage during a given year and the nature and extent of
 5 refurbishment or repair activities undertaken during outages.

6 **Table 3.9-7 Collective and Individual Worker Doses at Boiling Water Reactors from**
 7 **2016 to 2018**

Nuclear Power Plant	Reactor Years	Three-year Collective TEDE per Reactor Year 2016-2018 (person-rem)	Number of Workers with Measurable TEDE	Average TEDE per Worker (rem)
Browns Ferry 1, 2, 3	9	139.255	9,285	0.135
Brunswick 1, 2	6	94.421	5,047	0.112
Clinton	3	88.537	2,958	0.090
Columbia Generating	3	83.386	2,804	0.089
Cooper Station	3	119.565	2,686	0.134
Dresden 2, 3	6	64.987	5,689	0.069
Duane Arnold	3	68.644	2,053	0.100
Fermi 2	3	216.286	5,377	0.121
FitzPatrick	3	140.683	2,969	0.142
Grand Gulf	3	133.971	3,282	0.122
Hatch 1, 2	6	77.276	4,092	0.113
Hope Creek 1	3	107.282	3,666	0.088
Lasalle 1, 2	6	209.774	8,400	0.150
Limerick 1, 2	6	71.931	5,110	0.084
Monticello	3	57.866	1,401	0.124
Nine Mile Point 1, 2	6	130.573	4,985	0.157
Peach Bottom 2, 3	6	96.229	5,593	0.103
Perry	3	131.318	2,017	0.195
Pilgrim 1	3	82.006	2,966	0.083
Quad Cities 1, 2	6	79.658	5,441	0.088
River Bend 1	3	137.909	2,605	0.159

Nuclear Power Plant	Reactor Years	Three-year Collective TEDE per Reactor Year 2016-2018 (person-rem)	Number of Workers with Measurable TEDE	Average TEDE per Worker (rem)
Susquehanna 1, 2	6	91.689	5,007	0.110

1 TEDE = total effective dose equivalent.
 2 Source: NRC 2020i
 3 Note: To convert rem to Sv, multiply by 0.01.

4 **Table 3.9-8 Collective and Individual Worker Doses at Pressurized Water Reactors from**
 5 **2016 through 2018**

Nuclear Power Plant^(a)	Reactor Years	Three-year Collective TEDE per Reactor Year 2016-2018 (person-rem)	Number of Workers with Measurable TEDE	Average TEDE per Worker (rem)
Arkansas 1, 2	6	55.664	5,454	0.061
Beaver Valley 1, 2	6	28.776	2,448	0.071
Braidwood 1, 2	6	29.911	2,711	0.066
Byron 1, 2	6	27.836	2,779	0.060
Callaway 1	3	24.565	1,240	0.059
Calvert Cliffs 1, 2	6	31.945	2,465	0.078
Catawba 1, 2	6	32.773	2,853	0.069
Comanche Peak 1, 2	6	33.220	2,240	0.089
D.C. Cook 1, 2	6	32.038	2,990	0.064
Davis-Besse 1	3	57.032	1,807	0.095
Diablo Canyon 1, 2	6	19.610	2,312	0.051
Farley 1, 2	6	21.258	2,124	0.060
Ginna	3	25.329	1,155	0.066
Harris 1	3	25.276	1,295	0.059
Indian Point 2, 3	6	43.977	4,580	0.058
McGuire 1, 2	6	42.541	3,689	0.069
Millstone 2, 3	6	40.472	2,751	0.088
North Anna 1, 2	6	36.845	2,583	0.086
Oconee 1, 2, 3	9	16.433	3,286	0.045
Palisades	3	122.031	1,927	0.190
Palo Verde 1, 2, 3	9	17.754	3,390	0.047
Point Beach 1, 2	6	31.334	1,791	0.105
Prairie Island 1, 2	6	20.022	1,822	0.066
Robinson 2	3	41.480	1,974	0.063
Salem 1, 2	6	46.256	3,374	0.082
Seabrook	3	21.427	1,047	0.061
Sequoyah 1, 2	6	45.732	3,331	0.082
South Texas 1, 2	6	26.319	1,749	0.090
St. Lucie 1, 2	6	43.445	3,204	0.081
Summer 1	3	34.140	1,752	0.058
Surry 1, 2	6	36.714	2,596	0.085
Three Mile Island 1	3	34.047	1,396	0.073
Turkey Point 3, 4	6	39.260	2,676	0.088
Vogtle 1, 2	6	30.981	2,357	0.079
Waterford 3	3	21.750	1,247	0.052

Nuclear Power Plant^(a)	Reactor Years	Three-year Collective TEDE per Reactor Year 2016-2018 (person-rem)	Number of Workers with Measurable TEDE	Average TEDE per Worker (rem)
Watts Bar 1, 2 ^(b)	5 ^(b)	23.416	2,042	0.057
Wolf Creek 1	3	55.650	2,792	0.060
Totals and Averages	194	-	91,229	0.072
Average per Reactor-Year	-	33.992	470	-

1 TEDE = total effective dose equivalent.

2 (a) Sites where not all reactors had completed 3 full years of commercial operation as of December 31, 2018, are
3 not included.

4 (b) Watts Bar Nuclear Plant (Watts Bar) 2 came online in October of 2016 and even though the unit has not
5 completed 3 full years of commercial operation as of December 31, 2018, it is included in the total because
6 Watts Bar 1 and 2 report together.

7 No entry has been denoted by “-”.

8 Source: NRC 2020i.

9 To identify trends, Figure 3.9-1 and Figure 3.9-2 provide the average and median values of the
10 annual collective dose per reactor for BWRs and PWRs for the years 1994 through 2018. The
11 reported ranges of the values are shown by the vertical lines that extend to the minimum and
12 maximum observed values. The rectangles indicate the range of values of the collective dose
13 exhibited by those plants ranked in the 25th through the 75th percentiles. The median values
14 do not normally fluctuate as much as the average values from year to year because they are not
15 affected as much by the extreme values of the collective doses. The median collective dose
16 was 28 person-rem for PWRs and 89 person-rem for BWRs in 2018. Figure 3.9-1 also shows
17 that, in 2018, 50 percent of the PWRs reported collective doses between 19 and 44 person-rem,
18 while 50 percent of the BWRs reported collective doses between 70 and 167 person-rem (NRC
19 2020i).

20 Table 3.9-9 and Table 3.9-10 presents the average, maximum, and minimum collective and
21 individual occupational doses for all commercial nuclear power plants operating between 2006
22 and 2018.

23 For PWRs, the maximum variation in collective dose and annual average occupational dose
24 was observed for Palisades. From 2006 to 2018, the collective dose varied from 6 to
25 486 person-rem, and the annual average occupational dose varied from 0.04 to 0.39 rem. The
26 collective dose values were calculated per reactor rather than per site.

27 For BWRs, the maximum variation in collective dose and annual average occupational dose
28 was observed for Perry. From 2006 to 2018, the collective dose varied from 30 to 615 person-
29 rem and the annual average occupational dose was it varied from 0.10 to 0.34 rem. The
30 collective dose values were calculated per reactor rather than per site.

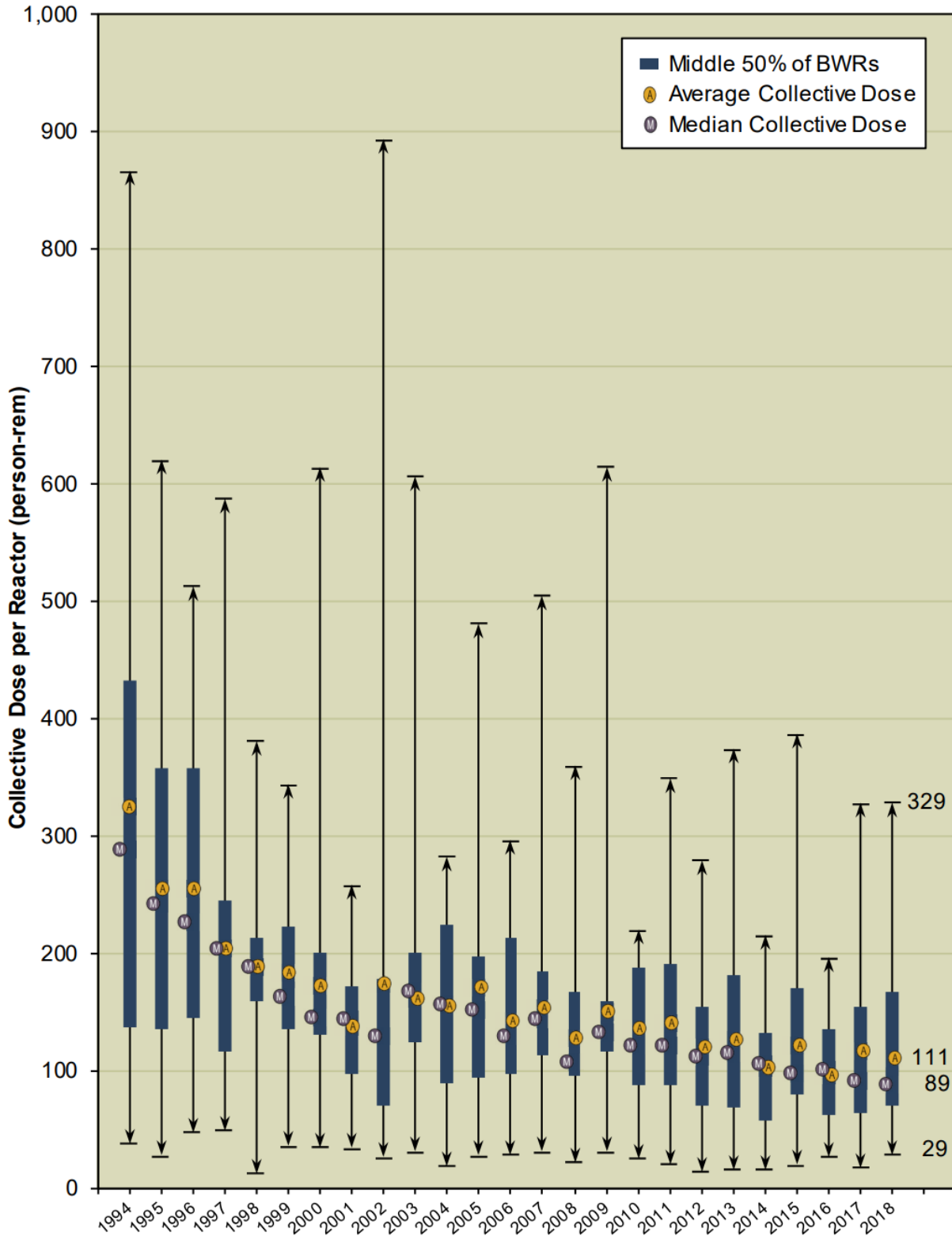

1
2
3

Figure 3.9-1 Average, Median, and Extreme Values of the Collective Dose per Boiling Water Reactors Reactor from 1994 to 2018. Source: NRC 2020i.

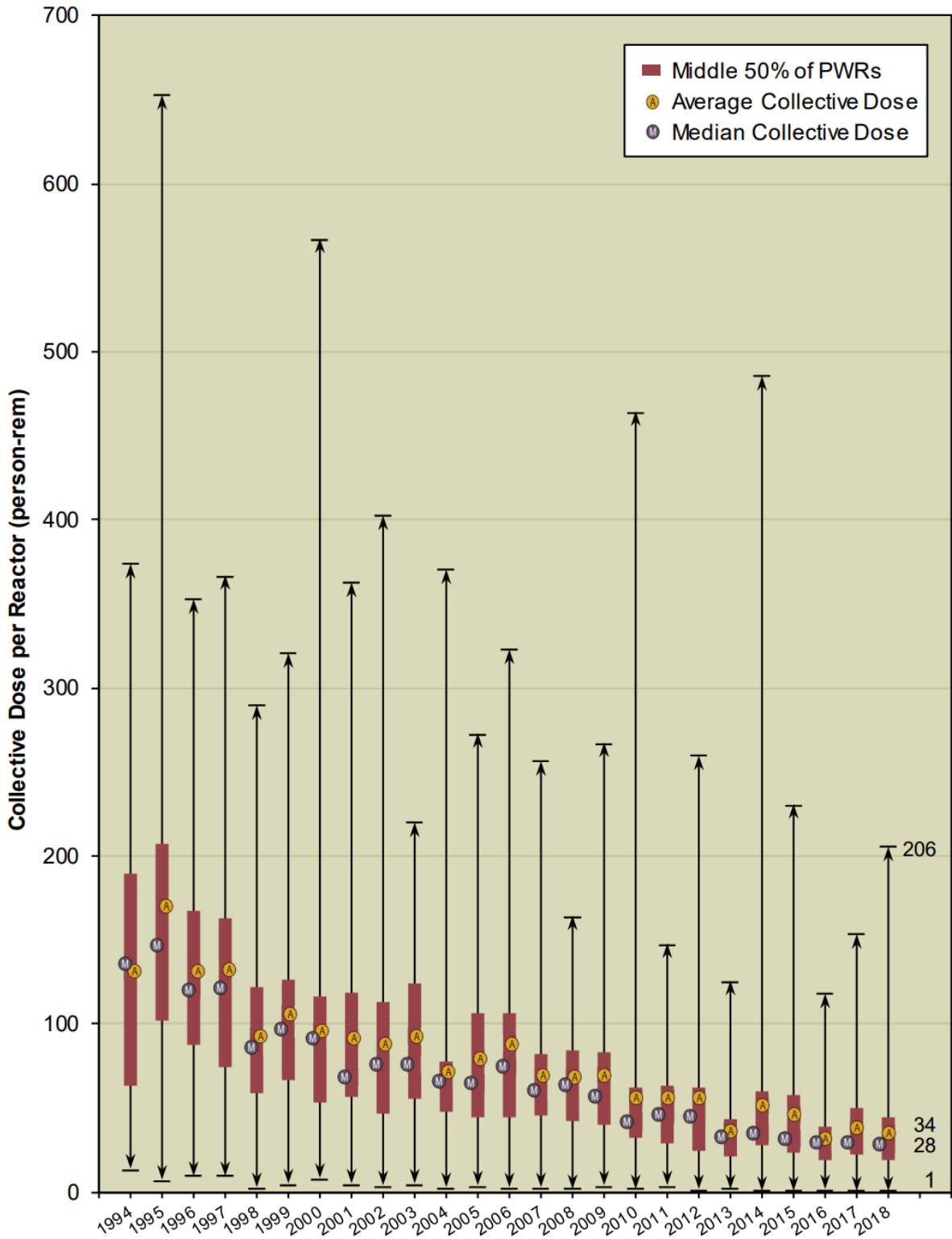

1
2
3

Figure 3.9-2 Average, Median, and Extreme Values of the Collective Dose per Pressurized Water Reactor from 1994 to 2018. Source: NRC 2020i.

1 **Table 3.9-9 Annual Collective Dose and Annual Occupational Dose for Pressurized**
 2 **Water Reactor Nuclear Power Plants from 2006 through 2018**

PWR Plant	Average Collective Dose (person-rem/reactor) ^(a)	Maximum Collective Dose (person-rem/reactor) ^(a)	Minimum Collective Dose (person-rem/reactor) ^(a)	Annual Average Occupational Dose (rem)	Annual Maximum Occupational Dose (rem)	Annual Minimum Occupational Dose (rem)
Arkansas 1, 2	54	98	22	0.07	0.12	0.05
Beaver Valley 1, 2	53	185	21	0.09	0.17	0.06
Braidwood	44	100	16	0.07	0.12	0.05
Byron 1, 2	46	122	13	0.08	0.13	0.04
Callaway 1	33	80	3	0.06	0.10	0.03
Calvert Cliffs 1, 2	47	102	23	0.11	0.17	0.06
Catawba 1, 2	49	106	16	0.08	0.12	0.05
Comanche Peak 1, 2	47	110	18	0.09	0.16	0.05
D.C. Cook 1, 2	48	156	15	0.09	0.18	0.05
Crystal River 3 ^(b)	38	222	1	0.06	0.16	0.02
Davis-Besse 1	98	464	1	0.09	0.28	0.02
Diablo Canyon 1, 2	48	169	14	0.07	0.13	0.04
Farley 1, 2	29	70	15	0.07	0.11	0.05
Fort Calhoun ^(b)	61	289	3	0.08	0.18	0.03
Ginna	39	102	2	0.07	0.11	0.02
Harris 1	43	87	0	0.06	0.10	0.02
Indian Point 2, 3 ^(b)	59	145	30	0.08	0.18	0.04
Kewaunee ^(b)	51	93	5	0.08	0.16	0.02
McGuire 1, 2	51	83	20	0.07	0.11	0.05
Millstone 2, 3	63	136	32	0.12	0.19	0.07
North Anna 1, 2	53	155	22	0.11	0.20	0.07
Oconee 1, 2, 3	46	84	12	0.08	0.13	0.04
Palisades	182	486	6	0.19	0.39	0.04
Palo Verde 1, 2, 3	30	53	14	0.06	0.10	0.04
Point Beach 1, 2	42	80	20	0.12	0.17	0.08
Prairie Island 1, 2	36	69	3	0.09	0.13	0.05
Robinson 2	46	86	3	0.06	0.09	0.03
Salem 1, 2	53	164	17	0.07	0.10	0.04
San Onofre ^(b)	46	158	0	0.07	0.19	0.01
Seabrook	44	96	2	0.05	0.08	0.01
Sequoyah 1, 2	62	145	22	0.09	0.14	0.06
South Texas 1, 2	43	94	16	0.10	0.16	0.07
St. Lucie 1, 2	81	205	36	0.11	0.17	0.08
Summer 1	44	111	2	0.06	0.12	0.02
Surry 1, 2	66	117	22	0.12	0.19	0.07
Three Mile Island 1	74	242	2	0.07	0.12	0.03
Turkey Point 3, 4	55	121	26	0.09	0.12	0.07
Vogtle 1, 2	46	78	23	0.10	0.13	0.07
Waterford 3	84	260	1	0.07	0.17	0.01
Watts Bar 1, 2	31	161	1	0.06	0.16	0.02
Wolf Creek 1	62	134	3	0.06	0.12	0.01

3 (a) The collective dose per reactor was calculated by dividing the "Collective Dose per Site" by the number of
 4 reactors on the site.
 5 (b) Indicates nuclear power plants that have been shut down.
 6 Note: To convert rem to Sv, multiply by 0.01.
 7 Source: NRC 2020i.

1
2**Table 3.9-10 Annual Collective Dose and Annual Occupational Dose for Boiling Water Reactor Nuclear Power Plants from 2006 through 2018**

BWR Plant	Average Collective Dose (person-rem/reactor) ^(a)	Maximum Collective Dose (person-rem/reactor) ^(a)	Minimum Collective Dose (person-rem/reactor) ^(a)	Annual Average Occupational Dose (rem)	Annual Maximum Occupational Dose (rem)	Annual Minimum Occupational Dose (rem)
Browns Ferry 1, 2, 3	145	214	96	0.16	0.20	0.12
Brunswick 1, 2	148	204	84	0.12	0.14	0.07
Clinton	119	296	14	0.11	0.18	0.07
Columbia	150	336	27	0.10	0.16	0.04
Cooper Station	173	360	28	0.13	0.21	0.07
Dresden 1, 2, 3	61	96	39	0.09	0.14	0.06
Duane Arnold	85	201	16	0.11	0.18	0.05
Fermi 2	153	329	24	0.10	0.13	0.04
FitzPatrick	120	234	21	0.11	0.16	0.07
Grand Gulf	121	276	21	0.09	0.13	0.04
Hatch 1, 2	87	130	42	0.12	0.18	0.05
Hope Creek 1	119	191	25	0.07	0.09	0.03
LaSalle 1, 2	171	285	109	0.15	0.20	0.09
Limerick 1, 2	82	117	61	0.10	0.15	0.07
Monticello	101	237	29	0.13	0.18	0.07
Nine Mile Point 1, 2	137	204	71	0.17	0.23	0.10
Oyster Creek	99	212	18	0.11	0.14	0.07
Peach Bottom 2, 3	152	242	89	0.14	0.20	0.10
Perry	220	615	30	0.19	0.34	0.10
Pilgrim 1	118	264	22	0.11	0.20	0.06
Quad Cities 1, 2	120	280	71	0.11	0.24	0.08
River Bend 1	147	312	16	0.11	0.18	0.05
Susquehanna 1, 2	101	133	74	0.11	0.14	0.08
Vermont Yankee	101	214	13	0.14	0.19	0.10

(a) The collective dose per reactor was calculated by dividing the "Collective Dose per Site" by the number of reactors on the site.

Note: To convert rem to Sv, multiply by 0.01.

Source: NRC 2020i.

3
4
5
6

1 Table 3.9-11 and Table 3.9-12 show the annual collective occupational dose for all commercial
2 nuclear power plants operating between 2006 to 2018 and Table 3.9-13 and Table 3.9-14 show
3 the annual individual average occupational dose for PWR and BWR commercial nuclear power
4 plants operating between 2006 to 2018. The year 2006 was chosen as a starting date because
5 the dose data for years prior to 2006 were presented in the 2013 LR GEIS and the 1996 LR
6 GEIS. From 2006 to 2018, operating nuclear power plants would have gone through many
7 refueling outages, 5-year ISI, 10-year ISI, and also some refurbishment activities. To check for
8 trends, data were divided into two time frames: from 2006 to 2012 and from 2013 to 2018. The
9 averages for these two time frames were calculated and compared. The yearly average
10 collective dose from 2013 to 2018 was lower than the dose from 2006 to 2012. For a few
11 nuclear power plants, the average annual collective dose from 2013 to 2018 was higher, but in
12 all cases, the yearly average occupational dose was less than 0.39 rem. The yearly average
13 occupational dose was lower from 2013 to 2018 than from 2006 to 2012.

14 The data in Table 3.9-11, Table 3.9-12, Table 3.9-13, and Table 3.9-14 show that although
15 there are variations from year to year, there is no consistent trend that shows that occupational
16 doses are increasing over time. The average, maximum, and minimum collective occupational
17 doses are presented in Table 3.9-15 and Table 3.9-16 for plants operated between 2014 to
18 2018. The average collective doses, however, are based on widely varying yearly doses. For
19 example, between 2014 to 2018, annual collective doses for operating PWRs ranged from 1 to
20 486 person-rem; for operating BWRs, they ranged from 16 to 387 person-rem.

21 Average, maximum, and minimum individual occupational doses per reactor type are presented
22 in Table 3.9-17 and Table 3.9-18 for plants that operated between 2006 and 2018. From 2006
23 through 2018, the annual dose per plant worker for operating PWRs ranged from 0.0 to
24 0.43 rem; for operating BWRs, it ranged from 0.03 to 0.34 rem.

25 Table 3.9-19 provides the distribution of individual whole-body doses for 2018. The dose
26 distribution indicates that no worker received doses greater than 3 rem in 2018. Only 1 worker
27 received a whole-body dose exceeding 2 rem during 2018. At BWRs, less than 0.003 percent
28 of the workers received doses greater than 2 rem. At PWRs, no worker received a dose greater
29 than 2 rem, and about 0.1 percent of the workers received a dose greater than 1 rem.
30 Figure 3.9-3 shows the collective dose distribution by dose range for all commercial U.S.
31 reactors from 2014 to 2018. The distribution of collective dose has been fairly constant over the
32 past 5 years.

33 As mentioned in Section 3.9.1.1, under 10 CFR 20.2206, the NRC requires licensees to submit
34 an annual report of the results of individual monitoring. In addition to reporting data on external
35 exposures, licensees are required to report information about internal exposures. Licensees are
36 required to list for each intake, the radionuclide, pulmonary clearance class, intake mode, and
37 amount of the intake in microcuries. Eleven intakes by ingestion were reported by licensees
38 during 2018 (5 for cobalt-60, 4 for manganese-54, and 2 for zinc-65). Fifty-five intakes were
39 reported for the inhalation mode in 2018 (10 for cobalt-60, 10 for cobalt-58, 1 for americium-241,
40 33 for iodine-131, and 1 niobium-95) (NRC 2020i). Table 3.9-20 lists the number of individuals
41 with measurable CEDE, collective CEDE, and average measurable CEDE per individual as
42 reported by different nuclear power reactor stations.

Table 3.9-11 Annual Collective Dose for Pressurized Water Reactor (PWR) Nuclear Power Plants from 2006 through 2018 (person-rem/reactor)

No. of Reactors	Nuclear Power Plant	2006	2007	2008	2009	2010	2011	2012	2013	2014	2015	2016	2017	2018
2	Arkansas 1, 2	72	53	98	51	50	58	22	25	36	68	56	43	68
2	Beaver Valley 1, 2	185	43	42	11	25	36	63	21	31	48	22	27	37
1	Braidwood	199	98	103	142	64	70	168	32	42	52	40	79	61
2	Byron 1, 2	67	64	70	42	28	122	25	29	40	21	27	44	13
1	Callaway 1	6	73	46	5	59	80	5	43	37	3	47	24	3
2	Calvert Cliffs 1, 2	102	77	37	48	64	48	58	31	31	23	43	25	28
2	Catawba 1, 2	106	72	43	85	49	26	47	41	25	49	39	16	44
2	Comanche Peak 1, 2	30	110	84	26	35	77	33	23	70	21	18	60	21
2	D.C. Cook 1, 2	156	119	38	20	42	29	25	52	27	15	47	29	20
1	Crystal River 3	4	185	16	222	32	8	2	1	1	1	15	4	1
1	Davis-Besse 1	204	7	107	4	464	73	43	3	200	1	118	2	51
2	Diablo Canyon 1, 2	41	56	118	169	63	16	22	14	34	29	19	24	16
2	Farley 1, 2	33	70	20	21	61	19	15	27	19	28	30	16	18
1	Fort Calhoun	289	4	96	111	10	79	39	64	5	76	11	3	7
1	Ginna	45	4	102	42	3	101	55	3	58	24	2	46	28
1	Harris 1	87	65	10	41	83	5	80	55	1	58	44	0	32
2	Indian Point 2, 3	145	55	71	40	100	32	55	37	71	30	36	51	44
1	Kewaunee	75	11	93	56	5	79	39	5	2	0	0	6	1
2	McGuire 1, 2	54	78	83	40	41	60	31	55	69	25	34	74	20
2	Millstone 2, 3	87	82	136	80	41	85	37	32	80	32	32	56	33
2	North Anna 1, 2	41	155	31	39	91	45	53	61	36	22	60	22	28
3	Oconee 1, 2, 3	74	84	62	60	64	61	44	35	36	23	18	12	19
1	Palisades	240	257	23	267	220	22	245	16	486	231	6	154	206
3	Palo Verde 1, 2, 3	51	50	53	33	38	20	20	31	20	19	22	18	14
2	Point Beach 1, 2	20	26	72	47	48	80	35	32	64	24	29	44	22
2	Prairie Island 1, 2	69	3	63	27	27	29	60	65	35	31	24	17	19
1	Robinson 2	3	81	68	7	86	4	65	81	29	56	4	59	62

No. of Reactors	Nuclear Power Plant	2006	2007	2008	2009	2010	2011	2012	2013	2014	2015	2016	2017	2018
2	Salem 1, 2	45	59	164	51	39	63	24	30	55	17	47	68	25
2	San Onofre	158	46	63	89	100	15	111	3	1	1	1	0	12
1	Seabrook	77	4	75	87	4	66	54	2	40	96	2	29	33
2	Sequoyah 1, 2	121	62	42	83	28	55	145	22	39	68	53	24	61
2	South Texas 1, 2	75	46	94	40	40	70	25	30	17	42	16	28	35
2	St. Lucie 1, 2	60	205	56	66	99	148	93	37	61	94	38	36	56
1	Summer 1	61	3	49	56	2	32	82	5	111	65	3	50	49
2	Surry 1, 2	117	104	75	97	56	57	84	34	29	91	22	29	59
1	Three Mile Island 1	5	114	2	242	39	130	13	126	13	171	17	83	3
2	Turkey Point 3, 4	75	54	49	83	43	31	121	41	57	40	38	54	26
2	Vogtle 1, 2	58	60	69	40	45	59	30	39	78	30	29	40	23
1	Waterford 3	110	20	134	255	5	100	260	3	69	66	3	61	1
2	Watts Bar 1, 2	161	2	35	32	3	26	31	1	14	32	2	38	18
1	Wolf Creek 1	97	4	95	74	11	134	8	111	28	75	91	3	73

Note: To convert rem to Sv, multiply by 0.01.

Source: NRC 2020i.

3 **Table 3.9-12 Annual Collective Dose for Boiling Water Reactor Nuclear Power Plants from 2006 through 2018 (person-**
4 **rem/reactor)**

No. of Reactors	Nuclear Power Plant	2006	2007	2008	2009	2010	2011	2012	2013	2014	2015	2016	2017	2018
3	Browns Ferry 1, 2, 3	214	185	161	116	186	99	155	128	130	96	135	117	166
2	Brunswick 1, 2	140	145	177	175	204	191	185	181	131	115	84	108	92
1	Clinton	296	31	205	48	220	228	14	129	18	98	33	155	78
1	Columbia	56	306	55	305	55	336	45	224	34	289	27	180	43
1	Cooper Station	270	50	360	254	61	349	279	36	203	28	196	30	133
3	Dresden 1, 2, 3	96	92	66	77	71	79	47	46	39	46	47	43	40
1	Duane Arnold	29	184	24	140	201	30	135	16	122	20	111	17	78
1	Fermi 2	181	194	35	149	146	24	145	26	200	235	55	265	329
1	FitzPatrick	234	59	185	35	220	35	170	39	136	21	28	162	232
1	Grand Gulf	60	178	168	31	188	21	276	35	182	25	195	40	167

No. of Reactors	Nuclear Power Plant	2006	2007	2008	2009	2010	2011	2012	2013	2014	2015	2016	2017	2018
2	Hatch 1, 2	130	69	95	93	123	88	96	70	95	42	111	51	70
1	Hope Creek 1	134	191	35	169	161	25	154	151	37	170	140	32	150
2	LaSalle 1, 2	124	114	109	148	192	170	112	192	183	251	169	285	175
2	Limerick 1, 2	97	99	88	117	84	92	80	67	69	62	63	92	61
1	Monticello	33	191	44	174	56	237	39	199	35	130	29	116	29
2	Nine Mile Point 1, 2	115	165	151	119	188	122	204	109	132	80	128	71	193
1	Oyster Creek	190	47	212	37	206	47	165	30	145	23	134	18	38
2	Peach Bottom 2, 3	124	192	106	155	110	195	153	242	215	198	101	99	89
1	Perry	65	505	52	615	32	308	43	374	85	387	36	328	40
1	Pilgrim 1	44	241	23	264	26	241	22	176	37	219	44	163	39
2	Quad Cities 1, 2	280	125	137	159	121	144	97	96	78	85	71	87	81
1	River Bend 1	214	131	312	219	40	211	34	188	16	128	71	273	70
2	Susquehanna 1, 2	92	132	96	133	88	84	88	117	107	103	119	83	74
1	Vermont Yankee	50	171	214	61	206	176	45 ^(a)	170	21	50	13	14	18

Note: To convert rem to Sv, multiply by 0.01.

Sources: NRC 2020i.

(a) NRC 2019f, data missing from Vol 40.

Table 3.9-13 Annual Average Measurable Occupational Doses at Pressurized Water Reactor Commercial Nuclear Power Plant Sites from 2006 through 2018 (in rem)

PWR Plants	2006	2007	2008	2009	2010	2011	2012	2013	2014	2015	2016	2017	2018
Arkansas 1, 2	0.12	0.08	0.11	0.09	0.07	0.08	0.05	0.05	0.05	0.07	0.07	0.05	0.07
Beaver Valley 1, 2	0.17	0.09	0.08	0.15	0.07	0.09	0.10	0.06	0.07	0.09	0.06	0.07	0.08
Big Rock ^(a)	0.01	-	-	-	-	-	-	-	-	-	-	-	-
Braidwood 1, 2	0.12	0.08	0.08	0.10	0.07	0.07	0.09	0.05	0.05	0.05	0.05	0.07	0.07
Byron 1, 2	0.12	0.10	0.09	0.08	0.06	0.13	0.06	0.06	0.07	0.05	0.06	0.07	0.04
Callaway 1	0.03	0.07	0.06	0.03	0.07	0.10	0.03	0.06	0.06	0.03	0.07	0.05	0.04
Calvert Cliffs 1, 2	0.17	0.13	0.10	0.11	0.15	0.14	0.16	0.11	0.11	0.08	0.10	0.07	0.06
Catawba 1, 2	0.12	0.10	0.08	0.12	0.09	0.05	0.08	0.08	0.05	0.08	0.08	0.05	0.07
Comanche Peak 1, 2	0.09	0.14	0.16	0.05	0.07	0.10	0.07	0.06	0.12	0.07	0.06	0.12	0.08
D.C. Cook 1, 2	0.18	0.18	0.08	0.06	0.07	0.07	0.07	0.09	0.07	0.05	0.08	0.07	0.05
Crystal River 3 ^(b)	0.03	0.16	0.06	0.13	0.05	0.03	0.02	0.02	0.03	0.04	0.16	0.06	0.05
Davis-Besse 1	0.15	0.04	0.11	0.03	0.28	0.06	0.07	0.03	0.10	0.03	0.12	0.02	0.07
Diablo Canyon 1, 2	0.08	0.09	0.11	0.13	0.09	0.04	0.05	0.04	0.07	0.07	0.05	0.06	0.04
Farley 1, 2	0.09	0.11	0.06	0.06	0.09	0.05	0.05	0.07	0.05	0.06	0.06	0.05	0.06
Fort Calhoun ^(c)	0.18	0.04	0.11	0.13	0.06	0.08	0.08	0.09	0.03	0.10	0.07	0.04	0.09
Ginna	0.09	0.04	0.10	0.07	0.04	0.11	0.08	0.03	0.09	0.06	0.02	0.08	0.06
Haddam Neck ^(d)	0.10	-	0.01	0.01	0.01	0.06	0.01	0.02	0.02	0.02	0.02	0.02	0.02
Harris 1	0.10	0.07	0.05	0.06	0.08	0.03	0.07	0.06	0.02	0.07	0.06	0.02	0.05
Humboldt T Bay ^(e)	0.10	0.07	0.04	0.02	0.06	0.04	0.10	0.14	0.10	0.08	-	-	-
Indian Point 1 ^(f)	0.04	0.01	0.02	0.00	0.01	0.00	0.00	0.09	-	-	-	-	-
Indian Point 2, 3 ^(g)	0.18	0.06	0.10	0.04	0.10	0.05	0.09	0.06	0.11	0.05	0.08	0.05	0.05
Kewaunee ^(h)	0.14	0.08	0.16	0.09	0.03	0.10	0.07	0.04	0.03	0.02	0.02	0.10	0.13
La Crosse ⁽ⁱ⁾	-	0.43	0.04	0.03	0.04	0.05	0.08	0.07	0.09	0.07	0.11	0.11	0.03
Maine Yankee ⁽ⁱ⁾	-	-	0.01	0.05	0.08	0.03	0.04	0.05	0.03	0.02	0.02	0.02	0.01
McGuire 1, 2	0.09	0.11	0.10	0.07	0.07	0.07	0.05	0.08	0.08	0.05	0.06	0.09	0.05
Millstone 1 ^(k)	0.15	0.03	-	-	-	-	-	-	-	-	-	-	-
Millstone 2, 3	0.15	0.14	0.19	0.16	0.11	0.16	0.10	0.09	0.13	0.08	0.07	0.10	0.09
North Anna 1, 2	0.11	0.20	0.08	0.10	0.18	0.11	0.14	0.13	0.10	0.07	0.11	0.07	0.07
Oconee 1, 2, 3	0.12	0.13	0.10	0.10	0.10	0.09	0.07	0.07	0.05	0.05	0.05	0.04	0.05
Palisades	0.27	0.24	0.09	0.27	0.24	0.06	0.22	0.05	0.39	0.25	0.04	0.19	0.22
Palo Verde 1, 2, 3	0.10	0.06	0.09	0.06	0.07	0.05	0.05	0.08	0.06	0.05	0.06	0.05	0.04
Point Beach 1, 2	0.09	0.10	0.15	0.12	0.11	0.16	0.12	0.12	0.17	0.11	0.11	0.12	0.08

PWR Plants	2006	2007	2008	2009	2010	2011	2012	2013	2014	2015	2016	2017	2018
Prairie Island 1, 2	0.12	0.05	0.12	0.10	0.08	0.09	0.13	0.09	0.09	0.08	0.07	0.06	0.07
Rancho Seco ^(l)	0.22	0.10	0.03	-	-	-	-	-	-	-	-	-	-
Robinson 2	0.04	0.09	0.09	0.05	0.09	0.03	0.06	0.07	0.06	0.06	0.03	0.07	0.06
Salem 1, 2	0.06	0.09	0.10	0.08	0.08	0.06	0.07	0.07	0.04	0.06	0.08	0.08	0.09
San Onofre 1 ^(m)	0.12	0.02	0.02	-	-	-	-	-	-	-	-	-	-
San Onofre 2, 3 ⁽ⁿ⁾	0.19	0.09	0.12	-	-	-	-	-	-	-	-	-	-
San Onofre 1 ^(m) , 2, 3 ⁽ⁿ⁾	-	-	-	0.11	0.12	0.05	0.10	0.03	0.02	0.01	0.02	0.01	0.19
Seabrook	0.06	0.01	0.06	0.07	0.01	0.06	0.05	0.01	0.04	0.08	0.03	0.06	0.07
Sequoyah 1, 2	0.14	0.10	0.09	0.12	0.07	0.08	0.11	0.07	0.09	0.09	0.09	0.06	0.09
South Texas 1, 2	0.14	0.10	0.16	0.07	0.09	0.12	0.08	0.07	0.08	0.09	0.08	0.09	0.10
St. Lucie 1, 2	0.10	0.17	0.10	0.12	0.15	0.14	0.11	0.08	0.11	0.13	0.08	0.08	0.10
Summer 1	0.09	0.04	0.08	0.07	0.02	0.05	0.11	0.03	0.12	0.08	0.02	0.06	0.07
Surry 1, 2	0.19	0.19	0.14	0.16	0.12	0.10	0.14	0.09	0.08	0.14	0.07	0.07	0.10
Three Mile Island 1 ^(o)	0.04	0.09	0.03	0.12	0.05	0.11	0.05	0.10	0.06	0.12	0.05	0.08	0.03
Turkey Point 3, 4	0.11	0.10	0.09	0.12	0.08	0.07	0.12	0.09	0.09	0.08	0.09	0.10	0.08
Vogtle 1, 2	0.13	0.13	0.12	0.09	0.10	0.10	0.08	0.09	0.11	0.07	0.08	0.09	0.07
Waterford 3	0.09	0.04	0.11	0.17	0.02	0.09	0.14	0.02	0.07	0.07	0.01	0.07	0.01
Watts Bar 1, 2	0.16	0.03	0.08	0.07	0.05	0.06	0.06	0.03	0.05	0.07	0.02	0.07	0.05
Wolf Creek 1	0.12	0.05	0.10	0.05	0.02	0.11	0.03	0.08	0.04	0.06	0.07	0.01	0.06
Yankee Rowe ^(p)	0.02	-	0.02	0.02	0.03	0.01	0.01	0.02	0.01	0.02	0.01	0.02	0.01
Zion 1, 2 ^(q)	0.02	0.03	0.02	-	0.03	0.22	0.41	0.20	0.22	0.42	0.24	0.06	0.01

1 PWR = pressurized water reactor.

- 2 (a) Big Rock Point ceased operations in August 1997 and is no longer included in the count of operating reactors. Parentheses indicate plant capacity when plant
3 was operational.
- 4 (b) Crystal River ceased power generation in 2010 due to problems associated with containment building delamination. In June 2013, it was decided that it would
5 not be put in commercial operation again and, therefore, it is no longer included in the count of operating reactors. Parentheses indicate plant capacity when
6 plant was operational.
- 7 (c) Fort Calhoun ceased power generation in October 2016 and is no longer included in the count of operating reactors. Parentheses indicate plant capacity
8 when plant was operational.
- 9 (d) Haddam Neck (also known as Connecticut Yankee) ceased operations on December 4, 1996, and is no longer in the count of operating reactors.
10 Parentheses indicate plant capacity when plant was operational.
- 11 (e) Humboldt Bay had been shut down since 1976, and in 1983, PG&E announced its intention to decommission the unit. Therefore, it is no longer included in
12 the count of operating reactors. Parentheses indicate plant capacity when plant was operational.
- 13 (f) Indian Point 1 was shut down October 31, 1974. All spent fuel was removed from the reactor vessel by January 1976. Therefore, it is no longer included in
14 the count of operating reactors. Parentheses indicate plant capacity when plant was operational.
- 15 (g) Indian Point 3 was purchased by a different utility in 1979 and subsequently reported its dose separately. Indian Point 1, 2, and 3 have been owned by the
16 same utility since 2001 and report together.

- 1 (h) Kewaunee Power Station (Kewaunee) ceased operations in May 2013 and is no longer included in the count of operating reactors. Parentheses indicate plant
 - 2 capacity when plant was operational.
 - 3 (i) La Crosse ceased operations in 1987 and will not be put in commercial operation again. Therefore, it is no longer included in the count of operating reactors.
 - 4 Parentheses indicate plant capacity when plant was operational.
 - 5 (j) Maine Yankee ceased operations in August 1997 and is no longer included in the count of operating reactors. Parentheses indicate plant capacity when plant
 - 6 was operational.
 - 7 (k) Millstone 1 ceased operations in 1998 and is no longer included in the count of operating reactors. Parentheses indicate plant capacity when plant was
 - 8 operational. From 2008-2014, Millstone 1 voluntarily provided an estimate of the collective dose for Unit 1, but not the number of individuals with measurable
 - 9 dose.
 - 10 (l) Rancho Seco ceased operations in June 1989 and is no longer in the count of operating reactors. Parentheses indicate plant capacity when plant was
 - 11 operational.
 - 12 (m) San Onofre 1 ceased operations in November 1992 and is no longer in the count of operating reactors. Parentheses indicate plant capacity when plant was
 - 13 operational.
 - 14 (n) San Onofre 2, 3 ceased power generation in January 2012, and in June 2013 it was decided that they would not be put back into commercial operation.
 - 15 Therefore, they are no longer included in the count of operating reactors. Parentheses indicate plant capacities when plants were operational.
 - 16 (o) Three Mile Island, Unit 1 (Three Mile Island) resumed commercial power generation in October 1985 after being under regulatory restraint since 1979.
 - 17 (p) Yankee Rowe ceased operations as of October 1991 and will not be put in commercial operation again. It is no longer in the count of operating reactors.
 - 18 Parentheses indicate plant capacity when plant was operational.
 - 19 (q) Zion 1, 2 ceased operations in 1997 and 1996, respectively, and are no longer included in the count of operating reactors.
 - 20 No entry has been denoted by “-”.
 - 21 Source: NRC 2020i.
-

February 2023

3-1111

Draft NUREG-1437, Revision 2

Table 3.9-14 Annual Average Measurable Occupational Doses at Boiling Water Reactor Commercial Nuclear Power Plant Sites from 2006 through 2018 (in rem)

BWR Plants	2006	2007	2008	2009	2010	2011	2012	2013	2014	2015	2016	2017	2018
Browns Ferry ^(a) 1 ^(a) , 2, 3	0.18	0.18	0.18	0.16	0.2	0.14	0.15	0.15	0.16	0.13	0.13	0.12	0.15
Brunswick 1, 2	0.13	0.13	0.14	0.13	0.13	0.14	0.11	0.09	0.07	0.09	0.10	0.12	0.12
Clinton	0.18	0.10	0.15	0.11	0.14	0.14	0.07	0.11	0.10	0.08	0.07	0.12	0.07
Columbia Generating ^(b)	0.09	0.14	0.08	0.16	0.07	0.15	0.04	0.13	0.04	0.14	0.05	0.10	0.09
Cooper Station	0.21	0.07	0.21	0.16	0.08	0.20	0.16	0.07	0.16	0.07	0.15	0.08	0.13
Dresden 1 ^(c) , 2, 3	0.14	0.12	0.09	0.12	0.10	0.10	0.07	0.08	0.07	0.07	0.08	0.07	0.06
Duane Arnold	0.12	0.17	0.09	0.15	0.18	0.07	0.12	0.06	0.12	0.05	0.10	0.08	0.11
Fermi 2	0.13	0.13	0.08	0.10	0.09	0.06	0.10	0.04	0.11	0.13	0.07	0.13	0.13
FitzPatrick	0.15	0.11	0.13	0.07	0.15	0.07	0.11	0.07	0.08	0.08	0.08	0.14	0.16
Grand Gulf	0.06	0.10	0.09	0.06	0.10	0.04	0.11	0.09	0.11	0.04	0.13	0.07	0.13
Hatch 1, 2	0.18	0.10	0.14	0.14	0.14	0.11	0.12	0.10	0.12	0.05	0.13	0.09	0.11
Hope Creek 1	0.06	0.09	0.03	0.08	0.08	0.06	0.07	0.07	0.04	0.06	0.08	0.08	0.09
Lasalle 1, 2	0.12	0.12	0.09	0.15	0.16	0.12	0.11	0.20	0.17	0.20	0.13	0.20	0.12
Limerick 1, 2	0.13	0.13	0.13	0.15	0.11	0.09	0.08	0.08	0.09	0.08	0.08	0.10	0.07
Monticello	0.12	0.18	0.12	0.14	0.11	0.12	0.07	0.16	0.13	0.15	0.09	0.14	0.11
Nine Mile Point 1, 2	0.20	0.18	0.22	0.16	0.22	0.18	0.23	0.15	0.18	0.10	0.15	0.10	0.20
Oyster Creek ^(d)	0.13	0.10	0.14	0.10	0.12	0.11	0.12	0.10	0.13	0.08	0.10	0.07	0.11
Peach Bottom 2, 3	0.16	0.20	0.12	0.15	0.13	0.14	0.12	0.17	0.14	0.13	0.10	0.11	0.10
Perry	0.13	0.31	0.10	0.34	0.12	0.19	0.11	0.23	0.19	0.24	0.10	0.23	0.14
Pilgrim 1	0.07	0.17	0.06	0.20	0.08	0.20	0.08	0.15	0.09	0.16	0.07	0.10	0.06
Quad Cities 1, 2	0.24	0.13	0.13	0.13	0.11	0.12	0.09	0.09	0.08	0.09	0.08	0.09	0.10
River Bend 1	0.14	0.12	0.17	0.11	0.05	0.11	0.05	0.10	0.05	0.14	0.13	0.18	0.12
Susquehanna 1, 2	0.10	0.11	0.10	0.14	0.09	0.09	0.08	0.13	0.11	0.12	0.11	0.11	0.11
Vermont Yankee ^(e)	0.13	0.14	0.15	0.16	0.19	0.17	0.16	0.11	0.12	0.10	0.11	0.10	-

BWR = boiling water reactor.

(a) All three Browns Ferry units were placed on administrative hold in 1985. Units 2 and 3 were restarted in 1991 and 1995, respectively. Browns Ferry Unit 1 was restarted during 2007.

(b) Energy Northwest changed the name of Washington Nuclear 2 to Columbia Generating Station in 2001.

(c) Dresden 1 ceased power generation in 1978, and in 1985, it was decided that it would not be put in commercial operation again. Therefore, it is no longer included in the count of operating reactors. Parentheses indicate plant capacity when plant was operational.

(d) Oyster Creek ceased operations in September 2018 and is no longer included in the count of operating reactors. Parentheses indicate plant capacity when plant was operational.

(e) Vermont Yankee ceased operations in December 2014 and is no longer in the count of operating reactors. Parentheses indicate plant capacity when plant was operational.

No entry has been denoted by “-”.

Source: NRC 2020i.

1 **Table 3.9-15 Average, Maximum, and Minimum Annual Collective Occupational Dose per**
 2 **Plant for Pressurized Water Reactor Nuclear Power Plants in person-rem**

Year	Average	Maximum	Minimum
2014	51	486	1
2015	44	231	1
2016	31	118	2
2017	37	154	1
2018	34	206	1

3 Note: To convert rem to Sv, multiply by 0.01.
 4 Source: NRC 2020i.

5 **Table 3.9-16 Average, Maximum, and Minimum Annual Collective Occupational Dose per**
 6 **Plant for Boiling Water Reactor Nuclear Power Plants in person-rem**

Year	Average	Maximum	Minimum
2014	109	215	16
2015	122	387	20
2016	98	196	27
2017	118	328	17
2018	111	329	29

7 Note: To convert rem to Sv, multiply by 0.01.
 8 Source: NRC 2020i.

9 **Table 3.9-17 Average, Maximum, and Minimum Annual Individual Occupational Whole-**
 10 **Body Dose for Pressurized Water Reactor Nuclear Power Plants in rem**

Year	Average Whole-Body Dose (rem) per Plant	Maximum Whole-Body Dose (rem) per Plant	Minimum Whole-Body Dose (rem) per Plant
2006	0.11	0.27	0.01
2007	0.10	0.43	0.01
2008	0.09	0.19	0.01
2009	0.09	0.27	0.00
2010	0.08	0.28	0.01
2011	0.08	0.22	0.00
2012	0.09	0.41	0.00
2013	0.07	0.20	0.01
2014	0.08	0.39	0.01
2015	0.08	0.42	0.01
2016	0.07	0.24	0.01
2017	0.07	0.19	0.01
2018	0.07	0.22	0.01

11 Note: To convert rem to Sv, multiply by 0.01.
 12 Source: NRC 2020i.

1 **Table 3.9-18 Average, Maximum, and Minimum Annual Individual Occupational Whole-**
 2 **Body Dose for Boiling Water Reactor Nuclear Power Plants in rem**

Year	Average Whole-Body Dose (rem) per Plant	Maximum Whole-Body Dose (rem) per Plant	Minimum Whole-Body Dose (rem) per Plant
2006	0.14	0.24	0.06
2007	0.14	0.31	0.07
2008	0.12	0.22	0.03
2009	0.14	0.34	0.06
2010	0.12	0.22	0.05
2011	0.12	0.20	0.04
2012	0.11	0.23	0.04
2013	0.11	0.23	0.04
2014	0.11	0.19	0.04
2015	0.11	0.24	0.04
2016	0.10	0.15	0.05
2017	0.11	0.23	0.07
2018	0.11	0.20	0.06

3 Note: To convert rem to Sv, multiply by 0.01.
 4 Source: NRC 2020i.

5 **Table 3.9-19 Number of Workers at Boiling Water Reactors and Pressurized Water**
 6 **Reactors Who Received Whole-Body Doses within Specified Ranges during**
 7 **2018**

Whole Body Dose Range (rem) ^(a)	BWRs (33)	PWRs (65)	Total (98)
Meas. <0.025	9,354	11,145	20,499
0.025-0.10	11,320	12,387	23,707
0.10-0.25	6,258	4,772	11,030
0.25-0.50	3,021	1,186	4,207
0.50-0.75	831	255	1,086
0.75-1.0	250	66	316
1.0-2.0	134	34	168
2.0-3.0	1	0	1
3.0-4.0	0	0	0
4.0-5.0	0	0	0
5.0-6.0	0	0	0
>6.0	0	0	0
Total Number Monitored	61,622	88,597	150,219
Number with Measured Dose	31,168	29,846	61,014
Total Collective Dose (Whole Body) (person-rem)	3,659.59	2,169.88	5,829.47

8 BWRs = boiling water reactors; PWRs = pressurized water reactors.
 9 (a) Dose values exactly equal to the values separating ranges are reported in the next higher range.
 10 Note: To convert rem to Sv, multiply by 0.01.
 11 Source: NRC 2020i.

12 A portion of the total workforce can be defined as “transient.” These individuals are usually
 13 employed for special functions and may be employed at multiple reactor sites during a given
 14 year. Data for individual reactors described earlier include these people, but only for each
 15 power plant. Thus, some people are counted more than once, and some people receive greater
 16 annual doses than are reported by individual plants. In 2018, there were about 25,000 of these
 17 people (NRC 2020i). Over the years, doses to transient workers at nuclear power plants have

1 been decreasing in the same way as doses to more permanent workers, going from an average
 2 of 0.32 rem in 2005 (NRC 2006f) to 0.20 rem in 2018 (NRC 2020i). In 2018, two transient
 3 workers received whole-body doses between 3 and 4 rem, and none received more than 4 rem
 4 (NRC 2020i).

5 Figure 3.9-3 shows the percentage of workers that received dose in five dose ranges for all
 6 commercial U.S. Reactors for 2014 through 2018 from NUREG-0713 (NRC 2020i). The data
 7 shows that the majority of the doses were less than 0.1 rem with much fewer dose contributions
 8 between 0.1 and 2 rem.

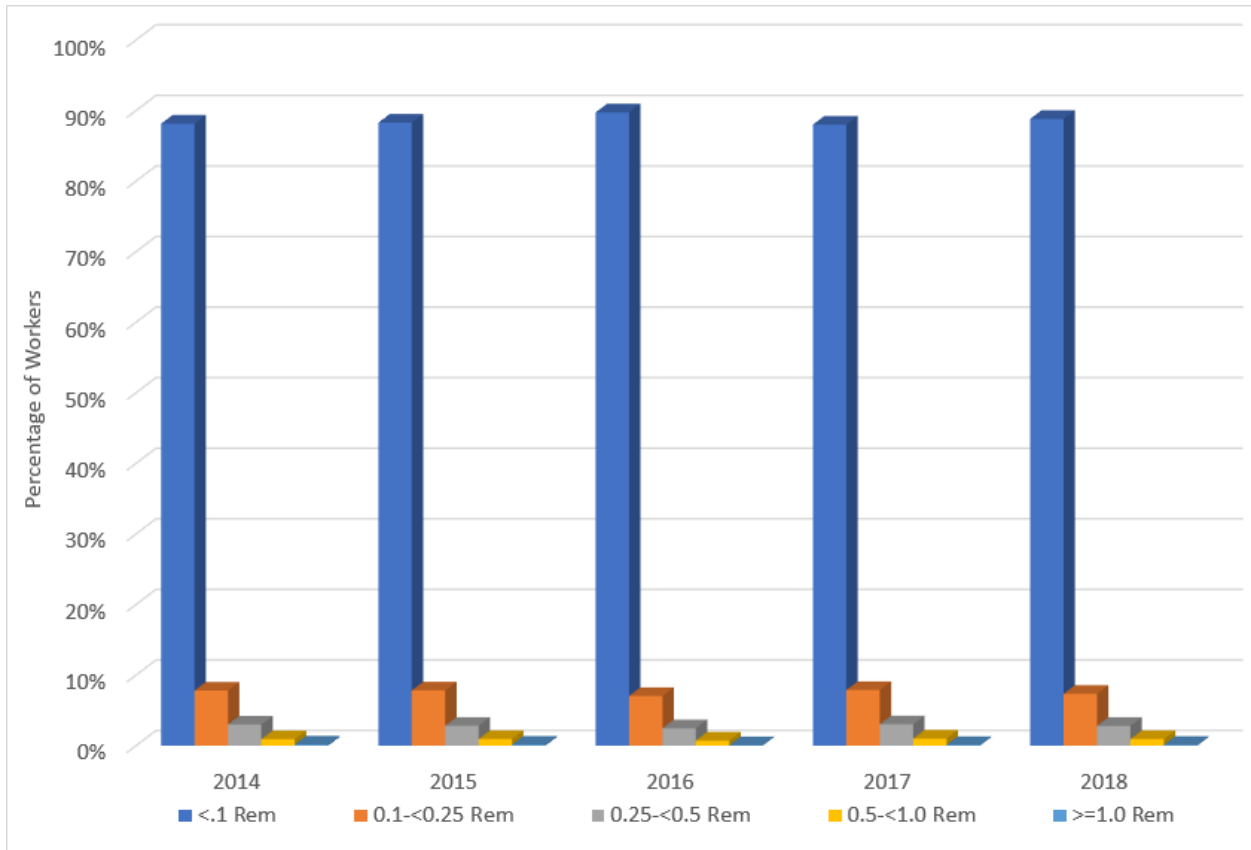

9
 10 **Figure 3.9-3 Dose Distribution for All Commercial U.S. Reactors by Dose Range (rem),**
 11 **2014 through 2018. Source: NRC 2020i.**

12 **Table 3.9-20 Collective and Average Committed Effective Dose Equivalent for**
 13 **Commercial U.S. Nuclear Power Plant Sites in 2018**

Nuclear Power Plant	Number of Individuals with Measurable CEDE	Collective CEDE (person-rem)	Average Measurable CEDE (rem)
Diablo Canyon	1	0.006	0.006
Duane Arnold	4	0.016	0.004
Indian Point	1	0.002	0.002
Millstone	1	0.001	0.001
Wolf Creek	96	0.194	0.002

14 CEDE = committed effective dose equivalent.
 15 Note: To convert rem to Sv, multiply by 0.01.
 16 Source: NRC 2020i.

Affected Environment

1 As mentioned in Section 3.9.1.1, under 10 CFR 20.2202 and 10 CFR 20.2203, the NRC
2 requires that all licensees submit reports of all occurrences involving personnel radiation
3 exposures and releases of radioactive material that exceed certain control levels. For 2018,
4 there was no occurrence reported for nuclear power reactors (NRC 2020i).

5 3.9.1.3 Public Radiological Exposures

6 Commercial nuclear power plants, under controlled conditions, release small amounts of
7 radioactive materials to the environment during normal operation. Radioactive waste
8 management systems are incorporated into each plant. They are designed to remove most of
9 the fission product radioactivity that leaks from the fuel, as well as most of the activation- and
10 corrosion-product radioactivity produced by neutrons in the vicinity of the reactor core. The
11 amounts of radioactivity released through vents and discharge points to areas outside the plant
12 boundaries are recorded and published annually in the radioactive effluent release reports for
13 each facility. These reports are publicly available on the NRC's ADAMS. The effluent releases
14 result in radiation doses to humans. Nuclear power plant licensees must comply with Federal
15 regulations (e.g., 10 CFR Part 20, Appendix I to 10 CFR Part 50, 10 CFR 50.36a, and 40 CFR
16 Part 190) and technical specifications in the operating license.

17 Potential environmental pathways through which persons may be exposed to radiation
18 originating in a nuclear power plant include the atmospheric and water pathways. Radioactive
19 materials released under controlled conditions include fission products and activation products.
20 Fission product releases consist primarily of the noble gases and some of the more volatile
21 materials like tritium, isotopes of iodine, and cesium. These materials are monitored before
22 release to determine whether the limits on releases can be met. Releases to the aquatic
23 pathways are similarly monitored. Radioactive materials in the liquid effluents are processed in
24 radioactive waste treatment systems. The major radionuclides released to aquatic systems
25 have been tritium, isotopes of cobalt, and cesium.

26 When an individual is exposed to radioactive materials released by the plant into air or water
27 pathways, the dose is determined in part by the amount of time spent in the vicinity of the
28 source or the amount of time the radionuclides inhaled or ingested are retained in the
29 individual's body (exposure). The consequences associated with this exposure are evaluated
30 by calculating the dose. The major exposure pathways include the following:

- 31 • inhalation of contaminated air;
- 32 • drinking milk or eating meat from animals that graze on open pasture on which radioactive
33 contamination may be deposited;
- 34 • eating vegetables grown near the site; and
- 35 • drinking (untreated) water or eating fish caught near the point of discharge of liquid effluents.

36 Radiation doses are calculated for the maximally exposed individual (MEI) (that is, a
37 hypothetical individual potentially subject to maximum exposure). Doses are calculated by
38 using plant-specific data where available. For those cases in which plant-specific data are not
39 readily available, conservative (overestimating) assumptions are used to estimate dose.

40 Members of the general public are also exposed when the low-level waste (LLW) is shipped
41 offsite. The public radiation exposures from radioactive material transportation have been
42 addressed in Table S-4 of 10 CFR Part 51. Table S-4 indicates that the cumulative dose to the

1 exposed public from the transport of both LLW and spent fuel is estimated to be about 0.03
2 person-Sv (3 person-rem) per reactor year (see Table 4.14-2).

3 *3.9.1.3.1 Effluent Pathways for Calculations of Dose to the Public*

4 Radioactive effluents can be divided into several groups on the basis of their physical
5 characteristics. Among the airborne effluents, the radioisotopes of the noble gases krypton,
6 xenon, and argon neither deposit on the ground nor are absorbed and accumulated within living
7 organisms; therefore, the noble gas effluents act primarily as a source of direct external
8 radiation emanating from the effluent plume. For these effluents, dose calculations are
9 performed for the site boundary where the highest external radiation doses to a member of the
10 general public are estimated to occur.

11 A second group of airborne radioactive effluents—the fission product radioiodines and tritium—
12 are also gaseous, but some of them can be deposited on the ground or inhaled during
13 respiration. For this class of effluents, estimates are made of direct external radiation doses
14 from ground deposits (as well as exposure to the plume). Estimates are also made of internal
15 radiation doses to the total body, thyroid, bone, and other organs from inhalation and from
16 vegetable, milk, and meat consumption.

17 A third group of airborne effluents consists of particulates and includes fission products, such as
18 cesium and strontium, and activated corrosion products, such as cobalt and chromium. These
19 effluents contribute to direct external radiation doses and to internal radiation doses through the
20 same pathways as those described above for the radioiodine. Doses from the particulates are
21 combined with those from the radioiodines and tritium for comparison with one of the design
22 objectives of Appendix I to 10 CFR Part 50.

23 Liquid effluent constituents could include fission products such as strontium and iodine;
24 activation and corrosion products, such as sodium, iron, and cobalt; and tritiated water. These
25 radionuclides contribute to the internal doses through the pathways described above from fish
26 consumption, water ingestion (as drinking water), and consumption of meat or vegetables raised
27 near a nuclear plant and using irrigation water, as well as from any direct external radiation from
28 recreational use of the water near the point of a plant's discharge.

29 The release of each radioisotope and the site-specific meteorological and hydrological data
30 serve as input to radiation dose models that estimate the maximum radiation dose that would be
31 received outside the facility by way of a number of pathways for individual members of the
32 public and for the general public as a whole. These models and the radiation dose calculations
33 are discussed in Revision 1 of Regulatory Guide 1.109 (NRC 1977).

34 Doses from gaseous radioactive iodine and radioactive material in particulate form in gaseous
35 effluents are calculated for individuals at the location or source point (e.g., site boundary,
36 garden, residence, dairy animal, meat animal) where the highest radiation dose to a member of
37 the public has been established from each applicable pathway (e.g., ground deposition,
38 inhalation, vegetable consumption, milk consumption, meat consumption). Only those
39 pathways associated with airborne effluents that are known to exist at a single location are
40 combined to calculate the total maximum exposure to an exposed individual. Pathway doses
41 associated with liquid effluents are conservatively combined without regard to any single
42 location but are assumed to be associated with the maximum exposure of an individual.

Affected Environment

1 A number of possible exposure pathways to humans are evaluated to determine the impact of
2 routine releases from each nuclear facility on members of the general public living and working
3 outside the site boundaries. A listing of these exposure pathways include external radiation
4 exposure from gaseous effluents, inhalation of iodines and particulate contaminants in the air,
5 consuming milk from dairy animals or eating meat from an animal that grazes on open pasture
6 near the site on which iodines or particulates may be deposited, eating vegetables from a garden
7 near the site (that may be contaminated by similar deposits), and drinking water or eating fish or
8 invertebrates caught near the point of liquid effluent discharge. Other exposure pathways may
9 include external irradiation from surface deposition; eating of animals and crops grown near the
10 site and irrigated with water contaminated by liquid effluents; shoreline, boating, and swimming
11 activities; drinking potentially contaminated water; and direct radiation being emitted from the
12 plant itself. Calculations for most pathways are limited to a radius of 50 mi (80 km). For this
13 study, effluent and MEI dose information was collected from a series of publicly available annual
14 radioactive effluent release reports that licensees submit to the NRC every year.

15 *3.9.1.3.2 Radiological Monitoring*

16 Background radiation measurements at all reactor sites were obtained prior to operation of the
17 nuclear reactor. Thus, each facility has characterized the natural background levels of
18 radioactivity and radiation and their variations among the anticipated important exposure
19 pathways in the areas surrounding the facilities. The operational, Radiological Environmental
20 Monitoring Program (REMP) is conducted at each site to provide data on measurable levels of
21 radiation and radioactive materials in the site environs in accordance with 10 CFR Parts 20
22 and 50. The REMP quantifies the environmental impacts associated with radioactive effluent
23 releases from the plant. The REMP monitors the environment throughout the plant's operating
24 lifetime to monitor radioactivity in the local environment. The REMP provides a mechanism for
25 determining the levels of radioactivity in the environment to ensure that any accumulation of
26 radionuclides released into the environment will not become significant as a result of plant
27 operations. The REMP also measures radioactivity from other nuclear facilities that may be in
28 the area (i.e., other nuclear power plants, hospitals using radioactive material, research
29 facilities, or any other facility licensed to use radioactive material). Thus, the REMP monitors
30 the cumulative impacts from all sources of radioactivity in the vicinity of the power plant. To
31 obtain information on radioactivity around the plant, samples of environmental media
32 (e.g., surface water; groundwater; drinking water; air; milk; locally grown crops; locally produced
33 food products; river, ocean, or lake sediment; and fish and other aquatic biota) are collected
34 from areas surrounding the plant for analysis to measure the amount of radioactivity, if any, in
35 the samples. The media samples reflect the radiation exposure pathways (i.e., inhalation,
36 ingestion, and physical location near the plant) to the public from radioactive effluents released
37 by the nuclear power plant and from background radiation (i.e., cosmic sources, naturally
38 occurring radioactive material, including radon, and global fallout). The NRC has standards for
39 the amount of radioactivity in the sample media, which if exceeded, must be reported to the
40 NRC, and the licensee must conduct an investigation. The REMP supplements the radioactive
41 effluent monitoring program by verifying that measurable concentrations of radioactive materials
42 and levels of radiation in the environment are not higher than expected when compared against
43 data on the amount of radioactive effluent discharged.

44 The REMP can also identify the existence of effluents from unmonitored release points. A
45 periodic land use survey identifies changes in the use of unrestricted areas to provide a basis
46 for modifying the monitoring programs to reflect a new exposure pathway or a different plant-
47 specific dose calculation parameter. The results of the REMP are documented by each
48 licensee in the annual radiological environmental monitoring reports and submitted to NRC

1 every year and are publicly available in NRC's ADAMS document system. The radiological
 2 environmental monitoring reports can also be accessed by navigating the reactor webpage for
 3 each site on the NRC website; effluent reports and environmental reports are available through
 4 the "Plant Environmental Report" section of the key documents.

5 3.9.1.3.3 Public Radiation Doses

6 Table 3.9-21 and Table 3.9-22 show the total body dose to the public, ground-level air dose,
 7 and dose to a critical organ for 3 years (2018 through 2020) from gaseous effluent releases for
 8 several PWRs and BWRs. The dose varies from year to year and also from reactor to reactor.
 9 The maximum total body dose is 0.47 mrem, maximum dose to a critical organ is 1.17 mrem,
 10 maximum ground-level air dose from gamma radiation is 0.99 mrad, and maximum ground-level
 11 dose from beta radiation is 0.011 mrad. All doses are much less than the design objectives of
 12 Appendix I of 10 CFR Part 50 provided in Table 3.9-2.

13 Table 3.9-23 and Table 3.9-24 show the total body dose to the public and dose to a critical
 14 organ for 3 years (2018 through 2020) from liquid effluent releases for the same PWRs and
 15 BWRs. The total body dose and dose to critical organ of the MEI from liquid effluent releases
 16 varies from year to year and also from reactor to reactor.

17 The doses from both gaseous and liquid effluents are much less than the design objectives of
 18 Appendix I of 10 CFR Part 50 provided in Table 3.9-2 and the EPA standards in 40 CFR 190,
 19 Subpart B provided in Table 3.9-3. Calculated MEI doses are also reported in annual effluent
 20 release reports based on the gaseous and liquid effluent releases for each plant. Under most
 21 circumstances, the dose calculations to the MEI, which are made by the plants, overestimate
 22 the calculated dose because of conservative assumptions. For most reactors, the annual MEI
 23 doses are a few millirem or less.

24 **Table 3.9-21 Doses from Gaseous Effluent Releases by Select Pressurized Water**
 25 **Reactors from 2018 through 2020**

Year	PWR	No. of Reactors	Total Body (mrem) ^(a)	Gamma (mrad) ^(a)	Beta (mrad) ^(a)	Critical Organ (mrem) ^(a)
2018	Comanche Peak	2	9.00E-02	3.69E-04	1.38E-04	5.17E-04
2018	D.C. Cook	2	2.14E-03	4.01E-03	3.34E-03	9.57E-02
2018	Palo Verde 1	1	NR	4.56E-04	1.62E-04	1.93E-01
2018	Palo Verde 2	1	NR	1.53E-03	7.79E-04	NR
2018	Palo Verde 3	1	NR	1.38E-04	4.87E-04	3.20E-01
2018	Robinson	1	3.31E-01	3.29E-03	1.67E-03	4.90E-01
2018	Salem 1	1	2.49E-02	9.89E-05	4.14E-05	1.20E-01
2018	Salem 2	1	2.17E-02	9.96E-05	5.20E-05	1.03E-01
2018	Seabrook	1	NR	1.40E-04	7.97E-05	3.49E-01
2018	Surry	2	NR	6.12E-04	1.81E-03	1.42E-01
2019	Comanche Peak	2	8.00E-02	3.12E-04	1.14E-04	4.35E-04
2019	D.C. Cook	2	1.33E-03	2.78E-03	2.06E-03	1.28E-01
2019	Palo Verde 1	1	NR	5.02E-04	2.86E-04	1.69E-01
2019	Palo Verde 2	1	NR	3.99E-04	1.41E-04	1.40E-01
2019	Palo Verde 3	1	NR	1.46E-03	5.89E-04	3.12E-01
2019	Robinson	1	4.74E-01	3.12E-03	1.18E-03	5.79E-01
2019	Salem 1	1	2.13E-02	1.01E-04	4.70E-05	9.35E-02
2019	Salem 2	1	2.52E-02	1.33E-04	4.83E-05	1.17E-01

Affected Environment

Year	PWR	No. of Reactors	Total Body (mrem) ^(a)	Gamma (mrad) ^(a)	Beta (mrad) ^(a)	Critical Organ (mrem) ^(a)
2019	Seabrook	1	NR	4.87E-05	3.17E-05	3.44E-01
2019	Surry	2	NR	7.14E-06	9.04E-06	9.40E-02
2020	Comanche Peak	2	8.00E-02	4.51E-04	1.65E-04	6.30E-04
2020	D.C. Cook	2	1.23E-03	2.26E-03	8.92E-04	1.02E-01
2020	Palo Verde 1	1	NR	6.23E-04	2.49E-04	3.11E-03
2020	Palo Verde 2	1	NR	9.90E-01	3.64E-04	1.95E-01
2020	Palo Verde 3	1	NR	8.50E-04	3.13E-04	2.32E-01
2020	Robinson	1	2.57E-01	7.90E-03	2.90E-03	5.18E-01
2020	Salem 1	1	NR	1.00E-04	4.61E-05	7.97E-02
2020	Salem 2	1	NR	1.43E-04	5.31E-05	1.01E-01
2020	Seabrook	1	NR	5.61E-01	2.89E-04	3.29E-01
2020	Surry	2	NR	9.84E-05	3.68E-05	1.05E-01

1 PWR = pressurized water reactor; mrem = millirem; mrad = millirad; NR = not reported.
 2 (a) Compare the values presented in this table with the design objectives presented in Table 3.9-2, Appendix I to 10
 3 CFR 50 and Table 3.9-3, 40 CFR Part 190, Subpart B.
 4 Note: To convert mrem to mSv, multiply by 0.01.
 5 Sources: Annual effluent release reports. The radiological environmental monitoring reports can also be accessed
 6 by navigating the reactor webpage for each site on the NRC website; effluent reports and environmental reports are
 7 available through the "Plant Environmental Report" section of the key documents.

8 **Table 3.9-22 Doses from Gaseous Effluent Releases by Select Boiling Water Reactors**
 9 **from 2018 through 2020**

Year	BWR	No. of Reactors	Total Body (mrem) ^(a)	Gamma (mrad) ^(a)	Beta (mrad) ^(a)	Critical Organ (mrem) ^(a)
2018	Fermi 2	1	1.28E-01	6.72E-04	4.75E-04	1.17E+00
2018	Hatch 1	1	5.07E-03	0.00E+00	0.00E+00	5.08E-03
2018	Hatch 2	1	9.68E-03	0.00E+00	0.00E+00	9.85E-03
2018	Hope Creek	1	4.52E-02	4.78E-05	1.42E-04	1.69E-01
2018	Limerick	2	3.25E-03	3.45E-03	2.13E-03	5.35E-03
2018	Columbia	1	NR	3.13E-02	1.11E-02	2.97E-01
2019	Fermi 2	1	1.40E-01	3.13E-06	1.23E-06	1.50E-01
2019	Hatch 1	1	1.19E-02	0.00E+00	0.00E+00	1.19E-02
2019	Hatch 2	1	1.39E-02	0.00E+00	0.00E+00	1.40E-02
2019	Hope Creek	1	4.11E-02	1.90E-03	3.21E-03	4.03E-02
2019	Limerick	2	9.79E-04	1.03E-03	6.12E-04	1.62E-03
2019	Columbia	1	NR	2.96E-02	1.04E-02	2.10E-01
2020	Fermi 2	1	1.10E-01	1.15E-05	4.51E-06	4.14E-01
2020	Hatch 1	1	2.09E-02	0.00E+00	0.00E+00	2.09E-02
2020	Hatch 2	1	1.99E-02	0.00E+00	0.00E+00	2.02E-02
2020	Hope Creek	1	NR	1.90E-03	3.20E-03	2.37E-01
2020	Limerick	2	2.52E-03	2.66E-03	2.13E-03	4.39E-03
2020	Columbia	1	NR	2.85E-02	1.00E-02	1.67E-01

10 BWR = boiling water reactor; mrem = millirem; mrad = millirad; NR = not reported.
 11 (a) Compare the values presented in this table with the design objectives presented in Table 3.9-2, Appendix I to 10
 12 CFR 50 and Table 3.9-3, 40 CFR Part 190, Subpart B.
 13 Note: To convert mrem to mSv, multiply by 0.01.
 14 Sources: Annual effluent release reports. The radiological environmental monitoring reports can also be accessed
 15 by navigating the reactor webpage for each site on the NRC website; effluent reports and environmental reports are
 16 available through the "Plant Environmental Report" section of the key documents.

1 **Table 3.9-23 Dose from Liquid Effluent Releases by Select Pressurized Water Reactor**
 2 **Nuclear Power Plants for 2018 through 2020**

Year	PWR Name	No. of Reactors	Total Body (mrem) ^(a)	Critical Organ (mrem) ^(a)
2018	Comanche Peak	2	1.14E-01	1.14E-01
2018	D.C. Cook	2	8.87E-02	4.80E-02
2018	Palo Verde 1-3	3	No Release	No Release
2018	Robinson	1	1.43E-04	3.64E-04
2018	Salem 1	1	1.06E-05	1.41E-04
2018	Salem 2	1	4.33E-05	1.46E-04
2018	Seabrook	1	6.58E-04	1.62E-03
2018	Surry	2	5.61E-04	8.72E-04
2019	Comanche Peak	2	1.27E-01	1.27E-01
2019	D.C. Cook	2	8.43E-02	8.46E-02
2019	Palo Verde 1-3	3	No Release	No Release
2019	Robinson	1	1.75E-06	1.83E-05
2019	Salem 1	1	1.35E-02	1.67E-02
2019	Salem 2	1	3.99E-03	2.60E-02
2019	Seabrook	1	1.86E-04	2.33E-04
2019	Surry	2	3.44E-04	4.08E-04
2020	Comanche Peak	2	1.14E-01	1.14E-01
2020	D.C. Cook	2	8.87E-02	4.80E-02
2020	Palo Verde 1-3	3	No Release	No Release
2020	Robinson	1	2.01E-03	5.63E-03
2020	Salem 1	1	1.36E-02	2.93E-02
2020	Salem 2	1	4.67E-03	3.40E-02
2020	Seabrook	1	5.15E-04	8.42E-04
2020	Surry	2	1.77E-04	2.33E-04

3 PWR = pressurized water reactor; mrem = millirem.

4 (a) Compare the values presented in this table with the design objectives from Table 3.9-2, Appendix I to 10
 5 CFR 50.

6 Note: To convert mrem to mSv, multiply by 0.01.

7 Sources: Annual effluent release reports. The radiological environmental monitoring reports can also be accessed
 8 by navigating the reactor webpage for each site on the NRC website; effluent reports and environmental reports are
 9 available through the "Plant Environmental Report" section of the key documents.

10 **Table 3.9-24 Dose from Liquid Effluent Releases from Select Boiling Water Reactor**
 11 **Nuclear Power Plants for 2018 through 2020**

Year	BWR Name	No. of Reactors	Total Body (mrem) ^(a)	Critical Organ (mrem) ^(a)
2018	Fermi 2	1	No Release	No Release
2018	Hatch 1	1	3.53E-04	4.40E-04
2018	Hatch 2	1	2.55E-04	3.33E-04
2018	Hope Creek	1	7.53E-03	2.07E-02
2018	Limerick	2	4.90E-04	6.59E-04
2018	Columbia	1	No Release	No Release
2019	Fermi 2	1	No Release	No Release
2019	Hatch 1	1	9.85E-04	8.01E-04
2019	Hatch 2	1	3.88E-04	1.01E-03
2019	Hope Creek	1	7.92E-04	2.41E-03

Affected Environment

Year	BWR Name	No. of Reactors	Total Body (mrem) ^(a)	Critical Organ (mrem) ^(a)
2019	Limerick	2	9.63E-03	1.23E-02
2019	Columbia	1	No Release	No Release
2020	Fermi 2	1	No Release	No Release
2020	Hatch 1	1	5.83E-04	7.56E-04
2020	Hatch 2	1	6.99E-04	7.66E-04
2020	Hope Creek	1	1.65E-02	5.13E-02
2020	Limerick	2	2.83E-04	2.34E-03
2020	Columbia	1	No Release	No Release

1 BWR = boiling water reactor; mrem = millirem.
 2 (a) Compare the values presented in this table with the design objectives from Table 3.9-2, Appendix I to 10 CFR
 3 50.
 4 Note: To convert mrem to mSv, multiply by 0.01.
 5 Sources: Annual effluent release reports. The radiological environmental monitoring reports can also be accessed
 6 by navigating the reactor webpage for each site on the NRC website; effluent reports and environmental reports are
 7 available through the "Plant Environmental Report" section of the key documents.

8 *3.9.1.3.4 Radiological Exposure from Naturally Occurring and Artificial Sources*

9 Table 3.9-25 identifies background doses to a typical member of the U.S. population as
 10 summarized in National Council on Radiation Protection and Measurements Report 160 (2009)
 11 and National Council on Radiation Protection and Measurements Report 180 (2019). In the
 12 table, the annual values are rounded to the nearest 1 percent. A total average annual effective
 13 dose equivalent of 554 mrem/yr to members of the U.S. population is contributed by two primary
 14 sources: naturally occurring background radiation and medical exposure to patients.

15 Natural radiation sources other than radon result in 15 percent of the typical radiation dose
 16 received. The larger source of radiation dose in ubiquitous background (41 %) is from radon,
 17 particularly because of homes and other buildings that trap radon and significantly enhance its
 18 dose contribution over open-air living. The remaining 44 percent of the average annual effective
 19 dose equivalent consists of radiation mostly from medical procedures (computed tomography,
 20 25 %; nuclear medicine, 7 %; interventional fluoroscopy, 5 percent; and conventional
 21 radiography and fluoroscopy, 4 %) and a small fraction from consumer products (2 %). The
 22 consumer product exposure category includes exposure to members of the public from building
 23 materials, commercial air travel, cigarette smoking, mining and agriculture products, combustion
 24 of fossil fuels, highway and road construction materials, and glass and ceramic. The industrial,
 25 security, medical, education, and research exposure category includes exposure to the
 26 members of the public from nuclear power generation; DOE installation; decommissioning and
 27 radioactive waste; industrial, medical, education, and research activities; contact with nuclear
 28 medicine patients; and security inspection systems. The occupational exposure category
 29 includes exposure to workers from medical, aviation, commercial nuclear power, industry and
 30 commerce, education and research, government, the DOE, and military installations. Radiation
 31 exposures from occupational activities, industrial, security, medical, educational and research
 32 contribute insignificantly to the total average effective dose equivalent.

1 **Table 3.9-25 Average Annual Effective Dose Equivalent of Ionizing Radiation to**
 2 **a Member of the U.S. Population for 2016**

Source	EDE (mrem)	EDE Percent of Total
Background (Total)	311	56
Ubiquitous background^(a)		
Radon and thoron	228	41
Natural^(a)		
Cosmic	33	6
Terrestrial	21	4
Internal	29	5
Medical^(b)(Total)	229	41
Computed tomography	140	25
Nuclear medicine	41	7
Interventional fluoroscopy	26	5
Conventional radiography and fluoroscopy	22	4
Industrial, security, medical, educational and research^(a)	0.3	0.05
Occupational^(a)	0.5	0.09
Consumer products^(a)	13	2
Total^(c)	553.8	100

3 EDE = effective dose equivalent; mrem = millirem.
 4 (a) NCRP 2009
 5 (b) NCRP 2019. This NCRP updates the contribution from medical exposure due to changes in how procedures are
 6 conducted through the Image Wisely and Image Gently campaigns.
 7 (c) Total includes background, medical, industrial, security, medical, and education research, occupational, and
 8 consumer products sources.

9 **3.9.1.3.5 Inadvertent Liquid Radioactive Releases**

10 As mentioned before, all commercial nuclear power plants routinely release radioactive material
 11 to the environment in the form of liquids and gases in accordance with regulations (Table 3.9-2).
 12 Each year, plant operators submit an effluent release report that documents the amount of
 13 radioactive material released to the environment during the year. This report also includes the
 14 public dose impact from the releases. Plant operators also conduct environmental monitoring in
 15 the vicinity and submit an environmental monitoring report every year to the NRC. All licensees
 16 must comply with the existing requirements to monitor and report effluents that are discharged,
 17 including abnormal discharges that may migrate offsite. A discussion of the historical
 18 inadvertent (unplanned) releases and the findings of the task force designated to conduct a
 19 lessons learned review following the inadvertent releases of tritium at the Braidwood, Indian
 20 Point, Byron, and Dresden sites is presented in Section 3.5.2.

21 **3.9.1.4 Radiation Health Effects Studies**

22 Radiation health effects have been the subject of published studies and a discussion of some of
 23 these studies and has been presented in the 2013 LR GEIS in Section 3.9.1.3.6 and is
 24 incorporated here by reference.

1 3.9.1.4.1 Risk Estimates from Radiation Exposure

2 In estimating the health effects resulting from both occupational and offsite radiation exposures
 3 as a result of operating nuclear power facilities, the normal probability coefficients for stochastic
 4 effects recommended by the ICRP (ICRP 1991) were used. The coefficients consider the most
 5 recent radiobiological and epidemiological information available and are consistent with the
 6 United Nations Scientific Committee on the Effects of Atomic Radiation. The coefficients used
 7 (Table 3.9-26) are the same as those published by ICRP in connection with a revision of its
 8 recommendations (ICRP 1991). Excess hereditary effects are listed separately because
 9 radiation-induced effects of this type have not been observed in any human population, as
 10 opposed to excess malignancies that have been identified among populations receiving
 11 instantaneous and near-uniform exposures in excess of 10 rem.

12 **Table 3.9-26 Nominal Probability Coefficients Used in ICRP (1991)^(a)**

Health Effect	Occupational	Public
Fatal cancer	4	5
Hereditary	0.8	1.3

13 (a) Estimated number of excess effects among 10,000 people receiving 10,000 person-rem. Coefficients are based
 14 on “central” or “best” estimates.
 15 Source: ICRP 1991.

16 In 2006, the National Research Council’s Advisory Committee on the Biological Effects of
 17 Ionizing Radiation (BEIR) published BEIR VII, entitled *Health Risks from Exposure to Low*
 18 *Levels of Ionizing Radiation* (National Research Council 2006).

19 BEIR VII provides estimates of the risk of incidence and mortality for males and females. If the
 20 total fatal cancer risk is the sum of cancer deaths from all solid cancers and leukemia, then the
 21 fatal cancer risk coefficient for the general public would be 6×10^{-4} /person-rem. The fatal
 22 cancer risk for the general public based on ICRP is 5×10^{-4} /person-rem (Table 3.9-26). There is
 23 a difference of approximately 20 percent in the fatal cancer risk coefficient based on ICRP
 24 recommendation and the BEIR VII report. The difference of 20 percent is within the margin of
 25 uncertainty associated with these estimates.

26 The NRC completed a review of the BEIR VII report and documented its findings in the
 27 Commission paper SECY-05-0202, *Staff Review of the National Academies Study of the Health*
 28 *Risks from Exposure to Low Levels of Ionizing Radiation* (BEIR VII), dated October 29, 2005
 29 (NRC 2005g). In this paper, the NRC concluded that the findings presented in the BEIR VII
 30 report agree with the NRC’s current understanding of the health risks from exposure to ionizing
 31 radiation. The NRC agreed with the BEIR VII report’s major conclusion that current scientific
 32 evidence is consistent with the hypothesis that there is a linear, no-threshold dose response
 33 relationship between exposure to ionizing radiation and the development of cancer in humans.
 34 In addition to the BEIR VII paper, NCRP also published Commentary No. 27 in May 2018
 35 providing a critical review of epidemiologic studies mostly published within the past ten years.
 36 NCRP concluded that the recent epidemiologic studies, along with judgements by other national
 37 and international scientific committees, support the continued use of the linear-non threshold
 38 model for radiation protection (NCRP 2018). The NRC has determined that the linear, no-
 39 threshold model continues to provide a sound regulatory basis for minimizing the risk to
 40 unnecessary radiation exposure to both members of the public and radiation workers; three
 41 petitions to move away from the linear, no-threshold model were denied in 2021 (86 FR 45923).

1 This conclusion is consistent with the process the NRC uses to develop its standards of
2 radiological protection. Therefore, the NRC's regulations continue to be adequately protective
3 of public health and safety and the environment.

4 If an occupational worker is exposed at 10 CFR Part 20 dose limits for 1 year, the probability of
5 developing fatal cancer (on the basis of ICRP recommendations) from exposure due to an
6 operating nuclear reactor is equal to 2×10^{-3} on the basis of ICRP recommendations. However,
7 the average individual worker doses are much less than the dose limits (see Table 3.9-5), and,
8 at the doses observed between 2006 and 2018, the probability of developing fatal cancer would
9 be in the range of 2.8×10^{-5} to 6.0×10^{-5} .

10 If a member of the public is exposed at 40 CFR Part 190 dose limits, the probability of
11 developing fatal cancer (on the basis of ICRP recommendations) from exposure resulting from
12 operating a nuclear reactor is equal to 1.25×10^{-5} . However, the MEI doses are much less than
13 the dose limits, and, at the doses observed between 2018 and 2020, the probability of
14 developing fatal cancer would be in the range of 2.40×10^{-10} to 1.3×10^{-6} .

15 3.9.1.5 Conclusion

16 Radiation doses to nuclear power plant workers and members of the public from the current
17 operation of nuclear power plants have been examined, and the radiation doses were found to
18 be well within design objectives and regulations in each instance.

19 3.9.2 Nonradiological Hazards

20 Nonradiological hazards, such as chemical, biological, EMFs, and physical hazards, are not
21 unique to nuclear power plants and can occur in many types of industrial facilities. However,
22 certain nonradiological hazards can be enhanced by physical plant elements or characteristics
23 of nuclear power plants, which this section will discuss.

24 While nonradiological hazards can be minimized when workers adhere to safety standards and
25 use appropriate protective equipment, fatalities and injuries from accidents can still occur. Risk
26 to members of the public can also be minimized when adhering to safety standards. See
27 Section 3.3 for information on meteorology, air quality, and noise, Section 3.5 for information on
28 water resources, Section 3.11 for information on waste management and Appendix E for
29 postulated accidents. The overall well-being of these resource areas is important to maintaining
30 nonradiological public and occupational health.

31 The Occupational Safety and Health Administration (OSHA) is responsible for developing and
32 enforcing workplace safety regulations. OSHA's mission is to ensure safe and healthful working
33 conditions. OSHA was created by the Occupational Safety and Health Act of 1970
34 (29 USC 651 et seq.). With specific regard to nuclear power plants, hazards which result in an
35 occupational risk, but do not affect the safety of licensed radioactive materials, are under the
36 statutory authority of OSHA rather than the NRC as set forth in a Memorandum of
37 Understanding (OSHA/NRC 2013) between the NRC and the OSHA. Additionally, the EPA,
38 through multiple statutes, is responsible for the regulation of hazardous chemicals that can enter
39 the environment and impact members of the public. As such, nuclear power plants have
40 developed various programs and processes to show compliance with OSHA's regulations,
41 including Chemical Safety Programs, Hazard Communication Programs, and/or an International
42 Organization for Standardizations 9001 Certification of Approval. The approval is not required
43 by OSHA or NRC but is a common industrial process that implements quality assurance by

Affected Environment

1 which safety requirements are met, hazards are identified, and risks are reduced. Additionally,
2 nuclear power plants are required to have Federal, State, and/or local permits for releases to air
3 (e.g., a Title V permit), surface or groundwater water (e.g., a NPDES permit), and other local
4 permits and ordinances depending on the municipality.

5 3.9.2.1 Chemical Hazards

6 Chemical exposure can exist in the form of dust, fumes, fibers (solids), liquids, mists, gases, or
7 vapors. Chemical exposure produces different effects on the body depending on the chemical
8 and the amount of exposure. Chemicals can cause cancer, affect reproductive capability,
9 disrupt the endocrine system, or have other health effects. Acute effects from chemical
10 exposure occur immediately (e.g., when somebody inhales or ingests a poisonous substance
11 such as cyanide). Chronic or delayed effects result in symptoms such as skin rashes,
12 headaches, breathing difficulties, and nausea. There are multiple pathways by which humans
13 can be exposed to chemicals. For example, a direct pathway would be a human breathing in a
14 gaseous effluent or swimming in water that was contaminated by a liquid effluent. An indirect
15 pathway would be a human eating a fish that had absorbed a pollutant into its body or eating
16 crops that had been irrigated with water contaminated by a liquid effluent. In nuclear power
17 plants, chemical exposure can result from discharges of chlorine or other biocides, small-
18 volume discharges of sanitary and other liquid wastes, chemical spills, and heavy metals
19 leached from cooling system piping and condenser tubing. Nuclear power plant backup diesel
20 generators, boilers, fire pump engines, and cooling towers can also result in chemical exposure,
21 but are generally low emitters of criteria air pollutants (e.g., SO₂, NO_x, and CO) and VOCs (e.g.,
22 such as components of petroleum fuels and hydraulic fluids [EPA 2022h]).

23 OSHA regulations in 29 CFR Part 1910 set enforceable permissible exposure limits for about
24 500 hazardous chemicals to protect workers against the health effects of exposure to hazardous
25 substances, including limits on the airborne concentrations of hazardous chemicals in the air
26 and skin contact. Most permissible exposure limits are 8-hour time-weighted averages,
27 although there are also ceiling and peak limits.

28 The EPA is responsible for the regulation of hazardous chemicals that can enter the
29 environment and impact members of the public. The EPA administers the following Federal
30 acts related to chemical contamination: the Federal Insecticide, Fungicide, and Rodenticide Act
31 (7 U.S.C. § 136 et seq.); Toxic Substances Control Act (15 U.S.C. § 2601 et seq.); RCRA (42
32 U.S.C. § 6901 et seq.); CWA (codified as the Federal Water Pollution Control Act of 1972;
33 33 U.S.C. § 1251 et seq.); Safe Drinking Water Act (SDWA; 42 U.S.C. § 300f et seq.); Clean Air
34 Act (CAA; 42 U.S.C. § 7401 et seq.); and Comprehensive Environmental Response
35 Compensation, and Liability Act (42 U.S.C. § 9601 et seq.). These Acts regulate the treatment,
36 storage, disposal, and release of hazardous chemicals. Heavy metals (e.g., copper, zinc, and
37 chromium) may be leached from condenser tubing and other heat exchangers and discharged
38 by power plants as small-volume waste streams or corrosion products. Although all are found in
39 small quantities in natural waters (and many are essential micronutrients), concentrations in the
40 power plant discharge are controlled in the NPDES permit because excessive concentrations of
41 heavy metals can be toxic to aquatic organisms (see Section 3.6). The ability of aquatic
42 organisms to bioaccumulate heavy metals, even at low concentrations, has led to concerns
43 about toxicity to both the humans and the biota that consume contaminated fish and shellfish.
44 For example, the bioconcentration of copper discharged from the Chalk Point plant (a fossil fuel
45 power plant on Chesapeake Bay) resulted in oyster “greening” (Roosenburg 1969). The
46 bioaccumulation of copper released from the H.B. Robinson Steam Electric Plant (Robinson)
47 resulted in malformations and decreased reproductive capacity among bluegill in the cooling

1 reservoir (Harrison 1985). At the Diablo Canyon nuclear plant, it was observed that the
2 concentration of soluble copper in effluent water was high during the startup of water circulation
3 through the condenser system after a shutdown (Harrison 1985). In all three examples of
4 excessive accumulation of copper (Diablo Canyon, Chalk Point, and Robinson), replacement of
5 the copper alloy condenser tubes with another material (e.g., titanium) eliminated the problem.

6 3.9.2.2 Microbiological Hazards

7 Microbiological hazards occur when workers or members of the public come into contact with
8 disease causing microorganisms, also known as etiological agents. Microbiological organisms
9 of concern for public and occupational health, include enteric pathogens (bacteria that typically
10 exists in the intestines of animals and humans (e.g., *Pseudomonas aeruginosa*), thermophilic
11 fungi, bacteria (e.g., *Legionella* spp. and *Vibrio* spp.), free-living amoebae (e.g., *Naegleria*
12 *fowleri* and *Acanthamoeba* spp.), as well as organisms that produce toxins that affect human
13 health (e.g., dinoflagellates (*Karenia brevis*) and blue-green algae). Some of these disease
14 causing organisms have been associated with the operation of nuclear power plant cooling
15 systems (see Section 3.9.2.2.2). Etiological agents have been referred to as “thermophilic
16 microorganisms” in previous NRC documents (e.g., NUREG-1555 [NRC 1999a]). Thermophilic
17 microorganisms have an optimum growth at temperatures of 122 degrees Fahrenheit (°F) (50
18 degree Celsius [°C]) or more, a maximum temperature tolerance of up to 158 °F (70 °C), and a
19 minimum tolerance of about 68 °F (20 °C) (Deacon 2006), which means improperly maintained
20 cooling towers, hot water tanks, and thermal discharges could be optimal environments for
21 microorganisms. Etiological agents associated with nuclear power stations also include more
22 than just thermophilic microorganisms and may be present in elevated numbers in unheated
23 and heated water systems as well as in cooling systems, receiving and source waterbodies, and
24 site sewage treatment facilities.

25 Members of the public could be exposed to microorganisms in thermal effluents at nuclear
26 plants that use cooling ponds, lakes, or canals that discharge to waters of the United States
27 accessible to the public.

28 For this update of the LR GEIS, the SEISs published since 2013 were reviewed to determine
29 the level of thermophilic microbiological organism enhancement. The SEISs note that health
30 departments were contacted and that the health departments did not have any concerns. In all
31 occurrences, with the exception of Turkey Point, the NRC staff concluded that impacts to the
32 public from microbiological organism were SMALL. For Turkey Point, microbiological organisms
33 impacts to members of the public was not discussed because Turkey Point discharges to a
34 canal cooling system not accessible by the public with discharge to groundwater in a saline-
35 water environment instead of a freshwater environment. See the 2013 LR GEIS for an
36 additional discussion of reactor sites that were reviewed to predict the level of thermophilic
37 microbiological organism enhancement. The 2013 LR GEIS review did not identify hazards to
38 the public from enhancement of thermophilic microbiological organisms.

39 OSHA has information and guidance regarding how improperly maintained human-made water
40 systems can serve as sources for a microbiological hazard, such as *Legionella* spp (OSHA
41 Undated). *Legionella* causes Legionnaires’ disease, which is an infection of the lungs.
42 *Legionella* also causes Pontiac fever, which is a milder infection than Legionnaires’ disease and
43 includes fever and muscle aches but not an infection of the lungs. People get these diseases
44 by breathing in droplets of water in the air that contain the hazard or by drinking contaminated
45 water that accidentally goes into the lungs. The Centers for Disease Control and Prevention
46 (CDC) also has general guidelines for preventing occupational exposure to *Legionella* and best

Affected Environment

1 practices for the control of *Legionella* (CDC 2021c). The American National Standards
2 Institute/American Society of Heating, Refrigerating and Air Conditioning Engineers Standard
3 188-2018 documents a standard for Legionellosis and risk management for building water
4 systems (ASHRAE 2021). A temperature range of 77–113 °F (25–45 °C) is best for
5 *Legionella* spp. growth (CDC 2018).

6 *Acanthamoeba* and *Pseudomonas aeruginosa* are single-cell living organisms and much like
7 *Legionella*, thrive in stagnant or untreated water and can enter the body through the eye, skin,
8 or inhalation (OSHA 2015). *Pseudomonas aeruginosa* has an optimal growth temperature of
9 98.6 °F (37 °C) and can tolerate a temperature as high as 107.6 °F (42 °C) (Todar 2004).
10 *Pseudomonas aeruginosa* can cause infections in the eye, blood, or lungs (CDC 2019a).
11 *Acanthamoeba* can also cause infections of the eye, skin, and central nervous system.

12 *Naegleria fowleri*, is a single-celled living organism commonly found in warm freshwater. It
13 thrives in warmer temperatures (up to 115 °F [46 °C]). *Naegleria fowleri* infections occur when
14 people go swimming or diving in warm freshwater and the amoeba travels up the nose, across
15 the blood-brain barrier, into the brain and destroys brain tissue. The disease is called primary
16 amoebic meningoencephalitis. Infections do not occur by drinking contaminated water, nor
17 through water vapor or aerosol droplets (CDC 2021d).

18 Toxins produced by some species of algae and cyanobacteria can cause harm to human health
19 when they grow rapidly and create blooms. In low amounts, the cyanobacteria toxin is not a
20 human health risk, but when the organisms cause a bloom, the toxin is harmful. Blooms occur
21 when water is warm (e.g., like a thermal discharge from a nuclear power plant), slow-moving,
22 and full of nutrients, such as phosphorus or nitrogen. An algae bloom can occur in freshwater
23 or saltwater (CDC 2021a). Cyanobacteria, also called blue-green algae, are a kind of single-
24 celled organism called phytoplankton. Exposure can be through skin contact, drinking water
25 containing the cyanobacteria, breathing in droplets in the air that contain the algae, or eating
26 shellfish or fish that are contaminated with the cyanobacteria. Symptoms of cyanobacteria
27 exposure include stomach pain, headache, muscle weakness, dizziness, vomiting, diarrhea,
28 and liver damage (CDC 2022). In saltwater, algal blooms are commonly caused by diatoms and
29 dinoflagellates, which are another kind of phytoplankton. Breathing in sea spray or getting the
30 contaminated seawater on skin can cause symptoms such as respiratory infection, shortness of
31 breath, throat irritation, eye irritation, skin irritation, and asthma attacks. Eating seafood
32 contaminated with the algae toxin can cause several illnesses, such as neurotoxic shellfish
33 poisoning (CDC 2021b). Based on a review of SEISs to the LR GEIS published since 2013, the
34 staff noted that the only occurrences of algal bloom occurred in Lake Anna in 2018, 2019, and
35 2020. In 2019, Dominion, the NRC-licensee for the North Anna Power Station, stated in a letter
36 to the Virginia Department of Health that the bloom was located in an upper arm many miles
37 from Outfall 001 (the primary discharge into Lake Anna) and outside the reach of the thermal
38 plume. Dominion did develop its own cyanobacteria sampling plan in 2018 (NRC 2021g). The
39 Fermi 2 SEIS (NRC 2016c) noted that the NRC received public comments regarding the role of
40 Fermi's effluent on algal blooms. Fermi is located halfway between Toledo, Ohio, and Detroit,
41 Michigan, on the lake basin where the algal blooms have been most prevalent. The SEIS also
42 noted that the frequency and intensity of the blooms have been increasing and that the Fermi
43 discharge is warmer and contains somewhat higher concentrations of nitrogen and phosphorus,
44 than the ambient intake water of Lake Erie. The SEIS did conclude that the information did not
45 contradict the conclusion of the LR GEIS which states, "Impacts of thermal discharge on the
46 geographic distribution of aquatic organisms are considered to be of SMALL significance if
47 populations in the overall region are not reduced. This is because heat is usually dissipated
48 rapidly from power plant discharge plumes, and heated plumes are often small relative to the

1 size of the receiving water body.” Occupational worker exposure to biological hazards can be
 2 limited through proper maintenance of systems, processes, and machinery and through the use
 3 of personal protective equipment. Exposure of members of the public can also be limited
 4 through proper maintenance of systems, processes, and equipment and separation from
 5 thermal discharges.

6 3.9.2.2.1 Studies of Microorganisms in Spent Fuel Pools

7 During the scoping meeting for the Calvert Cliffs Nuclear Power Plant (Calvert Cliffs) license
 8 renewal SEIS in 1998, one member of the public raised an issue about the microorganisms that
 9 live in high radiation and extreme heat conditions (such as within the spent fuel pool) based on
 10 the article “Something’s Bugging Nuclear Fuel” published in *Science News* (Raloff 1998). The
 11 commenter asked that consideration be given to these types of organisms, the possibility of
 12 their mutation, and consequences if they escaped from the plant into the natural aquatic
 13 environment. The NRC consulted specialists in the field; the following is a summary of their
 14 conclusions as presented in the SEIS (NRC 1999c):

- 15 • Many types of organisms can live in the temperature range of the spent fuel pools (100–
 16 150 °F [38–66 °C]).
- 17 • There is a potential for mutation in all living organisms, but microbes that have high levels of
 18 radiation resistance have also developed extremely efficient repair systems.
- 19 • Organisms that are associated with thermal waters of the spent fuel pool are likely to die if
 20 they are transferred into the relatively much lower water temperatures typical of surface
 21 waters. If the organisms are truly adapted to the high temperatures typical of the spent fuel
 22 pool, they probably would not be able to survive and compete with the indigenous
 23 microorganisms of the relatively cold waters of the natural water sources.

24 The NRC concluded that microorganisms that live in high radiation and extreme heat conditions
 25 typical of the spent fuel pool do not pose a risk to humans or the environment as discussed in
 26 the 2013 LR GEIS.

27 3.9.2.2.2 Studies of Microorganisms In and Around Cooling Towers

28 In 1981, cooling water systems at 11 nuclear power plants and associated control source waters
 29 were studied for the presence of thermophilic free-living amoebae, including *Naegleria fowleri*.
 30 The presence of pathogenic *Naegleria fowleri* in these waters was tested, and while all but one
 31 test site was positive for thermophilic free-living amoebae, only two test sites were positive for
 32 pathogenic *Naegleria fowleri*. Pathogenic *Naegleria fowleri* were not found in any control source
 33 waters (Tyndall 1982). In addition to testing for pathogenic amoebae in cooling water, testing for
 34 the presence of *Legionella* spp. was also done (Tyndall 1982). The concentrations of
 35 *Legionella* spp. in these waters were determined. In general, the artificially heated waters
 36 showed only a slight increase (i.e., no more than tenfold) in concentrations of *Legionella* spp.
 37 relative to source water. In a few cases, source waters had higher levels than did heated waters.
 38 Infectious *Legionella* spp. were found in 7 of 11 test waters and 5 of 11 control source waters.

39 Subsequently, a more detailed study of *Legionella* spp. in the environs of coal-fired power plants
 40 was undertaken to determine the distribution, abundance, infectivity, and aerosolization of
 41 *Legionella* spp. in power plant cooling systems (Tyndall 1983; Christensen et al. 1983; Tyndall
 42 1985). This study found that positive air samples did not occur often at locations that were not
 43 next to cleaning operations, which suggests that aerosolized *Legionella* spp. associated with

Affected Environment

1 downtime procedures have minimal impact beyond these locations. Even within plant
2 boundaries, detectable airborne *Legionella* spp. appear to be confined to very limited areas. In
3 these areas, however, the more contact individuals have with the most concentrated *Legionella*
4 spp. populations, particularly if they become aerosolized (as they do in some downtime
5 operations), the more likely it is that workers are exposed.

6 Another study suggested that *Legionella*-like amoebal pathogens may be an unrecognized
7 significant cause of respiratory disease (Berk et al. 2006). In this study, the occurrence of
8 infected amoebae in water, biofilm, and sediment samples from 40 cooling towers (non-nuclear
9 sites) and 40 natural aquatic environments were compared. The natural samples were
10 collected from rivers, creeks, lakes, and ponds from Tennessee, Kentucky, New Jersey, Florida,
11 and Texas. The cooling tower samples were collected from industries, hospitals, municipal
12 buildings, universities, and other public sites from Tennessee, Kentucky, and Texas. The
13 infected amoebae were found in 22 cooling tower samples and 3 natural samples. According to
14 this study, the probability of infected amoebae occurring in cooling towers is 16 times higher
15 than in natural environments.

16 3.9.2.3 *Electromagnetic Fields (EMFs)*

17 EMFs are generated by any electrical equipment. All nuclear power plants have electrical
18 equipment and power transmission systems associated with them. Power transmission
19 systems consist of switching stations (or substations) located on the plant site and the
20 transmission lines needed to connect the plant to the regional electrical distribution grid.
21 Transmission lines operate at a frequency of 60 Hz (60 cycles per second), which is low
22 compared with the frequencies of 55 to 890 MHz for television transmitters and 1,000 MHz and
23 greater for microwaves.

24 Electric and magnetic fields, collectively referred to as the EMF, are produced by operating
25 transmission lines. Electric fields are produced by voltage, and their strength increases with
26 increases in voltage. An electric field is present as long as equipment is connected to the
27 source of electric power. The unit of electric field strength is V/m or kV/m (1 kV/m = 1,000 V/m).
28 A magnetic field is produced from the flow of current through wires or electrical devices, and its
29 strength increases as the current increases. The unit of magnetic field strength is gauss (G),
30 milligauss (mG), or tesla (T). One tesla equals 10,000 G and 1 G equals 1,000 mG.

31 Occupational workers or members of the public near transmission lines may be exposed to the
32 EMFs produced by the transmission lines. The EMF varies in time as the current and voltage
33 change, so that the frequency of the EMF is the same (e.g., 60 Hz for standard alternating
34 current, or AC). Electrical fields can be shielded by objects such as trees, buildings, and
35 vehicles. Magnetic fields, however, penetrate most materials, but their strength decreases with
36 increasing distance from the source.

37 Power lines associated with nuclear plants usually have voltages of 230 kV, 345 kV, 500 kV, or
38 765 kV (a voltage occurring primarily in the eastern United States). EMF strength at ground-
39 level varies greatly under these lines, generally being stronger for higher-voltage lines, a flat
40 configuration of conductors, relatively flat terrain, terrain with no shielding obstructions
41 (e.g., trees or shrubs), and a closer approach of the lines to the ground. At locations where the
42 field strength is at a maximum, the measured values under 500-kV lines often average about
43 4 kV/m but sometimes exceed 6 kV/m. Maximum electric field strengths at ground-level are
44 9 kV/m for 500-kV lines and 12 kV/m for 765-kV lines (Lee et al. 1989).

1 Measured magnetic field strengths at the location of maximum values beneath 500-kV lines
2 often average about 70 mG. During peak electricity use, when line current is high, the field
3 strength may peak at 140 mG (about 1 percent or less of the time) (Lee et al. 1989).

4 The EMFs resulting from 60-Hz power transmission lines fall under the category of non-ionizing
5 radiation. Much of the general population has been exposed to power line fields since near the
6 turn of the 20th century. There was little concern about health effects from such exposures until
7 the 1960s. A series of events during the 1960s and 1970s heightened public interest in the
8 possibility of health effects from non-ionizing radiation exposures and resulted in increased
9 scientific investigation in this area (NRC 1996). Then, in 1979, results of an epidemiological
10 study suggested a correlation between proximity to high-current wiring configurations and
11 incidence of childhood leukemia (Wertheimer and Leeper 1979). This report resulted in
12 additional interest and scientific research; however, no consistent evidence linking harmful
13 effects with 60-Hz exposures has been presented. Additionally, many subsequent studies have
14 been conducted on the exposure to EMF sources, and have concluded that current evidence
15 does not support the existence of any health consequences from EMFs resulting from 60-Hz
16 power transmission lines (WHO 2020, NIOSH 1996, NIEHS 2002).

17 There are no U.S. Federal standards limiting residential or occupational exposure to EMFs from
18 power lines, but some States, such as Florida, Minnesota, Montana, New Jersey, New York,
19 and Oregon, have set electric field and magnetic field standards for transmission lines (NIEHS
20 2002). A voluntary occupational standard has been set for EMFs by the International
21 Commission on Non-Ionizing Radiation Protection. For occupational workers who are exposed
22 to 60 Hz (power lines), the electric field standard is 8.3 kV/m and the magnetic field standard is
23 4,200 mG, while for the general public who are exposed to 60 Hz, the electrical field standard is
24 4.2 kV/m and the magnetic field standard is 833 mG (ICNIRP 1998). The National Institute of
25 Occupational Safety and Health does not consider EMFs to be a proven health hazard (NIOSH
26 1996).

27 3.9.2.4 *Physical Hazards*

28 A physical hazard is an action, agent or condition that can cause harm upon contact. Physical
29 actions could include slips, trips, and falls from height. Physical agents could include noise,
30 vibration, and ionizing radiation. Physical conditions could include high heat, cold, pressure,
31 confined space, or psychosocial issues, such as work-related stress. Power plant and
32 maintenance workers could be working under potentially hazardous physical conditions
33 (e.g., excessive heat, cold, and pressure), including electrical work, power line maintenance,
34 and repair work.

35 Table 3.9-27 lists the total number of fatal occupational injuries that occurred in 2020 in different
36 industry sectors. For the utility sector, of which the nuclear industry is a part, 19 workers
37 suffered fatal occupational injuries. The rate of fatal injuries in the utility sector was less than
38 the rate in the construction; transportation and warehousing; agriculture, forestry, fishing, and
39 hunting; wholesale trade; and mining sectors. Table 3.9-28 lists the incidence rates of nonfatal
40 occupational injuries and illnesses in different utilities for 2020. The incidence rate of nonfatal
41 occupational injuries and illnesses is lowest for electric power generation, followed by electric
42 power transmission control and distribution.

1 **Table 3.9-27 Number and Rate of Fatal Occupational Injuries by Industry Sector in 2020**

Industry Sector	Number	Rate (per 100,000 employees)
Construction	1,008	10.2
Transportation and warehousing	805	13.4
Agriculture, forestry, fishing, and hunting	511	21.5
Government	415	1.8
Manufacturing	340	2.3
Retail trade	275	2.0
Leisure and hospitality	219	2.5
Other services (excluding Public Administration)	188	3.3
Wholesale trade	155	4.6
Educational and health services	145	0.7
Mining, quarrying, oil and gas extraction	78	N/A ^(d)
Financial activities	93	N/A
Information	31	N/A
Utilities ^(a)	19	N/A
Electric power generation, transmission, and distribution ^(b)	14	N/A
Electric power generation ^(c)	4	N/A
Electric power transmission, control, and distribution	10	N/A
Natural gas distribution	1	N/A
Water sewage and other system	4	N/A
All sectors	4,764	3.4

2 (a) The numbers of fatalities from transportation, falls, and exposure to harmful substances or the environment were
3 10, 1, and 6, respectively.

4 (b) The numbers of fatalities from transportation, falls, and exposure to harmful substances or the environment were
5 7, 1, and 6, respectively.

6 (c) The numbers of fatalities from falls was 1.

7 (d) N/A = not available.

8 Sources: BLS 2021a; BLS 2020, BLS 2021d.

9 **Table 3.9-28 Incidence Rate of Nonfatal Occupational Injuries and Illnesses in Different**
10 **Utilities in 2020**

Utility	Rate (per 100 Employees)
Utilities	8.4
Electric power generation, transmission, and distribution	5.7
Electric power generation	1.6
Fossil Fuel electric power generation	1.2
Nuclear electric power generation	0.1

Utility	Rate (per 100 Employees)
Electric power transmission, control, and distribution	6.0
Natural gas distribution	1.7
Water, sewage, and other system	1
Overall	2.7

1 Sources: BLS 2021b, BLS 2021c.

2 Table 3.9-29 lists the number and rate of fatal occupational injuries that occurred in 2020 for
 3 listed occupations. The occupational safety and health hazards issue is generic to all types of
 4 electrical generating stations, including nuclear power plants, and is of small significance if the
 5 workers adhere to safety standards and use protective equipment.

6 **Table 3.9-29 Number and Rate of Fatal Occupational Injuries for Selected Occupations**
 7 **in 2020**

Occupation	Number	Rate per 100,000 Full-Time Equivalent Workers
Fishers and hunting workers	42	132.14
Aircraft pilots and flight engineers	50	34.3
Logging workers	42	91.7
Structural iron and steel workers	16	32.5
Refuse and recyclable material collectors	30	33.1
Farmers, ranchers, and other agricultural managers	207	20.9
Drivers/sales workers and truck drivers	887	25.8
Helpers, construction trades	19	43.3

8 Source: BLS 2022.

9 *3.9.2.4.1 Electric Shock Hazards*

10 In-scope transmission lines are those lines that connect the plant to the first substation of the
 11 regional electric grid. This substation is frequently, but not always, located on the plant
 12 property. The greatest hazard from a transmission line is direct electrical contact with the
 13 conductors. The electrical contact can occur without physical contact between a grounded
 14 object and the conductor (e.g., when arcing occurs across an air gap) (BPA 2007). The electric
 15 field created by a high-voltage line extends from the energized conductors to other conducting
 16 objects, such as the ground, vegetation, buildings, vehicles, and persons. Potential field effects
 17 can include induced currents, steady-state current shocks, spark-discharge shocks, and, in
 18 some cases, field perception and neurobehavioral responses.

19 The shock hazard issue is evaluated by referring to the National Electric Safety Code (NESC).
 20 The purpose of the NESC is the practical safeguarding of persons during the installation,
 21 operation, or maintenance of electric supply and communication lines and associated
 22 equipment. The NESC contains the basic provisions that are considered necessary for the
 23 safety of employees and the public under the specified conditions (IEEE SA 2017).

24 Primary shock currents are produced mainly through direct contact with conductors and have
 25 effects ranging from a mild tingling sensation to death by electrocution. Tower designs preclude
 26 direct public access to the conductors. Secondary shock currents are produced when humans

Affected Environment

1 make contact with (1) capacitively charged bodies, such as a vehicle parked near a
2 transmission line, or (2) magnetically linked metallic structures, such as fences near
3 transmission lines. A person who contacts such an object could receive a shock and
4 experience a painful sensation at the point of contact. The intensity of the shock depends on
5 the EMF strength, the size of the object, and how well the object and the person are insulated
6 from ground.

7 Design criteria that limit hazards from steady-state currents are based on the NESC, which
8 requires that utility companies design transmission lines so that the short-circuit current to
9 ground, produced from the largest anticipated vehicle or object, is limited to less than
10 5 milliamperes (mA) (IEEE SA 2017).

11 Historically, in the licensing process for the earlier licensed nuclear power plants, the issue of
12 electrical shock safety was not addressed. Additionally, some nuclear power plants that
13 received operating licenses with a stated transmission line voltage may have chosen to upgrade
14 the line voltage for reasons of efficiency, possibly without reanalysis of induction effects. Also,
15 since the initial NEPA review for those utilities that evaluated potential shock situations under
16 the provision of the NESC, land use may have changed, resulting in the need for a reevaluation
17 of this issue. Electrical shock potential is minimized for transmission lines that are operated in
18 adherence with the NESC.

19 A review of the SEISs to the LR GEIS published since 2013, found that 3 transmission lines at
20 South Texas did not meet the criteria defined by NESC (NRC 2013b), nor did nine transmission
21 line spans at Sequoyah (NRC 2015f). Regarding South Texas, the staff concluded that the
22 three transmission lines exceeded the NESC criterion by a small percentage. The locations
23 where the lines exceed the standard are in remote locations or are on private property, and the
24 applicant considered potential mitigation measures to reduce or avoid adverse impacts from
25 electric shock. In the case of Sequoyah, TVA committed to upgrades to correct the deficiencies
26 in transmission lines that did not meet the NESC criteria for induced current. The transmission
27 lines discussed in South Texas and Sequoyah span areas beyond what was termed in the 2013
28 LR GEIS as in-scope transmission lines.

29 **3.10 Environmental Justice**

30 Under Executive Order 12898, "Federal Actions to Address Environmental Justice in Minority
31 Populations and Low-Income Populations" (59 FR 7629), Federal agencies are responsible for
32 identifying and addressing, as appropriate, disproportionately high and adverse human health
33 and environmental effects of its programs, policies, and activities on minority and low-income
34 populations. Although independent agencies, like the NRC, were only requested, rather than
35 directed, to comply with Executive Order 12898, the NRC Chairman, in a March 1994 letter to
36 the President, committed the NRC to endeavoring to carry out its measures "... as part of
37 NRC's efforts to comply with the requirements of NEPA" (NRC 1994). In 2004, the Commission
38 issued its *Policy Statement on the Treatment of Environmental Justice Matters in NRC*
39 *Regulatory and Licensing Actions* (69 FR 52040), which states, "The Commission is committed
40 to the general goals set forth in E.O. 12898, and strives to meet those goals as part of its NEPA
41 review process."

Executive Order 12898, Federal Actions to Address Environmental Justice in Minority Populations and Low-Income Populations

“Each Federal agency, whenever practicable and appropriate, shall collect, maintain, and analyze information assessing and comparing environmental and human health risks borne by populations identified by race, national origin, or income. To the extent practical and appropriate, Federal agencies shall use this information to determine whether their programs, policies, and activities have disproportionately high and adverse human health or environmental effects on minority populations and low-income populations.”

1 The Council on Environmental Quality (CEQ) provides the following information in
 2 *Environmental Justice: Guidance Under the National Environmental Policy Act* (CEQ 1997b):

3 • **Disproportionately high and adverse human health effects.** In determining whether
 4 human health effects are disproportionately high and adverse, agencies should consider to
 5 the extent practicable: “(a) Whether the health effects, which may be measured in risks and
 6 rates, are significant (as employed by NEPA), or above generally accepted norms. Adverse
 7 health effects may include bodily impairment, infirmity, illness, or death; and (b) Whether the
 8 risk or rate of hazard exposure by a minority population, low-income population, or Indian
 9 Tribe to an environmental hazard is significant (as employed by NEPA) and appreciably
 10 exceeds or is likely to appreciably exceed the risk or rate to the general population or other
 11 appropriate comparison group; and (c) Whether health effects occur in a minority population,
 12 low-income population, or Indian Tribe affected by cumulative or multiple adverse exposures
 13 from environmental hazards.”

14 • **Disproportionately high and adverse environmental effects.** In determining whether
 15 environmental effects are disproportionately high and adverse, agencies should consider to
 16 the extent practicable: “(a) Whether there is or will be an impact on the natural or physical
 17 environment that significantly (as employed by NEPA) and adversely affects a minority
 18 population, low-income population, or Indian Tribe. Such effects may include ecological,
 19 cultural, human health, economic, or social impacts on minority communities, low-income
 20 communities, or Indian Tribes when those impacts are interrelated to impacts on the natural
 21 or physical environment; and (b) Whether environmental effects are significant (as employed
 22 by NEPA) and are or may be having an adverse impact on minority populations, low-income
 23 populations, or Indian Tribes that appreciably exceeds or is likely to appreciably exceed
 24 those on the general population or other appropriate comparison group; and (c) Whether the
 25 environmental effects occur or would occur in a minority population, low-income population,
 26 or Indian Tribe affected by cumulative or multiple adverse exposures from environmental
 27 hazards.”

28 The environmental justice analysis identifies minority populations, low-income populations, and
 29 Indian Tribes that could be affected by continued reactor operations and refurbishment activities
 30 at a nuclear power plant. The following CEQ definitions of minority individuals and populations
 31 and low-income populations are used:

32 • **Minority.** Individual(s) who identify themselves as members of the following population
 33 groups: Hispanic or Latino, American Indian or Alaska Native, Asian, Black or African
 34 American, Native Hawaiian or Other Pacific Islander, or two or more races meaning
 35 individuals who identified themselves as being a member of two or more races, for example,
 36 Hispanic and Asian.

Affected Environment

- 1 • **Minority population.** Minority populations are identified when (1) the minority population of
2 an affected area exceeds 50 percent or (2) the minority population percentage of the
3 affected area is meaningfully greater than the minority population percentage in the general
4 population or other appropriate unit of geographic analysis. Minority populations may be
5 communities of individuals living in close geographic proximity to one another or they may
6 be a geographically dispersed or transient set of individuals, such as migrant workers or
7 Native Americans, who, as a group, experience common conditions with regard to
8 environmental exposure or environmental effects. The appropriate geographic unit of
9 analysis may be a political jurisdiction, county, region, or State, or some other similar unit
10 that is chosen so as not to artificially dilute or inflate the affected minority population.
- 11 • **Low-income population.** Low-income population is defined as individuals or families living
12 below the annual statistical poverty threshold as defined by the U.S. Census Bureau's
13 Current Population Reports, Series P-60 on Income and Poverty (CEQ 1997b). Low-income
14 populations may be communities of individuals living in close geographic proximity to one
15 another, or they may be a set of individuals, such as migrant workers or Native Americans,
16 who, as a group, experience common conditions of environmental exposure or effect.

17 Consistent with the definitions used in the public and occupational health and safety analysis,
18 affected populations are defined as minority and low-income populations who reside within a
19 50 mi (80 km) radius of a nuclear plant. Data on minority and low-income individuals are
20 collected and analyzed at the census block group or tract level.¹⁴

21 The presence of minority populations, low-income populations, and Indian Tribes within 50 mi
22 (80 km) of each nuclear power plant varies considerably depending on the location of Tribal
23 lands, population trends, and regional economic activity. Nuclear power plants in southern and
24 southwestern States have been found to have larger minority populations, including Browns
25 Ferry, Brunswick, Catawba, Joseph M. Farley Nuclear Plant (Farley), North Anna, Robinson,
26 Summer, and Surry nuclear plants. Nuclear power plants near metropolitan areas generally
27 have larger minority and low-income populations, including Dresden and Ginna nuclear plants.

28 Section 4–4 of EO 12898 directs Federal agencies, whenever practical and appropriate, to
29 collect and analyze information on the consumption patterns of populations who rely principally
30 on fish and/or wildlife for subsistence and to communicate the risks of these consumption
31 patterns to the public. Consideration is given to determine the means by which these
32 populations could be disproportionately affected by the continued operation of a nuclear power
33 plant. Consumption patterns (e.g., subsistence agriculture, hunting, and fishing) and certain
34 resource dependencies often reflect the traditional or cultural practices of minority populations,
35 low-income populations, and Indian Tribes.

36 In assessing human health effects, the NRC examines radiological risk from consumption of
37 fish, wildlife, and local produce; exposure to radioactive material in water, soils, and vegetation;
38 and the inhalation of airborne radioactive material during nuclear power plant operation. To
39 assess the effect of nuclear reactor operations, licensees are required to collect samples from

¹⁴ A census block group is a combination of census blocks, which are statistical subdivisions of a census tract. A census block is the smallest geographic entity for which the U.S. Census Bureau collects and tabulates decennial census information. A census tract is a small, relatively permanent statistical subdivision of counties delineated by local committees of census data users in accordance with U.S. Census Bureau guidelines for the purpose of collecting and presenting decennial census data. Census block groups are subsets of census tracts (USCB Undated).

1 the environment, as part of their REMP. These samples are analyzed annually for radioactivity
2 to assess the impact of nuclear power plant operations.

3 **3.11 Waste Management and Pollution Prevention**

4 As part of their normal operations and as a result of equipment repairs and replacements due to
5 normal maintenance activities, nuclear power plants routinely generate both radioactive and
6 nonradioactive wastes. Nonradioactive wastes include hazardous and nonhazardous wastes.
7 There is also a class of waste, called mixed waste, that is both radioactive and hazardous. The
8 systems used to manage (i.e., treat, store, and dispose of) these wastes are described in
9 Sections 3.1.4 and 3.1.5. The basic characteristics and current disposition paths for these
10 waste streams are discussed in Section 3.11.1 for radioactive waste, 3.11.2 for hazardous
11 waste, 3.11.3 for mixed waste, and 3.11.4 for nonradioactive nonhazardous waste. Waste
12 minimization and pollution prevention measures commonly employed at nuclear power plants
13 are reviewed in Section 3.11.5.

14 **3.11.1 Radioactive Waste**

15 There are two types of radiological wastes that could be associated with a commercial reactor:
16 LLW and spent nuclear fuel. Regulations regarding how a licensee shall dispose of licensed
17 materials is regulated in accordance with 10 CFR Part 20 Subpart K. The NRC requires that all
18 licensees implement measures to minimize, to the extent practicable, the generation of
19 radioactive waste (10 CFR 20.1406). These wastes are described in the sections below.

20 *3.11.1.1 Low-Level Radioactive Waste*

21 The Commission's licensing requirements for the land disposal of LLW are set forth in 10 CFR
22 Part 61, "Licensing Requirements for Land Disposal of Radioactive Waste." Part 61 defines
23 LLW as "radioactive waste not classified as high-level radioactive waste [HLRW], transuranic
24 [TRU] waste, spent nuclear fuel, or by-product material as defined in paragraphs (2), (3), and
25 (4) of the definition of by-product material set forth in § 20.1003 of this chapter."¹⁵ The NRC's
26 definition of LLW is included in 10 CFR 61.55. Depending on the types and concentrations of
27 radionuclides in the waste, the NRC classifies LLW as belonging to Class A, Class B, Class C,
28 or greater-than-Class C (GTCC). Class A wastes generally contain short-lived radionuclides at
29 relatively low concentrations, whereas the half-lives and concentrations of radionuclides in the
30 Class B and C wastes are progressively higher. In addition, Class B wastes must meet more
31 rigorous requirements with regard to their form to ensure they remain stable after disposal
32 (e.g., by adding chemical stabilizing agents such as cement to the waste or placing the waste in
33 a disposal container or structure that provides stability after disposal). Class C wastes must not
34 only meet the more rigorous requirements above but also require the implementation of
35 additional measures at the disposal facility to protect against inadvertent intrusion (e.g., by
36 increasing the thickness and hardness of the cover over the waste disposal cell). Wastes
37 containing radionuclides at concentrations that are higher than what is allowed for Class C
38 wastes are classified as GTCC. GTCC is LLW with concentrations of radionuclides that exceed
39 the limits established by the Commission for Class C LLW (NRC 2019e). Under the NRC's
40 regulations, GTCC waste is considered to be generally unacceptable for near-surface disposal
41 and must be disposed of in a geologic repository unless the Commission approves, on a case-
42 by-case basis, disposal of such waste in a disposal site licensed pursuant to 10 CFR
43 61.55(a)(2)(iv). Disposal of GTCC waste is the responsibility of the DOE (Public Law 99-240).

¹⁵ 10 CFR 61.2 (definition of "waste").

1 DOE prepared an EIS to evaluate the various alternatives for disposing of these wastes (DOE
2 2016) and presented the alternatives for disposal of GTCC LLW and GTCC-like waste (DOE
3 2017).

Definitions of Radioactive Wastes Associated with Commercial Nuclear Power Plants

- **Low-level waste:** Radioactive material that (1) is not high-level radioactive waste, spent nuclear fuel, or by-product material (as defined in Section 11e(2) of the AEA of 1954 [42 U.S.C. 2014(e)(2)]) and (2) is classified by the NRC, consistent with existing law, as low-level radioactive waste (as defined in the Low-Level Radioactive Waste Policy Act, as amended, Public Law 99 240; 42 U.S.C. § 2021b et seq.).
- **Spent nuclear fuel:** Fuel that has been withdrawn from a nuclear reactor following irradiation, the constituent elements of which have not been separated by reprocessing (as included in the Nuclear Waste Policy Act of 1982, as amended, Public Law 97-425 [42 U.S.C. § 10101 et seq.]).

4 LLW generated at nuclear power plants generally consists of air filters, cleaning rags, protective
5 tape, paper and plastic coverings, discarded contaminated clothing, tools, equipment parts, and
6 solid laboratory wastes (all of these are collectively known as dry active waste) and wet wastes
7 that result during the processing and recycling of contaminated liquids at the plants. Wet
8 wastes generally consist of evaporator bottoms, spent demineralizer or ion exchange resins,
9 and spent filter material from the equipment drain, floor drain, and water cleanup systems. The
10 wet wastes are generally solidified, dried, or dewatered to make them acceptable at a disposal
11 site. Some plants perform these operations onsite, while others ship their waste to a third-party
12 vendor offsite for processing before it is sent to a disposal facility. The radioactivity can range
13 from just above the background levels found in nature to very highly radioactive. LLW that
14 contains radionuclides that have shorter decay times can be stored onsite by licensees until it
15 can be released in accordance with 10 CFR Part 20, Subpart K. LLW that contains
16 radionuclides that have longer decay times can be stored onsite until material inventory
17 amounts are large enough for shipment to a LLW disposal site. The transportation and disposal
18 of solid radioactive wastes are performed in accordance with the applicable requirements of
19 10 CFR Part 71 and 10 CFR Part 61, respectively.

20 LLW shipments from nuclear power plants to disposal facilities or waste processing centers and
21 from waste processing centers to disposal facilities are generally made by trucks. Wastes are
22 segregated and packaged by class. For load-leveling purposes, the wastes may be stored
23 onsite at the plant temporarily before shipment offsite. Construction and operation of any LLW
24 storage areas and any activities related to storage and processing of LLW onsite, including the
25 preparation of waste for shipment and loading on vehicles before shipment, are carried out in
26 accordance with the licensing requirements imposed by the NRC. All such operations are
27 accounted for when the applicants prepare their annual radioactive effluent release reports to
28 demonstrate compliance with the applicable Federal standards and requirements. The primary
29 standards applicable to all the power plants are contained in 10 CFR Part 20, 40 CFR Part 190,
30 and Appendix I to 10 CFR Part 50.

31 The Low-Level Radioactive Waste Policy Amendments Act of 1985 (Public Law 99-240)¹⁶ gave
32 States the responsibility for disposal of the LLW generated at commercial facilities within their

¹⁶ The Low-Level Radioactive Waste Policy Amendments Act superseded, in its entirety, an earlier law, the Low-Level Radioactive Waste Policy Act of 1980 (Public Law 96-573).

1 states. As an incentive for States to manage waste on a regional basis, Congress consented to
 2 the formation of interstate agreements known as compacts, and it granted compact member
 3 States the authority to exclude LLW from States that are members of other compacts or
 4 unaffiliated with a compact. There are currently four operating disposal facilities in the United
 5 States that are licensed to accept LLW from commercial facilities (including nuclear power
 6 plants) (NRC 2020h). They are located in Clive, Utah; Andrews County, Texas; Barnwell, South
 7 Carolina; and near Richland, Washington. The EnergySolutions disposal facility in Clive, Utah,
 8 is licensed by the State of Utah to accept Class A LLW from all regions of the United States.
 9 The Waste Control Specialists, LLC site in Andrews County, Texas, is licensed by the State of
 10 Texas to accept Class A, B, and C LLW from the Texas Compact generators (Texas and
 11 Vermont) and from outside generators with permission from the Texas Compact.
 12 EnergySolutions Barnwell Operations located near Barnwell, South Carolina, accepts waste
 13 from the Atlantic Compact States (Connecticut, New Jersey, and South Carolina) and is
 14 licensed by the State of South Carolina to dispose of Class A, B, and C LLW. U.S. Ecology,
 15 located near Richland, Washington, accepts LLW from the Northwest and Rocky Mountain
 16 Compact States (Washington, Alaska, Hawaii, Idaho, Montana, Oregon, Utah, Wyoming,
 17 Colorado, Nevada, and New Mexico) and is licensed by the State of Washington to dispose of
 18 Class A, B, and C waste.

19 Annual quantities of LLW generated at the nuclear power plants vary from year to year
 20 depending on the number of maintenance activities undertaken and the number of unusual
 21 occurrences taking place in that year. However, on average, the volume and radioactivity of
 22 LLW generated at a PWR was approximately 10,600 ft³ (300 m³) and 1,000 Ci (3.7 × 10¹³ Bq)
 23 per year, respectively, according to the 1996 LR GEIS (Table 6.6 in NRC 1996). The annual
 24 volume and activity of LLW generated at a BWR are approximately twice the values indicated
 25 for a PWR. The total volume and activity of LLW generated at all the LWRs in the United States
 26 was approximately 706,000 ft³ (20,000 m³) and 60,000 Ci (2.2 × 10¹⁵ Bq), respectively,
 27 according to the 1996 LR GEIS (Table 6.6 in NRC 1996). Approximately 95 percent of this
 28 waste is Class A (NEI 2007b in the 2013 LR GEIS). Table 3.11-1 and Table 3.11-2 show the
 29 volume and activity of LLW shipped offsite per operating reactor unit from 11 power plant sites
 30 in 2020. For example, there are two operating units at the Comanche Peak site, and the
 31 volume and activity of LLW shipped from the Comanche Peak site in 2020 were 4,167 ft³
 32 (118 m³) and 394 Ci (1.46 × 10¹³ Bq). The numbers in Table 3.11-1 and Table 3.11-2 were
 33 obtained from the annual radioactive effluent release reports issued by each plant for 2020.

34 Almost all of the LLW generated at the reactor sites is shipped offsite, either directly to a
 35 disposal facility or to a processing center for volume reduction or another type of treatment
 36 before being sent to a disposal site. The number of shipments leaving each reactor site varies
 37 but generally ranges from a few to about 100 per year. 10 CFR Part 20, Subpart K, discusses
 38 the various means by which the licensees may dispose of their radioactive waste.

39 **Table 3.11-1 Solid Low-Level Radioactive Waste Shipped Offsite per Reactor from Select**
 40 **Pressurized Water Reactor Power Plant Sites in 2020^(a)**

Nuclear Power Plant	Volume (m ³)	Activity (Ci)	Number of Shipments	Number of Reactors
Comanche Peak	118	394	5	2
D.C. Cook	382.5	194.226	16	1
Palo Verde 1-3	850	150	40	3

Nuclear Power Plant	Volume (m ³)	Activity (Ci)	Number of Shipments	Number of Reactors
Robinson	1,440	17,800	45	2
Seabrook	44.35	124.497	5	1
Surry	261.76	170.93075	13	2

1 Ci = curies; m³= cubic meter.
 2 (a) Annual effluent release reports. The radiological environmental monitoring reports can also be accessed by
 3 navigating the reactor webpage for each site on the NRC website; effluent reports and environmental reports are
 4 available through the “Plant Environmental Report” section of the key documents.

5 **Table 3.11-2 Solid Low-Level Radioactive Waste Shipped Offsite per Reactor from**
 6 **Select Boiling Water Reactor Power Plant Sites in 2020^(a)**

Nuclear Power Plant	Volume (m ³)	Activity (Ci)	Number of Shipments	Number of Reactors
Fermi 2	2,719.616	2,490.1	82	1
Hatch	625.1	534.351	67	2
Hope Creek and Salem ^(b)	770	180.8	37	3
Limerick	739.8	494	35	1
Columbia	303.9	892	48	1

7 Ci = curies; m³= cubic meter.
 8 (a) Annual effluent release reports. The radiological environmental monitoring reports can also be accessed by
 9 navigating the reactor webpage for each site on the NRC website; effluent reports and environmental reports are
 10 available through the “Plant Environmental Report” section of the key documents.
 11 (b) Hope Creek is a BWR but is reported with the Salem Generating Station as a joint site, so it is included in this
 12 table.

13 **3.11.1.2 Spent Nuclear Fuel**

14 Spent nuclear fuel is fuel that has been withdrawn from a nuclear reactor following irradiation,
 15 the constituent elements of which have not been separated. When spent nuclear fuel is
 16 removed from a reactor, it is stored in racks placed in a pool (called the spent fuel pool) to
 17 isolate it from the environment and to allow the fuel rods to cool. Licensing plans contemplate
 18 disposal of spent fuel in a deep geological permanent repository. Siting and developing a
 19 permanent repository is required by the Nuclear Waste Policy Act of 1982. Delays in siting a
 20 permanent repository, coupled with rapidly filling spent fuel pools at some plants, have led
 21 utilities to seek means of continued onsite storage. These include (1) expanded pool storage,
 22 (2) aboveground dry storage, (3) longer fuel burnup to reduce the amount of spent nuclear fuel
 23 requiring interim storage, and (4) shipment of spent nuclear fuel to other plants. Any
 24 modification to the spent nuclear fuel storage configuration at a nuclear power plant is subject to
 25 NRC review and approval. Each review consists of a safety and environmental review. As
 26 part of the environmental review for such a modification, the NRC generally prepares an
 27 environmental assessment.

28 Expanded pool storage options include (1) enlarging the capacity of spent fuel racks, (2) adding
 29 racks to existing pool arrays (“dense-racking”), (3) reconfiguring spent fuel racks with neutron-
 30 absorbing racks, and (4) employing double-tiered storage (installing a second tier of racks
 31 above those on the spent fuel pool floor).

1 Aboveground dry storage involves moving the spent fuel assemblies, which have been stored in
 2 the spent fuel pool for a certain period of time, to aboveground, shielded enclosures that are air
 3 cooled (also known as dry storage). The spent nuclear fuel is stored in the spent fuel pool to
 4 cool, typically for several years, before it may be moved to a dry cask storage facility. In the late
 5 1970s and early 1980s, the need for alternative storage grew when pools at many nuclear
 6 reactors filled with stored spent fuel. Utilities looked at options such as dry cask storage for
 7 increasing their storage capacity for spent nuclear fuel.

8 Dry cask storage allows spent nuclear fuel to be surrounded by inert gas inside a container
 9 called a cask. The casks are typically steel cylinders that are either welded or bolted closed.
 10 The steel cylinder provides a leak-proof containment for the spent nuclear fuel. Each cylinder is
 11 surrounded by additional steel, concrete, or other material to provide radiation shielding to
 12 workers and members of the public. Some of the cask designs can be used for both storage
 13 and transportation.

14 There are various dry storage cask system designs. With some designs, the steel cylinders
 15 containing the spent nuclear fuel are placed vertically in a concrete vault; other designs orient
 16 the cylinders horizontally. The concrete vaults provide the radiation shielding. Other cask
 17 designs orient the steel cylinder vertically on a concrete pad at a dry cask storage site and use
 18 both metal and concrete outer cylinders for radiation shielding. Figure 3.11-1 shows two of the
 19 typical dry cask storage designs. The location of the dry casks is in a facility known as an
 20 ISFSI. This is a facility designed and constructed for the interim storage of spent nuclear fuel,
 21 solid reactor-related GTCC, and other radioactive materials associated with spent nuclear fuel
 22 and reactor-related GTCC storage. The ISFSI is generally located within the same site where
 23 the nuclear fuel is used and are licensed by the NRC under either a general license or a site-
 24 specific license (see 10 CFR Part 72). Figure 3.11-2 shows the locations of currently licensed
 25 ISFSIs.

26 Longer-burnup fuel is fuel from which more energy can be obtained before it is taken out of the
 27 reactor and declared spent. As a result of using this fuel, less spent fuel is generated for the
 28 same amount of energy produced in a reactor.

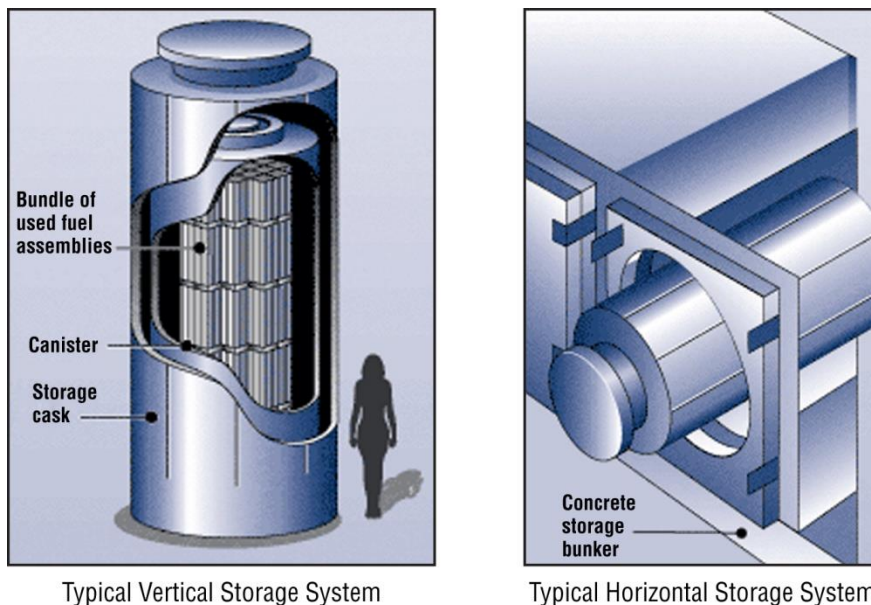

29 Typical Vertical Storage System
 30 Typical Horizontal Storage System
Figure 3.11-1 Typical Dry Cask Storage Systems. Source: NRC 2020k.

Definitions of Other Wastes Associated with Commercial Nuclear Power Plants

- **Hazardous Waste:** A solid waste or combination of solid wastes that, because of its quantity, concentration, or physical, chemical, or infectious characteristics, may (1) cause or significantly contribute to an increase in mortality or an increase in serious irreversible or incapacitating reversible illness, or (2) pose a substantial present or potential hazard to human health or the environment when improperly treated, stored, transported, disposed of, or otherwise managed (as defined in the Resource Conservation and Recovery Act, as amended, Public Law 94-580 [42 U.S.C. § 6901 et seq.]).
- **Mixed Waste:** Waste that is both hazardous and radioactive.
- **Nonradioactive Nonhazardous Waste:** Waste that is neither radioactive nor hazardous.

1



Licensed and Operating Independent Spent Fuel Storage Installations by State

October 2021

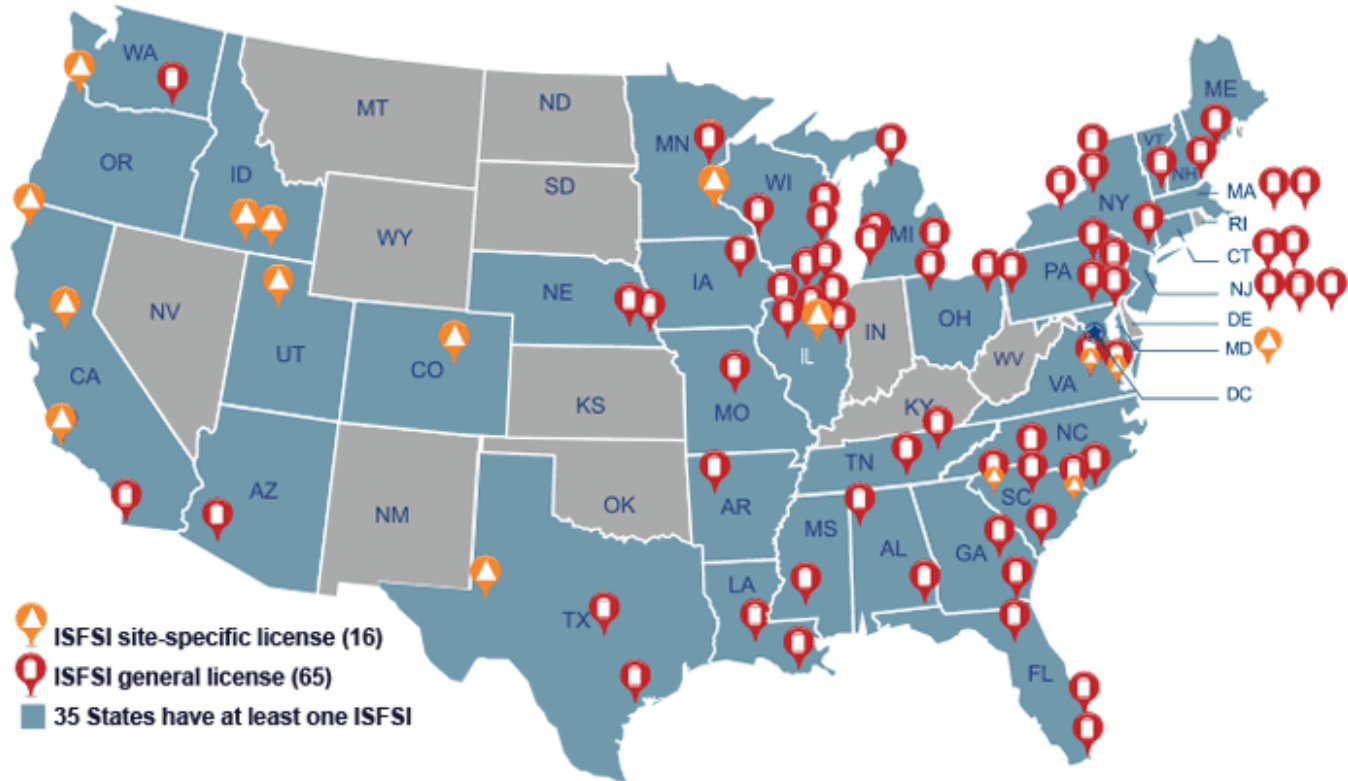

1
2 **Figure 3.11-2** Locations of Independent Spent Fuel Storage Installations Licensed by the NRC. Source: NRC 2021i.

1 **3.11.2 Hazardous Waste**

2 Hazardous waste is defined by the EPA in 40 CFR Part 261, "Identification and Listing of
3 Hazardous Waste" as solid waste that (1) is listed by the EPA as being hazardous; (2) exhibits
4 one of the characteristics of ignitability, corrosivity, reactivity, or toxicity; or (3) is not excluded by
5 the EPA from regulation as being hazardous.

6 All aspects of hazardous waste generation, treatment, transportation, and disposal are strictly
7 regulated by the EPA or by the States under agreement with the EPA per the regulations
8 promulgated under RCRA (Public Law 94-580 [42 U.S.C. § 6901 et seq.]).

9 The types of hazardous waste that nuclear power plants typically generate include waste paints,
10 lab packs, and solvents. The quantities of these wastes generated at individual plants are
11 highly variable but, generally, are relatively small compared to those at most other industrial
12 facilities that generate hazardous waste. Most nuclear power plants accumulate their
13 hazardous waste onsite as authorized under RCRA and transport it to a treatment facility for
14 processing. The remaining residues are sent to a permanent disposal facility. There are quite a
15 few RCRA-permitted treatment and disposal facilities throughout the United States that are used
16 by the owners of nuclear power plants.

17 A class of hazardous waste called universal waste is handled differently than hazardous waste
18 and includes batteries, pesticides, mercury-containing equipment, light bulbs, and aerosol cans.
19 Federal universal waste regulations can be found in 40 CFR Part 273. All aspects of hazardous
20 waste, such as generation, treatment, transportation, and disposal, are regulated by the EPA or
21 by States under agreements with the EPA per the regulations set forth under RCRA. RCRA
22 also defines categories of hazardous waste generators (EPA 2020a).

23 **3.11.3 Mixed Waste**

24 Mixed waste, regulated under RCRA and the AEA of 1954, as amended (42 U.S.C.
25 § 2011 et seq.), is waste that is both radioactive and hazardous (EPA 2019). Mixed waste is
26 subject to dual regulation: by the EPA or an authorized State for its hazardous component and
27 by the NRC or an agreement state for its radioactivity. The types of mixed wastes generated at
28 nuclear power plants include organics (e.g., liquid scintillation fluids, waste oils, halogenated
29 organics), metals (e.g., lead, mercury, chromium, and cadmium), solvents, paints, and cutting
30 fluids. The quantity of mixed waste generated varies considerably from plant to plant
31 (NRC 1996). Overall, the quantities generated during operations are generally relatively small,
32 but because of the added complexity of dual regulation, it is more problematic for plant owners
33 to manage and dispose of mixed wastes than the other types of wastes. Similar to hazardous
34 waste, mixed waste is generally accumulated onsite in designated areas as authorized under
35 RCRA then shipped offsite for treatment as appropriate and for disposal. The only disposal
36 facilities that are authorized to receive mixed LLW for disposal at present are the U.S. Ecology
37 and the Waste Control Specialists facilities discussed under Section 3.11.1.1.

38 Occupational exposures and any releases from onsite treatment of these and any other types of
39 wastes are considered when evaluating compliance with the applicable Federal standards and
40 regulations: for example, 10 CFR Part 20, 40 CFR Part 190, and Appendix I to 10 CFR Part 50.

1 **3.11.4 Nonhazardous Waste**

2 Nonhazardous waste is waste that is not contaminated with either radionuclides or hazardous
3 chemicals. These wastes include office trash, paper, wood, oils not mixed with hazardous
4 waste or radiological waste, and sewage. Solid wastes defined as nonhazardous by 40 CFR
5 Part 261 are collected and disposed of in a landfill. Sanitary wastes defined as nonhazardous
6 by 40 CFR Part 261 are treated either at an onsite sewage treatment plant (as in the case of
7 many large-scale industrial facilities), discharged directly to a municipal sewage system for
8 treatment, or discharged to onsite septic tanks. The uncontaminated wastes and sewage are
9 tested for radionuclides before being sent offsite to make sure that there is no inadvertent
10 contamination. Any offsite releases from the onsite sewage treatment plants are conducted
11 under NPDES permits. Most plants also collect and test the stormwater runoff from their sites
12 before discharging it offsite. Large LWRs have nonradioactive waste management systems in
13 place that manage both hazardous and nonhazardous wastes. For example, boiler blowdown,
14 water treatment wastes, boiler metal cleaning wastes, laboratory and sampling wastes, floor and
15 yard drains, and stormwater runoff are all managed by these systems and are regulated by an
16 NPDES permit, with the exception of wastes in solid form (NRC 2013a).

17 **3.11.5 Pollution Prevention and Waste Minimization**

18 Waste minimization and pollution prevention are important elements of operations at all nuclear
19 power plants. The licensees are required to consider pollution prevention measures as dictated
20 by the Pollution Prevention Act (Public Law 101-508 [42 U.S.C. § 13101 et seq.]) and RCRA
21 (Public Law 94-580 [42 U.S.C. § 6901 et seq.]).

22 In addition, licensees have waste minimization programs in place that are aimed at minimizing
23 the quantities of waste sent offsite for treatment or disposal. Waste minimization techniques
24 employed by the licensees may include (1) source reduction, which includes (a) changes in
25 input materials (e.g., using materials that are not hazardous or are less hazardous), (b) changes
26 in technology, and (c) changes in operating practices and (2) recycling of materials either onsite
27 or offsite. For example, the licensees tend to reuse lead shielding components onsite until they
28 have no further use for them. The establishment of a waste minimization program is also a
29 requirement for managing hazardous wastes under RCRA.

30 **3.12 Greenhouse Gas Emissions and Climate Change**

31 **3.12.1 Greenhouse Gas Emissions**

32 Gases found in the Earth's atmosphere that trap heat and play a role in the Earth's climate are
33 collectively termed greenhouse gases (GHGs). These GHGs include carbon dioxide (CO₂),
34 methane (CH₄), nitrous oxide (N₂O), water vapor (H₂O), and fluorinated gases, such as
35 hydrofluorocarbons (HCFs), perfluorocarbons, and sulfur hexafluoride. Operations at nuclear
36 power plants release GHGs from stationary combustion sources (e.g., diesel generators,
37 pumps, diesel engines, boilers), refrigeration systems, electrical transmission and distribution
38 systems, and mobile sources (worker vehicles and delivery vehicles).

39 The Earth's climate responds to changes in concentrations of GHGs in the atmosphere because
40 these gases affect the amount of energy absorbed and heat trapped by the atmosphere.
41 Increasing concentrations of GHGs in the atmosphere generally increase the Earth's surface
42 temperature. Atmospheric concentrations of CO₂, CH₄, and N₂O have significantly increased
43 since 1750 (IPCC 2013, IPCC 2021). Long-lived GHGs—CO₂, CH₄, N₂O, and fluorinated

1 gases—are well mixed throughout the Earth’s atmosphere, and their impact on climate is long-
 2 lasting and cumulative in nature as a result of their long atmospheric lifetimes (EPA 2016).
 3 Therefore, the extent and nature of climate change is not specific to where GHGs are emitted.
 4 Carbon dioxide is of primary concern for global climate change because it is the primary gas
 5 emitted as a result of human activities. The most recent report from the Intergovernmental
 6 Panel on Climate Change (IPCC) states that “[i]t is unequivocal that human influence has
 7 warmed the global climate system since pre-industrial times” (IPCC 2021). The EPA has
 8 determined that GHGs “may reasonably be anticipated both to endanger public health and to
 9 endanger public welfare” (74 FR 66496).

10 In 2009, the EPA issued a final rule requiring the reporting of GHG emissions from facilities that
 11 directly emit 25,000 MT (27,557 tons) of CO₂ equivalents (CO₂eq¹⁷) or more per year (74 FR
 12 56260). The 25,000 MT of CO₂eq reporting threshold EPA established in the above final rule is
 13 not an indication of what EPA considers to be a significant (or insignificant) level of GHG
 14 emissions on a scientific basis, but a threshold chosen by EPA for policy evaluation purposes
 15 (74 FR 56260). The Greenhouse Gas Reporting Program captures approximately 90 percent of
 16 total U.S. GHG emissions from more than 8,000 facilities, because facilities that fall below the
 17 25,000 MT of CO₂eq/yr are not required to report GHG emissions to the EPA. The EPA
 18 publishes GHG emission data from the Greenhouse Gas Reporting Program via the Facility
 19 Level Information on GreenHouse Gases Tool. The EPA also prepares an annual report,
 20 Inventory of U.S. Greenhouse Gas Emissions and Sinks (Inventory), that estimates total GHG
 21 emissions across all sectors of the U.S. economy by using national statistics (e.g., energy data,
 22 agricultural activities). EPA’s Inventory is an essential tool for addressing climate change and
 23 participating in the United Nations Framework Convention on Climate Change to compare the
 24 relative global contribution of different emission sources and GHGs to climate change. In 2020,
 25 U.S. gross GHG emissions totaled 6,692 million tons (5,981 million MT) of CO₂eq (EPA 2022a).
 26 Carbon dioxide represented 78.8 percent of total emissions, and the largest source of GHG
 27 emissions was fossil fuel combustion from transportation (e.g., passenger vehicles, freight
 28 trucks, light-duty trucks), followed by fossil fuel electric power generation (EPA 2022a). In 2020,
 29 the total amount of CO₂eq emissions related to fossil fuel electricity generation was 1,586 million
 30 tons (1,439 million MT) (EPA 2022a). Table 3.12-1 presents annual GHG emissions by State.

31 **Table 3.12-1 Greenhouse Gas Emissions by State, 2020**

State	Total GHG Emissions (tons)
Alabama	81,529,926
Arkansas	36,576,479
Arizona	48,145,971
California	101,817,155
Colorado	44,252,447
Connecticut	12,067,762
District of Columbia	331,144
Delaware	6,511,631

¹⁷ Carbon dioxide equivalent (CO₂eq) is a metric used to compare the emissions of GHG based on their global warming potential—a measure used to compare how much heat a GHG traps in the atmosphere. The global warming potential is the total energy that a gas absorbs over a period of time, compared to CO₂. Carbon dioxide equivalent is obtained by multiplying the amount of the GHG by the associated GWP. For example, the global warming potential of CH₄ is estimated to be 21; therefore, one ton of CH₄ emission is equivalent to 21 tons of CO₂ emission.

State	Total GHG Emissions (tons)
Florida	132,460,532
Georgia	59,044,565
Iowa	44,492,715
Idaho	5,523,906
Illinois	85,500,581
Indiana	123,154,493
Kansas	36,175,597
Kentucky	73,303,670
Louisiana	149,745,938
Massachusetts	10,341,372
Maryland	17,607,838
Maine	3,190,240
Michigan	73,847,686
Minnesota	38,502,904
Missouri	75,413,377
Mississippi	45,465,248
Montana	16,042,590
North Carolina	51,036,623
North Dakota	39,668,230
Nebraska	29,625,029
New Hampshire	2,399,564
New Jersey	23,096,674
New Mexico	30,164,049
Nevada	18,545,886
New York	39,777,988
Ohio	113,959,613
Oklahoma	53,666,856
Oregon	14,961,597
Pennsylvania	115,362,063
Rhode Island	4,008,019
South Carolina	35,370,551
South Dakota	5,764,182
Tennessee	37,853,626
Texas	397,341,699
Utah	36,718,856
Virginia	48,514,702
Vermont	481,491
Washington	25,666,160
Wisconsin	44,591,776

- 1 GHG = greenhouse gas.
- 2 To convert to MT multiply by 0.907
- 3 Source: EPA 2022d.

Affected Environment

1 GHG emissions from nuclear power plants are typically very minor because such plants, by their
2 very nature, do not normally burn fossil fuels to generate electricity. Sources include stationary
3 and mobile combustion sources, including diesel generators, pumps, diesel engines, boilers,
4 worker vehicles, or delivery vehicles. Other GHG sources from nuclear power plants may
5 include human-made fluorinated compounds. These include hydrofluorocarbons and
6 perfluorocarbons contained in refrigerants. Sulfur hexafluoride is used in electric power
7 transmission and distribution applications. Sulfur hexafluoride can be found in substations,
8 circuit breakers, and other switchgear. The gas has replaced flammable insulating oils in many
9 applications and allows for more compact substations. Fugitive emissions of sulfur hexafluoride
10 can escape from gas-insulated substations and switchgear through seals, especially those in
11 older equipment. The gas can also be released during equipment manufacturing, installation,
12 servicing, and disposal (EPA 2022a).

13 Operations at nuclear power plants release GHGs (primarily CO₂) from stationary combustion
14 sources (e.g., diesel generators, pumps, diesel engines, boilers), refrigeration systems,
15 electrical transmission and distribution systems, and mobile sources (e.g., worker vehicles and
16 delivery vehicles). GHG emissions generated can be categorized into direct and indirect
17 emissions. The EPA has developed guidance to identify and scope sources to delineate,
18 inventory, and account for GHG emissions. Direct GHG emissions include those that are
19 owned or controlled by an organization (EPA 2021b). The EPA categorizes direct GHG
20 emissions as Scope 1 emissions. This includes GHG emissions associated with stationary and
21 mobile combustion sources at nuclear power plants, as well as fugitive emissions from
22 refrigeration equipment and transmission lines. Indirect emissions are those associated with an
23 organization's activities but are emitted from sources owned by other entities. The EPA's
24 guidance categorizes indirect GHG emissions as Scope 2 and Scope 3 emissions. Scope 2
25 GHG emissions include emissions associated with the purchase of electricity consumed by the
26 organization (EPA 2020b). Scope 3 emissions includes those from upstream and downstream
27 activities such as transportation of purchased products, employee commuting, and end-of-life
28 treatment of sold products (EPA 2022c).

29 In 2009, the Commission issued a memorandum and order in CLI-09-21 (NRC 2009d) that
30 stated the following:

31 [B]ecause the Staff is currently addressing the emerging issues surrounding
32 greenhouse gas emissions in environmental reviews required for the
33 licensing of nuclear facilities, we believe it is prudent to provide the following
34 guidance to the Staff. We expect the Staff to include consideration of carbon
35 dioxide and other greenhouse gas emissions in its environmental reviews for
36 major licensing actions under the National Environmental Policy Act.

37 Following the issuance of CLI-09-21 (NRC 2009d), the NRC began to evaluate the effects of
38 GHG emissions and its implications for global climate change in its environmental reviews for
39 license renewal applications. For the 2013 LR GEIS, direct GHG emissions data for facilities
40 were not available to support an impact level determination for the license renewal term. Since
41 publication of the 2013 LR GEIS, the NRC has included within each SEIS a plant-specific
42 analysis of GHG emissions over the course of the license renewal term (initial and subsequent).
43 Table 3.12-2 presents direct and indirect GHG emissions from representative operating nuclear
44 power plants. The observed range and distribution of direct and indirect GHG emissions from
45 site to site is a result of different sources and contributors, as well as differences in GHG data
46 that nuclear power plant licensees inventory. Not all States have GHG emission reporting
47 requirements, and EPA requires reporting only if the 25,000 MT threshold is met. In the

1 absence of these reporting requirements, nuclear power plant licensees do not inventory GHG
2 data uniformly.

3 **Table 3.12-2 Estimated Greenhouse Gas Emissions from Operations at Nuclear Power**
4 **Plants**

Nuclear Power Plant	Direct Greenhouse Gas Emissions (T/yr)^(a)	Indirect Greenhouse Gas Emissions (T/yr)^(a)
Braidwood ^(b)	3,562—14,778	16,459—24,380
Byron ^(b)	4,761—7,638	6,307—7,638
Callaway ^(c)	845—5,042	N/A
Columbia ^(d)	650—856	N/A
Davis-Besse ^(e)	5,173	N/A
Fermi ^(f)	6,411—11,897	4,166
Indian Point ^(g)	540—7,188	4,928
LaSalle ^(h)	2,500	36,066
North Anna ⁽ⁱ⁾	430—690	4,490
Peach Bottom ^(j)	29,705	10,090
Point Beach ^(k)	660—1,110	3,460
River Bend ^(l)	360—820	2,900
Seabrook ^(m)	7,893—47,778	N/A
Surry ⁽ⁿ⁾	340—4,630	4,730
Turkey Point ^(o)	500—790	3,400
Waterford ^(p)	716—3,087	3,307

5 N/A = Not Available; T/yr = ton per year.

6 (a) To convert to MT multiply by 0.907.

7 (b) Data available for 2008–2012. Direct emissions include onsite combustion sources, refrigerants, and the CO₂
8 purge and fire protection system. Indirect emissions are from purchased electricity. Sources: NRC 2015c, NRC
9 2015d, Exelon Generation Company 2013, Exelon Generation Company 2014.

10 (c) Data available for 2007–2011. Direct emissions include onsite combustion sources. Source: NRC 2014f.

11 (d) Data available for 2006–2009. Direct emissions include onsite combustion sources. Source: NRC 2012b.

12 (e) Data available for 2010. Direct emissions include onsite combustion sources. Source: NRC 2015e.

13 (f) Data available for 2009–2013. Direct emissions include onsite combustion sources and refrigerants. Indirect
14 emissions source include worker vehicles. Source: NRC 2016c.

15 (g) Data available for 2009–2013. Direct emissions include onsite combustion sources and electrical equipment
16 related sources. Indirect emissions include worker vehicles. Source: NRC 2018e.

17 (h) Data available for 2010–2014. Direct emissions include onsite combustion sources, refrigerants, and fugitive
18 emissions sources (from the CO₂ injection system, fire protection system, and condensers). Indirect emissions
19 include purchased electricity. Source: NRC 2016d.

20 (i) Data available for 2013–2017. Direct emissions include onsite combustion sources. Indirect emissions from
21 worker vehicles. Source: NRC 2021g.

22 (j) Direct emissions include onsite combustion sources. Direct emissions are based on maximum allowable fuel
23 usage and hours as prescribed in Peach Bottom's air permit, rather than actual fuel usage and run time.
24 Therefore, the emissions are overestimates. Indirect emissions include worker vehicles. Source: NRC 2020g.

25 (k) Data available for 2014–2018. Direct emissions include onsite combustion sources. Indirect emissions from
26 worker vehicles. Source: NRC 2021f.

27 (l) Data available for 2011–2015. Direct emissions include onsite combustion sources. Indirect emissions from
28 worker vehicles. Source: NRC 2018c.

29 (m) Data available for 2005–2009. Direct emissions include onsite combustion sources and transmission substation.
30 In 2007, higher than normal GHG emissions resulted from two equipment failures that contributed to 42,479 tons
31 of CO₂eq (of the total 47,778 total direct emissions). Sources: NRC 2015b and NextEra Energy 2010.

Affected Environment

- 1 (n) Data available for 2011–2015. Direct emissions include onsite combustion sources. Indirect emissions from
2 worker vehicles. Source: NRC 2019d.
- 3 (o) Data available for 2012–2016. Direct emissions include onsite combustion sources. Indirect emissions from
4 worker vehicles. Source: NRC 2019c.
- 5 (p) Data available for 2010–2014. Direct emissions include onsite combustion sources. Indirect emissions from
6 worker vehicles.
7 Source: NRC 2018d.
-

8 **3.12.2 Observed Changes in Climate**

9 Climate change is the decades or longer change in climate measurements (e.g., temperature
10 and precipitation) that has been observed on a global, national, and regional level (IPCC 2007;
11 EPA 2016; USGCRP 2014). Climate change research indicates that the cause of the Earth's
12 warming over the last 50 to 100 years is due to the buildup of GHGs in the atmosphere resulting
13 from human activities (IPCC 2013, IPCC 2021; USGCRP 2014, USGCRP 2017, USGCRP
14 2018). On a global level, from 1901 to 2016, the average temperature has increased by 1.8 °F
15 (1.0 degree Celsius [°C]) (USGCRP 2018). Since 1901, precipitation has increased at an
16 average rate of 0.1 in. (0.25 cm) per decade on a global level (EPA 2021a). The observed
17 global change in average surface temperature and precipitation has been accompanied by an
18 increase in sea surface temperatures, a decrease in global glacier ice, an increase in sea level,
19 and changes in extreme weather events. Such extreme events include an increase in the
20 frequency of heat waves, very heavy precipitation (defined as the heaviest 1 percent of all daily
21 events), and recorded maximum daily high temperatures (IPCC 2007; EPA 2016; USGCRP
22 2009, USGCRP 2014). From 1880 to 2013, the global average sea level has risen at a rate of
23 0.06 in (0.15 cm) per year and from 1880 to 2020 global sea surface temperature has increased
24 at a rate of 0.14 °F (0.07 °C) per decade (EPA 2021a).

25 The 2013 LR GEIS summarized the findings of the Second Annual Climate Assessment
26 developed by the U.S. Global Change Research Program (USGCRP) (USGCRP 2009). The
27 USGCRP is a Federal program mandated by Congress to coordinate Federal research
28 conducted to better understand climate change. Since publication of the 2013 LR GEIS, Third
29 and Fourth Annual Climate Assessments have been published (USGCRP 2014 and USGCRP
30 2018). The Fourth Annual Climate Assessment (USGCRP 2018) builds on the work of the
31 previous assessments. The NRC uses consensus information from the USGCRP to evaluate
32 the effects of climate change in its SEISs for license renewal of nuclear power plants. The
33 USGCRP reports that from 1901 to 2016, average surface temperatures have increased by 1.8
34 °F (1.0 °C) across the contiguous United States (USGCRP 2018). Since 1901, average annual
35 precipitation has increased by 4 percent across the United States (USGCRP 2018). Observed
36 climate change indicators across the United States include increases in the frequency and
37 intensity of heavy precipitation, earlier onset of spring snowmelt and runoff, rise of sea level and
38 increased tidal flooding in coastal areas, an increased occurrence of heat waves, and a
39 decrease in the occurrence of cold waves. Since the 1980s, data show an increase in the
40 length of the frost-free season (i.e., the period between the last occurrence of 32 °F (0 °C) in the
41 spring and first occurrence of 32 °F (0 °C) in the fall), across the contiguous United States.
42 Over the period 1991 through 2011, the average frost-free season was 10 days longer (relative
43 to the 1901 through 1960 time period) (USGCRP 2014). Over just the past two decades, the
44 number of high-temperature records observed in the United States has far exceeded the
45 number of low-temperature records (USGCRP 2018). Since the 1980s, the intensity, frequency,
46 and duration of North Atlantic hurricanes have increased (USGCRP 2014).

47 Climate change and its impacts can vary regionally, spatially, and seasonally, depending on
48 local, regional, and global factors. Observed climate changes and impacts have not been

1 uniform across the United States. For instance, annual precipitation has increased across most
2 of the northern and eastern States and decreased across the southern and western States.
3 Sea level rise and coastal flooding have not been evenly distributed. Along the Atlantic coast,
4 the U.S. Northeast has experienced a faster-than-global increase in sea level rise since the
5 1970s (USGCRP 2017). To provide localized information and greater granularity, USGCRP's
6 Annual Climate Assessments (USGCRP 2014, USGCRP 2018) describe observed and
7 projected changes in climate by U.S. geographic regions: Northeast, Southeast, Caribbean,
8 Midwest, Northern Great Plains, Southern Great Plains, Northwest, Southwest, Midwest,
9 Alaska, and Hawaii and U.S. Pacific Islands (see Figure 3.12-1). As can be seen in
10 Figure 3.12-1, U.S. operating nuclear power plants are primarily located in the Northeast,
11 Southeast, and Midwest regions. The discussions below provide a summary of the observed
12 climate changes by the contiguous U.S. region, with a focus on regions where operating nuclear
13 power plants are located.

14 3.12.2.1 *Northeast*

15 In the Northeast region of the United States, average annual air temperatures increased by
16 1.98 °F (1.1 °C) between 1895 and 2011 (USGCRP 2014). This observed warming has not
17 been uniform; average temperatures increased less than 1 °F (0.6 °C) in West Virginia and 3 °F
18 (1.6 °C) or more across New England (USGCRP 2018). The frost-free season has increased by
19 10 days across the Northeast during the 1986 to 2015 timeframe relative to 1901 to 1960
20 timeframe (USGCRP 2017). Between 1958 and 2016, the Northeast experienced a 55 percent
21 increase in heavy precipitation events (i.e., the amount of annual precipitation falling in the
22 heaviest 1 percent of events). This is the largest increase of any region in the United States
23 (USGCRP 2018). Heavy precipitation events can lead to an increase in flooding because of
24 greater runoff (USGCRP 2014, USGCRP 2018). Since the 1920s, the magnitude of river
25 flooding has been increasing across the Northeast region by up to 12 percent per decade
26 (USGCRP 2014). Sea level rise along the Northeast coast has increased by 1 ft (0.3 m) since
27 1900, a rate that exceeds the global average of 8 in. (20 cm) (USGCRP 2014). From 1982 to
28 2006, sea surface temperatures in coastal waters of the Northeast warmed at almost twice the
29 global rate of warming during this period (USGCRP 2014). Surface ocean temperatures in the
30 Northeast have warmed faster than 99 percent of the global ocean since 2004, and a peak
31 temperature in 2012 was part of a large "ocean heat wave" in the northwest Atlantic that
32 persisted for nearly 18 months (USGCRP 2017). In the Indian Point initial LR SEIS, the NRC
33 staff noted that sea level rise along the New York State coastline is 1.2 in. (3 cm) per decade
34 since 1900, and a long-term warming trend in the Hudson River Estuary of 0.027 °F (0.015 °C)
35 per year over the course of 63 years (1946 to 2008) (NRC 2018e). As discussed in the Indian
36 Point and Seabrook license renewal SEISs, warming sea temperatures have shifted the
37 distribution and abundance of aquatic species northward (NRC 2018e, NRC 2015b).

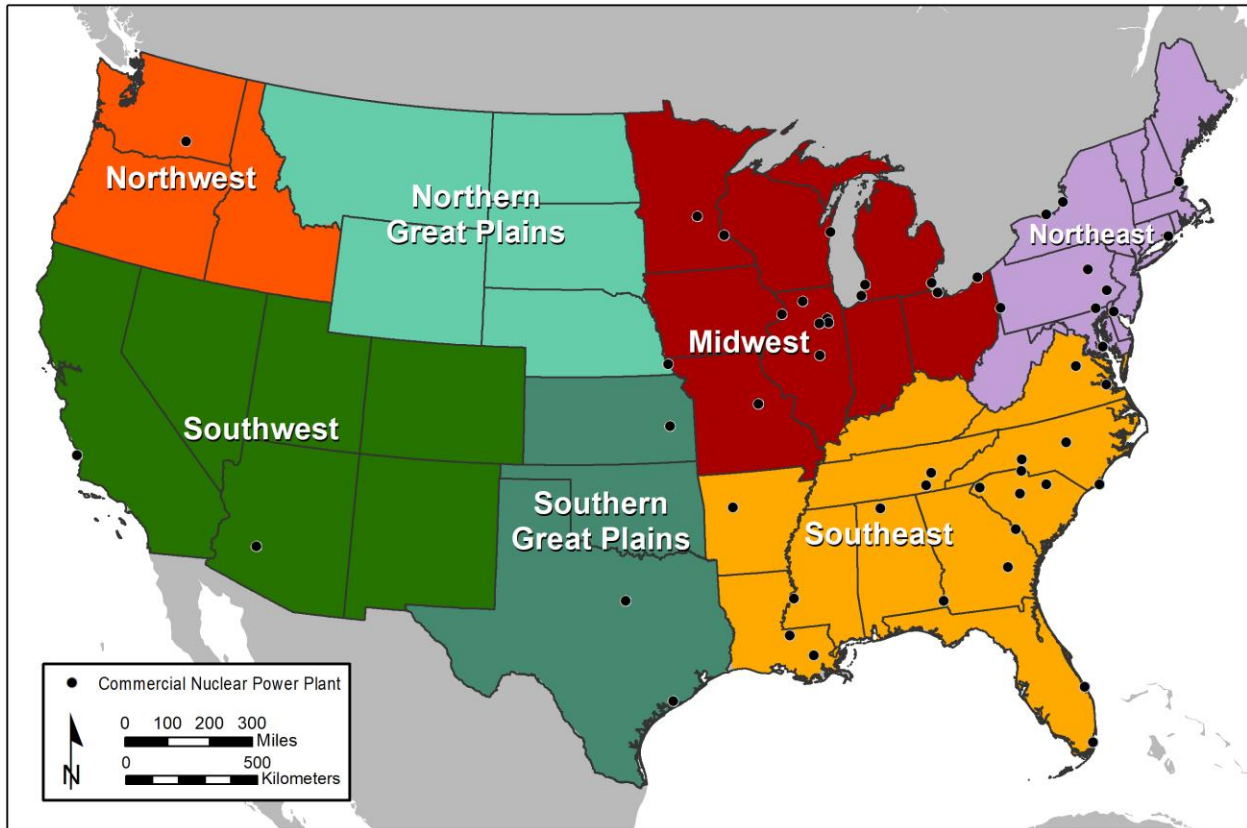

1
 2 **Figure 3.12-1 Locations of Operating Nuclear Power Plants Relative to National Climate**
 3 **Assessment Geographic Regions**

4 *3.12.2.2 Southeast*

5 In the Southeast, ambient air temperature increases have generally been uneven across the
 6 region. It is one of the few regions in the world where there has not been an overall increase in
 7 surface temperatures (NOAA 2013a; USGCRP 2018). The overall lack of long-term warming in
 8 the Southeast has been termed “the warming hole” (NOAA 2013a, NOAA 2013d; USGCRP
 9 2017; Partridge et al. 2018). Nonetheless, since the 1970s, average annual temperatures have
 10 steadily increased across the Southeast and have been accompanied by an increase in the
 11 number of hot days with maximum temperatures above 95 °F (35 °C) in the daytime and above
 12 75 °F (23.9 °C) in the nighttime (NOAA 2013a; USGCRP 2009, USGCRP 2014, USGCRP
 13 2018). Annual average temperatures have warmed by 0.46 °F (0.28 °C) between 1986–2016
 14 (relative to 1901–1960) (USGCRP 2014, USGCRP 2017). The average annual number of hot
 15 days observed since the 1960s remains lower than the average number during the first half of
 16 the 20th century. In contrast, the number of warm nights above 75 °F (23.9 °C) has doubled on
 17 average in the Southeast region compared to the first half of the 20th century (USGCRP 2018).
 18 Average annual precipitation data for the Southeast region do not exhibit an increasing or
 19 decreasing trend overall for the long-term period (1895–2011) (NOAA 2013d). Precipitation in
 20 the Southeast region varies considerably throughout the seasons, and average precipitation has
 21 generally increased in the fall and decreased in the summer (NOAA 2013d; USGCRP 2009).
 22 Across parts of the Southeast region, decreases in annual average precipitation of up to
 23 10 percent have occurred over the period 1986–2015 (relative to 1901–1960 for the contiguous
 24 United States) (USGCRP 2018). Between 1958 and 2016, heavy precipitation (i.e., the amount

1 of annual precipitation falling in the heaviest 1 percent of events) has increased by an average
2 of 27 percent across the Southeast region (USGCRP 2018).

3 Plant-specific environmental reviews of initial LR and SLR applications considered localized
4 observed changes in sea level rise. The variability of sea level rise along U.S. coasts becomes
5 apparent when comparing data presented in the NRC's license renewal SEISs. For instance, in
6 the Waterford initial LR SEIS, the NRC noted that the relative sea level along the Louisiana
7 coast increased by more than 8 in. (20 cm) between 1960 and 2015 (NRC 2018d). Sea level
8 rise in coastal Louisiana is partially driven by land subsidence, both as a result of natural and
9 anthropogenic processes (Jones et al. 2016). The Turkey Point SLR SEIS found that the
10 relative sea level rise trend at Miami, Florida, is 0.09 in./yr (0.24 cm/yr), or about 9 in. (23 cm)
11 per century (NRC 2019c). The Surry SLR SEIS found that the relative sea level rise trend at
12 Sewells Point, Virginia, near the mouth of the James River, is 0.18 in./yr (0.46 cm/yr), or about
13 18 in. (46 cm) per century (NRC 2019d). Sea level rise is causing an increase in the frequency
14 of high tide flood events in coastal areas of the Southeast region and saline water migrating
15 upstream in estuaries (USGCRP 2018).

16 3.12.2.3 *Midwest*

17 Across the Midwest region, the annual average temperature from 1905–2012 has warmed by
18 1.5 °F (0.5 °C) (USGCRP 2014). The rate of warming over recent decades has accelerated,
19 with average temperatures increasing twice as quickly between 1950 and 2010 relative to 1900-
20 2010 (USGCRP 2014; NOAA 2013b). The frost-free season has increased by 9 days across
21 the Midwest during the 1986 to 2015 timeframe relative to the 1901 to 1960 timeframe
22 (USGCRP 2017). Precipitation in the Midwest from 1895–2011 has increased 0.31 in.
23 (0.78 cm) per decade (NOAA 2013b). The Great Lakes have experienced increases in surface
24 temperatures, declining lake ice cover, increasing summer evaporation rates, and earlier
25 seasonal stratification of temperatures (USGCRP 2018). For instance, the NRC noted in the
26 Point Beach SLR SEIS that for the 1995–2019 period, the average rate of warming in Lake
27 Michigan has been 0.56–0.72 °F (0.31–0.40 °C), with the greatest warming occurring in October
28 (NRC 2021f). In the Fermi initial LR SEIS, the NRC staff obtained modeled monthly Lake Erie
29 surface water temperatures from the NOAA's Great Lakes Environmental Research Laboratory.
30 For the 1950 to 2012 period, Lake Erie annual surface water temperatures increased at a rate of
31 0.067 °F (0.037 °C) per decade (NRC 2016c).

32 3.12.2.4 *Northern Great Plains*

33 Temperature data for the northern Great Plains region between 1986–2016 exhibit an increase
34 of 1.69 °F (0.95 °C) (USGCRP 2017). The frost-free season has increased by 11 days across
35 the northern Great Plains during the 1986 to 2015 timeframe relative to the 1901 to 1960
36 timeframe (USGCRP 2017). Annual precipitation between 1986–2015 showed differences
37 featuring a general mixture of decreases in the western portion of the region and increases in
38 the eastern portion of the region. Between 1958 and 2016, the northern Great Plains
39 experienced a 29 percent increase in heavy precipitation events (USGCRP 2018).

40 3.12.2.5 *Southern Great Plains*

41 Temperature data for the southern Great Plains region between 1986–2016 exhibit an increase
42 of 1.61 °F (0.9 °C) (USGCRP 2017). Long-term (1895 to 2012) average annual precipitation
43 data for the southern Great Plains also exhibit an increasing trend. Since 1991, precipitation
44 has increased by 8 percent in the southern Great Plains. Between 1958 and 2016, heavy

Affected Environment

1 precipitation events have increased by 12 percent (USGCRP 2014, USGCRP 2018). The frost-free
2 season has increased by 7 days across the southern Great Plains during the 1986 to 2015
3 timeframe relative to the 1901 to 1960 timeframe (USGCRP 2017). Sea level rise along the
4 Texas Gulf Coast is twice that of the global average (USGCRP 2018). The Gulf Coast of Texas
5 has experienced several record-breaking floods and tropical cyclones, including Hurricane
6 Harvey (USGCRP 2018).

7 3.12.2.6 Northwest

8 The Northwest region has warmed significantly. Temperature data for the Northwest region
9 since 1900 exhibit an increase of 2 °F (1.1 °C) (USGCRP 2018). Warmer winters have resulted
10 in a reduction in mountain snowpack and river streamflow. For instance, since 1950, the area-
11 averaged snowpack in the Cascade Mountains has decreased by approximately 20 percent.
12 The frost-free season has increased by 17 days across the Northwest during the 1986 to 2015
13 timeframe relative to the 1901–1960 timeframe (USGCRP 2017).

14 Precipitation has generally increased, but the trends are small compared to natural variability
15 (USGCRP 2014). Between 1958 and 2016, the Northwest experienced an 8 percent increase in
16 heavy precipitation events. This is the smallest increase of any region in the United States
17 (USGCRP 2018). An increase in coastal and river water temperatures has been observed.
18 Surface ocean temperatures along the Northwest coast have increased by 1.2 °F (0.64 °C) per
19 century from 1900 to 2016 (USGCRP 2017). In July 2015, water temperature in the lower
20 Columbia River and tributaries were higher than any year on record (USGCRP 2018). As noted
21 in the Columbia initial LR SEIS, warmer water temperatures combined with less snowpack and
22 lower stream flows have changed the balance of aquatic resources in the Columbia River Basin
23 (NRC 2012b). The 2015 record temperatures led to a high rate of mortality for endangered
24 sockeye and threatened Chinook in the Columbia River (USGCRP 2018).

25 3.12.2.7 Southwest

26 Across the Southwest region, annual average temperature between 1901 and 2016 has
27 warmed by 1.6 °F (0.9 °C) (USGCRP 2017). Temperatures have increased across the entire
28 region from 1901 to 2016, with the greatest increases occurring in California and western
29 Colorado. Increased temperatures have decreased the snowpack and its water content and
30 ultimately the water cycle across this region. The frost-free season increased by 17 days
31 across the Southwest during the 1986 to 2015 timeframe relative to the 1901–1960 timeframe
32 (USGCRP 2017).

33 While temperature increases have been relatively uniform throughout the region, that has not
34 been the case for precipitation. For instance, precipitation since 1991 (relative to 1901–1960)
35 increased across western California, but decreased in Arizona (USGCRP 2014). Unlike other
36 regions of the United States, a trend in the frequency of extreme precipitation events in the
37 Southwest is not evident (NOAA 2013c; USGCRP 2014). The Southwest region experienced
38 the wettest conditions in the 1980s and 1990s, which coincide with El Niño-Southern Oscillation
39 events (NOAA 2013c). El Niño-Southern Oscillation events involve periodic warming in sea
40 surface temperatures in the central and eastern tropical Pacific Ocean that influences global
41 and regional precipitation and is typically associated with heavy rainfall in the Southwest
42 (USGCRP 2014). Over the last 50 years, there have been reductions in snowpack as a result of
43 higher temperatures causing a shift from snow to rain, with early springtime warming resulting in
44 earlier snowmelt-fed streamflow and less runoff throughout the summer season (USGCRP
45 2014; Thorne et al. 2012). Surface ocean temperatures along the Southwest coast have

1 increased by 1.3 °F (0.73 °C) per century from 1900 to 2016 (USGCRP 2017). Sea level
2 fluctuations along the California coast vary and result from a combination of factors, including
3 tides, the El Niño-Southern Oscillation, and coastal winds (Bromirski et al. 2012). At the Golden
4 Gate Bridge in San Francisco, sea level rose 9 in. (22 cm) between 1854 and 2016 and in San
5 Diego, sea level rose 9.5 in. (24 cm) from 1906 to 2016 (USGCRP 2018).

1 **4.0 ENVIRONMENTAL CONSEQUENCES AND MITIGATING ACTIONS**

2 The U.S. Nuclear Regulatory Commission (NRC) evaluated the environmental consequences of
3 the proposed action (i.e., license renewal) including the (1) impacts of continued reactor
4 operations and refurbishment activities associated with initial license renewal (initial LR) and
5 one term of subsequent license renewal (SLR); (2) impacts of various reasonable alternatives to
6 the proposed action; (3) impacts from the termination of nuclear power plant operations and
7 decommissioning after the license renewal term (with emphasis on the incremental effect
8 caused by an additional 20 years of subsequent operation); (4) impacts associated with the
9 uranium fuel cycle; (5) impacts of postulated accidents (design-basis accidents and severe
10 accidents); (6) cumulative impacts of the proposed action; and (7) resource commitments
11 associated with the proposed action, including unavoidable adverse impacts, the relationship
12 between short-term use and long-term productivity, and irreversible and irretrievable
13 commitment of resources.

Contents of Chapter 4.0

- Introduction (Section 4.1)
- Land Use and Visual Resources (Section 4.2)
- Air Quality and Noise (Section 4.3)
- Geologic Environment (Section 4.4)
- Water Resources (Section 4.5)
- Ecological Resources (Section 4.6)
- Historic and Cultural Resources (Section 4.7)
- Socioeconomics (Section 4.8)
- Human Health (Section 4.9)
- Environmental Justice (Section 4.10)
- Waste Management and Pollution Prevention (Section 4.11)
- Greenhouse Gas Emissions and Climate Change (Section 4.12)
- Cumulative Impacts of the Proposed Action (Section 4.13)
- Impacts Common to All Alternatives (Section 4.14)
- Resource Commitments Associated with the Proposed Action (Section 4.15)

14

1 **4.1 Environmental Consequences and Mitigating Actions**

2 **4.1.1 Introduction**

3 When considering whether the effects of the proposed action are significant, the NRC analyzes
4 the potentially affected environment and degree of the effects of the proposed action (initial LR
5 or SLR). The NRC has established three significance levels—SMALL, MODERATE, and
6 LARGE—and uses these levels in nuclear power plant-specific (hereafter called plant-specific)
7 supplemental environmental impact statements (SEISs) to the LR GEIS. As explained in
8 Section 1.5.2.3, the three significance levels are defined as follows:

- 9 • SMALL: Environmental effects are not detectable or are so minor that they will neither
10 destabilize nor noticeably alter any important attribute of the resource. For the purposes of
11 assessing radiological impacts, the Commission has concluded that those impacts that do
12 not exceed permissible levels in the Commission’s regulations are considered SMALL.
- 13 • MODERATE: Environmental effects are sufficient to alter noticeably, but not to destabilize,
14 important attributes of the resource.
- 15 • LARGE: Environmental effects are clearly noticeable and are sufficient to destabilize
16 important attributes of the resource.

17 These levels are used for describing the environmental impacts of the proposed action as well
18 as the impacts of a range of reasonable alternatives to the proposed action. Resource-specific
19 effects or impact definitions from applicable environmental laws and executive orders, other
20 than SMALL, MODERATE, and LARGE, are provided where appropriate. In this *Generic*
21 *Environmental Impact Statement for License Renewal of Nuclear Plants* (referred to in this
22 document as the LR GEIS), the NRC’s environmental impact levels are informed by Council on
23 Environmental Quality (CEQ) terminology and guidance including revisions in Part 1501—NEPA
24 and Agency Planning (see Title 40, Section 1501 in the *Code of Federal Regulations* [CEQ
25 2022]).

26 **4.1.2 Environmental Consequences of the Proposed Action**

27 As described in Section 2.1, activities associated with the proposed action could have
28 environmental consequences at a nuclear power plant site. The proposed action includes
29 activities associated with the normal operation of a nuclear power plant during the license
30 renewal (initial LR or SLR) term, including (1) reactor operations; (2) surveillance, monitoring,
31 and maintenance activities related to systems, structures, and components; (3) waste
32 management; (4) refueling and other outages; (5) activities needed to support facility
33 infrastructure requirements as part of routine operations and maintenance (e.g., road
34 improvements and the installation or construction of new structures and other support facilities);
35 and (6) any refurbishment activities needed to replace and/or repair critical portions of reactor
36 systems.

37 The assessment includes a determination of the magnitude of the impact (SMALL,
38 MODERATE, or LARGE) and whether or not the analysis of the environmental issue could be
39 applied to all or a subset of nuclear plants, and whether plant-specific mitigation measures
40 would be warranted. Environmental issues are assigned a Category 1 or a Category 2
41 designation as follows:

1 **Category 1** issues are those that meet all of the following criteria:

- 2 • The environmental impacts associated with the issue have been determined to apply either
3 to all plants or, for some issues, to plants having a specific type of cooling system or other
4 specified plant or site characteristics.
- 5 • A single significance level (i.e., SMALL, MODERATE, or LARGE) has been assigned to the
6 impacts (except for “Offsite radiological impacts of spent nuclear fuel and high-level waste
7 disposal and “Offsite radiological impacts—collective impacts from other than the disposal of
8 spent nuclear fuel and high-level waste”).
- 9 • The mitigation of adverse impacts associated with the issue has been considered in the
10 analysis, and it has been determined that additional plant-specific mitigation measures are
11 not likely to be sufficiently beneficial to warrant implementation.

12 For environmental issues that meet the three Category 1 criteria, no additional plant-specific
13 analysis is required in SEISs unless new and significant information is identified during the
14 review (see Section 1.5.2.3).

15 **Category 2** issues are those that do not meet one or more of the criteria of Category 1 and for
16 which, therefore, an additional plant-specific review is required.

17 A total of 80 environmental issues related to the proposed action were identified (summarized in
18 Table 2.1-1). For each potential environmental issue identified, the NRC (1) describes the
19 nuclear power plant activity during the initial LR or SLR term that could affect the resource,
20 (2) identifies environmental resources that may be affected, (3) evaluates past license renewal
21 reviews and other available information, including information related to impacts during a SLR
22 term, (4) assesses the nature and magnitude of the environmental impact on the affected
23 resource, (5) characterizes the significance of the effect, (6) determines whether the results of
24 the analysis apply to all or a subset of nuclear power plants (i.e., whether the impact issue is
25 Category 1 or Category 2), and (7) describes mitigation measures for adverse impacts.

26 **4.1.3 Environmental Consequences of Continued Operations and Refurbishment** 27 **Activities During the License Renewal Term (Initial or Subsequent)**

28 Activities occurring during the initial LR or SLR term are the subject of this evaluation and are
29 described in Section 2.1. The environmental impacts during the construction of a nuclear power
30 plant and past operational impacts are not the focus of this evaluation. Construction impacts
31 and the impacts of past operations have affected and, in many cases, shaped current
32 environmental conditions at each nuclear plant and in its surroundings. These environmental
33 conditions serve as the baseline for the impact analyses of continued operations and
34 refurbishment activities during the license renewal term. Past environmental impacts are
35 addressed in Chapter 3.0, Affected Environment. The impacts of continued operations and any
36 refurbishment activities during the initial LR or SLR term are the same or similar to the impacts
37 already occurring during the current license term. In most cases, impacts would remain the
38 same and are SMALL. This is because initial LR or SLR would continue current operating
39 conditions and environmental stressors rather than introduce wholly new impacts. In other
40 cases, impacts could change and may be MODERATE or LARGE. Further, in reviewing and
41 updating the 2013 LR GEIS to account for SLR, the NRC also considered whether any feature
42 of the analysis in the 2013 LR GEIS would be incompatible with SLR.

Environmental Consequences and Mitigating Actions

1 The NRC staff's review considered lessons learned, knowledge gained, and new information
2 identified from license renewal environmental reviews performed since development of the 2013
3 LR GEIS (NRC 2013a). The environmental reviews included initial LR for the following 15
4 nuclear power plants: Seabrook Station (Seabrook; NRC 2015b), Columbia Generating Station
5 (Columbia; NRC 2012a, NRC 2012b), South Texas Project Electric Generating Station (South
6 Texas; NRC 2013b), Limerick Generating Station (Limerick; NRC 2014d), Grand Gulf Nuclear
7 Station (Grand Gulf; NRC 2014e), Callaway Plant (Callaway; NRC 2014f), Davis-Besse Nuclear
8 Power Station (Davis-Besse; NRC 2015e), Sequoyah Nuclear Plant (Sequoyah; NRC 2015f),
9 Byron Station (Byron; NRC 2015c), Braidwood Station (Braidwood; NRC 2015d), Enrico Fermi
10 Atomic Power Plant (Fermi; NRC 2016c), LaSalle County Station (LaSalle; NRC 2016d), Indian
11 Point Energy Center (Indian Point; NRC 2018e), River Bend Station (River Bend; NRC 2018c),
12 and Waterford Steam Electric Station (Waterford; NRC 2018d).

13 Additionally, the staff considered the results from SLR environmental reviews for the following
14 5 nuclear power plants: Turkey Point Nuclear Plant (Turkey Point; NRC 2019c), Peach Bottom
15 Atomic Power Station (Peach Bottom; NRC 2020g), Surry Power Station (Surry; NRC 2020f),
16 North Anna Power Station (North Anna; NRC 2021g), and Point Beach Nuclear Plant (Point
17 Beach; NRC 2021f).

18 The NRC staff also considered new scientific research, public comments, changes in
19 environmental regulations and impacts methodology, and other new information in evaluating
20 the impacts associated with license renewal (initial LR or SLR).

21 Based on the NRC staff's review, a total of 80 environmental issues for the initial LR or SLR of
22 nuclear power plants were identified and evaluated; they are summarized in Table 2.1-1. This
23 revised LR GEIS provides the technical basis for the summary of findings on environmental
24 issues in Table B-1 in Appendix B, Subpart A, of 10 CFR Part 51. The identified issues are
25 discussed by resource area in this chapter. The assessment approaches specific to each
26 resource area are described in Appendix D.

27 **4.1.4 Environmental Consequences of the No Action Alternative**

28 The no action alternative represents a decision where the NRC does not issue a renewed
29 operating license. The licensee would then have to terminate reactor operations at the end of
30 its current license and permanently shut down the nuclear power plant. At some point, all
31 licensees will terminate nuclear plant operations and undergo decommissioning. Under the no
32 action alternative, this would occur sooner than it would if the NRC issued a renewed operating
33 license.

34 Not renewing the operating license and ceasing nuclear plant operation under the no action
35 alternative would lead to a variety of potential outcomes. These outcomes would be the same
36 as those that would occur after license renewal (see Section 4.14.3 for a discussion of these
37 effects). Termination of reactor operations would result in a net reduction in power generating
38 capacity. Power not generated by the nuclear plant during license renewal would likely be
39 replaced by (1) replacement energy alternatives, (2) energy conservation and efficiency
40 (demand-side management), (3) delayed retirements, (4) purchased power, or (5) some
41 combination of these options. The consideration of the no action alternative does not involve
42 the determination of whether replacement energy is needed or should be generated. The
43 decision to generate electric power and the determination of how much power is needed are at
44 the discretion of State, Federal (non-NRC), and utility officials.

1 **4.1.5 Environmental Consequences of Alternative Energy Sources**

2 Chapter 4 also considers the potential environmental impacts from the construction and
3 operation of generating technologies using alternative energy sources (including fossil fuel, new
4 nuclear, and renewable energy) to replace the amount of electric power generated by an
5 existing nuclear power plant. For each resource area addressed in this chapter the range of
6 possible environmental effects of constructing and operating various replacement energy
7 alternatives is generically assessed. Alternatives were selected on the basis of energy
8 technologies that are either currently commercially viable on a utility scale and operational or
9 could become commercially viable on a utility scale and operational prior to the expiration of the
10 original or renewed operating license. Other replacement energy technologies holding promise
11 for becoming part of a bulk electricity portfolio sometime in the future are identified.
12 Replacement energy is likely to be provided by a combination of electrical energy-producing
13 technologies. The number of possible combinations of alternative energy sources that could
14 replace or offset the generating capacity of a nuclear power plant is potentially unlimited. Based
15 on this, the NRC has only evaluated individual energy sources rather than combinations of
16 energy sources in this LR GEIS. However, combinations of energy sources may be considered
17 during plant-specific license renewal reviews. The NRC does not engage in energy-planning
18 decisions and makes no judgment as to which of the replacement energy alternatives evaluated
19 in this LR GEIS would ultimately be chosen.

20 In addition to alternative electrical energy-generating technologies, power needs could also be
21 offset by instituting demand-side management measures, delaying the scheduled retirement of
22 one or more existing plants, or purchasing an equivalent amount of power from other energy
23 suppliers. As summarized in Table 2.4-1 through Table 2.4-5, demand-side management
24 initiatives are anticipated to result in negligible to no incremental environmental impacts.
25 Delayed retirements and energy purchases would likely have characteristics similar to some of
26 the replacement energy alternatives considered and would be dependent on their availability at
27 the time they are needed. Historically, coal, natural gas, and nuclear-fueled power plants have
28 been the most-prevalent sources of baseload purchased power, though an increasing number
29 of renewable energy sources are emerging as viable options. As such, the effects of deploying
30 offsetting alternatives such as purchased power and delayed retirement are likely to be similar
31 to the effects of operating a combination of alternative electrical energy-generating
32 technologies, and are therefore more effectively considered in plant-specific license renewal
33 reviews.

34 **4.1.6 Environmental Consequences of Terminating Nuclear Power Plant Operations** 35 **and Decommissioning**

36 All operating nuclear power plants will terminate operations and begin decommissioning either
37 at the end of their operating license or after a decision is made to cease reactor operations.
38 License renewal would delay this eventuality for up to an additional 20 years beyond the current
39 operating license period. The environmental impacts of decommissioning nuclear power plants
40 were evaluated in the *Generic Environmental Impact Statement for Decommissioning Nuclear*
41 *Facilities: Supplement 1, Regarding the Decommissioning of Nuclear Power Reactors*
42 (NUREG-0586; NRC 2002c). The effects of renewing an operating license on the eventual
43 impacts of terminating a nuclear power reactor license and the ensuing decommissioning are
44 addressed as a single environmental issue. Because the impacts of license renewal on
45 terminating plant operations and decommissioning are expected to be SMALL at all nuclear
46 plants and for all environmental resources, it is considered a Category 1 issue. These impacts
47 are discussed in Section 4.14.3.

1 **4.2 Land Use and Visual Resources**

2 **4.2.1 Environmental Consequences of the Proposed Action – Continued Operations**
3 **and Refurbishment Activities**

4 Industrial land use at nuclear plants is not expected to change appreciably until after
5 decommissioning is completed. Similarly, land use activity within transmission line right-of-ways
6 (ROWs) would continue with few, if any, changes in land use restrictions and easements.

7 In addition, the visual appearance of nuclear power plants and transmission lines have been
8 well established. These conditions are expected to remain unchanged during the initial LR or
9 SLR term regardless of the prior number of years of nuclear plant operation.

10 *4.2.1.1 Land Use*

11 Environmental reviews have shown that license renewal and refurbishment have had little or no
12 effect on land use at or near nuclear power plants. Land use impact issues evaluated in this LR
13 GEIS revision include the impacts of continued plant operations and refurbishment activities on
14 (1) onsite land use, (2) offsite land use, and (3) offsite land use in transmission line ROWs.

15 *4.2.1.1.1 Onsite Land Use*

16 Operational activities during both the initial LR or SLR term would be similar to those already
17 occurring at the nuclear plant. The industrial nature of onsite land use would remain
18 unchanged. However, additional spent nuclear fuel and low-level radioactive waste would be
19 generated during the license renewal term. This could require the construction of new or the
20 expansion of existing onsite storage facilities. Future expanded installations would likely be
21 located adjacent to existing storage facilities or otherwise in existing industrialized areas of the
22 plant sites. This action would be addressed in separate environmental reviews. The NRC has
23 not identified any information or situations during license renewal environmental reviews that
24 would alter the conclusion that land use impacts from continued plant operations and
25 refurbishment would be SMALL for all nuclear plants. Refurbishment activities, such as steam
26 generator and vessel head replacement, have not permanently altered onsite land use.

27 Based on these considerations, the NRC concludes that impacts from continued nuclear plant
28 operations during the initial LR and SLR terms and refurbishment on onsite land use would be
29 the same—SMALL for all nuclear plants. The staff reviewed information from SEISs (for initial
30 LR and SLRs) completed since development of the 2013 LR GEIS and identified no new
31 information or situations that would result in different impacts for this issue for either an initial LR
32 or SLR term. Therefore, onsite land use impacts would be SMALL for all nuclear plants, and it
33 is a Category 1 issue for both initial LR and SLR.

34 *4.2.1.1.2 Offsite Land Use*

35 Environmental reviews have shown that initial LR or SLR and refurbishment activities have had
36 little to no direct effect on development trends near nuclear power plants including changes in
37 population or tax revenue in communities near nuclear power plants. Employment levels at
38 nuclear plants remain the same or have decreased with no increased demand for housing,
39 infrastructure improvements, or services. Operational activities during the license renewal term
40 would be similar to those already occurring at the nuclear plant and would not affect offsite land
41 use beyond what has already been affected. The NRC has not identified any information or

1 situations, including in low-population areas or population and tax revenue changes resulting
2 from initial LR or SLR that would alter the conclusion that impacts on offsite land use would be
3 SMALL for all nuclear power plants.

4 For nuclear plants located in a coastal zone or coastal watershed, as defined by each State
5 participating in the National Coastal Zone Management Program, applicants must submit to the
6 affected State a certification that the proposed license renewal action is consistent with the
7 State Coastal Zone Management Program. Applicants must receive a determination from the
8 State agency that manages the State Coastal Zone Management Program that the proposed
9 license renewal action would be consistent with the State program. Consistency with State
10 Coastal Zone Management Programs further assures that impacts in State coastal zones will be
11 small.

12 Based on these considerations, the NRC concludes that impacts from continued nuclear plant
13 operations during the initial LR and SLR terms and refurbishment on offsite land use would be
14 the same—SMALL for all nuclear plants. The staff reviewed information from SEISs (for initial
15 LR and SLRs) completed since development of the 2013 LR GEIS and identified no new
16 information or situations that would result in different impacts for this issue either for an initial LR
17 or SLR term. Therefore, offsite land use impacts would be SMALL for all nuclear plants, and it
18 is a Category 1 issue for both initial LR and SLR.

19 *4.2.1.1.3 Offsite Land Use in Transmission Line Right-of-Ways (ROWs)*

20 Transmission lines that connect the nuclear plant to the switchyard where electricity is fed into
21 the regional power distribution system (the first substation of the regional electric power grid)
22 and lines that feed electricity to the nuclear plant from the grid during outages are within the
23 scope of license renewal environmental reviews. Operational activities in transmission line
24 ROWs during the initial LR or SLR term would be the same or similar to those already occurring
25 and would not affect offsite land use beyond what has already been affected.

26 Transmission lines do not preclude the use of the land in ROWs for other purposes, such as
27 agriculture and recreation. Transmission lines connecting nuclear plants to the electrical grid
28 are no different from transmission lines connecting any other power plant to the grid. However,
29 certain land use activities in transmission line ROWs are restricted. Land cover is generally
30 managed through a variety of maintenance procedures so that vegetation growth and building
31 construction do not interfere with transmission line operation and access. Consequently, land
32 use within transmission line ROWs is limited to activities that do not endanger power line
33 operation; these activities include recreation, off-road vehicle use, grazing, agriculture, irrigation,
34 roads, environmental conservation, and use as wildlife areas.

35 The impact of transmission lines on offsite land use during the license renewal term is
36 considered to be SMALL for all nuclear plants and a Category 1 issue in the 2013 LR GEIS.

37 The staff reviewed information from SEISs (for initial LR and SLRs) completed since
38 development of the 2013 LR GEIS and identified no new information or situations that would
39 result in different impacts for this issue for either an initial LR or SLR term. Therefore, impacts
40 in offsite land use in transmission line ROWs would be SMALL for all nuclear plants, and it is a
41 Category 1 issue for both initial LR and SLR.

Environmental Consequences and Mitigating Actions

1 4.2.1.2 *Visual Resources*

2 License renewal environmental reviews have shown that nuclear power plants and transmission
3 lines do not change in appearance over time, so aesthetic impacts are not anticipated during the
4 initial LR or SLR term.

5 4.2.1.2.1 *Aesthetic Impacts*

6 The NRC considered the visual impact of continued nuclear plant operations and refurbishment
7 during the license renewal term in the 2013 LR GEIS. The NRC concluded aesthetic impacts
8 would be SMALL for all nuclear plants and a Category 1 issue, because the visual appearance
9 of nuclear power plants and transmission lines are not expected to change during the license
10 renewal term.

11 Separately, a case study found a limited number of situations where nuclear power plants have
12 had a negative effect on the public (NRC 1996). Negative perceptions were based on aesthetic
13 considerations (for instance, the nuclear plant is out of character or scale with the community or
14 the viewshed), physical environmental concerns, safety and perceived risk issues, an anti-
15 nuclear plant attitude, or an anti-nuclear outlook. It is believed that these negative perceptions
16 would persist regardless of any mitigation. Subsequently, license renewal environmental
17 reviews have not revealed any new information that would change this perception.

18 After cooling towers and the containment building, transmission line towers are probably the
19 most frequently observed structure associated with nuclear power plants. Transmission lines
20 from nuclear plants are generally indistinguishable from those from other power plants.
21 Because electrical transmission lines are common throughout the United States, they are
22 generally perceived with less prejudice than the nuclear power plant itself. Also, the visual
23 impact of transmission lines tends to wear off when viewed repeatedly. Replacing or moving
24 towers or burying cables to reduce the visual impact would be impractical from both a cost and
25 efficiency perspective. The visual impact of transmission lines during the license renewal term
26 was also considered to be SMALL for all nuclear plants and a Category 1 issue in the 2013 LR
27 GEIS. No new information or situations that would alter that conclusion has been identified in
28 initial LR or SLR environmental reviews.

29 Based on these considerations, the NRC concludes the aesthetic impact of continued nuclear
30 plant operations during initial LR and SLR terms and refurbishment would be the same—SMALL
31 for all nuclear plants. The staff reviewed information from SEISs (for initial LRs and SLRs)
32 completed since development of the 2013 LR GEIS and identified no new information or
33 situations that would result in different impacts for this issue for either an initial LR or SLR term.
34 The visual appearance of nuclear plants would not change or have a different level of impact.
35 Therefore, aesthetic impacts would be SMALL for all nuclear plants, and it is a Category 1 issue
36 for both initial LR and SLR.

37 **4.2.2 Environmental Consequences of Alternatives to the Proposed Action**

38 *Construction* – Various replacement energy alternatives would involve the permanent
39 commitment of land for the construction of a new power plant along with support structures and
40 other facilities. Other land use and visual impacts during construction would include land
41 clearing, excavation, and the installation of temporary facilities, such as material laydown areas
42 and concrete batch plants. Depending on the location, construction of an electrical substation,

1 switchyards, transmission lines, railroad spurs, and access roads may also be required. Some
2 of these facilities could affect offsite land use.

3 Construction of a new power plant at an existing nuclear plant or brownfield site would have less
4 of a land use and visual impact than at a greenfield site. Installation of a replacement energy
5 alternative at an existing nuclear plant site would require the least amount of land because the
6 new power plant could make use of existing intake and discharge structures, substations,
7 transmission lines, office buildings, parking lots, and access roads. Constructing a power plant
8 at a greenfield site would convert land from other uses such as agriculture (including prime
9 farmland) to industrial use. In addition, construction on a greenfield site could have a dramatic
10 visual impact because the industrial appearance of a new power plant would be quite different
11 from a surrounding rural landscape.

12 Increase in traffic to and from the construction site could require changes to existing
13 transportation infrastructure and traffic patterns resulting in offsite land use and visual impacts.

14 *Operations* – Land would be in use throughout the period of power plant operation. Aesthetic
15 impacts would be similar to those experienced at existing nuclear plants or industrial brownfield
16 sites. Power plant structures, transmission lines, cooling and meteorological towers would add
17 to the permanent visual impact. Vapor plumes during power plant operations may be visible for
18 some distance in certain weather conditions.

19 4.2.2.1 *Fossil Energy Alternatives*

20 *Construction and Operations* – Land use impacts from constructing coal- or natural gas-fired
21 power plants would be similar. However, a coal-fired power plant would need more land for coal
22 fuel delivery and storage. A coal-fired power plant would likely have a greater visual impact
23 than a natural gas-fired plant.

24 4.2.2.2 *New Nuclear Alternatives*

25 *Construction and Operations* – Land requirements for a new nuclear power plant would be the
26 same as license renewal and similar to a coal-fired power plant. The appearance of the new
27 nuclear power plant during operations would be the same as license renewal.

28 4.2.2.3 *Renewable Alternatives*

29 *Construction and Operation* – Land requirements for renewable energy facilities would vary
30 greatly. Hydroelectric dams and reservoirs capable of generating utility-scale power would
31 require a large land area resulting in a noticeable visual impact. Dams serving as flood control
32 could affect land use both upstream and downstream of the reservoir.

33 Geothermal facilities, typically located in remote areas, would require a small land area and
34 could generate vapor plumes in certain weather conditions. The appearance of wellheads,
35 exposed piping, and power plant structures in remote settings would have a noticeable visual
36 impact.

37 Land area required for biomass and municipal solid waste, refuse-derived and landfill gas-fired
38 power plants would be similar to that required for other fossil fuel-fired facilities. Additional land
39 would be required for biomass and municipal solid waste, refuse-derived and landfill gas-fuel

Environmental Consequences and Mitigating Actions

1 handling facilities. Buildings, smokestacks, cooling towers, and condensate plumes would have
2 a visual impact in open areas comparable to fossil fuel-fired facilities.

3 Utility-scale wind farms generally require large land or surface water areas. However, only a
4 small percentage of land and water would be occupied by wind turbines and other support
5 facilities. Land-based wind farms generally have a greater visual impact depending on the
6 height and placement of the turbines (e.g., along ridgelines). Once construction is completed,
7 the area between turbines can be used for other purposes (e.g., agriculture, grazing, boating,
8 fishing, etc.). In addition, land would be required to support utility-scale offshore energy facilities
9 for cable landings and substations. Distance from shore and the curvature of the Earth could
10 attenuate some of the visual impacts of offshore wind turbines.

11 Utility-scale solar thermal power block and photovoltaic (PV) farms could require large areas of
12 land. Visual impacts would depend on the size, location, and the amount of land needed for
13 power generation—height of thermal power block, cooling towers, and condensate plume, and
14 the array of solar collectors.

15 Offshore ocean wave and current energy-generating facilities would require a small land area
16 for cable landing, substation, warehouse, and repair facilities. Existing piers and docks could
17 also be used to support power generation. The relatively short height of above-water structures,
18 distance from shore, and the curvature of the Earth may attenuate most, if not all, of the visual
19 impacts.

20 **4.3 Air Quality and Noise**

21 **4.3.1 Environmental Consequences of the Proposed Action – Continued Operations** 22 **and Refurbishment Activities**

23 Ambient air quality and noise conditions at all nuclear power plants and associated transmission
24 lines have been well established during the current licensing term. These conditions are
25 expected to remain unchanged during the license renewal term (initial LR or SLR term).

26 This section focuses on the impacts of continued operations and refurbishment activities
27 associated with license renewal on air quality and noise. Refurbishment and associated
28 construction activities can affect air quality (e.g., fugitive dust, vehicle and equipment exhaust
29 emissions, and automobile exhaust from commuter traffic). Baseline meteorological,
30 climatological, and ambient air quality and noise conditions at operating plants are discussed in
31 Sections 3.3.1 and 3.3.2, respectively. License renewal is expected to result in a continuation of
32 similar conditions for an extended period commensurate with the license renewal term (initial LR
33 or SLR term). As a result, the criteria air pollutants emitted and the noise generated during
34 normal continued nuclear plant operations during the initial LR or SLR term are not expected to
35 change substantially and thus should remain SMALL.

36 *4.3.1.1 Air Quality*

37 Two issues related to impacts on air quality during the license renewal (initial LR or SLR) terms
38 are considered in this section:

- 39 • air quality impacts – this issue encompasses impacts of continued operations and
40 refurbishment activities on air quality, including nonattainment or maintenance area
41 conformity; and

- 1 • air quality effects of transmission lines.

2 4.3.1.1.1 Air Quality Impacts

3 Impacts on air quality during normal plant operations can result from operations of fossil fuel-
4 fired equipment needed for various plant functions (see Section 3.3.2). Each licensed plant
5 typically employs emergency diesel generators for use as a backup power source. These
6 generators provide a standby source of electric power for essential equipment required during
7 plant upset or an emergency event. They also provide for safe reactor shutdown and for the
8 maintenance of safe conditions at the power station during such an event. These diesel
9 generators are typically tested once a month with several test burns of various durations
10 (e.g., 1 to several hours). In addition to these maintenance tests, longer-running endurance
11 tests are also typically conducted at each plant. Each generator is typically tested for 24 hours
12 on a staggered test schedule (e.g., once every refueling outage). Plants with nonelectric fire
13 pumps, typically also diesel-fired, usually employ test protocols identical or similar to those used
14 for emergency generators. Maintenance procedures during these tests would include, for
15 example, checks for leaks of lubricating oil or fuel from equipment, and pumps would be
16 replaced as required.

17 In addition to the emergency diesel generators, fossil fuel (i.e., diesel-, oil-, or natural gas-fired)
18 boilers are used primarily for evaporator heating, plant space heating, and/or feed water
19 purification. These units typically operate at a variable load on a continuous basis throughout
20 the year unless end use is restricted to one application, such as space heating. For example,
21 the Peach Bottom plant uses two auxiliary boilers for space heating and to help with unit
22 startups (NRC 2020g). Air emissions include carbon monoxide (CO), nitrogen oxides (NO_x),
23 carbon dioxide (CO₂), methane, nitrous oxide, particulate matter (PM), and volatile organic
24 compounds (VOCs) for diesel-, natural gas-, and oil-fired units. Natural gas-fired units emit only
25 trace amounts of VOCs and PM that has an aerodynamic diameter of 10 μm or less (PM₁₀).
26 The utility boilers at commercial plants are relatively small compared to most industrial boilers
27 and are typically regulated through State-level operating permits.

28 Given the infrequency and short duration of maintenance testing of onsite combustion sources,
29 annual air emissions are minor. For example, the contribution of air emissions from sources at
30 the LaSalle, River Bend, Waterford, Peach Bottom, Turkey Point, Surry, Point Beach, and North
31 Anna plants constitute anywhere from 0.2 to 2 percent of the County's (where the plant is
32 located) annual air emissions (NRC 2016d, NRC 2018c, NRC 2018d, NRC 2019c, NRC 2020c,
33 NRC 2020f, NRC 2021f, NRC 2021g). Therefore, annual air emissions from nuclear power
34 plant sources would not be an air quality concern even at those plants located in or adjacent to
35 nonattainment areas. The locations of the currently designated nonattainment areas near
36 nuclear plants are shown in Section 3.3.2.

37 As discussed in Section 3.3.2, cooling tower drift can increase downwind PM concentrations,
38 impair visibility, ice roadways, cause drift deposition, and damage vegetation and painted
39 surfaces. Currently, 16 nuclear power plants use natural draft cooling towers and 11 nuclear
40 power plants use mechanical draft cooling towers. Currently, no dry or hybrid (combinations
41 incorporating elements of both dry and wet design) systems are being used at operating nuclear
42 plants. The natural draft cooling tower at the Hope Creek Generating Station (Hope Creek) in
43 New Jersey is the only operating tower at a plant that uses high-salinity water for cooling system
44 makeup, which results in greater PM₁₀ concentrations (NRC 2011b). An air quality impact
45 analysis performed in support of an extended power uprate request for Hope Creek assessed
46 emissions related to cooling tower drift droplets for this situation. The analysis determined that

Environmental Consequences and Mitigating Actions

1 cooling tower operations would result in average PM₁₀ emissions of 35.6 lb/hr, as summarized in
2 Section 3.3.2, and the New Jersey Department of Environmental Protection determined that the
3 PM₁₀ emissions would not exceed National Ambient Air Quality Standards. Thus, although
4 there is the potential for some air quality impacts to occur as a result of equipment and cooling
5 tower operations, as in the case with Hope Creek, the impacts have been small.

6 Diesel generators, pumps, fossil fuel boilers, and cooling towers typically require State or local
7 operating permits. Operating permits specify conditions that limit air emissions, hours of
8 operation, fuel content, or fuel consumption. Most State air pollution regulations provide air
9 permit exemptions for air pollution sources that are not routinely operated, which can be defined
10 as sources with insignificant activity meeting specified operating criteria (e.g., so many hours of
11 continuous operation over specified periods or so many hours of operation per year). For
12 example, the North Anna plant has one emergency generator, one diesel generator, and two fire
13 pump diesel generators that are exempt from the site's State Operating Permit conditions
14 because they are considered insignificant equipment emission units of minimal or no air quality
15 concern (NRC 2021g). The Fermi plant uses two natural draft hyperbolic cooling towers that
16 are exempt from Michigan's air permitting requirements. Particulate matter (with a diameter of
17 10 microns or less) emissions of each cooling tower are estimated to be 0.10 T/yr (NRC 2016c).

18 License renewal environmental reviews performed since publication of the 2013 LR GEIS (see
19 Section 4.1.3) have not identified new information or situations that would result in air quality
20 impacts that would differ from what was concluded in the 2013 LR GEIS for either an initial LR
21 or SLR term. In the SEISs (for initial LRs and SLRs), the NRC concluded that fossil fuel-fired
22 equipment is operated intermittently, primarily during testing or outages, annual air emissions
23 are minor, and air emissions and sources would not be expected to change or have different
24 impacts on air quality during the LR term. Therefore, the potential impact from onsite air
25 emission sources on air quality would be expected to be SMALL for all nuclear plants, and it is a
26 Category 1 issue for both initial LR and SLR.

27 Potential sources of impacts on air quality during refurbishment activities associated with
28 continued operations during the license renewal term include (1) fugitive dust from site
29 excavation and grading and (2) emissions from motorized equipment, construction vehicles, and
30 workers' vehicles. With application of adequate controls or mitigation measures and best
31 practices, the air quality impacts from these air pollution sources would be small and of
32 relatively short duration.

33 During site excavation and grading, some PM in the form of fugitive dust would be released into
34 the atmosphere. Construction vehicles and other motorized equipment would generate exhaust
35 emissions that include small amounts of CO, NO_x, VOCs, and PM. These emissions would be
36 temporary (restricted to the construction period) and localized (occurring only in the immediate
37 vicinity of construction areas). For refurbishment occurring in geographical areas with poor or
38 marginal air quality, the emissions generated from these activities could be cause for concern in
39 a few cases (e.g., building demolition, debris removal, and new construction). However, the
40 1990 Clean Air Act Amendments include a provision that requires Federal actions conform to an
41 applicable State Implementation Plan designed to achieve the National Ambient Air Quality
42 Standards for criteria pollutants (sulfur dioxide [SO₂], nitrogen dioxide, CO, ozone, lead, PM₁₀,
43 and PM with a mean aerodynamic diameter of 2.5 μm or less [PM_{2.5}]).

44 On April 5, 2010, the U.S. Environmental Protection Agency (EPA) issued its 40 CFR Part 51
45 and 93 revisions to the General Conformity Regulations in the *Federal Register* (75 FR 17254).
46 General conformity requires Federal agencies to ensure that a proposed Federal action, such

1 as initial LR or SLR, in air quality nonattainment or maintenance areas conforms to the
2 applicable State Implementation Plan. A conformity analysis must be completed before the
3 action is taken. A conformity analysis begins with an applicability analysis to determine whether
4 the action is exempt or has total net direct and indirect emissions below the *de minimis* levels.
5 The *de minimis* emission levels (40 CFR 93.153(b)) serve as screening values to determine
6 whether a conformity determination must be undertaken for a proposed Federal action. The
7 applicability analysis must be documented. If conformity applies, the agency must prepare a
8 written conformity analysis and determination for each pollutant for which the emissions caused
9 by a proposed Federal action would exceed the *de minimis* levels. An area is designated as
10 nonattainment for a criteria pollutant if it does not meet National Ambient Air Quality Standards
11 for the pollutant. A maintenance area is one that a State has redesignated from nonattainment
12 to attainment. The current nationwide designations of nonattainment areas are identified in
13 Section 3.3.2.

14 The *de minimis* levels for air emissions vary depending on air quality conditions in the area
15 where the plant is located. In most cases, the *de minimis* levels are established at 100 T/yr.
16 Exceptions include:

- 17 • NO_x or VOC emissions of 10, 25, and 50 T/yr in extreme, severe, and serious ozone
18 nonattainment areas, respectively;
- 19 • VOC emissions of 50 T/yr in ozone nonattainment areas inside an ozone transport region
20 stretching from Virginia to Maine;
- 21 • Lead emissions of 25 T/yr in lead nonattainment areas;
- 22 • PM₁₀ emissions of 70 T/yr in serious PM₁₀ nonattainment areas; and
- 23 • SO₂, NO_x, VOC, and ammonia emissions of 70 T/yr in serious PM_{2.5} nonattainment areas.

24 In maintenance areas, the *de minimis* levels are 100 T/yr for all pollutants, except for 50 T/yr for
25 VOCs inside the ozone transport region and 25 T/yr for lead.

26 The EPA regulations require that direct construction emissions including construction vehicle
27 and equipment exhaust and fugitive dust and indirect emissions, such as those from worker and
28 delivery vehicles, be included in the conformity analysis. Emissions from construction
29 equipment and vehicles are expected to be small for anticipated refurbishment projects on the
30 basis of activities that have occurred to date. In the 1996 LR GEIS, the NRC concluded that the
31 impacts from plant refurbishment associated with license renewal on air quality could range
32 from SMALL to LARGE, although these impacts were expected to be SMALL for most plants.
33 The 1996 LR GEIS determined that emissions from 2,300 vehicles over a 9-month
34 refurbishment period may exceed the thresholds for CO, NO_x, and VOCs in nonattainment and
35 maintenance areas. In the 2013 LR GEIS, the NRC concluded that the impact of refurbishment
36 activities on air quality would be SMALL for most plants. The 2013 LR GEIS noted that findings
37 from license renewal SEISs published since the 1996 LR GEIS have shown that refurbishment
38 activities, such as steam generator and vessel head replacement, have not required the large
39 numbers of workers, months of time, or the degree of land disturbance that was conservatively
40 estimated in the 1996 LR GEIS. For example, refurbishment activities associated with license
41 renewal for the Davis-Besse plant required an additional 1,400 workers for 90 days. It was
42 estimated that the additional worker vehicles for this duration would result in 25 T of VOCs, 49 T
43 of NO_x, 1.0 T of SO₂, and 1.5 T of PM_{2.5} (direct emissions) being emitted, which would not
44 exceed the *de minimis* levels of 100 T/yr of NO_x, 50 T/yr of VOCs for ozone maintenance areas,
45 100 T/yr of direct emissions of PM_{2.5}, 100 tons per year of SO₂, 100 T/yr for PM_{2.5} maintenance

Environmental Consequences and Mitigating Actions

1 areas and 100 T/yr for SO₂ nonattainment areas, as set forth in 40 CFR 93.153(b) (NRC 2015e).
2 Additionally, Exelon Generating Company LLC (Exelon) estimated that steam generator
3 replacement of Byron Unit 2 would require an additional 500 workers for 90 days (NRC 2015c).
4 The NRC staff concluded that the additional workforce for steam generator replacement
5 activities would be temporary and estimated to result in an additional 3.3 T (3.0 MT) of VOCs,
6 9.8 T(8.9 MT) of NO_x, 0.04 T (0.04 MT) of SO₂, and 0.40 T (0.36 MT) of PM_{2.5} (direct emissions)
7 being emitted, which do not exceed the *de minimis* levels of 100 T/yr set forth in 40 CFR
8 93.153(b). Therefore, the NRC concluded that the additional emissions resulting from these
9 activities would be minor (NRC 2015c). For Indian Point vessel head replacement and control
10 rod mechanism replacement, the NRC staff estimated that an additional 500 workers for
11 60 days would result in an additional 3.4 T (3.1 MT) of VOCs, 31.1 T (28.2 MT) of CO, 2.3 T
12 (2.1 MT) of NO_x, 0.08 T (0.07 MT) of SO₂, and 0.01 T (0.01 MT) of PM_{2.5} (NRC 2018e). These
13 additional emissions would not exceed the *de minimis* levels for designated maintenance areas
14 of 100 T (91 MT) for each pollutant.

15 The 1996 LR GEIS found that disturbed areas for refurbishment actions required 10 acres (ac)
16 (4 hectares [ha]) or less for laydown areas and storage. Since publication of the 1996 LR GEIS
17 and 2013 LR GEIS, the NRC has not identified refurbishment activities that would require
18 disturbance of land that exceeds 10 ac (4 ha). For example, as part of refurbishment activities
19 associated with license renewal for the Davis-Besse plant, temporary and permanent buildings
20 were constructed and laydown areas were needed, which resulted in land disturbance of less
21 than 10 ac (4 ha) (NRC 2015e). For Indian Point vessel head replacement and control rod
22 mechanism replacement, storage would require construction of a permanent building requiring
23 0.12 ac (0.04 ha) (NRC 2010a). Because of the (1) small size of the disturbed area,
24 (2) relatively short construction period, (3) availability of paved roadways at existing facilities,
25 and (4) use of best management practices (BMPs) (such as watering, chemical stabilization,
26 and seeding), fugitive dust resulting from these construction activities is minimal.

27 The staff reviewed information from SEISs (for initial LRs and SLRs) completed since
28 development of the 2013 LR GEIS identified no new information or situations that would result in
29 different impacts for this issue for either an initial LR or SLR term. The NRC concludes that the
30 impact of refurbishment activities on air quality during the initial LR or SLR terms would be
31 SMALL. Impacts would be temporary and cease once projects were completed and
32 implementation of BMPs, including fugitive dust controls and the imposition of new and/or
33 revised conditions in State and local air emissions permits, would ensure conformance with
34 applicable State or Tribal implementation plans.

35 The NRC also concludes that the air quality impacts of continued nuclear plant operations
36 during the initial LR and SLR terms and refurbishment would be SMALL for all plants. The staff
37 has identified no information that would lead to different impacts on air quality during the initial
38 LR term or SLR term. Therefore, the impacts of initial LR and SLR on air quality is a Category 1
39 issue.

40 4.3.1.1.2 Air Quality Effects of Transmission Lines

41 Small amounts of ozone and substantially smaller amounts of oxides of nitrogen are produced
42 by transmission lines during corona, a phenomenon that occurs when air ionizes near isolated
43 irregularities on the conductor surface such as abrasions, dust particles, raindrops, and insects.
44 Several studies have quantified the amount of ozone generated and concluded that the amount
45 produced by even the largest lines in operation (765 kilovolt [kV]) is insignificant (SNYPSC
46 1978; Scott-Walton et al. 1979; Janes 1978; Varfalvy et al. 1985). Monitoring of ozone levels for

1 2 years near a Bonneville Power Administration 1,200 kV prototype line revealed no increase in
2 ambient ozone levels caused by the line (Lee et al. 1989). Similarly, field tests conducted over
3 a 19-month period concerning ozone levels adjacent to Sequoyah transmission lines concluded
4 that high-voltage lines up to 765 kV do not generate ozone above ambient measurements made
5 at locations remote from transmission lines (TVA 2013; NRC 2015f). The ozone concentrations
6 generated by transmission lines are therefore too low to cause any significant effects. The
7 minute amounts of oxides of nitrogen produced are similarly insignificant. On the basis of these
8 considerations, the NRC concludes that the air quality impacts of transmission lines, within this
9 scope of review (see Sections 3.1.1 and 3.1.6.5 in this LR GEIS), during the initial LR and SLR
10 terms would be SMALL. The staff reviewed information from SEISs (for initial LRs and SLRs)
11 completed since development of the 2013 LR GEIS and identified no new information or
12 situations that would result in different impacts for this issue for either an initial LR or SLR term.
13 This is supported by the evidence that production of ozone and nitrogen oxide are insignificant
14 and does not measurably contribute to ambient levels of those gases. Potential mitigation
15 measures (e.g., burying transmission lines) would be very costly and would not be warranted.
16 Therefore, the issue of air quality impacts of transmission lines would be SMALL for all nuclear
17 plants, and it is a Category 1 issue for both initial LR and SLR.

18 4.3.1.2 *Noise*

19 One issue related to noise impacts during the license renewal (initial LR or SLR) term is
20 considered in this section:

- 21 • noise impacts of continued operations and refurbishment activities.

22 4.3.1.2.1 *Noise Impacts*

23 Noise from nuclear plant operations can often be detected offsite relatively close to the plant site
24 boundary. Sources of noise and the relative magnitude of impacts during normal nuclear power
25 plant operations are discussed in Section 3.3.3. Major sources of noise at operating nuclear
26 power plants include cooling towers, turbines, transformers, large pumps, firing range, steam
27 safety relief valves, and cooling water system motors. Nuclear plant operations have not
28 changed appreciably with time, and no change in noise levels or noise-related impacts are
29 expected during the initial LR or SLR term.

30 Given the industrial nature of the power plant and the number of years of plant operation, noise
31 from a nuclear plant is generally nothing more than a continuous minor nuisance. However,
32 noise levels may sometimes exceed the day-night average 55 A-weighted decibels (dBA) level
33 that the EPA uses as a threshold level to protect against excess noise during outdoor activities
34 (EPA 1974). For instance, continuous measurements at three noise-sensitive receptors from
35 Fermi Unit 2 resulted in a day-night sound level of between 55 and 63 dBA (NRC 2016c). While
36 the day-night sound levels measured are above EPA's recommended threshold, it does "not
37 constitute a standard, specification, or regulation," rather it is intended to provide a basis for
38 State and local governments establishing noise standards. Furthermore, the day-night sound
39 levels measured at noise-sensitive receptors near Fermi Unit 2 were below the Federal Housing
40 Administration guideline of a day-night average sound level of 65 dBA or less (NRC 2016c, 24
41 CFR Part 51). In 2008, an ambient noise-monitoring survey was performed in areas adjacent to
42 the Turkey Point site. Measurements (equivalent sound intensity level) at monitoring locations
43 offsite and beyond the site boundary (including nearest residence, day-care facility, and a park)
44 ranged from 46 dBA to 67 dBA during the daytime and from 41 dBA to 56 dBA at nighttime.
45 Audible noise sources contributing to noise levels included traffic, insects, and wind, indicating

Environmental Consequences and Mitigating Actions

1 that audible sound from the Turkey Point site does not reach these noise-sensitive receptors
2 (NRC 2016b). Ambient sound level surveys in the vicinity of nuclear power plants have not
3 approached 80–85 dBA, which is the threshold at which noise levels can become very annoying
4 (CDC 2019b).

5 In addition to EPA and U.S. Department of Housing and Urban Development noise threshold
6 guidelines, local governments can establish noise ordinances. For example, Louisa County,
7 VA, where the North Anna plant is located, has a noise ordinance that limits daytime sound
8 levels to 75 decibels (dB) and nighttime sound levels to 65 dB for industrial zoning districts
9 (NRC 2021g). Similarly, Waterford is located in a designated industrial land use area within a
10 heavy manufacturing zoning district. St. Charles Parish (where Waterford is located) has a
11 noise ordinance, but the ordinance does not set maximum permissible sounds levels for areas
12 zoned as industrial (NRC 2018d).

13 Nuclear power plants have received noise complaints associated with operational activities. For
14 instance, Braidwood received noise complaints related to the cooling water discharge system
15 into the Kankakee River. Prior to 2011, this system produced noticeable noise at the discharge
16 location. In 2011, Exelon installed a new diffuser for water discharge into the Kankakee River,
17 which, among other environmental benefits, nearly eliminated noise from the discharge location
18 (NRC 2015d). Furthermore, Exelon notifies the public about upcoming activities and the
19 potential for noise via their notification system. The notification system alerts residences and
20 other locations within 1 mi (1.6 km) of Braidwood prior to planned activities that may affect the
21 surrounding area. Similarly, in response to complaints regarding activities associated with
22 nighttime fire training at the range at Fermi, DTE Electric notifies the nearby municipalities of
23 upcoming scheduled training at the range and provides information about upcoming activities
24 (NRC 2016c).

25 Noise would also be generated by construction-related activities and equipment used during
26 refurbishment. Noise attenuates rapidly with distance. As a rule of thumb, with a doubling in
27 distance from a point source the sound level decreases by 6 dB. Additionally, this noise would
28 occur for relatively short periods of time (several weeks) and is not expected to be
29 distinguishable from other operational noises at the site boundary or create an adverse impact
30 on nearby residents.

31 In the 1996 LR GEIS, the NRC noted that there have been few noise complaints at power
32 plants, but that noise impacts have been found to be small. Because noise sources at power
33 plants do not change appreciably during the aging process, the 1996 LR GEIS concluded that
34 noise was not expected to be a problem at any nuclear plant during the license renewal term
35 and given the few noise complaints no additional mitigation measures are warranted. The
36 magnitude of noise impacts was therefore determined to be SMALL for all plants, and the issue
37 was designated as Category 1. The staff reviewed information from SEISs (for initial LRs and
38 SLRs) completed since development of the 2013 LR GEIS and identified no new information or
39 situations that would result in different impacts for this issue for either an initial LR or SLR term.
40 The NRC has found that noise sources and levels are not expected to change from current
41 operations and therefore would remain similar during the initial LR or SLR term.

42 On the basis of these considerations, the NRC concludes that the noise impact of continued
43 nuclear plant operations during the initial LR and SLR terms and refurbishment would be
44 SMALL for all plants. Therefore, this is a Category 1 issue.

1 4.3.2 Environmental Consequences of Alternatives to the Proposed Action

2 *Construction* – Construction of a replacement power alternative would result in temporary
3 impacts on local air quality. Air emissions would include criteria pollutants (PM, NO_x, CO, and
4 SO₂), hazardous air pollutants, and greenhouse gases (GHGs) from construction vehicles and
5 equipment and dust from land clearing and grading. VOCs could be released from organic
6 solvents used in cleaning, during the application of protective coatings, and the onsite storage
7 and use of petroleum-based fuels. Air emissions would be intermittent and would vary
8 depending on the level and duration of specific activities throughout the construction phase.
9 Engine exhaust emissions would be from heavy construction equipment and commuter,
10 delivery, and support vehicular traffic traveling to and from the facility as well as within the site.
11 Fugitive dust emissions would be from soil disturbances by heavy construction equipment (e.g.,
12 earthmoving, excavating, and bulldozing), vehicle traffic on unpaved surfaces, concrete batch
13 plant operations, and wind erosion to a lesser extent. Various mitigation techniques and BMPs
14 (e.g., watering disturbed areas, reducing equipment idle times, and using ultra-low sulfur diesel
15 fuel) could be used to minimize air emissions and reduce fugitive dust.

16 Construction of a replacement power alternative would be similar to the construction of any
17 industrial facility in that they all involve many noise-generating activities. In general, noise
18 emissions would vary during each phase of construction, depending on the level of activity,
19 types of equipment and machinery used, and site-specific conditions. Typical construction
20 equipment, such as dump trucks, loaders, bulldozers, graders, scrapers, air compressors,
21 generators, and mobile cranes, would be used, and pile-driving and blasting activities could take
22 place. Other noise sources include construction worker vehicle and truck delivery traffic.
23 Impacts, however, would be temporary, and both air quality and noise impacts would return to
24 preconstruction levels after construction was completed.

25 Air quality and noise impacts from construction activities would be similar whether occurring at a
26 greenfield site, brownfield site, or at an existing nuclear power plant.

27 *Operations* – The impacts on air quality as a result of operation of a facility for a replacement
28 power alternative would depend on the energy technology (e.g., fossil, new nuclear, or
29 renewable). Air quality would be affected during operations by cooling tower drift, auxiliary
30 power equipment, building heating, ventilation, and air conditioning (i.e., HVAC) systems, and
31 vehicle emissions. Auxiliary power equipment could include standby diesel generators and
32 power systems for emergency power and auxiliary steam.

33 Noise generated during operation would include noise from cooling towers (water pumps,
34 cascading water, or fans), transformers, turbines, pumps, compressors, loudspeakers, other
35 auxiliary equipment such as standby generators, and vehicles. Noise from vehicles would be
36 intermittent.

1 4.3.2.1 Fossil Energy Alternatives

2 Construction – Air quality and noise impacts would be the same as described in Section 4.3.2.

3 Operations – Fossil fuel (coal, natural gas) power plants can have a significant impact on air
 4 quality. The burning of fossil fuels is a major source of criteria pollutants and GHGs, primarily
 5 CO₂, as well as other hazardous air pollutants. The exact nature of these pollutants and their
 6 quantity depends on many factors, including the chemical constituency of the fuel, combustion
 7 technology, air pollution control devices, and onsite management of fuel and waste material.
 8 Table 4.3-1 presents representative emission factors for various fossil fuel power plants. The
 9 values presented in Table 4.3-1 are not all inclusive of fossil fuel-burning technologies, but
 10 represent the possible range of operational emissions that could result from fossil fuel-fired
 11 power plants. In comparing these emission factors, it is apparent that air emissions from a
 12 natural gas combined cycle (NGCC) power plant would be less than those from operation of an
 13 integrated gasification combined cycle (IGCC) or supercritical pulverized coal (SCPC) plant.

14 **Table 4.3-1 Emission Factors of Representative Fossil Fuel Plants**

Pollutant	Emission Factors ^(a) in kg/MWh (lb/MWh) for NGCC ^(b)	Emission Factors ^(a) in kg/MWh (lb/MWh) for SCPC ^(c)	Emission Factors ^(a) in kg/MWh (lb/MWh) for IGCC ^(d)
SO ₂	0.003 (0.006)	0.294 (0.648)	0.059 (0.130)
NO _x	0.010 (0.022)	0.318 (0.700)	0.177 (0.390)
PM	0.005 (0.012)	0.041 (0.090)	0.021 (0.047)
CO	0.005 (0.012)	N/A	N/A
CO ₂	336 (741)	738 (1,627)	602 (1,328)

15 SO₂ = sulfur dioxide; NO_x = nitrogen oxides; PM = particulate matter; CO = carbon monoxide; CO₂ = carbon dioxide;
 16 kg/MWh = kilograms per megawatt-hr; lb/MWh = pounds per megawatt-hr; NGCC = natural gas combined cycle;
 17 SCPC = supercritical pulverized coal; IGCC = integrated gasification combined cycle; N/A = not available.

18 (a) Values are based on gross output and no carbon capture technology.

19 (b) Emission factors are based on two combustion turbine-generators, a gross output of 740 MW, a capacity factor
 20 of 85 percent, NO_x emissions control technology (selective catalytic reduction and dry low NO_x burner), and low
 21 natural gas sulfur content.

22 (c) Emission factors are based on a gross output of 685 MW, a capacity factor of 85 percent, SO₂ emission control
 23 technology (wet limestone forced oxidation), NO_x control technology (low NO_x burner and selective catalytic
 24 reduction), and bituminous coal.

25 (d) Emission factors are based on two Shell gasifiers, a total gross output of 765 MW, a capacity factor of 80
 26 percent, two carbon beds to remove mercury, and bituminous coal.

27 Source: NETL 2019.

28 Air quality and noise impacts from operations of a fossil fuel power plant would be the same as
 29 described in Section 4.3.2. Operation of a natural gas power plant would also include offsite
 30 mechanical noise from compressor stations and pipeline blowdowns. The Federal Energy
 31 Regulatory Commission requires that any new compressor station or any modification, upgrade,
 32 or update of an existing station must not exceed a day-night sound intensity level of 55 dBA at
 33 the closest noise-sensitive area (18 CFR 157.206).

34 4.3.2.2 New Nuclear Alternatives

35 Construction – Air quality and noise impacts for the construction of a new nuclear power plant
 36 would be the same as those described in Section 4.3.2. Air emissions from construction would
 37 be limited, local, and temporary. Noise impacts during construction would be limited to the
 38 immediate vicinity of the site.

1 *Operations* – Air quality and noise impacts would be the same as those described in
 2 Section 4.3.2. An operating nuclear plant would have minor air emissions associated with
 3 stationary combustion sources (e.g., diesel generators, auxiliary boilers, pumps) and mobile
 4 sources (e.g., worker vehicles, truck deliveries). Additional air emissions would result from the
 5 use of cooling towers and could contribute to the impacts associated with the formation of
 6 visible plumes, fogging, and subsequent icing downwind of the towers. Noise sources would
 7 include turbines, cooling towers, transformers, and vehicular traffic associated with worker and
 8 delivery vehicles.

9 **4.3.2.3 Renewable Alternatives**

10 *Construction* – Air quality and noise impacts for the construction of land-based alternative
 11 energy technologies would be the same as those described in Section 4.3.2. Air quality impacts
 12 associated with the construction of offshore power-generating facilities and support structures
 13 include the emission of criteria pollutants from construction barges and equipment (e.g., cranes,
 14 compressors) and vehicles delivering materials and crews to embarkation locations on the
 15 shore, and dust from the construction of onshore facilities (e.g., cable landings, substations).

16 Construction-related noise impacts would be substantially different offshore than those
 17 associated with onshore construction because these activities would be distant from most
 18 human receptors and because noise propagates much greater distances in water. Sources of
 19 noise would include crew vessels and construction and equipment barges; seismic technologies
 20 used to characterize the site; explosives or pile-driving to construct foundations for offshore
 21 wind turbines or anchoring devices for wave, tidal, and current energy capturing equipment; and
 22 excavation of sea bottoms for installation of buried power and communication cables.
 23 Construction-related impacts on air quality and noise would generally be temporary.

24 *Operations* – In general, air quality impacts associated with most renewable energy alternatives
 25 would be negligible because no burning of fossil fuels resulting in direct air emissions would be
 26 required to generate electricity. Emission sources associated with the operation of renewable
 27 energy alternatives could include engine exhaust from worker vehicles, heavy equipment
 28 associated with site inspections, onsite combustion sources (emergency diesel generators,
 29 pumps), and cooling towers. Biomass, geothermal, and refuse-derived fuel facilities, however,
 30 can emit significant air emissions, including criteria pollutants, polycyclic aromatic hydrocarbons,
 31 mercury, and hazardous air pollutants (Ciferno and Marano 2002; NREL 2003; Kagel et al.
 32 2005; BLM 2008). Air emissions associated with the operation of offshore facilities will also
 33 result from engine exhaust of vessel traffic traveling to and from offshore sites for operation and
 34 maintenance activities.

35 Noise sources associated with operation of renewable energy alternatives can include
 36 transformers, transmission lines, cooling towers, pumps, and worker vehicles. Noise generated
 37 by onshore and offshore wind turbines includes aerodynamic noise from the blades and
 38 mechanical noise from turbine drivetrain components (generator, gearbox). Noise impacts
 39 would depend on the proximity of noise-sensitive receptors to noise sources.

1 **4.4 Geologic Environment**

2 **4.4.1 Environmental Consequences of the Proposed Action – Continued Operations**
3 **and Refurbishment Activities**

4 *4.4.1.1 Geology and Soils*

5 This issue was added in the 2013 LR GEIS. Geologic and soil conditions at all nuclear power
6 plants and associated transmission lines have been well established during the current licensing
7 term. These conditions are expected to remain unchanged during the 20-year license renewal
8 (initial LR or SLR) term.

9 The impact of continued operations and any refurbishment associated with license renewal on
10 geologic and soil resources would consist of soil disturbance, including sediment and/or any
11 associated bedrock, for projects, such as replacing or adding buildings, roads, parking lots, and
12 belowground and aboveground utility structures. For such projects, a licensee may also need to
13 obtain geologic resources (e.g., soil or sand borrow or backfill material, aggregate for road
14 building or concrete production) from locations on the nuclear power plant site or from offsite
15 borrow areas or quarries. However, it is more likely that these materials would be obtained from
16 commercial vendors. Regardless, for onsite activities, implementation of BMPs by the plant
17 licensee would reduce soil erosion and subsequent impacts on surface water quality. These
18 practices include, but are not limited to, minimizing the amount of disturbed land, stockpiling
19 topsoil before ground disturbance, mulching and seeding in disturbed areas, covering loose
20 materials with temporary covers such as geotextiles, using sediment (silt) fences to reduce
21 sediment loading to surface water, using check dams to minimize the erosive power of
22 drainages, and installing proper culvert outlets to direct flows in streams or drainages.

23 Detailed geotechnical analyses would be required to address the stability of excavations,
24 foundation footings, and slope cuts for building construction, road creation, or other
25 refurbishment-related construction projects. Depending on the plant location and design,
26 riverbank or coastline protection might need to be upgraded, especially at water intake or
27 discharge structures, if natural flows, such as storm surges, cause an increase in erosion. For
28 example, at the Point Beach plant, the bluffs along Lake Michigan are subject to erosion from
29 storm action. The licensee performs necessary shoreline and bank stabilization activities in
30 accordance with an authorization from the U.S. Army Corps of Engineers (USACE). In 2019,
31 the licensee initiated a project to construct a new breakwater structure (wave barrier) along the
32 plant boundary with Lake Michigan. The project was completed in August 2020. The work
33 included construction of a new breakwater structure extending north from near the midpoint of
34 the Point Beach Unit 2 discharge flume for approximately 600 ft (185 m) to an existing
35 breakwater structure. The second 600 ft (185 m) segment of the breakwater extends south
36 from near the midpoint of the Point Beach Unit 1 flume and curves back to the existing
37 shoreline. The breakwater structure consists of large armor stones (dolomite blocks) stacked
38 on the lake bottom. The project also included installation of additional riprap protection along
39 the shoreline, extending for 400 linear ft (120 m) and including the shoreline segment between
40 the plant's two discharge flumes (NRC 2021f).

41 In addition, the Farmland Protection Policy Act of 1981 (7 USC 4201 et seq.) requires Federal
42 agencies to take into account agency actions affecting the preservation of farmland, including
43 prime and other important farmland soils, as described in Section 3.4. While the Farmland
44 Protection Policy Act could apply in some circumstances at nuclear power plant sites
45 (e.g., development of renewable energy resources as an alternative to license renewal, other

1 projects completed with Federal assistance including funding), it does not apply to Federal
2 permitting or licensing actions for activities on private or non-Federal lands (7 CFR Part 658).

3 Plant-specific environmental reviews conducted by the NRC to date have not identified any
4 significant impact issues related to continued operations and refurbishment activities on geology
5 and soils.

6 The impacts of natural phenomena, including geologic hazards, on nuclear power plant
7 systems, structures, and components are outside the scope of the NRC's license renewal
8 environmental review. Nonetheless, the environmental review documents the potential effects
9 of continued nuclear power plant operation during the license renewal term, including any
10 refurbishment activities, on the environment. As discussed in Section 3.4, nuclear power plants
11 were originally sited, designed, and licensed in consideration of the geologic and seismic criteria
12 set forth in 10 CFR 100.10(c)(1) and 10 CFR Part 100, Appendix A, and, where applicable,
13 10 CFR Part 50, Appendix A. In its license renewal environmental reviews, for instance, the
14 NRC considers the risk to reactors from seismicity in the evaluation of severe accidents. Where
15 appropriate, seismic issues are also assessed in the plant-specific safety review that is
16 performed for license renewals. The NRC also conducts safety reviews prior to allowing
17 licensees to make operational changes due to changing environmental conditions.

18 Further, the NRC requires all licensees to take seismic activity into account in order to maintain
19 safe operating conditions at all nuclear power plants. When new seismic hazard information
20 becomes available, the NRC evaluates the new information to determine if any changes are
21 needed at existing plants, as discussed in Section 1.7.6 of this LR GEIS. This reactor oversight
22 process, which considers seismic safety, is separate and distinct from the NRC staff's license
23 renewal environmental review.

24 The impact of continued operations and refurbishment on geology and soils during the license
25 renewal term was considered to be SMALL for all plants and a Category 1 issue in the 2013 LR
26 GEIS. The staff reviewed information from SEISs (for initial LRs and SLRs) completed since
27 development of the 2013 LR GEIS and identified no new information or situations that would
28 result in different impacts for this issue for either an initial LR or SLR term. The staff concludes
29 that the impacts of continued nuclear plant operations during the initial LR or SLR terms and
30 any refurbishment activities on geology and soils would be the same (SMALL) for all nuclear
31 plants. As a result, geology and soils is a Category 1 issue.

32 **4.4.2 Environmental Consequences of Alternatives to the Proposed Action**

33 *Construction* – For all alternatives (including fossil energy, new nuclear, and renewable
34 alternatives) discussed in this section, the impacts of construction on geology and soils would
35 be similar in nature but would likely vary in intensity based on the land area required. Land
36 would be cleared of any vegetation during construction. Clearing and grading activities over
37 large land areas increases the risk of soil erosion, soil loss, and potential offsite water quality
38 impacts due to stormwater runoff. Soils would be stored onsite for redistribution at the end of
39 construction. Land clearing during construction and the installation of power plant structures
40 and impervious surfaces (e.g., roads, parking lots, buildings) would alter surface drainage.
41 Sources of engineered fill (e.g., compacted soil or other material) and aggregate such as
42 crushed stone and sand and gravel would be required for construction of buildings, foundations,
43 roads, and parking lots. Once facility construction is completed, areas disturbed during
44 construction would be within the footprint of the completed facilities, overlain by other
45 impervious surfaces (such as roadways and parking lots), or revegetated or stabilized as

Environmental Consequences and Mitigating Actions

1 appropriate, so there would be no additional land disturbance and no direct operational impacts
2 on geology and soils. Consumption of geologic resources (e.g., aggregate materials or topsoil)
3 for maintenance purposes during operations would be negligible.

4 4.4.2.1 *Fossil Energy Alternatives*

5 *Operations* – Impacts on soil and geologic resources during power plant operations would be
6 limited to the extraction of fossil fuel, typically at existing mining and drilling locations away from
7 the power plant. Surface mining or underground mining for coal would result in various degrees
8 of overburden clearing, soil stockpiling, waste rock disposal, re-routing of drainages, and
9 management of any co-located geologic resources. Drilling for petroleum resources would
10 involve clearing and grading for drill pads and construction of underground pipelines with
11 associated soil disturbance. Proper design of surface water crossings would be needed to
12 manage the potential for erosion at these locations. Eventual closure of extraction sites would
13 require proper restoration of mines and other sites to reduce environmental impacts.

14 4.4.2.2 *New Nuclear Alternatives*

15 *Operations* – Impacts on soil and geologic resources during operations would be limited to the
16 extraction of uranium ore material used to make nuclear fuel, typically at existing mining
17 locations away from the power plant. The extraction could involve mining techniques similar to
18 those used for fossil fuels, along with management of ore tailings. However, another method is
19 solution mining (in situ leach uranium recovery), which involves the construction of drilling pads
20 for injection and recovery wells to remove uranium from underground ore bodies.

21 4.4.2.3 *Renewable Alternatives*

22 *Operations* – For renewable energy facilities requiring large land areas (i.e., solar PV and solar
23 thermal), vegetation maintenance during operations would increase the potential for soil erosion
24 and loss by wind and precipitation runoff.

25 Other renewable technologies would entail potential operational impacts inherent to their
26 design. The operation of hydroelectric dams would induce downstream impacts, including
27 sediment transport and deposition patterns, and channel erosion or scouring. Geothermal
28 energy facilities can induce land subsidence due to the removal of large quantities of ground-
29 water. Farming to provide feedstock for biomass-fuel facilities would have the potential for
30 increased soil erosion and the release of pesticides and fertilizers to nearby surface water
31 bodies.

32 4.5 Water Resources

33 Hydrologic and water quality conditions at all nuclear power plants and associated transmission
34 lines have been well established during the current licensing terms. However, continued
35 operations and any refurbishment activities could have an impact on water resources during the
36 license renewal (initial LR or SLR) terms. This section describes the potential impact of these
37 proposed activities and alternatives on surface water and groundwater resources.

1 **4.5.1 Environmental Consequences of the Proposed Action – Continued Operations**
 2 **and Refurbishment Activities**

3 Continued operations and any refurbishment activities during the license renewal term could
 4 affect surface water and groundwater resources in a manner similar to what has occurred during
 5 the current license term (see Sections 3.5.1 and 3.5.2, respectively).

6 *4.5.1.1 Surface Water Resources*

7 For the most part, no significant surface water impacts are anticipated during the license
 8 renewal terms that would be different from those occurring during the current license term.
 9 Certain operational changes (such as a power uprate) affecting surface water would be
 10 evaluated by the NRC in a separate environmental review. For potential impacts on water
 11 resources, the use of surface water is of greatest concern because of the high volumetric flow
 12 rates required for condenser cooling at nuclear power plants. Withdrawals from surface water
 13 bodies are high for both once-through and closed-cycle cooling systems. Consumptive water
 14 use occurs through evaporation and drift, especially from cooling towers, and may affect water
 15 availability downstream from nuclear power plants along rivers. Associated impacts on surface
 16 water quality may result from the discharge of thermal effluent containing chemical additives.
 17 Other potential impacts on surface water are the result of normal industrial plant activities during
 18 the license renewal term.

19 The following issues concern impacts on surface water that may occur during the initial LR or
 20 SLR term:

- 21 • surface water use and quality (non-cooling system impacts);
- 22 • altered current patterns at intake and discharge structures;
- 23 • altered salinity gradients;
- 24 • altered thermal stratification of lakes;
- 25 • scouring caused by discharged cooling water;
- 26 • discharge of metals in cooling system effluent;
- 27 • discharge of biocides, sanitary wastes, and minor chemical spills;
- 28 • surface water use conflicts (plants with once-through cooling systems);
- 29 • surface water use conflicts (plants with cooling ponds or cooling towers using makeup water
 30 from a river);
- 31 • effects of dredging on surface water quality; and
- 32 • temperature effects on sediment transport capacity.

33 *4.5.1.1.1 Surface Water Use and Quality (Non-Cooling System Impacts)*

34 Continued operations and refurbishment activities could result in the degradation of water
 35 quality within the receiving watershed. Power plant sites and land-disturbing activities can
 36 increase the variety and quantity of pollutants entering receiving water bodies such as streams,
 37 rivers, and lakes. Pollutants within stormwater runoff from plant sites can include suspended
 38 sediment; pesticides and nutrients from landscaped areas; petroleum products including oil and
 39 grease and toxic chemicals from motor vehicles; spills of hydrocarbon fuels; paints; road salts;

Environmental Consequences and Mitigating Actions

1 water treatment chemicals including acids and biocides; heavy metals from roof shingles and
2 motor vehicles; and thermal pollution (i.e., heated stormwater runoff) from impervious surfaces.
3 These pollutants could potentially harm aquatic and terrestrial species, contaminate recreational
4 areas, and degrade drinking water supplies.

5 In an effort to minimize or eliminate impacts on the water quality of receiving water bodies,
6 BMPs are typically included as conditions within National Pollutant Discharge Elimination
7 System (NPDES) permits issued by the EPA, or, where delegated, by individual States. BMPs
8 are measures used to control the adverse water quality-related effects of land disturbance and
9 development or industrial activity. They include structural devices designed to remove
10 pollutants, reduce runoff rates and volumes, and protect aquatic habitats. BMPs also include
11 nonstructural or administrative approaches, such as training to educate staff in the proper
12 handling and disposal of potential pollutants.

13 Permanent BMPs are designed to control pollutants to the maximum extent practicable during
14 continued operations of the power plant. Extended detention and infiltration basins are
15 examples of pollutant-removal features designed to remove pollutants based on volume.
16 Hydrodynamic separator systems (hydrodynamic devices, baffle boxes, swirl concentrators, or
17 cyclone separators) are examples of pollutant-removal devices that are typically designed
18 based on flow rate.

19 Refurbishment activities involving construction-related land disturbance are expected to be
20 managed by an approved Stormwater Pollution Prevention Plan (SWPPP). Development and
21 implementation of a SWPPP is normally required as a condition of a NPDES permit. The
22 SWPPP would indicate the structural and nonstructural BMPs that must be implemented for the
23 duration of the refurbishment activity. Examples of construction BMPs include use of sediment
24 (silt) fences, check dams, staked hay bales, sediment ponds, mulching, and geotextile matting
25 of disturbed areas.

26 BMPs and conformance to plant site NPDES permits (individual sitewide or general permits),
27 encompassing those covering stormwater discharges associated with construction and
28 industrial activity, are expected to be followed during continued operations and refurbishment
29 activities. Implementation of spill prevention and control plans would further reduce the
30 likelihood of any liquid chemical spills.

31 Continued operations and refurbishment activities will require water for non-cooling-related
32 purposes, including some consumptive use (i.e., water that is used but not returned to the
33 source and effectively lost). The water source is dependent on the nuclear power plant site,
34 water availability, and the nature of any refurbishment activities. Typical water sources at
35 nuclear power plants are surface water, groundwater, and public domestic (potable) water.

36 Water may be used during refurbishment activities for concrete production, dust control,
37 washing stations, facility and equipment cleaning, and soil compaction and excavation
38 backfilling. However, the impacts due to the volume of water consumed from a surface water
39 source would be insignificant when compared with that used or consumed by a plant's cooling
40 system (either once-through or closed-cycle cooling system).

1 The use of groundwater for non-cooling system uses would have a minimal impact on the
 2 surface water source similar to that of a direct surface water withdrawal, assuming an
 3 interconnection between the groundwater source and surface water body. Groundwater
 4 withdrawal near a water body with a disconnected groundwater table would have no effect on
 5 the surface water resource.

6 The use of public domestic water would reduce the direct consumptive use impacts on surface
 7 water resources. Still, domestic water runoff and water main breaks have the potential to
 8 introduce an additional pollutant (residual chlorine), which could impact water quality. It is
 9 expected that such occurrences would be rare and would be identified and corrected as piped
 10 domestic water is metered at the point of interconnection with a plant's water distribution
 11 system. Any such occurrences are not expected to present a significant water quality concern
 12 over the license renewal term.

13 Surface water consumption for non-cooling water-related operational activities is anticipated to
 14 be negligible and limited to uses such as facility and equipment cleaning. As a result, no
 15 surface water use conflicts would be expected.

16 The impacts of refurbishment on surface water use and quality during the license renewal term
 17 were considered to be SMALL for all plants and designated as a Category 1 issue in the 2013
 18 LR GEIS. Further, non-cooling system operational impacts on water use and quality are
 19 expected to be SMALL, as described above. In addition, if refurbishment took place during a
 20 reactor shutdown, the overall water use by the facility would be greatly reduced. The staff
 21 reviewed information from SEISs (for initial LRs and SLRs) completed since development of the
 22 2013 LR GEIS and identified no new information or situations that would result in different
 23 impacts for this issue for either an initial LR or SLR term. On the basis of these considerations,
 24 the non-cooling system impacts of continued operations and refurbishment activities on surface
 25 water resources during the initial LR and SLR terms would be SMALL for all nuclear power
 26 plants. This is a Category 1 issue.

27 *4.5.1.1.2 Altered Current Patterns at Intake and Discharge Structures*

28 The large flow rates associated with cooling system water use have the potential to alter current
 29 patterns. The degree of influence depends on the design and location of the intake and
 30 discharge structures and the characteristics of the surface water body. The effect on currents
 31 near the intake and discharge locations is expected to be variable and localized, and any
 32 problems would have been mitigated during the early operational period of a nuclear power
 33 plant (NRC 1996). Most nuclear power plants are sited on large bodies of water to make use of
 34 the water for cooling purposes. The size of large rivers, lakes, or reservoirs precludes
 35 significant current alterations except in the vicinity of the structures. For ocean shore, bay, or
 36 tidally influenced river settings, the effect is further reduced when compared with the strong
 37 natural water movement patterns. For example, current patterns were modified at the Oyster
 38 Creek Nuclear Generating Station (Oyster Creek; which permanently shut down in September
 39 2018). The plant site is located inland from Barnegat Bay in New Jersey. The once-through
 40 cooling system for this plant was created by modifying two small rivers originally flowing parallel
 41 into the bay. On the north side of the plant, the South Branch of the Forked River was enlarged
 42 between the plant and the bay to serve as an intake canal. On the south side of the plant,
 43 Oyster Creek was enlarged between the plant and the bay for use as a discharge canal. Near
 44 the plant, the two waterways were joined. Bay water was pulled from the bay through the intake
 45 canal to the plant, against the original flow direction of the lowest reach of the South Branch of
 46 the Forked River. Flow at the mouth of this river was both reversed and significantly increased,

Environmental Consequences and Mitigating Actions

1 while flow at the mouth of the Oyster Creek discharge canal significantly increased during plant
2 operations. While current patterns in Barnegat Bay in the immediate vicinity of the intake and
3 discharge canals were affected by operations, the effect on the overall Barnegat Bay system
4 was minor (NRC 1996; NRC 2007b).

5 This issue has no relevance to nuclear power plants relying on cooling ponds or canal systems
6 because such structures are human-made (excavated earthworks or engineered
7 impoundments) without natural currents.

8 Impacts from altered current patterns at intake and discharge structures during the license
9 renewal term were considered to be SMALL for all plants and designated as Category 1 in the
10 2013 LR GEIS. The staff reviewed information from SEISs (for initial LRs and SLRs) completed
11 since development of the 2013 LR GEIS and identified no new information or situations that
12 would result in different impacts for this issue for either an initial LR or SLR term. On the basis
13 of these considerations, the impact of altered current patterns at intake and discharge structures
14 would be SMALL during the initial LR and SLR terms for all nuclear plants. This is a Category 1
15 issue.

16 *4.5.1.1.3 Altered Salinity Gradients*

17 This issue relates to the few (operating) nuclear power plants (Table 3.1-2) located on estuaries
18 and addresses changes in salinity caused by cooling system water withdrawals and discharges
19 directly to receiving waters. Using the same example site as for the current patterns issue,
20 construction of the Oyster Creek plant (no longer operating) included modification of the lower
21 reaches of two creeks. These portions of the creeks were originally brackish, with a mix of
22 freshwater from their upper reaches and tidally influenced bay water. Because of the cooling
23 system operations, the water quality of these lower reaches had approached that of Barnegat
24 Bay, with contributions of freshwater from their upper reaches being relatively minor. These
25 lower reaches were also affected by occasional dredging activities, and the discharge canal
26 received water to which heat and chemicals had been added. The salinity changes did not
27 affect the upper portions of the creeks. In the 1996 LR GEIS, only minor effects had been noted
28 in Barnegat Bay.

29 As documented in the 1996 LR GEIS and Calvert Cliffs Nuclear Power Plant (Calvert Cliffs)
30 SEIS (NRC 1999c), the NRC found that operation of the Calvert Cliffs plant has not had
31 significant effects on salinity in Chesapeake Bay. Altered salinity gradients are expected to be
32 noticeable only in the immediate vicinity of the intake and discharge structures.

33 More recently, in the Surry SLR SEIS, the NRC evaluated the plant's cooling water withdrawals
34 and discharges to the tidally influenced James River in Virginia. The range in measured
35 salinities in the James River for the period 1984 through 2018 indicated no significant effect
36 from Surry's operations, based on comparison to salinity data compiled prior to and immediately
37 after plant startup in 1975. Higher salinity does occur within Surry's engineered discharge canal
38 due to the withdrawal of higher salinity water (NRC 2020f).

39 Impacts from altered salinity gradients at intake and discharge structures during the license
40 renewal term were considered to be SMALL for all plants and designated as a Category 1 issue
41 in the 2013 LR GEIS. The staff reviewed information from SEISs (for initial LRs and SLRs)
42 completed since development of the 2013 LR GEIS and identified no new information or
43 situations that would result in different impacts for this issue for either an initial LR or SLR term.

1 On the basis of these considerations, the impact of altered salinity gradients would be SMALL
2 during the initial LR and SLR terms for all nuclear plants. This is a Category 1 issue.

3 *4.5.1.1.4 Altered Thermal Stratification of Lakes*

4 Because cooling systems typically withdraw from the deeper, cooler portion of the water column
5 of lakes or reservoirs and discharge to the surface, they have the ability to alter the thermal
6 stratification of the surface water. This has not been shown to be an issue for rivers or oceans
7 because of mixing caused by natural turbulence.

8 A thermal plume of discharge water loses heat to the atmosphere and to the receiving surface
9 water body. It also undergoes mixing with the surface water. In the 1996 LR GEIS, examples
10 included the Oconee Nuclear Station (Oconee) in South Carolina, where the withdrawal of cool,
11 deep water for cooling purposes favors warmwater fish species at the expense of coolwater fish.
12 Mitigation of this effect is possible by modifying the allowable discharge water temperature. In
13 an example from the McGuire Nuclear Station (McGuire) in North Carolina, a modeling study
14 indicated that increasing the permitted discharge temperature would reduce the withdrawal of
15 cool, deep water and conserve coolwater species habitat.

16 Thermal plumes may be studied through field measurements and modeling studies. For plants
17 on lakes or reservoirs, the thermal effect on stratification is examined periodically through the
18 NPDES permit renewal process. For example, as documented in the Point Beach SLR SEIS,
19 the plant's Wisconsin-issued NPDES permit imposes a heat-rejection limit on the plant's cooling
20 water discharge. This limit accounts for operational changes implemented at Point Beach
21 associated with the extended power uprate that the NRC approved in 2011 (NRC 2021f).
22 Problems with thermal stratification due to nuclear power plant operations have not been
23 encountered.

24 Impacts from altered thermal stratification of lakes and reservoirs during the license renewal
25 term were considered to be SMALL for all plants and were designated as a Category 1 issue in
26 the 2013 LR GEIS. The staff reviewed information from SEISs (for initial LRs and SLRs)
27 completed since development of the 2013 LR GEIS and identified no new information or
28 situations that would result in different impacts for this issue for either an initial LR or SLR term.
29 On the basis of these considerations, the impact of altered thermal stratification of lakes would
30 be SMALL during the initial LR and SLR terms for all nuclear plants. This is a Category 1 issue.

31 *4.5.1.1.5 Scouring Caused by Discharged Cooling Water*

32 The high-flow rate of water from a cooling system discharge structure has the potential to scour
33 sediments and redeposit them elsewhere. Scouring will remove fine-grained sediments,
34 resulting in turbidity, and leave behind coarse-grained sediments.

35 The degree of scouring depends on the design of the discharge structure and the character of
36 the sediments. Scouring is expected to occur only in the vicinity of the discharge structure
37 where flow rates are high. While scouring is possible during reactor startup, operational periods
38 would typically have negligible scouring. Natural sediment transport processes could bring
39 fresh sediment into the discharge flow area. These processes include transport due to ocean
40 currents, tides, river meandering, and storm events.

41 In the 1996 LR GEIS, scouring had not been noted as a problem at most plants and had been
42 observed at only three nuclear power plants (Calvert Cliffs, Connecticut Yankee [no longer

Environmental Consequences and Mitigating Actions

1 operating], and San Onofre Nuclear Generating Station [San Onofre; no longer operating]). The
2 effects at these plants were localized and minor.

3 Impacts from scouring caused by discharged cooling water during the license renewal term
4 were considered to be SMALL for all plants and were designated as a Category 1 issue in the
5 2013 LR GEIS. The staff reviewed information from SEISs (for initial LRs and SLRs) completed
6 since development of the 2013 LR GEIS and identified no new information or situations that
7 would result in different impacts for this issue for either an initial LR or SLR term. On the basis
8 of these considerations, the impact of scouring caused by discharged cooling water would be
9 SMALL during the initial LR and SLR terms for all nuclear plants. This is a Category 1 issue.

10 *4.5.1.1.6 Discharge of Metals in Cooling System Effluent*

11 Heavy metals such as copper, zinc, and chromium can be leached from condenser tubing and
12 other components of the heat exchange system by circulating cooling water. These metals are
13 normally addressed in NPDES permits because high concentrations of them can be toxic to
14 aquatic organisms. Operations at all nuclear power plants are subject to one or more NPDES
15 permits that require licensees to conduct effluent monitoring and reporting for a wide range of
16 pollutants that could potentially be discharged in cooling water and comingled effluents. For
17 example, as described in the SEIS for initial LR of the Byron plant, the plant's Illinois-issued
18 NPDES permit requires that the licensee monitor cooling system blowdown discharges to the
19 Rock River for various parameters, including the metals zinc, iron, lead, copper, nickel, and
20 chromium (NRC 2015c). During normal nuclear power plant operations, metal concentrations
21 are normally below laboratory detection levels. However, plants occasionally undergo planned
22 outages for refueling or unplanned maintenance, with stagnant water remaining in the heat
23 exchange system. During an outage at the Diablo Canyon Power Plant (Diablo Canyon) in
24 California, the longer residence time of water in the cooling system resulted in elevated copper
25 levels in the discharge when operations resumed; abalone (*Haliotis* spp.) deaths were attributed
26 to the increased copper (NRC 1996). At the H.B. Robinson Steam Electric Plant (Robinson) in
27 South Carolina, the gradual accumulation of copper in its reservoir resulted in impacts on the
28 bluegill (*Lepomis macrochirus*) population. In both cases, copper condenser tubes were
29 replaced with titanium ones, and the problem was eliminated (NRC 1996).

30 Impacts from the discharge of metals in cooling system effluent during the license renewal term
31 were considered to be SMALL for all nuclear power plants and were designated as a Category 1
32 issue in the 2013 LR GEIS. The staff reviewed information from SEISs (for initial LRs and
33 SLRs) completed since development of the 2013 LR GEIS and identified no new information or
34 situations that would result in different impacts for this issue for either an initial LR or SLR term.
35 On the basis of these considerations, the impact of the discharge of metals in cooling system
36 effluent would be SMALL during the initial LR and SLR terms for all nuclear plants. This is a
37 Category 1 issue.

38 *4.5.1.1.7 Discharge of Biocides, Sanitary Wastes, and Minor Chemical Spills*

39 The use of biocides and other water treatment chemicals is common and is required to control
40 biofouling and nuisance organisms in plant cooling systems. However, the types of chemicals,
41 their amounts or concentrations, and the frequency of their use may vary. The use of biocides
42 at nuclear power plants is discussed generally in Section 3.5.1. Ultimately, any residual
43 biocides used in the cooling system are discharged to surface water bodies. The discharge of
44 treated sanitary waste also occurs at plants. Discharge may occur via onsite wastewater
45 treatment facilities, via an onsite septic field, or through a connection to a municipal sewage

1 system. Minor chemical spills collected in floor drains are associated with industry in general
 2 and are a possibility at all plants. Each of these factors represents a potential impact on surface
 3 water quality.

4 Discharges of cooling water and other plant wastewaters are monitored through the NPDES
 5 program administered by the EPA, or, where delegated, by individual States. The NPDES
 6 permit contains requirements that limit the flow rates and pollutant concentrations that may be
 7 discharged at permitted outfalls, including chemical residuals from biocides and other water
 8 treatment chemicals. For example, as described in the SEIS for initial LR of the Fermi plant, the
 9 plant's Michigan-issued NPDES imposes effluent limits and monitoring requirements for residual
 10 chlorine and other listed biocides (used for zebra mussel control) on the plant's primary outfall to
 11 Lake Erie (NRC 2016c). NPDES permits normally include special conditions such as requiring
 12 preapproval from the regulatory agency for the use of new water treatment chemicals, as well
 13 as requiring that onsite sanitary wastewater treatment facilities be attended by a licensed
 14 operator. The permit may also include biological monitoring parameters that are primarily
 15 associated with the discharge of cooling water. NPDES permits may also include biochemical
 16 monitoring parameters. Discharge from building drains is also addressed in the NPDES permit.

17 Because of Federal or State regulatory involvement, and the fact that no significant problems
 18 with outfall monitoring have been found, the impacts from the discharge of chlorine and other
 19 biocides and minor spills of sanitary wastes and chemicals during license renewal and
 20 refurbishment were considered to be SMALL for all nuclear power plants and designated as a
 21 Category 1 issue in the 2013 LR GEIS. The staff reviewed information from SEISs (for initial
 22 LRs and SLRs) completed since development of the 2013 LR GEIS and identified no new
 23 information or situations that would result in different impacts for this issue for either an initial LR
 24 or SLR term. On the basis of these considerations, the discharge of biocides, sanitary wastes,
 25 and minor chemical spills would be SMALL during the initial LR and SLR terms for all nuclear
 26 plants. This is a Category 1 issue.

27 *4.5.1.1.8 Surface Water Use Conflicts (Plants with Once-Through Cooling Systems)*

28 Nuclear power plant cooling systems may compete with other users relying on surface water
 29 resources, including downstream municipal, agricultural, or industrial users. Once-through and
 30 closed-cycle cooling systems have different water consumption rates. As reported by Dieter
 31 et al. (2018), thermoelectric plant once-through cooling systems return most of their withdrawn
 32 water to the same surface water body, with evaporative losses of approximately 1 percent,
 33 compared to 57 percent for closed-cycle (recirculating) cooling systems. Consumptive use by
 34 plants with once-through cooling systems during the license renewal term is not expected to
 35 change unless power uprates, with associated increases in water use, are proposed. Because
 36 power uprates are a separate licensing action from license renewal, such uprates would
 37 normally require a separate environmental review by the NRC.

38 Future scenarios for water availability focus on climate change and associated changes in
 39 precipitation and temperature patterns. Since the beginning of the last century, annual
 40 precipitation has increased on average by 4 percent across the United States with increases in
 41 the Northeast, Midwest, and Great Plains and decreases over parts of the Southeast and
 42 Southwest. The frequency and intensity of heavy precipitation have increased average annual
 43 precipitation, with the highest observed changes occurring across the Northeast and Midwest.
 44 Climate models project that these trends will continue. Annual average temperature has
 45 increased by 1.2 degrees Fahrenheit (°F) (0.7 degree Celsius [°C]) across the contiguous
 46 United States for the period 1986–2016 relative to 1901–1960. In the coming decades, annual

Environmental Consequences and Mitigating Actions

1 average temperatures are projected to increase by about 2.2 °F (1.2 °C) (USGCRP 2018).
2 Increased temperatures and/or decreased rainfall would result in lower river flows, increased
3 cooling pond evaporation, and lowered water levels in the Great Lakes or reservoirs. Climate
4 change-induced impacts on water availability are less pronounced across large watersheds
5 (large river systems and lakes). As a result, surface water withdrawals by nuclear power plants
6 would be even less likely to affect water availability. While weather will vary from year to year,
7 the results of climate change models and the projected changes to surface water runoff support
8 increases in runoff across the eastern United States and decreases in runoff in the western
9 United States, where water remains less available due to drought and decreases in winter
10 snowpack. Regardless of overall climate change, droughts could result in problems with water
11 supplies and allocations. Because future agricultural, municipal, and industrial users would
12 continue to share their demands for surface water with power plants, conflicts might arise if the
13 availability of this resource decreased. This situation would then necessitate decisions by local,
14 State, and regional water-planning officials.

15 Population growth around nuclear power plants has caused increased demand on municipal
16 water systems, including systems that rely on surface water. Municipal intakes located
17 downstream of a nuclear power plant could experience water shortages, especially in times of
18 drought. Water demands upstream of a plant could affect the water availability at the plant's
19 intake.

20 In the 2013 LR GEIS, the impacts of continued operations and refurbishment on water use
21 conflicts associated with once-through cooling systems were considered to be SMALL and were
22 designated as a Category 1 issue. The staff reviewed information from SEISs (for initial LRs
23 and SLRs) completed since development of the 2013 LR GEIS and identified no new
24 information or situations that would result in different impacts for this issue either for an initial LR
25 or SLR term. On the basis of these considerations, the NRC concludes that the impact on water
26 use conflicts from the continued operation and refurbishment activities would be SMALL during
27 the initial LR and SLR terms for plants that use once-through cooling. This is a Category 1
28 issue.

29 *4.5.1.1.9 Surface Water Use Conflicts (Plants with Cooling Ponds or Cooling Towers Using* 30 *Makeup Water from a River)*

31 Nuclear power plant cooling systems may compete with other users relying on surface water
32 resources, including downstream municipal, agricultural, or industrial users. Closed-cycle
33 cooling is not completely closed, because the system discharges blowdown water to a surface
34 water body and withdraws water for makeup of both the consumptive water loss due to
35 evaporation and drift (for cooling towers) and blowdown discharge. For plants using cooling
36 towers, while the volume of surface water withdrawn is substantially less than once-through
37 systems for a similarly sized nuclear power plant, the makeup water needed to replenish the
38 consumptive loss of water to evaporation can be significant. As reported by the U.S. Geological
39 Survey (USGS 2019b), consumptive water use in thermoelectric power plants with recirculating
40 cooling systems can be up to 74 percent of the withdrawal flow rate. Cooling ponds also require
41 makeup water as a result of naturally occurring evaporation, evaporation of the warm effluent,
42 the potential need for periodic blowdown to maintain pond chemistry, and possible seepage to
43 groundwater.

44 Consumptive use by plants with cooling ponds or cooling towers using makeup water from a
45 river during the license renewal term is not expected to change unless power uprates, with
46 associated increases in water use, occur. Such uprates would normally require a separate

1 environmental review by the NRC. Any river, regardless of size, can experience low-flow
 2 conditions of varying severity during periods of drought and changing conditions in the affected
 3 watershed such as upstream diversions and use of river water. However, the potential for direct
 4 impacts on instream flow and potential water availability for other users from nuclear power
 5 plant surface water withdrawals are greater for smaller (i.e., low-flow¹) rivers.

6 As stated earlier, increased temperatures and/or decreased rainfall would result in lower river
 7 flows, increased cooling pond evaporation, and lowered water levels in lakes or reservoirs.
 8 Regardless of overall climate change, droughts could result in problems with water supplies and
 9 allocations. Conflicts might arise due to competing agricultural, municipal, and industrial user
 10 demands for surface water with power plants. Closed-cycle cooling systems are more
 11 susceptible to these issues than once-through cooling systems because they consume more
 12 water per unit volume of water withdrawn from the water source. For this reason, climate
 13 change is more of a potential concern for water use conflicts associated with nuclear power
 14 plants with closed-cycle cooling systems.

15 Population growth around nuclear power plants has caused increased demand on municipal
 16 water systems, including systems that rely on surface water. Municipal intakes located
 17 downstream from a nuclear power plant could experience water shortages, especially in times
 18 of drought. Similarly, water demands upstream from a nuclear power plant could affect the
 19 water availability at the plant's intake.

20 As discussed in the 2013 LR GEIS, potential water use conflicts have been documented for
 21 nuclear power plants with closed-cycle cooling systems. State regulatory agencies have
 22 imposed surface water withdrawal limits on a number of operating nuclear power plants with
 23 cooling towers and cooling ponds. The Limerick plant is equipped with natural draft cooling
 24 towers, on the Schuylkill River in Pennsylvania. It is cited as an example of a plant in the 1996
 25 LR GEIS on which limits were imposed on the rate of withdrawal from a river for the purpose of
 26 avoiding water use conflicts, including downstream water availability and water quality. As
 27 further documented in the SEIS for initial LR of Limerick, plant operations are subject to low-flow
 28 augmentation requirements during low river flow (NRC 2014d). In another example, as
 29 documented in the SEIS for initial LR of the Braidwood plant, the plant's makeup water
 30 withdrawal from the Kankakee River to its cooling pond is subject to a maximum withdrawal rate
 31 imposed by the State of Illinois (NRC 2015d). Further, availability problems for downstream
 32 habitat and users may be anticipated at other plants.

33 Water use conflicts associated with plants with cooling ponds or cooling towers using makeup
 34 water from a river with low flow are considered to vary among sites because of differing site-
 35 specific factors, such as makeup water requirements, water availability (especially in terms of
 36 varying river flow rates), changing or anticipated changes in population distributions, or changes
 37 in agricultural or industrial demands. The staff reviewed information from SEISs (for initial LRs
 38 and SLRs) completed since development of the 2013 LR GEIS and identified no new
 39 information or situations that would result in different impacts for this issue for either an initial LR
 40 or SLR term.

41 On the basis of these considerations, the impact of water use conflicts from the continued
 42 operation of nuclear power plants with cooling ponds or cooling towers using makeup water
 43 from a river could be SMALL or MODERATE during the initial LR and SLR terms, depending on

¹ A river with low flow was previously defined in 10 CFR 51.53(c)(3)(ii)(A) and in the 1996 LR GEIS as one with an annual flow rate that is less than 3.15×10^{12} ft³/yr (9×10^{10} m³/yr) (100,000 ft³/s (2,830 m³/s)).

Environmental Consequences and Mitigating Actions

1 factors such as plant-specific design characteristics affecting consumptive water use, the
2 characteristics of the water body serving as the source for makeup water, and the amount of
3 competing use for that water. Because the impact could vary among nuclear plants, this is a
4 Category 2 issue.

5 *4.5.1.1.10 Effects of Dredging on Surface Water Quality*

6 Dredging in the vicinity of surface water intakes, canals, and discharge structures is undertaken
7 by nuclear power plant licensees to remove deposited sediment and maintain the function of
8 plant cooling systems. Dredging may also be needed to maintain barge shipping lanes.
9 Whether accomplished by mechanical, suction, or other methods, dredging disturbs sediments
10 in the surface water body and affects surface water quality by temporarily increasing the
11 turbidity of the water column. In areas affected by industries, dredging can also mobilize heavy
12 metals, polychlorinated biphenyls (PCBs), or other contaminants in the sediments.

13 The frequency of dredging depends on the rate of sedimentation. At the Oyster Creek plant in
14 New Jersey (which permanently shut down in September 2018), dredging took place during site
15 construction to create canals for the once-through cooling system (NRC 2007b). Depth
16 measurements were performed there every 2 years, and dredging took place on portions of the
17 canal system during operations. At the Susquehanna Steam Electric Station (Susquehanna) in
18 Pennsylvania, the plant's river intake and diffuser pipe are dredged annually (NRC 2009c).

19 More recently, as documented by the NRC in the Surry SLR SEIS, the licensee conducts
20 maintenance dredging of its cooling water intake channel in the James River every 3 to 4 years
21 in accordance with a USACE permit. The licensee also performs debris removal on an as-
22 needed basis from its low-level intake structure under a USACE Nationwide Permit (NRC
23 2020f).

24 In general, maintenance dredging affects localized areas for a brief period of time. Dredging
25 operations are performed under permits issued by the USACE and possibly by State or local
26 agencies. The physical alteration of water bodies is regulated by Federal and State statutes
27 under Section 401 (Certification) and Section 404 (Permits) of the Clean Water Act (CWA;
28 33 U.S.C. § 1251 et seq.). The USACE regulates the discharge of dredged and/or fill material
29 under Section 404, while Section 401 requires the applicant for a Section 404 permit to also
30 obtain a Water Quality Certification from the State in order to confirm that the discharge of fill
31 materials will be in compliance with applicable State water quality standards. If dredging could
32 affect threatened or endangered species or critical habitat, as established under the
33 Endangered Species Act (ESA; 16 U.S.C. § 1531 et seq.), the USACE must consult with the
34 U.S. Fish and Wildlife Service (FWS) or the National Marine Fisheries Service (NMFS) before it
35 makes a permit decision. When issuing a Section 404 permit, the USACE also considers other
36 potential impacts on aquatic resources, archaeological resources, Tribal concerns, and the
37 permitting requirements of State and local agencies. The permitting process may include
38 planning for the sampling and disposal of the dredged sediments.

39 The impact of dredging has not been found to be a problem at operating nuclear power plants.
40 Dredging has localized effects on water quality that tend to be short-lived. The staff reviewed
41 information from SEISs (for initial LRs and SLRs) completed since development of the 2013 LR
42 GEIS and identified no new information or situations that would result in different impacts for this
43 issue for either an initial LR or SLR term. The impact of dredging on water quality would be
44 SMALL during the initial LR and SLR terms for all nuclear plants. This is a Category 1 issue.

1 *4.5.1.1.11 Temperature Effects on Sediment Transport Capacity*

2 Increased temperature and the resulting decreased viscosity have been hypothesized to change
 3 the sediment transport capacity of water, leading to potential sedimentation problems, altered
 4 turbidity of rivers, and changes in riverbed configuration. As referenced in the 2013 LR GEIS,
 5 there is no indication that this has been a significant problem at operating power plants.
 6 Examples of altered sediment characteristics are more likely the result of power plant structures
 7 (e.g., jetties or canals) or current patterns near intakes and discharges; such alterations are
 8 readily mitigated.

9 Based on review of literature and operational monitoring reports, consultations with utilities and
 10 regulatory agencies, and public comments on previous license renewal reviews, there is no
 11 evidence that temperature effects on sediment transport capacity have caused adverse
 12 environmental effects at any existing nuclear power plant. Regulatory agencies have expressed
 13 no concerns regarding the impacts of temperature on sediment transport capacity.
 14 Furthermore, because of the small area near a nuclear power plant affected by increased water
 15 temperature, it is not expected that plant operations would have a significant impact. The staff
 16 reviewed information from SEISs (for initial LRs and SLRs) completed since development of the
 17 2013 LR GEIS and identified no new information or situations that would result in different
 18 impacts for this issue for either an initial LR or SLR term. Effects are considered to be of
 19 SMALL significance during the initial LR and SLR terms for all plants. No change in the
 20 operation of the cooling system is expected during the license renewal term so no change in
 21 effects on sediment transport capacity is anticipated. This is a Category 1 issue.

22 *4.5.1.2 Groundwater Resources*

23 Operational activities during the license renewal term would be similar to those occurring during
 24 the current license term. The impact issues of concern are availability of groundwater and the
 25 effect of nuclear plant operations on groundwater quality.

26 The following issues concern impacts on groundwater that may occur during the license renewal
 27 (initial LR or SLR) term:

- 28 • groundwater contamination and use (non-cooling system impacts);
- 29 • groundwater use conflicts (plants that withdraw less than 100 gallons per minute [gpm]);
- 30 • groundwater use conflicts (plants that withdraw more than 100 gallons per minute [gpm]);
- 31 • groundwater use conflicts (plants with closed-cycle cooling systems that withdraw makeup
 32 water from a river);
- 33 • groundwater quality degradation resulting from water withdrawals;
- 34 • groundwater quality degradation (plants with cooling ponds) (consolidation of two issues
 35 from the 2013 LR GEIS: (1) groundwater quality degradation (plants with cooling ponds in
 36 salt marshes) and (2) groundwater quality degradation (plants with cooling ponds at inland
 37 sites); and
- 38 • radionuclides released to groundwater.

Environmental Consequences and Mitigating Actions

1 4.5.1.2.1 Groundwater Contamination and Use (Non-Cooling System Impacts)

2 As indicated in Section 3.5.2, the original construction of some plants required dewatering of a
3 shallow aquifer, and operational dewatering takes place at some plants, including for
4 groundwater contaminant plume control. This is accomplished by systems of pumping wells or
5 drain tiles. Continued operations and refurbishment activities during the initial LR or SLR term
6 are not expected to require any significant dewatering that would have an incremental effect on
7 groundwater availability over that which has already taken place. Such dewatering impacts are
8 expected to remain SMALL and confined to the boundaries of operating plants.

9 The contamination of soil and underlying groundwater can result from general industrial
10 practices at any site and is not limited to those occurring at nuclear power plants. Such
11 industrial practices can be evaluated generically, because they are common to industrial
12 facilities and nuclear power plants. Activities that result in contamination may include the use of
13 solvents, hydrocarbon fuels (diesel and gasoline), heavy metals, or other chemicals. These
14 materials all have the potential to affect soils, sediments, and groundwater if released.
15 Furthermore, contaminants present in the soil can act as long-term sources of contamination to
16 underlying groundwater depending on the severity of the spill.

17 Based on previous plant-specific reviews, these types of groundwater and soil contamination
18 problems have occurred at some operating plants. Release of contaminants into groundwater
19 and soil degrades the quality of these resources, even if applicable groundwater quality
20 standards are not exceeded. This includes *de minimis* quantities of contaminants that do not
21 typically require reporting to regulatory agencies because they are below applicable threshold
22 quantities and/or have been promptly remediated and would not otherwise pose a long-term
23 threat to human health and the environment.

24 Historical examples of the types of contamination that may be present at a nuclear power plant
25 include hydrocarbon leaks or spills at a storage tank, leaked or spilled solvents from barrels,
26 and a hydraulic oil-line break (NRC 2006d); thallium in soil at a seepage pit, heavy metals in soil
27 at a sand blasting site, a diesel fuel line leak, methyl tertiary butyl ether from spills of a gasoline
28 storage tank, and PCBs in soil as a result of former dielectric fluid use (NRC 2007b);
29 hydrocarbon spills and sulfuric acid leaks (NRC 2009c); and sodium hypochlorite solution spilled
30 to soil, diesel fuel spills to groundwater, sewage discharged to the ground from a sanitary sewer
31 line break, and nonradioactive oily water spilled to the ground from an oil/water separator (NRC
32 2016c). Some of these situations have required regulatory involvement by State agencies
33 during both monitoring and remediation phases. Remediation has taken place in the form of
34 excavation and recovery wells. In these instances, all contamination was either remediated with
35 no further action required by regulatory agencies or contamination was confined to the plant site
36 with remediation continuing until completed. Nevertheless, the number of occurrences of such
37 problems can be minimized by means of proper chemical storage, secondary containment, and
38 leak-detection equipment. In addition, nuclear plants have their own programs for handling
39 chemicals, waste, and other hazardous and toxic materials in accordance with Federal and
40 State regulations. Environmental permits held by nuclear power plant licensees (e.g., NPDES
41 permits) generally require the use of BMPs to prevent pollutant releases to the environment.
42 Continued implementation of such programs and procedures such as pollution and spill
43 prevention and control plans including BMPs (e.g., good housekeeping of the plant site,
44 preventive maintenance, routine inspections, etc.) would reduce the likelihood of any
45 inadvertent releases to soils and/or groundwater.

1 An additional source of groundwater contamination can be the use of wastewater disposal
2 ponds or lagoons. At the Donald C. Cook Nuclear Plant (D.C. Cook) in Michigan, permitted
3 wastewater ponds have been used for receiving treated sanitary wastewater and for process
4 wastes from the turbine room sump. Groundwater monitoring showed that concentrations of
5 water quality parameters had increased to levels above background but below drinking water
6 standards (EPA maximum contaminant levels) (NRC 2005c). As a result, in an arrangement
7 with the county, the use of groundwater by other users in a designated area was restricted and
8 the affected groundwater was limited to the southwestern portion of the plant property.

9 In contrast, a number of licensees have continued to operate treatment ponds and lagoons
10 without significant adverse impact. As described in the SEIS for initial LR of the Sequoyah
11 plant, the licensee operated two former metal-cleaning waste ponds that discharged to an
12 NPDES internal monitoring point to the plant's diffuser pond system. Ultimately, this system
13 discharged collected wastewater through the plant's submerged diffuser structure into the
14 Chickamauga Reservoir (NRC 2015f). In a more recent example, as described by the NRC in
15 the SEIS for the initial LR of the River Bend plant, the licensee operated two sets of open
16 aeration and sedimentation lagoons located at the sanitary wastewater treatment plant. The
17 lagoons received sanitary waste from across the plant. As a safeguard, waste from sinks and
18 drains within the plant containing waste that was known to be or was potentially contaminated
19 with chemicals or radioactivity were physically separated from the sanitary drains. Effluent from
20 the system was discharged to an NPDES-permitted outfall (NRC 2018c).

21 Contaminants in wastewater disposal ponds and lagoons, whether lined or unlined, at a plant
22 have the potential to enter groundwater and soils. However, the use of wastewater disposal
23 ponds and lagoons is subject to discharge authorizations under the NPDES and other
24 applicable State wastewater discharge permit and monitoring programs.

25 Remediation of groundwater contamination can involve long-duration cleanup processes that
26 depend on the types, properties, and concentrations of the contaminants; aquifer properties;
27 groundwater flow field characteristics; and remedial objectives. Contaminants may be able to
28 migrate to onsite potable wells or to the wells of offsite groundwater users. Groundwater
29 monitoring programs, including monitoring of onsite drinking water quality in accordance with
30 safe drinking water regulations, would be expected to identify problems before contaminated
31 groundwater reached receptors; however, monitoring wells need to be present and in proper
32 locations in order to detect contaminants.

33 In the 2013 LR GEIS, the NRC found that the impact of continued operations and refurbishment
34 activities on groundwater use and quality unrelated to cooling system operations would be
35 SMALL for all nuclear plants. The staff reviewed information from SEISs (for initial LRs and
36 SLRs) completed since development of the 2013 LR GEIS and identified no new information or
37 situations that would result in different impacts for this issue for either an initial LR or SLR term.
38 On the basis of these considerations, the impact of continued operations and refurbishment
39 activities on groundwater use would be SMALL during the initial LR and SLR terms for all
40 nuclear plants. Further, the impact of plant industrial practices and their impact on groundwater
41 quality associated with continued operations and refurbishment activities would continue to be
42 SMALL during the initial LR and SLR terms. This is a Category 1 issue.

Environmental Consequences and Mitigating Actions

1 4.5.1.2.2 Groundwater Use Conflicts (Plants That Withdraw Less Than 100 Gallons 2 per Minute [gpm])

3 Water wells are commonly used at nuclear power plant sites to provide water for the potable
4 water system, although municipal water is available at some nuclear plants. Groundwater may
5 also be used for landscaping (see Section 3.5.2). At some sites, groundwater is the source for
6 the makeup and service water systems. In this case, the water undergoes treatment to prepare
7 it for its intended use.

8 The pumping of groundwater creates a cone of depression in the potentiometric surface around
9 the pumping well. The amount the water table or potentiometric surface declines and the
10 overall extent of the cone depend on the pumping rate, characteristics of the aquifer (e.g., its
11 permeability), whether the aquifer is confined or unconfined, and certain boundary conditions
12 (including the nearby presence of a hydrologically connected surface water body). Generally,
13 plants with a peak withdrawal rate of less than 100 gpm (378 Lpm) do not have a significant
14 cone of depression. Depending upon hydrogeologic conditions and siting factors, withdrawal
15 rates in excess of 100 gpm (378 Lpm) may not create conflicts. The potential for nuclear plant
16 production wells to cause conflicts with other groundwater users would depend largely on the
17 proximity of other wells. As stated in the 2013 LR GEIS, cones of depression usually do not
18 extend past the property boundary, thereby reducing the possibility of a groundwater use
19 conflict.

20 For example, as documented in the Peach Bottom SLR SEIS, three active groundwater
21 production wells supply water for miscellaneous, nonpotable uses across the plant site. In total,
22 these wells withdraw a maximum of about 15 gpm (57 Lpm) of water from the crystalline rock
23 aquifer. The NRC found that this groundwater withdrawal would be unlikely to affect offsite
24 domestic water supplies (NRC 2020g).

25 In the 2013 LR GEIS, the groundwater impacts associated with continued operations during the
26 license renewal term were considered to be SMALL for all nuclear plants and designated as
27 Category 1. The staff reviewed information from SEISs (for initial LRs and SLRs) completed
28 since development of the 2013 LR GEIS and identified no new information or situations that
29 would result in different impacts for this issue either during an initial LR or SLR term. On the
30 basis of these considerations, the impact on groundwater use conflicts from continued
31 operations for all nuclear plants that withdraw less than 100 gpm (378 Lpm) would be SMALL
32 during the initial LR and SLR terms. This is a Category 1 issue.

33 4.5.1.2.3 Groundwater Use Conflicts (Plants That Withdraw More Than 100 Gallons 34 per Minute [gpm])

35 Nuclear power plants withdraw groundwater for various purposes. Most plants use groundwater
36 to supply their potable water and service water needs. In some cases, groundwater is pumped
37 to intentionally lower high water tables. At the Grand Gulf plant in Mississippi, Ranney wells in
38 the Mississippi River alluvium are used to provide cooling system makeup water (see
39 Section 3.5.2).

40 As described in the section above, the pumping of groundwater is expected to create a cone of
41 depression around the well, with the degree of aquifer dewatering dependent on various factors.
42 A nuclear plant may have several wells, with combined pumping in excess of 100 gpm
43 (378 Lpm). Overall site pumping rates of this magnitude have the potential to create conflicts
44 with other local groundwater users if the cone of depression extends to the offsite well(s). Large

1 offsite pumping rates for municipal, industrial, or agricultural purposes may, in turn, lower the
 2 water level at power plant wells. For any user, allocation is normally determined through a State-
 3 issued permit.

4 In the initial LR SEIS for the South Texas plant (NRC 2013b), the NRC evaluated the potential
 5 for groundwater use conflicts from operation of the plant's five onsite groundwater production
 6 wells completed in the confined Deep Chicot aquifer and located near the plant site boundary.
 7 Over a 10-year period, the site's actual groundwater withdrawals averaged 768 gpm
 8 (2,910 Lpm). The licensee maintained a permit from the Coastal Plains Groundwater
 9 Conservation District to withdraw groundwater at a rate of approximately 1,860 gpm
 10 (7,040 Lpm). The NRC performed a confirmatory analysis of the licensee's analysis of potential
 11 aquifer drawdown in the Deep Chicot aquifer after 40 and 60 years of pumping for an offsite
 12 production well and also performed drawdown analyses out to distances of 1 and 5 mi (1.6 and
 13 8 km). The NRC found that while operation of the South Texas production wells and associated
 14 drawdown could impact the pumping lift of nearby offsite wells, the overall increase in drawdown
 15 in the aquifer over an additional 20 years beyond the current license period would be less than
 16 1 ft (0.3 m). This would have a negligible impact on neighboring wells and the NRC concluded
 17 that groundwater use conflicts from groundwater withdrawals would be SMALL (NRC 2013b).

18 As described in the SEIS for initial LR of Callaway (NRC 2014f), the licensee maintained three
 19 deep groundwater wells to supply groundwater for plant uses. Potable groundwater was being
 20 supplied to the plant at a rate of 33 gpm (124 Lpm). Another well located near the Missouri
 21 River was used to lubricate intake structure pump bearings with a usage rate of 120 gpm (454
 22 Lpm). Groundwater was also being withdrawn from the backfill surrounding the nuclear island
 23 by a sump pump at a rate of 65 gpm (246 Lpm). Total groundwater withdrawal was 218 gpm
 24 (825 Lpm). The NRC determined that groundwater withdrawals at Callaway would likely have
 25 little impact on groundwater use as a result of the relatively small amount of groundwater
 26 consumed and the good aquifer yields in the area. The NRC concluded that the impact of
 27 groundwater consumption at Callaway on groundwater availability was SMALL (NRC 2014f).

28 In the Turkey Point SLR SEIS, the NRC evaluated the potential groundwater use conflicts
 29 associated with the licensee's sitewide groundwater withdrawals from the Biscayne and Upper
 30 Floridan aquifers (NRC 2019c). In 2018, the licensee's groundwater withdrawals from the
 31 Biscayne aquifer averaged 12.7 million gallons per day (Mgd) (48 million liters per day [MLd]).
 32 These withdrawals were associated with operating a site recovery well system installed to
 33 extract hypersaline groundwater from near the base of the Biscayne aquifer and to limit the
 34 operational influence of the plant's cooling canal system (CCS) on the regional saltwater
 35 interface. Construction and operation of this recovery well system was instituted by the licensee
 36 in order to meet the requirements of a Consent Agreement with the Miami-Dade County Division
 37 of Environmental Resources Management and a Consent Order issued by the Florida
 38 Department of Environmental Protection. As also described in the SEIS, the licensee operates
 39 the recovery well system under a State-issued permit (NRC 2019c).

40 During 2018, the licensee's groundwater withdrawals from the Upper Floridan aquifer averaged
 41 20.3 Mgd (76.8 MLD). This total included about 12.7 Mgd (48.1 MLd) associated with
 42 groundwater withdrawn and discharged into the Turkey Point CCS for salinity management
 43 (freshening) with the remainder (about 7.6 Mgd [28.8 MLd]) withdrawn for other site uses. The
 44 licensee's groundwater usage from the Upper Floridan aquifer is governed by a State power
 45 plant site certification issued for Turkey Point by the State of Florida Siting Board.

Environmental Consequences and Mitigating Actions

1 In consideration of groundwater modeling performed in support of the referenced withdrawals,
2 projected drawdowns in affected aquifers, potential impacts on other groundwater users, and
3 conditions imposed by State regulators, the NRC concluded that the potential for groundwater
4 use conflicts from the licensee's groundwater withdrawals would be SMALL for the Biscayne
5 aquifer and MODERATE for the Upper Floridan aquifer during the Turkey Point SLR term (NRC
6 2019c).

7 As described for the Turkey Point plant, this is the first time the NRC has identified groundwater
8 use conflicts at an operating nuclear power plant. The NRC considers this to be a unique
9 occurrence because the licensee has the need to withdraw large volumes of groundwater for
10 salinity management and groundwater remediation at a site located within a complex
11 hydrogeologic setting. For most operating nuclear power plants, no significant change in water
12 well systems would be expected over the license renewal term. If a conflict did occur, it might
13 be possible to resolve it if the power plant relocated its well or wellfield to a different part of the
14 property. The siting of new wells would be determined through a hydrogeologic assessment
15 and governed by applicable production well siting, construction, groundwater allocation
16 permitting processes.

17 In the 2013 LR GEIS, groundwater use conflicts were considered for plants that withdraw more
18 than 100 gpm (378 Lpm) or plants that use Ranney wells. The NRC concluded that the impacts
19 of continued operations and refurbishment would not necessarily be the same at all nuclear
20 plant sites (i.e., a Category 2 issue) because of site-specific factors (e.g., well pump rates, well
21 locations, and hydrogeologic factors) and that the impacts could be SMALL, MODERATE, or
22 LARGE. The staff reviewed information from SEISs (for initial LRs and SLRs) completed since
23 development of the 2013 LR GEIS and identified no new information or situations that would
24 result in different impacts for this issue for either an initial LR or SLR term. On the basis of
25 these considerations, groundwater use conflicts for plants that withdraw more than 100 gpm
26 (378 Lpm) could be SMALL, MODERATE, or potentially LARGE during the initial LR and SLR
27 terms, depending on the plant-specific characteristics described above. This is a Category 2
28 issue.

29 *4.5.1.2.4 Groundwater Use Conflicts (Plants with Closed-Cycle Cooling Systems That Withdraw* 30 *Makeup Water from a River)*

31 In the case of nuclear power plants with cooling towers or cooling ponds that rely on a river for
32 makeup of consumed (evaporated) cooling water, it is possible that water withdrawals from the
33 river could lead to groundwater use conflicts with other groundwater users. This situation could
34 occur because of the interaction between groundwater and surface water, especially in the
35 setting of an alluvial aquifer in a river valley. Consumptive use of the river water, if significant
36 enough to lower the river's water level, would also influence water levels in the alluvial aquifer.
37 Shallow wells of nearby groundwater users could therefore have reduced water availability or go
38 dry. During times of drought, the effect would occur naturally, although withdrawals for makeup
39 water would increase the effect. In the 1996 LR GEIS, a situation at the Duane Arnold Energy
40 Center (Duane Arnold) in Iowa (which permanently shut down on August 10, 2020) was
41 described in which a reservoir on a small tributary is used as a secondary supply of makeup
42 water for the plant's cooling towers. During low-flow conditions in the plant's usual source of
43 water, the Cedar River, the plant was not allowed to withdraw river water. Instead, it used the
44 reservoir temporarily. In such a situation, because the high rate of water usage can lower the
45 water level in the reservoir significantly, local users of shallow groundwater may be affected,
46 particularly during times of drought affecting a small river. Similar to other water resources-
47 related issues described in this section, such conflicts are highly dependent on the area's

1 hydrogeologic framework and the locations, depths, and pump rates of wells, in addition to the
2 amount that the surface water level declines. The NRC's license renewal environmental
3 reviews performed since 2013 have revealed no tangible instances where this issue is of
4 concern.

5 As described in the SEIS for initial LR of the South Texas plant (NRC 2013b), the NRC
6 assessed the impact of the licensee's withdrawal of water from the lower Colorado River as
7 makeup for the plant's main cooling reservoir. The NRC considered potential impacts on the
8 Shallow Chicot aquifer discharges and the alluvial aquifer that separates the Shallow Chicot
9 aquifer from the Colorado River. The Shallow Chicot aquifer is used primarily for low-yield
10 livestock watering near the plant site and this shallow aquifer is hydraulically separated from the
11 regional Deep Chicot aquifer. Separately, withdrawals from the lower Colorado River during
12 lower river flow are regulated by a Certificate of Adjudication for water use. The NRC found, in
13 part, that the Shallow Chicot aquifer would not be substantially influenced by the bank storage
14 effects of alluvial aquifer recharge and discharge to the lower Colorado River. Therefore, the
15 NRC concluded that continued withdrawals of surface water from the river for operation of South
16 Texas during low-flow periods would have a SMALL impact on recharge to the alluvial aquifer
17 during the license renewal term (NRC 2013b).

18 In the 2013 LR GEIS, groundwater use conflicts were evaluated for plants that use cooling
19 towers withdrawing makeup water from a river during continued operations and refurbishment.
20 The NRC found that that conflicts would not necessarily be the same at all nuclear power plant
21 sites because of site-specific factors (e.g., the amount of surface water decline, well pump rates,
22 well locations, and hydrogeologic conditions). The resulting impact could be SMALL,
23 MODERATE, or LARGE. Therefore, this was considered a Category 2 issue. The staff
24 reviewed information from SEISs (for initial LRs and SLRs) completed since development of the
25 2013 LR GEIS. On the basis of these considerations, groundwater use conflicts for nuclear
26 plants that use closed-cycle cooling systems that withdraw makeup water from a river could
27 have SMALL, MODERATE, or LARGE impacts during the initial LR and SLR terms, depending
28 on the plant-specific characteristics of surrounding areas described above. This is a Category 2
29 issue.

30 *4.5.1.2.5 Groundwater Quality Degradation Resulting from Water Withdrawals*

31 This issue considers the possibility of groundwater quality becoming degraded as a result of
32 drawing water of potentially lower quality into an aquifer.

33 A well near a river may draw lower quality river water into the aquifer as a function of the
34 interaction between groundwater and surface water. An example of this type of hydrologic
35 interaction is the use of Ranney wells (see Section 3.5.2) at the Grand Gulf plant in Mississippi.
36 The resulting induced infiltration of Mississippi River water into the alluvial aquifer was
37 discussed in the 1996 LR GEIS. This aspect of Ranney well operation was reexamined by the
38 NRC in the SEIS for the initial LR of the Grand Gulf plant (NRC 2014e). At Grand Gulf, the
39 sandstone layers comprising the Catahoula aquifer underlie the Mississippi River Alluvial
40 aquifer. The analysis in the SEIS confirms that the water quality from the plant's Ranney wells
41 that pump water from the Mississippi River Alluvial aquifer is nearly identical to the water quality
42 of the Mississippi River. As also stated in the SEIS, the transmissivity (ability of an aquifer to
43 transmit water) of the Catahoula aquifer is so substantially less than that of the Mississippi River
44 Alluvial aquifer that wells pumping water from the Mississippi River Alluvial aquifer would obtain
45 their water as induced infiltration from the Mississippi River rather than from upward discharge
46 of groundwater from the Catahoula aquifer. As a result, any groundwater contamination

Environmental Consequences and Mitigating Actions

1 entering the Mississippi River Alluvial aquifer would likely remain in the Mississippi River Alluvial
2 aquifer or discharge into the Mississippi River, rather than migrating to deeper aquifers (NRC
3 2014e).

4 While site-specific hydrogeologic factors and well design may provide some control of the flow
5 of surface water to the well, the bulk of the groundwater pumped by a well in an alluvial aquifer
6 near a river is expected to be induced surface water, with a smaller component of groundwater
7 from the direction opposite the river. If well pumping is continuous, the only portion of the
8 shallow aquifer significantly affected by induced infiltration remains in the capture zone of the
9 well(s). Therefore, the portion of the aquifer with water quality parameters approaching those of
10 the river water would usually be located on the power plant's property.

11 Wells in a coastal setting (e.g., ocean shore or estuary) have the potential to cause saltwater
12 intrusion into the aquifer. This water quality problem is a common concern for large pumping
13 centers associated with municipal or industrial users. The degree of saltwater intrusion
14 depends on the cumulative pumping rates of wells, their screen depths, and hydrogeologic
15 conditions. Deep, confined aquifers, for example, may be separated from saline aquifers closer
16 to the surface. However, as evaluated in the 2013 LR GEIS, the potential for inducing saltwater
17 intrusion was considered to be of SMALL significance at all sites because groundwater
18 consumption from confined aquifers for potable and service water uses by nuclear power plants
19 is a small fraction of groundwater use in all cases. Where saltwater intrusion has historically
20 been a problem, the large users have been those related to agricultural (irrigation) and
21 municipal water supply uses.

22 In the Turkey Point SLR SEIS (NRC 2019c), the aspect of induced saltwater intrusion and
23 groundwater quality degradation in general was previously considered and discussed, albeit
24 indirectly (see issue discussion in Section 4.5.1.2.3).

25 As previously described, at the Turkey Point plant, large volumes of groundwater are pumped
26 from both the upper Biscayne and Upper Floridan aquifers for a variety of applications in
27 support of Turkey Point operations, as well as for other activities conducted on the Turkey Point
28 site unrelated to Units 3 and 4. These principal uses include withdrawals of brackish water from
29 the Upper Floridan aquifer for freshening of the CCS, operation of a recovery well system and
30 associated underground injection well to extract and dispose of hypersaline groundwater from
31 the Biscayne aquifer, operation of Biscayne aquifer marine wells that withdraw saltwater to
32 supplement CCS freshening, and operation of Upper Floridan aquifer site production wells for
33 various onsite uses (e.g., Unit 5 gas-fired power plant usage) and including CCS freshening, as
34 previously described (NRC 2019c).

35 The NRC staff's analysis of potential groundwater use conflicts for SLR of Turkey Point first
36 considered the potential effects of site recovery well system and marine well operation on
37 existing groundwater quality. As described in the SEIS, the recovery well system is designed to
38 extract hypersaline groundwater radiating from the CCS. The permit for operation of the system
39 issued by the South Florida Water Management District requires the licensee to (1) mitigate
40 interference with existing legal uses of groundwater and (2) mitigate harm to natural resources.
41 The permit requires mitigation for harm including effects on surface water or groundwater that
42 result in lateral movement of the saltwater interface, reductions in the hydroperiod of wetlands
43 or natural water bodies, causes the movement of contaminants contrary to water quality
44 standards, or causes harm to the natural system including habitats for rare or endangered
45 species. In such cases, the licensee would be required to take corrective action. Based on the
46 NRC staff's review of groundwater modeling performed by the licensee and State regulators, it

1 is likely that operation of the recovery well system will have beneficial water quality impacts by
2 retracting the CCS hypersaline plume and the westward expansion of the regional saltwater
3 interface, while providing reasonable assurance that any impacts on groundwater resources and
4 users would be mitigated.

5 The Turkey Point marine wells, completed in the Biscayne aquifer, had been used intermittently
6 since they were installed in 2015 to lower salinity in the CCS under abnormal conditions. As
7 detailed in the Turkey Point SLR SEIS, the NRC staff determined that periodic use of the marine
8 wells during the period of continued operations extending through the SLR term would not have
9 any substantial impact on groundwater quality or quantity. This is because the permeable
10 Biscayne aquifer in the affected area is recharged from Biscayne Bay, and any future marine
11 well operation on a temporary basis would be unlikely to substantially alter groundwater flow
12 beyond the affected area or result in any substantial drawdown in the Biscayne aquifer (NRC
13 2019c).

14 Regarding continued operation of the Upper Floridan aquifer site production wells, the NRC staff
15 reviewed groundwater modeling commissioned by the licensee to support the 2014 site
16 certification modification approval process with the State of Florida. The licensee's modified site
17 certification and conditions (issued in 2016) authorize a total average daily withdrawal of
18 28.06 Mgd (106,200 m³/day) from the Upper Floridan aquifer. As of 2018, groundwater
19 withdrawals from the Upper Floridan aquifer have been less than the authorized amounts. As
20 documented in the SEIS, groundwater modeling indicated that operation of the freshening well
21 system would be unlikely to result in any changes in regional water quality because the Upper
22 Floridan aquifer is already brackish, no saltwater interface exists in the confined system, and
23 water quality changes experienced by other aquifer users have been minor. However, the SEIS
24 noted that there is the potential for degradation of water quality in wells producing from the
25 Upper Floridan aquifer over time due to vertical seepage or lateral movement of more saline
26 water. Nevertheless, the licensee's modified site certification and associated conditions of
27 certification for Turkey Point require the licensee to mitigate harm to offsite groundwater users
28 (either related to water quantity or quality) as well as to offsite water bodies, land uses, and
29 other beneficial uses. In conclusion, the staff found that while continued operation of the Upper
30 Floridan aquifer production wells at the Turkey Point site, including the freshening well system,
31 would increase regional drawdown in the aquifer, the effects would not be expected to affect
32 water availability or impair the Upper Floridan aquifer as a resource during the SLR term.

33 The issue of groundwater quality degradation from groundwater withdrawals for nuclear plants,
34 including induced saltwater intrusion, was designated as a Category 1 issue in the 2013 LR
35 GEIS. The staff reviewed information from SEISs (for initial LRs and SLRs) completed since
36 development of the 2013 LR GEIS and identified no new information or situations that would
37 result in different impacts for this issue for either an initial LR or SLR term. For this issue,
38 groundwater quality degradation resulting from water withdrawals, the impacts would be SMALL
39 for all nuclear plants during the initial LR and SLR terms. This is a Category 1 issue.

40 *4.5.1.2.6 Groundwater Quality Degradation (Plants with Cooling Ponds)*

41 This issue is a consolidation of two related issues in the 2013 LR GEIS: (1) groundwater quality
42 degradation (plants with cooling ponds in salt marshes) and (2) groundwater quality degradation
43 (plants with cooling ponds at inland sites). These two issues both consider the possibility of
44 groundwater quality and beneficial use becoming degraded as a result of the migration of
45 contaminants discharged to cooling ponds. For this reason, they are discussed here as a single
46 issue. This new combined issue is a Category 2 issue.

Environmental Consequences and Mitigating Actions

1 Nuclear plants that use cooling ponds, impoundments, or similar structures as part of their
2 recirculating cooling water system discharge heated cooling water effluent back to the pond.
3 The effluent's concentration of contaminants and other solids increases relative to that of the
4 makeup water as it passes through the cooling system. These changes include increased total
5 dissolved solids (TDS) because they concentrate as a result of evaporation, increased heavy
6 metals (because cooling water contacts the cooling system components), and increased
7 chemical additives to prevent biofouling.

8 Other relatively small volumes of wastewater are released from other plant systems depending
9 on the design of each plant. They are discharged from such sources as the service water and
10 auxiliary cooling systems, water treatment plant, laboratory and sampling wastes, boiler
11 blowdown, floor drains, stormwater runoff, and metal-treatment wastes. These waste streams
12 are discharged as separate point sources or are combined with the cooling water discharges.
13 While these discharges at operating nuclear power plants are normally addressed in NPDES
14 permits, upsets and bypasses of treatment systems along with spills and leaks of wastewater
15 and chemical substances can and do occur.

16 Because the ponds are generally unlined, the water discharged to them can interact with the
17 shallow groundwater system and may create a groundwater mound. In this case, groundwater
18 below the pond can flow radially outward, and this groundwater would have some of the
19 characteristics of the cooling system effluent.

20 In many coastal locations, including salt marshes, the groundwater is naturally brackish
21 (i.e., with a TDS concentration of about 1,000 to more than 10,000 milligrams per liter [mg/L])
22 and, thus, is already limited in its uses. As such, this issue primarily concerns the potential for
23 changing the groundwater use category of the underlying shallow and brackish groundwater
24 due to the introduction of cooling water contaminants. Two nuclear plants, the South Texas
25 plant in Texas and Turkey Point plant in Florida, have cooling systems (a human-made cooling
26 pond and CCS, respectively) located relatively near or constructed in salt marshes.

27 Plants relying on brackish water cooling systems would generally not be expected to further
28 degrade the quality of the shallow aquifer relative to its use classification. This is because
29 groundwater quality beneath salt marshes is already too poor for human use (i.e., it is
30 nonpotable water) and is only suitable for industrial use. Plants relying on cooling ponds in salt
31 marsh settings were expected to have a SMALL impact on groundwater quality.

32 The NRC staff evaluated new information related to the impact of the continued operation of the
33 Turkey Point CCS on surface water and groundwater quality in the Turkey Point SLR SEIS in
34 the context of new, plant-specific analyses (NRC 2019c). As described in the SEIS, no surface
35 water is withdrawn to provide makeup water for the plant's CCS. The plant's intake and
36 discharge structures are located within the enclosed CCS, which does not directly discharge to
37 the surface waters of Biscayne Bay. Instead, water in the CCS is sustained by groundwater
38 inflow from the underlying surficial aquifer (Biscayne aquifer) into which the CCS was
39 excavated. The Biscayne aquifer, in turn, is hydrologically connected to the surrounding marsh
40 land, mangrove areas, adjacent drainage canals, Biscayne Bay, and Card Sound. The surficial
41 groundwater underlying Turkey Point and CCS was classified by the State of Florida in 1983 as
42 Class G-III (nonpotable use) with TDS levels of 10,000 mg/L or greater, while the Biscayne
43 aquifer to the west side of the CCS was classified as Class G-II (potable use). Information
44 presented in the SEIS shows that the inland movement of seawater through the Biscayne
45 aquifer (marked by the saltwater interface) had already progressed inland and to the west of the
46 location of the Turkey Point site prior to construction of the CCS in the 1970s. As of 2017, the

1 saltwater interface was located about 4.7 mi (7.6 km) west of the CCS at its closest point, and
2 moving west at a projected rate of 460 ft (140 m) per year. Nevertheless, through wells located
3 inland of the saltwater interface, the Biscayne aquifer is the major public water supply source
4 across Miami-Dade County as well as for the Florida Keys.

5 Due to a variety of environmental and other factors, the average salinity in the CCS increased
6 over time from that in nearby Biscayne Bay (approximately 34 practical salinity unit (PSU)) to
7 approximately 90 PSU in 2014 and 2015, and becoming hypersaline (i.e., saltier than seawater).
8 When the NRC staff prepared the Turkey Point initial LR SEIS in 2002 (NRC 2002a), the staff
9 acknowledged the existence of a hypersaline plume in the Biscayne aquifer directly beneath the
10 CCS. What was not fully understood at the time was the potential for the hypersaline plume to
11 migrate vertically downward through the Biscayne aquifer and then to move laterally within the
12 Biscayne aquifer beyond the CCS boundaries. Over the operational life of the CCS, the size of
13 the hypersaline plume grew larger. By 2018, the maximum extent of the hypersaline plume was
14 approximately 3 mi (4.8 km) west of the CCS in the intermediate zone of the Biscayne aquifer
15 and also to the east beneath Biscayne Bay and Card Sound. At the direction of the Florida
16 Department of Environmental Protection, groundwater modeling performed by the licensee
17 indicated that operating the CCS with salinity in excess of 35 PSU was the single largest
18 contributor to changes (movement) in the location of the saltwater interface (NRC 2019c).

19 In general, the results of extensive groundwater monitoring conducted by the licensee under the
20 direction of State of Florida and Miami-Dade County have shown that the extent of “potential
21 CCS influence” is 4.5 mi (7.2 km) west of the CCS as measured at the base (deep interval) of
22 the Biscayne aquifer. At this distance, and as detailed in the SEIS, the composition of the
23 groundwater includes ambient saline water mixed with small quantities of CCS water (including
24 soluble salts, nutrients, and tritium), whereas the degree of CCS influence (marked by higher
25 chloride and tritium concentrations) increases closer to the CCS. Further, elevated tritium levels
26 in the intermediate and deep monitored portions of the aquifer also indicate the potential
27 influence of CCS water in groundwater to the east of the CCS beneath Biscayne Bay. At no
28 location outside the boundary of the Turkey Point site did tritium levels in groundwater approach
29 the EPA and State primary drinking water standard for tritium (20,000 picocuries per liter [pCi/L])
30 (40 CFR Part 141), while the highest tritium levels observed in offsite monitoring wells near the
31 site during the 2018 reporting period were approximately 15 percent of the standard. Further,
32 the monitoring showed that no CCS-sourced constituents had affected the overlying surface
33 water quality (NRC 2019c).

34 In accordance with the regulatory agreements reached with and requirements imposed by the
35 Florida Department of Environmental Protection and Miami-Dade County, the licensee
36 implemented a salinity management plan and has undertaken other measures to abate
37 hypersaline water discharges and to actively remediate the hypersaline groundwater west and
38 north of the CCS. In 2016, the licensee also instituted pumping of brackish groundwater into the
39 CCS for salinity management purposes and specifically to maintain the average annual salinity
40 of the CCS at or below 34 PSU (see issue discussion Section 4.5.1.2.3). In 2017, the licensee
41 commenced operation of a recovery well system to extract hypersaline groundwater from near
42 the base of the Biscayne aquifer, and to limit the operational influence of the plant’s CCS. As
43 described in the SEIS, it is projected that operation of the recovery well system will achieve
44 retraction of the hypersaline plume back to within the Turkey Point site boundaries within
45 10 years (i.e., by about 2028) (NRC 2019c).

46 Regarding surface water quality impacts, the NRC staff concluded that the impacts on adjacent
47 surface water bodies via the groundwater pathway from continued CCS operations were SMALL

Environmental Consequences and Mitigating Actions

1 and projected to remain SMALL during the SLR term. With respect to groundwater, the staff
2 found that hypersaline groundwater containing tritium had migrated beyond the boundaries of
3 the CCS and Turkey Point property at the base of the Biscayne aquifer from Class G-III
4 groundwater (i.e., nonpotable groundwater) to the west and to the east beneath Biscayne Bay.
5 The hypersaline groundwater plume was also a significant contributor to the westward migration
6 of the saltwater interface and would remain so without mitigation. The staff further determined
7 that based on the data evaluated in the SEIS, CCS-influenced water had migrated into portions
8 of the Biscayne aquifer that are a potential source of potable water. These aspects of cooling
9 pond operations and their effects on groundwater quality were not considered in the 1996 or
10 2013 LR GEIS, and thus represented new and significant information compared to the 2013 LR
11 GEIS. As a result, the NRC staff concluded that the plant-specific impacts for this issue at
12 Turkey Point were MODERATE for operations during the initial LR term but were projected to be
13 SMALL during the SLR term as a result of ongoing remediation measures and State and county
14 regulatory oversight (NRC 2019c).

15 For the South Texas plant initial LR, the NRC staff considered potential groundwater quality
16 impacts from operation of the plant's main cooling reservoir (MCR), a 7,000 ac (2,833 ha)
17 engineered impoundment enclosed by a 12.4 mi (20 km) embankment. It is unlined and is the
18 source of the plant's condenser cooling water and receives various wastewater effluents,
19 regulated under a Texas Pollutant Discharge Elimination System permit. As described in the
20 SEIS, the MCR is a local source of recharge for the Upper Shallow Chicot aquifer (NRC 2013b).

21 The unlined MCR acts as a local recharge source for the Upper Shallow Chicot aquifer.
22 Further, a substantial portion of the seepage through the MCR is collected by the 770 relief
23 wells that surround the MCR, which discharge the seepage water to a perimeter drainage
24 system and then to local drainages (NRC 2013b). Therefore, locally relative to the South Texas
25 site, the MCR influences the groundwater quality of the Upper Shallow Chicot aquifer and
26 potentially local surface water quality.

27 The NRC staff's analysis found that seepage from the MCR to the Upper Shallow aquifer would
28 initially have the same TDS concentration as the MCR (i.e., median concentration of about
29 2,000 mg/L). The staff also noted that for radionuclides the impact on water quality would be
30 bounded by the maximum observed ambient concentration of tritium in the MCR (i.e., 17,410 in
31 1996 and levels less than 14,000 pCi/L thereafter). Groundwater monitoring showed that tritium
32 levels in the Shallow Chicot aquifer around the MCR remained below the EPA drinking water
33 standard of 20,000 pCi/L (40 CFR Part 141), with a maximum concentration of 8,600 pCi/L in
34 2012. As also discussed in the SEIS, relief wells had measured tritium concentrations of less
35 than 7,000 pCi/L at the time of the staff's review (NRC 2013b).

36 The Shallow Chicot aquifer exhibits poor water quality and low productivity, with TDS
37 concentrations in the local groundwater exceeding the EPA secondary drinking water standard
38 of 500 mg/L (40 CFR Part 143) and averaging 1,200 mg/L. The shallow aquifer has been used
39 in the vicinity of the South Texas plant for livestock watering. In contrast, water drawn from the
40 Deep Chicot aquifer is of higher quality. The licensee's five onsite supply wells draw from the
41 deep aquifer, as do public supply wells for the nearby communities to the east of the plant site
42 (NRC 2013b).

43 In summary, for the South Texas plant initial LR, the NRC staff found that seepage from the
44 MCR and other onsite contaminant releases had not substantially affected the groundwater
45 quality within the plant site and impacts on groundwater quality offsite would be less. TDS
46 levels were consistent with the existing groundwater quality and its past and potential future use

1 as a source of water for livestock. Any impacts from this change in groundwater quality would
 2 be localized because the groundwater plumes originating from the MCR are local to the plant
 3 site and the region immediately downgradient of the site to the lower Colorado River. Thus, the
 4 staff concluded that groundwater quality impacts from MCR seepage and other contaminant
 5 releases to groundwater from South Texas operations would remain SMALL during the license
 6 renewal term (NRC 2013b).

7 Some nuclear power plants that rely on unlined cooling ponds are located at inland sites
 8 surrounded by farmland or forest or undeveloped open land. Degraded groundwater has the
 9 potential to flow radially from the ponds and reach offsite groundwater wells. The degree to
 10 which this occurs depends on the water quality of the cooling pond; site hydrogeologic
 11 conditions (including the interaction of surface water and groundwater); and the location, depth,
 12 and pump rate of water wells. Mitigation of significant problems stemming from this issue could
 13 include lining existing ponds, constructing new lined ponds, or installing subsurface flow barrier
 14 walls. At either coastal (salt marsh) sites as discussed above or inland sites, groundwater
 15 monitoring networks would be necessary to detect and evaluate groundwater quality
 16 degradation.

17 The degradation of groundwater quality associated with cooling ponds had not been reported for
 18 any inland nuclear plant sites at the time the 2013 LR GEIS was prepared.

19 In addition to the Turkey Point and South Texas plants, as evaluated above, the other operating
 20 plants with cooling ponds as identified in Section 3.1.3 are Dresden Nuclear Power Station
 21 (Dresden), Robinson, Virgil C. Summer Nuclear Station (Summer), and Wolf Creek Generating
 22 Station (Wolf Creek) plants. Since publication of the 2013 LR GEIS, the NRC has performed
 23 license renewal environmental reviews for two nuclear power plants with cooling ponds at inland
 24 sites (Braidwood and LaSalle).

25 As contained in the SEIS for the Braidwood plant initial LR review, the NRC notes that the
 26 plant's cooling pond (constructed from a former strip mine) was built with a slurry wall to isolate
 27 the pond from the Upper aquifer. As a result, no movement of water between the aquifer and
 28 cooling pond would be expected, and the bottom of the cooling pond is filled with low-
 29 permeability shale, clay, and siltstone mine spoils. Much of the cooling pond is accessible to
 30 the public for fishing and other recreational activities. Wastewater discharges from the pond
 31 (i.e., blowdown) to the Kankakee River are regulated under an Illinois-issued NPDES permit.
 32 The NRC staff concluded that the impact of the cooling pond on groundwater quality would be
 33 SMALL during the license renewal term (NRC 2015d).

34 In the LaSalle plant initial LR SEIS (NRC 2016d), the staff described the plant's cooling pond as
 35 being formed from the construction of earthen dikes to enclose the north, east, and south sides
 36 of the pond; a natural levee created by existing topography forms the fourth side. Engineered
 37 fill consisting of silty-clay, taken from borrow areas within the pond basin, was used in the
 38 construction of the dikes. A perimeter drainage ditch designed to intercept runoff and to capture
 39 and direct seepage toward surface drainages and away from the dikes flanks the pond's dikes.
 40 The staff found that seepage from the cooling pond is negligible because the pond was built on
 41 the Glacial Drift Aquitard (Wedron Silty-Clay Till), a geologic unit with very low permeability.
 42 The pond's ambient water quality has also supported a recreational fishery. Between 2009 and
 43 2014, with the exception of a few tritium samples that were near background values, no
 44 radionuclides have been detected in the pond above background values. Cooling pond
 45 blowdown is discharged to the Illinois River in accordance with an Illinois-issued NPDES permit.
 46 For these reasons, the NRC staff concluded that that the impact of operation of LaSalle's

Environmental Consequences and Mitigating Actions

1 cooling pond on groundwater quality would be SMALL during the license renewal term (NRC
2 2016d).

3 The staff reviewed information from SEISs (for initial LRs and SLRs) completed since
4 development of the 2013 LR GEIS. On the basis of the information reviewed and the preceding
5 discussion, the impacts of groundwater quality degradation for plants using cooling ponds in
6 either coastal (salt marsh) settings or at inland sites could be greater than SMALL (i.e., SMALL
7 or MODERATE) depending on site-specific differences in the cooling pond's construction and
8 operation; water quality; site hydrogeologic conditions (including the interaction of surface water
9 and groundwater); and the location, depth, and pump rate of any water supply wells contributing
10 to or impacted by outflow or seepage from a cooling pond. Therefore, this revised, consolidated
11 issue is a Category 2 issue.

12 4.5.1.2.7 Radionuclides Released to Groundwater

13 As described in the 2013 LR GEIS, this Category 2 issue was added to evaluate the potential
14 contamination of groundwater from the inadvertent (abnormal) release of liquids containing
15 radioactive material from nuclear power plant systems into the environment.

16 The issue remains relevant to license renewal because all commercial nuclear power plants
17 routinely release radioactive gaseous and liquid materials into the environment. These
18 radioactive releases are designed to be planned, monitored, documented, and released into the
19 environment at designated discharge points. However, numerous events at power reactor sites
20 have involved unknown, uncontrolled, and unmonitored releases of liquids containing
21 radioactive material into the environment and affecting groundwater. NRC regulations in
22 10 CFR Part 20 and in 10 CFR Part 50 limit the amount of radioactive material, from all sources
23 at a nuclear power plant, released into the environment to levels that are as low as is
24 reasonably achievable (ALARA) along with associated radiation dose limits. The regulations
25 are designed to protect the public and the environment.

26 The majority of the inadvertent liquid release events have involved tritium, which is a radioactive
27 isotope of hydrogen. However, other radioactive isotopes, such as cesium and strontium, have
28 also been inadvertently released into the groundwater. The types of events have included, but
29 have not been limited to, leakage from spent fuel pools (SFPs), storage tanks, buried piping,
30 failed pressure relief valves on an effluent discharge line, and other nuclear power plant
31 equipment.

32 As summarized in Section 3.5.2 of this LR GEIS, in 2006, the NRC's Executive Director for
33 Operations chartered a task force to conduct a lessons learned review of these incidents. On
34 September 1, 2006, the task force issued its report: *Liquid Radioactive Release Lessons
35 Learned Task Force Report* (NRC 2006e).

36 The most significant conclusion dealt with the potential health impacts on the public from the
37 inadvertent releases. Although there were numerous events where radioactive liquid was
38 released to the groundwater in an unplanned, uncontrolled, and unmonitored fashion, based on
39 the data available, the task force did not identify any instances where public health and safety
40 was adversely affected.

41 Specific examples from NRC (2006e), as discussed in the 2013 LR GEIS, focused on tritium
42 releases at 15 operating plants. Concentrations of tritium in sampled onsite groundwater at
43 many of these plants ranged well above the EPA drinking water standard of 20,000 pCi/L.

1 Examples include onsite monitoring well samples of up to 250,000 pCi/L at the Braidwood plant
 2 in Illinois, up to 211,000 pCi/L at the Indian Point plant in New York, up to 486,000 pCi/L at the
 3 Dresden plant in Illinois, more than 30,000 pCi/L at the Watts Bar Nuclear Plant (Watts Bar) in
 4 Tennessee, and 71,400 pCi/L at the Palo Verde Nuclear Generating Station (Palo Verde) in
 5 Arizona. Examples of samples taken either directly from the source of the leak or from nearby
 6 onsite monitoring wells included samples with up to 200,000 pCi/L of tritium at the Callaway
 7 Plant in Missouri, up to 15,000,000 pCi/L at the Salem Nuclear Generating Station (Salem) in
 8 New Jersey, and up to 750,000 pCi/L at the Seabrook Station (Seabrook) in New Hampshire.
 9 At the Byron plant in Illinois, tritium in monitoring wells was above the background level but
 10 below drinking water standards (up to 3,800 pCi/L). The location and construction of the
 11 monitoring wells relative to potential leak locations have not been evaluated. For each example,
 12 it is possible that a different well placement could detect higher or lower activity concentrations.

13 Other reported instances (NRC 2006e) of tritium above background levels have been a result of
 14 operator error, licensed discharge, or leaks or discharges to drain systems. At the Oyster Creek
 15 plant in New Jersey (which permanently shut down in September 2018), a mistake involving a
 16 valve allowed tritium-contaminated water to flow into the discharge canal. Sampling of this
 17 water showed levels of 16,000 pCi/L. At the Wolf Creek plant in Kansas, an onsite lake
 18 receiving liquid effluent was found to have a tritium activity concentration of 13,000 pCi/L. The
 19 Perry Nuclear Power Plant (Perry) in Ohio had water samples in its drainage system with an
 20 activity concentration of 60,000 pCi/L. In each of these cases, the tritium present at the surface
 21 could infiltrate or seep into the groundwater system.

22 The NRC task force did not find the referenced tritium releases to be a health risk to the public
 23 or onsite workers (NRC 2006e) because the tritiated groundwater is expected to remain onsite.
 24 However, one identified exception was an event at the Braidwood plant, which resulted in
 25 detectable concentrations of tritium at an offsite location. Sampling of an offsite residential well
 26 at Braidwood showed 1,600 pCi/L of tritium, a level that was above the background level but
 27 well below the EPA drinking water standard. There would be no potential for risk to workers
 28 unless onsite wells were used for the potable water system and if the leak was in the capture
 29 zone of the well. However, the NRC requires that the onsite potable well water be monitored for
 30 radioactivity to protect plant workers.

31 The task force identified that under current NRC regulations the potential exists for unplanned,
 32 uncontrolled, and unmonitored releases of radioactive liquids to migrate offsite into the public
 33 domain. The following elements collectively contribute to this conclusion:

- 34 • Some of the power plant components that contain radioactive fluids that have leaked were
 35 constructed to commercial standards, in contrast to plant safety systems that are typically
 36 fabricated to more stringent requirements. The result is a lower level of assurance that
 37 these types of components will be leak-proof over the life of the plant.
- 38 • Some of the components that have leaked were not required by NRC regulations to be
 39 subject to surveillance, maintenance, or inspection activities by the licensee. This increases
 40 the likelihood that leakage in such components can go undetected. Additionally, relatively
 41 low leakage rates may not be detected by plant operators, even over an extended period of
 42 time.
- 43 • Portions of some components or structures are physically not visible to operators, thereby
 44 reducing the likelihood that leakage will be identified. Examples of such components
 45 include buried pipes and SFPs.

Environmental Consequences and Mitigating Actions

- 1 • Leakage that enters the ground below the plant may be undetected because there are
2 generally no NRC requirements to monitor the groundwater onsite for radioactive
3 contamination unless an onsite well is used for drinking water or irrigation.
- 4 • Contamination in groundwater onsite may migrate offsite undetected. Although the power
5 plant operator is required by NRC regulations to perform offsite environmental monitoring,
6 the sampling locations are typically in the vicinity of the routine effluent discharge point into
7 the environment, not around plant systems, piping, and tanks containing radioactive liquids.

8 Another aspect encountered by the NRC due to the inadvertent releases was the high level of
9 concern from the public, even at the very low radiation levels caused by the events. There has
10 also been significant media coverage and demands by State and local government officials and
11 members of Congress for the NRC to take action to stop these events.

12 The NRC has continued its oversight and evaluation of inadvertent releases of liquids containing
13 radioactive material from nuclear power plants, particularly those that result in groundwater
14 contamination. A discussion of NRC staff and Commission engagement and actions on this
15 issue since 2006 is presented in Section 3.5.2.

16 The NRC has also considered the impact of the inadvertent release of radioactive liquids during
17 its environmental reviews performed for initial LR and SLR applications since 2013. The
18 following narrative discusses noteworthy findings from these reviews.

19 As described in the SEIS for initial LR of the Seabrook plant, the NRC evaluated the impact of
20 historical inadvertent releases of radionuclides on groundwater resources. The releases
21 originated from the cask loading area and transfer canal, which is connected to the plant's SFP.
22 Before repairs were completed in 2004, tritium concentrations in the primary auxiliary building
23 were reported at up to 84,000 pCi/L in 2000 and, in the Unit 1 containment enclosure ventilation
24 area (CEVA), concentrations were reported up to 3,560,000 pCi/L in 2003. As part of the
25 licensee's corrective actions, a groundwater dewatering and pumping system was installed to
26 provide hydraulic containment of contaminated groundwater, and an extensive groundwater
27 monitoring network was also installed. By 2011, tritium concentrations in the CEVA had
28 dropped substantially, and ranged from 2,150 to 50,000 pCi/L. By the end of 2011, the highest
29 detection of tritium in the shallow aquifer at the site was 2,850 pCi/L in a well located near the
30 Unit 1 containment structure. The NRC determined that inadvertent releases of tritium had not
31 substantially impaired site groundwater quality or affected groundwater use downgradient of the
32 Seabrook plant. The NRC further concluded that groundwater quality impacts would remain
33 SMALL during the license renewal term (NRC 2015b).

34 There is a long history of documented spills and leaks of liquids containing radioactive material
35 at the Indian Point site in New York (Units 2 and 3 permanently shut down on April 30, 2020 and
36 April 30, 2021, respectively). The NRC in the second supplement to the SEIS for the initial LR
37 of the Indian Point plant (NRC 2018e) evaluated the environmental impact of inadvertent
38 releases to site groundwater, along with actions taken by the licensee, the NRC, and State
39 regulators to assess contamination and to take corrective action. As detailed in the SEIS,
40 groundwater contamination across the site has primarily been traced to the Unit 1 and Unit 2
41 SFPs. Historically, leaks from the Unit 1 SFP created contaminant plumes consisting of
42 strontium-90 and tritium, and leaks from various sources associated with Unit 2 created another
43 plume of tritium. These plumes comingle with each other and extend to the Hudson River.
44 Over much of the site, the plumes occur under buildings and other plant structures. Before they
45 reach the Hudson River, all three plumes are confined to the site and both vertically and laterally

1 to the Inwood Marble. Other radionuclides have been sporadically identified in the groundwater
2 at discrete locations onsite. Since 2005, the licensee has maintained an extensive long-term
3 groundwater monitoring program designed in part to characterize the current and potential
4 future offsite groundwater contaminant migration to the Hudson River. Based on the data
5 presented in the SEIS, concentrations of several radionuclides (e.g., tritium, strontium-90,
6 cesium-137) in groundwater exceeded the EPA drinking water standard (i.e., yielding an
7 equivalent annual dose of 4 mrem). In February 2016, the licensee notified the NRC of a
8 significant increase in groundwater tritium levels in monitoring wells located near the Unit 2 fuel
9 storage building. Tritium concentrations in one well increased from 18,900 pCi/L to 8.97 million
10 pCi/L. Investigations and inspection by the licensee, the NRC, and State followed. The sources
11 of the spills were identified. As a followup action, the NRC on January 17, 2017, issued a notice
12 of violation with a finding of very low safety significance under 10 CFR 20.1406(c) for failure by
13 the licensee to conduct operations to minimize the introduction of residual radioactivity into the
14 site, including the subsurface. The NRC's environmental review determined that site
15 groundwater contamination will either remain onsite or be discharged into the Hudson River.
16 Offsite groundwater supplies should continue to be unaffected by ongoing operations.
17 However, the NRC concluded that the impact on onsite groundwater quality was MODERATE
18 and likely to remain MODERATE through the end of scheduled plant operations (i.e., by no later
19 than April 30, 2025, for Unit 3). However, with the elimination of radionuclide leaks to the
20 groundwater and with the use of monitored natural attenuation, the impact on onsite
21 groundwater quality could move to SMALL. The NRC also concluded that the impact of site
22 groundwater contamination on surface water quality was SMALL, because the concentrations of
23 radionuclides in groundwater discharging to the Hudson River should be rapidly diluted to low
24 levels (NRC 2018e).

25 A number of inadvertent releases of radionuclides to groundwater have been documented at the
26 River Bend plant over the period 2008–2015, as described in the initial LR SEIS (NRC 2018c).
27 These releases resulted in the NRC issuing the licensee a non-cited violation of 10 CFR
28 20.1406(c) in 2016 for failure to conduct operations to minimize the introduction of residual
29 radioactivity into the site. The licensee took corrective actions to remedy and prevent future
30 leaks from the turbine building in the power block, including pumping groundwater from areas
31 near the power block. However, as documented in the SEIS, tritium exists in site groundwater
32 in a small area within the power block area, including groundwater within the structural fill and in
33 the underlying Upland Terrace aquifer. Monitoring wells are installed at various depths within
34 the structural fill and the Upland Terrace aquifer. The direction of groundwater flow in the
35 structural fill and the Upland Terrace aquifer is southwestward toward the Mississippi River
36 aquifer and from there into the Mississippi River. In 2017, tritium concentrations in the structural
37 fill of the power block and in the underlying Upland Terrace aquifer were 740,000 pCi/L and
38 223,000 pCi/L, respectively. Meanwhile, a short distance away from the power block, tritium
39 concentrations were much lower, with a maximum value of 54,900 pCi/L. The NRC staff
40 concluded that the impact of radionuclides released to groundwater at River Bend during the
41 license renewal term could range from SMALL to MODERATE (i.e., if the licensee has not
42 identified and stopped all leak sources, and if tritium continued to leak into site groundwater)
43 (NRC 2018c).

44 In the SLR SEIS for the Peach Bottom plant, the NRC evaluated the history of inadvertent
45 releases of radionuclides at the site and corrective actions taken by the licensee since 2006.
46 While the licensee had recorded no inadvertent releases between 2011 and 2014, a release in
47 April 2015 was traced to floor drains in the Unit 3 turbine building moisture separator area. The
48 highest tritium level observed in a nearby overburden well was 38,100 pCi/L. As described in
49 the SEIS, a plume of tritium-contaminated groundwater remains in the overburden material

Environmental Consequences and Mitigating Actions

1 beneath the plant site. The plume is the result of previous inadvertent spills and leaks of
2 radionuclide-containing liquids from the plant. The plume extends northeast of the Unit 3
3 turbine building toward the Peach Bottom intake basins. The NRC found that inadvertent
4 releases of radionuclides (primarily tritium) had not substantially impaired or noticeably altered
5 groundwater quality with respect to drinking water standards within the overburden and bedrock
6 groundwater beneath the plant site. Onsite inadvertent releases had no measurable effect on
7 surface waters adjoining the site, and did not threaten offsite groundwater. The NRC concluded
8 that impacts on groundwater resources from inadvertent releases of radionuclides were SMALL
9 and projected to remain SMALL during the SLR term (NRC 2020g).

10 The staff reviewed information from SEISs (for initial LRs and SLRs) completed since
11 development of the 2013 LR GEIS. On the basis of the information reviewed and cited about
12 inadvertent releases at operating nuclear power plants, the NRC concludes that the impact on
13 groundwater quality from the release of radionuclides could be SMALL or MODERATE during
14 the initial LR and SLR terms, depending on the magnitude of the leak, radionuclides involved,
15 hydrogeologic factors, the distance to receptors, and the response time of plant personnel to
16 identify and stop the leak in a timely fashion. Therefore, this is a Category 2 issue.

17 **4.5.2 Environmental Consequences of Alternatives to the Proposed Action**

18 *Construction* – For all alternatives discussed in this section, the impacts of construction on water
19 resources would be similar but could vary considerably in magnitude. For land-based facilities,
20 construction-related impacts on hydrology (land clearing, excavation work, and installation of
21 impervious surfaces) could alter surface drainage patterns and groundwater recharge zones, as
22 applicable. Potential hydrologic impacts would vary depending on the nature and acreage of
23 the land area disturbed and the intensity of the excavation work. Surface water runoff over
24 disturbed ground, construction laydown areas, and material stockpiles could increase the levels
25 of dissolved and suspended solids and other contaminants. Water quality could also be
26 affected by spills and leaks of petroleum, oil, and lubricant products from construction
27 equipment and conveyed in stormwater runoff or otherwise discharge into water bodies and
28 potentially affecting underlying groundwater. Groundwater withdrawn from onsite wells and
29 dewatering systems could depress the water table and possibly change the direction of
30 groundwater flow near the affected sites. Concrete production and wetting of ground surfaces
31 and unpaved roadways for fugitive dust control could require substantial amounts of water.
32 Appropriate permits, including a CWA Section 404 permit for dredge and fill activities,
33 Section 401 certification, and Section 402(p) NPDES general stormwater permit, would be
34 required prior to construction. These impacts would apply generally to the construction phase of
35 each of the alternatives discussed below. Differences among alternatives would depend not
36 only on the selected technology but on site-specific factors, which cannot be evaluated here.
37 For example, locating new alternative facilities, particularly thermoelectric power-generating
38 plants, at existing or former power plant sites to maximize the use of existing infrastructure
39 would reduce environmental impacts. However, the discussion of such differences and
40 considerations is outside the scope of this LR GEIS but is considered in plant-specific SEISs.

41 *Operation* – Most large electrical power plants require water for cooling. As a result, fossil-
42 fueled and nuclear power plants are generally located near large surface water bodies, including
43 lakes, rivers, or oceans. Table 4.5-1 compares water demands and consumptive use for
44 various technologies. Water cooling systems at existing thermoelectric power plants use either
45 once-through or closed-cycle systems (i.e., cooling towers). New thermoelectric power plants
46 are generally constructed with a closed-cycle cooling system to meet CWA Section 316(b)
47 requirements. Surface water and any groundwater withdrawals for cooling or other uses would

1 be subject to applicable State water appropriation and registration requirements. Potable water
 2 could be purchased from municipalities or commercial water providers or obtained from onsite
 3 wells or a combination of the above.

4 Potential operational water quality impacts could occur from blowdown (from cooling towers,
 5 ponds, or other plant systems) and evaporative losses in the steam cycle and cooling system
 6 and from drift of chemically treated cooling water from the cooling tower. Releases of industrial
 7 wastewaters, stormwater, and other effluents would be controlled by an NPDES permit, issued
 8 by the EPA or State permitting authority. The operational aspects and impacts of alternative
 9 energy technologies on water resources are presented in the following sections.

10 **Table 4.5-1 Water Withdrawal and Consumptive Use Factors for Select Electric Power**
 11 **Technologies**

Electric Power Technologies	Water Withdrawal (gal/MWh) ^(a)	Consumptive Use (gal/MWh) ^(a)
IGCC (coal) with cooling towers	358 to 605	318 to 439
IGCC (coal) with cooling towers and carbon capture and sequestration (storage)	479 to 678	522 to 558
Supercritical (coal) with once-through cooling	22,551 to 22,611	64 to 124
Supercritical (coal) with cooling towers	582 to 669	458 to 594
Supercritical (coal) with cooling towers and carbon capture and sequestration (storage)	1,098 to 1,148	846 ^(c)
NGCC with once-through cooling	7,500 to 20,000	20 to 100
NGCC with cooling towers	150 to 283	130 to 300
NGCC with cooling towers and carbon capture and sequestration (storage)	487 to 506	378 ^(c)
Nuclear (conventional LWR) with once-through cooling	25,000 to 60,000	100 to 400
Nuclear (conventional LWR) with cooling towers	800 to 2,600	581 to 845
Nuclear (conventional LWR) with cooling pond	500 to 13,000	560 to 720
Biopower (steam) with cooling towers	500 to 1,460	480 to 965
Geothermal (EGS) with cooling towers	2,885 to 5,147 ^(b)	2,885 to 5,147 ^(b)
Concentrated solar power (power tower) with cooling towers	740 to 860 ^(b)	740 to 860 ^(b)
Solar photovoltaic	0 to 33 ^(b)	0 to 33 ^(b)
Wind turbine	0 to 1 ^(b)	0 to 1 ^(b)
Hydropower (instream and reservoir losses due to power production)	Not applicable	1,425 to 18,000

12 EGS = enhanced geothermal system; gal/MWh = gallons per megawatt-hour; IGCC = integrated gasification
 13 combined cycle; LWR = light water reactor; NGCC = natural gas combined cycle.
 14 (a) Water withdrawal and consumptive use are expressed in units of volume per unit of electrical output (gallons
 15 per megawatt-hour) to provide a direct comparison among technologies based on NREL 2011.
 16 (b) Water withdrawal factors and consumptive use for geothermal, concentrated solar, solar photovoltaic, and wind
 17 technologies are assumed to be equal (i.e., all water is assumed to be lost through evaporation or consumed in
 18 process, etc.).
 19 (c) Only a single value is included in the source data.
 20 Note: To convert gallons (gal) to liters, multiply by 3.7854.
 21 Source: NREL 2011.

1 4.5.2.1 *Fossil Energy Alternatives*

2 *Operation* – All thermoelectric energy facilities, including fossil fuel power plants, require a
3 continuous supply of water to operate. Water demands vary greatly among energy technologies
4 and cooling system designs. In general, facilities using once-through cooling systems withdraw
5 10 to 100 times more water per unit of electric generation than those using cooling towers, but
6 cooling tower consumptive use is twice as much or more water per unit of electricity production
7 (NREL 2011). As indicated in Table 4.5-1, coal-fired facilities generally have higher
8 consumptive water use than natural gas combined-cycle plants. The use of carbon capture and
9 sequestration (storage) increases both water withdrawal (demand) requirements and
10 consumptive use. In total, water usage is a function of the fossil fuel combustion technology,
11 heating value of the fuel being consumed, the design of the primary cooling systems, and the
12 operation of various other devices, many of which require water.

13 Water resources would be affected not only by water withdrawals but by reintroduction of water
14 from steam cycle, cooling tower, gasifier blowdown water, and other wastewaters, as applicable
15 to the technology. Water quality would also be affected by wastewater generated by exhaust-
16 gas cleaning devices that may be operating and by other ancillary industrial activities, such as
17 runoff and the leachate from onsite coal storage and ash piles.

18 4.5.2.2 *New Nuclear Alternatives*

19 Water resources would be affected by operation of the cooling system and by discharges of
20 blowdown water from the cooling system and steam cycle, both of which can introduce chemical
21 contaminants and heat to the receiving surface water body. Operation of these systems could
22 also affect hydrology by reducing available surface water volume, altering current patterns at
23 intake and discharge structures, altering salinity gradients where applicable, scouring and
24 increases in sediment caused by discharges of treated cooling water, and increasing water
25 temperature. Hydrologic impacts would vary, depending on the surface water source or
26 groundwater used for cooling as well as the cooling water system employed (see Table 4.5-1).
27 Hydrology can also be affected by a nuclear power plant's service water system, which provides
28 water for turbine and reactor auxiliary equipment cooling, reactor shutdown cooling, and other
29 services. Surface water and groundwater can also be affected by discharges authorized under
30 NPDES and other permits and by accidental spills and leaks of radionuclides, chemicals, and
31 fuels to the ground surface. Overall, impacts on water resources at a greenfield site could be
32 substantial and would depend highly on local circumstances and factors such as other
33 dependencies on the hydrologic resources. Hydrologic impacts at a brownfield site or an
34 existing nuclear facility could also be substantial, depending in part on whether or not the new
35 nuclear plant could use the existing cooling water system.

36 4.5.2.3 *Renewable Alternatives*

37 The operational impacts of renewable energy technologies on water resources would vary
38 greatly based on the technology (see Table 4.5-1).

1 For biomass-fired plants, water demands for cooling and steam would be similar to those of
2 some fossil fuel-fired power plants. Water demand could equal evaporative water loss from
3 cooling tower and flue gas scrubbers. Water quality could be affected by blowdown and
4 contaminants released in runoff from piles of feedstock materials, fly and bottom ash, and
5 scrubber sludge.

6 Geothermal plants have water demands and consumptive water use rates equal to or greater
7 than those of many conventional thermoelectric (nonrenewable) technologies (Table 4.5-1)
8 during operation. Potential operational impacts on surface water or groundwater from
9 geothermal plants include releases of contaminants from faulty geothermal wells or release of
10 geothermal fluids (brines) to the surface and being conveyed by stormwater runoff or otherwise
11 affecting surface water bodies. These potential impacts can be mitigated with proper
12 safeguards (DOE 1997b).

13 As shown in Table 4.5-1, solar PV facilities and wind farms (either onshore or offshore) have
14 minimal water demands during normal operation. Similarly, solar PV and wind farm installations
15 have little or no wastewater discharge during normal operation. In contrast, concentrated
16 thermal power facilities can have water demands similar to those of many other thermoelectric
17 (nonrenewable) technologies. For some facilities, cooling tower blowdown must be managed
18 (typically in an arid environment), and there is the potential for water quality impacts from
19 accidental release of heat transfer fluids or thermal storage media (molten salts) used in
20 concentrated solar plants (DOE 1997b).

21 Reservoirs used by hydroelectric dams could be affected by changes in water temperature and
22 amounts of dissolved oxygen. Surface water temperatures in the reservoir could be affected
23 when water flow is reduced. Warm water released from the top of a hydroelectric dam and
24 cooler water released from the lower portions of the dam could affect river water temperatures
25 downstream. Additionally, both low- and high-flow conditions would alter sediment transport
26 and deposition patterns.

27 **4.6 Ecological Resources**

28 **4.6.1 Environmental Consequences of the Proposed Action – Continued Operations** 29 **and Refurbishment Activities**

30 Environmental conditions at operating nuclear power plants have been well established during
31 the current licensing term. Continued operations are not expected to change substantially
32 during the license renewal term, and therefore, existing conditions are expected to persist
33 during initial LR and SLR terms. Initial LR or SLR generally represent a continuation of current
34 environmental stressors that have existed during many years of operation. License renewal is
35 unlikely to introduce wholly new stressors on the ecological environment. However, due to the
36 ever-changing nature of ecological communities, the magnitude of impact that these stressors
37 exhibit on ecological resources may change. Sections 3.6.1, 3.6.2, and 3.6.2.3 discuss
38 terrestrial resources, aquatic resources, and federally protected ecological resources,
39 respectively, and existing environmental stressors. The following sections present the potential
40 effects on these resources associated with continued operations of a nuclear power plant during
41 a license renewal term.

Environmental Consequences and Mitigating Actions

1 4.6.1.1 *Terrestrial Resources*

2 Continued operations of nuclear power plants during an initial LR or SLR term are expected to
3 include continued operation of the cooling water intake system (e.g., once-through system,
4 cooling pond, or cooling tower[s]), continued management of in-scope transmission lines and
5 associated ROWs, maintenance of site facilities, releases of gaseous and liquid effluents, and
6 ground disturbances and other effects associated with refurbishment, if applicable.

7 Terrestrial plants and animals would continue to be exposed to chemical and radionuclide
8 releases and cooling tower drift (at sites with cooling towers). Continued site and transmission
9 line maintenance could affect vegetation and disturb wildlife. Nuclear power plant structures
10 and transmission lines would continue to pose collision hazards for birds. Wildlife near the site
11 would experience elevated noise, vibration, and general human disturbance. Habitat loss,
12 degradation, disturbance, or fragmentation could result from construction, refurbishment, or
13 other site activities, including site maintenance and infrastructure repairs. Plants and animals
14 would also be exposed to electromagnetic fields (EMFs). Section 3.6.1 discusses the basis for
15 these factors; this section evaluates how these factors would affect terrestrial resources during
16 the course of a license renewal term.

17 This section considers the effects that terrestrial resources may experience as a result of initial
18 LR or SLR as eight issues. These issues are:

- 19 • non-cooling system impacts on terrestrial resources;²
- 20 • exposure of terrestrial organisms to radionuclides;
- 21 • cooling system impacts on terrestrial resources (plants with once-through cooling systems or
22 cooling ponds);
- 23 • cooling tower impacts on terrestrial plants;²
- 24 • bird collisions with plant structures and transmission lines;
- 25 • water use conflicts with terrestrial resources (plants with cooling ponds or cooling towers
26 using makeup water from a river);
- 27 • transmission line right-of-way (ROW) management impacts on terrestrial resources; and
- 28 • electromagnetic field effects on terrestrial plants and animals.²

29 4.6.1.1.1 *Non-Cooling System Impacts on Terrestrial Resources*

30 This issue concerns the effects of nuclear power plant operations on terrestrial resources during
31 an initial LR or SLR term that are unrelated to operation of the cooling system. Such activities
32 include landscape and grounds maintenance, stormwater management, elevated noise levels
33 and vibration, and ground-disturbing activities. These impacts are expected to be like past and
34 ongoing impacts that terrestrial resources are already experiencing at the nuclear power plant
35 site.

36 In the 1996 LR GEIS, the NRC evaluated the impacts of refurbishment on terrestrial resources.
37 In the 2013 LR GEIS, the NRC expanded this issue to include impacts of other site activities,
38 unrelated to cooling system operation, that may affect terrestrial resources. In both the 1996

² Issue retitled from the 2013 LR GEIS for clarity and consistency with other ecological resource issues. No substantive changes to this issue have been made.

1 and 2013 LR GEISs, the NRC concluded that effects could be SMALL, MODERATE, or LARGE.
2 Therefore, these were considered Category 2 issues for all nuclear power plants. This LR GEIS
3 refines the title of this issue from “effects on terrestrial resources (non-cooling system impacts)”
4 to “non-cooling system impacts on terrestrial resources” for clarity and consistency with other
5 ecological resource LR GEIS issue titles.

6 Industrial-use portions of nuclear power plant sites are typically maintained as modified habitats
7 with lawns and other landscaped areas; however, these areas may also include disturbed early
8 successional habitats or small areas of relatively undisturbed habitat. Developed areas are
9 generally maintained through physical (e.g., mowing and cutting) and chemical (e.g., herbicides
10 or pesticides) means. Plant diversity in these areas is generally low and often consists of
11 cultivated varieties or weedy species tolerant of disturbance. Nonindustrial-use portions of
12 nuclear power plant sites may include natural areas, such as forests, shrublands, prairies,
13 riparian areas, or wetlands. These habitats may be undisturbed or in various degrees of
14 disturbance.

15 Certain areas may also be managed to preserve natural resources, either privately by the
16 nuclear power plant operator or in conjunction with local, State, or Federal agencies. For
17 instance, approximately 13,000 ac (5,300 ha) of land to the south and west of the Turkey Point
18 site in Florida is part of the Everglades Mitigation Bank (NRC 2019c). Under the guidance of
19 Federal and State agencies, Florida Power and Light Company creates, restores, and enhances
20 this habitat to provide compensatory mitigation of wetland losses elsewhere. At Shearon Harris
21 Nuclear Power Plant (Harris) in North Carolina, Duke Energy leases land, including part of
22 Harris Lake, to Wake County which co-manages the area with the North Carolina Wildlife
23 Resources Commission for natural resource preservation and recreational opportunities (Duke
24 Energy 2017). Continued conservation efforts during the license renewal term would have
25 beneficial effects on the local ecology.

26 The characteristics of terrestrial vegetation and wildlife communities on nuclear power plant
27 sites have generally developed in response to many years of plant operations and maintenance.
28 While some communities may have reached a relatively stable condition, some may have
29 continued to change gradually over time. Operations and maintenance activities as well as any
30 refurbishment during the license renewal term are expected to be like current activities (see
31 Section 2.1). Because the plants and animals present on nuclear power plant sites are
32 generally tolerant of disturbance and acclimated to human activity, continued operations during
33 the license renewal term would not affect the composition of terrestrial communities or any
34 current trends of change.

35 Continued site landscape maintenance would maintain vegetation on developed portions of
36 nuclear power plant sites as low-diversity habitat. Wildlife diversity immediately surrounding
37 industrial-use portions of sites and within other landscaped areas is typically limited by low-
38 quality habitat and generally includes species adapted to developed land uses. Animals in
39 these areas may be exposed to elevated noise levels and vibration associated with
40 transformers, cooling towers, and other site activities that could cause animals to avoid suitable
41 habitat or otherwise disrupt behavioral patterns.

42 Stormwater management may affect onsite and adjacent wetlands. Effects may include
43 changes in plant community characteristics, altered hydrology, decreased water quality, and
44 sedimentation (EPA 1993, EPA 1996; Wright et al. 2006). Impervious surfaces within the
45 watershed generally result in increased runoff and reduced infiltration, which can cause
46 changes in the frequency or duration of inundation or soil saturation and greater fluctuations in

Environmental Consequences and Mitigating Actions

1 wetland water levels. Runoff may contain sediments, contaminants from road and parking
2 surfaces, or herbicides. Erosion of wetland substrates and plants can result from increased flow
3 from impervious surfaces.

4 If activities associated with continued nuclear power plant operations disturb nonindustrial-use
5 portions of sites, some wildlife could be displaced to nearby available habitats, and competition
6 could increase among species. Terrestrial plants and animals could experience adverse effects
7 from fugitive dust, altered surface water flow patterns, water quality degradation, introduction or
8 proliferation of non-native and invasive species, and general disturbance from human activity.
9 Species that are more sensitive to disturbance may be displaced by more tolerant species.
10 Impervious surfaces within watersheds generally result in more runoff and less infiltration to
11 shallow groundwater, which alters the hydrologic input to nearby wetlands (EPA 1993, EPA
12 1996; Wright et al. 2006). This can change the frequency or duration of inundation or soil
13 saturation, cause greater fluctuations in wetland water levels, and degrade or erode wetland
14 substrates. Site runoff often contains sediments, contaminants from road and parking surfaces,
15 or herbicides (EPA 1993, EPA 1996; Wright et al. 2006). In rare or unique plant communities,
16 sensitive habitats such as wetlands or bird rookeries, or high-quality undisturbed habitats occur
17 in or near affected areas, impacts on such resources could be considered MODERATE or
18 LARGE if they would noticeably alter or destabilize important attributes of those resources.
19 Impacts would be considered SMALL if only previously disturbed or other lower-quality habitats
20 would be affected and no noticeable or detectable impacts on the ecological environment would
21 result.

22 The 2013 LR GEIS indicates that elevated noise levels and vibration from transformers and
23 cooling towers could disrupt wildlife behavioral patterns or cause animals to avoid such areas.
24 However, limited wildlife inhabit most areas of nuclear power plant sites that experience
25 elevated noise levels due to the developed, industrial nature of the site, regular presence of
26 human activity, and associated lack of high-quality habitat. Wildlife that does occur in
27 developed areas has already adapted to the conditions of the plant site and is tolerant of
28 disturbance. The NRC staff have not identified noise or vibration associated with normal
29 nuclear power plant operations to be of concern in any SEISs (initial LR or SLR) completed
30 since development of the 2013 LR GEIS. Therefore, continued noise associated with the
31 operation of transformers and cooling towers during the license renewal term is unlikely to
32 create noticeable impacts on terrestrial resources.

33 In the 1996 and 2013 LR GEISs, the NRC staff anticipated that nuclear power plants may
34 require refurbishment to support continued operations during a license renewal term (see
35 Section 2.1.2). However, refurbishment has not typically been necessary for license renewal.
36 Only two nuclear power plants have undertaken refurbishment as part of license renewal
37 (Beaver Valley Power Station [Beaver Valley] and Three Mile Island, Unit 1 [Three Mile Island;
38 no longer operating], both of which are located in Pennsylvania) (NRC 2009a; NRC 2009b). In
39 addition to refurbishment, license renewal could also require construction of additional onsite
40 spent fuel storage. Refurbishment or spent fuel storage construction could require new parking
41 areas for workers as well as new access roads, buildings, and facilities. Temporary project
42 support areas for equipment storage, overflow parking, and material laydown areas could also
43 be required.

44 Any activities that require construction or involve ground disturbance could affect terrestrial
45 habitats. Ground-disturbing activities may be related to refurbishment or other planned activities
46 during the license renewal term that involve demolition or construction. Natural habitats could
47 be destroyed or altered and wildlife could be displaced or killed. Indirect effects include erosion

1 and sedimentation, both of which are typically proportional to the amount of surface disturbance,
2 slope of the disturbed land, and condition of the area at the time of disturbance. Chemical
3 contamination could also occur from fuel or lubricant spills. Temporarily disturbed habitats
4 would likely recover over time, while permanently disturbed habitats would be permanently lost.
5 Associated noise, vibration, and human activity could cause wildlife to temporarily avoid the
6 affected area or otherwise alter behaviors.

7 Some activities during a license renewal period could require Federal permits or review, which
8 would mitigate potential effects. For instance, site activities involving the discharge of dredge or
9 fill material into wetlands would likely require the nuclear power plant operator to obtain a CWA
10 Section 404 (33 U.S.C. § 1251 et seq.) permit from the USACE. Actions that may affect
11 federally endangered or threatened species or other federally protected resources would require
12 interagency consultation with the FWS or the National Oceanic and Atmospheric Administration
13 (NOAA). Some states and local jurisdictions also require permits for actions that may affect
14 State-listed species and rare habitats. Such permits would ensure that effects on sensitive
15 habitats and species are minimized during the license renewal term.

16 Many nuclear power plant operators have developed site or fleet-wide environmental review
17 procedures that help workers identify and avoid impacts on the ecological environment when
18 performing site activities. These procedures generally include checklists to help identify
19 potential effects and required permits and BMPs to minimize the affected area. BMPs relevant
20 to terrestrial resources may include measures to control fugitive dust, runoff, and erosion from
21 project sites; minimize the spread of nuisance and invasive species; and reduce wildlife
22 disturbance. Proper implementation of environmental procedures and BMPs would minimize or
23 mitigate potential effects on terrestrial resources during the license renewal term.

24 Some utilities are members of the Wildlife Habitat Council, which helps corporations manage
25 their land for broad-based biodiversity enhancement and conservation. As part of membership,
26 sites develop wildlife management plans that include a comprehensive strategy for enhancing
27 and conserving site ecological resources. For instance, at the Limerick plant in Pennsylvania,
28 Exelon places and monitors artificial avian nesting structures and bat roost boxes (NRC 2014d).
29 At the Peach Bottom plant in Pennsylvania, Exelon has established a butterfly garden to support
30 and promote native pollinator diversity (Exelon 2011). To maintain membership, sites must
31 undertake projects that promote native biodiversity, gather data on conservation efforts, and
32 report on their progress. Other nuclear power plant sites that maintain Wildlife Habitat Council
33 membership include Braidwood, Byron Station (Byron), Calvert Cliffs, Clinton Power Station
34 (Clinton), Dresden, James A. FitzPatrick Nuclear Power Plant (Fitzpatrick), R.E. Ginna Nuclear
35 Power Plant (Ginna), LaSalle, Nine Mile Point Nuclear Station (Nine Mile Point), and Quad
36 Cities Nuclear Power Station (Quad Cities). Continued participation in this or similar
37 environmental conservation organizations would minimize or mitigate potential effects on
38 terrestrial resources during the license renewal term.

39 The staff reviewed information from SEISs (for initial LR and SLRs) completed since
40 development of the 2013 LR GEIS. In summary, the potential non-cooling system effects during
41 an initial LR or SLR term depend on numerous site-specific factors, including the ecological
42 setting of the plant; the planned activities during the license renewal period; the characteristics
43 of the plants and animals present in the area (e.g., life history, distribution, population trends,
44 management objectives, etc.); and the implementation of BMPs or other conservation initiatives.
45 Non-cooling system impacts would be SMALL at most nuclear power plants but may be
46 MODERATE or LARGE at some plants. Therefore, a generic determination of potential impacts
47 on terrestrial resources from continued operations during a license renewal term is not possible.

Environmental Consequences and Mitigating Actions

1 The NRC concludes that non-cooling system effects on terrestrial resources during the license
2 renewal term (initial LR or SLR) could be SMALL, MODERATE, or LARGE. This is a
3 Category 2 issue.

4 *4.6.1.1.2 Exposure of Terrestrial Organisms to Radionuclides*

5 This issue concerns the potential impacts on terrestrial organisms from exposure to
6 radionuclides from routine radiological effluent releases during an initial LR or SLR term.

7 The 1996 LR GEIS did not address this issue. In 2007, the International Commission on
8 Radiation Protection (ICRP) issued revised recommendations for a system of protection to
9 control exposure from radiation sources (ICRP 2007). The recommendations included a section
10 about the protection of the environment in which the ICRP found that a clearer framework for
11 assessing nonhuman organisms was warranted. The ICRP indicated that it would develop a set
12 of reference animals and plants as the basis for relating exposure to dose, and dose to radiation
13 effects, for different types of organisms. This information would then provide a basis from which
14 agencies and responsible organizations could make policy and management decisions.
15 Subsequently, the ICRP developed and published a set of 12 reference animals and plants
16 (ICRP 2008a, ICRP 2009). They include a large and small terrestrial mammal, an aquatic bird,
17 and a large and small terrestrial plant, among others. The ICRP also issues publications and
18 information related to radiological effects and radiosensitivity in non-human biota (Adam-
19 Guillermin et al. 2018).

20 In 2009, following the NRC staff's review of the ICRP's 2007 recommendations, the
21 Commission found that there is no evidence that the NRC's current set of radiation protection
22 controls is not protective of the environment (NRC 2009e). For this reason, the Commission
23 determined that the NRC staff should not develop separate radiation protection regulations for
24 plant and animal species (NRC 2009e).³ The Commission directed the NRC staff to continue
25 monitoring international developments on this issue and to keep the Commission informed.
26 Nonetheless, the NRC addressed radiological exposure of nonhuman organisms in the 2013 LR
27 GEIS due to public concern about these impacts at some nuclear power plants.

28 In the 2013 LR GEIS, the NRC determined that the impacts of exposure of terrestrial organisms
29 to radionuclides would be SMALL at all nuclear power plants. Therefore, this was considered a
30 Category 1 issue for all nuclear power plants.

31 Radionuclides may be released from nuclear power plants into the environment through several
32 pathways. During normal operations and potentially during refurbishment, nuclear power plants
33 can release gaseous emissions that deposit small amounts of radioactive particulates in the
34 surrounding environment. Gaseous emissions typically include krypton, xenon, and argon
35 (which may or may not be radioactive), tritium, isotopes of iodine, and cesium. Emissions may
36 also include strontium, cobalt, and chromium. Radionuclides may also be released into water
37 as liquid effluent. Terrestrial plants can absorb radionuclides that enter shallow groundwater or
38 surface waters through their roots. Animals may experience exposure to ionizing radiation
39 through direct contact with air, water, or other media; inhalation; or ingestion of contaminated
40 food, water, or soil.

³ See also SECY-04-0223 (NRC 2004f), SECY-06-0168 (NRC 2006g), SECY-08-0197 (NRC 2008c), SECY-04-0055 (NRC 2004e), and related Staff Requirements Memorandums SRM-SECY-04-0223 (NRC 2005e), SRM-SECY-06-0168 (NRC 2005f), SRM-SECY-08-0197 (NRC 2009e), and SRM-SECY-04-0055 (NRC 2004d).

1 The DOE has produced a standard on a graded approach for evaluating radiation doses to
 2 terrestrial and aquatic biota (DOE 2019). The DOE standard provides methods, models, and
 3 guidance that can be used to characterize radiation doses to terrestrial and aquatic biota
 4 exposed to radioactive material (DOE 2019). The following DOE guidance dose rates are the
 5 levels below which no adverse effects to resident populations are expected:

- 6 • riparian animal (0.1 radiation-absorbed dose per day [rad/d]; 0.001 gray per day [Gy/d])
- 7 • terrestrial animal (0.1 rad/d) (0.001 Gy/d)
- 8 • terrestrial plant (1 rad/d) (0.01 Gy/d)
- 9 • aquatic animal (1 rad/d) (0.01 Gy/d)

10 Previously, in 1992, the International Atomic Energy Agency (IAEA) (IAEA 1992) had also
 11 concluded that chronic dose rates of 0.1 rad/d (0.001 Gy/d) or less do not appear to cause
 12 observable changes in terrestrial animal populations. The United Nations Scientific Committee
 13 on the Effects of Atomic Radiation concluded in 1996 and re-affirmed in 2008 that chronic dose
 14 rates of less than 0.1 mGy/hr (0.24 rad/d or 0.0024 Gy/d) to the most highly exposed individuals
 15 would be unlikely to have significant effects on most terrestrial communities (UNSCEAR 2010).

16 In the 2013 LR GEIS, the NRC estimated the total radiological dose that the four non-human
 17 receptors listed above (i.e., riparian animal, terrestrial animal, terrestrial plant, and aquatic
 18 animal) would be expected to receive during normal nuclear power plant operations based on
 19 plant-specific radionuclide concentrations in water, sediment, and soils at 15 operating nuclear
 20 power plants using Argonne National Laboratory’s RESRAD-BIOTA dose evaluation model.
 21 The NRC found that total calculated dose rates for all terrestrial receptors at all 15 plants were
 22 significantly less than the DOE guideline values. As a result, the NRC anticipated in the 2013
 23 LR GEIS that normal operations of these facilities would not result in negative effects on
 24 terrestrial biota. The 2013 LR GEIS concluded that the impact of radionuclides on terrestrial
 25 biota from past operations would be SMALL for all nuclear plants and would not be expected to
 26 change appreciably during the license renewal period.

27 In this revision, the NRC staff conducted an updated and expanded analysis for this issue to
 28 assess whether the 2013 LR GEIS conclusions are valid for initial LR and apply to the SLR
 29 term. As part of this expanded analysis, the staff reviewed effluent release reports, performed
 30 additional RESRAD-BIOTA dose calculations, and analyzed dose to biota using the ICRP biota
 31 dose calculator. The staff reviewed a subset of operating PWR and BWR plants⁴ to evaluate
 32 the potential impacts of radionuclides on terrestrial biota from continued operations. The staff
 33 reviewed effluent releases for this subset of plants between 2013 and 2020 to evaluate releases
 34 since the 2013 LR GEIS was published. The staff found that all data for this time period were
 35 below reportable thresholds.

36 The NRC staff evaluated Radiological Environmental Monitoring Program (REMP) reports for
 37 the year 2020 for the subset of operating PWR and BWR plants. This review yielded expected
 38 radionuclide concentrations in the environment that may be sourced from nuclear power plants.
 39 In addition to regulated Lower Limits of Detection (LLD) stated in NUREG-1301 and NUREG-
 40 1302 (NRC 1991b, NRC 1991a), the NRC staff obtained site-specific radionuclide
 41 concentrations and LLDs in water, sediment, and soils when available from the REMP reports.

⁴ The subset of plants included the following PWR plants: Comanche Peak, D.C. Cook, Palo Verde 1-3, Robinson, Salem 1-2, Seabrook, and Surry; and the following BWR plants: Fermi 2, Hatch 1-2, Hope Creek, Limerick, and Columbia.

Environmental Consequences and Mitigating Actions

1 To estimate radioactive impacts to environmental receptors, the staff used the RESRAD-BIOTA
2 dose evaluation model (DOE 2004c) to calculate estimated dose rates for terrestrial biota (see
3 Section D.5 in Appendix D for further details on this approach). The values reported in the
4 reviewed REMP reports were frequently listed as being below the LLD. Measurements below
5 the LLD are too low to statistically confirm the presence of the radionuclide in the sample.
6 Accordingly, the staff conducted a RESRAD-BIOTA analysis using either the maximum values
7 from a measured media concentration or an LLD, when all measurements for that radionuclide
8 were below detection limits. The staff then aggregated these values to form a single RESRAD-
9 BIOTA analysis. This method is considered a bounding analysis because it assumes that all
10 radionuclides included in the RESRAD-BIOTA analysis are present in the environment, even
11 though some radionuclides are not confirmed to actually be present (i.e., those radionuclides
12 that are below the LLD). Table 4.6-1 presents the results of the NRC staff's RESRAD-BIOTA
13 analysis. This table shows the total dose estimates to the four ecological receptors: riparian
14 animal,⁵ terrestrial animal, terrestrial plant, and aquatic animal.

15 **Table 4.6-1 Estimated Radiation Dose Rates to Terrestrial Ecological Receptors from**
16 **Radionuclides in Water, Sediment, and Soils at U.S. Nuclear Power Plants**

Receptor	Riparian Animal	Terrestrial Animal	Terrestrial Plant	Aquatic Animal
Sum of Total Dose (rad/d) ^{(a)(b)}	4.86 E-2	1.25 E-2	9.18 E-3	7.48 E-2

17 (a) Dose rates were estimated with RESRAD-BIOTA (DOE 2004c) by using site-specific radionuclide concentrations
18 and lower limits of detection in water, sediment, and soils obtained from the REMP reports.
19 (b) These values exclude potassium-40 because it is a naturally occurring radionuclide.

20 All dose estimates found using RESRAD-BIOTA and shown in Table 4.6-1 were below the DOE
21 guideline dose levels. Based on the staff's analysis, it is unlikely that radionuclide releases
22 during normal operations of these nuclear power plants would have adverse effects on resident
23 populations of these biota because calculated doses are below protective guidelines.

24 In addition to the RESRAD-BIOTA analysis discussed above, the NRC staff estimated dose
25 rates to a riparian organism using the ICRP biota dose calculator (ICRP 2022) (see Section D.5
26 in Appendix D for full description of ICRP BiotaDC methodology). A small subset of nuclear
27 power plant REMP reports⁶ were evaluated to determine available non-human biota tissue
28 concentrations for the ICRP biota dose calculator analysis. These tissue concentrations, as well
29 as site-specific LLDs and media measurements for surface water and soil when available, were
30 used to estimate a dose to a riparian organism. The staff used the ICRP BiotaDC tool to
31 develop dose coefficients (DCs, expressed in $\mu\text{Gy h}^{-1}$ per Bq kg^{-1}) for water and soil/sediment
32 exposure of a generic organism. A hypothetical small burrowing mammal with mass of 0.016 kg
33 was chosen as a representative "riparian" organism. The mass and dimensions of the animal
34 are similar to that of the meadow jumping mouse (*Zapus hudsonius*), a common North
35 American rodent (Smith 1999). The staff developed DCs using the ICRP's BiotaDC v.1.5.2,
36 which incorporates the radionuclide decay data of ICRP 107 (ICRP 2008b). The staff
37 established this methodology to obtain conservative dose estimates (see Section D.5 in
38 Appendix D for a further discussion of methodology). None of the radionuclides evaluated
39 singly, or in common, produced dose rates that approached the DOE's guidance dose rate of
40 0.1 rad/d for riparian animals using the ICRP BiotaDC tool (DOE 2019). The dose rates

⁵ Defined in RESRAD-BIOTA as an animal that was assumed to spend approximately 50 percent of its time in aquatic environments and 50 percent of its time in terrestrial environments.

⁶ The subset of plants included Comanche Peak, Columbia, and Callaway.

1 calculated for the riparian organism ranged between 2E-4 and 2E-5 rad per day, which is orders
2 of magnitude lower than the DOE guideline dose rate. Additionally, the calculated dose rates
3 did not approach the level advocated by the National Council on Radiation Protection and
4 Measurements to initiate additional evaluation (Cool et al. 2019). In fact, the dose rates for the
5 riparian organism calculated using the ICRP's calculator were lower than the RESRAD
6 conservative analysis, and both were well below the DOE guideline values.

7 Initial LR or SLR would continue current operating conditions and environmental stressors
8 rather than introduce wholly new impacts. Therefore, the impacts of current operations and
9 initial LR or SLR on terrestrial organisms would be similar. For these reasons, the effects of
10 exposure of terrestrial organisms to radionuclides would be minor and would neither destabilize
11 nor noticeably alter any important attribute of populations of exposed organisms during the initial
12 LR or SLR terms of any nuclear power plants. Continued adherence of nuclear power plants to
13 regulatory limits on radioactive effluent releases would minimize the potential impacts on the
14 terrestrial environment. Doses to terrestrial organisms would be expected to remain within the
15 DOE's guidance dose levels and, therefore, impacts to terrestrial communities are not expected.
16 The staff reviewed information in scientific literature and from SEISs (for initial LRs or SLRs)
17 completed since development of the 2013 LR GEIS and identified no new information or
18 situations that would result in different impacts for this issue for either an initial LR or SLR term.

19 The NRC concludes that the impacts of exposure of terrestrial organisms to radionuclides
20 during the license renewal term (initial LR or SLR) would be SMALL for all nuclear power plants.
21 This is a Category 1 issue.

22 *4.6.1.1.3 Cooling System Impacts on Terrestrial Resources (Plants with Once-Through Cooling* 23 *Systems or Cooling Ponds)*

24 This issue concerns the potential impacts of once-through cooling systems and cooling ponds at
25 nuclear power plants on terrestrial resources during an initial LR or SLR term. The impacts of
26 plants with cooling towers on terrestrial resources are addressed in Sections 4.6.1.1.4 and
27 4.6.1.1.5.

28 In the 1996 and 2013 LR GEISs, the NRC determined that cooling system impacts on terrestrial
29 resources would be SMALL. Therefore, this was considered a Category 1 issue. The 1996 LR
30 GEIS considered this issue for nuclear power plants with cooling ponds; the 2013 LR GEIS
31 expanded this issue to include plants with once-through cooling systems.

32 Cooling system operation can alter the ecological environment in a manner that affects
33 terrestrial resources. Such alterations may include thermal effluent additions to receiving water
34 bodies; chemical effluent additions to surface water or groundwater; impingement of waterfowl;
35 disturbance of terrestrial plants and wetlands associated with maintenance dredging; disposal of
36 dredged material; and erosion of shoreline habitat.

37 Thermal effluents discharged from once-through cooling systems and cooling ponds can
38 contribute to localized elevated water temperatures in receiving water bodies that may affect the
39 distributions of some terrestrial plants and animals in adjacent riparian or wetland habitats. For
40 example, at the Robinson plant in South Carolina, the growth of plants along the cooling pond
41 shoreline is restricted by the thermal effluent (NRC 2003a). In general, however, thermal
42 impacts on the terrestrial environment have not been identified at nuclear power plants.
43 Thermal effluents to waters of the United States are regulated through NPDES permits to limit
44 the effects of such discharges on the ecological environment. In addition, because wetland and

Environmental Consequences and Mitigating Actions

1 riparian plant communities present near nuclear power plants have been influenced by many
2 years of facility operation, elevated temperatures are unlikely to result in the mortality of any
3 plants that may be exposed to effluent discharges because vegetation present in these areas
4 has likely acclimated to local conditions. The available information indicates that the effects of
5 thermal effluents on the terrestrial environment is not of concern for license renewal.

6 Along with thermal effluents, nonradiological chemical contaminants may be present in cooling
7 system discharges. Terrestrial plants and animals may be exposed to these contaminants by
8 direct contact with effluent discharges or through uptake from contaminated food or water.
9 Plants and animals associated with wetland or riparian communities along the receiving water
10 body, along with waterfowl and other wildlife that forage in these waters, are the most likely to
11 be exposed to such chemicals, and exposure may have adverse impacts on these organisms.
12 Contaminants of potential concern include chlorine and other biocides, heavy metals, VOCs,
13 and oil products. NPDES permits typically limit the allowable concentrations of these
14 contaminants in liquid effluent to minimize impacts on the ecological environment. Because of
15 the low concentrations of nonradiological chemical contaminants within liquid effluents, the
16 uptake and accumulation of contaminants in the cells of exposed plants or animals are not
17 expected to be a significant issue for license renewal. Radionuclide contaminants, such as
18 tritium and strontium, are discussed in Section 4.6.1.1.2 as a separate license renewal issue.

19 In the past, heavy metals used in condenser tubing was found to be an issue at two plants.
20 Elevated concentrations of these contaminants are toxic to terrestrial organisms. Copper alloy
21 condenser tubes in the cooling systems at the Robinson plant and the Diablo Canyon plant in
22 California resulted in the discharge of copper in these plants' liquid effluent. At Robinson, these
23 metals resulted in adverse effects on the morphology and reproduction of resident bluegill
24 (*Lepomis macrochirus*) populations (Harrison 1985). At Diablo Canyon, abalone (*Haliotis*
25 species) deaths were attributed to exposure to copper in plant effluents (NRC 1996). Terrestrial
26 wildlife that feed on these aquatic organisms could have also been exposed to elevated copper
27 levels and could have experienced adverse effects. However, these nuclear power plants
28 subsequently replaced the copper alloy condenser tubes with tubes made of different materials
29 (e.g., titanium), which has eliminated these impacts. This issue has not been reported at any
30 other nuclear power plants. The available information indicates that the effects of heavy metals
31 on the terrestrial environment is not of concern for license renewal.

32 Groundwater quality can be degraded by nonradiological contaminants present in cooling ponds
33 and cooling canals. Deep-rooted terrestrial plants could be exposed to these contaminants.
34 However, as noted above, nonradiological contaminant concentrations are typically very low,
35 and any effects on terrestrial plants would be expected to be SMALL. Mitigation may also be
36 implemented where sensitive resources could be affected. At the Turkey Point plant in Florida,
37 for example, the flow of hypersaline groundwater from the cooling canals toward the Everglades
38 to the west is prevented by an interceptor ditch, located along the west side of the canal system,
39 from which groundwater inflow is extracted (NRC 2002a). However, since the publication of the
40 2013 LR GEIS, new information indicates that the interceptor ditch has not prevented movement
41 of hypersaline groundwater in the deeper Biscayne aquifer. Based on ecological monitoring
42 data, the NRC concluded that movement of the hypersaline water did not have discernable
43 ecological impacts. Data also suggest that the interceptor ditch did prevent westward
44 movement of near surface groundwater (NRC 2019c). This issue has not been identified at any
45 other operating nuclear power plant.

46 The impingement of waterfowl at cooling water intakes has been observed at some nuclear
47 power plants, such as the D.C. Cook plant in Michigan, Nine Mile Point plant in New York, and

1 Point Beach plant in Wisconsin. About 400 ducks, primarily lesser scaup (*Aythya affinis*), were
 2 impinged at D.C. Cook in December 1991 (Mitchell and Carlson 1993); about 100 ducks, both
 3 greater scaup (*Aythya marila*) and lesser scaup, were impinged in January 2000 at Nine Mile
 4 Point (NRC 2006b). At the Point Beach plant, several double-crested cormorants
 5 (*Phalacrocorax auritus*) were impinged in September 1990, and 33 birds (mostly gulls) were
 6 impinged from June 2001 through December 2003 (NRC 2005a). These nuclear power plants
 7 have changed operational procedures, such as periodically cleaning zebra mussels (*Dreissena*
 8 *polymorpha*) off intake structures or have changed intake structure designs to minimize impacts
 9 on waterfowl. This issue has not been found to be a problem at any other nuclear power plants
 10 or in any of the initial LR or SLR reviews conducted since publication of the 2013 LR GEIS. The
 11 available information indicates that bird impingement is not of concern for license renewal.

12 Maintenance dredging near cooling system intakes or outfalls may physically disturb or alter
 13 wetland or riparian habitats. Dredging may alter current patterns or increase local water
 14 velocities and cause erosion of shoreline wetlands or riparian habitats. Dredging and disposal
 15 of dredged material would likely require the nuclear power plant operator to obtain a CWA
 16 Section 404 permit from the USACE. BMPs and conditions associated with these permits would
 17 minimize impacts on the ecological environment. Granting of such permits would also require
 18 the USACE to conduct its own environmental reviews prior to the undertaking of dredging.

19 License renewal would continue current operating conditions and environmental stressors rather
 20 than introduce wholly new impacts. Therefore, the impacts of once-through cooling systems
 21 and cooling ponds on terrestrial resources would be similar. For these reasons, the effects of
 22 these systems on terrestrial resources would be minor and would neither destabilize nor
 23 noticeably alter any important attribute of populations of plants or animals during the initial LR or
 24 SLR terms of any nuclear power plants. The staff reviewed information in scientific literature
 25 and from SEISs (for initial LRs and SLRs) completed since development of the 2013 LR GEIS
 26 and identified no new information or situations that would result in different impacts for this issue
 27 for either an initial LR or SLR term, as described above.

28 The NRC concludes that cooling system impacts on terrestrial resources during the license
 29 renewal term (initial LR or SLR) would be SMALL for nuclear power plants with once-through
 30 cooling systems or cooling ponds. This is a Category 1 issue.

31 *4.6.1.1.4 Cooling Tower Impacts on Terrestrial Plants*

32 This issue concerns the potential impacts of cooling tower operation on terrestrial plant
 33 communities during an initial LR or SLR term. This issue applies only to nuclear power plants
 34 with cooling towers. Terrestrial habitats near cooling towers can be exposed to particulates,
 35 such as salt, and can experience increased humidity, which can deposit water droplets or ice on
 36 vegetation. These effects can lead to structural damage and changes in plant communities.

37 In the 1996 and 2013 LR GEISs, the NRC determined that cooling tower impacts on terrestrial
 38 plants would be SMALL. Therefore, this was considered a Category 1 issue for all nuclear
 39 power plants with cooling towers. The 1996 LR GEIS evaluated this issue as two separate
 40 issues; the 2013 LR GEIS consolidated the two issues into one issue. This GEIS refines the
 41 title of this issue from “cooling tower impacts on vegetation (plants with cooling towers)” to
 42 “cooling tower impacts on terrestrial plants” for clarity and consistency with other ecological
 43 resource GEIS issue titles.

Environmental Consequences and Mitigating Actions

1 Cooling tower drift contains small amounts of particulates that are dispersed over a wide area.
2 Most deposition from cooling towers, regardless of cooling tower type, occurs in close proximity
3 to the towers. Particulates from natural draft towers generally disperse over a larger area, while
4 particulates from mechanical draft towers tend to concentrate closer to the towers (Roffman and
5 Van Vleck 1974). Generally, particulate deposition from cooling towers has not resulted in
6 measurable adverse impacts on vegetation. At most nuclear power plants with cooling towers,
7 no effects on agricultural crops or natural plant communities have been observed (NRC 1996).
8 Where impacts have been observed, vegetation has typically adapted to cooling tower operation
9 following the period of initial operation. For instance, at Palisades Nuclear Plant (Palisades) (no
10 longer operating) on Lake Michigan, condensate plumes and drift associated with the site's two
11 mechanical draft cooling towers caused the loss of about 5 ac (2 ha) of vegetation on dune
12 ridges adjacent to the cooling towers within the first several years of operation (NRC 1996).
13 Within 4 months of plant startup, white pines (*Pinus strobus*) near the cooling towers began to
14 show signs of chemically induced injury. During the second summer of operation, deciduous
15 trees began exhibiting observable effects. Researchers determined that sulfate deposition from
16 the cooling towers was responsible for the damage. Severe icing associated with the cooling
17 towers during the following winter further damaged these trees, and within the first several years
18 of operation, early successional scrub-shrub vegetation had replaced the mature forest stand.
19 Subsequently, Palisades stopped adding sulfuric acid to the cooling water, which eliminated
20 observable effects on vegetation. The NRC (NRC 2006d) anticipated no additional impacts
21 associated with cooling tower drift during the license renewal period.

22 Icing of vegetation and roads can occur near mechanical draft towers when fog is present and
23 temperatures are below freezing. Associated impacts have been rare, minor, and localized.
24 The 1996 LR GEIS reports the results of vegetation monitoring at 10 plants with mechanical
25 draft cooling towers and 8 nuclear power plants with natural draft cooling towers. Vegetation at
26 only three sites exhibited ice-related damage: the Palisades plant (discussed above), Prairie
27 Island Nuclear Generating Plant (Prairie Island) in Minnesota, and Catawba Nuclear Station
28 (Catawba) in North Carolina. At Prairie Island, researchers observed frequent ice damage to
29 red oaks (*Quercus rubra*) adjacent to the site's mechanical draft cooling towers and a
30 subsequent change in canopy structure (NRC 1996). Acorn viability was also found to be low,
31 although acorn production appeared normal. In 1984, Prairie Island stopped operating the
32 cooling towers during the winter, which eliminated these impacts. At Catawba, researchers
33 observed the browning of the needles on several loblolly pines (*Pinus taeda*) within 200 ft
34 (61 m) of the mechanical draft cooling towers that was attributed to possible icing effects (NRC
35 1996). During license renewal, the NRC anticipated no additional impacts associated with
36 cooling tower drift at either of these nuclear power plants (NRC 2011a, NRC 2002b).

37 The 1996 LR GEIS contemplated that salt deposition could be a concern at coastal nuclear
38 power plants that use estuarine or marine water for cooling. The only such plant is Hope Creek
39 in New Jersey, whose natural draft cooling towers withdraw cooling water from the Delaware
40 River estuary (see Section 3.3.2 for a discussion of Hope Creek cooling tower drift emissions).
41 However, no measurable effects on plant communities near Hope Creek's cooling towers have
42 been observed (NRC 1996), and the NRC anticipated none during the license renewal period
43 (NRC 2011b). Soil salinization associated with cooling tower drift is also not expected to be an
44 issue because rainfall is sufficient to leach salts from the soil profile.

45 In summary, vegetation near nuclear power plant cooling towers has been exposed to many
46 years of cooling tower operation and have acclimated to any minor effects associated with
47 cooling tower drift. Icing effects would continue to be rare, minor, and localized. All nuclear

1 power plants at which effects of cooling tower drift were observed during the initial period of
2 operation have modified operations to mitigate these effects.

3 Initial LR or SLR would continue current operating conditions and environmental stressors
4 rather than introduce wholly new impacts. Therefore, the impacts of current operations and
5 license renewal on vegetation would be similar. For these reasons, the effects of cooling towers
6 on plants would be minor and would neither destabilize nor noticeably alter any important
7 attribute of plant populations during initial LR or SLR terms at nuclear power plants with cooling
8 towers. The staff reviewed information in scientific literature and from SEISs (for initial LRs and
9 SLRs) completed since development of the 2013 LR GEIS and identified no new information or
10 situations that would result in different impacts for this issue for either an initial LR or SLR term.

11 The NRC concludes that cooling tower impacts on terrestrial plants during the license renewal
12 term (initial LR or SLR) would be SMALL for all nuclear power plants with cooling towers. This
13 is a Category 1 issue.

14 *4.6.1.1.5 Bird Collisions with Plant Structures and Transmission Lines*

15 This issue concerns the risk of birds colliding with plant structures and transmission lines during
16 an initial LR or SLR term. Tall structures on nuclear power plant sites, such as cooling towers,
17 meteorological towers, and transmission lines, create collision hazards for birds that can result
18 in injury or death.

19 In the 1996 and 2013 LR GEISs, the NRC determined that the impacts of bird collisions with
20 plant structures and transmission lines would be SMALL. Therefore, this was considered a
21 Category 1 issue for all nuclear power plants. The 1996 LR GEIS evaluated this issue as two
22 separate issues; the 2013 LR GEIS consolidated them into one issue.

23 Throughout the United States, millions of birds are killed each year when they collide with
24 human-made objects, including buildings, windows, vehicles, transmission lines, communication
25 towers, wind turbines, cooling towers, and numerous other objects (Erickson et al. 2001).
26 Associated bird mortality is of concern if the stability of the population of a species is threatened
27 or if the reduction in numbers within any bird population significantly impairs its function within
28 the ecosystem. Table 4.6-2 shows estimated annual bird collision mortality in the United States
29 from several categories of human-made objects. Collisions with buildings and windows account
30 for the greatest number of collision mortalities annually (365 to 988 million). Transmission lines
31 account for 12 to 64 million mortalities per year (Table 4.6-2).

32 As of April 2022, more than 133,000 standing communication towers (32 to 3,280 ft (10 to
33 1,000 m) in height) are registered with the Federal Communications Commission Antenna
34 Structure Registration database (FCC Undated), some of which have caused large numbers of
35 avian collision mortalities (Able 1973; Kemper 1996; Crawford and Engstrom 2001). Most large
36 mortality events occur at night during spring and fall migration periods and involve songbirds
37 that appear to become confused by tower lights (Taylor and Kershner 1986; Larkin and Frase
38 1988; Manville 2005). For example, at a single television tower in northern Florida, Crawford
39 and Engstrom (2001) reported more than 44,000 bird collision mortalities over a 29-year period.
40 Communication towers involved with the most bird collisions are tall (exceeding 1,000 ft
41 [305 m]), illuminated at night with incandescent lights, guyed, and located near wetlands and
42 migration pathways (Manville 2005). During nights of heavy cloud cover or fog, the
43 incandescent lights illuminating the communication towers may attract migrating songbirds to
44 the towers, increasing the likelihood of collisions.

1 **Table 4.6-2 Estimated Annual Bird Collision Mortality in the United States**

Objects	Estimated Annual Mortality (in millions) ^(a)
Buildings and windows ^(b)	365 to 988
Vehicles ^(c)	89 to 340
Transmission lines ^(d)	12 to 64
Communication towers ^(e)	6.8
Wind generation facilities ^(f)	0.415 to 1.4 ^(g)

- 2 (a) Estimated annual mortality was extrapolated from literature reviews.
 3 (b) Includes residences, low-rises, and high-rises. Source: Loss et al. 2014.
 4 (c) Includes automobiles on U.S. roadways. Source: Loss et al. 2014.
 5 (d) Includes all electric communication lines and transmission lines. Source: Loss et al. 2014.
 6 (e) Includes mortality estimates from communication towers in Canada. Source: Longcore et al. 2012.
 7 (f) Includes wind turbines and supporting structures.
 8 (g) Based on projections from two studies (Smallwood et al. 2020 and Erickson et al. 2014).

9 Compared to communication towers, cooling towers at nuclear power plants are shorter
 10 (generally less than 500 ft [152 m]), which may reduce the likelihood that migrating birds would
 11 encounter cooling towers while in flight. Mechanical draft cooling towers, which are smaller
 12 (usually shorter than 100 ft [30 m]), are thought to cause negligible mortality (NRC 1996).
 13 Cooling towers are usually illuminated with low-intensity light sources (1.0 ft-candle or less) at
 14 night, although it is unknown whether this attracts or detracts birds. Several nuclear power
 15 plants with natural draft cooling towers have studied bird mortality, including plants within three
 16 of the four major United States flyways. These include plants in the Atlantic Flyway
 17 (Susquehanna, Beaver Valley, and Three Mile Island [no longer operating] in Pennsylvania),
 18 Mississippi Flyway (Davis-Besse in Ohio and Arkansas Nuclear One [Arkansas] in Arkansas),
 19 and Pacific Flyway (Trojan [no longer operating] in Oregon).

20 At the Susquehanna plant, researchers conducted bird mortality surveys during spring and fall
 21 migration from 1978 through 1986. The plant's natural draft towers are 165 m (540 ft) tall and
 22 illuminated with 480V aircraft warning strobe lights. Researchers collected about 1,500 dead
 23 birds representing 63 species during monitoring whose deaths were likely attributable to
 24 collisions with the cooling towers. Most were songbirds. Fewer collisions occurred after
 25 Susquehanna began commercial operations; researchers considered that cooling tower vapor
 26 plumes and noise may have discouraged birds from entering the area (NRC 1996).

27 At the Davis-Besse plant, researchers conducted bird mortality surveys during spring and fall
 28 migration from 1972 to 1979. During this period, early morning surveys were conducted almost
 29 daily at the 152 m tall (499 ft tall) cooling tower. Researchers collected 1,561 dead birds,
 30 including 1,229 at the cooling tower, 224 around Unit 1 structures, and 108 at the
 31 meteorological tower. Notably, after the cooling tower began operating in the fall of 1976, some
 32 dead birds were discovered in the water outlets of the tower basin. Most mortalities were of
 33 night-migrating songbirds, particularly wood-warblers (family Parulidae), vireos (*Vireo* species),
 34 and kinglets (*Regulus* species). Waterfowl, which were abundant in nearby marshes and
 35 ponds, suffered little collision mortality. Most collision mortalities at the cooling tower occurred
 36 during years when the tower was not well illuminated. After the completion of Unit 1 structures
 37 and installation of many safety lights around the buildings in the fall of 1978, collision mortality
 38 significantly decreased. Observed mortalities averaged 236 per year from 1974 through 1977,
 39 135 in 1978, and 51 in 1979. This reduction was attributed to low-intensity light sources (1.0 ft-
 40 candle or less) that illuminated the cooling tower at night. Researchers concluded that lights at

1 nuclear power plants more successfully detract birds than do lights on communication towers
2 (NRC 2015e).

3 At the Fermi plant, researchers studied bird strikes from 2005 to 2014. The highest number of
4 bird strikes occurred in October 2007 when researchers found a total of 45 dead birds near the
5 south cooling tower (approximately 400 ft (122 m) tall) in a 1-week period. The licensee
6 conducted 2 years of followup monitoring in 2008 and 2009 to further investigate the numbers
7 and species of birds colliding with nuclear power plant structures. During this period,
8 researchers collected 31 dead birds and no more than 4 in any given week (NRC 2016c).

9 At the Beaver Valley plant, researchers conducted surveys at the cooling tower during spring
10 and fall migration from 1974 to 1978. Researchers collected 27 dead birds over the five-year
11 period. At the Trojan plant (no longer operating) researchers conducted weekly surveys in 1984
12 and 1988 at the cooling tower, meteorological tower, switchyard, and generation building. No
13 dead birds were found. At the Three Mile Island plant, researchers collected 66 dead birds near
14 the cooling towers from 1973 to 1975. No dead birds were found at the Arkansas plant, where
15 cooling tower monitoring was conducted twice weekly from October through April from 1978 to
16 1980 (NRC 2013a).

17 The available data on bird collision mortality associated with nuclear power plant cooling towers
18 and other structures suggest that nuclear power plants cause a small number of bird mortalities
19 annually. A large percentage of these mortalities occur during the spring and fall migratory
20 periods and primarily involve songbirds migrating at night. Natural draft cooling towers appear
21 to be the structures that pose the largest collision risk at nuclear power plant sites. Operating
22 cooling towers appear to detract birds; the vapor plume, noise, or lighting may mitigate the risk
23 of bird collision. Data are not available on bird injuries, but the NRC staff assumes that some
24 birds that collide with nuclear power plant structures are injured and either die later or suffer
25 reduced fitness until they recover. The relatively few nuclear power plants in the United States
26 that have natural draft towers, combined with the relatively low bird mortality at studied sites,
27 indicate that bird populations are unlikely to be measurably affected by collisions with nuclear
28 power plant structures and that the contribution of nuclear power plant sites to the cumulative
29 effects of bird collision mortalities in the United States is very small.

30 The risk of bird collisions with site structures would remain the same for a given nuclear power
31 plant during an initial LR or SLR period. Because the number of associated bird mortalities is
32 small for any species, it is unlikely that losses would threaten the stability of local or migratory
33 bird populations or result in a noticeable impairment of the function of a species within the
34 ecosystem. Mitigation measures to reduce bird collisions may include illuminating natural draft
35 cooling towers and other tall structures at night with low-intensity lights so that birds can see the
36 structures and avoid colliding with them.

37 The potential for birds to collide with transmission lines depends on a number of factors, such
38 as species, migration behavior, and the location and physical characteristics of the transmission
39 line (Bevanger 1988; Janss 2000; Manville 2005). Larger-bodied bird species such as raptors
40 are more likely to collide with transmission lines (Harness and Wilson 2001; Manville 2005),
41 whereas smaller-bodied birds such as migrating songbirds are more likely to collide with towers
42 (Temme and Jackson 1979). This difference is most likely the result of differences in the
43 behaviors of raptors and songbirds. Raptors are known to use utility structures as perch
44 locations and nest sites more often than do songbirds (Blue 1996; Manville 2005), whereas
45 nocturnal migrating songbirds may become confused by the lights on communication towers

Environmental Consequences and Mitigating Actions

1 (Crawford and Engstrom 2001). Lights are not a contributing factor in bird collisions at
2 transmission lines because lights are not generally used to mark transmission lines.

3 Transmission lines cause 12 million to 64 million bird mortalities per year (see Table 4.6-2).
4 However, no nuclear power plants have reported high bird collision mortality associated with
5 in-scope transmission lines. In a 1974 through 1978 study conducted at the Prairie Island plant,
6 a total of 453 bird deaths were attributed to collisions with transmission lines; most collisions
7 occurred during inclement weather (NRC 1996). Researchers collected dead mourning doves
8 (*Zenaida macroura*), starlings (family Sturnidae), red-winged blackbirds (*Agelaius phoeniceus*),
9 common grackles (*Quiscalus quiscula*), brown-headed cowbirds (*Molothrus ater*), ring-necked
10 pheasants (*Phasianus colchicus*), American coots (*Fulica americana*), and sora rails (*Porzana*
11 *carolina*) (NSP 1978). This study was conducted along large tracts of transmission lines
12 constructed to connect the Davis-Besse plant to the regional electric grid upon initial operation.
13 As described in Section 3.1.6.5 and further in Section 3.1.1, transmission lines relevant to initial
14 LR or SLR include only those lines that connect the nuclear power plant to the first substation
15 that feeds into the regional power distribution system. This substation is frequently, but not
16 always, located on the plant property. Many of the transmission lines that were constructed with
17 nuclear power plants are now interconnected with the regional electric grid and would remain
18 energized regardless of license renewal. Thus, the length of transmission lines directly
19 associated with nuclear power plants is a small fraction of the total length of transmission lines
20 in the United States (Manville 2005). Therefore, transmission lines associated with nuclear
21 power plants are likely responsible for a negligible number of bird collision mortalities per year.

22 The risk of bird collisions with transmission lines associated with nuclear power plants would
23 remain the same for a given nuclear power plant during an initial LR or SLR period. Because
24 the number of associated bird mortalities is negligible for any species, it is unlikely that losses
25 would threaten the stability of resident or migratory bird populations or result in a noticeable
26 impairment of the function of a species within the ecosystem.

27 Initial LR or SLR would continue current operating conditions and environmental stressors
28 rather than introduce wholly new impacts. Therefore, the impacts of current operations and
29 license renewal on birds would be similar. For these reasons, the effects of bird collisions with
30 plant structures and transmission lines would be minor and would neither destabilize nor
31 noticeably alter any important attribute of bird populations during initial LR or SLR terms at
32 nuclear power plants. The staff reviewed information in scientific literature and from SEISs (for
33 initial LR and SLRs) completed since development of the 2013 LR GEIS and identified no new
34 information or situations that would result in different impacts for this issue for either an initial LR
35 or SLR term. The NRC concludes that the impacts of bird collisions with plant structures or
36 transmission lines during the license renewal term (initial LR or SLR) would be SMALL for all
37 nuclear power plants. This is a Category 1 issue.

38 *4.6.1.1.6 Water Use Conflicts with Terrestrial Resources (Plants with Cooling Ponds or Cooling* 39 *Towers Using Makeup Water from a River)*

40 This issue concerns water use conflicts that may arise at nuclear power plants with cooling
41 ponds or cooling towers that use makeup water from a river and how those conflicts could affect
42 terrestrial resources during an initial LR or SLR term.

43 In the 1996 and 2013 LR GEISs, the NRC determined that the impacts of water use conflicts on
44 terrestrial resources would be SMALL at many nuclear power plants but that these impacts
45 could be MODERATE at some plants. Therefore, this was considered a Category 2 issue for

1 nuclear power plants with cooling ponds or cooling towers using makeup water from a river.
2 The 1996 LR GEIS addressed cooling towers that withdraw water from small rivers with low
3 flow; the 2013 LR GEIS expanded this issue to include all cooling towers that withdraw water
4 from rivers. Notably, this issue also applies to nuclear power plants with hybrid cooling systems
5 that withdraw makeup water from a river (i.e., once-through cooling systems with helper cooling
6 towers) (e.g., NRC 2020g).

7 Nuclear power plant cooling systems may compete with other users relying on surface water
8 resources, including downstream municipal, agricultural, or industrial users. Closed-cycle
9 cooling is not completely closed because the system discharges blowdown water to a surface
10 water body and withdraws water for makeup of both the consumptive water loss due to
11 evaporation and drift (for cooling towers) and blowdown discharge. For plants using cooling
12 towers, while the volume of surface water withdrawn is substantially less than once-through
13 systems for a similarly sized nuclear power plant, the makeup water needed to replenish the
14 consumptive loss of water to evaporation can be significant. Cooling ponds also require
15 makeup water. Section 4.5.1 addresses factors relevant to water use conflicts at nuclear power
16 plants in detail. Water use conflicts with terrestrial resources, especially riparian communities,
17 could occur when water that supports these resources is diminished by a combination of
18 anthropogenic uses.

19 Consumptive use by nuclear power plants with cooling ponds or cooling towers using makeup
20 water from a river during the license renewal term is not expected to change unless power
21 uprates, with associated increases in water use, occur. Such uprates would require separate
22 NRC review and approval. Any river, regardless of size, can experience low-flow conditions of
23 varying severity during periods of drought and changing conditions in the affected watershed,
24 such as upstream diversions and use of river water. However, the direct impacts on instream
25 flow and potential water availability for other users from nuclear power plant surface water
26 withdrawals are greater for small (i.e., low-flow) rivers.

27 To date, the NRC has identified water use conflicts with terrestrial resources at only one nuclear
28 power plant: Wolf Creek plant in Kansas. This plant uses Coffey County Lake for cooling, and
29 makeup water for the lake is drawn from the Neosho River downstream of John Redmond
30 Reservoir (NRC 2008a). The Neosho River is a small river with especially low water flow during
31 drought conditions. Riparian communities downstream of this reservoir may be affected by Wolf
32 Creek makeup water withdrawals from the Neosho River during periods when the lake level is
33 low. During the license renewal review, the NRC found that water use conflicts would be
34 SMALL to MODERATE for this nuclear power plant. As part of the NRC's ESA consultation with
35 the FWS, Wolf Creek developed and implemented a water level management plan for Coffey
36 County Lake, which includes withdrawing makeup water proactively during high river flows to
37 support downstream populations of the federally endangered Neosho madtom (*Noturus*
38 *placidus*), a small species of catfish (FWS 2012). This plan effectively mitigated not only water
39 use conflicts that the Neosho madtom might experience, but also the effects that downstream
40 riparian communities might experience from the plant's cooling water withdrawals. The NRC
41 has identified no concerns about water use conflicts with terrestrial resources at any other
42 nuclear power plant with cooling ponds or cooling towers.

43 The staff reviewed information from SEISs (for initial LRs and SLRs) completed since
44 development of the 2013 LR GEIS. In summary, water use conflicts during an initial LR or SLR
45 term depend on numerous site-specific factors, including the ecological setting of the nuclear
46 power plant; the consumptive use of other municipal, agricultural, or industrial water users; and
47 the plants and animals present in the area. Water use conflicts with terrestrial resources would

Environmental Consequences and Mitigating Actions

1 be SMALL at most nuclear power plants with cooling ponds or cooling towers that withdraw
2 makeup from a river, but may be MODERATE at some plants. Therefore, a generic
3 determination of potential impacts on terrestrial resources from continued operations during a
4 license renewal term is not possible.

5 The NRC concludes that water use conflicts on terrestrial resources during the license renewal
6 term (initial LR or SLR) could be SMALL or MODERATE at nuclear power plants with cooling
7 ponds or cooling towers using makeup water from a river. This is a Category 2 issue.

8 *4.6.1.1.7 Transmission Line Right-of-Way (ROW) Management Impacts on Terrestrial* 9 *Resources*

10 This issue concerns the effects of transmission line ROW management on terrestrial plants and
11 animals during an initial LR or SLR term.

12 In the 1996 and 2013 LR GEISs, the NRC determined that transmission line ROW maintenance
13 impacts would be SMALL at all nuclear power plants. Therefore, this was considered a
14 Category 1 issue for all nuclear power plants. The 1996 LR GEIS evaluated this issue as two
15 separate issues; the 2013 LR GEIS consolidated them into one issue.

16 When this issue was originally contemplated in the 1996 LR GEIS, the NRC considered as part
17 of its plant-specific license renewal reviews all transmission lines that were constructed to
18 connect a nuclear power plant to the regional electric grid. However, in the 2013 GEIS, the
19 NRC clarified that the transmission lines relevant to license renewal include only the lines that
20 connect the nuclear power plant to the first substation that feeds into the regional power
21 distribution system (see Section 3.1.6.5 and 3.1.1). Typically, the first substation is located on
22 the nuclear power plant property within the primary industrial-use area. This decision was
23 informed by the fact that many of the transmission lines that were constructed with nuclear
24 power plants are now interconnected with the regional electric grid and would remain energized
25 regardless of initial LR or SLR. Accordingly, the discussion of this issue in this LR GEIS is brief
26 because in-scope transmission lines for license renewal tend to occupy only industrial-use or
27 other developed portions of nuclear power plant sites. Therefore, effects on terrestrial plants
28 and animals are generally negligible. The 1996 and 2013 LR GEISs provide further background
29 about this issue and discuss it in more detail.

30 Utilities maintain transmission line ROWs so that the ground cover is composed of low-growing
31 herbaceous or shrubby vegetation and grasses. Generally, ROWs are initially established by
32 clear-cutting during transmission line construction and are subsequently maintained by physical
33 (e.g., mowing and cutting) and chemical (e.g., herbicides or pesticides) means. These activities
34 alter the composition and diversity of plant communities and generally result in lower-quality
35 habitat for wildlife. Heavy equipment used for ROW maintenance can crush vegetation and
36 compact soils, which can affect soil quality and reduce infiltration to shallow groundwater. This
37 is especially of concern in sensitive habitats, such as wetlands. Chemical herbicides can be
38 transported to neighboring undisturbed habitats through precipitation and runoff. Disturbed
39 habitats often favor non-native or nuisance species and can lead to their proliferation.

40 Noise and general human disturbance during ROW management can temporarily disturb wildlife
41 and affect their behaviors. The presence of ROWs can favor wildlife species that prefer edge or
42 early successional habitats. Some species, such as neotropical migrating songbirds that prefer
43 interior forest habitat may be adversely affected by the increase in edge habitat. These species
44 require large blocks of forest for successful reproduction and survival (Wilcove 1988). Studies

1 have found that nests of these bird species placed near edges are more likely to fail as a result
 2 of predation or nest parasitism than nests located near the forest interior (Paton 1994; Robinson
 3 et al. 1995). Transmission line ROWs may represent a barrier for species, such as large
 4 mammalian carnivores, that require large tracts of contiguous forested habitat (Crooks 2002).
 5 Maintenance of ROWs may also have negative effects on smaller, less mobile wildlife species.
 6 For example, studies have shown that some amphibian species have difficulty crossing
 7 disturbed habitat and may experience increased rates of mortality as a result of physiological
 8 stress (Gibbs 1998; Rothermel 2004). Other wildlife may benefit from ROW habitat. For
 9 instance, in a study of rodent populations in Oregon, Wolff et al. (1997) found higher densities of
 10 gray-tailed voles (*Microtus canicaudus*) in disturbed open habitats than in other habitats.

11 Most nuclear power plants maintain procedures to minimize or mitigate the potential impacts of
 12 ROW management. For instance, heavy machinery and herbicide use is often prohibited in or
 13 near wetlands or surface waters. Procedures often include checklists to ensure that workers
 14 obtain the necessary local, State, or Federal permits if work could affect protected resources.
 15 At the Millstone Power Station (Millstone) in Connecticut, mowing is conducted only from
 16 November through April to protect saturated soils and minimize loss of fruit and seeds (NRC
 17 2005d). At the Seabrook plant in New Hampshire, workers are trained to recognize Federally or
 18 State-protected species to avoid impacts on them (NRC 2015b). At Browns Ferry Nuclear Plant
 19 (Browns Ferry) in Alabama, all vegetation clearing in sensitive habitats is done by hand, and
 20 vehicle and machinery use is prohibited (NRC 2005b).

21 Terrestrial communities in transmission line ROWs have been exposed to many years of
 22 transmission line operation and have acclimated to regular ROW maintenance. License
 23 renewal would continue current operating conditions and environmental stressors rather than
 24 introduce wholly new impacts. Therefore, the impacts of current operations and license renewal
 25 on terrestrial resources would be similar. Further, and as stated above, in-scope transmission
 26 lines for license renewal tend to occupy only industrial-use or other developed portions of
 27 nuclear power plant sites and, therefore, the effects of ROW maintenance on terrestrial plants
 28 and animals during an initial LR or SLR term would be negligible. The staff reviewed
 29 information in scientific literature and from SEISs (for initial LRs and SLRs) completed since
 30 development of the 2013 LR GEIS and identified no new information or situations that would
 31 result in different impacts for this issue for either an initial LR or SLR term.

32 The NRC concludes that the transmission line ROW maintenance impacts on terrestrial
 33 resources during the license renewal term (initial LR or SLR) would be SMALL for all nuclear
 34 power plants. This is a Category 1 issue.

35 *4.6.1.1.8 Electromagnetic Field Effects on Terrestrial Plants and Animals*

36 This issue concerns the effects of EMFs on terrestrial plants and animals, including agricultural
 37 crops, honeybees, wildlife, and livestock, during an initial LR or SLR term.

38 In the 1996 and 2013 LR GEISs, the NRC determined that the impacts of EMFs on terrestrial
 39 plants and animals would be SMALL at all nuclear power plants. Therefore, this was
 40 considered a Category 1 issue for all nuclear power plants. This LR GEIS refines the title of this
 41 issue from “electromagnetic fields on flora and fauna (plants, agricultural crops, honeybees,
 42 wildlife, livestock)” to “electromagnetic fields on terrestrial plants and animals” for clarity and
 43 consistency with other ecological resource LR GEIS issue titles.

Environmental Consequences and Mitigating Actions

1 When this issue was originally contemplated in the 1996 LR GEIS, the NRC considered as part
2 of its plant-specific license renewal reviews all transmission lines that were constructed to
3 connect a nuclear power plant to the regional electric grid. However, in the 2013 LR GEIS, the
4 NRC clarified that the transmission lines relevant to license renewal include only the lines that
5 connect the nuclear power plant to the first substation that feeds into the regional power
6 distribution system (see Section 3.1.6.5 and 3.1.1). Typically, the first substation is located on
7 the nuclear power plant property within the primary industrial-use area. This decision was
8 informed by the fact that many of the transmission lines that were constructed with nuclear
9 power plants are now interconnected with the regional electric grid and would remain energized
10 regardless of initial LR or SLR. Accordingly, the discussion of this issue in this LR GEIS is brief
11 because in-scope transmission lines for license renewal tend to occupy only industrial-use or
12 other developed portions of nuclear power plant sites. Therefore, the effects of EMFs on
13 terrestrial plants and animals are generally negligible. The 1996 and 2013 LR GEISs provide
14 further background about this issue and discuss it in more detail.

15 Operating transmission lines produce electric and magnetic fields, collectively referred to as
16 EMFs. EMF strength at the ground level varies greatly but is generally stronger for higher-
17 voltage lines. Corona is the electrical discharge occurring in air from EMFs; it can be detected
18 adjacent to phase conductors. Corona is generally not an issue for transmission lines of 345 kV
19 or less. Corona results in audible noise, radio and television interference, energy losses, and
20 ozone and nitrogen oxide production. Studies investigating the effects of EMFs produced by
21 operating transmission lines up to 1,100 kV have generally not detected any ecologically
22 significant impact on terrestrial plants and animals.

23 Miller (1983) determined that minor damage to plant foliage and buds can occur from corona-
24 related heat. Exhibited damage is like what plants might exhibit in response to drought. In one
25 experiment under an 1,100 kV prototype line, alder (*Alnus* species) and Douglas fir
26 (*Pseudotsuga menziesii*) trees exhibited reduced upward growth (Rogers et al. 1984). The
27 crowns of the trees became somewhat flattened on top and the overall crown developed a
28 broader appearance than usual. Growth of the lower parts of the trees and of lower-growing
29 plants, such as pasture grass, barley, and peas, were unaffected (Rogers and Hinds 1983).
30 Studies of agricultural crops, including corn, bluegrass, alfalfa, and sunflower, have detected no
31 effects or minor effects that did not ultimately affect germination or crop yield (Bankoske et al.
32 1976; Lee et al. 1989; Poznaniak and Reed 1978).

33 The literature on the effect of EMF on wildlife is somewhat mixed, although most studies have
34 detected virtually no concern about the impacts of EMFs on animals. For instance,
35 Kroodsmas (1984, 1987) found that the density of breeding birds under 500 kV lines in eastern
36 Tennessee is greater than that in adjacent forests and in most grassland habitats or agricultural
37 fields. A Minnesota study of a 500 kV line found little evidence of either a positive or negative
38 effect of the power line on bird populations (Niemi and Hanowski 1984). Schreiber et al. (1976)
39 as cited in the 2013 LR GEIS found that the density of small mammal populations near
40 transmission lines appears to depend on habitat type rather than on the presence of the lines.
41 Bird and small mammal populations under an 1,100 kV line in Oregon were also apparently
42 unaffected by line operation (Rogers and Hinds 1983). In a review of numerous studies on
43 livestock, Lee et al. (1989) found no evidence that the growth, production, or behavior of beef
44 and dairy cattle, sheep, hogs, or horses are affected by EMFs.

45 Other studies have observed the impacts of EMFs on animals. They showed that EMFs
46 influence the development, reproduction, and physiology of insects (Greenberg et al. 1981) and
47 mammals (Burchard et al. 1996). Fernie and Reynolds (2005) determined that EMF exposure

1 can alter the behavior, physiology, endocrine system, and the immune function of birds,
2 including passerines, birds of prey, and chickens studied in laboratory and field situations.
3 Nonetheless, birds often nest on transmission line structures. However, on high-voltage lines
4 supported by metal lattice towers, birds usually nest on the top bridge of the tower where EMF
5 strength is minimal (e.g., 5 kV/m or less) (Lee, Jr. 1980). The success of nests on transmission
6 line structures appears to be no different from nests in areas not exposed to EMFs (e.g., Gilmer
7 and Stewart 1983; Lee, Jr. 1980; Steenhof et al. 1993).

8 Honeybees in hives under transmission lines can suffer increased propolis (a resin-like material
9 produced to build hives) production, reduced growth, greater irritability, and increased mortality
10 (Greenberg and Bindokas 1985; Rogers and Hinds 1983). Bindokas et al. (1988) determined
11 that these impacts were the result of voltage buildup and electric currents within the hives.
12 Bees kept in moisture-free nonconductive conditions were not adversely affected, even in
13 electric fields as strong as 100 kV/m. These effects can also be mitigated by shielding hives
14 with a grounded metal screen or by moving them away from transmission lines (Rogers and
15 Hinds 1983; Lee, Jr. 1980).

16 Plants and animals near transmission lines have been exposed to many years of transmission
17 line operation and associated EMFs and have acclimated to regular ROW maintenance. Initial
18 LR or SLR would continue current operating conditions and environmental stressors rather than
19 introduce wholly new impacts. Therefore, the impacts of current operations and initial LR or
20 SLR on terrestrial resources would be similar. Further, and as stated above, in-scope
21 transmission lines for license renewal tend to occupy only industrial-use or other developed
22 portions of nuclear power plant sites and, therefore, the effects of EMF plants and animals
23 during an initial LR or SLR term would be negligible. The staff reviewed information in scientific
24 literature and from SEISs (for initial LRs and SLRs) completed since development of the 2013
25 LR GEIS and identified no new information or situations that would result in different impacts for
26 this issue for either an initial LR or SLR term. The NRC concludes that the effects of EMFs on
27 plants and animals during the license renewal term (initial LR or SLR) would be SMALL for all
28 nuclear power plants. This is a Category 1 issue.

29 4.6.1.2 *Aquatic Resources*

30 Continued operation of a nuclear power plant during a license renewal term involves continued
31 cooling water intake system operation, including source water withdrawals and effluent
32 discharges; gaseous and liquid effluent releases; facility upkeep, including transmission line
33 maintenance; and construction or ground-disturbing activities, in cases where license renewal
34 necessitates refurbishment. Aquatic organisms would continue to be subject to the effects of
35 impingement, entrainment, thermal discharges, chemical and radiological contaminants, and
36 erosion and sedimentation.

Environmental Consequences and Mitigating Actions

1 This section considers the effects that aquatic resources may experience as a result of initial LR
2 or SLR. These issues are as follows:

- 3 • impingement mortality and entrainment of aquatic organisms (plants with once-through
4 cooling systems or cooling ponds);^{7,8}
- 5 • impingement mortality and entrainment of aquatic organisms (plants with cooling towers);^{7,8}
- 6 • entrainment of phytoplankton and zooplankton;⁹
- 7 • effects of thermal effluents on aquatic organisms (plants with once-through cooling systems
8 or cooling ponds);⁹
- 9 • effects of thermal effluents on aquatic organisms (plants with cooling towers);⁹
- 10 • infrequently reported effects of thermal effluents;¹⁰
- 11 • effects of nonradiological contaminants on aquatic organisms;
- 12 • exposure of aquatic organisms to radionuclides;
- 13 • effects of dredging on aquatic resources;⁹
- 14 • water use conflicts with aquatic resources (plants with cooling ponds or cooling towers using
15 makeup water from a river);
- 16 • non-cooling system impacts on aquatic resources; and⁹
- 17 • impacts of transmission line right-of-way (ROW) management on aquatic resources.

18 **Impingement and Entrainment**

19 Impingement occurs when organisms are trapped against the outer part of an intake structure's
20 screening device (79 FR 48300). The force of the intake water traps the organisms against the
21 screen, and individuals are unable to escape. Impingement can kill organisms immediately or
22 cause exhaustion, suffocation, injury, and other physical stresses that contribute to later
23 mortality. The potential for injury or death is generally related to the amount of time an
24 organism is impinged, its fragility (susceptibility to injury), and the physical characteristics of the
25 screen wash and fish return systems of the intake structure. Because some individuals may
26 survive impingement, this effect is often assessed in terms of impingement mortality. The EPA
27 has found that impingement mortality is typically less than 100 percent if the cooling water
28 intake system includes fish return or backwash systems. Because impingeable organisms are
29 typically fish with fully formed scales and skeletal structures and well-developed survival traits,
30 such as behavioral responses to avoid danger, many impinged organisms can survive under
31 proper conditions.

⁷ This issue was modified from the 2013 LR GEIS to address updated regulatory criteria under CWA Section 316(b).

⁸ This issue was consolidated to include the impingement component of the 2013 LR GEIS issue, "losses from predation, parasitism, and disease among organisms exposed to sublethal stresses."

⁹ Issue retitled from the 2013 LR GEIS for clarity and consistency with other ecological resource issues. No substantive changes to this issue have been made.

¹⁰ Issue consolidated to include the 2013 LR GEIS issue, "effects of cooling water discharge on dissolved oxygen, gas supersaturation, and eutrophication," and the thermal effluent component of the 2013 LR GEIS issue, "losses from predation, parasitism, and disease among organisms exposed to sublethal stresses."

1 Depending on the configuration of the cooling water intake system, impinged organisms may
2 also become entrapped. Entrapment occurs when impingeable fish and shellfish lack the
3 means to escape the cooling water intake. Entrapment includes but is not limited to organisms
4 caught in the bucket of a traveling screen and unable to reach a fish return; organisms caught in
5 the forebay of a cooling water intake system without any means of being returned to the source
6 water body without experiencing mortality; or cooling water intake systems where the velocities
7 in the intake pipes or in any channels leading to the forebay prevent organisms from being able
8 to return to the source water body through the intake pipe or channel (40 CFR 125.92(j)).

9 Entrainment occurs when organisms pass through the screening device and travel through the
10 entire cooling system, including the pumps, condenser or heat exchanger tubes, and discharge
11 pipes (79 FR 48300). Organisms susceptible to entrainment are of smaller size, such as
12 ichthyoplankton, meriplankton, zooplankton, and phytoplankton. During travel through the
13 cooling system, entrained organisms experience physical trauma and stress, pressure changes,
14 excess heat, and exposure to chemicals (Mayhew et al. 2000). Because entrainable organisms
15 generally consist of fragile life stages (e.g., eggs, which exhibit poor survival after interacting
16 with a cooling water intake structure, and early larvae, which lack a skeletal structure and
17 swimming ability), the EPA has concluded that, for purposes of assessing the impacts of a
18 cooling water intake system on the aquatic environment, all entrained organisms die (79 FR
19 48300).

20 Entrainment susceptibility is highly dependent upon life history characteristics. For example,
21 broadcast spawners with nonadhesive, free-floating eggs that drift with water current may become
22 entrained in a cooling water intake system. Nest-building species or species with adhesive,
23 demersal eggs are less likely to become entrained during their early life stages. The susceptibility
24 of larval life stages to entrainment depends on body morphometrics and swimming ability.

25 If several life stages of a species occupy the source water, that species can be susceptible to
26 both impingement and entrainment. For instance, adults and juveniles of a given species of fish
27 may be impinged against the intake screens, while larvae and eggs may pass through the
28 screening device and be entrained through the cooling system. The susceptibility to either
29 impingement or entrainment is related to the size of the individual relative to the size of the
30 mesh on the screening device. By definition, the EPA considers aquatic organisms that can be
31 collected or retained on a sieve that has 0.56 in. (1.4 centimeters [cm]) diagonal openings to be
32 susceptible to impingement (79 FR 48300). This equates to screen device mesh openings of
33 1/2 in. by 1/4 in. (1.3 cm by 0.635 cm), which is slightly larger than the openings on the typical
34 3/8-in. (0.95-cm) square mesh found at many nuclear power plants. Organisms smaller than
35 the 0.56 in. (1.4 cm) mesh are considered susceptible to entrainment.

36 The magnitude of impact that impingement mortality and entrainment (IM&E) creates on the
37 aquatic environment depends on the nuclear power plant-specific characteristics of the cooling
38 system as well as characteristics of the local aquatic community. Relevant nuclear power plant
39 characteristics include the location of the cooling water intake structure, intake velocities,
40 withdrawal volumes, screening device technologies, and the presence or absence of a fish
41 return system. Impingement and impingement mortality reduction technologies can greatly
42 reduce the likelihood of impingement mortality of susceptible organisms. Relevant
43 characteristics of the aquatic community include species present in the environment, life history
44 characteristics, population abundances and distributions, special species statuses and
45 designations, and regional management objectives.

Environmental Consequences and Mitigating Actions

1 The most visible direct impacts of IM&E are the losses of large numbers of aquatic organisms,
 2 distributed nonuniformly among fish, benthic invertebrates, phytoplankton, zooplankton, and
 3 other susceptible aquatic taxa (e.g., sea turtles). These losses have immediate and direct
 4 effects on the population size and age distribution of affected species and may cascade through
 5 food webs (79 FR 48300).

Ichthyoplankton are early life stages of finfish, including eggs, yolk-sac larvae, and post yolk-sac larvae.

Meriplankton are larval stages of shellfish and other macroinvertebrates.

Zooplankton are animals that either spend their entire lives as plankton (holoplankton) or exist as plankton for a short time during development (meroplankton).

Phytoplankton are single-celled plant plankton and include diatoms (single-celled yellow algae) and dinoflagellates (a single-celled organism with two flagella).

6 In some cases, IM&E have been shown to be a significant source of anthropogenic mortality of
 7 depleted stocks of commercially targeted species. For example, approximately 5.4 percent of
 8 the estimated A1E population of the Southern New England/Massachusetts stock of winter
 9 flounder (*Pseudopleuronectes americanus*) is lost to IM&E (NEFSC 2011). IM&E also increase
 10 the pressure on native freshwater species, such as lake whitefish (*Coregonus clupeaformis*) and
 11 yellow perch (*Perca flavescens*), whose populations have seen dramatic declines in recent
 12 years (79 FR 48300).

13 IM&E are also likely to contribute to reduced population sizes of species targeted by commercial
 14 and recreational fishers, particularly for stocks that are being harvested at unsustainable levels
 15 or that are undergoing rebuilding. Thus, reducing IM&E may lead to more rapid stock recovery,
 16 a long-term increase in commercial fish catches, increased population stability following periods
 17 of poor recruitment and, as a consequence of increased resource utilization, an increased ability
 18 to minimize the invasion of exotic species (Stachowicz and Byrnes 2006).

19 Table 4.6-3 lists taxa commonly impinged or entrained at nuclear power plants by ecosystem
 20 type. Specific species vary by region. For instance, in northeastern estuaries, common
 21 herrings (family Clupeidae) include alewife (*Alosa pseudoharengus*), blueback herring
 22 (*A. aestivalis*), and American shad (*A. sapidissima*). In southeastern estuaries, skipjack herring
 23 (*A. chrysochloris*) and threadfin shad (*D. petenense*) are prevalent. Gizzard shad
 24 (*D. cepedianum*) are found in estuarine waters all along the eastern coast and the Gulf of
 25 Mexico.

26 **Table 4.6-3 Commonly Impinged and Entrained Taxa at Nuclear Power Plants by**
 27 **Ecosystem Type**

Family	Common Name	Ocean	Estuaries	Rivers	Great Lakes
Carangidae	jacks and pompanos	x	-	-	-
Centrarchidae	sunfishes and crappies	-	-	x	-
Clupeidae	herrings	-	x	x	x
Cottoidei	sculpins	-	-	-	x
Cyprinidae	carps and minnows	-	-	x	-

Family	Common Name	Ocean	Estuaries	Rivers	Great Lakes
Engraulidae	anchovies	x	x	-	-
Ephippidae	spadefishes, batfishes, and scats	x	-	-	-
Gobiidae	gobies	x	-	-	-
Ictaluridae	catfish	-	x	x	-
Lutjanidae	snappers	-	-	-	-
Moronidae	temperate basses	-	-	x	-
Osmeridae	smelts	-	-	-	x
Percidae	perch	-	-	x	x
Pleuronectidae	flounders	-	x	-	-
Pleuronectiformes	flatfishes	x	-	-	-
Sciaenidae	drums and croakers	x	x	x	-
Penaeidae	penaeid shrimp	x	-	-	-
Portunidae	swimming crabs	x	-	-	-

1 No entry has been denoted by “-”.

2 IM&E are more of a concern at nuclear power plants that withdraw large volumes of water at
3 higher velocities. In general, this means that plants with once-through cooling water intake
4 systems impinge and entrain more organisms than plants with closed-cycle cooling systems,
5 such as cooling towers because the former require more water to operate. The Palisades plant
6 (no longer operating), which lies on Lake Michigan on the Michigan coast, demonstrates this
7 difference. In 1972, the plant began operating with a once-through cooling system. In 1976, the
8 plant transitioned to a closed-cycle system after cooling towers were constructed. An
9 impingement study found that with the once-through cooling system, Palisade withdrew
10 400,000 gpm and impinged 654,000 fish annually (Consumers Energy Company and Nuclear
11 Management Company 2001 as cited in the 2013 LR GEIS). Once cooling towers were
12 installed, the plant withdrew only 78,000 gpm annually, and impingement dropped to 7,200 fish
13 per year.

14 Impingement risk is also related to a fish’s ability to avoid the flow of water into the cooling water
15 intake system. Fish swimming speeds are typically characterized as burst, prolonged, or
16 sustained. Burst speeds are the highest speeds a fish can attain over very short periods of time
17 (typically less than 20 seconds). Burst speeds are exhibited when an individual is capturing
18 prey, avoiding a predator, or negotiating high water velocities, such as those associated with
19 riffles and eddies in a fast-flowing river or the draw of a power plant’s intake. Sustained speeds
20 are low speeds fish can maintain indefinitely without fatigue. These speeds are observed during
21 routine activities, including foraging, holding, and schooling. Prolonged (or critical) speeds are
22 those of intermediate endurance that a fish could endure for approximately 20 to 30 minutes
23 before ending in fatigue. If a species’ reported swimming ability indicates that individuals can
24 typically swim faster than a nuclear power plant’s intake velocity, the species would exhibit a low
25 likelihood of being impinged. Certain species may not be capable of maintaining a sustained
26 speed that would allow escape from an intake velocity, but an individual could swim in a burst to
27 avoid impingement. Many fish can avoid becoming impinged when intake velocities are less
28 than 0.5 feet per second (fps) (0.15 meters per second [m/s]). As discussed below, the EPA
29 has established this rate as one of the impingement mortality CWA Section 316(b) compliance
30 options for existing facilities.

Environmental Consequences and Mitigating Actions

1 At the Turkey Point plant in Florida, the NRC found that all fish in the CCS would be susceptible
2 to impingement due to the 4.5 fps (1.4 m/s) intake velocity (NRC 2019c). Documented burst
3 speeds of the three known species in the canal system—sheepshead minnow (*Cyprinodon*
4 *variegatus*), sailfin molly (*Poecilia latipinna*), and eastern mosquitofish (*Gambusia holbrooki*)—
5 were all significantly less than this value. Depending on the ecosystem of the source water,
6 however, fish may be capable of navigating much higher flows than 0.5 fps (0.1-5 m/s) because
7 the environment they live in requires this capacity. For instance, unimpounded rivers can flow
8 at several feet per second during high seasonal flows. Fish and other aquatic organisms in
9 these rivers are likely already navigating waters of higher velocities than the draw of a cooling
10 water intake system, and this physiological capability of local populations reduces the risk of
11 impingement.

12 Intake velocities and swimming ability is not relevant to entrainment because early life stages of
13 fish and other organisms susceptible to entrainment are either not motile or are semi-motile.
14 Therefore, all organisms in the water column from which a cooling water intake structure draws
15 water are susceptible to entrainment. However, some nuclear power plants seasonally reduce
16 water consumption during periods of high entrainment. Several nuclear power plants operate a
17 once-through cooling system but have helper cooling towers that are seasonally operated to
18 reduce thermal load to the receiving water body, reduce entrainment during peak spawning
19 periods, or reduce consumptive water use during periods of low river flow. These seasonal
20 reductions are often conditions of NPDES permits or agreements made with regional water
21 quality control boards. Plants with helper cooling towers include the Dresden plant on the
22 Kankakee River in Illinois, Browns Ferry plant on the Tennessee River in Alabama, Monticello
23 Nuclear Generating Plant (Monticello) and Prairie Island plant on the Mississippi River in
24 Minnesota, Peach Bottom plant on Conowingo Pond in Pennsylvania, and Sequoyah plant on
25 the Chickamauga Reservoir in Tennessee.

26 IM&E often varies by season. Impingement can occur year-round, but it is often correlated with
27 seasonal movements and migrations of species, especially for plants located on estuaries and
28 bays. Entrainment is primarily of concern in the spring and summer when many species spawn
29 and early life stages of fish are present in the water column. For instance, Surry withdraws
30 cooling water from the James River in Virginia at the transitional zone between the tidally
31 influenced freshwater river upstream and the saline estuary downstream. Because of its
32 location, freshwater, estuarine, and marine fishes may all be found in the river near the plant
33 depending on season and salinity conditions. The local finfish community includes permanent
34 residents that occur year-round and diadromous species that pass through the region
35 seasonally during migrations to and from spawning grounds. Therefore, impingement frequency
36 for many migrating species is expected to be highly seasonal. Impingement studies confirm this
37 assumption. During impingement studies conducted at the plant, spot (*Leiostomus xanthurus*)
38 and Atlantic menhaden (*Brevortia tyrannus*) impingement was highest in summer and early fall,
39 which correlates with the seasonal movements of juveniles between oceanic spawning grounds,
40 inshore nurseries, and overwintering areas (NRC 2020f). In contrast, white perch (*Morone*
41 *americana*), blueback herring, and threadfin shad were primarily impinged in late fall and winter.
42 Bay anchovy (*Anchoa mitchilli*) and Atlantic croaker (*Micropogonias undulatus*) impingement
43 was prominent only in the spring. The catfishes (*Ictalurus* and *Pylodictis* species), which are
44 resident species, were impinged at relatively constant levels throughout the year. At Point
45 Beach plant on Lake Michigan in Wisconsin, approximately 96 percent of estimated
46 impingement occurs from late April through early August, which mirrors the annual die-offs of
47 alewife in the lake as well as the species' offshore/onshore movement patterns (NextEra Energy
48 2021; NRC 2021f). Alewife accounts for more than 99 percent of impingement at this plant
49 annually. Entrainment is also highly seasonal at Point Beach. Several studies have observed

1 that fish eggs and larvae are entrained in highest densities from early June to early August.
2 Rainbow smelt (*Osmerus mordax*) dominate the early sample period, while burbot (*Lota lota*)
3 become more abundant in the mid-season, correlating with these species' spawning habits
4 (NextEra Energy 2021; NRC 2021f). The 2013 LR GEIS discusses several additional examples
5 of seasonal impingement at the Quad Cities plant in Illinois, McGuire plant in North Carolina,
6 and Summer plant in South Carolina.

7 If a facility withdraws cooling water farther from shore, at greater depths, or otherwise in a less
8 biologically productive area of the source water, IM&E may be less than if the facility were to
9 withdraw water from elsewhere in the water body. In many water bodies, cooling water
10 withdrawal from shoreline locations can result in greater environmental impacts because
11 shoreline areas are typically the most biologically productive waters and contain a high density
12 of early life stage organisms. The lowest potential for impingement and entrainment is often at
13 far offshore locations at distances of several hundred feet (79 FR 48300). Although offshore
14 areas may exhibit a lower density of organisms, the species found will also change as a function
15 of the distance of the intake from the shoreline and the depth of the intake within the water
16 column. Thus, the assemblage of impingeable and entrainable organisms, in addition to the
17 sheer number of organisms, changes with distance from the shoreline. At the Point Beach
18 plant, fish and other aquatic organisms in the source water first interact with the cooling water
19 intake system at an intake crib that lies 1,750 ft (533 m) offshore at an approximate depth of
20 22 ft (7 m) below the lake's surface (NRC 2021f). A study conducted in 2007 determined that
21 the offshore location of Point Beach's intake reduces impingement by 79 percent and
22 entrainment by 89 percent relative to if the intake were to be located in the shallow nearshore
23 waters of Lake Michigan (NextEra Energy 2021). At the LaSalle plant on the Illinois River in
24 Illinois, estimated annual entrainment is 38 million organisms (EA Engineering 2015). However,
25 researchers estimated that this rate is 28 to 38 percent of annual entrainment at the Dresden
26 plant, which is located downstream at the confluence of the Kankakee and Illinois Rivers in a
27 more biologically rich region.

28 Some nuclear power plants have exclusion technologies that divert organisms that would have
29 otherwise been subject to impingement and entrainment away from the intake. Collection and
30 return technologies allow organisms to be impinged, but these technologies collect and return
31 the organisms to the source water, thereby reducing or preventing impingement mortality.
32 Collection and return technologies do not affect entrainment. The Surry plant's cooling water
33 intake system includes a fish return system that returns impinged fish to the James River. The
34 system includes continuously rotating Ristroph traveling screens, low-pressure spray washes,
35 steel fish buckets, and a return trough. Researchers determined that 56 of the 70 taxa impinged
36 at Surry during a 2015–2016 study exhibited an impingement survival rate of 70 percent or
37 greater (HDR 2017). This included many species that the EPA defines as fragile, such as
38 Atlantic menhaden and gizzard shad. The NRC staff calculated impingement mortality for all
39 taxa (fragile and nonfragile) at Surry to be between 2.03 percent (using 2015–2016 data) and
40 5.60 percent (1974–1978 data), which demonstrates the effectiveness of the fish return system
41 (NRC 2020f). The Columbia plant, which lies on the Columbia River in Washington, is equipped
42 with cylindrical intake screens, which could hydraulically deflect fish and stimulate the fish's
43 behavior to avoid the intake screens. Thus, there is low likelihood of impingement and
44 entrainment in nearly all river flow and direction cases due to the generally high ratio of
45 tangential (sweeping) flow to normal (approach) flow toward the screens (Anchor QEA, LLC
46 2020).

47 Impinged organisms that are returned to the source water body may experience stunning,
48 disorientation, or injury. These sublethal effects can subsequently affect an organism's

Environmental Consequences and Mitigating Actions

1 susceptibility to predation, parasitism, or disease. The 1996 and 2013 LR GEISs reported that
2 neither scientific literature reviews nor consultations with agencies or utilities yielded clear
3 evidence of sublethal effects on fish or finfish resulting in noticeable increases in impinged
4 organisms' susceptibility to predation, parasitism, or disease. Since the publication of the
5 2013 LR GEIS, the NRC has determined that the impacts of impingement and entrainment at
6 four nuclear power plants with once-through cooling systems or cooling ponds could be SMALL
7 to MODERATE (2 plants), MODERATE (1 plant), or SMALL to LARGE (1 plant) during the
8 license renewal term (see Table 4.6-4). However, increased susceptibility to predation,
9 parasitism, or disease or predation resulting from impingement was not found to be an issue in
10 any of these reviews. The available information indicates that these secondary impacts of
11 impingement are not expected to be of concern during initial LR or SLR terms at any nuclear
12 power plants. As stated earlier in this section, because entrainable organisms generally consist
13 of fragile life stages, all entrained organisms are assumed to die (79 FR 48300). Therefore,
14 sublethal effects of entrainment do not apply.

15 At some nuclear power plants, marine reptiles and marine mammals can be impinged or
16 entrained by the cooling water intake system in addition to finfish and shellfish. For instance, at
17 the Salem plant in New Jersey, sea turtles from the Delaware Estuary can become impinged in
18 the trash bars. When discovered, plant personnel remove the sea turtles and assess their
19 condition. Live, healthy turtles are returned to the estuary. At St. Lucie Nuclear Plant
20 (St. Lucie) in Florida, sea turtles and other marine organisms can enter one of three intake pipes
21 located in the Atlantic Ocean and be drawn into the intake canal where they become entrapped.
22 Because marine organisms that enter the intake canal cannot return to the ocean on their own,
23 divers capture sea turtles, transport them over the beach dunes, and release them back to the
24 ocean. Injured or sick sea turtles are sent to a rehabilitation facility. Sea turtle impingement or
25 entrainment has also occurred at the Diablo Canyon plant and San Onofre plant (no longer
26 operating) on the Pacific Ocean in California; Oyster Creek plant (no longer operating) on
27 Barnegat Bay in New Jersey; Brunswick Steam Electric Plant (Brunswick) on the Cape Fear
28 River estuary in Virginia, and Crystal River Nuclear Power Plant (Crystal River) (no longer
29 operating) on the Gulf Coast in Florida. Sea turtles are federally protected under the ESA.
30 Sections 3.6.3 and 4.6.1.3 address these species.

31 At Seabrook on the Gulf of Main in New Hampshire, harbor (*Phoca vitulina*), gray (*Halichoerus*
32 *grypus*), harp (*Pagophilus groenlandicus*), and hooded (*Cystophora cristata*) seals have been
33 entrained into the intake tunnels. From 1993 through 1998, approximately 55 seals drowned
34 from entrainment into the intake tunnels. In 1999, following coordination with NMFS, the plant
35 installed seal deterrents that included vertical barriers on each of the three intake structures that
36 reduced the vertical spacing of the bars to less than 5 in. (13 cm) (NRC 2015b). Since
37 installment of these barriers, no seals have been entrained at Seabrook (NRC 2015b). At
38 Diablo Canyon, several California sea lions (*Zalophus californianus*) and harbor seals and one
39 elephant seal (*Mirounga angustirostris*) have become entrapped in the cooling water intake
40 system. All of the California sea lions and harbor seals were discovered dead against the intake
41 trash bars or in one of the traveling screen forebays, and plant personnel removed the
42 carcasses from the intake structure in accordance with Diablo Canyon's Marine Mammal
43 Protection Act letter of authorization (PG&E 2007, PG&E 2008a, PG&E 2008c, PG&E 2008d,
44 PG&E 2009a, PG&E 2009b, PG&E 2014a, PG&E 2014b, PG&E 2015a, PG&E 2015b, PG&E
45 2015c). Most of these animals were in some state of decomposition, and their deaths were not
46 attributed to plant operation. The elephant seal, a juvenile, was discovered in a recess between
47 concrete tri-bars on the intake cover breakwater; plant personnel successfully returned it to the
48 intake cove (PG&E 2008b). The Diablo Canyon plant has not reported any marine mammal
49 impingements or strandings since 2015.

1 Table 4.6-4 summarizes the results of the NRC’s impingement and entrainment analyses for
 2 initial LR and SLR environmental reviews conducted since the 2013 LR GEIS was published.
 3 The 2013 LR GEIS discusses impingement and entrainment findings from reviews prior to 2013
 4 and includes many additional examples relevant to this issue.

5 **Table 4.6-4 Results of NRC Impingement and Entrainment Analyses at Nuclear Power**
 6 **Plants, 2013–Present**

Nuclear Power Plant	Cooling System Type	Cooling Water Source	Impingement and Entrainment Conclusion
Braidwood	Cooling pond	Constructed cooling pond with makeup water from the Kankakee River	SMALL to MODERATE ^(a)
Byron	Cooling towers (ND)	Rock River	SMALL
Callaway	Cooling towers (ND)	Missouri River	SMALL
Davis-Besse	Cooling towers (ND)	Lake Erie	SMALL
Fermi	Cooling towers (ND)	Lake Erie	SMALL
Grand Gulf	Cooling towers (ND)	Mississippi River	SMALL
Indian Point ^(b)	Once-through	Hudson River	MODERATE ^(c)
LaSalle	Cooling pond	Constructed cooling pond with makeup from the Illinois River	SMALL
Limerick	Cooling towers (ND)	Schuylkill River	SMALL
North Anna ^(d)	Cooling pond	Lake Anna	SMALL
Peach Bottom ^(d)	Hybrid: once-through (Unit 2); once-through and cooling towers (MD) (Unit 3)	Conowingo Pond	SMALL
Point Beach ^(d)	Once-through	Lake Michigan	SMALL
River Bend	Cooling towers (MD)	Mississippi River	SMALL
Seabrook	Once-through	Gulf of Maine	SMALL to LARGE ^(e)
Sequoyah	Hybrid: once-through and cooling towers (ND)	Chickamauga Reservoir	SMALL
South Texas	Cooling pond	Constructed cooling reservoir with makeup water from the Colorado River	SMALL
Surry ^(b)	Once-through	James River	SMALL
Turkey Point ^(b)	Cooling pond	Constructed CCS with makeup from the Upper Floridan aquifer	SMALL to MODERATE ^(f)
Waterford	Once-through	Mississippi River	SMALL

7 MD = mechanical draft; ND = natural draft; CCS = cooling canal system.

8 (a) Impingement and entrainment effects would be SMALL for aquatic resources in the Kankakee River as a whole.
 9 Impacts on cyprinids, especially uncommon cyprinids (pallid shiner [*Notropis amnis*], mimic shiner [*N. volucellus*],
 10 and ghost shiner [*N. buchanaui*]); darters; and *Percina* species would be MODERATE. The NRC cannot make a

Environmental Consequences and Mitigating Actions

- 1 determination on the impact of impingement and entrainment on the aquatic resources in the cooling pond
2 because no studies exist on impingement and entrainment at the lake screen house.
- 3 (b) This evaluation was a part of a review that supplemented the NRC's final SEIS.
- 4 (c) While most aquatic organisms would experience SMALL effects, some would experience noticeable effects as a
5 result of impingement and entrainment. These organisms include blueback herring, rainbow smelt, and
6 hogchoker (*Trinectes maculatus*).
- 7 (d) This review evaluated a subsequent license renewal term.
- 8 (e) Impingement and entrainment would be SMALL for most aquatic resources in the Gulf of Maine. Impacts on
9 winter flounder would be LARGE because monitoring data indicate that the abundance of winter flounder has
10 decreased to a greater and observable extent near the Seabrook plant compared to reference sites. The local
11 decrease suggests that local subpopulations of this species have been destabilized through operation of
12 Seabrook's cooling water system.
- 13 (f) Impingement and entrainment effects would be SMALL to MODERATE for aquatic organisms of the CCS.
14 Impingement and entrainment do not apply to aquatic organisms in Biscayne Bay and connected water bodies
15 (e.g., Card Sound, the Atlantic Ocean) because these organisms never interact with the Turkey Point intake
16 structure.
- 17 Sources: NRC 2013b, NRC 2014d, NRC 2014e, NRC 2014f, NRC 2015b, NRC 2015c, NRC 2015d, NRC 2015e,
18 NRC 2015f, NRC 2016c, NRC 2016d, NRC 2018c, NRC 2018e, NRC 2020f, NRC 2020g, NRC 2021f, NRC 2021g.
-

19 IM&E of aquatic organisms would continue throughout the license renewal term for any
20 operating nuclear power plant. The effects of IM&E are discussed below as three issues:

- 21 • impingement mortality and entrainment of aquatic organisms (plants with once-through
22 cooling systems or cooling ponds);
- 23 • impingement mortality and entrainment of aquatic organisms (plants with cooling towers);
24 and
- 25 • entrainment of phytoplankton and zooplankton.

26 A number of mitigative measures can reduce the effects of IM&E. These include withdrawal of
27 water at rates of 0.5 fps (0.15 m/s) or less, seasonal reductions in intake volume during peak
28 periods of entrainment; locating the cooling water intake system in a less biological productive
29 area of the source water, and use of exclusion technologies or fish return systems. Additionally,
30 Section 316(b) of the CWA addresses these effects and requires that cooling water intake
31 structures of regulated facilities must reflect the best technology available (BTA) for minimizing
32 IM&E, as discussed below.

33 **Clean Water Act Section 316(b) Requirements for Minimizing IM&E at Existing Facilities**

34 Section 316(b) of the CWA addresses the adverse environmental impacts caused by the intake
35 of cooling water from waters of the United States. This section of the CWA grants the EPA the
36 authority to regulate cooling water intake structures to minimize adverse impacts on the aquatic
37 environment. In 2014, pursuant to CWA Section 316(b), the EPA issued regulations for existing
38 facilities at 40 CFR 122 and 40 CFR 125, Subpart J (79 FR 48300). Existing facilities include
39 power generation and manufacturing facilities that are not new facilities as defined at
40 40 CFR 125.83 and that withdraw more than 2 Mgd of water from waters of the United States
41 and use at least 25 percent of the water they withdraw exclusively for cooling purposes.

42 Under the CWA Section 316(b) regulations, the location, design, construction, and capacity of
43 cooling water intake structures of regulated facilities must reflect the BTA for minimizing IM&E.
44 The EPA, or authorized States and Tribes, impose BTA requirements through NPDES
45 permitting programs.

1 With respect to impingement mortality, the BTA standard requires that existing facilities comply
2 with one of the following seven alternatives (40 CFR 125.94(c)):

- 3 • operate a closed-cycle recirculating system as defined at 40 CFR 125.92(c)
- 4 • operate a cooling water intake structure that has a maximum through-screen design intake
5 velocity of 0.5 fps (0.15 m/s)
- 6 • operate a cooling water intake structure that has a maximum through-screen intake velocity
7 of 0.5 fps (0.15 m/s)
- 8 • operate an offshore velocity cap as defined at 40 CFR 125.92 that is installed before
9 October 14, 2014
- 10 • operate a modified traveling screen that the NPDES Permit Director determines meets the
11 definition at 40 CFR 125.92(s) and that the NPDES Permit Director determines is the BTA
12 for impingement reduction at the site
- 13 • operate any other combination of technologies, management practices, and operational
14 measures that the NPDES Permit Director determines is the BTA for impingement reduction
- 15 • achieve the specified impingement mortality performance standard.

16 Options 1, 2, and 4 above are essentially preapproved technologies requiring no demonstration
17 or only a minimal demonstration that the flow reduction and control measures are functioning as
18 EPA envisioned. Options 3, 5, and 6 require that more detailed information be submitted to the
19 permitting authority before the permitting authority may specify it as BTA for a given facility.
20 Under Option 7, the permitting authority may also review plant-specific data and conclude that a
21 *de minimis* rate of impingement exists and, therefore, no additional controls are warranted to
22 meet the BTA impingement mortality standard.

23 With respect to entrainment, the CWA Section 316(b) regulations do not prescribe a single
24 nationally applicable entrainment performance standard because the EPA did not identify a
25 technology for reducing entrainment that is effective, widely available, feasible, and does not
26 lead to unacceptable non-water quality impacts. Instead, the permitting authority must establish
27 the BTA entrainment requirement for each facility on a plant-specific basis. In establishing
28 plant-specific requirements, the regulations direct the permitting authority to consider the
29 following factors (40 CFR 125.98(f)(2)):

- 30 • the numbers and types of organisms entrained, including, specifically, the numbers and
31 species (or lowest taxonomic classification possible) of federally listed, threatened and
32 endangered species, and designated critical habitat (e.g., prey base);
- 33 • the impact of changes in particulate emissions or other pollutants associated with
34 entrainment technologies;
- 35 • the land availability inasmuch as it relates to the feasibility of entrainment technology;
- 36 • the remaining useful plant life; and
- 37 • the quantified and qualitative social benefits and costs of available entrainment technologies
38 when such information about both benefits and costs is of sufficient rigor to make a decision.

39 In support of entrainment BTA determinations, facilities must conduct plant-specific studies and
40 provide data to the permitting authority to aid in its determination of whether plant-specific

Environmental Consequences and Mitigating Actions

1 controls would be required to reduce entrainment and which controls, if any, would be
2 necessary.

3 The NRC considers whether nuclear power plants have implemented BTA when assessing the
4 impacts of IM&E, as discussed below.

5 **Thermal Impacts**

6 Thermal impacts associated with thermal effluent discharges from cooling water systems
7 include acute effects, sublethal effects, and community-level effects. Acute effects cause
8 immediate or latent death of aquatic organisms. Sublethal effects include stunning,
9 disorientation, or injury that affect an organism's fitness, behavior, or susceptibility to predation,
10 parasitism, or disease. Community-level effects can include reduced habitat availability or
11 quality and reduced species diversity.

12 The primary thermal impact of concern at operating nuclear power plants is the acute effect of
13 heat shock. Heat shock occurs when water temperatures meet or exceed the thermal tolerance
14 of a species for some duration of exposure. In most situations, fish can move out of an area
15 that exceeds their thermal tolerance limits, although some aquatic species lack such mobility.
16 Heat shock is typically observable only for finfish, particularly those that float when dead. In
17 addition to heat shock, thermal plumes resulting from thermal effluents can create barriers to
18 fish passage, which is of particular concern for migratory species. Thermal effluents are not as
19 likely to affect shellfish because plumes tend to rise to the surface of the water and shellfish
20 typically inhabit the benthic zone. In addition to having direct effects on aquatic organisms,
21 thermal plumes can also reduce the available aquatic habitat or alter habitat characteristics in a
22 manner that results in cascading effects on the local aquatic community.

23 The magnitude of thermal impacts on the aquatic environment depends on the plant-specific
24 characteristics of the cooling system as well as the characteristics of the local aquatic
25 community. Relevant plant characteristics include discharge location, temperature of the
26 effluent when it enters the receiving water body, thermal plume characteristics, and any
27 technologies that assist in mixing or otherwise reducing thermal impacts. Relevant
28 characteristics of the aquatic community include the species present in the environment, life
29 history characteristics, population abundances and distributions, special species statuses and
30 designations, and regional management objectives, as well as the characteristics of the
31 receiving water, such as ambient temperatures and typical flow of water near the discharge
32 point.

33 Thermal effects are more of a concern at nuclear power plants that discharge large volumes of
34 heated effluents. In general, this means that plants with once-through cooling water intake
35 systems or cooling ponds have a larger thermal impact than plants with closed-cycle cooling
36 systems, such as cooling towers, because the former require more water to operate.

37 Fish kills are an acute thermal effect that is typically observed only at plants with cooling ponds.
38 This may be because heat dissipation of the thermal effluent is limited by the size of the
39 receiving water body and because aquatic organisms in cooling ponds are unable to escape
40 thermal plumes. Many freshwater fish, such as those species that inhabiting cooling ponds,
41 experience thermal stress and can die when they encounter water temperatures at or above
42 95 °F (35 °C). Fish kills tend to occur when water temperatures rise above this level for some
43 prolonged period of time and fish are unable to tolerate the higher temperatures or cannot
44 retreat into cooler waters. Fish that experience thermal effects within the region of a receiving

1 water body that is thermally affected by a nuclear power plant's effluent discharge are
2 experiencing effects that are, at least in part, attributable to plant operation.

3 Fish kills have been observed in the summer months at several midwestern plants with cooling
4 ponds, including the Braidwood and LaSalle plants in Illinois. Such events tend to be correlated
5 with periods of high ambient air temperatures, low winds, and high humidity. For instance, six
6 reportable fish kill events occurred in the Braidwood cooling pond from 2001 through 2015. The
7 fish kill events, which occurred in July 2001, August 2001, June 2005, August 2007, June 2009,
8 and July 2012, primarily affected threadfin shad and gizzard shad, although bass, catfish, carp,
9 and other game fish were also affected (NRC 2015d). Reported peak temperatures in the
10 cooling pond during these events ranged from 98.4 °F (36.9 °C) to over 100 °F (37.8 °C), and
11 each event resulted in the death of between 700 to as many as 10,000 fish. During the July
12 2012 event, cooling pond temperatures exceeded 100 °F (37.8 °C), which resulted in the death
13 of approximately 3,000 gizzard shad and 100 bass, catfish, and carp. This event coincided with
14 the NRC's granting of Enforcement Discretion to allow the Braidwood plant to continue to
15 operate above the technical specification limit of less than or equal to 100 °F (37.8 °C) (NRC
16 2021b). At the LaSalle plant, Exelon has reported four fish kill events since 2001. The events
17 occurred in July 2001, June 2005, June 2009, and August 2010, and primarily affected gizzard
18 shad. The Illinois Department of Natural Resources identified other dead fish to include carp
19 (*Cyprinus carpio*), smallmouth buffalo (*Ictiobus bubalus*), freshwater drum (*Aplodinotus*
20 *grunniens*), channel catfish (*Ictalurus punctatus*), striped bass hybrid (*Morone chrysops* x *M.*
21 *saxatilis*), smallmouth bass (*Micropterus dolomieu*), walleye (*Sander vitreus*), bluegill (*Lepomis*
22 *macrochirus*), white bass (*Morone chrysops*), yellow bullhead catfish (*Ameiurus natalis*), and
23 yellow bass (*M. mississippiensis*) (NRC 2016d). The temperature in the cooling pond during
24 these events ranged from 93 °F (33.9 °C) to 101 °F (38.3 °C), and each event resulted in the
25 death of approximately 1,500 to 94,500 fish (NRC 2021a).

26 Fish kill events have rarely been reported at nuclear power plants without cooling ponds. Two
27 fish kills occurred at Pilgrim Nuclear Power Station (Pilgrim) on Cape Cod in Massachusetts in
28 the 1970s, but no such events have been reported since then. In 1975, about 3,000 Atlantic
29 menhaden (*Brevoortia tyrannus*) were killed, and in 1978, about 2,300 Clupeidae (herrings,
30 shads, sardines, and menhadens) were killed (NRC 2007c). After several fish kills at the
31 Summer plant on the Monticello Reservoir in South Carolina in the 1980s, the licensee modified
32 the discharge to reduce the likelihood of future fish kills by removing a hump in the discharge
33 canal, dredging the canal, and limiting reservoir drawdowns (NRC 2004b).

34 Thermal effluents of nuclear power plants can also contribute to sublethal effects, such as the
35 stunning or disorientation of fish and other aquatic organisms exposed to elevated water
36 temperatures. Such effects can increase the susceptibility of affected individuals to predation.
37 Schubel et al. (1977) concluded that the exposure of blueback herring, American shad, and
38 striped bass (*Morone saxatilis*) larvae to an excess of 59 °F (15 °C) would significantly increase
39 their vulnerability to predation. However, such effects are difficult to prove from field studies.
40 The 1996 and 2013 LR GEISs did not report such effects, and no license renewal environmental
41 reviews since the publication of the 2013 LR GEIS have identified this issue to be of concern.

42 Aquatic organisms overwintering within thermal plumes can also experience chronic malnutrition
43 (Hall et al. 1978). Thermal discharges can also increase the susceptibility of fish to disease and
44 parasites because of a combination of increased density of fish within the thermal plume
45 (potentially leading to an increased risk of exposure to infectious diseases or other stresses)
46 and the proliferation of many diseases and parasites in warmer water. Examples of other
47 temperature-related impacts on aquatic resources could include the loss of smolt characteristics

Environmental Consequences and Mitigating Actions

1 in salmon (McCormick et al. 1999) and premature spawning (Hall et al. 1978). However, none
2 of these effects have been specifically linked to operation of any nuclear power plants.

3 Community-level effects of thermal effluent discharges can include reduced habitat availability
4 or quality and reduced species diversity. These effects are typically localized and often only
5 affect certain microhabitats, species, or taxa groups. For instance, at the Peach Bottom plant,
6 which discharges to Conowingo Pond in Pennsylvania, the NRC found that thermal effluents
7 would result in no noticeable effect on the aquatic community during most of the year and in
8 most areas of the cooling pond (NRC 2020g). However, during summer months, thermal
9 studies indicated that a narrow 12 ac (4.9 ha) band of shallow water habitat downstream of the
10 discharge canal exhibited short-term, observable changes, including reduced macroinvertebrate
11 community health and lower fish diversity. The NRC determined that these impacts would likely
12 continue during the license renewal term because the characteristics of thermal discharges
13 would remain the same as those during the initial period of operation. As a result, aquatic
14 organisms in this shallow water habitat would seasonally experience thermal stress and might
15 exhibit avoidance behaviors.

16 Table 4.6-5 summarizes the results of the NRC's thermal analyses for initial LR and SLR
17 environmental reviews conducted since the publication of the 2013 LR GEIS. The 2013 LR
18 GEIS discusses thermal findings from reviews prior to 2013 and includes many additional
19 examples relevant to this issue.

20 **Table 4.6-5 Results of NRC Thermal Analyses at Nuclear Power Plants, 2013–Present**

Nuclear Power Plant	Cooling System Type	Cooling Water Source	Thermal Impact Conclusion
Braidwood	Cooling pond	Constructed cooling pond with makeup water from the Kankakee River	SMALL to MODERATE ^(a)
Byron	Cooling towers (ND)	Rock River	SMALL
Callaway	Cooling towers (ND)	Missouri River	SMALL
Davis-Besse	Cooling towers (ND)	Lake Erie	SMALL
Fermi	Cooling towers (ND)	Lake Erie	SMALL
Grand Gulf	Cooling towers (ND)	Mississippi River	SMALL
Indian Point ^(b)	Once-through	Hudson River	SMALL
LaSalle	Cooling pond	Constructed cooling pond with makeup from the Illinois River	SMALL to MODERATE ^(c)
Limerick	Cooling towers (ND)	Schuylkill River	SMALL
North Anna ^(d)	Cooling pond	Lake Anna	SMALL
Peach Bottom ^(d)	Hybrid: once-through (Unit 2); once-through and cooling towers (MD) (Unit 3)	Conowingo Pond	SMALL to MODERATE ^(e)
Point Beach ^(d)	Once-through	Lake Michigan	SMALL

Nuclear Power Plant	Cooling System Type	Cooling Water Source	Thermal Impact Conclusion
River Bend	Cooling towers (MD)	Mississippi River	SMALL
Seabrook	Once-through	Gulf of Maine	SMALL
Sequoyah	Hybrid: once-through and cooling towers (ND)	Chickamauga Reservoir	SMALL
South Texas	Cooling pond	Constructed cooling reservoir with makeup water from the Colorado River	SMALL
Surry ^(b)	Once-through	James River	SMALL
Turkey Point ^(b)	Cooling pond	Constructed CCS with makeup from the Upper Floridan aquifer	SMALL to MODERATE ^(f)
Waterford	Once-through	Mississippi River	SMALL

- 1 MD = mechanical draft; ND = natural draft; cooling canal system = CCS.
2 (a) Thermal impacts associated with license renewal would result in SMALL impacts on aquatic resources in the
3 Kankakee River and SMALL to MODERATE impacts on aquatic resources in the cooling pond. MODERATE
4 impacts would primarily be experienced by gizzard shad and other non-stocked and low-heat tolerant species.
5 (b) This evaluation was a part of a review that supplemented the NRC's final SEIS.
6 (c) Thermal impacts would be SMALL for all aquatic resources in the Illinois River and SMALL for aquatic resources
7 in the cooling pond, except for gizzard shad and threadfin shad. Gizzard shad and threadfin shad would
8 experience MODERATE thermal impacts in the cooling pond.
9 (d) This review evaluated a subsequent license renewal term.
10 (e) During most of the year and in most areas of Conowingo Pond, the thermal effluent would not noticeably affect
11 the aquatic community and its impact would be SMALL. However, during summer months, a narrow 12 ac
12 (4.9 ha) band of shallow water habitat downstream of the discharge canal would exhibit short-term, observable
13 changes, including reduced macroinvertebrate community health and lower fish diversity. Seasonal impacts in
14 this region would be MODERATE because water temperatures would result in thermal stress and avoidance
15 behaviors.
16 (f) Thermal impacts would be SMALL to MODERATE for aquatic organisms because the thermal effluent may result
17 in some degree of physiological stress on cooling canal system aquatic organisms. However, thermal impacts
18 are unlikely to create effects great enough to destabilize important attributes of the aquatic environment over the
19 course of the subsequent license renewal term because the cooling canal system aquatic community is
20 composed of species that exhibit no unique ecological value or niche and have no commercial or recreational
21 value. Aquatic organisms inhabiting Biscayne Bay are not subject to thermal impacts associated with Turkey
22 Point because there are no surface water connections that allow flow between these waters and the cooling
23 canal system.
24 Sources: NRC 2013b, NRC 2014d, NRC 2014e, NRC 2014f, NRC 2015b, NRC 2015c, NRC 2015d, NRC 2015e,
25 NRC 2015f, NRC 2016c, NRC 2016d, NRC 2018c, NRC 2018e, NRC 2020f, NRC 2020g, NRC 2021f, NRC 2021g.

26 Thermal effluent discharges would continue throughout the license renewal term for any
27 operating nuclear power plant. The effects of thermal effluent discharges are discussed below
28 as three issues:

- 29 • effects of thermal effluents on aquatic organisms (plants with once-through cooling systems
30 or cooling ponds);
- 31 • effects of thermal effluents on aquatic organisms (plants with cooling towers); and
- 32 • infrequently reported effects of thermal effluents.

Environmental Consequences and Mitigating Actions

1 Several mitigative measures can reduce thermal effects. These include routing effluent through
2 discharge canals or settling ponds that dissipate heat before the effluent enters the receiving
3 water body and using high-velocity discharge jets that disperse thermal effluents and promote
4 rapid mixing. Additionally, Section 316(a) of the CWA addresses thermal effects and requires
5 that facilities operate under effluents limitations that assure the protection and propagation of a
6 balanced, indigenous population of shellfish, fish, and wildlife in and on the receiving body of
7 water, as discussed below.

8 **Clean Water Act Section 316(a) Requirements for Point Source Discharges**

9 CWA Section 316(a) (79 FR 48300) addresses the adverse environmental impacts associated
10 with thermal discharges into waters of the United States. Under this section of the Act, the EPA,
11 or authorized States and Tribes, establish thermal surface water quality criteria for waters of the
12 United States within their jurisdiction. States have established standards that incorporate
13 several different types of temperature criteria. These criteria include the following:

- 14 • **Maximum temperature limit:** a limit on the maximum temperature in a water body. This is
15 the core of temperature standards in nearly every state.
- 16 • **Temperature rise above ambient:** a limit on the temperature rise above ambient or natural
17 conditions. This criterion is common among states and is usually specific to habitat type,
18 seasons, designated uses, or specific water body.
- 19 • **Abrupt temperature change:** a restriction in the rate of temperature change over a brief
20 period of time to protect aquatic life from heat shock that can result in lethal or sub-lethal
21 effects.
- 22 • **Diel and seasonal variability:** an allowance for varied temperature depending on the time of
23 day or season. This type of standard is usually narrative rather than quantitative.
- 24 • **Species diversity:** a standard that ensures that the aquatic ecosystem continues to provide
25 an array of microhabitats with a range of temperatures to promote species and spatial
26 diversity. This type of standard is usually narrative.
- 27 • **Other criteria:** other types of temperature criteria have been established in certain states.
28 For instance, California has established a limit on the difference between the discharge
29 temperature and the receiving water body temperature. Florida maintains a maximum
30 temperature of the discharge itself.

31 Additionally, water quality criteria typically address thermal mixing zones, which the EPA (2017)
32 defines as “a limited area or volume of water where initial dilution of a discharge takes place and
33 where numeric water quality criteria can be exceeded but acutely toxic conditions are
34 prevented.” Mixing zones should provide a continuous zone of passage that meets water
35 quality criteria for free-swimming and drifting organisms and that prevents impairment of critical
36 resource areas. An example of State standards where the mixing zone is specified is in Illinois,
37 where the specified temperature criteria must be met outside the mixing zone, defined as no
38 greater than a circle with a radius of 1,000 ft (305 m) or equivalent simple shape.

39 Under CWA Section 316(a), the EPA, or authorized States and Tribes, also have the authority
40 to impose alternative, less-stringent, facility-specific effluent limits (called “variances”) on the
41 thermal component of individual point source discharges. To be eligible, regulated facilities
42 must demonstrate, to the satisfaction of the NPDES permitting authority, that facility-specific
43 effluent limitations will assure the protection and propagation of a balanced, indigenous
44 population of shellfish, fish, and wildlife in and on the receiving body of water. CWA

1 Section 316(a) variances are valid for the term of the NPDES permit (i.e., 5 years). Facilities
2 must reapply for variances with each NPDES permit renewal application. The EPA has issued
3 regulations under CWA Section 316(a) at 40 CFR 125, Subpart H.

4 The NRC considers whether nuclear power plants have valid CWA 316(a) variances when
5 assessing the impacts of thermal discharges on aquatic organisms, as discussed later in this
6 section (see Section 4.6.1.2.4).

7 *4.6.1.2.1 Impingement Mortality and Entrainment of Aquatic Organisms (Plants with Once-*
8 *Through Cooling Systems or Cooling Ponds)*

9 This issue pertains to IM&E of finfish and shellfish at nuclear power plants with once-through
10 cooling systems and cooling ponds during an initial LR or SLR term. This includes plants with
11 helper cooling towers that are seasonally operated to reduce thermal load to the receiving water
12 body, reduce entrainment during peak spawning periods, or reduce consumptive water use
13 during periods of low river flow. IM&E of finfish and shellfish at nuclear power plants with
14 cooling towers operated in a fully closed-cycle mode is addressed in Section 4.6.1.2.2.
15 Entrainment of phytoplankton and zooplankton is addressed in Section 4.6.1.2.3. Impingement
16 and entrainment of federally protected species subject to interagency consultation, such as sea
17 turtles and sturgeon, is addressed in Section 4.6.1.3.2.

18 In the 1996 and 2013 LR GEISs, the NRC determined that the impacts of impingement and
19 entrainment of aquatic organisms would be SMALL at many nuclear power plants with once-
20 through cooling systems or cooling ponds, as well as plants that operate in a hybrid mode
21 (i.e., once-through cooling with cooling towers that operate intermittently), but that these impacts
22 could be MODERATE or LARGE at some plants. Therefore, impingement and entrainment
23 were considered Category 2 issues for these plants. The 1996 LR GEIS addressed
24 impingement and entrainment as two distinct issues. The 2013 LR GEIS combined the two
25 issues into one issue titled, “impingement and entrainment of aquatic organisms (plants with
26 once-through cooling systems or cooling ponds).”

27 In this LR GEIS, the NRC refines the title of this issue to include impingement mortality, rather
28 than simply impingement. This change is consistent with the EPA’s 2014 CWA Section 316(b)
29 regulations and the EPA’s assessment that impingement reduction technology is available,
30 feasible, and has been demonstrated to be effective. For example, and as described above,
31 impingement mortality at the Surry plant is estimated at between 2.03 and 5.60 percent (NRC
32 2020f). Therefore, although the plant’s once-through cooling system impinges a large number
33 of organisms, the highly effective fish return system ensures that the majority of organisms are
34 returned back to the river unharmed. Additionally, the EPA’s 2014 CWA Section 316(b)
35 regulations establish BTA standards for impingement mortality based on the fact that survival is
36 a more appropriate metric for determining environmental impact than simply looking at total
37 impingement. Survival studies typically take into account latent mortality associated with
38 stunning, disorientation, or injury. Such effects can result from the injury itself or from increased
39 susceptibility to predation, parasitism, or disease that results from the sublethal effects of
40 impingement. Therefore, this LR GEIS also consolidates the impingement component of the

Environmental Consequences and Mitigating Actions

1 issue of “losses from predation, parasitism, and disease among organisms exposed to sublethal
2 stresses,”¹¹ for plants with once-through cooling systems or cooling ponds into this issue.

3 As a result of the 2014 CWA Section 316(b) regulations, nuclear power plants must submit
4 detailed information about their cooling water intake systems as part of NPDES permit renewal
5 applications to support the permitting authority in making BTA determinations. Of note, for
6 existing facilities that withdraw greater than 125 Mgd of water for cooling purposes, 40 CFR
7 122.21(r)(9) requires these facilities to submit an entrainment characterization study, and 40
8 CFR 122.21(r)(6) requires these facilities to submit their chosen method(s) of compliance with
9 the impingement mortality standard, including supporting studies and data for Options (3), (5),
10 and (6) listed above. In NPDES permits issued since 2014, permitting authorities have typically
11 included a timeline for submittal of this information as special conditions of the permit, and the
12 permitting authority has used this information to make final BTA determinations during the
13 subsequent five-year NPDES permitting cycle. Thus, some nuclear power plants have received
14 final BTA determinations under the 2014 CWA Section 316(b) regulations. Many others have
15 submitted the required information and are awaiting final determinations. The NRC staff
16 expects that most operating nuclear power plants will have final BTA determinations within the
17 next several years.

18 When available, the NRC staff relies on the expertise and authority of the NPDES permitting
19 authority with respect to the impacts of IM&E. Therefore, if the NPDES permitting authority has
20 made BTA determinations for a nuclear power plant pursuant to CWA Section 316(b) in
21 accordance with the current regulations at 40 CFR Part 122 and 40 CFR Part 125, which were
22 promulgated in 2014, and that plant has implemented any associated requirements or those
23 requirements would be implemented before the license renewal period, then the NRC staff
24 assumes that adverse impacts on the aquatic environment would be minimized (see 10 CFR
25 51.10(c); 10 CFR 51.53(c)(3)(ii)(B); 10 CFR 51.71(d)). In such cases, the NRC staff concludes
26 that the impacts of either impingement mortality, entrainment, or both would be SMALL over the
27 course of the initial LR or SLR renewal term for these nuclear power plants.

28 In cases where the NPDES permitting authority has not made BTA determinations, the NRC
29 staff analyzes the potential impacts of impingement mortality, entrainment, or both using a
30 weight-of-evidence approach. In this approach, the staff considers multiple lines of evidence to
31 assess the presence or absence of ecological impairment (i.e., noticeable or detectable impact)
32 on the aquatic environment. For instance, as its lines of evidence, the staff might consider
33 characteristics of the cooling water intake system design, the results of impingement and
34 entrainment studies performed at the facility, and trends in fish and shellfish population
35 abundance indices. The staff then considers these lines of evidence together to predict the
36 level of impact (SMALL, MODERATE, or LARGE) that the aquatic environment is likely to
37 experience over the course of the initial LR or SLR term.

38 The staff reviewed information from SEISs (for initial LRs and SLRs) completed since
39 development of the 2013 LR GEIS. In summary, the potential effects of IM&E during an initial
40 LR or SLR term depend on numerous site-specific factors, including the ecological setting of the
41 plant; the characteristics of the cooling system; and the characteristics of the fish, shellfish, and

¹¹ The potential for thermal effluents to cause sublethal stresses that increase the susceptibility of aquatic organisms to predation, parasitism, or disease is evaluated in Section 4.6.1.2.6. The potential for impingement to cause sublethal stresses at plants with cooling towers is addressed in Section 4.6.1.2.2. Entrainment would not result in sublethal stresses because entrainable organisms generally consist of fragile life stages, and all entrained organisms are assumed to die (79 FR 48300).

1 other aquatic organisms present in the area (e.g., life history, distribution, population trends,
 2 management objectives, etc.). Additionally, whether the NPDES permitting authority has made
 3 BTA determinations pursuant to CWA Section 316(b) and whether the nuclear power plant has
 4 implemented any associated requirements is also a relevant factor. In general, if the NPDES
 5 permitting authority has made such determinations and the nuclear power plant has
 6 implemented any associated requirements, then the NRC staff assumes that adverse impacts
 7 on the aquatic environment will be minimized and that the impacts of IM&E will be SMALL; if this
 8 is not the case, impacts could be SMALL, MODERATE, or LARGE.

9 The NRC concludes that the impacts of IM&E of aquatic organisms during the license renewal
 10 term (initial LR or SLR) at nuclear power plants with once-through cooling systems or cooling
 11 ponds could be SMALL, MODERATE, or LARGE. This is a Category 2 issue.

12 *4.6.1.2.2 Impingement Mortality and Entrainment of Aquatic Organisms (Plants with Cooling*
 13 *Towers)*

14 This issue pertains to IM&E of finfish and shellfish at nuclear power plants with cooling towers
 15 that operate in a fully closed-cycle mode during an initial LR or SLR term. IM&E of finfish and
 16 shellfish at nuclear power plants with once-through cooling systems or cooling ponds is
 17 addressed in Section 4.6.1.2.1. Entrainment of phytoplankton and zooplankton is addressed in
 18 Section 4.6.1.2.3. Impingement and entrainment of federally protected species subject to
 19 interagency consultation, such as sea turtles and sturgeon, are addressed in Section 4.6.1.3.2.

20 In the 1996 and 2013 LR GEISs, the NRC determined that the impacts of impingement and
 21 entrainment of aquatic organisms would be SMALL at all nuclear power plants with cooling
 22 towers operated in a fully closed-cycle mode. Therefore, impingement and entrainment were
 23 considered Category 1 issues for these plants. The 1996 LR GEIS addressed impingement and
 24 entrainment as two distinct issues. The 2013 LR GEIS combined the two issues into one issue
 25 titled, "impingement and entrainment of aquatic organisms (plants with cooling towers)." In this
 26 LR GEIS, the NRC refines the title of this issue to include impingement mortality, rather than
 27 simply impingement. This change is consistent with the EPA's 2014 CWA Section 316(b)
 28 regulations and because assessing survival of impinged organisms is a more appropriate metric
 29 for determining environmental impact than simply looking at total impingement. Survival studies
 30 typically take into account latent mortality associated with stunning, disorientation, or injury.
 31 Such effects can result from the injury itself or from increased susceptibility to predation,
 32 parasitism, or disease that results from the sublethal effects of impingement. Therefore, this LR
 33 GEIS also consolidates the impingement component of the issue of "losses from predation,
 34 parasitism, and disease among organisms exposed to sublethal stresses,"¹² for plants with
 35 cooling towers into this issue.

36 In the 1996 and 2013 LR GEISs, the NRC found that impingement and entrainment of finfish
 37 and shellfish at plants with cooling towers operated in a fully closed-cycle mode did not result in
 38 noticeable effects on finfish or shellfish populations within source water bodies, and this impact
 39 was not expected to be an issue during the license renewal term. This finding was based, in

¹² The potential for thermal effluents to cause sublethal stresses that increase the susceptibility of aquatic organisms to predation, parasitism, or disease is evaluated in Section 4.6.1.2.6. The potential for impingement to cause sublethal stresses at plants with once-through cooling systems or cooling ponds is addressed in Section 4.6.1.2.1. Entrainment would not result in sublethal stresses because entrainable organisms generally consist of fragile life stages, and all entrained organisms are assumed to die (79 FR 48300).

Environmental Consequences and Mitigating Actions

1 part, on the lower rates of water withdrawal at plants with cooling towers that operate in a fully
2 closed-cycle mode. Of the various factors that can influence IM&E, the volume of water
3 withdrawn by a cooling water intake system relative to the size of the source water body
4 appears to be the best predictor of the quantity of organisms that would be impinged or
5 entrained within a given aquatic system (Henderson and Seaby 2000). Because cooling towers
6 minimize the volume of water withdrawn by a nuclear power plant, the impacts of IM&E from a
7 plant with cooling towers that operates in a fully closed-cycle mode would generally be smaller
8 than the impacts from a plant with a once-through cooling system or a cooling pond. This
9 finding is further supported by the EPA's 2014 CWA Section 316(b) regulations for existing
10 facilities at 40 CFR 122 and 40 CFR 125, Subpart J (79 FR 48300). As described in
11 Section 4.6.1.2 under "Clean Water Act Section 316(b) Requirements for Minimizing IM&E at
12 Existing Facilities," operation of a closed-cycle recirculating system is an essentially
13 preapproved technology for achieving impingement mortality BTA. This finding does not apply
14 to nuclear power plants that seasonally or intermittently use cooling towers in a helper mode to
15 mitigate thermal effects, entrainment, or consumptive water use, but that otherwise operate as
16 once-through system. These hybrid systems are included under the evaluation of once-through
17 cooling water intake systems above.

18 The 1996 and 2013 LR GEISs determined that impingement may result in sublethal effects that
19 could increase the susceptibility of fish or shellfish to predation, disease, or parasitism.
20 However, only once-through cooling systems were anticipated to be of concern for this issue.
21 The lower volume of water required by nuclear power plants with cooling towers that operate in
22 a fully closed-cycle mode would also minimize this potential effect. The 1996 and 2013 LR
23 GEISs reported that neither scientific literature reviews nor consultations with agencies or
24 utilities yielded clear evidence of sublethal effects on fish or finfish resulting in noticeable
25 increases in impinged organisms' susceptibility to predation, parasitism, or disease, regardless
26 of cooling system type. Since the publication of the 2013 LR GEIS, the NRC has identified no
27 information about this issue for plants with cooling towers. The available information indicates
28 that these secondary impacts of impingement are not expected to be of concern during initial LR
29 or SLR terms at nuclear power plants with cooling towers. As stated earlier in this section,
30 because entrainable organisms generally consist of fragile life stages, all entrained organisms
31 are assumed to die (79 FR 48300). Therefore, sublethal effects of entrainment do not apply.

32 In considering the effects of IM&E of closed-cycle cooling systems on aquatic ecology, the NRC
33 evaluated the same issues that were evaluated for nuclear power plants with once-through
34 cooling systems or cooling ponds in Section 4.6.1.2.1. No significant impacts on aquatic
35 populations have been reported at any existing nuclear power plants with cooling towers
36 operating in a closed-cycle mode in scientific literature or in license renewal SEISs published to
37 date. Initial LR or SLR would continue current operating conditions and environmental stressors
38 rather than introduce wholly new impacts. Therefore, the impacts of current operations and
39 license renewal on aquatic resources would be similar. For these reasons, the effects of IM&E
40 on aquatic organisms at plants with cooling towers would be minor and would neither destabilize
41 nor noticeably alter any important attribute of finfish or shellfish populations in source water
42 bodies during initial LR or SLR terms. As part of obtaining BTA determinations under CWA
43 316(b), permitting authorities may require some nuclear power plants to implement additional
44 plant-specific controls to reduce IM&E. Implementation of such controls would further reduce or
45 mitigate IM&E during the license renewal term. The staff reviewed information in scientific
46 literature and from SEISs (for initial LRs and SLRs) completed since development of the 2013
47 LR GEIS and identified no new information or situations that would result in different impacts for
48 this issue for either an initial LR or SLR term. The NRC concludes that the impacts of IM&E on
49 aquatic organisms during the license renewal term (initial LR or SLR) would be SMALL for

1 nuclear power plants with cooling towers operated in a fully closed-cycle mode. This is a
2 Category 1 issue.

3 *4.6.1.2.3 Entrainment of Phytoplankton and Zooplankton*

4 This issue pertains to the entrainment of phytoplankton and zooplankton during an initial LR or
5 SLR term. The IM&E of fish and shellfish, including ichthyoplankton and larval stages of
6 shellfish, are addressed above in two issues based on cooling water intake system type in
7 Sections 4.6.1.2.1 and 4.6.1.2.2.

8 In the 1996 and 2013 LR GEISs, the NRC determined that entrainment of phytoplankton and
9 zooplankton would be SMALL at all nuclear power plants. Therefore, this was considered a
10 Category 1 issue for all plants regardless of cooling water intake system type. Impingement
11 does not apply to phytoplankton or zooplankton because these organisms are too small to be
12 trapped against intake structure screening devices.

13 Most nuclear power plants were required to monitor for entrainment effects during the initial
14 years of operation. The effects of entrainment on phytoplankton and zooplankton are
15 considered to be of SMALL significance if monitoring indicates no evidence that nuclear power
16 plant operation has reduced or otherwise affected populations of these organisms in the source
17 water body. For example, about 70 percent of the copepods (a group of planktonic
18 crustaceans) entrained at the Millstone plant in Connecticut suffered mortality, but this loss only
19 represented 0.1 to 0.3 percent of the copepod production of eastern Long Island Sound
20 (Carpenter et al. 1974). At the Calvert Cliffs plant, which withdraws cooling water from the
21 Chesapeake Bay in Maryland, entrainment survival for the five most abundant zooplankton
22 species was 65 to 100 percent (NRC 1999c). At the D.C. Cook plant on Lake Michigan,
23 researchers determined that zooplankton losses associated with entrainment were too small to
24 be detected in the lake. Researchers concluded that fish predation, rather than entrainment,
25 was the major source of zooplankton mortality in inshore waters during most of the year (Evans
26 et al. 1986). At the Seabrook plant on the Gulf of Maine in New Hampshire, researchers
27 compared the densities of holoplankton, meroplankton, and hyperbenthos taxa prior to and
28 during operation at nearfield and farfield sites and found no significant differences in densities
29 prior to and during operations or between the sampling sites (NAI 1998). Researchers also
30 found no significant differences in phytoplankton abundance or chlorophyll concentrations
31 between the nearfield and farfield sites, nor was there any significant difference prior to and
32 during operations (NAI 1998). Based on these results, the NRC (NRC 2015b) found that
33 Seabrook operation had not noticeably altered zooplankton or phytoplankton abundance near
34 the Seabrook site.

35 Initial LR or SLR would continue current operating conditions and environmental stressors
36 rather than introduce wholly new impacts. Therefore, the impacts of current operations and
37 license renewal on aquatic resources would be similar. For these reasons, the effects of
38 entrainment of phytoplankton and zooplankton would be minor and would neither destabilize nor
39 noticeably alter any important attribute of populations of these organisms in source water bodies
40 during the initial LR or SLR terms of any nuclear power plants. As part of obtaining BTA
41 entrainment determinations under CWA 316(b), permitting authorities may require some nuclear
42 power plants to implement additional plant-specific controls to reduce entrainment.
43 Implementation of such controls would further reduce or mitigate entrainment of phytoplankton
44 and zooplankton. The staff reviewed information in scientific literature and from SEISs (for initial
45 LRs and SLRs) completed since development of the 2013 LR GEIS and identified no new
46 information or situations that would result in different impacts for this issue for either an initial LR

Environmental Consequences and Mitigating Actions

1 or SLR term. The NRC concludes that the impacts of entrainment of phytoplankton and
2 zooplankton during the license renewal term (initial LR or SLR) would be SMALL for all nuclear
3 power plants. This is a Category 1 issue.

4 *4.6.1.2.4 Effects of Thermal Effluents on Aquatic Organisms (Plants with Once-Through Cooling* 5 *Systems or Cooling Ponds)*

6 This issue pertains to acute, sublethal, and community-level effects of thermal effluents on
7 finfish and shellfish from operation of nuclear power plants with once-through cooling systems
8 and cooling ponds during an initial LR or SLR term. This includes plants with helper cooling
9 towers that are seasonally operated to reduce thermal load to the receiving water body, reduce
10 entrainment in the during peak spawning periods, or reduce consumptive water use during
11 periods of low river flow. The effects of thermal effluents on aquatic organisms at nuclear power
12 plants with cooling towers operated in a fully closed-cycle mode are addressed in
13 Section 4.6.1.2.5. Infrequently reported effects of thermal effluents are addressed in
14 Section 4.6.1.2.6.

15 In the 1996 and 2013 LR GEISs, the NRC determined that the effects of thermal effluents on
16 aquatic organisms would be SMALL at many nuclear power plants with once-through cooling
17 systems or cooling ponds, as well as plants that operate in a hybrid mode (i.e., once-through
18 cooling with cooling towers that operate intermittently), but that these impacts could be
19 MODERATE or LARGE at some plants. Therefore, this was considered a Category 2 issue for
20 these plants. In the 1996 LR GEIS, this issue was evaluated as “heat shock.” The 2013 LR
21 GEIS retitled this issue to “thermal impacts on aquatic organisms (plants with once-through
22 cooling systems or cooling ponds)” to acknowledge that, in addition to acute effects, aquatic
23 organisms could suffer sublethal effects from exposure to thermal effluents. For instance,
24 during some license renewal environmental reviews, thermal effluents have been found to
25 seasonally affect the geographic distribution or diversity of aquatic organisms (see Table 4.6-5
26 and the discussion concerning Peach Bottom plant’s thermal effluent in Section 4.6.1.2 under,
27 “Thermal Impacts”). This LR GEIS refines the title of this issue from “thermal impacts on
28 aquatic organisms (plants with once-through cooling systems or cooling ponds)” to “effects of
29 thermal effluents on aquatic organisms (plants with once-through cooling systems or cooling
30 ponds)” for clarity and consistency with other ecological resource LR GEIS issue titles.

31 When available, the NRC staff relies on the expertise and authority of the NPDES permitting
32 authority with respect to thermal impacts on aquatic organisms. Therefore, if the NPDES
33 permitting authority has made a determination under CWA Section 316(a) that thermal effluent
34 limits are sufficiently stringent to assure the protection and propagation of a balanced,
35 indigenous population of shellfish, fish, and wildlife in and on the receiving body of water, and
36 the nuclear power plant has implemented any associated requirements, then the NRC staff
37 assumes that adverse impacts on the aquatic environment will be minimized (see
38 10 CFR 51.10(c); 10 CFR 51.53(c)(3)(ii)(B); and 10 CFR 51.71(d) [10 CFR Part 51]). In such
39 cases, the NRC staff concludes that thermal impacts on aquatic organisms would be SMALL
40 over the course of the initial LR or SLR term for these nuclear power plants.

41 In cases where the NPDES permitting authority has not granted a CWA Section 316(a)
42 variance, the NRC staff analyzes the potential impacts of thermal discharges using a weight-of-
43 evidence approach. In this approach, the staff considers multiple lines of evidence to assess
44 the presence or absence of ecological impairment (i.e., noticeable or detectable impact) on the
45 aquatic environment. For instance, as its lines of evidence, the staff might consider the
46 characteristics of the cooling water discharge system design, the results of thermal studies

1 performed at the facility, and the trends in fish and shellfish population abundance indices. The
 2 staff then considers these lines of evidence together to predict the level of impact (SMALL,
 3 MODERATE, or LARGE) that the aquatic environment is likely to experience over the course of
 4 the initial LR or SLR term.

5 The staff reviewed information from SEISs (for initial LRs and SLRs) completed since
 6 development of the 2013 LR GEIS. In summary, the potential effects of thermal effluent
 7 discharges during an initial LR or SLR term depends on numerous site-specific factors,
 8 including the ecological setting of the nuclear power plant; the characteristics of the cooling
 9 system and effluent discharges; and the characteristics of the fish, shellfish, and other aquatic
 10 organisms present in the area (e.g., life history, distribution, population trends, management
 11 objectives, etc.). Additionally, whether the NPDES permitting authority has granted a 316(a)
 12 variance is also a relevant factor. In general, if the NPDES permitting authority has granted such
 13 a variance and the nuclear power plant has implemented any associated requirements, then the
 14 NRC staff assumes that adverse impacts on the aquatic environment will be minimized and that
 15 thermal impacts will be SMALL; if this is not the case, impacts could be SMALL, MODERATE,
 16 or LARGE.

17 The NRC concludes that the effects of thermal effluents on aquatic organisms during the license
 18 renewal term (initial LR or SLR) at nuclear power plants with once-through cooling or cooling
 19 ponds could be SMALL, MODERATE, or LARGE. This is a Category 2 issue.

20 *4.6.1.2.5 Effects of Thermal Effluents on Aquatic Organisms (Plants with Cooling Towers)*

21 This issue pertains to acute, sublethal, and community-level effects of thermal effluents on
 22 finfish and shellfish from operation of nuclear power plants with cooling towers operated in a
 23 fully closed-cycle mode during an initial LR or SLR term. The effects of thermal effluents on
 24 aquatic organisms at nuclear power plants with once-through cooling systems or cooling ponds
 25 are addressed in Section 4.6.1.2.4. Infrequently reported effects of thermal effluents are
 26 addressed in Section 4.6.1.2.6.

27 In the 1996 and 2013 LR GEISs, the NRC determined that the effect of thermal effluents on
 28 aquatic organisms would be SMALL at all nuclear power plants with cooling towers operated in
 29 a fully closed-cycle mode. Therefore, this was considered a Category 1 issue for these plants.
 30 In the 1996 LR GEIS, this issue was evaluated as “heat shock.” The 2013 LR GEIS retitled this
 31 issue to “thermal impacts on aquatic organisms (plants with cooling towers)” to acknowledge
 32 that, in addition to acute effects, aquatic organisms could suffer sublethal effects from exposure
 33 to thermal effluents. This LR GEIS refines the title of this issue from “thermal impacts on
 34 aquatic organisms (plants with cooling towers)” to “effects of thermal effluents on aquatic
 35 organisms (plants with cooling towers)” for clarity and consistency with other ecological
 36 resource LR GEIS issue titles.

37 In the 1996 and 2013 LR GEISs, the NRC found that the effects of thermal effluents on aquatic
 38 organisms at plants with cooling towers operated in a fully closed-cycle mode did not result in
 39 noticeable effects on aquatic populations within receiving water bodies, and this impact was not
 40 expected to be an issue during the license renewal term. This finding was based, in part, on the
 41 presence of smaller thermal plumes at plants with closed-cycle cooling systems.

42 When considering the effects of thermal effluents of closed-cycle cooling systems on aquatic
 43 organisms, the NRC evaluated the same issues that were evaluated for plants with once-
 44 through cooling systems or cooling ponds in Section 4.6.1.2.4. No significant impacts on

Environmental Consequences and Mitigating Actions

1 aquatic populations have been reported at any existing nuclear power plants with cooling towers
2 operating in a closed-cycle mode in scientific literature or in license renewal SEISs published to
3 date. Initial LR or SLR would continue current operating conditions and environmental stressors
4 rather than introduce wholly new impacts. Therefore, the impacts of current operations and
5 initial LR or SLR on aquatic resources would be similar. For these reasons, the effects of
6 thermal effluents on aquatic organisms at plants with cooling towers would be minor and would
7 neither destabilize nor noticeably alter any important attribute of aquatic populations in receiving
8 water bodies during initial LR or SLR terms. As part of obtaining a variance under CWA
9 Section 316(a), permitting authorities may impose conditions concerning thermal effluent
10 discharges at some nuclear power plants. Implementation of such conditions would further
11 reduce or mitigate thermal impacts during the license renewal term. The staff reviewed
12 information in scientific literature and from SEISs (for initial LRs and SLRs) completed since
13 development of the 2013 LR GEIS and identified no new information or situations that would
14 result in different impacts for this issue for either an initial LR or SLR term.

15 The NRC concludes that the effects of thermal effluents on aquatic organisms during the license
16 renewal term (initial LR or SLR) would be SMALL for nuclear power plants with cooling towers
17 operated in a fully closed-cycle mode. This is a Category 1 issue.

18 *4.6.1.2.6 Infrequently Reported Effects of Thermal Effluents*

19 This issue concerns the infrequently reported effects of thermal effluents during an initial LR or
20 SLR term. These effects include cold shock, thermal migration barriers, accelerated maturation
21 of aquatic insects, and proliferated growth of aquatic nuisance species, as well as the effects of
22 thermal effluents on dissolved oxygen, gas supersaturation, and eutrophication. This issue also
23 considers sublethal stresses associated with thermal effluents that can increase the
24 susceptibility of exposed organisms to predation, parasitism, or disease.

25 In the 1996 and 2013 LR GEISs, the NRC determined that the infrequently reported effects of
26 thermal effluents would be SMALL at all nuclear power plants. Therefore, this was considered a
27 Category 1 issue. The 1996 LR GEIS evaluated this issue as eight separate issues; the 2013
28 LR GEIS consolidated these issues into two issues titled “infrequently reported thermal impacts
29 (all plants)” and “effects of cooling water discharge on dissolved oxygen, gas supersaturation,
30 and eutrophication.” This LR GEIS further consolidates these two issues, as well as the thermal
31 effluent component of the issue of “losses from predation, parasitism, and disease among
32 organisms exposed to sublethal stresses,”¹³ (a Category 1 issue in both the 1996 and 2013 LR
33 GEISs) into one issue. This LR GEIS refines the title of this issue to “infrequently reported
34 effects of thermal effluents” for clarity and consistency with other ecological resource LR GEIS
35 issue titles.

36 **Cold Shock**

37 Cold shock occurs when an organism has been acclimated to a specific water temperature or
38 range of temperatures and is subsequently exposed to a rapid decrease in temperature. This
39 can result in a cascade of physiological and behavioral responses and, in some cases, death

¹³ The potential for impingement to cause sublethal stresses that increase the susceptibility of aquatic organisms to predation, parasitism, or disease is evaluated in Section 4.6.1.2.1 (plants with once-through cooling systems or cooling ponds) and Section 4.6.1.2.2 (plants with cooling towers). Entrainment would not result in sublethal stresses because entrainable organisms generally consist of fragile life stages, and all entrained organisms are assumed to die (79 FR 48300).

1 (Donaldson et al. 2008). Rapid temperature decreases may occur from either natural sources
2 (e.g., thermocline temperature variation and storm events) or anthropogenic sources (e.g.,
3 thermal effluent discharges). The magnitude, duration, and frequency of the temperature
4 change, as well as the initial acclimation temperatures of individuals, can influence the extent of
5 the consequences of cold shock on fish and other aquatic organisms (Donaldson et al. 2008).
6 At nuclear power plants, cold shock could occur during refueling outages, reductions in power
7 generation level, or other situations that would quickly reduce the amount of cooling capacity
8 required at the plant. Cold shock is most likely to be observable in the winter. The 1996 LR
9 GEIS reports that cold shock events have only rarely occurred at nuclear power plants
10 (e.g., Haddam Neck [no longer operating] in Connecticut, Prairie Island and Monticello in
11 Minnesota, and Oyster Creek [no longer operating] in New Jersey). Fish mortalities usually
12 involved only a few fish and did not result in population-level effects. Gradual depowering or
13 shutdown of plant operations, especially in winter months, can mitigate the effects of cold shock.
14 No cold shock events have been reported since the events described in the 1996 LR GEIS
15 occurred, and no noticeable or detectable impacts on aquatic populations have been reported at
16 any existing nuclear power plants related to this issue in scientific literature or in license renewal
17 SEISs published to date. The available information indicates that cold shock resulting from
18 thermal effluents of nuclear power plants is not of concern for initial LR or SLR.

19 **Thermal Migration Barriers**

20 Thermal effluents have the potential to create migration barriers if the thermal plume covers an
21 extensive cross-sectional area of a river and temperatures within the plume exceed a species'
22 physiological tolerance limit. This impact has been examined at several nuclear power plants,
23 but it has not been determined to result in observable effects. For example, at Vermont Yankee
24 Nuclear Power Station (Vermont Yankee) (no longer operating) on the Connecticut River in
25 Vermont, the NRC examined the potential for the plant's thermal plume to affect the
26 outmigration of American shad and Atlantic salmon (*Salmo salar*). This potential effect was of
27 particular concern because the fish passage facility was located on the same side of the river as
28 the plant's discharge, and a hydroelectric facility was located immediately downstream (NRC
29 2007d). However, the licensee's CWA Section 316(b) demonstration found that smolt migration
30 of these species would not be affected because the thermal plume covered only a small cross-
31 sectional area of the river. The NRC staff also examined this potential effect related to
32 migration of federally endangered sturgeon (*Acipenser brevirostrum* and *A. oxyrinchus*
33 *oxyrinchus*) past the Surry plant on the James River in Virginia (NRC 2019d) and past the
34 Indian Point plant (no longer operating) on the Hudson River in New York (NRC 2018e). To
35 date, thermal effluents of nuclear power plants have resulted in no noticeable or detectable
36 impacts on the migrations of fish. The available information indicates that migration barriers
37 resulting from thermal effluents of nuclear power plants are not of concern for initial LR or SLR.

38 **Accelerated Maturation of Aquatic Insects**

39 The 1996 and 2013 LR GEISs determined that the heated effluents of nuclear power plants
40 could accelerate the maturation of aquatic insects in freshwater systems and cause premature
41 emergence. The maturation and emergence of aquatic insects are often closely associated with
42 water temperature regimes. If insects develop or emerge early in the season, they may be
43 unable to feed or reproduce or they may die because the local climate is not warm enough to
44 support them. Premature emergence has been observed in laboratory investigations
45 (e.g., Nebeker 1971) but not in field investigations (e.g., Langford 1975). To date, thermal
46 effluents of nuclear power plants have resulted in no noticeable or detectable impacts on the life
47 cycles of aquatic insects. The available information indicates that accelerated maturation of

1 aquatic insects resulting from thermal effluents of nuclear power plants is not of concern for
2 initial LR or SLR.

3 **Proliferation of Aquatic Nuisance Organisms**

4 The 1996 and 2013 LR GEISs also considered that heated effluents could proliferate the growth
5 of aquatic nuisance organisms. Aquatic nuisance species are organisms that disrupt the
6 ecological stability of infested inland (e.g., rivers and lakes), estuarine, or marine waters (EPA
7 2022b). The previous LR GEISs discuss zebra mussels (*Dreissena polymorpha*) and Asiatic
8 clam (*Corbicula fluminea*), two bivalves that are of particular concern in many freshwater
9 systems because they can cause significant biofouling of industrial intake pipes at power and
10 water facilities. These species are also of ecological concern because they outcompete and
11 lead to the decline of native freshwater mussels. Nuclear power plants that withdraw water from
12 water bodies in which these species are known to occur often periodically chlorinate intake
13 pipes or have other procedures in place to mitigate the spread of these bivalves. There is no
14 evidence, however, that thermal effluent leads to these species' proliferation. No noticeable or
15 detectable impacts on aquatic populations have been reported at any existing nuclear power
16 plants related to this issue in scientific literature or in license renewal SEISs published to date.

17 Langford (1983) reports several instances in which wood-boring crustaceans and mollusks,
18 notably "shipworms," have caused concern in British waters. Although increased abundance of
19 shipworms in the area influenced by heated power plant effluents caused substantial damage to
20 wooden structures, replacement of old wood with concrete or metal structures eliminated the
21 problem. Langford concluded that increased temperatures could enhance the activity and
22 reproduction of wood-boring organisms in enclosed or limited areas but that elevated
23 temperature patterns were not sufficiently stable to cause widespread effects. The influence of
24 the operation of the Oyster Creek plant (no longer operating) on Barnegat Bay on the
25 abundance and distribution of the shipworm *Teredo bartschi* has been extensively studied (see
26 summary by Kennish and Lutz 1984). Although studies have varied somewhat in their
27 conclusions, researchers have agreed that heated effluents from the Oyster Creek plant
28 increased the distribution and abundance of these organisms (Kennish and Lutz 1984). This
29 species has not been found in Barnegat Bay since 1982, perhaps because of reduced water
30 temperatures during a station outage in the winter of 1981-82 and the pathological effects of a
31 parasite, as well as the removal of substantial amounts of driftwood and the replacement of
32 untreated structural wood in the area of concern (NRC 1996). The NRC has identified no other
33 concerns about nuisance aquatic organisms associated with nuclear power plant thermal
34 effluents in scientific literature or in license renewal SEISs published to date. The available
35 information indicates that proliferation of nuisance organisms resulting from thermal effluents of
36 nuclear power plants is not of concern for initial LR or SLR.

37 **Dissolved Oxygen**

38 Aerobic organisms, such as fish, require oxygen, and the concentration of dissolved oxygen in a
39 water body is one of the most important ecological water quality parameters. Dissolved oxygen
40 also influences several inorganic chemical reactions. In general, dissolved oxygen
41 concentrations of less than 3 ppm in warmwater habitats or less than 5 ppm in cold-water
42 habitats can adversely affect fish (Morrow and Fischenich 2000). Oxygen dissolves into water
43 via diffusion, aeration, and as a product of photosynthesis. The amount of oxygen water can
44 absorb depends on temperature; the amount of oxygen that can dissolve in a volume of water
45 (i.e., the saturation point) is inversely proportional to the temperature of the water. Thus, when
46 other chemical and physical conditions are equal, the warmer the water is, the less dissolved

1 oxygen it can hold. Increased water temperatures also affect the amount of oxygen that aquatic
2 organisms need by increasing metabolic rates and chemical reaction rates. The rates of many
3 chemical reactions in water approximately doubles for every 18 °F (10 °C) increase in
4 temperature.

5 The thermal effluent discharges of nuclear power plants have the potential to stress aquatic
6 organisms by simultaneously increasing these organisms' need for oxygen and decreasing
7 oxygen availability. Aquatic organisms are more likely to experience adverse effects from
8 thermal effluents in ecosystems where dissolved oxygen levels are already approaching
9 suboptimal levels as a result of other factors in the environment. This is most likely to occur in
10 ecosystems where increased levels of detritus and nutrients (e.g., eutrophication), low flow, and
11 high ambient temperatures already exist. These conditions can occur as a result of drought
12 conditions or in hot weather, especially in lakes, reservoirs, or other dammed freshwaters.

13 Although the thermal effluents of nuclear power plants may contribute to reduced dissolved
14 oxygen in the immediate vicinity of the discharge point, as the effluent disperses, diffusion and
15 aeration from turbulent movement introduces additional oxygen into the water. As the water
16 cools, the saturation point increases, and the water can absorb additional oxygen as it is
17 released by aquatic plants and algae through photosynthesis, which is a continuously ongoing
18 process during daylight hours. Therefore, lower dissolved oxygen is generally only a concern
19 within the thermal mixing zone, which is typically a small area of the receiving water body. As
20 described earlier in Section 4.6.1.2 under "Clean Water Act Section 316(a) Requirements for
21 Point Source Discharges," many states address thermal mixing zones in State water quality
22 criteria to ensure that mixing zones provide a continuous zone of passage for aquatic
23 organisms. Additionally, the EPA, or authorized States and Tribes, often impose conditions
24 specifically addressing dissolved oxygen through NPDES permits to ensure that receiving water
25 bodies maintain adequate levels of oxygen to support aquatic life. These conditions are
26 established pursuant to CWA Section 316(a), which requires that regulated facilities operate
27 under effluents limitations that assure the protection and propagation of a balanced, indigenous
28 population of shellfish, fish, and wildlife in and on the receiving water body. No noticeable or
29 detectable impacts on aquatic populations have been reported at any existing nuclear power
30 plants related to oxygen availability in scientific literature or in license renewal SEISs published
31 to date. The available information indicates that reduced dissolved oxygen resulting from
32 thermal effluents of nuclear power plants is not of concern for initial LR or SLR.

33 **Gas Supersaturation**

34 Rapid heating of cooling water can also affect the solubility and saturation point of other
35 dissolved gases, including nitrogen. As water passes through the condenser cooling system, it
36 can become supersaturated with gases. Once the supersaturated water is discharged in the
37 receiving water body, dissolved gas levels equilibrate as the effluent cools and mixes with
38 ambient water. This process is of concern if aquatic organisms remain in the supersaturated
39 effluent for a long enough period to become equilibrated to the increased pressure associated
40 with the effluent. If these organisms then move into water of lower pressure too quickly when,
41 for example, swimming out of the thermal effluent or diving to depths, the dissolved gases within
42 the affected tissues may come out of solution and form embolisms (bubbles). The resulting
43 condition is known as gas bubble disease. In fish, it is most noticeable in the eyes and fins.
44 Affected tissues can swell or hemorrhage and result in behavioral abnormalities, increased
45 susceptibility to predation, or death (Noga 2000). Mortality in fish generally occurs at gas
46 supersaturation levels above 110 or 115 percent (EPA 1986). Aquatic insects and crustaceans
47 appear to be more tolerant of supersaturated water (Nebeker et al. 1981).

Environmental Consequences and Mitigating Actions

1 The ability to detect and avoid supersaturated waters varies among species. A fish can avoid
2 supersaturated waters by either not entering the affected area or by diving to avoid the onset of
3 supersaturated conditions near the surface. Some species, however, may not avoid
4 supersaturated waters until symptoms of gas bubble disease occur; at that point, some fish may
5 already be lethally exposed. Other species may be attracted to supersaturated waters because
6 it is often warmer (Gray et al. 1983).

7 As reported in the 1996 and 2013 LR GEISs, fish mortality from gas bubble disease has been
8 reported at hydroelectric dams and coal-fired power plants. Typically, gas bubble disease is of
9 concern at facilities where the configuration of the discharge allows organisms to reside in the
10 supersaturated effluent for extended periods of time (e.g., discharge canals that fish can freely
11 enter). Fish mortality from gas bubble disease has been observed at one nuclear power plant:
12 the Pilgrim plant (no longer operating) on Cape Cod in Massachusetts. In 1973 and 1976,
13 43,000 and 5,000 Atlantic menhaden deaths, respectively, were attributed to gas bubble
14 disease because of individuals entering and residing in the discharge canal for a prolonged
15 period (McInerney 1990). Some sources reported that other species of fish may also have been
16 affected (Fairbanks and Lawton 1977). After these events, the Pilgrim plant installed a barrier
17 net to prevent fish from entering the discharge canal, and no such events occurred again
18 following implementation of this mitigation. Discharges that promote the rapid mixing of effluent
19 into receiving waters, such as those equipped with multiport or jet diffusers, can also be
20 effective in preventing gas bubble disease mortalities because they limit the extent of the
21 thermal plume and promote rapid mixing (Lee and Martin 1975).

22 No noticeable or detectable impacts on aquatic populations have been reported at any other
23 nuclear power plants related to gas supersaturation in scientific literature or in license renewal
24 SEISs published to date. The one plant for which this was of concern (Pilgrim) successfully
25 mitigated the issue in the 1970s and did not report any other such events for the remainder of its
26 operating period (i.e., through 2019, when the plant permanently shut down). Additionally,
27 NPDES permit conditions established pursuant to CWA Section 316(a) may also address
28 thermal effluent factors that would reduce the potential for aquatic organisms to experience gas
29 bubble disease as a result of nuclear power plant thermal effluents. The available information
30 indicates that gas supersaturation resulting from thermal effluents of nuclear power plants is not
31 of concern for initial LR or SLR.

32 **Eutrophication**

33 An early concern about nuclear power plant discharges was that thermal effluents would cause
34 or speed eutrophication by stimulating biological productivity in receiving water bodies (NRC
35 1996). Eutrophication is the gradual increase in the concentration of phosphorus, nitrogen, and
36 other nutrients in a slow-flowing or stagnant aquatic ecosystem, such as a lake. These nutrients
37 enter the ecosystem primarily through runoff from agricultural land and impervious surfaces.
38 The increase in nutrient content allows algae to proliferate on the water's surface, which reduces
39 light penetration and oxygen absorption necessary for underwater life. The 1996 LR GEIS
40 reports that several nuclear power plants conducted long-term monitoring to investigate this
41 potential effect, including the McGuire plant on Lake Norman in North Carolina and Oconee
42 plant on Lake Keowee in South Carolina. No evidence of eutrophication was detected. No
43 such effects have been reported in scientific literature or in license renewal SEISs to date.
44 Therefore, eutrophication is not expected to be of concern during initial LR or SLR terms at any
45 nuclear power plants.

1 Susceptibility to Predation, Parasitism, and Disease

2 Fish and shellfish that are exposed to the thermal effluent of a nuclear power plant may
3 experience stunning, disorientation, or injury. These sublethal effects can subsequently affect
4 an organism's susceptibility to predation, parasitism, or disease.

5 With respect to susceptibility to predation, laboratory studies of the secondary mortality of fish
6 following exposure to heat or cold shock demonstrate increased susceptibility of these fish to
7 predation; however, field evidence of such effects is often limited to anecdotal information, such
8 as observations of increased feeding activity of seagulls and predatory fish near effluent outfalls
9 (e.g., Cada et al. 1981). For example, Barkley and Perrin (1971) and Romberg et al. (1974)
10 reported increased concentrations of predators feeding on forage fish attracted to thermal
11 plumes. However, these studies did not quantify whether the observed behaviors resulted in
12 population-level effects on prey species.

13 With respect to susceptibility to parasitism and disease, Langford (1983) found that the
14 tendency for fish to congregate in heated effluent plumes, the increased physiological stress
15 that higher water temperatures exert on fish, and the ability of some diseases and parasites to
16 proliferate at higher temperatures were all factors that could contribute to increased rates of
17 disease or parasitism in exposed fish. Some studies have suggested that crowding of fish
18 within the thermal plume, rather than the thermal plume itself, may lead to an increased risk of
19 exposure to infectious diseases (Coutant 1987).

20 The 1996 and 2013 LR GEISs reported that neither scientific literature reviews nor consultations
21 with agencies or utilities yielded clear evidence of sublethal effects on fish or finfish resulting in
22 noticeable increases in exposed organisms' susceptibility to predation, parasitism, or disease.
23 Since the publication of the 2013 LR GEIS, the NRC has determined that thermal effects on
24 aquatic organisms at four nuclear power plants could be SMALL to MODERATE during the
25 license renewal term (see Table 4.6-5). At three of the four plants (i.e., Braidwood, LaSalle, and
26 Turkey Point), these impacts were limited to species confined to cooling pond environments. In
27 the fourth example (Peach Bottom), the adverse effects were found to be confined to a narrow
28 band of shallow water habitat downstream of the discharge canal during the summer months.
29 However, increased susceptibility to predation, parasitism, or disease or predation resulting
30 from exposure to thermal effluent was not found to be responsible for these small to moderate
31 findings. Rather, these effects were attributed to other acute (i.e., heat shock) or community-
32 level effects (i.e., reduced habitat availability or quality and reduced species diversity over time)
33 of thermal effluents evaluated as part of the former Category 2 issue, "Thermal impacts on
34 aquatic organisms (plants with once-through cooling systems or cooling ponds)." This Category
35 2 issue has been renamed in this LR GEIS (see Section 4.6.1.2.4). The available information
36 indicates that this issue is not expected to be of concern during initial LR or SLR terms at any
37 nuclear power plants.

38 Conclusion

39 Initial LR or SLR would continue current operating conditions and environmental stressors
40 rather than introduce wholly new impacts. Therefore, the impacts of current operations and
41 license renewal on aquatic resources would be similar. For these reasons, the infrequently
42 reported effects of thermal effluents discussed in this section would be minor and would neither
43 destabilize nor noticeably alter any important attribute of aquatic populations in receiving water
44 bodies during initial LR or SLR terms of any nuclear power plants. As part of obtaining a
45 variance under CWA Section 316(a), permitting authorities may impose conditions concerning

Environmental Consequences and Mitigating Actions

1 thermal effluent discharges at some nuclear power plants. Implementation of such conditions
2 would further reduce or mitigate thermal impacts during the license renewal term. The staff
3 reviewed information in scientific literature and from SEISs (for initial LRs and SLRs) completed
4 since development of the 2013 LR GEIS and identified no new information or situations that
5 would result in different impacts for this issue for either an initial LR or SLR term. The NRC
6 concludes that infrequently reported effects of thermal effluents during the license renewal term
7 (initial LR or SLR) would be SMALL for all nuclear power plants. This is a Category 1 issue.

8 *4.6.1.2.7 Effects of Nonradiological Contaminants on Aquatic Organisms*

9 This issue concerns the potential effects of nonradiological contaminants on aquatic organisms
10 that could occur as a result of nuclear power plant operations during an initial LR or SLR term.

11 In the 1996 and 2013 LR GEISs, the NRC determined that the effects of nonradiological
12 contaminants on aquatic resources would be SMALL. Therefore, this was considered a
13 Category 1 issue.

14 This issue was originally of concern because some nuclear power plants used heavy metals in
15 condenser tubing that could leach from the tubing and expose aquatic organisms to these
16 contaminants. Because aquatic organisms can bioaccumulate heavy metals, even when
17 exposed at low levels, this can cause toxicity in fish and other animals that consume
18 contaminated organisms. Section 4.6.1.1.3 describes instances in which copper contamination
19 was an issue at operating nuclear power plants. Heavy metals have not been found to be of
20 concern other than these few instances, and in all cases, the nuclear power plants eliminated
21 leaching by replacing the affected piping.

22 In addition to heavy metals, nuclear power plants often add biocides to cooling water to kill
23 algae, bacteria, macroinvertebrates, and other organisms that could cause buildup in plant
24 systems and structures. For example, zebra mussels and Asiatic clams within the intake pipes
25 or cooling systems can cause partial to full blockage of grates and pipes or otherwise damage
26 the integrity of pipes and other cooling system components. Nuclear power plants in areas
27 where these mollusks are an operating concern typically treat cooling water with nonoxidizing
28 molluscicides that may include chlorine, chlorine dioxide, chloramines, ozone, bromine,
29 hydrogen peroxide and potassium permanganate. Most molluscicides have very restricted uses
30 due to their toxic effects on non-target organisms and are primarily used in closed systems.
31 Nuclear power plants typically maintain site procedures that specify when and how to treat the
32 cooling water system with such chemicals and BMPs to minimize impacts on the ecological
33 environment. For instance, plants use only EPA-approved biocides according to label
34 instructions. Some plants with cooling towers discharge blowdown to settling ponds to allow
35 heat and chemicals to dissipate before discharging the effluent to surface waters. NPDES
36 permits mitigate potential effects of chemical effluents by limiting the allowable concentrations in
37 effluent discharges to ensure the protection of the aquatic community within the receiving water
38 body. Some nuclear power plants also use physical deterrents to reduce the need for chemical
39 treatment. For instance, the Browns Ferry plant in Alabama recirculates small sponge balls
40 through the condenser tubes to keep them clear of Asiatic clams (NRC 2005b).

41 Initial LR or SLR would continue current operating conditions and environmental stressors
42 rather than introduce wholly new impacts. Therefore, the impacts of current operations and
43 license renewal on aquatic resources would be similar. For these reasons, the effects of
44 nonradiological contaminants on aquatic organisms would be minor and would neither
45 destabilize nor noticeably alter any important attribute of populations of these organisms in

1 source water bodies during initial LR or SLR terms of any nuclear power plants. Continued
2 adherence of nuclear power plants to chemical effluent limitations established in NPDES
3 permits would minimize the potential impacts of nonradiological contaminants on the aquatic
4 environment. The staff reviewed information in scientific literature and from SEISs (for initial
5 LRs and SLRs) completed since development of the 2013 LR GEIS and identified no new
6 information or situations that would result in different impacts for this issue for either an initial LR
7 or SLR term. The NRC concludes that the effects of nonradiological contaminants on aquatic
8 organisms during the license renewal term (initial LR or SLR) would be SMALL for all nuclear
9 power plants. This is a Category 1 issue.

10 *4.6.1.2.8 Exposure of Aquatic Organisms to Radionuclides*

11 This issue concerns the potential impacts on aquatic organisms from exposure to radionuclides
12 from routine radiological effluent releases during an initial LR or SLR term.

13 As explained in Section 4.6.1.1.2, radionuclides may be released from nuclear power plants into
14 the environment through several pathways, including via gaseous and liquid emissions. Aquatic
15 plants can absorb radionuclides that enter shallow groundwater or surface waters through their
16 roots. Aquatic animals can be exposed externally to ionizing radiation from radionuclides in
17 water, sediment, and other biota and can be exposed internally through ingested food, water,
18 and sediment and absorption through the integument and respiratory organs.

19 As discussed in Section 4.6.1.1.2, the DOE has produced a standard on a graded approach for
20 evaluating radiation doses to aquatic and terrestrial biota (DOE 2019). The DOE standard
21 provides methods, models, and guidance that can be used to characterize radiation doses to
22 terrestrial and aquatic biota exposed to radioactive material (DOE 2019). For aquatic animals,
23 the DOE guidance dose rate is 1 rad/d (0.1 Gy/d), which represents the level below which no
24 adverse effects to resident populations are expected. The DOE also recommends that the
25 screening-level concentrations of most radionuclides in aquatic environments should be based
26 on internal exposure as well as external exposure to contaminated sediments, rather than
27 external exposure to contaminated water (DOE 2019).

28 Previously, in the early 1990s, the IAEA (1992) and the National Council on Radiation
29 Protection and Measurements (NCRP) (1991) also concluded that a chronic dose rate of no
30 greater than 1 rad/d (0.01 Gy/d) to the maximally exposed individual in a population of aquatic
31 organisms would ensure protection of the population. The United Nations Scientific Committee
32 on the Effects of Atomic Radiation concluded in 1996 and re-affirmed in 2008 that chronic dose
33 rates less than 0.4 mGy/hr (1.0 rad/day or 0.01 Gy/day) to the most highly exposed individuals
34 would be unlikely to have significant effects on most aquatic communities (UNSCEAR 2010).

35 In the 2013 LR GEIS, the NRC estimated the total radiological dose that aquatic biota would be
36 expected to receive during normal nuclear power plant operations using plant-specific
37 radionuclide concentrations in water and sediments at 15 nuclear power plants using Argonne
38 National Laboratory's RESRAD-BIOTA dose evaluation model. The NRC found that total
39 calculated dose rates for aquatic animals at all 15 plants were all less than 0.2 rad/d
40 (0.002 Gy/d), which is less than the guideline value of 1 rad/d (0.01 Gy/d). As a result, the NRC
41 anticipated in the 2013 LR GEIS that normal operations of these facilities would not result in
42 negative effects on aquatic biota. The 2013 LR GEIS concluded that the impact of
43 radionuclides on aquatic biota from past operations would be SMALL for all nuclear power
44 plants and would not be expected to change appreciably during the license renewal period.

Environmental Consequences and Mitigating Actions

1 In this revision, the NRC staff conducted an updated and expanded analysis of this issue
2 relative to the 2013 LR GEIS. As part of this expanded analysis, the staff reviewed a subset of
3 operating nuclear power plants¹⁴ to evaluate the potential impacts of radionuclides on biota from
4 continued operations. Section 4.6.1.1.2 describes the NRC staff's methods, which included
5 reviewing effluent release reports, a RESRAD-BIOTA analysis, and an ICRP biota dose
6 calculator analysis (see Section D.5 in Appendix D for full description of methodology). Results
7 can be found in Section 4.6.1.1.2 and are summarized in this section.

8 Table 4.6-1 in Section 4.6.1.1.2 shows the estimated radiation dose rates to four ecological
9 receptors (i.e., riparian animal, terrestrial animal, terrestrial plant, and aquatic animal) resulting
10 from the staff's RESRAD-BIOTA dose modeling. Based on the staff's RESRAD-BIOTA
11 analysis, it is unlikely that radionuclide releases during normal operations of these nuclear
12 power plants would have adverse effects on resident populations of aquatic animals because
13 the calculated doses are well below DOE protective guidelines.

14 In addition to the RESRAD-BIOTA analysis discussed above, the NRC staff estimated dose
15 rates to a riparian organism using the ICRP biota dose calculator (ICRP 2022) (see
16 Section 4.6.1.1.2 and Section D.5 in Appendix D for full description of ICRP BiotaDC
17 methodology). The dose rates calculated for a riparian organism ranged between 2E-4 and 2E-
18 5 rad per day which is orders of magnitude lower than the DOE guideline dose rate. None of
19 the radionuclides evaluated singly, or in common, produced dose rates that approached the
20 DOE's guidance dose rate of 0.1 rad/d for riparian animals using the ICRP BiotaDC tool (DOE
21 2019). Additionally, the calculated dose rates did not approach the level advocated by the
22 National Council on Radiation Protection and Measurements to initiate additional evaluation
23 (Cool et al. 2019). In fact, the dose rates for the riparian organism calculated using the ICRP's
24 calculator were lower than the RESRAD conservative analysis, and both were well below the
25 DOE guideline values.

26 Initial LR or SLR would continue current operating conditions and environmental stressors
27 rather than introduce wholly new impacts. Therefore, the impacts of current operations and
28 initial LR or SLR on aquatic organisms would be similar. For these reasons, the effects of
29 exposure of aquatic organisms to radionuclides would be minor and would neither destabilize
30 nor noticeably alter any important attribute of populations of exposed organisms during initial LR
31 or SLR terms of any nuclear power plant. Continued adherence of nuclear power plants to
32 regulatory limits on radioactive effluent releases would minimize the potential impacts on the
33 aquatic environment. Doses to aquatic organisms would be expected to remain below the
34 DOE's dose limits and, therefore, impacts to aquatic communities are not expected. The staff
35 reviewed information in scientific literature and from SEISs (for initial LRs or SLRs) completed
36 since development of the 2013 LR GEIS and identified no new information or situations that
37 would result in different impacts for this issue for either an initial LR or SLR term.

38 The NRC concludes that the impacts of exposure of aquatic organisms to radionuclides during
39 the license renewal term (initial LR or SLR) would be SMALL for all nuclear power plants. This
40 is a Category 1 issue.

¹⁴ The subset of plants included the following PWR plants: Comanche Peak, D.C. Cook, Palo Verde 1-3, Robinson, Salem 1-2, Seabrook, and Surry; and the following BWR plants: Fermi 2, Hatch 1-2, Hope Creek, Limerick, and Columbia.

1 *4.6.1.2.9 Effects of Dredging on Aquatic Resources*

2 This issue concerns the effects of dredging at nuclear power plants on aquatic resources during
3 an initial LR or SLR term.

4 In the 2013 LR GEIS, the NRC determined that the effects of dredging on aquatic resources
5 would be SMALL at all nuclear power plants. Therefore, this was considered a Category 1
6 issue for all nuclear power plants. The 1996 LR GEIS did not address this issue.

7 Small-particle sediment, such as sand and silt, that enters water bodies through erosion can
8 subsequently deposit and accumulate along shorelines and in shallow water areas. If sediment
9 deposition affects cooling system function or reliability, a nuclear power plant may need to
10 periodically dredge to improve intake flow and keep the area clear of sediment. Nuclear power
11 plants where dredging may be necessary are typically located along fast-flowing waters with
12 sandy or silty bottoms, such as large rivers or the ocean. In some instances, dredging may be
13 performed to maintain barge slips for transport of materials and waste to and from the site.
14 Dredging entails excavating a layer of sediment from the affected areas and transporting that
15 sediment to onshore or offshore areas for disposal. The three main types of dredges are
16 mechanical dredges, hydraulic dredges, and airlift dredges. The selection of dredge type
17 generally is related to the sediment type, the size of the area to be dredged, and the aquatic
18 resources present.

19 At operating nuclear power plants, dredging is performed infrequently, if at all. For example,
20 dredging at the Peach Bottom plant is performed approximately once every 20 years over a total
21 area of approximately 6 ac (2.4 ha) (NRC 2003b). When it was operating, the Oyster Creek
22 plant dredged portions of either the intake or the discharge canals approximately every 10 years
23 (NRC 2007b). The Monticello plant requires dredging every 6 to 8 years (NRC 2006c). The
24 Surry plant is one exception; because of the tidal influence of the James River near the plant
25 and the site's location on a peninsula within the river, Surry dredges every 3 to 4 years (NRC
26 2020f).

27 Dredging results in the direct removal of soft bottom substrates along with infaunal and
28 epifaunal organisms of limited mobility inhabiting those substrates. Small organisms living
29 within and on the affected sediments are likely to be killed in the process. Smaller benthic
30 invertebrates, such as mollusks and crustaceans, may also be susceptible to entrainment into
31 the dredge head. Larger benthic individuals or those that are farther from the dredge head
32 could move away from the suction flow field to avoid being entrained. Thus, dredging can be
33 expected to cause short-term reductions in the biomass of benthic organisms. Dredging also
34 creates sediment plumes that increase water turbidity, which can adversely affect aquatic biota
35 and create short-term decreases in habitat quality during and after dredging. Turbidity primarily
36 affects liquid-breathing organisms, such as fish and shellfish, as well as aquatic plants, because
37 turbid conditions typically decrease photosynthetic capabilities. Turbidity levels associated with
38 the sediment plumes of cutterhead dredges typically range from 11.5 to 282.0 milligrams per
39 liter (mg/L) with decreasing concentrations at greater distances from the dredge head
40 (Nightingale and Simenstad 2001). Studies of benthic community recovery following dredging
41 indicate that species abundance and diversity can recover within several years of dredging
42 (Michel et al. 2013). Specifically, within temperate, shallow water regions containing a
43 combination of sand, silt, or clay substrate, benthic communities can recover in 1 to 11 months,
44 according to studies reviewed by Wilber et al. (2006). Recovery of benthic communities
45 following dredging also tends to be faster in areas exposed to periodic disturbances, such as
46 tidally influenced habitats (Diaz 1994).

Environmental Consequences and Mitigating Actions

1 With respect to turbidity and sedimentation caused by dredging, studies of the effects of turbid
2 waters on fish suggest that concentrations of suspended solids can reach thousands of
3 milligrams per liter before an acute toxic reaction occurs (Burton 1993 as cited in NMFS 2014a).
4 In a literature review, Burton (1993 as cited in NMFS 2014a) demonstrated that lethal effects on
5 fish due to turbid waters can occur at levels between 580 mg/L and 700,000 mg/L, depending
6 on the species. Studies of striped bass, an anadromous species, showed that pre-spawners did
7 not avoid concentrations of 954 to 1,920 mg/L to reach spawning sites (Summerfelt and Mosier
8 1976; Combs 1979). Sedimentation could also affect benthic macroinvertebrates. However,
9 these individuals could avoid the plume or uncover themselves from any sedimentation
10 experienced during dredging such that these impacts would be negligible and short term in
11 nature.

12 Sediments may be contaminated with a variety of pollutants from agricultural runoff and
13 stormwater runoff from impervious surfaces. These pollutants can also be introduced to
14 waterways from point sources, such as combined sewer overflows, municipal and industrial
15 discharges, and spills. Contaminants that have accumulated in buried layers of sediment are
16 often less readily bioavailable or less chemically active (EPA 2004). Depending on the
17 concentrations of specific contaminants in accumulated sediments, dredging could increase the
18 bioavailability of those contaminants if they are resuspended in the water column (Petersen
19 et al. 1997; Su et al. 2002; EPA 2004).

20 Dredging would require nuclear power plant licensees to obtain permits from the USACE under
21 CWA Section 404. BMPs and conditions associated with these permits would minimize impacts
22 on the ecological environment. The granting of such permits would also require the USACE to
23 conduct its own environmental reviews prior to undertaking dredging.

24 Initial LR or SLR would continue current operating conditions and environmental stressors
25 rather than introduce wholly new impacts. Therefore, the impacts of current operations and
26 license renewal on aquatic resources would be similar. For these reasons, the effects of
27 dredging on aquatic resources would be minor and would neither destabilize nor noticeably alter
28 any important attribute of the aquatic environment during initial LR or SLR terms of any nuclear
29 power plants. The NRC assumes that nuclear power plants would continue to implement site
30 environmental procedures and would obtain any necessary permits for dredging activities.
31 Implementation of such controls would further reduce or mitigate potential effects. The staff
32 reviewed information in scientific literature and from SEISs (for initial LRs and SLRs) completed
33 since development of the 2013 LR GEIS and identified no new information or situations that
34 would result in different impacts for this issue for either an initial LR or SLR term.

35 The NRC concludes that effects of dredging on aquatic resources during the license renewal
36 term (initial LR or SLR) would be SMALL for all nuclear power plants. This is a Category 1
37 issue.

38 *4.6.1.2.10 Water Use Conflicts with Aquatic Resources (Plants with Cooling Ponds or Cooling* 39 *Towers Using Makeup Water from a River)*

40 The issue concerns water use conflicts that may arise at nuclear power plants with cooling
41 ponds or cooling towers that use makeup water from a river and how those conflicts could affect
42 aquatic resources during an initial LR or SLR term.

43 In the 1996 and 2013 LR GEISs, the NRC determined that the impacts of water use conflicts on
44 aquatic resources would be SMALL at many nuclear power plants but that these impacts could

1 be MODERATE at some plants. Therefore, this was considered a Category 2 issue for nuclear
2 power plants with cooling ponds or cooling towers using makeup water from a river. The 1996
3 LR GEIS addressed cooling towers that withdraw from small rivers with low flow; the 2013 LR
4 GEIS expanded this issue to include all cooling towers that withdraw from rivers. Notably, this
5 issue also applies to nuclear power plants with hybrid cooling systems that withdraw makeup
6 water from a river (i.e., once-through cooling systems with helper cooling towers) (e.g., NRC
7 2020g).

8 Nuclear power plant cooling systems may compete with other users relying on surface water
9 resources, including downstream municipal, agricultural, or industrial users. Closed-cycle
10 cooling is not completely closed because the system discharges blowdown water to a surface
11 water body and withdraws water for makeup of both the consumptive water loss due to
12 evaporation and drift (for cooling towers) and blowdown discharge. For plants using cooling
13 towers, while the volume of surface water withdrawn is substantially less than once-through
14 systems for a similarly sized nuclear power plant, the makeup water needed to replenish the
15 consumptive loss of water to evaporation can be significant. Cooling ponds also require
16 makeup water. Section 4.5.1.1.9 addresses factors relevant to water use conflicts at nuclear
17 power plants in detail. Water use conflicts with aquatic resources could occur when water that
18 supports these resources is diminished by a combination of anthropogenic uses.

19 Consumptive use by nuclear power plants with cooling ponds or cooling towers using makeup
20 water from a river during the license renewal term is not expected to change unless power
21 uprates, with associated increases in water use, occur. Such uprates would require separate
22 NRC review and approval. Any river, regardless of size, can experience low-flow conditions of
23 varying severity during periods of drought and changing conditions in the affected watershed,
24 such as upstream diversions and use of river water. However, the direct impacts on instream
25 flow and potential water availability for other users from nuclear power plant surface water
26 withdrawals are greater for small (i.e., low-flow) rivers.

27 To date, the NRC has identified water use conflicts with aquatic resources at only one nuclear
28 power plant: the Wolf Creek plant in Kansas. This plant uses Coffey County Lake for cooling,
29 and makeup water for the lake is drawn from the Neosho River downstream of John Redmond
30 Reservoir (NRC 2008a). The Neosho River is a small river with especially low water flow during
31 drought conditions. During the license renewal review, the NRC found that the aquatic
32 communities in the Neosho River downstream included the federally endangered Neosho
33 madtom, a small species of catfish, and that this species could be adversely affected by the
34 nuclear power plant's water use during periods when the lake level is low and makeup water is
35 obtained from the Neosho River. The NRC concluded that water use conflicts would be SMALL
36 to MODERATE for this nuclear power plant. As part of the NRC's ESA consultation with the
37 FWS, the Wolf Creek plant developed and implemented a water level management plan for
38 Coffey County Lake, which includes withdrawing makeup water proactively during high river
39 flows in order to support downstream populations of the Neosho madtom (FWS 2012). This
40 plan effectively mitigated not only water use conflicts that the Neosho madtom might
41 experience, but also the effects that the entire downstream aquatic community might experience
42 from the plant's cooling water withdrawals. The NRC has identified no concerns about water
43 use conflicts with aquatic resources at any other nuclear power plant with cooling ponds or
44 cooling towers.

45 The staff reviewed information from SEISs (for initial LR and SLRs) completed since
46 development of the 2013 LR GEIS. In summary, water use conflicts during an initial LR or SLR
47 term depend on numerous site-specific factors, including the ecological setting of the plant; the

Environmental Consequences and Mitigating Actions

1 consumptive use of other municipal, agricultural, or industrial water users; and the aquatic
2 resources present in the area. Water use conflicts with aquatic resources would be SMALL at
3 most nuclear power plants with cooling ponds or cooling towers that withdraw makeup from a
4 river but may be MODERATE at some plants. Therefore, a generic determination of potential
5 impacts on terrestrial resources from continued operations during a license renewal term is not
6 possible.

7 The NRC concludes that water use conflicts on aquatic resources during the license renewal
8 term (initial LR or SLR) could be SMALL or MODERATE at nuclear power plants with cooling
9 ponds or cooling towers using makeup water from a river. This is a Category 2 issue.

10 *4.6.1.2.11 Non-Cooling System Impacts on Aquatic Resources*

11 This issue concerns the effects of nuclear power plant operations on aquatic resources during
12 an initial LR or SLR term that are unrelated to operation of the cooling system. Such activities
13 include landscape and grounds maintenance, stormwater management, and ground-disturbing
14 activities that could directly disturb aquatic habitat or cause runoff or sedimentation. These
15 impacts are expected to be like past and ongoing impacts that aquatic resources are already
16 experiencing at the nuclear power plant site.

17 In the 1996 LR GEIS, the NRC evaluated the impacts of refurbishment on aquatic resources. In
18 the 2013 LR GEIS, the NRC expanded this issue to include impacts of other site activities,
19 unrelated to cooling system operation, that may affect aquatic resources. In both the 1996 and
20 2013 LR GEISs, the NRC concluded that effects would be SMALL at all nuclear power plants.
21 Therefore, these were considered Category 1 issues for all nuclear power plants. This LR GEIS
22 refines the title of this issue from “effects on aquatic resources (non-cooling system impacts)” to
23 “non-cooling system impacts on aquatic resources” for clarity and consistency with other
24 ecological resource LR GEIS issue titles.

25 Industrial-use portions of nuclear power plant sites are typically maintained as modified habitats
26 with lawns and other landscaped areas; these areas typically do not include natural aquatic
27 features. Nonindustrial-use portions of nuclear power plant sites may include natural aquatic
28 habitats, such as streams, ponds, lakes, and usually interface with larger water bodies, such as
29 rivers, reservoirs, estuaries, bays, or the ocean. These habitats may be undisturbed or in
30 various degrees of disturbance (e.g., dammed reservoirs, human-made cooling lakes, and
31 channelized rivers).

32 Certain areas may also be managed to preserve natural resources, either privately by the
33 nuclear power plant operator or in conjunction with local, State, or Federal agencies. For
34 instance, approximately 13,000 ac (5,300 ha) of land to the south and west of the Turkey Point
35 site in Florida is part of the Everglades Mitigation Bank (NRC 2019c). Under the guidance of
36 Federal and State agencies, Florida Power and Light Company creates, restores, and enhances
37 this habitat to provide compensatory mitigation of wetland losses elsewhere. At the Harris plant
38 in North Carolina, Duke Energy leases land, including part of Harris Lake, to Wake County who
39 co-manages the area with the North Carolina Wildlife Resources Commission for natural
40 resource preservation and recreational opportunities (Duke Energy 2017). Continued
41 conservation efforts would have beneficial effects on the local aquatic ecology.

42 The characteristics of aquatic habitats and communities on nuclear power plant sites have
43 generally developed in response to many years of plant operations and maintenance. While
44 some communities may have reached a relatively stable condition, some may have continued to

1 change gradually over time. Operations and maintenance activities during the license renewal
2 term are expected to be like current activities (see Section 2.1).

3 In the 1996 and 2013 LR GEISs, the NRC staff anticipated that nuclear power plants may
4 require refurbishment to support continued operations during a license renewal term (see
5 Section 2.1.2). However, refurbishment has not typically been necessary for license renewal.
6 Only two nuclear power plants have undertaken refurbishment as part of license renewal
7 (Beaver Valley and Three Mile Island [no longer operating], both of which are located in
8 Pennsylvania) (NRC 2009a, NRC 2009b). In addition to refurbishment, license renewal could
9 require construction of additional onsite spent fuel storage. Refurbishment or spent fuel storage
10 construction could require new parking areas for workers as well as new access roads,
11 buildings, and facilities. Temporary project support areas for equipment storage, overflow
12 parking, and material laydown areas could also be required.

13 Any activities that require construction or involve ground disturbance could affect nearby aquatic
14 features and habitats. Surface water habitats could be directly affected if activities cause ponds
15 to be drained or blocked or streams to be redirected. Depending on the size and nature of the
16 water body affected, aquatic plants and animals could be displaced or killed, or the community
17 structure within the water body could be altered. Indirect effects include erosion and
18 sedimentation, both of which are typically proportional to the amount of surface disturbance,
19 slope of the disturbed land, condition of the area at the time of disturbance, and proximity to
20 aquatic habitats. Chemical contamination could also occur from fuel or lubricant spills. If
21 impacts to aquatic habitats are anticipated, these activities would require nuclear power plant
22 licensees to obtain applicable permits under the CWA, to develop stormwater management
23 plans and spill prevention plans, and to implement BMPs to minimize soil erosion and
24 deposition. Standard BMPs often include buffer zones surrounding waterways, aquatic
25 features, and wetlands. BMPs and conditions associated with necessary permits would
26 minimize impacts on the ecological environment. To date, the NRC staff has not identified
27 noticeable or detectable impacts on aquatic features or habitats in connection with construction
28 or ground disturbance during the license renewal period at any nuclear power plant.

29 Many nuclear power plant operators have developed site or fleet-wide environmental review
30 procedures that help workers identify and avoid impacts on the ecological environment when
31 performing site activities. These procedures generally include checklists to help identify
32 potential effects and required permits and BMPs to minimize the affected area. BMPs relevant
33 to aquatic resources may include measures to control runoff, erosion, and sedimentation from
34 project sites; revegetate disturbed areas to control future erosion; and avoid the use of
35 chemicals or machinery near waterways and aquatic features. Proper implementation of
36 environmental procedures and BMPs would minimize or mitigate potential effects on aquatic
37 resources during the license renewal term. Many activities that could affect aquatic habitats
38 would also require nuclear power plant licensees to obtain Federal permits under CWA
39 Section 404, which would include conditions to minimize or mitigate impacts on affected
40 waterways.

41 Some utilities are members of the Wildlife Habitat Council, which helps corporations manage
42 their land for broad-based biodiversity enhancement and conservation. As part of membership,
43 sites develop wildlife management plans that include a comprehensive strategy for enhancing
44 and conserving site ecological resources. For instance, at the Braidwood plant in Illinois,
45 Exelon places artificial habitats in Braidwood Lake to create microhabitats and support fish
46 populations, especially largemouth bass (*Micropterus salmoides*) (Exelon 2012). At the LaSalle
47 plant in Illinois, Exelon participates in supplemental stocking of a variety of warm and cool water

Environmental Consequences and Mitigating Actions

1 fish that are raised in an onsite hatchery (Exelon 2012). To maintain membership, sites must
2 undertake projects that promote native biodiversity, gather data on conservation efforts, and
3 report on their progress. Other nuclear power plant sites that maintain Wildlife Habitat Council
4 membership include the Byron, Calvert Cliffs, Clinton, Dresden, Fitzpatrick, Ginna, Limerick,
5 Nine Mile Point, Peach Bottom, and Quad Cities plants. Continued participation in this or similar
6 environmental conservation organizations would minimize or mitigate potential effects on
7 aquatic resources during the license renewal term.

8 Initial LR or SLR would continue current operating conditions and environmental stressors
9 rather than introduce wholly new impacts. Therefore, the impacts of current operations and
10 license renewal on aquatic resources would be similar. For these reasons, the effects of site
11 activities, unrelated to cooling system operation, would be minor and would neither destabilize
12 nor noticeably alter any important attribute of the aquatic environment during initial LR or SLR
13 terms of any nuclear power plants. The NRC assumes that nuclear power plants would
14 continue to implement site environmental procedures and would obtain any necessary permits
15 for activities that could affect waterways or aquatic features. Implementation of such controls
16 would further reduce or mitigate potential effects. The staff reviewed information in scientific
17 literature and from SEISs (for initial LRs and SLRs) completed since development of the 2013
18 LR GEIS and identified no new information or situations that would result in different impacts for
19 this issue for either an initial LR or SLR term. The NRC concludes that non-cooling system
20 effects on aquatic resources during the license renewal term (initial LR or SLR) would be
21 SMALL for all nuclear power plants. This is a Category 1 issue.

22 *4.6.1.2.12 Impacts of Transmission Line Right-of-Way (ROW) Management on Aquatic* 23 *Resources*

24 This issue concerns the effects of transmission line ROW management on aquatic plants and
25 animals during an initial LR or SLR term.

26 In the 1996 and 2013 LR GEISs, the NRC determined that transmission line ROW maintenance
27 impacts would be SMALL at all nuclear power plants. Therefore, this was considered a
28 Category 1 issue for all nuclear power plants.

29 When this issue was originally contemplated in the 1996 LR GEIS, the NRC considered as part
30 of its plant-specific license renewal reviews all transmission lines that were constructed to
31 connect a nuclear power plant to the regional electric grid. However, in the 2013 LR GEIS, the
32 NRC clarified that the transmission lines relevant to license renewal include only the lines that
33 connect the nuclear power plant to the first substation that feeds into the regional power
34 distribution system (see Section 3.1.6.5 and 3.1.1). Typically, the first substation is located on
35 the nuclear power plant property within the primary industrial-use area. This decision was
36 informed by the fact that many of the transmission lines that were constructed with nuclear
37 power plants are now interconnected with the regional electric grid and would remain energized
38 regardless of initial LR or SLR. Accordingly, the discussion of this issue in this LR GEIS is brief
39 because in-scope transmission lines for license renewal tend to occupy only industrial-use or
40 other developed portions of nuclear power plant sites. Therefore, effects on aquatic plants and
41 animals are generally negligible. The 2013 LR GEIS provides further background about this
42 issue and discusses it in more detail.

43 Transmission line management can directly disturb aquatic habitats if ROWs traverse aquatic
44 features and heavy machinery is used in these areas. Heavy equipment can also compact
45 soils, which can affect soil quality and reduce infiltration to shallow groundwater, resulting in

1 runoff and erosion in nearby aquatic habitats. Chemical herbicides applied in ROWs can be
2 transported to nearby aquatic habitats through precipitation and runoff. For small streams, trees
3 may grow sufficiently between cutting cycles to provide shading and support microhabitats.
4 Tree removal to maintain appropriate transmission line clearance could alter the suitability of
5 habitats for fish and other aquatic organisms and locally increase water temperatures.

6 Most nuclear power plants maintain procedures to minimize or mitigate the potential impacts of
7 ROW management. For instance, heavy machinery and herbicide use is often prohibited in or
8 near wetlands or surface waters. Vegetated buffers are often maintained near surface waters.
9 Procedures also often include checklists to ensure that workers obtain necessary local, State, or
10 Federal permits if work could affect protected resources.

11 Aquatic communities in transmission line ROWs have been exposed to many years of
12 transmission line operation and have acclimated to regular ROW maintenance. Initial LR or
13 SLR would continue current operating conditions and environmental stressors rather than
14 introduce wholly new impacts. Therefore, the impacts of current operations and license renewal
15 on aquatic resources would be similar. Further, and as stated above, in-scope transmission
16 lines for license renewal tend to occupy only industrial-use or other developed portions of
17 nuclear power plant sites and, therefore, the effects of ROW maintenance on aquatic plants and
18 animals during an initial LR or SLR term would be negligible. The staff reviewed information in
19 scientific literature and from SEISs (for initial LRs and SLRs) completed since development of
20 the 2013 LR GEIS and identified no new information or situations that would result in different
21 impacts for this issue for either an initial LR or SLR term. The NRC concludes that the
22 transmission line ROW maintenance impacts on aquatic resources during the license renewal
23 term (initial LR or SLR) would be SMALL for all nuclear power plants. This is a Category 1
24 issue.

25 4.6.1.3 *Federally Protected Ecological Resources*

26 The NRC must consider the effects of its actions on ecological resources protected under
27 several Federal statutes and must consult with the FWS or the NOAA prior to taking action in
28 cases where an agency action may affect those resources. These statutes include the
29 following:

- 30 • the Endangered Species Act of 1973 (16 U.S.C. § 1531 et seq.),
- 31 • the Magnuson-Stevens Fishery Conservation and Management Act (MSA)
32 (16 U.S.C. § 1801 et seq.), as amended by the Sustainable Fisheries Act of 1996, and
- 33 • the National Marine Sanctuaries Act (NMSA) (16 U.S.C. § 1431 et seq.).

34 Section 3.6.3 describes each of these statutes and the ecological resources protected under
35 them. During initial LR and SLR reviews, the NRC may be required to consult under one or
36 more of these statutes depending on the ecological setting of the nuclear power plant and the
37 federally protected species and habitats that may be affected by continued operation of the
38 plant. Under the ESA, the NRC may be required to consult with FWS, NMFS, or both.
39 Individually, these agencies are also referred to as the Service or jointly as the Services. The
40 NRC addresses the ecological resources that each type of interagency consultation addresses
41 as four separate issues in the subsections below. These issues are:

Environmental Consequences and Mitigating Actions

- 1 • Endangered Species Act: federally listed species and critical habitats under U.S. Fish and
2 Wildlife Service jurisdiction;¹⁵
- 3 • Endangered Species Act: federally listed species and critical habitats under National Marine
4 Fisheries Service jurisdiction;¹⁵
- 5 • Magnuson-Stevens Fishery Conservation and Management Act: essential fish habitat;¹⁵
6 and
- 7 • National Marine Sanctuaries Act: sanctuary resources.¹⁵

8 *4.6.1.3.1 Endangered Species Act: Federally Listed Species and Critical Habitats Under* 9 *U.S. Fish and Wildlife Jurisdiction*

10 This issue concerns the potential effects of continued nuclear power plant operation and any
11 refurbishment during an initial LR or SLR term on federally listed species and critical habitats
12 protected under the ESA and under the jurisdiction of the FWS.

13 Under the ESA, the FWS is responsible for listing and managing terrestrial and freshwater
14 species and designating critical habitat of these species. Continued operation of a nuclear
15 power plant during an initial LR or SLR term could affect these species and their habitat. Listed
16 species are likely to occur near all operating nuclear power plants. However, the potential for a
17 given species to occur in the action area of a specific nuclear power plant depends on the life
18 history, habitat requirements, and distribution of the species and the ecological environment
19 present on or near the plant site. Section 3.6.3.1 describes some of the listed species and
20 critical habitats under FWS jurisdiction that the NRC has analyzed during past license renewal
21 reviews and the relevant environmental stressors related to license renewal.

22 Potential effects of particular concern for listed terrestrial species, including bats, birds,
23 mammals, reptiles, amphibians, and invertebrates, include the following:

- 24 • habitat loss, degradation, disturbance, or fragmentation resulting from construction,
25 refurbishment, or other site activities, including site maintenance and infrastructure repairs
- 26 • noise and vibration and general human disturbance
- 27 • mortality or injury from collisions with plant structures and vehicles.

28 Additionally, terrestrial listed species and their habitats can be adversely affected by any of the
29 factors described in Section 4.6.1.1 relevant to terrestrial resources. However, the magnitude
30 and significance of such impacts can be greater for listed species because—by virtue of being
31 eligible for Federal listing—these species are significantly more sensitive to environmental
32 stressors because their populations are already in decline. Similarly, critical habitats are
33 afforded special protections because they are critical to the preservation of the listed species.

34 Potential effects of particular concern for listed aquatic species, including fish, shellfish and
35 other aquatic invertebrates, and sea turtles, include the following:

- 36 • impingement (including entrapment) and entrainment
- 37 • thermal effects

¹⁵ These issues have been separated from one 2013 LR GEIS issue into distinct issues that individually address specific categories of federally protected ecological resources that may require separate interagency consultation.

- 1 • exposure to radionuclides and other contaminants
- 2 • reduction in available food resources due to IM&E or thermal effects on prey species
- 3 • effects associated with maintenance dredging.

4 Additionally, aquatic listed species and their habitats can be adversely affected by any of the
 5 factors described in Section 4.6.1.1.2 relevant to aquatic resources. As noted above, the
 6 magnitude and significance of such effects can be greater for listed species and critical habitats
 7 than for other aquatic resources.

8 As established in the 2013 LR GEIS, the NRC reports findings under the ESA in accordance
 9 with terminology used in the ESA and its implementing regulations (see Table 4.6-6). Individual
 10 effect determinations are made for each listed species and critical habitat, so the number of
 11 ESA findings for a given license renewal will depend on the number of listed species and critical
 12 habitats present in the action area. Table 3.6-2 and Table 3.6-4 identify the NRC’s findings for
 13 listed species and critical habitats evaluated during initial LR and SLR environmental reviews
 14 conducted since the 2013 LR GEIS.

15 **Table 4.6-6 Possible ESA Effect Determinations**

Listed Species	Proposed Species	Designated or Proposed Critical Habitat
“may affect and is likely to adversely affect”	“may affect and is likely to adversely affect”	“is likely to destroy or adversely modify”
“may affect but is not likely to adversely affect”	“may affect but is not likely to adversely affect”	“is not likely to destroy or adversely modify”
“no effect”	“no effect”	“no effect”

16 Depending on the NRC’s ESA effect determinations, the NRC may be required to consult with
 17 the Services under ESA Section 7(a)(2). The Services maintain joint regulations that implement
 18 ESA Section 7 at 50 CFR Part 402, “Interagency Cooperation – Endangered Species Act of
 19 1973, as Amended.” Subpart B prescribes the Section 7 interagency consultation requirements.
 20 The NRC also relies upon the Services’ detailed procedural guidance for conducting Section 7
 21 consultation in *Endangered Species Consultation Handbook: Procedures for Conducting*
 22 *Consultation and Conference Activities Under Section 7 of the Endangered Species Act* (FWS
 23 and NMFS 1998).

24 Under ESA Section 7, Federal agencies must consult with the Services for actions that “may
 25 affect” federally listed species and critical habitats and to ensure that their actions do not
 26 jeopardize the continued existence of those species or destroy or adversely modify those
 27 habitats. Section 7 consultation may be informal or formal. Generally, the appropriate type of
 28 consultation is related to the effect determinations made by the Federal agency. For proposed
 29 species and proposed critical habitats (the species or habitats for which the Services have
 30 issued proposed listing or designation rules, but for which final rules have yet to be issued or
 31 adopted), the regulations prescribe a process called a conference. NUREG-1555,
 32 Supplement 1, Revision 2, *Standard Review Plans for Environmental Reviews for Nuclear*
 33 *Power Plants for Operating License Renewal* (NRC 2023), describes informal consultation,
 34 formal consultation, and conference in detail. The Services’ regulations also allow for early,
 35 special, and emergency consultations. However, instances that would necessitate these types
 36 of consultation are unlikely to arise for license renewal. Table 4.6-7 summarizes the appropriate
 37 type of consultation or conference for each possible effect determination.

1 **Table 4.6-7 Appropriate Type of Consultation by ESA Effect Determination**

Type of Consultation	Listed Species	Proposed Species	Designated Critical Habitats	Proposed Critical Habitats
Formal Consultation	“may affect and is likely to adversely affect”	N/A	“is likely to destroy or adversely modify”	N/A
Informal Consultation	“may affect but is not likely to adversely affect”	N/A	“is not likely to destroy or adversely modify”	N/A
Conference	N/A	“may affect and is likely to adversely affect”	N/A	“is likely to destroy or adversely modify”
No Consultation or Conference	“no effect”	“may affect but is not likely to adversely affect” ^(a) or “no effect”	“no effect”	“is not likely to destroy or adversely modify” or “no effect”

2 N/A = not applicable

3 (a) Although not required, it is a best practice to confer with the Services when a proposed action may affect but is
4 not likely to adversely affect proposed species.

5 In cases where adverse effects on listed species or critical habitats are possible, the NRC staff
6 has engaged the Services in formal ESA Section 7 consultation as part of the license renewal
7 review and obtained a biological opinion. The FWS has issued one biological opinion in
8 connection with initial LR and SLR environmental reviews conducted since the publication of the
9 2013 LR GEIS. This biological opinion is for continued operation of the Turkey Point plant
10 during an SLR term, and it addresses the American crocodile (*Crocodylus acutus*), its critical
11 habitat, and the eastern indigo snake (*Drymarchon corais couperi*) (FWS 2019a, FWS 2022a).
12 The incidental take statement of the opinion allows for a specified amount of take of these
13 species that is incidental to, and not the purpose of, carrying out the Federal action of license
14 renewal, as well as reasonable and prudent measures and terms and conditions to minimize
15 such take. In accordance with these requirements, the Turkey Point plant monitors and reports
16 the effects of continued operation under the license renewal term to the FWS and the NRC.
17 Section 3.6.3 discusses biological opinions in more detail.

18 The staff reviewed information from SEISs (for initial LRs and SLRs) completed since
19 development of the 2013 LR GEIS. In summary, the potential effects of continued nuclear
20 power plant operation during an initial LR or SLR term depends upon numerous site-specific
21 factors, including the ecological setting of the plant; the listed species and critical habitats
22 present in the action area; and plant-specific factors related to operations, including water
23 withdrawal, effluent discharges, and refurbishment and other ground-disturbing activities.
24 Section 7 of the ESA requires that Federal agencies consult with the Services for actions that
25 “may affect” federally listed species and critical habitats. Additionally, listing status is not static,
26 and the Services frequently issue new rules to list or delist species and designate or remove
27 critical habitats. Therefore, a generic determination of potential impacts on listed species and
28 critical habitats under FWS jurisdiction during a nuclear power plant’s license renewal term is
29 not possible. The NRC would need to perform a plant-specific impact assessment as part of
30 each initial LR or SLR environmental review to determine the potential effects on these
31 resources and consult with the FWS, as appropriate. Consequently, this is a Category 2 issue.

1 4.6.1.3.2 Endangered Species Act: Federally Listed Species and Critical Habitats Under
2 National Marine Fisheries Service Jurisdiction

3 This issue concerns the potential effects of continued nuclear power plant operation and any
4 refurbishment during an initial LR or SLR term on federally listed species and critical habitats
5 protected under the ESA and under the jurisdiction of NMFS.

6 Under the ESA, NMFS is responsible for listing and managing marine and anadromous species
7 and designating critical habitat of these species. Continued operation of a nuclear power plant
8 during an initial LR or SLR term could affect these species and their habitat. The potential for a
9 given species to occur in the action area of a specific nuclear power plant depends on the life
10 history, habitat requirements, and distribution of that species and the ecological environment
11 present on or near the power plant site. In general, listed species and critical habitats under
12 NMFS jurisdiction are only of concern at nuclear power plants that withdraw or discharge from
13 estuarine or marine waters. However, anadromous listed species under NMFS jurisdiction may
14 be seasonally present in the action area of plants located within freshwater reaches of rivers
15 well upstream of the saltwater interface. For instance, the Columbia plant in Washington
16 withdraws from and discharges to the Columbia River at approximately river mile 352 (river
17 kilometer 566). During the NRC's license renewal review, the NRC consulted with NMFS
18 concerning Upper Columbia River spring run chinook salmon (*Oncorhynchus tshawytscha*) and
19 Upper Columbia River steelhead (*O. mykiss*) due to these species' susceptibility to impingement
20 on the intake screens or entrainment into the intake system. These species migrate past the
21 plant seasonally as fry, which are only a few centimeters in length at this life stage (NRC 2012a,
22 NRC 2012b).

23 The discussion of potential effects on listed species and critical habitats under FWS jurisdiction
24 provided above in Section 4.6.1.3.1 also applies to this issue. As established in the 2013 LR
25 GEIS, the NRC reports findings under the ESA in accordance with terminology used in the ESA
26 and its implementing regulations (see Table 4.6-6). Depending on the NRC's ESA effect
27 determinations, the NRC may be required to consult with NMFS under ESA Section 7 (see
28 Table 4.6-7).

29 Since the publication of the 2013 LR GEIS, NMFS has issued several biological opinions in
30 connection with nuclear power plant operation during a license renewal term. These include the
31 following:

- 32 • Indian Point plant (no longer operating) biological opinion addressing the effects of
33 continued operation and decommissioning on shortnose sturgeon (*Acipenser brevirostrum*),
34 Atlantic sturgeon (*A. oxyrinchus oxyrinchus*), and critical habitat of the New York Bight
35 distinct population segment of Atlantic sturgeon (NMFS 2013, NMFS 2018a, NMFS 2018b,
36 NMFS 2020a)
- 37 • Salem plant and Hope Creek plant biological opinion addressing the effects of continued
38 operation on Atlantic sturgeon; shortnose sturgeon; and green (*Chelonia mydas*), Kemp's
39 (*Lepidochelys kempii*), and loggerhead (*Caretta caretta*) sea turtles (NMFS 2014c, NMFS
40 2018c)
- 41 • St. Lucie plant biological opinion addressing the effects of continued operation on green,
42 hawksbill (*Eretmochelys imbricata*), Kemp's, leatherback (*Dermochelys coriacea*), and
43 loggerhead sea turtles and smalltooth sawfish (*Pristis pectinata*) (NMFS 2016)

Environmental Consequences and Mitigating Actions

- 1 • Columbia plant biological opinion addressing the effects of continued operation on Upper
2 Columbia River spring run chinook salmon and Upper Columbia River steelhead (NMFS
3 2017)
- 4 • Oyster Creek plant (no longer operating) biological opinion addressing the effects of
5 continued operation and decommissioning on green, Kemp's, and loggerhead sea turtles
6 (NRC 2020b).

7 The incidental take statements of these opinions allow for a specified amount of take of listed
8 species that is incidental to, and not the purpose of, carrying out the Federal action of license
9 renewal, as well as reasonable and prudent measures and terms and conditions to minimize
10 such take. In accordance with these requirements, these plants monitor and report the effects
11 of continued operation under the license renewal term to the NMFS and the NRC. Notably, two
12 of these opinions (for the Indian Point and Oyster Creek plants) also address the effects of
13 shutdown and decommissioning. Section 3.6.3 discusses these and other biological opinions in
14 more detail.

15 The staff reviewed information from SEISs (for initial LRs and SLRs) completed since
16 development of the 2013 LR GEIS. In summary, the potential effects of continued nuclear
17 power plant operation during an initial LR or SLR term depend on numerous site-specific
18 factors, including the ecological setting of the plant; the listed species and critical habitats
19 present in the action area; and plant-specific factors related to operations, including water
20 withdrawal, effluent discharges, and refurbishment and other ground-disturbing activities.
21 Section 7 of the ESA requires that Federal agencies consult with the Services for actions that
22 "may affect" federally listed species and critical habitats. Additionally, listing status is not static,
23 and the Services frequently issue new rules to list or delist species and designate or remove
24 critical habitats. Therefore, a generic determination of potential impacts on listed species and
25 critical habitats under NMFS jurisdiction during a nuclear power plant's license renewal term is
26 not possible. The NRC would need to perform a plant-specific impact assessment as part of
27 each initial LR or SLR environmental review to determine the potential effects on these
28 resources and consult with NMFS, as appropriate. Consequently, this is a Category 2 issue.

29 *4.6.1.3.3 Magnuson-Stevens Act: Essential Fish Habitat*

30 This issue concerns the potential effects of continued nuclear power plant operation and any
31 refurbishment during an initial LR or SLR term on essential fish habitat (EFH) protected under
32 the MSA.

33 Under the MSA, the Fishery Management Councils, in conjunction with NMFS, designate areas
34 of EFH and manage marine resources within those areas. Within EFH, habitat areas of
35 particular concern (HAPCs) may be designated if the area meets certain additional criteria.
36 Continued operation of a nuclear power plant during an initial LR or SLR term could affect EFH,
37 including HAPCs. EFH may occur at nuclear power plants located on or near estuaries, coastal
38 inlets and bays, and the ocean. EFH is generally not relevant for license renewal reviews of
39 plants located on rivers well above the saltwater interface or confluence with marine waters;
40 plants located on freshwater lakes, including the Great Lakes; or at plants that draw cooling
41 water from human-made cooling ponds or canals that do not hydrologically connect to natural
42 surface waters. One exception is in cases where a plant draws cooling water from the
43 freshwater portion of a river that is inhabited by diadromous prey of federally managed species
44 (herein referred to as "EFH species") with designated EFH downstream of the plant.
45 Section 3.6.3.2 discusses this in more detail and provides examples of license renewal reviews

1 where this caveat has applied; it also describes EFH that the NRC has analyzed during other
2 past license renewal reviews and the relevant environmental stressors related to license
3 renewal.

4 EFH is assessed in terms of impacts on the habitat of each EFH species, life stage, and their
5 prey and each HAPC. Importantly, EFH effect determinations characterize the effects on the
6 habitat of the EFH species and their life stages. They do not characterize the effects on the
7 species or the life stages themselves. Similarly, effect determinations for EFH prey characterize
8 the effects on the prey as a food resource rather than the effects on the prey species
9 themselves. For instance, a proposed action that involves water withdrawal from a river for
10 cooling purposes could cause habitat loss (i.e., temporary or permanent physical loss of a
11 portion of the water column). Associated effluent discharge could cause chemical or biological
12 (i.e., temperature and dissolved oxygen content) alterations to the habitat. With respect to prey
13 species, water withdrawals could impinge or entrain prey organisms, which would represent a
14 reduction in available food resources for EFH species within that habitat. Potential effects of
15 particular concern for EFH include the following:

- 16 • physical removal of habitat through cooling water withdrawals
- 17 • physical alteration of habitat through heated effluent discharges
- 18 • chemical alteration of habitat through radionuclides and other contaminants in heated
19 effluent discharges
- 20 • physical removal of habitat through maintenance dredging
- 21 • reduction in the prey base of the habitat.

22 Additionally, EFH can be adversely affected by any of the factors described in Section 4.6.1.2
23 relevant to aquatic resources. However, the magnitude and significance of such impacts can be
24 greater for EFH because—by virtue of being designated as EFH—these habitats are
25 significantly more sensitive to environmental stressors because the EFH species they support
26 are already experiencing many pressures that affect their spawning, breeding, feeding, or
27 growth.

28 As established in the 2013 LR GEIS, the NRC reports findings under the MSA in accordance
29 with terminology used in the MSA and its implementing regulations (see Table 4.6-8). Individual
30 effect determinations are made for the EFH of each life stage of each EFH species, so the
31 number of MSA findings for a given license renewal will depend on the number of EFH species
32 and life stages with EFH present in the area. For instance, a license renewal could result in no
33 adverse effects to EFH of eggs of Atlantic butterfish (*Peprilus triacanthus*) but could result in
34 minimal adverse effects to EFH of juveniles and adults of the same species. Table 3.6-5
35 identifies the NRC's findings for EFH evaluated during initial LR and SLR environmental reviews
36 conducted since the publication of the 2013 LR GEIS.

1 **Table 4.6-8 Possible EFH Effect Determinations**

EFH Effect Determinations	Spatial Extent	Duration
“substantial adverse effects”		
“more than minimal, but less than substantial adverse effects”	surface area, depth, and seasonality described in writing with explicit measurements, to the extent possible, or pictorially on a map	temporary versus permanent
“minimal adverse effects”		short-term versus long-term
“no adverse effects”		

2 Depending on the NRC’s EFH effect determinations, the NRC may be required to consult with
 3 NMFS under MSA Section 305(b). The NMFS maintains regulations that implement MSA
 4 Section 305 at 50 CFR Part 600, “Magnuson-Stevens Act Provisions.” Subpart K of these
 5 regulations prescribes the EFH interagency consultation requirements. Subpart J includes
 6 definitions and other information relevant to EFH. The NRC also relies upon the NMFS’s
 7 detailed procedural guidance for conducting EFH consultation in *Essential Fish Habitat*
 8 *Consultation Guidance* (NMFS 2004a) and *Preparing Essential Fish Habitat Assessments: A*
 9 *Guide for Federal Action Agencies* (NMFS 2004b).

10 EFH consultation may be abbreviated, expanded, or programmatic. Generally, the appropriate
 11 type of consultation is related to effect determinations made by the Federal agency. NUREG-
 12 1555, Supplement 1, Revision 2, *Standard Review Plans for Environmental Reviews for Nuclear*
 13 *Power Plants for Operating License Renewal* (NRC 2023), describes informal consultation,
 14 formal consultation, and conference in detail. The NMFS regulations also allow for general
 15 concurrences concerning EFH. However, situations are rare in which a general concurrence
 16 would apply to an NRC action. Table 4.6-9 summarizes the appropriate type of consultation for
 17 each possible effect determination.

18 **Table 4.6-9 Appropriate Type of Consultation by Type of Proposed Action and**
 19 **EFH Effect Determination**

Types of Consultation	Type of Proposed Action	EFH Effect Determination
Abbreviated Consultation	individual proposed action	“minimal adverse effects” or “more than minimal, but less than adverse effects” ^(a)
Expanded Consultation	individual proposed action	“substantial adverse effects” or “more than minimal, but less than adverse effects” ^(a)
Programmatic Consultation	proposed actions with a large number of individual actions, such as rulemakings or those involving development of a GEIS	no more than “minimal adverse effects” either individually or cumulatively
No Consultation	any	“no adverse effects”

20 EFH = essential fish habitat; GEIS = generic environmental impact statement.

21 (a) For this finding, the NRC should work with NMFS to determine whether abbreviated or expanded consultation is
 22 most appropriate.

1 In cases where adverse effects on EFH are possible, the NRC staff has engaged NMFS in EFH
2 consultation as part of the license renewal review and obtained EFH conservation
3 recommendations. The NMFS has developed EFH conservation recommendations in
4 connection with four initial LR and SLR environmental reviews conducted since the publication
5 of the 2013 LR GEIS: the Columbia (NMFS 2017), Seabrook (NMFS 2011), Limerick (NMFS
6 2014b), and Surry (NMFS 2019) plant reviews. These recommendations are intended to help
7 an action agency avoid and minimize impacts on EFH, and when there is unavoidable impact,
8 offset this impact (NOAA 2021). For instance, NMFS (2014b) recommended restricting in-water
9 maintenance work during certain parts of the year during the Limerick license renewal term:

- 10 • “Avoid in-water maintenance work from March 1 to June 30 of each year to minimize
11 adverse effects on migrating and spawning activities of anadromous fish.”

12 If EFH consultation is conducted concurrently with ESA consultation, NMFS may make
13 recommendations based on requirements of the biological opinion. For instance, NMFS (2017)
14 made the following recommendations with respect to the Columbia plant license renewal:

- 15 (a) “Minimize adverse effects on water quality by monitoring and reporting as stated in term
16 and condition #1 in the accompanying [biological] opinion.”
- 17 (b) “Minimize the risk of artificial obstruction by conducting the entrainment and
18 impingement studies as stated in term and condition #2 in the accompanying [biological]
19 opinion.”

20 The NRC has a statutory obligation to reply to EFH conservation recommendations within
21 30 days of receiving the recommendations (50 CFR 600.920(k)(1)). A response must be
22 provided at least 10 days prior to the NRC’s issuance of a renewed license renewal if the
23 response is inconsistent with any of NMFS’s recommendations, unless NMFS and NRC agree
24 to an alternative timeline (50 CFR 600.920(k)(1)).

25 The staff reviewed information from SEISs (for initial LRs and SLRs) completed since
26 development of the 2013 LR GEIS. In summary, the potential effects of continued nuclear
27 power plant operation during an initial LR or SLR term depends upon numerous site-specific
28 factors, including the ecological setting of the plant; the EFH present in the action area,
29 including HAPCs; and plant-specific factors related to operations, including water withdrawal,
30 effluent discharges, and any other activities that may affect aquatic habitats during the license
31 renewal term, such as refurbishment or any in-water activities. Section 305(b) of the MSA
32 requires that Federal agencies consult with NMFS for actions that may adversely affect EFH.
33 Additionally, EFH status is not static. NMFS and the Fishery Management Councils frequently
34 update management plans for EFH species and issue new rules to designate or modify EFH
35 and HAPCs. Therefore, a generic determination of potential impacts on EFH during a nuclear
36 power plant’s license renewal term is not possible. The NRC would need to perform a plant-
37 specific impact assessment as part of each initial LR or SLR environmental review to determine
38 the potential effects on these resources and consult with NMFS, as appropriate. Consequently,
39 this is a Category 2 issue.

40 *4.6.1.3.4 National Marine Sanctuaries Act: Sanctuary Resources*

41 This issue concerns the potential effects of continued nuclear power plant operation and any
42 refurbishment during an initial LR or SLR term on sanctuary resources protected under the
43 NMSA.

Environmental Consequences and Mitigating Actions

1 Under the NMSA, NOAA's Office of National Marine Sanctuaries (ONMS) designates and
2 manages the National Marine Sanctuary System. Marine sanctuaries may occur near nuclear
3 power plants located on or near marine waters as well as the Great Lakes. Currently, five
4 operating nuclear power plants—Ginna, Nine Mile Point, and FitzPatrick on Lake Ontario; Point
5 Beach on Lake Michigan; and Turkey Point near Biscayne Bay—are located near designated or
6 proposed national marine sanctuaries (see Table 3.6-6).

7 Impacts on marine sanctuaries are broad-ranging because such resources include any living or
8 nonliving resource of a national marine sanctuary. With respect to ecological sanctuary
9 resources, potential effects of particular concern include the following:

- 10 • impingement (including entrapment) and entrainment
- 11 • thermal effects
- 12 • exposure to radionuclides and other contaminants
- 13 • reduction in available food resources due to IM&E or thermal effects on prey species
- 14 • effects associated with maintenance dredging.

15 Additionally, sanctuary resources can be adversely affected by any of the factors described in
16 Section 4.6.1.2 relevant to aquatic resources or, in the case of certain sanctuary resources,
17 such as seabirds, the factors described in Section 4.6.1.1 relevant to terrestrial resources.
18 However, the magnitude and significance of such impacts can be greater for sanctuary
19 resources because—by virtue of being part of a national marine sanctuary—these resources
20 are more sensitive to environmental stressors. Notably, because sanctuary resources can
21 include those that contribute to the recreational, ecological, historical, educational, cultural,
22 archaeological, scientific, or aesthetic value of the sanctuary, proper assessment of potential
23 impacts may require coordination with other environmental resource areas, such as visual
24 resources, socioeconomics, and historical and cultural resources. Table 4.6-10 provides
25 examples of types of sanctuary resources included in the regulatory definition at 15 CFR 922.3.

26 **Table 4.6-10 Types of Sanctuary Resources**

substratum of the area of the Sanctuary	phytoplankton and zooplankton
submerged features ^(a) and the surrounding seabed	fish
carbonate rock, corals, and other bottom formations	seabirds
coralline algae and other marine plants and algae	sea turtles and other marine reptiles
marine invertebrates	marine mammals
brine seep biota	historic resources ^(b)

27 (a) Submerged features may include human-made features, such as artificial coral reef structures and shipwrecks.
28 (b) Because sanctuary resources include historic resources, this review necessitates coordination with the historic
29 and cultural resource review to determine whether any historic resources are present that would be relevant to
30 the NMSA consultation. In such cases, multiple NRC staff may be involved in discussions with the ONMS.

31 The NRC reports findings under the NMSA in accordance with terminology used in the NMSA
32 (see Table 4.6-11). Depending on the NRC's effect determinations, the NRC may be required
33 to consult with ONMS under NMSA Section 304(d). Unlike ESA Section 7 or EFH consultation,
34 for which there are each several possible types of consultation depending on the specific
35 circumstances, the ONMS's guidance prescribes only a single process for consultation. NMSA
36 consultation is required when a Federal agency determines that an action "is likely to destroy,

1 cause the loss of, or injure” a sanctuary resource. Federal actions subject to consultation may
 2 be inside or outside the boundary of a national marine sanctuary.

3 **Table 4.6-11 Possible NMSA Effect Determinations**

“may affect and is likely to destroy, cause the loss of, or injure”
“may affect but is not likely to destroy, cause the loss of, or injure”
“no effect”

4 The NOAA has not promulgated regulations concerning NMSA Section 304(d). In 2008, NOAA
 5 issued an advance notice of proposed rulemaking in the *Federal Register* soliciting comments
 6 about whether development of regulations implementing certain aspects of the NMSA Section
 7 304(d) consultation provisions is appropriate (73 FR 50259). The NOAA later withdrew its
 8 proposal in 2011. However, the ONMS has issued guidance for conducting NMSA consultation,
 9 which the NRC relies upon, in *Overview of Conducting Consultation Pursuant to Section 304(d)*
 10 *of the National Marine Sanctuaries Act* (NOAA 2009). NUREG-1555, Supplement 1, Revision
 11 2, *Standard Review Plans for Environmental Reviews for Nuclear Power Plants for Operating*
 12 *License Renewal* (NRC 2023), describes NMSA consultation in detail.

13 The NRC staff has evaluated the potential impacts of license renewal on national marine
 14 sanctuaries in two environmental reviews conducted since the publication of the 2013 LR GEIS:
 15 Turkey Point and Point Beach plants, both of which were subsequent license renewals.
 16 Section 3.6.3.3 summarizes these reviews. Neither license renewal ultimately required NMSA
 17 consultation with ONMS. However, these reviews highlighted the need for the NRC to consider
 18 potential impacts on sanctuary resources within national marine sanctuaries in its license
 19 renewal reviews and to consult with ONMS, as appropriate.

20 If the initial LR or SLR would injure sanctuary resources, the NRC would consult with ONMS,
 21 and ONMS would formulate recommended reasonable and prudent alternatives. In the context
 22 of NMSA Section 304(d), these alternatives can best be understood as the actions necessary to
 23 protect sanctuary resources. Alternatives generally focus on the location, timing, and methods
 24 of the proposed action. For example, the ONMS may recommend that the proposed action be
 25 conducted:

- 26 • at an alternate location, including a location outside the sanctuary(ies),
- 27 • during a different season or that it be delayed for a specified period of time,
- 28 • with alternative equipment or procedures, or
- 29 • in some combination of these recommendations.

30 If the ONMS provides the NRC with recommended alternatives, the NRC must discuss the
 31 recommendations with the ONMS. If the NRC (or applicant) plans to fully implement the
 32 recommended alternatives and fully incorporate them into the proposed action, the NRC need
 33 not take any further action beyond this discussion to conclude the consultation. If the NRC (or
 34 applicant) does not follow the recommended alternatives, the NRC must prepare a written
 35 response that describes the reasons for not implementing the alternatives.

36 The staff reviewed information from SEISs (for initial LRs and SLRs) completed since
 37 development of the 2013 LR GEIS. In summary, the potential effects of continued nuclear
 38 power plant operation during an initial LR or SLR term depends upon numerous site-specific

Environmental Consequences and Mitigating Actions

1 factors, including the ecological setting of the plant; the sanctuary resources present in the
2 action area; and plant-specific factors related to operations, including water withdrawal, effluent
3 discharges, and any other activities that may affect sanctuary resources during the license
4 renewal term, such as refurbishment or any in-water activities. Section 304(d) of the NMSA
5 requires that Federal agencies consult with the ONMS for actions that may injure sanctuary
6 resources. Additionally, national marine sanctuary status is not static. The geographic extent of
7 existing sanctuaries may change or expand in the future, and NOAA is likely to designate new
8 sanctuaries as additional areas of conservation need are identified and assessed. Therefore, a
9 generic determination of potential impacts on sanctuary resources during a nuclear power
10 plant's license renewal term is not possible. The NRC would need to perform a plant-specific
11 impact assessment as part of each initial LR or SLR environmental review to determine the
12 potential effects on these resources and consult with NMFS, as appropriate. Consequently, this
13 new issue is being established as a plant-specific, or Category 2 issue.

14 **4.6.2 Environmental Consequences of Alternatives to the Proposed Action**

15 *Construction* – For all alternative energy technologies discussed in this section, the impacts of
16 construction on ecological resources would be similar but could vary considerably in magnitude.
17 For land-based facilities, land clearing, excavation work, and installation of impervious surfaces
18 could result in habitat loss, alteration, or fragmentation as well as disturbance, displacement, or
19 mortality of animals. Potential ecological impacts would vary depending on the nature and
20 acreage of the land area disturbed and the intensity of the excavation work. At greenfield sites,
21 impacts would likely be greater than at brownfield and other developed sites because habitat
22 could be permanently lost. Surface water runoff over disturbed ground, construction laydown
23 areas, and material stockpiles could increase levels of dissolved and suspended solids and
24 other contaminants in nearby waterways and aquatic features. Terrestrial and aquatic habitats
25 could also be affected by spills and leaks of petroleum, oil, and lubricant products from
26 construction equipment that is conveyed in stormwater runoff or that otherwise enters nearby
27 water bodies. Noise, vibration, and human activity could alter wildlife behaviors and result in
28 avoidance of neighboring areas of otherwise suitable habitat. Dredging and other in-water work
29 could directly remove or alter the aquatic environment and disturb or kill aquatic organisms.
30 Because construction effects would be short term, some of these effects would be relatively
31 localized and temporary. Effects could be minimized by using existing infrastructure at an
32 existing site, such as retired intake and discharge systems, as well as by using existing
33 transmission lines, roads, parking areas, and certain existing buildings and structures on the
34 site. Co-location of utility and transmission line ROWs with other existing ROWs would
35 minimize the amount of habitat disturbance. Aquatic habitat alteration and loss could be
36 minimized by siting components of the alternatives farther from water bodies and away from
37 drainages and other aquatic features.

38 Water quality permits required through Federal and State regulations would control, reduce, or
39 mitigate potential effects on the aquatic environment. Through such permits, the permitting
40 agencies could include conditions requiring BMPs or mitigation measures to avoid adverse
41 impacts. For instance, the USACE oversees Section 404 permitting for dredge and fill activities,
42 and EPA, or authorized States and Tribes, oversee NPDES permitting and general stormwater
43 permitting. Companies would likely be required to obtain each of these permits to construct a
44 new replacement power alternative. Notably, the EPA final rule under Phase I of the CWA
45 Section 316(b) regulations applies to new facilities and sets standards to limit intake capacity
46 and velocity to minimize impacts on fish and other aquatic organisms in the source water
47 (40 CFR 125.84). Any new replacement power alternative subject to this rule would be required

1 to comply with the associated technology standards, so construction of once-through cooling
2 systems for alternatives that require cooling water is unlikely.

3 *Operation* – Many of the operational impacts of a fossil fuel-fired or nuclear power plant
4 alternative would be like those resulting from continued operation of a nuclear power plant
5 during an initial LR or SLR term. Impacts on the ecological environment would include cooling
6 tower deposition of salt and moisture on plants; bird collisions with plant structures and
7 transmission lines; impingement and entrainment of aquatic organisms; thermal and chemical
8 effects related to cooling water effluent discharges; effects of periodic dredging; and potential
9 water use conflicts. Water quality permits required through Federal and State regulations would
10 control, reduce, or mitigate potential effects on the aquatic environment. The operational
11 impacts of other alternative energy technologies would differ and are presented in the following
12 sections.

13 The above-described impacts would apply generally to construction and operation of each of the
14 alternatives discussed below. Differences among alternatives would depend not only on the
15 selected technology but also on site-specific factors, which cannot be evaluated here.
16 Discussion of such differences is outside the scope of this LR GEIS but is considered in plant-
17 specific SEISs.

18 4.6.2.1 *Fossil Energy Alternatives*

19 The general impacts of the construction and operation of new fossil fuel energy technologies are
20 described above in Section 4.6.2. The magnitude of impacts on ecological resources would be
21 site-dependent. Impacts would depend on the type and location of a proposed facility, the size
22 of the area affected by construction, the type of cooling system, and the characteristics of the
23 ecological resources present on the site. The magnitude of potential impacts from a proposed
24 facility could be greater than or less than renewing the license for an existing nuclear power
25 plant depending upon site-specific and project-specific factors. Many of the potential ecological
26 impacts from operations of a new fossil fuel energy technologies (coal- or gas-fired) would
27 essentially be like those for a nuclear power plant.

28 Unique features of a coal-fired power plant that could affect ecological resources include coal
29 delivery, cleaning, and storage, which would involve periodic maintenance dredging (if coal is
30 delivered by barge); noise; dust; loss of habitat; sedimentation and turbidity; and introduction of
31 minerals and terrace elements (including contaminants that can cause impacts like acid mine
32 drainage). Limestone preparation and storage could result in fugitive dust and runoff. Air
33 emissions, most notably acid rain, can cause direct and indirect effects, including foliage injury,
34 nutrient leaching, and decreased biodiversity. Disposal of combustion waste can result in
35 habitat loss and potential seepage of trace and other elements into groundwater, soils, and
36 surface waters.

37 The unique features of a gas-fired power plant that could affect ecological resources would be
38 those associated with gas pipelines. Pipeline construction could result in the loss, modification,
39 and fragmentation of natural habitats. Co-location of these lines within existing utility ROWs
40 could minimize these impacts. Gas leaks and spills could also adversely affect terrestrial and
41 aquatic ecosystems.

Environmental Consequences and Mitigating Actions

1 4.6.2.2 *New Nuclear Alternatives*

2 Many of the impacts of construction and operation of new nuclear technologies are described
3 above in Section 4.6.2. The magnitude of these impacts on ecological resources would be site-
4 dependent and would depend on the type and location of a proposed facility, the size of the
5 area affected by construction, the type of cooling system, and the characteristics of the
6 ecological resources present on the site. For instance, small modular reactors can be more
7 easily sited on existing industrial-use sites, which would minimize disturbance of natural habitats
8 and maximize the use of existing infrastructure. The impacts of operation of a new nuclear
9 power plant and operation of an existing nuclear power plant during an initial LR or SLR term
10 would be similar. However, impacts could be greater than or less than renewing the license for
11 an existing nuclear power plant depending upon site-specific and project-specific factors.

12 4.6.2.3 *Renewable Alternatives*

13 The impacts of renewal energy technologies on the ecological environment would vary based
14 on the technology.

15 Biomass-fired plants would require large amounts of land for cultivation of energy crops, which
16 would result in habitat alteration and loss. Over time, cultivation could deplete the quality of
17 soils. For biomass plants that use agricultural residues (e.g., corn cobs, rice husk, jute sticks,
18 cotton stock, coffee prunings, and coconut shells that do not decompose easily and have
19 potential as energy sources), the impacts would potentially be smaller because the affected land
20 would already be in use for cultivation. For biomass plants that use municipal solid waste
21 feedstock, deposition of toxic constituents could adversely affect nearby ecosystems. Water
22 demands for cooling would be like those of fossil fuel-fired plants and, therefore, similar impacts
23 on the ecological environment would be expected (e.g., cooling tower deposition of salt and
24 moisture on plants; impingement and entrainment of aquatic organisms; thermal and chemical
25 effects related to cooling water effluent discharges; effects of periodic dredging; and potential
26 water use conflicts).

27 The effects of geothermal energy alternatives depend on how the geothermal energy is
28 converted to useful energy. Direct use applications and geothermal heat pumps have almost no
29 negative effects on the environment. Geothermal plants may release chemicals in liquid
30 fractions that could include various heavy metals, which could leach into nearby terrestrial and
31 aquatic habitats and bioaccumulate in plants and animals (Kristmannsdottir and Armannsson
32 2003). If makeup water is derived from natural water bodies, impacts would be like those of
33 fossil fuel-fired plants.

34 Onshore wind projects could affect terrestrial species through mechanical noise, collision with
35 turbines and meteorological towers, and interference with migratory behavior. Bird and bat
36 collision mortality is an ongoing concern at operating wind projects, but recent developments in
37 turbine design have reduced strike risk. At 43 wind facilities in Canada, researchers estimated
38 bird fatality at 8.2 birds (plus or minus 1.4 birds) per turbine per year (Zimmerling et al. 2013).
39 Publications examining 2012 data from U.S. wind energy facilities estimated that in total, about
40 a quarter to a half-million birds are killed per year at U.S. wind turbines (Johnson et al. 2016).
41 Another estimate using data through 2014 estimated that U.S. wind turbines account for the
42 death of over a half-million birds per year (Loss et al. 2015). Numbers are likely higher now
43 because many new wind projects have been developed in the past 10 years. At a wind facility
44 in southern Texas, researchers estimated bat fatalities at 16 bats per megawatt per year across
45 all species (Weaver et al. 2020). Onshore wind projects are generally sited away from

1 waterways. Therefore, construction would be unlikely to disturb or otherwise affect aquatic
2 habitats or features. Operation would not require cooling or consumptive water use and, thus,
3 would not affect aquatic resources.

4 Offshore wind projects could cause increased turbidity, noise, vibration, and other physical
5 disturbances to the aquatic environment from pile-driving, turbine construction, and submarine
6 power cable installation associated with construction. Cable installation could disturb large
7 spans of aquatic habitat and would be especially detrimental to nearshore and estuarine
8 habitats used by early life stages of finfish and shellfish. Dredging would likely be necessary in
9 some areas to prepare for cable installation and would result in destruction of the existing
10 benthic habitat and temporary habitat loss until the benthic community could repopulate the
11 area. Increased vessel anchoring during survey activities, construction, installation, and
12 maintenance would increase turbidity and disturb the benthic environment. Accidental releases
13 of contaminants from fuel and chemical spills would also pose a hazard to the aquatic
14 environment and would be especially detrimental to nearshore, estuarine, and unique or
15 sensitive habitats (BOEM 2020b). During operation, fuel and chemical spills would remain a
16 potential hazard. The presence of permanent structures could lead to impacts on finfish and
17 aquatic invertebrates through entanglement from gear loss, hydrodynamic disturbance, fish
18 aggregation, habitat conversion, and migration disturbances. These impacts may arise from
19 buoys, meteorological towers, foundations, scour/cable protection, and transmission cable
20 infrastructure. However, structure-oriented or hard-bottom species could benefit from the new
21 structures because they would have new material upon which to anchor themselves and build
22 colonies. Bird and bat collisions would remain a concern for offshore wind projects, although
23 such effects are not well studied. Offshore wind projects are more likely to affect birds that
24 conduct transoceanic migrations.

25 Solar PV facilities occupy large areas of land that could reduce or preclude natural vegetation
26 communities and wildlife use. Misalignment of mirrors could also increase fire risk. Impacts on
27 terrestrial habitats could be largely avoided if solar installations were installed on the roofs of
28 existing residential, commercial, or industrial buildings or at existing standalone solar facilities.
29 Synthetic organic heat transfer fluids could affect surrounding vegetation. Utility-scale solar
30 facilities may also pose hazards to birds and their insect prey if individual birds or insects
31 mistake a facilities' reflective panel arrays for water. Birds and insects may be injured or killed
32 by colliding with solar panels if they try to land on or enter what they interpret to be water, in
33 what has been termed by researchers as the "lake effect hypothesis" (Kosciuch et al. 2020).
34 The FWS is currently developing mitigation strategies and BMPs related to birds and solar
35 facilities (MASCWG 2016). Discussions with the FWS and other relevant agencies during the
36 planning phases of a new solar project could minimize impacts on birds and other wildlife by
37 incorporating mitigation and BMPs into the design of the facility and construction plans. Solar
38 projects are generally sited away from waterways. Therefore, construction would be unlikely to
39 disturb or otherwise affect aquatic habitats or features. Operation would not require cooling or
40 consumptive water use and, thus, would not affect aquatic resources.

41 For hydroelectric power alternatives, construction of dams could fragment river and stream
42 habitat and convert these free-flowing ecosystems into lake-like ecosystems. As a result, native
43 riverine species could suffer because many typically cannot thrive in the altered environment.
44 Fish species that migrate through the area to feed and spawn would be prohibited from
45 migrating if fish passages are not installed. Temperature and nutrient stratification in the
46 reservoir and reduced levels of dissolved oxygen could result in hypoxic or anoxic conditions
47 for aquatic organisms. Aquatic biodiversity would likely decline before reaching some new, less
48 diverse equilibrium within the newly created reservoir. Terrestrial animals that feed on fish and

Environmental Consequences and Mitigating Actions

1 shellfish could experience reduced prey availability. Water use conflicts could affect
2 downstream conditions. Aquatic and riparian habitats and wetlands could experience
3 fluctuating water levels downstream of the dam. When river levels are low, aquatic organisms
4 would temporarily lose habitat or could become stranded. Downstream habitats would be
5 affected by a variety of other dam-induced conditions, such as changes in sediment transport
6 and deposition patterns and channel erosion or scouring.

7 **4.7 Historic and Cultural Resources**

8 **4.7.1 Environmental Consequences of the Proposed Action – Continued Operations** 9 **and Refurbishment Activities**

10 For the issue of historic and cultural resources, the NRC evaluated the impact of continued
11 operations and refurbishment activities during the license renewal term on historic and cultural
12 resources located onsite and in transmission line ROWs. This issue was addressed in the 2013
13 LR GEIS (NRC 2013a), and it is a Category 2 issue. The issue has been updated to include
14 discussion of impacts on cultural resources that are not eligible for or listed in the National
15 Register of Historic Places that would also need to be considered during license renewal
16 reviews.

17 Section 106 of the National Historic Preservation Act (NHPA; 54 U.S.C. § 300101 et seq.)
18 requires Federal agencies to take into account the effects of their undertakings (e.g., initial LR
19 and SLR) on historic properties and consult with the appropriate parties as defined in 36 CFR
20 800.2. The NEPA requires Federal agencies to consider the potential effects of their actions on
21 the “affected human environment,” which includes “aesthetic, historic, and cultural resources.”
22 As discussed in Section 3.7.2, the NRC fulfills its Section 106 requirements through the NEPA
23 process in accordance with 36 CFR 800.8(c).

24 Historic and cultural resources, especially archaeological sites, are sensitive to ground
25 disturbance and are nonrenewable. Even a small amount of ground disturbance (e.g., ground
26 clearing and grading) could affect a significant resource. Much of the information contained in
27 an archaeological site is derived from the spatial relationships between soil layers and
28 associated artifacts. Once these spatial relationships are altered, they can never be reclaimed.
29 Aboveground resources and traditional cultural properties (TCPs) are sensitive to impacts from
30 alterations in the viewshed.

31 Continued operations and refurbishment activities during the renewal term (i.e., initial LR and
32 SLR) can affect historic and cultural resources through (1) ground-disturbing activities
33 associated with plant operations and ongoing maintenance (e.g., construction of new parking
34 lots or buildings), landscaping, agricultural or other use of plant property; (2) activities
35 associated with transmission line maintenance (e.g., maintenance of access roads or removal of
36 danger trees); and (3) changes in the appearance of nuclear power plants and transmission
37 lines. License renewal environmental reviews have shown that the appearance of nuclear
38 power plants and transmission lines has not changed significantly over time; therefore,
39 additional viewshed impacts on historic and cultural resources are not anticipated.

40 The NHPA requires the NRC to conduct a plant-specific assessment to determine whether
41 historic properties are present in the area of potential effect (APE), and if so, whether the
42 license renewal (initial LR or SLR) would result in any adverse effect upon such properties.
43 There are three potential determinations (see 36 CFR 800.4) for plant-specific license renewal
44 reviews:

- 1 • no historic properties present, the undertaking will have no effect to historic properties
- 2 • historic properties present, the undertaking will have no adverse effect upon them
- 3 • historic properties present, the undertaking will have an adverse effect upon one or more
- 4 historic properties (see 36 CFR 800.5).

5 For historic or cultural resources that do not meet the criteria to be considered a historic
6 property under the NHPA, the NRC will assess whether there would or would not be any
7 potential significant impacts on these resource through the NEPA process.

8 The staff reviewed information from SEISs (for initial LRs and SLRs) completed since
9 development of the 2013 LR GEIS. As discussed in Section 3.7, historic and cultural resources
10 vary widely from site to site; there is no generic way of determining their existence or
11 significance. Based on the information reviewed and the preceding discussion, the NRC
12 concludes that potential impacts from continued operations and refurbishment activities on
13 historic and cultural resources during the initial LR and SLR terms are unique to each nuclear
14 power plant site. Therefore, the impacts on historic and cultural resources cannot be
15 determined generically, and it is a Category 2 issue.

16 **4.7.2 Environmental Consequences of Alternatives to the Proposed Action**

17 If construction and operation of replacement energy alternatives require a Federal undertaking
18 (e.g., license, permit), the Federal agency would need to make a reasonable effort to identify
19 historic properties within the direct and indirect effects APE and consider the effects of the
20 undertaking on historic properties, in accordance with Section 106 of the NHPA. If historic
21 properties are present and are affected by the undertaking, adverse effects would be assessed,
22 and resolved in consultation with the State Historic Preservation Officer/Tribal Historic
23 Preservation Officer and any Indian Tribe that attaches religious and cultural significance to
24 identified historic properties through the NHPA Section 106 process. Additionally, NEPA
25 requires Federal agencies to consider the potential effects of their actions on the “affected
26 human environment,” which includes “aesthetic, historic, and cultural resources.”

27 *Construction* – Construction impacts would be similar regardless of the energy alternative
28 considered. Most impacts on historic and cultural resources would occur primarily from both
29 onsite and offsite preparation-related ground-disturbing activities (e.g., land clearing, grading
30 and excavation, and road work) and the construction of power-generating facilities and non-
31 safety-related facilities such as administration buildings, parking lots, switchyards, pipelines,
32 access roads, and transmission lines. Any land needed to support an alternative energy facility
33 including roads, transmission corridors, rail lines, or other ROWs would also need to be
34 assessed. Before constructing a new replacement power plant at a greenfield, brownfield, or
35 existing nuclear power plant site, cultural resource surveys would need to be performed by a
36 qualified cultural resource professional.

37 *Operations* – Operation of a replacement energy alternative can affect historic and cultural
38 resources through (1) ground-disturbing activities associated with plant operations and ongoing
39 maintenance (e.g., construction of new parking lots or buildings), landscaping, agricultural or
40 other use of plant property; (2) activities associated with transmission line maintenance (e.g.,
41 maintenance of access roads or removal of danger trees); and (3) changes in the appearance of
42 nuclear power plants and transmission lines. The appearance of the power-generating facility
43 and transmission lines could result in alterations to the visual setting, which, whether temporary
44 or permanent, could affect other types of historic and cultural resources such as cultural

Environmental Consequences and Mitigating Actions

1 landscapes, architectural resources, or TCPs. Impacts would vary with plant heights and
2 associated exhaust stacks or cooling towers.

3 4.7.2.1 *Fossil Energy Alternatives*

4 Impacts from operations of a fossil fuel power plant would be the same as those described in
5 Section 4.7.2.

6 4.7.2.2 *New Nuclear Alternatives*

7 Impacts from operations of a new nuclear power plant would be the same as those described in
8 Section 4.7.2.

9 4.7.2.3 *Renewable Alternatives*

10 Impacts from operations of a new renewable energy facility would be the same as those
11 described in Section 4.7.2.

12 **4.8 Socioeconomics**

13 **4.8.1 Environmental Consequences of the Proposed Action – Continued Operations** 14 **and Refurbishment Activities**

15 Environmental reviews have shown that continued operations and refurbishment activities in
16 support of license renewal have had little to no socioeconomic effect on communities near
17 nuclear plants. Socioeconomic effects of power plant operations have become well established
18 and normal fluctuations in employment, income, and tax revenue have not altered the quality
19 and availability of community services and housing or increased traffic volumes.

20 License renewal applicants consistently indicate they have no plans to add operations workers,
21 and increased maintenance and safety inspection activities during the renewal term can be
22 managed using the current workforce. Consequently, people living near nuclear power plants
23 have not experienced any significant socioeconomic impact since construction and the onset of
24 reactor operations. In addition, refurbishment activities, including steam generator and vessel
25 head replacement, have been conducted during regularly scheduled power plant refueling and
26 maintenance outages.

27 The environmental review of socioeconomic impacts conducted for this LR GEIS revision
28 consists of five issues.

- 29 • employment and income, recreation, and tourism
- 30 • tax revenue
- 31 • community services and education
- 32 • population and housing
- 33 • transportation

34 4.8.1.1 *Employment and Income, Recreation, and Tourism*

35 As explained in Section 3.8, the nuclear power plant and the communities that support it can be
36 described as a dynamic socioeconomic system. The communities provide the people, goods,

1 and services required to operate the nuclear power plant. Power plant operation, in turn,
2 provides employment and income and pays for goods and services from the communities.

3 Employees receive income from the nuclear power plant in the form of wages, salaries, and
4 benefits. Employees and their families, in turn, spend this income on goods and services within
5 the community, thereby creating additional employment opportunities and income. In addition,
6 people and businesses in the community receive income for the goods and services sold to the
7 nuclear power plant. Payments for these goods and services create additional employment and
8 income opportunities within the community.

9 As previously discussed, the number of nuclear plant operations workers is not expected to
10 change, and license renewal environmental reviews have shown no need for additional workers.
11 In addition, refurbishment activities, including steam generator and vessel head replacement,
12 are conducted during regularly scheduled refueling and maintenance outages. Consequently,
13 employment levels at a nuclear power plant are not expected to change as a result of license
14 renewal.

15 Some communities experience seasonal transient population growth due to local tourism and
16 recreational activities. Income from tourism and recreational activities creates employment and
17 income opportunities in the communities around nuclear power plants. Communities located
18 near nuclear power plants in coastal regions, notably the D.C. Cook and Palisades plants
19 (Palisades was shut down in May of 2022) on the eastern shore of Lake Michigan, experience
20 summer and weekend population increases due to the recreational and tourism activities that
21 attract visitors. Some communities attract visitors interested in outdoor recreational activities,
22 such as camping, hiking, and skiing.

23 As discussed in Section 4.2.1.2, the NRC considered the aesthetic impacts of nuclear plant
24 operations and refurbishment activities potentially affecting tourism and recreational business
25 interests. The NRC concluded in the 1996 and 2013 LR GEISs that aesthetic impacts would be
26 SMALL for all nuclear plants and a Category 1 issue. This is primarily because the visual
27 impact occurred during and after construction, and the appearance of nuclear power plants is
28 not expected to change as a result of license renewal.

29 However, a case study performed for the 1996 LR GEIS found situations where nuclear power
30 plants have had a negative effect on the public. Negative perceptions were based on aesthetic
31 considerations (for instance, the nuclear plant is out of character or scale with the community or
32 the viewshed), physical environmental concerns, safety and perceived risk issues, an anti-
33 nuclear plant attitude, or an anti-nuclear outlook. It is believed that these negative perceptions
34 would persist regardless of any mitigation. Subsequently, license renewal environmental
35 reviews have not revealed any new information that would change this perception.

36 Nevertheless, the effects of power plant operations on employment, income, recreation, and
37 tourism are ongoing and have become well-established for all nuclear power plants. The
38 impacts from power plant operations during the license renewal term on employment and
39 income in communities near nuclear power plants are not expected to change from those
40 currently being experienced. In addition, tourism and recreational activities in the vicinity of
41 nuclear plants are not expected to change as a result of license renewal. Based on these
42 considerations, the NRC concludes impacts from continued nuclear plant operations during
43 initial LR and SLR terms and refurbishment on employment, income, recreation, and tourism
44 would be the same—SMALL for all nuclear plants. The staff reviewed information from SEISs
45 (for initial LRs and SLRs) completed since development of the 2013 LR GEIS and identified no

Environmental Consequences and Mitigating Actions

1 new information or situations that would result in different impacts for this issue for either an
2 initial LR or SLR term. Therefore, employment, income, recreation, and tourism impacts would
3 be SMALL for all nuclear plants and a Category 1 issue for both initial LRs and SLRs.

4 4.8.1.2 Tax Revenue

5 Nuclear power plants are an important source of tax revenue for many local governments and
6 public school districts. Property taxes or payments in lieu of (property) taxes (PILOTs) are the
7 principal source of tax revenue in many tax jurisdictions with nuclear power plants, although in
8 some jurisdictions energy production is also taxed. County and municipal governments and
9 public school districts receive tax revenue either directly from the licensee, owner of the nuclear
10 plant, or indirectly through State tax and revenue-sharing programs.

11 Counties and municipal governments also receive revenue from sales taxes and fees paid by
12 the nuclear plant and its employees. Changes in the workforce and property taxes or PILOTs
13 paid to local governments and public schools can directly affect socioeconomic conditions in the
14 counties and communities near the nuclear power plant.

15 Environmental reviews have shown that refurbishment activities, such as steam generator and
16 vessel head replacement, have not had a noticeable effect on the assessed value of nuclear
17 plants, thus changes in tax revenues are not anticipated from these activities. Refurbishment
18 involving the one-for-one replacement of existing nuclear plant components and equipment are
19 generally not considered a taxable improvement. Also, property tax assessments; proprietary
20 PILOT stipulations, settlements, and agreements; and State tax laws are continually changing
21 the amount of taxes paid to tax jurisdictions by nuclear plant owners. These tax revenue
22 changes are independent of license renewal and refurbishment activities.

23 The primary impact of initial LR or SLR would be the continuation of the receipt of tax revenue
24 from nuclear plants to local governments and public school districts. The environmental impact
25 of continued power plant operations on tax revenue in local communities and the expenditure of
26 tax revenue are not expected to change appreciably. Tax payments during the license renewal
27 term would be similar to those already being paid. Based on these considerations, the NRC
28 concludes impacts from continued nuclear plant operations during initial LR and SLR terms and
29 refurbishment on tax revenue would be the same—SMALL for all nuclear plants. The staff
30 reviewed information from SEISs (for initial LRs and SLRs) completed since development of the
31 2013 LR GEIS and identified no new information or situations that would result in different
32 impacts for this issue for either an initial LR or SLR term. Therefore, tax revenue impacts would
33 be SMALL for all nuclear plants and a Category 1 issue for both initial LRs and SLRs.

34 4.8.1.3 Community Services and Education

35 Impacts from continued power plant operations and refurbishment activities on public
36 (community) services and education were evaluated based on the projected number of “in-
37 migrating” workers with families during the renewal term. Public safety, social services, and
38 public utility impacts were also considered.

39 Workforce changes at a nuclear plant can affect the demand for public services in local
40 communities. Environmental reviews have shown, however, that the number of operations
41 workers at nuclear plants has not changed significantly because of license renewal, so demand-
42 related impacts on community services and public utilities are not anticipated. In addition,

1 refurbishment activities, including steam generator and vessel head replacement, are being
2 conducted during regularly scheduled refueling and maintenance outages.

3 Tax payments support a range of community services, including public water, safety, fire
4 protection, health, social, and educational services. In some communities, tax revenue from
5 nuclear plants have had a noticeable beneficial impact on the quality and availability of public
6 services to local residents. Nevertheless, the impact of continued operations and refurbishment
7 activities on community services and education is SMALL and is not expected to change as a
8 result of license renewal.

9 Based on these considerations, the NRC concludes that impacts from continued nuclear plant
10 operations during initial LR and SLR terms and refurbishment on community services and
11 education would be the same—SMALL for all nuclear plants. The staff reviewed information
12 from SEISs (for initial LRs and SLRs) completed since development of the 2013 LR GEIS and
13 identified no new information or situations that would result in different impacts for this issue for
14 either an initial LR or SLR term. Therefore, community services and education impacts would
15 be SMALL for all nuclear plants and a Category 1 issue for both initial LRs and SLRs.

16 4.8.1.4 *Population and Housing*

17 Nuclear power plant-induced population changes, while not an impact in themselves, were
18 studied as a potential influence on a number of socioeconomic impact issues analyzed in the LR
19 GEIS. As previously discussed, however, employment levels at nuclear plants are not expected
20 to change. Therefore, the operational effects of continued operations and refurbishment
21 activities on population and housing values and availability are not expected to change from
22 what is already being experienced near nuclear power plants, and no changes in housing
23 demand is expected during the license renewal term.

24 The increased number of workers at nuclear power plants during regularly scheduled refueling
25 and maintenance outages increases the short-term demand for temporary (rental) housing units
26 near each nuclear plant. However, because of its short duration and repeated nature,
27 employment-related housing impacts have little or no long-term effect on the price and
28 availability of rental housing. In addition, refurbishment activities, including steam generator and
29 vessel head replacement, are being conducted during these refueling and maintenance
30 outages. Therefore, refurbishment-related housing demand impacts would be similar to what is
31 already being experienced during regularly scheduled refueling and maintenance outages.

32 Environmental reviews performed since development of the 2013 LR GEIS have shown that the
33 number of workers at nuclear plants are not expected to change because of license renewal, so
34 changes in population and housing availability and value are not anticipated. Based on these
35 considerations, the NRC concludes impacts from continued nuclear plant operations during
36 initial LR and SLR terms and refurbishment on population and housing would be the same—
37 SMALL for all nuclear plants. The staff reviewed information from SEISs (for initial LRs and
38 SLRs) completed since development of the 2013 LR GEIS and identified no new information or
39 situations that would result in different impacts for this issue for either an initial LR or SLR term.
40 Therefore, population and housing impacts would be SMALL for all nuclear plants and a
41 Category 1 issue for both initial LRs and SLRs.

Environmental Consequences and Mitigating Actions

1 4.8.1.5 *Transportation*

2 Transportation impacts depend on the size of the workforce, the capacity of the local road
3 network, traffic patterns, and the availability of alternate commuting routes to and from the
4 nuclear plant. Because most nuclear power plants have a single access road, there is often
5 congestion during shift changes.

6 Transportation impacts are ongoing and have become well-established at all nuclear power
7 plants. As previously discussed, the number of workers is unlikely to change during the license
8 renewal term, and environmental reviews have shown little or no need for additional operations
9 workers. In addition, refurbishment activities, including steam generator and vessel head
10 replacement, are being conducted during regularly scheduled refueling and maintenance
11 outages.

12 The increased number of workers at nuclear power plants during refueling and maintenance
13 outages have caused short-term increases in traffic volumes on roads in the vicinity of each
14 plant. However, because of the relative short duration of these outages, increased traffic
15 volumes have had little or no lasting impact. Therefore, there would be no transportation
16 impacts during the license renewal term beyond those already being experienced. Based on
17 these considerations, the NRC concludes transportation impacts from continued nuclear plant
18 operations during initial LR and SLR terms and refurbishment would be the same—SMALL for
19 all nuclear plants. The staff reviewed information from SEISs (for initial LRs and SLRs)
20 completed since development of the 2013 LR GEIS and identified no new information or
21 situations that would result in different impacts for this issue for either an initial LR or SLR term.
22 Therefore, transportation impacts would be SMALL for all nuclear plants and a Category 1 issue
23 for both initial LRs and SLRs.

24 **4.8.2 Environmental Consequences of Alternatives to the Proposed Action**

25 Communities have the potential to be both directly and indirectly affected by the construction
26 and operation of a new power plant. The power plant and the communities that support it can
27 be described as a dynamic socioeconomic system. Communities provide the people, goods,
28 and services needed to construct and operate the new power plant. The power plant, in turn,
29 provides employment and income (wages, salaries, and benefits) and pays for goods and
30 services. The measure of a communities' ability to support the new power plant depends on its
31 ability to respond to changing environmental, social, economic, and demographic conditions.

32 *Construction* – The scale and duration of the socioeconomic impact is determined by the cost,
33 complexity, and size of the replacement energy-generating facility and the workforce needed to
34 construct the new power plant. Socioeconomic impacts may be greater at greenfield sites in
35 rural areas than at brownfield sites in urban areas. Overall, construction would have a
36 temporary effect on the local economy.

37 Some construction workers may temporarily relocate from outside the region depending on the
38 need for and the availability of skilled crafts and trades workers. Larger numbers of workers
39 would likely relocate to rural construction sites, while urban construction sites would likely see
40 workers commuting daily to the job site. Some construction material (e.g., sand, gravel, fill, etc.)
41 and equipment may be available locally. Other construction materials, equipment, and
42 components may need to be shipped in from outside the region. Transportation during
43 construction would include commuter vehicles and truck, barge, or rail material and equipment
44 delivery to and from the construction site.

1 *Operations* – Operating a new power plant would have a greater permanent effect on the local
2 economy than during construction. Socioeconomic impacts would be greater in rural areas and
3 may be less noticeable in urban areas. Local property values could be affected by the need for
4 permanent housing by power plant operations workers. Conversely, the visual industrial impact
5 of the power plant during operations, traffic, and noise, could negatively affect property values.

6 Depending on location, an operating power plant could also negatively affect recreation and
7 tourism interests, resulting in reduced employment and income opportunities in these sectors of
8 the economy. Transportation during power plant operations includes commuter vehicle and
9 material and equipment truck deliveries and removal of waste.

10 The following sections briefly highlight the socioeconomic impacts of replacement energy
11 alternatives.

12 4.8.2.1 *Fossil Energy Alternatives*

13 Construction and operation of fossil fuel-fired power plants requires a very large workforce
14 compared to other types of power plants and renewable technologies. Differences between
15 natural gas- and coal-fired power plants include the transportation impacts associated with coal
16 deliveries (rail or barge) and the removal of coal ash, waste, and other byproducts that may
17 affect property values and, depending on location, recreation and tourism interests in the vicinity
18 of the power plant.

19 4.8.2.2 *New Nuclear Alternatives*

20 Similar to a fossil-fueled power plant, a large workforce would be required to construct and
21 operate a new nuclear power plant. The presence of a nuclear power plant could affect
22 property values and, depending on location, recreation and tourism interests in the vicinity of the
23 power plant.

24 4.8.2.3 *Renewable Alternatives*

25 *Construction and Operation* – Compared to fossil fuel and new nuclear energy, renewable
26 energy production would require a very small construction and operation workforce. In addition,
27 the construction of a new reservoir and dam for hydroelectric power generation would create
28 new recreational employment and income opportunities based on park, campground, and boat
29 ramp visitors. Traffic would increase on roads in the vicinity of the reservoir. Wind, solar, and
30 geothermal power generation could adversely affect recreation interests and property values in
31 rural communities. Transportation impacts would be limited due to the small size of the
32 workforce.

33 Conversely, local transportation networks could be affected by truck and rail traffic delivering
34 biomass fuel and removing waste to offsite disposal facilities. Property values, recreation, and
35 tourism interests could be adversely affected near the biomass and municipal solid waste,
36 refuse-derived and landfill gas-fired power plants.

37 Tourist and recreational interests and commerce on coastal beaches could be affected by the
38 visual impact of offshore wind turbines and ocean wave and current power-generating facilities.
39 Wave energy devices on the ocean surface could affect navigation and waterborne recreational
40 and commerce activities.

1 **4.9 Human Health**

2 **4.9.1 Environmental Consequences of the Proposed Action – Continued Operations**
3 **and Refurbishment Activities**

4 Human health conditions at all nuclear power plants and associated transmission lines have
5 been well established during the current licensing term. Based on past environmental
6 monitoring data and trends, no significant human health impacts are anticipated during the
7 license renewal (initial LR or SLR) term that would be different from those occurring during the
8 current license term. Certain operational changes (such as extended power uprates) that could
9 potentially affect human health would be evaluated by the NRC in a separate safety and
10 environmental review.

11 *4.9.1.1 Environmental Consequences of Normal Operating Conditions*

12 This section provides an evaluation of the impacts of radiological, chemical, microbiological,
13 EMFs, and physical hazards on occupational personnel and members of the public from
14 continued operation and any refurbishment activities during the initial LR and SLR terms. This
15 evaluation extends to all U.S. commercial nuclear power reactors. For safe and reliable
16 operation of a nuclear power plant, it is necessary to perform routine maintenance on plant
17 systems and components. Maintenance activities conducted at nuclear power plants include
18 inspection, surveillance, and repair and/or replacement of material and equipment to maintain
19 the current licensing basis of the plant and maintain compliance with environmental and public
20 safety requirements. Certain activities can be performed while the reactor is operating, and
21 others require that the reactor be shut down. Long-term outages are scheduled for refueling
22 and for certain types of repairs or maintenance activities, such as the replacement of steam
23 generators for pressurized water reactors (PWRs).

24 *4.9.1.1.1 Radiological Exposure and Risk*

25 Two environmental issues related to radiological exposure and risk are reviewed here:
26 (1) radiation exposures to plant workers and (2) radiation exposures to the public, both of which
27 would result from continued operation and refurbishment activities during the initial LR or SLR
28 terms.

29 For the purposes of assessing radiological impacts, impacts are considered to be SMALL if
30 releases and doses do not exceed the permissible levels in the NRC's regulations. This
31 definition of SMALL applies to occupational doses as well as to doses to individual members of
32 the public. Accidental releases or noncompliance with the standards could conceivably result in
33 releases that would cause MODERATE or LARGE radiological impacts. Such conditions are
34 beyond the scope of regulations for controlling normal operations and providing an adequate
35 level of protection. Environmental consequences and the human health effects of potential
36 accidents are addressed in Section 4.9.1.2.

37 **Radiation Exposures to Plant Workers**

38 The occupational radiological exposures from current operations at nuclear power plants and
39 the risk estimates from this radiation exposure are discussed in Section 3.9.

40 In the 1996 LR GEIS, the impacts from occupational radiological exposure from refurbishment
41 and continued operations were evaluated separately. To estimate radiation-related impacts on

1 workers over the license renewal term, occupational radiation exposure was used as the
 2 environmental impact initiator that was quantified. It was assumed that occupational radiation
 3 exposure would change relative to current nuclear plant operations as a result of actions taken
 4 to support license renewal. To evaluate the impacts, two types of license renewal programs
 5 were considered: a “typical” or “mid-stream” license renewal program, and a “conservative” or
 6 “bounding” program (NRC 1996). Each program applied to both PWRs and boiling water
 7 reactors (BWRs). Thus, in all, four scenarios were considered. It was assumed that activities
 8 carried out in support of license renewal would be performed primarily during selected outages.

9 Five types of outages were considered: normal refuelings, 5-year in-service inspection (ISI)
 10 outages, 10-year ISI outages, current-term refurbishment outages, and major refurbishment
 11 outages. The potential actions and activities that would be undertaken during these outages
 12 were identified. All of the rules and regulations, in particular the Maintenance Rule
 13 (10 CFR 50.65, “Requirements for Monitoring the Effectiveness of Maintenance at Nuclear
 14 Power Plants”), were taken into account in developing typical license renewals or plant-life
 15 extensions (NRC 1996). The occupational exposure for each of the five types of outages was
 16 estimated for all four scenarios (see Table 4.9-1). This analysis is bounding for both the initial
 17 LR and SLR terms as discussed below.

18 For refurbishment efforts, collective occupational dose estimates for activities during each of the
 19 four current-term refurbishment outages were 11 and 10 person-rem for PWRs and BWRs,
 20 respectively, for the typical case; and 200 and 191 person-rem, respectively, for the
 21 conservative case. Collective occupational dose estimates for the assumed single period of
 22 major refurbishment were 79 and 153 person-rem for PWRs and BWRs, respectively, for the
 23 typical case; and 1,380 and 1,561 person-rem, respectively, for the conservative case. The
 24 individual occupational doses would be well below regulatory limits specified in Table 3.9-1 (i.e.,
 25 the impact would be SMALL), and the issue was designated as a Category 1 issue.

26 **Table 4.9-1 Additional Collective Occupational Dose (person-rem) for Different Actions**
 27 **under Typical and Conservative Scenarios during the License Renewal**
 28 **Term**

Outage Type	Typical BWR	Conservative BWR	Typical PWR	Conservative PWR
Normal refueling ^(a)	4	10	3	7
5-yr ISI refueling ^(b)	71	27	30	35
10-yr ISI refueling ^(c)	91	108	51	66
Current-term refurbishment ^(d)	10	191	11	200
Major refurbishment outage ^(e)	153	1,561	79	1,380
Total all occurrences	457	2,666	261	2,374

29 BWR = boiling water reactor; ISI = in-service inspection; PWR = pressurized water reactor.

30 (a) 8 occurrences, 2-month duration each.

31 (b) 2 occurrences, 3-month duration each.

32 (c) 1 occurrence, 4-month duration for conservative and 3-month duration for typical scenario.

33 (d) 4 occurrences, 4-month duration for conservative and 3-month duration for typical scenario.

34 (e) 1 occurrence, 9-month for conservative and 4-month duration for typical scenario.

35 Sources: Tables 2.8 and 2.11 in the 1996 LR GEIS.

36 For continued operations during the license renewal term, the NRC observed in the 1996 LR
 37 GEIS that the greatest increment to occupational dose over the present dose would occur

Environmental Consequences and Mitigating Actions

1 during a 10-year ISI refueling. In a typical case, the collective occupational dose would increase
2 over the present dose by 91 person-rem for a BWR and by 51 person-rem for a PWR. In a
3 conservative case, the collective occupational dose would increase over the present dose by
4 108 person-rem and 66 person-rem, respectively, for BWRs and PWRs. The individual
5 occupational doses would be well below regulatory limits (i.e., the impact would be SMALL), and
6 the issue was designated as a Category 1 issue.

7 For estimating the impacts from continued operation and any refurbishment activities during the
8 initial LR or SLR term in this LR GEIS revision, the occupational exposure histories for all
9 commercial nuclear power plants were evaluated for trends.

10 Throughout the nuclear power industry, modification and upgrade activities have continued at
11 each operating plant. They have included a broad range of activities in response to NRC
12 requirements and industry initiatives, including post-Three Mile Island upgrades, radioactive
13 waste system modifications, and spent fuel storage upgrades. In addition, several nuclear
14 power plants have undergone major refurbishment efforts, such as PWR steam generator
15 replacement and the replacement of coolant recirculation piping in BWRs. These activities
16 offered a significant potential for occupational exposure. Thus, occupational exposure histories
17 accumulated to date reflect normal operation plus modifications and additions to existing
18 systems. This information forms the basis for evaluating the occupational doses that result from
19 refurbishment and continued operations during initial LR or SLR terms. The data in
20 Table 3.9-11, Table 3.9-12, Table 3.9-13, and Table 3.9-14 show that there are variations in
21 occupational dose from year to year, but there is no consistent trend that shows that
22 occupational doses are increasing over time.

23 Since 1996, 96 operating reactors at approximately 59 nuclear power plant sites have
24 undergone an environmental review for license renewal. Many nuclear power plants have
25 already replaced major components like steam generators during their current license term.
26 Moreover, as part of the license renewal application, the plant licensees have conducted an
27 aging management review. All of the plant licensees expect to conduct the activities related to
28 managing impacts from aging during plant operation or normal refueling and other outages, but
29 they do not plan any outage specifically for the purpose of refurbishment. License renewal
30 applicants have indicated that the activities conducted during the initial LR or SLR terms are
31 expected to be within the bounds of normal operations; thus, even the typical scenario in the
32 1996 LR GEIS can be considered conservative.

33 Overall, data presented in tables in Section 3.9 provide ample evidence that occupational doses
34 at all commercial power plants are far below the occupational dose limit of 5 rem/yr established
35 by 10 CFR Part 20 and that the continuing efforts to maintain doses at ALARA levels have been
36 successful.

37 The wide range of annual collective doses experienced at PWRs and BWRs in the
38 United States results from a number of factors, such as the reactor design, amount of required
39 maintenance, and amount of reactor operations and in-plant surveillance. Because these
40 factors can vary widely and unpredictably, it is difficult to determine in advance specific year-to-
41 year occupational radiation doses for a particular plant over its operating lifetime. On occasion,
42 relatively high collective occupational doses (compared to the average annual collective dose)
43 may be unavoidable, even at plants with radiation protection programs designed to make sure
44 that occupational doses will be kept to ALARA levels.

1 Occupational doses have shown a declining trend over the past 10 years and have recently
2 leveled off. As plants age, there may be slight increases in radioactive inventories, which would
3 result in slight increases in occupational radiation doses, but no such trend has been observed
4 in the monitoring data.

5 Overall, data presented in the tables in Section 3.9 provide evidence that doses to nearly all
6 radiation workers are far below the worker dose limit established by 10 CFR Part 20 and that
7 the continuing efforts to maintain doses at ALARA levels have been successful.

8 Occupational doses from refurbishment activities associated with license renewal and
9 occupational doses for continued operations during the initial LR or SLR terms are expected to
10 be similar to the doses during the current operations and bounded by the analysis conducted in
11 the 1996 LR GEIS. It is estimated that the occupational doses would be much less than the
12 regulatory dose limits, as described above. Expected occupational radiation exposures meet
13 the standard for being of SMALL significance. No mitigation measures beyond those
14 implemented during the current license term would be warranted, because the ALARA process
15 continues to be effective in reducing radiation doses.

16 In the 1996 and 2013 LR GEISs, the NRC concluded that the occupational radiological
17 exposure impact during license renewal and refurbishment would be SMALL for all plants; it was
18 therefore designated as a Category 1 issue. The staff reviewed information from SEISs (for
19 initial LRs and SLRs) completed since development of the 2013 LR GEIS and identified no new
20 information or situations that would result in different impacts for this issue for either an initial LR
21 or SLR term. On this basis, the NRC concludes that the impact of continued operations during
22 initial LR or SLR terms and any refurbishment activities on occupational radiological exposure
23 during the initial LR or SLR terms would be SMALL for all nuclear plants. This is a Category 1
24 issue.

25 **Radiation Exposures to the Public**

26 Radiological exposures to the public from current operations at nuclear power plants are
27 discussed in Section 3.9.1.3. That section includes a discussion of the effluent pathways used
28 in calculating dose and the radiological monitoring performed at each nuclear plant site to make
29 sure that unanticipated buildup of radioactivity has not occurred in the environment. The risk
30 estimates for the public from radiation exposure are discussed in Section 3.9.1.4.

31 During continued operations following initial LRs or SLRs, small quantities of radioactivity
32 (fission, corrosion, and activation products) will continue to be released to the environment in a
33 manner similar to that occurring during present operations (see Section 3.9).

34 In both the 1996 and 2013 LR GEIS, the NRC evaluated the significance of the estimated public
35 dose from refurbishment activities such as steam generator replacement in PWRs and
36 replacement of recirculation piping in BWRs. Public radiation exposures from gaseous and
37 liquid effluents produced during refurbishment activities can be evaluated on the basis of
38 effluent data from the replacement of steam generators and recirculation piping as discussed in
39 the 2013 LR GEIS. During the replacement of steam generators and recirculation piping,
40 releases of effluents have occurred under controlled conditions and in accordance with ALARA
41 principles. Similar refurbishment efforts that may occur as part of continued operations
42 following initial LR or SLR would also take place under controlled conditions and in accordance
43 with ALARA principles.

Environmental Consequences and Mitigating Actions

1 The concentration of radioactive materials in soils and sediments increases in the environment
2 at a rate that depends on the rate of release and the rate of removal. Removal can take place
3 through radioactive decay or through chemical, biological, or physical processes. For a given
4 rate of release, the concentrations of longer-lived radionuclides and, consequently, the dose
5 rates attributable to them would continue to increase if license renewal was granted.

6 Regulatory Guide 1.109 (NRC 1977) provides guidance for calculating the dose for significant
7 release pathways. To account for the buildup of radioactive materials, buildup factors are
8 included in the calculations. The accumulation of radioactive materials in the environment is of
9 concern not only with regard to license renewal but also with regard to operation under current
10 licenses. NRC reporting rules require that pathways that may arise as a result of unique
11 conditions at a specific nuclear power plant site be considered in licensees' evaluations of
12 radiation exposures. If an exposure pathway is likely to contribute significantly to total dose
13 (10 percent or more to the total dose from all pathways), it must be routinely monitored and
14 evaluated. Environmental monitoring programs are in place at all plant sites to provide a
15 backup to the calculated doses based on effluent release measurements. Because these
16 programs are ongoing for the duration of the plant's license, locations where unique situations
17 give rise to significant pathways that are not detailed in NRC Regulatory Guide 1.109 are to be
18 identified if and when they become significant. If such pathways result in doses at a plant
19 exceeding the design objectives of Appendix I to 10 CFR Part 50, action is required.

20 The radiation dose to the public from current operations results from gaseous effluent releases
21 and from liquid effluent releases, as presented in Section 3.9.1.3. At present, for all operating
22 nuclear plants, doses to the maximally exposed individual (MEI) are much less than the design
23 objectives of Appendix I to 10 CFR Part 50 (Table 3.9-2). No aspect of future operation has
24 been identified that would substantially alter this situation.

25 Maximum individual doses are reported in annual effluent release reports, and if these doses
26 exceed Appendix I to 10 CFR Part 50 design objectives, the NRC would pursue remedial action.
27 Thus, these issues are handled on a case-by-case basis. Almost all nuclear power plants have
28 gone through initial LR, and no aging phenomenon that would increase public radiation doses
29 has been identified. The operating reactors are not expected to reach regulatory dose limits
30 more often in the period after initial LR or SLR than they do at present. For these reasons, dose
31 impacts on MEIs in the public during future operation are judged to be unchanged from those
32 during present operations. Although dose rates (mrem/yr) are not expected to change during
33 initial LRs or SLRs, the cumulative dose (total mrem) would increase as a result of 20 to 40
34 more years of operations. However, it is unlikely that the same person would be exposed to
35 these doses during the initial LR or SLR term.

36 One of the pathways considered when calculating the MEI doses is direct radiation from
37 operating plants. Radiation fields are produced around nuclear plants as a result of radioactivity
38 within the reactor and its associated components, low-level storage containers, and components
39 such as steam generators that have been removed from the reactor. Direct radiation from
40 sources within a light water reactor (LWR) plant is due primarily to nitrogen-16, a radionuclide
41 produced in the reactor core by neutron activation of oxygen-16 in the water. Because the
42 primary coolant of an LWR is contained in a heavily shielded area, dose rates in the vicinity of
43 LWRs are generally undetectable and less than 1 mrem/yr at the site boundary. Some plants
44 (mostly BWRs) do not have completely shielded secondary systems and may contribute some
45 measurable offsite dose. However, these sources of direct radiation will be unaffected by
46 license renewal.

1 In addition to the regulations within 10 CFR 20.1101 that speak directly to required operation
2 under ALARA principles, 10 CFR 50.36a imposes conditions on nuclear plant licensees in the
3 form of technical specifications on effluents from nuclear power reactors. These specifications
4 are intended to keep releases of radioactive materials to unrestricted areas during operations to
5 ALARA levels. Appendix I to 10 CFR Part 50 provides numerical guidance on dose-design
6 objectives and limiting conditions for the operation of LWRs to meet the ALARA requirements.
7 These regulations will remain in effect during the period of license renewal.

8 To date, 96 operating reactors at 59 nuclear power plant sites have gone through license
9 renewal. In all cases, the radiation dose to members of the public from routine operations was
10 within NRC regulations as presented in Section 3.9.1.3. This information was used to support
11 the conclusion that the radiation dose to the public will continue at current levels associated with
12 normal operations and is expected to remain much lower than the applicable standards.

13 Offsite doses to the public attributable to refurbishment activities were examined for the MEI.
14 Because the focus of the analysis is on annual dose, only the results based on the most likely
15 major refurbishment action were examined (i.e., replacing steam generators in PWRs and
16 primary recirculation piping in BWRs). For this action, doses to the public were found to be
17 SMALL. To date, effluents and doses during periods of major refurbishments have not been
18 observed to differ significantly from those during normal operations. Consequently, gaseous
19 effluents and liquid discharges occurring during major refurbishment actions are not expected to
20 result in maximum individual doses exceeding the design objectives of Appendix I to
21 10 CFR Part 50 (Table 3.9-2) or the allowable EPA standards of 40 CFR Part 190, Subpart B
22 (Table 3.9-3).

23 Radiation doses to members of the public from current operations of nuclear power plants have
24 been examined from a variety of perspectives, and the impacts were found to be well within
25 design objectives and regulations in each instance. No effect of aging that would significantly
26 affect the radioactive effluents has been identified. Public doses are expected to remain well
27 within design objectives and regulations.

28 Because there is no reason to expect effluents to increase in the period during the initial LR or
29 SLR term, doses from continued operation are expected to be well within regulatory limits. No
30 mitigation measures beyond those implemented during the current-term license would be
31 warranted because current mitigation practices have kept public radiation doses well below
32 regulatory standards and are expected to continue to do so.

33 Public radiological exposure impacts during license renewal and refurbishment activities were
34 considered to be SMALL for all plants and were designated as Category 1 issues in the 1996
35 and 2013 LR GEISs. The staff reviewed information from SEISs (for initial LRs and SLRs)
36 completed since development of the 2013 LR GEIS and identified no new information or
37 situations that would result in different impacts for this issue for either an initial LR or SLR term.
38 On the basis of these considerations, the NRC concludes that the impact of continued
39 operations and refurbishment activities on public radiological exposure during the initial LR and
40 SLR terms would be SMALL for all nuclear plants. This is a Category 1 issue.

41 *4.9.1.1.2 Nonradiological Hazards*

42 Nonradiological hazards, such as chemical, biological, EMFs, and physical hazards are not
43 unique to nuclear power plants and occur in many types of industrial facilities. However, certain

Environmental Consequences and Mitigating Actions

1 nonradiological hazards can be enhanced by physical plant elements or characteristics of
2 nuclear power plants, as discussed in detail in Section 3.9.2.

3 **Chemical Hazards**

4 This renamed issue has been revised from the issue “Human health impact from chemicals” in
5 the 2013 LR GEIS for the purposes of clarity and to reflect the fact that chemicals can have
6 environmental effects beyond human health.

7 A chemical hazard occurs when workers or members of the public are exposed to a
8 nonradiological hazardous substance by inhalation, skin absorption, or ingestion. Chemical
9 hazards can have immediate effects (nausea, vomiting, acid burns, asphyxiation—also known
10 as acute hazards) or the effects might take time to develop (dermatitis, asthma, liver damage,
11 cancer—also known as chronic hazards). In nuclear power plants, chemical effects could result
12 from discharges of chlorine or other biocides, small-volume discharges of sanitary and other
13 liquid wastes, chemical spills, or heavy metals leached from cooling system piping and
14 condenser tubing. Impacts of chemical discharges on human health are considered to be
15 SMALL if the discharges of chemicals to water bodies are within effluent limitations designed to
16 protect water quality and if ongoing discharges have not resulted in adverse effects on aquatic
17 biota. During the initial LR or SLR term, human health impacts from chemicals are expected to
18 be the same as those experienced during operations under the original license term (see
19 Section 3.9.2 for more details).

20 The types of chemical hazards that exist at a nuclear power plant are discussed in
21 Section 3.9.2.1. Plant workers may encounter hazardous chemicals when the chemistries of
22 the primary and secondary coolant systems are being adjusted, biocides are being applied to
23 address the fouling of cooling system components, equipment containing hazardous oils or
24 other chemicals is being repaired or replaced, solvents are being used for cleaning, or other
25 equipment is being repaired. Exposures to hazardous chemicals are minimized when plant
26 workers follow good industrial hygiene practices.

27 Reviews of the literature and operational monitoring reports and consultations with utilities and
28 regulatory agencies that were conducted for the 1996 LR GEIS indicated that the effects of the
29 discharge of chlorine and other biocides on water quality would be of SMALL significance for all
30 nuclear power plants. Small quantities of biocides are readily dissipated and/or chemically
31 altered in the water body receiving them, so significant cumulative impacts on water quality
32 would not be expected. Major changes in the operation of the cooling system are not expected
33 during the license renewal terms, so no change in the effects of biocide discharges on the
34 quality of the receiving water is anticipated. Major proposed changes in cooling system
35 operations (e.g., those affecting the plant’s licensing basis and possibly triggering a license
36 amendment) would require a separate NEPA review, including an examination of human health
37 effects. In addition, proposed changes in the use of cooling water treatment chemicals would
38 require review by the plant’s NPDES permit-issuing authority and possible modification of the
39 existing NPDES permit, including examination of the human health effects of the change. The
40 effects of biocide discharges could be reduced by increasing the degree to which discharge
41 water is treated, reducing the concentration of biocides, or treating only a portion of the plant
42 cooling and service water systems at one time. Discharges of sanitary wastes are regulated by
43 the plant’s NPDES permit or other regulatory approval, and discharges that do not violate the
44 permit limits are considered to be of SMALL significance.

1 The effects of minor chemical discharges and spills at nuclear plants on water quality have been
2 of SMALL significance and mitigated as needed. Significant cumulative impacts on water
3 quality would not be expected because the small amounts of chemicals released by these minor
4 discharges or spills are readily dissipated in the receiving water body. While there may be
5 additional management practices or discharge-control devices that could further reduce the
6 frequency of accidental spills and off-specification discharges, they are not warranted because
7 impacts are already SMALL and occur at a low frequency.

8 Heavy metals (e.g., copper, zinc, and chromium) may be leached from condenser tubing and
9 other heat exchangers and discharged by power plants as small-volume waste streams or
10 corrosion products. Although all are found in small quantities in natural waters (and many are
11 essential micronutrients), concentrations in the power plant discharge are controlled in the
12 NPDES permit because excessive concentrations of heavy metals can be toxic to aquatic
13 organisms.

14 Nuclear power plants may be required in some instances to submit annual reports on the
15 environmental releases of listed toxic chemicals manufactured, processed, or otherwise used
16 that are above identified threshold quantities depending on State regulations or other specific
17 circumstances. The disposal of essentially all of the hazardous chemicals used at nuclear
18 power plants is regulated by Resource Conservation and Recovery Act (RCRA; 42 U.S.C. §
19 6901 et seq.) or NPDES permits. The NRC requires nuclear power plants to operate in
20 compliance with all of its environmental permits, thereby minimizing adverse impacts on the
21 environment and on workers and the public. It is anticipated that all plants will continue to
22 operate in compliance with all applicable permits, and no mitigation measures beyond those
23 implemented during the current-term license would be warranted as a result of initial LR or SLR.

24 The staff reviewed information from SEISs (for initial LRs and SLRs) completed since
25 development of the 2013 LR GEIS and identified no new information or situations that would
26 result in different impacts for this issue for either an initial LR or SLR term. On the basis of
27 these considerations, the health impact from chemicals on workers and the public, as well as on
28 the environment, during the initial LR and SLR terms is considered SMALL for all nuclear plants.
29 This renamed issue is a Category 1 issue.

30 4.9.1.1.3 Microbiological Hazards

31 Microbiological hazards occur when workers or members of the public come into contact with
32 disease-causing microorganisms, also known as etiological agents. Microbiological organisms
33 of concern for public and occupational health, include enteric pathogens (bacteria that typically
34 exist in the intestines of animals and humans [e.g., *Pseudomonas aeruginosa*]), thermophilic
35 fungi, bacteria (e.g., *Legionella spp.* and *Vibrio spp.*), free-living amoebae (e.g., *Naegleria*
36 *fowleri* and *Acanthamoeba spp.*), as well as organisms that produce toxins that affect human
37 health (e.g., dinoflagellates [*Karenia brevis*] and blue-green algae). During initial LR and SLR
38 terms, plant workers and members of the public would be exposed to microbiological hazards in
39 the same way that they are exposed during operations under the original license term (see
40 Section 3.9.2.2 for details).

Environmental Consequences and Mitigating Actions

1 Two environmental issues related to microbiological hazards are reviewed here:
2 (1) microbiological hazards to plant workers and (2) microbiological hazards to the public (this
3 issue was modified and renamed from the 2013 LR GEIS to include waters of the United States
4 accessible to the public).

5 **Microbiological Hazards to Plant Workers**

6 No change in existing microbiological hazards is expected due to license renewal, for the
7 reasons discussed in detail in the 2013 LR GEIS. It is considered unlikely that any plants that
8 have not already experienced occupational microbiological hazards would do so during the
9 license renewal term or that hazards would increase during that period. The staff reviewed
10 information from SEISs (for initial LRs and SLRs) completed since development of the 2013 LR
11 GEIS and identified no new information or situations that would result in different impacts for this
12 issue for either an initial LR or SLR term. It is anticipated that all plants will continue to employ
13 proven industrial hygiene principles so that adverse occupational health effects associated with
14 microorganisms during the initial LR and SLR terms will be of SMALL significance at all sites,
15 and no mitigation measures beyond those implemented during the current-term license would
16 be warranted. Aside from continued application of accepted industrial hygiene procedures, no
17 additional mitigation measures are expected to be warranted as a result of license renewal.
18 This is a Category 1 issue.

19 **Microbiological Hazards to the Public**

20 This renamed issue is an expansion of the issue “Microbiological hazards to the public (plants
21 with cooling ponds or canals or cooling towers that discharge to a river)” in the 2013 LR GEIS
22 because this issue is a concern wherever receiving waters are accessible to the public.
23 Specifically, members of the public could be exposed to microorganisms in thermal effluents at
24 nuclear power plants that use cooling ponds, lakes, canals, or that discharge to any waters of
25 the United States accessible to the public. As discussed in Section 3.9.2.2, the SEISs
26 published since 2013 were reviewed to determine the level of thermophilic microbiological
27 organism enhancement in waters accessible to the public. Although reviews to date note that
28 health departments did not have concerns related to microbiological hazards, changes in
29 microbial populations and in the public use of water bodies might occur after the operating
30 license is issued and the application for initial LR or SLR is filed. Other factors could also
31 change, including the average temperature of the water, which could result from climate change
32 affecting water levels and air temperature. Finally, the long-term presence of a power plant
33 might change the natural dynamics of harmful microorganisms within a body of water.
34 Therefore, the magnitude of the potential public health impacts associated with thermal
35 enhancement of thermophilic organisms during the initial LR and SLR terms could be SMALL,
36 MODERATE, or LARGE, depending on plant-specific conditions. This renamed issue is a
37 Category 2 issue.

38 *4.9.1.1.4 Electromagnetic Fields (EMFs)*

39 This renamed issue is a clarification of the issue “Chronic effects of electromagnetic fields” in
40 the 2013 LR GEIS because this issue concerns effects beyond just those that might be chronic
41 in nature. Nuclear power plants use power transmission systems that consist of switching
42 stations (or substations) located on the plant site and transmission lines located primarily offsite
43 that connect the power plant to the regional electric grid. Electric fields and magnetic fields,
44 collectively referred to as EMFs, are produced by any electrical equipment, including operating
45 transmission lines. During the initial LR or SLR, plant workers and members of the public who

1 live, work, or pass near an associated operating transmission line may be exposed to EMFs in
2 the same way that they are exposed during the current license term (see Section 3.9.2.3 for
3 more detail). One environmental issue related to EMFs is reviewed in this section: chronic
4 effects of EMFs. The issue was further evaluated in the 2013 LR GEIS by reviewing the
5 relevant literature.

6 As in the 2013 LR GEIS, it should be noted that the scope of the evaluation of transmission
7 lines includes only those transmission lines that connect the plant to the switchyard where
8 electricity is fed into the regional power distribution system (encompassing those lines that
9 connect the plant to the first substation of the regional electric power grid) and power lines that
10 feed the plant from the grid are considered within the regulatory scope of license renewal
11 environmental review (see Sections 3.1.1 and 3.1.6.5 in this GEIS).

12 EMF health studies have been the subject of published studies, and a discussion of some of
13 these studies was presented in the 2013 LR GEIS in Section 4.9.1.1.4 and is incorporated here
14 by reference. A review of the biological and physical studies of 60 hertz (Hz) EMFs completed
15 during preparation of the 2013 LR GEIS did not find any consistent evidence that would link
16 harmful effects with field exposures. EMFs are unlike other agents that have a toxic effect (e.g.,
17 toxic chemicals and ionizing radiation) in that dramatic acute effects cannot be forced, and
18 longer-term effects, if real, are subtle. Nonetheless, a wide range of biological responses have
19 been reported to be affected by EMFs.

20 Even if clear adverse effects were apparent in the epidemiology literature or with some
21 biological assay, considerable additional work would be required to determine how and what to
22 mitigate because evidence suggests that the severity of some EMF biological effects may not
23 correlate directly with exposure. Furthermore, there may be a subtle relationship between the
24 intensity of the local geomagnetic field and the appearance of effects for some intensities of
25 60 Hz fields. This complicating evidence points to the fact that, while much experimental and
26 epidemiological evidence has been accrued, understanding of this issue continues to evolve.

27 For this renamed issue, because of inconclusive scientific evidence, the health effects of EMFs
28 during the initial LR and SLR terms are considered UNCERTAIN, and currently, no generic
29 impact level can be assigned. The NRC will continue to monitor the research initiatives—both
30 those within the national EMF program and others internationally—to evaluate the potential
31 carcinogenicity of EMFs as well as other progress in the EMF study disciplines. If the NRC
32 finds that the appropriate Federal health agencies have reached a consensus on the potential
33 human health effects of exposure to EMF, the NRC will revise the LR GEIS to include the new
34 information and describe effective mitigating measures.

35 *4.9.1.1.5 Physical Hazards*

36 Two additional human health issues are addressed in this section: (1) physical occupational
37 hazards and (2) electric shock hazards, both previously considered in the LR GEIS. Nuclear
38 power plants are industrial facilities that have many of the typical occupational hazards found at
39 any other electric power generation facility. Power plant and maintenance workers could be
40 working under potentially hazardous physical conditions (e.g., excessive heat, cold, and
41 hazardous locations), including those experienced when conducting electrical work, power line
42 maintenance, and repair work. The issue of physical occupational hazards is generic to all
43 nuclear power plants.

Environmental Consequences and Mitigating Actions

1 Transmission lines are needed to transfer energy from the nuclear power plant to consumers.
2 The workers and general public at or around the nuclear power plants and along the
3 transmission lines are potentially exposed to acute electrical shock from these lines. The issue
4 of electrical shock is generic to all nuclear power plants. As described in Sections 3.1.1 and
5 3.1.6.5, in-scope transmission lines include only those lines that would not continue to operate if
6 a plant's license was not renewed. Using this criterion, in-scope transmission lines are those
7 lines that connect the plant to the first substation of the regional electric grid. This substation is
8 frequently, but not always, located on the nuclear plant property.

9 During the initial LR or SLR terms, human health impacts from physical occupational hazards
10 and acute shock hazards would be the same as those from operations during the original
11 license term (see Section 3.9.2.4 for more detail).

12 **Physical Occupational Hazards**

13 The types of physical hazards that exist at a nuclear power plant are discussed in
14 Section 3.9.2.4. The issue of occupational hazards is evaluated by comparing the rate of fatal
15 injuries and nonfatal occupational injuries and illnesses in the utility sector with the rate in all
16 industries combined. Occupational hazards can be minimized when workers adhere to safety
17 standards and use appropriate personal protective equipment; however, fatalities and injuries
18 from accidents can still occur. Data for occupational injuries from the U.S. Bureau of Labor
19 Statistics are discussed in detail in Section 3.9.2.4. The staff reviewed information from SEISs
20 (for initial LRs and SLRs) completed since development of the 2013 LR GEIS and identified no
21 new information or situations that would result in different impacts for this issue for either an
22 initial LR or SLR term. It is expected that during the initial LR or SLR term, workers would
23 continue to adhere to safety standards and use protective equipment, so adverse occupational
24 impacts during the initial LR and SLR terms would be of SMALL significance at all sites, and no
25 mitigation measures beyond those implemented during the current license term would be
26 warranted. This is a Category 1 issue.

27 **Electric Shock Hazards**

28 In-scope transmission lines are those lines that connect the plant to the first substation of the
29 regional electric grid. This substation is frequently, but not always, located on the plant
30 property. The greatest hazard from a transmission line is direct contact with the conductors.
31 Tower designs preclude direct access to the conductors. However, electrical contact can be
32 made without physical contact between a grounded object and the conductor, as discussed in
33 Section 3.9.2.4.1. A person who contacts such an object could receive a shock and experience
34 a painful sensation at the point of contact. The intensity of the shock would depend on the EMF
35 strength, size of the object, and how well the object and person were insulated from ground.

36 The staff reviewed information from SEISs (for initial LRs and SLRs) completed since
37 development of the 2013 LR GEIS. Design criteria for nuclear power plants that limit hazards
38 from steady-state currents are based on the National Electrical Safety Code (NESC), adherence
39 to which requires that power companies design transmission lines so that the short-circuit
40 current to ground produced from the largest anticipated vehicle or object is limited to less than
41 5 mA (IEEE SA 2017). The electrical shock issue, which is generic to all types of electrical
42 generating stations, including nuclear plants, is of SMALL significance for transmission lines that
43 are operated in adherence with the NESC. Without a review of the conformance of each
44 nuclear plant's transmission lines, within this scope of review, with NESC criteria, it is not
45 possible to determine the significance of the electrical shock potential generically during the

1 initial LR or SLR term; it could be SMALL, MODERATE, or LARGE. The hazard of electric
2 shock is a Category 2 issue.

3 *4.9.1.2 Environmental Consequences of Postulated Accidents*

4 *4.9.1.2.1 Design-Basis Accidents and Severe Accidents*

5 Chapter 5 of the 1996 LR GEIS assessed the impacts of postulated accidents at nuclear power
6 plants on the environment. The postulated accidents included design-basis accidents and
7 severe accidents (e.g., those with reactor core damage). The impacts considered included:

- 8 • dose and health effects of accidents (5.3.3.2 through 5.3.3.4 of the 1996 LR GEIS);
- 9 • economic impacts of accidents (5.3.3.5 of the 1996 LR GEIS); and
- 10 • impact of uncertainties on results (5.3.4 of the 1996 LR GEIS).

11 The estimated impacts were based upon the analysis of severe accidents at 28 nuclear power
12 plants,¹⁶ as reported in the environmental impact statements (EISs) and/or final environmental
13 statements prepared for each of the 28 plants in support of their operating licenses. With few
14 exceptions, the severe accident analyses were limited to consideration of reactor accidents
15 caused by internal events. The 1996 LR GEIS addressed the impacts from external events
16 qualitatively. The severe accident analysis for the 28 plants was extended to the remainder of
17 plants whose EISs did not consider severe accidents (because such analysis was not required
18 at the time the other plants' EISs were prepared). The estimates of environmental impact
19 contained in the 1996 LR GEIS used 95th percentile upper confidence bound estimates
20 whenever available. This provides conservatism to cover uncertainties, as described in
21 Section 5.3.3.2.2 of the 1996 LR GEIS. The 1996 LR GEIS concluded that the probability-
22 weighted consequences and impacts were SMALL compared to other risks to which the
23 populations surrounding NPPs are routinely exposed.

24 Appendix E of this document provides an update on postulated accident risk. Because the
25 NRC's understanding of accident risk has evolved since the issuance of the 1996 LR GEIS and
26 extends beyond issuance of the 2013 LR GEIS, Appendix E assesses more recent information
27 about postulated accidents that might have had the potential to alter the conclusions in
28 Chapter 5 of the 1996 LR GEIS. This update considers how these developments would affect
29 the conclusions in the original LR GEIS and provides comparative data where appropriate.

30 The different sources of new information can be generally categorized by their effect of either
31 decreasing, not affecting, or increasing the best-estimate environmental impacts associated with
32 postulated severe accidents. The areas where a decrease in best-estimate impacts would be
33 expected are:

- 34 • new internal events information (decreases in impacts by over an order of magnitude), and
- 35 • new source term information (significant decreases).

¹⁶ The 28 sites are listed in Table 5.1 of the 1996 LR GEIS. There are a total of 44 units included in this list, but 4 of the units never operated (Grand Gulf 2, Harris 2, Perry 2, and Seabrook 2). For the purpose of this document, this list will be referred to as containing 28 NPPs, but when mean values are calculated for this subset of NPPs, the 40 units that operated are considered.

Environmental Consequences and Mitigating Actions

1 Areas likely leading to either a small change or no change include:

- 2 • use of Biological Effects of Ionizing Radiation VII (BEIR-VII) risk coefficients.

3 Lastly, the areas leading to an increase in best-estimate impacts would consist of:

- 4 • consideration of external events (comparable to internal event impacts),
5 • power uprates (small increase),
6 • higher fuel burnup (small increases),
7 • low power and reactor shutdown events (could be comparable to at-power event impacts),
8 and
9 • new SFP accidents (newer studies demonstrate less risk, much less than full power event
10 impacts).

11 Given the difficulty in conducting a rigorous aggregation of these results (due to the differences
12 in the information sources used and in the impact metrics evaluated), a fairly simple approach is
13 taken. The latter group contains two areas (power uprates and higher fuel burnup) where the
14 increase in environmental impact (probability-weighted consequences) would cumulatively be
15 less than 50 percent. For one area (SFP accidents) the increase in environmental impact would
16 be less than that from power reactor operations, but is conservatively considered to be
17 comparable to that from full power reactor operations. The increase in environmental impact
18 from consideration of low power and shutdown events is comparable to that from at-power
19 operations, but is conservatively assumed to be up to a factor of 2 to 3 higher. The final factor,
20 external events, wasn't assessed separately but as an integrated assessment considering all
21 hazards. The net increase from the four factors is conservatively an increase of up to a factor of
22 4 to 5, or 400 to 500 percent.

23 The reduction in environmental impact associated with the new source term information is
24 dramatic. The early fatality risk is orders-of-magnitude less than the NRC safety goal, and the
25 latent cancer fatality risk is well below the NRC safety goal. However, because the state-of-the-
26 art reactor consequence analysis (SOARCA) (NUREG-1935; NRC 2012i) did not evaluate the
27 risk of all accident scenarios, this reduction in environmental impact is not credited in this
28 assessment. The other factor that has resulted in a decrease in environmental impact is the risk
29 of at-power severe reactor accidents due to internal events. The internal events core damage
30 frequency (CDF) has decreased, on average, by a factor of 4 to 6. However, the reduction in
31 environmental impact is substantial, ranging from a factor of 2 to 600 and, on average is about a
32 factor of 30 lower when compared to the expected value of the population dose risk reported in
33 the 1996 LR GEIS. Because the 1996 LR GEIS did not consider the environmental impact
34 contribution from external events, consideration of these events results in an increase in the
35 environmental impact. The net result when all hazards are considered is that the All Hazards
36 CDF, on average, is comparable to that assumed for just internal events in the 1996 LR GEIS.
37 However, the reduction in All Hazards population dose risk, or probability-weighted dose
38 consequence, ranges from a factor of 3 to over 1000 and is, on average, about a factor of 120
39 (or 12,000%) less than the corresponding predicted 95 percent upper confidence bound values.

40 The net effect of a maximum increase of accident risk on the order of 400 to 500 percent and an
41 average decrease in accident risk of 12,000 percent would be a substantial reduction in
42 estimated impacts (compared to the 1996 LR GEIS assessment). This result demonstrates the
43 substantial level of conservatism incorporated in the upper bound estimates used in the 1996
44 LR GEIS, which supported the conclusion that the probability-weighted consequences of

1 atmospheric releases, fallout onto open bodies of water, releases to ground water, and societal
2 and economic impacts of severe accidents are of small significance for all plants.

3 With respect to uncertainties, the 1996 LR GEIS contained an assessment of uncertainties in
4 the information used to estimate the environmental impacts. Section 5.3.5 of the 1996 LR GEIS
5 discusses the uncertainties and concludes that they could cause the impacts to vary anywhere
6 from a factor of 10 to a factor of 1,000. This range of uncertainties bounds the uncertainties
7 discussed in Section E.3.9 of Appendix E of this revised LR GEIS, as well as the uncertainties
8 brought in by the other sources of new information, by one or more orders of magnitude.
9 Section E.3.9 of this LR GEIS notes that more recent detailed quantitative analyses indicate that
10 the 95th percentile bounds of consequence uncertainty are likely to be about a factor of 10 or
11 less compared to point-estimates or compared to other central-tendency estimates.

12 Based on the analysis presented in Appendix E, the staff concludes that the reduction in
13 environmental impacts from the use of new information (since the 1996 and 2013 LR GEIS
14 analyses) outweighs any increases resulting from this same information for initial LR or SLR. In
15 part, the staff reviewed information from SEISs (for initial LRs and SLRs) completed since
16 development of the 2013 LR GEIS and identified no new information or situations that would
17 result in different impacts for this issue for either an initial LR or SLR term. As a result, the
18 findings in the 1996 LR GEIS and 2013 LR GEIS remain valid. Therefore, the environmental
19 impacts of design-basis accidents are SMALL for all plants during the initial LR and SLR terms
20 and the issue is Category 1.

21 In the 2013 LR GEIS, the issue of severe accidents remained a Category 2 issue to the extent
22 that only the alternatives to mitigate severe accidents must be considered for all nuclear power
23 plants where the licensee had not previously performed a severe accident mitigation
24 alternatives analysis for the plant. This LR GEIS update provides a technical basis for
25 reclassifying this issue as Category 1.

26 Consistent with the NRC's approach to severe accident mitigation in the 1996 LR GEIS and the
27 2013 LR GEIS, alternatives to mitigate severe accidents still must be considered for all plants
28 that have not considered such alternatives and would be the functional equivalent of a Category
29 2 issue requiring site-specific analysis; however, as discussed further in Appendix E, the plants
30 that have already had a severe accident mitigation alternatives analysis considered by the NRC
31 as part of an EIS, supplement to an EIS, or environmental assessment, need not perform an
32 additional severe accident mitigation alternatives analysis for license renewal. Appendix E,
33 Table E.5-1 provides a summary of the NRC staff's findings with respect to these issues. Based
34 on current industry plans, the NRC expects very few, if any, license renewal applications for a
35 plant that has not previously considered severe accidents under NEPA. Consequently, severe
36 accidents are most accurately categorized as a Category 1 issue because it will be resolved
37 generically for the vast majority of, if not all, applicants. The impacts of all new information in
38 this update confirms the basis for the NRC's previous requirement that license renewal
39 applicants need not consider severe accident mitigation for plants that have already done so.
40 This new information demonstrates that further mitigation analysis would not contribute
41 sufficiently to reducing the environmental impacts of severe accident risk to warrant further
42 severe accident mitigation alternatives analysis because the likelihood of finding cost-effective
43 significant plant improvements is small.

44 In part, the staff reviewed information from SEISs (for initial LRs and SLRs) completed since
45 development of the 2013 LR GEIS and identified no new information or situations that would
46 result in different impacts for this issue for either an initial LR or SLR term. On the basis of

1 these considerations, the NRC staff concludes that the probability-weighted consequences of
2 severe accidents during the initial LR and SLR terms is SMALL for all operating nuclear power
3 plants. As a result, the issue of severe accidents is revised from Category 2, as evaluated in
4 the 2013 LR GEIS, to Category 1.

5 **4.9.2 Environmental Consequences of Alternatives to the Proposed Action**

6 Impacts on human health from construction of a replacement power station (including fossil
7 energy, new nuclear, and renewable or other energy replacement alternatives) discussed in this
8 section, would be similar to those experienced during construction of any major industrial
9 facility. Compliance with worker protection rules, the use of personal protective equipment,
10 training, and placement of engineered barriers would limit those impacts on workers to
11 acceptable levels. Because the NRC staff expects that access to active construction areas
12 would be limited to only authorized individuals, the impacts on human health from construction
13 are minimal.

14 *4.9.2.1 Fossil Energy Alternatives*

15 Operational human health impacts for fossil energy alternatives (i.e., natural gas, coal, and oil)
16 include significant impacts on air quality, as discussed in Section 4.3.2.1. The operation of
17 fossil energy alternatives has a range of potential human health impacts such as risks from coal
18 and limestone mining; worker and public risk from coal, lime, and limestone transportation;
19 worker and public risk from disposal of coal-combustion waste; public risk from inhalation of
20 stack emissions; and noise both onsite and offsite (i.e., natural gas). There are also potential
21 impacts from nonradiological hazards, including exposure to microbiological organisms,
22 occupational safety risks, impacts from EMFs, and exposure to chemicals used onsite by the
23 workforce. In addition, human health risks may extend beyond the facility workforce to the
24 public depending on their proximity to the facility or associated waste disposal site. The
25 character and the constituents of the waste depend on both the chemical composition and the
26 technology used to combust it. The human health impacts from the operation of a fossil energy
27 power station include public risk from inhalation of gaseous emissions. Regulatory agencies,
28 including both Federal and State agencies, base air emission standards and requirements on
29 human health impacts. These agencies also impose facility-specific emission limits to protect
30 human health (e.g., coal-combustion residuals) (40 CFR Part 257).

31 *4.9.2.2 New Nuclear Alternatives*

32 Operational human health impacts for a new nuclear plant (i.e., advanced light water reactors
33 and small modular reactors) would include radiation exposure to the public and to the
34 operational workforce at levels below regulatory limits, as discussed for current operating
35 reactors in Section 3.9. In addition to radiological impacts, there are also potential impacts from
36 the same nonradiological hazards as discussed in Section 3.9.1.1 for current reactors and
37 described in Section 4.9.2.1 above for fossil energy alternatives. Impacts on human health for
38 initial LR and SLR for operating nuclear plants, in most cases, were determined to be SMALL.
39 Similar human health impacts would be expected from the operation of a new nuclear facility.

40 A detailed analysis of postulated accidents in currently operating reactors (affected by initial LR
41 or SLR) is provided in Section 4.9.1.2 and Appendix E. Although the analysis is specific to initial
42 LR and SLR, the impacts are representative of the impacts expected for new reactors. New
43 reactor designs incorporate additional safety features not found in currently operating reactors.
44 As a result, the risks associated with the new reactors are expected to be comparable to or less

1 than the risks associated with current operating reactors. Before a license is granted, the
2 application for a new reactor would undergo a detailed safety and environmental review to make
3 sure that the plant, if constructed, would operate in accordance with all applicable NRC rules
4 and regulations.

5 4.9.2.3 *Renewable Alternatives*

6 The operational impacts of renewable and other energy replacement alternative technologies on
7 human health are similar to the impacts related to construction and current operations of
8 industrial facilities. Operational hazards for the workforce include potential exposure to toxic
9 gas or chemicals (i.e., geothermal, biomass, municipal solid waste, refuse-derived fuel, and
10 landfill gas), working in extreme weather (i.e., wind and ocean wave and ocean currents for
11 offshore wind turbines), and physical hazards that include working at heights, near energized or
12 rotating systems, high pressure water (i.e., hydroelectric), exposure to low-frequency sound,
13 EMF exposure (i.e., wind and solar), and potential for electric shock. These operational impacts
14 are reduced by compliance with worker protection rules, the use of personal protective
15 equipment, and training, which would limit those impacts on workers to acceptable levels.

16 **4.10 Environmental Justice**

17 **4.10.1 Environmental Consequences of the Proposed Action – Continued Operations** 18 **and Refurbishment Activities**

19 As explained in Chapter 3, Executive Order 12898, “Federal Actions to Address Environmental
20 Justice in Minority Populations and Low-Income Populations” (1994) (59 FR 7629), directs each
21 Federal agency to identify and address, as appropriate, “disproportionately high and adverse
22 human health or environmental effects of its programs, policies, and activities on minority
23 populations and low-income populations.” Although independent agencies, like the NRC, were
24 only requested, rather than directed, to comply with Executive Order 12898, the NRC Chairman,
25 in a March 1994 letter to the President, committed the NRC to endeavoring to carry out its
26 measures “ ... as part of NRC’s efforts to comply with the requirements of NEPA” (NRC 1994).

27 *4.10.1.1 Impacts on Minority Populations, Low-Income Populations, and Indian Tribes*

28 The environmental justice impact analysis determines whether human health or environmental
29 effects from continued reactor operations and refurbishment activities at a nuclear power plant
30 would disproportionately affect a minority population, low-income population, or Indian Tribe and
31 whether these effects may be high and adverse. Adverse health effects are measured in terms
32 of the risk and rate of fatal or nonfatal exposure to an environmental hazard. Disproportionately
33 high and adverse human health effects occur when the risk or rate of exposure for a minority
34 population, low-income population, or Indian Tribe to an environmental hazard is significant and
35 exceeds the risk or rate to the general population or other comparison group.

36 Disproportionately high and adverse environmental effects occur when an impact on the natural
37 or physical environment significantly and adversely affects a minority population, low-income
38 population, or Indian Tribe and exceeds those on the general population or other comparison
39 group. Such effects may include ecological, cultural, socioeconomic, or social impacts. These
40 environmental effects are discussed in this chapter for each of these and other resource areas.
41 For example, increased demand for rental housing during the construction of a new power plant
42 for one of the energy replacement alternatives could disproportionately affect low-income
43 populations.

Environmental Consequences and Mitigating Actions

1 The NRC's environmental justice impact analysis (1) identifies minority populations, low-income
2 populations, and Indian Tribes that could be affected by continued reactor operations during the
3 license renewal term and refurbishment activities at a nuclear power plant, (2) determines
4 whether there would be any human health or environmental effects on these populations, and
5 (3) determines whether these effects may be disproportionately high and adverse. The NRC
6 strives to engage with representatives of affected environmental justice communities and Tribal
7 Nations to establish long-term relationships and identify license renewal-related concerns and
8 issues to be addressed in the NEPA review. Minority and low-income populations, Indian
9 Tribes, and environmental justice issues are different at each nuclear power plant site.

10 Continued reactor operations during the license renewal term and refurbishment activities at a
11 nuclear power plant could affect land, air, water, and ecological resources, which could result in
12 human health or environmental effects. Consequently, minority and low-income populations
13 and Indian Tribes could be disproportionately affected. The NRC's environmental justice impact
14 analysis must therefore determine whether continued reactor operations during the license
15 renewal term and refurbishment activities at a nuclear power plant would result in
16 disproportionately high and adverse human health or environmental effects on a minority
17 population, low-income population, or Indian Tribe.

18 Section 4-4 of Executive Order 12898 also directs Federal agencies, whenever practical and
19 appropriate, to collect and analyze information about the consumption patterns of populations
20 that rely principally on fish and wildlife for subsistence and to communicate the risks of these
21 consumption patterns to the public. Consumption patterns (e.g., subsistence agriculture,
22 hunting, and fishing) and certain resource dependencies often reflect the traditional or cultural
23 practices of minority populations, low-income populations, and Indian Tribes. Consequently, the
24 NRC considers the means by which these populations could be disproportionately affected by
25 examining potential human health and environmental effects from continued reactor operations
26 and refurbishment activities at nuclear power plants. In assessing the human health effects of
27 license renewal, the NRC examines radiological risk from consumption of fish, wildlife, and local
28 produce; exposure to radioactive material in water, soils, and vegetation; and the inhalation of
29 airborne radioactive material during nuclear power plant operation. To assess the effect of
30 nuclear reactor operations, licensees are required to collect samples from the environment, as
31 part of their REMP. These samples are then analyzed for radioactivity to assess the impact
32 from nuclear power plant operations.

33 A nuclear plant effect may be indicated if the radiation level detected in a sample is higher than
34 the background level. Two types of samples are collected. The first type—control samples—
35 are collected from areas of the environment beyond or outside the influence of the nuclear
36 power plant. Control samples are used to determine normal background radiation levels. The
37 second type—indicator samples—are collected from the environment near the nuclear power
38 plant where any radioactivity would be at its highest concentration. Indicator samples are then
39 compared to control samples to determine the contribution of nuclear power plant operation to
40 radiation or radioactivity levels in the environment. A nuclear plant effect is indicated if
41 radioactivity levels in an indicator sample exceeds the background radiation levels in the control
42 sample.

43 Moreover, as noted in the Commission's "Policy Statement on the Treatment of Environmental
44 Justice Matters in NRC Regulatory and Licensing Actions" (69 FR 52040), the NRC recognizes
45 that environmental justice issues "differ from site to site and, thus, do not lend themselves to
46 generic resolutions. Consequently, [environmental justice], as well as other ... issues, are

1 considered in site-specific EISs.” For this reason, environmental justice is a Category 2 issue,
2 and the NRC makes its license renewal impact determination in nuclear plant-specific SEISs.

3 Based on these considerations, the NRC concludes environmental justice impacts during initial
4 LR and SLR terms and refurbishment are unique to each nuclear power plant. In addition, the
5 NRC identified no new information or situations regarding initial LR or SLR that would result in
6 different conclusions from the 2013 LR GEIS. Therefore, the environmental justice impacts of
7 license renewal cannot be determined generically and is a Category 2 issue for both initial LRs
8 and SLRs.

9 **4.10.2 Environmental Consequences of Alternatives to the Proposed Action**

10 *Construction and Operation* – Minority populations, low-income populations, and Indian Tribes
11 could be directly or indirectly affected by the construction and operation of a new power plant.
12 However, the extent of human health or environmental effects is difficult to determine because it
13 depends on the location and type of power plant. For example, emissions from fossil fuel-fired
14 power plants may disproportionately affect human health conditions in minority populations,
15 low-income populations, and Indian Tribes. Power plant operations may also affect populations
16 that subsist on the consumption of fish, wildlife, and local produce.

17 New replacement power-generating facilities are often located at an existing power plant or
18 industrial brownfield site to make use of the existing infrastructure. Unfortunately, these sites
19 are also frequently located in or near low-income and minority communities who may be
20 disproportionately affected by construction dust, noise, truck, and commuter traffic. In addition,
21 during construction, increased demand for temporary rental housing could disproportionately
22 affect low-income populations who rely on low-cost rental housing. Conversely, the construction
23 and operation of new power-generating facilities can create new employment and income
24 opportunities in these communities. Also, rental housing demand could be mitigated if the new
25 replacement power plant is located near a metropolitan area where construction workers could
26 commute to the job site.

27 Low-income populations can also benefit from demand-side management energy conservation
28 and efficiency weatherization and insulation programs. This would have a beneficial economic
29 effect because low-income households generally experience greater home energy cost burdens
30 than the average household. Conversely, higher utility bills due to increasing power-generating
31 costs could disproportionately affect low-income families. However, the Federal Low Income
32 Home Energy Assistance Program and State energy assistance programs (if available) can help
33 low-income families pay for electricity.

34 **4.11 Waste Management and Pollution Prevention**

35 **4.11.1 Environmental Consequences of the Proposed Action – Continued Operations**
36 **and Refurbishment Activities**

37 The effects of license renewal including operations and refurbishment on waste management
38 are presented in this section. Baseline conditions at operating reactors are discussed in
39 Section 3.11. License renewal is expected to result in a continuation of these conditions for an
40 extended period commensurate with the license renewal term (initial LR or SLR). Accumulated
41 quantities of waste material needing long-term storage or disposal are expected to increase at a
42 rate proportional to the length of operation.

Environmental Consequences and Mitigating Actions

1 The impacts associated with onsite waste management activities during a license renewal term
2 (initial LR and SLR) at nuclear power plants are addressed in other sections of Chapter 4 under
3 various resource discussions. These activities include waste collection, treatment, packaging,
4 and loading onto conveyance vehicles for shipment offsite. These activities are considered to
5 be part of the normal operations at a plant site. For example, the annual radioactive effluent
6 release reports issued by plant licensees include a summary of radioactive effluent releases
7 from all the facilities on the plant site, including the waste management and storage facilities.
8 The same reports also provide data on the volume and radioactivity content of solid radioactive
9 waste shipped offsite for processing and disposal. Similarly, the REMP conducted by nuclear
10 power plant licensees measures the direct radiation as well as environmental concentrations of
11 all radionuclides originating at the site as well as background radiation. The impact from the
12 transportation of wastes from the reactor to a third-party waste treatment center or directly to a
13 disposal site is addressed generically in Table S-4 in 10 CFR 51.52 (see Section 4.14.1.1).

14 The issues addressed in this section regarding waste management during the license renewal
15 term (as evaluated in the 2013 LR GEIS) include:

- 16 • low-level radioactive waste (LLW) storage and disposal,
- 17 • onsite storage of spent nuclear fuel,
- 18 • offsite radiological impacts of spent nuclear fuel and high-level waste disposal,
- 19 • mixed waste storage and disposal, and
- 20 • nonradiological waste storage and disposal.

21 These five issues relate to waste management at all nuclear fuel cycle facilities, including
22 nuclear power plants. Four other issues, which pertain specifically to aspects of the uranium
23 fuel cycle other than the nuclear power plants themselves, are addressed in Section 4.14.1.1.
24 These fuel cycle facilities include uranium mining and milling, uranium hexafluoride (UF₆)
25 production, isotopic enrichment, fuel fabrication, fuel reprocessing, and disposal facilities.

26 *4.11.1.1 Low-Level Waste Storage and Disposal*

27 Section 3.11.1.1 provides a detailed discussion of the quantities and characteristics of LLW that
28 are normally generated at nuclear plants under routine operating conditions. As stated in the
29 introduction to Section 4.11.1, these baseline conditions are expected to continue during the
30 license renewal (initial LR and SLR) terms.

31 The NRC requires that all licensees implement measures to minimize, to the extent practicable,
32 the generation of radioactive waste (10 CFR 20.1406). Licensees may consider construction of
33 additional radiological storage facilities on their plant sites and/or enter into an agreement with a
34 third-party contractor to process, store, own, and ultimately dispose of LLW from the reactor
35 sites. The environmental impacts, if these options are chosen, would be assessed at that time.

36 Most of the LLW generated at reactor sites continues to be shipped offsite for disposal either
37 immediately after generation or after a brief storage period onsite. This trend is expected to
38 continue during the license renewal (initial LR and SLR) term. Operating disposal facilities for
39 radioactive waste are discussed in Section 3.11.1.1. In addition, the reactor sites have the
40 option to store their Class B and C (and Class A as appropriate) wastes onsite. Such activities
41 are conducted in accordance with NRC regulations and any applicable State or local
42 requirements.

1 The NRC believes that the comprehensive regulatory controls that are in place and the low
 2 public doses being achieved at reactors ensure that the radiological impacts on the environment
 3 from low-level waste (LLW) storage and disposal will remain SMALL during the term of a
 4 renewed license (initial LR and SLR). The maximum additional onsite land that may be required
 5 for LLW storage during the term of a renewed license and associated impacts would be SMALL.
 6 The radiological and nonradiological environmental impacts of long-term disposal of LLW from
 7 any individual plant at licensed sites are SMALL. In addition, the NRC concludes that the
 8 available information supports a conclusion that sufficient LLW disposal capacity will be made
 9 available when needed for facilities to be decommissioned consistent with NRC
 10 decommissioning requirements.

11 Based on the above considerations and the information presented in Section 3.11.1.1, the
 12 existing radiological waste infrastructure and management program could support the additional
 13 radiological wastes generated by the operation of the nuclear power plant through the renewal
 14 licensing term. The impact of LLW storage and disposal during the renewal term (initial LR and
 15 SLR) is considered SMALL for all sites and is designated as a Category 1 issue. The staff
 16 reviewed information from SEISs (for initial LRs and SLRs) completed since development of the
 17 2013 LR GEIS and identified no new information or situations that would result in different
 18 impacts for this issue for either an initial LR or SLR term. Therefore, the environmental impacts
 19 associated with LLW storage and disposal during the initial LR and SLR terms would be SMALL
 20 for all nuclear plants. This issue is Category 1.

21 In addition to being generated at the reactor sites, LLW is also generated from the rest of the
 22 uranium fuel cycle as part of the front-end operations during the mining and milling of uranium
 23 ores and during the steps leading up to the manufacture of new fuel. If the recycling option is
 24 made available and the decision is made to reprocess the spent nuclear fuel in the
 25 United States, the reprocessing operations would also generate LLW. The impacts associated
 26 with management of LLW from these other fuel cycle operations are addressed in Table S-3 in
 27 10 CFR 51.51 (see Section 4.14.1.1).

28 *4.11.1.2 Onsite Storage of Spent Nuclear Fuel*

29 A history of the NRC's Waste Confidence activities related to this issue is provided in
 30 Section 1.1, History of Waste Confidence, of NUREG-2157, *Generic Environmental Impact*
 31 *Statement for Continued Storage of Spent Nuclear Fuel* (Continued Storage GEIS; NRC 2014c).
 32 The scope of this LR GEIS with regard to the management and ultimate disposition of spent
 33 nuclear fuel is limited to the findings codified in the September 19, 2014 Continued Storage of
 34 Spent Nuclear Fuel, Final Rule (79 FR 56238) and associated NUREG-2157 (79 FR 56263),
 35 Continued Storage GEIS (NRC 2014c). (See Section 1.7.2 of this LR GEIS for the history of
 36 this document and associated rulemaking.) During the license renewal term, which corresponds
 37 to part of the licensed life for operation of a reactor described in NUREG-2157, the expected
 38 increase in the volume of spent fuel from an additional 20 years of operation (either during initial
 39 LR or SLR) can be safely accommodated onsite during the license renewal term with small
 40 environmental impacts through dry or pool storage at all plants. For the period after the
 41 licensed life for reactor operations, the impacts of onsite storage of spent nuclear fuel during the
 42 continued storage period are discussed in NUREG-2157 and are as stated in § 51.23(b). As
 43 defined in NUREG-2157 and clarified in the Continued Storage Final Rule (79 FR 56263), the
 44 licensed life for operation of a reactor assumes an original licensed life of 40 years and up to
 45 two 20-year license extensions for each reactor, for a total of up to 80 years of operation.

Environmental Consequences and Mitigating Actions

1 As discussed in Section 3.11.1.2, spent fuel is currently stored at reactor sites either in SFPs or
2 in ISFSIs. This onsite storage of spent fuel and HLW is expected to continue into the
3 foreseeable future.

4 As previously considered in the 2013 LR GEIS, and further supported by analyses presented in
5 the 2014 Continued Storage GEIS (NRC 2014c) for the short-term storage timeframe for spent
6 nuclear fuel, current and potential environmental impacts from spent fuel storage at the current
7 reactor sites have been studied extensively, are well understood, and the environmental
8 impacts were found to be SMALL. The issue of onsite storage during the license renewal term
9 was designated a Category 1 issue in the 2013 LR GEIS with an impact of SMALL. The staff
10 reviewed information from SEISs (for initial LRs and SLRs) completed since development of the
11 2013 LR GEIS and identified no new information or situations that would result in different
12 impacts for this issue for either an initial LR or SLR term. Therefore, the environmental impacts
13 associated with the storage of spent nuclear fuel during the initial LR and SLR terms would be
14 SMALL for all nuclear plants. For the period after the licensed life for reactor operations, the
15 impacts of onsite storage of spent nuclear fuel during the continued storage period are
16 discussed in NUREG-2157 and are stated in § 51.23(b) (NRC 2014c). This issue is
17 Category 1.

18 *4.11.1.3 Offsite Radiological Impacts of Spent Nuclear Fuel and High-Level Waste Disposal*

19 A history of the NRC's Waste Confidence activities (related to this issue) is provided in
20 Section 1.1, History of Waste Confidence, of NUREG-2157, Continued Storage GEIS (NRC
21 2014c). The scope of this LR GEIS with regard to the management and ultimate disposition of
22 spent nuclear fuel is limited to the findings codified in the September 19, 2014 Continued
23 Storage of Spent Nuclear Fuel, Final Rule (79 FR 56238) and associated NUREG-2157 (79 FR
24 56263), the Continued Storage GEIS (NRC 2014c). (See Section 1.7.2 of this LR GEIS for the
25 history of this document and associated rulemaking.)

26 The ultimate disposal of spent fuel in a potential future geologic repository is a separate and
27 independent licensing action that is outside the regulatory scope of license renewal. The
28 following discussion provides relevant information with respect to developments pertaining to
29 the consideration of an ultimate repository site for the disposal of spent fuel.

30 At the time the 1996 LR GEIS was issued, there were no established regulatory limits for offsite
31 releases of radionuclides from the ultimate disposal of spent fuel and HLW, because a
32 candidate repository site had not been established. It was assumed that for such a site, limits
33 would eventually be developed along the lines of those given in the 1995 National Academy of
34 Sciences report, *Technical Bases for Yucca Mountain Standards* (National Research Council
35 1995).

36 On February 15, 2002, on the basis of a recommendation by the Secretary of Energy, the
37 President recommended the Yucca Mountain site for the development of a repository for the
38 geologic disposal of spent fuel and HLW. Congress approved this recommendation on July 9,
39 2002, in Joint Resolution 87, which designated Yucca Mountain as the repository for spent fuel.
40 On July 23, 2002, the President signed Joint Resolution 87 into law. Public Law 107-200, 116
41 *Statutes at Large* 735, 42 U.S.C. 10135 (note) (H.J. Res. 87), designates Yucca Mountain as
42 the site for the development of the repository for spent fuel.

43 Subsequently, the EPA developed Yucca-Mountain-specific repository release standards, which
44 were also adopted by the NRC in 10 CFR Part 63. These standards:

- 1 • Establish a dose limit of 15 millirem (0.15 mSv) per year for the first 10,000 years after
2 disposal.
- 3 • Establish a dose limit of 100 millirem (1.0 mSv) exposure per year between 10,000 years
4 and 1 million years.
- 5 • Require the DOE to consider the effects of climate change, earthquakes, volcanoes, and
6 corrosion of the waste packages to safely contain the waste during the 1 million-year period.
- 7 • Establish a radiological protection standard consistent with the recommendations of the
8 National Academy of Sciences for this facility at the time of peak dose up to 1 million years
9 after disposal.

10 On June 3, 2008, the DOE submitted a license application to the NRC, seeking authorization to
11 construct a geologic repository for the disposal of spent fuel and HLW at Yucca Mountain,
12 Nevada. As part of the site characterization and recommendation process for the proposed
13 geologic repository at Yucca Mountain the DOE was required by the Nuclear Waste Policy Act
14 of 1982, 42 U.S.C. 10101 et seq., to prepare an EIS. In accordance with the Nuclear Waste
15 Policy Act (42 U.S.C. 10134(f)(4)), the NRC was required to adopt DOE's EIS, to "the extent
16 practicable," as part of any possible NRC construction authorization decision. DOE submitted
17 the following NEPA documents along with its application, which include analyses that address
18 radiological impacts to workers and the public:

- 19 • *Final Environmental Impact Statement for a Geologic Repository for the Disposal of Spent
20 Nuclear Fuel and High-Level Radioactive Waste at Yucca Mountain, Nye County, Nevada
21 (FEIS) (DOE 2002).*
- 22 • *Final Supplemental Environmental Impact Statement for a Geologic Repository for the
23 Disposal of Spent Nuclear Fuel and High-Level Radioactive Waste at Yucca Mountain, Nye
24 County, Nevada (Repository SEIS) (DOE 2008).*

25 The NRC formally accepted for docketing DOE's license application for Yucca Mountain,
26 Nevada, on September 8, 2008. In its acceptance, the NRC staff also recommended that the
27 Commission adopt, with further supplementation, the EIS and supplements prepared by DOE
28 (73 FR 53284). With respect to radiological impacts, DOE's FEIS and Repository SEIS indicate
29 that the disposal of spent fuel and HLW would be SMALL with exposures well below regulatory
30 limits. However, on March 3, 2010, the DOE filed a motion with the Atomic Safety and
31 Licensing Board (Board) seeking permission to withdraw its application for authorization to
32 construct a HLW geological repository at Yucca Mountain, Nevada. The Board denied that
33 request on June 29, 2010, in LBP-10-11 (NRC 2010d), whereupon the parties involved in the
34 preceding filed petitions asking the Commission to uphold or reverse this decision.

35 On September 9, 2011, the Commission issued a Memorandum and Order, CLI-11-07, stating
36 that it found itself evenly divided on whether to take the affirmative action of overturning or
37 upholding the Board's June 29, 2010, decision (NRC 2011c). Exercising its inherent
38 supervisory authority, the Commission directed the Board to complete all necessary and
39 appropriate case management activities by September 30, 2011. On September 30, 2011, the
40 Board issued a Memorandum and Order suspending the proceeding.

41 The NRC staff initiated an orderly closure of its Yucca Mountain activities. As part of the orderly
42 closure, the NRC staff prepared three technical evaluation reports documenting its work.
43 Subsequently, the NRC resumed work on its technical and environmental reviews of the Yucca
44 Mountain application using available funds in response to an August 2013 ruling by the U.S.

Environmental Consequences and Mitigating Actions

1 Court of Appeals for the District of Columbia Circuit (see Section 1.7.2). The staff completed
2 and published the final volumes of the safety evaluation report in January 2015. In 2016, the
3 NRC completed and issued a supplement (NUREG-2184; NRC 2016a) to the DOE's 2002
4 Yucca Mountain FEIS (DOE 2002) and the DOE's 2008 Repository Supplemental EIS (DOE
5 2008). The NRC's supplement evaluated the potential environmental impacts on groundwater
6 and impacts associated with the discharge of any contaminated groundwater to the ground
7 surface due to potential releases from the proposed Yucca Mountain geologic repository. The
8 NRC staff evaluated the potential impacts on the aquifer environment, soils, ecology, and public
9 health, as well as the potential for disproportionate impacts on minority or low-income
10 populations. The impacts on all of the resources evaluated in the supplement were found to be
11 SMALL.

12 The adjudicatory hearing for the licensing of the repository, which must be completed before a
13 licensing decision can be made, remains suspended.

14 The NRC's nonsensitive Yucca Mountain-related documents have been preserved and made
15 available to the public as part of the NRC staff's activities to retain the accumulated knowledge
16 and experience gained as a result of its Yucca Mountain-related activities. These documents
17 can be viewed on the NRC's public website, <http://www.NRC.gov/waste/hlw-disposal.html>.

18 NRC decisions and recommendations concerning the ultimate disposition of spent nuclear fuel
19 are ongoing and outside the scope of license renewal, and as such, are beyond the scope of
20 this LR GEIS.

21 Separate from the regulatory actions taken by the NRC, in 2009 and early 2010 the President
22 and his administration decided not to proceed with the Yucca Mountain nuclear waste
23 repository. Instead, on January 29, 2010, the Secretary of Energy announced the formation of a
24 Blue Ribbon Commission to conduct a comprehensive review of policies for managing the back
25 end of the nuclear fuel cycle (The White House 2010). The Blue Ribbon Commission would
26 provide advice and make recommendations on issues including alternatives for the storage,
27 processing, and disposal of civilian and defense spent fuel and HLW. The Blue Ribbon
28 Commission issued its recommendations to the Secretary of Energy on January 26, 2012 (BRC
29 2012). The report contained eight key elements:

- 30 • A new, consent-based approach to siting future nuclear waste management facilities.
- 31 • A new organization dedicated solely to implementing the waste management program and
32 empowered with the authority and resources to succeed.
- 33 • Access to the funds nuclear utility ratepayers are providing for the purpose of nuclear waste
34 management.
- 35 • Prompt efforts to develop one or more geologic disposal facilities.
- 36 • Prompt efforts to develop one or more consolidated storage facilities.
- 37 • Prompt efforts to prepare for the eventual large-scale transport of spent nuclear fuel and
38 HLW to consolidated storage and disposal facilities when such facilities become available.
- 39 • Support for continued U.S. innovation in nuclear energy technology and for workforce
40 development.
- 41 • Active U.S. leadership in international efforts to address safety, waste management,
42 nonproliferation, and security concerns.

1 DOE will be the lead Federal agency responsible for developing a new national strategy for
2 nuclear waste management; the NRC will play a supporting role in the areas associated with its
3 regulatory review.

4 If a repository is not available and away-from-reactor ISFSIs are developed, the operations and
5 maintenance activities that would be conducted at an away-from-reactor ISFSI would be the
6 same as those described in NUREG-2157 (NRC 2014c). NUREG-2157 also describes offsite
7 radiological impacts from the continued storage of spent fuel at an away-from-reactor ISFSI.

8 In NUREG-2157, the NRC concluded that a range of potential impacts could occur for some
9 resource areas if the spent nuclear fuel from multiple reactors is shipped to a large (roughly
10 40,000 metric tonnes of uranium) away-from-reactor ISFSI (see Section 5.20 of NRC 2014c).
11 The ranges for some resources are driven by the uncertainty regarding the location of such a
12 facility and the local resources that would be affected.

13 For away-from-reactor storage, the unavoidable adverse environmental impacts for most
14 resource areas is SMALL across all timeframes, except for air quality, terrestrial resources,
15 aesthetics, waste management, and transportation where the impacts are SMALL to
16 MODERATE. Socioeconomic impacts range from SMALL (adverse) to LARGE (beneficial) and
17 historic and cultural resource impacts could be SMALL to LARGE across all timeframes. The
18 potential MODERATE impacts on air quality, terrestrial wildlife, and transportation are based on
19 potential construction-related fugitive dust emissions, terrestrial wildlife direct and indirect
20 mortalities, terrestrial habitat loss, and temporary construction traffic impacts. The potential
21 impacts on aesthetics and waste management are based on noticeable changes to the
22 viewshed from constructing a new away-from-reactor ISFSI, and the volume of nonhazardous
23 solid waste generated by assumed facility ISFSI and Dry Transfer System replacement activities
24 for the indefinite timeframe, respectively. The potential LARGE beneficial impacts on
25 socioeconomics are due to local economic tax revenue increases from an away-from-reactor
26 ISFSI.

27 The potential impacts on historic and cultural resources during the short-term storage timeframe
28 would range from SMALL to LARGE. The magnitude of adverse effects on historic properties
29 and impacts on historic and cultural resources largely depends on where facilities are sited,
30 what resources are present, the extent of proposed land disturbance, whether the area has
31 been previously surveyed to identify historic and cultural resources, and if the licensee has
32 management plans and procedures that are protective of historic and cultural resources. Even
33 a small amount of ground disturbance (e.g., clearing and grading) could affect a small but
34 significant resource. In most instances, placement of storage facilities on the site can be
35 adjusted to minimize or avoid impacts on any historic and cultural resources in the area.
36 However, the NRC recognizes that this may not always be possible. The NRC's plant-specific
37 environmental review and compliance with the NHPA process could identify historic properties,
38 identify adverse effects, and potentially resolve adverse effects on historic properties and
39 impacts on other historic and cultural resources. Under the NHPA, mitigation does not eliminate
40 a finding of adverse effect on historic properties. The potential impacts on historic and cultural
41 resources during the long-term and indefinite storage timeframes would also range from SMALL
42 to LARGE. This range takes into consideration routine maintenance and monitoring (i.e., no
43 ground-disturbing activities), the absence or avoidance of historic and cultural resources, and
44 potential ground-disturbing activities that could affect historic and cultural resources. The
45 analysis also considers uncertainties inherent in analyzing this resource area over long
46 timeframes. These uncertainties include any future discovery of previously unknown historic
47 and cultural resources and resources that gain significance within the vicinity and the viewshed

Environmental Consequences and Mitigating Actions

1 (e.g., nomination of a historic district) due to improvements in knowledge, technology, and
2 excavation techniques and changes associated with predicting resources that future
3 generations will consider significant. If construction of a Dry Transfer System and replacement
4 of the ISFSI and Dry Transfer System occurs in an area with no historic or cultural resource
5 present or construction occurs in a previously disturbed area that allows avoidance of historic
6 and cultural resources, then impacts would be SMALL. By contrast, a MODERATE or LARGE
7 impact could result if historic and cultural resources are present at a site and, because they
8 cannot be avoided, they are affected by ground-disturbing activities during the long-term and
9 indefinite timeframes.

10 Impacts on Federally listed species, designated critical habitat, and EFH would be based on
11 site-specific conditions and determined as part of consultations required by the ESA and the
12 Magnuson-Stevens Fishery Conservation and Management Act.

13 Continued storage of spent nuclear fuel at an away-from-reactor ISFSI is not expected to cause
14 disproportionately high and adverse human health and environmental effects on minority and
15 low-income populations. As indicated in the Commission's policy statement on environmental
16 justice, if the NRC receives an application for a proposed away-from-reactor ISFSI, a site-
17 specific NEPA analysis would be conducted, and this analysis would include consideration of
18 environmental justice impacts. Pursuant to 10 CFR 51.23, the impact determinations for away-
19 from-reactor storage are presented in NUREG-2157 (NRC 2014c).

20 The impact levels determined in NUREG-2157 of at-reactor storage, away-from-reactor storage,
21 and cumulative impacts of continued storage when added to other past, present, and
22 reasonably foreseeable activities are summarized in Table 6-4 of NUREG-2157 (NRC 2014c).
23 The impact levels are denoted as SMALL, MODERATE, and LARGE as a measure of their
24 expected adverse environmental impacts. Most impacts were found to be SMALL and SMALL
25 to MODERATE. For some resource areas, the impact determination language is specific to the
26 authorizing regulation, executive order, or guidance. Impact determinations that include a range
27 of impacts reflect uncertainty related to both geographic variability and the temporal scale of the
28 analysis. As a result, based on analyses performed in NUREG-2157, the NRC assumes that
29 further project-specific analysis would be unlikely to result in impact conclusions with different
30 ranges. The analyses of NUREG-2157 were codified in 10 CFR 51.23 (79 FR 56238).

31 Per 10 CFR Part 51 Subpart A the Commission concludes that the impacts presented in
32 NUREG-2157 would not be sufficiently large to require the NEPA conclusion, for any plant, that
33 the option of extended operation under 10 CFR Part 54 should be eliminated. Accordingly,
34 while the Commission has not assigned a single level of significance for the impacts of spent
35 nuclear fuel and HLW disposal, this issue is considered a Category 1 issue. The staff reviewed
36 information from SEISs (for initial LRs and SLRs) completed since development of the 2013 LR
37 GEIS and identified no new information or situations that would result in different impacts for this
38 issue for either an initial LR or SLR term.

39 *4.11.1.4 Mixed Waste Storage and Disposal*

40 This issue addresses the storage and disposal of mixed waste generated at nuclear power
41 plants and other uranium fuel cycle facilities during the license renewal term. As discussed in
42 Section 3.11.3, nuclear power plants generate small quantities of mixed waste. Other uranium
43 fuel cycle facilities are also expected to generate small quantities of mixed waste. Mixed waste
44 is regulated both by the EPA or the authorized State agency under RCRA and by the NRC or
45 the Agreement State agency under the Atomic Energy Act of 1954, as amended (Public

1 Law 83-703). The waste is either treated onsite or sent offsite for treatment followed by
2 disposal at a permitted site. The comprehensive regulatory controls and the facilities and
3 procedures that are in place at nuclear power plants ensure that the mixed waste is properly
4 handled and stored and that doses to and exposure to toxic materials by the public and the
5 environment are negligible at all plants. The accumulated quantities of mixed waste generated
6 onsite needing long-term storage or disposal are expected to increase at a rate proportional to
7 the length of operation. License renewal (initial LR and SLR) will not increase the small but
8 continuing risk to human health and the environment posed by mixed waste at all plants. The
9 radiological and nonradiological environmental impacts from the long-term disposal of mixed
10 waste at any individual plant at licensed sites are considered SMALL for all sites. The staff
11 reviewed information from SEISs (for initial LRs and SLRs) completed since development of the
12 2013 LR GEIS and identified no new information or situations that would result in different
13 impacts for this issue for either an initial LR or SLR term. Therefore, the environmental impacts
14 associated with mixed waste storage and disposal during the initial LR and SLR terms would be
15 SMALL for all nuclear plants. This is a Category 1 issue.

16 *4.11.1.5 Nonradioactive Waste Storage and Disposal*

17 This issue addresses the storage and disposal of nonradioactive waste generated at
18 commercial nuclear power plants and during the rest of the uranium fuel cycle during the license
19 renewal term. Nonradioactive waste consists of hazardous and nonhazardous waste. Storage
20 and disposal of hazardous waste generated at nuclear plants are discussed in Section 3.11.2.
21 As indicated in that section, nuclear plants generate small quantities of hazardous waste during
22 operation and maintenance. A special class of hazardous waste, known as universal waste,
23 consisting of commonly used yet hazardous materials (batteries, pesticides, mercury-containing
24 equipment, and lamps), is also generated. Similar types of hazardous wastes are also
25 generated at other uranium fuel cycle facilities. The management of hazardous wastes
26 generated at all of these facilities, both onsite and offsite, is strictly regulated by the EPA or the
27 responsible State agencies per the requirements of RCRA.

28 As does any industrial facility, nuclear power plants and the rest of the uranium fuel cycle
29 facilities also generate nonradioactive, nonhazardous waste (see Section 3.11.4). These
30 wastes are managed by following good housekeeping practices and are generally disposed of in
31 local landfills permitted under RCRA Subtitle D regulations.

32 In the 2013 LR GEIS, the impacts associated with managing nonradioactive wastes at uranium
33 fuel cycle facilities, including nuclear power plants, were found to be SMALL and designated as
34 a Category 1 issue. The staff reviewed information from SEISs (for initial LRs and SLRs)
35 completed since development of the 2013 LR GEIS and identified no new information or
36 situations that would result in different impacts for this issue for either an initial LR or SLR term.
37 Therefore, the environmental impacts associated with nonradioactive waste storage and
38 disposal during the initial LR and SLR terms would be SMALL for all nuclear plants. The
39 accumulated quantities of nonradioactive waste generated onsite needing long-term storage or
40 disposal is expected to increase at a rate proportional to the length of operation. It was
41 indicated that no changes in nonradioactive waste generation would be anticipated for license
42 renewal (initial LR or SLR), and that systems and procedures are in place to ensure continued
43 proper handling and disposal of the wastes at all plants. This is a Category 1 issue.

1 **4.11.2 Environmental Consequences of Alternatives to the Proposed Action**

2 *Construction* – Construction-related wastes include various fluids from the onsite maintenance
3 of construction vehicles and equipment (e.g., used lubricating oils, hydraulic fluids, glycol-based
4 coolants, spent lead-acid storage batteries) and incidental chemical wastes from the
5 maintenance of equipment and the application of corrosion control protective coatings
6 (e.g., solvents, paints, coatings), construction-related debris (e.g., lumber, stone, and brick), and
7 packaging materials (primarily wood and paper). All materials and wastes would be
8 accumulated onsite and disposed of or recycled through licensed offsite disposal and treatment
9 facilities. Life-cycle management of chemicals and wastes generated during construction and
10 pollution prevention initiatives (such as spill prevention plans) will serve to mitigate the impact of
11 wastes. The impacts of waste management are expected to be the same for greenfield,
12 brownfield, and existing nuclear power plant sites.

13 *Operations* – Solid wastes would be generated throughout the period of plant operations. The
14 character of wastes would depend on chemical constituents of the fuel, efficiency of
15 combustion, and operational efficiencies of the various air pollution control devices. Wastes
16 routinely associated with the maintenance of mechanical and electrical equipment include used
17 lubricating oils and hydraulic fluids, cleaning solvents, corrosion control paints and coatings, and
18 dielectric fluids.

19 *4.11.2.1 Fossil Fuel Alternatives*

20 *Operations* – Solid wastes in the form of coal-combustion waste (and, in some instances, flue
21 gas desulfurization sludge and spent catalysts) would be generated during plant operations.
22 The exact character of the coal-combustion waste would depend on the chemical constituents
23 of the coal, efficiency of the combustion device, and operational efficiencies of the various air
24 pollution control devices.

25 *4.11.2.2 New Nuclear Alternatives*

26 *Operations* – Liquid, gaseous, and solid radioactive waste management systems would be used
27 to collect and treat radioactive materials during operations. Waste processing systems would
28 be designed so that radioactive effluents released to the environment would meet the objectives
29 of Appendix I to 10 CFR Part 50. LLW disposal is assumed to occur at an offsite location, while
30 spent nuclear fuel would be stored onsite either in SFP storage or dry cask storage.

31 Nonradioactive effluent and wastes include cooling water and steam condensate blowdowns
32 that contain various water treatment chemicals or biocides, wastes from the onsite treatment of
33 cooling water and steam cycle water, floor and equipment drain effluent, stormwater runoff,
34 laboratory waste, trash, hazardous waste, effluent from the sanitary sewer system,
35 miscellaneous gaseous emissions, and liquid and solid effluent. Wastes discharged to waters
36 of the United States would be regulated by NPDES permits. All other wastes would be properly
37 disposed of in accordance with Federal, State, and local regulations. Waste management
38 impacts for a nuclear plant are described in Section 4.11.1. Impacts are expected to be SMALL
39 for all facilities, whether located on greenfield sites, brownfield sites, or at existing nuclear plant
40 sites.

1 **4.11.2.3 Renewable Alternatives**

2 Most renewable energy technologies would produce various wastes during operations.
 3 Biomass-fired and waste-derived fuel-fired facilities would produce combustion wastes such as
 4 fly ash and bottom ash. Toxic constituents in municipal solid waste or refuse-derived fuel could
 5 cause solid wastes from air pollution devices to become hazardous due to leachability of toxic
 6 constituents. Operational solid wastes from geothermal plants could include precipitates (scale)
 7 resulting from cooling and depressurized hydrothermal fluids that must be periodically removed
 8 from equipment; some precipitates may include naturally occurring radioactive material.
 9 Concentrated solar thermal plants have the potential to release heat transfer fluids, requiring the
 10 removal and disposal of affected soil. Sanitary and other wastewaters such as cooling water
 11 blowdown and steam cycle blowdown may be discharged to the land surface, surface water, or
 12 to surface impoundments in accordance with applicable regulatory requirements.

13 For all power-generating facilities, especially those with power substations, spills or leaks from
 14 electrical components could create waste dielectric fluids (all assumed to be free of PCBs).

15 Most facilities would also produce small amounts of industrial solid wastes associated with
 16 onsite maintenance of equipment and infrastructure. Such wastes could include used oils, used
 17 glycol-based antifreeze, waste lead-acid storage batteries, spent cleaning solvents, and excess
 18 corrosion control coatings, requiring proper characterization and disposal. However, normal
 19 operational maintenance activities associated with solar PV facilities and wind farms (either
 20 onshore or offshore) would generate minimal amounts of waste. For solar PV facilities, proper
 21 precautions would have to be taken for the disposal of solar cells, although recycling of
 22 materials would reduce impacts.

23 **4.12 Greenhouse Gas Emissions and Climate Change**

24 Research indicates that the cause of the Earth’s changing climate and warming over the last 50
 25 to 100 years is the buildup of GHGs in the atmosphere resulting from human activities
 26 (USGCRP 2014; IPCC 2021). The GHGs are well-mixed throughout the Earth’s atmosphere,
 27 and their impact on climate is long-lasting and cumulative in nature as a result of their long
 28 atmospheric lifetime (EPA 2016). The extent and nature of climate change is not specific to
 29 where GHGs are emitted. Climate models indicate that over the next few decades, temperature
 30 increases will continue due to current GHG emission concentrations in the atmosphere
 31 (USGCRP 2014). This is because it takes time for Earth’s climate system to respond to
 32 changes in GHG levels.

33 The CEQ has recognized that climate change is a fundamental environmental issue within
 34 NEPA’s purview (CEQ 2016). In accordance with Executive Order 13990, CEQ rescinded draft
 35 guidance entitled, “Draft National Environmental Policy Act Guidance on Consideration of
 36 Greenhouse Gas Emissions,” and is reviewing, revising, and updating its 2016 final guidance
 37 entitled, “Final Guidance for Federal Departments and Agencies on Consideration of
 38 Greenhouse Gas Emissions and the Effects of Climate Change in National Environmental
 39 Policy Act Reviews,” (86 FR 7037). At the time of publication of this LR GEIS, CEQ had not
 40 published updated guidance on the consideration of the effects of GHG emissions and climate
 41 change when evaluating proposed Federal Actions.

42 The effects of a proposed action on climate change can be evaluated by quantifying the
 43 proposed action’s GHG emissions. Therefore, the contribution to GHG emissions over the
 44 license renewal term serves as proxy in assessing the impact from continued power plant

Environmental Consequences and Mitigating Actions

1 operation on climate change. Changes in climate have broader implications for environmental
2 resources (e.g., water resources, air quality, and ecosystems). For instance, changes in
3 precipitation patterns and increase in air temperature can affect water availability and quality.
4 As a consequence, climate change can have overlapping impacts on environmental resources
5 by inducing changes in resource conditions that can also be affected by the proposed action.

6 On the basis of these considerations, the following two issues are considered in this section:

- 7 • Greenhouse gas impacts on climate change (new issue not considered in the 2013 LR
8 GEIS).
- 9 • Climate change impacts on environmental resources (new issue not considered in the 2013
10 LR GEIS).

11 **4.12.1 Greenhouse Gas Impacts on Climate Change**

12 The issue of GHG impacts on climate change associated with nuclear power plant operations
13 was not identified as either a generic or plant-specific issue in the 2013 LR GEIS. In the 2013
14 LR GEIS, the NRC staff presented GHG emission factors associated with the nuclear power life
15 cycle.

16 At the time of publication of the 2013 LR GEIS, insufficient data existed to support a
17 classification of GHG emission impacts and climate change as a generic or plant-specific issue.
18 The 2013 LR GEIS, however, included a discussion summarizing nuclear power plant-based
19 GHG emissions and climate change. Furthermore, following the issuance of Commission order
20 CLI-09-21 (NRC 2009d), the NRC began to evaluate the effects of GHG emissions in
21 environmental reviews for license renewal applications.

22 Impacts on climate change during normal operations at nuclear power plants can result from the
23 release of GHGs from stationary combustion sources (e.g., diesel generators, pumps, diesel
24 engines, boilers), refrigeration systems, electrical transmission and distribution systems, and
25 mobile sources (worker vehicles and delivery vehicles) (see Section 3.12). The GHG emissions
26 from nuclear power plants are typically very minor, because such plants do not normally
27 combust fossil fuels to generate electricity. As can be observed from Table 3.12-2, direct and
28 indirect GHG emissions from operations at nuclear power plants rarely exceed the 25,000 MT
29 (27,557 T) of carbon dioxide equivalents (CO₂eq) reporting threshold established by EPA.
30 Furthermore, when compared to State GHG emissions (see Table 3.12-1), GHG emissions from
31 operating nuclear power plants are orders of magnitude lower. When compared to different
32 GHG emission inventories for other facilities, GHG emissions from nuclear power plant
33 operations are minor. For example, in the initial LR SEISs for Byron, Fermi, LaSalle, River
34 Bend, and Waterford, the NRC compared the nuclear plant's GHG emissions to total annual
35 county-level GHG emissions (NRC 2015c, NRC 2016c, NRC 2016d, NRC 2018c, NRC 2018d).
36 The GHG emissions from these nuclear power plants ranged from less than 0.03 to about
37 3.9 percent of their respective county's total GHG emissions. In the Peach Bottom SLR SEIS,
38 the NRC concluded that continued operation would result in at least 4.4 million tons/year
39 (3.9 MMT/yr) of CO₂eq emissions avoidance compared to other replacement energy (power)
40 alternatives (e.g., supercritical pulverized coal, natural gas-combined cycle, and combination
41 alternatives) (NRC 2020g). Similarly, in the Surry SLR SEIS, the NRC concluded that continued
42 operation would result in at least 4.8 MMT/yr (4.3 MMT/yr) of CO₂eq emission avoidance when
43 compared to replacement energy alternatives considered (natural gas-combined cycle and
44 combination alternative) (NRC 2020f).

1 Potential sources of GHG emissions during any license renewal refurbishment activities include
 2 motorized equipment, construction vehicles, and worker vehicles. Construction vehicles and
 3 other motorized equipment would generate exhaust emissions that include GHG emissions
 4 (primarily CO₂). These emissions, however, would be intermittent, temporary, and restricted to
 5 the refurbishment period. The GHG emissions would result primarily from the additional
 6 workforce. Findings from SEISs completed since development of the 2013 LR GEIS have
 7 shown that the duration of refurbishment activities would occur over a 2 to 3 month period and
 8 would require an additional 500-1,400 workers. The NRC estimates that this can result in up to
 9 an additional 5,800¹⁷ tons (5,260 MT) of CO₂eq (NRC 2015d, NRC 2015e, NRC 2018e,).
 10 Emissions of GHGs from worker vehicles during refurbishment would be similar to those during
 11 normal nuclear power plant operations (see indirect emissions presented in Table 3.12-2).
 12 Therefore, GHG emissions from refurbishment activities would be minor.

13 On the basis of these considerations, the NRC concludes that the impacts of GHG emissions on
 14 climate change from continued operations and refurbishment during the initial LR and SLR
 15 terms and any refurbishment activities would be SMALL for all plants. This is a new Category 1
 16 issue.

17 **4.12.2 Environmental Consequences of Alternatives to the Proposed Action**

18 *Construction* – Sources of GHG emissions would include earthmoving equipment, non-road
 19 vehicles, and worker and delivery vehicles. Operation of construction equipment (e.g.,
 20 excavator, concrete batch plant, bulldozer, backhoe loader) release GHG emissions during fuel
 21 consumption (e.g., diesel). Similarly, employee and delivery vehicular exhaust will emit GHG
 22 emissions. The GHG emissions from construction equipment can be minimized by reducing the
 23 idling time of equipment and regularly maintaining diesel engines.

24 *Operations* – The impact from climate change as a result of GHG emissions from facility
 25 operations for a replacement power alternative would depend on the energy technology (e.g.,
 26 nuclear, renewable, etc.). In general, fossil fuel power alternatives will emit more GHG
 27 emissions than nuclear or renewable replacement power alternatives.

28 **4.12.2.1 Fossil Energy Alternatives**

29 *Construction* – The GHG impacts would be the same as those described in Section 4.12.2
 30 above.

31 *Operations* – The GHG emissions associated with operation of fossil fuel power plants can be
 32 significant. Fossil fuel power plants can emit large amounts of carbon dioxide, particularly if
 33 they are not equipped with carbon capture and storage devices. Table 4.12-1 presents
 34 representative carbon dioxide emission factors for various fossil fuel power plants with and
 35 without carbon capture technology. In comparing these emission factors, it is apparent that
 36 NGCC power plants would have lower carbon dioxide emissions than operation of an IGCC or
 37 SCPC plant, and that installation of carbon capture technology reduces emissions significantly.

¹⁷ Calculated by conservatively assuming a 90 day refurbishment duration, 1,400 workers-vehicles, 100-mile roundtrip travel per vehicle, and 420 grams of CO₂eq/mi (DOE 2021a).

1 **Table 4.12-1 Carbon Dioxide Emission Factors^(a) (CO₂ kg/MWh [lb/MWh]) for**
 2 **Representative Fossil Fuel Plants**

NGCC		SCPC		IGCC	
without carbon capture and storage ^(b)	with carbon capture and storage ^(c)	without carbon capture and storage ^(d)	with carbon capture and storage ^(e)	without carbon capture and storage ^(f)	with carbon capture and storage ^(g)
336 (741)	36 (80)	738 (1,627)	84 (185)	602 (1,328)	73 (161)

3 CO₂ = carbon dioxide; IGCC = integrated gasification combined cycle; kg/MWh = kilograms per megawatt-hr; lb/MWh
 4 = pounds per megawatt-hr; NGCC = natural gas combined cycle; SCPC = supercritical pulverized coal.

5 (a) Values based on gross output.

6 (b) Emission factors based on two combustion turbine-generators, and gross output of 740 MW.

7 (c) Emission factors based on two combustion turbine-generators, and gross output of 690 MW.

8 (d) Emission factors based on gross output of 685 MW and bituminous coal.

9 (e) Emission factors based on gross output of 770 MW and bituminous coal.

10 (f) Emission factors based on two Shell gasifiers, total gross output of 765 MW, and bituminous coal.

11 (g) Emission factors based on two Shell gasifiers, total gross output of 696 MW, and bituminous coal.

12 Source: NETL 2019.

13 **4.12.2.2 New Nuclear Alternatives**

14 *Construction* – The GHG impacts would be the same as those described in Section 4.12.2
 15 above.

16 *Operations* – The GHG emissions from operation of a new nuclear alternative would be emitted
 17 from onsite combustion sources (diesel generators, boilers, pumps) and worker vehicles. GHG
 18 emissions would be intermittent and minor.

19 **4.12.2.3 Renewable Alternatives**

20 *Construction* – The GHG impacts would be the same as those described in Section 4.12.2
 21 above. For facilities without a power block (solar PV, onshore, and offshore wind) the number
 22 of heavy equipment and workforce, level of activities, and construction duration would be lower
 23 and therefore GHG emissions would be less.

24 *Operations* – The GHG emissions associated with operation of renewable energy alternatives
 25 are generally negligible because no direct fossil fuels are burned to generate electricity.
 26 Sources of GHG emissions include engine exhaust from worker vehicles and equipment
 27 associated with site inspections or maintenance activities. Biomass facilities, however, can emit
 28 significant GHG emissions. For example, a biomass-fueled power plant can emit 2,650–
 29 3,852 lb of CO₂eq/MWh (NREL 1997, NREL 2004).

30 **4.12.3 Climate Change Impacts on Environmental Resources**

31 The issue of climate change impacts was not identified as either a generic or plant-specific
 32 issue in the 2013 LR GEIS. However, the 2013 LR GEIS described the environmental impacts
 33 that could occur on resource areas (land use, air quality, water resources, etc.) that are affected
 34 by the proposed action (license renewal). Climate change is an environmental trend (i.e.,
 35 change in climate indicators such as precipitation over time) that could result in changes to the
 36 affected environment irrespective of license renewal. In plant-specific initial LR and SLR SEISs
 37 prepared since development of the 2013 LR GEIS, the NRC has considered climate change
 38 impacts for those resources that could be incrementally affected by the proposed action as part
 39 of the cumulative impacts analysis. As discussed in Section 3.12 of this LR GEIS, climate

1 change and its impacts on resources can vary regionally. Observed climate change has not
2 been uniform across the United States. For instance, annual precipitation has increased across
3 most of the northern and eastern States and decreased across the southern and western
4 States; along the Atlantic coast in the Northeast region, sea surface temperatures and sea level
5 rise have increased at rates that exceed global averages; the Southeast region has not
6 experienced an overall long-term increase in surface temperatures; the Northwest experienced
7 the smallest increase in heavy precipitation events of any region in the United States.

8 Climate change may impact the affected environment in a way that alters the environmental
9 resources that are impacted by the proposed action (license renewal). Similar to cumulative
10 impacts, climate change impacts can occur across all resource areas that could be affected by
11 the proposed action, including the effects of continued reactor operations during the license
12 renewal term and any refurbishment activities at a nuclear power plant. In order for there to be
13 a climate change impact on an environmental resource, the proposed action (license renewal)
14 must have an incremental new, additive, or increased physical effect or impact on the resource
15 or environmental condition beyond what is already occurring. The goal of the impacts of climate
16 change on environmental resources analysis is to identify potentially significant impacts.

17 Future global GHG emission concentrations (emission scenarios) and climate models are
18 commonly used to project possible climate change. Climate models indicate that over the next
19 few decades, temperature increases will continue due to current GHG emission concentrations
20 in the atmosphere (USGCRP 2014). If GHG concentrations were to stabilize at current levels,
21 this would still result in at least an additional 1.1 °F (0.6 °C) of warming over this century
22 (USGCRP 2018). Over the longer term, the magnitude of temperature increases and climate
23 change related effects will depend on future global GHG emissions (IPCC 2021; USGCRP
24 2009, USGCRP 2014, USGCRP 2018). Climate model simulations often use GHG emission
25 scenarios to represent possible future social, economic, technological, and demographic
26 development that, in turn, drive future emissions. Consequently, the GHG emission scenarios,
27 their supporting assumptions, and the projections of possible climate change effects entail
28 substantial uncertainty.

29 The Intergovernmental Panel on Climate Change (IPCC) has generated various representative
30 concentration pathway (RCP) scenarios commonly used by climate modeling groups to project
31 future climate conditions (IPCC 2000, IPCC 2013, USGCRP 2017, USGCRP 2018). In the
32 IPCC Fifth Assessment Report, four RCPs were developed and are based on the predicted
33 changes in radiative forcing (a measure of the influence that a factor, such as GHG emissions,
34 has in changing the global balance of incoming and outgoing energy) in the year 2100, relative
35 to preindustrial conditions. The four RCP scenarios are numbered in accordance with the
36 change in radiative forcing measured in watts per square meter (i.e., +2.6 [very low], +4.5
37 [lower], +6.0 [mid-high], and +8.5 [higher]) (USGCRP 2018). For example, RCP2.6 is
38 representative of a mitigation scenario aimed at limiting the increase of global mean
39 temperature to 1.1 °F (2 °C) (IPCC 2014). The RCP8.5 reflects a continued increase in global
40 emissions resulting in increased warming by 2100. In the IPCC Sixth Assessment Report, five
41 shared socioeconomic pathways were used along with associated modeling results as the basis
42 for their climate change assessments (IPCC 2021). These five socioeconomic pathway
43 scenarios cover a range of greenhouse pathways and climate change mitigation.

44 The Fourth National Climate Assessment relies on the four RCPs in the IPCC Fifth Assessment
45 Report and presents projected climate change categorized by U.S. geographic region (see
46 Figure 3-12; USGCRP 2018). Similar to the observed climate changes categorized by U.S.
47 geographic region, as discussed in Section 3.12 of this LR GEIS, climate model projections

Environmental Consequences and Mitigating Actions

1 indicate that changes in climate will not be uniform across the United States. Observed and
2 projected differences in climate changes in the United States are further presented in initial LR
3 and SLR SEISs prepared since 2013. For instance, the Point Beach plant SLR SEIS states that
4 climate models predict an increase of 4–6 °F (2.2–3.3 °C) in annual mean temperature for
5 Wisconsin under the RCP4.5 and RCP8.5 scenarios for the midcentury (NRC 2021f). The
6 Turkey Point plant SLR SEIS indicates that for the same scenarios and timeframe models
7 predict an increase in the annual mean temperature of 2–4 °F (1.1–2.2 °C) for Florida (NRC
8 2019c).

9 The North Anna and the Surry SLR SEISs discuss climate change projections in the Northeast
10 region and the Commonwealth of Virginia along with associated impacts on the environment. In
11 the Surry plant SLR SEIS, the NRC considered the salinity effects of sea level rise projections
12 on the James River and deterioration of surface water quality due to saltwater intrusion (NRC
13 2021g). Unlike Surry, North Anna is not located on a tidal river, but on the Lake Anna Reservoir
14 which is not directly affected by sea level changes along the Atlantic coast. Consequently, sea
15 level rise projections were not pertinent in the consideration of climate change impacts to
16 surface water quality in the North Anna SEIS. The Turkey Point plant SLR SEIS and the
17 Waterford plant initial LR SEIS considered the impacts of projected sea level rise. However,
18 these SEISs illustrate how sea levels can affect water resources differently. As noted in the
19 Waterford plant initial LR SEIS, projected sea level rise could increase the upstream migration
20 of the saltwater wedge, which could cause a general deterioration in surface water quality in the
21 Lower Mississippi River (NRC 2018d). However, as noted in the Turkey Point SLR SEIS, for
22 South Florida, higher sea levels will increase the rate of saltwater intrusion leading to the
23 degradation of groundwater quality of aquifers designated as sources of drinking water (NRC
24 2019c).

25 While sea level rise impacts may occur in certain areas, decreases in water levels for the Great
26 Lakes are projected for the future. For instance, the Fermi plant initial LR SEIS and the Point
27 Beach SLR SEIS both discuss that while long-term water level projections are uncertain, model
28 simulations indicate a future decline in lake levels for Lake Erie and Lake Michigan, due to
29 increases in evaporative losses and warmer water temperatures (NRC 2016c; NRC 2021f).
30 Higher surface water temperatures can result in a decrease in cooling efficiency and therefore
31 have the potential to increase the use of cooling water and result in a slightly larger volume of
32 heated water discharged back to the lake (NRC 2016c; NRC 2021f).

33 On the basis of these considerations, the NRC concludes that the impacts of climate change on
34 environmental resources that are affected by continued nuclear power plant operations and any
35 refurbishment during the initial LR and SLR terms are location-specific and cannot be evaluated
36 generically. Changes in climate parameters and trends (e.g., temperature, precipitation, floods,
37 storm frequency, sea level rise) affect environmental resource baseline conditions (i.e., the
38 affected environment) that are incrementally affected by license renewal, thereby changing the
39 future state of the environment. The effects of climate change can vary regionally and climate
40 change information at the regional and local scale is necessary to assess the trends and
41 impacts on the human environment for a specific location. Therefore, this is a new Category 2
42 issue because it requires a plant-specific evaluation.

43 **4.13 Cumulative Effects of the Proposed Action**

44 Actions considered in the cumulative effects (impacts) analysis include the proposed license
45 renewal action (initial LR or SLR) when added to past, present, and reasonably foreseeable
46 actions, including projects and programs that are conducted, regulated, or approved by a

- 1 Federal agency. The analysis takes into account all actions, however minor, because the
- 2 effects of individually minor actions may be significant when considered collectively over time.
- 3 The goal of the cumulative effects analysis is to identify potentially significant impacts.

Definition of Cumulative Effects

Effects on the environment that result from the incremental effects of the action when added to the effects of other past, present, and reasonably foreseeable actions, regardless of what agency (Federal or non-Federal) or person undertakes such other actions (40 CFR 1508.1(g)(3)).

- 4 The cumulative effects or impacts analysis only considers resources and environmental
 - 5 conditions that could be affected by the proposed license renewal action, including the effects of
 - 6 continued reactor operations during the license renewal term and any refurbishment activities at
 - 7 a nuclear power plant. In order for there to be a cumulative effect, the proposed action (license
 - 8 renewal) must have an incremental new, additive, or increased physical effect or impact on the
 - 9 resource or environmental condition beyond what is already occurring.
- 10 The CEQ's report, *Considering Cumulative Effects Under the National Environmental Policy Act*,
- 11 provides a framework for addressing the cumulative effects of the proposed action in an EIS
- 12 (CEQ 1997a). Using guidance from the CEQ report, the cumulative effects analysis considers
- 13 the following:
- 14 • The geographic region of influence that encompasses the areas of potential effect and the
 - 15 distance at which the environmental effects of the proposed action and past, present, and
 - 16 reasonably foreseeable actions may be experienced. Geographic regions of influence vary
 - 17 by affected resource.
 - 18 • The timeframe for the cumulative effects analysis incorporates the incremental effects of the
 - 19 proposed action (license renewal) with past, present, and reasonably foreseeable actions
 - 20 because these combined effects may accumulate or develop over time. Past and present
 - 21 actions include all actions up to and including the date of the license renewal request. The
 - 22 timeframe for the consideration of reasonably foreseeable future actions is the 20-year
 - 23 license renewal (initial LR or SLR) term. Reasonably foreseeable future actions include
 - 24 current and ongoing planned activities, approved and funded for implementation.
 - 25 • The environmental effects from past and present actions are accounted for in baseline
 - 26 assessments presented in affected environment discussions in Chapter 3.0 of this LR GEIS.
 - 27 Chapter 4.0 accounts for the incremental effects or impacts of the proposed action (license
 - 28 renewal).
 - 29 • The incremental effects of the proposed action (license renewal) when added to the effects
 - 30 from past, present, and reasonably foreseeable future actions and other actions (including
 - 31 trends such as global climate change) result in the overall cumulative effect. A qualitative
 - 32 cumulative effects analysis is conducted in instances where the incremental effects of the
 - 33 proposed action (license renewal) and past, present, and reasonably foreseeable future
 - 34 actions are uncertain or not well known.
 - 35 • For some resource areas (e.g., water and aquatic resources), the incremental contributions
 - 36 of ongoing actions within a region are regulated and monitored through a permitting process
 - 37 (e.g., NPDES) under State or Federal authority. In these cases, it may be assumed that

Environmental Consequences and Mitigating Actions

1 cumulative effects are managed as long as these actions (facilities) are in compliance with
2 their respective permits.

3 The following sections discuss the potential for cumulative effects to occur in environmental
4 resources near a nuclear power plant—when the incremental environmental effects of the
5 proposed license renewal action are compounded by the effects from past, present, and
6 reasonably foreseeable future actions. For the most part, environmental conditions near the
7 nuclear power plant are not expected to change appreciably during the license renewal term
8 beyond what is already being experienced. Because environmental conditions are different at
9 every nuclear power plant, cumulative effects is a Category 2 issue requiring a plant-specific
10 analysis during the license renewal environmental review.

11 The staff reviewed information from SEISs (for initial LRs and SLRs) completed since
12 development of the 2013 LR GEIS. Based on the information reviewed and the preceding
13 discussion, the NRC concludes that cumulative effects during the initial LR and SLR terms and
14 refurbishment are unique to each nuclear power plant. Therefore, the cumulative effects of
15 license renewal (initial LR or SLR) cannot be determined generically and it is a Category 2
16 issue.

17 **4.13.1 Air Quality**

18 Regional air quality conditions, due to past and present activities, could be affected by the
19 emissions from continued reactor operations and refurbishment at a nuclear power plant when
20 combined with the emissions from planned industrial, commercial, agricultural, and
21 transportation development. These activities generate dust and emissions—affecting regional
22 air quality. The magnitude of the cumulative effect depends on the location of the nuclear
23 power plant, intensity of planned development, and the presence of air quality nonattainment
24 areas.

25 **4.13.2 Surface Water Resources**

26 Surface water withdrawals, effluent discharges, stormwater runoff, and accidental spills and
27 releases and their impacts on water quality and availability could increase due to the combined
28 effects of continued reactor operations and refurbishment and existing and planned industrial,
29 commercial, and agricultural development activities. The incremental effect of the proposed
30 action, continued surface water withdrawal for nuclear power plant cooling systems (both once-
31 through and closed-cycle), generally has had the greatest contributory effect. Water withdrawal
32 for nuclear plant cooling often conflicts with the water needs of other surface water users. The
33 magnitude of the cumulative effect depends on the location of the nuclear power plant, intensity
34 of existing and planned development activities, and affected surface water resources.

35 **4.13.3 Groundwater Resources**

36 Groundwater demands and groundwater quality impacts could increase because of the
37 combined effects of continued reactor operations and refurbishment, and existing and planned
38 industrial, commercial, and agriculture development activities. The magnitude of the cumulative
39 effect depends on the location of the nuclear power plant, intensity of existing and planned
40 development activities that withdraw water, water demand, and the hydrogeologic
41 characteristics of the affected aquifers.

1 **4.13.4 Ecological Resources**

2 Terrestrial wildlife impacts include habitat loss and degradation, disturbance and displacement,
3 injury and mortality, and obstruction of movement due to the combined effects of continued
4 reactor operations and refurbishment and existing and planned industrial, commercial, and
5 agriculture development activities. Other impacts include exposure to noise and contaminants,
6 altered surface water and groundwater quality and flow patterns, and collisions with buildings
7 and other structures. Adverse effects typically result from construction activities associated with
8 planned industrial and commercial development, agriculture, transportation, water projects, and
9 tourism and recreation. Migratory bird species may be affected by activities occurring away
10 from the nuclear power plant. Ecological communities (including floodplain and wetland) may
11 also be affected by development activities (e.g., land clearing and grading) that create
12 conditions that favor invasive species. The magnitude of the cumulative effect depends on the
13 location of the nuclear power plant relative to important wildlife habitats and ecological
14 communities and the intensity of existing and planned development activities.

15 There are three scales of aquatic resource effects: (1) cumulative effects from the nuclear
16 power plant (e.g., entrainment, impingement, thermal discharges, and chemical discharges),
17 (2) cumulative effects from other power plants, and (3) cumulative effects from activities
18 affecting water bodies (e.g., dams, agriculture, urban, and industrial development). Aquatic
19 impacts include the (1) loss and degradation of habitat; (2) species disturbance, displacement,
20 injury, and mortality; (3) obstruction of movement; and (4) the introduction and spread of
21 invasive species due to the combined effects of continued reactor operations and refurbishment
22 and existing and planned industrial, commercial, and agriculture development activities. These
23 effects result in increased water use and discharges to natural water bodies, increased and
24 contaminated runoff from planned industrial, commercial, agriculture, and transportation
25 development; water projects; and tourism and recreation. Similarly, the magnitude of the
26 cumulative effect depends on the location of the nuclear power plant relative to important water
27 bodies and the intensity of existing and planned development activities.

28 **4.13.5 Historic and Cultural Resources**

29 Historic and cultural resources (e.g., archaeological sites, historic structures, and TCPs) could
30 be adversely affected by ground-disturbing maintenance and refurbishment activities at a
31 nuclear power plant and by planned industrial and commercial development. Historic and
32 cultural resource impacts from ground-disturbing activities (e.g., land clearance, grading, and
33 excavation) could occur during the construction of planned industrial, commercial, and
34 transportation infrastructure and maintenance activities—damaging or destroying cultural
35 material. The magnitude of the cumulative effect depends on the location of the nuclear power
36 plant, intensity of planned development, and mitigation.

37 **4.13.6 Socioeconomics**

38 Employment and income generated by the combined effects of continued reactor operations
39 and refurbishment and industrial, commercial, and housing development can have a significant
40 cumulative socioeconomic effect. Income generated from goods and services creates
41 additional employment and income opportunities. New employment could increase the
42 population and demand for public services, housing, and transportation. The magnitude of the
43 cumulative socioeconomic effect depends on the location of the nuclear power plant and the
44 intensity of development.

1 **4.13.7 Human Health**

2 Exposure to radiological, chemical, and microbiological hazards and the potentially chronic
3 effects of EMFs could result in a cumulative health effect. Exposure may occur as a result of
4 the accumulation of harmful constituents released from existing facilities and planned industrial
5 and commercial development. The magnitude of the cumulative human health effect depends
6 on the location of past, present, and reasonably foreseeable future actions, the number of
7 facilities and activities involving radiological and hazardous material, and the amount of
8 exposure.

9 **4.13.8 Environmental Justice**

10 The cumulative effects of license renewal (proposed action) at a nuclear power plant combined
11 with the environmental effects of past, present, and reasonably foreseeable future actions could
12 exacerbate any human health or environmental effects in a minority population, low-income
13 population, or Indian Tribe. In addition, the combined effects of license renewal and industrial,
14 commercial, and housing development near the nuclear plant could disproportionately affect
15 consumption patterns (e.g., subsistence agriculture, hunting, and fishing) and the environmental
16 resources on which these populations may depend (e.g., fish, wildlife, and local produce).
17 Whether these effects are disproportionately high and adverse depends on the unique
18 characteristics of these populations and their proximity to the nuclear power plant and planned
19 development.

20 **4.13.9 Waste Management and Pollution Prevention**

21 Nuclear power plants, uranium fuel cycle facilities, and other commercial industrial facilities
22 generate radioactive and nonradioactive waste material. Depending on the location of waste
23 treatment and disposal facilities, nearby communities and people could experience the
24 cumulative effects of transportation, treatment, and disposal activities. However, some nuclear
25 power plants may be the only radioactive waste generator in a region. All commercial industrial
26 waste-generating facilities must comply with Federal and State waste storage, treatment, and
27 disposal regulations. These facilities must also ensure waste is properly handled and stored,
28 and its release is closely monitored. The magnitude of the cumulative effect depends on the
29 location of past, present, and reasonably foreseeable future actions involving facilities and
30 activities that generate, treat, and store radiological and hazardous waste material.

31 **4.13.10 Climate Change**

32 Changes in climate during the license renewal term have the potential to significantly affect
33 environmental resources and human health conditions near a nuclear power plant due to
34 changes in precipitation, temperature, storm frequency and severity, sea level rise, floods, and
35 droughts. Climate change caused by GHG emissions is a global concern; observations and
36 future climate scenarios are being documented in reports developed by the NOAA and the
37 IPCC. The direction and nature of these changes are expected to vary widely across the
38 country. These effects are being documented in the U.S. Global Change Research Program
39 state of knowledge reports.

1 **4.14 Impacts Common to All Alternatives**

2 This section describes impacts that are considered common to all alternatives discussed in this
 3 LR GEIS, including the proposed action (initial LR or SLR) and replacement power alternatives.
 4 The continued operation of a nuclear power plant and replacement fossil-fueled power plants
 5 both involve the mining, processing, and consumption of fuel, which results in comparative
 6 environmental impacts. Environmental impacts associated with the uranium fuel cycle are
 7 presented in Section 4.14.1.1, and impacts for other power plant fuel cycles are presented in
 8 Section 4.14.2. The impacts of license renewal on termination of operations and the
 9 decommissioning of a nuclear power plant and replacement energy facilities are presented in
 10 Section 4.14.3.1. In addition, GHG emissions from the nuclear life cycle and replacement fossil
 11 fuel power plants and climate change impacts are presented in Section 4.12.

12 **4.14.1 Environmental Consequences of Fuel Cycles**

13 Most replacement power alternatives use a process to obtain their fuels. Nuclear power plants
 14 use a process to obtain the uranium from the Earth and refine it for its use within the reactors.
 15 The continued operation of the nuclear power plants during the license renewal term (initial LR
 16 or SLR) requires uranium processing. Getting fuel may include extracting, transforming,
 17 transporting, and combusting, among other activities. Emissions may result at each step within
 18 the processing. Also, some aspects of any fuel cycle (for example, storage and disposal)
 19 described here are common to each alternative.

20 *4.14.1.1 Uranium Fuel Cycle*

21 In the United States, all currently operating commercial plants are LWRs and use uranium for
 22 fuel. Therefore, in this section and in the rest of this LR GEIS, the term “uranium fuel cycle” is
 23 used interchangeably with “nuclear fuel cycle.”

24 *4.14.1.1.1 Background on Uranium Fuel Cycle Facilities*

25 The NRC evaluated the environmental impacts that would be associated with operating uranium
 26 fuel cycle facilities other than the reactors themselves in two NRC publications: WASH-1248
 27 (AEC 1974a) and NUREG-0116 (NRC 1976). More recently, facilities for managing the back
 28 end of the nuclear fuel cycle were considered in NUREG-2157 (NRC 2014c). The types of
 29 facilities considered in these documents include the following:

- 30 • uranium mining – facilities where the uranium ore is mined.
- 31 • uranium milling – facilities where the uranium ore is refined to produce uranium
 32 concentrates in the form of triuranium octaoxide (U_3O_8).
- 33 • UF_6 production – facilities where the uranium concentrates are converted to UF_6 .
- 34 • isotopic enrichment – facilities where the isotopic ratio of the uranium-235 isotope in natural
 35 uranium is increased to meet the requirements of LWRs.
- 36 • fuel fabrication – facilities where the enriched UF_6 is converted to uranium dioxide (UO_2) and
 37 made into sintered UO_2 pellets. The pellets are subsequently encapsulated in fuel rods, and
 38 the rods are assembled into fuel assemblies ready to be inserted into the reactors. Two
 39 options were considered: (1) carrying out all steps involved in manufacturing the fuel
 40 assemblies at the same location, and (2) carrying the steps out at two separate facilities (at

Environmental Consequences and Mitigating Actions

- 1 one facility, uranium dioxide is produced in powder form from the enriched UF₆; and at the
2 other facility, the fuel assemblies are manufactured).
- 3 • reprocessing – facilities that disassemble the spent fuel assemblies, chop up the fuel rods
4 into small sections, chemically dissolve the spent fuel out of sectioned fuel rod pieces, and
5 chemically separate the spent fuel into reusable uranium, plutonium, and other radionuclides
6 (primarily fission products and actinides).
 - 7 • independent spent fuel storage installations (ISFSIs) – Two options are considered:
 - 8 – At-Reactor Continued Storage ISFSIs – facilities designed and constructed at a
9 nuclear power plant for the interim storage of spent nuclear fuel pending permanent
10 disposal, used by operating plants to add spent nuclear fuel storage capacity beyond
11 that available in the nuclear power plant's SFP.
 - 12 – Away-from-Reactor ISFSIs – facilities designed and constructed away from a nuclear
13 power plant for the short-term, long-term, and indefinite storage of spent nuclear fuel
14 pending permanent disposal, used by operating and formerly operating nuclear
15 plants to add spent nuclear fuel storage capacity beyond that available in the nuclear
16 power plant's SFP and at-reactor ISFSIs.
 - 17 • disposal – facilities where the radioactive wastes generated at all fuel cycle facilities,
18 including the reactors, are buried. Spent nuclear fuel that is removed from the reactors and
19 not reprocessed was also assumed to be disposed of at a geologic repository.

20 As evaluated in NUREG-2157 (NRC 2014c), the NRC reaffirmed in 2014 that geological
21 disposal remains technically feasible and that acceptable sites can be identified.

22 4.14.1.1.2 Environmental Impacts

23 In addition to impacts occurring at the above facilities, the impacts associated with the
24 transportation of radioactive materials among these facilities, including the transportation of
25 wastes to disposal facilities, were evaluated. The results were summarized in a table and
26 promulgated as Table S-3 in 10 CFR 51.51(b). Table S-3 is provided at the end of this section
27 as Table 4.14-1 for ease of reference. 10 CFR 51.51(a) states:

28 Every environmental report prepared for the construction permit stage of a light-
29 water-cooled nuclear power reactor, and submitted on or after September 4,
30 1979, shall take Table S-3, Table of Uranium Fuel Cycle Environmental Data, as
31 the basis for evaluating the contribution of the environmental effects of uranium
32 mining and milling, the production of uranium hexafluoride, isotopic enrichment,
33 fuel fabrication, reprocessing of irradiated fuel, transportation of radioactive
34 materials and management of low level wastes and high level wastes related to
35 uranium fuel cycle activities to the environmental costs of licensing the nuclear
36 power reactor. Table S-3 shall be included in the environmental report and may
37 be supplemented by a discussion of the environmental significance of the data
38 set forth in the table as weighed in the analysis for the proposed facility.

39 Specific categories of natural resource use included in Table 4.14-1 relate to land use; water
40 consumption and thermal effluents; radioactive releases; burial of transuranic waste, HLW, and
41 LLW; and radiation doses from transportation and occupational exposures. The contributions in
42 the table for reprocessing, waste management, and transportation of wastes are maximized for
43 either of the two fuel cycles (uranium only and no recycle); that is, the cycle that results in the

1 greater impact is used. For each resource area, Table 4.14-1 presents a result that has been
2 integrated over the entire fuel cycle except the reactors. The only exception to this is that the
3 waste quantities provided under the entry called “solids (buried onsite)” also includes wastes
4 generated at the reactor.

5 The environmental impact values are expressed in terms normalized to show the potential
6 impacts attributable to processing the fuel required for the operation of a 1,000 MWe nuclear
7 power plant for 1 year at an 80 percent availability factor to produce about 800 MW-yr
8 (0.8 GW-yr) of electricity. This is referred to as 1 reference reactor year.

9 Many of the nuclear fuel cycle facilities and processes assessed for Table 4.14-1 still exist
10 today. However, some have undergone several industrial developments and technological
11 advances that have significantly reduced their environmental effects. As discussed in NUREG-
12 2226, the Clinch River ESP FEIS (NRC 2019b), recent changes in the uranium fuel cycle may
13 have some bearing on environmental impacts. As discussed below, the NRC is confident that
14 the contemporary normalized uranium fuel cycle impacts for LWRs are less than those identified
15 in Table 4.14-1. This assertion is true in light of the following recent uranium fuel cycle trends in
16 the United States:

- 17 • Increasing use of in situ leach uranium mining, which does not produce mine tailings and
18 would lower the release of radon gas (NRC 2020e).
- 19 • Transitioning of U.S. uranium enrichment technology from gaseous diffusion to gas
20 centrifugation. The latter process uses only a fraction of the electrical energy per separation
21 unit compared to gaseous diffusion and U.S. gaseous-diffusion plants that relied on
22 electricity derived mainly from the burning of coal.
- 23 • Current LWRs are using nuclear fuel more efficiently because of higher levels of fuel
24 burnup. Thus, less uranium fuel per year of reactor operation is required than in the past to
25 generate the same amount of electricity (an increase in the time for refueling [from
26 12 months to 18 months or more] as applied for Table S-3).

27 The values in Table 4.14-1 were calculated from industry averages for the performance of each
28 type of facility or operation within the fuel cycle. Recognizing that this approach meant that
29 there would be a range of reasonable values for each estimate, the staff chose the assumptions
30 or factors to be applied so that the calculated values would not be underestimated. This
31 approach was intended to make sure that the actual environmental impacts would be less than
32 the quantities shown in Table 4.14-1 for all LWR nuclear power plants within the widest range of
33 operating conditions. The staff recognizes that many of the fuel cycle parameters and
34 interactions vary in small ways from the estimates in Table 4.14-1 and concludes that these
35 variations would have no impacts on the Table 4.14-1 calculations. For example, to determine
36 the quantity of fuel required for a year’s operation of a nuclear power plant in Table 4.14-1, the
37 staff defined the reference reactor as a 1,000 MW LWR operating at 80 percent capacity with a
38 12-month fuel-reloading cycle and an average fuel burnup of 33,000 MWd/MTU. These values
39 are not challenged by the current LWR fleet, which is operating with an average factor of
40 approximately 95 percent capacity for peak fuel rod burnup of up to 62,000 MWd/MTU with
41 refueling occurring at approximately 18-months to 2-year intervals (NRC 2019b). This means
42 fuel can be used more efficiently, requiring less total fuel, resulting in less environmental effects
43 than those presented in Table 4.14-1 (Table S-3).

44 The analysis presented in Table 4.14-1 (circa 1970s) was also based on most of the electricity
45 generated in the United States being produced in plants that burn fossil fuels, and coal

Environmental Consequences and Mitigating Actions

1 composing the bulk of fossil fuel utilization (AEC 1974a). However, today the energy sources
2 for utility-scale electrical generation are more diverse (DOE/EIA 2020b):

- 3 • 23 percent from coal;
- 4 • 38 percent from natural gas, for which air emissions are much less than those from coal;
- 5 • 20 percent from nuclear power plants;
- 6 • 17 percent from renewables (10 percent from non-hydroelectric renewables and 7 percent
7 from hydroelectric); and
- 8 • 1 percent from petroleum and other sources.

9 Therefore, environmental impacts related to air emissions, associated pollutants, and
10 water/thermal impacts from today's electrical generation contribution to the nuclear fuel cycle
11 are clearly less than and are bounded by the coal-electrical generation data assessed by
12 WASH-1248 (AEC 1974a) and found in Table 4.14-1. This trend of decreasing reliance on
13 fossil fuels for electrical generation will continue, spurred by actions to combat climate change
14 (DOE/EIA 2020c).

15 Based on several of the items discussed above, the 2013 LR GEIS states:

16 It was concluded that even though certain fuel cycle operations and fuel
17 management practices have changed over the years, the assumptions and
18 methodology used in preparing Table S-3 were conservative enough that the
19 impacts described by the use of Table S-3 would still be bounding. The NRC
20 believes that this conclusion still holds.

21 A detailed discussion of impacts associated with the production and processing of fuel needed
22 for 1 reference reactor year operation of the model LWR was provided in the 1996 LR GEIS.
23 Included in the discussion were the collective offsite radiological impacts that would be
24 associated with radon-222 and technetium-99 releases to the environment during the fuel cycle
25 operations, which Table 4.14-1 does not address.

26 One part of the fuel cycle that was not discussed either in the technical support documents for
27 the original Table 4.14-1 or in the 1996 LR GEIS was the disposition of the depleted UF₆ tails
28 generated during the enrichment process. Originally, these tails were intended to be used as a
29 feedstock to make fuel for proposed fast breeder reactors. However, the United States
30 abandoned the fast breeder reactor program in 1983 (Breeder Reactor Corporation 1985).
31 Before the creation of the United States Enrichment Corporation in 1993, DOE was the
32 custodian of all the depleted UF₆ generated in the United States at the three gaseous-diffusion
33 plants (in Oak Ridge, Tennessee; Portsmouth, Ohio; and Paducah, Kentucky). DOE prepared
34 several NEPA documents evaluating the impacts associated with the disposition of
35 approximately 700,000 MT (1.54 billion lb) of depleted UF₆ (DOE 1999, DOE 2004a, DOE
36 2004b, DOE 2007). DOE decided to convert the depleted UF₆ back to U₃O₈ and dispose of it as
37 LLW (69 FR 44654, 69 FR 44649). The results of these analyses indicate that the operational
38 impacts of the depleted UF₆ management facilities would not be very different from the impacts
39 estimated for other parts of the fuel cycle in Table 4.14-1. In particular, the impacts of the
40 depleted UF₆ conversion facilities, where the depleted UF₆ is converted to triuranium octaoxide,
41 would be similar to the impacts of the UF₆ production facilities, where U₃O₈ is converted to UF₆.
42 If the depleted uranium oxide is disposed of as LLW, the conversion product corresponding to 1
43 reference reactor year would be in addition to the LLW quantities already listed in Table 4.14-1.

1 This value is estimated to be approximately 12 Ci (4.4×10^{11} Bq) (35 MT of uranium per
2 reference reactor year multiplied by 0.34 Ci/MT of depleted uranium).

3 As discussed above and in the following sections, the NRC staff reviewed information from
4 technical literature as well as from SEISs (for initial LR and SLRs) completed since
5 development of the 2013 LR GEIS and identified no new information or situations that would
6 result in different impacts for either an initial LR or SLR term with respect to the uranium fuel
7 cycle.

8 **Table 4.14-1 Table S-3 Taken from 10 CFR 51.51 on Uranium Fuel Cycle Environmental**
9 **Data (Normalized to model light water reactor annual fuel requirement**
10 **[WASH-1248; AEC 1974a] or reference reactor year [NUREG-0116; NRC**
11 **1976])^(a)**

Environmental Considerations	Total	Maximum Effect per Annual Fuel Requirement or Reference Reactor Year of Model 1,000 MWe Light Water Reactor
Natural Resource Use		
Land (acres)		
Temporarily committed ^(b)	100	
Undisturbed area	79	
Disturbed area	22	Equivalent to a 110 MWe coal-fired power plant.
Permanently committed	13	
Overburden moved (millions of MT)	2.8	Equivalent to 95 MWe coal-fired power plant.
Water (millions of gallons)		
Discharged to air	160	Equal to 2 percent of model 1,000 MWe light water reactor with cooling tower.
Discharged to water bodies	11,090	
Discharged to ground	127	
Total	11,377	Less than 4 percent of model 1,000 MWe light water reactor with once-through cooling.
Fossil Fuel		
Electrical energy (thousands of MW-hour)	323	Less than 5 percent of model 1,000 MWe output.
Equivalent coal (thousands of MT)	118	Equivalent to the consumption of a 45 MWe coal-fired power plant.
Natural gas (millions of scf)	135	Less than 0.4 percent of model 1,000 MWe energy output.
Effluents – Chemical (MT)		
Gases (including entrainment)^(c)		
SO _x	4,400	
NO _x ^(d)	1,190	Equivalent to emissions from 45 MWe coal-fired plant for a year.

Environmental Consequences and Mitigating Actions

Environmental Considerations	Total	Maximum Effect per Annual Fuel Requirement or Reference Reactor Year of Model 1,000 MWe Light Water Reactor
Hydrocarbons	14	
CO	29.6	
Particulates	1,154	
Other gases		
F	0.67	Principally from UF ₆ production, enrichment, and reprocessing. Concentration within range of State standards and below level that has effects on human health.
HCl	0.014	
Liquids		
SO ₄ ⁻	9.9	From enrichment, fuel fabrication, and reprocessing steps. Components that constitute a potential for adverse environmental effects are present in dilute concentrations and receive additional dilution by receiving bodies of water to levels below permissible standards. The constituents that require dilution and the flow of dilution water are NH ₃ : 600 cfs, NO ₃ : 20 cfs, fluoride: 70 cfs.
NO ₃ ⁻	25.8	
Fluoride	12.9	
Ca ⁺	5.4	
Cl ⁻	8.5	
Na ⁺	12.1	
NH ₃	10.0	
Fe	0.4	
Tailings solutions (thousands of MT)	240	From mills only – no significant effluents to environment.
Solids	91,000	Principally from mills – no significant effluents to environment.
Effluents – Radiological (curies)		
Gases (including entrainment)		
Rn-222	–	Presently under reconsideration by the Commission.
Ra-226	0.02	
Th-230	0.02	
Uranium	0.034	
Tritium (thousands)	18.1	
C-14	24	
Kr-85 (thousands)	400	
Ru-106	0.14	Principally from fuel reprocessing plants.
I-129	1.3	
I-131	0.83	

Environmental Consequences and Mitigating Actions

Environmental Considerations	Total	Maximum Effect per Annual Fuel Requirement or Reference Reactor Year of Model 1,000 MWe Light Water Reactor
Tc-99	–	Presently under consideration by the Commission.
Fission products and transuranics	0.203	
Liquids		
Uranium and daughters	2.1	Principally from milling –included tailings liquor and returned to ground, no effluents; therefore, no effect on the environment.
Ra-226	0.0034	From UF ₆ production.
Th-230	0.0015	
Th-234	0.01	From fuel fabrication plants – concentration 10 percent of 10 CFR Part 20 for total processing 26 annual fuel requirements for model light water reactor.
Fission and activation products	5.9×10^{-6}	
Solids (buried onsite)		
Other than high level (shallow)	11,300	9,100 Ci comes from low-level reactor wastes and 1,500 Ci comes from reactor decontamination and decommissioning – buried at land burial facilities. 600 Ci comes from mills – included in tailing returned to ground. Approximately 60 Ci comes from conversion and spent fuel storage. No significant effluent to the environment.
Transuranic and high-level waste (deep)	1.1×10^7	Buried at Federal Repository.
Effluents – Thermal (billions of Btu)	4,063	Less than 5 percent of model 1,000 MWe light water reactor.
Transportation (person-rem)		
Exposure of workers and general public	2.5	
Occupational exposure	22.6	From reprocessing and waste management.

(a) In some cases where no entry appears, it is clear from the background documents that the matter was addressed and that, in effect, the table should be read as if a specific zero entry had been made. However, there are other areas that are not addressed in the table. Table S-3 does not include health effects from the effluents described in the table, estimates of releases of radon-222 from the uranium fuel cycle, or estimates of technetium-99 released from waste management or reprocessing activities. These issues may be the subject of litigation in the individual licensing proceedings.

Data supporting this table are given in the *Environmental Survey of the Uranium Fuel Cycle*, WASH-1248, April 1974; the *Environmental Survey of the Reprocessing and Waste Management Portion of the LWR Fuel Cycle*, NUREG-0116 (Supp. 1 to WASH-1248); the *Public Comments and Task Force Responses Regarding the Environmental Survey of the Reprocessing and Waste Management Portions of the LWR Fuel Cycle*, NUREG-0216 (Supp. 2 to WASH-1248); and in the record of the final rulemaking pertaining to *Uranium Fuel Cycle Impacts from Spent Fuel Reprocessing and Radioactive Waste Management*, Docket RM-50-3. The contributions from reprocessing, waste management, and transportation of wastes are maximized for either of the two fuel cycles (uranium only and no recycle). The contribution from transportation excludes transportation

Environmental Consequences and Mitigating Actions

- 1 of cold fuel to a reactor and transportation of irradiated fuel and radioactive wastes from a reactor, which are
2 considered in Table S-4 of Section 51.20(g) [sic, Table S-4 now appears in Section 51.52(c)]. The contributions
3 from the other steps of the fuel cycle are given in columns A–E of Table S-3A of WASH-1248.
- 4 (b) The contributions to temporarily committed land from reprocessing are not prorated over 30 years, because the
5 complete temporary impact accrues regardless of whether the plant services 1 reactor for 1 year or 57 reactors
6 for 30 years.
- 7 (c) Estimated effluents based upon combustion of equivalent coal for power generation.
- 8 (d) 1.2 percent from natural gas use and process.
- 9 Source: 10 CFR 51.51.
-

10 4.14.1.1.3 Consideration of Environmental Justice

11 As stated in the NRC's *Policy Statement on the Treatment of Environmental Justice Matters in*
12 *NRC Regulatory and Licensing Actions* (69 FR 52040),

13 An NRC EJ [environmental justice] analysis should be limited to the impacts
14 associated with the proposed action (i.e., the communities in the vicinity of the
15 proposed action). EJ-related issues differ from site to site and normally cannot
16 be resolved generically. Consequently, EJ, as well as other socioeconomic
17 issues, are normally considered in site-specific EISs. Thus, due to the site-
18 specific nature of an EJ analysis, EJ-related issues are usually not considered
19 during the preparation of a generic or programmatic EIS. EJ assessments would
20 be performed as necessary in the underlying licensing action for each particular
21 facility.

22 The environmental impacts of various individual operating uranium fuel cycle facilities are
23 addressed in separate site-specific environmental reviews and NEPA documents prepared by
24 the NRC. These documents include analyses that address human health and environmental
25 impacts on minority populations, low-income populations, and Indian Tribes. Electronic copies
26 of these NEPA documents are available through the NRC's public Web site under Publications
27 Prepared by NRC Staff document collection of the NRC's Electronic Reading Room at
28 <http://www.nrc.gov/reading-rm/doc-collections/>; and the NRC's Agencywide Documents Access
29 and Management System (ADAMS) at <http://www.nrc.gov/reading-rm/adams.html>.

30 4.14.1.1.4 Transportation Impacts

31 The impacts associated with transporting fresh fuel to one 1,000 MWe model LWR and with
32 transporting spent fuel and radioactive waste (LLW and mixed waste) from that LWR are
33 provided in Table S-4 in 10 CFR 51.52. Similar to Table S-3 (Table 4.14-1), and as indicated in
34 10 CFR 51.52, every environmental report prepared for the construction permit stage of a
35 commercial nuclear power plant must contain a statement concerning the transportation of fuel
36 and radioactive waste to and from the reactor. A similar statement is also required in license
37 renewal (initial LR and SLR) applications. Table S-4 forms the basis of such a statement and is
38 presented here as Table 4.14-2.

39 A discussion of the values included in Table S-4 of 10 CFR 51.52 (see Table 4.14-2) and how
40 they may change during the license renewal term was included in Section 6.3 of the 1996 LR
41 GEIS. However, after the 1996 LR GEIS was issued and during the rulemaking process for
42 codifying Table B-1 in 10 CFR Part 51, a number of comments were received from the public
43 that raised some questions about the adequacy of Table 4.14-2 values for license renewal
44 application reviews. As a result, the NRC reevaluated the transportation issues and the
45 adequacy of Table 4.14-2 values for license renewal (initial LR or SLR) application reviews. In
46 1999, the NRC issued an addendum to the 1996 LR GEIS in which the agency evaluated the

1 applicability of Table S-4 (Table 4.14-2) to future license renewal proceedings, given that the
 2 spent fuel is likely to be shipped to a single repository (as opposed to several destinations, as
 3 originally assumed in the preparation of Table S-4) and given that shipments of spent fuel are
 4 likely to involve more highly enriched fresh fuel (more than 4 percent as assumed in Table S-4)
 5 and higher-burnup spent fuel (higher than 33,000 MWd/MTU as assumed in Table 4.14-2). In
 6 the addendum, the NRC evaluated the impacts of transporting the spent fuel from reactor sites
 7 to the proposed geologic repository at Yucca Mountain in Nevada and the impacts of shipping
 8 more highly enriched fresh fuel and higher-burnup spent fuel. On the basis of the evaluations,
 9 the NRC concluded that the values given in Table 4.14-2 (Table S-4 in 10 CFR 51.52) would still
 10 be bounding, as long as the (1) enrichment of the fresh fuel was 5 percent or less, (2) burnup of
 11 the spent fuel was 62,000 MWd/MTU or less, and (3) higher-burnup spent fuel (higher
 12 than 33,000 MWd/MTU) was cooled for at least 5 years before being shipped offsite. The
 13 conditions evaluated in Addendum 1 have not changed, and no new conditions have been
 14 introduced that would alter the conclusions in Addendum 1 (NRC 1999a). A later study found
 15 that the impacts from the transportation of spent nuclear fuel with up to 75,000 MWd/MTU
 16 burnup would not have significant adverse environmental impacts, provided that the impacts are
 17 not significantly affected by fission gas releases and the fuel is cooled for at least 5 years before
 18 shipment (Ramsdell et al. 2001). Table 4.14-2 as currently encoded in 10 CFR 51.52 is
 19 provided below.

20 **Table 4.14-2 Table S-4 Taken from 10 CFR 51.52 on the Environmental Impact of**
 21 **Transporting Fuel and Waste to and from One Light-Water-Cooled Nuclear**
 22 **Power Reactor^(a)**

Normal Conditions of Transport		Environmental Impact	
Heat (per irradiated fuel cask in transit)		250,000 Btu/hr	
Weight (governed by Federal or State restrictions)		73,000 lb per truck; 100 tons per cask per rail car	
Traffic density:			
Truck		Less than 1 per day	
Rail		Less than 3 per month	
Exposed Population	Estimated No. of Persons Exposed	Range of Doses to Exposed Individuals ^(b) (per reactor year)	Cumulative Dose to Exposed Population (per reactor year) ^(c)
Transportation workers	200	0.01 to 300 millirem	4 person-rem
General public:			
Onlookers	1,100	0.003 to 1.3 millirem	3 person-rem
Along route	600,000	0.0001 to 0.06 millirem	

23

Environmental Consequences and Mitigating Actions

Accidents in Transport

Types of Effects	Environmental Risk
Radiological effects	Small ^(d)
Common (nonradiological) causes	1 fatal injury in 100 reactor years; 1 nonfatal injury in 10 reactor years; \$475 property damage per reactor year

- 1 (a) Data supporting this table are given in the Commission's *Environmental Survey of Transportation of Radioactive*
2 *Materials to and from Nuclear Power Plants*, WASH-1238, December 1972, and Supp. 1, NUREG-75/038,
3 April 1975. Both documents are available for inspection and copying at the Commission's Public Document
4 Room, One White Flint North, 11555 Rockville Pike (first floor), Rockville, Maryland 20852 and may be obtained
5 from National Technical Information Service, Springfield, VA 22161.
- 6 (b) The Federal Radiation Council has recommended that the radiation doses from all sources of radiation other
7 than natural background and medical exposures should be limited to 5,000 millirem per year for individuals as a
8 result of occupational exposure and should be limited to 500 millirem per year for individuals in the general
9 population. The dose to individuals due to average natural background radiation is about 130 millirem per year.
- 10 (c) Man-rem is an expression for the summation of whole body doses to individuals in a group. Thus, if each
11 member of a population group of 1,000 people received a dose of 0.001 rem (1 millirem), or if 2 people received
12 a dose of 0.5 rem (500 millirem) each, the total man-rem dose in each case would be 1 man-rem.
- 13 (d) Although the environmental risk of radiological effects stemming from transportation accidents is currently
14 incapable of being numerically quantified, the risk remains small, regardless of whether it is being applied to a
15 single reactor or a multireactor site.
- 16 Source: 10 CFR 51.52.

17 4.14.1.1.5 Consideration of Environmental Justice

18 The human health effects of transporting spent nuclear fuel were originally addressed in an
19 addendum to the 1996 GEIS (NRC 1999b) in which the agency evaluated the applicability of
20 Table S-4 to future license renewal proceedings given that spent fuel is likely to be shipped to a
21 single geologic repository. As part of the site characterization and recommendation process for
22 the proposed geologic repository at Yucca Mountain, Nevada, the DOE is required by the
23 Nuclear Waste Policy Act of 1982 to prepare an EIS. By law, the NRC is required to adopt
24 DOE's EIS, to "the extent practicable," as part of any possible NRC construction authorization
25 decision. As a result, DOE prepared and submitted to NRC the *Supplemental Environmental*
26 *Impact Statement for a Geologic Repository for the Disposal of Spent Nuclear Fuel and High-*
27 *Level Radioactive Waste at Yucca Mountain, Nye County, Nevada* (Repository Supplemental
28 EIS) (DOE/EIS-0250F-S1; DOE 2008). This document includes analyses that address the
29 human health and environmental impacts on minority populations, low-income populations, and
30 Indian Tribes.

31 As noted in DOE's Repository Supplemental EIS, shipments of spent nuclear fuel (as well as
32 fresh fuel) would use the nation's existing railroads and highways. Consequently, DOE
33 estimates that transportation-related environmental impacts affecting land use; air quality;
34 hydrology; biological resources and soils; cultural resources; socioeconomics; noise and
35 vibration; aesthetic resources; utilities, energy, and materials; and waste management would be
36 SMALL. Nonetheless, segments of the population, including minority populations, low-income
37 populations, and Indian Tribes, would likely experience some transportation-related
38 environmental effects.

39 The DOE did not identify any high and adverse human health or environmental impacts on
40 members of the public from the transport of spent nuclear fuel, and determined that subsections
41 of the population, including minority populations, low-income populations, and Indian Tribes,
42 would not experience disproportionate effects. In addition, DOE did not identify any unique
43 patterns of subsistence consumption, exposure pathways, sensitivities, or cultural practices that

1 would expose these populations to disproportionately high and adverse effects. Consequently,
 2 DOE concluded that minority populations, low-income populations, and Indian Tribes would not
 3 experience any disproportionately high and adverse human health or environmental effects from
 4 the transportation of spent nuclear fuel to Yucca Mountain (DOE 2008). On September 8, 2008,
 5 the NRC staff recommended the Commission adopt DOE's Repository Supplemental EIS with
 6 supplements (73 FR 53284).

7 As discussed in Section 4.11.1.3, the NRC prepared and issued an EIS supplement in 2016
 8 (NUREG-2184; NRC 2016a) that evaluated environmental impacts due to potential radiological
 9 releases from the proposed Yucca Mountain geologic repository. The supplement did not
 10 evaluate transportation impacts. The NRC determined that there would be no disproportionately
 11 high and adverse human health or environmental effects from the use or discharge of
 12 groundwater flowing from the repository on minority or low-income populations.

13 In light of DOE's decision to not proceed with the Yucca Mountain nuclear waste geologic
 14 repository and comprehensive reevaluation of policies for managing spent nuclear fuel from
 15 nuclear power plants (see Section 4.11.1.3), some or all of the environmental impact analyses
 16 in DOE's Repository Supplemental EIS will have to be revisited. Nevertheless, as reaffirmed by
 17 the NRC in the 2014 Continued Storage Final Rule (79 FR 56238) and as supported by the
 18 analyses in NUREG-2157, disposal in a geologic repository continues to be technically feasible.
 19 International progress in the development of repositories provides confidence that it is likely that
 20 a repository can and will be developed in the United States, with 25 to 35 years being a
 21 reasonable period for repository development. The NRC expects that DOE's analysis for the
 22 Yucca Mountain geologic repository would be representative of any future repository.

23 *4.14.1.1.6 Environmental Impact Issues of the Uranium Fuel Cycle*

24 Nuclear fuel is needed for the operation of light water reactors during the license renewal term
 25 (initial LR or SLR) in the same way that it is needed during the current license period.
 26 Therefore, the factors that affect the data presented in Tables S-3 (Table 4.14-1) and S-4
 27 (Table 4.14-2) of 10 CFR 51.51 and 51.52, respectively, do not change whether a light water
 28 reactor is operating under its original license or a renewed license. In the 1996 LR GEIS, there
 29 are nine issues that relate to uranium fuel cycle and waste management; five of them that relate
 30 to waste management are addressed in Section 4.11.1.

31 The remaining four impact issues include the following (as evaluated in the 2013 LR GEIS):

- 32 • offsite radiological impacts – individual impacts from other than the disposal of spent fuel
 33 and high-level waste;
- 34 • offsite radiological impacts – collective impacts from other than the disposal of spent fuel
 35 and high-level waste);
- 36 • nonradiological impacts of the uranium fuel cycle; and
- 37 • transportation.

38 **Offsite Radiological Impacts – Individual Impacts from Other than the Disposal of Spent**
 39 **Fuel and High-Level Waste**

40 This issue addresses the radiological impacts on individuals who live near uranium fuel cycle
 41 facilities. The primary indicators of impact are the concentrations of radionuclides in the
 42 effluents from the fuel cycle facilities and the radiological doses received by an MEI (a

Environmental Consequences and Mitigating Actions

1 maximally exposed individual) on the site boundary or at some location away from the site
2 boundary. As discussed in Section 3.9.1 of this LR GEIS, an MEI can be exposed to radiation
3 from radionuclides found in the effluents of nuclear fuel cycle facilities and from radiation “shine”
4 from buildings, storage facilities, and storage tanks containing radioactive material. The basis
5 for establishing the significance of individual effects is the comparison of the releases in the
6 effluents and the MEI doses with the permissible levels in applicable regulations. The analyses
7 performed by the NRC in the preparation of Table 4.14-1 and found in the 1996 LR GEIS
8 indicate that as long as the facilities operate under a valid license issued by either the NRC or
9 an agreement State, the individual effects will meet the applicable regulations. On the basis of
10 these considerations, the NRC has concluded that the impacts on individuals from radioactive
11 gaseous and liquid releases during the initial LR or SLR term would remain at or below the
12 NRC’s regulatory limits. Accordingly, the NRC concludes that offsite radiological impacts of the
13 uranium fuel cycle (individual effects from sources other than the disposal of spent fuel and
14 high-level waste) are SMALL. The efforts to keep the releases and doses ALARA will continue
15 to apply to fuel-cycle-related activities. This was considered a Category 1 issue in the 2013 LR
16 GEIS. The staff reviewed information from SEISs (for initial LRs and SLRs) completed since
17 development of the 2013 LR GEIS and identified no new information or situations that would
18 result in different impacts for this issue for either an initial LR or SLR term. Therefore, this is a
19 Category 1 issue for both initial LR and SLR.

20 **Offsite Radiological Impacts – Collective Impacts from Other than the Disposal of Spent** 21 **Fuel and High-Level Waste**

22 The focus of this issue is the collective radiological doses to and health impacts on the general
23 public resulting from uranium fuel cycle facilities over the license renewal term. The radiological
24 doses received by the general public are calculated on the basis of releases from the facilities to
25 the environment, as provided in Table 4.14-1. These estimates were provided in the 1996 LR
26 GEIS for the gaseous and liquid releases listed in Table S-3 as well as for radon-222 and
27 technetium-99 releases (Rn-222 and Tc-99), which are not listed in Table 4.14-1. The
28 population dose commitments were normalized for each year of operation of the model
29 1,000 MWe LWR (reference reactor year).

30 On the basis of the analyses provided in the 1996 LR GEIS and reexamined and discussed in
31 the 2013 LR GEIS, the estimated involuntary 100-year dose commitment to the U.S. population
32 resulting from the radioactive gaseous releases from uranium fuel cycle facilities (excluding the
33 reactors and releases of Rn-222 and Tc-99) was estimated to be 400 person-rem (4 person-Sv)
34 for 1 reference reactor year. Similarly, the environmental dose commitment to the U.S.
35 population from the liquid releases was estimated to be 200 person-rem (3 person-Sv) per
36 reference reactor year. As a result, the total estimated involuntary 100-year dose commitment
37 to the U.S. population from radioactive gaseous and liquid releases listed in Table 4.14-1 was
38 given as 600 person-rem (6 person-Sv) per reference reactor year (see Section 6.2.2 of the
39 1996 LR GEIS).

40 The 1996 and 2013 LR GEISs also provided a detailed analysis of potential doses to the U.S.
41 population from Rn-222 releases, which primarily occur during mining and milling operations
42 and as emissions from mill tailings, and Tc-99 releases, which primarily occur during the
43 enrichment process (Section 6.2.2 of the 1996 LR GEIS). Tc-99 releases during enrichment
44 occurred through a gaseous diffusions process that is no longer used within the United States.
45 Tc-99 is not released through centrifuge enrichment processes and is not reconsidered in this
46 analysis. The U.S. population doses resulting from the Rn-222 releases for 1 reference reactor
47 year are summarized in Table 4.14-3 from the 2013 LR GEIS. The total population dose from

1 all releases to the environment, including the Rn-222, is given as 838.6 person-rem
 2 (8.386 person-Sv) per reference reactor year.

3 **Table 4.14-3 Population Doses from Uranium Fuel Cycle Facilities Normalized to One**
 4 **Reference Reactor Year**

Source	Collective Dose (person-rem) ^(a)
Gaseous releases	400
Liquid releases	200
Rn-222 releases from uranium mining and milling	140
Rn-222 releases from unreclaimed open-pit mines	96
Rn-222 releases from stabilized tailings piles	2.6
Total	838.6

5 Rn-222 = Radon-222.

6 (a) To convert person-rem to person-Sv, multiply by 0.01.

7 Source: Modified from NRC 1996.

8 As discussed in the 1996 LR GEIS and as confirmed in the 2013 LR GEIS, the dose estimates
 9 given above were based on highly conservative assumptions. In actuality, the doses received
 10 by most members of the public would be so small that they would be indistinguishable from the
 11 variations in natural background radiation. There are no regulatory limits applicable to collective
 12 doses to the general public from fuel cycle facilities. All regulatory limits are based on individual
 13 doses. All fuel cycle facilities are designed and operated to meet the applicable regulatory
 14 limits.

15 As discussed in the 1996 LR GEIS and as confirmed in the 2013 LR GEIS, despite the lack of
 16 definitive data, some judgment as to the regulatory NEPA implications of these matters should
 17 be made and it makes no sense to repeat the same judgment in every case. The Commission
 18 concludes that these impacts are acceptable in that these impacts would not be sufficiently
 19 large to require the NEPA conclusion, for any plant, that the option of extended operation under
 20 10 CFR Part 54 should be eliminated. Accordingly, while the Commission has not assigned a
 21 single level of significance for the collective effects of the fuel cycle; this issue was considered
 22 Category 1. The staff reviewed information from SEISs (for initial LRs and SLRs) completed
 23 since development of the 2013 LR GEIS and identified no new information or situations that
 24 would result in different impacts for this issue for either an initial LR or SLR term. This is a
 25 Category 1 issue for both initial LR and SLR.

26 **Nonradiological Impacts of the Uranium Fuel Cycle**

27 This section addresses the nonradiological impacts associated with the uranium fuel cycle
 28 facilities as they relate to license renewal. Data on the nonradiological impacts of the fuel cycle
 29 are provided in Table 4.14-1. These data cover land use, water use, fossil fuel use, and
 30 chemical effluents. The significance of the environmental impacts associated with these data
 31 was evaluated in the 1996 LR GEIS on the basis of several relative comparisons. The land
 32 requirements were compared to those for a coal-fired power plant that could be built to replace
 33 the nuclear capacity if the operating license is not renewed. Water requirements for the
 34 uranium fuel cycle were compared to the annual requirements for a nuclear power plant. The
 35 amount of fossil fuel (coal and natural gas) consumed to produce electrical energy and process
 36 heat during the various phases of the uranium fuel cycle was compared to the amount of fossil

Environmental Consequences and Mitigating Actions

1 fuel that would have been used if the electrical output from the nuclear plant were supplied by a
2 coal-fired plant. Similarly, the gaseous effluents SO₂, nitric oxide (NO), hydrocarbons, carbon
3 monoxide (CO), and other particulate matter (PM) released as a consequence of the coal-fired
4 electrical energy used in the uranium fuel cycle were compared with equivalent quantities of the
5 same effluents that would be released from a 45 MWe coal-fired plant. It was noted that the
6 impacts associated with uses of all of the above resources would be SMALL. Any impacts
7 associated with nonradiological liquid releases from the fuel cycle facilities would also be
8 SMALL. As a result, the aggregate nonradiological impacts of the uranium fuel cycle resulting
9 from the renewal (initial LR or SLR) of an operating license for a plant would be SMALL, and it
10 was considered a Category 1 issue in the 2013 LR GEIS. The staff reviewed information from
11 SEISs (for initial LRs and SLRs) completed since development of the 2013 LR GEIS and
12 identified no new information or situations that would result in different impacts for this issue for
13 either an initial LR or SLR term. Thus, this is a Category 1 issue for both initial LR and SLR.

14 **Transportation**

15 This section addresses the impacts associated with transportation of fuel and waste to and from
16 one light water reactor during the license renewal term (initial LR and SLR). Table S-4
17 (Table 4.14-2) in 10 CFR 51.52 forms the basis for analysis of these impacts when evaluating
18 the applications for license renewal (initial LR and SLR) from owners of light water reactors. As
19 discussed previously in this section, the applicability of Table 4.14-2 for license renewal (initial
20 LR and SLR) applications was extensively studied in the 1996 LR GEIS and its Addendum 1
21 (NRC 1999b) and confirmed in the 2013 LR GEIS. The impacts were found to be SMALL, and
22 the findings were stated as follows:

23 The impacts of transporting spent fuel enriched up to 5 percent uranium-235 with
24 average burnup for the peak rod to current levels approved by NRC up to
25 62,000 MWd/MTU and the cumulative impacts of transporting high-level waste to
26 a single repository, such as Yucca Mountain, Nevada are found to be consistent
27 with the impact values contained in 10 CFR 51.52(c), Summary Table S-4,
28 “Environmental Impact of Transportation of Fuel and Waste to and from One
29 Light-Water-Cooled Nuclear Power Reactor.” If fuel enrichment or burnup
30 conditions are not met, the applicant must submit an assessment of the
31 implications for the environmental impact values reported in 10 CFR 51.52.

32 The issue was designated as Category 1. The staff reviewed information from SEISs (for initial
33 LRs and SLRs) completed since development of the 2013 LR GEIS and identified no new
34 information or situations that would result in different impacts from what was concluded in the
35 2013 LR GEIS for this issue for either an initial LR or SLR term. This is a Category 1 issue for
36 both initial LR and SLR.

37 **4.14.2 Replacement Energy Alternative Fuel Cycles**

38 *4.14.2.1 Fossil Energy Alternatives*

39 The environmental consequences of the fuel cycle for a fossil fuel-fired plant result from the
40 initial extraction of the fuel from its natural setting, fuel cleaning and processing, transport of the
41 fuel to the facility, and management and ultimate disposal of solid wastes resulting from
42 combustion of the fuel.

- 1 The environmental impacts of coal mining vary with the location and type of mining technology
2 employed, but generally includes:
- 3 • Significant change in land uses, especially when surface mining is employed.
 - 4 • Degradation of visual resource values.
 - 5 • Air quality impacts, including release of criteria pollutants from vehicles and equipment,
6 release of fugitive dust from ground disturbance and vehicle travel on unpaved surfaces,
7 release of VOCs from the storage and dispensing of vehicle and equipment fuels and the
8 use of solvents and coatings in maintenance activities, and release of coalbed methane into
9 the atmosphere as coal seams are exposed and overburden is removed.
 - 10 • Noise impacts from the operation of vehicles and equipment and the possible use of
11 explosives.
 - 12 • Impacts on geology and soils due to land clearing, excavations, soil and overburden
13 stockpiling (for strip mining operations), and mining.
 - 14 • Water resources impacts, including degradation of surface water quality due to increased
15 sediment and runoff to surface water bodies, possible degradation of groundwater resources
16 due to consumptive use and potential contamination (especially when shaft mining
17 techniques are employed), as well as generation of wastewater from coal cleaning
18 operations and other supporting industrial activities.
 - 19 • Ecological impacts, including extensive loss of natural habitat, loss of native vegetative
20 cover, disturbance of wildlife, possible introduction of invasive species, changes in surface
21 water hydrology, and degradation of aquatic systems.
 - 22 • Impacts on historic and cultural resources within the mine footprint, as well as additional
23 potential impacts resulting from auxiliary facilities and appurtenances (e.g., access roads,
24 rail spurs).
 - 25 • Direct socioeconomic impacts from employment of the workforce and indirect impacts from
26 increased employment in service and support industries.
 - 27 • Potential environmental justice impacts as a result of the presence of minority or low-income
28 populations in the surrounding communities and/or within the workforce.
 - 29 • Potential health impacts on workers from exposure to airborne dust, gases such as
30 methane, and exhaust from internal combustion engines on vehicles and mining machinery.
 - 31 • Generation of coal wastes and industrial wastes associated with the maintenance of
32 vehicles and equipment, increased potential for spills of fuels from onsite fuel storage and
33 dispensing.

34 4.14.2.2 *New Nuclear Alternatives*

35 Environmental impacts of the fuel cycle result from the initial extraction of the fuel from its
36 natural setting, transport of the fuel to the facility, and management and ultimate disposal of
37 solid wastes resulting from combustion of the fuel. For the fuel cycle associated with a nuclear
38 power plant, these activities include uranium mining and milling, the production of uranium
39 hexafluoride, isotopic enrichment, fuel fabrication, reprocessing of irradiated fuel, transportation
40 of radioactive materials, and management of LLW and HLW (10 CFR Part 51). The NRC has
41 summarized environmental data associated with the uranium fuel cycle in Table S-3 of 10 CFR
42 51.51 (Table 4.14-1). The analysis provides a basis for evaluating the environmental effects of

Environmental Consequences and Mitigating Actions

1 the fuel cycle for all nuclear power plants, regardless of site location. The information is based
2 on a 1000 MW LWR with an 80 percent capacity factor. The impacts associated with the
3 transportation of fuel and waste to and from a power reactor are summarized in Table S-4 of
4 10 CFR 51.52 (Table 4.14-2). Detailed analysis of the uranium fuel cycle is also considered in
5 Section 4.14.1.1. Although the uranium fuel cycle analysis is specific to the impacts of license
6 renewal, it is applicable to new nuclear energy alternatives because existing the advanced
7 reactor designs use the same type of fuel as existing operational designs. One difference may
8 be that the new reactor may have a power rating of greater than 1,000 MWe, which may exceed
9 the power rating of the existing reactor. In those cases, the impacts would be proportionally
10 higher. However, all impacts associated with the uranium fuel cycle, as discussed in
11 Section 4.14.1.1.6, would still be SMALL.

12 4.14.2.3 *Renewable Alternatives*

13 The term “fuel cycle” has varying degrees of relevance for renewable energy facilities. Clearly,
14 the term has meaning for renewable energy technologies that rely on combustion of fuels such
15 as biomass grown or harvested for the express purpose of power production. The term is
16 somewhat more difficult to define for renewable technologies such as wind, solar, geothermal,
17 and ocean wave and current. This is because the associated natural resources continue to
18 exist (i.e., the resources are not consumed or irreversibly committed) regardless of any effort to
19 harvest them for electricity production. The common technological strategy for harvesting
20 energy from such natural resources is to convert the kinetic or thermal energy inherent in that
21 resource to mechanical energy or torque. The torque is then applied directly (e.g., as in the
22 case of a wind turbine) or indirectly (e.g., for the facilities that use conventional steam cycles to
23 drive turbines that drive generators) to produce electricity. However, because such renewable
24 technologies capture very small fractions of the total kinetic or thermal energy contained in the
25 resources, impacts from the presence or absence of the renewable energy technology are often
26 indistinguishable.

27 Environmental consequences of fuel cycles for biomass (e.g., energy crops, wood wastes,
28 municipal solid waste, refuse-derived fuel, landfill gas) include the following:

- 29 • Land use impacts from the growing and harvesting of the energy crops.
- 30 • Reduced impacts on land from the avoidance of land disposal of anthropogenic biomass
31 feedstocks such as municipal solid waste and refuse-derived fuel.
- 32 • Visual impacts from the establishment of farm fields and forest areas and processing
33 facilities for the growing, harvesting, and preparation of biomass feedstocks.
- 34 • Air impacts from operation of vehicles and equipment used in the planting, cultivating, and
35 harvesting of energy crops.
- 36 • Reductions in GHG emissions from landfills as a result of the capture and destruction by
37 combustion of landfill gas for energy production.
- 38 • Removal of GHGs from the air (e.g., CO₂) by growing crops.
- 39 • Noise impacts from the operation of agriculture and silviculture equipment and transport
40 vehicles in otherwise rural settings with low ambient noise levels.
- 41 • Soil impacts from the cultivation of fields and the potential for increased sediment in
42 precipitation runoff.

- 1 • Hydrologic impacts from irrigation of the energy crops; impacts on groundwater resources
2 from water removal for agricultural or silvicultural purposes or industrial water uses
3 associated with the preparation of biomass feedstocks.
- 4 • Ecological impacts from the loss of habitat resulting from crop production; loss of hydrologic
5 resources due to diversion for irrigation purposes; potential intrusion of invasive species on
6 disturbed land surfaces; and potential contamination of adjacent habitat by pesticide and
7 fertilizer runoff.
- 8 • Ecological impacts from the alteration of habitat due to human presence and activities in
9 agricultural and silvicultural areas.
- 10 • Historic and cultural resource impacts from inadvertent destruction of resources in virgin
11 fields that have not undergone appropriate efforts to survey, identify, and relocate cultural
12 resources that may be present.
- 13 • Human health impacts from the exposure of workers to pesticides and fertilizers used in
14 growing biomass fuels; work around mechanical planting, cultivating, and harvesting
15 equipment; work in weather extremes; and exposure to dangerous plants and wildlife.
- 16 • Waste impacts in the form of residual wastes from the application of pesticides and fertilizers
17 and wastes associated with the routine maintenance of equipment and vehicles used in crop
18 production and transport (used lubricating oils, hydraulic fluids, glycol-based coolants, and
19 battery electrolytes from maintenance of equipment and vehicles with internal combustion
20 engines).
- 21 • Positive economic impacts from the creation of jobs in the agriculture, silviculture, and
22 transportation sectors.

23 **4.14.3 Environmental Consequences of Terminating Operations and Decommissioning**

24 The following sections briefly summarize the environmental impacts of license renewal on
25 terminating reactor operations and the decommissioning of nuclear power plants and
26 replacement energy facilities. All electrical power-generating facilities will be decommissioned
27 after the end of their operating life or after a decision is made to terminate its operation. For the
28 proposed action, license renewal would delay this eventuality for up to an additional 20 years.

29 *4.14.3.1 Termination of Nuclear Power Plant Operations and Decommissioning*

30 This section describes the environmental consequences of terminating reactor operations and
31 decommissioning nuclear power plants. Impacts attributable to the proposed action (license
32 renewal) would be the environmental effects from an additional 20 years of nuclear power plant
33 operations and refurbishment. The impacts from decommissioning a nuclear power plant are
34 evaluated in the *Generic Environmental Impact Statement for Decommissioning of Nuclear*
35 *Facilities: Supplement 1, Regarding the Decommissioning of Nuclear Power Reactors,*
36 *NUREG-0586 (NRC 2002c).*

37 Most nuclear plant activities and systems dedicated to reactor operations would cease after
38 reactor shutdown. Some activities (e.g., security and spent nuclear fuel management) would
39 continue, while other activities (administration, laboratory analysis, and reactor surveillance,
40 monitoring, and maintenance) may be reduced or eliminated. Shared systems at a nuclear
41 power plant with multiple units, would continue to operate but at reduced capacity until all units
42 cease operation. The cessation of activities needed to maintain and operate the reactor would

Environmental Consequences and Mitigating Actions

1 reduce the need for workers at the nuclear power plant, but would not lead to the immediate
2 dismantlement of the reactor or its infrastructure.

3 The decommissioning process begins when the licensee informs the NRC that it has
4 permanently ceased reactor operation, defueled, and intends to decommission the nuclear
5 plant. The licensee may notify the NRC of the permanent cessation of reactor operations prior
6 to the end of the license term while still operating. Regulations in 10 CFR 50.82(a)(4)(i) and 10
7 CFR 52.110(d)(1) require licensees to submit a post-shutdown decommissioning activity report
8 (PSDAR) to the NRC, with a copy forwarded to the affected State(s), no later than 2 years after
9 the cessation of reactor operations.

10 The licensee must describe all planned activities in the PSDAR, including the schedule and
11 estimated costs for radiological decommissioning (excluding site restoration and spent fuel
12 management costs). The licensee also documents the evaluation of the environmental impacts
13 of planned decommissioning activities at the nuclear plant, providing a basis for why impacts
14 are bounded by previously issued environmental review documents (e.g., Decommissioning
15 GEIS; NRC 2002c). The licensee must also describe any decommissioning activities whose
16 impacts are not bounded and how the impacts will be addressed prior to conducting these
17 activities at the nuclear plant (e.g., through regulatory exemption or license amendment
18 requests). The licensee is required to update the PSDAR if there are any significant changes in
19 decommissioning activity, costs, schedule, or environmental impact.

20 Once the NRC receives the PSDAR, the report will be docketed, and a notice of receipt will be
21 published in the *Federal Register* to solicit public comments. The NRC conducts a public
22 meeting near the nuclear plant to discuss the licensee's decommissioning plans and schedule,
23 answer questions, and solicit comments.

24 The licensee submits a License Termination Plan with final status survey strategy to the NRC
25 near the end of decommissioning, at least 2 years before the operating license can be
26 terminated. Prior to completing decommissioning, the licensee must conduct a survey
27 demonstrating compliance with site release criteria established in the License Termination Plan.
28 The NRC verifies the survey results by one or more of the following: a quality assurance/quality
29 control review, side-by-side or split sampling of radiological surveys of selected areas, and
30 independent confirmatory surveys. When the NRC confirms that the criteria in the License
31 Termination Plan and all other NRC regulatory requirements have been met, the NRC either
32 terminates or amends the operating license, depending on the licensee's decision to use the
33 licensed area. The nuclear plant and any remaining structures on the site can then be released
34 for restricted or unrestricted use. The criteria for restricted use conditions and alternate criteria
35 that the NRC may approve under certain conditions are listed in 10 CFR 20.1403 and
36 10 CFR 20.1404, respectively. The radiological criteria for releasing sites for unrestricted use
37 are given in 10 CFR 20.1402.

38 Three decommissioning options are evaluated in the Decommissioning GEIS (NRC 2002c):
39 DECON, SAFSTOR, and ENTOMB. In the DECON option, equipment, structures, and portions
40 of a nuclear plant containing radioactive contaminants are removed and safely buried in a LLW
41 landfill or are decontaminated to a level that permits the property to be released for unrestricted
42 use shortly after the cessation of reactor operations. In the SAFSTOR option, the facility is
43 maintained in such condition that the nuclear plant can be safely stored and subsequently
44 decontaminated later to levels that permit the property to be released for restricted or
45 unrestricted use. In the ENTOMB option, radioactive contaminants are encased in a structurally
46 long-lived material, such as concrete. The entombment structure is maintained and surveillance

1 is carried out until the radioactivity decays to a level permitting unrestricted release of the
2 property.

3 The following sections discuss the potential effects from terminating reactor operations and the
4 decommissioning nuclear power plants on environmental resources near a nuclear power plant.

5 *4.14.3.2 Land Use*

6 Land use activities after terminating reactor operations and during decommissioning would be
7 comparable to what was experienced during construction and would not require land outside the
8 developed areas of the site. Activities requiring land include equipment and large component
9 laydown areas. Temporary changes in onsite land use would not affect the industrial use of the
10 site.

11 *4.14.3.3 Visual Resources*

12 The termination of reactor operations would not change the visual appearance of the nuclear
13 plant. The most notable change, however, would be the elimination of condensate plumes from
14 cooling towers. License renewal would only delay decommissioning, prolonging the visual
15 impact. The delay would have no new or added visual impact.

16 *4.14.3.4 Air Quality*

17 After the termination of reactor operations, air emissions from the nuclear power plant would
18 continue, but at reduced levels. Natural or mechanical draft cooling tower drift would also be
19 greatly reduced or eliminated. Air emissions from boilers and emergency diesel generators
20 would continue until the decommissioning of the nuclear plant has been completed.

21 *4.14.3.5 Noise*

22 During decommissioning, noise would generally be far enough away from sensitive receptors
23 outside nuclear plant boundaries, attenuated to nearly ambient levels, and scarcely noticeable
24 offsite. However, during the demolition, offsite noise levels could be loud enough that activities
25 may need to be curtailed during early morning and evening hours. Noise abatement procedures
26 could also be used during decommissioning to reduce noise.

27 *4.14.3.6 Geology and Soils*

28 Termination of reactor operations and decommissioning are not expected to affect geology and
29 soils. The demolition and removal of buildings, foundation slabs, parking lots, and roads would
30 expose soil to possible erosion. Geologic resources in the form of gravel or crushed stone may
31 be needed to construct temporary roads for heavy equipment.

Environmental Consequences and Mitigating Actions

1 4.14.3.7 *Water Resources – Surface Water and Groundwater*

2 After the termination of reactor operations, water use would be dramatically reduced; however,
3 water demands would continue for the service water system to support activities such as
4 temperature control of the spent fuel pool and other miscellaneous industrial maintenance
5 applications. Surface water or groundwater intake and consumptive use would be very low
6 compared to use during the operational phase. Discharge of liquid wastes and biocides would
7 also be proportionately reduced.

8 Because the site workforce would be reduced, the volume of sanitary sewage effluent would be
9 less than that during reactor operations. Pumping rates for groundwater used for potable water
10 systems would also decrease because of the reduced workforce.

11 Hydrology and water quality impacts from soil erosion and storm events are expected to be
12 unchanged. Erosion would be mitigated as part of general site maintenance during
13 decommissioning.

14 4.14.3.8 *Ecological Resources*

15 Termination of reactor operations would reduce some ecological resource impacts and eliminate
16 others. Nuclear plant structures including cooling towers and transmission lines would continue
17 to be collision hazards for birds. The impingement and entrainment of aquatic organisms would
18 decrease after reactor operations cease, and the potential for impacts on aquatic communities
19 would be reduced. In general, the termination of entrainment and impingement would have
20 positive effects on affected organisms. Because significantly smaller volumes of heated water
21 would be discharged after reactor operations cease, the nuclear plant's influence on the thermal
22 conditions in the receiving waters would be greatly reduced.

23 Aquatic communities and organisms acclimated to warmer temperatures and biocides may have
24 developed within the nuclear plant discharge mixing zone during years of reactor operation
25 because of the warmer environment. These organisms would be adversely affected as the
26 water temperature cooled and the original environmental conditions were restored within the
27 body of water. Organisms susceptible to cold shock would be affected. Such effects, which
28 normally occur during winter months, would occur after the reactor ceases operations.

29 Cooling ponds maintained during reactor operations by pumping water from another water body
30 would likely revert to a terrestrial system after the termination of reactor operations and pumping
31 stops and thermal effects on them cease. Cessation of the heated effluent would change the
32 composition and dynamics of the pond community until it resembled that of other ponds in the
33 region not used for cooling.

34 Dredging would no longer be needed in the vicinity of cooling water structures, thereby
35 eliminating the effect on aquatic biota. The potential for gas supersaturation and its effect on
36 biota would also be eliminated or decreased.

37 There is the potential for some effects on aquatic resources to continue regardless of whether
38 the reactor is operating. Dams and reservoirs constructed to supply water may continue to
39 prevent migration of anadromous fish unless these structures are removed.

40 The termination of reactor operations could have a beneficial impact on the Federally listed
41 loggerhead sea turtle (threatened), green sea turtle (*Chelonia mydas*, threatened), leatherback

1 sea turtle (endangered), hawksbill sea turtle (endangered), and Kemp's ridley sea turtle
2 (endangered), which have been impinged at several nuclear power plants (e.g., St. Lucie and
3 Oyster Creek). Similarly, potential benefits to the Federally endangered West Indian manatee
4 and pinnipeds, protected under the Marine Mammal Protection Act, could occur. For example,
5 the West Indian manatee has been impinged at St. Lucie, and incidental takes of harbor seals,
6 gray seals, harp seals, and hooded seals occur at the Seabrook plant. Elimination of high-
7 temperature discharges at nuclear plants in Florida may reduce habitat suitability for the West
8 Indian manatee, particularly during winter. However, the West Indian manatee occupies other
9 habitats in Florida that do not have artificially elevated temperatures, and it uses a number of
10 thermal discharges from fossil fuel plants along both coasts of Florida (Laist and Reynolds
11 2005). Potential impingement and entrainment losses of special status fish species could also
12 decrease.

13 The overall impact on ecological resources depends on the decommissioning activity. The
14 greatest potential decommissioning impact on protected species is associated with the
15 dismantlement of the nuclear plant, including intake and discharge structures. Many activities
16 that could affect ecological resources during decommissioning are the same activities that occur
17 during reactor operation. Continued reactor operations during initial LR and SLR terms will not
18 change the level of impact during decommissioning.

19 *4.14.3.9 Historic and Cultural Resources*

20 The termination of reactor operations would not affect historic or cultural resources at a nuclear
21 power plant. The continued reactor operations at a nuclear plant under a renewed license (i.e.,
22 initial LR or SLR) would not alter this conclusion. Most historic and cultural resource impacts
23 occurred during construction of the nuclear power plant. Continued operations and
24 maintenance activities have the potential to affect these resources, as discussed in
25 Section 4.7.1. There is nothing inherent in operating a nuclear plant for a longer time period
26 that would increase or decrease the impact on these resources from decommissioning.
27 Delaying decommissioning is not expected to have any effect on historic and cultural resources
28 within a transmission line ROW.

29 *4.14.3.10 Socioeconomics*

30 Terminating reactor operations could have a noticeable impact on socioeconomic conditions in
31 the region around the nuclear plant. There would be immediate socioeconomic impacts from
32 the loss of jobs (some, though not all, employees would begin to leave after reactor shutdown);
33 and tax revenues generated by plant operations would also be reduced. Depending on the tax
34 formula used to determine property tax payments, the amount of money paid to local taxing
35 jurisdictions may be reduced. However, property tax payments would continue. Demand for
36 services and housing would likely decline. Indirect employment and income created as a result
37 of nuclear power plant operations would also be reduced.

38 Loss of employment at nuclear plants in rural communities would likely mean workers and their
39 families would leave in search of jobs elsewhere. The decrease in the demand for housing and
40 the increase in available housing would depress rural housing market prices. Conversely, in
41 urban areas, nuclear plant workers and their families may remain because there are greater
42 opportunities for reemployment.

43 Traffic congestion caused by commuting workers and truck deliveries during plant operations
44 would also be reduced.

1 4.14.3.11 *Human Health*

2 After the termination of reactor operations, there is a period of time before the decommissioning
3 of the nuclear plant begins—ranging from months to years. During this time, the reactor would
4 be placed in a cold shutdown condition and maintained. Workers would continue to be exposed
5 to radiation. Radioactive gaseous and liquid effluent releases to the environment would
6 continue, although at lower levels. The radiological impacts on workers and members of the
7 public during decommissioning would be less than those during reactor operations.

8 4.14.3.11.1 *Radiological Exposure*

9 During decommissioning activities, workers and members of the public would be exposed to
10 radioactive materials released to the environment. Regulatory requirements and dose limits
11 during decommissioning are the same as when reactors are operating (see Section 3.9.1.1).
12 Many decommissioning activities are similar to those that occur during reactor operations
13 including maintenance outages (e.g., decontamination of piping and surfaces; removal of piping,
14 pumps, and valves; and removal of heat exchangers). Some activities, such as removal of the
15 reactor vessel or demolition of facilities, are unique to decommissioning. Doses to the public
16 would be well below applicable regulatory standards, regardless of which decommissioning
17 option is chosen.

18 4.14.3.11.2 *Chemical Hazards*

19 Decommissioning involves many activities that expose workers to chemical hazards, including
20 paints, asbestos, lead, polychlorobiphenyls, mercury, quartz, and other hazardous materials in
21 building materials. A delay in terminating reactor operations and decommissioning would not
22 change the projected human health impact from chemical hazards because there would not be
23 any more hazardous chemicals present.

24 4.14.3.11.3 *Microbiological Hazards*

25 During decommissioning, workers may be exposed to molds and other biological organisms.
26 License renewal (initial LR and SLR) would not change the microbiological hazard during
27 decommissioning because workers would be practicing good industrial hygiene and using
28 personal protective equipment when biological hazards were identified.

29 4.14.3.11.4 *Electromagnetic Fields*

30 After the termination of reactor operations, electricity is no longer being generated. Power
31 would still be provided to the nuclear plant, and workers might be exposed to EMFs during
32 decommissioning. The EMF impact during decommissioning would be unaffected by license
33 renewal.

1 *4.14.3.12 Accidents During Termination of Reactor Operations and Decommissioning*

2 The impacts of postulated accidents during the license renewal term are discussed in
 3 Section 4.9.1.2. General characteristics and consequences of postulated accidents, including
 4 source term, are expected to be similar after reactor shutdown. Because of aging management
 5 activities and the extended life of certain systems, structures, and components, there may be
 6 small differences in the probabilities of occurrence of these accidents after reactor shutdown.
 7 These differences, however, are not expected to be significant, and the risks of accidents after
 8 reactor shutdown would generally be less than the risks discussed in Section 4.9.1.2.

9 The impacts associated with accidents during the decontamination and decommissioning of
 10 nuclear power plants are analyzed in the Decommissioning GEIS (NRC 2002c). Radiological
 11 accidents considered in the analysis included onsite storage and handling of spent nuclear fuel
 12 and decontamination, dismantlement, and storage accidents. Accidents included fires, handling
 13 accidents, explosions (e.g., explosion of liquid propane gas tanks), and accidental releases of
 14 liquid radioactive wastes from storage tanks.

15 License renewal would merely delay when accidents associated with the termination of reactor
 16 operations and decommissioning could occur and would not significantly affect their probability
 17 or consequence.

18 *4.14.3.13 Environmental Justice*

19 Termination of reactor operations and the resulting loss of jobs, income, and tax revenue could
 20 disproportionately affect minority and low-income populations and Indian Tribes. The loss of tax
 21 revenue, for example, could reduce the availability or eliminate some of the community services
 22 that low-income and minority populations may depend on. This situation could be offset with the
 23 construction and operation of replacement power generating facilities and the creation of other
 24 employment opportunities at or near the nuclear plant site.

25 Decontamination and decommissioning activities could affect air and water quality in the area
 26 around each nuclear plant site. This could cause health and other environmental effects in
 27 minority populations, low-income populations, or Indian Tribes, if present. Populations with
 28 resource dependencies or practices (e.g., subsistence agriculture, hunting, fishing) could be
 29 disproportionately affected. License renewal would only delay, but not alter, the impact of
 30 decommissioning on minority and low-income populations around each nuclear plant.

31 *4.14.3.14 Waste Management and Pollution Prevention*

32 After terminating operations, the reactor is placed in a cold shutdown condition and maintained
 33 prior to active decommissioning. The types of waste generated after reactor shutdown would be
 34 the same as those generated during operations. However, the volume of waste generated each
 35 day may be less than that generated during reactor operations.

36 Pollution prevention and waste minimization measures would likely continue. As discussed in
 37 Section 4.11.1.2, spent nuclear fuel can be safely stored onsite with minimal environmental
 38 impact during the license renewal term. The NRC's *Generic Environmental Impact Statement*
 39 *for Continued Storage of Spent Nuclear Fuel* (NUREG-2157; NRC 2014c) addresses the
 40 environmental impacts of spent nuclear fuel storage after the termination of reactor operations.

Environmental Consequences and Mitigating Actions

1 Wastes generated after the termination of reactor operations and during decommissioning
2 would be shipped offsite for treatment and disposal. Of the three decommissioning options,
3 DECON would generate the most waste. In SAFSTOR or ENTOMB, contaminated materials
4 remain onsite temporarily or permanently, respectively.

5 The types of wastes generated during decommissioning include LLW, mixed waste, hazardous
6 waste, and nonradioactive, nonhazardous waste (see Section 3.11 for waste type definitions).
7 No spent nuclear fuel, HLW, or transuranic waste would be generated after the termination of
8 reactor operations and during decommissioning because any remaining fuel in the reactor
9 would have been moved to either the spent fuel pool or an ISFSI.

10 Most of the waste generated during decommissioning would be LLW and nonradioactive,
11 nonhazardous waste. Small quantities of mixed waste would be managed per RCRA and the
12 Atomic Energy Act. Hazardous waste would mainly consist of paints, solvents, and batteries.
13 Materials used to decontaminate surfaces could be classified as mixed waste. Mixed and
14 hazardous wastes could be treated prior to being sent to a disposal facility. Nonradioactive,
15 nonhazardous waste, mostly concrete rubble and debris, would be sent to a local landfill.

16 The volume of waste generated during decommissioning may be greater because of license
17 renewal. Waste accumulated at the nuclear plant, and the radioactivity of some components
18 undergoing decommissioning might be slightly higher after the license renewal term. Material
19 near the core of the reactor may have slightly higher radioactivity because of the additional
20 years of reactor operation due to the buildup in long-lived radionuclides. This situation would
21 mainly affect the amount of greater-than-Class C LLW at the site. There would also be more
22 spent fuel generated because of license renewal.

23 For the most part, environmental conditions near the nuclear plant are not expected to change
24 appreciably because of license renewal. The impacts of license renewal on terminating reactor
25 operations and decommissioning is considered to be SMALL for all nuclear plants and are a
26 Category 1 issue in the 2013 LR GEIS. As previously noted, the impacts of decommissioning
27 nuclear power plants are evaluated in the Decommissioning GEIS (NUREG-0586; NRC 2002c).

28 Based on these considerations, the NRC concludes that impacts from continued nuclear plant
29 operations during initial LR and SLR terms and refurbishment on terminating reactor operations
30 and decommissioning would be the same—SMALL for all nuclear plants. The staff reviewed
31 information from SEISs (for initial LRs and SLRs) completed since development of the 2013 LR
32 GEIS and identified no new information or situations that would result in different impacts for this
33 issue for either an initial LR or SLR term. License renewal reviews have revealed no difference
34 in environmental impacts whether decommissioning occurs at the end of the current operating
35 license or following a 20-year initial LR or SLR term. Therefore, terminating reactor operations
36 and decommissioning impacts would be SMALL for all nuclear plants and it is a Category 1
37 issue for both initial LR and SLR.

1 4.14.3.15 Termination of Operations and Decommissioning of Replacement Power Plants

2 4.14.3.15.1 Fossil Energy Alternatives

3 The environmental consequences of terminating operations and decommissioning a fossil fuel
4 energy facility depends on planned decommissioning activities and other requirements.
5 Decommissioning plans may include the following elements and requirements, intended to
6 ensure site restoration to a condition equivalent in character and value to the greenfield or
7 brownfield site on which the power-generating facility was first constructed:

- 8 • Removal of all unneeded structures and facilities to at least 3 ft (1 m) below grade (in order
9 to provide an adequate root zone for site revegetation).
- 10 • Removal of fuel, all fuel combustion waste, and all flue gas desulfurization sludge and/or
11 byproducts.
- 12 • Removal of water intake and discharge structures.
- 13 • Dismantlement and removal of ancillary facilities, including rail spurs, fuel-handling and -
14 preparation facilities, cooling towers, natural gas pipelines, onsite wastewater treatment
15 facilities, and access roads.
- 16 • Removal of all surface water intake and discharge structures.
- 17 • Removal of all accumulated sludge, and closure and removal of all surface water
18 impoundments.
- 19 • Closure of all onsite groundwater wells.
- 20 • Recycling of removed equipment and dismantled building components; materials awaiting
21 recycling would be stored at an offsite facility.
- 22 • Disposal of solid and hazardous wastes at approved facilities; as necessary, remediation of
23 waste handling and storage areas.
- 24 • Cleanup and remediation of all incidental spills and leaks.
- 25 • Execution of an approved revegetation plan for the site.
- 26 • Other actions as necessary to ensure restoration of the site.

27 Environmental impacts (greenfield or brownfield site) would include:

- 28 • Air quality and noise impacts from vehicles and equipment needed to deconstruct structures
29 and facilities; release of criteria pollutants, fugitive dust, and noise (e.g., from explosives);
30 impacts would be similar to those experienced during construction.
- 31 • Land use and visual impacts; temporary land use holding areas for dismantled components
32 and deconstruction debris; restoration of land to its previous use and visual appearance by
33 removing human-made structures.
- 34 • Reduction in water use and water quality impacts as water consumption decreases after
35 termination of operations. Dewatering and water used for spent nuclear fuel cooling would
36 continue. Surface water runoff would continue.
- 37 • Increased truck and rail traffic delivering equipment and transporting dismantled material
38 and deconstruction debris.
- 39 • Ecological resource impacts and disturbance during active decommissioning.

Environmental Consequences and Mitigating Actions

- 1 • Increase in economic activity followed by economic downturn due to loss of jobs at the
2 former power-generating facility.
- 3 • Health and safety risks during dismantlement and removal of facility and risk of
4 transportation-related accidents delivering equipment and transporting dismantled material
5 and deconstruction debris.

6 *4.14.3.16 New Nuclear Alternatives*

7 According to 10 CFR Part 52, decommissioning impacts for a nuclear power plant include all
8 activities related to the safe removal of the facility or site from service and the reduction of
9 residual radioactivity to a level that permits release of the property under restricted conditions or
10 unrestricted use and termination of the license. The process and activities during
11 decommissioning would be similar to those discussed in Section 4.14.2.1.

12 *4.14.3.17 Renewable Alternatives*

13 The termination of operations and decommissioning of renewable energy systems would follow
14 a decommissioning plan and would involve removal of the power-generating facility, waste
15 material, and restoration of the land to its original state. Decommissioning involves the following
16 actions:

- 17 • Removal of unneeded power-generating facilities and support structures.
- 18 • Removal of unspent biomass fuel and wastes from combustion.
- 19 • Removal of water intake and discharge structures (if present).
- 20 • Dismantlement and removal of ancillary facilities, including rail spurs, fuel-handling facilities,
21 cooling towers, onsite wastewater treatment facilities, and/or access roads.
- 22 • Removal of surface water intake and discharge structures.
- 23 • Removal of sludge and surface water impoundments.
- 24 • Closure of onsite groundwater wells.
- 25 • Recycling of equipment and dismantled components.
- 26 • Disposal of hazardous wastes; remediation of waste handling and storage areas, as
27 necessary.
- 28 • Cleanup and remediation of incidental spills and leaks.
- 29 • Ancillary facilities (access roads, utilities, pipelines, electrical transmission towers) would be
30 removed unless it is determined that they can serve other purposes; buried utilities and
31 pipelines could be abandoned in place if their removal would result in significant disruption
32 to ecosystems.
- 33 • Other site restoration actions, as necessary.

34 Termination of operations and decommissioning of offshore power-generating facilities involve
35 the following actions:

- 36 • Wind turbine tower foundations and communication and power cables buried in the seafloor
37 could remain to avoid ecological disruption that would result if removed.

- 1 • Underwater structures that served as electrical service platforms could remain in place to
2 serve as artificial reefs and fish habitats.

3 The termination of operations and the decommissioning of hydroelectric facilities may result in
4 various environmental impacts. For large store-and-release hydroelectric facilities, eliminating
5 the dam and reservoir and restoring the river to its natural flow would have a dramatic effect on
6 upstream and downstream ecosystems. Turbines, generators, and electric power-generating
7 equipment would be removed. Devices that control the release of water from the reservoir
8 could remain functional, requiring a reduced workforce.

9 Small-scale, low-impact, run-of-the-river hydro facilities, causing limited impact on upstream
10 water levels and downstream water flow rates, would be dismantled and removed during
11 decommissioning.

12 **4.15 Resource Commitments Associated with the Proposed Action**

13 This section addresses the resources that would be committed under the proposed action
14 (license renewal). In particular, it describes unavoidable adverse environmental impacts
15 (Section 4.15.1), the relationship between short-term uses of the environment and the
16 maintenance and enhancement of long-term productivity (Section 4.15.2), and the irreversible
17 and irretrievable commitment of resources (Section 4.15.3) that would be associated with the
18 proposed action. Potential unavoidable adverse environmental impacts and irreversible and
19 irretrievable resource commitments that would be associated with alternatives to the proposed
20 action are also discussed.

21 **4.15.1 Unavoidable Adverse Environmental Impacts**

22 Unavoidable adverse environmental impacts are impacts that would occur after implementation
23 of all feasible mitigation measures. Continued nuclear power plant operations and the
24 implementation of any of the replacement energy alternatives considered in this LR GEIS would
25 result in some unavoidable adverse environmental impacts.

26 The impacts of continued nuclear power plant operations that are anticipated to occur are
27 discussed for each resource area in Sections 4.1 through 4.12. Some of these impacts cannot
28 be avoided because they are inherently associated with nuclear power plant operations and
29 cannot be fully mitigated. Minor unavoidable adverse impacts on air quality would occur due to
30 emission and release of various chemical and radiological constituents into the environment
31 from plant operations. Nonradiological emissions are expected to comply with EPA emissions
32 standards, though the alternative of operating a fossil-fueled power plant in some areas may
33 worsen existing air quality attainment issues. Routine chemical and radiological emissions
34 would not exceed the National Emission Standards for Hazardous Air Pollutants. Other
35 unavoidable adverse impacts (depending on the plant) include the impact on land use and
36 visual resources, some minor noise effects, surface water and groundwater use, thermal
37 effluents discharged to the environment from the power conversion equipment, and entrainment
38 and impingement of aquatic organisms in the cooling water system. Industrial wastewater
39 effluents and cooling water system operations would be subject to regulations promulgated
40 pursuant to the CWA.

41 During nuclear power plant operations, workers and members of the public would face
42 unavoidable exposure to radiation and hazardous and toxic chemicals, but releases would be
43 controlled and the resulting exposures would not exceed any standards or regulatory limits.

Environmental Consequences and Mitigating Actions

1 Workers would be exposed to radiation and chemicals associated with routine plant operations
2 and the handling of nuclear fuel and waste material. Workers would have a higher risk of
3 exposure than members of the public, but doses would be administratively controlled and would
4 not exceed any standards or administrative control limits. Construction and operation of
5 alternative replacement energy-generating facilities would also result in unavoidable exposure
6 of workers and the general public to hazardous and toxic chemicals.

7 Also unavoidable would be the generation of spent nuclear fuel and waste material, including
8 LLW, hazardous waste, and nonhazardous waste. Hazardous and nonhazardous wastes would
9 also be generated at non-nuclear power-generating facilities. Wastes generated during plant
10 operations would be collected, stored, and shipped for suitable treatment, recycling, or disposal
11 in accordance with applicable Federal and State regulations. Due to the costs of handling these
12 materials, power plant operators would be expected to conduct all activities and optimize all
13 operations in a way that minimizes waste generation. Although pollution prevention and waste
14 minimization efforts are intended to prevent emissions to the environment and prevent and/or
15 minimize the quantities of waste generated and disposed of, some wastes and emissions
16 cannot be entirely eliminated due to current technology.

17 Many of these unavoidable impacts are being mitigated by incorporating safety features and/or
18 applying operational procedures at the nuclear power plants and are monitored by plant
19 personnel and regulatory agencies. Thermal, entrainment, and impingement impacts at plants
20 with once-through cooling water systems are unavoidable. These impacts could be reduced by
21 modifying the once-through cooling system or by converting to a closed-cycle cooling system.
22 Although closed-cycle cooling water systems can reduce thermal, entrainment, and
23 impingement impacts, they increase water consumption (through cooling tower evaporation),
24 fogging, icing, and salt drift. However, the NRC has neither the statutory nor the regulatory
25 authority to determine which cooling water system or technology should be used, or to decide
26 other environmental permitting issues.

27 Nuclear power plants being considered for license renewal already exist and nearly all have
28 been operating for several decades. The environmental impacts considered for license renewal
29 are those associated with continued nuclear power plant operation and refurbishment.
30 Replacement energy (power) and other alternatives to license renewal generally involve major
31 construction impacts. Therefore, unavoidable adverse impacts of a replacement energy
32 alternative could be greater than those associated with the continued operation of an existing
33 nuclear power plant.

34 Unavoidable adverse impacts would vary among the nuclear power plants, and the scale of the
35 impact would depend on the specific characteristics of each power plant and its interaction with
36 the environment. These unavoidable adverse impacts are evaluated in plant-specific SEISs.

37 **4.15.2 Relationship between Short-Term Use of the Environment and Long-Term** 38 **Productivity**

39 The operation of power-generating facilities would result in short-term uses of the environment
40 as described earlier in this Chapter. "Short-term" is the period of time during which continued
41 power-generating activities would take place.

42 Power plant operations would necessitate short-term use of the environment and commitments
43 of resources and would also commit certain resources (e.g., land and energy) indefinitely or
44 permanently. Certain short-term resource commitments would be substantially greater under

1 most energy alternatives, including license renewal (initial LR or SLR), than under the no action
2 alternative due to the continued generation of electrical power as well as continued use of
3 generating sites and associated infrastructure. During operations, all energy alternatives would
4 entail similar relationships between local short-term uses of the environment and the
5 maintenance and enhancement of long-term productivity.

6 Short-term use of the environment can affect long-term productivity of the ecosystem if the use
7 alters the ability of the ecosystem to reestablish an equilibrium that is comparable to that of its
8 original (natural) condition. An initial commitment regarding the trade-off between short-term
9 use and long-term productivity at a nuclear power plant was made when the nuclear plant was
10 first constructed. Renewal of the operating license and the continued operation of the nuclear
11 power plant would not alter any existing effects on long-term productivity, but they might
12 postpone the availability of the power plant site for other uses. The no action alternative would
13 lead to a cessation of operations and shutdown of the power plant (an eventuality regardless
14 whether or not a license is renewed).

15 Air emissions from power plant operations would introduce small amounts of radiological and
16 nonradiological constituents to the region around the plant site. Over time, these emissions
17 could result in increased concentrations and exposure but are not expected to affect air quality
18 or radiation exposure to the extent that public health and long-term productivity of the
19 environment would be impaired.

20 Continued employment, expenditures, and tax revenues generated during power plant
21 operations would directly benefit local, regional, and State economies over the short-term.
22 Local governments investing project-generated tax revenues into infrastructure and other
23 required services could enhance economic productivity over the long term.

24 The management and disposal of spent nuclear fuel, LLW, hazardous waste, and
25 nonhazardous waste would require an increase in energy and would consume space at
26 treatment, storage, or disposal facilities. Regardless of the location, the conversion of land to
27 meet waste disposal needs would reduce the long-term productivity of the land.

28 Power plant facilities would be committed to electricity production over the short term. After
29 decommissioning these facilities and restoring the power plant site, the land would become
30 available for other productive uses.

31 The nature of the relationship between short-term use of the environment and long-term
32 productivity would vary among nuclear power plants and would depend on the specific
33 characteristics of each plant and its interaction with the environment. This relationship is
34 evaluated in plant-specific SEISs.

35 **4.15.3 Irreversible and Irretrievable Commitment of Resources**

36 An irreversible or irretrievable commitment of resources refers to impacts on or losses of
37 resources that cannot be recovered or reversed. Irreversible and irretrievable commitment of
38 resources for electrical power generation are considered to include the commitment of land,
39 water, energy, raw materials, and other natural and human-made resources required for power
40 plant operations during the license renewal term and any refurbishment activities that might be
41 carried out that would not otherwise have taken place if the operating licenses had not been
42 renewed. This section describes the irreversible and irretrievable commitments of resources
43 that have been identified in this LR GEIS. A commitment of resources is irreversible when

Environmental Consequences and Mitigating Actions

1 primary or secondary impacts limit the future options for a resource. It primarily applies to the
2 impacts of use of nonrenewable resources, such as minerals or cultural resources, or to factors,
3 such as soil productivity, that are renewable only over long periods of time. An irretrievable
4 commitment refers to the use or consumption of resources neither renewable nor recoverable
5 for future use. Irretrievable commitment applies to the loss of production, harvest, or natural
6 resources. For example, if farmland is used for a nonagricultural purpose such as energy
7 generation, some or all of the agricultural production from the farmland is lost irretrievably while
8 the area is temporarily used for another purpose. The production lost is irretrievable, but the
9 action is not irreversible. In general, the commitment of capital, energy, labor, and material
10 resources would also be irreversible.

11 Resources include materials and equipment required for nuclear power plant maintenance and
12 operation, energy and water needed to run the plants, the nuclear fuel used by the reactors to
13 generate electricity, and the land required to permanently dispose of the radioactive and
14 nonradioactive wastes. Some of these resources could be retrieved and reused at the end of
15 the license renewal (initial LR or SLR) term. For example, some reactor equipment can be used
16 at other reactors or can be decontaminated and released for recycling or restricted or
17 unrestricted use by others. However, some of the equipment and irradiated components that
18 might be replaced during the license renewal term might not be reused or recycled and
19 therefore would need to be permanently disposed of. In addition, the fossil fuels used by power
20 plants would be permanently lost. Most of the water used by power plants relying on once-
21 through cooling is returned to the surface water bodies that supply the cooling water. The
22 relatively small portion of the water that evaporates to the air would be lost to the local water
23 bodies and the region but would be returned to the environment as part of the hydrologic cycle,
24 potentially within another watershed. For closed-cycle cooling systems, a much larger
25 percentage of the water used for cooling would be lost to evaporation, but that, too, would be
26 returned as part of the hydrologic cycle.

27 The most significant irreversible and irretrievable commitment of resources related to nuclear
28 power plant operations during the license renewal term would be the nuclear fuel used to
29 generate electricity and the land used to dispose of and store wastes, including spent nuclear
30 fuel generated during the license renewal term. The treatment, storage, and disposal of LLW,
31 hazardous waste, and nonhazardous waste would require the irretrievable commitment of
32 energy and fuel and could result in the irreversible commitment of space in disposal facilities.
33 Some of the land used for the disposal of LLW may be available for other uses in a few hundred
34 years because of the nearly complete decay of short-lived radionuclides in LLW, but most of the
35 land used for the disposal of some mixed or hazardous wastes could be permanently
36 (irreversibly) lost.

37 The irreversible and irretrievable commitment of resources would not be the same for all nuclear
38 power plants and would depend on the specific characteristics of the power plant and its
39 resource needs. This commitment is evaluated in plant-specific SEISs.

40 The implementation of any of the replacement energy alternatives would entail the irreversible
41 and irretrievable commitment of energy, water, chemicals, and, in some cases, fossil fuels.
42 These resources would be committed over the entire life cycle of the power plant—construction,
43 operation, and decommissioning—and would essentially be unrecoverable.

44 Energy expended would be in the form of fuel for equipment, vehicles, power plant operations,
45 and electricity for power plant construction and facility operations. Electricity and fuels would be
46 purchased from offsite commercial sources. Water would be obtained from existing water

1 supply systems. These resources are generally available, and the amounts required would not
2 be expected to deplete available supplies or exceed available system capacities.

3 The irreversible and irretrievable commitment of material resources are the materials that
4 cannot be recovered or recycled, materials that are rendered radioactive and/or cannot be
5 decontaminated, and materials consumed or reduced to unrecoverable forms of waste.
6 However, none of the resources used by potential replacement energy-generating facilities is in
7 short supply, and, for the most part, they are readily available.

8 Various materials and chemicals, including acids and caustics, would be required to support
9 operations activities. These materials would be derived from commercial vendors, and their
10 consumption would not be expected to affect local, regional, or national supplies.

1

5.0 REFERENCES

2 7 CFR Part 657. *Code of Federal Regulations*, Title 7, *Agriculture*, Part 657, "Prime and Unique
3 Farmlands." Washington, D.C.

4 7 CFR Part 658. *Code of Federal Regulations*, Title 7, *Agriculture*, Part 658, "Farmland
5 Protection Policy Act."

6 10 CFR Part 2. *Code of Federal Regulations*, Title 10, *Energy*, Part 2, "Rules of Practice for
7 Domestic Licensing Proceedings and Issuance of Orders."

8 10 CFR Part 20. *Code of Federal Regulations*, Title 10, *Energy*, Part 20, "Standards for
9 Protection Against Radiation."

10 10 CFR Part 40. *Code of Federal Regulations*, Title 10, *Energy*, Part 40, "Domestic Licensing of
11 Source Material."

12 10 CFR Part 50. *Code of Federal Regulations*, Title 10, *Energy*, Part 50, "Domestic Licensing of
13 Production and Utilization Facilities."

14 10 CFR Part 51. *Code of Federal Regulations*, Title 10, *Energy*, Part 51, "Environmental
15 Protection Regulations for Domestic Licensing and Related Regulatory Functions."

16 10 CFR Part 52. *Code of Federal Regulations*, Title 10, *Energy*, Part 52, "Licenses,
17 Certifications, and Approvals for Nuclear Power Plants."

18 10 CFR Part 54. *Code of Federal Regulations*, Title 10, *Energy*, Part 54, "Requirements for
19 Renewal of Operating Licenses for Nuclear Power Plants."

20 10 CFR Part 61. *Code of Federal Regulations*, Title 10, *Energy*, Part 61, "Licensing
21 Requirements for Land Disposal of Radioactive Waste."

22 10 CFR Part 63. *Code of Federal Regulations*, Title 10, *Energy*, Part 63, "Disposal of High-
23 Level Radioactive Wastes in a Geologic Repository at Yucca Mountain, Nevada."

24 10 CFR Part 71. *Code of Federal Regulations*, Title 10, *Energy*, Part 71, "Packaging and
25 Transportation of Radioactive Material."

26 10 CFR Part 72. *Code of Federal Regulations*, Title 10, *Energy*, Part 72, "Licensing
27 Requirements for the Independent Storage of Spent Nuclear Fuel, High-Level Radioactive
28 Waste, and Reactor-Related Greater than Class C Waste."

29 10 CFR Part 100. *Code of Federal Regulations*, Title 10, *Energy*, Part 100, "Reactor Site
30 Criteria."

31 15 CFR Part 922. *Code of Federal Regulations*, Title 15, *Commerce and Foreign Trade*, Title
32 922, "National Marine Sanctuary Program Regulations."

References

- 1 18 CFR Part 157. *Code of Federal Regulations*, Title 18, *Conservation of Power and Water*
2 *Resources*, Part 157, "Applications for Certificates of Public Convenience and Necessity and for
3 Orders Permitting and Approving Abandonment Under Section of the Natural Gas Act."
- 4 24 CFR Part 51. *Code of Federal Regulations*, Title 24, *Housing and Urban Development*,
5 Part 51, "Environmental Criteria and Standards."
- 6 29 CFR Part 1910. *Code of Federal Regulations*, Title 29, *Labor*, Part 1910, "Occupational
7 Safety and Health Standards."
- 8 36 CFR Part 60. *Code of Federal Regulations*, Title 36, *Parks, Forests, and Public Property*,
9 Part 60, "National Register of Historic Places."
- 10 36 CFR Part 61. *Code of Federal Regulations*, Title 36, *Parks, Forests, and Public Property*,
11 Part 61, "Procedures for State, Tribal, and Local Government Historic Preservation Programs."
- 12 36 CFR Part 800. *Code of Federal Regulations*, Title 36, *Parks, Forests, and Public Property*,
13 Part 800, "Protection of Historic Properties."
- 14 40 CFR Part 51. *Code of Federal Regulations*, Title 40, *Protection of Environment*, Part 51,
15 "Requirements for Preparation, Adoption, and Submittal of Implementation Plans."
- 16 40 CFR Part 61. *Code of Federal Regulations*, Title 40, *Protection of Environment*, Part 61,
17 "National Emission Standards for Hazardous Air Pollutants."
- 18 40 CFR Part 93. *Code of Federal Regulations*, Title 40, *Protection of Environment*, Part 93,
19 "Determining Conformity of Federal Actions to State or Federal Implementation Plans."
- 20 40 CFR Part 122. *Code of Federal Regulations*, Title 40, *Protection of Environment*, Part 122,
21 "EPA Administered Permit Programs: The National Pollutant Discharge Elimination System."
- 22 40 CFR Part 125. *Code of Federal Regulations*, Title 40, *Protection of Environment*, Part 125,
23 "Criteria and Standards for the National Pollutant Discharge Elimination System."
- 24 40 CFR Part 125 Subpart H. *Code of Federal Regulations*, Title 40, *Protection of Environment*,
25 Part 125, "Criteria and Standards for the National Pollutant Discharge Elimination System,"
26 Subpart H, *Criteria for Determining Alternative Effluent Limitations Under Section 316(a) of the*
27 *Act*.
- 28 40 CFR Part 141. *Code of Federal Regulations*, Title 40, *Protection of Environment*, Part 141,
29 "National Primary Drinking Water Standards."
- 30 40 CFR Part 143. *Code of Federal Regulations*, Title 40, *Protection of Environment*, Part 143,
31 "National Secondary Drinking Water Regulations."
- 32 40 CFR Part 190. *Code of Federal Regulations*, Title 40, *Protection of Environment*, Part 190,
33 "Environmental Radiation Protection Standards for Nuclear Power Operations."

- 1 40 CFR Part 257. *Code of Federal Regulations*, Title 40, *Protection of Environment*, Part 257,
2 "Criteria for Classification of Solid Waste Disposal Facilities and Practices."
- 3 40 CFR Part 261. *Code of Federal Regulations*, Title 40, *Protection of Environment*, Part 261,
4 "Identification and Listing of Hazardous Waste."
- 5 40 CFR Part 273. *Code of Federal Regulations*, Title 40, *Protection of Environment*, Part 273,
6 "Standards for Universal Waste Management."
- 7 40 CFR Part 1501. *Code of Federal Regulations*, Title 40, *Protection of Environment*, Part
8 1501, "NEPA and Agency Planning."
- 9 40 CFR Part 1502. *Code of Federal Regulations*, Title 40, *Protection of Environment*, Part
10 1502, "Environmental Impact Statement."
- 11 40 CFR Part 1508. *Code of Federal Regulations*, Title 40, *Protection of Environment*, Part
12 1508, "Definitions."
- 13 44 CFR Part 353 Appendix A. *Code of Federal Regulations*, Title 44, *Emergency Management
14 and Assistance*, Appendix A to Part 353, "Memorandum of Understanding Between Federal
15 Emergency Management Agency and Nuclear Regulatory Commission."
- 16 49 CFR Parts 171-177. *Code of Federal Regulations*, Title 49, *Transportation*, Subchapter C,
17 "Hazardous Materials Regulations (49 CFR Parts 171-177)."
- 18 50 CFR Part 17. *Code of Federal Regulations*, Title 50, *Wildlife and Fisheries*, Part 17,
19 "Endangered and Threatened Wildlife and Plants."
- 20 50 CFR Part 402. *Code of Federal Regulations*, Title 50, *Wildlife and Fisheries*, Part 402,
21 "Interagency Cooperation—Endangered Species Act of 1973, as Amended."
- 22 50 CFR Part 600. *Code of Federal Regulations*. Title 50, *Wildlife and Fisheries*, Part 600,
23 "Magnuson-Stevens Act Provisions."
- 24 42 FR 26951. May 25, 1977. "Executive Order 11988 of May 24, 1977: Floodplain
25 Management." *Federal Register*, Office of the President.
- 26 42 FR 26961. May 25, 1977. "Executive Order 11990 of May 24, 1977: Protection of
27 Wetlands." *Federal Register*, Office of the President.
- 28 46 FR 18026. March 23, 1981. "Forty Most Asked Questions Concerning CEQ's National
29 Environmental Policy Act Regulations." *Federal Register*, Council on Environmental Quality,
30 Executive Office of the President. ADAMS Accession No. ML12088A274.
- 31 51 FR 19926. 1986. "Interagency Cooperation - Endangered Species Act of 1973, as
32 Amended." Final Rule, *Federal Register*, Fish and Wildlife Service, Interior; National Marine
33 Fisheries Service, National Oceanic and Atmospheric Administration, Commerce.

References

- 1 56 FR 47016. September 17, 1991. "Environmental Review for Renewal of Operating
2 Licenses." Proposed Rule, *Federal Register*, Nuclear Regulatory Commission.
- 3 56 FR 64966. December 13, 1991. "Rule and Regulations." No. 240, *Federal Register*,
4 Nuclear Regulatory Commission.
- 5 59 FR 7629. February 16, 1994. "Executive Order 12898 of February 11, 1994: Federal
6 Actions To Address Environmental Justice in Minority Populations and Low-Income
7 Populations." *Federal Register*, Office of the President.
- 8 60 FR 46206. September 5, 1995. "National Emission Standards for Radionuclide Emissions
9 From Facilities Licensed by the Nuclear Regulatory Commission and Federal Facilities not
10 Covered by Subpart H." *Federal Register*, Environmental Protection Agency.
- 11 61 FR 28467. June 5, 1996. "Environmental Review for Renewal of Nuclear Power Plant
12 Operating Licenses." *Federal Register*, Nuclear Regulatory Commission.
- 13 61 FR 66537. December 18, 1996. "Environmental Review for Renewal of Nuclear Power
14 Plant Operating Licenses." Final Rule, *Federal Register*, Nuclear Regulatory Commission.
- 15 64 FR 6183. February 8, 1999. "Executive Order 13112 of February 3, 1999: Invasive
16 Species." *Federal Register*, Office of the President.
- 17 64 FR 48496. September 3, 1999. "Changes to Requirements for Environmental Review for
18 Renewal of Nuclear Power Plant Operating Licenses." *Federal Register*, Nuclear Regulatory
19 Commission.
- 20 67 FR 2343. January 17, 2002. "Magnuson-Stevens Act Provisions; Essential Fish Habitat
21 (EFH)." Final Rule, *Federal Register*, National Marine Fisheries Service.
- 22 69 FR 44649. 2004. "Record of Decision for Construction and Operation of a Depleted
23 Uranium Hexafluoride Conversion Facility at the Portsmouth, OH, Site." Record of Decision,
24 *Federal Register*, Department of Energy.
- 25 69 FR 44654. 2004. "Record of Decision for Construction and Operation of a Depleted
26 Uranium Hexafluoride Conversion Facility at the Paducah, KY, Site." Record of Decision,
27 *Federal Register*, Department of Energy.
- 28 69 FR 52040. August 24, 2004. "Policy Statement on the Treatment of Environmental Justice
29 Matters in NRC Regulatory and Licensing Actions." *Federal Register*, Nuclear Regulatory
30 Commission.
- 31 73 FR 50259. August 26, 2008. "Conducting Consultations Pursuant to Section 304(d) of the
32 National Marine Sanctuaries Act." *Federal Register*, National Oceanic and Atmospheric
33 Administration.

- 1 73 FR 53284. September 15, 2008. "Department of Energy; Notice of Acceptance for
2 Docketing of a License Application for Authority To Construct a Geologic Repository at a
3 Geologic Repository Operations Area at Yucca Mountain, NV." *Federal Register*.
- 4 74 FR 56260. October 30, 2009. "Mandatory Reporting of Greenhouse Gases; Final Rule."
5 *Federal Register*, Environmental Protection Agency.
- 6 74 FR 66496. December 15, 2009. "Endangerment and Cause or Contribute Findings for
7 Greenhouse Gases Under Section 202(a) of the Clean Air Act." *Federal Register*,
8 Environmental Protection Agency.
- 9 75 FR 17254. April 5, 2010. "Revisions to the General Conformity Regulations." Final Rule,
10 *Federal Register*, Environmental Protection Agency.
- 11 75 FR 81032. December 23, 2010. "Consideration of Environmental Impacts of Temporary
12 Storage of Spent Fuel After Cessation of Reactor Operation." *Federal Register*, Nuclear
13 Regulatory Commission.
- 14 75 FR 81037. December 23, 2010. "Waste Confidence Decision Update." *Federal Register*,
15 Nuclear Regulatory Commission.
- 16 78 FR 37282. June 20, 2013. "Revisions to Environmental Review for Renewal of Nuclear
17 Power Plant Operating Licenses." Final Rule, *Federal Register*, Nuclear Regulatory
18 Commission.
- 19 78 FR 53058. 2013. "Endangered and Threatened Wildlife and Plants; Revisions to the
20 Regulations for Impact Analyses of Critical Habitat." Final Rule, *Federal Register*, Fish and
21 Wildlife Service, Interior; National Marine Fisheries Service (NMFS), National Oceanic and
22 Atmospheric Administration (NOAA), Commerce.
- 23 79 FR 48300. August 15, 2014. "National Pollutant Discharge Elimination System—Final
24 Regulations to Establish Requirements for Cooling Water Intake Structures at Existing Facilities
25 and Amend Requirements at Phase I Facilities." *Federal Register*, Environmental Protection
26 Agency.
- 27 79 FR 56238. September 19, 2014. "Continued Storage of Spent Nuclear Fuel." Final Rule,
28 *Federal Register*, Nuclear Regulatory Commission.
- 29 79 FR 56263. September 19, 2014. "Generic Environmental Impact Statement for Continued
30 Storage of Spent Nuclear Fuel." *Federal Register*, Nuclear Regulatory Commission.
- 31 84 FR 54436. 2019. "Endangered and Threatened Wildlife and Plants; Removing the Kirtland's
32 Warbler From the Federal List of Endangered and Threatened Wildlife." Final Rule, *Federal*
33 *Register*, Fish and Wildlife Service.
- 34 85 FR 24040. April 30, 2020. "Notice To Conduct Scoping and Prepare an Advanced Nuclear
35 Reactor Generic Environmental Impact Statement." *Federal Register*, Nuclear Regulatory
36 Commission.

References

- 1 85 FR 42210. July 13, 2020. "Clean Water Act Section 401 Certification Rule." Final Rule,
2 *Federal Register*, Environmental Protection Agency.
- 3 85 FR 47252. August 4, 2020. "Notice of Intent To Review and Update the Generic
4 Environmental Impact Statement for License Renewal of Nuclear Plants." *Federal Register*,
5 Nuclear Regulatory Commission.
- 6 86 FR 4937. 2021. "Expansion of Flower Garden Banks National Marine Sanctuary." Final
7 Rule, *Federal Register*, Office of National Marine Sanctuaries (ONMS), National Ocean Service
8 (NOS), National Oceanic and Atmospheric Administration (NOAA), Department of Commerce
9 (DOC).
- 10 86 FR 7037. January 25, 2021. "Executive Order 13990 of January 20, 2021: Protecting
11 Public Health and the Environment and Restoring Science To Tackle the Climate Crisis."
12 *Federal Register*, Office of the President.
- 13 86 FR 29541. 2021. "Notice of intention to reconsider and 17 revise the Clean Water Act
14 Section 401 Certification Rule." *Federal Register*, Environmental Protection Agency.
- 15 86 FR 45860. 2021. "Designation of Wisconsin Shipwreck Coast National Marine Sanctuary."
16 *Federal Register*, Office of National Marine Sanctuaries (ONMS), National Ocean Service
17 (NOS), National Oceanic and Atmospheric Administration (NOAA), Department of Commerce
18 (DOC).
- 19 86 FR 45923. 2021. "Linear No-Threshold Model and Standards for Protection Against
20 Radiation." Petition for Rulemaking; Denial. *Federal Register*, Nuclear Regulatory Commission.
- 21 Able, K.P. 1973. "The Changing Seasons." *American Birds* 27(1):19-23. Delaware City,
22 Delaware.
- 23 Adam-Guillermin, C., T. Hertal-Aas, D. Oughton, L. Blanchard, F. Alonzo, O. Armant, and N.
24 Horemans. 2018. "Radiosensitivity and transgenerational effects in non-human species."
25 *Annals of the ICRP* 47(3-4):327-341. <https://doi.org/10.1177/0146645318756844>.
- 26 AEC (U.S. Atomic Energy Commission). 1973. *Final Environmental Statement Related to the*
27 *Nuclear Generating Station Diablo Canyon Units 1 & 2*. May. Washington, D.C. ADAMS
28 Accession No. ML15043A481.
- 29 AEC (U.S. Atomic Energy Commission). 1974a. *Environmental Survey of the Uranium Fuel*
30 *Cycle*. WASH-1248, Washington, D.C. ADAMS Accession No. ML14092A628.
- 31 AEC (U.S. Atomic Energy Commission). 1974b. *Final Environmental Statement Related to the*
32 *Operation of Oyster Creek Nuclear Generating Station*. Jersey Central Power and Light
33 Company. December. Washington, D.C. ADAMS Accession No. ML072200150.
- 34 Anchor QEA, LLC. 2020. *Final Fish Entrainment Characterization Report, Columbia*
35 *Generating Station*. Project Number: 171376-01.01. Energy Northwest, Richland Washington.
36 ADAMS Accession No. ML20059K319.

- 1 Armantrout, N.B. 1998. *Aquatic Habitat Inventory Terminology*. American Fisheries Society,
2 Bethesda, Maryland.
- 3 ASHRAE (American Society of Heating, Refrigerating and Air-Conditioning Engineers). 2021.
4 "Legionellosis: Risk Management for Building Water Systems." ASHRAE 188-2021, Atlanta,
5 Georgia. Available from [https://www.techstreet.com/standards/ashrae-188-
6 2021?product_id=2229689](https://www.techstreet.com/standards/ashrae-188-2021?product_id=2229689).
- 7 Atomic Energy Act of 1954. 42 U.S.C. § 2011 et seq.
- 8 Bald and Golden Eagle Protection Act. 16 U.S.C. § 668-668d et seq.
- 9 Bankoske, J.W., H.B. Graves, and G.W. McKee. 1976. "The Effects of High-Voltage Electric
10 Fields on the Growth and Development of Plants and Animals." In *Proceedings of the First
11 National Symposium on Environmental Concerns in Rights-of-Way Management*, pp. 112–123.
12 Mississippi State, Mississippi.
- 13 Barkley, S.W., and C. Perrin. 1971. "The Effects of the Lake Catherine Steam Electric Plant
14 Effluent on the Distribution of Fishes in the Receiving Embayment." In *Proceedings of the
15 Twenty-Fifth Annual Conference of the Southeastern Association of Game and Fish
16 Commissioners*, Columbia, South Carolina. Accessed June 13, 2022, at
17 <https://seafwa.org/sites/default/files/journal-articles/BARKLEY-384.pdf>.
- 18 Batty, R.S., and H.S. Blaxter. 1992. "The Effect of Temperature on the Burst Swimming
19 Performance of Fish Larvae." *Journal of Experimental Biology* 170(1):187–201.
20 DOI:10.1242/jeb.170.1.187. Cambridge, United Kingdom. Accessed May 12, 2022, at
21 <https://doi.org/10.1242/jeb.170.1.187>.
- 22 Beitinger, T.L., W.A. Bennett, and R.W. McCauley. 2000. "Temperature Tolerances of North
23 American Freshwater Fishes Exposed to Dynamic Changes in Temperature." *Environmental
24 Biology of Fishes* 58:237-275, New York, New York.
- 25 Berk, S.G., J.H. Gunderson, A.L. Newsome, A.L. Farone, B.J. Hayes, K.S. Redding, N. Uddin,
26 E.L. Williams, R.A. Johnson, M. Farsian, A. Reid, J. Skimmyhorn, and M.B. Farone. 2006.
27 "Occurrence of Infected Amoebae in Cooling Towers Compared with Natural Aquatic
28 Environments: Implications for Emerging Pathogens." *Environmental Science and Technology*
29 40(23):7440-7444. DOI: 10.1021/es0604257. Washington, D.C. Accessed May 12, 2022, at
30 <https://doi.org/10.1021/es0604257>.
- 31 Bevanger, K. 1988. "Biological and Conservation Aspects of Bird Mortality Caused by
32 Electricity Power Lines: A Review." *Biological Conservation* 86(1):67-76. DOI:10.1016/S0006-
33 3207(97)00176-6. Amsterdam, The Netherlands. Accessed June 9, 2022, at
34 [https://doi.org/10.1016/S0006-3207\(97\)00176-6](https://doi.org/10.1016/S0006-3207(97)00176-6).

References

- 1 Bindokas, V.P., J.R. Gauger, and B. Greenberg. 1988. "Mechanisms of Biological Effects
2 Observed in Honey Bees (*Apis mellifera*, L.) Hived under Extra-High-Voltage Transmission
3 Lines: Implications Derived from Bee Exposure to Simulated Intense Electric Fields and
4 Shocks." *Bioelectromagnetics* 9(3):285–301. DOI:10.1002/bem.2250090310. Hoboken, New
5 Jersey. Accessed June 12, 2022, at <https://doi.org/10.1002/bem.2250090310>.
- 6 BLM (Bureau of Land Management). 2008. *Final Programmatic Environmental Impact*
7 *Statement for Geothermal Leasing in the Western United States, Volume 1: Programmatic*
8 *Analysis*. FES08-44, Washington, D.C. October. Accessed June 2, 2022, at
9 <https://azmemory.azlibrary.gov/digital/collection/feddocs/id/1458/>.
- 10 BLS (U.S. Bureau of Labor Statistics). 2020. "Number and Rate of Fatal Work Injuries, by
11 Industry Sector." Washington, D.C. Accessed May 4, 2022, at
12 [https://www.bls.gov/charts/census-of-fatal-occupational-injuries/number-and-rate-of-fatal-work-](https://www.bls.gov/charts/census-of-fatal-occupational-injuries/number-and-rate-of-fatal-work-injuries-by-industry.htm)
13 [injuries-by-industry.htm](https://www.bls.gov/charts/census-of-fatal-occupational-injuries/number-and-rate-of-fatal-work-injuries-by-industry.htm).
- 14 BLS (U.S. Bureau of Labor Statistics). 2021a. "Census of Fatal Occupational Injuries News
15 Release, National Census of Fatal Occupational Injuries in 2020." Washington, D.C. Accessed
16 May 6, 2022, at https://www.bls.gov/news.release/archives/cfoi_12162021.htm.
- 17 BLS (U.S. Bureau of Labor Statistics). 2021b. Employer-Reported Workplace Injuries and
18 Illnesses - 2020. USDL-21-1927, Washington, D.C. Accessed June 12, 2022, at
19 https://www.bls.gov/news.release/archives/osh_11032021.pdf.
- 20 BLS (U.S. Bureau of Labor Statistics). 2021c. "Injuries, Illnesses, and Fatalities: Table 2.
21 Numbers of nonfatal occupational injuries and illnesses by industry and case types, 2020
22 [thousands]." Washington, D.C. Accessed June 12, 2022, at
23 https://www.bls.gov/iif/oshwc/osh/os/summ2_00_2020.htm.
- 24 BLS (U.S. Bureau of Labor Statistics). 2021d. "Injuries, Illnesses, and Fatalities: Table A-1
25 Fatal occupational injuries by industry and event or exposure, all United States, 2020."
26 Washington, D.C. Accessed June 12, 2022, at <https://www.bls.gov/iif/oshwc/cfoi/cftb0340.htm>.
- 27 BLS (U.S. Bureau of Labor Statistics). 2022. "Civilian Occupations with High Fatal Work Injury
28 Rates, 2020." Washington, D.C. Accessed May 2, 2022, at [https://www.bls.gov/charts/census-](https://www.bls.gov/charts/census-of-fatal-occupational-injuries/civilian-occupations-with-high-fatal-work-injury-rates.htm)
29 [of-fatal-occupational-injuries/civilian-occupations-with-high-fatal-work-injury-rates.htm](https://www.bls.gov/charts/census-of-fatal-occupational-injuries/civilian-occupations-with-high-fatal-work-injury-rates.htm).
- 30 Blue, R. 1996. "Documentation of Raptor Nests on Electric Utility Facilities Through a Mail
31 Survey." Chapter 11 in *Raptors in Human Landscapes: Adaptations to Built and Cultivated*
32 *Environments*. Academic Press, San Diego, California.

- 1 BOEM (Bureau of Ocean Energy Management). 2019. *National Environmental Policy Act*
2 *Documentation for Impact-Producing Factors in the Offshore Wind Cumulative Impacts*
3 *Scenario on the North Atlantic Outer Continental Shelf*. OCS Study, BOEM 2019-036,
4 Washington, D.C. Accessed June 12, 2022, at
5 [https://www.boem.gov/sites/default/files/environmental-stewardship/Environmental-](https://www.boem.gov/sites/default/files/environmental-stewardship/Environmental-Studies/Renewable-Energy/IPFs-in-the-Offshore-Wind-Cumulative-Impacts-Scenario-on-the-N-OCS.pdf)
6 [Studies/Renewable-Energy/IPFs-in-the-Offshore-Wind-Cumulative-Impacts-Scenario-on-the-N-](https://www.boem.gov/sites/default/files/environmental-stewardship/Environmental-Studies/Renewable-Energy/IPFs-in-the-Offshore-Wind-Cumulative-Impacts-Scenario-on-the-N-OCS.pdf)
7 [OCS.pdf](https://www.boem.gov/sites/default/files/environmental-stewardship/Environmental-Studies/Renewable-Energy/IPFs-in-the-Offshore-Wind-Cumulative-Impacts-Scenario-on-the-N-OCS.pdf).
- 8 BOEM (Bureau of Ocean Energy Management). 2020a. *Comparison of Environmental Effects*
9 *from Different Offshore Wind Turbine Foundations*. OCS Study, BOEM 2020-041, Washington,
10 D.C. Accessed June 12, 2022, at
11 [https://www.boem.gov/sites/default/files/documents/environment/Wind-Turbine-Foundations-](https://www.boem.gov/sites/default/files/documents/environment/Wind-Turbine-Foundations-White%20Paper-Final-White-Paper.pdf)
12 [White%20Paper-Final-White-Paper.pdf](https://www.boem.gov/sites/default/files/documents/environment/Wind-Turbine-Foundations-White%20Paper-Final-White-Paper.pdf).
- 13 BOEM (Bureau of Ocean Energy Management, Office of Renewable Energy Programs). 2020b.
14 *Vineyard Wind 1 Offshore Wind Energy Project: Supplement to the Draft Environmental Impact*
15 *Statement*. OCS EIS/EA BOEM 2020-025. U.S. Department of the Interior, Washington, D.C.
16 Accessed June 3, 2022, at [https://www.boem.gov/sites/default/files/documents/renewable-](https://www.boem.gov/sites/default/files/documents/renewable-energy/Vineyard-Wind-1-Supplement-to-EIS.pdf)
17 [energy/Vineyard-Wind-1-Supplement-to-EIS.pdf](https://www.boem.gov/sites/default/files/documents/renewable-energy/Vineyard-Wind-1-Supplement-to-EIS.pdf).
- 18 BOEM (Bureau of Ocean Energy Management). 2021. *Commercial Wind Lease Issuance and*
19 *Site Assessment Activities on the Atlantic Outer Continental Shelf Offshore North Carolina, Draft*
20 *Supplemental Environmental Assessment*. Washington, D.C. Accessed June 12, 2022, at
21 [https://www.boem.gov/renewable-energy/lease-issuance-wind-ocs-activities-north-carolina-](https://www.boem.gov/renewable-energy/lease-issuance-wind-ocs-activities-north-carolina-draft-supplemental-ea)
22 [draft-supplemental-ea](https://www.boem.gov/renewable-energy/lease-issuance-wind-ocs-activities-north-carolina-draft-supplemental-ea).
- 23 BOEM (Bureau of Ocean Energy Management). Undated. "Renewable Energy on the Outer
24 Continental Shelf: Ocean Wave Energy." Washington, D.C. Accessed June 12, 2022, at
25 [https://www.boem.gov/Renewable-Energy-Program/Renewable-Energy-Guide/Ocean-Wave-](https://www.boem.gov/Renewable-Energy-Program/Renewable-Energy-Guide/Ocean-Wave-Energy.aspx)
26 [Energy.aspx](https://www.boem.gov/Renewable-Energy-Program/Renewable-Energy-Guide/Ocean-Wave-Energy.aspx).
- 27 BPA (Bonneville Power Administration). 2007. *Living and Working Safely Around High-Voltage*
28 *Power Lines*. DOE/BP-3804, Portland, Oregon. October. Accessed June 13, 2022, at
29 https://digital.library.unt.edu/ark:/67531/metadc676265/m2/1/high_res_d/291040.pdf.
- 30 BRC (Blue Ribbon Commission on America's Nuclear Future). 2012. *Report to the Secretary of*
31 *Energy*. Washington, D.C. ADAMS Accession No. ML120970375.
- 32 Breeder Reactor Corporation. 1985. *The Clinch River Breeder Reactor Plant Project*. Final
33 Report, Oak Ridge, Tennessee. ADAMS Accession No. ML18064A893.
- 34 Bromirski, P.D., D.R. Cayan, N. Graham, R.E. Flick, and M. Tyree. 2012. *Coastal Flooding*
35 *Potential Projections: 2000-2100*. CEC-500-2012-011. California Energy Commissions,
36 Sacramento, California. Accessed May 19, 2022, at <https://escholarship.org/uc/item/88879br>.

References

- 1 Burchard, J.F., D.H. Nguyen, L. Richard, and E. Block. 1996. "Biological effects of electric and
2 magnetic fields on productivity of dairy cows." *Journal of Dairy Science* 79(9):1549-1554,
3 Amsterdam, The Netherlands.
- 4 Cada, G.F., J.A. Solomon, and J.M. Loar. 1981. *Effects of Sublethal Entrainment Stresses on*
5 *the Vulnerability of Juvenile Bluegill Sunfish to Predation*. ORNL/TM-7801. Oak Ridge National
6 Laboratory, Oak Ridge, Tennessee. Accessed June 13, 2022, at
7 <https://www.osti.gov/servlets/purl/6484168>.
- 8 Carpenter, E.J., B.B. Peck, and S.J. Anderson. 1974. "Survival of Copepods Passing through a
9 Nuclear Power Station on Northeastern Long Island Sound, USA." *Marine Biology* 24:49–55.
10 DOI:10.1007/BF00402846. Cham, Switzerland. Accessed June 12, 2022, at
11 <https://doi.org/10.1007/BF00402846>.
- 12 CDC (Centers for Disease Control and Prevention). 2018. "What Owners and Managers of
13 Buildings and Healthcare Facilities Need to Know about the Growth and Spread of Legionella."
14 Atlanta, Georgia. Accessed June 12, 2022, at
15 [https://www.cdc.gov/legionella/wmp/overview/growth-and-
16 spread.html#:~:text=Legionella%20grows%20best%20within%20a,and%20keep%20hot%20wat
17 er%20hot](https://www.cdc.gov/legionella/wmp/overview/growth-and-spread.html#:~:text=Legionella%20grows%20best%20within%20a,and%20keep%20hot%20water%20hot).
- 18 CDC (Centers for Disease Control and Prevention). 2019a. "Pseudomonas aeruginosa in
19 Healthcare Settings." Atlanta, Georgia. Accessed May 3, 2022, at
20 <https://www.cdc.gov/hai/organisms/pseudomonas.html>.
- 21 CDC (Centers for Disease Control and Prevention). 2019b. "What Noises Cause Hearing
22 Loss?" Atlanta, Georgia. Accessed June 1, 2022, at
23 [https://www.cdc.gov/nceh/hearing_loss/what_noises_cause_hearing_loss.html#:~:text=A%20w
24 hisper%20is%20about%2030,immediate%20harm%20to%20your%20ears](https://www.cdc.gov/nceh/hearing_loss/what_noises_cause_hearing_loss.html#:~:text=A%20whisper%20is%20about%2030,immediate%20harm%20to%20your%20ears).
- 25 CDC (Centers for Disease Control and Prevention). 2021a. "Harmful Algal Bloom (HAB)-
26 Associated Illness, General Information." Atlanta, Georgia. Accessed May 3, 2022, at
27 <https://www.cdc.gov/habs/general.html>.
- 28 CDC (Centers for Disease Control and Prevention). 2021b. "Illness and Symptoms: Marine
29 (Saltwater) Algal Blooms." Atlanta, Georgia. Accessed May 3, 2022, at
30 <https://www.cdc.gov/habs/illness-symptoms-marine.html>.
- 31 CDC (Centers for Disease Control and Prevention). 2021c. "Legionella (Legionnaires' Disease
32 and Pontiac Fever), Guidelines, Standards, and Laws." Atlanta, Georgia. Accessed May 12,
33 2022, at <https://www.cdc.gov/legionella/resources/guidelines.html>.
- 34 CDC (Centers for Disease Control and Prevention). 2021d. "Parasites – Naegleria fowleri –
35 Primary Amebic Meningoencephalitis (PAM) – Amebic Encephalitis, General Information."
36 Atlanta, Georgia. Accessed May 3, 2022, at
37 <https://www.cdc.gov/parasites/naegleria/general.html>.

- 1 CDC (Centers for Disease Control and Prevention). 2022. "Illness and Symptoms:
2 Cyanobacteria In Fresh Water." Atlanta, Georgia. Accessed May 3, 2022, at
3 <https://www.cdc.gov/habs/illness-symptoms-freshwater.html>.
- 4 CEQ (Council on Environmental Quality). 1997a. *Considering Cumulative Effects Under the*
5 *National Environmental Policy Act*. Washington, D.C. ADAMS Accession No. ML12243A349.
- 6 CEQ (Council on Environmental Quality). 1997b. *Environmental Justice Guidance under the*
7 *National Environmental Policy Act*. Washington, D.C. ADAMS Accession No. ML103430030.
- 8 CEQ (Council on Environmental Quality). 2016. Memorandum from C. Goldfuss to Heads of
9 Federal Departments and Agencies, dated August 1, 2016, regarding "Final Guidance for
10 Federal Departments and Agencies on Consideration of Greenhouse Gas Emissions and the
11 Effects of Climate Change in National Environmental Policy Act Reviews." Washington, D.C.
12 ADAMS Accession No. ML16266A244.
- 13 CEQ (Council on Environmental Quality). 2022. *National Environmental Policy Act*
14 *Implementing Regulations, 40 CFR Parts 1500-1508*. Washington, D.C. May.
- 15 CEQ and ACHP (Council on Environmental Quality and Advisory Council on Historic
16 Preservation). 2013. *NEPA and NHPA: A Handbook for Integrating NEPA and Section 106*.
17 Washington, D.C. ADAMS Accession No. ML14172A044.
- 18 Christensen, S.W., J.A. Solomon, S.B. Gough, R.L. Tyndall, and C.B. Fliermans. 1983.
19 *Legionnaires' Disease Bacterium Power Plant Cooling Systems: Phase I Final Report*. Interim
20 Report, EPRI/EA-3153, Oak Ridge, Tennessee. ADAMS Accession No. ML093240252.
- 21 Ciferno, J.P., and J.J. Marano. 2002. *Benchmarking Biomass Gasification Technologies for*
22 *Fuels, Chemicals and Hydrogen Production*. Washington, D.C. Accessed June 10, 2022, at
23 https://netl.doe.gov/sites/default/files/netl-file/BMassGasFinal_0.pdf.
- 24 Claireaux, G., C. Couturier, and A.-L. Groison. 2006. "Effect of Temperature on Maximum
25 Swimming Speed and Cost of Transport in Juvenile European Sea Bass (*Dicentrarchus*
26 *labrax*)." *Journal of Experimental Biology* 209(17):3420–3428. DOI: 10.1242/jeb.02346.
27 Cambridge, United Kingdom. Accessed May 12, 2022, at
28 [https://journals.biologists.com/jeb/article/209/17/3420/16223/Effect-of-temperature-on-](https://journals.biologists.com/jeb/article/209/17/3420/16223/Effect-of-temperature-on-maximum-swimming-speed)
29 [maximum-swimming-speed](https://journals.biologists.com/jeb/article/209/17/3420/16223/Effect-of-temperature-on-maximum-swimming-speed).
- 30 Clean Air Act. 42 U.S.C. § 7401 et seq.
- 31 Coastal Zone Management Act of 1972. 16 U.S.C. § 1451 et seq.
- 32 Combs, DL. 1979. "Striped bass spawning in the Arkansas River tributary of Keystone
33 Reservoir, Oklahoma." *Proceedings of the Southeastern Association of Fish and Wildlife*
34 *Agencies* 33:371-383.
- 35 Comprehensive Environmental Response, Compensation, and Liability Act, as amended. 42
36 U.S.C. § 9601 et seq.

References

- 1 Cool, D.A., K.R. Kase, and J.D. Boice. 2019. "NCRP Report no. 180—management of
2 exposure to ionizing radiation: NCRP radiation protection guidance for the United States."
3 *Journal of Radiological Protection* 39(3):966. <http://doi.org/10.1088/1361-6498/ab1826>.
- 4 Coutant, C.C. 1987. "Thermal Preference: When Does an Asset Become a Liability?"
5 *Environmental Biology of Fishes* 18(3):161–72. DOI:10.1007/BF00000356. Cham, Switzerland.
6 Accessed June 13, 2022, at <https://doi.org/10.1007/BF00000356>.
- 7 Cowardin, L.M., V. Carter, F.C. Golet, and E.T. LaRoe. 1979. *Classification of Wetlands and*
8 *Deepwater Habitats of the United States*. FWS/OBS-79/31, Fish and Wildlife Service,
9 Washington, D.C. ADAMS Accession No. ML18019A904.
- 10 Crawford, R.L., and R.T. Engstrom. 2001. "Characteristics of Avian Mortality at a North Florida
11 Television Tower: A 29-Year Study." *Journal of Field Ornithology* 72(3):380-388.
12 DOI:10.1648/0273-8570-72.3.380. Washington, D.C. Accessed June 9, 2022, at
13 <https://dx.doi.org/10.1648/0273-8570-72.3.380>.
- 14 Cristina, S., and M. D'Amore. 1985. "Analytical Method for Calculating Corona Noise on HVAC
15 Power Line Carrier Communication Channels." *IEEE Transactions on Power Apparatus and*
16 *Systems* PAS-104(5):1017-1024, DOI: 10.1109/TPAS.1985.323451. Piscataway, New Jersey.
17 Accessed May 16, 2022, at <https://dx.doi.org/10.1109/TPAS.1985.323451>.
- 18 Crooks, K.R. 2002. "Relative Sensitivities of Mammalian Carnivores to Habitat Fragmentation."
19 *Conservation Biology* 16(2):488–502. DOI:10.1046/j.1523-1739.2002.00386.x. Hoboken, New
20 Jersey. Accessed June 9, 2022, at <https://dx.doi.org/10.1046/j.1523-1739.2002.00386.x>.
- 21 Crooks, K.R., and M.E. Soule. 1999. "Mesopredator Release and Avifaunal Extinctions in a
22 Fragmented System." *Nature* 400(6744):563–566. DOI: 10.1038/23028. Berlin, Germany.
23 Accessed May 16, 2022, at <https://doi.org/10.1038/23028>.
- 24 Deacon, J. 2006. "The Microbial World: Thermophilic Microorganisms. Institute of Cell and
25 Molecular Biology." Edinburgh, United Kingdom. ADAMS Accession No. ML070170579.
26 Accessed June 12, 2022, at <https://www.nrc.gov/docs/ML0701/ML070170579.pdf>.
- 27 Diaz, R.J. 1994. "Response of Tidal Freshwater Macrobenthos to Sediment Disturbance."
28 *Hydrobiologia* 278:201-212. DOI:10.1007/BF00142328. Cham, Switzerland. Accessed June
29 14, 2022, at <https://doi.org/10.1007/BF00142328>.
- 30 Dieter, C.A., M.A. Maupin, R.R. Caldwell, M.A. Harris, T.I. Ivahnenko, J.K. Lovelace, N.L.
31 Barber, and K.S. Linsey. 2018. *Estimated Use of Water in the United States in 2015*. USGS
32 Circular 1441, U.S. Geological Survey, Reston, Virginia. Accessed October 19, 2020, at
33 <https://pubs.usgs.gov/circ/1441/circ1441.pdf>.
- 34 DOE (U.S. Department of Energy). 1997a. *Biocide Usage in Cooling Towers in the Electric*
35 *Power and Petroleum Refining Industries, Topical Report*. DOE/BC -98000455, DOE.BC/W-31-
36 109-ENG38-3, Distribution Category UC-122, Washington, D.C.

- 1 DOE (U.S. Department of Energy). 1997b. *Renewable Energy Technology Characterizations,*
2 *Topical Report TR-109496.* Washington, D.C. December. Accessed June 5, 2022, at
3 <https://www.nrel.gov/docs/gen/fy98/24496.pdf>.
- 4 DOE (U.S. Department of Energy). 1999. "*DOE/EIS-0269: Final Programmatic Environmental*
5 *Impact Statement (April 1999).*" DOES/EIS-0269, Washington, D.C. Accessed June 11, 2022,
6 at [https://www.energy.gov/nepa/articles/doeeis-0269-final-programmatic-environmental-impact-](https://www.energy.gov/nepa/articles/doeeis-0269-final-programmatic-environmental-impact-statement-april-1999)
7 [statement-april-1999](https://www.energy.gov/nepa/articles/doeeis-0269-final-programmatic-environmental-impact-statement-april-1999).
- 8 DOE (U.S. Department of Energy). 2000. *Transmission System Vegetation Management*
9 *Program, Final Environmental Impact Statement.* DOE/EIS-0285. Washington, D.C.
- 10 DOE (U.S. Department of Energy). 2002. Final Environmental Impact Statement for a Geologic
11 Repository for the Disposal of Spent Nuclear Fuel and High-Level Radioactive Waste at Yucca
12 Mountain, Nye County, Nevada. DOE/EIS-0250, Office of Civilian Radioactive Waste
13 Management, Washington, D.C. ADAMS Accession No. ML14024A327.
- 14 DOE (U.S. Department of Energy). 2004a. "EIS-0359: Final Environmental Impact Statement."
15 DOES/EIS-0359, Washington, D.C. Accessed June 11, 2022, at
16 <https://www.energy.gov/nepa/downloads/eis-0359-final-environmental-impact-statement>.
- 17 DOE (U.S. Department of Energy). 2004b. "EIS-0360: Final Environmental Impact Statement."
18 DOES/EIS-0360, Washington, D.C. Accessed June 11, 2022, at
19 <https://www.energy.gov/nepa/downloads/eis-0360-final-environmental-impact-statement-0>.
- 20 DOE (U.S. Department of Energy). 2004c. *RESRAD-BIOTA: A Tool for Implementing a*
21 *Graded Approach to Biota Dose Evaluation.* ISCORS Technical Report 2004-02, Interagency
22 Steering Committee on Radiation Standards, Washington, D.C. ADAMS Accession No.
23 ML21140A412.
- 24 DOE (U.S. Department of Energy). 2007. *Draft Supplement Analysis for Location(S) to*
25 *Dispose of Depleted Uranium Oxide Conversion Product Generated from DOE's Inventory of*
26 *Depleted Uranium Hexafluoride (DOE/EID-0359-SA1 and DOE/EIS-0360-SA1).* Washington,
27 D.C. March. Accessed June 11, 2022, at
28 http://web.evs.anl.gov/uranium/documents/sa/DUF6_SA.pdf.
- 29 DOE (U.S. Department of Energy). 2008. *Final Supplemental Environmental Impact Statement*
30 *for a Geologic Repository for the Disposal of Spent Nuclear Fuel and High-Level Radioactive*
31 *Waste at Yucca Mountain, Nye County, Nevada.* DOE/EIS-0250F-S1, Washington, D.C.
32 ADAMS Accession No. ML14024A329.
- 33 DOE (U.S. Department of Energy). 2016. *Summary Final Environmental Impact Statement for*
34 *the Disposal of Greater-Than-Class C (GTCC) Low-Level Radioactive Waste and GTCC-Like*
35 *Waste, (DOE/EIS-0375).* Washington, D.C. January. ADAMS Accession No. ML16063A484.
- 36 DOE (U.S. Department of Energy). 2017. *Alternatives for the Disposal of Greater-Than-Class*
37 *C Low-Level Radioactive Waste and Greater-Than-Class C-Like Waste.* Report to Congress,
38 Washington, D.C. November.

References

- 1 DOE (U.S. Department of Energy). 2019. *A Graded Approach for Evaluating Radiation Doses*
2 *to Aquatic and Terrestrial Biota*. DOE-STD-1153-2019, Washington, D.C. Available at
3 https://www.standards.doe.gov/standards-documents/1100/1153-astd-2019/@_@images/file.
- 4 DOE (U.S. Department of Energy). 2021a. "FOTW #1208, Oct 18, 2021: Life Cycle
5 Greenhouse Gas Emissions for a 2020 Electric Small SUV Were Half Those of a Conventional
6 Gasoline Small SUV." Accessed June 7, 2022, at
7 [https://www.energy.gov/eere/vehicles/articles/fotw-1208-oct-18-2021-life-cycle-greenhouse-gas-](https://www.energy.gov/eere/vehicles/articles/fotw-1208-oct-18-2021-life-cycle-greenhouse-gas-emissions-2020-electric)
8 [emissions-2020-electric](https://www.energy.gov/eere/vehicles/articles/fotw-1208-oct-18-2021-life-cycle-greenhouse-gas-emissions-2020-electric).
- 9 DOE (U.S. Department of Energy). 2021b. *Hydrogen Shot: An Introduction*. Office of Energy
10 Efficiency and Renewable Energy, Hydrogen and Fuel Cells Technology Office. Washington,
11 D.C. Accessed June 12, 2022, at [https://www.energy.gov/eere/fuelcells/articles/hydrogen-shot-](https://www.energy.gov/eere/fuelcells/articles/hydrogen-shot-introduction)
12 [introduction](https://www.energy.gov/eere/fuelcells/articles/hydrogen-shot-introduction).
- 13 DOE (U.S. Department of Energy). 2022a. "Advanced Small Modular Reactors (SMRs): Office
14 of Nuclear Energy". Washington, D.C. Available at [https://www.energy.gov/ne/advanced-small-](https://www.energy.gov/ne/advanced-small-modular-reactors-smrs)
15 [modular-reactors-smrs](https://www.energy.gov/ne/advanced-small-modular-reactors-smrs).
- 16 DOE (U.S. Department of Energy). 2022b. *Offshore Wind Energy Strategies*. Washington,
17 D.C. Accessed June 16, 2022, at [https://www.energy.gov/sites/default/files/2022-01/offshore-](https://www.energy.gov/sites/default/files/2022-01/offshore-wind-energy-strategies-report-january-2022.pdf)
18 [wind-energy-strategies-report-january-2022.pdf](https://www.energy.gov/sites/default/files/2022-01/offshore-wind-energy-strategies-report-january-2022.pdf).
- 19 DOE (U.S. Department of Energy). Undated-a. "Fuel Cell Basics: Hydrogen and Fuel Cell
20 Technologies Office." Washington, D.C. Accessed June 12, 2022, at
21 <https://www.energy.gov/eere/fuelcells/fuel-cell-basics>.
- 22 DOE (U.S. Department of Energy). Undated-b. "Geothermal Basics: Geothermal."
23 Washington, D.C. Accessed June 12, 2022, at
24 <https://www.energy.gov/eere/geothermal/geothermal-basics>.
- 25 DOE (U.S. Department of Energy). Undated-c. "Types of Hydropower Plants." Washington,
26 D.C. Accessed June 12, 2022, at <https://www.energy.gov/eere/water/types-hydropower-plants>.
- 27 DOE (U.S. Department of Energy). Undated-d. "Vogtle Loan Program Office." Washington,
28 D.C. Accessed June 12, 2022, at <https://www.energy.gov/lpo/vogtle>.
- 29 DOE (U.S. Department of Energy). Undated-e. "WINDEXchange: Wind Energy State
30 Information." Washington, D.C. Accessed June 12, 2022, at
31 <https://windexchange.energy.gov/states>.
- 32 DOE/EIA (U.S. Department of Energy/Energy Information Administration). 2015a. *Levelized*
33 *Cost and Levelized Avoided Cost of New Generation Resources in the Annual Energy Outlook*
34 *2015*. Washington, D.C. Accessed June 12, 2022, at
35 https://www.eia.gov/outlooks/archive/aeo15/pdf/electricity_generation_2015.pdf.

- 1 DOE/EIA (U.S. Department of Energy/Energy Information Administration). 2015b. *Annual*
2 *Energy Outlook 2015 with Projections to 2040*. DOE/EIA-0383(2015), Washington, D.C.
3 ADAMS Accession No. ML16172A121.
- 4 DOE/EIA (U.S. Department of Energy/Energy Information Administration). 2017. "Today in
5 Energy: Oil-fired Power Plants Provide Small Amounts of U.S. Electricity Capacity and
6 Generation." Washington, D.C. Accessed June 6, 2022, at
7 <https://www.eia.gov/todayinenergy/detail.php?id=31232>.
- 8 DOE/EIA (U.S. Department of Energy/Energy Information Association). 2019a. "More new
9 natural gas combined-cycle power plants are using advanced designs." Washington, D.C.
10 Accessed May 17, 2022, at <https://www.eia.gov/todayinenergy/detail.php?id=39912>.
- 11 DOE/EIA (U.S. Department of Energy/Energy Information Administration). 2019b. "Today In
12 Energy: Demand-side Management Programs Save Energy and Reduce Peak Demand."
13 Washington, D.C.
- 14 DOE/EIA (U.S. Department of Energy/Energy Information Association). 2020a. *Annual Energy*
15 *Outlook 2020, with projections to 2050*. AEO2020. Washington, D.C.
- 16 DOE/EIA (U.S. Department of Energy/Energy Information Administration). 2020b. "Electricity
17 Explained: Electricity Generation, Capacity, and Sales in the United States." Washington, D.C.
18 ADAMS Accession No. ML21140A433.
- 19 DOE/EIA (U.S. Department of Energy/Energy Information Administration). 2020c. "Form EIA-
20 860 Detailed Data with Previous Form Data (EIA-860A/860B)." Final 2019 Data, Washington,
21 D.C. ADAMS Accession No. ML21141A320.
- 22 DOE/EIA (U.S. Department of Energy/Energy Information Administration). 2021a. "Electric
23 Power Monthly: Table 6.07.B Capacity Factors for Utility Scale Generators Primarily Using
24 Non-Fossil Fuels, Data for August 2021." Washington, D.C. Accessed June 12, 2022, at
25 https://www.eia.gov/electricity/monthly/epm_table_grapher.php?t=epmt_6_07_b.
- 26 DOE/EIA (U.S. Department of Energy/Energy Information Administration). 2021b. "Frequently
27 Asked Questions (FAQS)." November. Washington, D.C. Accessed May 10, 2022, at
28 <https://www.eia.gov/tools/faqs/faq.php?id=92&t=4>.
- 29 DOE/EIA (U.S. Department of Energy/Energy Information Administration). 2021c. "Today in
30 Energy: Less Electricity Was Generated by Coal than Nuclear in the United States in 2020."
31 Washington, D.C. Accessed June 12, 2022, at
32 <https://www.eia.gov/todayinenergy/detail.php?id=47196>.
- 33 DOE/EIA (U.S. Department of Energy/Energy Information Administration). 2021d. "Today in
34 Energy: Solar Generation Was 3% of U.S. Electricity in 2020, But We Project It Will Be 20% by
35 2050." Washington, D.C. Accessed June 12, 2022, at
36 <https://www.eia.gov/todayinenergy/detail.php?id=50357>.

References

- 1 DOE/EIA (U.S. Department of Energy/Energy Information Administration). 2021e. "Today in
2 Energy: U.S. Large-Scale Battery Storage Capacity Up 35% in 2020, Rapid Growth to
3 Continue." Washington, D.C. Accessed June 12, 2022, at
4 <https://www.eia.gov/todayinenergy/detail.php?id=49236>.
- 5 DOE/EIA (U.S. Department of Energy/Energy Information Administration). 2022a. "Annual
6 Energy Outlook 2022." Washington, D.C. Accessed May 10, 2022, at
7 <https://www.eia.gov/outlooks/aeo/narrative/electricity/sub-topic-04.php>.
- 8 DOE/EIA (U.S. Department of Energy/Energy Information Administration). 2022b. *Annual
9 Energy Outlook 2022 with Projections to 2050, Narrative*. Washington, D.C.
- 10 DOE/EIA (U.S. Department of Energy/Energy Information Administration). 2022c. *Cost and
11 Performance Characteristics of New Generating Technologies, Annual Energy Outlook 2021*.
12 Washington, D.C. Accessed June 12, 2022, at
13 https://www.eia.gov/outlooks/aeo/assumptions/pdf/table_8.2.pdf.
- 14 DOE/EIA (U.S. Department of Energy/Energy Information Administration). 2022d. *Electric
15 Power Annual 2020*. Washington, D.C.
- 16 DOE/EIA (U.S. Department of Energy/Energy Information Administration). 2022e. "Electricity
17 Explained: Electricity in the United States." Washington, D.C. Accessed May 11, 2022, at
18 <https://www.eia.gov/energyexplained/electricity/electricity-in-the-us.php>.
- 19 DOE/EIA (U.S. Department of Energy/Energy Information Administration). 2022f. "Hydrogen
20 Explained, Use of Hydrogen." Washington, D.C. Accessed June 16, 2022, at
21 <https://www.eia.gov/energyexplained/hydrogen/use-of-hydrogen.php>.
- 22 DOE/EIA (U.S. Department of Energy/Energy Information Administration). 2022g. "Nuclear
23 explained, U.S. Nuclear Industry." Washington, D.C. Accessed June 12, 2022, at
24 <https://www.eia.gov/energyexplained/nuclear/us-nuclear-industry.php>.
- 25 DOE/EIA (U.S. Department of Energy/Energy Information Administration). 2022h. "Today in
26 Energy: EIA Projects That Renewable Generation Will Supply 44% of U.S. Electricity by 2050."
27 Washington, D.C. Accessed June 12, 2022, at
28 <https://www.eia.gov/todayinenergy/detail.php?id=51698>.
- 29 DOE/EIA (U.S. Department of Energy/Energy Information Administration). 2022i. "Today in
30 Energy: U.S. nuclear electricity generation continues to decline as more reactors retire."
31 Washington, D.C. Accessed June 12, 2022, at
32 <https://www.eia.gov/todayinenergy/detail.php?id=51978#>.
- 33 DOE/EIA (U.S. Department of Energy/Energy Information Administration). Undated-a. "Electric
34 Power Annual 2020, Table 1.2. Summary Statistics for the United States, 2009–2019. Utility
35 Scale Capacity: Solar Photovoltaic." Washington, D.C. Accessed June 12, 2022, at
36 https://www.eia.gov/electricity/annual/html/epa_01_02.html.

- 1 DOE/EIA (U.S. Department of Energy/Energy Information Administration). Undated-b. *Form*
2 *EIA-861 Annual Electric Power Industry Report Instructions*. Washington, D.C. Accessed June
3 12, 2022, at https://www.eia.gov/survey/form/eia_861/instructions.pdf.
- 4 Donaldson, M., S. Cooke, D.A. Patterson, and J.S. MacDonald. 2008. "Cold shock and fish."
5 *Journal of Fish Biology* 73(7):1491-1530. DOI:10.1111/j.1095-8649.2008.02061.x. Hoboken,
6 New Jersey. Accessed June 6, 2022, at <https://doi.org/10.1111/j.1095-8649.2008.02061.x>.
- 7 Duke Energy. 2017. *Why Nuclear Plants Are Great Places For Wildlife*. Charlotte, North
8 Carolina. Accessed June 6, 2022, at [https://nuclear.duke-energy.com/2017/09/29/why-nuclear-](https://nuclear.duke-energy.com/2017/09/29/why-nuclear-plants-are-a-great-place-for-wildlife)
9 [plants-are-a-great-place-for-wildlife](https://nuclear.duke-energy.com/2017/09/29/why-nuclear-plants-are-a-great-place-for-wildlife).
- 10 EA Engineering. (EA Engineering, Science, and Technology, Inc.) 2015. *Final Impingement*
11 *and Entrainment Characterization Study LaSalle County Station*. Exelon Generation Company,
12 LLC. Kennett Square, Pennsylvania. ADAMS Accession No. ML15243A204.
- 13 Ellingson, E.F. 1979. "Transformer Noise Abatement Using Tuned Sound Enclosure Panels."
14 *1979 7th IEEE/PES Transmission and Distribution Conference and Exposition*. Milwaukee,
15 Wisconsin.
- 16 Endangered Species Act of 1973. 16 U.S.C. § 1531 et seq.
- 17 EPA (U.S. Environmental Protection Agency). 1974. *Information on Levels of Environmental*
18 *Noise Requisite to Protect Public Health and Welfare with an Adequate Margin of Safety*.
19 Washington, D.C. ADAMS Accession No. ML12241A393.
- 20 EPA (U.S. Environmental Protection Agency). 1981. *Noise Effects Handbook: A Desk*
21 *Reference to Health and Welfare, Effects of Noise*. EPA 350/9-82-106. Washington, D.C.
- 22 EPA (U.S. Environmental Protection Agency). 1986. *Quality Criteria for Water*. EPA 440/5-86-
23 001. U.S. Environmental Protection Agency, Office of Water, Washington, D.C. Accessed June
24 13, 2022, at [https://www.epa.gov/sites/default/files/2018-10/documents/quality-criteria-water-](https://www.epa.gov/sites/default/files/2018-10/documents/quality-criteria-water-1986.pdf)
25 [1986.pdf](https://www.epa.gov/sites/default/files/2018-10/documents/quality-criteria-water-1986.pdf).
- 26 EPA (U.S. Environmental Protection Agency). 1993. *Natural Wetlands and Urban Stormwater:*
27 *Potential Impacts and Management*. 843-R-9300. Washington, D.C.
- 28 EPA (U.S. Environmental Protection Agency). 1996. *A Guide to Stormwater Best Management*
29 *Practices*. EPA-B43-B-96-001. Washington, D.C.
- 30 EPA (U.S. Environmental Protection Agency). 2002. *Case Study Analysis for the Proposed*
31 *Section 316(b) Phase II Existing Facilities Rule, Part A - B*. EPA-821-R-02-002. Washington,
32 D.C.

References

- 1 EPA (U.S. Environmental Protection Agency). 2004. *The Incidence and Severity of Sediment*
2 *Contamination in Surface Waters of the United States, National Sediment Quality Survey:*
3 *Second Edition*. EPA-823-R-04-007. U.S. Environmental Protection Agency, Office of Science
4 and Technology, Washington, D.C. Accessed June 13, 2022, at
5 <https://archive.epa.gov/water/archive/polwaste/web/pdf/nsqs2ed-complete-2.pdf>.
- 6 EPA (U.S. Environmental Protection Agency). 2016. *Climate Change Indicators in the United*
7 *States 2016*. Fourth Edition, EPA 430-R-16-004, Washington, D.C. Accessed June 7, 2022, at
8 https://www.epa.gov/sites/default/files/2016-08/documents/climate_indicators_2016.pdf.
- 9 EPA (U.S. Environmental Protection Agency). 2017. *Water Quality Standards Handbook*.
10 EPA-823-B-17-001. EPA Office of Water, Office of Science and Technology, Washington, D.C.
11 Accessed June 6, 2022, at <https://www.epa.gov/wqs-tech/water-quality-standards-handbook>.
- 12 EPA (U.S. Environmental Protection Agency). 2019. "How is Mixed Waste Regulated?"
13 Washington, D.C. ADAMS Accession No ML21141A337.
- 14 EPA (U.S. Environmental Protection Agency). 2020a. "Categories of Hazardous Waste
15 Generators." Washington, D.C. ADAMS Accession No. ML21141A344.
- 16 EPA (U.S. Environmental Protection Agency). 2020b. *Greenhouse Gas Inventory Guidance:*
17 *Indirect Emissions from Purchased Electricity*. EPA Center for Corporate Climate Leadership.
18 U.S. Environmental Protection Agency, Washington, D.C. Accessed May 23, 2022, at
19 <https://www.epa.gov/sites/default/files/2020-12/documents/electricityemissions.pdf>.
- 20 EPA (U.S. Environmental Protection Agency). 2021a. "Climate Change Indicators: U.S. and
21 Global Precipitation." Washington, D.C. Available at [https://www.epa.gov/climate-](https://www.epa.gov/climate-indicators/climate-change-indicators-us-and-global-precipitation)
22 [indicators/climate-change-indicators-us-and-global-precipitation](https://www.epa.gov/climate-indicators/climate-change-indicators-us-and-global-precipitation).
- 23 EPA (U.S. Environmental Protection Agency). 2021b. "EPA Center for Corporate Climate
24 Leadership: Scope 1 and Scope 2 Inventory Guidance." Washington, D.C. Accessed May 24,
25 2022, at <https://www.epa.gov/climateleadership/scope-3-inventory-guidance>.
- 26 EPA (U.S. Environmental Protection Agency). 2021c. "Impaired Waters and TMDLs: Overview
27 of Listing Impaired Waters under CWA Section 303(d)." Washington, D.C. Available at
28 <https://www.epa.gov/tmdl/overview-listing-impaired-waters-under-cwa-section-303d>.
- 29 EPA (U.S. Environmental Protection Agency). 2022a. *Inventory of U.S. Greenhouse Gas*
30 *Emissions and Sinks, 1990-2020*. EPA 430-R-22-003. Washington, D.C. Accessed May 23,
31 2022, at [https://www.epa.gov/system/files/documents/2022-04/us-ghg-inventory-2022-main-](https://www.epa.gov/system/files/documents/2022-04/us-ghg-inventory-2022-main-text.pdf)
32 [text.pdf](https://www.epa.gov/system/files/documents/2022-04/us-ghg-inventory-2022-main-text.pdf).
- 33 EPA (U.S. Environmental Protection Agency). 2022b. "Aquatic Nuisance Species (ANS)."
34 Washington D.C. Accessed June 6, 2022, at [https://www.epa.gov/vessels-marinas-and-](https://www.epa.gov/vessels-marinas-and-ports/aquatic-nuisance-species-ans)
35 [ports/aquatic-nuisance-species-ans](https://www.epa.gov/vessels-marinas-and-ports/aquatic-nuisance-species-ans).

- 1 EPA (U.S. Environmental Protection Agency). 2022c. "EPA Center for Corporate Climate
2 Leadership: Scope 3 Inventory Guidance." Washington, D.C. Accessed May 24, 2022, at
3 <https://www.epa.gov/climateleadership/scope-3-inventory-guidance>.
- 4 EPA (U.S. Environmental Protection Agency). 2022d. "Facility Level Information on
5 GreenHouse Gases Tool (FLIGHT): 2020 Greenhouse Gas Emissions from Large Facilities."
6 Washington, D.C. Available at <https://ghgdata.epa.gov/ghgp/main.do>.
- 7 EPA (U.S. Environmental Protection Agency). 2022e. "Green Book GIS Download."
8 Washington, D.C. Accessed May 23, 2022, at [https://www.epa.gov/green-book/green-book-gis-](https://www.epa.gov/green-book/green-book-gis-download)
9 [download](https://www.epa.gov/green-book/green-book-gis-download).
- 10 EPA (U.S. Environmental Protection Agency). 2022f. "NAAQS Table." Washington, D.C.
11 Accessed May 2, 2022, at <https://www.epa.gov/criteria-air-pollutants/naaqs-table>.
- 12 EPA (U.S. Environmental Protection Agency). 2022g. "NPDES Permit Basics." Washington,
13 D.C. Accessed May 26, 2022, at <https://www.epa.gov/npdes/npdes-permit-basics>.
- 14 EPA (U.S. Environmental Protection Agency). 2022h. "What are Volatile Organic Compounds
15 (VOCs)?" Washington, D.C. Accessed June 12, 2022, at [https://www.epa.gov/indoor-air-](https://www.epa.gov/indoor-air-quality-iaq/what-are-volatile-organic-compounds-vocs)
16 [quality-iaq/what-are-volatile-organic-compounds-vocs](https://www.epa.gov/indoor-air-quality-iaq/what-are-volatile-organic-compounds-vocs).
- 17 EPRI (Electric Power Research Institute). 1982. *Transmission Line Reference Book, 345 kV
18 and Above/Second Edition*. DE82-905-265. Palo Alto, California.
- 19 Erickson, W.P., G.D. Johnson, M.D. Strickland, K.J. Sernka, and R.E. Good. 2001. *Avian
20 Collisions with Wind Turbines: A Summary of Existing Studies and Comparisons to Other
21 Sources of Avian Collision Mortality in the United States*. National Wind Coordinating
22 Committee Resource Document. Western EcoSystems Technology, Inc., Cheyenne, Wyoming.
23 DOI:10.2172/822418. Accessed June 9, 2022, at <https://dx.doi.org/10.2172/822418>.
- 24 Erickson W.P., M.M. Wolfe, K.J. Bay, D.H. Johnson, and J.L. Gehring. 2014. "A
25 Comprehensive Analysis of Small-Passerine Fatalities from Collision with Turbines at Wind
26 Energy Facilities." *PLoS ONE* 9(9): e107491. DOI:10.1371/journal.pone.010749. San
27 Francisco, California. Accessed June 9, 2022, at <https://doi.org/10.1371/journal.pone.0107491>.
- 28 Evans, D.R., and J.E. Gates. 1997. "Cowbird Selection of Breeding Areas: The Role of Habitat
29 and Bird Species Abundance." *Wilson Bulletin* 109(3):470–480. Ann Arbor, Michigan.
30 Accessed May 17, 2022, at <http://www.jstor.org/stable/4163842>.
- 31 Evans, M.S., G.J. Warren, and D.I. Page. 1986. "The Effects of Power Plant Passage on
32 Zooplankton Mortalities: Eight Years of Study at the Donald C. Cook Nuclear Plant." *Water
33 Research* 20(6):725-734. DOI:10.1016/0043-1354(86)90096-5. Amsterdam, The Netherlands.
34 Accessed June 12, 2022, at [https://doi.org/10.1016/0043-1354\(86\)90096-5](https://doi.org/10.1016/0043-1354(86)90096-5).

References

- 1 Exelon (Exelon Generation Company). 2011. "Peach Bottom Receives International Habitat
2 Conservation Award." Chicago, Illinois. Accessed June 6, 2022, at
3 https://www.exeloncorp.com/NEWSROOM/Pages/pr_20110106_nuclear_peachbottomWHCrelease3.aspx.
4
- 5 Exelon (Exelon Generation Company). 2012. "Exelon's Braidwood and LaSalle Awarded
6 Wildlife at Work Certification." Chicago, Illinois. Accessed June 6, 2022, at
7 https://www.exeloncorp.com/newsroom/Pages/pr_03293012_nuclear_Wildlifeatworkka.aspx.
- 8 Exelon Generation Company, LLC. 2013. Letter from M.P. Gallagher, Vice President, to NRC,
9 dated December 19, 2013, regarding "Response to NRC Request for Additional Information,
10 dated November 21, 2013, related to the Byron and Braidwood Stations, Units 1 and 2 License
11 Renewal Application, Byron Station Applicant's Environmental Report." Kennett Square,
12 Pennsylvania. ADAMS Accession No. ML14007A082.
- 13 Exelon Generation Company, LLC. 2014. Letter from M.P. Gallagher, Vice President, to NRC,
14 dated January 21, 2014, regarding "Response to NRC Request for Additional Information, dated
15 December 20, 2013, related to the Byron and Braidwood Stations, Units 1 and 2 License
16 Renewal Application, Braidwood Station Applicant's Environmental Report." Kennett Square,
17 Pennsylvania. ADAMS Accession No. ML14030A264.
- 18 Fairbanks, R.B., and R.P. Lawton. 1977. "Occurrence of Large Striped Mullet, *Mugil cephalus*,
19 in Cape Cod Bay, Massachusetts." *Chesapeake Science* 18:309-310. DOI:10.2307/1350805.
20 Cham, Switzerland. Accessed June 13, 2022, at <https://doi.org/10.2307/1350805>.
- 21 Farmland Protection Policy Act of 1981. 7 U.S.C. § 4201 et seq.
- 22 FCC (Federal Communications Commission). Undated. *Antenna Structure Registration*.
23 Washington D.C. Accessed June 11, 2022, at
24 <https://wireless2.fcc.gov/UlsApp/AsrSearch/asrRegistrationSearch.jsp>.
- 25 Federal Insecticide, Fungicide, and Rodenticide Act, as amended. 7 U.S.C. § 136 et seq.
- 26 Federal Water Pollution Control Act of 1972 (commonly referred to as the Clean Water Act). 33
27 U.S.C. § 1251 et seq.
- 28 FEMA (Federal Emergency Management Agency). 2021. "Flood Insurance Manuals - Effective
29 October 1, 2021." Washington, D.C. Accessed June 9, 2022, at [https://www.fema.gov/flood-
30 insurance/work-with-nfip/manuals/current](https://www.fema.gov/flood-insurance/work-with-nfip/manuals/current).
- 31 Fernie, K.J., and S.J. Reynolds. 2005. "The Effects of Electromagnetic Fields From Power
32 Lines on Avian Reproductive Biology and Physiology: A Review." *Journal of Toxicology and
33 Environmental Health, Part B: Critical Reviews* 8(2):127-140.
34 DOI:10.1080/10937400590909022. London, England. Accessed June 6, 2022, at
35 <https://doi.org/10.1080/10937400590909022>.

- 1 FGDC (Federal Geographic Data Committee). 2013. *Classification of Wetlands and Deepwater*
2 *Habitats of the United States*. FGDC-STD-004-2013, Second Edition. Wetlands Subcommittee,
3 Federal Geographic Data Committee and U.S. Fish and Wildlife Service. Washington, D.C.
- 4 FWS (U.S. Fish and Wildlife Service). 2012. Letter from M.J. LeValley, Field Supervisor to A.
5 Imboden, Branch Chief, NRC, dated April 2, 2012, regarding "Conclusion of ESA Section 7
6 Consultation for Wolf Creek License Renewal." FWS Tracking # 2012-CPA-0577. Manhattan,
7 Kansas. ADAMS Accession No. ML12122A447.
- 8 FWS (U.S. Fish and Wildlife Service). 2014. Letter from F. Clark, Acting Field Supervisor to
9 D.J. Wrona, NRC, dated September 30, 2014, regarding "Threatened and endangered species
10 within the vicinity of the Davis-Besse Nuclear Power Station." TAILS: 03E15000-2014-I-1089.
11 Columbus, Ohio. ADAMS Accession No. ML14296A559.
- 12 FWS (U.S. Fish and Wildlife Service). 2015a. Letter from T.R. Chapman to D.J. Wrona, NRC,
13 dated December 7, 2015, regarding "Submittal of Draft Supplemental Environmental Impact
14 Statement for License Renewal of Fermi 2 and request for concurrence under Section 7 of the
15 Endangered Species Act." East Lansing, Michigan. ADAMS Accession No. ML16029A074.
- 16 FWS (U.S. Fish and Wildlife Service). 2015b. Letter from D.A. Stilwell to D.J. Wrona, NRC,
17 dated July 14, 2015, regarding "This responds to your July 1, 2015, letter regarding the
18 proposed renewal of Facility Operating Licenses DPR-26 and DPR-64 for an additional 20 years
19 at the Indian Point Nuclear Generating Units 2 and 3 located in the Village of Buchanan,
20 Westchester County, New York." Cortland, New York. ADAMS Accession No. ML15196A013.
- 21 FWS (U.S. Fish and Wildlife Service). 2016. *Programmatic Biological Opinion on Final 4(d)*
22 *Rule for the Northern Long-Eared Bat and Activities Excepted from Take Prohibitions*. Midwest
23 Regional Office, Bloomington, Minnesota.
- 24 FWS (U.S. Fish and Wildlife Service). 2018. Letter from T.R. Chapman to B. Beasley, NRC,
25 dated September 20, 2018, regarding "Seabrook Station Unit 1 License Renewal, Seabrook
26 NH." TAILS: 2018-I-2970, Concord, New Hampshire. ADAMS Accession No. ML18263A200.
- 27 FWS (U.S. Fish and Wildlife Service). 2019a. Letter from R. Hiznman, Field Supervisor to
28 B. Grange, Conservation Biologist, NRC, dated July 25, 2019, regarding "Service Consultation
29 Code: 04EF2000-2014-F-0177-R001, Project: Turkey Point Nuclear Plant Units 3 and 4
30 License Renewal." Vero Beach, Florida. ADAMS Accession No. ML19221B583.
- 31 FWS (U.S. Fish and Wildlife Service). 2019b. Letter from Virginia Ecological Services Field
32 Office, dated June 6, 2019, regarding "Updated list of threatened and endangered species that
33 may occur in your proposed project location, and/or may be affected by your proposed project."
34 Consultation Code: 05E2VA00-2019-SLI-1750, Gloucester, Virginia. ADAMS Accession No.
35 ML19157A113.

References

- 1 FWS (U.S. Fish and Wildlife Service). 2021. Letter from D. Simpkins, FWS, to A. Briana, NRC,
2 dated November 10, 2021, regarding "NRC Request for Concurrence with Endangered Species
3 Act Determination for Point Beach Subsequent License Renewal, Issuance of Draft
4 Supplemental Environmental Impact Statement, and Opportunity for Public Comment." FWS
5 No. 03E17000-2021-SLI-0702. Washington, D.C. ADAMS Accession No. ML21314A421.
- 6 FWS (U.S. Fish and Wildlife Service). 2022a. *Amendment to the July 25, 2019 Biological
7 Opinion for the Turkey Point Nuclear Plant Units 3 and 4 License Renewal, 2014-F-0177-R001,
8 memorandum*. Florida Ecological Services Field Office, Gainesville, Florida. ADAMS
9 Accession No. ML22089A060.
- 10 FWS (U.S. Fish and Wildlife Service). 2022b. "National Wetlands Inventory, Wetlands Data
11 Layer." Washington, D.C. Accessed May 5, 2022, at [https://www.fws.gov/program/national-
12 wetlands-inventory/wetlands-data](https://www.fws.gov/program/national-wetlands-inventory/wetlands-data).
- 13 FWS and NMFS (U.S. Fish and Wildlife Service and National Marine Fisheries Service). 1998.
14 *Endangered Species Act Consultation Handbook, Procedures for Conducting Section 7
15 Consultation and Conference*. Washington, D.C. ADAMS Accession No. ML14171A801.
- 16 FWS/NMFS (U.S. Fish and Wildlife Service and National Marine Fisheries Service). 2014.
17 *Endangered Species Act Section 7 Consultation Programmatic Biological Opinion on the U.S.
18 Environmental Protection Agency's Issuance and Implementation of the Final Regulations
19 Section 316(b) of the Clean Water Act*. Arlington, Virginia, and Silver Spring, Maryland.
20 Accessed June 11, 2022, at [https://www.epa.gov/sites/default/files/2015-
21 04/documents/final_316b_bo_and_appendices_5_19_2014.pdf](https://www.epa.gov/sites/default/files/2015-04/documents/final_316b_bo_and_appendices_5_19_2014.pdf).
- 22 GAO (U.S. General Accounting Office). 2015. *Technology Assessment, Nuclear Reactors,
23 Status and Challenges in Development and Deployment of New Commercial Concepts*.
24 Washington, D.C. July. Accessed June 15, 2022, at [https://www.gao.gov/assets/gao-15-
25 652.pdf](https://www.gao.gov/assets/gao-15-652.pdf).
- 26 Gibbs, J.P. 1998. "Distribution of Woodland Amphibians along a Forest Fragmentation
27 Gradient." *Landscape Ecology* 13:263–268. DOI:10.1023/A:1008056424692. Cham,
28 Switzerland. Accessed June 11, 2022, at <https://doi.org/10.1023/A:1008056424692>.
- 29 Gilmer, D.S., and R.E. Stewart. 1983. "Ferruginous Hawk Populations and Habitat Use in
30 North Dakota." *Journal of Wildlife Management* 47(1):146–157. DOI: 10.2307/3808061.
31 Hoboken, New Jersey. Accessed June 11, 2022, at <https://doi.org/10.2307/3808061>.
- 32 Gray, R.H., T.L. Page, and M.G. Saroglia. 1983. "Behavioral Response of Carp, *Cyprinus
33 carpio*, and Black Bullhead, *Ictalurus melas*, from Italy to Gas Supersaturated Water."
34 *Environmental Biology of Fishes* 8:163-167. DOI:10.1007/BF00005183. Cham, Switzerland.
35 Accessed June 13, 2022, at <https://doi.org/10.1007/BF00005183>.
- 36 Greenberg, B., and V. Bindokas. 1985. *Extra-High Voltage Transmission Lines: Mechanisms
37 of Biological Effects on Honeybees. Final Report*. EPRI EA-4218. Electric Power Research
38 Institute, Palo Alto, California.

- 1 Greenberg, B., V.P. Bindokas, and J.R. Gaujer. 1981. "Biological effects of a 760-kV
2 transmission line: Exposures and thresholds in honeybee colonies." *Bioelectromagnetics*
3 2(4):315-328. DOI: 10.1002/bem.2250020404. Hoboken, New Jersey. Accessed June 6,
4 2022, at <https://doi.org/10.1002/bem.2250020404>.
- 5 H.J. Res. 87. 42 U.S.C. § 10135 Note. Public Law 107-200.
- 6 Hall, C.A.S., R. Howarth, B. Moore, III, and C.J. Vörösmarty. 1978. "Environmental Impacts of
7 Industrial Energy Systems in the Coastal Zone." *Annual Review of Energy* (3):395-475, Annual
8 Reviews Inc., San Mateo, California. Accessed June 9, 2022, at
9 <https://doi.org/10.1146/annurev.eg.03.110178.002143>.
- 10 Harness, R.E., and K.R. Wilson. 2001. "Electric-Utility Structures Associated with Raptor
11 Electrocutions in Rural Areas." *Wildlife Society Bulletin* 29(2):612-623. Hoboken, New Jersey.
12 Accessed June 21, 2022, at <http://www.jstor.org/stable/3784188>.
- 13 Harrison, F.L. 1985. "Effect of Physiochemical Form on Copper Availability to Aquatic
14 Organisms." In *Aquatic Toxicology and Hazard Assessment: Seventh Symposium*. ASTM STP
15 854, pages 469-484. R.C. Bahner, ed. American Society for Testing and Materials,
16 Philadelphia, Pennsylvania. DOI: 10.1520/STP36284S.
- 17 HDR (HDR Engineering). 2017. *2015-2016 Impingement Characterization Study Report*. Surry
18 *Power Station*. VPDES Permit VA0004090. HDR Engineering, Surry, Virginia.
- 19 Henderson, P.A., and R.M.H. Seaby. 2000. *Technical Evaluation of U.S. Environmental*
20 *Protection Agency Proposed Cooling Water Intake Regulations for New Facilities*. Pisces
21 Conservation Ltd., Lymington, England. ADAMS Accession No. ML090770970.
- 22 IAEA (International Atomic Energy Agency). 1992. *Effects of Ionizing Radiation on Plants and*
23 *Animals at Levels Implied by Current Radiation Protection Standards*. Technical Report Series
24 332, Vienna, Austria.
- 25 ICNIRP (International Commission on Non-Ionizing Radiation Protection). 1998. "Guidelines
26 for Limiting Exposure to Time-Varying Electric, Magnetic, and Electromagnetic Fields (up to
27 300 GHz)." *Health Physics* 74(4):494-522, Philadelphia, Pennsylvania. Accessed October 7,
28 2020, at <https://www.icnirp.org/cms/upload/publications/ICNIRPemfgdl.pdf>.
- 29 ICRP (International Commission on Radiological Protection). 1977. *Recommendations of the*
30 *International Commission on Radiological Protection*. ICRP Publication 26, Pergamon Press,
31 New York, New York.
- 32 ICRP (International Commission on Radiological Protection). 1991. *1990 Recommendations of*
33 *the International Commission on Radiological Protection*. ICRP Publication 60, Pergamon
34 Press, New York, New York.

References

- 1 ICRP (International Commission on Radiological Protection). 2007. "The 2007
2 Recommendations of the International Commission on Radiological Protection." ICRP
3 Publication 103, *Ann. ICRP*, 37(2-4). Amsterdam, Netherlands. Elsevier. Available at
4 http://journals.sagepub.com/doi/pdf/10.1177/ANIB_37_2-4.
- 5 ICRP (International Commission on Radiological Protection). 2008a. "Environmental Protection
6 - the Concept and Use of Reference Animals and Plants." ICRP Publication 108. *Annals of the*
7 *ICRP* 38(4-6). Ottawa, Canada. Accessed June 7, 2022, at
8 <https://www.icrp.org/publication.asp?id=icrp%20publication%20108>.
- 9 ICRP (International Commission on Radiological Protection). 2008b. *Nuclear Decay Data for*
10 *Dosimetric Calculations*. ICRP Publication 107, *Ann ICRP* 38(3):7-96, DOI:
11 10.1016/j.icrp.2008.10.004.
- 12 ICRP (International Commission on Radiological Protection). 2009. "Environmental Protection:
13 Transfer Parameters for Reference Animals and Plants." ICRP Publication 114. *Annals of the*
14 *ICRP* 39(6). DOI: 10.1016/j.icrp.2011.08.009. Ottawa, Canada. Accessed June 7, 2022, at
15 <https://dx.doi.org/10.1016/j.icrp.2011.08.009>.
- 16 ICRP (International Commission on Radiological Protection). 2022. "BiotaDC v.1.5.2. A
17 Complement to ICRP Publication 136." Ottawa, Ontario, Canada. Accessed July 28, 2022, at
18 <http://biotadc.icrp.org>.
- 19 IEEE SA (Institute of Electrical and Electronics Engineers Standards Association). 2017. *2017*
20 *National Electrical Safety Code*. IEEE C2-2017. Piscataway, New Jersey.
- 21 IPCC (Intergovernmental Panel on Climate Change). 2000. *Summary for Policymakers,*
22 *Emissions Scenarios, A Special Report of IPCC Working Group III*. Intergovernmental Panel on
23 Climate Change, Geneva, Switzerland. Accessed June 11, 2022, at
24 <https://www.ipcc.ch/site/assets/uploads/2018/03/sres-en.pdf>.
- 25 IPCC (Intergovernmental Panel on Climate Change). 2007. *Climate Change 2007: The*
26 *Physical Science Basis. Contribution of Working Group I to the Fourth Assessment Report of*
27 *the Intergovernmental Panel on Climate Change*. ADAMS No. ML112710385. Accessed May
28 23, 2022, at https://www.ipcc.ch/site/assets/uploads/2018/05/ar4_wg1_full_report-1.pdf.
- 29 IPCC (Intergovernmental Panel on Climate Change). 2013. *Climate Change 2013: The*
30 *Physical Science Basis. Contribution of Working Group I to the Fifth Assessment Report of the*
31 *Intergovernmental Panel on Climate Change*. T.F. Stocker, D. Qin, G.-K. Plattner, M. Tignor,
32 S.K. Allen, J. Boschung, A. Nauels, Y. Xia, V. Bex, and P.M. Midgley, eds. Cambridge
33 University Press, Cambridge, United Kingdom. Accessed May 25, 2022, at
34 <https://www.ipcc.ch/report/ar5/wg1/>.
- 35 IPCC (Intergovernmental Panel on Climate Change). 2014. *Climate Change 2014, Synthesis*
36 *Report*. Geneva, Switzerland. Accessed June 11, 2022, at [https://ar5-](https://ar5-syr.ipcc.ch/ipcc/ipcc/resources/pdf/IPCC_SynthesisReport.pdf)
37 [syr.ipcc.ch/ipcc/ipcc/resources/pdf/IPCC_SynthesisReport.pdf](https://ar5-syr.ipcc.ch/ipcc/ipcc/resources/pdf/IPCC_SynthesisReport.pdf).

- 1 IPCC (Intergovernmental Panel on Climate Change). 2021. "Climate Change 2021: The
2 Physical Science Basis." Accessed May 24, 2022, at <https://www.ipcc.ch/report/ar6/wg1/>.
- 3 Janes, D.E. 1978. *Evaluation of Health and Environmental Effects of Extra-High-Voltage (EHV)*
4 *Transmission*. 520179501, U.S. Environmental Protection Agency, Office of Radiation
5 Programs, Washington, D.C.
- 6 Janss, G.F.E. 2000. "Avian Mortality from Power Lines: A Morphological Approach of a
7 Species-Specific Mortality." *Biological Conservation* 95(3):353-359. DOI:10.1016/S0006-
8 3207(00)00021-5. Amsterdam, The Netherlands. Accessed June 9, 2022, at
9 [https://doi.org/10.1016/S0006-3207\(00\)00021-5](https://doi.org/10.1016/S0006-3207(00)00021-5).
- 10 Johnson, D.H., S.R. Loss, K.S. Smallwood, and W.P. Erickson. 2016. "Avian Fatalities at Wind
11 Energy Facilities in North America: a Comparison of Recent Approaches." *Human-Wildlife*
12 *Interactions* 10(1):7-18. DOI:10.26077/a4ec-ed37. Logan, Utah. Accessed June 7, 2022, at
13 <https://doi.org/10.26077/a4ec-ed37>.
- 14 Jones, C.E., K. An, R.G. Blom, J.D. Kent, E.R. Ivins, and D. Bekaert. 2016. "Anthropogenic
15 and geologic influences on subsidence in the vicinity of New Orleans, Louisiana." *Journal of*
16 *Geophysical Research, Solid Earth*, 121(5):3867–3887. DOI: 10.1002/2015JB02636. Hoboken,
17 New Jersey. Accessed May 16, 2022, at <https://doi.org/10.1002/2015JB02636>.
- 18 Kagel, A., D. Bates, and K. Gawell. 2005. *A Guide to Geothermal Energy and the*
19 *Environment*. Geothermal Energy Association, Washington, D.C. Accessed June 1, 2022, at
20 <https://doi.org/10.2172/897425>.
- 21 Kemper, C. 1996. "A Study of Bird Mortality at a West Central Wisconsin TV Tower from 1957-
22 1995." *The Passenger Pigeon* 58:219-235. Madison, Wisconsin. Accessed June 14, 2022, at
23 [https://search.library.wisc.edu/digital/AKZ4IZ3KFBZNZU8S/pages/AGWK5M6OG7BQOB8H?as](https://search.library.wisc.edu/digital/AKZ4IZ3KFBZNZU8S/pages/AGWK5M6OG7BQOB8H?as=text&view=one)
24 [=text&view=one](https://search.library.wisc.edu/digital/AKZ4IZ3KFBZNZU8S/pages/AGWK5M6OG7BQOB8H?as=text&view=one).
- 25 Kennish, M.J., and R.A. Lutz. 1984. *Ecology of Barnegat Bay. Lecture Notes on Coastal and*
26 *Estuarine Studies*. Springer-Verlag, New York, New York. ADAMS Accession No.
27 ML20079N264.
- 28 Kosciuch, K., D. Riser-Espinoza, M. Geringer, and W. Erickson. 2020. *A Summary of Bird*
29 *Mortality at Photovoltaic Utility Scale Solar Facilities in the Southwestern U.S.* PLoS ONE
30 15(4):e0232034. Available at <https://doi.org/10.1371/journal.pone.0232034>.
- 31 Kristmannsdottir, H., and H. Armannsson. 2003. "Environmental Aspects of Geothermal
32 Energy Utilization." *Geothermics* 32(4-6):451-461. DOI:10.1016/S0375-6505(03)00052-X.
33 Amsterdam, The Netherlands. Accessed June 7, 2022, at [https://doi.org/10.1016/S0375-](https://doi.org/10.1016/S0375-6505(03)00052-X)
34 [6505\(03\)00052-X](https://doi.org/10.1016/S0375-6505(03)00052-X).
- 35 Kroodsma, R.L. 1984. "Effects of Power-Line Corridors on the Density and Diversity of Bird
36 Communities in Forested Areas." In *Proceedings of the Third International Symposium on*
37 *Environmental Concerns in Rights-of-Way Management*, pp 551-561, Mississippi State,
38 Mississippi.

References

- 1 Kroodsma, R.L. 1987. "Edge Effect on Breeding Birds Along Power-Line Corridors in East
2 Tennessee." *American Midland Naturalist* 118(2):275–283. DOI:10.2307/2425785. South
3 Bend, Indiana. Accessed June 11, 2022, at <https://doi.org/10.2307/2425785>.
- 4 Lagler, K.F., J.E. Bardach, and R.R. Miller. 1962. *Ichthyology*. John Wiley & Sons, Inc., New
5 York, New York.
- 6 Laist, D.W., and J.E. Reynolds, III. 2005. "Florida Manatees, Warm-Water Refuges, and an
7 Uncertain Future." *Coastal Management* (33):279-295, Philadelphia, Pennsylvania.
- 8 Langford, T.E. 1975. "The Emergence of Insect from a British River, Warmed by Power Station
9 Cooling-Water. Part II: The Emergence Patterns of Some Species of Ephemeroptera,
10 Trichoptera and Megaloptera in Relation to Water Temperature and River Flow, Upstream and
11 Downstream of the Cooling-Water Outfalls." *Hydrobiologia* 47(1):91–133.
12 DOI:10.1007/BF00036746. Cham, Switzerland. Accessed June 12, 2022, at
13 <https://doi.org/10.1007/BF00036746>.
- 14 Langford, T.E. 1983. *Electricity Generation and the Ecology of Natural Waters*. Liverpool
15 University Press, Liverpool, England.
- 16 Larkin, R.P., and B.A. Frase. 1988. "Circular Paths of Birds Flying near a Broadcasting Tower
17 in Cloud." *Journal of Comparative Physiology* 102(1):90-93. DOI:10.1037/0735-7036.102.1.90.
18 Washington, D.C. Accessed June 14, 2022, at <https://doi.org/10.1037/0735-7036.102.1.90>.
- 19 Lee, G.F., and P.H. Martin. 1975. "Dissolved Gas Supersaturation and Dilution in Thermal
20 Plumes from Steam Electric Generating Stations." *Water Research* 9(7):643-648.
21 DOI:/10.1016/0043-1354(75)90170-0. Amsterdam, The Netherlands. Accessed June 13, 2022,
22 at [https://doi.org/10.1016/0043-1354\(75\)90170-0](https://doi.org/10.1016/0043-1354(75)90170-0).
- 23 Lee, J.M., V.L. Chartier, D.P. Hartmann, G.E. Lee, K.S. Pierce, F.L. Shon, R.D. Stearns, and
24 M.T. Zeckmeister. 1989. *Electrical and Biological Effects of Transmission Lines: A Review*.
25 DOE/BP-945. U.S. Department of Energy, Bonneville Power Administration, Portland, Oregon.
26 June. Accessed June 1, 2022, at <https://doi.org/10.2172/5712107>.
- 27 Lee, J.M., Jr. 1980. "Raptors and the BPA Transmission System." In *Proceedings of the*
28 *Workshop on Raptors and Energy Developments*, pp. 41-55, Portland, Oregon. Accessed June
29 11, 2022, at <https://tethys.pnnl.gov/sites/default/files/publications/Howard-and-Gore-1980.pdf>.
- 30 Longcore, T., C. Rich, P. Mineau, B. MacDonald, D.G. Bert, L.M. Sullivan, E. Mutrie, S.A.
31 Gauthreaux Jr., M.L. Avery, R.L. Crawford, A.M. Manville II, E.R. Travis, and D. Drake. 2012.
32 An Estimate of Avian Mortality at Communication Towers in the United States and Canada.
33 *PLoS ONE* 7(4):e34025. DOI: 10.1371/journal.pone.0034025. San Francisco, California.
34 Accessed June 9, 2022, at <https://dx.doi.org/10.1371/journal.pone.0034025>.
- 35 Loss, S.R., T. Will, S.S. Loss, and P.P. Marra. 2014. "Bird–Building Collisions in the United
36 States: Estimates of Annual Mortality and Species Vulnerability." *The Condor: Ornithological*
37 *Applications* 116:8–23, Chicago, Illinois. DOI: 10.1650/CONDOR-13-090.1.

- 1 Loss, S.R., T. Will, and P.P. Marra. 2015. "Direct Mortality of Birds from Anthropogenic
2 Causes." *Annual Review of Ecology, Evolution, and Systematics* 46:99-120.
3 DOI:10.1146/annurev-ecolsys-112414-054133. Palo Alto, California. Accessed June 7, 2022,
4 at <https://doi.org/10.1146/annurev-ecolsys-112414-054133>.
- 5 Low-Level Radioactive Waste Policy Act of 1980. 42 U.S.C. § 2021b et seq. Public Law 96-
6 573.
- 7 Low-Level Radioactive Waste Policy Amendments Act of 1985, as amended. Public Law 99-
8 240, 99 Stat. 1842.
- 9 Magnuson-Stevens Fishery Conservation and Management Act. 16 U.S.C. § 1801 et seq.
- 10 Maize, K. 2019. "Waste-to-Energy: A Niche Market in Decline?" *POWER*, Rockville,
11 Maryland. Accessed June 12, 2022, at [https://www.powermag.com/waste-to-energy-a-niche-](https://www.powermag.com/waste-to-energy-a-niche-market-in-decline/)
12 [market-in-decline/](https://www.powermag.com/waste-to-energy-a-niche-market-in-decline/).
- 13 Manville, A.M., II. 2005. "Bird Strikes and Electrocutions at Power Lines, Communication
14 Towers, and Wind Turbines: State of the Art and State of the Science—Next Steps Toward
15 Mitigation." In *Proceedings 3rd International Partners in Flight Conference 2002*, U.S. Forest
16 Service General Technical Report PSW–GTR–191, Albany, California. Available at
17 [https://www.fs.usda.gov/psw/publications/documents/psw_gtr191/psw_gtr191_1051-](https://www.fs.usda.gov/psw/publications/documents/psw_gtr191/psw_gtr191_1051-1064_manville.pdf)
18 [1064_manville.pdf](https://www.fs.usda.gov/psw/publications/documents/psw_gtr191/psw_gtr191_1051-1064_manville.pdf).
- 19 Marine Mammal Protection Act of 1972, as amended. 16 U.S.C. § 1361 et seq.
- 20 Marston, L., Y. Ao, M. Konar, M.M. Mekonnen, and A.Y. Hoekstra. 2018. "High-Resolution
21 Water Footprints of Production of the United States." *Water Resources Research*, 54, 2288-
22 2316. Available at <https://doi.org/10.1002/2017WR021923>.
- 23 Maruvada, P.S. 2000. *Corona Performance of High Voltage Transmission Lines*. Research
24 Studies Press Ltd., Philadelphia, Pennsylvania.
- 25 MASCWG (Multiagency Avian-Solar Collaborative Working Group). 2016. *Multiagency Avian-*
26 *Solar Science Coordination Plan*. Multiagency Avian-Solar Collaborative Working Group,
27 Washington, D.C. Accessed June 7, 2022, at [https://blmsolar.anl.gov/program/avian-](https://blmsolar.anl.gov/program/avian-solar/docs/Final_Avian-Solar_Science_Coordination_Plan.pdf)
28 [solar/docs/Final_Avian-Solar_Science_Coordination_Plan.pdf](https://blmsolar.anl.gov/program/avian-solar/docs/Final_Avian-Solar_Science_Coordination_Plan.pdf).
- 29 Mayhew, D.A., L.D. Jensen, D.F. Hanson, and P.H. Muessig. 2000. "A Comparative Review of
30 Entrainment Survival Studies at Power Plants in Estuarine Environments." *Environmental*
31 *Science & Policy* 3:S295-S301, New York, New York.
- 32 MCAQD (Maricopa County Air Quality Department). 2010. *Air Quality Permit, Palo Verde*
33 *Nuclear Generating Station, Tonopah, Arizona, Permit Number: 030132, Issue Date: August 8,*
34 *2005, Renewal Date: July 31, 2010*. Phoenix, Arizona. November. ADAMS Accession No.
35 ML101620032.

References

- 1 MCAQD (Maricopa County Air Quality Department). 2019. *2017 Periodic Emissions Inventory*
2 *for Ozone Precursors*. Phoenix, Arizona. November.
- 3 McCormick, S.D., R.A. Cunjak, B. Dempson, M.F. O’Dea, and J.B. Carey. 1999.
4 "Temperature-Related Loss of Smolt Characteristics in Atlantic Salmon (*Salmo salar*) in the
5 Wild." *Canadian Journal of Fisheries and Aquatic Sciences* 56(9):1649–1658.
6 DOI:10.1139/f99-099. Ottawa, Canada. Accessed June 12, 2022, at
7 <https://doi.org/10.1139/f99-099>.
- 8 McInerny, M.C. 1990. "Gas-Bubble Disease in Three Fish Species Inhabiting the Heated
9 Discharge of a Steam-Electric Station Using Hypolimnetic Cooling Water." *Water, Air, and Soil*
10 *Pollution* 49:7-15. DOI:10.1007/BF00279506. Cham, Switzerland. Accessed June 13, 2022, at
11 <https://doi.org/10.1007/BF00279506>.
- 12 MDNR (Maryland Department of Natural Resources). 2019. "Environmental Radionuclide
13 Concentrations in the Vicinity of the Calvert Cliffs Nuclear Power Plant and the Peach Bottom
14 Atomic Power Station: 2014 – 2015." PPRP-R-35. DNR Publication No. 12-092419-171.
15 Maryland Power Plant Research Program, Annapolis, Maryland.
- 16 Michaels, T., and K. Krishnan. 2019. *Energy Recovery Council, 2018 Directory of Waste-to-*
17 *Energy Facilities*. Washington, D.C. Accessed June 12, 2022, at
18 <https://energyrecoverycouncil.org/wp-content/uploads/2019/10/ERC-2018-directory.pdf>.
- 19 Michel, J., A.C. Bejarano, C.H. Peterson, and C. Voss. 2013. *Review of Biological and*
20 *Biophysical Impacts from Dredging and Handling of Offshore Sand*. OCS Study, BOEM 2013-
21 0119, Columbia, South Carolina.
- 22 Migratory Bird Treaty Act of 1918. 16 U.S.C. § 703 et seq.
- 23 Miller, M.W. 1983. "Biological Effects from Exposure to Transmission Line Electromagnetic
24 Fields." *Right of Way* 30(3):8–15, Gardena, California.
- 25 Mitchell, C.A., and J. Carlson. 1993. "Lesser Scaup Forage on Zebra Mussels at Cook Nuclear
26 Plant, Michigan." *Journal of Field Ornithology* 64(2):219-222. Hoboken, New Jersey.
- 27 MMS (Minerals Management Service). 2007. *Programmatic Environmental Impact Statement*
28 *for Alternative Energy Development and Production and Alternate Use of Facilities on the Outer*
29 *Continental Shelf, Volume II, Chapter 5*. OCS EIS/EA, MMS 2007-046, U.S. Department of the
30 Interior, Washington, D.C.
- 31 Morrow, Jr., J.V., and J.C. Fischenich. 2000. *Habitat Requirements for Freshwater Fishes*.
32 EMRRP Technical Notes Collection. ERDC TN-EMRRP-SR-06. U.S. Army Engineer Research
33 and Development Center, Vicksburg, Mississippi.
- 34 Murdy, E.O., R.S. Birdsong, and J.A. Musick. 1997. *Fishes of Chesapeake Bay*. Smithsonian
35 Institution, Washington, D.C.

- 1 NAI (Normandeau Associates, Inc.). 1998. *Seabrook Station 1996 Environmental Monitoring in*
2 *the Hampton-Seabrook Area: A Characterization of Environmental Conditions During the*
3 *Operation of Seabrook Station*. SBK-L-10185, Attachment 2, Volume 4. North Atlantic Energy
4 Service Corp., Seabrook, New Hampshire. ADAMS Accession No. ML103360306.
- 5 National Environmental Policy Act of 1969 (NEPA), as amended. 42 U.S.C. § 4321 et seq.
- 6 National Historic Preservation Act. 54 U.S.C. § 300101 et seq.
- 7 National Marine Sanctuaries Act, as amended. 16 U.S.C. § 1431 et seq.
- 8 National Marine Sanctuaries Program Amendments Act of 1992. 16 U.S.C. § 1431 Note.
9 Public Law 102-587.
- 10 National Research Council. 1995. *Technical Bases for Yucca Mountain Standards*. The
11 National Academies Press. Washington, D.C. Accessed Jun 11, 2022, at
12 <https://doi.org/10.17226/4943>.
- 13 National Research Council. 2006. *Health Risks from Exposure to Low Levels of Ionizing*
14 *Radiation: BEIR VII Phase II*. Washington, D.C. <https://doi.org/10.17226/11340>.
- 15 NCRP (National Council on Radiation Protection and Measurements). 1991. *Effects of Ionizing*
16 *Radiation on Aquatic Organisms*. NCRP Report No. 109, Bethesda, Maryland.
- 17 NCRP (National Council on Radiation Protection and Measurements). 2009. *Ionizing Radiation*
18 *Exposure of the Population of the United States*. NCRP Report No. 160, Bethesda, Maryland.
19 Available at <https://app.knovel.com/kn/resources/kplIREPUS05/toc>.
- 20 NCRP (National Council on Radiation Protection and Measurements). 2019. *Medical Radiation*
21 *Exposure of Patients in the United States (2019)*. Report No. 184, ISBN: 9781944888169,
22 Bethesda, Maryland. Available at [https://ncrponline.org/shop/reports/report-no-184-medical-](https://ncrponline.org/shop/reports/report-no-184-medical-radiation-exposure-of-patients-in-the-united-states-2019/)
23 [radiation-exposure-of-patients-in-the-united-states-2019/](https://ncrponline.org/shop/reports/report-no-184-medical-radiation-exposure-of-patients-in-the-united-states-2019/).
- 24 NCRP (National Council on Radiation Protection and Measurements). 2018. *Implications of*
25 *Recent Epidemiologic Studies for the Linear-Nonthreshold Model and Radiation Protection*.
26 NCRP Commentary No. 27, Bethesda, Maryland.
- 27 Nebeker, A.V. 1971. "Effect of High Winter Water Temperatures on Adult Emergence of
28 Aquatic Insects." *Water Resources* 5(9):777–783. DOI:10.1016/0043-1354(71)90100-X.
29 Amsterdam, The Netherlands. Accessed June 12, 2022, at [https://doi.org/10.1016/0043-](https://doi.org/10.1016/0043-1354(71)90100-X)
30 [1354\(71\)90100-X](https://doi.org/10.1016/0043-1354(71)90100-X).
- 31 Nebeker, A.V., F.D. Baker, and S.L. Weitz. 1981. "Survival and Adult Emergence of Aquatic
32 Insects in Air-Supersaturated Water." *Journal of Freshwater Ecology* 1(3):243-250. London,
33 England. DOI:10.1080/02705060.1981.9664039. Accessed June 13, 2022, at
34 <https://doi.org/10.1080/02705060.1981.9664039>.

References

- 1 NEFSC (Northeast Fisheries Science Center). 2011. *52nd Northeast Regional Stock*
2 *Assessment Workshop (52nd SAW): Assessment Summary Report*. NEFSC Reference
3 Document 11-11. Northeast Fisheries Science Center, Woods Hole, Massachusetts. Accessed
4 June 7, 2022, at <https://repository.library.noaa.gov/view/noaa/3843>.
- 5 NEI (Nuclear Energy Institute). 2015a. *Economic Impacts of the Davis-Besse Nuclear Power*
6 *Station*. Washington, D.C.
- 7 NEI (Nuclear Energy Institute). 2015b. *Economic Impacts of the R.E. Ginna Nuclear Power*
8 *Plant*. Washington, D.C.
- 9 NEI (Nuclear Energy Institute). 2015c. *The Economic Benefits of Texas' Nuclear Power Plants*.
10 Washington, D.C.
- 11 NEI (Nuclear Energy Institute). 2018. *Economic Impacts of the Cooper Nuclear Station an*
12 *Analysis by the Nuclear Energy Institute*. Washington, D.C.
- 13 NEI (Nuclear Energy Institute). 2019. *Industry Groundwater Protection Initiative – Final*
14 *Guidance Document, Rev. 1*. NEI-07-07, Revision 1, Washington, D.C. ADAMS Accession No.
15 ML19142A071.
- 16 Neller, J., and D.A. Snow. 2003. "Cooling Towers." *Plant Engineer's Reference Book*. Second
17 Edition, Amsterdam, The Netherlands. Available at [https://doi.org/10.1016/B978-075064452-](https://doi.org/10.1016/B978-075064452-5/50076-6)
18 [5/50076-6](https://doi.org/10.1016/B978-075064452-5/50076-6).
- 19 NETL (National Energy Technology Laboratory). 2019. *Cost and Performance Baseline for*
20 *Fossil Energy Plants Volume 1: Bituminous Coal and Natural Gas to Electricity*. NETL-PUB-
21 22638, Pittsburgh, Pennsylvania.
- 22 NETL (National Energy Technology Laboratory). Undated. "High Temperature Material Supply
23 Chain." Pittsburgh, Pennsylvania. Accessed June 15, 2022, at
24 https://netl.doe.gov/high_temp_materials_supply_chain.
- 25 *New York v. NRC (State of New York et al. v. U.S. Nuclear Regulatory Commission)*. 681 F.3d
26 471 (D.C. Cir. 2012). ADAMS Accession No. ML14094A018.
- 27 NextEra Energy. 2010. Letter from P. Freeman, Site Vice President, to NRC dated November
28 23, 2010, regarding "Seabrook Station Response to Request for Additional Information NextEra
29 Energy Seabrook License Renewal Environmental Report." SBK-L-10185, Docket No. 50-443,
30 Juno Beach, Florida. ADAMS Accession No. ML103350639.
- 31 NextEra Energy. 2021. Letter from W. Maher, Licensing Director, to NRC dated May 10, 2021,
32 regarding "Subsequent License Renewal Application - Environmental Report Supplement 1,
33 Point Beach Nuclear Plant Units 1 and 2, Dockets 50-266 and 50-301. Renewed License Nos.
34 DPR-24 and DPR 27. L-2021-100." Juno Beach, Florida. ADAMS Accession No.
35 ML21131A105.

- 1 NIEHS (National Institute of Environmental Health Sciences). 2002. *Electric and Magnetic*
2 *Fields Associated with the Use of Electric Power: Questions and Answers*. National Institutes
3 of Health, Research Triangle Park, North Carolina. ADAMS Accession No. ML112660024.
- 4 Niemi, G.J., and J.M. Hanowski. 1984. "Effects of a Transmission Line on Bird Populations in
5 the Red Lake Peatland, Northern Minnesota." *Auk* 101(3):487–98.
6 DOI:10.1093/auk/101.3.487. Oxford, United Kingdom. Accessed June 11, 2022, at
7 <https://doi.org/10.1093/auk/101.3.487>.
- 8 Nightingale, B., and C. Simenstad. 2001. *Overwater Structures: Marine Issues*. White Paper.
9 Research Project T1803, Task 35. Washington State Department of Transportation, Olympia,
10 Washington. Accessed June 7, 2022, at
11 <https://www.wsdot.wa.gov/research/reports/fullreports/508.1.pdf>.
- 12 NIOSH (National Institute for Occupational Safety and Health). 1996. *EMFs In The Workplace*.
13 Washington, D.C. ADAMS Accession No. ML21145A339.
- 14 NJ Admin. Code 7:27-6. 1998. Title 7, Chapter 27, Sub Chapter 6, "Control and Prohibition of
15 Particles from Manufacturing Processes." *New Jersey State Department of Environmental*
16 *Protection, New Jersey Administrative Code*, Trenton, New Jersey.
- 17 NMFS (National Marine Fisheries Service). 2002. Letter from J.E. Powers to H.N. Berkow,
18 dated August 8, 2002, regarding "Endangered Species Act (ESA) Section 7 consultation for the
19 operation of the Crystal River Energy Complex's (CREC) cooling water intake system located
20 near the Gulf of Mexico in Citrus County, Florida, and its effects on loggerhead turtles (*Caretta*
21 *caretta*), Kemp's ridley turtles (*Lepidochelys kempii*), leatherback turtles (*Dermochelys*
22 *coriacea*), hawksbill turtles (*Eretmochelys imbricata*), and green turtles (*Chelonia mydas*)." St.
23 Petersburg, Florida. ADAMS Accession No. ML022460361.
- 24 NMFS (National Marine Fisheries Service). 2004a. *Essential Fish Habitat Consultation*
25 *Guidance*. Version 1.1, Silver Spring, Maryland. Accessed September 2, 2020, at
26 <https://repository.library.noaa.gov/view/noaa/4187>.
- 27 NMFS (National Marine Fisheries Service). 2004b. *Preparing Essential Fish Habitat*
28 *Assessments: A Guide for Federal Action Agencies*. Version 1, Washington, D.C. ADAMS
29 Accession No. ML14309A276.
- 30 NMFS (National Marine Fisheries Service). 2006. Letter from R.R. McInnis to P.T. Kuo, dated
31 September 18, 2006, regarding "Nuclear Regulatory Commission's (NRC) continued operation
32 of the Diablo Canyon Power Plant (DCPP) and the San Onofre Nuclear Generating Station
33 (SONGS) on threatened and endangered species in accordance with Section 7 of the
34 Endangered Species Act (ESA) of 1973, as amended." Long Beach, California. ADAMS
35 Accession No. ML063000348.

References

- 1 NMFS (National Marine Fisheries Service). 2011. Letter from P.D. Colosi, Assistant Regional
2 Administrator for Habitat Conservation, to C. Bladey, NRC dated, October 26, 2011, regarding
3 "*Draft Supplemental Environmental Impact Statement, License Renewal for Seabrook Station*
4 *Including EFH Conservation Recommendations.*" Gloucester, Massachusetts. ADAMS
5 Accession No. ML11304A057.
- 6 NMFS (National Marine Fisheries Service). 2013. Letter from J.K. Bullard to A. Hull, dated
7 January 30, 2013, regarding "Biological Opinion for Continued Operation of Indian Point Nuclear
8 Generating Unit Nos. 2 and 3." Gloucester, Massachusetts. ADAMS Accession No.
9 ML13032A256.
- 10 NMFS (National Marine Fisheries Service). 2014a. *Endangered Species Act Section 7*
11 *Consultation Biological Opinion for Tappan Zee Bridge Replacement April 2, 2014.* NER-2013-
12 10768. Northeast Regional Office, National Marine Fisheries Service. Gloucester,
13 Massachusetts.
- 14 NMFS (National Marine Fisheries Service). 2014b. Email from M. Magliocca, Habitat
15 Conservation Division, to M. Mosert, NRC dated August 13, 2014, regarding "EFH Conservation
16 Recommendations for License Renewal of Limerick Generation Station." Annapolis, Maryland.
17 ADAMS Accession No. ML14227A713.
- 18 NMFS (National Marine Fisheries Service). 2014c. *Final Biological Opinion for the Continued*
19 *Operation of Salem and Hope Creek Generating Stations.* NER-2010-6581, Greater Atlantic
20 Fisheries Office, Gloucester, Massachusetts. ADAMS Accession No. ML14202A146.
- 21 NMFS (National Marine Fisheries Service). 2016. *National Marine Fisheries Service*
22 *Endangered Species Act Section 7 Biological Opinion on the Continued Operation of St. Lucie*
23 *Nuclear Power Plant, Units 1 and 2 in St. Lucie County, Florida.* SER-2006-832, National
24 Marine Fisheries Service, Silver Spring, Maryland. ADAMS Accession No. ML16084A616.
- 25 NMFS (National Marine Fisheries Service). 2017. Letter from B.A. Thom to J.J. Rikhoff, dated
26 March 10, 2017, regarding "Endangered Species Act Section 7(a)(2) Biological Opinion, and
27 Magnuson-Stevens Fishery Conservation and Management Act Essential Fish Habitat
28 Response for Renewing the Operating License for the Columbia Generating Station, Richland,
29 Washington." Portland, Oregon. ADAMS Accession No. ML17072A036.
- 30 NMFS (National Marine Fisheries Service). 2018a. Letter from J.E. Crocker to B. Beasley,
31 dated April 10, 2018, regarding "Amended ITS for Indian Point Units 2 and 3 Indian Point
32 Amended ITS with all Appendices.pdf; Sturgeon Genetic Sample Submission sheet for
33 S7_v1.1_Form to Use.xlsx." Gloucester, Massachusetts. ADAMS Accession No.
34 ML18101A588.
- 35 NMFS (National Marine Fisheries Service). 2018b. Letter from M. Pentony, Regional
36 Administrator, to B. Beasley, Chief, NRC dated February 9, 2018, regarding, "Amendment to the
37 January 30, 2013, Biological Opinion Issued to NRC." Gloucester, Massachusetts. ADAMS
38 Accession No. ML18043A130.

- 1 NMFS (National Marine Fisheries Service). 2018c. Letter from M. Asaro to B. Grange, dated
2 November 23, 2018, regarding "This correspondence serves to clarify the amount of take
3 exempted by the Incidental Take Statement included with the July 17, 2014, biological opinion
4 issued by us to the Nuclear Regulatory Commission regarding the continued operations of
5 Salem Unit I and Salem Unit 2." Gloucester, Massachusetts. ADAMS Accession No.
6 ML18348A467.
- 7 NMFS (National Marine Fisheries Service). 2019. Letter from L. Chiarella, Assistant Regional
8 Administrator for Habitat Conservation, to B. Grange, Consultation Coordinator, NRC dated
9 December 19, 2019, regarding, "Surry Power Station, Units 1 and 2 License Renewal, Draft
10 SEIS and EFH Assessment." Gloucester, Massachusetts. ADAMS Accession No.
11 ML20006F317.
- 12 NMFS (National Marine Fisheries Service). 2020a. Letter from J. Anderson to B. Grange,
13 dated October 5, 2020, regarding "By this letter, we amend the 2018 ITS to remove the
14 requirement to make up the missed April 2020 sampling dates at IP2 and the April and May
15 2020 sampling dates at IP3." Gloucester, Massachusetts. ADAMS Accession No.
16 ML20280A271.
- 17 NMFS (National Marine Fisheries Service). 2020b. Letter from B. Grange, FWS, to A. Briana,
18 NRC, dated January 30, 2020, regarding "Endangered Species Act Consultation - Surry Power
19 Station Proposed License Renewal." Gloucester, Massachusetts. ADAMS Accession No.
20 ML20030B278.
- 21 NMFS (National Marine Fisheries Service). 2022. Letter from N.A. Farmer, Chief, Species
22 Conservation Branch, to J.D. Parrott, NRC, dated January 34, 2022, regarding "Status of
23 Section 7 Consultation Under The Endangered Species Act for the cooling water intake system
24 at the Crystal River Energy Complex (F/SER/2001/01080)." St. Petersburg, Florida. ADAMS
25 Accession No. ML22024A214.
- 26 NOAA (National Oceanic and Atmospheric Administration). 2009. *Overview of Conducting*
27 *Consultation Pursuant to Section 304(d) of the National Marine Sanctuaries Act*. September
28 2009. Silver Spring, Maryland. Accessed October 13, 2020, at
29 <https://sanctuaries.noaa.gov/management/pdfs/304d.pdf>.
- 30 NOAA (National Oceanic and Atmospheric Administration). 2013a. *Regional Climate Trends*
31 *and Scenarios for the U.S. National Climate Assessment, Part 2. Climate of the Southeast U.S.*
32 Technical Report NESDIS 142-2. Washington, D.C.
- 33 NOAA (National Oceanic and Atmospheric Administration). 2013b. *Regional Climate Trends*
34 *and Scenarios for the U.S. National Climate Assessment, Part 3. Climate of the Midwest U.S.*
35 Technical Report NESDIS 142-3. Washington, D.C.
- 36 NOAA (National Oceanic and Atmospheric Administration). 2013c. *Regional Climate Trends*
37 *and Scenarios for the U.S. National Climate Assessment, Part 5. Climate of the Southwest U.S.*
38 Technical Report NESDIS 142-5. Washington, D.C.

References

- 1 NOAA (National Oceanic and Atmospheric Administration). 2013d. *Regional Climate Trends*
2 *and Scenarios for the U.S. National Climate Assessment, Part 9. Climate of the Contiguous*
3 *United States*. Technical Report NESDIS 142-9. Washington, D.C.
- 4 NOAA (National Oceanic and Atmospheric Administration). 2020. "Habitat Areas of Particular
5 Concern within Essential Fish Habitat." Washington, D.C. Accessed May 19, 2022, at
6 [https://www.fisheries.noaa.gov/southeast/habitat-conservation/habitat-areas-particular-concern-](https://www.fisheries.noaa.gov/southeast/habitat-conservation/habitat-areas-particular-concern-within-essential-fish-habitat)
7 [within-essential-fish-habitat](https://www.fisheries.noaa.gov/southeast/habitat-conservation/habitat-areas-particular-concern-within-essential-fish-habitat).
- 8 NOAA (National Oceanic and Atmospheric Administration). 2021. *Frequently Asked Questions*
9 *about Essential Fish Habitat in the Pacific Islands*. Washington, D.C. Accessed June 7, 2022,
10 at [https://www.fisheries.noaa.gov/pacific-islands/consultations/frequently-asked-questions-](https://www.fisheries.noaa.gov/pacific-islands/consultations/frequently-asked-questions-about-essential-fish-habitat-pacific)
11 [about-essential-fish-habitat-pacific](https://www.fisheries.noaa.gov/pacific-islands/consultations/frequently-asked-questions-about-essential-fish-habitat-pacific).
- 12 NOAA (National Oceanic and Atmospheric Administration). 2022a. "National Marine Sanctuary
13 System." Washington, D.C. Accessed June 11, 2022, at <https://sanctuaries.noaa.gov/>.
- 14 NOAA (National Oceanic and Atmospheric Administration). 2022b. "Storm Events Database."
15 Washington, D.C. Accessed May 31, 2022, at
16 <https://www.ncdc.noaa.gov/stormevents/choosedates.jsp?statefips=-999%2CALL>.
- 17 Noga, E.J. 2000. *Fish Disease: Diagnosis and Treatment*. Iowa State University Press, Ames,
18 Iowa.
- 19 NPCC (Northwest Power and Conservation Council). 2010. *Sixth Northwest Conservation and*
20 *Electric Power Plan*. Portland, Oregon. ADAMS Accession No. ML14093A352.
- 21 NRC (U.S. Nuclear Regulatory Commission). 1976. *Environmental Survey of the Reprocessing*
22 *and Waste Management Portions of the LWR Fuel Cycle*. W.P. Bishop and F.J. Miraglia, Jr.
23 (eds.). NUREG-0116 (Supplement 1 to WASH-1248), Washington, D.C. ADAMS Accession
24 No. ML14098A013.
- 25 NRC (U.S. Nuclear Regulatory Commission). 1977. *Calculation of Annual Doses to Man from*
26 *Routine Releases of Reactor Effluents for the Purpose of Evaluating Compliance with 10 CFR*
27 *Part 50, Appendix I*. Regulatory Guide 1.109, Revision 1, Washington, D.C. ADAMS Accession
28 No. ML003740384.
- 29 NRC (U.S. Nuclear Regulatory Commission). 1991a. *Offsite Dose Calculation Manual*
30 *Guidance: Standard Radiological Effluent Controls for Boiling Water Reactors (Generic Letter*
31 *89-01, Supplement No. 1)*. NUREG-1302, Washington, D.C. ADAMS Accession No.
32 ML091050059.
- 33 NRC (U.S. Nuclear Regulatory Commission). 1991b. *Offsite Dose Calculation Manual*
34 *Guidance: Standard Radiological Effluent Controls for Pressurized Water Reactors (Generic*
35 *Letter 89-01, Supplement No. 1)*. NUREG-1301, Washington, D.C. ADAMS Accession No.
36 ML091050061.

- 1 NRC (U.S. Nuclear Regulatory Commission). 1994. Letter from I. Selin to The President dated
2 March 31, 1994. Washington, D.C. ADAMS Accession No. ML033210526.
- 3 NRC (U.S. Nuclear Regulatory Commission). 1996. *Generic Environmental Impact Statement*
4 *for License Renewal of Nuclear Plants*. Volumes 1 and 2, NUREG-1437, Washington, D.C.
5 ADAMS Accession Nos. ML040690705, ML040690738.
- 6 NRC (U.S. Nuclear Regulatory Commission). 1999a. *Environmental Standard Review Plan,*
7 *Standard Review Plans for Environmental Reviews for Nuclear Power Plants, Supplement 1:*
8 *Operating License Renewal*. NUREG–1555, Supplement 1, Washington, D.C. ADAMS
9 Accession No. ML003702019.
- 10 NRC (U.S. Nuclear Regulatory Commission). 1999b. *Generic Environmental Impact Statement*
11 *for License Renewal of Nuclear Plants Addendum to Main Report, NUREG–1437, Volume 1,*
12 *Addendum 1*. Washington, D.C. ADAMS Accession No. ML040690720.
- 13 NRC (U.S. Nuclear Regulatory Commission). 1999c. *Generic Environmental Impact Statement*
14 *for License Renewal of Nuclear Plants, Supplement 1 Regarding Calvert Cliffs Nuclear Power*
15 *Plant*. NUREG–1437, Supplement 1, Washington, D.C. ADAMS Accession No. ML063400277.
- 16 NRC (U.S. Nuclear Regulatory Commission). 2000. *Endangered Species Act - Section 7*
17 *Consultation Biological Opinion*. Washington, D.C. January. ADAMS Accession No.
18 ML003689317.
- 19 NRC (U.S. Nuclear Regulatory Commission). 2002a. *Generic Environmental Impact Statement*
20 *for License Renewal of Nuclear Plants Supplement 5 Regarding Turkey Point Units 3 and 4.*
21 NUREG–1437, Final Report, Washington, D.C. ADAMS Accession No. ML020280236.
- 22 NRC (U.S. Nuclear Regulatory Commission). 2002b. *Generic Environmental Impact Statement*
23 *for License Renewal of Nuclear Plants, Supplement 9 Regarding Catawba Nuclear Station,*
24 *Units 1 and 2, Final Report*. NUREG–1437, Supplement 9, Washington, D.C. ADAMS
25 Accession No. ML030020316 and ML030020350.
- 26 NRC (U.S. Nuclear Regulatory Commission). 2002c. *Generic Environmental Impact Statement*
27 *on Decommissioning of Nuclear Facilities, Supplement 1: Regarding the Decommissioning of*
28 *Nuclear Power Reactors, Main Report - Final Report*. NUREG–0586, Supplement 1, Volume 1
29 and 2, Washington, D.C. ADAMS Accession Nos. ML023470304, ML023470323,
30 ML023500187, ML023500211, ML023500223.
- 31 NRC (U.S. Nuclear Regulatory Commission). 2003a. *Generic Environmental Impact Statement*
32 *for License Renewal of Nuclear Plants, Supplement 13: Regarding H.B. Robinson Steam*
33 *Electric Plant, Unit No. 2, Final Report*. NUREG-1437, Supplement 13, Washington, D.C.
34 ADAMS Accession No. ML033450517.
- 35 NRC (U.S. Nuclear Regulatory Commission). 2003b. *Generic Environmental Impact Statement*
36 *for License Renewal of Nuclear Plants; Supplement 10 Regarding Peach Bottom Atomic Power*
37 *Station, Units 2 and 3 Final Report*. NUREG–1437, Supplement 10, Washington, D.C. ADAMS
38 Accession Nos. ML030270025, ML030270038, ML030270055.

References

- 1 NRC (U.S. Nuclear Regulatory Commission). 2004a. "Final Safety Evaluation Report Related
2 to Certification of the AP1000 Standard Design (NUREG-1793, Initial Report)." Washington,
3 D.C. Accessed June 14, 2022, at [https://www.nrc.gov/reading-rm/doc-](https://www.nrc.gov/reading-rm/doc-collections/nuregs/staff/sr1793/initial/index.html)
4 [collections/nuregs/staff/sr1793/initial/index.html](https://www.nrc.gov/reading-rm/doc-collections/nuregs/staff/sr1793/initial/index.html).
- 5 NRC (U.S. Nuclear Regulatory Commission). 2004b. *Generic Environmental Impact Statement*
6 *for License Renewal of Nuclear Plants, Supplement 15: Regarding Virgil C. Summer Nuclear*
7 *Station, Final Report*. NUREG-1437, Supplement 15, Washington, D.C. ADAMS Accession
8 No. ML040540718.
- 9 NRC (U.S. Nuclear Regulatory Commission). 2004c. *Generic Environmental Impact Statement*
10 *for License Renewal of Nuclear Plants, Supplement 17: Regarding Dresden Nuclear Power*
11 *Station, Units 2 and 3, Final Report*. NUREG-1437, Supplement 17, Washington, D.C. ADAMS
12 Accession No. ML041890266.
- 13 NRC (U.S. Nuclear Regulatory Commission). 2004d. Memorandum from A.L. Vietti-Cook to
14 NRC Executive Director for Operations, dated May 13, 2004, regarding "Staff Requirements -
15 SECY-04-0055 - Plan for Evaluating Scientific Information and Radiation Protection
16 Recommendations." SRM-SECY-04-0055, Washington, D.C. ADAMS Accession No.
17 ML041340304.
- 18 NRC (U.S. Nuclear Regulatory Commission). 2004e. *Policy Issue: Plan for Evaluating*
19 *Scientific Information and Radiation Protection Recommendations*. SECY-04-0055 with
20 attachments, Washington, D.C. ADAMS Package Accession No. ML040820916.
- 21 NRC (U.S. Nuclear Regulatory Commission). 2004f. *Policy Issue: Request for Approval of*
22 *Staff Comments on the 2005 Recommendations of the International Commission on*
23 *Radiological Protection*. SECY-04-0223, Washington, D.C. ADAMS Accession No.
24 ML043230277.
- 25 NRC (U.S. Nuclear Regulatory Commission). 2005a. *Generic Environmental Impact Statement*
26 *for License Renewal of Nuclear Plants, Supplement 23 Regarding Point Beach Nuclear Plant*
27 *Units 1 and 2, Final Report*. NUREG-1437, Supplement 23, Washington, D.C. ADAMS
28 Accession No. ML052230490.
- 29 NRC (U.S. Nuclear Regulatory Commission). 2005b. *Generic Environmental Impact Statement*
30 *for License Renewal of Nuclear Plants Supplement 21 Regarding Browns Ferry Nuclear Plant,*
31 *Units 1, 2, and 3*. NUREG-1437, Final Report, Washington, D.C. ADAMS Accession No.
32 ML051730443.
- 33 NRC (U.S. Nuclear Regulatory Commission). 2005c. *Generic Environmental Impact Statement*
34 *for License Renewal of Nuclear Plants, Supplement 20, Regarding Donald C. Cook Nuclear*
35 *Plant, Units No. 1 and 2, Final Report*. NUREG-1437, Supplement 20, Washington, D.C. May.
36 ADAMS Accession No. ML051150556.

- 1 NRC (U.S. Nuclear Regulatory Commission). 2005d. *Generic Environmental Impact Statement*
2 *for License Renewal of Nuclear Plants, Supplement 22 Regarding Millstone Power Station,*
3 *Units 2 and 3, Final Report.* NUREG-1437, Supplement 22, Washington, D.C. ADAMS
4 Accession Nos. ML051960295, ML051960299.
- 5 NRC (U.S. Nuclear Regulatory Commission). 2005e. Memorandum from A.L. Vietti-Cook to
6 L.A. Reyes, dated January 4, 2005, regarding "Staff Requirements - SECY-04-0223 - Request
7 for Approval of Staff Comments on the 2005 Recommendations of the International Commission
8 on Radiological Protection." SRM-SECY-04-0223, Washington, D.C. ADAMS Accession No.
9 ML050040487.
- 10 NRC (U.S. Nuclear Regulatory Commission). 2005f. Memorandum from A.L. Vietti-Cook to
11 L.A. Reyes, dated January 4, 2005, regarding "Staff Requirements - SECY-06-0168 - Staff
12 Comments on the Draft Recommendations of the International Commission on Radiological
13 Protection." SRM-SECY-06-0168, Washington, D.C. ADAMS Accession No. ML062350176.
- 14 NRC (U.S. Nuclear Regulatory Commission). 2005g. *Policy Issue: Staff Review of the*
15 *National Academies Study of the Health Risks from Exposure to Low Levels of Ionizing*
16 *Radiation (BEIR VII).* SECY-05-0202, Washington, D.C. ADAMS Accession No.
17 ML052640532.
- 18 NRC (U.S. Nuclear Regulatory Commission). 2006a. *Frequently Asked Questions on License*
19 *Renewal of Nuclear Power Reactors, Final Report.* NUREG-1850, Washington, D.C. March.
20 ADAMS Accession No. ML061110022.
- 21 NRC (U.S. Nuclear Regulatory Commission). 2006b. *Generic Environmental Impact Statement*
22 *for License Renewal of Nuclear Plants, Supplement 24: Regarding Nine Mile Point Nuclear*
23 *Station, Units 1 and 2, Final Report.* NUREG-1437, Supplement 24, Washington, D.C. ADAMS
24 Accession No. ML061290310.
- 25 NRC (U.S. Nuclear Regulatory Commission). 2006c. *Generic Environmental Impact Statement*
26 *for License Renewal of Nuclear Plants, Supplement 26: Regarding Monticello Nuclear*
27 *Generating Plant, Final Report.* NUREG-1437, Supplement 26, Washington, D.C. ADAMS
28 Accession No. ML062490078.
- 29 NRC (U.S. Nuclear Regulatory Commission). 2006d. *Generic Environmental Impact Statement*
30 *for License Renewal of Nuclear Plants Supplement 27: Regarding Palisades Nuclear Plant,*
31 *Final Report.* NUREG-1437, Supplement 27, Washington, D.C. ADAMS Accession No.
32 ML062710300.
- 33 NRC (U.S. Nuclear Regulatory Commission). 2006e. *Liquid Radioactive Release Lessons*
34 *Learned Task Force Final Report.* Washington, D.C. ADAMS Accession No. ML083220312.
- 35 NRC (U.S. Nuclear Regulatory Commission). 2006f. *Occupational Radiation Exposure at*
36 *Commercial Nuclear Power Reactors and Other Facilities 2005, Thirty-Eighth Annual Report.*
37 NUREG-0713, Vol. 27, Washington, D.C. ADAMS Accession No. ML070600506.

References

- 1 NRC (U.S. Nuclear Regulatory Commission). 2006g. *Policy Issue: Staff Comments on the*
2 *Draft Recommendations of the International Commission on Radiological Protection*. SECY-06-
3 0168, Washington, D.C. ADAMS Accession No. ML061950113.
- 4 NRC (U.S. Nuclear Regulatory Commission). 2007a. *Essential Fish Habitat Assessment for*
5 *Hope Creek Generating Station, Extended Power Uprate*. U.S. Nuclear Regulatory
6 Commission, Washington, D.C. Accession No. ML071520463.
- 7 NRC (U.S. Nuclear Regulatory Commission). 2007b. *Generic Environmental Impact Statement*
8 *for License Renewal of Nuclear Plants, Supplement 28: Regarding Oyster Creek Nuclear*
9 *Generating Station, Final Report - Main Report*. NUREG-1437, Volume 1, Supplement 28,
10 Washington, D.C. ADAMS Accession No. ML070100234.
- 11 NRC (U.S. Nuclear Regulatory Commission). 2007c. *Generic Environmental Impact Statement*
12 *for License Renewal of Nuclear Plants, Supplement 29: Regarding Pilgrim Nuclear Power*
13 *Station, Final Report - Main Report*. NUREG-1437, Volume 1, Supplement 28, Washington,
14 D.C. ADAMS Accession No. ML071990020.
- 15 NRC (U.S. Nuclear Regulatory Commission). 2007d. *Generic Environmental Impact Statement*
16 *for License Renewal of Nuclear Plants, Supplement 30: Regarding Vermont Yankee Nuclear*
17 *Power Station Final Report – Main Report*. NUREG-1437, Supplement 30, Volumes 1 and 2,
18 Washington, D.C. ADAMS Accession No. ML072050012; ML072050013.
- 19 NRC (U.S. Nuclear Regulatory Commission). 2007e. *Meteorological Monitoring Programs for*
20 *Nuclear Power Plants*. Regulatory Guide 1.23, Revision 1, Washington, D.C. ADAMS
21 Accession No. ML070350028.
- 22 NRC (U.S. Nuclear Regulatory Commission). 2008a. *Generic Environmental Impact Statement*
23 *for License Renewal of Nuclear Plants, Supplement 32: Regarding Wolf Creek Generating*
24 *Station, Final Report*. NUREG-1437, Supplement 32, Washington, D.C. ADAMS Accession
25 No. ML081260608.
- 26 NRC (U.S. Nuclear Regulatory Commission). 2008b. Letter from J.G. Lamb to Public Service
27 Enterprise Group Inc. (PSEG), dated March 3, 2008, regarding "Hope Creek Generating
28 Station, Final Environmental Assessment and Finding of No Significant Impact Related to the
29 Proposed Extended Power Uprate (TAC NO. MD3002)." Docket No. 50-354, Hancocks Bridge,
30 New Jersey. ADAMS Accession No. ML080220549.
- 31 NRC (U.S. Nuclear Regulatory Commission). 2008c. *Policy Issue: Options to Revise*
32 *Radiation Protection Regulations and Guidance with Respect to the 2007 Recommendations of*
33 *the International Commission on Radiological Protection*. SECY-08-0197, Washington, D.C.
34 ADAMS Accession No. ML12089A650.
- 35 NRC (U.S. Nuclear Regulatory Commission). 2009a. *Generic Environmental Impact Statement*
36 *for License Renewal of Nuclear Plants; Supplement 37 Regarding Beaver Valley Power Station,*
37 *Units 1 and 2, Final Report*. NUREG–1437, Supplement 37, Washington, D.C. ADAMS
38 Accession No. ML091260011.

- 1 NRC (U.S. Nuclear Regulatory Commission). 2009b. *Generic Environmental Impact Statement*
2 *for License Renewal of Nuclear Plants; Supplement 37 Regarding Three Mile Island Nuclear*
3 *Station, Unit 1 Final Report*. NUREG-1437, Supplement 37, Washington, D.C. ADAMS
4 Accession No. ML091751063.
- 5 NRC (U.S. Nuclear Regulatory Commission). 2009c. *Generic Environmental Impact Statement*
6 *for License Renewal of Nuclear Plants—Supplement 35 Regarding Susquehanna Steam*
7 *Electric Station Units 1 and 2. Final Report*. NUREG-1437, Supplement 35, Washington, D.C.
8 ADAMS Accession No. ML090700454.
- 9 NRC (U.S. Nuclear Regulatory Commission). 2009d. "Memorandum and Order in the Matter of
10 Duke Energy Carolinas, LLC and Tennessee Valley Authority." CLI-09-21, Rockville,
11 Maryland. ADAMS Accession No. ML093070690.
- 12 NRC (U.S. Nuclear Regulatory Commission). 2009e. Memorandum from A.L. Vietti-Cook to
13 R.W. Borchardt, dated April 2, 2009, regarding "Staff Requirements - SECY-08-0197 - Options
14 to Revise Radiation Protection Regulations and Guidance with Respect to the 2007
15 Recommendations of the International Commission on Radiological Protection." SRM-SECY-
16 08-0197, Washington, D.C. ADAMS Accession No. ML090920103.
- 17 NRC (U.S. Nuclear Regulatory Commission). 2009f. *Preliminary Deterministic Analysis of*
18 *Seismic Hazard at Diablo Canyon Nuclear Power Plant from Newly Identified "Shoreline Fault."*
19 Research Information Letter RIL 09-001. Washington, D.C. ADAMS Accession No.
20 ML090330523.
- 21 NRC (U.S. Nuclear Regulatory Commission). 2010a. *Generic Environmental Impact Statement*
22 *for License Renewal of Nuclear Plants; Supplement 38 Regarding Indian Point Nuclear*
23 *Generating Unit Nos. 2 and 3, Final Report, Main Report and Comment Responses*. NUREG-
24 1437, Supplement 38, Volume 1. Washington, D.C. ADAMS Accession No. ML091260011.
- 25 NRC (U.S. Nuclear Regulatory Commission). 2010b. *Groundwater Task Force Final Report*.
26 Washington, D.C. ADAMS Accession No. ML101740509.
- 27 NRC (U.S. Nuclear Regulatory Commission). 2010c. Memorandum from R.W. Borchardt to
28 Martin J. Virgilio et. al. Dated June 17, 2010, regarding "Groundwater Task Force Final Report,
29 June 2010." Washington, D.C. ADAMS Accession No. ML101680435.
- 30 NRC (U.S. Nuclear Regulatory Commission). 2010d. "In the Matter of U.S. Department of
31 Energy (High Level Waste Repository): Memorandum and Order (Granting Intervention to
32 Petitioners and Denying Withdrawal Motion)." Docket No. 63-001-HLW, LBP-10-11, Rockville,
33 Maryland. ADAMS Accession No. ML101800299.
- 34 NRC (U.S. Nuclear Regulatory Commission). 2010e. Memorandum from R.W. Borchardt, to
35 B.S. Mallett and C.A. Casto, dated March 5, 2010, regarding "Groundwater Contamination Task
36 Force." Washington, D.C. ADAMS Accession No. ML100640188.

References

- 1 NRC (U.S. Nuclear Regulatory Commission). 2011a. *Generic Environmental Impact Statement*
2 *for License Renewal of Nuclear Plants, Supplement 39 Regarding Prairie Island Nuclear*
3 *Generating Plant, Units 1 and 2, Final Report*. NUREG-1437, Supplement 39, Washington,
4 D.C. ADAMS Accession No. ML11133A029.
- 5 NRC (U.S. Nuclear Regulatory Commission). 2011b. *Generic Environmental Impact Statement*
6 *for License Renewal of Nuclear Plants, Supplement 45 Regarding Hope Creek Generating*
7 *Station and Salem Nuclear Generating Station, Units 1 and 2—Final Report*. NUREG-1437,
8 Office of Nuclear Reactor Regulation, Washington, D.C. ADAMS Accession No. ML11089A021.
- 9 NRC (U.S. Nuclear Regulatory Commission). 2011c. Memorandum and Order in the Matter of
10 U.S. Department of Energy (High Level Waste Repository). LBP-11-24, Docket No. 63-001-
11 HLW, Rockville, Maryland. ADAMS Accession No. ML11273A041.
- 12 NRC (U.S. Nuclear Regulatory Commission). 2011d. Memorandum from A.L. Vietti-Cook to
13 R.W. Borchardt, dated August 15, 2011, regarding "Staff Requirements - SECY-11-0019 -
14 Senior Management Review of Overall Regulatory Approach to Groundwater Protection."
15 Washington, D.C. ADAMS Accession No. ML112270292.
- 16 NRC (U.S. Nuclear Regulatory Commission). 2011e. Memorandum from Chairman Jaczko to
17 Commissioners Svinicki, Apostolakis, Magwood, and Ostendorff, dated March 21, 2011,
18 regarding "NRC Actions Following the Events in Japan." COMGBJ-11-0002, Washington, D.C.
- 19 NRC (U.S. Nuclear Regulatory Commission). 2011f. *Policy Issue (Information), Senior*
20 *Management Review of Overall Regulatory Approach to Groundwater Protection*. SECY-11-
21 0019. Washington, D.C. ADAMS Accession No. ML110050525.
- 22 NRC (U.S. Nuclear Regulatory Commission). 2012a. *Generic Environmental Impact Statement*
23 *for License Renewal of Nuclear Plants; Supplement 47 Regarding Columbia Generating Station*
24 *Final Report*. NUREG-1437, Supplement 47, Volume 2 Appendices, Washington, D.C. ADAMS
25 Accession Nos. ML12097A239, ML12097A258, ML12097A264, ML12097A271.
- 26 NRC (U.S. Nuclear Regulatory Commission). 2012b. *Generic Environmental Impact Statement*
27 *for License Renewal of Nuclear Plants; Supplement 47 Regarding Columbia Generating Station*
28 *Final Report*. NUREG-1437, Supplement 47, Volume 1, Washington, D.C. ADAMS Accession
29 No. ML12096A334.
- 30 NRC (U.S. Nuclear Regulatory Commission). 2012c. Letter from A.S. Imboden to National
31 Marine Fisheries Service, dated March 20, 2012, regarding "Request to Initiate Abbreviated
32 Essential Fish Habitat Consultation for Proposed Extended Power Uprate at St. Lucie Plant,
33 Units 1 and 2 (TAC NO. ME5091)." Washington, D.C. ADAMS Accession No. ML12053A345.

- 1 NRC (U.S. Nuclear Regulatory Commission). 2012d. Letter from E. Leeds to All Power
2 Reactor Licensees and Holders of Construction Permits in Active or Deferred Status, dated
3 March 12, 2012, regarding "Request for Information Pursuant to Title 10 of the *Code of Federal*
4 *Regulations* 50.54(f) Regarding Recommendations 2.1, 2.3, and 9.3, of the Near-Term Task
5 Force Review of Insights from the Fukushima Dai-ichi Accident." Washington, D.C. ADAMS
6 Accession No. ML12053A340.
- 7 NRC (U.S. Nuclear Regulatory Commission). 2012e. "Memorandum and Order in the Matter of
8 Calvert Cliffs Nuclear Project, LLC; Detroit Edison Co.; Duke Energy Carolinas, LLC; et al.
9 (Received a Series of Substantively Identical Petitions to Suspend Final Licensing Decisions)."
10 CLI-12-16, Rockville, Maryland. ADAMS Accession No. ML12220A096.
- 11 NRC (U.S. Nuclear Regulatory Commission). 2012f. Memorandum from A.L. Vietti-Cook to
12 R.W. Borchardt, dated May 24, 2012, regarding "Staff Requirements - SECY-12-0046 - Options
13 for Revising the Regulatory Approach to Ground Water Protection." Washington, D.C.
- 14 NRC (U.S. Nuclear Regulatory Commission). 2012g. Memorandum from A.L. Vietti-Cook to
15 R.W. Borchardt, dated September 6, 2012, regarding "Staff Requirements—COMSECY—12—
16 0016—Approach for Addressing Policy Issues Resulting from Court Decision to Vacate Waste
17 Confidence Decision and Rule." Washington, D.C. ADAMS Accession No. ML12250A032.
- 18 NRC (U.S. Nuclear Regulatory Commission). 2012h. *Policy Issue Notation Vote: Options for*
19 *Revising the Regulatory Approach to Ground Water Protection*. SECY-12-0046, Washington,
20 D.C. ADAMS Accession No. ML12025A113.
- 21 NRC (U.S. Nuclear Regulatory Commission). 2012i. *State-of-the-Art Reactor Consequence*
22 *Analyses (SOARCA) Report*. NUREG—1935, Washington, D.C. ADAMS Accession No.
23 ML12332A057.
- 24 NRC (U.S. Nuclear Regulatory Commission). 2013a. *Generic Environmental Impact Statement*
25 *for License Renewal of Nuclear Plants [GEIS]*. NUREG—1437, Revision 1, Washington, D.C.
26 ADAMS Package Accession No. ML13107A023.
- 27 NRC (U.S. Nuclear Regulatory Commission). 2013b. *Generic Environmental Impact Statement*
28 *for License Renewal of Nuclear Plants, Supplement 48, Regarding South Texas Project, Units 1*
29 *and 2, Final Report*. NUREG-1437, Washington, D.C. ADAMS Accession No. ML13322A890.
- 30 NRC (U.S. Nuclear Regulatory Commission). 2013c. Memorandum from K.R. Hart to M.A.
31 Satorius, dated December 20, 2013, regarding "Staff Requirements - SECY-12-0108 - Staff
32 Recommendations for Addressing Remediation of Residual Radioactivity During Operations."
33 Washington, D.C.
- 34 NRC (U.S. Nuclear Regulatory Commission). 2013d. *Policy Issue Notation Vote: Staff*
35 *Recommendation for Addressing Remediation of Residual Radioactivity During Operations*.
36 SECY-13-0108, Washington, D.C.

References

- 1 NRC (U.S. Nuclear Regulatory Commission). 2014a. Email from B.A. Grange to U.S. Fish and
2 Wildlife Service, dated June 17, 2014, regarding "Davis Besse Operating License Renewal."
3 Washington, D.C. ADAMS Accession No. ML14168A616.
- 4 NRC (U.S. Nuclear Regulatory Commission). 2014b. Letter from D.J. Wrona to Greater
5 Atlantic Regional Fisheries Office, dated July 24, 2014, regarding "Essential Fish Habitat
6 Assessment for License Renewal of the Limerick Generating Stations, Units 1 and 2." Docket
7 Nos. 50-352 and 50-353, Washington, D.C. ADAMS Accession No. ML14195A346.
- 8 NRC (U.S. Nuclear Regulatory Commission). 2014c. *Generic Environmental Impact Statement*
9 *for Continued Storage of Spent Nuclear Fuel*. Final Report, NUREG–2157, Washington, D.C.
10 ADAMS Package Accession No. ML14198A440.
- 11 NRC (U.S. Nuclear Regulatory Commission). 2014d. *Generic Environmental Impact Statement*
12 *for License Renewal of Nuclear Plants, Supplement 49: Regarding Limerick Generating*
13 *Station, Units 1 and 2, Chapters 1 to 12, Final Report*. NUREG-1437, Supplement 49, Volumes
14 1 and 2, Washington, D.C. ADAMS Accession Nos. ML14238A284, ML14238A290.
- 15 NRC (U.S. Nuclear Regulatory Commission). 2014e. *Generic Environmental Impact Statement*
16 *for License Renewal of Nuclear Plants, Supplement 50: Regarding Grand Gulf Nuclear Station,*
17 *Unit 1, Final Report*. NUREG-1437, Supplement 50, Washington, D.C. ADAMS Accession No.
18 ML14328A171.
- 19 NRC (U.S. Nuclear Regulatory Commission). 2014f. *Generic Environmental Impact Statement*
20 *for License Renewal of Nuclear Plants, Supplement 51: Regarding Callaway Plant, Unit 1, Final*
21 *Report*. NUREG-1437, Supplement 51, Washington, D.C. ADAMS Accession No.
22 ML14289A140.
- 23 NRC (U.S. Nuclear Regulatory Commission). 2014g. Letter from D.J. Wrona to L. Chiarella,
24 dated August 27, 2014, regarding "Response to Essential Fish Habitat Conservation
25 Recommendation for License Renewal of the Limerick Generating Station, Units 1 and 2."
26 Washington, D.C. ADAMS Accession No. ML14233A270.
- 27 NRC (U.S. Nuclear Regulatory Commission). 2015a. *Biological Assessment on the Northern*
28 *Long-Eared Bat (*Myotis septentrionalis*) and Indiana Bat (*Myotis sodalis*), Indian Point Nuclear*
29 *Generating Units 2 and 3, Proposed License Renewal*. Docket Numbers 50-247 and 50-286,
30 Rockville, Maryland. ADAMS Accession No. ML15161A086.
- 31 NRC (U.S. Nuclear Regulatory Commission). 2015b. *Generic Environmental Impact Statement*
32 *for License Renewal of Nuclear Plants, Supplement 46: Regarding Seabrook Station, Final*
33 *Report*. NUREG-1437, Supplement 46, Volumes 1 and 2, Washington, D.C. ADAMS
34 Accession Nos. ML15209A575, ML15209A870.
- 35 NRC (U.S. Nuclear Regulatory Commission). 2015c. *Generic Environmental Impact Statement*
36 *for License Renewal of Nuclear Plants, Supplement 54: Regarding Byron Station, Units 1 and*
37 *2, Final Report*. NUREG-1437, Supplement 54, Washington, D.C. ADAMS Accession No.
38 ML15196A263.

- 1 NRC (U.S. Nuclear Regulatory Commission). 2015d. *Generic Environmental Impact Statement*
2 *for License Renewal of Nuclear Plants Supplement 55: Regarding Braidwood Station, Units 1*
3 *and 2, Final Report*. NUREG-1437, Supplement 55, Washington, D.C. ADAMS Accession No.
4 ML15314A814.
- 5 NRC (U.S. Nuclear Regulatory Commission). 2015e. *Generic Environmental Impact Statement*
6 *for License Renewal of Nuclear Plants; Supplement 52: Regarding Davis-Besse Nuclear Power*
7 *Station Final Report*. NUREG-1437, Supplement 52, Volume 1, Washington, D.C. ADAMS
8 Accession No. ML15112A098.
- 9 NRC (U.S. Nuclear Regulatory Commission). 2015f. *Generic Environmental Impact Statement*
10 *for License Renewal of Nuclear Plants; Supplement 53: Regarding Sequoyah Nuclear Plant,*
11 *Units 1 and 2, Final Report*. NUREG-1437, Supplement 53, Washington, D.C. ADAMS
12 Accession No. ML15075A438.
- 13 NRC (U.S. Nuclear Regulatory Commission). 2016a. *Final Report Supplement to the U.S.*
14 *Department of Energy's Environmental Impact Statement for a Geologic Repository for the*
15 *Disposal of Spent Nuclear Fuel and High-Level Radioactive Waste at Yucca Mountain, Nye*
16 *County, Nevada*. NUREG-2184, Washington, D.C. ADAMS Accession No. ML16125A032.
- 17 NRC (U.S. Nuclear Regulatory Commission). 2016b. *Environmental Impact Statement for*
18 *Combined Licenses (COLs) for Turkey Point Nuclear Plant Units 6 and 7*. NUREG-2176,
19 Volume 1, Washington, D.C. ADAMS Accession No. ML16300A104.
- 20 NRC (U.S. Nuclear Regulatory Commission). 2016c. *Generic Environmental Impact Statement*
21 *for License Renewal of Nuclear Plants, Supplement 56: Regarding Fermi 2, Nuclear Power*
22 *Plant, Final Report, Chapter 1 to 8*. NUREG-1437, Volume 1, Washington, D.C. ADAMS
23 Accession No. ML16259A103.
- 24 NRC (U.S. Nuclear Regulatory Commission). 2016d. *Generic Environmental Impact Statement*
25 *for License Renewal of Nuclear Plants; Supplement 57: Regarding LaSalle County Station,*
26 *Units 1 and 2. Final Report*. NUREG-1437, Supplement 57. Washington, D.C. ADAMS
27 Accession No. ML16238A029.
- 28 NRC (U.S. Nuclear Regulatory Commission). 2016e. Memorandum from A.L. Vietti-Cook to
29 V.M. McCree, dated December 21, 2016, regarding "Staff Requirements - SECY-16-0121 - Staff
30 Recommendations for Rulemaking to Address Remediation of Residual Radioactivity During
31 Operation." Washington, D.C. ADAMS Accession No. ML16356A583.
- 32 NRC (U.S. Nuclear Regulatory Commission). 2016f. Policy Issue: Proposed Resolution of
33 Remaining Tier 2 and 3 Recommendations Resulting from the Fukushima Dai-ichi Accident.
34 SECY-15-0144, Washington, D.C. ADAMS Accession No. ML16286A552.
- 35 NRC (U.S. Nuclear Regulatory Commission). 2016g. *Rulemaking Issue Notation Vote: Staff*
36 *Recommendations for Rulemaking to Address Remediation of Residual Radioactivity During*
37 *Operation*. SECY-16-0121, Washington, D.C. ADAMS Accession No. ML16235A298.

References

- 1 NRC (U.S. Nuclear Regulatory Commission). 2017. Memorandum to V.M. McCree from A.L.
2 Vietti-Cook, dated May 3, 2017, regarding "Staff Requirements – SECY-16-0144 – Proposed
3 Resolution of Remaining Tier 2 and 3 Recommendations Resulting From the Fukushima Dai-
4 ichi Accident." Washington, D.C. ADAMS Accession No. ML17123A453.
- 5 NRC (U.S. Nuclear Regulatory Commission). 2018a. *Biological Evaluation of Impacts to*
6 *Northern Long-Eared Bat, Rufa Red Knot, Piping Plover, and Roseate Tern, Seabrook Station,*
7 *Unit 1, Proposed License Renewal to Operating License No. NPF-86.* Docket No. 50-443,
8 Rockville, Maryland. ADAMS Accession No. ML18186A692.
- 9 NRC (U.S. Nuclear Regulatory Commission). 2018b. *Environmental Impact Statement for an*
10 *Early Site Permit (ESP) at the Clinch River Nuclear Site, Draft Report for Comment.* NUREG-
11 2226, Volumes 1 and 2, Washington, D.C. ADAMS Accession No. ML18100A220.
- 12 NRC (U.S. Nuclear Regulatory Commission). 2018c. *Generic Environmental Impact Statement*
13 *for License Renewal of Nuclear Plants, Supplement 58: Regarding River Bend Station, Unit 1*
14 *Final.* NUREG-1437, Supplement 58, Washington, D.C. ADAMS Accession No.
15 ML18310A072.
- 16 NRC (U.S. Nuclear Regulatory Commission). 2018d. *Generic Environmental Impact Statement*
17 *for License Renewal of Nuclear Plants, Supplement 59: Regarding Waterford Steam Electric*
18 *Station, Unit 3, Final Report.* NUREG-1437, Supplement 59, Washington, D.C. ADAMS
19 Accession No. ML18323A103.
- 20 NRC (U.S. Nuclear Regulatory Commission). 2018e. *Generic Environmental Impact Statement*
21 *for License Renewal of Nuclear Plants; Supplement 38: Regarding Indian Point Nuclear*
22 *Generating Unit Nos. 2 and 3. Final Report.* NUREG-1437, Supplement 38, Volume 5,
23 Washington, D.C. ADAMS Accession No. ML18107A759.
- 24 NRC (U.S. Nuclear Regulatory Commission). 2018f. *Status of the Decommissioning Program*
25 *2018 Annual Report.* Washington, D.C. November. ADAMS Accession No. ML18257A301.
- 26 NRC (U.S. Nuclear Regulatory Commission). 2019a. *Biological Assessment of Impacts to Sea*
27 *Turtles and Smalltooth Sawfish St. Lucie Plant, Unit Nos. 1 and 2 Continued Operations Under*
28 *Renewed Facility Operating License Nos. DPR-67 and NPF-16.* Docket Nos. 50-335 and 50-
29 389, Rockville, Maryland. ADAMS Accession No. ML19093A064.
- 30 NRC (U.S. Nuclear Regulatory Commission). 2019b. *Environmental Impact Statement for an*
31 *Early Site Permit (ESP) at the Clinch River Nuclear Site.* NUREG-2226, Washington, D.C.
32 ADAMS Package Accession ML19087A266.
- 33 NRC (U.S. Nuclear Regulatory Commission). 2019c. *Generic Environmental Impact Statement*
34 *for License Renewal of Nuclear Plants, Supplement 5, Second Renewal, Regarding*
35 *Subsequent License Renewal for Turkey Point Nuclear Generating Unit Nos. 3 and 4.* NUREG-
36 1437, Supplement 5, Second Renewal, Washington, D.C. ADAMS Accession No.
37 ML19290H346.

- 1 NRC (U.S. Nuclear Regulatory Commission). 2019d. *Generic Environmental Impact Statement*
2 *for License Renewal of Nuclear Plants Supplement 6, Second Renewal: Regarding*
3 *Subsequent License Renewal for Surry Power Station, Units 1 and 2, Draft Report for*
4 *Comment*. NUREG-1437, Supplement 6, Second Renewal, Washington, D.C. ADAMS
5 Accession No. ML19274C676.
- 6 NRC (U.S. Nuclear Regulatory Commission). 2019e. "Greater-Than-Class C and Transuranic
7 Waste." Washington, D.C. ADAMS Accession No. ML21145A383.
- 8 NRC (U.S. Nuclear Regulatory Commission). 2019f. *Occupational Radiation Exposure at*
9 *Commercial Nuclear Power Reactors and other Facilities 2017, Fiftieth Annual Report*.
10 NUREG-0173, Volume 39. Washington, D.C. ADAMS Accession No. ML19091A130.
- 11 NRC (U.S. Nuclear Regulatory Commission). 2020a. *2020–2021 Information Digest*. NUREG-
12 1350, Volume 32, Washington, D.C. ADAMS Accession No. ML20282A632.
- 13 NRC (U.S. Nuclear Regulatory Commission). 2020b. "Biological Opinion for Oyster Creek
14 Generating Station Shutdown and Decommissioning." Washington, D.C. ADAMS Accession
15 No. ML20153A226.
- 16 NRC (U.S. Nuclear Regulatory Commission). 2020c. "Design Certification Application for New
17 Reactors." Washington, D.C. Accessed June 12, 2022, at [https://www.nrc.gov/reactors/new-](https://www.nrc.gov/reactors/new-reactors/design-cert.html)
18 [reactors/design-cert.html](https://www.nrc.gov/reactors/new-reactors/design-cert.html).
- 19 NRC (U.S. Nuclear Regulatory Commission). 2020d. Letter from NRC to J.M. Welsch at
20 Pacific Gas and Electric Company, dated May 8, 2020, regarding "Diablo Canyon Power Plant,
21 Unit Nos. 1 and 2 – Documentation of the Completion of Required Actions Taken in Response
22 to the Lessons Learned from the Fukushima Dai-ichi Accident." Washington, D.C. ADAMS
23 Accession No. ML20093B934.
- 24 NRC (U.S. Nuclear Regulatory Commission). 2020e. "Generic Environmental Impact
25 Statement for In Situ Leach Uranium Milling Facilities (NUREG-1910)." Washington, D.C.
26 ADAMS Accession No. ML21145A382.
- 27 NRC (U.S. Nuclear Regulatory Commission). 2020f. *Generic Environmental Impact Statement*
28 *for License Renewal of Nuclear Plants Supplement 6, Second Renewal: Regarding*
29 *Subsequent License Renewal for Surry Power Station Units 1 and 2, Final Report*. NUREG-
30 1437, Supplement 6, Second Renewal, Washington, D.C. ADAMS Accession No.
31 ML20071D538.
- 32 NRC (U.S. Nuclear Regulatory Commission). 2020g. *Generic Environmental Impact Statement*
33 *for License Renewal of Nuclear Plants, Supplement 10, Second Renewal, Regarding*
34 *Subsequent License Renewal for Peach Bottom Atomic Power Station, Units 2 and 3, Final*
35 *Report*. NUREG-1437, Supplement 10, Second Renewal, Washington, D.C. ADAMS
36 Accession No. ML20023A937.
- 37 NRC (U.S. Nuclear Regulatory Commission). 2020h. "Low-Level Waste Disposal."
38 Washington, D.C. ADAMS Accession No. ML21145A388.

References

- 1 NRC (U.S. Nuclear Regulatory Commission). 2020i. *Occupational Radiation Exposure at*
2 *Commercial Nuclear Power Reactors and Other Facilities 2018, Fifty-First Annual Report.*
3 NUREG-0713, Volume 40, Washington, D.C. ADAMS Accession No. ML20087J424.
- 4 NRC (U.S. Nuclear Regulatory Commission). 2020j. "Public Scoping Meeting to Discuss the
5 Review and Potential Update of NUREG-1437, Generic Environmental Impact Statement for
6 License Renewal of Nuclear Plants - Final Report (LR GEIS)." August 27, 2020, Webinar
7 Corrected Transcript, Washington, D.C. ADAMS Package Accession No. ML20296A250.
- 8 NRC (U.S. Nuclear Regulatory Commission). 2020k. "Typical Dry Cask Storage System."
9 Washington, D.C. Accessed June 2, 2022, at [https://www.nrc.gov/waste/spent-fuel-](https://www.nrc.gov/waste/spent-fuel-storage/diagram-typical-dry-cask-system.html)
10 [storage/diagram-typical-dry-cask-system.html](https://www.nrc.gov/waste/spent-fuel-storage/diagram-typical-dry-cask-system.html).
- 11 NRC (U.S. Nuclear Regulatory Commission). 2021a. *LaSalle County Station, Units 1 and 2,*
12 *Environmental Assessment and Finding of No Significant Impact Related to a Requested*
13 *Revise the Ultimate Heat Sink Technical Specifications.* NRC-2021-0034. U.S. Nuclear
14 Regulatory Commission, Washington, D.C. ADAMS Accession No. ML21008A328.
- 15 NRC (U.S. Nuclear Regulatory Commission). 2021b. Letter from J.S. Wiebe, Senior Project
16 Manager, to D.P. Rhoades, Senior Vice President, Exelon Generation Company, LLC dated
17 June 30, 2021, regarding "Braidwood Station, Units 1 and 2 - Environmental Assessment and
18 Finding of No Significant Impact Related to a Requested Increase in Ultimate Heat Sink
19 Temperature." EPID: L-2021-LLA-0095. Washington, D.C. ADAMS Accession No.
20 ML21008A328.
- 21 NRC (U.S. Nuclear Regulatory Commission). 2021c. *2021-2022 Information Digest.* NUREG-
22 1350, Volume 33. Washington, D.C. ADAMS Accession No. ML21300A280.
- 23 NRC (U.S. Nuclear Regulatory Commission). 2021d. "Appendix B to Part 20—Annual Limits
24 on Intake (ALIs) and Derived Air Concentrations (DACs) of Radionuclides for Occupational
25 Exposure; Effluent Concentrations; Concentrations for Release to Sewerage." Washington,
26 D.C. Accessed February 21, 2022, at [https://www.nrc.gov/reading-rm/doc-](https://www.nrc.gov/reading-rm/doc-collections/cfr/part020/part020-appb.html)
27 [collections/cfr/part020/part020-appb.html](https://www.nrc.gov/reading-rm/doc-collections/cfr/part020/part020-appb.html).
- 28 NRC (U.S. Nuclear Regulatory Commission). 2021e. *Environmental Impact Statement Scoping*
29 *Process Summary Report Review and Update of the Generic Environmental Impact Statement*
30 *for License Renewal of Nuclear Plants.* NUREG-1437, Rockville, Maryland. ADAMS Accession
31 No. ML21039A576.
- 32 NRC (U.S. Nuclear Regulatory Commission). 2021f. *Generic Environmental Impact Statement*
33 *for License Renewal of Nuclear Plants, Supplement 23: Second Renewal Regarding*
34 *Subsequent License Renewal for Point Beach Nuclear Plant, Units 1 and 2, Draft Report for*
35 *Comment.* NUREG-1437, Supplement 23, Second Renewal, Washington, D.C. ADAMS
36 Accession No. ML21306A226.

- 1 NRC (U.S. Nuclear Regulatory Commission). 2021g. *Generic Environmental Impact Statement*
2 *for License Renewal of Nuclear Plants, Supplement 7, Second Renewal: Regarding*
3 *Subsequent License Renewal for North Anna Power Station, Units 1 and 2, Draft Report for*
4 *Comment*. NUREG-1437, Supplement 7, Second Renewal, Washington, D.C. ADAMS
5 Accession No. ML21228A084.
- 6 NRC (U.S. Nuclear Regulatory Commission). 2021h. Letter from S.R. Helton to J.D. Isakson,
7 dated September 13, 2021, regarding "Issuance of Materials License No. SNM-2515 for the
8 WCS Consolidated Interim Storage Facility Independent Spent Fuel Storage Installation (Docket
9 No. 72-1050)." Washington, D.C. ADAMS Accession No. ML21188A096.
- 10 NRC (U.S. Nuclear Regulatory Commission). 2021i. "Licensed and Operating Independent
11 Spent Fuel Storage Installations by State." Washington, D.C. Accessed June 2, 2022, at
12 [https://www.nrc.gov/images/reading-rm/doc-collections/maps/isfsi-facility-types-without-](https://www.nrc.gov/images/reading-rm/doc-collections/maps/isfsi-facility-types-without-sites.png)
13 [sites.png](https://www.nrc.gov/images/reading-rm/doc-collections/maps/isfsi-facility-types-without-sites.png).
- 14 NRC (U.S. Nuclear Regulatory Commission). 2021j. *List of Leaks and Spills at Operating U.S.*
15 *Commercial Nuclear Power Plants October, 2021*. Washington, D.C. ADAMS Accession No.
16 ML21278A082.
- 17 NRC (U.S. Nuclear Regulatory Commission). 2021k. "Plant Sites with Licensed Radioactive
18 Material in Groundwater." Washington, D.C. Accessed May 13, 2022, at
19 <https://www.nrc.gov/reactors/operating/ops-experience/tritium/sites-grndwtr-contam.html>.
- 20 NRC (U.S. Nuclear Regulatory Commission). 2021l. *Policy Issue Notation Vote: Rulemaking*
21 *Plan For Renewing Nuclear Power Plant Operating Licenses – Environmental Review (RIN*
22 *3150-AK32; NRC-2018-0296)*. SECY-21-0066, Washington, D.C. ADAMS Accession No.
23 ML20364A007.
- 24 NRC (U.S. Nuclear Regulatory Commission). 2021m. "Power Reactor Status Report for
25 August 24, 2014." Washington, D.C. Accessed May 26, 2022, at [https://www.nrc.gov/reading-](https://www.nrc.gov/reading-rm/doc-collections/event-status/reactor-status/2014/20140824ps.html)
26 [rm/doc-collections/event-status/reactor-status/2014/20140824ps.html](https://www.nrc.gov/reading-rm/doc-collections/event-status/reactor-status/2014/20140824ps.html).
- 27 NRC (U.S. Nuclear Regulatory Commission). 2021n. "Power Reactor Status Report for August
28 28, 2018." Washington, D.C. Accessed May 26, 2022, at [https://www.nrc.gov/reading-rm/doc-](https://www.nrc.gov/reading-rm/doc-collections/event-status/reactor-status/2018/20180828ps.html)
29 [collections/event-status/reactor-status/2018/20180828ps.html](https://www.nrc.gov/reading-rm/doc-collections/event-status/reactor-status/2018/20180828ps.html).
- 30 NRC (U.S. Nuclear Regulatory Commission). 2021o. "Power Reactor Status Report for July 1,
31 2012." Washington, D.C. Accessed May 26, 2022, at [https://www.nrc.gov/reading-rm/doc-](https://www.nrc.gov/reading-rm/doc-collections/event-status/reactor-status/2012/20120701ps.html)
32 [collections/event-status/reactor-status/2012/20120701ps.html](https://www.nrc.gov/reading-rm/doc-collections/event-status/reactor-status/2012/20120701ps.html).
- 33 NRC (U.S. Nuclear Regulatory Commission). 2021p. "Power Reactor Status Report for July
34 25, 2016." Washington, D.C. Accessed May 26, 2022, at [https://www.nrc.gov/reading-rm/doc-](https://www.nrc.gov/reading-rm/doc-collections/event-status/reactor-status/2016/20160725ps.html)
35 [collections/event-status/reactor-status/2016/20160725ps.html](https://www.nrc.gov/reading-rm/doc-collections/event-status/reactor-status/2016/20160725ps.html).
- 36 NRC (U.S. Nuclear Regulatory Commission). 2021q. *Seismic Hazard Evaluations for U.S.*
37 *Nuclear Power Plants: Near-Term Task Force Recommendation 2.1 Results*. NUREG/KM-
38 0017, Washington, D.C. ADAMS Accession No. ML21344A126.

References

- 1 NRC (U.S. Nuclear Regulatory Commission). 2021r. *Status of the Decommissioning Program*
2 *2021 Annual Report*. Washington, D.C. November. ADAMS Accession No. ML21280A402.
- 3 NRC (U.S. Nuclear Regulatory Commission). 2022a. "Design Certification Application –
4 NuScale." Washington, D.C. Available at [https://www.nrc.gov/reactors/new-](https://www.nrc.gov/reactors/new-reactors/smr/nuscale.html)
5 [reactors/smr/nuscale.html](https://www.nrc.gov/reactors/new-reactors/smr/nuscale.html).
- 6 NRC (U.S. Nuclear Regulatory Commission). 2022b. Memorandum from D.H. Dorman to The
7 Commissioners, dated March 25, 2022, regarding "Rulemaking Plan for Renewing Nuclear
8 Power Plant Operating Licenses—Environmental Review (RIN 3150-AK32; NRC 2018-0296)."
9 SECY-22-0024, Washington, D.C. ADAMS Accession No. ML22062B643.
- 10 NRC (U.S. Nuclear Regulatory Commission). 2022c. Memorandum from A.L. Vietti-Cook to
11 D.H. Dorman, dated February 24, 2022, regarding "Staff Requirements – SECY-21-0066 –
12 Rulemaking Plan for Renewing Nuclear Power Plant Operating Licenses – Environmental
13 Review (RIN 3150 AK32; NRC 2018 0296)." Washington, D.C. ADAMS Accession No.
14 ML22053A308.
- 15 NRC (U.S. Nuclear Regulatory Commission). 2022d. Memorandum from B.P. Clark to
16 D.H. Dorman, dated April 5, 2022, regarding "Staff Requirements - SECY-22-0024 - Rulemaking
17 Plan for Renewing Nuclear Power Plant Operating Licenses - Environmental Review (RIN 3150-
18 AK32; NRC 2018-0296)." Washington, D.C. ADAMS Accession No. ML22096A035.
- 19 NRC (U.S. Nuclear Regulatory Commission). 2023. *Standard Review Plans for Environmental*
20 *Reviews for Nuclear Power Plants, Supplement 1: Operating License Renewal, Draft Report for*
21 *Comment*. NUREG–1555, Revision 2, Washington, D.C. ADAMS Accession No.
22 ML22165A070.
- 23 NREL (National Renewable Energy Laboratory). 1997. *The Environmental Costs and Benefits*
24 *of Biomass Energy Use in California*. NREL/SR-430-22765, UC Category 600, DE97000254,
25 Golden, Colorado. Accessed June 9, 2022, at <https://doi.org/10.2172/481490>.
- 26 NREL (National Renewable Energy Laboratory). 2003. *Biopower Technical Assessment:*
27 *State of the Industry and the Technology*. NREL/TP-510-33123, U.S. Department of Energy,
28 Golden, Colorado. March. Accessed June 2, 2022, at
29 <https://www.nrel.gov/docs/fy03osti/33123.pdf>.
- 30 NREL (National Renewable Energy Laboratory). 2004. *Biomass Power and Conventional*
31 *Fossil Systems with and without CO2 Sequestration – Comparing the Energy Balance,*
32 *Greenhouse Gas Emissions and Economics*. NREL/SR-430-22765, Golden, Colorado.
33 Accessed June 9, 2022, at <https://doi.org/10.2172/15006537>.
- 34 NREL (National Renewable Energy Laboratory). 2011. *A Review of Operational Water*
35 *Consumption and Withdrawal Factors for Electricity Generating Technologies*. NREL/TP–
36 6A20–50900, Golden, Colorado. ADAMS Accession No. ML14286A088.

- 1 NREL (National Renewable Energy Laboratory). 2012. *Renewable Electricity Futures Study*.
2 NREL/TP-6A20-52409, 4 Volumes, Golden, Colorado. Accessed June 15, 2022, at
3 <https://www.nrel.gov/docs/fy13osti/52409-ES.pdf>.
- 4 NREL (National Renewable Energy Laboratory). 2016. *Water-Related Power Plant*
5 *Curtailments: An Overview of Incidents and Contributing Factors*. NREL/TP-6A20-67084,
6 Golden, Colorado.
- 7 NREL (National Renewable Energy Laboratory). Undated. "Concentrating Solar Power."
8 Golden, Colorado. Accessed June 12, 2022, at <https://www.nrel.gov/csp/index.html>.
- 9 NSP (Northern States Power Company). 1978. *Environmental Monitoring Program and*
10 *Ecological Studies Program, 1978 Annual Report, Volume 1, Prairie Island Nuclear Generating*
11 *Plant*. Volume 1. Northern States Power Company, Minneapolis, Minnesota. ADAMS
12 Accession No. ML19246A546.
- 13 Nuclear Waste Policy Act of 1982. 42 U.S.C. § 10101 et seq.
- 14 NuScale (NuScale Power LLC). 2022. "Frequently Asked Questions: NuScale FAQs."
15 Portland, Oregon. Available at <https://www.nuscalepower.com/about-us/faq>.
- 16 Occupational Safety and Health Act of 1970, as amended. 29 U.S.C. § 651 et seq.
- 17 On Petition for Writ of Mandamus Regarding Aiken County, et al., Petitioners, State of Nevada,
18 Intervenor 11-1271 (D.C. Cir) Opinion Granting Writ. USCA Case #11-1271, U.S. Court of
19 Appeals for the District of Columbia Circuit Decision, August 13, 2013. ADAMS Accession No.
20 ML13234A460.
- 21 Orsted. Undated. "Our Offshore Wind Projects in the U.S." Boston, Massachusetts. Accessed
22 June 12, 2022, at <https://us.orsted.com/wind-projects>.
- 23 OSHA (Occupational Safety and Health Administration). 2015. "Information Sheet: Health
24 Effects from Contaminated Water in Eyewash Stations." Washington, D.C.
- 25 OSHA (Occupational Safety and Health Administration). Undated. "Legionellosis (Legionnaires'
26 Disease and Pontiac Fever), Hazard Recognition." Washington, D.C. Accessed May 12, 2022,
27 at <https://www.osha.gov/legionnaires-disease/hazards>.
- 28 OSHA/NRC (Occupational Safety and Health Administration/U.S. Nuclear Regulatory
29 Commission). 2013. "Memorandum of Understanding Between The U.S. Nuclear Regulatory
30 Commission and The Occupational Safety and Health Administration." Washington, D.C.
31 Accessed June 12, 2022, at <https://www.osha.gov/laws-regs/mou/2013-09-06#:~:text=The%20purpose%20of%20this%20Memorandum,to%20achieve%20worker%20protection%20at>.
- 34 Parker, P.L., and T.F. King. 1998. "Guidelines for Evaluating and Documenting Traditional
35 Cultural Properties." *National Register Bulletin 38*, National Park Service, Washington, D.C.
36 ADAMS Accession No. ML13011A335.

References

- 1 Partridge, TF, J.M. Winter, E.C. Osterberg, D.W. Hyndman, A.D. Kendall, and F.J. Magilligan.
2 2018. "Spatially Distinct Seasonal Patterns and Forcings of the U.S. Warming Hole."
3 *Geophysical Research Letters* 45(4):2055–2063. DOI: 10.1002/2017GL076463. Washington,
4 D.C. Accessed May 17, 2022, at <https://doi.org/10.1002/2017GL076463>.
- 5 Paton, P.W.C. 1994. "The Effect of Edge on Avian Nest Success: How Strong Is the
6 Evidence?" *Conservation Biology* 8(1):17–26. DOI:10.1046/j.1523-1739.1994.08010017.x.
7 Hoboken, New Jersey. Accessed June 9, 2022, at [https://dx.doi.org/10.1046/j.1523-
8 1739.1994.08010017.x](https://dx.doi.org/10.1046/j.1523-1739.1994.08010017.x).
- 9 Petersen, W., E. Willer, and C. Williamowski. 1997. "Remobilization of Trace Elements from
10 Polluted Anoxic Sediments After Resuspension in Oxidic Water." *Water, Air, and Soil Pollution*
11 99(1-4):515-522. DOI:10.1007/BF02406891. Cham, Switzerland. Accessed June 13, 2022, at
12 <https://doi.org/10.1007/BF02406891>.
- 13 Petersen, M.D., A.M. Shumway, P.M. Powers, C.S. Mueller, M.P. Moschetti, A.D. Frankel, S.
14 Rezaeian, D.E. McNamara, N. Luco, O.S. Boyd, K.S. Rukstales, K.S. Jaiswal, E.M. Thompson,
15 S.M. Hoover, B.S. Clayton, E.H. Field, and Y. Zeng. 2020. "The 2018 update of the U.S.
16 National Seismic Hazard Model: Overview of model and implications." *Earthquake Spectra*
17 36(1):5-41, Los Angeles, California.
- 18 PG&E (Pacific Gas and Electric Company). 2007. Letter from J.R. Becker, Site Vice President
19 and Station Director, to J.G. Cordaro, Wildlife Biologist, National Marine Fisheries Service dated
20 November 20, 2007, regarding "Enclosed is a National Marine Fisheries Service (NMFS) Marine
21 Mammal and Marine Turtle Stranding Report for a dead California sea lion." PG&E Letter DCL-
22 2007-553. Avila Beach, California. ADAMS Accession No. ML073330470.
- 23 PG&E (Pacific Gas and Electric Company). 2008a. Letter from J.R. Becker, Site Vice
24 President and Station Director, to J.G. Cordaro, Wildlife Biologist, National Marine Fisheries
25 Service dated February 15, 2008, regarding "Enclosed is a National Marine Fisheries Service
26 (NMFS) Marine Mammal and Marine Turtle Stranding Report for a dead California sea lion."
27 PG&E Letter DCL-2008-508. Avila Beach, California. ADAMS Accession No. ML080580202.
- 28 PG&E (Pacific Gas and Electric Company). 2008b. Letter from J.R. Becker, Site Vice
29 President and Station Director, to J.G. Cordaro, Wildlife Biologist, National Marine Fisheries
30 Service dated July 18, 2008, regarding "Enclosed is a National Marine Fisheries Service
31 (NMFS) Marine Mammal and Marine Turtle Stranding Report for Live elephant seal." PG&E
32 Letter DCL-2008-533. Avila Beach, California. ADAMS Accession No. ML082140271.
- 33 PG&E (Pacific Gas and Electric Company). 2008c. Letter from J.R. Becker, Site Vice President
34 and Station Director, to J.G. Cordaro, Wildlife Biologist, National Marine Fisheries Service dated
35 June 3, 2008, regarding "Marine Mammal Stranding Report for Dead California Sea Lion."
36 PG&E Letter DCL-2008-521. Avila Beach, California. ADAMS Accession No. ML081700237.

- 1 PG&E (Pacific Gas and Electric Company). 2008d. Letter from K.J. Peters, Station Director, to
2 J.G. Cordaro, Wildlife Biologist, National Marine Fisheries Service dated November 26, 2008,
3 regarding "Marine Mammal Stranding Report for Dead California Sea Lion." PG&E Letter DCL-
4 2008-557. PG&E Letter DCL-2008-521. Avila Beach, California. ADAMS Accession No.
5 ML083440312.
- 6 PG&E (Pacific Gas and Electric Company). 2009a. Letter from K.J. Peters, Station Director, to
7 J.G. Cordaro, Wildlife Biologist, National Marine Fisheries Service dated July 17, 2009,
8 regarding "Marine Mammal Stranding Report for Dead Harbor Seal." PG&E Letter DCL-2009-
9 527. Avila Beach, California. ADAMS Accession No. ML092090196.
- 10 PG&E (Pacific Gas and Electric Company). 2009b. Letter from K.J. Peters, Station Director, to
11 J.G. Cordaro, Wildlife Biologist, National Marine Fisheries Service dated May 27, 2009,
12 regarding "Marine Mammal Stranding Report for Dead Harbor Seal." PG&E Letter DCL-2009-
13 519. Avila Beach, California. ADAMS Accession No. ML091680382.
- 14 PG&E (Pacific Gas and Electric Company). 2014a. Letter from K.W. Cortese, Manager of
15 Chemistry and Environmental Operations, to J. Viezbicke, California Stranding Network
16 Coordinator, National Marine Fisheries Service dated June 17, 2014, regarding "Marine
17 Mammal Stranding Report (Sea Lion) Diablo Canyon Power Plant." PG&E Letter DCL-2014-
18 523. Avila Beach, California. ADAMS Accession No. ML14191A634.
- 19 PG&E (Pacific Gas and Electric Company). 2014b. Letter from K.W. Cortese, Manager of
20 Chemistry and Environmental Operations, to J. Viezbicke, California Stranding Network
21 Coordinator, National Marine Fisheries Service dated May 19, 2014, regarding "Marine Mammal
22 Stranding Report (Harbor Seal) Diablo Canyon Power Plant." PG&E Letter DCL-2014-521.
23 Avila Beach, California. ADAMS Accession No. ML14167A076.
- 24 PG&E (Pacific Gas and Electric Company). 2015a. Letter from K.W. Cortese, Manager of
25 Chemistry and Environmental Operations, to J. Viezbicke, California Stranding Network
26 Coordinator, National Marine Fisheries Service dated March 17, 2015, regarding "Marine
27 Mammal Stranding Report (Sea Lion) Diablo Canyon Power Plant." PG&E Letter DCL-2015-
28 513. Avila Beach, California. ADAMS Accession No. ML15097A179.
- 29 PG&E (Pacific Gas and Electric Company). 2015b. Letter from K.W. Cortese, Manager of
30 Chemistry and Environmental Operations, to J. Viezbicke, California Stranding Network
31 Coordinator, National Marine Fisheries Service dated March 24, 2015, regarding "Marine
32 Mammal Stranding Report (Sea Lion) Diablo Canyon Power Plant." PG&E Letter DCL-2015-
33 517. Avila Beach, California. ADAMS Accession No. ML15097A261.
- 34 PG&E (Pacific Gas and Electric Company). 2015c. Letter from K.W. Cortese, Manager of
35 Chemistry and Environmental Operations, to J. Viezbicke, California Stranding Network
36 Coordinator, National Marine Fisheries Service dated May 27, 2015, regarding "Marine Mammal
37 Stranding Report (Sea Lion) Diablo Canyon Power Plant." PG&E Letter DCL-2015-525. Avila
38 Beach, California. ADAMS Accession No. ML15161A317.
- 39 Pollution Prevention Act of 1990. 42 U.S.C. § 13101 et seq.

References

- 1 Popeck, R.A., and R.F. Knapp. 1981. "Measurement and Analysis of Audible Noise from
2 Operating 765 kV Transmission Lines." *IEEE Transactions on Power Apparatus and Systems*,
3 PAS-100(4):2138-2148. The Detroit Edison Company, Detroit, Michigan.
- 4 Poznaniak, D.T., and T.J. Reed. 1978. "Recent Studies Examining the Biological Effects of
5 UHV Transmission Line Ground Gradients." *Proceedings of the American Power Conference*,
6 40:1272-1284. Chicago, Illinois.
- 7 Pruppacher, H.R., and J.D. Klett. 1980. *Microphysics of Clouds and Precipitation*. D. Reidel
8 Publishing Company, Dordrecht, Holland.
- 9 Raloff, J. 1998. "Something's Bugging Nuclear Fuel." *Science News*, 153(21):325,
10 Washington, D.C.
- 11 Ramsdell, J.V. Jr., C.E. Beyer, D.D. Lanning, U.P. Jenquin, R.A. Schwarz, D.L. Strenge, P.M.
12 Daling, and R.T. Dahowski. 2001. *Environmental Effects of Extending Fuel Burnup Above*
13 *60 GWd/MTU*. NUREG/CR-6703, Pacific Northwest National Laboratory, Richland,
14 Washington. ADAMS Accession No. ML010310298.
- 15 Resource Conservation and Recovery Act of 1976 (RCRA). 42 U.S.C. § 6901 et seq.
- 16 Robinson, S.K., F.R. Thompson, T.M. Donovan, D.R. Whitehead, and J. Faaborg. 1995.
17 "Regional Forest Fragmentation and the Nesting Success of Migratory Birds." *Science*
18 31(5206):1987–1990. DOI:10.1126/science.267.5206.1987. Washington, D.C. Accessed June
19 9, 2022, at <https://dx.doi.org/10.1126/science.267.5206.1987>.
- 20 Roffman, A., and L.D. Van Vleck. 1974. "The State-of-the-Art of Measuring and Predicting
21 Cooling Tower Drift and Its Deposition." *Journal of the Air Pollution Control Association*
22 24(9):855-859, Pittsburgh, Pennsylvania.
- 23 Rogers, L., and R. Hinds. 1983. *Environmental Studies for a 1100-kV Power Line in Oregon.*
24 *A Special Report*. DOE/BP-181. Battelle, Pacific Northwest Laboratories, Richland,
25 Washington.
- 26 Rogers, L.E., P.A. Beedlow, D.W. Carlile, and K.A. Gano. 1984. Environmental Studies of a
27 1100-kV Prototype Transmission Line: *Effects on Trees Growing Below the Line. An Annual*
28 *Report for the 1984 Study Period*. Battelle, Pacific Northwest Laboratories, Richland,
29 Washington.
- 30 Romberg, G.P., S.A. Spigarelli, W. Prepejchal, M.M. Thommes, J.W. Gibbons, and R.R. Sharitz.
31 1974. "Fish Behavior at a Thermal Discharge into Lake Michigan." *Thermal Ecology*
32 *Symposium*. CONF-730505. Aiken, South Carolina.
- 33 Roosenburg, W.H. 1969. "Greening and Copper Accumulation in the American Oyster,
34 *Crassostrea virginica*, in the Vicinity of a Steam Electric Generating Station." *Chesapeake*
35 *Science* 10(3):241–252. DOI: 10.2307/1350461. Berlin, Germany. Accessed May 12, 2022, at
36 <https://doi.org/10.2307/1350461>.

- 1 Rothermel, B.B. 2004. "Migratory Success of Juveniles: A Potential Constraint on Connectivity
2 for Pond-Breeding Amphibians." *Ecological Applications* 14(5):1535–1546. Hoboken, New
3 Jersey. DOI:10.1890/03-5206. Accessed June 11, 2022, at <https://doi.org/10.1890/03-5206>.
- 4 Rukstales, K.S., and M.D. Petersen. 2019. "Data Release for 2018 Update of the U.S. National
5 Seismic Hazard Model." U.S. Geological Survey data release. December. Washington, D.C.
6 Accessed May 4, 2022, at <https://doi.org/10.5066/P9WT5OVB>.
- 7 Safe Drinking Water Act of 1974, as amended. 42 U.S.C. § 300f et seq.
- 8 Schreiber, R.K., W.C. Johnson, J.D. Story, C. Wenzel, and J.T. Kitchings. 1976. "Effects of
9 Power Line Rights-of-Way on Small Nongame Mammal Community Structure." In Proceedings
10 of the First National Symposium on Environmental Concerns in Rights-of-Way Management, pp.
11 264–273. Mississippi State, Mississippi.
- 12 Schubel, J.R., C.F. Smith, and T.S. Koo. 1977. "Thermal Effects of Power Plant Entrainment
13 on Survival of Larval Fishes: A Laboratory Assessment." *Chesapeake Science* 18(3):290–298.
14 DOI:10.2307/1350803. Cham, Switzerland. Accessed June 12, 2022, at
15 <https://doi.org/10.2307/1350803>.
- 16 Scott-Walton, B., K.M. Clark, B.R. Holt, D.C. Jones, S.D. Kaplan, J.S. Krebs, P. Polson, R.A.
17 Shepherd, and J.R. Young. 1979. *Potential Environmental Effects of 765-kV Transmission*
18 *Lines: Views Before the New York State Public Service Commission, Cases 26529 and 26559,*
19 *1976–1978.* DOE/EV-0056, U.S. Department of Energy, Washington, D.C. Accessed June 1,
20 2022, at <https://doi.org/10.2172/5766103>.
- 21 Smallwood, K.S., D.A. Bell, and S. Standish. 2020. "Dogs Detect Larger Wind Energy Effects
22 on Bats and Birds." *Journal of Wildlife Management* 84(5):852-864. DOI:10.1002/jwmg.21863.
23 Hoboken, New Jersey. Accessed June 9, 2022, at <https://doi.org/10.1002/jwmg.21863>.
- 24 Smith, J. 1999. "Zapus hudsonius: Meadow Jumping Mouse." *Animal Diversity Web*. Ann
25 Arbor, Michigan. Accessed July 28, 2022, at
26 https://animaldiversity.org/accounts/Zapus_hudsonius/.
- 27 SNYPSC (State of New York Public Service Commission). 1978. *Opinion No. 78-13, Opinion*
28 *and Order Determining Health and Safety Issues, Imposing Operating Conditions, and*
29 *Authorizing, in Case 26529, Operation Pursuant to Those Conditions.* Power Authority of the
30 State of New York, Albany, New York.
- 31 Stachowicz, J.J., and J.E. Byrnes. 2006. "Species diversity, invasion success, and ecosystem
32 functioning: disentangling the influence of resource competition, facilitation, and extrinsic
33 factors." *Marine Ecology Progress Series* 311:251-262. DOI:10.3354/meps311251. Oldendorf,
34 Germany. Accessed June 7, 2022, at <https://dx.doi.org/10.3354/meps311251>.
- 35 Stantial, M.L. 2014. *Flight Behavior of Breeding Piping Plovers: Implications for Risk of*
36 *Collision with Wind Turbines.* Master of Science Thesis, State University of New York.
37 Syracuse, New York. Accessed June 10, 2022, at
38 https://www.nifishandwildlife.org/ensp/pdf/plover-turbine_stantialthesis14.pdf.

References

- 1 Stantial, M.L., and J.B. Cohen. 2015. "Estimating Flight Height and Flight Speed of Breeding
2 Piping Plover." *Journal of Field Ornithology* 86(4):369-377. Hoboken, New Jersey. DOI:
3 10.1111/jfo.12120. Accessed May 12, 2022, at <https://doi.org/10.1111/jfo.12120>.
- 4 State of New Jersey. 2021. *Air Pollution Control Operating Permit Minor Modification*. New
5 Jersey Department of Environment Operating Permit, Hope Creek and Salem Generating
6 Stations, Title V, Permit Activity Number: BOP210001, Program Interest Number: 65500,
7 Trenton, New Jersey.
- 8 Steenhof, K., M.N. Kochert, and J.A. Roppe. 1993. "Nesting by Raptors and Common Ravens
9 on Electrical Transmission Line Towers." *Journal of Wildlife Management* 57(2):271–281.
10 DOI:10.2307/3809424. Hoboken, New Jersey. Accessed June 12, 2022, at
11 <https://doi.org/10.2307/3809424>.
- 12 Su, S.H., L.C. Pearlman, J.A. Rothrock, T.J. Iannuzzi, and B.L. Finley. 2002. "Potential Long-
13 Term Ecological Impacts Caused by Disturbance of Contaminated Sediments: A Case Study."
14 *Environmental Management* 29(2):234-249. DOI:10.1007/s00267-001-0005-3. Cham,
15 Switzerland. Accessed June 13, 2022, at <https://doi.org/10.1007/s00267-001-0005-3>.
- 16 Summerfelt, R.C., and D. Mosier. 1976. *Final Report, Evaluation of Ultrasonic Telemetry to*
17 *Track Striped Bass to Their Spawning Grounds 15 January 1974 – 30 June 1975*. Stillwater,
18 Oklahoma.
- 19 Sustainable Fisheries Act of 1996. 16 U.S.C. § 1801 Note. Public Law 104-297, October 11,
20 1996, 110 Stat. 3559.
- 21 Taylor, W.K., and M.A. Kershner. 1986. "Migrant Birds Killed at the Vehicle Assembly Building
22 (VAB), John F. Kennedy Space Center." *Journal of Field Ornithology* 57:142-154. Portland,
23 Maine. Accessed June 14, 2022, at <https://sora.unm.edu/node/51254>.
- 24 Temme, M., and W.B. Jackson. 1979. "Cooling Towers as Obstacles in Bird Migrations." In
25 *Proceedings of the 8th Bird Control Seminar*. pp. 111-118. Stevens Point, Wisconsin.
26 Accessed June 11, 2022, at <https://digitalcommons.unl.edu/icwdmbirdcontrol/16/>.
- 27 Tetra Tech. 2010. *Cooling Tower Noise, Plume and Drift Abatement Costs, Technical*
28 *Memorandum*. AR-330. Fairfax, Virginia.
- 29 The White House. 2010. "Presidential Memorandum - Blue Ribbon Commission on America's
30 Nuclear Future." Washington, D.C. Accessed June 13, 2022, at
31 [https://obamawhitehouse.archives.gov/the-press-office/presidential-memorandum-blue-ribbon-](https://obamawhitehouse.archives.gov/the-press-office/presidential-memorandum-blue-ribbon-commission-americas-nuclear-future)
32 [commission-americas-nuclear-future](https://obamawhitehouse.archives.gov/the-press-office/presidential-memorandum-blue-ribbon-commission-americas-nuclear-future).
- 33 Thorne, J.H., R. Boynton, L. Flint, A. Flint, and T. N'goc Le. 2012. *Development and*
34 *Application of Downscale Hydroclimatic Predictor Variable for Use in Climate Vulnerability and*
35 *Assessment Studies*. CEC-500-2012-010. California Energy Commission, Sacramento,
36 California. Accessed May 25, 2022, at <https://escholarship.org/uc/item/160016sh>.

- 1 Todar, K. 2004. "Pseudomonas aeruginosa." In *Todar's Online Textbook of Bacteriology*.
2 University of Wisconsin-Madison, Department of Bacteriology, Madison, Wisconsin. Accessed
3 June 12, 2022, at <http://textbookofbacteriology.net/pseudomonas.html>.
- 4 Toxic Substances Control Act, as amended. 15 U.S.C. § 2601 et seq.
- 5 TVA (Tennessee Valley Authority). 2013. *Sequoyah Nuclear Plant, Units 1 and 2, License
6 Renewal Application, Appendix E, Applicant's Environmental Report, Operating License
7 Renewal Stage*. Chattanooga, Tennessee: TVA. January 7, 2013. ADAMS Nos.
8 ML13024A012, ML13024A013, ML13024A006, ML13024A007, ML13024A008, ML13024A009,
9 and ML13024A010.
- 10 Tyndall, R.L. 1982. *Presence of Pathogenic Microorganisms in Power Plant Cooling Waters,
11 Report for October 1, 1979 to September 30, 1981*. NUREG/CR-2980, ORNL/TM-8523, Oak
12 Ridge, Tennessee. Accessed June 12, 2022, at [https://www.osti.gov/biblio/6738834-presence-
13 pathogenic-microorganisms-power-plant-cooling-waters-report-october-september](https://www.osti.gov/biblio/6738834-presence-pathogenic-microorganisms-power-plant-cooling-waters-report-october-september).
- 14 Tyndall, R.L. 1983. *Presence of Pathogenic Microorganisms in Power Plant Cooling Waters,
15 Final Report for October 1, 1981 to June 30, 1983*. NUREG/CR-3364, ORNL/TM-8809, Oak
16 Ridge, Tennessee. ADAMS Accession No. ML20080C001.
- 17 Tyndall, R.L. 1985. *Legionnaires' Disease Bacteria in Power Plant Cooling Systems: Phase 2*.
18 EPRI EA-4017, Oak Ridge, Tennessee. ADAMS Accession No. ML093240284.
- 19 UNSCEAR (United Nations Scientific Committee on the Effects of Atomic Radiation). 2010.
20 "Sources and Effects of Ionizing Radiation. UNSCEAR 2008 Report to the General Assembly
21 with Scientific Annexes. Volume 1: Sources." New York, New York. Available at
22 [https://www.unscear.org/unscear/uploads/documents/unscear-
23 reports/UNSCEAR_2008_Report_Vol.I-CORR.pdf](https://www.unscear.org/unscear/uploads/documents/unscear-reports/UNSCEAR_2008_Report_Vol.I-CORR.pdf).
- 24 USCB (U.S. Census Bureau). Undated. "Geographic Entities and Concepts, Geography
25 Division." Washington, D.C.
- 26 USDA (U.S. Department of Agriculture). 2019. "Web Soil Survey, Home." Washington, D.C.
27 Accessed May 9, 2022, at <https://websoilsurvey.sc.egov.usda.gov/App/HomePage.htm>.
- 28 USDA (U.S. Department of Agriculture). 2021. "Gridded National Soil Survey Geographic
29 (gNATSGO) Database for the Conterminous United States." Washington, D.C. Accessed June
30 10, 2022, at <https://nrscs.app.box.com/v/soils>.
- 31 USGCRP (U.S. Global Change Research Program). 2009. *Global Climate Change Impacts in
32 the United States*. T.R. Karl, J.M. Melillo, and T.C. Peterson (editors). Cambridge University
33 Press, New York, New York. ADAMS Accession No. ML100580077.
- 34 USGCRP (U.S. Global Change Research Program). 2014. *Climate Change Impacts in the
35 United States: The Third National Climate Assessment*. J.M. Melillo, T.C. Richmond, and G.W.
36 Yohe (eds.). U.S. Government Printing Office, Washington, D.C. ADAMS Accession No.
37 ML14129A233.

References

- 1 USGCRP (U.S. Global Change Research Program). 2017. *Climate Science Special Report:*
2 *Fourth National Climate Assessment*. Volume I. D.J. Wuebbles, D.W. Fahey, K.A. Hibbard,
3 D.J. Dokken, B.C. Stewart, and T.K. Maycock (eds.). Washington, D.C. ADAMS Accession No.
4 ML19008A410. DOI: 10.7930/J0J964J6.
- 5 USGCRP (U.S. Global Change Research Program). 2018. *Impacts, Risks, and Adaptation in*
6 *the United States: Fourth National Climate Assessment*. Volume II. D.R. Reidmiller, C.W.
7 Avery, D.R. Easterling, K.E. Kunkel, K.L.M. Lewis, T.K. Maycock, and B.C. Stewart (eds.).
8 Washington, D.C. ADAMS Accession No. ML19008A414. DOI: 10.7930/NCA4.2018.
- 9 USGS (U.S. Geological Survey). 1999. *Ecological Status and Trends of the Upper Mississippi*
10 *River System 1998: A Report of the Long Term Resources Monitoring Program*. LTRMP 99-
11 T001, U.S. Geological Survey, Upper Midwest Environmental Sciences Center, La Crosse,
12 Wisconsin. Accessed May 17, 2022, at
13 https://www.umesc.usgs.gov/reports_publications/status_and_trends.html.
- 14 USGS (U.S. Geological Survey). 2008. *Assessment of Moderate- and High-Temperature*
15 *Geothermal Resources of the United States*. Fact Sheet 2008–3082, Menlo Park, California.
16 Accessed June 12, 2022, at <https://pubs.usgs.gov/fs/2008/3082/pdf/fs2008-3082.pdf>.
- 17 USGS (U.S. Geological Survey). 2019a. "NLCD 2019 Land Cover (CONUS)." Multi-Resolution
18 Land Characteristics Consortium Project. Sioux Falls, South Dakota. Accessed May 6, 2022,
19 at <https://www.mrlc.gov/data/nlcd-2019-land-cover-conus>.
- 20 USGS (U.S. Geological Survey). 2019b. *Withdrawal and Consumption of Water by*
21 *Thermoelectric Power Plants in the United States, 2015*. M.A. Harris and T.H. Diehl (eds.).
22 Scientific Investigations Report 2019–5103, Reston, Virginia.
- 23 USGS (U.S. Geological Survey). 2021. "The Modified Mercalli Intensity Scale." Washington,
24 D.C. Accessed May 31, 2022, at [https://www.usgs.gov/programs/earthquake-hazards/modified-](https://www.usgs.gov/programs/earthquake-hazards/modified-mercalli-intensity-scale)
25 [mercalli-intensity-scale](https://www.usgs.gov/programs/earthquake-hazards/modified-mercalli-intensity-scale).
- 26 Varfalvy, L., R.D. Dallaire, P.S. Maruvada, and N. Rivest. 1985. "Measurement and Statistical
27 Analysis of Ozone from HVDC and HVAC Transmission Lines." *IEEE Transactions on Power*
28 *Apparatus and Systems* PAS- 104(10):2789 - 2797. DOI: 10.1109/TPAS.1985.319122.
29 Piscataway, New Jersey. Accessed May 16, 2022, at
30 <https://dx.doi.org/10.1109/TPAS.1985.319122>.
- 31 Vér, I.L., and L.L. Beranek. 2005. *Noise and Vibration Control Engineering: Principles and*
32 *Applications*. Second Edition, University of Michigan, Ann Arbor, Michigan. Available at
33 <https://onlinelibrary.wiley.com/doi/book/10.1002/9780470172568>.
- 34 Weaver, S.P., A.K. Jones, C.D. Hein, and I. Castro-Arellano. 2020. "Estimating bat fatality at a
35 Texas wind energy facility: implications transcending the United States–Mexico border."
36 *Journal of Mammalogy* 101(6):1533–1541. DOI:10.1093/jmammal/gyaa132. Oxford, United
37 Kingdom. Accessed June 7, 2020 at <https://dx.doi.org/10.1093/jmammal/gyaa132>.

- 1 Wertheimer, N., and E. Leeper. 1979. "Electrical Wiring Configurations and Childhood
2 Cancer." *American Journal of Epidemiology*, 109(3):273–284. Oxford, England. Accessed
3 June 12, 2022, at <https://doi.org/10.1093/oxfordjournals.aje.a112681>.
- 4 WHO (World Health Organization). 2020. "What are Electromagnetic Fields?" Geneva,
5 Switzerland. Accessed October 1, 2020, at [https://www.who.int/peh-](https://www.who.int/peh-emf/about/WhatisEMF/en/index3.html)
6 [emf/about/WhatisEMF/en/index3.html](https://www.who.int/peh-emf/about/WhatisEMF/en/index3.html).
- 7 Wilber, D.H., D.G. Clarke, and M.H. Burlas. 2006. "Suspended Sediment Concentrations
8 Associated with a Beach Nourishment Project on the Northern Coast of New Jersey." *Journal of*
9 *Coastal Research* 22(5):1035-1042. DOI:10.2112/04-0268.1. Accessed June 8, 2022, at
10 <https://doi.org/10.2112/04-0268.1>.
- 11 Wilcove, D.S. 1988. "Changes in the Avifauna of the Great Smoky Mountains: 1947–1983."
12 *Wilson Bulletin* 100(2):256–271. Ann Arbor, Michigan. Accessed June 9, 2022, at
13 <https://www.jstor.org/stable/4162565>.
- 14 Wisner, R., and M. Bolinger. 2019. *2018 Wind Technologies Market Report*. Office of Energy
15 Efficiency and Renewable Energy, Washington, D.C. Accessed June 12, 2022, at
16 <https://www.energy.gov/eere/wind/downloads/2018-wind-technologies-market-report>.
- 17 Wolff, J.O., E.M. Schaubert, and W.D. Edge. 1997. "Effects of Habitat Loss and Fragmentation
18 on the Behavior and Demography of Gray-Tailed Voles." *Conservation Biology* 11(4):945–956.
19 DOI:10.1046/j.1523-1739.1997.96136.x. Hoboken, New Jersey. Accessed June 11, 2022, at
20 <https://doi.org/10.1046/j.1523-1739.1997.96136.x>.
- 21 Worden, C.B., E.M. Thompson, M. Hearne, and D.J. Wald. 2020. ShakeMap 4 Manual. Online
22 Manual, Technical Manual, User's Guide, and Software Guide, U.S. Geological Survey, Reston,
23 Virginia. Accessed May 31, 2022, at DOI: <https://doi.org/10.5066/F7D21VPQ>.
- 24 Wright, T., J. Tomlinson, T. Schueler, K. Cappiella, A. Kitchell, and D. Hirschman. 2006. *Direct*
25 *and Indirect Impacts of Urbanization on Wetland Quality*. Center for Watershed Protection.
26 Ellicott City, Maryland. ADAMS Accession No. ML091520194.
- 27 WSEC (Wind Science and Engineering Center). 2006. *Enhanced Fujita Scale (EF-Scale)*,
28 Revision 2. Submitted to The National Weather Service and Other Interested Users. Lubbock,
29 Texas.
- 30 Zimmerling, J.R., A.C. Pomeroy, M.V. d'Entremont, and C.M. Francis. 2013. "Canadian
31 Estimate of Bird Mortality Due to Collisions and Direct Habitat Loss Associated with Wind
32 Turbine Developments." *Avian Conservation and Ecology* 8(2):10. DOI:10.5751/ACE-00609-
33 080210. Nova Scotia, Canada. Accessed June 7, 2022, at [http://dx.doi.org/10.5751/ACE-](http://dx.doi.org/10.5751/ACE-00609-080210)
34 [00609-080210](http://dx.doi.org/10.5751/ACE-00609-080210).

1

6.0 LIST OF PREPARERS

2 This revision of NUREG-1437, *Generic Environmental Impact Statement for License Renewal of*
3 *Nuclear Plants* (LR GEIS) was prepared by U.S. Nuclear Regulatory Commission (NRC) staff in
4 the Office of Nuclear Material Safety and Safeguards (see Table 6-1) with assistance from other
5 NRC organizations, and Pacific Northwest National Laboratory (Table 6-2).

6 **Table 6-1 U.S. Nuclear Regulatory Commission Preparers**

Name	Education/Expertise	Contribution
Beth Alferink	M.S., Environmental Engineering; M.S., Nuclear Engineering; B.S., Nuclear Engineering; 25 years of national laboratory, industry, and government experience including radiation detection and measurements, nuclear power plant emergency response, operations, health physics, decommissioning, shielding and criticality	Human Health; Waste Management; Decommissioning
Briana Arlene	Masters Certification, National Environmental Policy Act; B.S., Conservation Biology; 16 years of experience in ecological impact analysis, Endangered Species Act Section 7 consultations, and Essential Fish Habitat consultations	Aquatic Resources; Terrestrial Resources; Federally Protected Ecological Resources
Phyllis Clark	M.S., Nuclear Engineering; M.B.A., Business Administration; B.S., Physics; 39 years of industry and government experience including nuclear power plant and production reactor operations, systems engineering, reactor engineering, fuels engineering, criticality analysis, safety analysis, nuclear power plant emergency response, and project management	Waste Management; Uranium Fuel Cycle; Human Health
Jennifer Davis	B.A., Historic Preservation and Classical Civilization (Archaeology); 5 years of archaeological fieldwork; 20 years of experience in NEPA compliance, project management, cultural resources impact analysis, and National Historic Preservation Act Section 106 consultations	Project Manager; Historic and Cultural Resources
Jerry Dozier	M.S., Reliability Engineering; M.B.A., Business Administration; B.S., Mechanical Engineering; 30 years of experience including operations, reliability engineering, technical reviews, and NRC branch management	Postulated Accidents; Severe Accident Mitigation Alternatives

List of Preparers

Name	Education/Expertise	Contribution
Kevin Folk	M.S., Environmental Biology; B.A., Geoenvironmental Studies; 33 years of experience in NEPA compliance; geologic, hydrologic, and water quality impacts analysis; utility infrastructure analysis, environmental regulatory compliance; and water supply and wastewater discharge permitting	Project Manager; Geologic Environment; Water Resources; Cumulative Effects; Greenhouse Gas Emissions
Lifeng Guo	Ph.D., M.S., Geology; B.S., Hydrogeology and Engineering Geology; Certified Professional Geologist; over 30 years of combined experience in hydrogeologic investigation, remediation, and research	Water Resources
Bob Hoffman	B.S., Environmental Resource Management; 35 years of experience in NEPA compliance, environmental impact assessment, alternatives identification and development, and energy facility siting	Alternatives; Meteorology, Air Quality, and Noise; Historic and Cultural Resources
Nancy Martinez	B.S., Earth and Environmental Science; A.M., Earth and Planetary Science; 9 years of experience in environmental impact analysis	Greenhouse Gas Emissions; Meteorology, Air Quality, and Noise; Socioeconomic Resources; Environmental Justice; Water Resources
Don Palmrose	B.S., Nuclear Engineering; M.S., Nuclear Engineering; Ph.D., Nuclear Engineering; 35 years of experience including operations on U.S. Navy nuclear powered surface ships, technical safety and NEPA analyses, nuclear authorization basis support for DOE, and NRC project management	Uranium Fuel Cycle; Postulated Accidents; Severe Accident Mitigation Alternatives; Human Health
Jeffrey Rikhoff	B.A., English; M.S., Development Economics; M.R.P., Regional Planning; 42 years of industry and government experience including 35 years in NEPA compliance, comprehensive land use and development planning, energy facility siting and permitting, socioeconomics, and environmental justice impact analysis, and historic and cultural resource impacts	Land Use; Socioeconomics; Environmental Justice; Alternatives; Cumulative Effects; Termination of Reactor Operations and Decommissioning

1 DOE = U.S. Department of Energy; NEPA = National Environmental Policy Act of 1969; NRC = U.S. Nuclear
2 Regulatory Commission.

1

Table 6-2 Pacific Northwest National Laboratory^(a) Preparers

Name	Education/Expertise	Contribution
Dave Anderson	B.S., Forest Resources; M.S., Forest Economics; 25 years of experience in NEPA compliance, socioeconomics, and environmental justice impact analysis	Socioeconomic Resources; Environmental Justice
Teresa Carlon	B.S., Information Technology; 25 years SharePoint Administer and database experience	Reference Coordinator
Garill Coles	B.S., Mechanical Engineering, 30 years of nuclear safety analysis, Probabilistic Risk Assessment, risk research, and review of risk-informed applications for NRC	Postulated Accidents; Severe Accident Mitigation Alternatives
Caitlin Condon	B.S., Environmental Health and Industrial Hygiene; Ph.D., Radiation Health Physics; 3 years of experience in NEPA compliance in human health, waste management/fuel cycle, and decommissioning	Human Health; Waste Management/Fuel Cycle; Decommissioning
Susan Ennor	B.J., Journalism; more than 40 years of experience in full-spectrum communications and document production services	Document production, technical editing/formatting
Julia Flaherty	B.S., Civil Engineering; M.S., Environmental Engineering; 17 years of experience in boundary layer meteorology, emergency response, project management, and NEPA	Meteorology, Air Quality, and Noise
Harish Gadey	B.S., Mechanical Engineering; M.S., Nuclear Engineering; Ph.D., Nuclear Engineering (Health Physics Minor); 6 years of experience in radiation detection, simulations, and spent fuel analysis	Human Health; Waste Management/Fuel Cycle; Decommissioning
Dave Goodman	B.S., Economics; J.D., Law; 12 years of experience in NEPA compliance, land use and visual resources, noise, and alternatives	Land Use and Visual Resources; Noise; Alternatives
Ellen Kennedy	B.A., Anthropology; M.A., Anthropology; 25 years of experience in NEPA and NHPA Section 106 assessment and consultation, and Tribal Nation engagement	Historic and Cultural Resources
Kim Leigh	B.S., Environmental Science; 20 years of experience in NEPA compliance, project management, and human health	Deputy Team Lead; Human Health

List of Preparers

Name	Education/Expertise	Contribution
Philip Meyer	B.A., Physics; M.S., Civil Engineering; Ph.D., Civil Engineering; 30 years of experience in the application of hydrologic principles to the solution of environmental and engineering problems, including 13 years of NEPA experience in water, soil, and geological resources impact evaluations	Groundwater Resources; Geological Environment; Cooling Water Systems
Ann Miracle	B.A., Biology; M.S., Population Genetics; Ph.D., Molecular Genetics; 12 years of experience in NEPA compliance and 25 years in ecological resources	Ecological Resources
Sadie Montgomery	B.S., Mathematics; 12 years of experience in GIS data processing, visualizations, and mapping	Geographic Information Systems
Jon Napier	B.S., Environmental Science; Ph.D. and M.S. in Radiation Health Physics; 3 years of experience in Radiological Air Monitoring Inspection and Licensing, 2 years of experience in Occupational Health Physics, 1 year experience in NEPA compliance, human health, waste management/fuel cycle, and decommissioning	Human Health; Waste Management/Fuel Cycle; Decommissioning
Tara O'Neil	B.A., Anthropology; MBA, Business Administration; 30 years of experience project management, NEPA compliance, environmental impact assessment, cultural resource compliance, NHPA Section 106 consultation, Tribal engagement	Historic and Cultural Resources; Program Management
Mike Parker	B.S., English Literature and Creative Writing; 25 years of experience copyediting, document design, and formatting and 20 years of experience in technical editing	Technical Editing
Rajiv Prasad	B.E., Civil Engineering; Master in Technology, Hydraulic and Water Resources Engineering; Ph.D., Civil and Environmental Engineering; 25 years of experience in applying hydrologic principles to water resources engineering, hydrologic design, flooding assessments, environmental engineering, and impacts assessment including 15 years of experience in NEPA environmental assessments of surface water resources	Water Resources
Bo Saulsbury	B.A., History; M.S., Planning; 35 years of experience in NEPA environmental assessment, land use, socioeconomics, and alternatives	Alternatives

Name	Education/Expertise	Contribution
Kacoli Sen	B.S., Zoology; M.S., Zoology (Ecology specialization); Ph.D., Cancer Biology, Diploma in Environmental Law; 3 years post-doctoral experience in cancer nanotherapeutics; and 3 years of editing experience	Document Production; Technical Editing/Formatting; References
Steven Short	M.S., Nuclear Engineering; M.B.A., Business Administration; B.S., Nuclear Engineering; 38 years of experience including nuclear safety analysis, probabilistic risk assessment, technical reviews of risk-informed license amendment requests and severe accident mitigation alternative analyses	Postulated Accidents; Severe Accident Mitigation Alternatives
Kazi Tamaddun	B.S., Civil Engineering; M.B.A., Business Administration; M.S., Civil and Environmental Engineering; Ph.D., Civil and Environmental Engineering; 8 years of experience in hydrologic, hydraulic, ecosystem, and water systems modeling; hydro-climatology; climate change modeling and analysis	Water Resources
Kenneth Thomas	B.S., Mathematics; M.S., Mathematics; 35 years of experience in operations in Navy nuclear and conventional powered surface ships, and teaching at Naval Nuclear Power Training Command; training, operations, and emergency preparedness at two commercial nuclear power plants; nuclear reactor licensing, policy and rulemaking at the NRC; and emergency management policy at NNSA	Senior Advisor; Nuclear power plant operations and infrastructure
Katie Wagner	B.S., Biology; M.S., Biology; 12 years of experience in project management and aquatic ecology; 8 years of experience in NEPA compliance and ecological resources	Team Lead; Ecological Resources

1 DOE = U.S. Department of Energy; GIS = geographic information system; NEPA = National Environmental Policy Act
2 of 1969; NHPA = National Historic Preservation Act; NNSA = National Nuclear Security Administration; NRC = U.S.
3 Nuclear Regulatory Commission.
4 (a) Pacific Northwest National Laboratory is managed for the U.S. Department of Energy by Battelle Memorial
5 Institute.

7.0 DISTRIBUTION LIST

1		
2	George Brozowski	U.S. Environmental Protection Agency (EPA), Region 6
3	Glenn Corbin	Texas Department of State Health Services, Radiation Control
4		Program
5	Cliff Custer	Preferred Licensing Services, Inc.
6	Lloyd Generette	EPA, Region 4
7	Arun Kapur	Duke Energy
8	Peter Kissinger	Nuclear Energy Institute
9	Thomas Lentz	Energy Harbor
10	Tony Leshinskie	Vermont Public Service Department
11	Beckie Maddox	Exelon
12	Lisa Matis	Tetra Tech
13	Alexandra McCleary	San Manuel Band of Mission Indians, California
14	Richard Orthen	Private Citizen
15	Joseph Rustick	EPA
16	Maggie Sager	National Oceanic and Atmospheric Administration (NOAA)
17		Fisheries
18	Jay Santillan	EPA
19	Daniel Schultheisz	EPA
20	Alberto Sifuentes	Federal Emergency Management Agency
21	Amanetta Somerville	EPA, Region 4
22	Allison Stalker	Exelon Generation
23	Robert Tomiak	EPA, Office of Federal Activities
24	Rachel Turney-Work	Enercon Services, Inc.
25	Steve Vance	Cheyenne River Sioux Tribe

8.0 GLOSSARY

- 1
- 2 **absorbed dose:** The energy imparted by ionizing radiation per unit mass of tissue. The units
3 of absorbed dose are the rad and the gray (Gy).
- 4 **acid:** A solution with a potential of hydrogen (pH) measurement less than 7.
- 5 **acid rain:** Also called acid precipitation or acid deposition, acid rain is precipitation containing
6 harmful amounts of nitric and sulfuric acids formed from the smokestacks of coal and oil burning
7 power plants and from nitrogen oxides emitted by motor vehicles. It can be wet precipitation
8 (rain, snow, or fog) or dry precipitation (absorbed gaseous and particulate matter, aerosol
9 particles, or dust). The term pH is a measure of acidity or alkalinity and ranges from 0 to 14. A
10 pH measurement of 7 is regarded as neutral. Normal rain has a pH of about 5.6, which is
11 slightly acidic. Acid rain has a pH below 5.6.
- 12 **activation products:** Radionuclides produced from the interaction of radiation with matter.
13 Generally it is the neutrons that interact with stable atoms and make them radioactive.
- 14 **activity:** The rate of disintegration (transformation) or decay of radioactive material. The units
15 of radioactivity are the curie (Ci) and the Becquerel (Bq).
- 16 **acute effects:** Effects resulting from short-term exposure to relatively high levels of a stressing
17 factor (e.g., contaminant, disease, electromagnetic field, noise, and radionuclides) over long
18 periods.
- 19 **acute radiation exposure:** A single accidental exposure to high doses of radiation for a short
20 period of time, which may produce biological effects within a short time after exposure.
- 21 **adverse environmental impacts:** Impacts that are determined to be harmful to the
22 environment.
- 23 **Advisory Council on Historic Preservation (ACHP):** Established by the National Historic
24 Preservation Act of 1966, the Advisory Council on Historic Preservation is an independent
25 Federal agency that promotes the preservation, enhancement, and productive use of the
26 nation's historic resources *and advises the President and the Congress on national historic*
27 *preservation policy.* The agency provides guidance on the application of Federal law
28 concerning cultural resources and serves as an arbiter when disputes arise.
- 29 **aerobic:** Requiring the presence of oxygen to support life.
- 30 **air quality:** Assessment of the health-related and visual characteristics of the air often derived
31 from quantitative measurements of the concentrations of specific injurious or contaminating
32 substances. Air quality standards are the prescribed levels of substances in the outside air that
33 cannot be exceeded during a specific time in a specified area.
- 34 **ALARA:** Acronym for “as low as (is) reasonably achievable.” This means making every
35 reasonable effort to maintain exposures to ionizing radiation as far below the dose limits as
36 practical, consistent with the purpose for which the licensed activity is undertaken, taking into
37 account the state of technology, the economics of improvements in relation to state of
38 technology, the economics of improvements in relation to benefits to the public health and

Glossary

- 1 safety, and other societal and socioeconomic considerations, and in relation to utilization of
2 nuclear energy and licensed materials in the public interest (see 10 CFR 20.1003).
- 3 **alkalinity:** The capacity of water to neutralize acids; a property imparted by the water's content
4 of carbonate, bicarbonate, hydroxide, and on occasion borate, silicate, and phosphate.
- 5 **alluvial:** Refers to soil or unconsolidated sediment that has been deposited by running water,
6 as in a riverbed, floodplain, or delta.
- 7 **alluvial aquifer:** An aquifer composed of alluvial sediments, generally located in a river valley.
- 8 **alternatives to the proposed action considered in the license renewal generic**
9 **environmental impact statement (LR GEIS):** (1) Not renewing the operating licenses of
10 commercial nuclear power plants (no action alternative). This is the only alternative to the
11 proposed action that is within the NRC's decision-making authority; (2) replacing existing
12 nuclear generating capacity with other energy sources (including fossil energy generation, new
13 nuclear generation, and renewable energy); (3) compensating for lost nuclear generation
14 capacity by using demand-side management (conservation) or purchasing power.
- 15 **ambient air:** The surrounding atmosphere as it exists around people, plants, and structures.
- 16 **ambient noise level:** The level of acoustic noise at a given location, such as in a room or
17 outdoors, that is representative of typical conditions unaffected by human activities.
- 18 **ambient water temperature:** The water temperature in a water body that is representative of
19 typical conditions unaffected by human activities (e.g., the temperature of the surface water
20 body away from the thermal effluent).
- 21 **anadromous:** Pertaining to fish that spend a part of their life cycle in the sea and return to
22 freshwater streams to spawn; for example, salmon, steelhead, and shad.
- 23 **annual dose:** Dose received in one year.
- 24 **anoxic:** Absence of oxygen. Usually used in reference to an aquatic habitat when the water
25 becomes completely depleted of oxygen and results in the death of any organism that requires
26 oxygen for survival.
- 27 **anthropogenic:** Made or generated by a human or caused by human activity.
- 28 **aquatic biota:** Consisting of, relating to, or being in water; living or growing in, or near the
29 water. An organism that lives in, on, or near the water.
- 30 **aquifer:** An underground layer of permeable, unconsolidated sediments or porous or fractured
31 bedrock that yields usable quantities of water to a well or spring.
- 32 **Archaeological Resources Protection Act of 1979:** Requires Federal permitting for
33 excavation or removal of archaeological resources from public or Native American lands.
- 34 **area of potential effect (APE):** The geographic area or areas within which an undertaking may
35 directly or indirectly cause alterations in the character or use of historic properties, if any such
36 properties exist. The APE for a license renewal action is the area at the power plant site and its

- 1 immediate environs and viewshed that may be impacted by post-license renewal land-disturbing
2 operations or possible refurbishment activities associated with the proposed action. The APE
3 may extend beyond the immediate environs in those instances where post-license renewal land-
4 disturbing operations or projected refurbishment activities specifically related to license renewal
5 may potentially have an effect on known or proposed historic sites. This determination is made
6 irrespective of ownership or control of the lands of interest (see also 36 FR 800.16(d)).
- 7 **Atomic Energy Act (AEA):** The AEA of 1954 is a United States Federal law that is, according
8 to the Nuclear Regulatory Commission, “the fundamental U.S. law on both the civilian and the
9 military uses of nuclear materials.” It covers the laws for the “development and the regulation of
10 the uses of nuclear materials and facilities in the United States.” It was an amendment to the
11 AEA of 1946 and substantially refined certain aspects of the law, including increased support for
12 the possibility of a civilian nuclear industry.
- 13 **attainment:** An area is deemed in attainment by the U.S. Environmental Protection Agency
14 (EPA) when the air quality is monitored and the resultant concentrations are found to be
15 consistently below the National Ambient Air Quality Standards (NAAQS). Areas can be in
16 attainment for some pollutants, while designated as nonattainment for others. Some areas are
17 designated as “maintenance” areas. These are regions that were initially designated as
18 attainment or unclassifiable and have since attained compliance with the NAAQS.
- 19 **attenuation:** The reduction or lessening in amount, such as in the concentration or effects of a
20 pollutant.
- 21 **auxiliary buildings:** Auxiliary buildings house support systems, such as the ventilation system,
22 emergency core cooling system, laundry facilities, water treatment system, and waste treatment
23 system. An auxiliary building may also contain the emergency diesel generators and, in some
24 pressurized water reactors, the fuel storage facility. The facility’s control room is often located in
25 the auxiliary building.
- 26 **avian:** Of, relating to, or characteristic of birds.
- 27 **background radiation:** Radiation from cosmic sources; naturally occurring radioactive
28 material, including radon (except as a decay product of source or special nuclear material); and
29 global fallout as it exists in the environment from the testing of nuclear explosive devices or from
30 past nuclear accidents such as Chernobyl and are not under the control of the licensee.
31 Background radiation does not include radiation from sources, by-products, or special nuclear
32 materials regulated by the Commission.
- 33 **baseline:** A quantitative expression of conditions, costs, schedule, or technical progress that
34 constitutes the standard against which to measure the performance of an effort. For National
35 Environmental Policy Act evaluations, baseline is defined as the existing environmental
36 conditions against which impacts of the proposed action and its alternatives can be compared.
37 The environmental baseline is the site environmental conditions as they exist or are estimated
38 to exist in the absence of the proposed action.
- 39 **becquerel:** The unit of radioactive decay equal to 1 disintegration per second. 37 billion
40 (3.7×10^{10}) becquerels = 1 curie.

Glossary

- 1 **BEIR reports:** Series of reports issued by the National Research Council to advise the Federal
2 government on the relationship between exposure to ionizing radiation and human health. BEIR
3 stands for Biological Effects of Ionizing Radiation.
- 4 **benthic:** Of, relating to, or occurring at the bottom of a body of water.
- 5 **Best Available Control Technology (BACT):** A pollution control standard created by the EPA
6 that is used to determine what air pollution control technology will be used to control a specific
7 pollutant to a specified limit.
- 8 **best management practice (BMP):** A practice or combination of pollution control techniques
9 that aim to reduce pollution.
- 10 **beta particle:** An electron that is ejected from the nucleus of a radioactive atom. It is much
11 lighter than an alpha particle and can travel a longer distance in air compared to an alpha
12 particle, but can still be stopped by a thin sheet of aluminum foil.
- 13 **bioamplification:** Also known as biological magnification and bioconcentration, is the
14 progressive increase in the concentration of chemical contaminants (e.g., dichloro-diphenyl-
15 trichloroethane, polychlorinated biphenyls, methyl mercury) from the bottom of the food chain
16 (e.g., bacteria, phytoplankton, zooplankton) to the top of the food chain (e.g., fishing-eating birds
17 such as a bald eagle).
- 18 **bioavailability:** The degree to which chemicals can be taken up by organisms.
- 19 **biocide:** A chemical agent, such as a pesticide, that is used to kill and control living organisms.
- 20 **biological assessment:** Information prepared by or under the direction of the Federal agency
21 concerning listed and proposed species and designated and proposed critical habitat that may
22 be present in the action area and the evaluation of potential effects of the action on such
23 species and habitat.
- 24 **biomass:** Organic nonfossil material of biological origin constituting a renewable energy
25 source.
- 26 **biota:** The combined flora and fauna of a region.
- 27 **bituminous coal:** A dense black or brown coal that has on average 45–86 percent carbon by
28 weight and a heating value as much as five times greater than lignite coal. U.S. deposits are
29 100–300 million years old and are found primarily in the states of West Virginia, Kentucky, and
30 Pennsylvania, with lesser amounts in the Midwest. Bituminous coal is the most abundant rank
31 of coal in the United States. It is used primarily to produce electricity, and in the industrial
32 sector, to produce heat and process steam and as a starting material for the production of coke,
33 an intensely hot-burning derivative fuel used in the steel industry.
- 34 **blast furnace:** A furnace in which solid fuel (coke) is burned with an air blast to smelt ore.
- 35 **blowdown:** Continual or periodic purging of a circulating working fluid to prevent buildup of
36 impurities in the fluid.

- 1 **boiler:** A device for generating steam for power, processing, or heating purposes; or hot water
2 for heating purposes or hot water supply. Heat from an external combustion source is
3 transmitted to a fluid contained within the tubes found in the boiler shell. This fluid is delivered
4 to an end-use at a desired pressure, temperature, and quality.
- 5 **boiling water reactor (BWR):** A reactor in which water, used as both coolant and moderator,
6 boils in the core to produce steam, which drives a turbine connected to an electrical generator,
7 thereby producing electricity.
- 8 **brownfield site:** Abandoned, idled, or under-used industrial and commercial facilities in which
9 expansion or redevelopment is sometimes complicated by real or perceived environmental
10 contaminations. (See also greenfield site).
- 11 **Btu:** British thermal unit. A measure of the energy required to raise the temperature of one
12 pound of water by one degree Fahrenheit.
- 13 **burnup spent fuel:** See spent-fuel burnup.
- 14 **cap and trade:** An environmental policy instrument used by governments to limit the amount of
15 pollutants emitted to the environment. The total emissions are capped at a specified level but
16 polluters can trade the emission allowances among themselves as long as the total amount is
17 not exceeded.
- 18 **capacity:** See generator capacity.
- 19 **capacity factor:** The actual energy output of an electricity-generating device divided by the
20 energy output that would be produced if it operated at its rated power output for the entire year.
21 Generally expressed as percentage.
- 22 **capacity rating:** See rated power.
- 23 **carbon:** A naturally abundant nonmetallic element that occurs in many inorganic and in all
24 organic compounds, which exists freely as graphite and diamond and as a constituent of coal,
25 limestone, and petroleum. Carbon is capable of chemical self-bonding to form an enormous
26 number of chemically, biologically, and commercially important molecules. Carbon's atomic
27 number is 6.
- 28 **carbon capture and storage:** Refers to the capture of carbon dioxide generated at fossil-
29 fueled power plants and the storing of carbon dioxide so it is not released into the air.
30 Underground storage media are being investigated for this feasibility (e.g., abandoned mines,
31 depleted oil or natural gas fields, and other types of geologic media).
- 32 **carbon monoxide (CO):** A colorless, odorless gas formed when carbon in fuel is not burned
33 completely. Motor vehicle exhaust is a major contributor to nationwide CO emissions, followed
34 by other engines and vehicles. CO interferes with the blood's ability to carry oxygen to the
35 body's tissues and results in numerous adverse health effects. CO is listed as a criteria air
36 pollutant under Title I of the Clean Air Act.
- 37 **carbonaceous:** Consisting of, containing, relating to, or yielding carbon.
- 38 **carbon sequestration:** See carbon capture and storage.

Glossary

- 1 **carcinogenesis:** The process by which normal cells are transformed into cancer cells.
- 2 **cask:** A heavily shielded container used to store and/or ship radioactive materials. Lead and
3 steel are common materials used in the manufacture of casks.
- 4 **Category 1 issue:** Environmental impact issues that meet all of the following criteria: (1) the
5 environmental impacts associated with the issue have been determined to apply either to all
6 nuclear plants or, for some issues, to nuclear plants that have a specific type of cooling system
7 or other specified plant or site characteristics; (2) a single significance level (i.e., small,
8 moderate, or large) has been assigned to the impacts (except for collective offsite radiological
9 impacts from the fuel cycle and from high-level waste and spent fuel disposal); (3) mitigation of
10 adverse impacts associated with the issue has been considered in the analysis, and it has been
11 determined that additional plant-specific mitigation measures are likely not to be sufficiently
12 beneficial to warrant implementation. For issues that meet the three Category 1 criteria, no
13 additional plant-specific analysis is required in future supplemental environmental impact
14 statements unless new and significant information is identified.
- 15 **Category 2 issue:** Environmental impact issues that do not meet one or more of the criteria of
16 Category 1, and, therefore, additional plant-specific review for these issues is required.
- 17 **cesium:** A metal that may be stable (nonradioactive) or unstable (radioactive). The most
18 common radioactive form of cesium is cesium-137. Another fairly common radioisotope is
19 cesium-134.
- 20 **chain reaction:** A reaction that initiates its own repetition. In a fission chain reaction, a
21 fissionable nucleus absorbs a neutron and fissions spontaneously, releasing additional
22 neutrons. These, in turn, can be absorbed by other fissionable nuclei, releasing more neutrons.
23 A fission chain reaction is self-sustaining when the number of neutrons released in a given time
24 equals or exceeds the number of neutrons lost by absorption in nonfissionable material or by
25 escape from the system.
- 26 **chlorinated hydrocarbons:** Organic compounds made up of atoms of carbon, hydrogen, and
27 chlorine. All chlorinated hydrocarbons have a carbon-chlorine bond. Sometimes hydrogen is
28 not present at all, as in carbon tetrachloride. Examples of chlorinated hydrocarbons include
29 dichloro-diphenyl-trichloroethane and polychlorinated biphenyls. Chlorinated hydrocarbons tend
30 to be very long-lived and persistent in the environment; they tend to be toxic; and they tend to
31 accumulate in the food web and undergo bioamplification.
- 32 **chronic effects:** Effects resulting from exposure to low levels of a stressing factor
33 (e.g., contaminant, disease, electromagnetic field, noise, and radionuclides) over long periods.
- 34 **chronic radiation exposure:** Long-term, low-level overexposure to radiation or radioactive
35 materials.
- 36 **cladding:** The thin-walled metal tube that forms the outer jacket of a nuclear fuel rod. It
37 prevents corrosion of the fuel by the coolant and the release of fission products into the coolant.
38 Aluminum, stainless steel, and zirconium alloys are common cladding materials.
- 39 **Class I areas (Clean Air Act):** Class I areas are Federally owned properties for which air
40 quality-related values are highly prized and for which no diminution of air quality, including
41 visibility, can be tolerated. Class I areas fall under the stewardship of four Federal agencies: the

- 1 U.S. Bureau of Land Management, National Park Service, U.S. Fish and Wildlife Service, and
2 the U.S. Forest Service. Air quality impacts in Class I areas are strictly limited, while restrictions
3 in Class II areas are less strict.
- 4 **Class II areas (Clean Air Act):** See Class I areas.
- 5 **Class 2B carcinogenic:** Agents (e.g., electromagnetic fields) or substances that are possibly
6 carcinogenic to humans.
- 7 **Clean Air Act (CAA):** Establishes NAAQS and requires facilities to comply with emission limits
8 or reduction limits stipulated in State Implementation Plans. Under this act, construction and
9 operating permits, as well as reviews of new stationary sources and major modifications to
10 existing sources, are required. The Act also prohibits the Federal government from approving
11 actions that do not conform to State Implementation Plans.
- 12 **clean coal technologies:** Technologies that would allow the continued use of coal (or coal-
13 derived synthetic fuels) for electricity production, while at the same time, mitigating the potential
14 adverse impacts to air quality and guaranteeing compliance with regulatory requirements.
15 Clean coal initiatives include coal-cleaning processes to remove constituents that would
16 ultimately be converted to problematic pollutants during combustion, synthesis of clean
17 derivative fuels through coal gasification technologies, improved combustion technologies, and
18 improved devices, and ancillary support systems for capturing and sequestering pollutants.
- 19 **Clean Water Act (CWA):** An Act, which amended the Federal Water Pollution Control Act,
20 requiring National Pollutant Discharge Elimination System (NPDES) permits for discharges of
21 effluents to surface waters, permits for stormwater discharges related to industrial activity,
22 permits for discharges to or dredging of wetlands, notification of oil discharges to navigable
23 waters of the United States, and water quality certification from the State in which the discharge
24 will occur.
- 25 **climatology:** The meteorological study of climates and their phenomena.
- 26 **closed-cycle cooling:** In this type of cooling water system, the cooling water is recirculated
27 through the condenser after the waste heat is removed by dissipation to the atmosphere,
28 usually by circulating the water through large cooling towers constructed for that purpose.
- 29 **coal:** A readily combustible black or brownish-black rock whose composition, including inherent
30 moisture, consists of more than 50 percent by weight and more than 70 percent by volume of
31 carbonaceous material. It is formed from plant remains that have been compacted, hardened,
32 chemically altered, and metamorphosed by heat and pressure over geologic time.
- 33 **coal combustion wastes:** Wastes produced from the combustion of coal, which contains
34 concentrated levels of numerous contaminants, particularly metals like arsenic, mercury, lead,
35 chromium, cadmium, and radioactive elements found naturally in coal.
- 36 **coal gasification:** The process of converting coal into gas. The basic process involves
37 crushing coal to a powder, which is then heated in the presence of steam and oxygen to
38 produce a gas. The gas is then refined to reduce sulfur and other impurities. The gas can be
39 used as a fuel or processed further and concentrated into chemical or liquid fuel.

Glossary

- 1 **Code of Federal Regulations (CFR):** The codification of the general and permanent rules
2 published in the *Federal Register* by the executive departments and agencies of the Federal
3 government. It is divided into 50 titles that represent broad areas subject to Federal regulation.
4 Each volume of the CFR is updated once each calendar year and is issued on a quarterly basis.
- 5 **co-firing:** The process of burning natural gas in conjunction with another fuel to reduce air
6 pollutants.
- 7 **cold shutdown:** The term used to define a reactor coolant system at atmospheric pressure
8 and at a temperature below 200 degrees Fahrenheit following a reactor cooldown.
- 9 **collective dose:** The sum of the individual doses received in a given period by a specified
10 population from exposure to a specified source of radiation.
- 11 **combined cycle:** A technology through which electricity is produced from otherwise lost waste
12 heat exiting from one or more gas (combustion) turbines. The exiting heat is routed to a
13 conventional boiler or to a heat recovery steam generator for utilization by a steam turbine in the
14 production of electricity. This process increases the efficiency of the electric generating unit.
- 15 **combustion:** Chemical oxidation accompanied by the generation of energy, typically in the
16 form of light and heat.
- 17 **committed dose equivalent:** The dose equivalent to organs or tissues of reference that will be
18 received from an intake of radioactive material by an individual during the 50-year period
19 following the intake.
- 20 **compact:** A group of two or more States formed to dispose of low-level radioactive waste on a
21 regional basis. The Low-Level Radioactive Waste Policy Act of 1980 encouraged States to form
22 compacts to ensure continuing low-level waste disposal capacity. As of December 2000,
23 44 States have formed 10 compacts. No compact has successfully sited and constructed a
24 disposal facility.
- 25 **condenser:** A large heat exchanger designed to cool exhaust steam from a turbine below the
26 boiling point so that it can be returned to the heat source as water. In a pressurized water
27 reactor, the water is returned to the steam generator. In a boiling water reactor, it returns to the
28 reactor core. The heat removed from the steam by the condenser is transferred to a circulating
29 water system and is exhausted to the environment, either through a cooling tower or directly into
30 a body of water.
- 31 **coniferous:** Of or relating to or part of trees or shrubs bearing cones and evergreen leaves.
- 32 **containment or reactor building:** The containment or reactor building in a pressurized water
33 reactor is a massive concrete or steel structure that houses the reactor vessel, reactor coolant
34 piping and pumps, steam generators, pressurizer, pumps, and associated piping. The reactor
35 building structure of a BWR generally includes a containment structure and a shield building.
36 The BWR containment reactor building is a massive concrete or steel structure that houses the
37 reactor vessel, the reactor coolant piping and pumps, and the suppression pool. It is located
38 inside a somewhat less substantive structure called the shield building. The shield building for a
39 BWR also generally contains the spent fuel pool and the new fuel pool. The reactor building for
40 both pressurized water reactor s and BWRs is designed to withstand natural disasters, such as
41 hurricanes and earthquakes. The containment's ability to withstand such events and to contain

- 1 the effects of accidents initiated by system failures constitutes the principal protection against
2 releasing radioactive material to the environment.
- 3 **cooling pond:** A natural or man-made body of water that is used for dissipating waste heat
4 from power plants.
- 5 **cooling tower:** Structures designed to remove excess heat from the condenser without
6 dumping the heated cooling water directly into water bodies, such as lakes or rivers. There are
7 two principal types of cooling towers: mechanical draft towers and natural draft towers. Most
8 nuclear plants that have once-through cooling do not rely on cooling towers. However, five
9 facilities with once-through cooling also have cooling towers.
- 10 **cooling tower drift:** Water lost from a cooling tower in the form of liquid droplets entrained in
11 the exhaust air. Drift is independent of water lost through evaporation. Units may be in lb/hr or
12 a percentage of circulating water flow. Drift eliminators control this loss from the tower.
- 13 **cooling water intake structure:** The structure and any associated constructed waterways
14 used to withdraw cooling water from water bodies. The cooling water intake structure extends
15 from the point at which water is withdrawn from the surface water source to the first intake pump
16 or series of pumps.
- 17 **corona discharge:** The electrical breakdown of air into charged particles that results in the
18 creation of ions or charged particles in air due to electric field discharge near transmission lines,
19 most noticeable during thunder or rainstorms. Corona is a phenomenon associated with all
20 energized transmission lines. It is the electrical breakdown of air into charged particles. The
21 phenomenon appears as a bluish-purple glow on the surface of and adjacent to a conductor
22 when the voltage gradient exceeds a certain critical value, thereby producing light, audible noise
23 (described as crackling or hissing), and ozone.
- 24 **Council on Environmental Quality (CEQ):** Established by the National Environmental Policy
25 Act (NEPA). Council on Environmental Quality regulations (40 CFR Parts 1500–1508) describe
26 the process for implementing NEPA, including preparation of environmental assessments and
27 environmental impact statements, and the timing and extent of public participation.
- 28 **criteria pollutants:** A group of very common air pollutants whose presence in the environment
29 is regulated by the EPA on the basis of certain criteria (information on health and/or
30 environmental effects of pollution). Criteria air pollutants are widely distributed all over the
31 United States. There are six common air pollutants for which National Ambient Air Quality
32 Standards have been established by the EPA under Title I of the Clean Air Act: sulfur dioxide,
33 nitrogen oxides, carbon monoxide, ozone, particulate matter (PM_{2.5} and PM₁₀), and lead.
34 Standards were developed for these pollutants on the basis of scientific knowledge about their
35 health and environmental effects.
- 36 **critical habitat:** Specific geographic areas, whether occupied by a listed species or not, that
37 are essential for its conservation and that have been formally designated by rules published in
38 the *Federal Register*.
- 39 **criticality:** A term used in reactor physics to describe the state when the number of neutrons
40 released by fission is exactly balanced by the neutrons being absorbed (by the fuel and
41 poisons) and escaping the reactor core. A reactor is said to be “critical” when it achieves a
42 self-sustaining nuclear chain reaction, as when the reactor is operating.

Glossary

- 1 **crude oil:** A mixture of hydrocarbons that exists in liquid phase in natural underground
2 reservoirs and remains liquid at atmospheric pressure after passing through surface separating
3 facilities. Depending upon the characteristics of the crude stream, it may also include: (1) small
4 amounts of hydrocarbons that exist in the gaseous phase in natural underground reservoirs but
5 are liquid at atmospheric pressure; (2) small amounts of nonhydrocarbons produced with the oil,
6 such as sulfur and various metals, and (3) drip gases and liquid hydrocarbons produced from tar
7 sands, oil sands, gilsonite, and oil shale.
- 8 **cultural resources:** The remains of past human activities that have historic or cultural
9 meaning. They include archaeological sites (e.g., precontact campsites and villages), historic-
10 era resources (e.g., farmsteads, forts, and canals), and traditional cultural properties
11 (e.g., resource collection areas and sacred areas). Culture is understood to mean the traditions,
12 beliefs, practices, lifeways, arts, crafts, and social institutions of any community, be it an Indian
13 Tribe, a local ethnic group, or the people of the nation as a whole (see also National Park
14 Service Bulletin #38).
- 15 **cumulative dose:** The total dose resulting from repeated or prolonged exposures to ionizing
16 radiation over time.
- 17 **cumulative impacts:** The impacts on the environment that result from the incremental impacts
18 of an action when added to other past, present, and reasonably foreseeable future actions,
19 regardless of what agency (Federal or nonfederal) or person undertakes such other actions.
- 20 **cumulative risk:** The risk of a common toxic effect associated with concurrent exposure by all
21 relevant pathways and routes of exposure to a group of chemicals that share a common
22 mechanism of toxicity.
- 23 **curie (Ci):** The basic unit used to describe the intensity of radioactivity in a sample of material.
24 The curie is equal to 37 billion (3.7×10^{10}) disintegrations per second, which is approximately
25 the activity of 1 gram of radium. A curie is also a quantity of any radionuclide that decays at a
26 rate of 37 billion disintegrations per second. It is named for Marie and Pierre Curie, who
27 discovered radium in 1898.
- 28 **decibel, A-weighted (dBA):** A standard unit for the measure of the relative loudness or
29 intensity of sound. The relative intensity is the ratio of the intensity of a sound wave to a
30 reference intensity. In general, a sound doubles in loudness with every increase of 10 dB. By
31 convention, the intensity level of sound at the threshold of hearing for a young healthy individual
32 is 0 dB.
- 33 **deciduous:** Trees and shrubs that shed their leaves on an annual cycle.
- 34 **decommissioning:** The process of closing down a facility followed by reducing residual
35 radioactivity to a level that permits the release of the property for unrestricted use or restricted
36 use (see 10 CFR 20.1003).
- 37 **DECON:** A method of decommissioning in which the equipment, structures, and portions of a
38 facility and site containing radioactive contaminants are removed and safety buried in a
39 low-level radioactive waste landfill or decontaminated to a level that permits the property to be
40 released for unrestricted use shortly after cessation of operations.

- 1 **decontamination:** Removal of unwanted radioactive or hazardous contamination by a
2 chemical or mechanical process.
- 3 **deep-dose equivalent:** The dose equivalent at a tissue depth of 1 cm; applies to external
4 whole-body exposure.
- 5 **demand-side management:** The planning, implementation, and monitoring of utility activities
6 designed to encourage consumers to modify patterns of electricity usage, including the timing
7 and level of electricity demand. It only refers to energy and load-shape modifying activities that
8 are undertaken in response to utility-administered programs. It does not refer to energy and
9 load-shaped changes arising from the normal operation of the marketplace or from government-
10 mandated energy-efficiency standards. Demand-side management covers the complete range
11 of load-shape objectives, including strategic conservation and load management, as well as
12 strategic load growth.
- 13 **demographics:** A term used to describe specific population characteristics such as age,
14 gender, education, and income level.
- 15 **densitometer:** An apparatus for measuring the optical density of a material, such as a
16 photographic negative.
- 17 **depleted uranium:** Uranium having a percentage of uranium-235 smaller than the 0.7 percent
18 found in natural uranium. It results from uranium isotope enrichment operations.
- 19 **deposition:** The laying down of matter by a natural process (e.g., the settling of particulate
20 matter out of air or water onto soil or sediment surfaces).
- 21 **design-basis accident:** A postulated accident that a nuclear facility must be designed and built
22 to withstand without loss to the systems, structures, and components necessary to ensure
23 public health and safety.
- 24 **desquamation:** To shed, peel, or come off in scales.
- 25 **detritus:** Dead, decaying plant material.
- 26 **dewatering:** To remove or drain water from an area.
- 27 **dielectric:** A nonconductor of electricity.
- 28 **diesel generator:** An electric generator that runs on diesel fuel.
- 29 **diffusion:** A process in which substances are transported from one area to another due to
30 differences in the concentration of that material or in temperature.
- 31 **disposal:** The act of placing unwanted materials in an area with the intent of not recovering in
32 the future.
- 33 **dissolved gas:** Gas dissolved in water or in other liquid without change in its chemical
34 structure.

Glossary

- 1 **dissolved oxygen:** Oxygen dissolved in water. Dissolved oxygen is necessary for the life of
2 fish and most other aquatic organisms, and is one of the most important indicators of the
3 condition of a water body.
- 4 **dose:** The absorbed dose, given in rads (or in SI units, grays), that represents the energy
5 absorbed from the radiation in a gram of any material. The biological dose or dose equivalent,
6 given in rem or sieverts, is a measure of the biological damage to living tissue from radiation
7 exposure.
- 8 **dose equivalent:** The product of the absorbed dose in tissue, quality factor, and all other
9 modifying factors at the location of interest. The units of dose equivalent are the rem and
10 sievert.
- 11 **dose rates:** The ionizing radiation dose delivered per unit of time (e.g., rem or sieverts per
12 hour).
- 13 **dosimeter:** A small, portable instrument (such as a film badge or thermoluminescent or pocket
14 dosimeter) for measuring and recording the total accumulated personal dose of ionizing
15 radiation.
- 16 **dredging:** Removing accumulated sediments from a water body to increase depth or remove
17 contaminants.
- 18 **dry cask:** Large, rugged container made of steel or steel-reinforced concrete, 18 or more
19 inches thick. A cask uses materials like steel, concrete and lead—instead of water—as a
20 radiation shield.
- 21 **dry cask storage:** A method for storing spent nuclear fuel (see dry cask).
- 22 **dry steam:** Geothermal plants that use the steam from the geothermal reservoir as it comes
23 from wells, and route it directly through turbine/generator units to produce electricity.
- 24 **dual-fired unit:** A generating unit that can produce electricity using two or more input fuels. In
25 some of these units, only the primary fuel can be used continuously; the alternate fuel(s) can be
26 used only as a start-up fuel or in emergencies.
- 27 **earthquake:** A sudden ground motion or vibration of the earth. It can be produced by a rapid
28 release of stored-up energy along an active fault in the earth's crust.
- 29 **ecoregion:** A geographically distinct area of land that is characterized by a distinctive climate,
30 ecological features, and plant and animal communities.
- 31 **ecosystem:** A group of organisms and their physical environment interacting and functioning
32 as a unit.
- 33 **effective dose equivalent:** The sum of the products of the dose equivalent to the organ or
34 tissue and the weighting factors applicable to each of the body organs or tissues that are
35 irradiated.
- 36 **effluent:** Wastewater (treated or untreated) that flows out of a treatment plant, sewer, or
37 industrial outfall. This term generally refers to wastes discharged into surface waters.

- 1 **electric power:** The rate at which electric energy is transferred. Electric power is measured by
2 capacity and is commonly expressed in megawatts (MW).
- 3 **electric power grid:** A system of synchronized power providers and consumers connected by
4 transmission and distribution lines and operated by one or more control centers. In the
5 continental United States, the electric power grid consists of three systems: the Eastern
6 Interconnect, the Western Interconnect, and the Texas Interconnect. In Alaska and Hawaii,
7 several systems encompass areas smaller than the State (e.g., the interconnect serving
8 Anchorage, Fairbanks, and the Kenai Peninsula).
- 9 **electricity:** A form of energy characterized by the presence and motion of elementary charged
10 particles generated by friction, induction, or chemical change.
- 11 **electricity generation:** The process of producing electric energy or the amount of electric
12 energy produced by transforming other forms of energy, commonly expressed in kilowatt
13 hours (kWh) or megawatt hours (MWh).
- 14 **electromagnetic field (EMF):** The field of energy resulting from the movement of alternating
15 electric current along the path of a conductor, composed of both electrical and magnetic
16 components and existing in the immediate vicinity of, and surrounding, the electric conductor.
17 Electromagnetic fields exist in both high-voltage electric transmission power lines and in
18 low-voltage electric conductors in homes and appliances.
- 19 **electromagnetic radiation:** A traveling wave motion resulting from changing electric or
20 magnetic fields. Familiar electromagnetic radiation ranges from x-rays (and gamma rays) of
21 short wavelength, through the ultraviolet, visible, and infrared regions, to radar and radio waves
22 of relatively long wavelength.
- 23 **endangered species:** Any species, plant or animal, that is in danger of extinction throughout
24 all or a significant part of its range. Requirements for declaring a species endangered are found
25 in the Endangered Species Act.
- 26 **Endangered Species Act of 1973 (ESA):** Requires consultation with the U.S. Fish and Wildlife
27 Service and/or the National Marine Fisheries Service to determine whether endangered or
28 threatened species or their habitats will be affected by a proposed activity and what, if any,
29 mitigation measures are needed to address the impacts.
- 30 **energy:** The capacity for doing work as measured by the capability of doing work (potential
31 energy) or the conversion of this capability to motion (kinetic energy). Energy has several
32 forms, some of which are easily convertible and can be changed to another form useful for
33 work. Most of the world's convertible energy comes from fossil fuels that are burned to produce
34 heat that is then used as a transfer medium to mechanical or other means in order to
35 accomplish tasks. Electrical energy is usually measured in kilowatt hours, while heat energy is
36 usually measured in British thermal units (Btu).
- 37 **energy demand:** The energy needed by consumers at any point in time for household,
38 business, or industrial purposes.
- 39 **Energy Information Administration:** An independent agency within the U.S. Department of
40 Energy (DOE) that develops surveys, collects energy data, and analyzes and models energy
41 issues. The Energy Information Administration must meet (1) the requests of Congress, other

Glossary

- 1 elements within the DOE, Federal Energy Regulatory Commission, and Executive Branch;
2 (2) its own independent needs; and (3) assist the general public or other interest groups, without
3 taking a policy position.
- 4 **energy supply:** Energy made available for use. Supply can be considered and measured from
5 the point of view of the energy provider or the receiver.
- 6 **ENTOMB:** A method of decommissioning nuclear facilities in which radioactive contaminants
7 are encased in a structurally long-lived material, such as concrete. The entombment structure
8 is appropriately maintained and continued surveillance is carried out until the radioactivity
9 decays to a level permitting unrestricted release of the property.
- 10 **entrainment:** The incorporation of all life stages of fish and shellfish with intake water flow
11 entering and passing through a cooling water intake structure and into a cooling water system.
- 12 **environmental assessment (EA):** A concise public document that a Federal agency prepares
13 under the National Environmental Policy Act to provide sufficient evidence and analysis to
14 determine whether a proposed action requires preparation of an environmental impact
15 statement or whether a Finding of No Significant Impact can be issued. An EA must include
16 brief discussions on the need for the proposed action and the environmental impacts of the
17 proposed action and the no action alternative.
- 18 **environmental impact statement (EIS):** A document required of Federal agencies by the
19 National Environmental Policy Act for major proposals or legislation that will or could
20 significantly affect the environment.
- 21 **environmental justice:** The fair treatment of people of all races, cultures, incomes, and
22 educational levels with respect to the development, implementation, and enforcement of
23 environmental laws, regulations, and policies.
- 24 **erosion:** The process where wind, water, ice, and other mechanical and chemical forces wear
25 away materials such as rocks and soil, breaking up particles and moving them from one place to
26 another.
- 27 **erythema:** Superficial reddening of the skin due to the dilatation of blood vessels. Erythema is
28 often a sign of infection or inflammation.
- 29 **essential fish habitat (EFH):** Those waters and substrates necessary to fish for spawning,
30 breeding, feeding or growth to maturity. EFH is protected under the Magnuson-Stevens Fishery
31 Conservation and Management Act of 1976.
- 32 **estuary:** A transitional zone along the coastline where ocean saltwater mixes with freshwater
33 from the land, subject to tidal influences. Estuaries are often semi-enclosed by land, but their
34 currents always have access to the open ocean.
- 35 **eutrophication:** A condition in an aquatic ecosystem where high nutrient concentrations
36 stimulate blooms of algae (e.g., phytoplankton). Algal decomposition may lower dissolved
37 oxygen concentrations. Although eutrophication is a natural process in the aging of lakes and
38 some estuaries, it can be accelerated by both point and nonpoint sources of nutrients.

- 1 **exceedance probability:** The average frequency with which an event (e.g., flood, earthquake)
2 of a particular magnitude will be exceeded during a certain length of time. Expressed as the
3 probability that a level will be exceeded in any year (the annual exceedance probability) or as
4 the average recurrence interval (e.g., a 100-year flood).
- 5 **exposure:** Being exposed to ionizing radiation, radioactive material, or other contaminants.
- 6 **external dose:** That portion of the dose equivalent received from radiation sources outside the
7 body.
- 8 **Farmland Protection Policy Act:** An Act whose purpose is to reduce the conversion of
9 farmland to nonagricultural uses as a result of Federal projects and programs. The Act requires
10 that Federal agencies comply to the fullest extent possible with state and local government
11 policies to preserve farmland. It includes a recommendation that evaluations and analyses of
12 prospective farmland conversion impacts be made early in the planning process—before a site
13 or design is selected—and that, where possible, agencies make such evaluations and analyses
14 part of the National Environmental Policy Act process.
- 15 **fault (geology):** A fracture or a zone of fractures within a rock formation along which vertical,
16 horizontal, or transverse slippage has occurred. A normal fault occurs when the hanging wall
17 has been depressed in relation to the footwall. A reverse fault occurs when the hanging wall
18 has been raised in relation to the footwall. A strike-slip fault occurs where two geologic plates
19 are sliding past each other and stress builds up between them.
- 20 **fecundity:** Number of eggs an animal produces during each reproductive cycle; the potential
21 reproductive capacity of an organism or population.
- 22 **Federal Energy Regulatory Commission:** Independent Federal agency with jurisdiction over
23 interstate electricity sales, wholesale electric rates, hydroelectric licensing, natural gas pricing,
24 and oil pipeline rates.
- 25 **Federal Register:** The official daily publication for rules, proposed rules, and notices of Federal
26 agencies and organizations, as well as Executive Orders and other presidential documents.
- 27 **fission:** The splitting of a nucleus into at least two other nuclei and the release of a relatively
28 large amount of energy. Two or three neutrons are usually released during this type of
29 transformation.
- 30 **fission products:** The radioactive isotopes formed by the fission of heavy elements.
- 31 **floodplain:** Lowlands and relatively flat areas adjoining the channel of a river, stream, or other
32 watercourse; or ocean, lake, or other body of water, which have been or may be inundated by
33 flood water, and those other areas subject to flooding. Floodplains include, at a minimum, that
34 area with at least a 1.0 percent chance of being inundated by a flood in any given year.
- 35 **flue gas:** The air coming out of a chimney after combustion in the burner it is venting. It can
36 include nitrogen oxides, carbon oxides, water vapor, sulfur oxides, particles, and many chemical
37 pollutants.

Glossary

- 1 **flue gas desulfurization:** Equipment (also referred to as scrubbers) used to remove sulfur
2 oxides from the combustion gases of a boiler plant before discharge to the atmosphere.
3 Chemicals such as lime are used as scrubbing media.
- 4 **fluidized bed combustion:** A method of burning particulate fuel, such as coal, in which the
5 amount of air required for combustion far exceeds that found in conventional burners. The fuel
6 particles are continually fed into a bed of mineral ash in the proportions of 1 part fuel to
7 200 parts ash, while a flow of air passes up through the bed, causing it to act like a turbulent
8 fluid.
- 9 **fossil fuel:** Fuel derived from ancient organic remains such as peat, coal, crude oil, and natural
10 gas.
- 11 **fossil fuel plant:** A plant using coal, petroleum, or gas as its source of energy.
- 12 **fossil fuel electric (power) generation:** Electric generation in which the prime mover is a
13 turbine rotated by high-pressure steam produced in a boiler by heat from burning fossil fuels.
- 14 **fuel:** Any material substance that can be consumed to supply heat or power. Includes
15 petroleum, coal, and natural gas (the fossil fuels), and other consumable materials, such as
16 uranium, biomass, and hydrogen.
- 17 **fuel assembly:** A cluster of fuel rods (or plates) that are also called fuel pins or fuel elements.
18 Many fuel assemblies make up a reactor core.
- 19 **fuel cladding:** See cladding.
- 20 **fuel cycle:** The entire set of sequential processes or stages involved in the utilization of fuel,
21 including extraction, transformation, transportation, and combustion. Emissions generally occur
22 at each stage of the fuel cycle.
- 23 **fuel oil:** A liquid petroleum product less volatile than gasoline, used as an energy source. Fuel
24 oil includes distillate fuel oil (No. 1, No. 2, and No. 4), and residual fuel oil (No. 5 and No. 6).
- 25 **fuel pellets:** As used in pressurized water reactors and boiling water reactors, a pellet is a
26 small cylinder approximately 3/8-in. in diameter and 5/8-in. in length, consisting of uranium fuel
27 in a ceramic form—uranium dioxide (UO₂). Typical fuel pellet enrichments in nuclear power
28 reactors range from 2.0 percent to 5 percent uranium-235.
- 29 **fuel rod:** A long, slender tube that holds fissionable material (fuel) for nuclear reactor use. Fuel
30 rods are assembled into bundles called fuel elements or fuel assemblies, which are loaded
31 individually into the reactor core.
- 32 **fugitive dust:** Particulate air pollution released to the ambient air from ground-disturbing
33 activities related to construction, manufacturing, or transportation (i.e., the discharges are not
34 released through a confined stream such as a stack, chimney, vent, or other functionally
35 equivalent opening). Specific activities that generate fugitive dust include, but are not limited to,
36 land-clearing operations, travel of vehicles on disturbed land or unpaved access roads, or onsite
37 roads.

- 1 **fugitive emissions:** Unintended leaks of gas from vessels, pipes, valves, or fittings used in the
2 processing, transmission, and/or transportation of liquids or gases. These emissions can
3 include the release of volatile vapors from a diesel fuel, natural gas, or solvent leak.
- 4 **fujita scale:** Classifies tornadoes based on wind damage. The scale ranges from F0 for the
5 weakest to F5 for the strongest tornadoes.
- 6 **gamma rays:** High-energy, short wavelength, electromagnetic radiation emitted from the
7 nucleus of an atom. Gamma radiation frequently accompanies alpha and beta emissions and
8 always accompanies fission. Gamma rays are very penetrating and are best stopped or
9 shielded by dense materials, such as lead or depleted uranium. Gamma rays are similar to
10 x-rays. See also x-rays and gamma rays.
- 11 **gas bubble disease:** A condition that occurs when aquatic organisms are exposed to water
12 with high partial pressures of certain gases (usually nitrogen) and then subsequently are
13 exposed to water with lower partial pressures of the same gases. Dissolved gas (especially
14 nitrogen) within the tissues comes out of solution and forms embolisms (bubbles) within the
15 affected tissues, most noticeably the eyes and fins.
- 16 **gas supersaturation:** Concentrations of dissolved gases in water that are above the normal
17 saturation limit.
- 18 **gas turbine:** A gas turbine consists typically of an axial-flow air compressor and one or more
19 combustion chambers where liquid or gaseous fuel is burned and the hot gases are passed to
20 the turbine, and where the hot gases expand, drive the generator, and are then used to run the
21 compressor.
- 22 **gasification:** A method for converting coal, petroleum, biomass, wastes, or other
23 carbon-containing materials into a gas that can be (1) burned to generate power or
24 (2) processed into chemicals and fuels.
- 25 **generator capacity:** The maximum output, commonly expressed in megawatts (MW), that
26 generating equipment can supply to system load, adjusted for ambient conditions.
- 27 **generic environmental impact statement (GEIS):** A GEIS assesses the scope and impact of
28 environmental effects that would be associated with an action at numerous sites.
- 29 **geologic repository:** A deep underground engineered facility used to permanently isolate
30 used nuclear fuel or high-level nuclear waste while its radioactivity decays safely.
- 31 **geology:** The science that deals with the study of the earth: its materials, processes,
32 environments, and its history, including rocks and their formations and structures.
- 33 **geothermal energy:** Hot water or steam extracted from geothermal reservoirs in the earth's
34 crust. Water or steam extracted from geothermal reservoirs can be used for geothermal heat
35 pumps, water heating, or electricity generation.
- 36 **geothermal plant:** A plant in which the prime mover is a steam turbine driven either by steam
37 produced from hot water or by natural steam that derives its energy from heat found in rock.

Glossary

- 1 **global climate change:** Changes in the earth's surface temperature thought to be caused by
2 the greenhouse effect and responsible for changes in global climate patterns. The greenhouse
3 effect is the trapping and buildup of heat in the atmosphere (troposphere) near the earth's
4 surface. Some of the heat flowing back toward space from the earth's surface is absorbed by
5 water vapor, carbon dioxide, ozone, and certain other gases in the atmosphere and then
6 reradiated back toward the earth's surface.
- 7 **global warming:** An increase in the near-surface temperature of the earth. Global warming
8 has occurred in the distant past as the result of natural influences, but the term is today most
9 often used to refer to the warming many scientists predict will occur as a result of increased
10 anthropogenic emissions of greenhouse gases.
- 11 **global warming potential:** An index used to compare the relative radiative forcing per unit
12 molecule or unit mass change for varied greenhouse gases of different gases without directly
13 calculating the changes in atmospheric concentrations. The global warming potential s of a
14 particular greenhouse gas are calculated as a time-integrated ratio of the radiative or climate
15 forcing that would result from the emission of one kilogram of that greenhouse gas to that
16 resulting from the emission of one kilogram of carbon dioxide over a fixed period of time, such
17 as 100 years.
- 18 **gonads:** Male and female sex organs (testes and ovaries).
- 19 **graphite:** Pure carbon in mineral form. Technically, graphite at 100 percent carbon is the
20 highest rank of coal. However, its relatively limited availability and physical characteristics and
21 chemical characteristics have limited its use as an energy source. Instead, it is used primarily in
22 lubricants.
- 23 **gray:** The international system (SI) unit of absorbed dose. One gray is equal to an absorbed
24 dose of 1 Joule/kilogram (one gray equals 100 rads) (see 10 CFR 20.1004).
- 25 **greater-than-Class C (GTCC) waste:** Greater-than-Class C waste means low-level radioactive
26 waste that exceeds the concentration limits of radionuclides established for Class C waste
27 in 10 CFR 61.55.
- 28 **greenfield site:** Vacant land that has never been developed or was formerly occupied by farms
29 or low-density development that left the land free of environmental contamination. Greenfield
30 sites are typically located in suburban or ex-urban areas and can be less costly to develop than
31 the brownfield sites that are often located in urban areas.
- 32 **greenhouse gases:** Gases, such as carbon dioxide, nitrous oxide, methane,
33 hydrofluorocarbons, perfluorocarbons, and sulfur hexafluoride, that are transparent to solar
34 (short-wave) radiation but opaque to long-wave (infrared) radiation, thus preventing long-wave
35 radiant energy from leaving the earth's atmosphere. The net effect is a trapping of absorbed
36 radiation and a tendency to warm the planet's surface. While also a product of industrial
37 activities, carbon dioxide, nitrous oxide, methane, ozone, and water vapor are naturally
38 occurring greenhouse gases.
- 39 **grid:** See electric power grid.
- 40 **gross generation:** The total amount of electric energy produced by generating units and
41 measured at the generating terminal in kilowatt hours (kWh) or megawatt hours (MWh).

- 1 **groundwater:** The water found beneath the earth's surface, usually in porous rock formations
2 (aquifers) or in a zone of saturation, which may supply wells and springs, as well as base flow to
3 major streams and rivers. Generally, it refers to all water contained in the ground.
- 4 **habitat:** The place, including physical and biotic conditions, where a population or community
5 of organisms, both plants and animals, lives.
- 6 **half-life:** The time in which one-half of the atoms of a particular radioactive substance
7 disintegrate into another nuclear form. Measured half-lives vary from millionths of a second to
8 billions of years. Also called physical or radiological half-life.
- 9 **hazardous air pollutants:** Air pollutants that are not covered by ambient air quality standards
10 but which, as defined in the Clean Air Act, may present a threat of adverse human health effects
11 or adverse environmental effects. Such pollutants include asbestos, beryllium, mercury,
12 benzene, coke oven emissions, radionuclides, and vinyl chloride.
- 13 **hazardous waste:** A solid waste or combination of solid wastes that, because of its quantity,
14 concentration, or physical, chemical, or infectious characteristics, may (1) cause or significantly
15 contribute to an increase in mortality or an increase in serious irreversible or incapacitating
16 reversible illness or (2) pose a substantial present or potential hazard to human health or the
17 environment when improperly treated, stored, transported, disposed of, or otherwise managed
18 (as defined in the Resource Conservation and Recovery Act, as amended, Public Law 94-580).
- 19 **heat sink:** Anything that absorbs heat. It is usually part of the environment, such as the air, a
20 river, or a lake.
- 21 **heavy metals:** Metallic elements with higher atomic weights, many of which are toxic at higher
22 concentrations. Examples are mercury, chromium, cadmium, and lead.
- 23 **high-level waste (HLW):** The highly radioactive materials produced as a by-product of the
24 reactions that occur inside nuclear reactors. High-level wastes take one of two forms, (1) Spent
25 (used) reactor fuel when it is accepted for disposal, or (2) Waste materials remaining after spent
26 fuel is reprocessed.
- 27 **historic property:** Any prehistoric or historic district, site, building, structure, or object included
28 in, or eligible for inclusion in, the *National Register of Historic Places* maintained by the
29 Secretary of the Interior. This term includes artifacts, records, and remains that are related to
30 and located within such properties. The term can also include properties of traditional religious
31 and cultural importance that meet the *National Register* criteria (see also 36 CFR 800.16(l)(1)).
- 32 **horizontal axis wind turbine:** The most common type of wind turbine, in which the axis of
33 rotation is oriented horizontally.
- 34 **hydrocarbons:** Any compound or mix of compounds, solids, liquids, or gases, composed of
35 carbon and hydrogen (e.g., coal, crude oil, and natural gas).
- 36 **hydrochlorofluorocarbons:** Chemicals composed of one or more carbon atoms and varying
37 numbers of hydrogen, chlorine, and fluorine atoms.
- 38 **hydroelectric power:** The use of flowing water to produce electrical energy.

Glossary

- 1 **hydrofluorocarbons:** A group of man-made chemicals composed of one or two carbon atoms
2 and varying numbers of hydrogen and fluorine atoms. Most hydrofluorocarbons have 100-year
3 Global Warming Potentials in the thousands.
- 4 **hydrology:** The study of water that considers its occurrence, properties distribution, circulation,
5 and transport and includes groundwater, surface water, and rainfall.
- 6 **integrated gasification combined cycle:** See integrated gasification combined cycle
7 technology.
- 8 **impacting factors:** The mechanisms by which an action affects a given resource or receptor.
- 9 **impingement:** The entrapment of all life stages of fish and shellfish on the outer part of an
10 intake structure or against a screening device during periods of intake water withdrawal.
- 11 **impulse turbine:** A turbine that is driven by high-velocity jets of water or steam from a nozzle
12 directed onto vanes or buckets attached to a wheel.
- 13 **independent spent fuel storage installation (ISFSI):** An ISFSI is designed and constructed
14 for the interim storage of spent nuclear fuel and other radioactive materials associated with
15 spent fuel storage. ISFSIs may be located at the site of a nuclear power plant or at another
16 location. The most common design for an ISFSI, at this time, is a concrete pad with dry casks
17 containing spent fuel bundles. ISFSIs are used by operating plants that require increased spent
18 fuel storage capability because their spent fuel pools have reached capacity.
- 19 **in situ:** In its original place.
- 20 **integrated gasification combined cycle technology:** An energy generation technology in
21 which coal, water, and oxygen are fed to a gasifier, which produces syngas. This medium-Btu
22 gas is cleaned (particulates and sulfur compounds removed) and fed to a gas turbine. The hot
23 exhaust of the gas turbine and heat recovered from the gasification process is routed through a
24 heat recovery generator to produce steam, which drives a steam turbine to produce electricity.
- 25 **internal dose:** That portion of the dose equivalent received from radioactive material taken into
26 the body.
- 27 **ionizing radiation:** Any radiation capable of displacing electrons from atoms or molecules,
28 thereby producing ions. Some examples are alpha, beta, gamma, x-rays, neutrons, and
29 ultraviolet light. High doses of ionizing radiation may produce severe skin or tissue damage.
- 30 **isotopic enrichment:** A process by which the relative abundance of the isotopes of a given
31 element is altered, thus producing a form of the element that has been enriched in one
32 particular isotope and depleted in its other isotopic forms.
- 33 **landfill gas:** Gas that is generated by decomposition of organic material at landfill disposal
34 sites. The average composition of landfill gas is approximately 50 percent methane and
35 50 percent carbon dioxide and water vapor by volume. The methane percentage, however, can
36 vary from 40 to 60 percent, depending on several factors including waste composition
37 (e.g., carbohydrate and cellulose content). The methane in landfill gas may be vented, flared, or
38 combusted to generate electricity or heat, or injected into a pipeline for combustion elsewhere.

- 1 **leachate:** The liquid that has percolated through the soil or other medium.
- 2 **license renewal:** Renewal of the operating license of a nuclear power plant.
- 3 **license renewal term:** That period of time, either an initial license renewal or the first
4 subsequent license renewal, past the current license term for which the renewed license is in
5 force. Although the length of license renewal terms can vary, they cannot exceed 20 years in
6 addition to the balance on the current license up to a maximum of 40 years.
- 7 **licensee:** The entity (usually an energy company) that holds the license to operate a nuclear
8 power plant.
- 9 **light water reactors (LWRs):** Reactors that use ordinary water as coolant, including boiling
10 water reactors (BWRs) and pressurized water reactors (PWRs), the most common types used
11 in the United States.
- 12 **lower limit of detection (LLD):** The lowest limit that a detector can measure.
- 13 **lowest observed effects level (LOEL):** The lowest exposure level at which there are
14 statistically or biologically significant increases in frequency or severity of an effect between the
15 exposed population and its appropriate control group.
- 16 **low-income populations:** Persons whose average family income is below the poverty line.
17 The poverty line takes into account family size and age of individuals in the family. In 1999, the
18 poverty line for a family of five with three children below the age of 18 was \$19,882. For any
19 family below the poverty line, all family members are considered to be below the poverty line.
- 20 **low-level radioactive waste (LLW):** A general term for a wide range of wastes having low
21 levels of radioactivity. Nuclear fuel cycle facilities (e.g., nuclear power reactors and fuel
22 fabrication plants) that use radioactive materials generate low-level wastes as part of their
23 normal operations. These wastes are generated in many physical and chemical forms and
24 levels of contamination (see 10 CFR 61.2). Low-level radioactive wastes containing source,
25 special nuclear, or by-product material are acceptable for disposal in a land disposal facility.
26 For the purposes of this definition, low-level waste has the same meaning as in the Low-Level
27 Radioactive Waste Policy Act, that is, radioactive waste not classified as high-level radioactive
28 waste, transuranic waste, spent nuclear fuel, or by-product material as defined in
29 Section 11e.(2) of the AEA (uranium or thorium tailings and waste).
- 30 **macroinvertebrates:** Nonplanktonic, aquatic invertebrates, including insects, crustaceans,
31 mollusks, and worms, which typically inhabit the bottom sediments of rivers, ponds, lakes,
32 wetlands, or oceans. Their abundance and diversity are often used as an indicator of
33 ecosystem health.
- 34 **maintenance areas:** Regions that were initially designated as nonattainment or unclassifiable
35 and have since attained compliance with the National Ambient Air Quality Standards. The
36 Clean Air Act outlines several conditions that must be met before an area can be reclassified
37 from nonattainment to an attainment maintenance area, one of which is the development and
38 EPA approval of a maintenance plan.
- 39 **man-rem:** See person-rem.

Glossary

- 1 **marine:** Of or pertaining to ocean environments.
- 2 **maximally exposed individual (MEI):** A hypothetical individual who, because of proximity,
3 activities, or living habits, could potentially receive the maximum possible dose of radiation or of
4 a hazardous chemical from a given event or process.
- 5 **maximum achievable control technology:** The emission standard for sources of air pollution
6 requiring the maximum reduction of hazardous emissions, taking cost and feasibility into
7 account. Under the Clean Air Act Amendments of 1990, the maximum achievable control
8 technology must not be less than the average emission level achieved by controls on the best
9 performing 12 percent of existing sources, by category of industrial and utility sources.
- 10 **mechanical draft tower:** Cooling tower system that sprays heated cooling water downward,
11 while large fans pull air across the dropping water to remove the heat. As the water drops
12 downward onto the slats in the cooling tower, the drops break up into a finer spray, and, thus,
13 facilitate cooling.
- 14 **megawatt:** A unit of power equal to 1 million watts. Megawatt-thermal is commonly used to
15 define heat produced, while megawatt-electric defines electricity produced.
- 16 **methane:** A colorless, flammable, odorless hydrocarbon gas, which is the major component of
17 natural gas. Methane is an important source of hydrogen in various industrial processes.
18 Methane is a greenhouse gas.
- 19 **methyl tertiary butyl ether:** A gasoline additive, an oxygenate produced by reacting methanol
20 with isobutylene.
- 21 **microorganism:** An organism that can be seen only through a microscope. Microorganisms
22 include bacteria, protozoa, algae, and fungi.
- 23 **minority populations:** Include American Indian or Alaskan Native; Asian; Native Hawaiian or
24 other Pacific Islander; Black races; or people of Hispanic ethnicity. "Other" races and multiracial
25 individuals may be considered as separate minorities.
- 26 **mitigation:** A method or process by which impacts from actions can be made less injurious to
27 the environment through appropriate protective measures.
- 28 **mixed waste:** Waste that contains both radioactive and hazardous constituents.
- 29 **motile:** Moving or having the power to move.
- 30 **municipal solid waste:** Residential solid waste and some nonhazardous commercial,
31 institutional, and industrial wastes.
- 32 **National Ambient Air Quality Standards (NAAQS):** Air quality standards established by the
33 Clean Air Act, as amended. The primary NAAQS specify maximum outdoor air concentrations
34 of criteria pollutants that would protect the public health within an adequate margin of safety.
35 The secondary NAAQS specify maximum concentrations that would protect the public welfare
36 from any known or anticipated adverse effects of a pollutant.

- 1 **National Environmental Policy Act of 1969 (NEPA):** Act requiring Federal agencies to
2 prepare a detailed statement on the environmental impacts of their proposed major actions that
3 may significantly affect the quality of the human environment.
- 4 **National Historic Preservation Act (NHPA) of 1966:** Section 106 of the NHPA addresses the
5 impacts of Federal undertakings on historic properties. Undertakings are defined in the NHPA
6 as any project or activity that is funded or under the direct jurisdiction of a Federal agency, or
7 any project or activity that requires a Federal permit, license, or approval (see also
8 36 CFR 800.16(y)).
- 9 **National Pollutant Discharge Elimination System (NPDES):** A Federal or, where delegated,
10 State or Tribal permitting system controlling the discharge of pollutants into waters of the United
11 States and regulated through the Clean Water Act, as amended.
- 12 **Native American Graves Protection and Repatriation Act:** This Act provides a process for
13 museums and Federal agencies to return certain Native American cultural items—human
14 remains, funerary objects, sacred objects, or objects of cultural patrimony—to lineal
15 descendants and culturally affiliated Indian Tribes and Native Hawaiian organizations. The Act
16 includes provisions for unclaimed and culturally unidentifiable Native American cultural items,
17 intentional and inadvertent discovery of Native American cultural items on Federal and Tribal
18 lands, and penalties for noncompliance and illegal trafficking. The Act also allows the
19 intentional removal from or excavation of Native American cultural items from Federal or Tribal
20 lands only with a permit or upon consultation with the appropriate Tribe.
- 21 **natural draft cooling towers:** Natural draft cooling towers use the differential pressure
22 between the relatively cold outside air and the hot humid air on the inside of the tower as the
23 driving force to move and cool water without the use of fans.
- 24 **natural gas:** A gaseous mixture of hydrocarbon compounds, the primary one being methane.
- 25 **natural gas combined-cycle technology:** An advanced power generation technology that
26 improves the fuel efficiency of natural gas. Most new gas power plants in North America and
27 Europe use natural gas combined-cycle technology.
- 28 **natural gas liquids:** Those hydrocarbons in natural gas that are separated from the gas as
29 liquids through the process of absorption, condensation, adsorption, or other methods in gas
30 processing or cycling plants. Generally, such liquids consist of propane and heavier
31 hydrocarbons and are commonly referred to as lease condensate, natural gasoline, and
32 liquefied petroleum gases. Natural gas liquids include natural gas plant liquids (primarily
33 ethane, propane, butane, and isobutene).
- 34 **naturally occurring radioactive materials:** Radioactive materials that are found in nature.
- 35 **neutron:** An uncharged elementary particle, with a mass slightly greater than that of the proton,
36 found in the nucleus of every atom heavier than hydrogen.
- 37 **natural gas combined-cycle:** See natural gas combined cycle technology.
- 38 **nitrogen oxides:** Nitrogen oxides include various nitrogen compounds, primarily nitrogen
39 dioxide and nitric oxide. They form when fossil fuels are burned at high temperatures and react
40 with volatile organic compounds to form ozone, the main component of urban smog. They are

Glossary

- 1 also a precursor pollutant that contributes to the formation of acid rain. Nitrogen oxides are
2 among the six criteria air pollutants specified under Title I of the Clean Air Act.
- 3 **no action alternative:** For this LR GEIS, the no action alternative represents a decision by the
4 Nuclear Regulatory Commission to not allow for continued operation of nuclear power plants
5 beyond the current operating license terms. All plants eventually would be required to shut
6 down and undergo decommissioning. Under the no action alternative, these eventualities would
7 occur sooner rather than later.
- 8 **noble gases:** A gaseous chemical element that does not readily enter into chemical
9 combination with other elements. Examples are helium, argon, krypton, xenon, and radon.
- 10 **noise:** Unwanted sound; a subjective term reflective of societal values regarding what
11 constitutes unwanted or undesirable intrusions of sound.
- 12 **nonattainment:** Any area that does not meet the national primary or secondary ambient air
13 quality standard established by the EPA for designated pollutants, such as carbon monoxide
14 and ozone.
- 15 **nonradioactive nonhazardous waste:** Waste that is neither radioactive nor hazardous.
- 16 **nonrenewable fuels:** Fuels that cannot be easily made or “renewed,” such as oil, natural gas,
17 and coal.
- 18 **nonrenewable waste fuels:** Municipal solid wastes from nonbiogenic sources and tire-derived
19 fuels.
- 20 **nonstochastic effect:** Health effects, the severity of which varies with the dose and for which a
21 threshold is believed to exist. Radiation-induced cataract formation is an example of a
22 nonstochastic effect (also called a deterministic effect).
- 23 **North American Electric Reliability Council:** A council formed in 1968 by the electric utility
24 industry to promote the reliability and adequacy of bulk power supply in the electric utility
25 systems of North America. North American Electric Reliability Council consists of regional
26 reliability councils and encompasses essentially all the power regions of the contiguous United
27 States, Canada, and Mexico.
- 28 **North American Industry Classification System (NAICS):** A coding system developed jointly
29 by the United States, Canada, and Mexico to classify businesses and industries according to
30 the type of economic activity in which they are engaged. NAICS replaces the Standard
31 Industrial Classification codes.
- 32 **nuclear fuel:** Fuel that produces energy in a nuclear reactor through the process of nuclear
33 fission.
- 34 **nuclear fuel cycle:** The series of steps involved in supplying fuel for nuclear power reactors,
35 including mining, milling, isotopic enrichment, fabrication of fuel elements, use in reactors,
36 chemical reprocessing to recover the fissionable material remaining in the spent fuel,
37 re-enrichment of the fuel material refabrication into new fuel elements, and waste disposal.

- 1 **nuclear power (nuclear electric power):** Electricity generated by the use of the thermal
2 energy released from the fission of nuclear fuel in a reactor.
- 3 **nuclear power plant:** A facility that uses a nuclear reactor to generate electricity.
- 4 **nuclear reactor:** A device in which nuclear fission may be sustained and controlled in a
5 self-supporting nuclear reaction. There are many types of reactors, but all incorporate certain
6 features, including fissionable material or fuel, a moderating material (unless the reactor is
7 operated on fast neutrons), a reflector to conserve escaping neutrons, provisions of removal of
8 heat, measuring and controlling instruments, and protective devices. The reactor is the heart of
9 a nuclear power plant.
- 10 **occupational dose:** The dose received by an individual in the course of employment in which
11 the individual's assigned duties involve exposure to radiation or to radioactive material.
12 Occupational dose does not include dose received from background radiation, from any medical
13 administration the individual has received, from exposure to individuals administered radioactive
14 materials and released in accordance with 10 CFR 35.75, from voluntary participation in medical
15 research programs, or as a member of the general public.
- 16 **occupational exposure:** An exposure that occurs during work with sources of ionizing
17 radiation. For example, exposures received from working on a nuclear reactor, in nuclear
18 reprocessing, or by a dental nurse taking x-rays would be classed as occupational.
- 19 **Occupational Safety and Health Administration:** Independent Federal agency whose
20 mission is to prevent work-related injuries, illnesses, and deaths. Congress created
21 Occupational Safety and Health Administration under the Occupational Safety and Health Act
22 on December 29, 1970.
- 23 **once-through cooling system:** In this cooling system, circulating water for condenser cooling
24 is obtained from an adjacent body of water, such as a lake or river, passed through the
25 condenser tubes, and returned directly at a higher temperature to the adjacent body of water.
- 26 **organ dose:** Dose received as a result of radiation energy absorbed in a specific organ.
- 27 **organism:** An individual of any form of animal or plant life.
- 28 **Outer Continental Shelf:** The Outer Continental Shelf consists of the submerged lands,
29 subsoil, and seabed, lying between the seaward extent of the States' jurisdiction and the
30 seaward extent of Federal jurisdiction.
- 31 **overburden:** Any material, consolidated or unconsolidated, that overlies a coal or other rock or
32 mineral deposit.
- 33 **ozone:** A strong-smelling, reactive toxic chemical gas consisting of three oxygen atoms
34 chemically attached to each other. It is formed in the atmosphere by chemical reactions
35 involving nitrogen oxide and volatile organic compounds. The reactions are energized by
36 sunlight. Ozone is a criteria air pollutant under the Clean Air Act and is a major constituent of
37 smog.

Glossary

- 1 **particulate matter:** Fine solid or liquid particles, such as dust, smoke, mist, fumes, or smog,
2 found in air or emissions. The size of the particulates is measured in micrometers. One
3 micrometer is 1 millionth of a meter or 0.000039 inch. The EPA has set standards for PM_{2.5} and
4 PM₁₀ particulates.
- 5 **pathway (exposure):** The way in which people are exposed to radiation or other contaminants.
6 The three basic pathways are inhalation (contaminants are taken into the lungs), ingestion
7 (contaminants are swallowed), and direct (external) exposure (contaminants cause damage
8 from outside the body).
- 9 **peak load:** The maximum load during a specified period of time.
- 10 **perched aquifer/groundwater:** A body of groundwater of small lateral dimensions separated
11 from an underlying body of groundwater by an unsaturated zone.
- 12 **perfluorocarbons (PFCs):** A group of man-made chemicals composed of one or two carbon
13 atoms and four to six fluorine atoms, containing no chlorine. PFCs have no commercial uses
14 and are emitted as a by-product of aluminum smelting and semiconductor manufacturing. PFCs
15 have very high 100-year Global Warming Potentials and are very long-lived in the atmosphere.
- 16 **personal protective equipment:** Clothing and equipment that are worn to reduce exposure to
17 potentially hazardous chemicals and other pollutants.
- 18 **person-rem:** The sum of the individual radiation dose equivalents received by members of a
19 certain group or population. It may be calculated by multiplying the average dose per person by
20 the number of persons exposed. For example, a thousand people, each exposed to
21 one millirem, would have a collective dose of one person-rem.
- 22 **petroleum:** A broadly defined class of liquid hydrocarbon mixtures. Includes crude oil, lease
23 condensate, unfinished oils, refined products obtained from the processing of crude oil, and
24 natural gas plant liquids. Volumes of finished petroleum products include nonhydrocarbon
25 compounds, such as additives and detergents, after they have been blended into products.
- 26 **photosynthesis:** The process in green plants and certain other organisms by which
27 carbohydrates are synthesized from carbon dioxide and water using sunlight as an energy
28 source. Most forms of photosynthesis release oxygen as a by-product. Chlorophyll typically
29 acts as the catalyst in this process.
- 30 **photovoltaic and solar thermal energy:** Energy radiated by the sun as electromagnetic
31 waves (electromagnetic radiation) that is converted at electric utilities into electricity by means of
32 solar (photovoltaic) cells or concentrating (focusing) collectors.
- 33 **photovoltaic cell:** An electronic device consisting of layers of semiconductor materials
34 fabricated to form a junction (adjacent layers of materials with different electronic
35 characteristics) and electrical contacts and being capable of converting incident light directly into
36 electricity (direct current).
- 37 **photovoltaic system:** A system that converts light into electric current.
- 38 **phytoplankton:** Small, often single-celled plants that live suspended in bodies of water.

- 1 **plutonium:** A heavy, man-made, radioactive metallic element. The most important isotope is
2 Pu-239, which has a half-life of more than 20,000 years; it can be used in reactor fuel and is the
3 primary isotope in weapons.
- 4 **plume:** A visible or measurable emission or discharge of a contaminant from a given point of
5 origin into any medium, such as that formed from a cooling water outfall into a receiving water
6 body or smokestack into the atmosphere.
- 7 **PM₁₀:** Particulate matter with a mean aerodynamic diameter of 10 micrometers (0.0004 in.) or
8 less. Particles less than this diameter are small enough to be deposited in the lungs.
- 9 **PM_{2.5}:** Particulate matter with a mean aerodynamic diameter of 2.5 micrometers (0.0001 in.) or
10 less.
- 11 **polycyclic aromatic hydrocarbons:** Aromatic hydrocarbons containing more than one fused
12 benzene ring. Polycyclic aromatic hydrocarbons are commonly formed during the incomplete
13 burning of coal, oil, and gas, garbage, or other organic substances.
- 14 **population dose:** Dose received collectively by a population.
- 15 **potable water:** Water that is fit for humans to drink.
- 16 **power:** The rate of producing, transferring, or using energy, most commonly associated with
17 electricity. Power is measured in watts and often expressed in kilowatts (kW) or
18 megawatts (MW).
- 19 **pressurized water reactor (PWR):** A power reactor in which thermal energy is transferred
20 from the core to a heat exchanger by high-temperature water kept under high-pressure in the
21 primary system. Steam is generated in the heat exchanger in a secondary circuit.
- 22 **prevention of significant deterioration (PSD):** A Federal permit program for facilities defined
23 as major sources under the New Source Review program. The intent of the program is to
24 prevent the air quality in an attainment area from deteriorating.
- 25 **primary system:** A term that refers to the circulating water system in a pressurized water
26 reactor, which removes the energy from the reactor and delivers it to the heat exchanger.
- 27 **proposed action:** An action proposed by a Federal agency and evaluated in an environmental
28 impact statement or environmental assessment. In this LR GEIS, the proposed action is to
29 renew commercial nuclear power plant operating licenses.
- 30 **proton:** A small particle, typically found within an atom's nucleus, that possesses a positive
31 electrical charge. The number of protons is unique for each chemical element.
- 32 **proximity:** Used sparingly to evaluate the remoteness of areas in which nuclear plants are
33 located. A measure of the distance to larger cities.
- 34 **public dose:** The dose received by members of the public from exposure to radiation or to
35 radioactive material released by a licensee, or to any other source of radiation under the control
36 of a licensee. Public dose does not include occupational dose or doses received from
37 background radiation, from any medical administration the individual has received, from

Glossary

- 1 exposure to individuals administered radioactive materials and released in accordance with
2 10 CFR 35.75, or from voluntary participation in medical research programs.
- 3 **pulverized coal:** Coal that has been crushed to a fine dust in a grinding mill. It is blown into
4 the combustion zone of a furnace and burns very rapidly and efficiently.
- 5 **pumped-storage hydroelectric plant:** A hydropower plant that usually generates electric
6 energy during peak load periods by using water previously pumped into an elevated storage
7 reservoir during off-peak periods when excess generating capacity is available to do so. When
8 additional generating capacity is needed, the water can be released from the reservoir through a
9 conduit to turbine generators located in a power plant at a lower level.
- 10 **quality factor:** The modifying factor that is used to derive dose equivalent from absorbed dose.
- 11 **rad:** The special unit for radiation absorbed dose, which is the amount of energy from any type
12 of ionizing radiation (e.g., alpha, beta, gamma, neutrons) deposited in any medium (e.g., water,
13 tissue, air). A dose of one rad means the absorption of 100 ergs (a small but measurable
14 amount of energy) per gram of absorbing tissue (100 rad = 1 gray).
- 15 **radiation (ionizing radiation):** Alpha particles, beta particles, gamma rays, x-rays, neutrons,
16 high-speed electrons, high-speed protons, and other particles capable of producing ions.
17 Radiation, as used in <http://www.nrc.gov/reading-rm/doc-collections/cfr/part020/>, 10 CFR Part
18 20, does not include nonionizing radiation, such as radiowaves or microwaves, or visible,
19 infrared, or ultraviolet light (see also 10 CFR 20.1003).
- 20 **radioactive decay:** The decrease in the amount of any radioactive material with the passage
21 of time due to the spontaneous emission from the atomic nuclei of either alpha or beta particles,
22 often accompanied by gamma radiation.
- 23 **radioactive waste:** Radioactive materials at the end of a useful life cycle or in a product that is
24 no longer useful and should be properly disposed of.
- 25 **radioactivity:** The spontaneous emission of radiation, generally alpha or beta particles, often
26 accompanied by gamma rays, from the nucleus of an unstable isotope. Also, the rate at which
27 radioactive material emits radiation. Measured in units of becquerels or disintegrations per
28 second.
- 29 **radioisotope:** An unstable isotope of an element that decays or disintegrates spontaneously,
30 emitting radiation. Approximately 5,000 natural and artificial radioisotopes have been identified.
- 31 **radionuclide:** A radioisotope of an element.
- 32 **raptor:** A bird of prey such as a falcon, hawk, or eagle.
- 33 **rated power:** The design power level of an electrical generating device, which is the maximum
34 power the device is allowed to generate.
- 35 **reactor vessel:** A device in which nuclear fission may be sustained and controlled in a
36 self-supporting nuclear reaction. It houses the core (made up of fuel rods, control rods, and
37 instruments contained within a reactor vessel) of most types of power reactors.

- 1 **receptor:** The individual or resource being affected by the impact.
- 2 **reference reactor year:** Refers to one year of operation of a 1,000-MW electric capacity
3 nuclear power plant operating at an 80 percent availability factor to produce about 80 MW-yr
4 (0.8 GW-yr) of electricity.
- 5 **refurbishment:** Repair or replacement of reactor systems, structures, and components, such
6 as turbines, steam generators, pressurizers, and recirculation piping systems.
- 7 **region of Influence:** Area occupied by affected resources and the distances at which impacts
8 associated with license renewal may occur.
- 9 **rem (roentgen equivalent man):** The acronym for roentgen equivalent man is a standard unit
10 that measures the effects of ionizing radiation on humans. The dose equivalent in rem is equal
11 to the absorbed dose in rads multiplied by the quality factor of the type of radiation
12 (see 10 CFR 20.1004).
- 13 **renewable energy resources:** Energy resources that are naturally replenishing but
14 flow-limited. They are virtually inexhaustible in duration, but limited in the amount of energy that
15 is available per unit of time. Renewable energy resources include biomass, hydro, geothermal,
16 solar, wind, ocean thermal, wave action, and tidal action.
- 17 **renewable portfolio standards:** State policies that require electricity providers to generate a
18 certain percentage, or, in some cases a certain specified amount, of electrical power through
19 the use of renewable energy sources by a certain date.
- 20 **residual fuel oil:** A general classification for the heavier oils, known as No. 5 and No. 6 fuel
21 oils, that remain after the distillate fuel oils and lighter hydrocarbons are distilled away in refinery
22 operations.
- 23 **Resource Conservation and Recovery Act (RCRA):** Act that regulates the storage,
24 treatment, and disposal of hazardous and nonhazardous wastes.
- 25 **right-of-way:** The land and legal right to use and service the land along which a transmission
26 line is located. Transmission line right-of-ways are usually acquired in widths that vary with the
27 kilovolt (kV) size of the line.
- 28 **riparian:** Relating to, living in, or located on the bank of a river, lake, or tidewater.
- 29 **risk:** The combined answers to the following questions: (1) What can go wrong? (2) How
30 likely is it? (3) What are the consequences?
- 31 **risk coefficient:** A coefficient used to convert dose to risk.
- 32 **roentgen equivalent man (rem):** See rem.
- 33 **runoff:** The portion of rainfall, melted snow, or irrigation water that flows across the ground and
34 that may eventually enter surface waters.
- 35 **run-of-river hydroelectric plant:** A hydropower plant that uses the flow of a stream as it
36 occurs and has little or no reservoir capacity for storage.

Glossary

- 1 **SAFSTOR:** A method of decommissioning in which the nuclear facility is placed and
2 maintained in such condition that the nuclear facility can be safely stored and subsequently
3 decontaminated to levels that permit release for restricted or unrestricted use.
- 4 **savanna:** Grassland with scattered individual trees.
- 5 **scouring:** The rapid erosion of sediment caused by the movement of water.
- 6 **scrubbers:** Air pollution control devices that are used to remove particulates and/or gases from
7 industrial or power exhaust streams.
- 8 **sediment:** Particles of geologic origin that sink to the bottom of a body of water, or materials
9 that are deposited by wind, water, or glaciers.
- 10 **seismic:** Of, subject to, or caused by an earthquake or earth vibration.
- 11 **seismicity:** The frequency and distribution of earthquakes.
- 12 **service water:** Water used to cool heat exchangers or coolers in the powerhouse other than
13 the condenser. Service water may or may not be treated for use.
- 14 **sievert (Sv):** The international system (SI) unit for dose equivalent equal to 1 Joule/kilogram.
15 1 sievert = 100 rem. Named for physicist Rolf Sievert.
- 16 **sludge:** A dense, slushy, liquid-to-semifluid product that accumulates as an end result of an
17 industrial or technological process. Industrial sludges are produced from the processing of
18 energy-related raw materials, chemical products, water, mined ores, sewage, and other natural
19 and man-made products.
- 20 **socioeconomics:** Social and economic characteristics of a human population. Includes both
21 the social impacts of economic activity and the economic impacts of social activity.
- 22 **soils:** All unconsolidated materials above bedrock. Natural earthy materials on the earth's
23 surface, in places modified or even made by human activity, containing living matter, and
24 supporting or capable of supporting plants.
- 25 **solar energy:** The radiant energy of the sun, which can be converted into other forms of
26 energy, such as heat or electricity.
- 27 **solar power tower:** A solar energy conversion system that uses a large field of independently
28 adjustable mirrors (heliostats) to focus solar rays on a near single point atop a fixed tower
29 (receiver). The concentrated energy may be used to directly heat the working fluid of a Rankin
30 cycle engine or to heat an intermediary thermal storage medium (such as a molten salt).
- 31 **solar radiation:** A general term for the visible and near-visible (ultraviolet and near-infrared)
32 electromagnetic radiation that is emitted by the sun. It has a spectral, or wavelength,
33 distribution that corresponds to different energy levels; short wavelength radiation has a higher
34 energy than long wavelength radiation.
- 35 **solar thermal systems or concentrating solar power:** See solar power tower.

- 1 **sound intensity:** The measure of the amount of energy that is transported over a given area
2 per unit of time. Sound intensity is expressed in units of W/m^2 .
- 3 **sparseness:** Used (with proximity) to evaluate the remoteness of areas in which nuclear plants
4 are located. A measure of population density.
- 5 **spawning:** Release or deposition of spermatozoa or ova, of which some will fertilize or be
6 fertilized to produce offspring.
- 7 **spent fuel burnup:** A measure of how much energy is extracted from the nuclear fuel before it
8 is removed from the core. Its units are MW-day per metric tonne of uranium in fresh fuel.
- 9 **spent nuclear fuel:** Nuclear reactor fuel that has been removed from a nuclear reactor
10 because it can no longer sustain power production for economic or other reasons.
- 11 **spent fuel pool:** An underwater storage and cooling facility for spent fuel elements that have
12 been removed from a reactor.
- 13 **State Historic Preservation Office(r) (SHPO):** The State agency (or officer) charged with the
14 identification and protection of prehistoric and historic resources in accordance with the National
15 Historic Preservation Act in the State (see also 36 CFR 800.2(c)(1)).
- 16 **state implementation plan:** State-specific air quality plan for controlling air pollution emissions
17 at levels that would attain and maintain compliance with the National Ambient Air Quality
18 Standards or State-specific air quality standards. Each State must develop its own regulations
19 to monitor, permit, and control air emissions within its boundaries.
- 20 **steam turbine:** A device that converts high-pressure steam, produced in a boiler, into
21 mechanical energy that can then be used to produce electricity by forcing blades in a cylinder to
22 rotate and turn a generator shaft.
- 23 **stochastic effect:** Health effects that occur randomly and for which the probability of the effect
24 occurring, rather than its severity, is assumed to be a linear function of dose without threshold.
25 Hereditary effects and cancer incidence are examples of stochastic effect.
- 26 **store and release dam:** Hydropower facilities that store water in a reservoir behind a dam and
27 release the water through turbines as needed to generate electricity.
- 28 **stormwater:** Stormwater runoff, snowmelt runoff, and surface runoff and drainage.
- 29 **stratification:** The formation, accumulation, or deposition of materials in layers, such as layers
30 of freshwater overlying higher salinity water (saltwater) in estuaries.
- 31 **strip mine:** An open cut in which the overburden is removed from a coal bed or other mineral
32 deposit prior to the removal of the desired underlying material.
- 33 **sulfur:** A yellowish nonmetallic element. It is present at various concentrations in many fossil
34 fuels whose combustion releases sulfur compounds that are considered harmful to the
35 environment. Some of the most commonly used fossil fuels are categorized according to their
36 sulfur content, with lower sulfur fuels usually selling at a higher price.

Glossary

- 1 **sulfur dioxide:** A gas formed from burning fossil fuels. Sulfur dioxide is one of the six criteria
2 air pollutants specified under Title I of the Clean Air Act and contributes to the formation of acid
3 rain.
- 4 **sulfur oxides:** Pungent, colorless gases that are formed primarily by fossil fuel combustion.
5 Sulfur oxides may damage the respiratory tract, as well as plants and trees.
- 6 **supercritical and subcritical:** Supercritical and subcritical define the thermodynamic state of
7 the water in the steam cycle. In supercritical steam generating units, the pressure at which the
8 steam cycle is maintained is above water's critical point so there is no distinction between
9 water's liquid and gaseous phases and the steam behaves as a homogenous supercritical fluid.
10 The supercritical point for water is 22.1 MPa (approximately 3,207 pounds per square inch).
11 Supercritical steam generators offer numerous advantages over their subcritical counterparts,
12 including higher thermal efficiencies, greater flexibility in changing loads, and greater
13 combustion efficiencies, resulting in lesser amounts of pollutants per units of power generated.
14 No ultra-supercritical units are operating in the United States.
- 15 **supplemental environmental impact statement (SEIS):** A SEIS updates or supplements an
16 existing environmental impact statement (such as the LR GEIS). The NRC directs the staff to
17 issue site-specific supplements to the LR GEIS for each license renewal application.
- 18 **surface mine (surface mining):** A coal-producing mine that is usually within a few hundred
19 feet of the surface. Earth above or around the coal (overburden) is removed to expose the
20 coalbed, which is then mined with surface excavation equipment, such as draglines, power
21 shovels, bulldozers, loaders, and augers. It may also be known as an area, contour, open-pit,
22 strip, or auger mine.
- 23 **surface water:** Water on the earth's surface that is directly exposed to the atmosphere, as
24 distinguished from water in the ground (groundwater).
- 25 **switchyard:** A facility used at power plants to increase the electric voltage and feed into the
26 regional power distribution system. Electricity generated at the plant is carried off the site by
27 transmission lines.
- 28 **tallgrass:** Any of various grasses that are tall and that flourish with abundant moisture, typically
29 associated with the prairies of the Midwestern United States.
- 30 **terrestrial:** Belonging to or living on land.
- 31 **thermal:** Having to do with heat. Also, a term used to identify a type of electric generating
32 station, capacity, capability, or output in which the source of energy for the prime mover is heat.
- 33 **thermal efficiency:** A measure of the efficiency of converting the thermal energy generated by
34 the burning of the fossil fuels or the fission of nuclear fuel to electrical energy.
- 35 **thermal effluents:** Heated discharge from a cooling water system.
- 36 **thermal plume:** The hot water discharged from a power-generating facility or other industrial
37 plant. When the water at elevated temperature enters a receiving stream or body of water, it is
38 not immediately dispersed and mixed with the cooler waters. The warmer water moves as a

- 1 single mass (plume) from the discharge point until it cools and gradually mixes with that of the
2 receiving water.
- 3 **thermal stratification:** The formation of layers of different temperatures in a lake or reservoir.
- 4 **thermophilic:** Organisms such as bacteria that require a relatively high-temperature
5 environment for normal development.
- 6 **threatened species:** Any species that is likely to become an endangered species within the
7 foreseeable future throughout all or a significant portion of its range. Requirements for declaring
8 a species threatened are contained in the Endangered Species Act.
- 9 **total body dose/whole-body dose:** Sum of the dose received from external exposure to the
10 total body, gonads, active blood-forming organs, head and trunk, or lens of the eye and the
11 dose due to the intake of radionuclides by inhalation and ingestion where a radioisotope is
12 uniformly distributed throughout the body tissues rather than being concentrated in certain parts.
- 13 **total effective dose equivalent:** The sum of the deep-dose equivalent (for external exposure)
14 and the committed effective dose equivalent (for internal exposure).
- 15 **transformer:** An electrical device for changing the voltage of alternating current.
- 16 **transmission:** The movement or transfer of electric energy over an interconnected group of
17 lines and associated equipment between points of supply and points at which it is transformed
18 for delivery to consumers or is delivered to other electric systems. Transmission is considered
19 to end when the energy is transformed for distribution to the consumer.
- 20 **transmission line:** A set of conductors, insulators, supporting structures, and associated
21 equipment used to move large quantities of power at high-voltage, usually over long distances
22 between a generating or receiving point and major substations or delivery points.
- 23 **transuranic elements:** The chemical elements with atomic numbers greater than 92, the
24 atomic number of uranium.
- 25 **transuranic waste:** Material contaminated with transuranic elements that is produced primarily
26 from reprocessing spent fuel and from use of plutonium in fabrication of nuclear weapons.
- 27 **tritium:** A radioactive isotope of hydrogen with one proton and two neutrons. It decays by beta
28 emission. It has a radioactive half-life of about 12.5 years.
- 29 **turbine:** A device in which a stream of water or gas turns a bladed wheel, converting the kinetic
30 energy of the flow into mechanical energy available from the turbine shaft. Turbines are
31 considered the most economical means of turning large electrical generators. They are typically
32 driven by steam, fuel vapor, water, or wind.
- 33 **U.S. Environmental Protection Agency (EPA):** A Federal agency, created for the purpose of
34 promoting human health by protecting the nation's air, water, and soil from harmful pollution by
35 enforcing environmental regulations based on laws passed by Congress. The agency conducts
36 environmental assessment, research, and education. It has the responsibility of maintaining
37 and enforcing national standards under a variety of environmental laws (e.g., Clean Air Act), in
38 consultation with State, Tribal, and local governments. It delegates some permitting,

Glossary

1 monitoring, and enforcement responsibility to States and Native American Tribes. EPA
2 enforcement powers include fines, sanctions, and other measures. The agency also works with
3 industries and all levels of government in a wide variety of voluntary pollution prevention
4 programs and energy conservation efforts.

5 **U.S. Nuclear Regulatory Commission (NRC):** An independent regulatory agency that is
6 responsible for overseeing the civilian use of nuclear materials in the United States. The NRC
7 was established on October 11, 1974, by President Gerald Ford as one of two successor
8 organizations to the Atomic Energy Commission, which became defunct on that same day. The
9 NRC took over the Atomic Energy Commission's responsibility for seeing that civilian nuclear
10 materials and facilities are used safely and affect neither the public health nor the quality of the
11 environment. The Commission's activities focus on the nuclear reactors in the United States
12 that are used to generate electricity on a commercial basis. It licenses the construction of new
13 nuclear reactors and regulates their operation on a continuing basis. It oversees the use,
14 processing, handling, and disposal of nuclear materials and wastes; inspects nuclear power
15 plants and monitors both their safety procedures and their security measures; enforces
16 compliance with established safety standards; and investigates nuclear accidents. The NRC's
17 Commissioners are appointed by the President of the United States and confirmed by the
18 Senate for five-year terms.

19 **uranium:** A radioactive element with the atomic number 92 and, as found in natural ores, an
20 atomic weight of approximately 238. The two principal natural isotopes are uranium-235
21 (0.7 percent of natural uranium) and uranium-238 (99.3 percent of natural uranium). Natural
22 uranium also includes a minute amount of uranium-234.

23 **universal waste:** A special class of hazardous waste consisting of commonly used and yet
24 hazardous materials: batteries, pesticides, mercury-containing equipment, and lamps.

25 **vertebrate:** Any species having a backbone or spinal column including fish, amphibians,
26 reptiles, birds, and mammals.

27 **visual impact:** The creation of an intrusion or perceptible contrast that affects the scenic
28 quality of a landscape.

29 **visual resources:** Refers to all objects (man-made and natural, moving and stationary) and
30 features such as landforms and water bodies that are visible on a landscape.

31 **volatile organic compounds (VOCs):** A broad range of organic compounds that readily
32 evaporate at normal temperatures and pressures. Sources include certain solvents, degreasers
33 (e.g., benzene), and fuels. Volatile organic compounds react with other substances (primarily
34 nitrogen oxides) to form ozone. They contribute significantly to photochemical smog production
35 and certain health problems.

36 **waste coal:** Usable material that is a by-product of previous coal processing operations.
37 Waste coal may be relatively clean material composed primarily of coal fines, material in which
38 extraneous noncombustible constituents have been partially removed, or mixed coal, soil, and
39 rock (mine waste) burned as is in unconventional boilers, such as fluidized bed units. Examples
40 include fine coal, coal obtained from a refuse bank or slurry dam, anthracite culm, bituminous
41 gob, and lignite waste.

- 1 **wastewater:** The used water and solids that flow to a treatment plant and/or are discharged to
2 a receiving water body. Stormwater, surface water, and groundwater infiltration also may be
3 included in the wastewater that enters a wastewater treatment plant. Domestic or sanitary
4 wastewater is water originating from human sanitary water use and industrial wastewater is that
5 derived from a variety of industrial processes.
- 6 **water table:** The boundary between the unsaturated zone and the deeper, saturated zone.
7 The upper surface of an unconfined aquifer.
- 8 **water quality:** The condition of water with respect to the amount of impurities in it.
- 9 **weir:** A structure in a waterway or stormwater control device, over which water flows that
10 serves to raise the water level or to direct or regulate flow.
- 11 **wetlands:** Areas that are inundated or saturated by surface water or groundwater and that
12 typically support vegetation adapted for life in saturated soils. Wetlands generally include
13 swamps, marshes, bogs, and similar areas (e.g., sloughs, potholes, wet meadows, river
14 overflow areas, mudflats, natural ponds).
- 15 **wind energy:** Kinetic energy present in wind motion that can be converted to mechanical
16 energy for driving pumps, mills, and electric power generators.
- 17 **wind farm:** One or more wind turbines operating within a contiguous area for the purpose of
18 generating electricity. See also wind power plant.
- 19 **wind power plant:** Wind turbines interconnected to a common utility system through a system
20 of transformers, distribution lines, and (usually) one substation. Operation, control, and
21 maintenance functions are often centralized through a network of computerized monitoring
22 systems, supplemented by visual inspection.
- 23 **wind turbine:** Wind energy conversion device that produces electricity; typically three blades
24 rotating about a horizontal axis and positioned upwind of the supporting tower.
- 25 **X-rays and gamma rays:** Waves of pure energy that travel with the speed of light that are very
26 penetrating and require thick concrete or lead shielding to stop them.
- 27 **Yucca Mountain:** The Yucca Mountain, Nevada, site of the DOE's proposed location for a
28 repository for spent nuclear fuel and high-level radioactive waste. The EPA established the
29 public health and environmental radiation protection standards for the facility. However, in
30 March 2010, DOE filed a request with the NRC's Atomic Safety and Licensing Board to
31 withdraw its application for authorization to construct a high-level waste geological repository at
32 Yucca Mountain. The decisions and recommendations concerning the ultimate disposition of
33 spent nuclear fuel are ongoing.
- 34 **zooplankton:** Small animals that float passively in the water column. Includes eggs and larvae
35 of many fish and invertebrate species.

BIBLIOGRAPHIC DATA SHEET

(See instructions on the reverse)

1. REPORT NUMBER
(Assigned by NRC, Add Vol., Supp., Rev.,
and Addendum Numbers, if any.)
NUREG-1437, Volume 2,
Revision 2
Draft Report

2. TITLE AND SUBTITLE

Generic Environmental Impact Statement for License Renewal of Nuclear Plants
Appendices

Draft Report

3. DATE REPORT PUBLISHED

MONTH	YEAR
February	2023

4. FIN OR GRANT NUMBER

5. AUTHOR(S)

See Chapter 6 of this report.

6. TYPE OF REPORT

Technical

7. PERIOD COVERED (Inclusive Dates)

8. PERFORMING ORGANIZATION - NAME AND ADDRESS (If NRC, provide Division, Office or Region, U. S. Nuclear Regulatory Commission, and mailing address; if contractor, provide name and mailing address.)

Office of Nuclear Material Safety and Safeguards
U.S. Nuclear Regulatory Commission
Washington, DC 20555-0001

9. SPONSORING ORGANIZATION - NAME AND ADDRESS (If NRC, type "Same as above", if contractor, provide NRC Division, Office or Region, U. S. Nuclear Regulatory Commission, and mailing address.)

Same as 8 above.

10. SUPPLEMENTARY NOTES

11. ABSTRACT (200 words or less)

U.S. Nuclear Regulatory Commission (NRC) regulations allow for the renewal of commercial nuclear power plant operating licenses. There are no specific limitations in the Atomic Energy Act or the NRC's regulations restricting the number of times a license may be renewed. To support license renewal environmental reviews, the NRC published the first Generic Environmental Impact Statement for License Renewal of Nuclear Plants (LR GEIS) in 1996. Per NRC regulations, a review and update of the LR GEIS is conducted every 10-years, if necessary. The proposed action is the renewal of nuclear power plant operating licenses.

Since publication of the 1996 LR GEIS, 59 nuclear power plants (96 reactor units) have undergone license renewal environmental reviews and have received renewed licenses, the results of which were published as supplements to the LR GEIS. This revision evaluates the issues and findings of the 2013 LR GEIS (Revision 1). Lessons learned and knowledge gained from initial license renewal and subsequent license renewal (SLR) environmental reviews provide major sources of new information for this assessment. In addition, new research, findings, public comments, changes in applicable laws and regulations, and other information were considered in evaluating the environmental impacts associated with license renewal. Additionally, this revision fully considers and evaluates the environmental impacts of one term of SLR as well as initial license renewal.

12. KEY WORDS/DESCRIPTORS (List words or phrases that will assist researchers in locating the report.)

Generic Environmental Impact Statement for License Renewal of Nuclear Plants
LR GEIS
NUREG-1437, Revision 2
National Environmental Policy Act
NEPA
License Renewal
Initial LR
Subsequent License Renewal
SLR

13. AVAILABILITY STATEMENT

unlimited

14. SECURITY CLASSIFICATION

(This Page)

unclassified

(This Report)

unclassified

15. NUMBER OF PAGES

16. PRICE

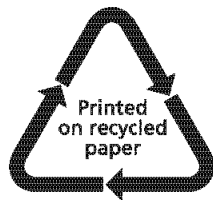

Federal Recycling Program



UNITED STATES
NUCLEAR REGULATORY COMMISSION
WASHINGTON, DC 20555-0001

OFFICIAL BUSINESS



@NRCgov



**NUREG-1437, Volume 1
Revision 2, Draft**

Generic Environmental Impact Statement for License Renewal of Nuclear Plants

February 2023