

NEI 99-02 [Revision 7]

Regulatory Assessment Performance Indicator Guideline

August 31, 2013

[THIS PAGE IS LEFT BLANK INTENTIONALLY]

NEI 99-02 [Revision 7]

Nuclear Energy Institute

**Regulatory Assessment
Performance Indicator
Guideline**

August 31, 2013

Nuclear Energy Institute, 1201 F Street N.W., Suite 1100, Washington D.C. 20004 (202.739.8000)

ACKNOWLEDGMENTS

This guidance document, Regulatory Assessment Performance Indicator Guideline, NEI 99-02, was **originally** developed by the NEI Safety Performance Assessment Task Force in conjunction with the NRC staff. We appreciate the direct participation of the many utilities, INPO and the NRC who contributed to the development of the **original** guidance. **Today (2013), the industry role in supporting and maintaining NEI 99-02 is led by the efforts of the NEI Reactor Oversight Process Task Force (ROPTF). The ROPTF is comprised of representatives of NEI member utilities and vendors, and INPO. This document benefits from their collaboration and from our continuing interactions with, and inputs from, the NRC staff.**

Additional information on the ROPTF can be found at www.nei.org, or by contacting James Slider at NEI, phone number (202) 739-8015 and e-mail jes@nei.org.

INFORMATION COLLECTION

Licensee submission of performance indicator information to the Nuclear Regulatory Commission (NRC) is an information collection that was approved by the Office of Management and Budget. Additional information regarding this information collection is contained in NRC Regulatory Issue Summary 2000-08, Revision 1, "Voluntary Submission of Performance Indicator Data."

NOTICE

Neither NEI, nor any of its employees, members, supporting organizations, contractors, or consultants make any warranty, expressed or implied, or assume any legal responsibility for the accuracy or completeness of, or assume any liability for damages resulting from any use of, any information apparatus, methods, or process disclosed in this report or that such may not infringe privately-owned rights.

EXECUTIVE SUMMARY

In 2000 the Nuclear Regulatory Commission revised its regulatory oversight process for inspection, assessment and enforcement of commercial nuclear power reactors. This process utilizes information obtained from licensee-reported performance indicators and NRC inspection findings. The purpose of this manual is to provide the guidance necessary for power reactor licensees to collect and report the data elements that will be used to compute the Performance Indicators.

An overview of the complete oversight process is provided in NUREG 1649¹, “Reactor Oversight Process.” More detail is provided in SECY 99-007², “Recommendations for Reactor Oversight Process Improvements,” as amended in SECY 99-007A³ and SECY 00-049⁴ “Results of the Revised Reactor Oversight Process Pilot Program.”

This revision is effective for data collection as of October 1, 2013 and includes Frequently Asked Questions approved through March 31, 2013.

¹ NUREG-1649, “Reactor Oversight Process”, Revision 4, December 2006, available at URL: <http://www.nrc.gov/reading-rm/doc-collections/nuregs/staff/sr1649/r4/>.

² SECY-99-007, “Recommendations for Reactor Oversight Process Improvements”, January 8, 1999, available at URL: http://www.nrc.gov/reading-rm/doc-collections/commission/secys/1999/secy1999-007/1999-007scy_attach.pdf.

³ SECY-99-007A, Recommendations for Reactor Oversight Process Improvements (Follow-up to SECY-99-007)”, March 22, 1999, available at URL: <http://www.nrc.gov/reading-rm/doc-collections/commission/secys/1999/secy1999-007/1999-007ascy.pdf>

⁴ SECY-00-0049, “Results of the Revised Reactor Oversight Process Pilot Program”, February 24, 2000, available at URL: <http://www.nrc.gov/reading-rm/doc-collections/commission/secys/2000/secy2000-0049/2000-0049scy.pdf>

**Summary of Changes to NEI 99-02
Revision 6 to Revision 7**

Page or Section	Major Changes
p. iii	Added list of FAQs incorporated in Rev. 7
pp. 1-6	Editorial corrections from Slider, Heffner, Balazik
p. 4	Tabularized the criteria for submitting comments in CDE.
pp. 8-9	Editorial corrections to Table 2, Performance Indicators
p. 13	Editorial corrections to data example
p. 14-16	Incorporated FAQ 469 (09-09) for unplanned power changes indicator
p. 17-19	Editorial corrections from Gary Miller eliminating repetition in definition of unplanned power changes
p. 20	Editorial corrections to data example
pp. 21-29	Incorporated numerous changes to unplanned scrams with complications per FAQ 481 (10-02)
p. 28	Editorial corrections to data example
p. 32	Amplified guidance saying SSFF report date is tied to date of revised LER.
p. 33	Editorial corrections to data example
pp. 34-39	Incorporated numerous changes on guidance for updating PRA data and basis document, per FAQ 477 (11-02) and conforming changes per Roy Linthicum.
p. 40	Editorial corrections to data example
p. 43	Editorial corrections to data example
p. 45	Editorial corrections to data example
p. 46	Incorporated clarification on notification criterion, per FAQ 12-06
p. 49	Incorporated clarification on multi-site ERO members, per FAQ 09-10
p. 49	Incorporated clarification on phone-talker, per FAQ 09-06
p. 53	Editorial corrections to data example
p. 54	Incorporated clarification on multi-site ERO members, per FAQ 09-10
p. 53	Incorporated clarification on performance enhancing opportunities, per FAQ 12-06
pp. 55-56	Incorporated clarification on multi-site ERO members, per FAQ 09-10
p.59	Editorial corrections to data example
p. 61	Incorporated guidance on sirens deliberately unavailable, per FAQ 11-13
p. 64	Editorial corrections to data example
p. 70	Editorial corrections to data example
p. 72	Editorial corrections to data example
pp. 73-78	Misc. clarifications per FAQ 12-02
p. 79	Editorial corrections to data example
Table B-1	Corrected MSPI data element descriptions
App. D	Replaced discussion of FAQ timeliness with a reference pointing to App. E
p. D-13	Inserted Point Beach addition of auxiliary feedwater pumps, per FAQ 11-05
p. D-15	Inserted Fort Calhoun case on sirens de-powered because of flood, per FAQ 11-11
App. E	Inserted guidance on timely submittal of FAQs per whitepaper accepted May 2013
p. E-3	Inserted guidance on withdrawal of FAQs, per FAQ 10-01
Figure E-1	Revised FAQ template to link to updates of PRA information or basis document
App. F	Incorporated numerous conforming changes and corrections provided by Roy Linthicum throughout this appendix (e.g., adding “segment” where “train” appears)
pp. F-1 to F-3, F-7, F-	Clarified guidance on no cascading of unavailability, per FAQ 10-06.

Page or Section	Major Changes
33	
p. F-5	Clarified guidance on operability, per FAQ 09-08
p. F-10	Clarified guidance on changes in baseline unavailability, per FAQ 09-07
F2.1.2	Clarified that the fuel oil transfer pump is part of the EDG super-component, per FAQ 11-07
p. F-29	Revised EDG failure mode definitions per FAQ 09-08
App. F, Table 7	Incorporated Browns Ferry generic common cause factor adjustments, per FAQ 10-03.
p. F-57	Clarified treatment of last isolation valve in a cooling water line, per FAQ 11-01
Fig. F-1	Revised to show FOTP is within the boundary of the EDG, per FAQ 11-07
Fig. F-6	Revised to show treatment of last isolation valve, per FAQ 11-01
App. G	Incorporated conforming changes and corrections provided by Roy Linthicum
App. H	Clarified guidance regarding availability of main feedwater in determining complicated scrams, per FAQ 10-02

Frequently Asked Questions

The following table identifies where NRC-approved FAQs were incorporated in the text. Not all FAQs required a text change, and those FAQs are also identified. All of these FAQs will be placed in the archived FAQ file which is available on the NRC website for reference only.

FAQ#	PI	Subject	Subject Text Rev.6	Changes Text?	Final Approval Date and Documentation	Where Found in Revision 7?
09-04 (467)	IE04	USwC, Availability of Feedwater	pp. 21-22.	No	October 15, 2009 Meeting http://pbadupws.nrc.gov/docs/ML0930/ML093060290.html	Subject was Brunswick scram on 11/26/2008 that was judged to be uncomplicated. The proposed resolution called for generic guidance to be clarified in a future generic FAQ.
09-08 (472)	MS06 MS07 MS08 MS09 MS10	Definition of Availability	App. F, §1.2.1	Yes Done.	December 2, 2009 Meeting http://pbadupws.nrc.gov/docs/ML0930/ML093060290.html Changes are effective April 1, 2010 for data to be reported on July 21, 2010.	Page F-6, "Return to Service..." Page F-8, "or return to service..." Page F-29, "...when the EDG output breaker..." Page F-30, Added "Include all failures..." text to definitions of pump and valve failures.
09-07 (468)	MS06 MS07 MS08 MS09 MS10	Baseline Revisions	App. F, §1.2.1	Yes Done.	January 21, 2010 Meeting http://pbadupws.nrc.gov/docs/ML1002/ML100261638.html Changes are effective April 1, 2010 for data to be reported on July 21, 2010.	Page F-10, "Prior to implementation..."
09-09 (469)	IE03	Unplanned Power Changes	p. 14	Yes Done.	March 18, 2010 Meeting http://pbadupws.nrc.gov/docs/ML1008/ML100850185.html	Pages 14-16, delineation of applicable power changes
10-01 (470)	None	Withdrawal of FAQs	App. E	Yes Done.	March 18, 2010 Meeting http://pbadupws.nrc.gov/docs/ML1008/ML100850185.html	Page E-3, "Withdrawal of FAQs..."
09-06 (471)	EP01	Designated Notifier	pp. 45-46	Yes Done.	April 21, 2010 Meeting http://pbadupws.nrc.gov/docs/ML1011/ML101130117.html Effective July 1, 2010.	Page 51, "Demonstrating sufficient knowledge..."
10-04 (473)	MS06	Browns Ferry CCF Values	App. F, Table 7	Yes Done.	May 26, 2010 Meeting http://pbadupws.nrc.gov/docs/ML1015/ML101530434.html	Page F-42, Table 7, Added Unit 1 CCF adjustment value.
10-03 (474)	IE04	Wolf Creek Scrams	App. H	No	June 23, 2010 Meeting http://pbadupws.nrc.gov/docs/ML1018/ML101800474.pdf	Decided scram should count as complicated
10-05 (475)	IE04	Palo Verde Scrams	App. H	No	June 23, 2010 Meeting http://pbadupws.nrc.gov/docs/ML1018/ML101800474.pdf	NRC suggests generic FAQ should follow. This was later determined to be unneeded.
09-10 (476)	EP02	Common EOF	p. 50	Yes Done.	February 16, 2011 http://pbadupws.nrc.gov/docs/ML1106/ML11068A001.pdf Effective 3Q2011, for data to be reported by October 21, 2011.	Page 50, "If an ERO member..." Page 55, "The participation indicator..." Pages 56-58, "Option for ERO..."
11-02 (477)	MS05	MSPI Basis Document Update	pp. 33- 34	Yes Done.	February 16, 2011 http://pbadupws.nrc.gov/docs/ML1106/ML11068A001.pdf	Page 37-38, Inserted various mentions of when to update the basis document.
11-03 (478)	IE04	Robinson Scram	App. H	No	February 16, 2011 http://pbadupws.nrc.gov/docs/ML1106/ML11068A001.pdf	Scram determined not to count as complicated. No change in text needed.
11-05 (479)	MS08	Point Beach AFW Pumps	App. D	Yes Done	May 4, 2011 http://pbadupws.nrc.gov/docs/ML1114/ML11140A101.html	Page D-13, "Point Beach..." Page F-43, Table 7, Revised Point Beach MDP Standby value.

FAQ#	PI	Subject	Subject Text Rev.6	Changes Text?	Final Approval Date and Documentation	Where Found in Revision 7?
10-02 (481)	IE04	USwC	p. 20, lines 22-46	Yes Done	September 21, 2011 http://pbadupws.nrc.gov/docs/ML1128/ML11284A011.pdf Effective October 1, 2011, for data to be reported by January 21, 2012	Pages 20-26, Edited in role of MFW availability. Page H-1, Revised introduction to mention unavailability of MFW. Page H-4, Extensive revisions of Question H1.5. Page H-5, conforming edits to text of H1.5. Page H-20, conforming edits to H3.5.
11-01 (482)	MS10	Cooling Water Valve	p. F-52	Yes Done	September 21, 2011 http://pbadupws.nrc.gov/docs/ML1128/ML11284A011.pdf Effective January 1, 2012 for data to be reported by April 21, 2012.	Page F-58, Revised "Cooling Water Support System" description. Page F-66, Revised Figure F-6 to show train boundaries consistent with FAQ.
11-04 (483)	IE03	Downpower to Recover Lost Recirc Pump	p. 13, lines 24-29	Yes Done	September 21, 2011 http://pbadupws.nrc.gov/docs/ML1128/ML11284A011.pdf Effective October 1, 2011 for data to be reported by January 21, 2012.	Page 17, "Power changes to restore..."
11-06 (480)	MS06	EDG Run Hours	App. F, §2.2.1	Yes Done	September 21, 2011 http://pbadupws.nrc.gov/docs/ML1128/ML11284A011.pdf	Page F-24, "For pumps, run hours..."
11-07 (484)	MS05	Fuel Oil Transfer Pump	App. F, §2.1.2	Yes Done	May 4, 2011 http://pbadupws.nrc.gov/docs/ML1114/ML11140A101.html Effective January 1, 2012 for data to be reported by April 21, 2012	Page F-21, "...which are part of the EDG super-component..." Page F-22, Table 2, "Diesel Generators..." Page F-50, Revised "Scope" section to mention fuel oil transfer pump and valve. Page F-60, Revised Figure F-1 to clarify that FOTP is within EDG Component Boundary depicted.
11-08 (487)	MS06	EDG Failure Modes	p.F-26, lines 3-15	Yes Done	October 26, 2011 http://pbadupws.nrc.gov/docs/ML1130/ML11304A260.pdf Effective January 1, 2012 for data to be reported by April 21, 2012	Page F-29, Revised definition of EDF failure to run.
11-11 (485)	EP03	Siren Testing	p. 57, lines 6-10	Yes Done	September 21, 2011 http://pbadupws.nrc.gov/docs/ML1128/ML11284A011.pdf Effective 2Q2011	Page D-15, "Fort Calhoun..."
10-06 (486)	MS06	Cascaded Unavailability	§2.2, pp.31-36	Yes Done	October 26, 2011 http://pbadupws.nrc.gov/docs/ML1130/ML11304A260.pdf Effective April 1, 2012, for data to be reported by July 21, 2012.	Pages 35-40, "...train/system boundaries..." Page F-1, "The cooling water support system..." Page F-2, "The impact of room cooling..." Page F-7, "No Cascading..." Page F-33, Revised "Failures of Discovered Conditions". Page F-55, Revised Scope to mention CST.
11-09 (488)	MS	Crystal River Shutdown	App. D	No	October 26, 2011 http://pbadupws.nrc.gov/docs/ML1130/ML11304A260.pdf	Withdrawn
10-07	IE04	Vendor EOPs		No	May 4, 2011 http://pbadupws.nrc.gov/docs/ML1114/ML11140A101.html	Withdrawn
11-10	PP01	Security OUO		No	January 19, 2012 http://pbadupws.nrc.gov/docs/ML1203/ML12030A117.pdf	Approved final; see generic FAQ 12-02 for text changes needed
11-12	IE03	Fitzpatrick Downpowers		No	January 19, 2012 http://pbadupws.nrc.gov/docs/ML1203/ML12030A117.pdf	Approved final; determination only; no change required.
11-13	EP03	Suspension of		Yes	March 28, 2012	Page 63, "Additionally, if

FAQ#	PI	Subject	Subject Text Rev.6	Changes Text?	Final Approval Date and Documentation	Where Found in Revision 7?
		Siren Testing		Done	http://pbadupws.nrc.gov/docs/ML1211/ML12110A103.pdf Effective April 1, 2012, for data to be reported by July 21, 2012.	sirens are not..."
12-01	MS06	Columbia EDG Failure		No	August 29, 2012 http://pbadupws.nrc.gov/docs/ML1224/ML12249A179.html	Withdrawn
12-02	PP01	Counting of Compensatory Hours for PIDS		Yes Done	August 29, 2012 http://pbadupws.nrc.gov/docs/ML1224/ML12249A179.html	Page 77, "This indicator serves as a measure of..." Page 79, "Compensatory measures: Measures..." Page 81, "Degradation:..."
12-03	IE04	St. Lucie USwC		No	August 29, 2012 http://pbadupws.nrc.gov/docs/ML1224/ML12249A179.html	
12-06	EP02	DEP Oppys	p. 51	Yes Done	March 27, 2013 http://pbadupws.nrc.gov/docs/ML1311/ML13113A355.html	Section 2.4

[This page left intentionally blank]

TABLE OF CONTENTS

EXECUTIVE SUMMARY	i
SUMMARY OF CHANGES TO NEI 99-02	ii
FAQ TABLE	iv
1 INTRODUCTION	1
Background.....	1
General Reporting Guidance	2
Guidance for Correcting Previously Submitted Performance Indicator Data ...	3
Comment Fields.....	3
Numerical Reporting Criteria.....	5
Submittal of Performance Indicator Data	5
2 PERFORMANCE INDICATORS	10
2.1 INITIATING EVENTS CORNERSTONE.....	10
UNPLANNED SCRAMS PER 7,000 CRITICAL HOURS.....	10
UNPLANNED POWER CHANGES PER 7,000 CRITICAL HOURS.....	14
UNPLANNED SCRAMS WITH COMPLICATIONS.....	21
2.2 MITIGATING SYSTEMS CORNERSTONE.....	30
SAFETY SYSTEM FUNCTIONAL FAILURES	30
MITIGATING SYSTEM PERFORMANCE INDEX	34
2.3 BARRIER INTEGRITY CORNERSTONE.....	41
REACTOR COOLANT SYSTEM (RCS) SPECIFIC ACTIVITY	41
REACTOR COOLANT SYSTEM LEAKAGE	44
2.4 EMERGENCY PREPAREDNESS CORNERSTONE.....	46
DRILL/EXERCISE PERFORMANCE	46
EMERGENCY RESPONSE ORGANIZATION DRILL PARTICIPATION.....	53
ALERT AND NOTIFICATION SYSTEM RELIABILITY	60
2.5 OCCUPATIONAL RADIATION SAFETY CORNERSTONE	65
OCCUPATIONAL EXPOSURE CONTROL EFFECTIVENESS	65
2.6 PUBLIC RADIATION SAFETY CORNERSTONE.....	71
RETS/ODCM RADIOLOGICAL EFFLUENT OCCURRENCE	71
2.7 PHYSICAL PROTECTIONSECURITY CORNERSTONE.....	73
PROTECTED AREA (PA) SECURITY EQUIPMENT PERFORMANCE INDEX	73

Appendices

A.	Acronyms & Abbreviations.....	A-1
B.	Structure and Format of NRC Performance Indicator Data Files	B-1
C.	Background Information and Cornerstone Development.....	C-1
D.	Plant-Specific-Specific Design Issues	D-1
E.	Frequently Asked Questions.....	E-1
F.	Methodologies for Computing the Unavailability Index, the Unreliability Index and Component Performance Limits	F-1
G.	MSPI Basis Document Development	G-1
H.	USwC Basis Document	H-1

1 1 INTRODUCTION

2 This guideline describes the data and calculations for each performance indicator in the **United**
3 **States** Nuclear Regulatory Commission's (NRC) power reactor licensee assessment process. The
4 guideline also describes the licensee quarterly indicator reports that are to be submitted to the
5 NRC for use in its licensee assessment process.
6

7 This guideline provides the definitions and guidance for the purposes of reporting performance
8 indicator data. Responses to Frequently Asked Questions (FAQs) that have been approved by
9 the Industry/NRC working group and posted on the NRC's external website become addenda to
10 this guideline. No other documents should be used for definitions or guidance unless specifically
11 referenced in this document. This guideline should not be used for purposes other than
12 collection and reporting of performance indicator data in the NRC licensee assessment process.
13

14 **Background**

15 In 1998 and 1999, the NRC conducted a series of public meetings to develop a more objective
16 process for assessing a licensee's regulatory and safety performance. The new process uses risk-
17 informed insights to focus on those matters that are of safety significance. The objective is to
18 monitor performance in three broad areas – reactor safety (avoiding accidents and reducing the
19 consequences of accidents if they occur); radiation safety for plant workers and the public during
20 routine operations; and protection of the plant against sabotage or other security threats.
21

22 The three broad areas are divided into **seven** cornerstones: Initiating Events, Mitigating Systems,
23 Barrier Integrity, Emergency Preparedness, Public Radiation Safety, Occupational Radiation
24 Safety and **Physical Protection Security**. Performance indicators are used to assess licensee
25 performance in each cornerstone. The NRC ~~will~~-uses a risk-informed baseline inspection
26 process to supplement and complement the performance indicator(s). This guideline focuses on
27 the performance indicator segment of the assessment process.
28

29 The thresholds for each performance indicator provide objective indication of the **potential** need
30 to modify NRC inspection resources or to take other regulatory actions based on licensee
31 performance. Table 1 provides a summary of the performance indicators and their associated
32 thresholds.
33

34 The overall objectives of the process are to:

- 35 • improve the objectivity of the oversight processes so that subjective decisions and
36 judgment are not central process features,
- 37 • improve the scrutability of the NRC assessment process so that NRC actions have a clear
38 tie to licensee performance, and
- 39 • ~~risk~~-**Risk**-inform the regulatory assessment process so that NRC and licensee resources
40 are focused on those aspects of performance having the greatest impact on safe plant
41 operation.
42

1 In identifying those aspects of licensee performance that are important to the NRC's mission,
2 adequate protection of public health and safety, the NRC set high level performance goals for
3 regulatory oversight. These goals are:

- 4
- 5 • maintain a low frequency of events that could lead to a nuclear reactor accident;
- 6 • zero significant radiation exposures resulting from civilian nuclear reactors;
- 7 • no increase in the number of offsite releases of radioactive material from civilian nuclear
- 8 reactors that exceed 10 CFR Part 20 limits; and
- 9 • ~~no~~ No substantiated breakdown of physical protection that significantly weakens
10 protection against radiological sabotage, theft, or diversion of special nuclear materials.
- 11

12 These performance goals are represented in the new assessment framework as the strategic
13 performance areas of Reactor Safety, Radiation Safety, and Safeguards.

14
15 | Figure 1-~~0~~ provides a graphical representation of the licensee assessment process.

16 17 **General Reporting Guidance**

18 At quarterly intervals, each licensee will submit to the NRC the performance assessment data
19 described in this guideline. The data is submitted electronically to the NRC by the 21st calendar
20 day of the month following the end of the reporting quarter. If a submittal date falls on a
21 | Saturday, Sunday, or federal holiday,⁵ the next federal working day becomes the official due date
22 (in accordance with 10 CFR 50.4). The format and examples of the data provided in each
23 subsection show the complete data record for an indicator, and provide a chart of the indicator.
24 | These are provided for illustrative purposes only. Each licensee ~~only~~ sends to the NRC ~~only~~ the
25 data set from the previous quarter, as defined in each *Data Reporting Elements* subsection (See
26 Appendix B) along with any changes to previously submitted data.

27
28 The reporting of performance indicators is a separate and distinct function from other NRC
29 reporting requirements. Licensees will continue to submit other regulatory reports as required by
30 | regulations,⁵ such as, 10 CFR 50.72 and 10 CFR 50.73.

31
32 Performance indicator reports are submitted to the NRC for each power reactor unit. Some
33 indicators are based on station parameters. In these cases the station value is reported for each
34 power reactor unit at the station.

35
36 Issues regarding interpretation or implementation of NEI 99-02 guidance may occur during
37 implementation. Licensees are encouraged to resolve these issues with the Region. In those
38 instances where the NRC staff and the Licensee are unable to reach resolution, or to address
39 | plant-~~specific-specific~~ exceptions, the issue should be escalated to appropriate industry and NRC
40 management using the FAQ process.⁵ In the interim period until the issue is resolved, the
41 Licensee is encouraged to maintain open communication with the NRC. Issues involving
42 | enforcement are not ~~included in this~~ addressed through the FAQ process.

43
44

5 See additional information on FAQs in Appendix E, Frequently Asked Questions, and Appendix D, Plant Specific Design Issues.

1 Guidance for Correcting Previously Submitted Performance Indicator Data

2 ~~In instances where~~If data errors or a newly identified faulted condition are determined to have
3 occurred in a previous reporting period, ~~the~~ previously submitted indicator data are amended
4 only to the extent necessary to ~~correctly~~ calculate the indicator(s) for the current reporting period
5 ~~correctly~~.⁶ This amended information is submitted using ~~a~~the “change report” feature provided
6 in the INPO Consolidated Data Entry (CDE) software. The values of previous reporting periods
7 are revised, as appropriate, when the amended data is used by the NRC to recalculate the affected
8 performance indicator. The current report should reflect the new information, as discussed in the
9 detailed sections of this document. In these cases, the quarterly data report should include a
10 comment to indicate that the indicator values for past reporting periods are different than
11 previously reported. If ~~an~~a Licensee Event Report (LER) was required and the number is
12 available at the time of the report, the LER reference is noted.

13
14 If a performance indicator data reporting error is discovered, an amended “mid-quarter” report
15 does not need to be submitted if both the previously reported and amended performance
16 indicator values are within the ~~“green”~~same performance indicator band. In these instances,
17 corrected data should be included in the next quarterly report along with a brief description of
18 the reason for the change(s). If a performance indicator data error is discovered that causes a
19 threshold to be crossed, a “mid-quarter” report should be submitted as soon as practical
20 following discovery of the error. ~~Probabilistic Risk Assessment (PRA~~**Error! Bookmark not**
21 **defined.**) model changes are the exception to this guidance (see “Clarifying Notes” under
22 ~~Mitigating System Performance Index description on pages 33-34~~35-37 for additional details).

Heffner
2/6/13

23 Comment Fields

24
25 The quarterly report allows comments to be included with performance indicator data. A general
26 comment field is provided for comments pertinent to the quarterly submittal that are not specific
27 to an individual performance indicator. A separate comment field is provided for each
28 performance indicator. Comments included in the report should be brief and understandable by
29 the general public. Comments provided as part of the quarterly report will be included along
30 with performance indicator data as part of the NRC Public Web⁷ site on the oversight program.
31 If multiple PI comments are received by NRC that are applicable to the same unit/PI/quarter, the
32 NRC Public Web site will display all applicable comments for the quarter in the order received
33 (e.g., If a comment for the current quarter is received via quarterly report and a comment for the
34 same PI is received via a change report, then both comments will be displayed on the Web site.)
35 For General Comments, the NRC Public Web site will display only the latest “general” comment
36 received for the current quarter (e.g., A “general” comment received via a change report will
37 replace any “general” comment provided via a previously submitted quarterly report.)

38
39 Comments should be generally limited to instances as directed in this guideline. These instances
40 ~~include~~are summarized in Table 1 below.

41

⁶ Changes to data collection rules or practices required by the current revision of this document will not be applied retroactively to previously submitted data. Previously submitted data will not require correction or amendment provided it was collected and reported consistent with the NEI 99-02 revision and FAQ guidance in effect at the time of submittal.

⁷ www.nrc.gov/NRR/OVERSIGHT/ASSESS/index.html

1

Table 1 – Guidance for Submitting Comments with PI Data⁸

Submit a Comment When...	Guidance
A threshold has been exceeded	Comment should include a brief explanation and should be repeated in subsequent quarterly reports as necessary to address the exceedance.
Revising previously submitted data	Comment should include a brief characterization of the change, should identify affected time periods and should identify whether the change affects the “color” of the indicator.
Data is unavailable for the quarterly report	For example, RCS activity may be unavailable for one or more months due to plant conditions that do not require calculation of RCS activity.
An FAQ has been submitted that could impact current or previously submitted data	
A Safety System Functional Failure (SSFF) is reported	Comment shall include the LER number
A Notice of Enforcement Discretion or Technical Specification change has been granted without which the unit would have had an unplanned power change of greater than 20-percent of full power	
There is a failure to perform regularly-scheduled tests of the Alert and Notification System (ANS)	
There is a change in the ANS test methodology	
There is a change in Mitigating System Performance Index (MSPI) coefficients	The comments automatically generated by CDE do not fulfill this requirement. The plant must generate a plant-specific comment that describes what was changed.
There is a change in the MSPI Basis Document that affects the value of an indicator t	
Compensatory hours for security equipment upgrade modifications are excluded	
Engineering evaluations of a degraded condition are incomplete	

2

- ~~• Exceedance of a threshold (Comment should include a brief explanation and should be repeated in subsequent quarterly reports as necessary to address the threshold exceedance)~~
- ~~• Revision to previously submitted data (Comment should include a brief characterization of the change, should identify affected time periods and should identify whether the change affects the “color” of the indicator.)~~
- ~~• Unavailability of data for quarterly report (Examples include unavailability of RCS Activity data for one or more months due to plant conditions that do not require RCS activity to be calculated.)~~
- ~~• When an FAQ has been submitted that could impact the current or previously submitted data~~
- ~~• When a Safety System Functional Failure is reported, the LER number shall be listed~~
- ~~• If an NOED or technical specification change has been granted which would otherwise have resulted in an unplanned power change of greater than 20% full power~~
- ~~• Failure to perform regularly scheduled ANS tests~~

15

⁸ Text reformatted as table to improve readability; no change in Rev. 6 content is intended herein Rev. 7.

- ~~• Changes in ANS test methodology~~
- ~~• Changes to MSPI coefficients~~
- ~~• Changes to MSPI Basis Documents~~
- ~~• Excluded compensatory hours for security equipment upgrade modifications~~
- ~~• Uncompleted engineering evaluations of a degraded condition~~

~~Changes to MSPI coefficients require comments to be submitted. The comments automatically generated by CDE when MSPI coefficients are changed do not fulfill this requirement. The plant must generate a plant specific comment that describes what was changed.~~

In specific circumstances, some plants, because of unique design characteristics, may typically appear in the “increased regulatory response band,” as shown in Table 42. In such cases the unique condition and the resulting impact on the specific indicator should be explained in the associated comment field. Additional guidance is provided under the appropriate indicator sections.

The quarterly data reports are submitted to the NRC under 10 CFR 50.4 requirements. The quarterly reports are to be submitted in electronic form only. Separate submittal of a paper copy is not requested. Licensees should apply standard commercial quality practices to provide ~~reasonable~~ assurance that the quarterly data submittals are correct, ~~since they are subject to the requirements of 10 CFR 50.9~~. Licensees should plan to retain the data consistent with the historical data requirements for each performance indicator. For example, data associated with the barrier cornerstone should be retained for 12 months.

Heffner
2/6/13

The criterion for reporting is based on the time the failure or deficiency is identified, with the exception of the Safety System Functional Failure indicator, which is based on the Report Date of the LER. In some cases the time of failure is immediately known, in other cases there may be a time-lapse while calculations are performed to determine whether a deficiency exists, and in some instances the time of occurrence is not known and has to be estimated. Additional clarification is provided in specific indicator sections.

Numerical Reporting Criteria

Final calculations are rounded up or down to the same number of significant ~~figures-digits~~ as shown in Table 42. Where required, percentages are reported and noted as: 9.0%, 25%.

Balazik
6/3/13

Submittal of Performance Indicator Data

Performance indicator data should be submitted as a delimited text file (data stream) for each unit, attached to an email addressed to Pidata.Resource@nrc.gov. The structure and format of the delimited text files is discussed in Appendix B. The email message can include report files containing PI data for the quarter (quarterly reports) for all units at a site and can also include any report file(s) providing changes to previously submitted data (change reports). The title/subject of the email should indicate the unit(s) for which data is included, the applicable quarter, and whether the attachment includes quarterly report(s) (QR), change report(s) (CR) or both. The recommended format of the email message title line is “<Plant Name(s)>-

1 <quarter/year>-PI Data Elements (QR and/or CR)” (e.g., “Salem Units 1 and 2 – 1Q2000 – PI
2 Data Elements (QR)”). Licensees should not submit hard copies of the PI data submittal (with
3 the possible exception of a ~~back-back~~-up if the email system is unavailable).

4
5 The NRC will send return emails with the licensee’s submittal attached to confirm and
6 authenticate receipt of the proper data, generally within 2 business days. The licensee is
7 responsible for ensuring that the submitted data is received without corruption by comparing the
8 response file with the original file. Any problems with the data transmittal should be identified
9 in an email to Pidata.Resource@nrc.gov within 4 business days of the original data transmittal.

10
11 Additional guidance on the collection of performance indicator data and the creation of quarterly
12 reports and change reports is provided in the INPO CDE Job Aids available on the INPO CDE
13 webpage.⁹

14
15 ~~The reports made to the NRC under the regulatory assessment process [:- what does this mean? Is~~
16 ~~it still needed?] are in addition to the standard reporting requirements prescribed by NRC~~
17 ~~regulations.~~

18
⁹ <http://www.inpo.org/inpo/CDE.asp>

1
2

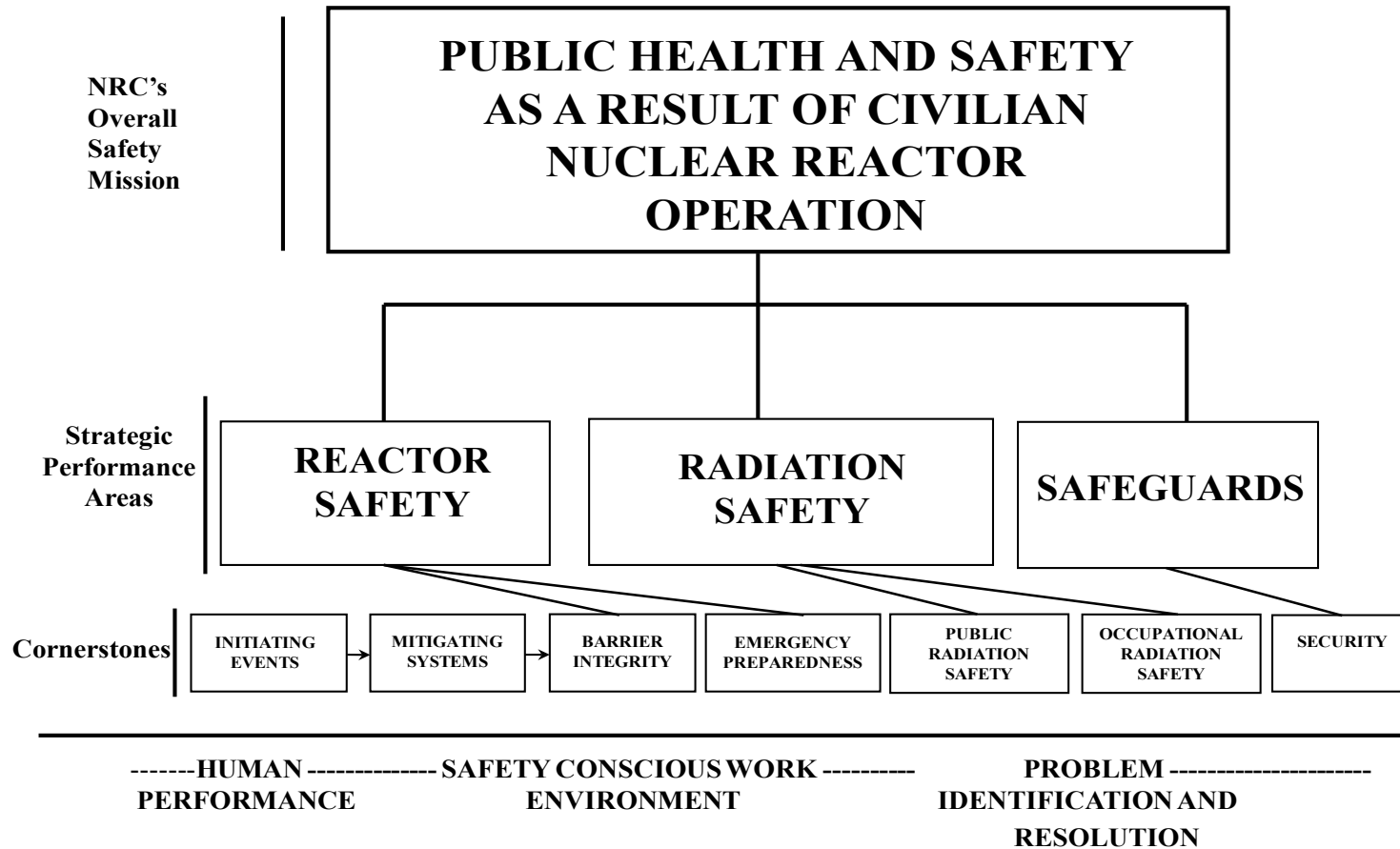

3
4
5

Figure 1 - Regulatory Oversight Framework

Table 21 – PERFORMANCE INDICATORS

Cornerstone	Indicator		Thresholds (see Note 1 and Note 2 for PLE)		
			Increased Regulatory Response Band	Required Regulatory Response Band	Unacceptable Performance Band
Initiating Events	IE01	Unplanned Scrams per 7000 Critical Hours (automatic and manual scrams during the previous four quarters)	>3.0	>6.0	>25.0
	IE03	Unplanned Power Changes per 7000 Critical Hours (over previous four quarters)	>6.0	N/A	N/A
	IE04	Unplanned Scrams with Complications (over the previous four quarters)	>1	N/A	N/A
Mitigating Systems	MS05	Safety System Functional Failures (over previous four quarters)	>6	N/A	N/A
		BWRs PWRs	>5	N/A	N/A
	MS06	Mitigating System Performance Index (Emergency AC Power Systems)	>1.0E-06 OR or PLE = YES	>1.0E-05	>1.0E-04
	MS07	Mitigating System Performance Index (High Pressure Injection Systems)	>1.0E-06 OR or PLE = YES	>1.0E-05	>1.0E-04
	MS08	Mitigating System Performance Index (Heat Removal Systems)	>1.0E-06 OR or PLE = YES	>1.0E-05	>1.0E-04
	MS09	Mitigating System Performance Index (Residual Heat Removal Systems)	>1.0E-06 or OR PLE = YES	>1.0E-05	>1.0E-04
	MS10	Mitigating System Performance Index (Cooling Water Systems)	>1.0E-06 or OR PLE = YES	>1.0E-05	>1.0E-04
Barrier Integrity Fuel Cladding Reactor Coolant System	BI01	Reactor Coolant System (RCS) Specific Activity (maximum monthly values, percent of Tech. Spec limit)	>50.0%	>100.0%	N/A
	BI02	RCS Identified Leak Rate (maximum monthly values, percent of Tech. Spec. limit)	>50.0%	>100.0%	N/A

Table 1-2 - PERFORMANCE INDICATORS Cont'd

Cornerstone	Indicator		Thresholds (see Note 1 and Note 2 for PLE)		
			Increased Regulatory Response Band	Required Regulatory Response Band	Unacceptable Performance Band
Emergency Preparedness	EP01	Drill/Exercise Performance (over previous eight quarters)	<90.0%	<70.0%	N/A
	EP02	ERO Drill Participation (percentage of Key ERO personnel that have participated in a drill or exercise in the previous eight quarters)	<80.0%	<60.0%	N/A
	EP03	Alert and Notification System Reliability (percentage reliability during previous four quarters)	<94.0%	<90.0%	N/A
Occupational Radiation Safety	OR01	Occupational Exposure Control Effectiveness (occurrences during previous 4 quarters)	>2	>5	N/A
Public Radiation Safety	PR01	RETS/ODCM Radiological Effluent Occurrence (occurrences during previous four quarters)	>1	>3	N/A
Physical Protection Security	PP01	Protected Area Security Equipment Performance Index (over a four quarter period)	>0.080	N/A	N/A

- 1
- 2 Note 1: Thresholds that are specific to a site or unit will be provided in Appendix D when identified.
- 3 Note 2: PLE — System Component Performance Limit Exceeded (see Appendix F, section F4)
- 4

Balazik
6/3/13

2 PERFORMANCE INDICATORS

2.1 INITIATING EVENTS CORNERSTONE

The objective of this cornerstone is to limit the frequency of those events that upset plant stability and challenge critical safety functions, during power operations. If not properly mitigated, and if multiple barriers are breached, a reactor accident could result which may compromise the public health and safety. Licensees can reduce the likelihood of a reactor accident by maintaining a low frequency of these initiating events. Such events include reactor scrams due to turbine trips, loss of feedwater, loss of off-site power, and other significant reactor transients.

The indicators for this cornerstone are reported and calculated per reactor unit.

There are three indicators in this cornerstone:

- Unplanned (automatic and manual) ~~scrams~~-Scrams per 7,000 critical hours
- Unplanned Power Changes per 7,000 critical hours
- Unplanned Scrams with Complications

UNPLANNED SCRAMS PER 7,000 CRITICAL HOURS
--

Purpose

This indicator monitors the number of unplanned scrams. It measures the rate of scrams per year of operation at power and provides an indication of initiating event frequency.

Indicator Definition

The number of unplanned scrams during the previous four quarters, both manual and automatic, while critical per 7,000 hours.

Data Reporting Elements

The following data are reported for each reactor unit:

- the number of unplanned automatic and manual scrams while critical in the previous quarter
- the number of hours of critical operation in the previous quarter

1 **Calculation**

2 The indicator is determined using the values for the previous four quarters as follows:

3

4
$$\text{valueValue} = \frac{(\text{total unplanned scrams while critical in the previous 4 qtrs}) \times 7,000 \text{ hrs}}{(\text{total number of hours critical in the previous 4 qtrs})}$$

5

6 **Definition of Terms**

7 *Scram* means the shutdown of the reactor by the rapid addition of negative reactivity by any
8 means, e.g., insertion of control rods, boron, use of diverse scram switch, or opening reactor trip
9 breakers.

10

11 *Unplanned scram* means that the scram was not an intentional part of a planned evolution or test
12 as directed by a normal operating or test procedure. This includes scrams that occurred during
13 the execution of procedures or evolutions in which there was a high chance of a scram occurring
14 but the scram was neither planned nor intended.

15

16 *Criticality*, for the purposes of this indicator, typically exists when a licensed reactor operator
17 declares the reactor critical. There may be instances where a transient initiates from a subcritical
18 condition and is terminated by a scram after the reactor is critical—this condition would count as
19 a scram.

20

21 **Clarifying Notes**

22 The value of 7,000 hours is used because it represents one year of reactor operation at about an
23 80% availability factor.

24

25 If there are fewer than 2,400 critical hours in the previous four quarters the indicator value is
26 displayed as N/A because rate indicators can produce misleadingly high values when the
27 denominator is small. The data elements (unplanned scrams and critical hours) are still reported.

28

29 Dropped rods, single rod scrams, or half scrams are not considered reactor scrams. Partial rod
30 insertions, such as runbacks, and rod insertion by the control system at normal speed also do not
31 count unless the resulting conditions subsequently cause a reactor scram.

32

33 Anticipatory plant shutdowns intended to reduce the impact of external events, such as tornadoes
34 or range fires threatening offsite power transmission lines, are excluded.

35

36 Examples of the types of scrams that **are included**:

37

- 38 • Scrams that resulted from unplanned transients, equipment failures, spurious signals, human
39 error, or those directed by abnormal, emergency, or annunciator response procedures.
- 40 • A scram that is initiated to avoid exceeding a technical specification action statement time
41 limit.

- 1 • A scram that occurs during the execution of a procedure or evolution in which there is a high
2 likelihood of a scram occurring but the scram was neither planned nor intended.
3

4 Examples of scrams that **are not** included:
5

- 6 • Scrams that are planned to occur as part of a test (e.g., a reactor protection system
7 actuation test), or scrams that are part of a normal planned operation or evolution.
8
9 • Reactor protection system actuation signals or operator actions to trip the reactor that occur
10 while the reactor is sub-critical.
11
12 • Scrams that are initiated at less than or equal to 35% reactor power in accordance with
13 normal operating procedures (i.e., not an abnormal or emergency operating procedure) to
14 complete a planned shutdown and scram signals that occur while the reactor is shut down.
15
16 • Plant shutdown to comply with technical specification **Limiting Condition for Operation**
17 **(LCOs)**¹⁰, if conducted in accordance with normal shutdown procedures which include a
18 manual scram to complete the shutdown.
19

Balazik
6/3/13

¹⁰ The section of Technical Specifications that identifies the lowest functional capability or performance level of equipment required for safe operation of the facility. (<http://www.nrc.gov/reading-rm/basic-ref/glossary/limiting-condition-for-operation.html>)

1 **Data Example**

Unplanned Scrams Per 7,000 Critical Hours								
	2Q97	3Q97	4Q97	1Q98	2Q98	3Q98	4Q98	1Q99
No. of Scrams Critical in Qtr	1	0	0	1	1	1	2	2
Total Scrams over 4 Qtrs	NA	NA	NA	2	2	3	5	6
No. Hrs Critical in Qtr	1500	1000	2160	2136	2160	2136	2136	1751
Total Hrs Critical in 4 Qtrs	NA	NA	NA	6796	7456	8592	8568	8183
Indicator Value	(Grayed)	(Grayed)	(Grayed)	Grayed)	1.9	2.4	4.1	5.1

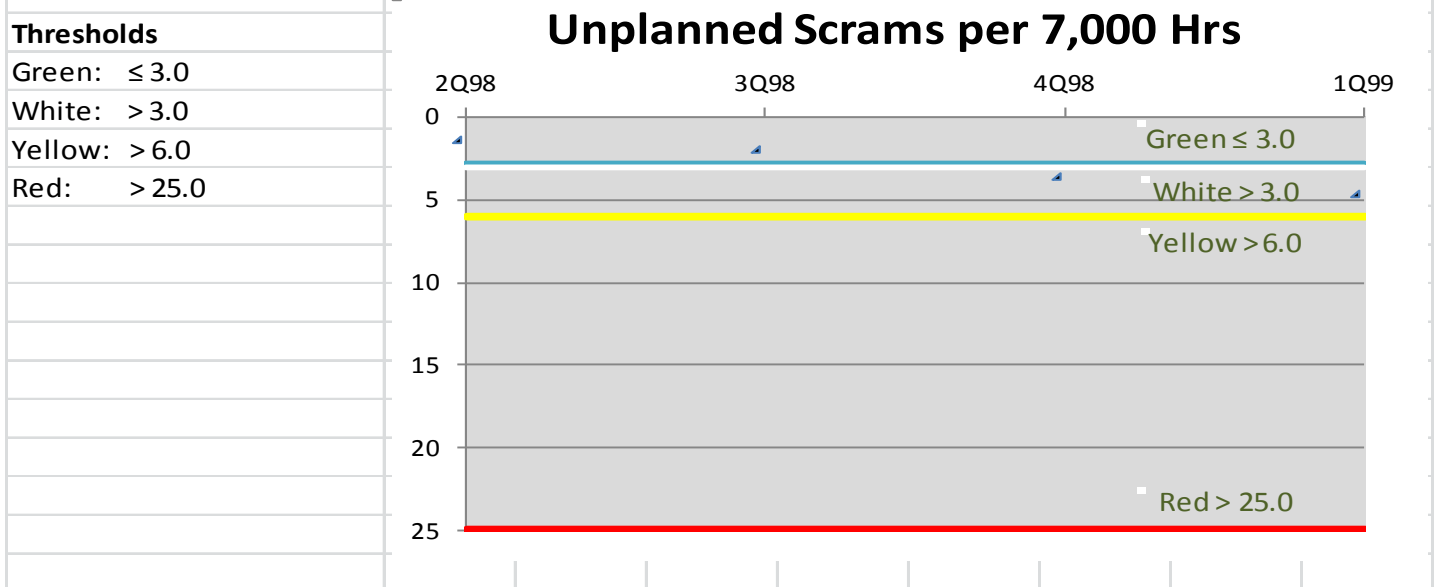

2
3

UNPLANNED POWER CHANGES PER 7,000 CRITICAL HOURS

Purpose

This indicator monitors the number of unplanned power changes (excluding scrams) that could have, under other plant conditions, challenged safety functions. It may provide leading indication of risk-significant events but is not itself risk-significant. The indicator measures the number of plant power changes for a typical year of operation at power.

Indicator Definition

The number of unplanned changes in reactor power of greater than 20% of full-power, per 7,000 hours of critical operation excluding manual and automatic scrams.

Data Reporting Elements

The following data is reported for each reactor unit:

- the number of unplanned power changes, excluding scrams, during the previous quarter
- the number of hours of critical operation in the previous quarter

Calculation

The indicator is determined using the values reported for the previous ~~4~~four quarters as follows:

$$\text{value} = \frac{\text{(total number of unplanned power changes over the previous 4 qtrs)}}{\text{(total number of hours critical during the previous 4 qtrs)}} \times 7,000 \text{ hrs}$$

Definition of Terms

Unplanned changes in reactor power, for the purposes of this indicator, ~~are~~ is a changes in reactor power that (1) ~~are was~~ initiated less than 72 hours following the discovery of an off-normal condition that required or resulted in a power change, ~~and that result in, or require a change in power level~~ of greater than 20% of full power to resolve, and (2) has not been excluded from counting per the guidance below. Unplanned changes in reactor power also include uncontrolled excursions of greater than 20% of full power that occur in response to changes in reactor or plant conditions and are not an expected part of a planned evolution or test.

FAQ469
(09-09)

Clarifying Notes

The value of 7,000 hours is used because it represents one year of reactor operation at about an 80% availability factor.

If there are fewer than 2,400 critical hours in the previous four quarters the indicator value is displayed as "N/A" because rate indicators can produce misleadingly high values when the

1 denominator is small. The data elements (unplanned power changes and critical hours) are still
2 reported.

3
4 The ~~72-72~~-hour period between discovery of an off-normal condition and the corresponding
5 change in power level is based on the typical time to assess the plant condition, and prepare,
6 review, and approve the necessary work orders, procedures, and ~~necessary~~ safety reviews, to
7 effect a repair. The key element to be used in determining whether a power change should be
8 counted as part of this indicator is the 72-hour period and not the extent of the planning that is
9 performed between the discovery of the condition and initiation of the power change.

10
11 Given the above, it is incumbent upon licensees to provide objective evidence that
12 identifies when the off-normal condition was discovered and when the power change of
13 more than 20% was initiated. Such objective evidence may include logs, troubleshooting
14 plans, meeting minutes, corrective action program documents, or similar type
15 documentation.

FAQ469
(09-09)

16
17 Examples of occurrences that **would be counted** against this indicator include:

- 18 • Power reductions that exceed 20% of full power and are not part of a planned and
19 documented evolution or test. Such power changes may include those conducted in
20 response to equipment failures or personnel errors or those conducted to perform
21 maintenance.
- 22 • Runbacks and power oscillations greater than 20% of full power. A power oscillation
23 that results in an unplanned power decrease of greater than 20% followed by an
24 unplanned power increase of 20% should be counted as two separate PI events, unless the
25 power restoration is implemented using approved procedures. For example, an operator
26 mistakenly opens a breaker causing a recirculation flow decrease and a decrease in power
27 of greater than 20%. The operator, hearing an alarm, suspects it was caused by his action
28 and closes the breaker resulting in a power increase of greater than 20%. Both transients
29 would count since they were the result of two separate errors (or unplanned/non-
30 proceduralized action).
- 31 • Unplanned downpowers of greater than 20% of full power for ALARA¹¹ reasons.
- 32 • Power reductions due to equipment failures that are under the control of the nuclear unit
33 are included in this indicator.

Balazik
6/3/13

34
35 Examples of occurrences that are **not** counted include the following:

- 36 • Planned power reductions (anticipated and contingency) that exceed 20% of full power
37 and are initiated in response to an off-normal condition discovered at least 72 hours
38 before initiation of the power change.

¹¹ As defined in Title 10, Section 20.1003, of the Code of Federal Regulations (10 CFR 20.1003), ALARA is an acronym for "as low as (is) reasonably achievable," which means making every reasonable effort to maintain exposures to ionizing radiation as far below the dose limits as practical, consistent with the purpose for which the licensed activity is undertaken, taking into account the state of technology, the economics of improvements in relation to state of technology, the economics of improvements in relation to benefits to the public health and safety, and other societal and socioeconomic considerations, and in relation to utilization of nuclear energy and licensed materials in the public interest. (Source: <http://www.nrc.gov/reading-rm/basic-ref/glossary/alara.html>)

- 1 • Unanticipated equipment problems that are encountered and repaired during a planned
2 power reduction greater than 20% that alone could have required a power reduction of
3 20% or more to repair.
- 4 • Apparent power changes that are determined to be caused by instrument problems.
- 5 • If conditions arise that would normally require unit shutdown, and a Notice of
6 Enforcement Discretion ~~NOED~~ (NOED) is granted that allows continued operation
7 before power is reduced greater than 20%, an unplanned power change is not reported
8 because no actual change in power greater than 20% of full power occurred. However, a
9 comment should be made that the NRC had granted an NOED during the quarter, which,
10 if not granted, may have resulted in an unplanned power change.
- 11 • Anticipatory power reductions intended to reduce the impact of external events such
12 as hurricanes or range fires threatening offsite power transmission lines, and power
13 changes requested by the system load dispatcher.
- 14 • Power changes to make rod pattern adjustments.
- 15 • Power changes directed by the load dispatcher under normal operating conditions due to
16 load demand, for economic reasons, for grid stability, or for nuclear plant safety
17 concerns.

FAQ469
(09-09)

18
19 Anticipated power changes greater than 20% in response to expected environmental problems
20 (such as accumulation of marine debris, biological contaminants, or frazil icing) which are
21 proceduralized but cannot be predicted greater than 72 hours in advance may not need to be
22 counted unless they are reactive to the sudden discovery of off-normal conditions. However,
23 unique environmental conditions which have not been previously experienced and could not
24 have been anticipated and mitigated by procedure or plant modification, may not count, even if
25 they are reactive. The licensee is expected to take reasonable steps to prevent intrusion of
26 marine or other biological growth from causing power reductions. Intrusion events that can be
27 anticipated as part of a maintenance activity or as part of a predictable cyclic behavior would
28 normally be counted unless the down power was planned 72 hours in advance. The
29 circumstances of each situation are different and should be identified to the NRC in a FAQ if the
30 licensee and resident inspector disagree so that a determination can be made concerning whether
31 the power change should be counted.

32
33 Licensees should use the power indication that is used to control the plant to determine if a
34 change of greater than 20% of full power has occurred.

35
36 If a condition is identified that is slowly degrading and the licensee prepares plans to reduce
37 power when the condition reaches a predefined limit, and 72 hours have elapsed since the
38 condition was first identified, the power change does not count. If however, the condition
39 suddenly degrades beyond the predefined limits and requires rapid response, this situation would
40 count. If the licensee has previously identified a slowly degraded off-normal condition but has
41 not prepared plans recognizing the potential need to reduce power when the condition reaches
42 predefined limits, then a sudden degradation of that condition requiring rapid response would
43 constitute a new off-normal condition and therefore, a new time of discovery.

1 Off-normal conditions that begin with one or more power reductions and end with an unplanned
2 reactor trip are counted in the unplanned reactor scram indicator only. However, if the cause of
3 the downpower(s) and the scram are different, an unplanned power change and an unplanned
4 scram must both be counted. For example, an unplanned power reduction is made to take the
5 turbine generator off line while remaining critical to repair a component. However, when the
6 generator is taken off line, vacuum drops rapidly due to a separate problem and a scram occurs.
7 In this case, both an unplanned power change and an unplanned scram would be counted. If an
8 off-normal condition occurs above 20% power, and the plant is shut down by a planned reactor
9 trip using normal operating procedures, only an unplanned power change is counted.

10
11 In developing a plan to conduct a power reduction, additional contingency power reductions may
12 be incorporated. These additional power reductions are not counted if they are implemented to
13 address the initial condition.

14
15 Equipment problems encountered during a planned power reduction greater than 20% that alone
16 may have required a power reduction of 20% or more to repair are not counted as part of this
17 indicator if they are repaired during the planned power reduction. However, if during the
18 implementation of a planned power reduction, power is reduced by more than 20% of full power
19 beyond the planned reduction, then an unplanned power change has occurred.

20
21 Unplanned power changes and shutdowns include those conducted in response to equipment
22 failures or personnel errors and those conducted to perform maintenance. They do not include
23 automatic or manual scrams or load-follow power changes. **Power changes to restore
24 equipment to service in accordance with approved procedures are excluded.**

FAQ483
(11-04)

25
26 ~~Apparent power changes that are determined to be caused by instrumentation problems are not
27 included.~~

Miller
2/11/13

28
29 Unplanned power changes include runbacks and power oscillations greater than 20% of full
30 power. ~~A power oscillation that results in an unplanned power decrease of greater than 20%
31 followed by an unplanned power increase of 20% should be counted as two separate PI events,
32 unless the power restoration is implemented using approved procedures. For example, an
33 operator mistakenly opens a breaker causing a recirculation flow decrease and a decrease in
34 power of greater than 20%. The operator, hearing an alarm, suspects it was caused by his action
35 and closes the breaker resulting in a power increase of greater than 20%. Both transients would
36 count since they were the result of two separate errors (or unplanned/non-proceduralized action).
37 Alternately, if the power change is implemented to restore equipment to service and is
38 performed using an approved procedure, the power change(s) (increases or decreases) to
39 restore the equipment to service would not count against this indicator. For example, in
40 BWRs, a power reduction for the purpose of re-starting a recently tripped reactor recirculation
41 pump to re-establish two-loop operation is excluded if the initial power reduction is caused by
42 the recirculation pump trip. The second power reduction to recover the tripped recirculation
43 pump does not count if it is implemented by an approved procedure in response to the initial
44 condition.~~

Miller
2/11/13

FAQ483
(11-04)

~~If conditions arise that would normally require unit shutdown, and an NOED is granted that allows continued operation before power is reduced greater than 20%, an unplanned power change is not reported because no actual change in power greater than 20% of full power occurred. However, a comment should be made that the NRC had granted an NOED during the quarter, which, if not granted, may have resulted in an unplanned power change.~~

Miller
2/11/13

~~Anticipatory power reductions intended to reduce the impact of external events such as hurricanes or range fires threatening offsite power transmission lines, and power changes requested by the system load dispatchers, are excluded.~~

Miller
2/11/13

~~Anticipated power changes greater than 20% in response to expected environmental problems (such as accumulation of marine debris, biological contaminants, animal intrusion, environmental regulations, or frazil icing) may qualify for an exclusion from the indicator. The licensee is expected to take reasonable steps to prevent intrusion of animals, marine debris, or other biological growth from causing power reductions. Intrusion events that can be anticipated as a part of a maintenance activity or as part of a predictable cyclic behavior would normally be counted, unless the downpower was planned 72 hours in advance or the event meets the guidance below.~~

Miller
2/11/13

~~In order for~~ For an environmental event to be excluded, any of the following may be applied:

- If the conditions have been experienced before and they exhibit a pattern of predictability or periodicity (e.g., seasons, temperatures, weather events, animals, etc.), the station must have a monitoring procedure in place or make a permanent modification to prevent recurrence for the event to be considered for exclusion from the indicator. If monitoring identifies the condition, the licensee must have implemented a proactive procedure (or procedures) to specifically address mitigation of the condition before it results in impact to operation. This procedure cannot be a general Abnormal Operating Procedure (AOP) or Emergency Operating Procedure (EOP) addressing the symptoms or consequences of the condition (e.g., low condenser vacuum); rather, it must be a condition-specific procedure that directs actions to be taken to address the specific environmental conditions (e.g., jellyfish, gracilaria, frazil ice, etc.)
- If the event is predictable, but the magnitude of the event becomes unique, the licensee must take appropriate actions and equipment designed to mitigate the event must be fully functional at the time of the event to receive an exclusion.
- Environmental conditions that are unpredictable (i.e., lightning strikes) may not need to count if equipment designed to mitigate the event was fully functional at the time of the event.
- Downpowers caused by adherence to environmental regulations, NPDES permits, or ultimate heat sink temperature limits may be excluded from the indicator.

The circumstances of each situation are different. In all cases, the NRC Region and Resident Inspectors should evaluate the circumstances of the power change, and if in disagreement with the licensee's position, the event should be identified in an FAQ so that a decision can be made concerning whether the power change should be counted. If the event is truly unique, an FAQ should be submitted unless the NRC Region and Resident Inspectors agree with the licensee's position.

1 ~~Power changes to make rod pattern adjustments are excluded.~~

Miller
2/11/13

2
3 ~~Power changes directed by the load dispatcher under normal operating conditions due to load~~
4 ~~demand, for economic reasons, for grid stability, or for nuclear plant safety concerns arising~~
5 ~~from external events outside the control of the nuclear unit are not included in this indicator.~~
6 ~~However, power reductions due to equipment failures that are under the control of the nuclear~~
7 ~~unit are included in this indicator.~~

8
9 ~~Licensees should use the power indication that is used to control the plant to determine if a~~
10 ~~change of greater than 20% of full power has occurred.~~

Miller
2/11/13

11
12 This indicator captures changes in reactor power that are initiated following the discovery of an
13 off-normal condition. If a condition is identified that is slowly degrading and the licensee
14 prepares plans to reduce power when the condition reaches a predefined limit, and 72 hours have
15 elapsed since the condition was first identified, the power change does not count. If, however,
16 the condition suddenly degrades beyond the predefined limits and requires rapid response, this
17 situation would count.

18
19 ~~Off-normal conditions that begin with one or more power reductions and end with an unplanned~~
20 ~~reactor trip are counted in the unplanned reactor scram indicator only. However, if the cause of~~
21 ~~the downpower(s) and the scram are different, an unplanned power change and an unplanned~~
22 ~~scram must both be counted. For example, an unplanned power reduction is made to take the~~
23 ~~turbine generator off line while remaining critical to repair a component. However, when the~~
24 ~~generator is taken off line, vacuum drops rapidly due to a separate problem and a scram occurs.~~
25 ~~In this case, both an unplanned power change and an unplanned scram would be counted. If an~~
26 ~~off-normal condition occurs above 20% power, and the plant is shutdown by a planned reactor~~
27 ~~trip using normal operating procedures, only an unplanned power change is counted.~~

Miller
2/11/13

28
29 ~~Downpowers of greater than 20% of full power for ALARA reasons are counted in the indicator.~~

1 **Data Example**

Unplanned Power Changes per 7,000 Critical Hours								
	2Q97	3Q97	4Q97	1Q98	2Q98	3Q98	4Q98	1Q99
No. of Power Changes in Qtr	1	0	0	1	2	2	1	3
Total Power Changes in 4 Qtrs	1	1	1	2	3	5	6	8
No. Hrs Critical in Qtr	1500	1000	2160	2136	2160	2136	2136	1751
Total Hrs Critical in 4 Qtrs	NA	NA	NA	6796	7456	8592	8568	8183
Indicator Value	(Grayed)	(Grayed)	(Grayed)	Grayed)	2.8	4.1	4.9	6.8

Thresholds
 Green: ≤ 6.0
 White: > 6.0
 Yellow: NA
 Red: NA

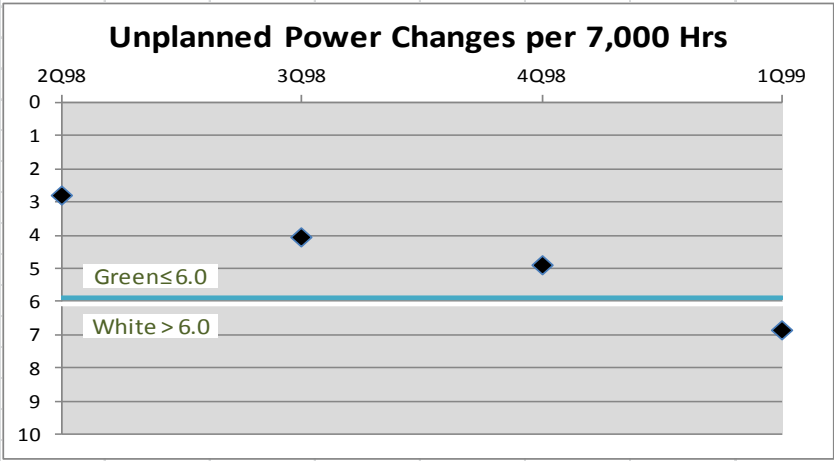

2

UNPLANNED SCRAMS WITH COMPLICATIONS (USWC)

Purpose

This indicator monitors that subset of unplanned automatic and manual scrams that either require additional operator actions beyond that of the “normal” scram or involve the unavailability of or inability to recover main feedwater. Such events or conditions have the potential to present additional challenges to the plant operations staff and therefore, may be more risk-significant than uncomplicated scrams.

FAQ481
(10-02)

Indicator Definition

The USWC indicator is defined as the number of unplanned scrams while critical, both manual and automatic, during the previous 4-four quarters that require additional operator actions or involve the unavailability of or inability to recover main feedwater as defined by the applicable flowchart (Figure 2) during the scram response (see definition of *scram response* in the Definitions of Terms section) and the associated flowchart questions.

FAQ481
(10-02)

Data Reporting Elements

The following data are required to be reported for each reactor unit.

The number of unplanned automatic and manual scrams while critical in the previous quarter that required additional operator response-actions or involved the unavailability of or inability to recover main feedwater as determined by the flowchart criteria during the scram response.

FAQ481
(10-02)

Calculation

The indicator is determined using the values reported for the previous 4-four quarters as follows:

Value = total unplanned scrams while critical in the previous 4-four quarters that required additional operator response-actions or involved the unavailability of or inability to recover main feedwater as defined by the applicable flowchart and the associated flowchart questions (Figure 2) during the scram response.

FAQ481
(10-02)

Definition of Terms

Scram means the shutdown of the reactor by the rapid addition of negative reactivity by any means, e.g., insertion of control rods, boron, use of diverse scram switches, or opening reactor trip breakers.

Normal Scram means any scram that is not determined to be complicated in accordance with the guidance provided in the Unplanned Scrams with Complications indicator. A normal scram is synonymous with an uncomplicated scram.

FAQ481
(10-02)

1 *Unplanned scram* means that the scram was not an intentional part of a planned evolution or test
2 as directed by a normal operating or test procedure. This includes scrams that occurred during
3 the execution of procedures or evolutions in which there was a high chance of a scram occurring
4 but the scram was neither planned nor intended.

5
6 *Criticality*, for the purposes of this indicator, typically exists when a licensed reactor operator
7 declares the reactor critical. There may be instances where a transient initiates from a subcritical
8 condition and is terminated by a scram after the reactor is critical—this condition would count as
9 a scram.

10
11 *Scram Response* refers to the period of time that starts with the scram and concludes
12 when operators have completed the scram response procedures and the plant has
13 achieved a stabilized condition in accordance with approved plant procedures and as
14 demonstrated by meeting the following criteria:-

FAQ481
(10-02)

15
16 For a PWR:

- 17 • Pressurizer pressure is within the normal operating pressure band.
- 18 • Pressurizer level is within the no-load pressurizer band.
- 19 • Level and pressure of all steam generators are within the normal operating bands.
- 20 • RCS temperature is within the allowable RCS no-load temperature band (T_{ave} if any RCS
21 pump running, T_{cold} if no RCS pumps running).

22
23 For a BWR:

- 24 • No emergency operating procedure (EOP) entry conditions exist related to either the
25 primary containment or the reactor.
- 26 • Reactor cool-down rates are less than 100 degrees F/hr.
- 27 • Reactor water level is being maintained within the range specified by plant procedures.

28 29 **Clarifying Notes**

30 This indicator is a subset of the IE01 indicator “Unplanned Scrams” and to be considered in this
31 indicator the scram must have counted in IE01.

32 33 **PWR FLOWCHART QUESTIONS (See Figure 2)**

34 **Did two or more control rods fail to fully insert?**

35
36 Did control rods that are required to move on a reactor trip fail to fully insert into the core as
37 evidenced by the Emergency Operating Procedure (EOP) evaluation criteria? As an example, for
38 some PWRs using rod bottom light indications, if more than one- rod bottom light is not
39 illuminated, this question must be answered "Yes." The basis of this step is to determine if
40 additional actions are required by the operators as a result of the failure of all rods to insert.
41 Additional actions, such as emergency boration, pose a complication beyond the normal scram
42 response that this metric is attempting to measure. It is allowable to have one control rod not
43 fully inserted since core protection design accounts for one control rod remaining fully
44 withdrawn from the core on a reactor trip. This question must be evaluated using the criteria
45 contained in the plant EOP used to verify that control rods inserted. During performance of this

1 | step of the EOP, the licensee staff would not need to apply the “Response Not Obtained” actions.
2 | Other means not specified in the EOPs are not allowed for this metric.
3 |

4 | **Did the turbine fail to trip?**
5 |

6 | Did the turbine fail to trip automatically/manually as required on the reactor trip signal? To be a
7 | successful trip, steam flow to the main turbine must have been isolated by the turbine trip logic
8 | actuated by the reactor trip signal, or by operator action from a single switch or pushbutton. The
9 | allowance of operator action to trip the turbine is based on the operation of the turbine trip logic
10 | from the operator action if directed by the EOP. Operator action to close valves or secure pumps
11 | to trip the turbine beyond use of a single turbine trip switch would count in this indicator as a
12 | failure to trip and a complication beyond the normal reactor trip response. Trips that occur prior
13 | to the turbine being placed in service or “latched” should have this question answered as “No”.
14 |

15 | **Was power lost to any ESF¹² bus?**
16 |

17 | During a reactor trip or during the period operators are responding to a reactor trip using reactor
18 | trip response procedures, was power lost to any ESF (Emergency Safeguards Features) bus that
19 | was not restored automatically by the Emergency Alternating Current (EAC) power system and
20 | remained de-energized for greater than 10 minutes? Operator action to re-energize the ESF bus
21 | from the main control board is allowed as an acceptable action to satisfy this metric.
22 |

23 | This question is looking for a loss of power at any time for any duration where the bus was not
24 | energized/re-energized within 10 minutes. The bus must have:

- 26 | • Remained energized until the scram response procedure was exited, or
- 27 | • Been re-energized automatically by the plant EAC power system (i.e., EDG), or
- 28 | • Been re-energized from normal or emergency sources by an operator closing a
29 | breaker from the main control board.

30 |
31 | The question applies to all ESF busses (switchgear, load centers, motor control centers and DC
32 | busses). This does NOT apply to 120-volt power panels. It is expected that operator action to
33 | re-energize an ESF bus would not take longer than 10 minutes.
34 |

35 | **Was a Safety Injection signal received?**
36 |

37 | Was a Safety Injection signal generated either manually or automatically during the reactor trip
38 | response? The question’s purpose is to determine if the operator had to respond to an abnormal
39 | condition that required a safety injection or respond to the actuation of additional equipment that
40 | would not normally actuate on an uncomplicated scram. This question would include any
41 | condition that challenged Reactor Coolant System (RCS) inventory, pressure, or temperature
42 | severely enough to require a safety injection. A severe steam generator tube leak that would
43 | require a manual reactor trip because it was beyond the capacity of the normal at power running

¹² Engineered Safety Features are provisions made in the design of nuclear power plants to mitigate the consequences of postulated accidents by maintaining the integrity of the fuel cladding, reactor coolant pressure boundary, and primary reactor containment, and thereby limiting releases of radioactive material. (Source: <http://pbadupws.nrc.gov/docs/ML0909/ML090900198.pdf>):

1 charging system should be counted even if a safety injection was not used since additional
2 charging pumps would be required to be started.

3
4 **Was Main Feedwater unavailable or not recoverable using approved plant**
5 **procedures following during the scram response?**

FAQ481
(10-02)

6
7 If operating prior to the scram, did Main Feedwater cease to operate and was it unable to be
8 restarted during the reactor scram response? The consideration for this question is whether Main
9 Feedwater could be used to feed the steam generators if necessary. The qualifier of “not
10 recoverable using approved plant procedures” will allow a licensee to answer “No” to this
11 question if there is no physical equipment restraint to prevent the operations staff from starting
12 the necessary equipment, aligning the required systems, or satisfying required logic using plant
13 procedures approved for use and in place prior to the reactor scram occurring.

14
15 The operations staff must be able to start and operate the required equipment using
16 normal alignments and approved emergency, normal and off-normal operating
17 procedures to provide the required flow to feed the minimum number of steam generators
18 required by the EOPs to satisfy the heat sink criteria. Manual operation of
19 controllers/equipment, even if normally automatic, is allowed if addressed by procedure.
20 Situations that require maintenance or repair activities or non-proceduralized operating
21 alignments require an answer of “Yes.” Additionally, the restoration of Feedwater must be
22 capable of feeding the Steam Generators in a reasonable period of time. Operations should be
23 able to start a Main Feedwater pump and start feeding Steam Generators with the Main
24 Feedwater System within about 30 minutes from the time it was recognized that Main Feedwater
25 was needed. During startup conditions where Main Feedwater was not placed in service prior to
26 the scram this question would not be considered and should be skipped. If For plants with design
27 features or procedural prohibitions that prevent restarting Main Feedwater, this question should
28 be answered as “No.” if Main Feedwater is free from damage or failure that would prevent it
29 from performing its intended function and is available for use.

FAQ481
(10-02)

30
31 **Was the scram response procedure unable to be completed without entering another EOP?**

32
33 The response to the scram must be completed without transitioning to an additional EOP after
34 entering the scram response procedure (e.g., ES01 for Westinghouse). This step is used to
35 determine if the scram was uncomplicated by counting if additional procedures beyond the
36 normal scram response required entry after the scram. A plant exiting the normal scram response
37 procedure without using another EOP would answer this step as “No”. The discretionary use of
38 the lowest level Function Restoration Guideline (Yellow Path) by the operations staff is an
39 approved exception to this requirement. Use of the Re-diagnosis Procedure by Operations is
40 acceptable unless a transition to another EOP is required.

1 **BWR FLOWCHART QUESTIONS (See Figure 2)**
2

3 **Did an RPS¹³ actuation fail to indicate / establish a shutdown rod pattern for a cold clean**
4 **core?**
5

6 Withdrawn control rods are required to be inserted to ensure the reactor will remain shutdown
7 under all conditions without boron to ensure the reactor will have the required shutdown margin
8 in a cold, xenon-free state.
9

10 Any initial evaluation that calls into question the shutdown condition of the reactor requires this
11 question to be answered “Yes.” The required entry into the Anticipated Transient
12 ~~Without~~ Scram (ATWS) leg of the EOP or required use of Alternate Rod Insertion (ARI)
13 requires this question to be answered “Yes.” Failure of the rod position indication in conjunction
14 with the loss of full-in-lights on enough rods to question the cold clean core shutdown status
15 would require this question to be answered “Yes.”
16

17 The basis of this step is to determine if additional actions are required by the operators to ensure
18 the plant remains shutdown as a result of the failure of any withdrawn rods to insert (or indicate
19 inserted). Additional actions, such as boron injection, or other actions to insert control rods to
20 maintain shutdown, pose a complication beyond a normal scram response. This question must be
21 evaluated using the criteria contained in the plant EOP used to verify the insertion of withdrawn
22 control rods.
23

24 **Was pressure control unable to be established following the initial transient?**
25

26 To be successful, reactor pressure must be controlled following the initial transient without the
27 use of Safety Relief Valves (SRVs). Automatic cycling of the SRV(s) that may have occurred as
28 a result of the initial transient would result in a “No” response, but automatic cycling of the
29 SRV(s) subsequent to the initial transient would result in a “Yes” response. Additionally, the
30 SRV(s) cannot fail open. The failure of the pressure control system (i.e., turbine valves / turbine
31 bypass valves / HPCI / RCIC/isolation condenser) to maintain the reactor pressure or a failed
32 open SRV(s) counts in this indicator as a complication beyond the normal reactor trip response
33 and would result in a “Yes” response.
34

35 **Was power lost to any Class 1E Emergency / ESF bus?**
36

37 During a reactor trip or during the period operators are responding to a reactor trip using reactor
38 trip response procedures, was power lost to any ESF bus that was not restored automatically by
39 the Emergency Alternating Current (EAC) power system and remained de-energized for greater
40 than 10 minutes? Operator action to re-energize the ESF bus from the main control board is
41 allowed as an acceptable action to result in a “No” response. The focus of this question is a loss
42 of power for any duration where the bus was not energized/re-energized within 10 minutes. The
43 bus must have:
44

¹³ Reactor Protection System (RPS): a complex control system that provides the ability to produce an automatic or manual rapid shutdown of the nuclear reactor, known as a reactor trip or scram. (Source: <http://nrcoe.inel.gov/resultsdb/SysStudy/W.aspx>)

- Remained energized until the scram response procedure was exited, or
- Been re-energized automatically by the plant EAC power system (i.e., EDG), or
- Been re-energized from normal or emergency sources by an operator closing a breaker or switch from the main control board.

The question applies to all ESF busses (switchgear, load centers, motor control centers and DC busses). This does NOT apply to 120-volt power panels. It is expected that operator action to re-energize an ESF bus would not take longer than 10 minutes.

Was a Level 1 Injection signal received?

Was a Level 1 Injection signal generated either manually or automatically during the reactor scram response? The consideration here is whether or not the operator had to respond to abnormal conditions that required a low pressure safety injection or the actuation of additional equipment that would not normally actuate on an uncomplicated scram. This question would include any condition that challenged RCS inventory, or ~~Drywell-drywell~~ pressure severely enough to require a safety injection. Alternately the question would be plants that do not have a high pressure Emergency Core Cooling System (ECCS) level signal that is different from the low pressure ECCS level signal would ask “was low pressure injection required?”

Was Main Feedwater not available or not recoverable using approved plant procedures during the scram response?

FAQ481
(10-02)

If operating prior to the scram, did Main Feedwater cease to operate and was it unable to be restarted during the reactor scram response? The consideration for this question is whether Main Feedwater could be used to feed the reactor vessel if necessary. The qualifier of “not recoverable using approved plant procedures” will allow a licensee to answer “NO” to this question if there is no physical equipment restraint to prevent the operations staff from starting the necessary equipment, aligning the required systems, or satisfying required logic circuitry using plant procedures approved for use that were in place prior to the scram occurring.

The operations staff must be able to start and operate the required equipment using normal alignments and approved **emergency**, normal and off-normal operating procedures.

Manual operation of controllers/equipment, even if normally automatic, is allowed if addressed by procedure. Situations that require maintenance **or repair** activities or non-proceduralized operating alignments will not satisfy this question. Additionally, the restoration of Main Feedwater must be capable of being restored to provide feedwater to the reactor vessel in a reasonable period of time. Operations should be able to start a Main Feedwater pump and start feeding the reactor vessel with the Main Feedwater System within **about 30 minutes from the time it was recognized that Main Feedwater was needed**. During startup conditions where Main Feedwater was not placed in service prior to the scram, this question would not be considered, and should be skipped.

FAQ481
(10-02)

1 **Following initial transient, did stabilization of reactor pressure/level and drywell pressure**
2 **meet the entry conditions for EOPs?**
3

4 This step is used to determine if the scram was uncomplicated and did not require using other
5 procedures beyond the normal scram response. Following the initial transient, maintaining
6 reactor and drywell pressures below the Emergency Procedure entry values while ensuring
7 reactor water level is above the Emergency Procedure entry values allows answering "No." The
8 requirement to remain in the EOPs because of reactor pressure/water level and drywell pressure
9 following the initial transient indicates complications beyond the typical reactor scram.

10 Additionally, ~~repeated~~ reactor water level scram signal(s) during the ~~initial transients~~ scram
11 ~~response~~ indicate level could not be stabilized and require this question be answered
12 "Yes".

Heffner
2/6/13

Data Examples

Unplanned Scrams with Complications											
	1Q05	2Q05	3Q05	4Q05	1Q06	2Q06	3Q06	4Q06	1Q07	2Q07	3Q07
No. Unplanned Scrams in Qtr	0	1	0	0	1	0	1	0	0	1	0
Total in 4 Qtrs	0	1	1	1	2	1	2	2	1	2	1
Indicator Value	0	1	1	1	2	1	2	2	1	2	1

Notes

Example assumes unit achieves first criticality in 1Q05 and ROP is in effect for this unit at that time.

Unit shut down in middle of 3Q06 and restarted in 2Q07; therefore value in 1Q07 is shown as not available.

"NA" value shown for 1Q07 is illustrative only. Actual value entered into INPO's Consolidated Data Entry system may differ.

Thresholds

Green: ≤ 1

White: > 1

Yellow: NA

Red: NA

Unplanned Scrams with Complications

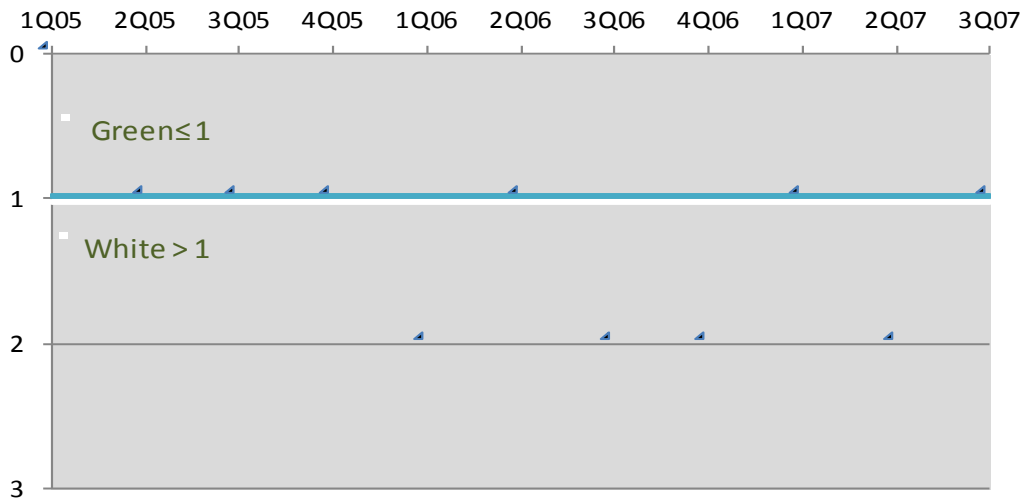

1
2

IE04 Unplanned Scrams with Complications – Flowchart
Figure 2

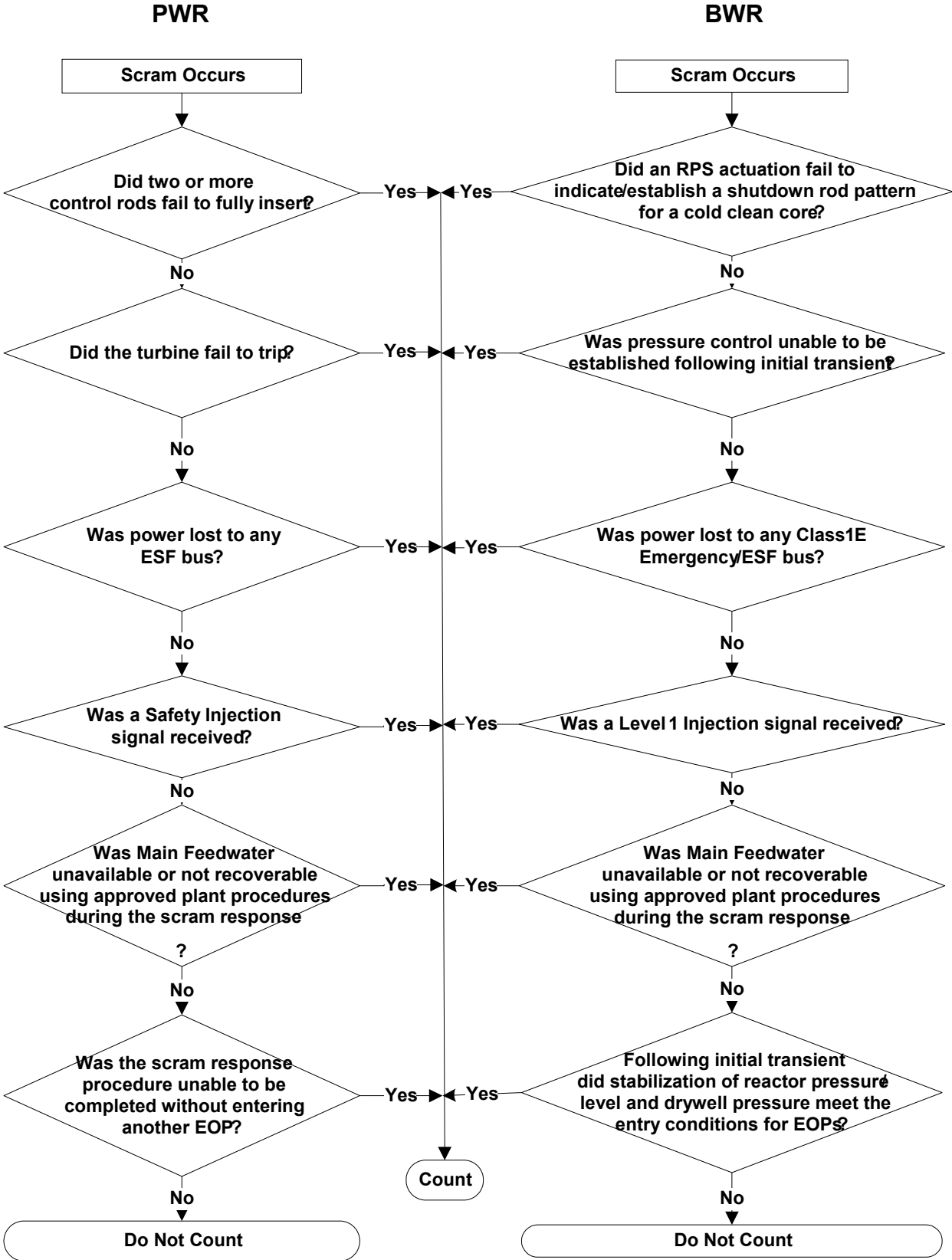

3

1 **2.2 MITIGATING SYSTEMS CORNERSTONE**

2 The objective of this cornerstone is to monitor the availability, reliability, and capability of
3 systems that mitigate the effects of initiating events to prevent core damage. Licensees reduce
4 the likelihood of reactor accidents by maintaining the availability and reliability of mitigating
5 systems. Mitigating systems include those systems associated with safety injection, decay heat
6 removal, and their support systems, such as emergency AC power. This cornerstone includes
7 mitigating systems that respond to both operating and shutdown events.

8
9 The definitions and guidance contained in this section, while similar to guidance developed in
10 support of INPO/WANO indicators and the Maintenance Rule, are unique to the Reactor
11 Oversight Process (ROP). Differences in definitions and guidance in most instances are
12 deliberate and are necessary to meet the unique requirements of the ROP.

13
14 While safety systems are generally thought of as those that are designed to mitigate design basis
15 accidents, not all mitigating systems have the same risk importance. PRAs have shown that risk
16 is often influenced not only by front-line mitigating systems, but also by support systems and
17 equipment. Such systems and equipment, both safety- and non-safety related, have been
18 considered in selecting the performance indicators for this cornerstone. Not all aspects of
19 licensee performance can be monitored by performance indicators, and risk-informed baseline
20 inspections are used to supplement these indicators.

21
22

23 **SAFETY SYSTEM FUNCTIONAL FAILURES**

24 **Purpose**

25 This indicator monitors events or conditions that prevented, or could have prevented, the
26 fulfillment of the safety function of structures or systems that are needed to:

27

- 28 (a) Shut down the reactor and maintain it in a safe shutdown condition;
29 (b) Remove residual heat;
30 (c) Control the release of radioactive material; or
31 (d) Mitigate the consequences of an accident.

32

33 **Indicator Definition**

34 The number of events or conditions that prevented, or could have prevented, the fulfillment of
35 the safety function of structures or systems in the previous four quarters.

36

37 **Data Reporting Elements**

38 The following data is reported for each reactor unit:

39

- 40 • the number of safety system functional failures reported during the previous quarter

41

42 **Calculation**

43 | **Unit** value = number of safety system functional failures in previous four quarters

1
2
3
4
5
6
7
8
9
10
11
12
13
14
15
16
17
18
19
20
21
22
23
24
25
26
27
28
29
30
31
32
33
34
35
36
37
38
39
40
41
42
43
44
45
46

Definition of Terms

A Safety System Functional Failure (SSFF) is any event or condition that could have prevented the fulfillment of the safety function of structures or systems that are needed to:

- (A) Shut down the reactor and maintain it in a safe shutdown condition;
- (B) Remove residual heat;
- (C) Control the release of radioactive material; or
- (D) Mitigate the consequences of an accident.

The indicator includes a wide variety of events or conditions, ranging from actual failures on demand to potential failures attributable to various causes, including environmental qualification, seismic qualification, human error, design or installation errors, etc. Many SSFFs do not involve actual failures of equipment.

Because the contribution to risk of the structures and systems included in the SSFF varies considerably, and because potential as well as actual failures are included, it is not possible to assign a risk-significance to this indicator. It is intended to be used as a possible precursor to more important equipment problems, until an indicator of safety system performance more directly related to risk can be developed.

Clarifying Notes

The definition of SSFFs is identical to the wording of the current revision to 10 CFR 50.73(a)(2)(v). Because of overlap among various reporting requirements in 10 CFR 50.73, some events or conditions that result in safety system functional failures may be properly reported in accordance with other paragraphs of 10 CFR 50.73, particularly paragraphs (a)(2)(i), (a)(2)(ii), and (a)(2)(vii). An event or condition that meets the requirements for reporting under another paragraph of 10 CFR 50.73 should be evaluated to determine if it also prevented the fulfillment of a safety function. Should this be the case, the requirements of paragraph (a)(2)(v) are also met and the event or condition should be included in the quarterly performance indicator report as an SSFF. **Error! Bookmark not defined.** The level of judgment for reporting an event or condition under paragraph (a)(2)(v) as an SSFF is a reasonable expectation of preventing the fulfillment of a safety function.

In the past, LERs may not have explicitly identified whether an event or condition was reportable under 10 CFR 50.73(a)(2)(v) (i.e., all pertinent boxes may not have been checked). It is important to ensure that the applicability of 10 CFR 50.73(a)(2)(v) has been explicitly considered for each LER considered for this performance indicator.

NUREG-1022: Unless otherwise specified in this guideline, guidance contained in the latest revision to NUREG-1022, “Event Reporting Guidelines, 10CFR 50.72 and 50.73,” that is applicable to reporting under 10 CFR 50.73(a)(2)(v), should be used to assess reportability for this performance indicator. Questions regarding interpretation of NUREG-1022 should not be referred to the FAQ process. They must be addressed to the appropriate NRC branch responsible for NUREG-1022.

1 Planned Evolution for maintenance or surveillance testing: NUREG-1022, Revision 2, page 56
2 states, “The following types of events or conditions generally are not reportable under these
3 criteria: . . . Removal of a system or part of a system from service as part of a planned evolution
4 for maintenance or surveillance testing. . .”

5
6 “Planned” means the activity is undertaken voluntarily, at the licensee’s discretion, and is not
7 required to restore operability or for continued plant operation.

8
9 A single event or condition that affects several systems: counts as only one failure.

10
11 Multiple occurrences of a system failure: the number of failures to be counted depends upon
12 whether the system was declared operable between occurrences. If the licensee knew that the
13 problem existed, tried to correct it, and considered the system to be operable, but the system was
14 subsequently found to have been inoperable the entire time, multiple failures will be counted
15 whether or not they are reported in the same LER. But if the licensee knew that a potential
16 problem existed and declared the system inoperable, subsequent failures of the system for the
17 same problem would not be counted as long as the system was not declared operable in the
18 interim. Similarly, in situations where the licensee did not realize that a problem existed (and
19 thus could not have intentionally declared the system inoperable or corrected the problem), only
20 one failure is counted.

21
22 Additional failures: a failure leading to an evaluation in which additional failures are found is
23 only counted as one failure; new problems found during the evaluation are not counted, even if
24 the causes or failure modes are different. The intent is to not count additional events when
25 problems are discovered while resolving the original problem.

26
27 Engineering analyses: events in which the licensee declared a system inoperable but an
28 engineering analysis later determined that the system was capable of performing its safety
29 function are not counted, even if the system was removed from service to perform the analysis.

30
31 Reporting date: the date of the SSFF is the Report Date of the LER. **If the LER is revised to**
32 **reflect the occurrence of an SSFF, the date of the SSFF is the Report Date of the revised**
33 **LER.**

Klett
Whitepaper
2/23/2012

34 The LER number should be entered in the comment field when an SSFF is reported.

1 **Data Examples**

Safety System Functional Failures									
	2Q98	3Q98	4Q98	1Q99	2Q99	3Q99	4Q99	1Q00	2Q00
Number this Quarter	1	3	2	1	1	2	0	1	0
Total over 4 Qtrs	1	4	6	7	7	6	4	4	3
Indicator Value	1	4	6	7	7	6	4	4	3
<i>Notes</i>									
<i>Example assumes the unit becomes subject to 10 CFR 50.73 and the ROP during 2Q98.</i>									
<i>Unit was shut down in 2Q99 and restarted in 1Q00.</i>									

Thresholds for PWRs

- Green: ≤ 5
- White: > 5
- Yellow: NA
- Red: NA

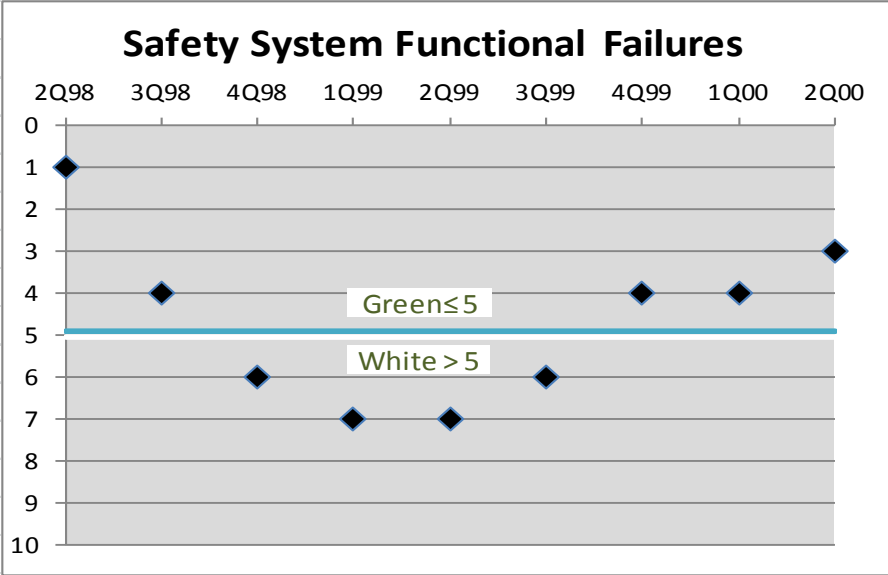

2

MITIGATING SYSTEM PERFORMANCE INDEX

Purpose

The purpose of the Mitigating System Performance Index is to monitor the performance of selected systems based on their ability to perform risk-significant functions as defined herein. It is comprised of three elements - system unavailability, system unreliability and system component performance limits. The index is used to determine the cumulative significance of failures and unavailability over the monitored time period.

Indicator Definition

Mitigating System Performance Index (MSPI) is the sum of changes in a simplified core damage frequency evaluation resulting from differences in unavailability and unreliability relative to industry standard baseline values. The MSPI is supplemented with system component performance limits.

Unavailability is the ratio of the hours the train/system was unavailable to perform its monitored functions (as defined by **the train/system boundaries**, PRA success criteria and mission times) due to planned and unplanned maintenance or test during the previous 12 quarters while critical to the number of critical hours during the previous 12 quarters. (Fault exposure hours are not included; unavailable hours are counted only from the time of discovery of a failed condition to the time the train's monitored functions are recovered.) Time of discovery of a failed monitored component is when the licensee determines that a failure has occurred or when an evaluation determines that the train would not have been able to perform its monitored function(s). In any case where a monitored component has been declared inoperable due to a degraded condition, if the component is considered available, there must be a documented basis for that determination, otherwise a failure will be assumed and unplanned unavailability would accrue. If the component is degraded but considered operable, timeliness of completing additional evaluations would be addressed through the inspection process.

FAQ486
(10-06)

Unreliability is the probability that the train/system would not perform its monitored functions, as defined by PRA success criteria, for a 24 hour run, when called upon during the previous 12 quarters.

Baseline values are the values for unavailability and unreliability against which current plant unavailability and unreliability are measured.

Component performance limit is a measure of degraded performance that indicates when the performance of a monitored component in an MSPI system is significantly lower than expected industry performance.

The MSPI is calculated separately for each of the following five systems for each reactor type.

BWRs

- emergency AC power system
- high pressure injection system (high pressure coolant injection, high pressure core spray, or feedwater coolant injection)
- reactor core isolation cooling (or isolation condenser)

- residual heat removal system (or the equivalent function as described in the Additional Guidance for Specific Systems section of Appendix F)
- cooling water support system (includes direct cooling functions provided by service water and component cooling water or their cooling water equivalents for the above four monitored systems)

PWRs

- emergency AC power system
- high pressure safety injection system
- auxiliary feedwater system
- residual heat removal system (or the equivalent function as described in the Additional Guidance for Specific Systems section of Appendix F)
- cooling water support system (includes direct cooling functions provided by service water and component cooling water or their cooling water equivalents for the above four monitored systems)

Data Reporting Elements

The following data elements are reported for each train/system

- Unavailability Index (UAI) due to unavailability for each monitored system
- Unreliability Index (URI) due to unreliability for each monitored system
- Systems that have exceeded their component performance limits

Calculation

The MSPI for each system is the sum of the UAI due to unavailability for the system plus URI due to unreliability for the system during the previous twelve quarters.

$$MSPI = UAI + URI$$

Component performance limits for each system are calculated as a maximum number of allowed failures (F_m) from the plant specific number of system demands and run hours. Actual numbers of equipment failures (F_a) are compared to these limits. **When the actual number of failures exceeds the component performance limit (i.e., $F_a > F_m$), this is designated as “Performance Limit Exceeded” or PLE=“yes”.** This part of the indicator only applies to the green-white threshold.

Balazik

See Appendix F for the calculation methodology for UAI due to system unavailability, URI due to system unreliability and system component performance limits.

The decision rules for assigning a performance color to a system are:

IF[(MSPI \leq 1.0e - 06) AND ($F_a \leq F_m$)] THEN performance is GREEN

IF{[(MSPI \leq 1.0e - 06) AND ($F_a > F_m$)] OR [(MSPI $>$ 1.0e - 06) AND (MSPI \leq 1.0e - 05)] }
THEN performance is WHITE

IF[(MSPI $>$ 1.0e - 05) AND (MSPI \leq 1.0e - 04)] THEN performance is YELLOW

IF(MSPI $>$ 1.0e - 04) THEN performance is RED

1
2 **Plant-Specific PRA**

3 The MSPI calculation uses coefficients that are developed from plant-specific PRAs.
4 The PRA used to develop these coefficients should reasonably reflect the as-built, as-operated
5 configuration of each plant.

6
7 Specific requirements appropriate for this PRA application are defined in Appendix G. Any
8 questions related to the interpretation of these requirements, the use of alternate methods to meet
9 the requirements or the conformance of a plant-specific PRA to these requirements will
10 be arbitrated by an Industry/NRC expert panel. If the panel determines that a plant-specific
11 specific PRA does not meet the requirements of Appendix G such that the MSPI would be
12 adversely affected, an appropriate remedy will be determined by the licensee and approved by
13 the panel. The decisions of this panel will be binding.

14
15 **Definition of Terms**

16 ***Risk Significant Functions:*** those at-at-power functions, described in the Appendix F section
17 “Additional Guidance for Specific Systems,” that were determined to be risk-significant in
18 accordance with NUMARC 93-01, or NRC-NRC-approved equivalents (e.g., the STP exemption
19 request). The risk-risk-significant system functions described in Appendix F, “Additional
20 Guidance for Specific Systems,” should be modeled in the plant’s PRA/PSA. System and
21 equipment performance requirements for performing the risk-risk-significant functions are
22 determined from the PRA success criteria, mission times, and boundaries for the system.

FAQ486
(10-06)

23 ***Mission Time:*** The mission time modeled in the PRA for satisfying the function of reaching a
24 stable plant condition where normal shutdown cooling is sufficient. Note that PRA models
25 typically use a mission time of 24 hours. However, shorter intervals, as justified by analyses and
26 modeled in the PRA, may be used.

27 ***Success criteria:*** The plant-specific values of parameters the train/system is required to
28 achieve to perform its monitored functions. Success criteria to be used are those documented in
29 the plant-specific PRA. Design Basis success criteria should be used in the case where
30 the plant-specific PRA has not documented alternative success criteria for use in the
31 PRA.

32 Individual component capability must be evaluated against train/system level success criteria
33 (e.g., a valve stroke time may exceed an ASME requirement, but if the valve still strokes in time
34 to meet the PRA success criteria for the train/system, the component has not failed for the
35 purposes of this indicator.).

36
37 **Clarifying Notes**

38 **Documentation and Changes**

39 Each licensee will have the system boundaries, monitored components, and monitored functions
40 and success criteria which differ from design basis readily available for NRC inspection on site.
41 Design basis criteria do not need to be separately documented. Additionally, plant-specific
42 information used in Appendix F should also be readily available for inspection. An acceptable
43 format, listing the minimum required information, is provided in Appendix G. **As stated in the**
44 **Introduction section of NEI 99-02, plant-specific comments should be provided in the data**

FAQ477
(11-02)

1 | ~~submittal when either the MSPI basis document or an MSPI coefficient is changed.~~ Changes
2 | ~~to the site PRA of record, the site basis document, and the CDE database should be made in~~
3 | ~~accordance with the following:~~

FAQ477
(11-02)

5 | ~~**Changes to PRA coefficient**~~ **PRA Model Revisions:** Updates to the MSPI coefficients
6 | ~~developed from the plant specific PRA will be made as soon as practical following an update to~~
7 | ~~the plant specific PRA (which are directly obtained from the plant-specific PRA) will be made~~
8 | ~~in the quarter following approval of an update to the plant-specific PRA of record. The revised~~
9 | ~~coefficients will be used in the MSPI calculation the quarter following the update.~~ Thus, the
10 | ~~PRA-MSPI~~ coefficients in use at the beginning of a quarter will remain in effect for the
11 | remainder of that quarter. ~~In addition, Changes~~ changes to the CDE database and MSPI basis
12 | document that are necessary to reflect changes to the ~~plant~~ plant-specific PRA of record should
13 | be incorporated ~~as soon as practical but need not be~~
14 | ~~completed prior to the start of the reporting quarter in which they become effective. The~~
15 | ~~quarterly data submittal should include a comment that provides a summary of any changes to~~
16 | ~~the MSPI coefficients. The comments automatically generated by CDE when PRA coefficients~~
17 | ~~are changed do not fulfill this requirement. The plant must generate a plant specific comment~~
18 | ~~that describes what was changed. Any PRA model changes will take effect the following quarter~~
19 | ~~(model changes include error, corrections, updates, etc.).~~ For example, if a plant's PRA model of
20 | record is approved on September 29 (~~3rd~~ third quarter), MSPI coefficients based on that model
21 | of record should be used for the ~~4th~~ fourth quarter. Updates to the MSPI basis document and the
22 | ~~The calculation of the new coefficients should be completed (including a revision of the MSPI~~
23 | ~~basis document if required by the plant specific processes) and input to CDE database should be~~
24 | ~~made~~ prior to reporting the ~~4th~~ fourth quarter's data (i.e., completed by January 21).

FAQ477
(11-02)

26 | **Changes to non-PRA information:** Updates to information that is not directly obtained from
27 | the PRA (e.g., unavailability baseline data, estimated demands/run hours) ~~can affect both the~~
28 | ~~MSPI basis document and the MSPI inputs into the CDE database. Changes to the MSPI~~
29 | ~~basis document and MSPI inputs into the CDE database that are needed to reflect changes to~~
30 | ~~non-PRA information will be made prior to the next quarterly data submittal. This does not~~
31 | ~~imply that any change to estimated demands/run hours is required to be reflected in the MSPI~~
32 | ~~basis document or CDE (See Appendix F, Section F.2.2.1 for requirements on when MSPI basis~~
33 | ~~document and CDE changes are required for estimated demands/run hours). will become~~
34 | ~~effective in the quarter following an approved revision to the site MSPI basis document. Changes~~
35 | ~~to the CDE database that are necessary to reflect changes to the site basis document should be~~
36 | ~~incorporated as soon as practical but need not be completed prior to the start of the reporting~~
37 | ~~quarter in which they become effective.~~ The quarterly data submittal should include a comment
38 | that provides a summary of any changes to the ~~MSPI~~ MSPI basis document and inputs to the CDE
39 | ~~database. The comments automatically generated by CDE when PRA coefficients are changed~~
40 | ~~do not fulfill this requirement. The plant must generate a plant specific comment that describes~~
41 | ~~what was changed.~~ For example, changes to the planned unavailability baseline that do not
42 | require a change to the PRA model must be documented in an MSPI basis document revision in
43 | the quarter prior to the revised values being used as inputs into the CDE database. This means
44 | completed by the 21st day of the month after the end of the quarter.

FAQ477
(11-02)

Linthicum
3/3/12

46 | **Plant Modifications:** Any changes to the plant should be evaluated for their impact on the
47 | MSPI basis document, MSPI inputs into the CDE database, and the PRA of record. Plant

FAQ477
(11-02)

1 modifications have the potential to involve both changes to the PRA model and non-PRA
2 information, while some modifications may be limited to either the PRA model or non-PRA
3 information. Modifications to the plant design that result in a change to segment or train
4 boundaries, monitored components, or affect monitored functions or success criteria, shall
5 be reflected in the MSPI basis document the quarter following the completed
6 implementation (i.e., completed by the 21st day of the month after the end of the quarter).
7 Additionally, if modifications are made to sub-components within the boundary of a monitored
8 component (such as the replacement of an emergency AC voltage regulator with a different type)
9 and that sub-component is described in the basis document, the basis document should be
10 updated to reflect the sub-component modification the quarter following the completed
11 implementation (i.e., completed by the 21st day of the month after the end of the quarter).

FAQ477
(11-02)
Linthicum
3/3/12

12 If the plant modification has the potential to impact the PRA model in a manner that affects
13 MSPI results, the modification shall be evaluated to determine if it results in a factor of three
14 change in the corrected Birnbaum value of an MSPI monitored train or component. If the new
15 Birnbaum value is greater than 1E-6, the MSPI basis document shall be updated to reflect the
16 new Birnbaum values the quarter following the completed implementation (i.e., completed by
17 the 21st day of the month after the end of the quarter). Note that the use of supplemental
18 evaluations to estimate the revised MSPI inputs for pending PRA model changes is allowed as an
19 interim alternative until the PRA model of record is updated.

FAQ477
(11-02)
Linthicum
3/3/12

20 ***Example CDE Comments:***

21 Following a periodic update to a PRA model, the following CDE comment would be
22 appropriate:

23 The XYZ PRA Model Revision 6 was approved on 7/6/10 with a corresponding MSPI
24 Basis Document Revision 3 approved on 12/21/10. The PRA model revision was a
25 periodic update to the model which included a data update, incorporation of an Auxiliary
26 Feedwater Crosstie between Units and a change in Human Error Probabilities using the
27 EPRI HRA calculator. As a result of the PRA model change, the CDF, Fussel-Vesely
28 and Basic Event Probabilities for all monitored trains and components were revised.

29
30 Following a change to baseline unavailability, the following CDE comments would be
31 appropriate:

FAQ477
(11-02)

32
33 **Scenario 1: Change Results in Negligible ($\leq 1E-8$) Increase in Train Birnbaum**

34
35 The planned unavailability baseline for the Residual Heat Removal was system was
36 increased by 30 hours per three years as a result of a new preventive maintenance task.
37 The increase in planned unavailability baseline was evaluated in the MSPI basis
38 document Revision 3, dated 3/23/11, and determined to result in a negligible increase in
39 Train Birnbaum values. Therefore, the revised values were incorporated into CDE
40 effective the second quarter 2011.

41
42 **Scenario 2: Change Results in Significant ($> 1E-8$) Increase in Train Birnbaum Values**

43
44 The planned unavailability baseline for the Residual Heat Removal was system was
45 increased by 30 hours per three years as a result of a new preventive maintenance task.
46 The increase in planned unavailability baseline was evaluated in the MSPI basis

FAQ477
(11-02)

1 document Revision 3, dated 3/23/11, concluding that a revision to the PRA model was
2 required prior to implementing the change. PRA model Revision 4 to reflect this change
3 in planned unavailability was approved on 2/15/11. The revised values were
4 incorporated into CDEError! Bookmark not defined. effective the second quarter 2011.
5

6 Following a design change that has a significant impact (\geq factor of three increase) on Birnbaum
7 values, the following CDE comment would be appropriate:
8

9 A modification was completed on 1/15/11 that removed a monitored MOV in the
10 Residual Heat Removal system. The MSPI basis document Revision 2 was approved
11 on 3/12/11 to account for this impact. As removal of the MOV had a negligible impact
12 on the overall CDF, the PRA model was not updated to reflect this change. The MSPI
13 Basis Document Revision includes an evaluation of the impact on MSPI inputs which
14 will be used until the next revision of the PRA model is completed.
15

FAQ477
(11-02)

16 Monitored Systems

17 Systems have been generically selected for this indicator based on their importance in preventing
18 reactor core damage. The systems include the principal systems needed for maintaining reactor
19 coolant inventory following a loss of coolant accident, for decay heat removal following a
20 reactor trip or loss of main feedwater, and for providing emergency AC power following a loss
21 of plant off-site power. One support function (cooling water support system) is also monitored.
22 The cooling water support system monitors the cooling functions provided by service water and
23 component cooling water, or their direct cooling water equivalents, for the four front-line
24 monitored systems. Other support systems (e.g., HVAC room coolers, DC power, instrument
25 air, etc.) will not be cascaded onto the monitored systems' unavailability or reliability data.
26 For the purposes of MSPI, a failure or unavailability of a support system component that is
27 outside the system and train boundary of a monitored system will not result in unavailability
28 of a monitored train or failure of a monitored component. ~~No support systems are to be~~
29 ~~cascaded onto the monitored systems, e.g., HVAC room coolers, DC power, instrument air, etc.~~

FAQ486
(10-06)
Linthicum
3/3/12

30 Diverse Systems

31 Except as specifically stated in the indicator definition and reporting guidance, no credit is given
32 for the achievement of a monitored function by an unmonitored system in determining
33 unavailability or unreliability of the monitored systems.

34 Use of Plant-Specific PRAError! Bookmark not defined. and SPAR Models

35 The MSPI is an approximation using information from a plant's PRA and is intended as an
36 indicator of system performance. More accurate calculations using plant-specific PRAs or SPAR
37 models cannot be used to question the outcome of the PIs computed in accordance with this
38 guideline.

1 **Data Examples**

Mitigating System Performance Index					
	1Q05	2Q05	3Q05	4Q05	1Q06
Unavailability Index (UAI)	8.48E-08	1.00E-09	8.72E-08	1.00E-06	1.00E-07
Unreliability Index (URI)	1.42E-06	1.00E-09	3.55E-07	1.00E-06	1.00E-07
Performance Limit Exceeded	No	No	No	Yes	No
Indicator Value (Calculated)	1.50E-06	2.00E-09	4.42E-07		2.00E-07
Indicator Value (Displayed)	1.5E-06	2.0E-09	4.4E-07	PLE	2.0E-07
Thresholds					
Green: $\leq 1.0E-06$	9.00E-07	9.00E-07	9.00E-07	9.00E-07	9.00E-07
White: $> 1.0E-06$ or PLE=Yes	1.10E-06	1.10E-06	1.10E-06	1.10E-06	1.10E-06
Yellow: $> 1.0E-05$	1.00E-05	1.00E-05	1.00E-05	1.00E-05	1.00E-05
Red: $> 1.0E-04$	1.00E-04	1.00E-04	1.00E-04	1.00E-04	1.00E-04

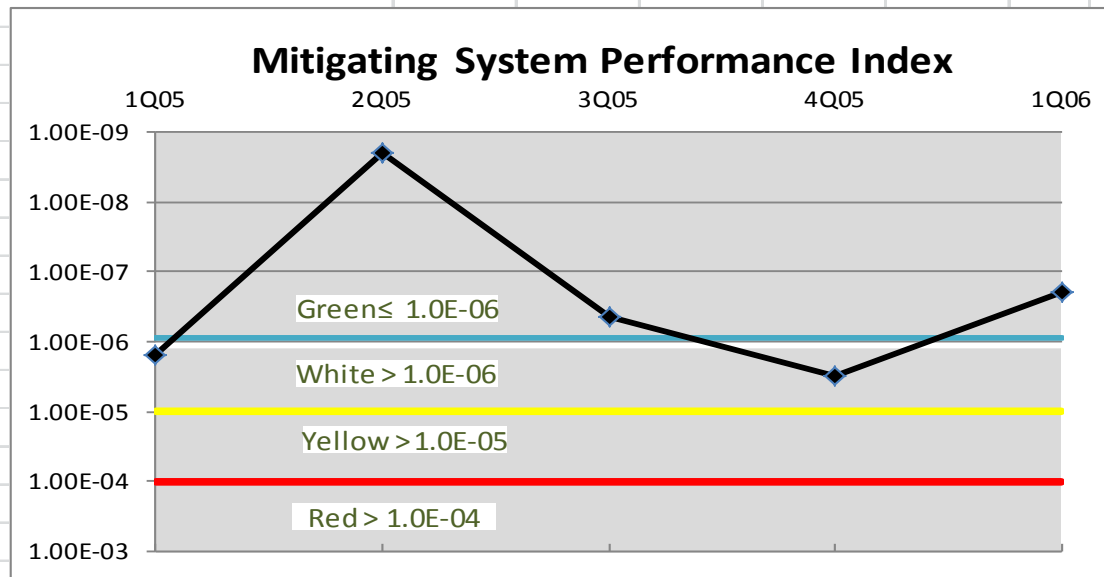

2

1 **2.3 BARRIER INTEGRITY CORNERSTONE**

2 The purpose of this cornerstone is to provide reasonable assurance that the physical design
3 barriers (fuel cladding, reactor coolant system, and containment) protect the public from
4 radionuclide releases caused by accidents or events. These barriers are an important element in
5 meeting the NRC mission of assuring adequate protection of public health and safety. The
6 performance indicators assist in monitoring the functionality of the fuel cladding and the reactor
7 coolant system. There is currently no performance indicator for the containment barrier. The
8 performance of this barrier is assured through the inspection program.

9
10 There are two performance indicators for this cornerstone:

- 11
- 12 • Reactor Coolant System (RCS) Specific Activity
- 13 • RCS Identified Leak Rate
- 14

15 **REACTOR COOLANT SYSTEM (RCS) SPECIFIC ACTIVITY**

16 **Purpose**

17 This indicator monitors the integrity of the fuel cladding, the first of the three barriers to prevent
18 the release of fission products. It measures the radioactivity in the RCS as an indication of
19 functionality of the cladding.

20
21 **Indicator Definition**

22 The maximum monthly RCS activity in micro-Curies per gram ($\mu\text{Ci/gm}$) dose equivalent Iodine-
23 131 per the technical specifications, and expressed as a percentage of the technical specification
24 limit. Those plants whose technical specifications are based on micro-curies per gram ($\mu\text{Ci/gm}$)
25 total Iodine should use that measurement.

26
27 **Data Reporting Elements**

28 The following data are reported for each reactor unit:

- 29
- 30 • ~~maximum~~Maximum calculated RCS activity for each unit, in micro-Curies per gram
31 dose equivalent Iodine-131, as required by technical specifications at steady state
32 power, for each month during the previous quarter (three values are reported).
- 33
- 34 • Technical Specification limit
- 35
- 36

37 **Calculation**

38 The indicator is calculated as follows:

39

$$40 \quad \text{Unit value} = \frac{\text{the maximum monthly value of calculated activity}}{\text{Technical Specification limit}} \times 100$$

1
2
3
4
5
6
7
8
9
10
11
12
13
14
15
16
17
18
19
20
21
22
23
24
25
26
27
28
29
30
31
32
33
34
35
36

Definitions of Terms

(Blank)

Clarifying Notes

This indicator is recorded monthly and reported quarterly.

The indicator is calculated using the same methodology, assumptions and conditions as for the Technical Specification calculation. If more than one method can be used to meet Technical Specifications, use the results of the method that was used at the time to satisfy the Technical Specifications.

Unless otherwise defined by the licensee, steady state is defined as continuous operation for at least three days at a power level that does not vary more than ± 5 percent.

This indicator monitors the steady state integrity of the fuel-cladding barrier at power. Transient spikes in RCS Specific Activity following power changes, shutdowns and scrams may not provide a reliable indication of cladding integrity and should not be included in the monthly maximum for this indicator.

Samples taken using technical specification methodology, when shutdown, are not reported. However, samples taken using the technical specification methodology at steady state power more frequently than required are to be reported. If in the entire month, plant conditions do not require RCS activity to be calculated, the data field is left blank for that month and the status "Final – N/A" is selected.

Licensees should use the most restrictive regulatory limit (e.g., technical specifications (TS) or license condition). However, if the most restrictive regulatory limit is insufficient to assure plant safety, then NRC Administrative Letter 98-10 applies, which states that imposition of administrative controls is an acceptable short-term corrective action. When an administrative control is in place as a temporary measure to ensure that TS limits are met and to ensure public health and safety (i.e., to ensure 10 CFR Part 100 dose limits are not exceeded), that administrative limit should be used for this PI.

1 **Data Examples**

Reactor Coolant System Specific Activity

	4/98	5/98	6/98	7/98	8/98	9/98	10/98	11/98	12/98	1/99	2/99	Prev. mth
Indicator, % of T.S. Limit	10	20	5	4	0.5	2	20	50	60	40	30	10
Max Activity $\mu\text{Ci/gm I-131 Equivalent}$	0.1	0.2	0.05	0.04	0.005	0.02	0.2	0.5	0.6	0.4	0.3	0.1
T.S Limit	1	1	1	1	1	1	1	1	1	1	1	1
Thresholds	Green	$\leq 50\%$ T.S. limit										
	White	$> 50\%$ T.S. limit										
	Yellow	$>100\%$ T.S. limit										

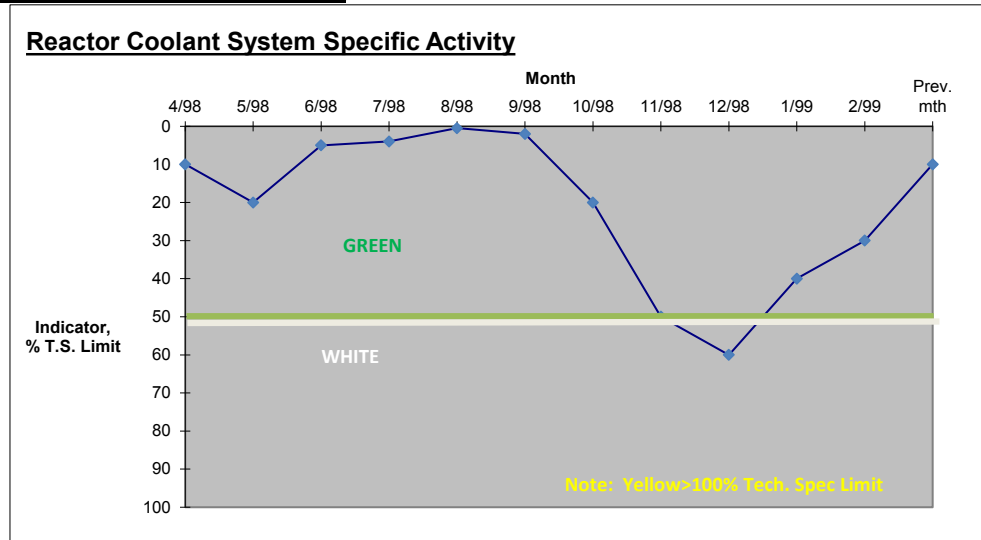

2
3
4

REACTOR COOLANT SYSTEM LEAKAGE

Purpose

This indicator monitors the integrity of the RCS pressure boundary, the second of the three barriers to prevent the release of fission products. It measures RCS Identified Leakage as a percentage of the technical specification allowable Identified Leakage to provide an indication of RCS integrity.

Indicator Definition

The maximum RCS Identified Leakage in gallons per minute each month per the technical specifications and expressed as a percentage of the technical specification limit.

Data Reporting Elements

The following data are required to be reported each quarter:

- The maximum RCS Identified Leakage calculation for each month of the previous quarter (three values).
- Technical Specification limit

Calculation

The unit value for this indicator is calculated as follows:

$$\text{Unit value} = \frac{\text{the maximum monthly value of identified leakage}}{\text{Technical Specification limiting value}} \times 100$$

Definition of Terms

RCS Identified Leakage as defined in Technical Specifications.

Clarifying Notes

This indicator is recorded monthly and reported quarterly.

Normal steam generator tube leakage is included in the unit value calculation if required by the plant's Technical Specification definition of RCS identified leakage.

For those plants that do not have a Technical Specification limit on Identified Leakage, substitute RCS Total Leakage in the Data Reporting Elements.

Any RCS leakage determination made in accordance with plant Technical Specifications methodology is included in the performance indicator calculation. If in the entire month, plant conditions do not require RCS leakage to be calculated, the data field is left blank for that month and the status "Final-N/A" is selected)

1
2 If the source and collection point of the leakage were unknown during the time period of the
3 leak, and the actual collection point was not a monitored tank or sump per the RCS Leakage
4 Calculation Procedure, then, for the purposes of this indicator, the leakage is not considered RCS
5 identified leakage and is not to be included in PI data. RCS leakage not captured under this
6 indicator may be evaluated in the inspection program.

7
8 **Data Examples**

Reactor Coolant System Leakage (RCSL)

	4/98	5/98	6/98	7/98	8/98	9/98	10/98	11/98	12/98	1/99	2/99
Indicator %T.S. Value	60	40	10	70	50	60	40	30	30	20	20
Identified Leakage (gpm)	6	4	1	7	5	6	4	3	3	2	2
TS Value (gpm)	10	10	10	10	10	10	10	10	10	10	10
Threshold											
Green	≤50% TS limit										
White	>50% TS limit										
Yellow	>100%TS limit										
Data collected monthly, reported quarterly											

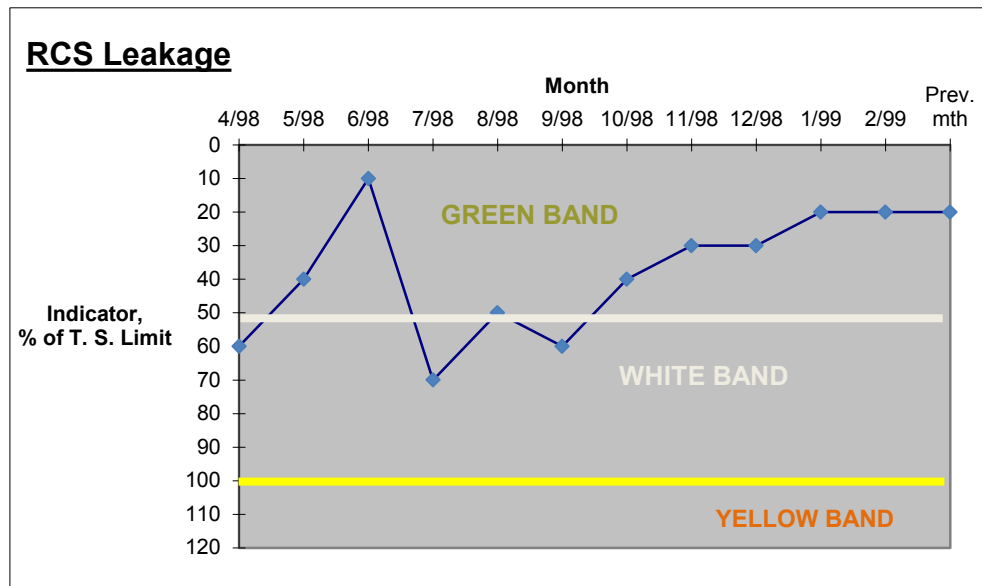

9

2.4 EMERGENCY PREPAREDNESS CORNERSTONE

The objective of this cornerstone is to ensure that the licensee is capable of implementing adequate measures to protect the public health and safety during a radiological emergency. Licensees maintain this capability through Emergency Response Organization (ERO) participation in drills, exercises, actual events, training, and subsequent problem identification and resolution. The Emergency Preparedness performance indicators provide a quantitative indication of the licensee's ability to implement adequate measures to protect the public health and safety. These performance indicators create a licensee response band that allows NRC oversight of Emergency Preparedness programs through a baseline inspection program. These performance indicators measure onsite Emergency Preparedness programs. Offsite programs are evaluated by FEMA.

The protection of public health and safety is assured by a defense in depth philosophy that relies on: safe reactor design and operation, the operation of mitigation features and systems, a multi-layered barrier system to prevent fission product release, and emergency preparedness.

The Emergency Preparedness cornerstone performance indicators are:

- Drill/Exercise performance (DEP),
- Emergency Response Organization Drill Participation (ERO),
- Alert and Notification System Reliability (ANS)

DRILL/EXERCISE PERFORMANCE

Purpose

This indicator monitors timely and accurate licensee performance in drills and exercises when presented with opportunities for classification of emergencies, notification of offsite authorities, and development of protective action recommendations (PARs). It is the ratio, in percent, of timely and accurate performance of those actions to total opportunities.

The notification timeliness criterion for this PI is met when the licensee makes contact with the first responsible State or local governmental agency within 15 minutes. This success criterion normalizes the notification capabilities of licensees, regardless of the number of site specific offsite notification requirements. As such, NRC and licensees can assess a site's specific capability to a common industry baseline to identify the possible need for additional inspection resources. Further, the notification performance enhancement opportunity provides the NRC assurance that a licensee is conducting the notification process in its entirety and evaluating compliance with the regulatory offsite notification requirement of Appendix E.IV.D.3 to 10 CFR Part 50.

FAQ 12-06

Indicator Definition

The percentage of all drill, exercise, and actual opportunities that were performed timely and accurately by Key Positions, as defined in the ERO Drill Participation performance indicator, during the previous eight quarters.

1 **Data Reporting Elements**

2 The following data are required to calculate this indicator:

- 3
- 4 • ~~the~~The number of drill, exercise, and actual event opportunities during the previous quarter.
 - 5
 - 6 • ~~the~~The number of drill, exercise, and actual event opportunities performed timely and
 - 7 accurately during the previous quarter.
 - 8

9 The indicator is calculated and reported quarterly. (See clarifying notes)

10 **Calculation**

11 The site average values for this indicator are calculated as follows:

12

$$13 \left[\frac{\text{\# of timely \& accurate classifications, notifications, \& PARs from DE \& AEs * during the previous 8 quarters}}{\text{The total opportunities to perform classifications, notifications \& PARs during the previous 8 quarters}} \right] \times 100$$

14

15 *DE & AEs = Drills, Exercises, and Actual Events

16

17 **Definition of Terms**

18 *Opportunities* should include multiple events during a single drill or exercise (if supported by the

19 scenario) or actual event, as follows:

- 20
- 21 • each expected classification or upgrade in classification
 - 22 • each initial notification of an emergency class declaration
 - 23 • each initial notification of PARs or change to PARs
 - 24 • each PAR developed

25

26 *Timely* means:

- 27
- 28 • classifications are made consistent with the goal of 15 minutes once available plant
 - 29 parameters reach an Emergency Action Level (EAL)
 - 30 • PARs are made consistent with the goal of 15 minutes once data is available.
 - 31 • offsite notifications are initiated within 15 minutes of event classification and/or PAR
 - 32 development (see clarifying notes)

33

34 *Accurate* means:

- 35
- 36 • Classification and PAR appropriate to the event as specified by the approved plan and
 - 37 implementing procedures (see clarifying notes)
 - 38 • Initial notification form completed appropriate to the event to include (see clarifying notes):
 - 39 - Class of emergency
 - 40 - EAL number
 - 41 - Description of emergency
 - 42 - Wind direction and speed
 - 43 - Whether offsite protective measures are necessary

- 1 - Potentially affected population and areas
- 2 - Whether a release is taking place
- 3 - Date and time of declaration of emergency
- 4 - Whether the event is a drill or actual event
- 5 - Plant and/or unit as applicable

6
7 **Clarifying Notes**

8 While actual event opportunities are included in the performance indicator data, the NRC will
9 also inspect licensee response to all actual events.

10
11 As a minimum, actual emergency declarations and evaluated exercises are to be included in this
12 indicator. In addition, other simulated emergency events that the licensee formally assesses for
13 performance of classification, notification or PAR development may be included in this indicator
14 (opportunities cannot be removed from the indicator due to poor performance).

15
16 The following information provides additional clarification of the accuracy requirements
17 described above:

- 18
19 • It is understood that initial notification forms are negotiated with offsite authorities. If
20 the approved form does not include these elements, they need not be added. Alternately,
21 if the form includes elements in addition to these, those elements need not be assessed for
22 accuracy when determining the DEP PI. It is, however, expected that errors in such
23 additional elements would be critiqued and addressed through the corrective action
24 system.
- 25
26 • The description of the event causing the classification may be brief and need not include
27 all plant conditions. At some sites, the EAL number is the description.
- 28
29 • “Release” means a radiological release attributable to the emergency event.
- 30
31 • Minor discrepancies in the wind speed and direction provided on the emergency
32 notification form need not count as a missed notification opportunity provided the
33 discrepancy would not result in an incorrect PAR being provided.

34
35 The licensee shall identify, in advance, drills, exercises and other performance enhancing
36 experiences in which opportunities will be formally assessed, and shall be available for NRC
37 review. The licensee has the latitude to include opportunities in the PI statistics as long as the
38 drill (in whatever form) simulates the appropriate level of inter-facility interaction. The criteria
39 for suitable drills/performance enhancing experiences are provided under the ERO Drill
40 Participation PI clarifying notes.

41
42 If credit for an opportunity is given in the ERO Drill Participation performance indicator, then
43 that opportunity must be included in the drill/exercise performance indicator. For example, if the
44 communicator performing the entire notification during performance enhancing scenario is an
45 ERO member in a Key Position, then the notification may be considered as an opportunity and, if
46 so, participation credit awarded to the ERO member in the Key Position.

47 |

1 If an ERO member in a Key Position supports multiple units (at one or more sites),
2 Drill/Exercise Performance (DEP) opportunities performed by the ERO member may be
3 credited to all sites potentially served by the ERO member, in addition to the specific site
4 participating in the drill or exercise.

FAQ476
(09-10)

5
6 When a performance enhancing experience occurs before an individual is assigned to a Key
7 Position in the ERO, then opportunities for that individual that were identified in advance shall
8 contribute to the Drill/Exercise (DEP) metric at the time the member is assigned to the ERO.

9
10 Performance statistics from operating shift simulator training evaluations may be included in this
11 indicator only when the scope requires classification. Classification, ~~PAR notifications~~ and
12 PARs performed in the simulator may be included in the indicator. Notifications for
13 Classification and Notifications for PARs may be included in this indicator if they are
14 performed to the point of filling out the appropriate forms and demonstrating sufficient
15 knowledge to perform the actual notification.

Hug
01/23/13

16
17 “Demonstrating sufficient knowledge” is defined as demonstrating the use of communications
18 equipment to contact the first offsite stakeholder for the purpose of transmitting initial
19 notification information (offsite stakeholder maybe role-played) in accordance with site
20 communication procedure(s), as well as, if used, demonstration of the needed interface
21 between the key ERO communicator and the phone-talker. It is recognized that key control
22 room positions may not perform the actual communication with offsite agencies as part of the
23 notification process. Personnel filling non-key positions for contacting offsite agencies (phone-
24 talker) may not be available during simulator training. If an evaluator role-plays the phone-
25 talker during the simulator session, a phone-talker is required to complete the notification
26 process out of sequence (e.g. notification form completed in the simulator is provided to a
27 phone-talker at a later time and the phone-talker demonstrates use of the telephone equipment to
28 an evaluator). Interactions normally between the Key Communicator and the phone-talker (e.g.
29 receiving instruction, discussion of the notification and correction of errors in the notification
30 form) occur between the phone-talker and an evaluator role playing the Key Communicator for
31 this off-sequence demonstration. Timeliness is determined by adding the time required to
32 complete the notification form in the simulator to the time required by the phone-talker to
33 interact and then utilize the communications equipment out of sequence. However, there is no
34 intent to disrupt ongoing operator qualification programs. Appropriate operator training
35 evolutions should be included in the indicator only when Emergency Preparedness aspects are
36 consistent with training goals. A successful PI opportunity is determined by evaluating
37 performance against program expectations. Thus, if it is part of a pre-established expectation to
38 enhance the realism of the training environment by marking “actual” on the notification forms, it
39 should be considered a successful PI opportunity if a simulator crew marks “actual” on the
40 notification form. However, all notification forms must be marked consistently, either “drill” or
41 “actual” in accordance with the requirements of the licensee’s emergency preparedness program
42 expectation. Not marking either drill or actual event (regardless of expectations) shall be a failed
43 opportunity.

FAQ471
(09-06)

44
45 Some licensees have specific arrangements with their State authorities that provide for different
46 notification requirements than those prescribed by the performance indicator, e.g., within one
47 hour, not 15 minutes. In these instances the licensee should determine success against the
48 specific state requirements.

1
2 For sites with multiple agencies to notify, the notification is considered to be initiated when
3 contact is made with the first agency to transmit the initial notification information.
4

5 Simulation of notification to offsite agencies is allowed. It is not expected that State/local
6 agencies be available to support all drills conducted by licensees. The drill should reasonably
7 simulate the contact and the participants should demonstrate their ability to use the equipment.
8

9 Classification is expected to be made promptly following indication that the conditions have
10 reached an emergency threshold in accordance with the licensee's EAL scheme. With respect to
11 classification of emergencies, the 15 minute goal is a reasonable period of time for assessing and
12 classifying an emergency once indications are available to control room operators that an EAL
13 has been exceeded. Allowing a delay in classifying an emergency up to 15 minutes will have
14 minimal impact upon the overall emergency response to protect the public health and safety.
15 The 15-minute goal should not be interpreted as providing a grace period in which a licensee
16 may attempt to restore plant conditions and avoid classifying the emergency.
17

18 If an event has occurred that resulted in an emergency classification where no EAL was
19 exceeded, the incorrect classification should be considered a missed opportunity. The subsequent
20 notification should be considered an opportunity and evaluated on its own merits.
21

22 During drill performance, the ERO may not always classify an event exactly the way that the
23 scenario specifies. This could be due to conservative decision making, Emergency Director
24 judgment call, or a simulator driven scenario that has the potential for multiple 'forks'. Situations
25 can arise in which assessment of classification opportunities is subjective due to deviation from
26 the expected scenario path. In such cases, evaluators should document the rationale supporting
27 their decision for eventual NRC inspection. Evaluators must determine if the classification was
28 appropriate to the event as presented to the participants and in accordance with the approved
29 emergency plan and implementing procedures.
30

31 If the expected classification level is missed because an EAL is not recognized within 15 minutes
32 of availability, but a subsequent EAL for the same classification level is subsequently
33 recognized, the subsequent classification is not an opportunity for DEP statistics. The reason
34 that the classification is not an opportunity is that the appropriate classification level was not
35 attained in a timely manner.
36

37 If a controller intervenes (e.g., coaching, prompting) with the performance of an individual to
38 make an independent and correct classification, notification, or PAR, then that DEP PI
39 opportunity shall be considered a failure.
40

41 Failure to appropriately classify an event counts as only one failure: This is because notification
42 of the classification, development of any PARs and PAR notification are subsequent actions to
43 classification. Similarly, if the same error occurs in follow-up notifications, it should only be
44 considered a missed opportunity on the initial notification form.

45 A Classification based on a downgrade from a previously existing higher classification is not
46 counted as an opportunity. It was not the intent to count downgrades as opportunities for the
47 DEP performance indicator. When a higher classification is reached in a drill, exercise or real
48 event it is probable that multiple EALs at equal or lower levels have also been exceeded. When

1 the reason for the highest classification is cleared, many of the lower conditions may still exist.
2 It is impractical to evaluate downgrades in classification from a timeliness and accuracy
3 standpoint. The notification of the downgrade should be handled as an update rather than a
4 formal opportunity for the performance indicator.

5
6 The notification associated with a PAR is counted separately: e. g., an event triggering a GE
7 classification would represent a total of 4 opportunities: 1 for classification of the GE, 1 for
8 notification of the GE to the State and/or local government authorities, 1 for development of a
9 PAR and 1 for notification of the PAR. All PAR notifications resulting in a Recommendation of
10 Evacuation or Shelter, whether default or not, should be counted as an opportunity for the
11 drill/exercise performance indicator.

12
13 If PARs at the SAE are in the site Emergency Plan they could be counted as opportunities.
14 However, this would only be appropriate where assessment and decision making is involved in
15 development of the PAR. Automatic PARs with little or no assessment required would not be an
16 appropriate contributor to the PI. PARs limited to livestock or crops and ~~no-no-PAR-PAR-~~
17 necessary decisions are also not appropriate.

18
19 Dose assessment and PAR development are expected to be made promptly following indications
20 that the conditions have reached a threshold in accordance with the licensee's PAR scheme. The
21 15 minute goal from data availability is a reasonable period of time to develop or expand a PAR.
22 Plant conditions, meteorological data, field monitoring data, and/or radiation monitor data should
23 provide sufficient information to determine the need to change PARs. If radiation monitor
24 readings provide sufficient data for assessments, it is not appropriate to wait for field monitoring
25 to become available to confirm the need to expand the PAR. The 15 minute goal should not be
26 interpreted as providing a grace period in which the licensee may attempt to restore conditions
27 and avoid making the PAR recommendation.

28
29 If a licensee has identified in its scenario objectives that Protective Action Guidelines (PAGs)
30 will be exceeded beyond the 10 mile plume exposure pathway emergency planning zone (EPZ)
31 boundary, then this would constitute a PI opportunity. In addition, there is a DEP PI opportunity
32 associated with the timeliness of the notification of the PAR to offsite agencies. Essential to
33 understanding that these DEP PI opportunities exist is the need to realize that it is a regulatory
34 requirement for a licensee to develop and communicate a PAR when EPA PAG doses may be
35 exceeded beyond the 10 mile plume exposure pathway EPZ. However, the licensee always has
36 the latitude to identify which DEP PI opportunities will be included in the PI statistics prior to
37 the exercise. Thus, a licensee may choose to not include a PAR beyond the 10-mile EPZ as a
38 DEP PI statistic due to its ad hoc nature.

39
40 If a licensee discovers after the fact (greater than 15 minutes) that an event or condition had
41 existed which exceeded an EAL, but no emergency had been declared and the EAL is no longer
42 exceeded at the time of discovery, the following applies:

- 43
- 44 • If the indication of the event was not available to the operator, the event should not be
45 evaluated for PI purposes.
 - 46 • If the indication of the event was available to the operator but not recognized, it should be
47 considered an unsuccessful classification opportunity.
 - 48 • In either case described above, notification should be performed in accordance with
NUREG-1022 and not be evaluated as a notification opportunity.

1 **Data Example**

2

Emergency Response Organization																
Drill/Exercise Performance																
						3Q/96	4Q/96	1Q/97	2Q/97	3Q/97	4Q/97	1Q/98	2Q/98	3Q/98	4Q/98	Prev. Q
Successful Classifications, Notifications & PARs over qtr						0	0	11	11	0	8	10	0	23	11	12
Opportunities to Perform Classifications, Notifications, & PARs in qtr						0	0	12	12	0	12	12	0	24	12	12
Total # of succesful Classifications, Notifications, & PARs in 8 qtrs													40	63	74	75
Total # of opportunities to perform Classification, Notifications & PARs in 8 qtrs													48	72	84	84
													2Q/98	3Q/98	4Q/98	Prev. Q
Indicator expressed as a percentage of Opportunities to perform Classifications, Communications & PARs													83.3%	87.5%	88.1%	89.3%

Threshold	
Green	≥ 90%
White	< 90%
Yellow	< 70%
Red	Not Applicable

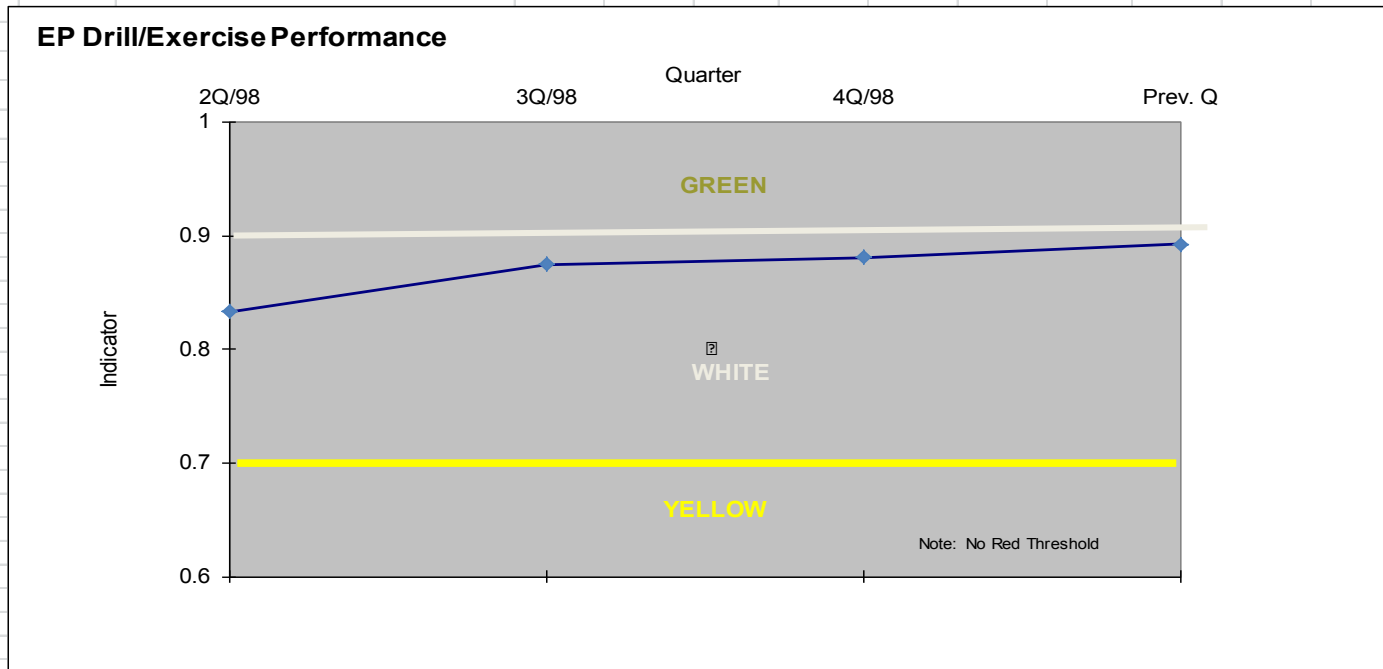

EMERGENCY RESPONSE ORGANIZATION DRILL PARTICIPATION

Purpose

This indicator tracks the participation of ERO members assigned to fill Key Positions in performance enhancing experiences, and through linkage to the DEP indicator ensures that the risk significant aspects of classification, notification, and PAR development are evaluated and included in the PI process. This indicator measures the percentage of ERO members assigned to fill Key Positions who have participated recently in performance-enhancing experiences such as drills, exercises, or in an actual event.

Indicator Definition

The percentage of ERO members assigned to fill Key Positions that have participated in a drill, exercise, or actual event during the previous eight quarters, as measured on the last calendar day of the quarter.

Data Reporting Elements

The following data are required to calculate this indicator and are reported:

- total number of ERO members assigned to fill Key Positions
- total number of ERO members assigned to fill Key Positions that have participated in a drill, exercise, or actual event in the previous eight quarters

The indicator is calculated and reported quarterly, based on participation over the previous eight quarters (see clarifying notes).

The participation indicator may include participation in a facility that supports multiple units.

FAQ476
(09-10)

Calculation

The site indicator is calculated as follows:

$$\frac{\text{\# of ERO members assigned to Key Positions that have participated in drill, exercise or actual event the previous 8 qtrs}}{\text{Total number of Key Positions assigned to ERO Members}} \times 100$$

Definition of Terms

Key Positions are defined below

- Control Room
 - Shift Manager (Emergency Director) - Supervision of reactor operations, responsible for classification, notification, and determination of protective action recommendations
 - Shift Communicator - provides initial offsite (state/local) notification

- 1
- 2 • Technical Support Center
- 3
- 4 • Senior Manager - Management of plant operations/corporate resources
- 5 • Key Operations Support
- 6 • Key Radiological Controls - Radiological effluent and environs monitoring,
- 7 assessment, and dose projections
- 8 • Key TSC Communicator- provides offsite (state/local) notification
- 9 • Key Technical Support
- 10
- 11 • Emergency Operations Facility
- 12
- 13 • Senior Manager - Management of corporate resources
- 14 • Key Protective Measures - Radiological effluent and environs monitoring,
- 15 assessment, and dose projections
- 16 • Key EOF Communicator- provides offsite (state/local) notification
- 17
- 18 • Operational Support Center
- 19
- 20 • Key OSC Operations Manager
- 21 • Assigned: Those ERO personnel filling Key Positions listed on the licensee duty roster on the
- 22 last day of the quarter of the reporting period.
- 23

24 **Clarifying Notes**

25 When the performance of Key Positions includes classification, notification, or PAR
26 development opportunities, the success rate of these opportunities must contribute to
27 Drill/Exercise Performance (DEP) statistics for participation of those Key Positions to contribute
28 to ERO Drill Participation. Participation drill credit before being assigned to the ERO may be
29 counted for these Key Positions once the individual is assigned to the ERO as long as the success
30 rate for the opportunities contributes to Drill/Exercise (DEP) statistics.

31
32 The licensee may designate drills as not contributing to DEP and, if the drill provides a
33 performance enhancing experience as described herein, those Key Positions that do not involve
34 classification, notification or PARs may be given credit for ERO Drill Participation.
35 Additionally, the licensee may designate elements of the drills not contributing to DEP (e.g.,
36 classifications will not contribute but notifications will contribute to DEP.) In this case, the
37 participation of all Key Positions, except those associated with the non-contributing elements,
38 may contribute to ERO Drill Participation. Participation drill credit before being assigned to the
39 ERO may be counted for the Key Positions not contributing to DEP if the drill provides a
40 performance enhancing experience as described herein. The licensee must document such
41 designations in advance of drill performance and make these records available for NRC
42 inspection.

43
44 **In order for an opportunity to be considered a performance enhancing experience for a Key**
45 **Communicator, the opportunity must include demonstration of the ability to perform a**
46 **notification of the emergency classification level to required agencies. Documentation of the**
47 **opportunity and its evaluation/critique is to be comprehensive enough to allow an Inspector to reasonably**
48 **reach the same conclusion as the licensee as to the adequacy of the performing enhancing experience.**

FAQ 12-06

1
2 Option for Emergency Response Organizations with Common Facilities

FAQ476
(09-10)

3
4 If an ERO member in a Key Position supports multiple units (at one or more sites) and
5 demonstrates similar skill sets during a performance-enhancing experience, participation
6 credit may be granted for all sites supported.

7
8 Negative performance credit as well as positive performance credit will be assigned to all
9 units.

FAQ476
(09-10)

10
11 Similarity of Skill Sets

12
13 Skill sets are considered similar when the procedures, processes and protocols involved
14 accomplish the same task or goal. Examples of similar skill sets are provided below.

15
16 Classification

17
18 Classification of Emergencies are similar when Emergency Action Level procedures,
19 processes and protocols used by the ERO members in the Key Position are essentially the
20 same (for example all units would use NEI 99-01 or in the case where a unit may be an
21 advanced passive light water reactor it would be acceptable to utilize NEI 99-01 for
22 existing technology and NEI 07-01 for passive technology). Training for key ERO
23 members performing this function is to include unit-specific and/or technology differences
24 relating to Initiating Conditions/Emergency Action Levels (e.g., ISFSI, unique hazards,
25 design considerations, etc.).

26
27 Protective Action Recommendations (PARs)

28
29 Protective Action Recommendations, when developed with the same protective action
30 strategies, are similar provided that the procedures, processes and protocols for the
31 development of the protective action recommendations are essentially the same. For
32 example:

- 33
34
35
36
37
38
39
40
41
42
- Logic flow charts may differ (e.g., because of population differences among the sites), but should serve the same purpose and be used in the same way.
 - Protective Action Zones may differ, but the process used to identify the action taken for the zones is the same.
 - Implementation of potassium iodide (KI) strategies may differ based on the implementation strategies of responsible authorities at the State and/or Local level, but the procedures, processes and protocols used to determine if KI is warranted should be the same.
 - PAR development discussion strategies should be the same for each site supported by the common facility.

43
44 Dose Assessment

45
46 Dose assessment is similar when methodologies, applicable computer programs, and
47 models are the same across sites and/or unit technologies served by the common facility.
48 Definitions of what constitutes a radiological release during a classified emergency are

1 the same. Training for key ERO members performing this function must include unit-
2 specific differences in effluent monitors and release pathways, local meteorological
3 regimes and topography impacts and how these differences impact the dose assessment.
4

5 Emergency Notifications

6
7 The emergency communicator functions are similar when procedures, processes and
8 protocols are performed utilizing a similar emergency notification form design and
9 content. Emergency communicators will be trained on all notification procedures,
10 processes and protocol differences including, but not limited to, offsite contacts, form
11 content, methods and equipment.
12

13 Link to Drill and Exercise Performance

14
15 Lessons learned (positive and negative) are shared to ensure that the benefits of the
16 performance enhancing experience of the key ERO member(s) are applied across all
17 units. Corrective actions from the performance of key ERO members performing DEP
18 activities are shared with and applied to all key ERO members of all units. Similarly,
19 corrective actions associated with common facility Key ERO member performance (e.g.
20 training or qualification gaps, procedure deficiencies, equipment issues) are applied
21 across all units corrective action programs. DEP opportunities performed shall be
22 credited to all units, in addition to the unit participating in the drill or exercise.
23

FAQ476
(09-10)

24 Records

25
26 Lesson plans, rosters, records, etc., are available for NRC inspection.
27

28 Credit can be granted to Key Positions for ERO Participation for a Security related Drill or
29 Exercise as long as the Key Positions are observed evaluating the need to upgrade to the next
30 higher classification level and/or evaluating the need to change protective action
31 recommendations. Key TSC Communicator and Key EOF Communicator may be granted
32 participation credit as long as the Key Position performs a minimum of one offsite (state/local)
33 update notification. If an individual participates in more than one Security-related Drill/Exercise
34 in a three year period, only one of the Security-related Drills/Exercise can be credited. A station
35 cannot run more than one credited Security-related Drill/Exercise in any consecutive 4 quarter
36 period. Objective evidence shall be documented to demonstrate the above requirements were
37 met.
38

39 Evaluated simulator training evolutions that contribute to Drill/Exercise Performance indicator
40 statistics may be considered as opportunities for ERO Drill Participation. The scenarios must at
41 least contain a formally assessed classification and the results must be included in DEP statistics.
42 However, there is no intent to disrupt ongoing operator qualification programs. Appropriate
43 operator training evolutions should be included in this indicator only when Emergency
44 Preparedness aspects are consistent with training goals.
45

46 If an ERO member filling a Key Position has participated in more than one drill during the eight
47 quarter evaluation period, the most recent participation should be used in the Indicator statistics.
48

1 If a change occurs in the number of ERO members filling Key Positions, this change should be
2 reflected in both the numerator and denominator of the indicator calculation.

3
4 If a person is assigned to more than one Key Position, it is expected that the person be counted in
5 the denominator for each position and in the numerator only for drill participation that addresses
6 each position. Where the skill set is similar, a single drill might be counted as participation in
7 both positions.

8
9 Assigning a single member to multiple Key Positions and then only counting the performance for
10 one Key Position could mask the ability or proficiency of the remaining Key Positions. The
11 concern is that an ERO member having multiple Key Positions may never have a performance
12 enhancing experience for all of them, yet credit for participation will be given when any one of
13 the multiple Key Positions is performed; particularly, if more than one ERO position is assigned
14 to perform the same Key Position.

15
16 ERO participation should be counted for each Key Position, even when multiple Key Positions
17 are assigned to the same ERO member. In the case where a utility has assigned two or more Key
18 Positions to a single ERO member, each Key Position must be counted in the denominator for
19 that ERO member and credit given in the numerator when the ERO member performs each Key
20 Position.

21
22 Similarly, ERO members need not individually perform an opportunity of classification,
23 notification, or PAR development in order to receive ERO Drill Participation credit. The
24 evaluation of the DEP opportunities is a crew evaluation for the entire Emergency Response
25 Organization. ERO members may receive credit for the drill if their participation is a meaningful
26 opportunity to gain proficiency in their ERO function.

27
28 When an ERO member changes from one Key Position to a different Key Position with a skill
29 set similar to the old one, the last drill/exercise participation may count. If the skill set for the
30 new position is significantly different from the old position then the previous participation would
31 not count.

32
33 Participation may be as a participant, mentor, coach, evaluator, or controller, but not as an
34 observer. Multiple assignees to a given Key Position could take credit for the same drill if their
35 participation is a meaningful opportunity to gain proficiency.

36
37 Drills performed by an individual before being assigned to a Key Position in the ERO may be
38 counted once the individual is assigned to the ERO as long as the performance enhancing
39 experience(s) contributes to the Drill/Exercise (DEP) metric. The meaning of “drills” in this
40 usage is intended to include performance enhancing experiences (exercises, functional drills,
41 simulator drills, table top drills, mini drills, etc.) that reasonably simulate the interactions
42 between appropriate centers and/or individuals that would be expected to occur during
43 emergencies. For example, control room interaction with offsite agencies could be simulated by
44 instructors or OSC interaction could be simulated by a control cell simulating the TSC functions,
45 and damage control teams.

1 In general, a drill does not have to include all ERO facilities to be counted in this indicator. A
2 drill is of adequate scope if it reasonably simulates the interaction between one or more of the
3 following facilities, as would be expected to occur during emergencies:
4

- 5 • the control room,
- 6 • the Technical Support Center (TSC),
- 7 • the Operations Support Center,
- 8 • the Emergency Operations Facility (EOF),
- 9 • field monitoring teams,
- 10 • damage control teams, and
- 11 • ~~offsite~~Offsite governmental authorities.

12
13 The licensee need not develop new scenarios for each drill or each team. However, it is expected
14 that the licensee will maintain a reasonable level of confidentiality so as to ensure the drill is a
15 performance enhancing experience. A reasonable level of confidentiality means that some
16 scenario information could be inadvertently revealed and the drill remain a valid performance
17 enhancing experience. It is expected that the licensee will remove from drill performance
18 statistics any opportunities considered to be compromised. There are many processes for the
19 maintenance of scenario confidentiality that are generally successful. Examples may include
20 confidentiality statements on the signed attendance sheets and spoken admonitions by drill
21 controllers. Examples of practices that may challenge scenario confidentiality include drill
22 controllers or evaluators or mentors, who have scenario knowledge becoming participants in
23 subsequent uses of the same scenarios and use of scenario reviewers as participants.
24

25 All individuals qualified to fill the Control Room Shift Manager/ Emergency Director position
26 that actually might fill the position should be included in this indicator.
27

28 The communicator is the Key Position that fills out the notification form, seeks approval and
29 usually communicates the information to ~~off-site~~offsite agencies. Performance of these duties is
30 assessed for accuracy and timeliness and contributes to the DEP PI. Senior managers who do not
31 perform these duties should not be considered communicators even though they approve the
32 form and may supervise the work of the communicator. However, there are cases where the
33 senior manager actually collects the data for the form, fills it out, approves it and then
34 communicates it or hands it off to a phone talker. Where this is the case, the senior manager is
35 also the communicator and the phone talker need not be tracked. The communicator is not
36 expected to be just a phone talker who is not tasked with filling out the form. There is no intent
37 to track a large number of shift communicators or personnel who are just phone talkers.
38
39
40

1 **Data Example**

Emergency Response Organization (ERO) Drill Participation

					2Q/98	3Q/98	4Q/98	Prev. Q
Total number of Key ERO personnel					56	56	64	64
Number of Key personnel participating in drill/event in 8 qtrs					48	52	54	53
					2Q/98	3Q/98	4Q/98	Prev. Q
Indicator percentage of Key ERO personnel participating in a drill in 8 qtrs					86%	93%	84%	83%

Thresholds	
Green	≥80%
White	<80%
Yellow	<60%
No Red Threshold	

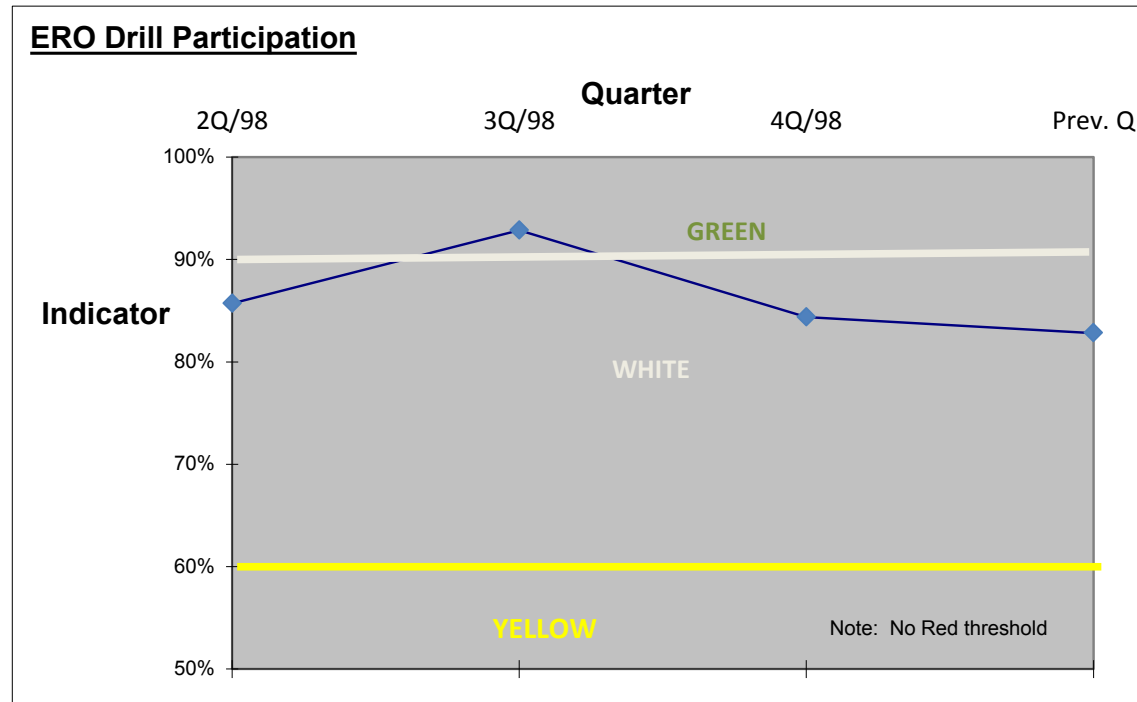

2

ALERT AND NOTIFICATION SYSTEM RELIABILITY

Purpose

This indicator monitors the reliability of the offsite Alert and Notification System (ANS), a critical link for alerting and notifying the public of the need to take protective actions. It provides the percentage of the sirens that are capable of performing their safety function based on regularly scheduled tests.

Indicator Definition

The percentage of ANS sirens that are capable of performing their function, as measured by periodic siren testing in the previous 12 months.

Periodic tests are the regularly scheduled tests (documented in the licensee's test plan or guidelines) that are conducted to actually test the ability of the sirens to perform their function (e.g., silent, growl, siren sound test). Tests performed for maintenance purposes should not be counted in the performance indicator database. Actions that could affect the as found condition of sirens prior to testing are not allowed.

Data Reporting Elements

The following data are reported: (see clarifying notes)

- the total number of ANS siren-tests during the previous quarter
- the number of successful ANS siren-tests during the previous quarter

Calculation

The site value for this indicator is calculated as follows:

$$\frac{\text{\# of succesful siren - tests in the previous 4 qtrs}}{\text{total number of siren - tests in the previous 4 qtrs}} \times 100$$

Definition of Terms

Siren-Tests: the number of sirens times the number of times they are tested. For example, if 100 sirens are tested 3 times in the quarter, there are 300 siren-tests.

Successful siren-tests are the sum of sirens that performed their function when tested. For example, if 100 sirens are tested three times in the quarter and the results of the three tests are: first test, 90 performed their function; second test, 100 performed their function; third test, 80 performed their function. There were 270 successful siren-tests.

Clarifying Notes

The purpose of the ANS PI is to provide a uniform industry reporting approach and is not intended to replace the FEMA Alert and Notification reporting requirement at this time.

1
2 For those sites that do not have sirens, the performance of the licensee's alert and notification
3 system will be evaluated through the NRC baseline inspection program. A site that does not
4 have sirens does not report data for this indicator.

5
6 If a siren is out of service for maintenance or is inoperable at the time a regularly scheduled test
7 is conducted, then it counts as both a siren test and a siren failure. Regularly scheduled tests
8 missed for reasons other than siren unavailability (e.g., out of service for planned maintenance or
9 repair) should be considered non opportunities. The failure to perform a regularly scheduled test
10 should be noted in the comment field. **Additionally, if sirens are not available for operation because of**
11 **intentional actions to disable them, and the area is deemed uninhabitable by State and/or Local agencies,**
12 **the siren(s) in question are not required to be counted in the numerator or denominator of the**
13 **Performance Indicator for testing throughout the event. The conditions causing the suspension of testing,**
14 **its duration and restoration are to be noted in the comment field for the indicator.**

15
16 For plants where scheduled siren tests are initiated by local or state governments, if a scheduled
17 test is not performed either intentionally or accidentally, the missed test is not considered as valid
18 test opportunities. Missed test occurrences should be entered in the plant's corrective action
19 program.

20
21 If a siren failure is determined to be due only to testing equipment, and subsequent testing shows
22 the siren to be operable (verified by telemetry or simultaneous local verification) without any
23 corrective action having been performed, the siren test should be considered a success.
24 Maintenance records should be complete enough to support such determinations and validation
25 during NRC inspection.

26
27 A licensee may change ANS test methodology at any time consistent with regulatory guidance.
28 For the purposes of this performance indicator, only the testing methodology in effect on the first
29 day of the quarter shall be used for that quarter. Neither successes nor failures beyond the testing
30 methodology at the beginning of the quarter will be counted in the PI. (No actual siren activation
31 data results shall be included in licensees' ANS PI data.) Any change in test methodology shall
32 be reported as part of the ANS Reliability Performance Indicator effective the start of the next
33 quarterly reporting period. Changes should be noted in the comment field.

34
35 Siren systems may be designed with equipment redundancy, multiple signals or feedback
36 capability. It may be possible for sirens to be activated from multiple control stations or signals.
37 If the use of redundant control stations or multiple signals is in approved procedures and is part
38 of the actual system activation process then activation from either control station or any signal
39 should be considered a success. A failure of both systems would only be considered one failure,
40 whereas the success of either system would be considered a success. If the redundant control
41 station is not normally attended, requires setup or initialization, it may not be considered as part
42 of the regularly scheduled test. Specifically, if the station is only made ready for the purpose of
43 siren tests it should not be considered as part of the regularly scheduled test.

44
45 Actions specifically taken to improve the performance of a scheduled test are not appropriate.
46 The test results should indicate the actual as-found condition of the ANS. Such practices will
47 result in an inaccurate indication of ANS reliability.

48

1 Examples of actions that are NOT allowed and DO affect the as found conditions of sirens (not
2 | an ~~all-inclusive~~all-inclusive list):

- 3
- 4 ○ Preceding test with an unscheduled test with the sole purpose to validate the siren
5 is functional.
- 6
- 7 ○ Prior to a scheduled test, adjustment or calibration of siren system activation
8 equipment that was not scheduled to support post maintenance testing.
- 9
- 10 ○ Prior to a scheduled test, testing siren system activation equipment or an
11 individual siren(s) unless the equipment is suspected damaged from adverse
12 weather, vandalism, vehicular strikes, etc.
- 13
- 14 ○ Prior to a scheduled test, testing siren system activation equipment or an
15 individual siren(s) unless the equipment is suspected as being non-functional as a
16 result of a computer hardware or software failure, radio tower failure, cut phone
17 line, etc.
- 18

19 However, in no case should response preclude the timely correction of ANS problems and
20 subsequent post-maintenance testing, or the execution of a comprehensive preventive
21 maintenance program.

22

23 Testing opportunities that will be included in the ANS performance indicator are required to be
24 defined in licensee ANS procedures. These are typically: bi-weekly, monthly quarterly and
25 annual tests. The site specific ANS design and testing document approved by FEMA is a
26 reference for the appropriate types of test, however licensees may perform tests in addition to
27 what is discussed in the FEMA report.

28

29 Examples of actions that ARE allowed and do not affect the as found conditions of sirens (not an
30 | ~~all-inclusive~~all-inclusive list):

- 31
- 32 ○ Regardless of the time, an unscheduled diagnostic test and subsequent
33 maintenance and repair followed by post maintenance testing after any event that
34 causes actual or suspected damage, such as:
 - 35
 - 36 1. Severe/inclement weather (high winds, lightning, ice, etc.),
 - 37 2. Suspected or actual vandalism,
 - 38 3. Physical damage from impact (vehicle, tree limbs, etc.),
 - 39 4. Computer hardware and software failures,
 - 40 | 5. Damaged communication cables or phone lines.
 - 41 6. Problems identified by established routine use of the siren
42 feedback systems.
- 43
- 44 ○ Scheduled polling tests for the purpose of system monitoring to optimize system
45 availability and functionality.
- 46
- 47

1 If a siren is out of service for scheduled planned refurbishment or overhaul maintenance
2 performed in accordance with an established program, or for scheduled equipment upgrades, the
3 siren need not be counted as a siren test or a siren failure. However, sirens that are out of service
4 due to unplanned corrective maintenance would continue to be counted as failures. Unplanned
5 corrective maintenance is a measure of program reliability. The exclusion of a siren due to
6 temporary unavailability during planned maintenance/upgrade activities is acceptable due to the
7 level of control placed on scheduled maintenance/upgrade activities. It is not the intent to create
8 a disincentive to performing maintenance/upgrades to ensure the ANS performs at its peak
9 reliability.

10
11 As part of a refurbishment or overhaul plan, it is expected that each utility would communicate
12 to the appropriate state and/or local agencies the specific sirens to be worked and ensure that a
13 functioning backup method of public alerting would be in-place. The acceptable timeframe for
14 allowing a siren to remain out of service for system refurbishment or overhaul maintenance
15 should be coordinated with the state and local agencies. Based on the impact to their
16 organization, these timeframes should be specified in upgrade or system improvement
17 implementation plans and/or maintenance procedures. Deviations from these plans and/or
18 procedures would constitute unplanned unavailability and would be included in the PI.

19
20 Siren testing conducted at redundant control stations, such as county EOCs that are staffed
21 during an emergency by an individual capable of activating the sirens, may be credited provided
22 the redundant control station is in an approved facility as documented in the FEMA ANS design
23 report.

1 Data Example

Alert & Notification System Reliability							
Quarter	3Q/97	4Q/97	1Q/98	2Q/98	3Q/98	4Q/98	Prev. Q
Number of succesful siren-tests in the qtr	47	48	49	49	49	54	52
Total number of sirens tested in the qtr	50	50	50	50	50	55	55
Number of successful siren-tests over 4 qtrs				193	195	201	204
Total number of sirens tested over 4 qtrs				200	200	205	210
				2Q/98	3Q/98	4Q/98	Prev. Q
Indicator expressed as a percentage of sirens				96.5%	97.5%	98.0%	97.1%
Thresholds							
Green	≥94%						
White	<94%						
Yellow	<90%						
Red	N/A						

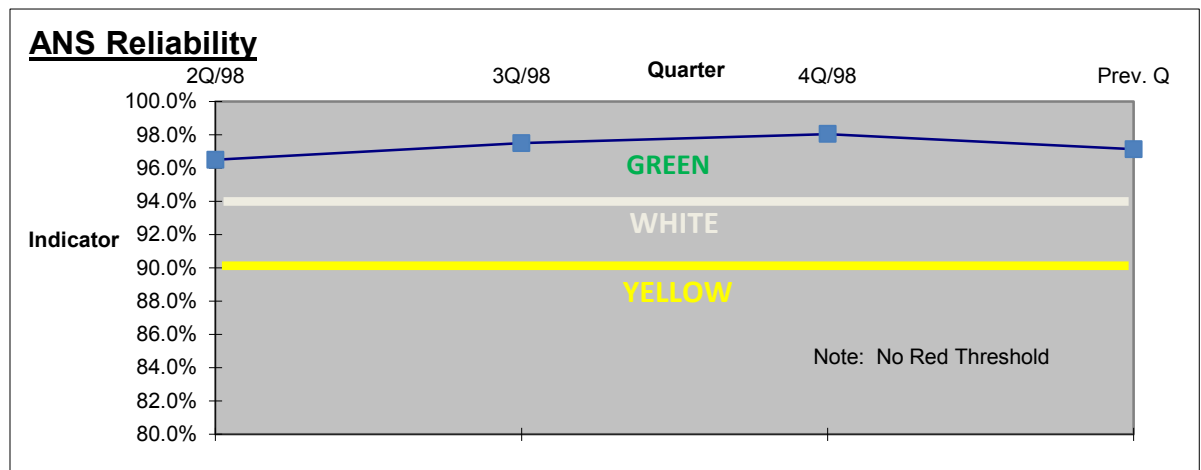

2
3

1 **2.5 OCCUPATIONAL RADIATION SAFETY CORNERSTONE**

2 The objectives of this cornerstone are to:

3

4 (1) keep occupational dose to individual workers below the limits specified in
5 10 CFR Part 20 Subpart C; and

6

7 (2) use, to the extent practical, procedures and engineering controls based upon sound
8 radiation protection principles to achieve occupational doses that are as low as is
9 reasonably achievable (ALARA) as specified in 10 CFR 20.1101(b).

10

11 There is one indicator for this cornerstone:

12

- 13 • Occupational Exposure Control Effectiveness

14

15 **OCCUPATIONAL EXPOSURE CONTROL EFFECTIVENESS**

16 **Purpose**

17 The purpose of this performance indicator is to address the first objective of the occupational
18 radiation safety cornerstone. The indicator monitors the control of access to and work activities
19 within radiologically-significant areas of the plant and occurrences involving degradation or
20 failure of radiation safety barriers that result in readily-identifiable unintended dose.

21

22 The indicator includes dose-rate and dose criteria that are risk-informed, in that the indicator
23 encompasses events that might represent a substantial potential for exposure in excess of
24 regulatory limits. The performance indicator also is considered “leading” because the indicator:

25

- 26 • encompasses less-significant occurrences that represent precursors to events that might
27 represent a substantial potential for exposure in excess of regulatory limits, based on industry
28 experience; and

29

- 30 • ~~employs~~**Employs** dose criteria that are set at small fractions of applicable dose limits (e.g.,
31 the criteria are generally at or below the levels at which dose monitoring is required in
32 regulation).

33

34 **Indicator Definition**

35 The performance indicator for this cornerstone is the sum of the following:

36

- 37 • Technical specification high radiation area (>1 rem per hour) occurrences
- 38 • Very high radiation area occurrences
- 39 • Unintended exposure occurrences

40

41

1 Data Reporting Elements

2 The data listed below are reported for each site. For multiple unit sites, an occurrence at one unit
3 is reported identically as an input for each unit. However, the occurrence is only counted once
4 against the site-wide threshold value.

- 5
- 6 • The number of technical specification high radiation area (>1 rem per hour)
7 occurrences during the previous quarter
 - 8 • The number of very high radiation area occurrences during the previous quarter
 - 9 • The number of unintended exposure occurrences during the previous quarter

10

11 Calculation

12 The indicator is determined by summing the reported number of occurrences for each of the
13 three data elements during the previous 4 quarters.

14

15 Definition of Terms

16 *Technical Specification High Radiation Area (>1 rem per hour) Occurrence - A*
17 *nonconformance (or concurrent¹⁴ nonconformances) with technical specifications¹⁵ or*
18 *comparable requirements in 10 CFR 20¹⁶ applicable to technical specification high radiation*
19 *areas (>1 rem per hour) that results in the loss of radiological control over access or work*
20 *activities within the respective high-radiation area (>1 rem per hour). For high radiation areas*
21 *(>1 rem per hour), this PI does not include nonconformance with licensee-initiated controls that*
22 *are beyond what is required by technical specifications and the comparable provisions in 10 CFR*
23 *Part 20.*

24

25 Technical ~~Specification-specification~~ high radiation areas, commonly referred to as locked high
26 radiation areas, includes any area, accessible to individuals, in which radiation levels from
27 radiation sources external to the body are in excess of 1 rem (10 mSv) per 1 hour at 30
28 centimeters from the radiation source or 30 centimeters from any surface that the radiation
29 penetrates, and excludes very high radiation areas. Technical specification high radiation areas,
30 in which radiation levels from radiation sources external to the body are less than or equal to 1
31 rem (10 mSv) per 1 hour at 30 centimeters from the radiation source or 30 centimeters from any
32 surface that the radiation penetrates, are excluded from this performance indicator.

33

- 34 • “Radiological control over access to technical specification high radiation areas” refers to
35 measures that provide assurance that inadvertent entry¹⁷ into the technical specification high
36 radiation areas by unauthorized personnel will be prevented.
- 37 • “Radiological control over work activities” refers to measures that provide assurance that
38 dose to workers performing tasks in the area is monitored and controlled.

39

40 Examples of occurrences that would be counted against this indicator include:

¹⁴ “Concurrent” means that the nonconformances occur as a result of the same cause and in a common timeframe.

¹⁵ Or comparable provisions in licensee procedures if the technical specifications do not include provisions for high radiation areas.

¹⁶ Includes 10 CFR 20, §20.1601(a), (b), (c), and (d) and §20.1902(b).

¹⁷ In reference to application of the performance indicator definition in evaluating physical barriers, the term “inadvertent entry” means that the physical barrier cannot be easily circumvented (i.e., an individual who incorrectly assumes, for whatever reason, that he or she is authorized to enter the area, is unlikely to disregard, and circumvent, the barrier). The barriers used to control access to technical specification high radiation areas should provide reasonable assurance that they secure the area against unauthorized access. (FAQ 368)

- 1 • Failure to post an area as required by technical specifications,
- 2 • Failure to secure an area against unauthorized access,
- 3 • Failure to provide a means of personnel dose monitoring or control required by technical
- 4 specifications,
- 5 • Failure to maintain administrative control over a key to a barrier lock as required by technical
- 6 specifications, ~~or~~
- 7 • An occurrence involving unauthorized or unmonitored entry into an area, **or**
- 8 • Nonconformance with a requirement of an RWP (as specified in the licensee's technical
- 9 specifications) that results in a loss of control of access to or work within a technical
- 10 specification high radiation area.

11
12 Examples of occurrences that are not counted include the following:

- 13 • Situations involving areas in which dose rates are less than or equal to 1 rem per hour,
- 14 • Occurrences associated with isolated equipment failures. This might include, for example,
- 15 discovery of a burnt-out light, where flashing lights are used as a technical specification
- 16 control for access, or a failure of a lock, hinge, or mounting bolts, when a barrier is checked
- 17 or tested.¹⁸
- 18 • Nonconformance with an RWP requirement that does not result in a loss of control of access
- 19 to or work within a technical specification high radiation area (e.g., signing in on the wrong
- 20 RWP, but having received the pre-job brief and implemented all of the access work control
- 21 requirements of the correct RWP).

22
23 *Very High Radiation Area Occurrence* - A nonconformance (or concurrent nonconformances)

24 with 10 CFR 20 and licensee procedural requirements that results in the loss of radiological

25 control over access to or work activities within a very high radiation area. "Very high radiation

26 area" is defined as any area accessible to individuals, in which radiation levels from radiation

27 sources external to the body could result in an individual receiving an absorbed dose in excess of

28 500 rads (5 grays) in 1 hour at 1 meter from a radiation source or 1 meter from any surface that

29 the radiation penetrates.

- 30
- 31 • "Radiological control over access to very high radiation areas" refers to measures to ensure
- 32 that an individual is not able to gain unauthorized or inadvertent access to very high radiation
- 33 areas.
- 34 • "Radiological control over work activities" refers to measures that provide assurance that
- 35 dose to workers performing tasks in the area is monitored and controlled.

36
37 *Unintended Exposure Occurrence* - A single occurrence of degradation or failure of one or more

38 radiation safety barriers that results in unintended occupational exposure(s), as defined below.

39
40 Following are examples of an occurrence of degradation or failure of a radiation safety barrier

41 included within this indicator:

- 42
- 43 • failure to identify and post a radiological area
- 44 • failure to implement required physical controls over access to a radiological area
- 45 • failure to survey and identify radiological conditions

¹⁸ Presuming that the equipment is subject to a routine inspection or preventative maintenance program, that the occurrence was indeed isolated, and that the causal condition was corrected promptly upon identification.

- 1 • failure to train or instruct workers on radiological conditions and radiological work controls
- 2 • failure to implement radiological work controls (e.g., as part of a radiation work permit)

3
4 An occurrence of the degradation or failure of one or more radiation safety barriers is only
5 counted under this indicator if the occurrence resulted in unintended occupational exposure(s)
6 equal to or exceeding any of the dose criteria specified in the table below. The dose criteria were
7 selected to serve as “screening criteria,” only for the purpose of determining whether an
8 occurrence of degradation or failure of a radiation safety barrier should be counted under this
9 indicator. The dose criteria should not be taken to represent levels of dose that are “risk-
10 significant.” In fact, the dose criteria selected for screening purposes in this indicator are
11 generally at or below dose levels that are required by regulation to be monitored or to be
12 routinely reported to the NRC as occupational dose records.
13

14 **Table: Dose Values Used as Screening Criteria to Identify an Unintended Exposure**
15 **Occurrence in the Occupational Exposure Control Effectiveness PI**

2% of the stochastic limit in 10 CFR 20.1201 on total effective dose equivalent. The 2% value is 0.1 rem.	
10 % of the non-stochastic limits in 10 CFR 20.1201. The 10% values are as follows:	
5 rem	the sum of the deep-dose equivalent and the committed dose equivalent to any individual organ or tissue
1.5 rem	the lens dose equivalent to the lens of the eye
5 rem	the shallow-dose equivalent to the skin or any extremity, other than dose received from a discrete radioactive particle (DRP) ¹⁹
20% of the limits in 10 CFR 20.1207 and 20.1208 on dose to minors and declared pregnant women. The 20% value is 0.1 rem.	

16
17 “Unintended exposure” refers to exposure that results in dose in excess of the administrative
18 guideline(s) set by a licensee as part of their radiological controls for access or entry into a
19 radiological area. Administrative dose guidelines may be established:

- 20
- 21 • within radiation work permits, procedures, or other documents,
- 22 • via the use of alarm setpoints for personnel dose monitoring devices, or
- 23 • by other means, as specified by the licensee.
24

25 It is incumbent upon the licensee to specify the method(s) being used to administratively control
26 dose. An administrative dose guideline set by the licensee is not a regulatory limit and does not,
27 in itself, constitute a regulatory requirement. A revision to an administrative dose guideline(s)
28 during job performance is acceptable (with regard to this PI) if conducted in accordance with
29 plant procedures or programs.
30

31 If a specific type of exposure was not anticipated or specifically included as part of job planning
32 or controls, the full amount of the dose resulting from that type of exposure should be considered
33 as “unintended” in making a comparison with the respective criteria in the PI. For example, this

¹⁹ Controls established for DRPs are intended to minimize the possibility of exposures that could result in the SDE dose limit being exceeded, not to maintain the exposure to some intended SDE dose. Therefore, for the purpose of this PI, any DRP exposure is considered “unintended” and is a reportable PI event if it results (by itself, or added to previous “uniform” SDE exposures) in an SDE in excess of the regulatory limit in 20.1201(a)(2)(ii).

1 might include Committed Effective Dose Equivalent (CEDE), Committed Dose Equivalent
2 (CDE), or Shallow Dose Equivalent (SDE).
3
4

5 **Clarifying Notes**

6 An occurrence (or concurrent occurrences) that potentially meet the definition of more than one
7 element of the performance indicator will only be counted once. In other words, an occurrence
8 (or concurrent occurrences) will not be double-counted (or triple-counted) against the
9 performance indicator. If two or more individuals are exposed in a single occurrence, the
10 occurrence is only counted once.
11

12 Radiography work conducted at a plant under another licensee's 10 CFR Part 34 license is
13 generally outside the scope of this PI. However, if a Part 50 licensee opts to establish additional
14 radiological controls under its own program consistent with technical specifications or
15 comparable provisions in 10 CFR Part 20, then a non-conformance with such additional controls
16 or unintended dose resulting from the non-conformance shall be evaluated under the criteria in
17 the PI.
18

1 Data Example

Occupational Exposure Control Effectiveness

	3Q95*	4Q95	1Q96	2Q96	3Q96	4Q96	1Q97	2Q97	3Q97	4Q97	1Q98	2Q98	3Q98	4Q98
Number of Technical Specification High Radiation Area Occurrences this quarter	0	0	3	0	0	0	0	0	0	0	0	0	0	0
Number of Very High Radiation Area Occurrences this Quarter	0	0	0	0	0	0	1	0	1	0	0	0	0	0
Number of Unintended Exposure Occurrences this Quarter	1	0	0	0	0	0	0	0	0	0	0	0	0	1
Cumulative Total Over the Current Four Quarters	1	1	4	4	3	3	1	1	2	2	1	1	0	1

Notes: Example assumes 3Q95 is the first quarter in which the PI is to be considered valid.

Thresholds
 Green: <= 2
 White: > 2
 Yellow: > 5
 No Red Threshold

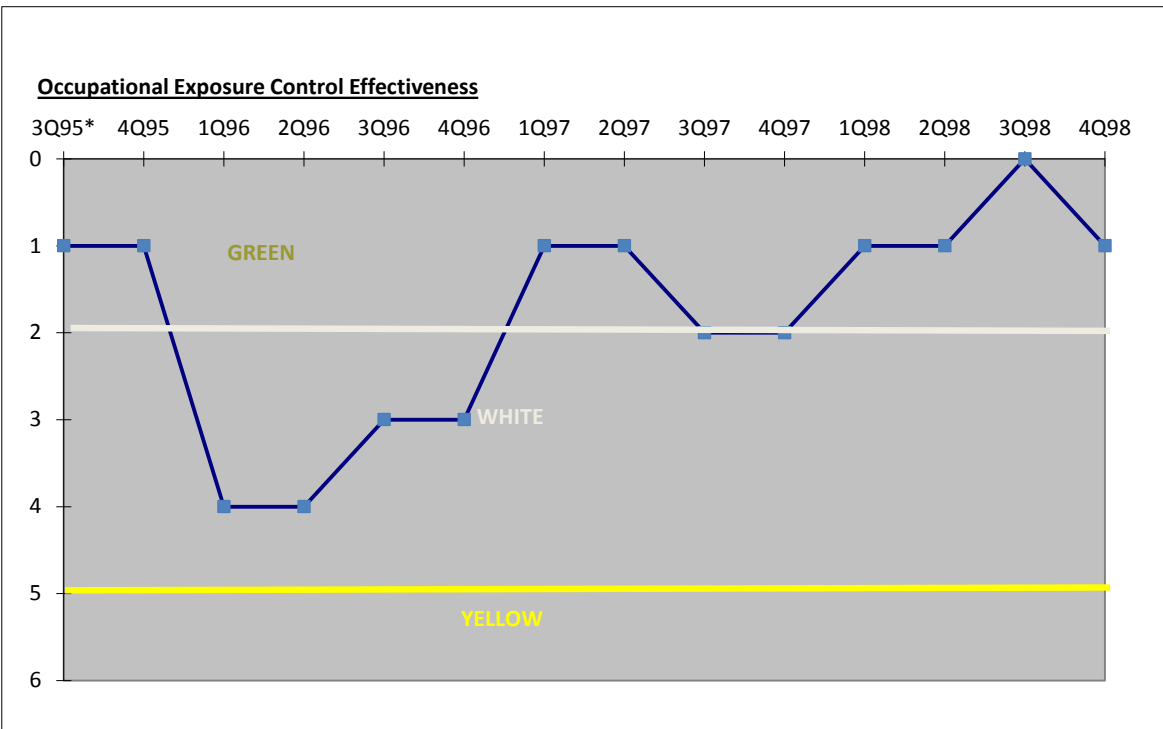

2
3

1 **2.6 PUBLIC RADIATION SAFETY CORNERSTONE**

2 **RETS/ODCM RADIOLOGICAL EFFLUENT OCCURRENCE**

3 **Purpose**

4 To assess the performance of the radiological effluent control program.

5
6 **Indicator Definition**

7 Radiological effluent release occurrences per site that exceed the values listed below:

8

Radiological effluent releases in excess of the following values:		
Liquid Effluents	Whole Body	1.5 mrem/qtr
	Organ	5 mrem/qtr
Gaseous Effluents	Gamma Dose	5 mrads/qtr
	Beta Dose	10 mrads/qtr
	Organ Doses from I-131, I-133, H-3 & Particulates	7.5 mrems/qtr

9
10 Note:

- 11 (1) Values are derived from the Radiological Effluent Technical Specifications (RETS) or
12 similar reporting provisions in the Offsite Dose Calculation Manual (ODCM), if applicable
13 RETS have been moved to the ODCM in accordance with Generic Letter 89-01.
14 (2) The dose values are applied on a per reactor unit basis in accordance with the RETS/ODCM.
15 (3) For multiple unit sites, allocation of dose on a per reactor unit basis from releases made via
16 common discharge points is to be calculated in accordance with the methodology specified in
17 the ODCM.
18

19 **Data Reporting Elements**

20 Number of RETS/ODCM Radiological Effluent Occurrences each quarter involving assessed
21 dose in excess of the indicator effluent values.
22

23 **Calculation**

24 Number of RETS/ODCM Radiological Effluent Occurrences per site in the previous four
25 quarters.
26

27 **Definition of Terms**

28 A *RETS/ODCM Radiological Effluent Occurrence* is defined as a release that exceeds any or all
29 of the five identified values outlined in the above table. These are the whole body and organ
30 dose values for liquid effluents and the gamma dose, beta dose, and organ dose values for
31 gaseous effluents.
32

1 **Clarifying Notes**

2 The following conditions do not count against the RETS/ODCM Radiological Effluent
3 Occurrence:

- 4
- 5 • Liquid or gaseous monitor operability issues
- 6
- 7 • Liquid or gaseous releases in excess of RETS/ODCM concentration or instantaneous
- 8 dose-rate values
- 9
- 10 • Liquid or gaseous releases without treatment but that do not exceed values in the table
- 11

12 Not all effluent sample (e.g., composite sample analysis) results are required to be finalized at
13 the time of submitting the quarterly PI reports. Therefore, the reports should be based upon the
14 best-available data. If subsequently available data indicates that the number of occurrences for
15 this PI is different than that reported, then the report should be revised, along with an explanation
16 regarding the basis for the revision.

17

18 **Data Example**

RETS/ODCM Radiological Effluent Occurrence	3Q97*	4Q97	1Q98	2Q98	3Q98	4Q98	Prev. Q
Number of RETS/ODCM Occurrences this Quarter	1	0	0	1	0	0	1
Number of RETS/ODCM Occurrences in Last Four Quarters	1	1	1	2	1	1	2

Notes: * Example assumes 3Q97 is first quarter in which the PI is considered valid.

Thresholds

- Green: <= 1
- > 1 White <=3
- Yellow: > 3
- Red: N/A

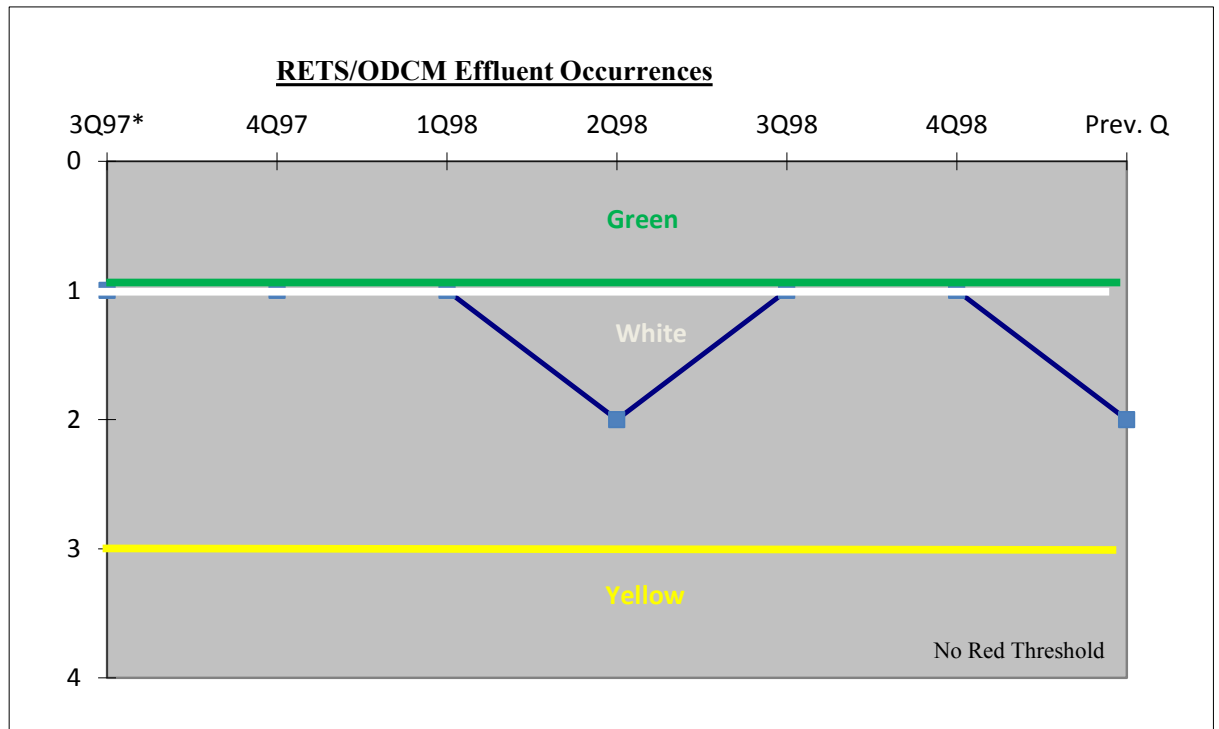

19
20
21
22

1 **2.7 SECURITY CORNERSTONE**

2 The performance indicator for this cornerstone was selected to provide baseline and trend
3 information needed to evaluate each licensee’s physical protection system. The regulatory
4 purpose is to provide high assurance that this system will function to protect against the design
5 basis threat of radiological sabotage as defined in 10 CFR Part 73. As a surrogate to any
6 engineered physical security protection system, posted security officers provide compensation
7 when a portion of the system is unavailable to perform its intended function. The performance
8 indicator value is not an indication that the protection afforded by the plant’s physical security
9 organization is less than required by the regulatory requirements.

10 |
11 There is one performance indicator for the physical protection system. The performance
12 indicator is assessed against established thresholds using the data and methodology as
13 established in this guideline. The NRC baseline inspections will validate and verify the testing
14 requirements for each system to assure performance standards and testing periodicity are
15 appropriate to provide valid data.

16 |
17 Performance Indicator

18 | The only ~~physical protection~~security performance indicator is the Protected Area Security
19 Equipment Performance Index.

20 |
21 | This indicator serves as a measure of ~~a plant’s ability to maintain unavailability of security~~
22 | equipment ~~—to be available~~ to perform its intended function. When compensatory measures
23 | are employed because a segment of equipment is unavailable (i.e., not adequately performing its
24 | intended function), there is no security vulnerability but there is an indication that something
25 | needs to be fixed. The PI **also** provides trend indications for evaluation of the effectiveness of
26 | the maintenance process, and also provides a method of monitoring equipment degradation as a
27 | result of aging that might adversely impact reliability. Maintenance considerations for protected
28 | area and vital area portals are appropriately and sufficiently covered by the inspection program.

FAQ
12-02

29 |
30 |

Protected Area (PA) Security Equipment Performance Index

31 **Purpose:**

32 Operability of the PA security system is necessary to detect and assess safeguards events and to
33 provide the first line of the defense-in-depth physical protection of the plant perimeter. In the
34 event of an attempted encroachment, the intrusion detection system identifies the existence of the
35 threat, the barriers provide a delay to the person(s) posing the threat and the alarm assessment
36 system is used to determine the magnitude of the threat. The PI is used to monitor the
37 unavailability of PA intrusion detection systems and alarm assessment systems to perform their
38 intended function.

39 |
40 **Indicator Definition:**

41 PA Security equipment performance is measured by an index that compares the amount of the
42 time CCTVs and IDS are unavailable, as measured by compensatory hours, to the total hours in

1 the period. A normalization factor is used to take into account site variability in the size and
2 complexity of the systems.

3
4 **Data Reporting Elements:**

5 Report the following site data for the previous quarter for each unit:

- 6
7 • Compensatory hours, CCTVs: The hours (expressed to the nearest tenth of an hour)
8 expended in posting a security officer as required compensation for camera(s) unavailability
9 because of degradation or defects.
- 10 • Compensatory hours, IDS: The hours (expressed to the nearest tenth of an hour) expended in
11 posting a security officer as required compensation for IDS unavailability because of
12 degradation or defects.
- 13 • CCTV Normalization factor: The number of CCTVs divided by 30. If there are 30 or fewer
14 CCTVs, a normalization factor of 1 should be used.
- 15
16 • IDS Normalization factor: The number of physical security zones divided by 20. If there are
17 20 or fewer zones, a normalization factor of 1 should be used.

18
19 **Calculation**

20
21 The performance indicator is calculated using values reported for the previous four quarters. The
22 calculation involves averaging the results of the following two equations.

23
24
$$\text{IDS Unavailability Index} = \frac{\text{IDS Compensatory hours in the previous 4 quarters}}{\text{IDS Normalization Factor} \times 8760 \text{ hrs}}$$

25
26
$$\text{CCTV Unavailability Index} = \frac{\text{CCTV Compensatory hours in the previous 4 quarters}}{\text{CCTV Normalization Factor} \times 8760 \text{ hrs}}$$

27
28
$$\text{Indicator Value} = \frac{\text{IDS Unavailability Index} + \text{CCTV Unavailability Index}}{2}$$

29
30 **Definition of Terms**

31 *Intrusion detection system (IDS)* - E-fields, microwave fields, etc.

32 *CCTV* - The closed circuit television cameras that support the IDS.

33 *Normalization factors* - Two factors are used to compensate for larger than nominal size sites.

34 – *IDS Normalization Factor:* Using a nominal number of physical security zones across the
35 industry, the normalization factor for IDS is twenty. If a site has twenty or fewer intrusion
36 detection zones, the normalization factor will be 1. If a site has more zones than 20, the
37 factor is the total number of site zones divided by 20 (e.g., $50 \div 20 = 2.5$).

38 – *CCTV Normalization Factor:* Using a nominal number of perimeter cameras across the
39 industry, the normalization factor for cameras is 30. If a site has thirty or fewer perimeter

1 cameras, the normalization factor is 1. If a site has more than 30 perimeter cameras, the
2 factor is the total number of perimeter cameras divided by 30 (e.g., $50 \div 30 = 1.7$).

3 Note: The normalization factors are general approximations and may be modified as
4 experience in the pilot program dictates.

5
6 *Compensatory measures:* Measures used to meet physical security requirements **pending**
7 **when the return of required equipment to service is unavailable.** Protected Area protection is
8 not diminished by the use of compensatory measures for equipment unavailability.

FAQ
12-02

9
10 *Compensatory man-hours:* The man-hours (expressed to the nearest tenth of an hour) that
11 compensatory measures are in place (posted) to address a degradation in the IDS and CCTV
12 systems. When a portion of the system becomes unavailable—incapable of performing its
13 intended function—and requires posting of compensatory measures, the compensatory man-hour
14 clock is started. The period of time ends when the cause of the degraded state has been repaired,
15 tested, and system declared operable.

16
17 If a zone is posted for a degraded IDS and a CCTV camera goes out in the same posted area, the
18 hours for the posting of the IDS will not be double counted. However, if the IDS problem is
19 corrected and no longer requires compensatory posting but the camera requires posting, the hours
20 will start to count for the CCTV category.

21
22 *Equipment unavailability:* When the system has been posted because of a degraded condition
23 (unavailability), the compensatory hours are counted in the PI calculation. If the degradation is
24 caused by environmental conditions, preventive maintenance or scheduled system upgrade, the
25 compensatory hours are not counted in the PI calculation. However, if the equipment is
26 degraded after preventive maintenance or periodic testing, compensatory posting would be
27 required and the compensatory hours would count. Compensatory hours stop being counted
28 when the equipment deficiency has been corrected, equipment tested and declared back in
29 service.

30 **Clarifying Notes**

31 **Compensatory posting:**

- 32 • The posting for this PI is only for the protected area perimeter, not vital area doors or other
33 places **where** such posting may be required.
- 34 • Postings for IDS segments for false alarms in excess of security program limits would be
35 counted in the PI. In the absence of a false alarm limit in the security program, qualified
36 individuals can disposition the condition and determine whether compensatory posting is
37 required.
- 38 • Some postings are the result of non-equipment failures, which may be the result of
39 test/maintenance conditions. For example, in a situation where a part of the IDS is taken out-
40 of-service to check a condition for false alarms not in excess of security program false alarm
41 limits, no compensatory hours would be counted. If the equipment is determined to have
42 malfunctioned, it is not operable and maintenance/repair is required, the hours would count.
- 43
- 44

- 1 • Compensatory hours expended to address simultaneous equipment problems (IDS & CCTV)
2 are counted beginning with the initial piece of equipment that required compensatory hours.
3 When this first piece of equipment is returned to service and no longer requires
4 compensatory measures, the second covered piece of equipment carries the hours. If one IDS
5 zone is required to be covered by more than one compensatory post, the total man-hours of
6 compensatory action are to be counted. If multiple IDS zones are covered by one
7 compensatory post, the man-hours are only counted once.
- 8 • IDS equipment issues that do not require compensatory hours would not be counted.
- 9 • Compensatory ~~man-man~~-hours for a failed Pan-Tilt-Zoom (PTZ) camera count for the PI
10 only if the PTZ is either being used as a CCTV or is substituting for a failed CCTV.
- 11 • The PI metric is based on expended compensatory hours and starts when the IDS or CCTV is
12 actually posted. There are no "fault exposure hours" or other consideration beyond the actual
13 physical compensatory posting. Also, this indicator only uses compensatory man-hours to
14 provide an indication of CCTV or IDS unavailability. If a PTZ camera or other non-
15 personnel (no expended portion of a compensatory man-hour) item is used as the
16 compensatory measure, it is not counted for this PI.
- 17 • In a situation where security persons are already in place at continuously manned remote
18 location security booths around the perimeter of the site and there is a need to provide
19 compensatory coverage for the loss of IDS equipment, security persons already in these
20 booths can fulfill this function. If they are used to perform the compensatory function, the
21 hours are included in the PI. The ~~man-man~~-hours for all persons required to provide
22 compensation are counted. If more persons are assigned than required, only the required
23 compensatory ~~man-man~~-hours would be counted.
- 24 • Compensatory hours for this PI cover hours expended in posting a security officer as required
25 as compensation for IDS and/or CCTV unavailability because of a degradation or defect. If
26 other problems (e.g., security computer or multiplexer) result in compensatory postings
27 because the IDS/CCTV is no longer capable of performing its intended safeguards function,
28 the hours would count. Equipment malfunctions that do not require compensatory posting
29 are not included in this PI.
- 30 • If an ancillary system is needed to support proper operability of IDS or CCTV and it fails,
31 and the supported system does not operate as intended, the hours would count. For example,
32 a CCTV camera requires sufficient lighting to perform its function so that such a lighting
33 failure would result in compensatory hours counted for this PI.

34
35 Data reporting: For this performance indicator, rounding may be performed as desired provided
36 it is consistent and the reporting hours are expressed to the nearest tenth of an hour. Information
37 supporting performance indicators is reported on a per unit basis. For performance indicators that
38 reflect site conditions (IDS or CCTV), this requires that the information be repeated for each unit
39 on the site. The criterion for data reporting is from the time the failure or deficiency is identified
40 to the time it is placed back in service.

41

1 Degradation: Required system, ~~equipment, or component~~ is no longer available ~~or capable~~
2 of performing its ~~intended~~ ~~Intended safeguards function~~ ~~Function—manufacturer's equipment~~
3 ~~design capability and/or as covered in the PSP.~~

4
5 Extreme environmental conditions:

6 Compensatory hours do not count for extreme environmental conditions beyond the design
7 specifications of the system, including severe storms, heavy fog, heavy snowfall, and sun glare
8 that renders the IDS or CCTV temporarily inoperable. If after the environmental condition
9 clears, the zone remains unavailable, despite reasonable recovery efforts, the compensatory hours
10 would not begin to be counted until technically feasible corrective action could be completed.
11 For example, a hurricane decimates a portion of the perimeter IDS and certain necessary
12 components have to be obtained from the factory. Any restoration delay would be independent of
13 the licensee's maintenance capability and therefore would not be counted in the indicator.

14
15 Other naturally occurring conditions that are beyond the control of the licensee, such as damage
16 or nuisance alarms from animals are not counted.

17
18 Independent Spent Fuel Storage Installations (ISFSIs): This indicator does not include protective
19 measures associated with such installations.

20
21 Intended function: The ability of a component to detect the presence of an individual or display
22 an image as intended by manufacturer's equipment design capability and ~~or as covered as~~
23 ~~described~~ in the **Physical Security Plan PSP.**

24
25 Operational support: E-fields or equivalent that are taken out of service to support plant
26 operations and are not equipment failures but are compensatorily posted do not count for this PI.

27
28 Scheduled equipment upgrade:

- 29 • In the situation where system degradation results in a condition that cannot be corrected
30 under the normal maintenance program (*e.g.*, engineering evaluation specifies the need for a
31 system/component²⁰ modification or upgrade), and the system requires compensatory
32 posting, the compensatory hours stop being counted toward the PI for those conditions
33 addressed within the scope of the modification after such an evaluation has been made and
34 the station has formally approved an upgrade with descriptive information about the upgrade
35 plan including scope of the project, anticipated schedule, and expected expenditures. This
36 formally initiated upgrade is the result of established work practices to design, fund, procure,
37 install and test the project. A note should be made in the comment section of the PI submittal
38 that the compensatory hours are being excluded under this provision. Compensatory hour
39 counting resumes when the upgrade is complete and operating as intended as determined by
40 site requirements for sign-off. Reasonableness should be applied with respect to a justifiable
41 length of time the compensatory hours are excluded from the PI.
- 42
43 • For the case where there are a few particularly troubling zones that result in formal initiation
44 of an entire system upgrade for all zones, counting compensatory hours would stop only for
45 zones out of service for the upgrade. However, if subsequent failures would have been
46 prevented by the planned upgrade those would also be excluded from the count. This

²⁰ A modification to prevent the circumvention of the IDS (or CCTV) (such as the installation of a razor wire barrier) would fall under these provisions because the modification would be acting as an ancillary system of the IDS.

1 exclusion applies regardless of whether the failures are in a zone that precipitated the upgrade
2 action or not, as long as they are in a zone that will be affected by the upgrade, and the
3 upgrade would have prevented the failure.
4

5 Preventive maintenance:

- 6 • Scheduled preventive maintenance (PM) on system/equipment/component to include
7 probability and/or operability testing. Includes activities necessary to keep the system at the
8 required functional level. Planned plant support activities are considered PM.
- 9 • If during preventive maintenance or testing, a camera does not function correctly, and can be
10 compensated for by means other than posting an officer, no compensatory man-hours are
11 counted.
- 12 • Predictive maintenance is treated as preventive maintenance. Since the equipment has not
13 failed and remains capable of performing its intended security function, any maintenance
14 performed in advance of its actual failure is preventive. It is not the intent to create a
15 disincentive to performing maintenance to ensure the security systems perform at their peak
16 reliability and capability.
- 17 • Scheduled system upgrade: Activity to improve, upgrade or enhance system performance, as
18 appropriate, in order to be more effective in its reliability or capability.
19

1 **Data Example**

Protected Area Security Equipment Performance Indicator

	2Q97*	3Q97	4Q97	1Q98	2Q98	3Q98	4Q98	Prev. Q
IDS Compensatory Hours in the Quarter	36	48	96	126	65	45	60	55
CCTV Compensatory Hours in the Quarter	24	36	100	100	48	56	53	31
IDS Compensatory Hrs in Previous Four Quarters	36	84	180	306	335	332	296	225
CCTV Compensatory Hrs in the Previous Four Quarters	24	60	160	260	284	304	257	188
IDS Normalization Factor	1.05	1.05	1.05	1.05	1.1	1.1	1.1	1.1
CCTV Normalization Factor	1.2	1.2	1.2	1.2	1.3	1.3	1.3	1.3
IDS Unavailability Index	0.003914	0.009132	0.01957	0.0332681	0.03476546	0.03445413	0.03071814	0.02334994
CCTV Unavailability Index	0.002283	0.005708	0.01522	0.02473364	0.02493853	0.02669477	0.02256762	0.01650861
Indicator Value	0.00	0.01	0.02	0.03	0.03	0.03	0.03	0.02

Notes: *Example assumes 2Q97 is first quarter in which the PI is considered valid.

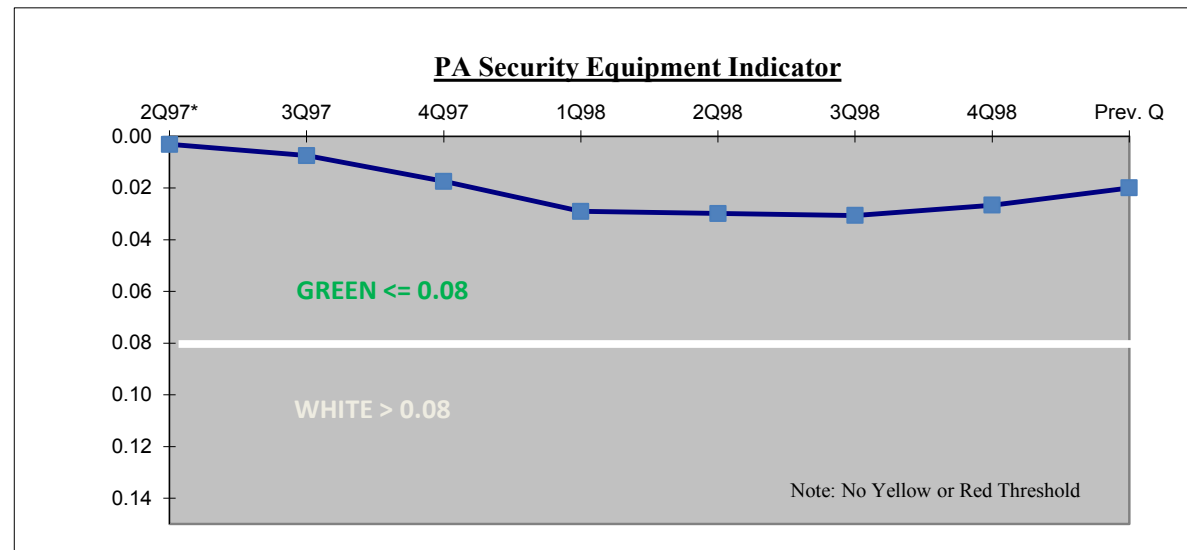

2

1
2
3
4
5

[This page left intentionally blank]

APPENDIX A

Acronyms & Abbreviations

1		
2		
3		
4	AC	Alternating (Electrical) Current
5	AFW	Auxiliary Feedwater System
6	ALARA	As Low As Reasonably Achievable
7	ANS	Alert & Notification System
8	AOT	Allowed Outage Time
9	AOV	Air Operated Valve
10	ATWS	Anticipated Transient Without Scram
11	BWR	Boiling Water Reactor
12	CCF	Common Cause Failure
13	CCW	Component Cooling Water
14	CDE	Consolidated Data Entry
15	CDF	Core Damage Frequency
16	CFR	Code of Federal Regulations
17	CCTV	Closed Circuit Television
18	DC	Direct (Electrical) Current
19	DE & AEs	Drills, Exercises and Actual Events
20	EAC	Emergency AC
21	EAL	Emergency Action Levels
22	EDG	Emergency Diesel Generator
23	EOF	Emergency Operations Facility
24	EFW	Emergency Feedwater
25	ERO	Emergency Response Organization
26	ESF	Engineered Safety Features
27	FAQ	Frequently Asked Question
28	FEMA	Federal Emergency Management Agency
29	FSAR	Final Safety Analysis Report
30	FV	Fussel-Vesely
31	FWCI	Feedwater Coolant Injection
32	IC	Isolation Condenser
33	IDS	Intrusion Detection System
34	ISFSI	Independent Spent Fuel Storage Installation
35	HOV	Hydraulic Operated Valve
36	HPCI	High Pressure Coolant Injection
37	HPCS	High Pressure Core Spray
38	HPSI	High Pressure Safety Injection
39	HVAC	Heating, Ventilation and Air Conditioning
40	INPO	Institute of Nuclear Power Operations
41	LER	Licensee Event Report
42	LPCI	Low Pressure Coolant Injection
43	LPSI	Low Pressure Safety Injection
44	LOCA	Loss of Coolant Accident
45	MD	Motor Driven
46	MOV	Motor Operated Valve

1	MSIV	Main Steam Isolation Valve
2	MSPI	Mitigating Systems Performance Index
3	N/A	Not Applicable
4	NEI	Nuclear Energy Institute
5	NRC	Nuclear Regulatory Commission
6	NSSS	Nuclear Steam Supply System
7	ODCM	Offsite Dose Calculation Manual
8	OSC	Operations Support Center
9	PA	Protected Area
10	PARs	Protective Action Recommendations
11	PI	Performance Indicator
12	PLE	Performance Limit Exceeded
13	PRA	Probabilistic Risk Analysis
14	PSA	Probabilistic Safety Assessment
15	PORV	Power Operated Relief Valve
16	PWR	Pressurized Water Reactor
17	RETS	Radiological Effluent Technical Specifications
18	RCIC	Reactor Core Isolation Cooling
19	RCS	Reactor Coolant System
20	RHR	Residual Heat Removal
21	ROP	Reactor Oversight Process
22	RWST	Refueling Water Storage Tank
23	SOV	Solenoid Operated Valve
24	SPAR	Standardized Plant Analysis Risk
25	SSFF	Safety System Functional Failure
26	SSU	Safety System Unavailability performance indicator
27	SWS	Service Water System
28	TD	Turbine Driven
29	TSC	Technical Support Center
30	UAI	Unavailability Index
31	URI	Unreliability Index
32	USwC	Unplanned Scrams with Complications

APPENDIX B

STRUCTURE AND FORMAT OF NRC PERFORMANCE INDICATOR DATA FILES

Performance indicator data files submitted to the NRC as part of the Regulatory Oversight Process should conform to the structure and format identified below. The INPO CDE software automatically produces files with the structure and format outlined below.

File Naming Convention

Each NRC PI data file should be named according to the following convention. The name should contain the unit docket number, underscore, the date and time of creation and (if a change file) a “C” to indicate that the file is a change report. A file extension of .txt is used to indicate a text file.

Example: 05000399_20000103151710.txt

In the above example, the report file is for a plant with a docket number of 05000399 and the file was created on January 3, 2000 at 10 seconds after 3:17 p.m. The absence of a C at the end of the file name indicates that the file is a quarterly data report.

General Structure

Each line of the report begins with a left bracket (e.g., “[”) and ends with a right bracket (e.g., “]”). Individual items of information on a line (elements) are separated by a vertical “pipe” (e.g., “|”).

Each file begins with [BOF] as the first line and [EOF] as the last line. These indicate the beginning and end of the data file. The file may also contain one or more “buffer” lines at the end of the file to minimize the potential for file corruption. The second line of the file contains the unit docket number and the date and time of file creation (e.g., [05000399|1/2/2000 14:20:32]). Performance indicator information is contained beginning with line 3 through the next to last line (last line is [EOF]). The information contained on each line of performance indicator information consists of the performance indicator ID, applicable quarter/year (month/year for Barrier Integrity indicators), comments, and each performance indicator data element. Table B-1 provides a description of the data elements and order for each line of performance indicator data in a report file.

Example:
[IE01|3Q1998|Comments here|2|2400]

In the above example, the line contains performance indicator data for Unplanned Scrams per 7000 Critical Hours (IE01), during the 3rd quarter of 1998. The applicable comment text is “Comments here”. The data elements identify that (see Table B-1) there were 2 unplanned automatic and manual scrams while critical and there were 2400 hours of critical operation during the quarter.

1

TABLE B-1 – PI DATA ELEMENTS IN NRC DATA REPORT

Performance Indicator	Data Element Number	Description
General Comment	1	Performance Indicator Flag (i.e., GEN)
	2	Report quarter and year (e.g., 1Q2000)
	3	Comment text
Unplanned Scrams per 7,000 Critical Hours	1	Performance Indicator Flag (i.e., IE01)
	2	Quarter and year (e.g., 1Q2000)
	3	Comment text
	4	Number of unplanned automatic and manual scrams while critical in the reporting quarter
	5	Number of hours of critical operation in the reporting quarter
Unplanned Power Changes per 7,000 Critical Hours	1	Performance Indicator Flag (i.e., IE03)
	2	Quarter and year (e.g., 1Q2000)
	3	Comment text
	4	Number of unplanned power changes, excluding scrams, during the reporting quarter
	5	Number of hours of critical operation in the reporting quarter
Unplanned Scrams with Complications	1	Performance Indicator Flag (i.e., IE04)
	2	Quarter and year (e.g., 1Q2000)
	3	Comment text
	4	Number of unplanned scrams with complications during the reporting quarter
Safety System Functional Failures	1	Performance Indicator Flag (i.e., MS05)
	2	Quarter and year (e.g., 1Q2000)
	3	Comment text
	4	Number of safety system functional failures during the reporting quarter
Mitigating Systems Performance Index (MSPI)– Emergency AC Power Systems	1	Performance Indicator Flag (i.e., MS06)
	2	Quarter and year (e.g., 1Q2000)
	3	Comment text
	4	MSPI Calculated Value Unavailability Index
	5	Unavailability Index Unreliability Index
	6	MSPI Calculated Value Unreliability Index
	7	Performance Limit Exceeded Error! Bookmark not defined.
Mitigating Systems Performance Index (MSPI)- High Pressure Injection Systems	1	Performance Indicator Flag (i.e., MS07)
	2	Quarter and year (e.g., 1Q2000)
	3	Comment text
	4	MSPI Calculated Value
	5	Unavailability Index
	6	Unreliability Index
	7	Performance Limit Exceeded Error! Bookmark not defined.

Performance Indicator	Data Element Number	Description
Mitigating Systems Performance Index (MSPI)– Heat Removal Systems	1	Performance Indicator Flag (i.e., MS08)
	2	Quarter and year (e.g., 1Q2000)
	3	Comment text
	4	MSPI Calculated Value
	5	Unavailability Index
	6	Unreliability Index
	7	Performance Limit ExceededError! Bookmark not defined.
Mitigating Systems Performance Index (MSPI)– Residual Heat Removal Systems	1	Performance Indicator Flag (i.e., MS09)
	2	Quarter and year (e.g., 1Q2000)
	3	Comment text
	4	MSPI Calculated Value
	5	Unavailability Index
	6	Unreliability Index
	7	Performance Limit ExceededError! Bookmark not defined.
Mitigating Systems Performance Index (MSPI)– Cooling Water Systems	1	Performance Indicator Flag (i.e., MS10)
	2	Quarter and year (e.g., 1Q2000)
	3	Comment text
	4	MSPI Calculated Value
	5	Unavailability Index
	6	Unreliability Index
	7	Performance Limit ExceededError! Bookmark not defined.
Reactor Coolant System Activity (RCSA)	1	Performance Indicator Flag (i.e., BI01)
	2	Month and year (e.g., 3/2000)
	3	Comment text
	4	Maximum calculated RCS activity, in micro curies per gram dose equivalent Iodine 131, as required by technical specifications, for reporting month
	5	Technical Specification limit for RCS activity in micro curies per gram dose equivalent Iodine 131
Reactor Coolant System Identified Leakage (RCSL)	1	Performance Indicator Flag (i.e., BI02)
	2	Month and year (e.g., 3/2000)
	3	Comment text
	4	Maximum RCS Identified Leakage calculation for reporting month in gpm
	5	Technical Specification limit for RCS Identified Leakage in gpm
Emergency Response Organization Drill/Exercise Performance	1	Performance Indicator Flag (i.e., EP01)
	2	Quarter and year (e.g., 1Q2000)
	3	Comment text
	4	Number of drill, exercise and actual event opportunities performed timely and accurately during the reporting quarter
	5	Number of drill, exercise and actual event opportunities during the reporting quarter

Performance Indicator	Data Element Number	Description
Emergency Response Organization (ERO) Drill Participation	1	Performance Indicator Flag (i.e., EP02)
	2	Quarter and year (e.g., 1Q2000)
	3	Comment text
	4	Total Key ERO members that have participated in a drill, exercise, or actual event in the previous 8 quarters
	5	Total number of Key ERO personnel at end of reporting quarter
Alert & Notification System Reliability	1	Performance Indicator Flag (i.e., EP03)
	2	Quarter and year (e.g., 1Q2000)
	3	Comment text
	4	Total number of successful ANS siren-tests during the reporting quarter
	5	Total number of ANS sirens tested during the reporting quarter
Occupational Exposure Control Effectiveness	1	Performance Indicator Flag (i.e., OR01)
	2	Quarter and year (e.g., 1Q2000)
	3	Comment text
	4	Number of technical specification high radiation area occurrences during the reporting quarter
	5	Number of very high radiation area occurrences during the reporting quarter
	6	The number of unintended exposure occurrences during the reporting quarter
RETS/ODCM Radiological Effluent Indicator	1	Performance Indicator Flag (i.e., PR01)
	2	Quarter and year (e.g., 1Q2000)
	3	Comment text
	4	Number of RETS/ODCM occurrences in the quarter
Protected Area Security Equipment Performance Indicator Index	1	Performance Indicator Flag (i.e., PP01)
	2	Quarter and year (e.g., 1Q2000)
	3	Comment text
	4	IDS Compensatory Hours in the quarter
	5	CCTV Compensatory Hours in the quarter
	6	IDS Normalization Factor
	7	CCTV Normalization Factor

APPENDIX C

Background Information and Cornerstone Development

INTRODUCTION

This section discusses the overall objectives and basis for the performance indicators used for each of the seven cornerstone areas. A more in-depth discussion of the background behind each of the performance indicators identified in the main report may be found in SECY 99-07.

INITIATING EVENTS CORNERSTONE

GENERAL DESCRIPTION

The objective of this cornerstone is to limit the frequency of those events that upset plant stability and challenge critical safety functions, during shutdown as well as power operations. When such an event occurs in conjunction with equipment and human failures, a reactor accident may occur. Licensees can therefore reduce the likelihood of a reactor accident by maintaining a low frequency of these initiating events. Such events include reactor trips due to turbine trip, loss of feedwater, loss of offsite power, and other reactor transients. There are a few key attributes of licensee performance that determine the frequency of initiating events at a plant.

PERFORMANCE INDICATORS

PRAs have shown that risk is often determined by initiating events of low frequency, rather than those that occur with a relatively higher frequency. Such low-frequency, high-risk events have been considered in selecting the PIs for this cornerstone. All of the PIs used in this cornerstone are counts of either initiating events, or transients that could lead to initiating events (see Table 42 in the main body of NEI 99-02). They have face validity for their intended use because they are quantifiable, have a logical relationship to safety performance expectations, are meaningful, and the data are readily available. The PIs by themselves are not necessarily related to risk. They are however, the first step in a sequence which could, in conjunction with equipment failures, human errors, and off-normal plant configurations, result in a nuclear reactor accident. They also provide indication of problems that, if uncorrected, increase the risk of an accident. In most cases, where PIs are suitable for identifying problems, they are sufficient as well, since problems that are not severe enough to cause an initiating event (and therefore result in a PI count) are of low risk significance. In those cases, no baseline inspection is required (the exception is shutdown configuration control, for which supplemental baseline inspections is necessary).

MITIGATING SYSTEMS CORNERSTONE

GENERAL DESCRIPTION

The objective of this cornerstone is to ensure the availability, reliability, and capability of systems that respond to initiating events to prevent undesirable consequences (i.e., core damage). When such an event occurs in conjunction with equipment and human failures, a reactor accident may result. Licensees therefore reduce the likelihood of reactor accidents by enhancing the availability and reliability of mitigating systems. Mitigating systems include those systems associated with

1 safety injection, residual heat removal, cooling water support systems, and emergency AC power.
2 This cornerstone includes mitigating systems that respond to both operating and shutdown events.

3 **PERFORMANCE INDICATORS**

4 While safety systems and components are generally thought of as those that are designed for
5 design-basis accidents, not all mitigating systems have the same risk importance. PRAs have
6 shown that risk is often influenced not only by front-line mitigating systems, but also by support
7 systems and equipment. Such systems and equipment, both safety- and non-safety-related, have
8 been considered in selecting the PIs for this cornerstone. The PIs are all direct counts of either
9 mitigating system availability or reliability or surrogates of mitigating system performance. They
10 have face validity for their intended use, because they are quantifiable, have a logical relationship
11 to safety performance expectations, are meaningful, and the data are readily available. Not all
12 aspects of licensee performance can be monitored by PIs. Risk-significant areas not covered by
13 PIs will be assessed through inspection.

14 **BARRIER INTEGRITY CORNERSTONE**

15 **GENERAL DESCRIPTION**

16 The purpose of this cornerstone is to provide reasonable assurance that the physical design
17 barriers (fuel cladding, reactor coolant system, and containment) protect the public from
18 radionuclide releases caused by accidents or events. These barriers play an important role in
19 supporting the NRC Strategic Plan goal for nuclear reactor safety, “Prevent radiation-related
20 deaths or illnesses due to civilian nuclear reactors.” The defense in depth provided by the
21 physical design barriers which comprise this cornerstone allow achievement of the reactor safety
22 goal.

23 **PERFORMANCE INDICATORS**

24 The performance indicators for this cornerstone cover two of the three physical design barriers.
25 The first barrier is the fuel cladding. Maintaining the integrity of this barrier prevents the release
26 of radioactive fission products to the reactor coolant system, the second barrier. Maintaining the
27 integrity of the reactor coolant system reduces the likelihood of loss of coolant accident initiating
28 events and prevents the release of radioactive fission products to the containment atmosphere in
29 transients and other events. Performance indicators for reactor coolant system activity and reactor
30 coolant system leakage monitor the integrity of the first two physical design barriers. Even if
31 significant quantities of radionuclides are released into the containment atmosphere, maintaining
32 the integrity of the third barrier, the containment, will limit radioactive releases to the
33 environment and limit the threat to the public health and safety. The integrity of the containment
34 barrier is ensured through the inspection process.

35
36 Therefore, there are three desired results associated with the barrier integrity cornerstone. These
37 are to maintain the functionality of the fuel cladding, the reactor coolant system, and the
38 containment.

1 **EMERGENCY PREPAREDNESS CORNERSTONE**

2 **GENERAL DESCRIPTION**

3 Emergency Preparedness (EP) is the final barrier in the *defense in depth* approach to safety that
4 NRC regulations provide for ensuring the adequate protection of the public health and safety.
5 Emergency Preparedness is a fundamental cornerstone of the Reactor Safety Strategic
6 Performance Area. 10 CFR Part 50.47 and Appendix E to Part 50 define the requirements of an
7 EP program and a licensee commits to implementation of these requirements through an
8 Emergency Plan (the Plan). The performance indicators for this cornerstone are designed to
9 ensure that the licensee is capable of implementing adequate measures to protect the public health
10 and safety in the event of a radiological emergency.

11 **PERFORMANCE INDICATORS**

12 Compliance of EP programs with regulation is assessed through observation of response to
13 simulated emergencies and through routine inspection of onsite programs. Demonstration
14 exercises involving onsite and offsite programs, form the key observational tool used to support,
15 on a continuing basis, the reasonable assurance finding that *adequate protective measures can*
16 *and will be taken in the event of a radiological emergency*. This is especially true for the most
17 risk significant facets of the EP program. This being the case, the PIs for onsite EP draw
18 significantly from performance during simulated emergencies and actual declared emergencies,
19 but are supplemented by direct NRC inspection and inspection of licensee ~~self assessment~~
20 ~~self-~~ **assessment**. NRC assessment of the adequacy of offsite EP will rely (as it does currently) on
21 regular FEMA evaluations.

22 **OCCUPATIONAL EXPOSURE CORNERSTONE**

23 **GENERAL DESCRIPTION**

24 This cornerstone includes the attributes and the bases for adequately protecting the health and
25 safety of workers involved with exposure to radiation from licensed and unlicensed radioactive
26 material during routine operations at civilian nuclear reactors. The desired result is the adequate
27 protection of worker health and safety from this exposure. The cornerstone uses as its bases the
28 occupational dose limits specified in 10 CFR 20 Subpart C and the operating principle of
29 maintaining worker exposure “as low as reasonably achievable (ALARA)” in accordance with
30 10 CFR 20.1101. These radiation protection criteria are based upon the assumptions that a linear
31 relationship, without threshold, exists between dose and the probability of stochastic health
32 effects (radiological risk); the severity of each type of stochastic health effect is independent of
33 dose; and non-stochastic radiation-induced health effects can be prevented by limiting exposures
34 below thresholds for their induction. Thus, 10 CFR Part 20 requires occupational doses to be
35 maintained ALARA with the exposure limits defined in 10 CFR 20 Subpart C constituting the
36 maximum allowable radiological risk. Industry experience has shown that the occurrences of
37 uncontrolled occupational exposure that potentially could result in an individual exceeding a dose
38 limit have been low frequency events. These potential overexposure incidents are associated with
39 radiation fields exceeding 1000 millirem per hour (mrem/hr) and have involved the loss of one or
40 more radiation protection controls (barriers) established to manage and control worker exposure.
41 The probability of undesirable health effects to workers can be maintained within acceptable
42 levels by controlling occupational exposures to radiation and radioactive materials to prevent

1 regulatory overexposures and by implementing an aggressive and effective ALARA program to
2 monitor, control and minimize worker dose.

3 **PERFORMANCE INDICATORS**

4 A combined performance indicator is used to assess licensee performance in controlling worker
5 doses during work activities associated with high radiation fields or elevated airborne
6 radioactivity areas. The PI was selected based upon its ability to provide an objective measure of
7 an uncontrolled measurable worker exposure or a loss of access controls for areas having
8 radiation fields exceeding 1000 millirem per hour (mrem/hr). The data for the PI are currently
9 being collected by most licensees in their corrective action programs. The PI either directly
10 measures the occurrence of unanticipated and uncontrolled dose exceeding a percentage of the
11 regulatory limits or identifies the failure of barriers established to prevent unauthorized entry into
12 those areas having dose rates exceeding 1000 mrem/hr. The indicator may identify declining
13 performance in procedural guidance, training, radiological monitoring, and in exposure and
14 contamination control prior to exceeding a regulatory dose limit. The effectiveness of the
15 licensee's assessment and corrective action program is considered a cross-cutting issue and is
16 addressed elsewhere.

17 **PUBLIC EXPOSURE CORNERSTONE**

18 **GENERAL DESCRIPTION**

19 This cornerstone includes the attributes and the bases for adequately protecting public health and
20 safety from exposure to radioactive material released into the public domain as a result of routine
21 civilian nuclear reactor operations. The desired result is the adequate protection of public health
22 and safety from this exposure. These releases include routine gaseous and liquid radioactive
23 effluent discharges, the inadvertent release of solid contaminated materials, and the offsite
24 transport of radioactive materials and wastes. The cornerstone uses as its bases, the dose limits
25 for individual members of the public specified in 10 CFR 20, Subpart D; design objectives
26 detailed in Appendix I to 10 CFR Part 50 which defines what doses to members of the public
27 from effluent releases are "as low as reasonably achievable" (ALARA); and the exposure and
28 contamination limits for transportation activities detailed in 10 CFR Part 71 and associated
29 Department of Transportation (DOT) regulations. These radiation protection standards require
30 doses to the public be maintained ALARA with the regulatory limits constituting the maximum
31 allowable radiological risk based on the linear relationship between dose received and the
32 probability of adverse health effects.

33 **PERFORMANCE INDICATORS**

34 One PI for the radioactive effluent release program has been initially developed to monitor for
35 inaccurate or increasing projected offsite doses. The effluent radiological occurrence (ERO) PI
36 does not evaluate performance of the radiological environmental monitoring program (REMP)
37 which will be assessed through the routine baseline inspection. For transportation activities, the
38 infrequent occurrences of elevated radiation or contamination limits in the public domain from
39 this measurement area precluded identification of a corresponding indicator. A second PI has been
40 proposed for future use to monitor the inadvertent release of potentially contaminated materials
41 which could result in a measurable dose to a member of the public. These indicators will provide
42 partial assessments of licensee radioactive effluent monitoring and offsite material release

1 activities and were selected to identify decreasing performance prior to exceeding public
2 regulatory dose limits.

3 **~~PHYSICAL~~ SECURITY CORNERSTONE**

4 **GENERAL DESCRIPTION**

5 This cornerstone addresses the attributes and establishes the basis to provide assurance that the
6 physical protection system can protect against the design basis threat of radiological sabotage as
7 defined in 10 CFR 73.1(a). The key attributes in this cornerstone are based on the defense in
8 depth concept and are intended to provide protection against both external and internal threats.
9 To date, there have been no attempted assaults with the intent to commit radiological sabotage
10 and, although there has been no PRA work done in the area of safeguards, it is assumed that there
11 exists a small probability of an attempt to commit radiological sabotage. Although radiological
12 sabotage is assumed to be a small probability, it is also assumed to be risk significant since a
13 successful sabotage attempt could result in initiating an event with the potential for disabling of
14 the safety systems necessary to mitigate the consequences of the event with substantial
15 consequence to public health and safety. An effective security program decreases the risk to
16 public health and safety associated with an attempt to commit radiological sabotage.

17 **PERFORMANCE INDICATORS**

18 One performance indicator is used to assess licensee performance in this cornerstone.

19
20 The performance of the physical protection system will be measured by the percent of the time all
21 components (barriers, alarms and assessment aids) in the systems are available and capable of
22 performing their intended function. When systems are not available and capable of performing
23 their intended function, compensatory measures must be implemented. Compensatory measures
24 are considered acceptable pending equipment being returned to service, but historically have been
25 found to degrade over time. The degradation of compensatory measures over time, along with the
26 additional costs associated with implementation of compensatory measures provides the incentive
27 for timely maintenance/I&C support to return equipment to service. The percent of time
28 equipment is available and capable of performing its intended function will provide data on the
29 effectiveness of the maintenance process and also provide a method of monitoring equipment
30 degradation as a result of aging that could adversely impact on reliability.

31
32

1
2
3

[This page left intentionally blank.]

APPENDIX D

Plant-Plant-Specific Design Issues

This appendix provides additional guidance on plant-specific Frequently Asked Questions and identifies resolutions to performance indicator reporting issues that are specific to individual plant designs. Refer to Appendix E for guidance on the process for submitting an FAQ. FAQs should be submitted as soon as possible once the Licensee and resident inspector or region has identified an issue on which there is not agreement. If the Licensee is not sure how to interpret a situation and the quarterly report is due, an FAQ should be submitted and a comment in the PI comment field would be appropriate. It is incumbent on NRC and the Licensee to work expeditiously and cooperatively, sharing concerns, questions and data in order that the issue can be resolved quickly.

Plant-specific Issues

The NEI 99-02 guidance was written to accommodate situations anticipated to arise at a typical nuclear power plant. However, uncommon plant designs or unique conditions may exist that have not been anticipated. In these cases, licensees should first apply the guidance as written to determine the impact on the indicators. Then, if the licensee believes that there are unique circumstances sufficient to warrant an exception to the guidance as written, the licensee should submit a Frequently Asked Question to NEI for consideration at a public meeting with the NRC. If the FAQ is approved, the issue will be included in Appendix D of this document as a plant-specific issue.

Some provisions in NEI 99-02 may differ from the design, programs, or procedures of a particular plant. Examples include (1) the overlapping Emergency Planning Zones at Kewaunee and Point Beach and (2) actions to address storm-driven debris on intake structures.

In evaluating each request for a plant-specific exception, this forum will take into consideration factors related to the particular issue.

Kewaunee and Point Beach

Issue: The Kewaunee and Point Beach sites have overlapping Emergency Planning Zones (EPZ). We report siren data to the Federal Emergency Management Agency (FEMA) grouped by criterion other than entire EPZs (such as along county lines). May we report siren data for the PIs in the same fashion to eliminate confusion and prevent 'double reporting' of sirens that exist in both EPZs? Kewaunee and Point Beach share a portion of EPZs and responsibility for the sirens has been divided along the county line that runs between the two sites. FEMA has accepted this, and so far the NRC has accepted this informally.

Resolution: The purpose of the Alert and Notification System Reliability PI is to indicate the licensee's ability to maintain risk-significant EP equipment. In this unique case, each neighboring plant maintains sirens in a different county. Although the EPZ is shared, the plants do not share the same site. In this case, it is appropriate for the licensees to report the sirens they are

1 responsible for. The NRC Web site display of information for each site will contain a footnote
2 recognizing this shared EPZ responsibility.
3

4 **North Anna and Surry**

5 Continue to report PP01 in accordance with the current guidance in NEI 99-02.
6

7 **Grand Gulf**

8
9 Issue: Of the 43 sirens associated with our Alert Notification System, two of the sirens are located
10 in flood plain areas. During periods of high river water, the areas associated with these sirens are
11 inaccessible to personnel and are uninhabitable. During periods of high water, the electrical power
12 to the entire area and the sirens is turned off. The frequency and duration of this occurrence varies
13 based upon river conditions but has occurred every year for the past five years and lasts an average
14 of two months on each occasion.
15

16 Assuming the sirens located in the flood plain areas are operable prior to the flooded and
17 uninhabitable conditions, would these sirens be required to be included in the performance
18 indicator during flooded conditions?
19

20 Resolution: If sirens are not available for operation due to high flood water conditions and the area
21 is deemed inaccessible and uninhabitable by State and/or Local agencies, the siren(s) in question
22 will not be counted in the numerator or denominator of the Performance Indicator for that testing
23 period.
24

25 **Diablo Canyon Units 1 and 2**

26
27 Issue: At Diablo Canyon (DC), intrusion of marine debris (kelp and other marine vegetation) at the
28 circulating water intake structures can occur and, under extreme storm conditions result in high
29 differential pressure across the circulating water traveling screens, loss of circulating water pumps
30 and loss of condenser. Over the past several years, DC has taken significant steps, including
31 changes in operating strategy as well as equipment enhancements, to reduce the vulnerability of
32 the plant to this phenomenon. DC has also taken efforts to minimize kelp, however environmental
33 restrictions on kelp removal and the infeasibility of removing (and maintaining removal of)
34 extensive marine growth for several miles around the plant prevent them from eliminating the
35 source of the storm-driven debris. To minimize the challenge to the plant under storm conditions
36 which could likely result in loss of both circulating water pumps, DC procedurally reduces power
37 to 25% power or less. From this power level, the plant can be safely shut down by control rod
38 motion and use of atmospheric dump valves without the need for a reactor trip.
39

40 Is this anticipatory plant shutdown in response to an external event, where DC has taken all
41 reasonable actions within environmental constraints to minimize debris quantity and impact, able
42 to be excluded from being counted under IE01 and IE02?
43

44 Resolution: In consideration of the intent of the performance indicators and the extensive actions
45 taken by PG&E to reduce the plant challenge associated with shutdowns in response to severe
46 storm-initiated debris loading, the following interpretation will be applied to Diablo Canyon. A
47 controlled shutdown from reduced power (less than 25%), which is performed in conjunction with

1 securing of the circulating water pumps to protect the associated traveling screens from damage
2 due to excessive debris loading under severe storm conditions, will not be considered a "scram." If,
3 however, the actions taken in response to excessive debris loading result in the initiation of a
4 reactor trip (manual or automatic), the event would require counting under both the Unplanned
5 Scrams (IE01) and Scrams with a Loss of Normal Heat Removal (IE02) indicators.
6

7 **Diablo Canyon**

8

9 Issue: The response to PI FAQ #158 states "Anticipatory power changes greater than 20% in
10 response to expected problems (such as accumulation of marine debris and biological
11 contaminants in certain seasons) which are proceduralized but cannot be predicted greater than 72
12 hours in advance may not need to be counted if they are not reactive to the sudden discovery of
13 off-normal conditions."

14 Due to its location on the Pacific coast, Diablo Canyon is subject to kelp/debris intrusion at the
15 circulating water intake structure under extreme storm conditions. If the rate of debris intrusion is
16 sufficiently high, the traveling screens at the intake of the main condenser circulating water pumps
17 (CWPs) become overwhelmed. This results in high differential pressure across the screens and
18 necessitates a shutdown of the affected CWP(s) to prevent damage to the screens.

19 To minimize the challenge to the plant should a shutdown of the CWP(s) be necessary in order to
20 protect the circulating water screens, the following operating strategy has been adopted:

- 21 • If a storm of sufficient intensity is predicted, reactor power is procedurally curtailed to 50% in
22 anticipation of the potential need to shut down one of the two operating CWPs. Although the
23 plant could remain at 100% power, this anticipatory action is taken to avoid a reactor trip in the
24 event that intake conditions necessitate securing a CWP. One CWP is fully capable of
25 supporting plant operation at 50% power.
- 26 • If one CWP must be secured based on adverse traveling screen/condenser differential pressure,
27 the procedure directs operators to immediately reduce power to less than 25% in anticipation of
28 the potential need to secure the remaining CWP. Although plant operation at 50% power could
29 continue indefinitely with one CWP, this anticipatory action is taken to avoid a reactor trip in
30 the event that intake conditions necessitate securing the remaining CWP. Reactor shutdown
31 below 25% power is within the capability of the control rods, being driven in at the maximum
32 rate, in conjunction with operation of the atmospheric dump valves.
- 33 • Should traveling screen differential pressure remain high and cavitation of the remaining CWP
34 is imminent/occurring, the CWP is shutdown and a controlled reactor shutdown is initiated.
35 Based on anticipatory actions taken as described above, it is expected that a reactor trip would
36 be avoided under these circumstances.

37 How should each of the above power reductions (i.e., 100% to 50%, 50% to 25%, and 25% to
38 reactor shutdown) count under the Unplanned Power Changes PI?
39

40 Resolution: Anticipatory power reductions, from 100% to 50% and from 50% to less than 25%,
41 that result from high swells and ocean debris are proceduralized and cannot be predicted 72 hours
42 in advance. Neither of these anticipatory power reductions would count under the Unplanned
43 Power Changes PI. However, a power shutdown from less than 25% that is initiated on loss of the
44 main condenser (i.e., shutdown of the only running CWP) would count as an unplanned power
45 change since such a reduction is forced and can therefore not be considered anticipatory.

1
2
3
4
5
6
7
8
9
10
11
12
13
14
15
16
17
18
19
20
21
22
23
24
25
26
27
28
29
30
31
32
33
34
35
36
37
38
39
40
41
42
43
44
45
46
47

D.C. Cook

Issue: The definition for the Reactor Coolant System (RCS) Leakage performance indicator is "The maximum RCS Identified Leakage in gallons per minute each month per the technical specification limit and expressed as a percentage of the technical specification limit."

Cook Nuclear Plant Unit 1 and 2 report Identified Leakage since the Technical Specifications have a limit for Identified Leakage with no limit for Total Leakage. Plant procedures for RCS leakage calculation requires RCS leakage into collection tanks to be counted as Unidentified Leakage due to non-RCS sources directed to the collection tanks. All calculated leakage is considered Unidentified until the leakage reaches an administrative limit at which point an evaluation is performed to identify the leakage and calculate the leak rate. Consequently, Identified Leakage is unchanged until the administrative limit is reached. This does not allow for trending allowed RCS Leakage. The procedural requirements will remain in place until plant modifications can be made to remove the non-RCS sources from the drain collection tanks. What alternative method should be used to trend allowed RCS leakage for the Barrier Integrity Cornerstone?

Resolution: Report the maximum RCS Total Leakage calculated in gallons per minute each month per the plant procedures instead of the calculated Identified Leakage. This value will be compared to and expressed as a percentage of the combined Technical Specification Limits for Identified and Unidentified Leakage. This reporting is considered acceptable to provide consistency in reporting for plants with the described plant configuration.

Nine Mile Point

Issue: Some plants are designed to have a residual transfer of the non-safety electrical buses from the generator to an off-site power source when the turbine trip is caused by a generator protective feature. The residual transfer automatically trips large electrical loads to prevent damaging plant equipment during re-energization of the switchgear. These large loads include the reactor feedwater pumps, reactor recirculation pumps, and condensate booster pumps. After the residual transfer is completed the operators can manually restart the pumps from the control room. The turbine trip will result in a reactor scram. Should the trip of the reactor feedwater pumps be counted as a scram with a loss of normal heat removal?

Resolution: No. In this instance, the electrical transfer scheme performed as designed following a scram and the residual transfer. In addition the pumps can be started from the control room. Therefore, this would not count as a scram with a loss of normal heat removal.

Point Beach

Issue: On June 27th, Point Beach Unit 2 was manually scrammed, in accordance with Abnormal Operating Procedure AOP 13A, "Circulating Water System Malfunction," and power was reduced on Point Beach Unit 1 by greater than 20% (from 100% to 79%) due to reduced water level in the pump bay attributable to an influx of small forage fish (alewives). The large influx of fish created a high differential water level across the traveling screens and ultimately failure of shear pins for the screen drive system, leading to a rapid drop in bay level. The plant knows when the alewife

1 spawning and hatching seasons occur and the effects of Lake Michigan temperature fluctuations on
2 the route of alewife schools. It was aware of the presence of large schools at other Lake Michigan
3 plants this spring and discussed those events and the potential of them occurring at Point Beach at
4 the morning staff meetings. During the thirty years of plant operation, there have been a few
5 instances where a large number of fish entered the plant circulating water system.

6
7 High alewife populations coupled with seasonal variations, lake conditions and wind conditions
8 created the situation that resulted in the downpower on June 27th. Point Beach staff believes that
9 these are uncontrollable environmental conditions. Plant procedures are in place which direct
10 actions when the water level in the pump bay decreases. However, it is not possible to predict the
11 exact time of an influx of schooling fish nor the massive population of fish that arrived in the
12 pump bay. Page 17 of NEI 99-02 Revision 1 states, "Anticipated power changes greater than 20%
13 in response to expected problems (such as accumulation of marine debris and biological
14 contaminants in certain seasons) which are proceduralized but cannot be predicted greater than 72
15 hours in advance may not need to be counted if they are not reactive to the sudden discovery of
16 off-normal conditions." Would this situation count as an unplanned power change?

17
18 Resolution: No. The influx of alewives was expected as evidenced by the discussion of events at
19 other plants on Lake Michigan but was not predictable greater than 72 hours in advance due to the
20 variables involved. Large schools of alewives are a result of environmental and aquatic conditions
21 that occur in certain seasons. The response to the drop in bay level is proceduralized.

22 23 **Quad Cities**

24
25 Issue: 1) At Quad Cities, load reductions in excess of 20% during hot weather are sometimes
26 necessary if the limits of the NPDES Permit limit would be exceeded. Actual initiation of a power
27 change is not predictable 72 hrs in advance, as actions are not taken until temperatures actually
28 reach predefined levels. Would these power changes be counted?

29 2) Power reductions are sometimes necessary during summer hot weather and/or lowered river
30 level conditions when conducting standard condenser flow reversal evolutions. The load reduction
31 timing is not predictable 72 hrs in advance as the accumulation of Mississippi River debris/silt
32 drives the actual initiation of each evolution. The main condenser system design allows for
33 cleaning by flow reversal, which is procedurally controlled to assure sufficient vacuum is
34 maintained. It is sometimes necessary, due to high inlet temperatures, to reduce power more than
35 20% to meet procedural requirements during the flow reversal evolution. These conditions are
36 similar to those previously described in FAQ 158. Would these power changes be counted for this
37 indicator?

38
39 Resolution:

40 1) No.

41 2) No. Power changes in excess of 20% for the purposes of condenser flow reversal are not
42 counted as an unplanned power change.

1 **River Bend Station**

2
3 Issue: River Bend Station (RBS) seeks clarification of BI-02 information contained in NEI 99-02
4 guidance, specifically page 80, lines 36 and 37 “Only calculations of RCS leakage that are
5 computed in accordance with the calculational methodology requirements of the Technical
6 Specifications are counted in this indicator.”

7 NEI 99-02, Revision 2 states that the purpose for the Reactor Coolant System (RCS) Leakage
8 Indicator is to monitor the integrity of the reactor coolant system pressure boundary. To do this,
9 the indicator uses the identified leakage as a percentage of the technical specification allowable
10 identified leakage. Moreover, the definition provided is “the maximum RCS identified leakage in
11 gallons per minute each month per technical specifications and expressed as a percentage of the
12 technical specification limit.”

13 The RBS Technical Specification (TS) states “Verify RCS unidentified LEAKAGE, total
14 LEAKAGE, and unidentified LEAKAGE increase are within limits (12 hour frequency).” RBS
15 accomplishes this surveillance requirement using an approved station procedure that requires the
16 leakage values from the 0100 and 1300 calculation be used as the leakage “of record” for the
17 purpose of satisfying the TS surveillance requirement. These two data points are then used in the
18 population of data subject to selection for performance indicator calculation each quarter (highest
19 monthly value is used).

20 The RBS approved TS method for determining RCS leakage uses programmable controller
21 generated points for total RCS leakage. The RBS’ programmable controller calculates the average
22 total leakage for the previous 24 hours and prints a report giving the leakage rate into each sump it
23 monitors, showing the last four calculations to indicate a trend and printing the total unidentified
24 LEAKAGE, total identified LEAKAGE, their sum, and the 24 hour average. The programmable
25 controller will print this report any time an alarm value is exceeded. The printout can be ordered
26 manually or can be automatic on a 1 or 8 hour basis. While the equipment is capable of generating
27 leakage values at any frequency, the equipment generates hourly values that are summarized in a
28 daily report.

29 The RBS’ TS Bases states “In conjunction with alarms and other administrative controls, a 12 hour
30 Frequency for this Surveillance is appropriate for identifying changes in LEAKAGE and for
31 tracking required trends.”

32 The Licensee provides that NEI 99-02 requires only the calculations performed to accomplish the
33 approved TS surveillance using the station procedure be counted in the RCS leakage indicator. In
34 this case, the surveillance procedure captures and records the 0100 and 1300 RCS leakage values
35 to satisfy the TS surveillance requirements. The NRC Resident has taken the position that all
36 hourly values from the daily report should be used for the RCS leakage performance indicator
37 determination, even though they are not required by the station surveillance procedure. The
38 Resident maintains that all hourly values use the same method as the 0100 and 1300 values and
39 should be included in the leakage determination.

40 Is the Licensee interpretation of NEI 99-02 correct?

41
42 Resolution:

43 All calculations of RCS leakage that are computed in accordance with the calculational
44 methodology requirements of the Technical Specifications are counted in this indicator. Since the
45 River Bend Station leakage calculation is an average of the previous 24 hourly leakage rates which
46 are calculated in accordance with the technical specification methodology, it is acceptable for
47 River Bend Station to include only those calculations that are performed to meet the technical
48 specifications surveillance requirement when determining the highest monthly values for reporting.

1 The ROP Working Group is forming a task force to review this performance indicator based on
2 industry practices.

3 4 **Catawba**

5
6 Issue: Catawba Nuclear Station has 89 sirens in their 10-mile EPZ; 68 of these are located in York
7 County. Duke Power's siren testing program includes a full cycle test for performance indicator
8 purposes once each calendar quarter. On Tuesday, September 7, 2004, York County sounded the
9 sirens in their county's portion of the EPZ to alert the public of the need to take protective actions
10 for a Tornado Warning. Catawba is uncertain whether to include the results of the actual activation
11 in their ANS PI statistics. The definition in NEI 99-02 does not address actual siren activations. In
12 contrast, the Drill/Exercise Performance (DEP) Indicator requires that actual events be included in
13 the PI. Should the performance during the actual siren activation be included in the Alert and
14 Notification System (ANS) Performance Indicator Data?

15
16 Resolution: For this instance, Catawba may include the results of the September 7, 2004 actual
17 siren activations in their ANS PI data. However, for all future instances, no actual siren activation
18 data results shall be included in licensees' ANS PI data.

19 20 **Fitzpatrick**

21
22 Issue: Frazil icing is a condition that is known to occur in northern climates, under certain
23 environmental conditions involving clear nights, open water, and low air temperatures. Under
24 these conditions the surface of the water will experience a super-cooling effect. The super-cooling
25 allows the formation of small crystals of ice, frazil ice. Strong winds also play a part in the
26 formation of frazil ice in lakes. The strong winds mix the super-cooled water and the entrained
27 frazil crystals, which have little buoyancy, to the depths of the lake. The submerged frazil crystals
28 can then form slushy irregular masses below the surface. The crystals will also adhere to any
29 submerged surface regardless of shape that is less than 32°F.

30
31 In order to prevent the adherence of frazil ice crystals to the intake structure bars and ensure
32 maintenance of the ultimate heat sink, the bars of the intake structure are continuously heated.
33 Surveillance tests conducted before and after the event confirmed the operability of the intake
34 structure deicing heaters. While heating assists in preventing formation of frazil ice crystals
35 directly on the bars of the intake structure, the irregular slushy masses discussed above can be
36 drawn to the intake structure in quantities that reduce flow to the intake canal. If the flow to the
37 intake canal is restricted in this manner, then the circulating (lake) water flow must be reduced, to
38 allow frazil ice formations to clear. This water flow reduction necessitates a reduction of reactor
39 power.

40
41 The plant put procedural controls in place to monitor the potential for frazil ice formation during
42 periods of high susceptibility. A surveillance test requires evaluating the potential for frazil ice
43 formation during the winter months, when intake temperature is less than 33°F. In support of the
44 surveillance test, the Chemistry Department developed a test procedure for assessing the potential
45 for frazil ice formation. An abnormal operating procedure was developed to mitigate the
46 consequences of an event should frazil icing reduce the flow through the intake structure. During
47 the overnight hours between March 2, and March 3 the environmental conditions were conducive

1 to the formation of frazil ice. Chemistry notified Operations that the potential for frazil icing was
2 very high. Operators were briefed on this condition, the very high potential for frazil ice
3 formation, and the need to closely monitor intake level.
4

5 When indications showed a lowering intake canal level with no other abnormalities indicated,
6 operations entered the appropriate abnormal operating procedure and reduced power from 100% to
7 approximately 30% so that circulating water pumps could be secured, thereby reducing flow
8 through the intake structure heated bars, to slow the formation or accumulation of frazil ice and
9 allow melting and break-up of the ice already formed.
10

11 As noted above NEI 99-02 Revision 3, in discussing down-powers that are initiated in response to
12 environmental conditions states “The circumstances of each situation are different and should be
13 identified to the NRC in a FAQ so that a determination can be made concerning whether the power
14 change should be counted.”
15

16 Does the transient meet the conditions for the environmental exception to reporting Unplanned
17 Power changes of greater than 20% RTP?
18

19 Resolution: Yes, the downpower was caused by environmental conditions, beyond the control of
20 the licensee, which could not be predicted greater than 72 hours in advance. Procedures, specific to
21 frazil ice, were in place to address this expected condition. In lieu of additional FAQ submittals,
22 this response may be applied by the licensee to future similar instances of frazil ice formation.
23

24 **Turkey Point**

25

26 Issue 1: For the MSPI truncation requirements, three methods were provided whereby licensees
27 could demonstrate sufficient convergence for PRA model acceptability for MSPI. If a licensee is
28 unable to demonstrate either: (1) a truncation level of 7 orders of magnitude below the baseline
29 CDF or (2) that Birnbaum values converge within 80% for event with Birnbaum values $>1E-6$ or
30 (3) that CDF has converged within 5% when using the approach detailed in section F.6.
31

32 What if a licensee, due to limitations with their PRA can “come close” but not meet either of these
33 requirements?
34

35 Is our approach described in the MSPI basis document excerpted below acceptable, given that the
36 5% guideline is exceeded by only 0.2%, and that we cannot reduce the increase in CDF due to the
37 last decade decrease in truncation further due to hardware/software limitations?
38

39 What should be done in the future when model updates may result in a different degree of
40 compliance with the truncation guidelines, e.g., the increase in CDF due to the last decade
41 decrease in truncation is, say, now 6% instead of 5.2%?
42

43 NEI 99-02 Guidance needing interpretation (include page and line citation):
44

45 Appendix F, Sections F.6, page F-48, which states: “*The truncation level used for the method*
46 *described in this section should be sufficient to provide a converged value of CDF. CDF is*
47 *considered converged when decreasing the truncation level by a decade results in a change in*
48 *CDF of less than 5%”*

1
2 Event or circumstances requiring guidance interpretation:

3
4 *As documented in the Turkey Point MSPI Basis document, due to limitations with Turkey Point's*
5 *PRA they were only able to achieve a truncation of 3E-11 per year, and the increase in CDF due*
6 *to the last decade decrease in truncation is 5.2%, only slightly greater than the 5% guideline.*

7
8 Turkey Point's Basis Document states in part:

9
10 *"...The baseline CDF is 4.07E-6 per year, quantified at truncation of 1.0E-11 per year. This*
11 *truncation is about five-and-a-half orders of magnitude below the baseline CDF. Attempts to*
12 *quantify at lower truncations failed due to hardware/software limitations; therefore, the "7 orders*
13 *of magnitude less than the baseline CDF" criterion defined in the first paragraph of Appendix*
14 *F, Sections 1.3.1 and 2.3.1 cannot be met. However, an alternative is described in the second*
15 *paragraph of these sections. For all MSPI basic events with a Birnbaum importance of greater*
16 *than 1E-6, If the ratio of the Birnbaum importances calculated at one decade above*
17 *The lowest truncation (for our case, 1E-10 per year) to their Respective importances*
18 *calculated at the lowest truncation (for our case, 1E-11 Per year) is greater than 0.8, then the*
19 *baseline CDF cutset file at the Lowest truncation can be used to generate the MSPI Birnbaum*
20 *importances.*

21
22 *Turkey Point meets this criterion for all but a few of the MSPI basic events with a Birnbaum*
23 *importance of greater than 1E-6. The Birnbaum importances for these basic events were*
24 *calculated using the alternative described in Section 6 of Appendix F. This alternative allows the*
25 *user to calculate the Birnbaum importances by regenerating cutsets provided the truncation level*
26 *is "sufficient to provide a converged value of CDF. CDF is considered to be converged when*
27 *decreasing the truncation level by a decade results in a change in CDF of less than 5%."*

28
29 For Turkey Point, at 1E-11 per year, the increase in the baseline CDF due to the last decade
30 decrease in truncation is 4.1%, meeting this criterion. However, when the Birnbaum calculations
31 were attempted at a truncation of 1E-11 per year, the runs failed due to hardware/software
32 limitations. This was most likely due to the fact that many more cutsets were being generated due
33 to the quantification of the model with an important component out of service. However, the
34 quantification of these Birnbaum importances via regeneration was possible at a truncation level of
35 3E-11 per year. This is the truncation that was used to calculate the Birnbaum importances for the
36 few basic events in the MSPI calculation that did not meet the "0.8" criterion. Birnbaum
37 importance is not input into the MSPI calculation, FV importance is, and the Birnbaum importance
38 is calculated using the FV, the basic event probability (p), and the baseline CDF. The FV for these
39 basic events was calculated using the formula below.

40
41
$$FV = B * p / CDF(\text{baseline})$$

42
43 The MSPI calculation takes the FVs calculated in this manner, divides them by their respective
44 basic event probabilities, and multiplies the results by the baseline CDF input to the MSPI
45 calculation, which is the CDF baseline calculated at a truncation of 1E-11 per year. This will
46 effectively apply a "correction factor" to the Birnbaum equal to the ratio of the baseline CDF
47 calculated at a truncation of 1E-11 per year and the baseline CDF calculated at a truncation
48 of 3E-11 per year. This correction Factor should serve to allay any concerns over using a slightly

1 higher truncation level for quantification of the Birnbaum importances for these basic events.
2 Further, at a truncation of 3E-11 per year, the increase in CDF due to the last decade decrease in
3 truncation is 5.2%, just slightly greater than the 5% guideline."
4

5 Issue 2: The Turkey Point High Head Safety Injection (HHSI) design is different than the
6 description provided in Appendix F for Train Determination. Therefore, there is no system-specific
7 guidance for HHSI which is applicable to the HHSI system at Turkey Point.
8

9 At Turkey Point, each unit (Unit 3 and Unit 4) has two HHSI pumps. The Unit 3 and Unit 4 HHSI
10 pumps start on an SI signal from either unit, and all of them feed the stricken unit. Should the
11 Turkey Point reporting model be revised to address the four train approach?
12

13 Resolution 1: It is acknowledged that there may be limitations with PRA software modeling such
14 that a few licensees may not meet the explicit guidance limits for truncation and convergence.
15

16 In such cases, the licensee shall submit a FAQ and present the details of their analyses. Approval
17 will be on a case by case basis.

18 For Turkey Point, their model was able to approach 5.2% (vice 5%) convergence and that is
19 considered sufficient for the purposes of MSPI calculation.
20

21 Resolution 2: Yes. In order to ensure accurate reporting, add the opposite-unit HHSI pump trains
22 for unavailability monitoring for each unit, and the opposite-unit HHSI pumps for reliability
23 monitoring for each unit. Although the opposite-unit HHSI pumps are cooled by the opposite-unit
24 component cooling water (CCW) pumps, they should not be added as they are already monitored
25 for their associated unit, and their Birnbaum importances for the opposite-unit are several orders of
26 magnitude less than their Birnbaum importances for their own unit.
27

28 **Prairie Island and Surry Stations**

29
30 Issue: Prairie Island has two diesel-driven service water pumps that are monitored under MSPI.
31 Surry has 3 diesel-driven service water pumps that are monitored under MSPI. There is no
32 industry prior information associated with this component type on Table 4 on page F-37
33

34 Resolution: Due to insufficient industry data upon which to develop a separate set of parameters
35 for this component type, an existing component type should be chosen. Given that the failures for
36 this type of pump are expected to be dominated by the driver rather than the pump, the diesel-
37 driven AFW pump component type should be used.
38

39 **San Onofre**

40
41 Issue: During March 2006, the San Onofre Nuclear Generating Station (SONGS) completed the
42 MSPI Basis Document. The MSPI Basis Document contained a calculation of the FV/UA values
43 for the CCW and SWC systems. The FV/UA values were derived by assuming that Train A is
44 constantly running for the entire year and therefore all unavailability would be assigned to the non-
45 running Train B. The resultant FV/UA value for Train B was then conservatively applied to both
46 Train A and Train B without averaging.
47

1 Since the system is symmetric in importance, what should have occurred is that the FV/UA values
2 should have been calculated for each train and averaged since each train is run approximately 50%
3 of the time. This would be equivalent to calculating each train's FV/UA value assuming the other
4 train is running and then multiplying each train's FV/UA value by an "operating factor" – the
5 percentage of time the respective train is actually the running train (approximately 50% in this
6 case) – and then averaging the two (Train A and Train B) FV/UA values.
7

8 In summary, an error was made in application of the NEI 99-02R4, Section F.1.3.4 guidance.
9

10 Resolution: The SONGS misapplication of the guidance in NEI 99-02R4 regarding the treatment
11 of FV/UA due to the modeling asymmetries of the SSC systems were discussed with the NRC at
12 the May 18 Reactor Oversight Process Task Force public meeting. It was concluded that the MSPI
13 Basis Document of April 1, 2006 was in error and requires correction to reflect the train averaging
14 of section F 1.3.4 prior to submittal of the 2Q06 data on July 21, 2006.
15

16 **Oyster Creek**

17

18 Issue: An intake structure sea grassing event occurred on 8/6/2005 resulting in an abnormal low
19 level in the north side of the intake structure and a subsequent unplanned downpower from 100%
20 power to approximately 41% power for a duration of approximately 40 hours. The event was
21 reported as Unplanned, excluded per NEI 99-02.
22

23 Oyster Creek had been maintaining the intake structure in a summer seasonal readiness condition
24 that was consistent with conditions in previous summer seasons. Appropriate preventive
25 maintenance had been performed on the intake traveling screens. Daily flushing of the screen
26 wash headers and periodic header cleaning had been instituted, in accordance with plant
27 procedures and monitoring practices for summer readiness. These were expected conditions that
28 the plant is forced to deal with during summer seasons. However, this event involved larger
29 amounts of submerged sea grass than had been seen in the past.
30

31 Higher than normal levels of grass were experienced between 2300 hours on August 6, 2005 and
32 0235 hours on August 6, 2006 at the intake structure. At approximately 0235 hours the Control
33 Room received a report from the operator at the intake that intake level on the north side of the
34 intake structure downstream of the screens was at < 1.4 psig as sensed by the bubbler indicator.
35 This equates to a level of <-2.0 ft Mean Sea Level (MSL) and required entry into Abnormal
36 Operating Procedure ABN-32, Abnormal Intake Level. This required more frequent grass removal
37 from intake structure components. Backwashing, raking and screen cleaning were in progress
38 prior to the event, in accordance with plant procedures. At approximately 0305 hours, an
39 unexpected large influx of submerged sea grass (*Gracilaria*) entered the North Side of the intake
40 structure resulting in a collapse of the Trash grates. The grass loading caused each screen's shear
41 pin on the #1, 2, & 3 screens to break, as designed to provide a measure of protection for the intake
42 structure. The three screens on the South Side of the intake structure were not affected during the
43 entire event. Water level downstream of the screens on the North Side lowered due to operation of
44 #1 and #2 Circulating Water Pumps, #1 New Radwaste Service Water Pump and #1 Service Water
45 Pump. The Control Room Unit Operator was informed by the Shift Manager at the intake that
46 level on the North Side of the intake was 0 psig on the bubbler gage at the Screen Wash Control
47 Panel (which corresponds to -5.13' Mean Sea Level). This level exceeded the Alert threshold for
48 EAL HA3. At 0330 hours Emergency Service Water (ESW) System 1 pumps were declared

1 inoperable and Technical Specification LCO 3.4.C.3. (7-day clock) was entered. The sudden,
2 unexpected, large influx of submerged grass impacted the North Side of the Intake Structure
3 resulting in a collapse of the Trash grates and the #1, 2 & 3 Intake Screen shear pins had broken.
4 The Trash Rake was caught in #1 Bay. The shear pin for #1 Screen was replaced but sheared
5 immediately. Both the 1-1 and the 1-2 Main Circulating Water Pumps were secured due to the low
6 intake level resulting in pump cavitation, which required the power reduction to approximately
7 40%.

8
9 Resolution: The downpower that is described in this FAQ does count. The facility has not
10 developed a specific procedure to proactively monitor for environmental conditions that would
11 lead to sea grass intrusion, to direct proactive actions to take before the intrusion, and actions to
12 take to mitigate an actual intrusion that are appropriate for the station and incorporate lessons
13 learned. Development and use of a such a procedure in the future, instead of standing orders, may
14 provide the basis for a future FAQ allowing excluding a downpower >20% for this PI.

15
16 No change to PI guidance is needed.

17 18 **Calvert Cliffs**

19
20 Issue: Anticipated power changes greater than 20% in response to expected environmental
21 problems (such as accumulation of marine debris, biological contaminants, or frazil icing) which
22 are proceduralized but cannot be predicted greater than 72 hours in advance may not need to be
23 counted unless they are reactive to the sudden discovery of off normal conditions... . The licensee
24 is expected to take reasonable steps to prevent intrusion of marine or other biological growth from
25 causing power reductions... The circumstances of each situation are different and should be
26 identified to the NRC in a FAQ so that a determination can be made concerning whether the power
27 change should be counted.'

28
29 During summer months, under certain environmental conditions, Calvert Cliffs can experience
30 instances of significant marine life impingements which can cause high differential pressure across
31 our Circulating Water (bay water) System traveling screens, restricting flow capability of our
32 Circulating Water (CW) pumps which could ultimately result in a plant derate or trip due to being
33 unable to maintain sufficient condenser vacuum.

34
35 In anticipation of these potential marine life impingement conditions, the site has proceduralized
36 actions to be taken within an Abnormal Operating Procedure (AOP). The actions to be taken in
37 these circumstances include placing travel screens in manual mode of operation and using the
38 intake aerator and fire hoses to disperse the fish population. Although instances of biological
39 blockages are expected, neither the time of nor the severity of the intrusions can be predicted.
40 During July 2006 the site had been periodically dealing with instances of jellyfish intrusions which
41 had challenged maintaining sufficient CW flow, but had not been severe enough to threaten plant
42 full power operation. On July 7, 2006 the site experienced a severe jellyfish intrusion and
43 implemented the applicable AOP. This time the actions were unable to ensure sufficient CW flow
44 to maintain Unit 1 at 100% power and a rapid power reduction was initiated on Unit 1, which
45 ultimately reduced power to 40%. When the jellyfish intrusion was controlled, sufficient CW flow
46 was restored, and power was restored to 100%. Given that the circumstances of this jellyfish
47 intrusion was beyond the control of the plant, and that appropriate site actions have been
48 proceduralized, should this event be exempted from counting as an unplanned power change? In

1 addition, can this exemption be applied to future, similar marine life impingements at Calvert
2 Cliffs, where the site carries out the approved actions designed to counter act these conditions,
3 without submittal of future FAQs?
4

5 Resolution: The downpower that is described in this FAQ does count. The facility has not
6 developed a specific procedure to proactively monitor for environmental conditions that would
7 lead to jelly fish intrusion, to direct proactive actions to take before the intrusion, and actions to
8 take to mitigate an actual intrusion that are appropriate for the station and incorporate lessons
9 learned: e.g.: staging equipment, assigning additional personnel or watches, implementing finer
10 mesh screen use, use of hose spray to ward off jelly fish. Development and use of a such a
11 procedure in the future, may provide the basis for a future FAQ allowing excluding a downpower
12 >20% for this PI.
13

14 No change to PI guidance is needed.
15

16 **Point Beach**

FAQ479
(11-05)

17
18 Issue: Point Beach is upgrading the Unit 1 and Unit 2 auxiliary feedwater systems (AF) during the
19 second quarter of 2011 with Unit 2 being completed during the spring outage and Unit 1 while the
20 plant is on line. The current AF design has two motor-driven AF pumps that are shared between
21 the two units. In the current configuration, the operating unit has planned unavailability during the
22 other unit's refueling outage. After the upgrade modifications are completed, the AF system will
23 have one new motor-driven pump dedicated to each unit and will no longer have planned
24 unavailability during the other unit's refueling outage. The new pumps will be the same model
25 casing as the old pumps, but will have a different impeller, resulting in a higher flow rate, and will
26 be powered by 4160V versus 480V. The preventive maintenance activities for the new pumps and
27 associated monitored valves will be essentially the same as those for the existing pumps and
28 associated monitored valves. The change will reduce the number of motor-driven AF trains from
29 two to one per unit and will change the Point Beach generic common cause failure adjustment
30 value from 1.25 to 1.0 in NEI 99-02, Appendix F, Table 7.
31

32 The refueling outage is scheduled to be completed during the second quarter of 2011. As the units
33 will be putting the new AF pumps and associated monitored valves in service during the middle of
34 a quarter, the device records in CDE will be updated upon entry into MODE 4 ascending for Unit 2
35 and when the new AF pump and associated monitored valves are placed in service for Unit 1.
36 However, CDE and the MSPI Basis Document will not be updated until the end of the second
37 quarter to reflect the new PRA and the new train definitions.
38

39 The completion of the modification during the middle of a quarter will result in the inability to
40 implement all of the guidance in NEI 99-02 related to reporting of data in CDE. The goal is to
41 provide a second quarter MSPI submittal for AF that accurately reflects the actual availability and
42 reliability of the existing and new AF system configurations and implements the guidance of NEI
43 99-02 as much as reasonable. However, as CDE does not support the submittal of split data and
44 does not allow PRA model changes mid-quarter, an MSPI result for MS08, Heat Removal
45 Systems, reflecting second quarter 2011 AF system unavailability and reliability would not be
46 representative of the new system and would not provide meaningful results. Therefore,
47 exemptions from NEI 99-02 reporting guidance are requested for Point Beach based upon the
48 system design changes being implemented in the second quarter of 2011.

1
2 Resolution: Point Beach may have a one-time exemption from the reporting guidance on
3 Page 2, Lines 15-23, of NEI 99-02, Revision 6. The 2Q2011 MS08 PI will be characterized
4 as “Insufficient Data to Calculate PI,” as indicated by:
5

FAQ479
(11-05)

6
7
8 **I**

9 on the NRC’s “ROP Performance Indicators Summary” Web site because (1) the results will not
10 be representative of the current PRA and MSPI Basis Document for that quarter and (2) the data
11 reflecting the actual plant configuration cannot be processed in CDE software. A comment shall
12 be added to the CDE submittal file explaining the basis for this characterization, which will
13 include that the modification was installed mid-quarter, CDE is not capable of processing a “data
14 split” within the same quarter, CDE does not allow mid-quarter PRA model changes, and an MSPI
15 result for MS08, Heat Removal Systems, reflecting 2Q2011 AF system unavailability and
16 reliability would not be representative of the new system nor provide meaningful results.

17 AF unavailability and reliability data will be reported to the NRC for 2Q2011. The data will
18 be used for assessing MS08 data for subsequent quarters.
19

FAQ479
(11-05)

20 Because the new pumps and associated monitored valves will be similar to the existing pumps and
21 associated monitored valves, Point Beach will determine the baseline unavailability data
22 (nominally 2002-2004) for the new trains by using the unavailability data for the existing trains,
23 removing the unavailability that was reported when the other unit was in an outage, and averaging
24 the data over three years. With respect to historical unavailability data, because the new pumps
25 and associated monitored valves will be similar to the existing pumps and associated monitored
26 valves, Point Beach will determine the past three years of historical unavailability for the new
27 trains by using the data for the existing trains, removing the unavailability taken when the other
28 unit was in an outage, and averaging the data over three years. Point Beach will also update the
29 MSPI basis document at the end of 2Q2011 to reflect the modification’s impact on system and
30 train boundaries.
31

32 With respect to reliability data, Point Beach will update the device records and associated
33 reliability data in CDE at the time the new pumps and associated monitored valves are placed in
34 service and will update the MSPI basis document at the end of 2Q2011 to reflect the
35 modification’s impact on monitored component boundaries. The most recent three years of
36 reliability data for the currently installed pumps will serve as the reliability data for the new pumps
37 because of their similar design and function
38

39 It is acceptable to revise the HRS/MDP Standby generic common cause failure adjustment value
40 from 1.25 to 1.00, which will take effect upon the implementation of the modification, in NEI 99-
41 02, Revision 6, Appendix F, Table 7.
42

1 **Fort Calhoun**

2
3 Issue: Under normal circumstances and in accordance with the Fort Calhoun Radiological
4 Emergency Response Plan, section E, sirens are tested bi-weekly for functionality via Emergency
5 Planning Test (EPT) EPT-1 (Alert Notification System Silent Test), quarterly via EPT-2 (Alert
6 Notification System Growl Test), and annually via EPT-3 (Alert Notification System Complete
7 Cycle Test).

8
9 Current flooding along the Missouri River and within the 10-mile EPZ has resulted in several
10 sirens being [deliberately] disabled by disconnecting AC power due to rising river levels. These
11 flooding conditions do not only affect the operability/functionality of the sirens, but have also
12 resulted in power disconnections for and evacuation of residents in the areas for which these sirens
13 provide coverage. Additionally, backup route-alerting is still available for any remaining affected
14 residents as verified through local and state governments.

15
16 In accordance with NEI 99-02, Revision 6 (Regulatory Assessment Performance Indicator
17 Guideline), page 57 concerning siren testing states “Regularly scheduled tests missed for reasons
18 other than siren unavailability (e.g., out of service for planned maintenance or repair) should be
19 considered non opportunities.” This evaluation and exemption was applied to the sirens that have
20 been removed from service due to flooding.

21
22 These sirens were removed from service intentionally; and will remain out of service for an
23 extended period of time; therefore they will not be counted in the performance indicator for Alert
24 and Notification System Reliability. For all EPTs conducted on sirens during the time period
25 when power has been removed from the siren due to flooding, the number of sirens tested will only
26 be those that have normal power available.

27
28 Resolution: If sirens are not available for operation due to high flood water conditions, and the
29 area is deemed inaccessible and uninhabitable by State and/or Local agencies, the siren(s) in
30 question will not be counted in the numerator or denominator of the Performance Indicator for that
31 testing period.

32
33
34
35 | ~~{This page left intentionally blank.}~~

APPENDIX E

FREQUENTLY ASKED QUESTIONS

Purpose

The Frequently Asked Question (FAQ) process is the mechanism for resolving interpretation issues with NEI 99-02. FAQs and responses are posted on the NRC Website (www.nrc.gov/NRR/OVERSIGHT/ASSESS/index.html) and INPO's Consolidated Data Entry webpage. **They-Approved FAQs** represent NRC approved interpretations of performance indicator guidance and should be treated as an extension of NEI 99-02.

There are several reasons for submitting an FAQ:

- 1. To clarify the guidance when the licensee and NRC regional staff do not agree on the meaning or ~~how to apply~~ application of the guidance to a particular situation.*
- 2. To provide guidance for a class of plants whose design or system functions differ from that described in the guidance.*
- 3. To request an exemption from the guidance for plant-specific circumstances, such as design features, procedures, or unique conditions.*
- 4. When recommended in NEI 99-02, such as in response to unplanned power changes due to environmental conditions.*

Proposed changes to the guidance are not a reason to submit an FAQ. A formal process exists for changing the guidance, which usually includes analysis and piloting before being implemented. White papers that are submitted for guidance changes, if approved by the Industry/NRC working group, are converted into an FAQ for use and inclusion in the next revision of NEI 99-02. In some circumstances, while reviewing an FAQ, the Industry/NRC working group may determine that a change in the guidance is necessary.

The FAQ process is not the arena in which to resolve interpretation issues with any other NRC regulatory documents. In addition, the FAQ process is not used to make licensing or engineering decisions.

Process

1. Issue identification

Either the licensee or the NRC may identify the need for an interpretation of the guidance. FAQs should be submitted as soon as possible, **but generally no later than the quarter following identification of the issue requiring interpretation. Once the licensee and resident inspector or region have identified an issue on which there is either disagreement or where both parties agree that guidance clarification is necessary, an FAQ should be submitted as soon as possible. The FAQ should be provided to the ROP Task Force by the next scheduled ROP Task Force meeting, if practical, but no later than its subsequent meeting. The ROP Task Force should submit the FAQ to the ROP Working Group by the following month's meeting, if practical. If both the resident inspector and licensee agree that the issue is complex and more time is required (e.g., to complete a causal evaluation, obtain a vendor report, perform**

1 a simulator run, etc.), the FAQ submittal may be delayed until the issue is sufficiently
2 understood. ~~once the licensee and resident inspector or region has identified an issue on which~~
3 ~~there is not agreement.~~
4

5 The licensee submits the FAQ by email to pihelp@nei.org. The email should include “FAQ” as
6 part of the subject line and should provide the name and phone number of a contact person. If the
7 licensee is not sure how to interpret a situation and the quarterly report is due, an FAQ should be
8 submitted and a comment in the PI comment field would be appropriate. If the licensee has
9 reasonable confidence that its position will be accepted, it is under no obligation to report the
10 information (e.g., unavailability). Conversely, if the licensee is not confident that it will succeed
11 in its FAQ, the information should be included in the submitted data. In either case, the report
12 can be amended, if required, at a later date.
13

14 2. Expediitousness, Completeness and Factual Agreement

15

16 In order for the performance indicators to be a timely element of the ROP, it is incumbent on
17 NRC and the licensee to work expeditiously and cooperatively, sharing concerns, questions and
18 data in order that the issue can be resolved quickly. Where possible, agreement should be
19 achieved prior to submittal of the FAQ on the factual elements of the FAQ, e.g., the engineering,
20 maintenance, or operational situation. The FAQ must describe the situation clearly and
21 concisely and must be complete and accurate in all respects. If agreement cannot be reached on
22 the wording of the FAQ, NRC will provide its alternate view to the licensee for inclusion in the
23 FAQ.
24

25 3. FAQ Format

26

27 See Figure E-1 for the format for submitting an FAQ. It is important to provide contact
28 information and whether the FAQ should be considered generic to all plants, or only specific to
29 the licensee submitting the FAQ. In most cases the FAQ will become effective as soon as
30 possible; however, the licensee can recommend an effective date. The question section of the
31 FAQ includes the specific wording of the guidance which needs to be interpreted, the
32 circumstances involved, and the specific question. All relevant information should be included
33 and should be as complete as possible. Incomplete or omitted information will delay the
34 resolution of the FAQ. The licensee also provides a proposed response to the FAQ. The
35 response should answer the question and provide the reasoning for the answer. (There must not
36 be any new information presented in the response that was not already discussed in the question.)
37 The NRC may or may not opt to request that the FAQ include an alternative response. Finally,
38 the FAQ may include proposed wording to revise the guidance in the next revision.
39

40 4. Screening of licensee FAQs

41

42 Typically, FAQs are forwarded to and reviewed by NEI. New FAQs should be submitted at least
43 one week prior to the ROP meeting, revisions to previously accepted FAQs can be submitted at
44 any time. NEI may request that the FAQ be revised. After acceptance by NEI, the FAQ is
45 reviewed by the industry’s ROP Task Force (Formerly SPATF). Additional wording may be
46 suggested to the licensee. In some cases, the task force may believe the FAQ is without merit
47 and may recommend that the FAQ be withdrawn. An accepted FAQ is entered in the FAQ log
48 which includes all unresolved FAQs. All open FAQs and the log are forwarded to NRC and the

1 task force members approximately one week prior to the (approximately) monthly ROP meeting
2 between the task force and NRC or as soon as reasonably practical.

3 4 5. Public Meeting Discussions of FAQs

5
6 The FAQ log is reviewed at each monthly ROP meeting, and the Industry/NRC working group is
7 responsible for achieving a consensus response, if possible. In most cases, the licensee is
8 expected to present and explain the details of its FAQ. Licensee and resident/regional NRC staff
9 are usually available (at the meeting or by teleconferencing) to respond to questions posed by the
10 Industry/NRC) working group. The new FAQ is introduced by the licensee to ensure the
11 working group understands the issues, but discussion of the FAQ may be referred to the next
12 meeting if participants have not had an opportunity to research the issues involved. The FAQ
13 will be discussed in detail, until all of the facts have been resolved and consensus has been
14 reached on the response. The FAQ will then be considered “Tentatively Approved,” and
15 typically one additional month will be allowed for reconsideration. At the following meeting the
16 FAQ becomes “Final.” Typically, an FAQ is introduced one month; the facts are discussed for
17 two or three months and a tentative decision reached; and it goes final the following month.

18
19 In cases where minor changes are necessary after final or tentative approval has occurred, the
20 changes can be made if representatives from both industry and NRC concur on the final wording
21 prior to FAQ issuance on the NRC website.

22
23 In some limited cases (involving an issue with no contention and where exigent resolution is
24 needed), it is possible for the ROP working group to reach immediate consensus and take the
25 FAQ to Final; however, this will generally be an exception.

26 27 6. Withdrawal of FAQs

28
29 A licensee may withdraw an FAQ after it has been accepted by the joint ROP Working Group.
30 Withdrawals must occur during an ROP Working Group ~~monthly (approximately)~~ meeting.
31 However, the ROP Working Group should further discuss and decide if a guidance issue exists in
32 NEI 99-02 that requires additional clarification. If additional clarification is needed then the
33 original FAQ should be revised to become a generic FAQ. **In many cases, there are lessons
34 learned from the resources expended by the ROP Working Group that should be captured. In
35 those cases, the FAQ will be entered in the FAQ log as a generic FAQ. If there is disagreement
36 between the staff and industry, both positions should be articulated in the FAQ. These
37 withdrawn FAQs should be considered as historical and are not considered to be part of NEI 99-
38 02. Although they do not establish ~~precedence~~precedent, they do offer insights into perspectives
39 of both industry and NRC staff and, as such, can inform future decisions to submit an FAQ.**

FAQ470
(10-01)

40 41 7. Appeal Process

42
43 Once the facts and circumstances are agreed upon, if consensus cannot be reached after two
44 consecutive working group meetings, the FAQ will be referred to the NRC Director of the
45 Division of Inspection & Regional Support (DIRS). The director will conduct a public meeting
46 at which both the licensee and NRC will present their positions as well as respond to any
47 questions from the director. The director then will make the determination. Any additional

1 appeal to higher management is outside of this process and is solely at the licensee's discretion
2 and initiative.

3
4 8. Promulgation and Effective Date of FAQs

5
6 Once approved by NRC, the accepted response will be posted on the NRC Website and is treated
7 as an extension of this guideline.

8
9 For the licensee that submitted the FAQ, the FAQ is effective when the event occurred. Unless
10 otherwise directed in an FAQ response, for other licensees, FAQs are to be applied to the data
11 submittal for the quarter following the one in which the FAQ was posted and beyond. For
12 example, an FAQ with a posting date of 9/30/2009 would apply to 4th quarter 2009 PI data,
13 submitted in January 2010 and subsequent data submittals. However, an FAQ with a posting
14 date of 10/1/2009 would apply on a forward fit basis to first quarter 2010 PI data submitted in
15 April 2010. Licensees are encouraged to check the NRC Web site frequently, particularly at the
16 end of the reporting period, for FAQs that may have applicability for their sites.

17
18 At the time of a revision of NEI 99-02, active FAQs will be reviewed for inclusion in the text.
19 These FAQs will then be placed in an "archived" file. Archived FAQs are for historical
20 purposes and are not considered to be part of NEI 99-02.

21

FAQ TEMPLATE

1
2
3
4
5
6
7
8
9
10
11
12
13
14
15
16
17
18
19
20
21
22
23
24
25
26
27
28
29
30
31
32
33
34
35
36
37
38
39
40
41
42
43
44
45
46

Plant: _____
Date of Event: _____
Submittal Date: _____
Licensee Contact: _____ Tel/email: _____
NRC Contact: _____ Tel/email: _____

Performance Indicator:

Site-Specific FAQ (see Appendix D)? Yes or No

FAQ ~~requested~~ to become effective when approved or (other date) _____

Question Section

NEI 99-02 Guidance needing interpretation (include page and line citation):

Event or circumstances requiring guidance interpretation:

If licensee and NRC resident/region do not agree on the facts and circumstances, explain:

Potentially relevant FAQs:

Response Section

Proposed Resolution of FAQ:

If appropriate, provide proposed rewording of guidance for inclusion in next revision:

~~PRA update required to implement this FAQ?~~

~~MSPI Basis Document update required to implement this FAQ?~~

Zimmerman
11/15/11

Figure E-1

~~[This page left intentionally blank.]~~

APPENDIX F

METHODOLOGIES FOR COMPUTING THE UNAVAILABILITY INDEX, THE UNRELIABILITY INDEX AND COMPONENT PERFORMANCE LIMITS

This appendix provides the details of three calculations: the System Unavailability Index, the System Unreliability Index, and component performance limits.

F 1. SYSTEM UNAVAILABILITY INDEX (UAI) DUE TO TRAIN UNAVAILABILITY

Unavailability is monitored at the train/segment level for the purpose of calculating UAI. The process for calculation of the System Unavailability Index has three major steps:

- Identification of system trains/segments
- Collection of plant data
- Calculation of UAI

The first of these steps is performed for the initial setup of the index calculation (and if there are significant changes to plant configuration or at the licensee's discretion. The second step has some parts that are performed initially and then only performed again when a revision to the plant-specific PRA is made or changes are made to the normal preventive maintenance practices. Other parts of the calculation are performed periodically to obtain the data elements reported to the NRC. This section provides the detailed guidance for the calculation of UAI.

F 1.1. IDENTIFICATION OF SYSTEM TRAINS/SEGMENTS

The identification of system trains/segments is accomplished in two steps:

- Determine the system boundaries
- Identify the trains/segments within the system boundary

The use of simplified P&IDs can be used to document the results of this step and will also facilitate the completion of the directions in section F2.1.1 later in this document.

F 1.1.1. MONITORED FUNCTIONS AND SYSTEM BOUNDARIES

The first step in the identification of system trains is to define the monitored functions and system boundaries. Include all components within the system boundary that are required to satisfy the monitored functions of the system.

~~The cooling water support system is a system that is calculated separately in MSPI~~**Error!**
Bookmark not defined.; however, trains/segments of other support systems (e.g., HVAC room coolers, DC power, instrument air, etc.) that may be needed to satisfy a monitored function are not monitored in MSPI for unavailability if the components within those trains/segments are not included within the boundary of a monitored train/segment or the supported system.

Additional guidance for determining the impact on availability and unreliability from unmonitored component failures can be found in Section F.2.2.2.

Linthicum
3/3/12

Linthicum
3/3/12

FAQ486
(10-06)

1 | The monitored functions of the system are those functions in section F5 of this appendix that
2 | have been determined to be risk-significant functions per NUMARC 93-01 and are reflected in
3 | the PRA **Error! Bookmark not defined.** If none of the functions listed in ~~section five~~ **Section F5**
4 | for a system are determined to be risk significant, then:

- 6 | • If only one function is listed for a system, then this function is the monitored function (for
7 | example, CE NSSS designs use the Containment Spray system for RHR but this system is
8 | redundant to the containment coolers and may not be risk significant. The Containment Spray
9 | system would be monitored.)
- 10 | • If multiple functions are listed for a system, the most risk significant function is the
11 | monitored function for the system. Use the Birnbaum Importance values to determine which
12 | function is most risk significant.

13 |
14 | For fluid systems the boundary should extend from **and include** the water source (e.g., tanks, Linthicum
3/3/12
15 | sumps, etc.) to the injection point (e.g., RCS, Steam Generators). For example, high-pressure
16 | injection may have both an injection mode with suction from the refueling water storage tank
17 | and a recirculation mode with suction from the containment sump. For Emergency AC systems,
18 | the system consists of all class 1E generators at the station (**for multi-unit sites, see Unit Crosstie**
19 | **Capability below**).

20 |
21 | Additional system specific guidance on system boundaries can be found in ~~section~~ **Section 5**
22 | titled “Additional Guidance for Specific Systems” at the end of this appendix.

23 |
24 | Some common conditions that may occur are discussed below.

25 | System Interface Boundaries

26 | For water connections from systems that provide cooling water to a single component in a
27 | monitored system, the final connecting valve is included in the boundary of the frontline system
28 | rather than the cooling water system. For example, for service water that provides cooling to
29 | support an AFW pump, only the final valve in the service water system that supplies the cooling
30 | water to the AFW system is included in the AFW system scope. This same valve is not included
31 | in the cooling water support system scope. The equivalent valve in the return path, if present,
32 | will also be included in the frontline system boundary.

33 |
34 | **The impact of room cooling or other related HVAC supports is excluded from the system/train**
35 | **boundary. Unavailability of these systems/components is not counted as unavailability of a**
36 | **monitored system/train. The only exception to this are is EDG ventilation systems that have a** FAQ486
(10-06)
37 | **shared function of both providing room cooling/ventilation that also provide a flow path for EDG**
38 | **combustion or exhaust. In these cases, unavailability of components that result in unavailability**
39 | **of an EDG due to not having a combustion or exhaust flow path is included in EDG**
40 | **unavailability.**

41 |
42 | **For control functions and electrical power, the system/train boundary includes all system**
43 | **dedicated relays, controllers, and contactors that support the monitored system functions, and all**
44 | **dedicated voltage supply breakers (both motive and control power) and their associated control**
45 |

1 | circuits (relay contacts for normally auto actuated components, control board switches for
2 | normally operator actuated components). If a relay, breaker, or contactor exists solely to support
3 | the operation of a monitored train/segment, it should be considered part of the train's/segment's
4 | boundary. If a relay, breaker, or contactor supports multiple trains/segments, it should not be
5 | considered as part of the monitored train's/segment's boundary. For turbine driven pumps, the
6 | system/train boundary includes the associated control system (relay contacts for normally auto
7 | actuated components, control board switches for normally operator actuated components), the
8 | control valve, and its voltage supply breaker. Failure or unavailability of components outside of
9 | the system/train boundary is **not** counted as unavailability of the impacted system/train.

FAQ486
(10-06)

Linthicum
3/3/12

11 | Water Sources and Inventory

12 | Water tanks are not considered to be monitored components. As such, they do not contribute to
13 | URI. However, **since tanks can be in the train/segment boundary**, periods of insufficient water
14 | inventory contribute to UAI if they result in loss of the monitored train/segment function for the
15 | required mission time. If additional water sources are required to satisfy train/segment mission
16 | times, only the connecting active valve from the additional water source is considered as a
17 | monitored component for calculating **UAIURI**. If there are valves in the primary water source
18 | that must change state to permit use of the additional water source, these valves are considered
19 | monitored and should be included in UAI for the system.

FAQ486
(10-06)

Linthicum
3/3/12

21 | Unit Cross-Tie Capability

22 | At multiple unit sites cross ties between systems frequently exist between units. For example at a
23 | two unit site, the Unit 1 Emergency Diesel Generators may be able to be connected to the Unit 2
24 | electrical bus through cross tie breakers. In this case the Unit 1 EAC system boundary would end
25 | at the cross tie breaker in Unit 1 that is closed to establish the cross-tie. The similar breaker in
26 | Unit 2 would be the system boundary for the Unit 2 EAC system. Similarly, for fluid systems the
27 | fluid system boundary would end at the valve that is opened to establish the cross-tie.

29 | Common Components

30 | Some components in a system may be common to more than one system/train/segment, in which
31 | case the unavailability of a common component is included in all affected
32 | systems/trains/segments.

34 | **F 1.1.2. Identification of Trains within the System**

35 | Each monitored system shall then be divided into trains/segments to facilitate the monitoring of
36 | unavailability.

37 |
38 | *A train* consists of a group of components that together provide the monitored functions of the
39 | system described in the “additional guidance for specific mitigating systems”. The number of
40 | trains in a system is generally determined as follows:

- 41 |
42 | • For systems that provide cooling of fluids, the number of trains is determined by the number
43 | of parallel heat exchangers, or the number of parallel pumps, or the minimum number of
44 | parallel flow paths, whichever is fewer.

- 1 • For emergency AC power systems the number of trains is the number of class 1E emergency
2 (diesel, gas turbine, or hydroelectric) generators at the station that are installed to power
3 shutdown loads in the event of a loss of off-site power. (For example, this does not include
4 the diesel generator dedicated to the BWR HPCS system, which is included in the scope of
5 the HPCS system.)

6 Some components or flow paths may be included in the scope of more than one train. For
7 example, one set of flow regulating valves and isolation valves in a three-pump, two-steam
8 generator system are included in the motor-driven pump train with which they are electrically
9 associated, but they are also included (along with the redundant set of valves) in the turbine-
10 driven pump train. In these instances, the effects of unavailability of the valves should be
11 reported in all affected trains. Similarly, when two trains provide flow to a common header, the
12 effect of isolation or flow regulating valve failures in paths connected to the header should be
13 considered in both trains.
14

15 | Additional system specific guidance on train definition can be found in ~~section~~Section F5 titled
16 “Additional Guidance for Specific Systems” at the end of this appendix.

17 Additional guidance is provided below for the following specific circumstances that are
18 commonly encountered:

- 19 | • Cooling Water Support Systems and Trains
20 • Swing Trains and Components Shared Between Units
21 • Maintenance Trains and Installed Spares
22 • Trains or Segments that Cannot Be Removed from Service.
23

24 Cooling Water Support Systems and Trains

25 The cooling water function is typically accomplished by multiple systems, such as service water
26 and component cooling water. A separate value for UAI will be calculated for each of the
27 systems in this indicator and then they will be added together to calculate an overall UAI value.
28

29 In addition, cooling water systems are frequently not configured in discrete trains. In this case,
30 the system should be divided into logical segments and each segment treated as a train. This
31 approach is also valid for other fluid systems that are not configured in obvious trains. The way
32 these functions are modeled in the plant-specific PRA will determine a logical approach for
33 | train/~~segment~~ determination. For example, if the PRA modeled separate pump and line segments
34 (such as suction and discharge headers), then the number of pumps and line segments would be
35 the number of trains.
36

37 Unit Swing trains and components shared between units

38 Swing trains/components are trains/components that can be aligned to any unit. To be credited
39 as such, their swing capability must be modeled in the PRA to provide an appropriate Fussell-
40 Vesely value.
41

42 | ~~Maintenance Trains and~~ Installed Spares

~~Some power plants have systems with extra trains to allow preventive maintenance to be carried out with the unit at power without impacting the monitored function of the system. That is, one of the remaining trains may fail, but the system can still perform its monitored function. To be a maintenance train, a train must not be needed to perform the system's monitored function.~~

Linthicum
3/3/12

Linthicum
3/3/12

An "installed spare" is a component (or set of components) that is used as a replacement for other equipment to allow for the removal of equipment from service for preventive or corrective maintenance without impacting the ~~number operability~~ of trains available to achieve the monitored function of the system. To be an "installed spare," a component must not be needed for any train of the system to perform the monitored function. A typical installed spare configuration is a two train system with a third pump that can be aligned to either train (both from a power and flow perspective), but is normally not aligned and when it is not aligned receives no auto start signal. In a two train system where each train has two 100% capacity pumps that are both normally aligned, the pumps are not considered installed spares, but are redundant components within that train.

Linthicum
3/3/12

Unavailability of an installed spare is not monitored **unless the system is monitored in segments, rather than trains**. Trains in a system with an installed spare are not considered to be unavailable when the installed spare is aligned to that train. In the example above, a train would be considered to be unavailable if neither the normal component nor the spare component is aligned to the train.

Linthicum
3/3/12

Trains or Segments that Cannot Be Removed from Service

In some normally operating systems (e.g. Cooling Water Systems), there may exist trains or segments of the system that cannot physically be removed from service while the plant is operating at power for the following reasons:

- Directly causes a plant trip
- Procedures direct a plant trip
- Technical Specifications requires immediate shutdown (LCO 3.0.3)

These should be documented in the Basis Document and not included in unavailability monitoring.

F 1.2. Collection of Plant Data

Plant data for the UAI portion of the index includes:

- Actual train total unavailability (planned and unplanned) data for the most recent 12 quarter period collected on a quarterly basis,
- Plant ~~specific~~ **specific** baseline planned unavailability, and
- Generic baseline unplanned unavailability.

Linthicum
3/3/12

Each of these data inputs to UAI will be discussed in the following sections.

1 | **F 1.2.1. ACTUAL TRAIN/SEGMENT UNAVAILABILITY**

2 | The Consolidated Data Entry (CDE) inputs for this parameter are Train Planned Unavailable
3 | Hours and Train Unplanned Unavailable Hours. Critical hours are derived from reactor startup
4 | and shutdown occurrences. The actual calculation of Train Unavailability is performed by CDE.

5 |
6 | *Train/Segment Unavailability:* Train/Segment unavailability is the ratio of the hours the
7 | train/segment was unavailable to perform its monitored functions due to planned or unplanned
8 | maintenance or test during the previous 12 quarters while critical to the number of critical hours
9 | during the previous 12 quarters.

Linthicum
3/3/12

10 |
11 | *Train/Segment unavailable hours:* The hours the train/segment was not able to perform its
12 | monitored function while critical. Fault exposure hours are not included; unavailable hours are
13 | counted only for the time required to recover the train's/segment's monitored functions. In all
14 | cases, a train/segment that is considered to be OPERABLE is also considered to be available.

15 | **Trains/segments that are not OPERABLE must be returned to service in order to be considered**
16 | **available.** Unavailability must be by train/segment; do not use average unavailability for each
17 | train/segment because trains/segments may have unequal risk weights.

FAQ472
(09-08)

18 |
19 | **Return to Service:** Return to service is the transition from unavailable to available. A
20 | train/segment is "returned to service" when the following conditions are met: clearance tags have
21 | been removed, the train/segment has been aligned and prepared for operation, (e.g., valve line-up
22 | complete, system filled and vented), further adjustment of associated equipment is not required
23 | or expected as the result of the unavailability period, and operators concur that the train/segment
24 | is able to perform its expected functions. For standby equipment, automatic functions are
25 | aligned or can be promptly restored by an operator consistent with the requirements for crediting
26 | operator recovery stated later in this section.

FAQ472
(09-08)
Linthicum
3/3/12

27 |
28 | *Planned unavailable hours:* These hours include time a train or segment is removed from service
29 | for a reason other than equipment failure or human error. Examples of activities included in
30 | planned unavailable hours are preventive maintenance, testing, equipment modification, or any
31 | other time equipment is electively removed from service to correct a degraded condition that had
32 | not resulted in loss of function. ~~Based on the plant history of previous three years, planned~~
33 | ~~baseline hours for functional equipment that is electively removed from service but could not~~
34 | ~~be planned in advance can be estimated and the basis documented.~~ When used in the calculation
35 | of UAI, if the planned unavailable hours are less than the baseline planned unavailable hours, the
36 | planned unavailable hours will be set equal to the baseline value.

Linthicum
3/3/12

37 |
38 | *Unplanned unavailable hours:* These hours include elapsed time between the discovery and the
39 | restoration to service of an equipment failure or human error (such as a misalignment) that
40 | makes the train/segment unavailable. Time of discovery of a failed monitored component is
41 | when the licensee determines that a failure has occurred or when an evaluation determines that
42 | the train would not have been able to perform its monitored function(s). In any case where a
43 | monitored component has been declared inoperable due to a degraded condition, if the
44 | component is considered available, there must be a documented basis for that determination,
45 | otherwise a failure will be assumed and unplanned unavailability would accrue. If the component
46 | is degraded but considered operable, timeliness of completing additional evaluations would be

Linthicum
3/3/12

1 addressed through the inspection process. Unavailable hours to correct discovered conditions
2 that render a monitored ~~component-train/segment~~ incapable of performing its monitored function
3 are counted as unplanned unavailable hours. An example of this is a condition discovered by an
4 operator on rounds, such as an obvious oil leak, that was determined to have resulted in the
5 equipment being non-functional even though no demand or failure actually occurred.
6 Unavailability due to mis-positioning of components that renders a train incapable of performing
7 its monitored functions is included in unplanned unavailability for the time required to recover
8 the monitored function.

9
10 *No Cascading of Unavailability:* ~~The failure or unavailability of an SSC that is not within the~~
11 ~~boundary of the monitored MSPI~~**Error! Bookmark not defined.** ~~system that it supports does~~
12 ~~not cause the supported monitored system to accrue unavailability. Although such a failure or~~
13 ~~condition may require a monitored train or segment of the supported system to be declared~~
14 ~~inoperable, the monitored train or segment of the supported system would not accrue~~
15 ~~unavailability. If the monitored component of the supported system is rendered non-functional~~
16 ~~through tag out or physical plant conditions (other than as discussed below), then unavailable~~
17 ~~time should be accrued for the monitored train or segment of the supported system. Otherwise,~~
18 ~~unavailability is not accrued.~~

FAQ486
(10-06)

19
20 ~~Plants will sometimes disable the autostart of a supported monitored system when its support~~
21 ~~system is out of service. For example, a diesel generator may have the start function inhibited~~
22 ~~when the service water system that provides diesel generator cooling is removed from service.~~
23 ~~This is done for the purposes of equipment protection. This could be accomplished by putting a~~
24 ~~supported system's monitored ~~train/segment~~ component in "maintenance" mode or by pulling the~~
25 ~~control fuses of the supported component. If no maintenance is being performed on a component~~
26 ~~that's within a supported system's monitored train/segment, and the supported system's~~
27 ~~train/segment is only unavailable because of a monitored support system being out of service, no~~
28 ~~unavailability should be reported for the supported system's train/segment. If, however,~~
29 ~~maintenance is performed on the supported system's monitored train/segment, then the~~
30 ~~unavailability must be counted.~~

FAQ486
(10-06)
RRL
3/3/12

31
32 For example, if an Emergency Service Water train/segment (~~i.e., a monitored support system~~
33 ~~train/segment~~) is ~~under clearance~~unavailable, and the autostart of the associated High
34 Pressure Safety Injection (HPSI) pump (~~a monitored supported system~~) is disabled, there is no
35 unavailability to be reported for the HPSI pump; ~~however, the ESW train/segment does accrue~~
36 ~~unavailability.~~ If a maintenance task to collect a lube oil sample is performed ~~and it can be~~
37 ~~performed~~ with no additional tag out, no unavailability has to be reported for the HPSI pump. If
38 however, the sample required an additional tag out that would make the HPSI pump unavailable,
39 then the time that the additional tag out was in place must be reported as planned unavailable
40 hours for the HPSI pump.

FAQ486
(10-06)

41
42 Additional guidance on the following topics for counting train unavailable hours is provided
43 below.

- 44 • Short Duration Unavailability

- Credit for Operator Recovery Actions to Restore the Monitored Function

Short Duration Unavailability

Trains are generally considered to be available during periodic system or equipment realignments to swap components or flow paths as part of normal operations. Evolutions or surveillance tests that result in less than 15 minutes of unavailable hours per train/segment at a time need not be counted as unavailable hours. Licensees should compile a list of surveillances or evolutions that meet this criterion and have it available for inspector review. The intent is to minimize unnecessary burden of data collection, documentation, and verification because these short durations have insignificant risk impact.

Linthicum
3/3/12

Credit for Operator Recovery Actions to Restore the Monitored Functions

1. *During testing ~~or~~, operational alignment or return to service:*

Unavailability of a monitored function during testing, ~~or~~ operational alignment *or return to service* need not be included if the test or operational alignment configuration is automatically overridden by a valid starting signal, or the function can be promptly restored either by an operator in the control room or by a designated operator¹ stationed locally for that purpose. Restoration actions must be contained in a written procedure², must be uncomplicated (*a single action or a few simple actions*), must be capable of being restored in time to satisfy PRA success criteria, and must not require diagnosis or repair. Credit for a designated local operator can be taken only if ~~(s)he~~ *the operator* is positioned at the proper location throughout the duration of the test or operational alignment for the purpose of restoration of the train should a valid demand occur. The intent of this paragraph is to allow licensees to take credit for restoration actions that are virtually certain to be successful (i.e., probability nearly equal to 1) during accident conditions.

FAQ472
(09-08)

Slider

The individual performing the restoration function can be the person conducting the test or operational alignment and must be in communication with the control room. Credit can also be taken for an operator in the main control room provided ~~(s)he~~ *the operator* is in close proximity to restore the equipment when needed. Normal staffing for the test or operational alignment may satisfy the requirement for a ~~dedicated-designated~~ operator, depending on work assignments. In all cases, the staffing must be considered in advance and an operator identified to perform the restoration actions independent of other control room actions that may be required.

Slider

Linthicum
3/3/12

Under stressful, chaotic conditions, otherwise simple multiple actions may not be accomplished with the virtual certainty called for by the guidance (e.g., lifting test leads and landing wires; or clearing tags). In addition, some manual operations of systems designed to operate automatically, such as manually controlling HPCI turbine to establish and control injection flow, are not virtually certain to be successful. These situations should be resolved on a case-by-case basis through the FAQ process.

¹“Operator” in this circumstance refers to any plant personnel qualified and designated to perform the restoration function.

²Including restoration steps in an approved test procedure.

1
2 | 2. *During ~~Maintenance~~ maintenance*

3
4 Unavailability of a monitored function during maintenance need not be included if the
5 monitored function can be promptly restored either by an operator in the control room or by a
6 | designated operator (*see footnote 1 below*) stationed locally for that purpose. Restoration
7 actions must be contained in an approved procedure, must be uncomplicated (*a single*
8 | *action or a few simple actions*), must be capable of being restored in time to satisfy PRA
9 success criteria and must not require diagnosis or repair. Credit for a designated local
10 | operator can be taken only if ~~(s)he~~ *the operator* is positioned at a proper location throughout
11 the duration of the maintenance activity for the purpose of restoration of the train should a
12 valid demand occur. The intent of this paragraph is to allow licensees to take credit for
13 restoration of monitored functions that are virtually certain to be successful (i.e., probability
14 nearly equal to 1).

Linthicum
3/3/12

15
16 The individual performing the restoration function can be the person performing the
17 maintenance and must be in communication with the control room. Credit can also be taken
18 | for an operator in the main control room provided ~~(s)he~~ *the operator* is in close proximity to
19 restore the equipment when needed. Normal staffing for the maintenance activity may
20 | satisfy the requirement for a ~~dedicated-designated~~ *'* operator, depending on work
21 assignments. In all cases, the staffing must be considered in advance and an operator
22 identified to perform the restoration actions independent of other control room actions that
23 may be required.

Linthicum
3/3/12

24
25 Under stressful chaotic conditions otherwise simple multiple actions may not be
26 accomplished with the virtual certainty called for by the guidance (e.g., lifting test leads and
27 landing wires, or clearing tags). These situations should be resolved on a case-by-case basis
28 through the FAQ process.

29
30 | 3. *During degraded conditions*

31 In accordance with current regulatory guidance, licensees may credit limited operator actions
32 to determine that degraded equipment remains operable in accordance with Technical
33 | Specifications. If a train/~~segment~~ is determined to be operable, then it is also available.
34 Beyond this, no credit is allowed for operator actions during degraded conditions that render
35 | the train/~~segment~~ unavailable to perform its monitored functions.

Linthicum
3/3/12

36
37 Counting Unavailability when Planned and Unplanned Maintenance are Performed in the Same
38 Work Window

39
40 All maintenance performed in the work window should be classified with the classification for
41 which the work window was entered. For example, if the initial work window was caused by
42 unplanned maintenance then the duration of the entire work window would be classified as
43 unplanned even if some additional planned maintenance were added that extended the work
44 window. Another example is if a planned maintenance work window results in adding additional
45 unplanned work due to a discovered condition during the maintenance, the entire work window

Linthicum
3/3/12

1 duration would be classified as planned maintenance. ~~If, however, maintenance is performed on~~
2 ~~the monitored component, then the unavailability must be counted.~~

3
4 ~~For example, if an Emergency Service Water train/segment is under clearance, and the autostart~~
5 ~~of the associated High Pressure Safety Injection (HPSI) pump is disabled, there is no~~
6 ~~unavailability to be reported for the HPSI pump. If a maintenance task to collect a lube oil~~
7 ~~sample is performed and it can be performed with no additional tag out, no unavailability has to~~
8 ~~be reported for the HPSI pump. If however, the sample required an additional tag out that would~~
9 ~~make the HPSI pump unavailable, then the time that the additional tag out was in place must be~~
10 ~~reported as planned unavailable hours for the HPSI pump.~~

11
12 **F 1.2.2. ~~PLANT-PLANT-SPECIFIC~~ BASELINE PLANNED UNAVAILABILITY**

13 The initial baseline planned unavailability is based on actual plant-specific values for the period
14 2002 through 2004. (~~Plant-specific-specific~~ values of the most recent data are used so that the
15 indicator accurately reflects deviation from expected planned maintenance.) These values ~~are~~
16 ~~expected to~~ may change if the plant maintenance philosophy is substantially changed with
17 respect to on-line maintenance or preventive maintenance. In these cases, the planned
18 unavailability baseline value should be adjusted to reflect the current maintenance practices,
19 including low frequency maintenance evolutions.

Linthicum
3/3/2012

20
21 ~~Prior to implementation of an adjustment to the planned unavailability baseline value, the~~
22 ~~impact of the adjusted values on all MSPI PRA inputs should be assessed. A change to the~~
23 ~~PRA model and associated changes to the MSPI PRA inputs values is required prior to~~
24 ~~changing the baseline unavailability if $\Delta CDF > 1E-8$, where:~~

FAQ468
(09-07)

25
$$\Delta CDF_{\text{baseline}} = \sum(\Delta UA_i * \text{Birnbau}m_i)$$

26
$$\Delta UA_i = UA_{\text{current}} - UA_{\text{baseline}} \text{ for segment } i$$

27
$$UA_{\text{current}} = \text{proposed unavailability (expressed as a probability) to be used as the new}$$

28
$$\text{baseline}$$

29
$$UA_{\text{baseline}} = \text{the base unavailability (expressed as a probability) for 2002 – 2004}$$

30
$$\text{Birnbau}m_i = \text{Birnbau}m \text{ value of segment } i$$

31
32 The following changes are considered a “change in plant maintenance philosophy:”

- 33
- 34 • A change in frequency or scope of a current preventative maintenance activity or
surveillance test.
 - 35 • The addition of a new preventative maintenance activity or surveillance test.
 - 36 • The occurrence of a periodic maintenance activity at a higher or lower frequency during a
37 three year data window (e.g., a maintenance overhaul that occurs once every 24 months
38 will occur twice two-thirds of the time and once one-third of the time). If the
39 unavailability hours required for the additional maintenance activity are included in the
40 PRA modeled unavailability, the baseline unavailability can be changed without further
41 assessment.

FAQ468
(09-07)

- Planned maintenance activities that occur less than once every three years (e.g., five- or 10-year overhauls). If the unavailability hours required for the additional maintenance activity are included in the PRA-modeled unavailability, the baseline unavailability can be changed without further assessment.
- The performance of maintenance in response to a condition-based preventive maintenance activity.
- Performance of an on-line modification that has been determined to be consistent with the unavailability values contained in the PRA in that the PRA includes unavailability hours for the proposed modification, and current maintenance and testing programs; and the hours in the MSPI UA baseline do not reflect this total unavailability.

The following changes are **not** considered a “change in plant maintenance philosophy:”

- The performance of maintenance in response to a degraded condition (even when it is taken out of service to address the degraded condition) unless this action is in response to a condition-based preventive maintenance activity.
- Planned maintenance activity that exceeds its planned duration.
- The performance of an online modification that does not meet the change in plant maintenance philosophy online modification criterion.

Note: Condition-based maintenance consists of periodic preventive maintenance tasks or online monitoring of the health or condition of a component (e.g., vibration analysis, oil analysis, MOVAT) and predefined acceptance criteria where corrective action is to be taken on exceeding these criteria. Condition-based maintenance does not include discovery of a degraded condition as a result of actions that are outside of the maintenance programs.

Some significant maintenance evolutions, such as EDG overhauls, are performed at an interval greater than the three year monitoring period (5 or 10 year intervals). The baseline planned unavailability should be revised as necessary in the basis document during the quarter prior to the planned maintenance evolution and then removed after twelve quarters. A comment should be placed in the comment field of the quarterly report to identify a substantial change in planned unavailability. The comments automatically generated by CDE when PRA coefficients are changed do not fulfill this requirement. The plant must generate a plant-specific comment that describes what was changed. The baseline value of planned unavailability is changed at the discretion of the licensee to ensure the baseline is consistent with the current maintenance philosophy of the plant. Revised values will be used in the calculation the quarter following the basis document revision.

To determine the initial value of planned unavailability:

- 1) Record the total train unavailable hours reported under the Reactor Oversight Process for 2002-2004.
- 2) Subtract any fault exposure hours still included in the 2002-2004 period.
- 3) Subtract unplanned unavailable hours.

- 1 4) Add any on-line overhaul hours¹ and any other planned unavailability previously excluded
- 2 under SSU in accordance with NEI 99-02, but not excluded under the MSPI. Short duration
- 3 unavailability, for example, would not be added back in because it is excluded under both
- 4 SSU and MSPI.
- 5 5) Add any planned unavailable hours for functions monitored under MSPI which were not
- 6 monitored under SSU in NEI 99-02.
- 7 6) Subtract any unavailable hours reported when the reactor was not critical.
- 8 7) Subtract hours cascaded onto monitored systems by support systems. (However, do not
- 9 subtract any hours already subtracted in the above steps.)
- 10 8) Divide the hours derived from steps 1-7 above by the total critical hours during 2002-2004.
- 11 This is the baseline planned unavailability.

12 Support cooling planned unavailability baseline data is based on plant-specific-specific
 13 maintenance rule unavailability for years 2002-2004. Maintenance Rule practices do not
 14 typically differentiate planned from unplanned unavailability. However, best efforts will be made
 15 to differentiate planned and unplanned unavailability during this time period.

16
 17 ~~If maintenance practices at a plant have changed since the baseline years (e.g. increased~~
 18 ~~planned online maintenance due to extended AOTs), then the baseline values should be~~
 19 ~~adjusted to reflect the current maintenance practices and the basis for the adjustment~~
 20 ~~documented in the plant's MSPI Basis Document.~~

Linthicum
3/3/2012

22 F 1.2.3. GENERIC BASELINE UNPLANNED UNAVAILABILITY

23 The unplanned unavailability values are contained in Table 1 and remain fixed. They are based
 24 on ROP PI industry data from 1999 through 2001. (Most baseline data used in PIs come from
 25 the 1995-1997 time period. However, in this case, the 1999-2001 ROP data are preferable,
 26 because the ROP data breaks out systems separately. Some of the industry 1995-1997 INPO data
 27 combine systems, such as HPCI and RCIC, and do not include PWR RHR. It is important to
 28 note that the data for the two periods is very similar.)

30 **Table 1. Historical Unplanned Unavailability Train Values**
 31 **(Based on ROP Industry-wide Data for 1999 through 2001)**

SYSTEM	UNPLANNED UNAVAILABILITY/TRAIN
EAC *	1.7 E-03
PWR HPSI	6.1 E-04
PWR AFW (TD)	9.1 E-04
PWR AFW (MD)	6.9 E-04
PWR AFW (DieselD)	7.6 E-04
PWR (except CE) RHR	4.2 E-04
CE RHR	1.1 E-03
BWR HPCI**	3.3 E-03
BWR HPCS	5.4 E-04
BWR FWCI	Use plant-specific Maintenance Rule data for 2002-2004

¹ Note: The plant-specific PRA should model significant on-line overhaul hours.

SYSTEM	UNPLANNED UNAVAILABILITY/TRAIN
BWR RCIC	2.9 E-03
BWR IC	1.4E-03
BWR RHR	1.2 E-03
Support Cooling	Use plant-specific Maintenance Rule data for 2002-2004

- 1 * Oconee to use EAC plant-specific Maintenance Rule data for 2002-2004
 2 ** Oyster Creek to use Core Spray plant-specific Maintenance Rule data for
 3 2002-2004
 4

5 Generic Baseline Unplanned Unavailability for Front Line systems divided into segments for
 6 unavailability monitoring

7 If a front line system is divided into segments rather than trains, the following approach is
 8 followed for determining the generic unplanned unavailability:

- 9 1. Determine the number of trains used for SSU unavailability reporting that was in use
 10 prior to MSPI.
 11 2. Multiply the appropriate value from Table 1 by the number of trains determined in (1).
 12 3. Take the result and distribute it among the MSPI segments, such that the sum is equal to
 13 (2) for the whole MSPI system.
 14

15 Unplanned unavailability baseline data for the support cooling systems should be developed
 16 from plant-specific Maintenance Rule data from the period 2002-2004. Maintenance
 17 Rule practices do not typically differentiate planned from unplanned unavailability. However,
 18 best efforts will be made to differentiate planned and unplanned unavailability during this time
 19 period. NOTE: The sum of planned and unplanned unavailability cannot exceed the total
 20 unavailability.
 21

22 **F 1.3. CALCULATION OF UAI**

23 The specific formula for the calculation of UAI is provided in this section. Each term in the
 24 formula will be defined individually and specific guidance provided for the calculation of each
 25 term in the equation. Required inputs to the INPO Consolidated Data Entry (CDE) System will
 26 be identified.
 27

28 Calculation of System UAI due to train/segment unavailability is as follows:

Linthicum
3/3/2012

$$29 \quad UAI = \sum_{j=1}^n UAI_{tj} \quad \text{Eq. 1}$$

30 where the summation is over the number of trains/segments (n) and UAI_t is the unavailability
 31 index for a train/segment.

32 Calculation of UAI_t for each train/segment due to actual train/segment unavailability is as
 33 follows:

$$UA_{It} = CDF_p \left[\frac{FV_{UA_p}}{UA_p} \right]_{\max} (UA_t - U_{ABL_t}) \quad \text{Eq. 2}$$

where:

CDF_p is the plant-specific Core Damage Frequency,

FV_{UA_p} is the train/segment-specific Fussell-Vesely value for unavailability,

UA_p is the plant-specific PRA value of unavailability for the train/segment,

UA_t is the actual unavailability of train/segment t, defined as:

$$UA_t = \frac{\text{Unavailable hours (planned and unplanned) during the previous 12 quarters while critical}}{\text{Critical hours during the previous 12 quarters}}$$

and, determined in section 1.2.1

U_{ABL_t} is the historical baseline unavailability value for the train/segment (sum of planned unavailability determined in section 1.2.2 and unplanned unavailability in section 1.2.3)

A method for calculation of the quantities in equation 2 from importance measures calculated using cutsets from an existing PRA solution is discussed in sections F 1.3.1 through F 1.3.3.

An alternate approach, based on re-quantification of the PRA model, and calculation of the importance measures from first principles is also an acceptable method. Guidance on this alternate method is contained in section F6 of this appendix. A plant using this alternate approach should use the guidance in section F6 and skip sections F 1.3.1 through F 1.3.3.

F 1.3.1. TRUNCATION LEVELS

The values of importance measures calculated using an existing cutset solution are influenced by the truncation level of the solution. The truncation level chosen for the solution should be 7 orders of magnitude less than the baseline CDF for the alternative defined in sections F 1.3.2 and F 1.3.3.

As an alternative to using this truncation level, the following sensitivity study may be performed to establish the acceptability of a higher (e.g. 6 orders of magnitude) truncation level.

1. Solve the model at the truncation level you intend to use (e.g. 6 orders of magnitude below the baseline CDF).
2. Identify the limiting Birnbaum value for each train/component (this is the case 1 value).
3. Solve the model again with a truncation 10 times larger (e.g. 5 orders of magnitude below the baseline CDF).
4. Identify the limiting Birnbaum value for each train/component (this is the case 2 value. For each component with Birnbaum-case 1 greater than 1.0E-06 calculate the ratio [(Birnbaum-case 2)/(Birnbaum-case 1)].
5. If the value for the calculated ratio is greater than 0.8 for all components with Birnbaum-case 1 value greater than 1.0E-06, then the case 1 truncation level may be used for this analysis.

Linthicum
3/3/2012

Linthicum
3/3/2012

Linthicum
3/3/12

1
2 This process may need to be repeated several times with successively lower truncation levels to
3 achieve acceptable results.

5 **F 1.3.2. CALCULATION OF CORE DAMAGE FREQUENCY (CDFP)**

6 The Core Damage Frequency is a CDE input value. The required value is the internal events,
7 average maintenance, at power value. Internal flooding and **external events, including**
8 **internal** fire are not included in this calculated value. ~~In general, a~~All inputs to this indicator
9 from the PRA are calculated from the internal events model only.

Linthicum
3/3/2012

11 **F 1.3.3. CALCULATION OF [FV/UA]MAX FOR EACH TRAIN**

12 FV and UA are separate CDE **Error! Bookmark not defined.** input values. Equation 2 includes
13 a term that is the ratio of a Fussell-Vesely importance value divided by the related
14 unavailability or probability. This ratio is calculated for each train/**segment** in the system and
15 both the FV and UA are CDE inputs. (It may be recognized that the quantity [FV/UA]
16 multiplied by the CDF is the Birnbaum importance measure, which is used in section 2.3.3.)

Linthicum
3/3/2012

18 Calculation of these quantities is generally complex, but in the specific application used here, can
19 be greatly simplified.

21 The simplifying feature of this application is that only those components (or the associated
22 basic events) that can make a train unavailable are considered in the performance index. **A**
23 **simplifying assumption is made that** ~~Components-components~~ within a train that can each
24 make the train unavailable are logically equivalent and the ratio FV/UA is a constant value for
25 any basic event in that train. It can also be shown that for a given component or train represented
26 by multiple basic events, the ratio of the two values for the component or train is equal to the
27 ratio of values for any basic event within the train. Or:

Linthicum
3/3/2012

$$28 \quad \frac{FV_{be}}{UA_{be}} = \frac{FV_{Up}}{UA_{p}} = \text{Constant}$$

29 Thus, the process for determining the value of this ratio for any train/**segment** is to identify a
30 basic event that fails the train, determine the probability for the event, determine the associated
31 FV value for the event and then calculate the ratio.

Linthicum
3/3/2012

33 The set of basic events to be considered for use in this section will obviously include any test
34 and maintenance (T&M) events applicable to the train/**segment** under consideration. Basic
35 events that represent failure on demand that are logically equivalent to the test and maintenance
36 events should also be considered. (Note that many PRAs use logic that does not allow T&M
37 events for multiple trains to appear in the same cutset because this condition is prohibited by
38 Technical specifications. For PRAs that use this approach, failure on demand events will not be
39 logically equivalent to the T&M events, and only the T&M events should be considered.)

Linthicum
3/3/2012

40 Failure to run events **and valve transfer open/close events** should **not** be considered as they are
41 often not logically equivalent to test and maintenance events. Use the basic event from this set
42 that results in the largest ratio (hence the maximum notation on the bracket) to minimize the
43 effects of truncation on the calculation. **If all events for the train/segment have been truncated,**
44 **either a lower truncation value or the method provided in section F.6 should be used.**

Linthicum
3/3/2012

1
2 Some systems have multiple modes of operation, such as PWR HPSI systems that operate in
3 injection as well as recirculation modes. In these systems all monitored components are not
4 logically equivalent; unavailability of the pump ~~fails-may fail~~ all operating modes while
5 unavailability of the sump suction valves ~~only fails-may only fail~~ the recirculation mode. In
6 cases such as these, if unavailability events exist separately for the components within a train,
7 the appropriate ratio to use is the maximum.
8

Linthicum
3/3/2012

Linthicum
3/3/2012

9 **F 1.3.4. CORRECTIONS TO FV/UA RATIO**

10 Treatment of PRA Modeling Asymmetries

11 In systems with rotated normally running pumps (e. g. cooling water systems), the
12 **PRAError! Bookmark not defined.** models may assume one pump is always ~~the~~ running
13 and another is in standby. For example, a service water system may have two 100% capacity
14 pumps in one train, an A and B pump. In practice the A and B pumps are rotated and each one is
15 the running pump 50% of the time. In the PRA model however, the A pump is assumed to be
16 always running and the B pump is always ~~in~~ assumed to be in standby. This will result in one
17 pump appearing to be more important than the other when they are, in fact, of equal importance.
18 This asymmetry in importance is driven by the assumption in the PRA, not the design of the
19 plant.
20

Linthicum
3/3/2012

21
22 In the case where the system is known to be symmetric in importance, for calculation of UAI, the
23 importance measures for each train, or segment, should be averaged and the average applied to
24 each train or segment. Care should be taken when applying this method to be sure the system is
25 actually symmetric.
26

27 If the system is not symmetric and the capability exists to specify a specific alignment in the
28 **PRAError! Bookmark not defined.** model, the model should be solved in each specific
29 alignment and the importance measures for the different alignments combined by a weighted
30 average based on the estimated time each specific alignment is used in the plant.
31

32 Cooling Water and Service Water System [FV/UA]max Values

33 Component Cooling Water Systems (CCW) and Service Water Systems (SWS) at some nuclear
34 stations contribute to risk in two ways. First, the systems provide cooling to equipment used for
35 the mitigation of events and second, the failures (and unavailability) in the systems may also
36 result in the initiation of an event. The contribution to risk from failures to provide cooling to
37 other plant equipment is modeled directly through dependencies in the PRA model. ~~The~~
38 ~~contribution to risk from failures to provide cooling to other plant equipment is modeled~~
39 ~~directly through dependencies in the PRA model.~~ However, the contribution due to event
40 initiation is treated in four general ways in current PRAs:
41

Linthicum
3/3/2012

- 42 1) The use of linked initiating event fault trees for these systems with the same basic event
43 names used in the initiator and mitigation trees.
- 44 2) The use of linked initiating event fault trees for these systems with different basic event
45 names used in the initiator and mitigation trees.

- 1 3) Fault tree solutions are generated for these systems external to the PRA and the calculated
2 value is used in the PRA as a point estimate
- 3 4) A point estimate value is generated for the initiator using industry and plant-specific-specific
4 event data and used in the PRA. **Error! Bookmark not defined.**

5 Each of these methods is discussed below.

6
7 *Modeling Method 1*

8 If a PRA uses the first modeling option, then the FV values calculated will reflect the total
9 contribution to risk for a component in the system. No additional correction to the FV values is
10 required.

11
12 *Modeling Methods 2 and 3*

13 The corrected ratio may be calculated as described for modeling method 4 or by the method
14 described below.

15
16 If a linked initiating event fault tree with different basic events used in the initiator and
17 mitigation trees is the modeling approach taken, or fault tree solutions are generated for these
18 systems external to the PRA and the calculated value is used in the PRA as a point estimate, then
19 the corrected ratio is given by:

20
$$[FV/UA]_{corr} = \left[\frac{FVc}{UAc} + \sum_{m=1}^i \left\{ \frac{IE_{m,n}(1) - IE_{m,n}(0)}{IE_{m,n}(q_n)} * FVie_m \right\} \right].$$

21
22 In this expression the summation is taken over all system initiators i that involve component n ,
23 where

24 FVc is the Fussell-Vesely for component C as calculated from the PRA Model. This does
25 not include any contribution from initiating events,

26 UAc is the basic event probability used in computing FVc ; i.e. in the system response
27 models,

28 $IE_{m,n}(q_n)$ is the system initiator frequency of initiating event m when the component n
29 unreliability basic event is q_n . The event chosen in the initiator tree should represent the
30 same failure mode for the component as the event chosen for UAc ,

31 $IE_{m,n}(1)$ is as above but $q_n=1$,

32 $IE_{m,n}(0)$ is as above but $q_n=0$

33 and

34 $FVie_m$ is the Fussell-Vesely importance contribution for the initiating event m to the
35 CDF.

36 Since FV and UA are separate CDE inputs, use UAc and calculate FV from

37
$$FV = UAc * [FV/UA]_{corr}$$

38
39 *Modeling Method 4*

40 If a point estimate value is generated for the initiator using industry and plant-specific-specific
41 event data and used in the PRA, then the corrected $[FV/UA]_{MAX}$ for a component C is calculated
42 from the expression:

43
$$[FV/UA]_{MAX} = [(FVc + FVie * FVsc) / UAc]$$

1
2
3
4
5
6
7
8
9
10
11
12
13
14
15
16
17
18
19

Where:

FV_c is the Fussell-Vesely for CDF for component C as calculated from the PRA Model. This does not include any contribution from initiating events.

FV_{ie} is the Fussell-Vesely contribution for the initiating event in question (e.g. loss of service water).

FV_{sc} is the Fussell-Vesely **within the system fault tree only** for component C (i.e. the ratio of the sum of the cut sets in the fault tree solution in which that component appears to the overall system failure probability). Note that this may require the construction of a “satellite” system fault tree to arrive at an exact or approximate value for FV_{sc} depending on the support system fault tree logic.

UAc is the basic event probability used in computing FV_c , i.e., in the system response models.

Linthicum
3/3/2012

FV and UA are separate CDEError! **Bookmark not defined.** input values.

1 **F 2. SYSTEM UNRELIABILITY INDEX (URI) DUE TO COMPONENT**
2 **UNRELIABILITY**

3
4 Calculation of the URI is performed in three major steps:

- 5 • Identification of the monitored components for each system,
- 6 • Collection of plant data, and
- 7 • Calculation of the URI.

8 Only the most risk significant components in each system are monitored to minimize the burden
9 for each utility. It is expected that most, if not all the components identified for monitoring are
10 already being monitored for failure reporting to INPO and are also monitored in accordance with
11 the maintenance rule.

12
13 **F 2.1. IDENTIFY MONITORED COMPONENTS**

14 *Monitored Component:* A component whose failure to change state or remain running renders
15 the train incapable of performing its monitored functions. In addition, all pumps and diesels in
16 the monitored systems are included as monitored components.

17
18 The identification of monitored components involves the use of the system boundaries and
19 success criteria, identification of the components to be monitored within the system boundary
20 and the scope definition for each component. Note that the system boundary defined in section
21 1.1.1 defines the scope of equipment monitored for unavailability. Only selected components
22 within this boundary are chosen for unreliability monitoring. The first step in identifying these
23 selected components is to identify the system success criteria.

24
25 **F 2.1.1. SUCCESS CRITERIA**

26 The system boundaries and monitored functions developed in section F 1.1.1 should be used to
27 complete the steps in the following section.

28
29 For each system, the monitored functions shall be identified. Success criteria used in the PRA
30 shall then be identified for these functions.

31
32 ~~If the licensee has chosen to use success criteria documented in the plant specific-specific~~
33 ~~PRA that are different from design basis success criteria, examples of plant specific-specific~~
34 ~~performance factors that should be used to identify the required capability of the train/system~~
35 ~~to meet the monitored functions are provided below.~~

- 36
37 ~~• Actuation~~
 - 38 ~~○ Time~~
 - 39 ~~○ Auto/manual~~
 - 40 ~~○ Multiple or sequential~~
- 41 ~~• Success requirements~~
 - 42 ~~○ Numbers of components or trains~~

Linthicum
3/3/2012

- 1 ~~○ Flows~~
- 2 ~~○ Pressures~~
- 3 ~~○ Heat exchange rates~~
- 4 ~~○ Temperatures~~
- 5 ~~○ Tank water level~~
- 6 ● ~~Other mission requirements~~
- 7 ~~○ Run time~~
- 8 ~~○ State/configuration changes during mission~~
- 9 ● ~~Accident environment from internal events~~
- 10 ~~○ Pressure, temperature, humidity~~
- 11 ● ~~Operational factors~~
- 12 ~~○ Procedures~~
- 13 ~~○ Human actions~~
- 14 ~~○ Training~~
- 15 ~~○ Available externalities (e.g., power supplies, special equipment, etc.)~~

17 If the licensee has chosen to use design basis success criteria in the PRA, it is not required to
18 separately document them other than to indicate that is what was used. If success criteria from
19 the PRA are different from the design basis, then the specific differences from the design basis
20 success criteria shall be documented in the basis document.

Linthicum
3/3/2012

21 If success criteria for a system vary by function or initiator, the most restrictive set will be used
22 for the MSPI. Success criteria related to ATWS need not be considered.

23 PRA **Error! Bookmark not defined.** analyses (e.g. operator action timing requirements) are
24 sometimes based on thermal-hydraulic calculations that account for the best estimate physical
25 capability of a system. These calculations should not be confused with calculations that are
26 intended to establish system success criteria. For example a pump's flow input for PRA thermal-
27 hydraulic calculations may be based on its actual pump curve showing 12,000 gpm at runout
28 while the design basis minimum flow for the pump is 10,000 gpm. The 10,000 gpm value should
29 be used for determination of success or failure of the pump for this indicator. This prevents the
30 scenario of a component or system being operable per Technical Specifications and design basis
31 requirements but unavailable or failed under this indicator.

32 ~~If the licensee has chosen to use design basis success criteria in the PRA, it is not required to~~
33 ~~separately document them other than to indicate that is what was used. If success criteria from~~
34 ~~the PRA are different from the design basis, then the specific differences from the design basis~~
35 ~~success criteria shall be documented in the basis document.~~

Linthicum
3/3/2012

36 ~~If success criteria for a system vary by function or initiator, the most restrictive set will be used~~
37 ~~for the MSPI. Success criteria related to ATWS need not be considered.~~

38 Examples of plant-specific performance factors that should be used to identify the required
39 capability of the train/system to meet the monitored functions are provided below.

Linthicum
3/3/2012

- 41 ● Actuation
- 42 ○ Time
- 43 ○ Auto/manual

Linthicum
3/3/2012

- 1 ○ Multiple or sequential
- 2 ● Success requirements
- 3 ○ Numbers of components or trains
- 4 ○ Flows
- 5 ○ Pressures
- 6 ○ Heat exchange rates
- 7 ○ Temperatures
- 8 ○ Tank water level
- 9 ● Other mission requirements
- 10 ○ Run time
- 11 ○ State/configuration changes during mission
- 12 ● Accident environment from internal events
- 13 ○ Pressure, temperature, humidity
- 14 ● Operational factors
- 15 ○ Procedures
- 16 ○ Human actions
- 17 ○ Training
- 18 ○ Available externalities (e.g., power supplies, special equipment, etc.)

19

20 F 2.1.2. SELECTION OF COMPONENTS

21 For unreliability, use the following process for determining those components that should be
22 monitored. These steps should be applied in the order listed.

23

- 24 1) INCLUDE all pumps (except EDG fuel oil transfer pumps, which are part of the EDG
25 super-component) and emergency power generators/diesels.
- 26 2) Identify all AOVs, SOVs, HOVs and MOVs that change state to achieve the monitored
27 functions for the system as potential monitored components. Solenoid and Hydraulic valves
28 identified for potential monitoring are only those in the process flow path of a fluid system.
29 Solenoid valves that provide air to AOVs are considered part of the AOV. Hydraulic valves
30 that are control valves for turbine driven pumps are considered part of the pump and are not
31 monitored separately. Check valves and manual valves are not included in the index.

FAQ484
(11-07)
Linthicum
3/3/12

- 32 a. INCLUDE those valves from the list of valves from step 2 whose failure alone can
33 fail a train/segment. The success criteria used to identify these valves are those
34 identified in the previous section. (See Figure F-5)
- 35 b. INCLUDE redundant valves from the list of valves from step 2 within a multi-train
36 system, whether in series or parallel, where the failure of both valves would prevent
37 all trains/segments in the system from performing a monitored function. The success
38 criteria used to identify these valves are those identified in the previous section.(See
39 Figure F-5)

Linthicum
3/3/12

Linthicum
3/3/12

- 40 3) INCLUDE components that cross tie monitored systems between units (i.e. Electrical
41 Breakers and Valves) if they are modeled in the PRA.
- 42 4) EXCLUDE those valves and breakers from steps 2 and 3 above whose Birnbaum importance,
43 (See section F 2.3.5) as calculated in this appendix (including adjustment for support system

1 initiator, if applicable, and common cause), is less than 1.0E-06. This rule is applied at the
2 discretion of the individual plant. A balance should be considered in applying this rule
3 between the goal to minimize the number of components monitored and having a large
4 enough set of components to have an adequate data pool. If a decision is made to exclude
5 some valves based on low Birnbaum values, but not all, to ensure an adequate data pool, then
6 the valves eliminated from monitoring shall be those with the smallest Birnbaum values.
7 Symmetric valves in different trains should be all eliminated or all retained.

8 **F 2.1.3. DEFINITION OF COMPONENT BOUNDARIES**

9 Table 2 defines the boundaries of components, and Figures F-1, F-2, F-3 and F-4 provide
10 examples of typical component boundaries as described in Table 2.

11 **Table 2. Component Boundary Definition**

Component	Component boundary
Diesel Generators	The diesel generator boundary includes the generator body, generator actuator, lubrication system (local), fuel system (local), fuel oil transfer pumps/valves, ¹ cooling components (local), startup air system receiver, exhaust and combustion air system, dedicated diesel battery (which is not part of the normal DC distribution system), individual diesel generator control system, cooling water isolation valves, circuit breaker for supply to safeguard buses and their associated control circuit (relay contacts for normally auto actuated components, control board switches for normally operator actuated components*).
Motor-Driven Pumps	The pump boundary includes the pump body, motor/actuator, lubrication system, cooling components of the pump seals, the voltage supply breaker, and its associated control circuit (relay contacts for normally auto actuated components, control board switches for normally operator actuated components*).
Turbine-Driven Pumps	The turbine-driven pump boundary includes the pump body, turbine/actuator, lubrication system (including pump), extractions, turbo-pump seal, cooling components, and associated control system (relay contacts for normally auto actuated components, control board switches for normally operator actuated components*) including the control valve.
Motor-Operated Valves	The valve boundary includes the valve body, motor/actuator, the voltage supply breaker (both motive and control power) and its associated control circuit (relay contacts for normally auto actuated components, control board switches for normally operator actuated components*).
Solenoid Operated Valves	The valve boundary includes the valve body, the operator, the supply breaker (both power and control) or fuse and its associated control circuit (relay contacts for normally auto actuated components, control board switches for normally operator actuated components*).
Hydraulic Operated Valves	The valve boundary includes the valve body, the hydraulic operator, associated local hydraulic system, associated solenoid operated valves, the power supply breaker or fuse for the solenoid valve, and its associated control circuit (relay contacts for normally auto actuated components, control board switches for normally operator actuated components*).
Air-Operated Valves	The valve boundary includes the valve body, the air operator, associated solenoid-operated valve, the power supply breaker or fuse for the solenoid valve, and its associated control circuit (relay contacts for normally auto actuated components, control board switches for normally operator actuated components*).
<i>*Note: If the control circuit for any normally auto actuated component includes the control board switch and a failure of the control board switch prevents auto actuation of the component, it is considered to be a failure of the control circuit within the component boundary.</i>	

FAQ484
(11-07)

14 For control and motive power, supporting components as described in INPO 98-01 should be
15 included in the monitored component boundary. In other words, if the relay, breaker or contactor
16 exists solely to support the operation of the monitored component, it should be considered part of
17 the component boundary. If a relay, breaker or contactor supports multiple components, it
18

¹ The word “valves” is included here for plants with a gravity-fed fuel oil transfer system. For these designs, the valve serves the function fulfilled by the FOTP in pump-fed designs.

1 should not be considered as part of the monitored component boundary. If a relay/switch
2 supports operation of several monitored components, failure of relay/switch would not be
3 considered an MSPI failure. However, failure of individual contacts on the relay/switch, which
4 each support a single monitored component, would be considered a failure of the monitored
5 component.

6
7 Example 1: If a limit switch in an MOV fails to make-up, which fails an interlock and prevents a
8 monitored pump from starting, and the limit switch has no other function, a failure to start should
9 be assigned to the pump. If the limit switch prevents both the pump and another monitored valve
10 from functioning, no MPSI failures would be assigned.

11
12 Example 2: If a relay prevents an MOV from closing and the relay performs no other function,
13 an MOV failure would be assigned, assuming failure to close is a monitored function of the
14 valve. If the MOV also has a limit switch interlocked with another monitored component, the
15 presence of the limit switch should not be interpreted as the relay having multiple functions to
16 preclude assigning a failure. If, in addition to the relay failure, there were a separate failure of
17 the limit switch, both an MOV and pump failure would be assigned.

18
19 Example 3: If a relay/switch supports operation of several monitored components, failure of
20 relay/switch would not be considered an MSPI failure. However, failure of individual contacts
21 on the relay, which each support a single monitored component, would be considered a failure of
22 the monitored component.

23
24 If a system is designed to auto start, and a control circuit failure results in the monitored
25 component not **being capable of** auto starting (whatever component actually fails) it is a failure
26 to start. If a system is designed to auto start, and a manual start fails, it is not an MSPI failure
27 unless the auto start feature would also have been affected (discovered condition). Control
28 switches (either in the control room or local) that provide the primary means for actuating a
29 component are monitored as part of the component it actuates.

Linthicum
3/3/12

30
31 Each plant will determine its monitored components and have them available for NRC
32 inspection.

33 34 **F 2.2. COLLECTION OF PLANT DATA**

35 Plant data for the URI includes:

- 36 • Demands and run hours
- 37 • Failures

38 39 **F 2.2.1. DEMANDS AND RUN HOURS**

40 There are two methods that can be used to calculate the number of demands and run hours for
41 use in the URI. These two methods are use of actual demands and run hours and estimated
42 demands and run hours. Best judgment should be used to define each category of demands. But
43 strict segregation of demands between each category is not as important as the validity of total
44 number of demands **and run hours**.

Linthicum
3/3/12

1
2 For MSPI monitored components, the duty cycle (demand or run hour) categories shown in
3 Table 3 are reported to CDE to support the URI derivation.
4

5 **Table 3. Required Duty Cycle Categories by Component Type**
6

Component Type	Duty Cycle Categories Required
All valves and circuit breakers	Demands
All pumps	Demands Run Hours
All Emergency Power Generators (both diesel and hydro electric)	Start Demands Load Run Demands Run Hours

7 Demands (including start demands for the emergency power generators) are defined as any
8 requirements for the component to successfully start (pumps and emergency power generators)
9 or open or close (valves and circuit breakers). Exclude post maintenance test demands, unless in
10 case of a failure, the cause of the failure was independent of the maintenance performed. In this
11 case the demand may be counted as well as the failure. Post maintenance tests are tests
12 performed following maintenance but prior to declaring the train/component operable, consistent
13 with Maintenance Rule implementation. Some monitored valves will include a throttle function
14 as well as open and close functions. One should not include every throttle movement of a valve
15 as a counted demand. Only the initial movement of the valve should be counted as a demand.
16 Demands for valves that do not provide a controlling function are based on a full duty cycle.
17

18 Load run demands (emergency power generators only) are defined as any requirements for the
19 output breaker to close given that the generator has successfully started and reached rated speed
20 and voltage. Exclude post maintenance test load run demands, unless in case of a failure, the
21 cause of the failure was independent of the maintenance performed. In this case, the load run
22 demand should be counted, depending on whether the actual or estimated demand method will
23 be used, as well as the failure.
24

25 Run hours (pumps and emergency power generators only) are defined as the time the component
26 is operating. For pumps, Run-run hours include the first hour of operation of the component.
27 For EDG emergency diesel generators, exclude all hours before the output breaker is closed (or
28 EDG-hours when the EDG emergency diesel generator is run unloaded) and the first hour after
29 the breaker is closed (the first hour of operation after the breaker is closed is considered part of
30 the load/run demand). Failures during shutdown of an emergency generation after the output
31 breaker is opened are included as a failure to run. Exclude post maintenance test run hours,
32 unless in case of a failure, the cause of the failure was independent of the maintenance
33 performed. In this case, the run hours may be counted as well as the failure. Pumps that remain
34 running for operational reasons following the completion of post--maintenance testing, accrue
35 run hours from the time the pump was declared operable.

Linthicum
3/3/12
2/19/13

Table 4. Duty Cycle Data Types

Type	Definition
Actual ESF (ESF Nontest Actual in CDE)	Any demands or run hours incurred as a result of a valid ESF signal.
Operational/Alignment (Operational Nontest in CDE)	Any demands or run hours incurred supporting normal plant operations not associated with test activities or as a result of a valid ESF signal.
Test	Any demands or run hours incurred supporting test activities. Normally return to service tests and test for which a component is not expected to fully cycle (e.g., bumps for rotation checks after pump maintenance) are not included.

For each type of duty cycle data, the three data types defined in Table 4 are reported to CDE.

Best judgment should be used to define each type of demand or run hour data, but strict segregation of data between types is not as important as the validity of the total number (ESF nontest + operational nontest + test).

The duty cycle data category types may be reported as either actual or estimated data. Since valid ESF signals are essentially random in frequency, actual ESF demands (start demands, load run demands, and run hours) are always reported as actual data. Operational/Alignment and test data, however, can be reasonably estimated based on plant scheduled test frequencies and operating history. Therefore, either or both operational/alignment and test data may be reported as estimated data if so designated in the unit's MSPI basis document. Optionally, either or both operational/alignment and test data may be reported as actual data if so designated in the unit's MSPI basis document.

An actual ESF demand (also start demand, load run demand, or run hour) is any condition that results in valid actuation, manual or automatic, of any of the MSPI systems due to actual or perceived plant conditions requiring the actuation. These conditions should be counted in MSPI as actual ESF demands except when:

- 1) The actuation resulted from and was part of a pre-planned sequence during testing or reactor operation; or
- 2) The actuation was invalid; or
- 3) Occurred while the system was properly removed from service; or
- 4) Occurred after the safety function had been already completed.

Valid actuations are those actuations that result from "valid signals" or from intentional manual initiation, unless it is part of a preplanned test. Valid signals are those signals that are initiated in response to actual plant conditions or parameters satisfying the requirements for initiation of the safety function of the system. They do not include those which are the result of other signals. Invalid actuations are, by definition, those that do not meet the criteria for being valid. Thus, invalid actuations include actuations that are not the result of valid signals and are not intentional manual actuations.

1 For preplanned actuations, operation of a system as part of a planned test or operational
2 evolution should not be counted in MSPI as actual ESF demands, but rather as
3 operational/alignment or test demands. Preplanned actuations are those which are expected to
4 actually occur due to preplanned activities covered by procedures. Such actuations are those for
5 which a procedural step or other appropriate documentation indicates the specific actuation is
6 actually expected to occur. Control room personnel are aware of the specific signal generation
7 before its occurrence or indication in the control room. However, if during the test or evolution,
8 the system actuates in a way that is not part of the planned evolution, that actuation should be
9 counted.

10 Actual ESF demands occur when the setpoints for automatic safety system actuation are met or
11 exceeded and usually include the actuation of multiple trains and systems. Automatic actuation
12 of standby trains on a failure of a running train should not be considered as an actual ESF
13 demand. Actuations caused by operator error, maintenance errors, etc. that are not due to actual
14 plant requirements should be considered as “invalid” actuations and not counted in MSPI. **Error!**
15 **Bookmark not defined.** as actual ESF demands.

16 CDE will use the actual ESF data, the actual/estimated operational data, and the actual/estimated
17 test data to derive a total number of demands (start demand, load run demands, and run hours as
18 required) for each MSPI monitored component for use in the URI derivation for the applicable
19 MSPI system.

20 | *Reporting of Actual ~~Demands~~Data:* Actual ~~demands-data~~ is a count of the number of demands,
21 start demands, load run demands, and run hours occurring in the specific month (or quarter
22 prior to April 2006). For the reporting of Actual demands, Table 5 shows the requirements for
23 data to be reported each month if actual demands will be reported (or quarter prior to April
24 | 2006), for all actual ESF ~~demands~~, operational/alignment ~~demands~~, and test duty cycle data.

Linthicum
3/3/12

25 | *Reporting of Estimated ~~Demands~~Data:* Estimated demands ~~and run hours~~ can be derived based
26 on the number of times a procedure or maintenance activity is performed, or based on the
27 historical data over an operating cycle or more. Table 6 shows the requirements for estimated
28 data to be reported to CDE.

Linthicum
3/3/12

29 | Estimated ~~demands-data~~ are not reported to CDE on a periodic (monthly or quarterly) basis,
30 rather, they are entered initially, typically for the period of a refueling cycle (e.g., 48 demands
31 in 24 months) then updated as required. An update is required if a change to the basis for the
32 estimate results in a >25% change in the estimate of the total (operational/alignment + test) value
33 for a group of components within an MSPI system. For example, a single MOV in a system may
34 have its estimated demands change by greater than 25%, but revised estimates are not required
35 unless the total number of estimated demands for all MOVs in the system changes by >25%.
36 The new estimate will be used in the calculation the quarter following the input of the updated
37 estimates into CDE.

Linthicum
3/3/12

1
2

Table 5. Required Reporting by Component Type (Actual Demands Commitment)

Component Type	Report Each Month (or Quarter Prior to April 2006)
All valves and circuit breakers	Actual ESF Demands Actual Operational/Alignment Demands Actual Test Demands
All pumps	Actual ESF Demands Actual Operational/Alignment Demands Actual Test Demands Actual ESF Run Hours Actual Operational/Alignment Run Hours Actual Test Run Hours
All Emergency Power Generators (both diesel and hydroelectric)	Actual ESF Start Demands Actual Operational/Alignment Start Demands Actual Test Start Demands Actual ESF Load Run Demands Actual Operational/Alignment Load Run Demands Actual Test Load Run Demands Actual ESF Run Hours Actual Operational/Alignment Run Hours Actual Test Run Hours

3

1 | **Table 6. -Required Reporting by Component Type (Estimated Data Commitment)**
2

Component Type	Report
All valves and circuit breakers	Actual ESF Demands ¹ Estimated Operational/Alignment Demands Estimated Test Demands
All pumps	Actual ESF Demands ¹ Estimated Operational/Alignment Demands Estimated Test Demands Actual ESF Run Hours ¹ Estimated Operational /Alignment Run Hours Estimated Test Run Hours
All Emergency Power Generators (both diesel and hydro electric)	Actual ESF Start Demands ¹ Estimated Operational /Alignment Start Demands Estimated Test Start Demands Actual ESF Load Run Demands ¹ Estimated Operational/Alignment Load Run Demands Estimated Test Load Run Demands Actual ESF Run Hours ¹ Estimated Operational /Alignment Run Hours Estimated Test Run Hours

3
4 | **Note 1 for Table 6:** For plants that have elected to use estimated test and operational/alignment demands
5 and run hours, the reporting of ESF demands and run hours should be either “zero” or the actual
6 demands/run hours.” If there were no actual ESF demands and run hours for the quarter, a "zero"
7 must be entered into CDE**Error! Bookmark not defined.** for actual ESF demands and run
8 hours.
9

10
11 | **F 2.2.2. FAILURES**

12 In general, a failure of a component for the MSPI is any circumstance when the component is
13 not in a condition to meet the performance requirements defined by the PRA success criteria or
14 mission time for the functions monitored under the MSPI. For **EDG emergency power**
15 **generators**, the mission time for failure determinations should be the maximum mission time
16 considered in the PRA model (generally 24 hours), even if a shorter mission time is used for
17 input into CDE. Note that a run failure that occurs beyond **24 hours the mission time** after the
18 **EDG-emergency power generator or pump** is started is still counted as a MSPI failure. This
19 accounts for the time during which the **EDG-component** was in an unknown condition when it
20 would have been unable to run for a full **24 hours mission time**. In addition, such failures are
21 included in the data used to generate the baseline failure rates.
22

23 Failures for the MSPI are not necessarily equivalent to failures in the maintenance
24 rule. Specifically, the MSPI failure determination does not depend on whether a failure is

1 maintenance preventable. Additionally, the functions monitored for the MSPI are normally a
2 subset of those monitored for the maintenance rule.

3
4 ~~**EDG-Emergency power generator failure to start:**~~ A failure to start includes those failures up
5 to the point when the ~~EDG~~ emergency power generator output breaker has received a signal to
6 close. ~~has achieved required speed and voltage.~~ (Exclude post maintenance tests (PMTs), unless
7 the cause of failure was independent of the maintenance performed. **Include all failures that**
8 **result from a non-PMT demand following return to service. If a PMT failure occurs following**
9 **return to service and was dependent of caused by the maintenance performed activity, then this**
10 **failure is excluded and the train, during the period from the completion of the maintenance**
11 **activity to the declaration of return to service, is counted as unavailable.)** (See the
12 ~~EDG~~ emergency power generator¹ failure to run definition for treatment of fuel oil transfer
13 pump/valve failures.¹)

FAQ472
(09-08)

Linthicum
3/3/12

FAQ472
(09-08)
FAQ 487
(11-08)

14
15 ~~**EDG-Emergency power generator failure to load/run:**~~ Given that ~~it~~ the ~~EDG~~ emergency power
16 generator has successfully started and the output breaker has received a signal to close, a failure
17 of the ~~EDG~~ generator output breaker to close, ~~to successfully load sequence and~~ or a failure to
18 run/operate for one hour ~~to perform its monitored functions~~ after breaker closure. The
19 ~~EDG~~ emergency power generator does not have to be fully loaded to count the failure. Failure to
20 load/run also includes failures of the ~~EDG~~ emergency power generator output breaker to re-close
21 following a grid disturbance if the ~~EDG~~ emergency power generator was running paralleled to the
22 grid, provided breaker closure is required by plant design. ~~This failure mode is treated as a~~
23 ~~demand failure for calculation purposes.~~ (Exclude post maintenance tests, unless the cause of
24 failure was independent of the maintenance performed. **Include all failures that result from a**
25 **non-PMT demand following return to service. If a PMT failure occurs following return to**
26 **service and was dependent on caused by the maintenance performed activity, then this failure is**
27 **excluded and the train, during the period from the completion of the maintenance activity to the**
28 **declaration of return to service, is counted as unavailable. }**)

Linthicum
3/3/12

FAQ472
(09-08)
FAQ 487
(11-08)

FAQ472
(09-08)

29
30 ~~**EDG-Emergency power generator failure to run:**~~ A failure after the ~~EDG~~ emergency power
31 generator has successfully started, the output breaker has closed and the ~~EDG~~ generator has run
32 for an hour after the breaker has closed. The ~~EDG~~ generator does not have to be fully loaded to
33 count the failure. ~~Given that it has successfully started and loaded and run for an hour, a failure~~
34 ~~of an EDG to run/operate.~~ (Exclude post maintenance tests, unless the cause of failure was
35 independent of the maintenance performed. Failures of the EDG fuel oil transfer
36 pump(s)/valve(s) are considered to be EDG failures to run if the failure of the EDG fuel oil
37 transfer pump/valve results in the failure of the EDG to be able to run for 24 hours (e.g., no
38 redundant transfer pump/valve is available², or the redundant pump/valve is disabled in a manner
39 preventing it from performing its intended function). Regardless of when the fuel oil transfer
40 pump/valve(s) fails, this counts as a run failure. In the case where a fuel oil transfer
41 pump/valve(s) failure results in more than ~~one~~ EDG to not be able to run for 24 hours, a failure
42 is counted for each affected EDG.

RRL
3/3/12
FAQ 487
(11-08)

¹ Information Systems Laboratories, Inc. performed a review for the NRC of EDG and FOTP failures to support the changes made to EDG failure definitions in 2011. See Accession No. ML11259A101 in NRC's Agencywide Documents Access and Management System (ADAMS).

² In order for a redundant fuel oil transfer pump/valve to be credited in a failure determination, it must either automatically actuate or be able to be manually actuated in the time needed to satisfy the PRA **Error! Bookmark not defined.** success criteria. If the pump/valve requires manual actuation, indication must be available to alert the operating staff of the need to actuate the pump/valve in the time required.

1
2 Include all failures that result from a non-PMT demand following return to service. If a PMT
3 failure occurs following return to service and was ~~dependent on~~ caused by the maintenance
4 ~~performed~~ activity, then this failure is excluded and the train, during the period from the
5 completion of the maintenance activity to the declaration of return to service, is counted as
6 unavailable.)

Slider
12/27/12

7
8 **Pump failure on demand:** A failure to start and run for at least one hour is counted as failure on
9 demand. ~~(Exclude post maintenance tests, unless the cause of failure was independent of the~~
10 maintenance performed. ~~Include all failures that result from a non-PMT demand following~~
11 ~~return to service. If a PMT failure occurs following return to service and was dependent on~~
12 ~~caused by the maintenance performed activity, then this failure is excluded and the train,~~
13 during the period from the completion of the maintenance activity to the declaration of return
14 to service, is counted as unavailable.)

FAQ472
(09-08)
Slider
12/27/12

15
16 **Pump failure to run:** Given that it has successfully started and run for an hour, a failure of a
17 pump to run/operate. ~~(Exclude post maintenance tests, unless the cause of failure was~~
18 independent of the maintenance performed. ~~Include all failures that result from a non-PMT~~
19 ~~demand following return to service. If a PMT failure occurs following return to service and~~
20 ~~was dependent on~~ caused by the maintenance ~~performed~~ activity, then this failure is excluded
21 and the train, during the period from the completion of the maintenance activity to the
22 declaration of return to service, is counted as unavailable.)

FAQ472
(09-08)
Slider
12/27/12

23
24 **Valve failure on demand:** A failure to transfer to the required monitored state (open, close, or
25 throttle to the desired position as applicable) is counted as failure on demand. ~~(Exclude post~~
26 maintenance tests, unless the cause of failure was independent of the maintenance performed.
27 ~~Include all failures that result from a non-PMT demand following return to service. If a PMT~~
28 ~~failure occurs following return to service and was caused by the maintenance~~
29 ~~performed~~ activity, then this failure is excluded and the train, during the period from the
30 completion of the maintenance activity to the declaration of return to service, is counted as
31 unavailable.)

FAQ472
(09-08)
Slider
12/27/12

32
33 **Breaker failure on demand:** A failure to transfer to the required monitored state (open or close
34 as applicable) is counted as failure on demand. ~~(Exclude post maintenance tests, unless the~~
35 cause of failure was independent of the maintenance performed. ~~Include all failures that result~~
36 ~~from a non-PMT demand following return to service. If a PMT failure occurs following return~~
37 ~~to service and was dependent on~~ caused by the maintenance ~~performed~~ activity, then this failure is
38 excluded and the train, during the period from the completion of the maintenance activity to the
39 declaration of return to service, is counted as unavailable.)

FAQ472
(09-08)
Slider
12/27/12

40 41 Treatment of Demand and Run Failures

42 Failures of monitored components on demand or failures to run, either actual or test are included
43 in unreliability. Failures on demand or failures to run while not critical are included unless an
44 evaluation determines the failure would not have affected the ability of the component to
45 perform it's monitored at power function. ~~In no case can a postulated action to recover a failure~~
46 ~~be used as a justification to exclude a failure from the count.~~

Linthicum
3/3/12

1
2 Human errors/component trips, inadvertent actuations or unplanned unavailability introduced as
3 part of a test or maintenance activity are not indicative of the reliability of the equipment had the
4 activity not been performed, and should NOT be counted as failures as long as they are
5 immediately revealed and promptly reported to the control room.

6
7 This applies to human errors which result in tripping an MSPI component that:

- 8
9 1. Occur while the MSPI train/segment is considered available;
10 2. Do not result in actual equipment damage;
11 3. Are immediately revealed through clear and unambiguous indication;
12 4. Are promptly reported to the control room without delay prior to the performance
13 of corrective actions, and;
14 5. Are clearly associated with a test or maintenance activity such that the failure
15 sequence would not have occurred and cannot occur if the test or maintenance
16 activity was not being performed.

17
18 Unplanned unavailability should be counted from the time of the event until the equipment is
19 returned to service.

20
21 Latent failures (failures that existed prior to the maintenance) that are discovered as part of
22 maintenance or test activity are considered failures.

23
24 Treatment of Failures Discovered During Post Maintenance Tests

25 Failures identified during post maintenance tests (PMT) are not counted unless the cause of the
26 failure was independent of the maintenance performed. The maintenance scope of work includes
27 the activities required to be performed to conduct the maintenance, including support activities,
28 the actual maintenance activities, and the activities required for restoration of the monitored
29 component(s) to their available and operable conditions. This includes, but is not limited to,
30 typical tasks such as scaffolding erection and removal, coatings applications, insulation removal
31 and installation, rigging activities, health physics activities, interference removal and restoration,
32 as required to support and perform the required maintenance activity. Support activities may be
33 planned, scheduled and implemented on separate work orders from the work order for the
34 monitored component(s). System or component failures introduced during the scope of work are
35 not indicative of the reliability of the equipment, since they would not have occurred had the
36 maintenance activity not been performed. In addition, the potential exists that components or
37 devices not included in the direct scope of work may be affected by the ongoing activities. Such
38 failures are not counted providing:

- 39
40 • They are identified during or prior to the post-maintenance testing and are corrected
41 prior to the component(s) being returned to operable status,
42 • The repair is documented in a work package, and
43 • The critical components not directly in the scope of work, but that have the potential
44 to be affected by the maintenance activity, are noted by means such as cautions in the
45 procedures, inclusion in the pre-job briefings, protection by signs, placards or
padding, and

- The licensee uses the corrective action program to document the basis for the determination that the cause of the failure was dependent on the maintenance performed. This determination must establish a clear relationship between the maintenance performed and the failure.

Treatment of Discovered Conditions that Result in the Inability to Perform a Monitored Function

Discovered conditions of monitored components (conditions within the component boundaries defined in section F 2.1.3) that render a monitored component incapable of performing its monitored function are included in unreliability as a failure, even though no actual failure on demand or while running existed. This treatment accounts for the amount of time that the condition existed prior to discovery, when the component was in an unknown failed state.

In accordance with current regulatory guidance, licensees may credit limited operator actions to determine that degraded equipment remains operable in accordance with Technical Specifications. If a component is determined to be operable, then no failure is counted. Beyond this, no credit is allowed for operator actions during degraded conditions that render the component unable to perform its monitored function.

Linthicum
3/3/12

Conditions that render a monitored component incapable of performing its monitored function that are immediately annunciated in the control room without an actual demand occurring are a special case of a discovered condition. In this instance the discovery of the condition is coincident with the failure. This condition is applicable to normally energized control circuits that are associated with monitored components, which annunciate on loss of power to the control circuit. For this circumstance there is no time when the component is in an unknown failed state. In this instance appropriate train unavailable hours will be accounted for, but no additional failure will be counted.

For other discovered conditions where the discovery of the condition is not coincident with the failure, the appropriate failure mode must be accounted for in the following manner:

- For valves and breakers a demand failure would be assumed and included. An additional demand may also be counted.
- For pumps and ~~diesel~~emergency power generators, if the discovered condition would have prevented a successful start, a ~~start~~ failure is included, but there would be no run time hours or run failure. An additional demand may also be counted.
- For ~~emergency power generators~~diesels, if it was determined that the ~~diesel~~generator would start, but would fail to load (e.g. a condition associated with the output breaker), a load/run failure would be assumed and included. An additional start demand and load/run demand may also be counted.
- For pumps and ~~emergency power generators~~diesels, if it was determined that the pump/~~diesel~~generator would start and load run, but would fail sometime prior to completing its mission time, a run failure would be assumed. A start demand and a load/run demand would also be assumed and included. The evaluated failure time may be included in run hours.

Linthicum
3/3/12

Linthicum
3/3/12

1 For a running component that is secured from operation due to observed degraded performance,
2 but prior to failure, then a run failure shall be assumed unless evaluation of the condition shows
3 that the component would have continued to operate for the mission time starting from the time
4 the component was secured.

5
6 Unplanned unavailability would accrue in all instances from the time of discovery or
7 annunciation consistent with the definition in section F 1.2.1.
8

9 Loss of monitored function(s) is assumed to have occurred if the established success criteria have
10 not been met. If subsequent analysis identifies additional margin for the success criterion, future
11 impacts on URI or UAI for degraded conditions may be determined based on the new criterion.
12 However, the current quarter's URI and UAI must be based on the success criteria of record at
13 the time the degraded condition is discovered. If the new success criteria causes a revision to the
14 PRA affecting the numerical results (i.e. CDF and FV), then the change must be included in the
15 PRA model and the appropriate new values calculated and incorporated in the MSPI Basis
16 Document prior to use in the calculation of URI and UAI. If the change in success criteria has no
17 effect on the numerical results of the PRA (representing only a change in margin) then only the
18 MSPI Basis Document need be revised prior to using the revised success criteria.
19

20 If the degraded condition is not addressed by any of the pre-defined success criteria, an
21 engineering evaluation to determine the impact of the degraded condition on the monitored
22 function(s) should be completed and documented. The use of component failure analysis, circuit
23 analysis, or event investigations is acceptable. Engineering judgment may be used in
24 conjunction with analytical techniques to determine the impact of the degraded condition on the
25 monitored function. The engineering evaluation should be completed as soon as practical. If it
26 cannot be completed in time to support submission of the PI report for the current quarter, a
27 preliminary determination should be reported and the comment field shall note that an
28 evaluation is pending. The evaluation must be completed in time to accurately account for
29 unavailability/unreliability in the next quarterly report. Exceptions to this guidance are expected
30 to be rare and will be treated on a case-by-case basis. Licensees should identify these situations
31 to the resident inspector.
32

Linthicum
3/3/12

33 Failures and Discovered Conditions of Non-Monitored Structures, Systems, and Components 34 (SSC)

35 ~~Failures of SSCs that are not included in the performance index will not be counted as a~~
36 ~~failure or a demand. Failures of SSCs that would have caused an SSC within the scope of the~~
37 ~~performance index to fail will not be counted as a failure or demand. An example could be a~~
38 ~~manual suction isolation valve left closed which would have caused a pump to fail. This would~~
39 ~~not be counted as a failure of the pump.~~ Unmonitored components within a monitored
40 train/segment boundary do not contribute to unreliability. If an unmonitored component within a
41 monitored train/segment fails, unreliability is not accrued if the unmonitored component does not
42 cause an actual demand and/or actual failure of a monitored component within the monitored
43 train/segment. If the unmonitored component causes a monitored component within the
44 monitored train/segment to actually fail when demanded, then the monitored component demand
45 and failure are counted for unreliability. The failure of an unmonitored component within a

FAQ486
(10-06)
Heffner
2/6/13

1 monitored train/segment can cause unavailability of that train/segment to be counted if the
 2 train/segment is rendered unavailable.

3
 4 Unmonitored components outside a monitored train/segment boundary do not contribute to
 5 unreliability of monitored components or to unavailability of the monitored train/segment. If
 6 an unmonitored component outside a monitored train/segment fails, unreliability is not
 7 accrued regardless whether the unmonitored component causes an actual demand and/or actual
 8 failure of a monitored component. The failure of an unmonitored component outside a
 9 monitored train/segment cannot cause unavailability of that train/segment to be counted.

FAQ486
(10-06)

10
 11 For example, a manual suction isolation valve (an unmonitored component within the train
 12 boundary) is left closed, which would have caused a pump to fail. The closed valve would
 13 not be counted as a failure of the pump, nor would unavailability be accrued. Any mis-
 14 positioning of the valve that caused the train to be unavailable would be counted as
 15 unavailability from the time of discovery. The significance of the mis-positioned valve prior to
 16 discovery would be addressed through the inspection process. (Note, however, in the above
 17 example, if the shut manual suction isolation valve resulted in an actual pump failure, the pump
 18 failure would be counted as a demand and failure of the pump and unplanned unavailability
 19 would be counted against the appropriate train/segment.)

FAQ486
(10-06)

20
 21
 22 **F 2.3. CALCULATION OF URI**

23 Unreliability is monitored at the component level and calculated at the system level. URI is
 24 proportional to the weighted difference between the plant-specific component
 25 unreliability and the industry average unreliability. The Birnbaum importance is the weighting
 26 factor. Calculation of system URI due to this difference in component unreliability is as follows:
 27

28
$$URI = \sum_{j=1}^m \left[\begin{array}{l} B_{Dj}(UR_{DBCj} - UR_{DBLj}) \\ + B_{Lj}(UR_{LBCj} - UR_{LBLj}) \\ + B_{Rj}(UR_{RBCj} - UR_{RBLj}) \end{array} \right] \quad \text{Eq. 3}$$

29
 30 Where the summation is over the number of monitored components (m) in the system, and:

31
 32 B_{Dj} , B_{Lj} and B_{Rj} are the Birnbaum importance measures for the failure modes fail on
 33 demand, fail to load and fail to run respectively,
 34

35 UR_{DBC} , UR_{LBC} , and UR_{RBC} are Bayesian corrected plant-specific values of
 36 unreliability for the failure modes fail on demand, fail to load and fail to run respectively,
 37 and
 38

39 UR_{DBL} , UR_{LBL} , and UR_{RBL} are Baseline values of unreliability for the failure modes fail on
 40 demand, fail to load and fail to run respectively.

1 The Birnbaum importance for each specific component failure mode is defined as

$$2 \quad B = CDF_p \left[\frac{FV_{URc}}{UR_{pc}} \right]_{MAX} \quad \text{Eq. 4}$$

3 Where,

4 CDF_p is the plant-specific internal events, at power, core damage frequency,
5 FV_{URc} is the component and failure mode specific Fussell-Vesely value for unreliability,
6 UR_{pc} is the plant-specific PRA value of component and failure mode unreliability,
7

8 Failure modes defined for each component type are provided below. There may be several basic
9 events in a PRA that correspond to each of these failure modes used to collect plant-specific-
10 specific data. These failure modes are used to define how the actual failures in the plant are
11 categorized.

12
13 Valves and Breakers:

14 Fail on Demand (Open/Close)

15 Pumps:

16 Fail on Demand (Start)

17 Fail to Run

18 Emergency Diesel Generators:

19 Fail on Demand (Start)

20 Fail to Load/Run

21 Fail to Run

22 A method for calculation of the quantities in equation 3 and 4 from importance measures
23 calculated using cutsets from an existing PRA solution is discussed in sections F 2.3.1 through F
24 2.3.3.

25
26 An alternate approach, based on re-quantification of the PRA model, and calculation of the
27 importance measures from first principles is also an acceptable method. Guidance on this
28 alternate method is contained in section F6 of this appendix. A plant using this alternate
29 approach should use the guidance in section F6 and skip sections F 2.3.1 through F 2.3.3.
30

31 **F 2.3.1. TRUNCATION LEVELS**

32 The values of importance measures calculated using an existing cutset solution are influenced by
33 the truncation level of the solution. The truncation level chosen for the solution should be 7
34 orders of magnitude less than the baseline CDF for the alternative defined in sections F 2.3.2 and
35 F 2.3.3.

36
37 As an alternative to using this truncation level, the following sensitivity study may be performed
38 to establish the acceptability of a higher (e.g. 6 orders of magnitude) truncation level.
39

- 40 1. Solve the model at the truncation level you intend to use. (e.g. 6 orders of magnitude
- 41 below the baseline CDF)
- 42 2. Identify the limiting Birnbaum value for each component. (this is the case 1 value)

3. Solve the model again with a truncation 10 times larger (e.g.. 5 orders of magnitude below the baseline CDF)
4. Identify the limiting Birnbaum value for each component. (this is the case 2 value)
5. For each component with Birnbaum-case 1 greater than 1.0E-06 calculate the ratio [(Birnbaum-case 2)/(Birnbaum-case 1)]
6. If the value for the calculated ratio is greater than 0.8 for all components with Birnbaum-case 1 value greater than 1.0E-06, then the case 1 truncation level may be used for this analysis.

This process may need to be repeated several times with successively lower truncation levels to achieve acceptable results.

F 2.3.2. CALCULATION OF CORE DAMAGE FREQUENCY (CDFP)

The Core Damage Frequency is a CDE input value. The required value is the internal events average maintenance at power value. Internal flooding and **external events, including internal fires** are not included in this calculated value. In general, all inputs to this indicator from the PRA are calculated from the internal events model only.

Linthicum
3/3/12

F 2.3.3. CALCULATION OF [FV/UR]MAX

The FV, UR and common cause adjustment values developed in this section are separate CDE input values.

Equation 4 includes a term that is the ratio of a Fussell-Vesely importance value divided by the related unreliability. The calculation of this ratio is performed in a similar manner to the ratio calculated for UAI, except that the ratio is calculated for each monitored component. One additional factor needs to be accounted for in the unreliability ratio that was not needed in the unavailability ratio, the contribution to the ratio from common cause failure events. The discussion in this section will start with the calculation of the initial ratio and then proceed with directions for adjusting this value to account for the cooling water initiator contribution, as in the unavailability index, and then the common cause correction.

It can be shown that for a given component represented by multiple basic events, the ratio of the two values for the component is equal to the ratio of values for any basic event representing the component. Or,

$$\frac{FV_{be}}{UR_{be}} = \frac{FV_{URc}}{UR_{Pc}} = \text{Constant}$$

as long as the basic events under consideration are logically equivalent.

Note that the constant value may be different for the unreliability ratio and the unavailability ratio because the two types of events are frequently not logically equivalent. For example recovery actions may be modeled in the PRA for one but not the other. This ratio may also be different for fail on demand and fail to run events for the same component. This is particularly true for cooling water pumps that have a trip initiation function as well as a mitigation function.

1
2 There are two options for determining the initial value of this ratio: The first option is to identify
3 one maximum ratio that will be used for all applicable failure modes for the component. The
4 second option is to identify a separate ratio for each failure mode for the component. These two
5 options will be discussed next.

6
7 *Option 1*

8 Identify one maximum ratio that will be used for all applicable failure modes for the component.
9 The process for determining a single value of this ratio for all failure modes of a component is to
10 identify all basic events that fail the **monitored function of the** component (excluding
11 common cause events and test and maintenance events). It is typical, given the component
12 scope definitions in Table 2, that there will be several plant components modeled separately in
13 the plant PRA that make up the MSPI component definition. For example, it is common that in
14 modeling an MOV, the actuation relay for the MOV and the power supply breaker for the MOV
15 are separate components in the plant PRA. Ensure that the basic events related to all of these
16 individual components are considered when choosing the appropriate $[FV/UR]$ ratio.

Linthicum
3/3/12

17
18 Determine the failure probabilities for the events, determine the associated FV values for the
19 events and then calculate the ratios, $[FV/UR]_{ind}$, where the subscript refers to independent
20 failures. Choose from this list the basic event for the component and its associated FV value that
21 results in the largest $[FV/UR]$ ratio. This will typically be the event with the largest failure
22 probability to minimize the effects of truncation on the calculation. **If all events for the**
23 **component have been truncated, either a lower truncation value or the method provided in**
24 **sSection F.6 should be used.**

Linthicum
3/3/12

25
26 *Option 2*

27 Identify a separate ratio for each failure mode for the component The process for determining a
28 ratio value for each failure mode proceeds similarly by first identifying all basic events
29 related to each **monitored function of the** component. After this step, each basic event must
30 be associated with one of the specific defined failure modes for the component. Proceed as
31 in option 1 to find the values that result in the largest ratio for each failure mode for the
32 component. In this option the CDE inputs will include FV and UR values for each failure mode
33 of the component.

Linthicum
3/3/12

34
35 **F 2.3.4. CORRECTIONS TO FV/UR RATIO**

36
37 Treatment of PRA Modeling Asymmetries

38 In systems with rotated normally running pumps (e. g. cooling water systems), the PRA models
39 may assume one pump is always the running and another is in standby. For example, a service
40 water system may have two 100% capacity pumps in one train, an A and B pump. In practice the
41 A and B pumps are rotated and each one is the running pump 50% of the time. In the PRA model
42 however, the A pump is assumed to be always running and the B pump is always in assumed to
43 be in standby. This will result in one pump appearing to be more important than the other when
44 they are, in fact, of equal importance. This asymmetry in importance is driven by the assumption
45 in the PRA, not the design of the plant.

1 When this is encountered, the importance measures may be used as they are calculated from the
2 PRA model for the component importance used in the calculation of URI. Although these are not
3 actually the correct importance values, the method used to calculate URI will still provide the
4 correct result because the same value of unreliability is used for each component as a result of
5 the data being pooled. Note that this is different from the treatment of importance in the
6 calculation of UAI.

7 8 Cooling Water and Service Water System [FV/UR]ind Values

9 Ensure that the correction term in this section is applied prior to the calculation of the common
10 cause correction in the next section. Component Cooling Water Systems (CCW) and Service
11 Water Systems (SWS) at some nuclear stations contribute to risk in two ways. First, the systems
12 provide cooling to equipment used for the mitigation of events and second, the failures in the
13 systems may also result in the initiation of an event. Depending on the manner in which the
14 initiator contribution is treated in the PRA, it may be necessary to apply a correction to the
15 FV/UR ratio calculated in the section above.

16 The correction must be applied to each FV/UR ratio used for this index. If the option to use
17 separate ratios for each component failure mode was used in the section above then this
18 correction is calculated for each failure mode of the component.

19
20 The contribution to risk from failures to provide cooling to other plant equipment is modeled
21 directly through dependencies in the PRA model. However, the contribution due to event
22 initiation is treated in four general ways in current PRAs:

- 23 1) The use of linked initiating event fault trees for these systems with the same basic
24 events used in the initiator and mitigation trees.
- 25 2) The use of linked initiating event fault trees for these systems with different basic
26 events used in the initiator and mitigation trees.
- 27 3) Fault tree solutions are generated for these systems external to the PRA and the
28 calculated value is used in the PRA as a point estimate
- 29 4) A point estimate value is generated for the initiator using industry and plant-~~specific-~~
30 ~~specific~~ event data and used in the PRA.

31
32 Each of these methods is discussed below.

33 34 *Modeling Method 1*

35 If a PRA uses the first modeling option, then the FV values calculated will reflect the total
36 contribution to risk for a component in the system. No additional correction to the FV values is
37 required.

38 39 *Modeling Methods 2 and 3*

40 The corrected ratio may be calculated as described for modeling method 4 or by the method
41 described below.

42
43 If a linked initiating event fault tree with different basic events used in the initiator and
44 mitigation trees is the modeling approach taken, or fault tree solutions are generated for these
45 systems external to the PRA and the calculated value is used in the PRA as a point estimate, then
46 the corrected ratio is given by:

$$[FV/UR]_{corr} = \left[\frac{FVc}{URc} + \sum_{m=1}^i \left\{ \frac{IE_{m,n}(1) - IE_{m,n}(0)}{IE_{m,n}(q_n)} * FVie_m \right\} \right]$$

In this expression the summation is taken over all system initiators i that involve component n , where

FVc is the Fussell-Vesely for component C as calculated from the PRA Model. This does not include any contribution from initiating events,

URc is the basic event unreliability used in computing FVc ; i.e. in the system response models,

$IE_{m,n}(q_n)$ is the system initiator frequency of initiating event m when the component n unreliability basic event is q_n . The event chosen in the initiator tree should represent the same failure mode for the component as the event chosen for URc ,

$IE_{m,n}(1)$ is as above but $q_n=1$,

$IE_{m,n}(0)$ is as above but $q_n=0$

and

$FVie_m$ is the Fussell-Vesely importance contribution for the initiating event m to the CDF.

Since FV and UR are separate CDE inputs, use URc and calculate FV from

$$FV = URc * [FV/UR]_{corr}$$

Modeling Method 4

If a point estimate value is generated for the initiator using industry and plant-specific-specific event data and used in the PRA, then the corrected $[FV/UR]_{MAX}$ for a component C is calculated from the expression:

$$[FV/UR]_{MAX} = [(FVc + FVie * FVsc) / URc]$$

Where:

FVc is the Fussell-Vesely for CDF for component C as calculated from the PRA Model. This does not include any contribution from initiating events.

$FVie$ is the Fussell-Vesely contribution for the initiating event in question (e.g. loss of service water).

$FVsc$ is the Fussell-Vesely **within the system fault tree only** for component C (i.e. the ratio of the sum of the cut sets in the fault tree solution in which that component appears to the overall system failure probability). Note that this may require the construction of a "satellite" system fault tree to arrive at an exact or approximate value for $FVsc$ depending on the support system fault tree logic.

URc is the basic event unreliability used in computing FVc ; i.e., in the system response models.

Linthicum
3/3/12

FV and UR are separate CDE input values.

Including the Effect of Common Cause in $[FV/UR]_{max}$

Be sure that the correction factors from the previous section are applied prior to the common cause correction factor being calculated.

1
2 Changes in the independent failure probability of an SSC imply a proportional change in the
3 common cause failure probability, even though no actual common cause failures have occurred.
4 The impact of this effect on URI is considered by including a multiplicative adjustment to the
5 $[FV/UR]_{ind}$ ratio developed in the section above. This multiplicative factor (A) is entered into
6 CDE as “CCF.”

7
8 Two methods are provided for including this effect, a simple generic approach that uses
9 bounding generic adjustment values and a more accurate plant-specific method that uses
10 values derived from the plant-specific PRA. Different methods can be used for different
11 systems. However, within an MSPI system, either the generic or plant-specific method
12 must be used for all components in the system, not a combination of different methods. For the
13 cooling water system, different methods may be used for the subsystems that make up the
14 cooling water system. For example, component cooling water and service water may use
15 different methods.

16
17 The common cause correction factor is only applied to components within a system and does not
18 include cross system (such as between the BWR HPCI and RCIC systems) common cause. If
19 there is only one component within a component type within the system, the adjustment value is
20 1.0. Also, if all components within a component type are required for success, then the
21 adjustment value is 1.0.

22 23 Generic CCF Adjustment Values

24 Generic values have been developed for monitored components that are subject to common
25 cause failure. The correction factor is used as a multiplier on the $[FV/UR]$ ratio for each
26 component in the common cause group. This method may be used for simplicity and is
27 recommended for components that are less significant contributors to the URI (e.g. $[FV/UR]$ is
28 small). The multipliers are provided in ~~table~~ Table 7.

29
30 The EDG is a “super-component” that includes valves, pumps and breakers within the super-
31 component boundary. The EDG generic adjustment value should be applied to the EDG “super-
32 component” even if the specific event used for the $[FV/UR]$ ratio for the EDG is a valve or
33 breaker failure.

34

1
2

Table 7. Generic CCF Adjustment Values

	EPS	HPI		HRS/		RHR
	EDG	MDP Running or Alternating ⁺	MDP Standby	MDP Standby	TDP **	MDP Standby
Arkansas 1	1.25	2	1	1	1	1.5
Arkansas 2	1.25	1	2	1	1	1.5
Beaver Valley 1	1.25	2	1	1.25	1	1.5
Beaver Valley 2	1.25	2	1	1.25	1	1.5
Braidwood 1 & 2	3	1.25	1.25	1	1	1.5
Browns Ferry 1, 2 & 3	1.25	1	1	1	1	3
Browns Ferry 2	1.25	1	1	1	1	3
Browns Ferry 3	1.25	1	1	1	1	3
Brunswick 1 & 2	1.25	1	1	1	1	3
Byron 1 & 2	3	1.25	1.25	1	1	1.5
Callaway	1.25	1.25	1.25	1.25	1	1.5
Calvert Cliffs 1 & 2	1.25	1	2	1.25	1.5	1.5
Catawba 1 & 2	1.25	1.25	1.25	1.25	1	1.5
Clinton 1	1.25	1	1	1	1	1.5
Columbia Nuclear	1.25	1	1	1	1	1.5
Comanche Peak 1 & 2	1.25	1.25	1.25	1.25	1	1.5
Cook 1 & 2	1.25	1.25	1.25	1.25	1	1.5
Cooper Station	1.25	1	1	1	1	3
Crystal River 3	1.25	2	1	1	1	1.5
Davis-Besse	1.25	1.25	1.25	1	1.5	1.5
Diablo Canyon 1 & 2	2	1.25	1.25	1.25	1	1.5
Dresden 2 & 3	1.25	3	1	1	1	3
Duane Arnold	1.25	1	1	1	1	3
Farley 1 & 2	2	2	1	1.25	1	1.5
Fermi 2	1.25	1	1	1	1	3
Fitzpatrick	3	1	1	1	1	3
Fort Calhoun	1.25	1	2	1	1	1.5
Ginna	1.25	1	2	1.25	1	1.5
Grand Gulf	1.25	1	1	1	1	1.5
Harris	1.25	2	1	1.25	1	1.5
Hatch 1 & 2	2	1	1	1	1	3
Hope Creek	1.25	1	1	1	1	1.5
Indian Point 2	1.25	1	2	1.25	1	1.5
Indian Point 3	1.25	1	2	1.25	1	1.5
Kewaunee	1.25	1	1.25	1.25	1	1.5
LaSalle 1 & 2	1.25	1	1	1	1	1.5
Limerick 1 & 2	3	1	1	1	1	3
McGuire 1 & 2	1.25	1.25	1.25	1.25	1	1.5
Millstone 2	1.25	1	2	1.25	1	1.5
Millstone 3	1.25	2	1.25	1.25	1	1.5
Monticello	1.25	1	1	1	1	3
Nine Mile Point 1	1.25	3	1	1	1	3

FAQ473
(10-04)

	EPS	HPI		HRS/		RHR
	EDG	MDP Running or Alternating ⁺	MDP Standby	MDP Standby	TDP **	MDP Standby
Nine Mile Point 2	1.25	1	1	1	1	1.5
North Anna 1 & 2	1.25	2	1	1.25	1	1.5
Oconee 1, 2 & 3	3 *	2	1	1.25	1	1.5
Oyster Creek	1.25	1	3	1	1	3
Palisades	1.25	1	1.25	1.25	1	1.5
Palo Verde 1, 2 & 3	1.25	1	1.25	1.25	1	1.5
Peach Bottom 2 & 3	1.25	1	1	1	1	3
Perry	1.25	1	1	1	1	1.5
Pilgrim	1.25	1	1	1	1	3
Point Beach 1 & 2	1.25	1	1.25	1.25	1	1.5
Prairie Island 1 & 2	1.25	1	1.25	1	1	1.5
Quad Cities 1 & 2	1.25	1	1	1	1	3
River Bend	1.25	1	1	1	1	1.5
Robinson 2	1.25	1	1.25	1.25	1	1.5
Salem 1 & 2	1.25	1.25	1.25	1.25	1	1.5
San Onofre 2 & 3	1.25	1	2	1.25	1	1.5
Seabrook	1.25	1.25	1.25	1	1	1.5
Sequoyah 1 & 2	1.25	1.25	1.25	1.25	1	1.5
South Texas 1 & 2	2	1	2	2	1	1.5
St. Lucie 1	1.25	1	1.25	1.25	1	1.5
St. Lucie 2	1.25	1	1.25	1.25	1	1.5
Summer	1.25	2	1	1.25	1	1.5
Surry 1 & 2	1.25	2	1	1.25	1	1.5
Susquehanna 1 & 2	3	1	1	1	1	3
Three Mile Island 1	1.25	2	1	1.25	1	1.5
Turkey Point 3 & 4	1.25	1	3	1	3	1.5
Vermont Yankee	1.25	1	1	1	1	3
Vogtle 1 & 2	1.25	1.25	1.25	1.25	1	1.5
Waterford 3	1.25	1	2	1.25	1	1.5
Watts Bar 1	1.25	1.25	1.25	1.25	1	1.5
Wolf Creek	1.25	1.25	1.25	1.25	1	1.5

FAQ479
(11-05)

- 1 * hydroelectric units ** as applicable
2 ⁺ Alternating pumps are redundant pumps where one pump is normally running, that are
3 operationally rotated on a periodic basis.
4

	SWS			CCW		All	All
	MDP Running or Alternating	MDP Standby	DDP **	MDP Running or Alternating	MDP Standby	MOV _s and Breakers	AOV _s , SOV _s , HOV _s
All Plants	3	1.5	1.25	1.5	2	2	1.5

5 ** as applicable
6
7

1 Plant-Specific-specific Common Cause Adjustment

2 The plant-specific-specific correction factor should be calculated for each FV/UR ratio that is
3 used in the index. If the option to use a different ratio for each failure mode of a component is
4 used, then the ratio is calculated for each failure mode. The general form of a plant-specific-
5 specific common cause adjustment factor is given by the equation:

$$A = \frac{\left[\left(\sum_{i=1}^n FV_i \right) + FV_{cc} \right]}{\sum_{i=1}^n FV_i} \quad \text{Eq. 5}$$

7 Where:

8 n = is the number of components in a common cause group,

9 FV_i = the FV for independent failure of component i ,

10 and

11 FV_{cc} = the FV for the common cause failure of components in the group.

12
13 In the expression above, the FV_i are the values for the specific failure mode for the component
14 group that was chosen because it resulted in the maximum $[FV/UR]$ ratio. The FV_{cc} is the FV
15 that corresponds to all combinations of common cause events for that group of components for
16 the same specific failure mode. Note that the FV_{cc} may be a sum of individual FV_{cc} values that
17 represent different combinations of component failures in a common cause group.

18
19 For cooling water systems that have an initiator contribution, the FV values used should be from
20 the non-initiator part of the model.

21
22 For example consider again a plant with three one hundred percent capacity emergency diesel
23 generators. In this example, three failure modes for the EDG are modeled in the PRA, fail to start
24 (FTS), fail to load (FTL) and fail to run (FTR). Common cause events exist for each of the three
25 failure modes of the EDG in the following combinations:

- 26 1) Failure of all three EDGs,
- 27 2) Failure of EDG-A and EDG-B,
- 28 3) Failure of EDG-A and EDG-C,
- 29 4) Failure of EDG-B and EDG-C.

30 This results in a total of 12 common cause events.

31
32 Assume the maximum $[FV/UR]$ resulted from the FTS failure mode, then the FV_{cc} used in
33 equation 5 would be the sum of the four common cause FTS events for the combinations listed
34 above.

35
36 It is recognized that there is significant variation in the methods used to model common cause. It
37 is common that the 12 individual common cause events described above are combined into a
38 fewer number of events in many PRAs. Correct application of the plant-specific-specific method
39 would, in this case, require the decomposition of the combined events and their related FV
40 values into the individual parts. This can be accomplished by application of the following
41 proportionality:

1
$$FV_{part} = FV_{total} \times \frac{UR_{part}}{UR_{total}} \quad \text{Eq. 6}$$

2 Returning to the example above, assume that common cause was modeled in the PRA by
 3 combining all failure modes for each specific combination of equipment modeled. Thus there
 4 would be four common cause events corresponding to the four possible equipment groupings
 5 listed above, but each of the common cause events would include the three failure modes FTS,
 6 FTL and FTR. Again, assume the FTS independent failure mode is the event that resulted in the
 7 maximum [FV/UR] ratio. The FV_{cc} value to be used would be determined by determining the
 8 FTS contribution for each of the four common cause events. In the case of the event representing
 9 failure of all three EDGs this would be determined from

10
$$FV_{FTSABC} = FV_{ABC} \times \frac{UR_{FTSABC}}{UR_{ABC}}$$

11 Where,

- 12 FV_{FTSABC} = the FV for the FTS failure mode and the failure of all three EDGs
- 13 FV_{ABC} = the event from the PRA representing the failure of all three EDGs due to all
- 14 failure modes
- 15 UR_{FTSABC} = the failure probability for a FTS of all three EDGs, and
- 16 UR_{ABC} = the failure probability for all failure modes for the failure of all three EDGs.

17
 18 After this same calculation was performed for the remaining three common cause events, the
 19 value for FV_{CC} to be used in equation 5 would then be calculated from:

20
$$FV_{CC} = FV_{FTSABC} + FV_{FTSAB} + FV_{FTSAC} + FV_{FTSBC}$$

21
 22 This value is used in equation 5 to determine the value of A . The final quantity used in equation 4
 23 is given by:

24
$$[FV/UR]_{max} = A * [FV/UR]_{ind}$$

25
 26 In this case the individual values on the right hand side of the equation above are input to CDE.

27
 28 **F 2.3.5. BIRNBAUM IMPORTANCE**

29 One of the rules used for determining the valves and circuit breakers to be monitored in this
 30 performance indicator permitted the exclusion of valves and circuit breakers with a Birnbaum
 31 importance less than 1.0E-06. To apply this screening rule the Birnbaum importance is
 32 calculated from the values derived in this section as:

33
 34
$$B = CDF * A * [FV/UR]_{ind} = CDF * [FV/UR]_{max}$$

35
 36 Ensure that the support system initiator correction (if applicable) and the common cause
 37 correction are included in the Birnbaum value used to exclude components from monitoring.

38
 39

1 **F 2.3.6. CALCULATION OF UR_{DBC} , UR_{LBC} AND UR_{RBC}**

2 Equation 3 includes the three quantities UR_{DBC} , UR_{LBC} and UR_{RBC} which are the Bayesian
3 corrected plant-specific values of unreliability for the failure modes fail on demand,
4 fail to load/run and fail to run respectively. This section discusses the calculation of these
5 values. As discussed in section F 2.3 failure modes considered for each component type are
6 provided below.

7
8 Valves and Breakers:
9 Fail on Demand (Open/Close)

10 Pumps:
11 Fail on Demand (Start)
12 Fail to Run

13 Emergency Diesel Generators:
14 Fail on Demand (Start)
15 Fail to Load/Run
16 Fail to Run

17
18 UR_{DBC} is calculated as follows.¹

19
$$UR_{DBC} = \frac{(N_d + a)}{(a + b + D)} \quad \text{Eq. 7}$$

20 where in this expression:

21 N_d is the total number of failures on demand during the previous 12 quarters,
22 D is the total number of demands during the previous 12 quarters determined in
23 section 2.2.1

24 The values a and b are parameters of the industry prior, derived from
25 industry experience (see Table 48).

Dorathy
8/14/13

26
27 In the calculation of equation 7 the numbers of demands and failures is the sum of all demands
28 and failures for similar components within each system. Do not sum across units for a multi-unit
29 plant. For example, for a plant with two trains of Emergency Diesel Generators, the demands and
30 failures for both trains would be added together for one evaluation of equation 7 which would be
31 used for both trains of EDGs.

32
33 UR_{LBC} is calculated as follows.

34
$$UR_{LBC} = \frac{(N_l + a)}{(a + b + D)} \quad \text{Eq. 8}$$

35
36 where in this expression:

37 N_l is the total number of failures to load (applicable to EDG only) during the
38 previous 12 quarters,
39 D is the total number of load demands during the previous 12 quarters determined
40 in section 2.2.1

¹ Atwood, Corwin L., Constrained noninformative priors in risk assessment, *Reliability Engineering and System Safety*, 53 (1996; 37-46)

1 The values a and b are parameters of the industry prior, derived from industry
2 experience (see Table 4).

3
4 In the calculation of equation 8 the numbers of demands and failures is the sum of all demands
5 and failures for similar components within each system.

6
7 UR_{RBC} is calculated as follows.

$$8 \quad UR_{RBC} = \frac{(N_r + a)}{(T_r + b)} * T_m \quad \text{Eq. 9}$$

9 where:

10 N_r is the total number of failures to run during the previous 12 quarters
11 (determined in section 2.2.2),

12 T_r is the total number of run hours during the previous 12 quarters (determined in
13 section 2.2.1)

14 T_m is the mission time for the component based on plant-specific-specific PRA
15 model assumptions. For EDGs, the mission time associated with the Failure To
16 Run Basic Event with the highest Birnbaum value is to be used.¹ For all other
17 equipment, where there is more than one mission time for different initiating
18 events or sequences (e.g., turbine-driven AFW pump for loss of offsite power
19 with recovery versus loss of Feedwater), the longest mission time is to be used.
20 and

21 a and b are parameters of the industry prior, derived from industry experience (see
22 Table 4).

23
24 ~~Note, however, that even though a PRA mission time can be less than 24 hours, when~~
25 ~~determining if an MSPI failure has occurred, the monitored component must have been able to~~
26 ~~perform its monitored function for a 24 hour run.~~

Linthicum
3/3/12

27
28 In the calculation of equation 9 the numbers of demands and run hours is the sum of all run hours
29 and failures for similar components within each system. Do not sum across units for a multi-unit
30 plant, ~~unless the system is shared between multiple units~~. For example, a plant with two trains of
31 Emergency Diesel Generators, the run hours and failures for both trains would be added together
32 for one evaluation of equation 9 which would be used for both trains of EDGs.

Linthicum
3/3/12

¹ **NOTE: The basis document should be revised in 4Q2009 and applied for 1Q2010 data. Though the PRA mission time used in the MSPI calculations can be less than 24 hours for the EDGs, when determining if an MSPI failure has occurred, the EDG must have been able to perform its monitored function for a 24 hour run.**

Linthicum
3/3/12

1 **F 2.3.7. BASELINE UNRELIABILITY VALUES**

2 The baseline values for unreliability are contained in Table 8 and remain fixed.

3
4
5

Table 8. Industry Priors and Parameters for Unreliability

Component	Failure Mode	a ^a	b ^a	Industry Mean Value ^b URBLC
Circuit Breaker	Fail to open (or close)	4.99E-1	6.23E+2	8.00E-4
Hydraulic-operated valve	Fail to open (or close)	4.98E-1	4.98E+2	1.00E-3
Motor-operated valve	Fail to open (or close)	4.99E-1	7.12E+2	7.00E-4
Solenoid-operated valve	Fail to open (or close)	4.98E-1	4.98E+2	1.00E-3
Air-operated valve	Fail to open (or close)	4.98E-1	4.98E+2	1.00E-3
Motor-driven pump, standby	Fail to start	4.97E-1	2.61E+2	1.90E-3
	Fail to run	5.00E-1	1.00E+4	5.00E-5
Motor-driven pump, running or alternating	Fail to start	4.98E-1	4.98E+2	1.00E-3
	Fail to run	5.00E-1	1.00E+5	5.00E-6
Turbine-driven pump, AFWS	Fail to start	4.85E-1	5.33E+1	9.00E-3
	Fail to run	5.00E-1	2.50E+3	2.00E-4
Turbine-driven pump, HPCI or RCIC	Fail to start	4.78E-1	3.63E+1	1.30E-2
	Fail to run	5.00E-1	2.50E+3	2.00E-4
Diesel-driven pump, AFWS	Fail to start	4.80E-1	3.95E+1	1.20E-2
	Fail to run	5.00E-1	2.50E+3	2.00E-4
Emergency diesel generator	Fail to start	4.92E-1	9.79E+1	5.00E-3
	Fail to load/run	4.95E-1	1.64E+2	3.00E-3
	Fail to run	5.00E-1	6.25E+2	8.00E-4

6
7
8
9

a. A constrained, non-informative prior is assumed. For failure to run events, $a = 0.5$ and $b = (a)/(\text{mean rate})$. For failure upon demand events, a is a function of the mean probability:

Mean Probability	a
0.0 to 0.0025	0.50
>0.0025 to 0.010	0.49
>0.010 to 0.016	0.48
>0.016 to 0.023	0.47
>0.023 to 0.027	0.46

10
11
12
13
14
15
16
17

Then $b = (a)(1.0 - \text{mean probability})/(\text{mean probability})$.

b. Failure to run events occurring within the first hour of operation are included within the failure to start failure mode. Failure to run events occurring after the first hour of operation (after the first hour following closure of the load breaker for emergency power generators) are included within the failure to run failure mode.

1 **F 3. ESTABLISHING STATISTICAL SIGNIFICANCE**

2 This performance indicator establishes an acceptable level of performance for the monitored
3 systems that is reflected in the baseline reliability values in Table 4. Plant-specific differences
4 from this acceptable performance are interpreted in the context of the risk
5 significance of the difference from the acceptable performance level. It is expected that a system
6 that is performing at an acceptable performance level will see variations in performance over the
7 monitoring period. For example a system may, on average, see three failures in a three year
8 period at the accepted level of reliability. It is expected, due to normal performance variation,
9 that this system will sometimes experience two or four failures in a three year period. It is not
10 appropriate that a system should be placed in a white performance band due to expected
11 variation in measured performance. This problem is most noticeable for risk sensitive systems
12 that have few demands in the three year monitoring period.

13
14 This problem is resolved by applying a limit of 5.0E-07 to the magnitude of the most significant
15 failure in a system. This ensures that one failure beyond the expected number of failures alone
16 cannot result in MSPI > 1.0E-06. A MSPI > 1.0E-06 will still be a possible result if there is
17 significant system unavailability, or failures in other components in the system.

18
19 This limit on the maximum value of the most significant failure in a system is only applied if the
20 MSPI value calculated without the application of the limit is less than or equal to 1.0E-05.

21 This calculation will be performed by the CDE software; no additional input values are required.
22

23 **F 4. CALCULATION OF SYSTEM COMPONENT PERFORMANCE LIMITS**

24 The mitigating systems chosen to be monitored are generally the most important systems in
25 nuclear power stations. However, in some cases the system may not be as important at a specific
26 station. This is generally due to specific features at a plant, such as diverse methods of achieving
27 the same function as the monitored system. In these cases a significant degradation in
28 performance could occur before the risk significance reached a point where the MSPI would
29 cross the white boundary. In cases such as this it is not likely that the performance degradation
30 would be limited to that one system and may well involve cross cutting issues that would
31 potentially affect the performance of other mitigating systems.

32 A performance based criterion for determining declining performance is used as an additional
33 decision criterion for determining that performance of a mitigating system has degraded to the
34 white band. This decision is based on deviation of system performance from expected
35 performance. The decision criterion was developed such that a system is placed in the white
36 performance band when there is high confidence that system performance has degraded even
37 though MSPI \leq 1.0E-06.

Zimmerman
2/7/13

38
39 The criterion is applied to each component type in a system. If the number of failures in a 36
40 month period for a component type exceeds a performance based limit, then the system is
41 considered to be performing at a white level, regardless of the MSPI calculated value. The
42 performance based limit is calculated in two steps:

- 43 1. Determine the expected number of failures for a component type and
- 44 2. Calculate the performance limit from this value.

1 The expected number of failures is calculated from the relation

$$2 \quad Fe = Nd * p + \lambda * Tr$$

3 Where:

4 N_d is the number of demands

5 p is the probability of failure on demand, from Table 8 (URLBC).

6 λ is the failure rate, from Table 8 (URLBC)

7 T_r is the runtime of the component

8
9 This value is used in the following expression to determine the maximum number of failures:

$$10 \quad Fm = 4.65 * Fe + 4.2$$

11
12 If the actual number of failures (F_a) of a similar group of components (components that are
13 grouped for the purpose of pooling data) within a system in a 36 month period exceeds F_m , then
14 the system is placed in the white performance band or the level dictated by the MSPI calculation
15 if the MSPI calculation is $> 1E-5$.

16
17 This calculation will be performed by the CDE software, no additional input values are required.

18 19 **F 5. ADDITIONAL GUIDANCE FOR SPECIFIC SYSTEMS**

20 This section identifies the potential monitored functions for each system and describes typical
21 system scopes and train determinations.

22 23 **Emergency AC Power Systems**

24 25 **Scope**

26 The function monitored for the emergency AC power system is the ability of the emergency
27 generators to provide AC power to the class 1E buses following a loss of off-site power. The
28 emergency AC power system is typically comprised of two or more independent emergency
29 generators that provide AC power to class 1E buses following a loss of off-site power. The
30 emergency generator dedicated to providing AC power to the high pressure core spray system in
31 BWRs is not within the scope of emergency AC power.

32
33 The EDG component boundary includes the generator body, generator actuator, lubrication
34 system (local), fuel system (local or day tank and fuel oil transfer pumps/valves¹), cooling
35 components (local), startup air system receiver, exhaust and combustion air system, dedicated
36 diesel battery (which is not part of the normal DC distribution system), individual diesel
37 generator control system, cooling water isolation valves, circuit breaker for supply to safeguard
38 buses and their associated control circuit. Air compressors are not part of the EDG component
39 boundary.

FAQ484
(11-07)

40
41 The fuel oil transfer pumps required to meet the PRA mission time are within the **system-EDG**
42 **component** boundary, but are not considered to be a **separate** monitored component for reliability
43 monitoring in the EDG system. Additionally they are monitored for contribution to train
44 unavailability **only** if the fuel oil transfer pump(s) is (are) required to meet the EDG mission time

FAQ484
(11-07)

¹The word "valves" is included here for plants with a gravity-fed fuel oil transfer system. For these designs, the valve(s) provide the functional equivalent of the FOTP in pump-fed designs.

1 ~~(as specified in Section F.2.2.2 and as defined in the MSPI Definition of Terms section). an EDG~~
2 ~~train can only be supplied from a single transfer pump. Where the capability exists to supply an~~
3 ~~EDG from redundant transfer pumps, the contribution to the EDG MSPI from these components~~
4 ~~is expected to be small compared to the contribution from the EDG itself. Monitoring the transfer~~
5 ~~pumps for reliability is not practical because accurate estimations of demands and run hours are~~
6 ~~not feasible (due to the auto start and stop feature of the pump) considering the expected small~~
7 ~~contribution to the index. (See also the EDG Failure-to-Run definition in Section F.2.2.2 as~~
8 ~~revised by FAQ 11-08.)~~

FAQ484
(11-07)

9
10 Emergency generators that are not safety grade, or that serve a backup role only (e.g., an
11 alternate AC power source), are not included in the performance reporting.

12 13 **Train Determination**

14 The number of emergency AC power system trains for a unit is equal to the number of class 1E
15 emergency generators that are available to power safe-shutdown loads in the event of a loss of
16 off-site power for that unit. There are three typical configurations for EDGs at a multi-unit
17 station:

- 18 1. EDGs dedicated to only one unit.
- 19 2. One or more EDGs are available to “swing” to either unit
- 20 3. All EDGs can supply all units

21 For configuration 1, the number of trains for a unit is equal to the number of EDGs dedicated to
22 the unit. For configuration 2, the number of trains for a unit is equal to the number of dedicated
23 EDGs for that unit plus the number of “swing” EDGs available to that unit (i.e., The “swing”
24 EDGs are included in the train count for each unit). For configuration 3, the number of trains is
25 equal to the number of EDGs.

26 27 **Clarifying Notes**

28
29 An EDG is not considered to have failed due to any of the following events:

- 30 • spurious operation of a trip that would be bypassed in a loss of offsite power event
- 31 • malfunction of equipment that is not required to operate during a loss of offsite power event
32 (e.g., circuitry used to synchronize the EDG with off-site power sources)
- 33 • failure to start because a redundant portion of the starting system was intentionally disabled
34 for test purposes, if followed by a successful start with the starting system in its normal
35 alignment

36
37

1 **BWR High Pressure Injection Systems**

2
3 **(High Pressure Coolant Injection, High Pressure Core Spray, and Feedwater Coolant**
4 **Injection)**

5
6 **Scope**

7 These systems function at high pressure to maintain reactor coolant inventory and to remove
8 decay heat.

9
10 The function monitored for the indicator is the ability of the monitored system to take suction
11 from the suppression pool (and from the condensate storage tank, if required to meet the PRA
12 success criteria and mission times) and inject into the reactor vessel. . The mitigation of ATWS
13 events with a high pressure injection system is not considered a function to be monitored by the
14 MSPI. (Note, however, that the FV values will include ATWS events).

15
16 Plants should monitor either the high-pressure coolant injection (HPCI), the high-pressure core
17 spray (HPCS), or the feedwater coolant injection (FWCI) system, whichever is installed. The
18 turbine and governor and associated piping and valves for turbine steam supply and exhaust are
19 within the scope of the HPCI system. The flow path for the steam supply to a turbine driven
20 pump is included from the steam source (main steam lines) to the pump turbine. The motor
21 driven pump for HPCS and FWCI are in scope along with any valves that must change state such
22 as low flow valves in FWCI. Valves in the feedwater line are not considered within the scope of
23 these systems because they are normally open during operation and do not need to change state
24 for these systems to operate. However waterside valves up to the feedwater line are in scope if
25 they need to change state such as the HPCI injection valve.

26
27 The emergency generator dedicated to providing AC power to the high-pressure core spray
28 system is included in the scope of the HPCS. The HPCS system typically includes a "water leg"
29 pump to prevent water hammer in the HPCS piping to the reactor vessel. The "water leg" pump
30 and valves in the "water leg" pump flow path are ancillary components and are not included in
31 the scope of the HPCS system. Unavailability is not included while critical if the system is below
32 steam pressure specified in technical specifications at which the system can be operated.

33
34 **Oyster Creek**

35 For Oyster Creek the design does not include any high pressure injection system beyond the
36 normal feedwater system. For the BWR high pressure injection system, Oyster Creek will
37 monitor the Core Spray system, a low pressure injection system.

38
39 **Train Determination**

40 The HPCI and HPCS systems are considered single-train systems. The booster pump and other
41 small pumps are ancillary components not used in determining the number of trains. The effect
42 of these pumps on system performance is included in the system indicator to the extent their
43 failure detracts from the ability of the system to perform its monitored function. For the FWCI
44 system, the number of trains is determined by the number of feedwater pumps. The number of
45 condensate and feedwater booster pumps are not used to determine the number of trains. It is
46 recommended that the DG that provides dedicated power to the HPCS system be monitored as a

1 separate “train” (or segment) for unavailability as the risk importance of the DG is **less**
2 **different** than the fluid parts of the system.

3
4 **Reactor Core Isolation Cooling**
5 **(or Isolation Condenser)**

6
7 **Scope**

8 This system functions at high pressure to remove decay heat. The RCIC system also functions to
9 maintain reactor coolant inventory.

10
11 The function monitored for the indicator is the ability of the RCIC system to cool the reactor
12 vessel core and provide makeup water by taking suction from the suppression pool (and from the
13 condensate storage tank, if required to meet the PRA success criteria and mission times) and
14 inject into the reactor vessel

15
16 The Reactor Core Isolation Cooling (RCIC) system turbine, governor, and associated piping and
17 valves for steam supply and exhaust are within the scope of the RCIC system. Valves in the
18 feedwater line are not considered within the scope of the RCIC system because they are normally
19 open during operation and do not have to change state for RCIC to perform its function.

20
21 The function monitored for the Isolation Condenser is the ability to cool the reactor by
22 transferring heat from the reactor to the Isolation Condenser water volume. The Isolation
23 Condenser and inlet valves are within the scope of Isolation Condenser system along with the
24 connecting active valve for isolation condenser makeup. Unavailability is not included while
25 critical if the system is below steam pressure specified in technical specifications at which the
26 system can be operated.

27
28 **Train Determination**

29 The RCIC system is considered a single-train system. The condensate and vacuum pumps are
30 ancillary components not used in determining the number of trains. The effect of these pumps on
31 RCIC performance is included in the system indicator to the extent that a component failure
32 results in an inability of the system to perform its monitored function.

33
34 For Isolation Condensers, a train is a flow path from the reactor to the isolation condenser back
35 to the reactor. The connecting active valve for isolation condenser makeup is included in the
36 train.

37
38 **BWR Residual Heat Removal Systems**

39
40 **Scope**

41 The function monitored for the BWR residual heat removal (RHR) system is the ability of the
42 RHR system to provide suppression pool cooling. The pumps, heat exchangers, and associated
43 piping and valves for this function are included in the scope of the RHR system. If an RHR
44 system has pumps that do not perform a heat removal function (e.g. cannot connect to a heat
45 exchanger, dedicated LPCI pumps) they are not included in the scope of this indicator.

46

1
2 **Train Determination**

3 The number of trains in the RHR system is determined as follows. If the number of heat
4 exchangers and pumps is the same, the number of heat exchangers determines the number of
5 trains. If the number of heat exchangers and pumps are different, the number of trains should be
6 that used by the PRA model. Typically this would be two pumps and one heat exchanger
7 forming a train where the train is unavailable only if both pumps are unavailable, or two pumps
8 and one heat exchanger forming two trains with the heat exchanger as a shared component where
9 a train is unavailable if a pump is unavailable and both trains are unavailable if the heat
10 exchanger is unavailable.

11
12 **PWR High Pressure Safety Injection Systems**

13
14 **Scope**

15 These systems are used primarily to maintain reactor coolant inventory at high RCS pressures
16 following a loss of reactor coolant. HPSI system operation involves transferring an initial supply
17 of water from the refueling water storage tank (RWST) to cold leg piping of the reactor coolant
18 system. Once the RWST inventory is depleted, recirculation of water from the reactor building
19 emergency sump is required. The function monitored for HPSI is the ability of a HPSI train to
20 take a suction from the primary water source (typically, a borated water tank), or from the
21 containment emergency sump, and inject into the reactor coolant system.

22
23 The scope includes the pumps and associated piping and valves from both the refueling water
24 storage tank and from the containment sump to the pumps, and from the pumps into the reactor
25 coolant system piping. For plants where the high-pressure injection pump takes suction from the
26 residual heat removal pumps, the residual heat removal pump discharge header isolation valve to
27 the HPSI pump suction is included in the scope of HPSI system. Some components may be
28 included in the scope of more than one train. For example, cold-leg injection lines may be fed
29 from a common header that is supplied by both HPSI trains. In these cases, the effects of testing
30 or component failures in an injection line should be reported in both trains.

31
32 **Train Determination**

33 In general, the number of HPSI system trains is defined by the number of high head injection
34 paths that provide cold-leg and/or hot-leg injection capability, as applicable.

35
36 For Babcock and Wilcox (B&W) reactors, the design features centrifugal multi-stage pumps
37 used for high pressure injection (about 2,500 psig) and no hot-leg injection path. Recirculation
38 from the containment sump requires lining up the HPI pump suctions to the Low-Pressure
39 Injection (LPI) pump discharges for adequate NPSH. This is typically a two-train system, with
40 an installed spare pump (depending on plant-specific design) that can be aligned to either train.

41
42 For two-loop Westinghouse plants, the pumps operate at a lower pressure (about 1600 psig) and
43 there may be a hot-leg injection path in addition to a cold-leg injection path (both are included as
44 a part of the train).

1 For Westinghouse three-loop plants, the design features three centrifugal pumps that operate at
2 high pressure (about 2500 psig), a cold-leg injection path through the BIT (with two trains of
3 redundant valves), an alternate cold-leg injection path, and two hot-leg injection paths. One of
4 the pumps is considered an installed spare. Recirculation is provided by taking suction from the
5 RHR pump discharges. A train consists of a pump, the pump suction valves and boron injection
6 tank (BIT) injection line valves electrically associated with the pump, and the associated hot-leg
7 injection path. The alternate cold-leg injection path is required for recirculation, and should be
8 included in the train with which its isolation valve is electrically associated. This represents a
9 two-train HPSI system.

10
11 For Four-loop Westinghouse plants, the design features two centrifugal pumps that operate at
12 high pressure (about 2500 psig), two centrifugal pumps that operate at an intermediate pressure
13 (about 1600 psig), a BIT injection path (with two trains of injection valves), a cold-leg safety
14 injection path, and two hot-leg injection paths. Recirculation is provided by taking suction from
15 the RHR pump discharges. Each of two high pressure trains is comprised of a high pressure
16 centrifugal pump, the pump suction valves and BIT valves that are electrically associated with
17 the pump. Each of two intermediate pressure trains is comprised of the safety injection pump, the
18 suction valves and the hot-leg injection valves electrically associated with the pump. The cold-
19 leg safety injection path can be fed with either safety injection pump, thus it should be associated
20 with both intermediate pressure trains. This HPSI system is considered a four-train system for
21 monitoring purposes.

22
23 For Combustion Engineering (CE) plants, the design features two or three centrifugal pumps that
24 operate at intermediate pressure (about 1300 psig) and provide flow to four cold-leg injection
25 paths or two hot-leg injection paths. In most designs, the HPSI pumps take suction directly from
26 the containment sump for recirculation. In these cases, the sump suction valves are included
27 within the scope of the HPSI system. This is a two-train system (two trains of combined cold-leg
28 and hot-leg injection capability). One of the three pumps is typically an installed spare that can
29 be aligned to either train or only to one of the trains (depending on plant-specific design).

30 31 **PWR Auxiliary Feedwater Systems**

32 33 **Scope**

34 The function of the AFW system is to provide decay heat removal via the steam generators to
35 cool down and depressurize the reactor coolant system following a reactor trip. The mitigation of
36 ATWS events with the AFW system is not considered a function to be monitored by the MSPI.
37 (Note, however, that the FV values will include ATWS events).

38
39 The function monitored for the indicator is the ability of the AFW system to **autostart**, take
40 a suction from a water source (typically, the condensate storage tank and if required to meet
41 the PRA success criteria and mission time, from an alternate source) and to inject into at least
42 one steam generator.

FAQ486
(10-06)

43
44 The scope of the auxiliary feedwater (AFW) or emergency feedwater (EFW) systems includes
45 the pumps, **the condensate storage tank (CST), and** the components in the flow paths **from**
46 **between the pumps and the condensate storage tank** CST, and, if required, the valve(s) that

FAQ486
(10-06)

1 connect the alternative water source to the auxiliary feedwater system. The flow path for the
2 steam supply to a turbine driven pump is included from the steam source (main steam lines) to
3 the pump turbine. Pumps included in the Technical Specifications (subject to a Limiting
4 Condition for Operation) are included in the scope of this indicator. Some initiating events, such
5 as a feedwater line break, may require isolation of AFW flow to the affected steam generator to
6 prevent flow diversion from the unaffected steam generator. This function should be considered
7 a monitored function if it is required.
8

9 **Train Determination**

10 The number of trains is determined primarily by the number of parallel pumps. For example, a
11 system with three pumps is defined as a three-train system, whether it feeds two, three, or four
12 injection lines, and regardless of the flow capacity of the pumps. Some components may be
13 included in the scope of more than one train. For example, one set of flow regulating valves and
14 isolation valves in a three-pump, two-steam generator system are included in the motor-driven
15 pump train with which they are electrically associated, but they are also included (along with the
16 redundant set of valves) in the turbine-driven pump train. In these instances, the effects of testing
17 or failure of the valves should be reported in both affected trains. Similarly, when two trains
18 provide flow to a common header, the effect of isolation or flow regulating valve failures in
19 paths connected to the header should be considered in both trains.
20

21 **PWR Residual Heat Removal System**

22 **Scope**

23 The function monitored for the PWR residual heat removal (RHR) system is the long term decay
24 heat removal function to mitigate those transients that cannot rely on the steam generators alone
25 for decay heat removal. These typically include the low-pressure injection function and the
26 recirculation mode used to cool and recirculate water from the containment sump following
27 depletion of RWST inventory to provide decay heat removal. The pumps, heat exchangers, and
28 associated piping and valves for those functions are included in the scope of the RHR system.
29 Containment spray function should be included if it provides a risk significant decay heat
30 removal function. Containment spray systems that only provide containment pressure control are
31 not included.
32
33

34 **CE Designed NSSS**

35 CE ECCS designs differ from the description above. CE designs run all ECCS pumps during the
36 injection phase (Containment Spray (CS), High Pressure Safety Injection (HPSI), and Low
37 Pressure Safety Injection (LPSI)), and on Recirculation Actuation Signal (RAS), the LPSI
38 pumps are automatically shutdown, and the suction of the HPSI and CS pumps is shifted to the
39 containment sump. The HPSI pumps then provide the recirculation phase core injection, and the
40 CS pumps by drawing inventory out of the sump, cooling it in heat exchangers, and spraying the
41 cooled water into containment, support the core injection inventory cooling.
42

43 For the RHR function the CE plant design uses HPSI to take a suction from the sump, CS to cool
44 the fluid, and HPSI to inject at low pressure into the RCS. Due to these design differences, CE
45 plants with this design should monitor this function in the following manner. The two
46 containment spray pumps and associated coolers should be counted as two trains of RHR

1 providing the recirculation cooling. Therefore, for the CE designed plants two trains should be
2 monitored, as follows:

- 3 • Train 1 (recirculation mode) Consisting of the "A" containment spray pump, the required
4 spray pump heat exchanger and associated flow path valves.
- 5 • Train 2 (recirculation mode) Consisting of the "B" containment spray pump, the required
6 spray pump heat exchanger and associated flow path valves.

7 8 **Surry, North Anna and Beaver Valley Unit 1**

9 The at power RHR function, is provided by two 100% low head safety injection pumps taking
10 suction from the containment sump and injecting to the RCS at low pressure and with the heat
11 exchanger function (containment sump water cooling) provided by four 50% containment
12 recirculation spray system pumps and heat exchangers.

13 The RHR Performance Indicator should be calculated as follows. The low head safety injection
14 and recirculation spray pumps and associated coolers should be counted as two trains of RHR
15 providing the recirculation cooling, function as follows:

- 16 • "A" train consisting of the "A" LHSI pump, associated MOVS and the required "A" train
17 recirculation spray pumps heat exchangers, and MOVS.
- 18 • "B" train consisting of the "B" LHSI pump, associated MOVS and the required "B" train
19 recirculation spray pumps, heat exchangers, and MOVS.

20 21 **Beaver Valley Unit 2**

22 The at power RHR function, is provided by two 100% containment recirculation spray pumps
23 taking suction from the containment sump, and injecting to the RCS at low pressure. The heat
24 exchanger function is provided by two 100% capacity containment recirculation spray system
25 heat exchangers, one per train. The RHR Performance Indicator should be calculated as follows.
26 The two containment recirculation spray pumps and associated coolers should be counted as two
27 trains of RHR providing the recirculation cooling.

28 Two trains should be monitored as follows:

- 29 • Train 1 (recirculation mode) Consisting of the containment recirculation spray pump
30 associated MOVS and the required recirculation spray pump heat exchanger and MOVS.
- 31 • Train 2 (recirculation mode) Consisting of containment recirculation spray pump
32 associated MOVS and the required recirculation spray pump heat exchanger, and MOVS.

33 34 **Train Determination**

35 The number of trains in the RHR system is determined by the number of parallel RHR heat
36 exchangers. Some components are used to provide more than one function of RHR. If a
37 component cannot perform as designed, rendering its associated train incapable of meeting one
38 of the monitored functions, then the train is considered to be failed. Unavailable hours would be
39 reported as a result of the component failure.

1 Cooling Water Support System

3 Scope

4 The functions monitored for the cooling water support system are those functions that are
5 necessary (i.e. Technical Specification-required) to provide for direct cooling of the components
6 in ~~the other~~ monitored ~~system~~ trains or segments of systems supported by the cooling water
7 system. It does not include indirect cooling provided by room coolers or other HVAC features.

FAQ482
(11-01)

8
9 Systems that provide this function typically include service water and component cooling water
10 or their cooling water equivalents. ~~Service water systems are typically open “raw water”~~
11 ~~systems that use natural sources of water such as rivers, lakes, or oceans. Component cooling~~
12 ~~water systems are typically closed “clean water” systems.~~

FAQ482
(11-01)

13
14 Pumps, valves, heat exchangers and line segments that are necessary to provide cooling to ~~the~~
15 ~~other~~ monitored trains or segments of system(s) supported by the cooling water system ~~systems~~
16 are included within the cooling water system ~~scope~~ boundary up to, but not including, the ~~last~~
17 ~~isolation~~ valve(s) that connects the cooling water ~~support~~ system to components in a single
18 monitored train or segment of the supported system. This ~~last isolation~~ valve is included within
19 the ~~other~~ boundary of the monitored train or segment of the supported system ~~boundary~~. ~~If~~
20 ~~the~~ The last valve(s) that provides cooling to SSCs in more than one monitored train or segment
21 of supported system(s), ~~then it~~ is included within the boundary of the cooling water ~~support~~
22 system. All valves (e.g., manual isolation valves or motor operated valves) in a cooling water
23 line to a single monitored train or segment of a supported system are included within the
24 boundary of the monitored train or segment of the supported system. Figure F-6 depicts this
25 concept and the treatment of multiple isolation valves. The SSCs outside the dashed boxes are
26 included within the boundary of the cooling water system. The SSCs within the dashed boxes
27 are included within the boundaries of the supported systems. ~~Service water systems are typically~~
28 ~~open “raw water” systems that use natural sources of water such as rivers, lakes or oceans.~~
29 ~~Component Cooling Water systems are typically closed “clean water” systems.~~

FAQ482
(11-01)

30
31 Valves in the cooling water support system that must close to ensure sufficient cooling to the
32 other monitored system components to meet risk significant functions are included in the system
33 boundary.

34
35 If a cooling water system provides cooling to only one monitored system, then it should be
36 included in the scope of that monitored system. Systems that are dedicated to cooling RHR heat
37 exchangers only are included in the cooling water support system scope.

39 Train Determination

40 The number of trains in the Cooling Water Support System will vary considerably from plant to
41 plant. The way these functions are modeled in the plant-specific PRA will determine a logical
42 approach for train determination. For example, if the PRA modeled separate pump and line
43 segments, then the number of pumps and line segments would be the number of trains.

1 **Clarifying Notes**

2 Service water pump strainers, cyclone separators, and traveling screens are not considered to be
3 monitored components and are therefore not part of URI. However, clogging of strainers and
4 screens that render the train unavailable to perform its monitored cooling function (which
5 includes the mission times) are included in UAI. Note, however, if the service water pumps fail
6 due to a problem with the strainers, cyclone separators, or traveling screens, the failure is
7 included in the URI.
8
9

10 **F 6. CALCULATION OF THE BIRNBAUM IMPORTANCE BY REQUANTIFICATION**

11 This section provides an alternative to the method outlined in sections F 1.3.1-F 1.3.3 and F
12 2.3.1-F 2.3.3. If ~~you are using~~ the method outlined in this section ~~is used~~, ~~do not perform~~ the
13 calculations outlined in sections F 1.3.1-F 1.3.3 and F 2.3.1-F 2.3.3 ~~are not applicable~~.

Linthicum
3/3/12

14 The truncation level used for the method described in this section should be sufficient to
15 provide a converged value of CDF. CDF is considered to be converged when decreasing the
16 truncation level by a decade results in a change in CDF of less than 5%.

17 The Birnbaum importance measure can be calculated from:

18
$$B = CDF_1 - CDF_0$$

19 or

20
$$B = \frac{CDF_1 - CDF_B}{1 - p}$$

21 Where

22 CDF_1 is the Core Damage Frequency with the failure probability for the component (any
23 representative basic event) set to one,

24 CDF_0 is the Core Damage Frequency with the failure probability for the component (any
25 representative basic event) set to zero,

26 CDF_B is the Base Case Core Damage Frequency,

27 and

28 p is the failure probability of the representative basic event.

29 As a special case, if the component is truncated from the base case then

30
$$CDF_B = CDF_0$$

31 and

32
$$B = CDF_1 - CDF_B$$

33
34 With the Birnbaum importance calculated directly by re-quantification, the CDE input values
35 must be calculated from this quantity.

36
37 The CDF value input to CDE for this method is the value of CDF_B from the baseline
38 quantification.

1
2 The value of UA or UR is taken from the representative basic event (p) used in the
3 quantification above. The FV value is then calculated from the expression
4

5
$$FV = \frac{B * p}{CDF}$$

6

Figure F-1

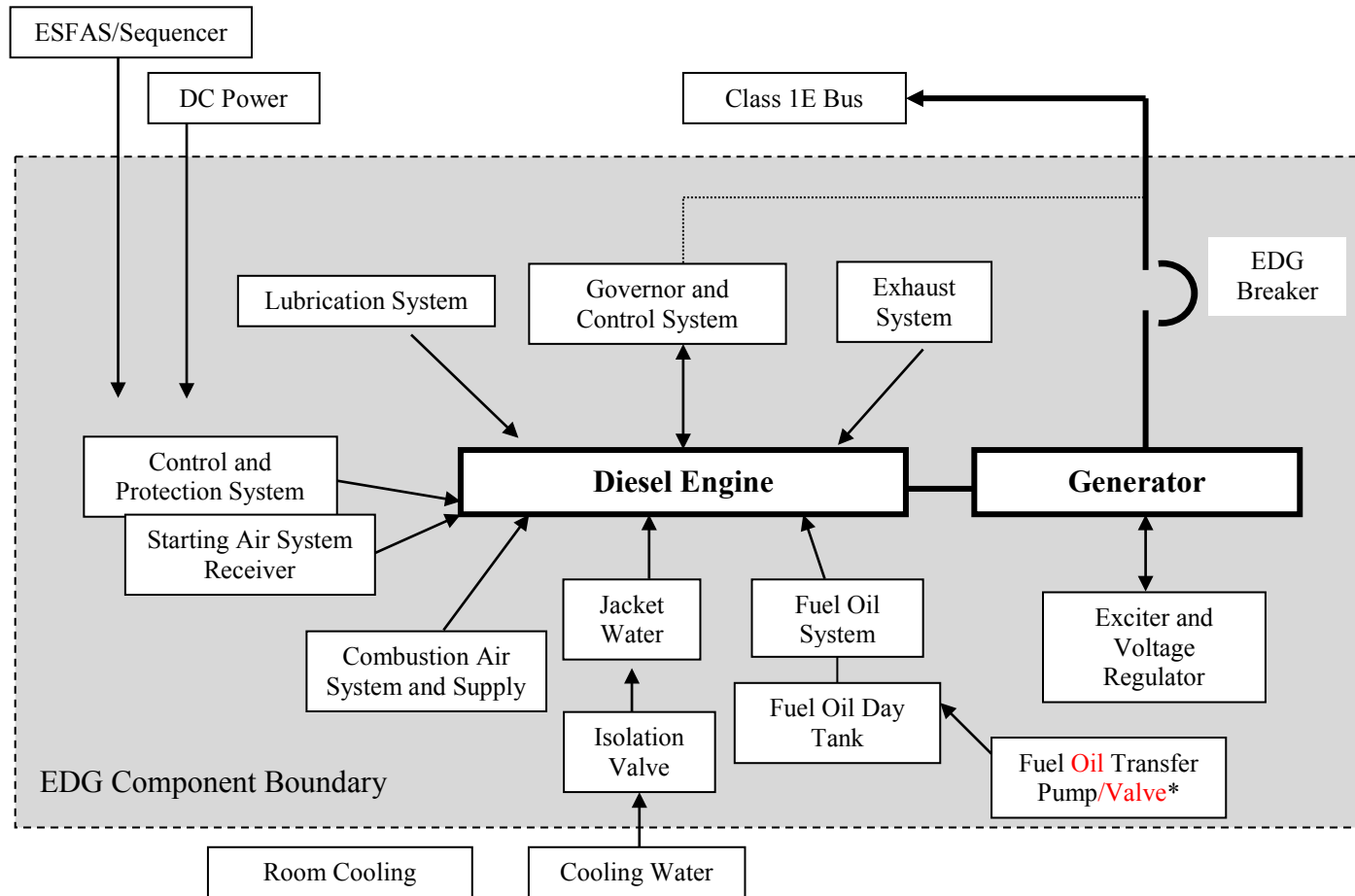

1

2
3

* The Fuel Oil Transfer Pump(s)/Valve(s) are/is included in the EDG System-Component Boundary. See Section 5 for monitoring requirements.

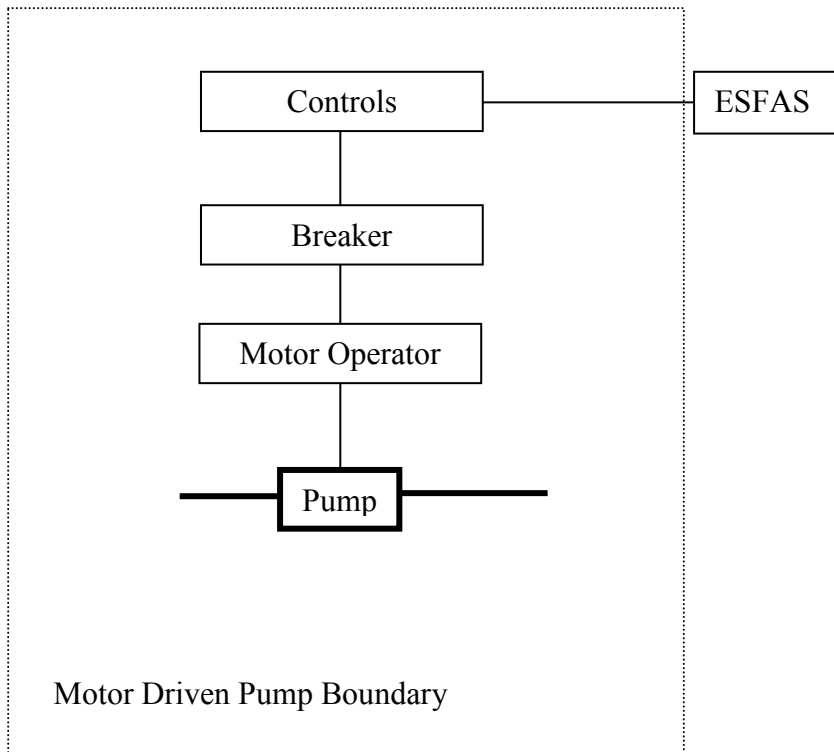

Motor Driven Pump Boundary

Figure F-2

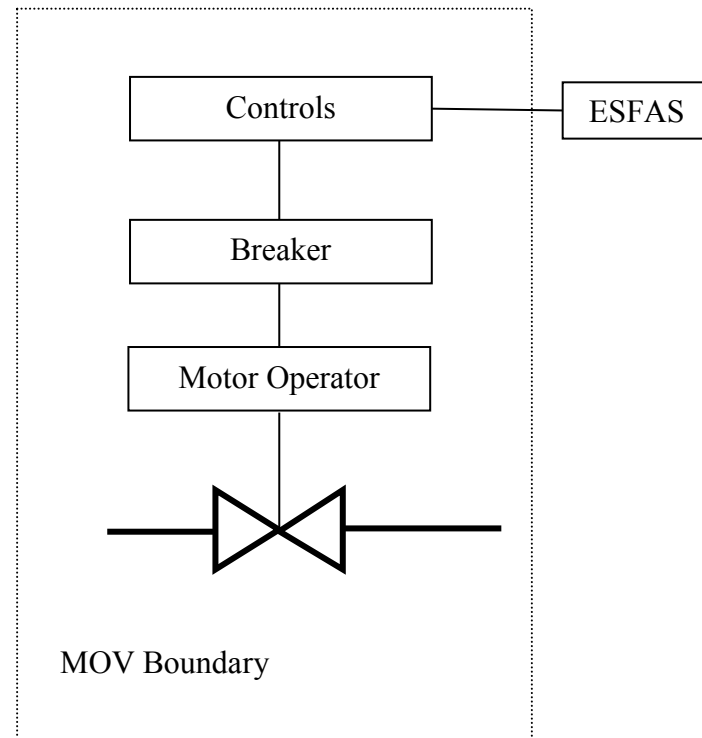

MOV Boundary

Figure F-3

1
2

1
2

Figure F-4

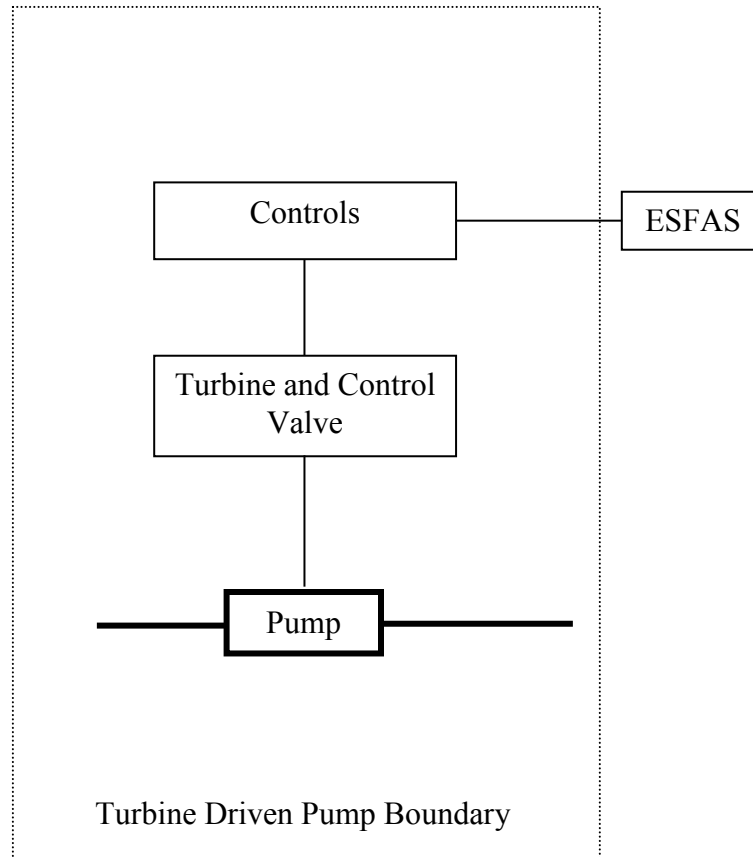

3
4

1
2
3
4

Figure F-5

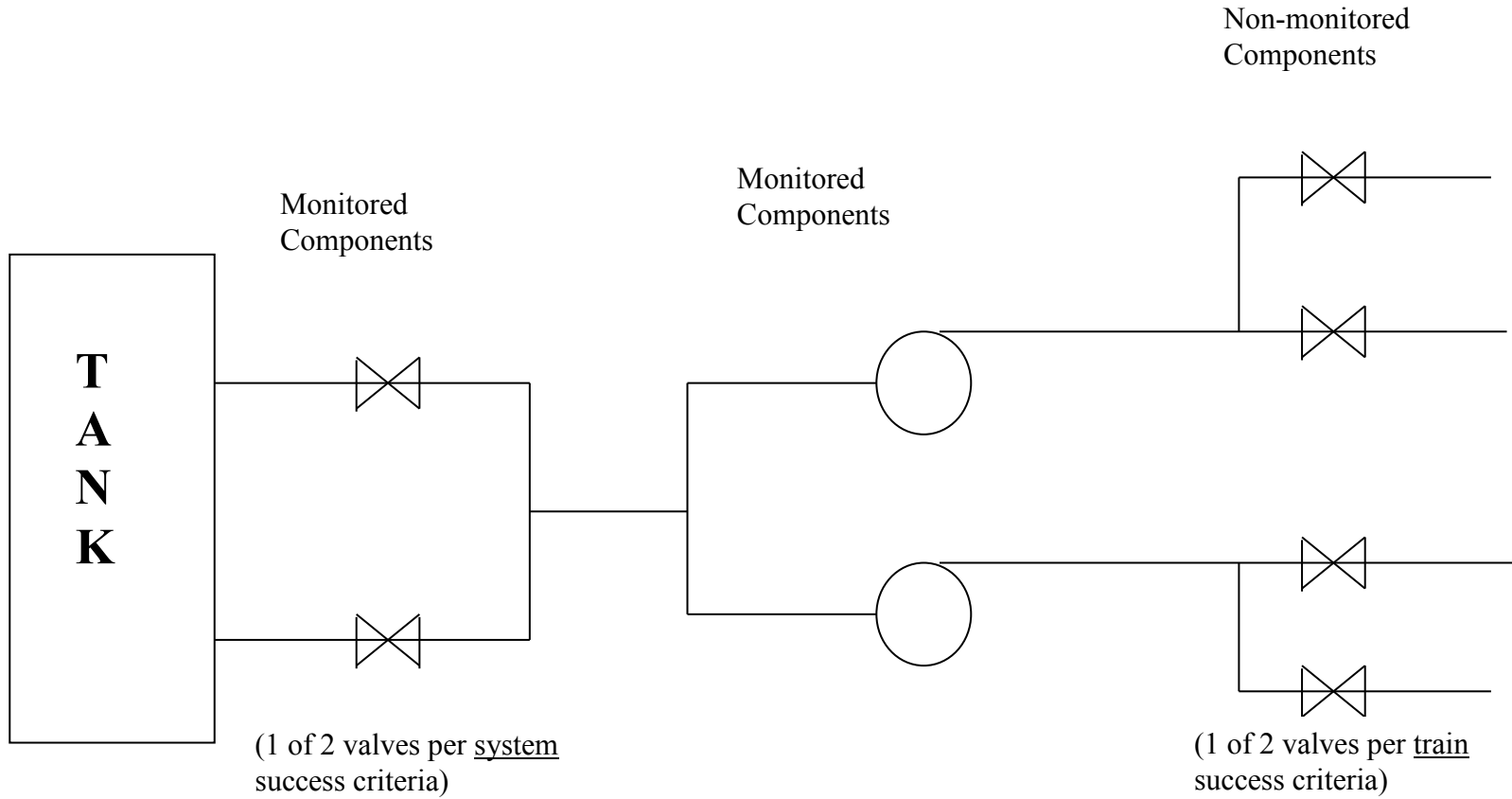

5
6
7
8

1
2

Figure F-6

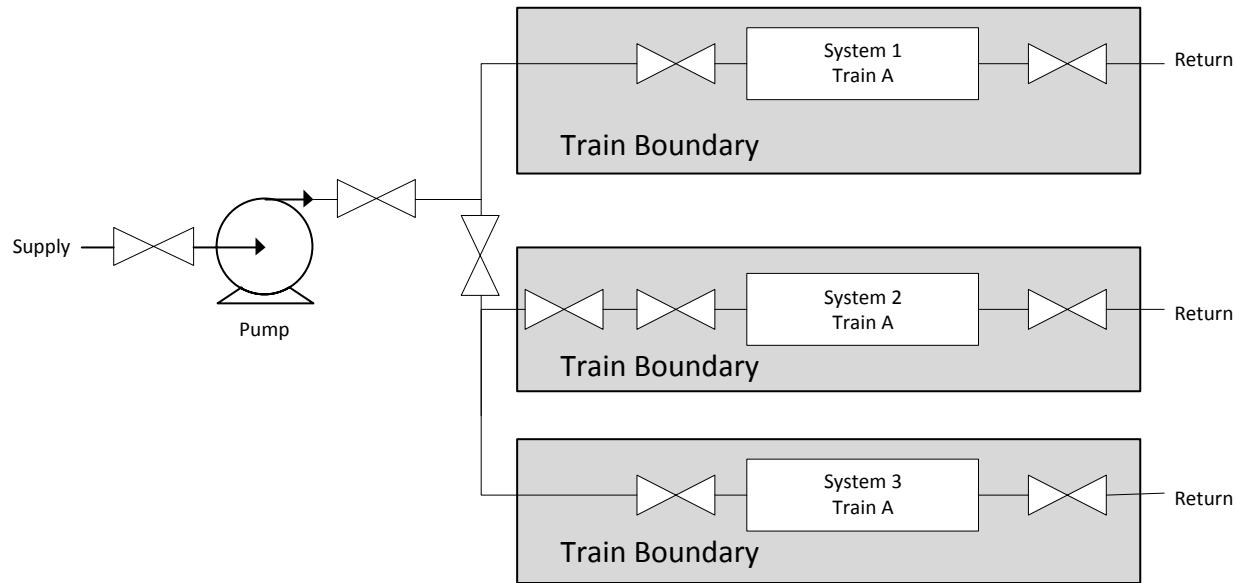

3
4
5

FAQ 482
(11-01)

APPENDIX G

MSPI Basis Document Development

To implement the Mitigating Systems Performance Index (MSPI), Licensees will develop a plant ~~specific~~ **specific** basis document that documents the information and assumptions used to calculate the Reactor Oversight Program (ROP) MSPI. This basis document is necessary to support the NRC inspection process, and to record the assumptions and data used in developing the MSPI on each site. A summary of any changes to the basis document are noted in the comment section of the quarterly data submission to the NRC.

The Basis document will have two major sections. The first described below will document the information used in developing the MSPI. The second section will document the conformance of the plant specific PRA to the requirements that are outlined in this appendix.

G 1. MSPI Data

The basis document provides a separate section for each monitored system as defined in Section 2.2 of NEI 99-02. The section for each monitored system contains the following subsections:

G 1.1 System Boundaries

This section contains a description of the boundaries for each train of the monitored system. A plant drawing or figure (training type figure) should be included and marked adequately (i.e., highlighted trains) to show the boundaries. The guidance for determining the boundaries is provided in Appendix F, Section 1.1 of NEI 99-02.

G 1.2 Risk Significant Functions

This section lists the risk significant functions for each train of the monitored system. Risk Significant Functions are defined in section 2.2 of NEI 99-02. Additional detail is given in Appendix F, Section 1.1.1 and Section 5 “Additional Guidance for Specific Systems”. A single list for the system may be used as long as any differences between trains are clearly identified. This section may also be combined with the section on Success Criteria if a combination of information into a table format is desired. If none of the functions for the system are considered risk significant, identify the monitored function as defined in section F 1.1.1

G 1.3 Success Criteria

This section documents the success criteria as defined in Section 2.2 of NEI 99-02 for each of the identified monitored functions for the system. Additional detail is given in Appendix F, Section 2.1.1. **The criteria used are the documented PRA success criteria.**

- If the licensee has chosen to use design basis success criteria in the PRA, then provide a statement in this section that states the PRA uses design basis success criteria.
- If success criteria from the PRA are different from the design basis, then the specific differences from the design basis success criteria shall be documented in this section.

1 Provide the actual values used to characterize success such as: *The time required in the*
2 *PRA for the EDG to successfully reach rated speed and voltage is 15 seconds.*

3 | Where there are different success criteria for different monitored functions or different success
4 criteria for different initiators within a monitored function, all should be recorded and the most
5 restrictive shown as the one used, **with the exception of ATWS-related success criteria which**
6 **are not in the scope of MSPI.**

Linthicum
3/3/12

8 **G 1.4 Mission Time**

9 This section documents the risk significant mission time, as defined in Section 2.3.6 of
10 Appendix F, for each of the identified monitored functions identified for the system. The
11 following specific information should be included in support of the EDG mission time if a value
12 less than 24 hours is used:

- 13 • EDG Mission Time with highest Birnbaum
- 14 • Basic Event and Description (basis for Birnbaum)
- 15 • Other Emergency Power Failure to Run Basic Events, Descriptions, mission time and
- 16 Birnbaums (those not selected)
- 17 • Method for reduced mission time (e.g., Convolution, Multiple Discrete LOOP (Loss of
- 18 Offsite Power) Initiating Events, Other)
- 19 • Loss of Offsite Power (LOOP) Initiating Events, Description and Frequency
- 20 • Basis for LOOP Frequency (Industry/NRC Reference)
- 21 • Basis for LOOP Non-recovery Failure (Industry/NRC Reference)
- 22 • Credit for Emergency Power Repair (Yes/No)
- 23 • If repair credited, failure probability of repair and basis

25 **G 1.5 Monitored Components**

26 | This section documents the selection of monitored components as defined in Appendix F,
27 Section 2.1.2 of NEI 99-02 in each train of the monitored system. A listing of all monitored
28 pumps, breakers and **EDGs-emergency power generators** should be included in this section. A
29 listing of AOVs, HOVs, SOVs and MOVs that change state to achieve the monitored
30 functions should be provided as potential monitored components. The basis for excluding valves
31 **and breakers** in this list from monitoring should be provided. Component boundaries as
32 described in Appendix F, Section 2.1.3 of NEI 99-02 should be included where appropriate.

Linthicum
3/3/12

34 **G 1.6 Basis for Demands/Run Hours (estimate or actual)**

35 The determination of reliability largely relies on the values of demands, run hours and failures of
36 components to develop a failure rate. This section documents how the licensee will determine
37 the demands on a component. Several methods may be used.

- 38 • Actual counting of demands/run hours during the reporting period
- 39 • An estimate of demands/run hours based on the number of times a procedure or other
- 40 activities are performed plus either actual ESF demands/run hours or “zero” ESF
- 41 demands/run hours
- 42 • An estimate based on historical data over a year or more averaged for a quarterly average
- 43 plus either actual ESF demands/run hours or “zero” ESF demands/run hours

44 The method used, either actual or estimated values, shall be stated. If estimates are used for test
45 or operational demands or run hours then the process used for developing the estimates shall be

1 described and estimated values documented. If the estimates are based on performance of
2 procedures, list the procedures and the frequencies of performance that were used to develop the
3 estimates.
4

5 **G 1.7 Short Duration Unavailability**

6 This section provides a list of any periodic surveillances or evolutions of less than 15 minutes of
7 unavailability that the licensee does not include in train unavailability. The intent is to minimize
8 unnecessary burden of data collection, documentation, and verification because these short
9 durations have insignificant risk impact.
10

11 **G 1.8 PRA Information used in the MSPI**

12 **G 1.8.1 Unavailability FV and UA**

13 This section includes a table or spreadsheet that lists the basic events for unavailability for each
14 train of the monitored systems. This listing should include the probability, FV, and
15 FV/probability ratio and text description of the basic event or component ID. An example format
16 is provided as Table 1 at the end of this appendix. If the event chosen to represent the train is not
17 the event that results in the largest ratio, provide information that describes the basis for the
18 choice of the specific event that was used.
19
20

21 **G 1.8.1.1 Unavailability Baseline Data**

22 This section includes the baseline unavailability data by train for each monitored system. The
23 discussion should include the basis for the baseline values used. The detailed basis for the
24 baseline data may be included in an appendix to the MSPI Basis Document if desired.
25

26 The basis document should include the specific values for the planned and unplanned
27 unavailability baseline values that are used for each train or segment in the system.
28

29 **G 1.8.1.2 Treatment of Support System Initiator(s)**

30 This section documents whether the cooling water systems are an initiator or not. This section
31 provides a description of how the plant will include the support system initiator(s) as described
32 in Appendix F of NEI 99-02. If an analysis is performed for a plant-specific value, the
33 calculation must be documented in accordance with plant processes and referred to here. The
34 results should also be included in this section. A sample table format for presenting the results of
35 a plant-specific calculation for those plants that do not explicitly model the effect on the
36 initiating event contribution to risk is shown in Table 4 at the end of this appendix.
37

38 **G 1.8.2 Unreliability FV and UR**

39 There are two options described in Appendix F for the selection of FV and UR values, the
40 selected option should be identified in this section. This section also includes a table or
41 spreadsheet that lists the PRA information for each monitored component. This listing should
42 include the Component ID, event probability, FV, the common cause adjustment factor and
43 FV/probability ratio and text description of the basic event or component ID. An example format
44 is provided as Table 2 at the end of this appendix. If individual failure mode ratios (vice the
45 maximum ratio) will be used in the calculation of MSPI, then each failure mode for each
46 component will be listed in the table.

1
2 A separate table should be provided in an appendix to the basis document that provides the
3 complete set of basic events for each component. An example of this for one component is
4 shown in Table 3 at the end of this appendix. Only the basic event chosen for the MSPI
5 calculation requires completion of all table entries.
6

7 **G 1.8.2.1 Treatment of Support System Initiator(s)**

8 This section documents whether the cooling water systems are an initiator or not. This section
9 provides a description of how the plant will include the support system initiator(s) as described
10 in Appendix F of NEI 99-02. If an analysis is performed for a plant-specific value, the
11 calculation must be documented in accordance with plant processes and referred to here. The
12 results should also be included in this section. A sample table format for presenting the results of
13 a plant-specific calculation for those plants that do not explicitly model the effect on the
14 initiating event contribution to risk is shown in Table 4 at the end of this appendix.
15

16 **G 1.8.2.2 Calculation of Common Cause Factor**

17 This section contains the description of how the plant will determine the common cause factor as
18 described in Appendix F of NEI 99-02. If an analysis is performed for a plant-specific
19 value, the calculation must be documented in accordance with plant processes and referred to
20 here. The results should also be included in this section.
21
22

23 **G 1.9 Assumptions**

24 This section documents any specific assumptions made in determination of the MSPI
25 information that may need to be documented. Causes for documentation in this section could be
26 special methods of counting hours or runtimes based on plant-specific designs or
27 processes, or other instances not clearly covered by the guidance in NEI 99-02.
28

29 **G 2. PRA Requirements**

30 **G 2.1 Discussion**

31 The MSPI application can be considered a Phase 2 application under the NRC's phased approach
32 to PRA quality. The MSPI is an index that is based on internal initiating events, full-power
33 PRA, for which the ASME Standard has been written. The Standard has been endorsed by the
34 staff in RG 1.200, which has been issued for trial use.
35
36

37 Licensees should assure that their PRA is of sufficient technical adequacy to support the MSPI
38 application by one of the following alternatives:
39

40 **G 2.1.1 Alternative A (Consistent with MSPI PRA Task Group recommendations)**

- 41
42 a) Resolve the peer review Facts and Observations (F&Os) for the plant PRA that are
43 classified as being in category A or B, or document the basis for a determination that any
44 open A or B F&Os will not significantly impact the MSPI calculation. Open A or B F&Os
45 are significant if collectively their resolution impacts any Birnbaum values used in MSPI
46 by more than a factor of 3. Appropriate sensitivity studies may be performed to quantify

1 the impact. If an open A or B F&O cannot be resolved by April 1, 2006 and significantly
2 impacts the MSPI calculation, a modified Birnbaum value equal to a factor of 3 times the
3 median Birnbaum value from the associated cross comparison group for pumps/diesels and
4 3 times the plant values for valves/breakers should be used in the MSPI calculation at the
5 index, system or component level, as appropriate, until the F&O is resolved.
6

7 **And**
8

- 9 b) Perform a self assessment using the NEI-00-02 process as modified by Appendix B of RG
10 1.200 for the ASME PRA Standard supporting level requirements identified by the MSPI
11 PRA task group and resolve any identified issues or document the basis for a determination
12 that any open issues will not significantly impact the MSPI calculation. Identified issues
13 are considered significant if they impact any Birnbaum values used in MSPI by more than a
14 factor of 3. Appropriate sensitivity studies may be performed to quantify the impact. If an
15 identified issue cannot be resolved by April 1, 2006 and significantly impacts the MSPI
16 calculation, a modified Birnbaum value equal to a factor of 3 times the median Birnbaum
17 value from the associated cross comparison group for pumps/diesels and 3 times the plant
18 value for valves/breakers should be used in the MSPI calculation at the index, system or
19 component level, as appropriate, until the issue is resolved.
20

21 **G 2.1.2 Alternative B (Consistent with RG 1.174 guidance)**
22

- 23 a) Resolve the peer review Facts and Observations (F&Os) for the plant PRA that are
24 classified as being in category A or B, or document the basis for a determination that any
25 open A or B F&Os will not significantly impact the MSPI calculation. Open A or B F&Os
26 are significant if collectively their resolution impacts any Birnbaum values used in MSPI
27 by more than a factor of 3. Appropriate sensitivity studies may be performed to quantify
28 the impact. If an open A or B F&O cannot be resolved by April 1, 2006 and significantly
29 impacts the MSPI calculation, a modified Birnbaum value equal to a factor of 3 times the
30 median Birnbaum value from the associated cross comparison group for pumps/diesels and
31 3 times the plant values for valves/breakers should be used in the MSPI calculation at the
32 index, system or component level, as appropriate, until the F&O is resolved.
33
34

35 **And**
36

- 37 b) Disposition any candidate outlier issues identified by the industry PRA cross comparison
38 activity. The disposition of candidate outlier issues can be accomplished by:
39
- 40 • Correcting or updating the PRA model;
 - 41 • Demonstrating that outlier identification was due to valid design or PRA modeling
42 methods; or
 - 43 • Using a modified Birnbaum value equal to a factor of 3 times the median value from the
44 associated cross comparison group for pumps/diesels and 3 times the plant value for
45 valves/breakers until the PRA model is corrected or updated.
46

1
2
3
4
5
6
7
8
9
10
11
12
13
14
15
16
17
18
19
20
21
22
23
24
25
26

G 2.2 PRA MSPI Documentation Requirements

- A. Licensees should provide a summary of their PRA models to include the following:
 - 1. Approved version and date used to develop MSPI data
 - 2. Plant base CDF for MSPI
 - 3. Truncation level used to develop MSPI data

- B. Licensees should document the technical adequacy of their PRA models, including:
 - 1. Justification for any open category A or B F&Os that will not be resolved prior to April 1, 2006.
 - 2. Justification for any open issues from:
 - a. the self-assessment performed for the supporting requirements (SR) identified in Table 5, taking into consideration Appendix B of RG 1.200 (trial), with particular attention to the notes in Table 4 of the MSPI PRA task group report.
 - **OR** --
 - b. identification of any candidate outliers for the plant from the group cross-comparison studies.

- C. Licensees should document in their PRA archival documentation:
 - 1. A description of the resolution of the A and B category F&Os identified by the peer review team.
 - 2. Technical bases for the PRA.

1
2
3
4
5
6
7
8
9
10

G 3. TABLES

Table G 1 Unavailability Data HPSI (one table per system)

Train	Basic Event Name	Basic Event Description	Basic Event Probability (UAP)	Basic Event FVUAP ¹	FVUAP/UAP
A	1SIAP02----MP6CM	HPSI Pump A Unavailable Due to Mntc	3.20E-03	3.19E-03	9.97E-01
B	1SIBP02----MP6CM	HPSI Pump B Unavailable Due to Mntc	3.20E-03	3.85E-03	1.20E+00

1. Adjusted for IEF correction if used

Table G 2 – AFW System Monitored Component PRA Information

Component	Basic Event	Description	Basic Event Probability (URPC)	Basic Event FVURC	[FV/UR]ind	CC Adjustment Factor (A)	CC Adjustment Used	Adjusted Birnbaum
1MAFAP01	1AFASYS----AFACM	Train A Auxiliary Feedwater Pump Fails to Start	2.75E-03	2.33E-02	8.49E+00	1	Generic	1.1E-04
1MAFBP01	1AFBP01----MPAFS	Train B Auxiliary Feedwater Pump Fails to Start	6.73E-04	4.44E-02	6.59E+01	1.25	Generic	1.1E-03
1MAFNP01	1AFNSYS----AFNCM	Train N Auxiliary Feedwater Pump Fails to Start	1.05E-03	1.10E-02	1.05E+01	1.25	Generic	1.7E-04
1JCTAHV0001	1CTAHV001--MV-FO	CST to AFW Pump N Supply Valve HV1 Fails to Open (Local Fault)	3.17E-03	2.48E-02	7.83E+00	2	Generic	2.0E-04
1JCTAHV0004	1CTAHV004--MV-FO	CST to AFW Pump N Supply Valve HV4 Fails to Open (Local Fault)	3.17E-03	2.48E-02	7.83E+00	2	Generic	2.0E-04

1 **Table G 3 - Unreliability Data (one table per monitored component)**

2 **Component Name and ID: HPSI Pump B - 1SIBP02**

Basic Event Name	Basic Event Description	Basic Event Probability (URPC)	Basic Event FVURC ₁	[FV/UR] _{in d}	Common Cause Adjustment Factor (CCF)	Common Cause Adjustment Generic or Plant-Specific	Adjusted Birnbaum
1SIBP02---XCYXOR	HPSI Pump B Fails to Start Due to Override Contact Failure	6.81E-04	7.71E-04	1.13E+00	3.0	Generic	5.0E-05
1SIBP02----MPAFS	HPSI Pump B Fails to Start (Local Fault)	6.73E-04	7.62E-04	1.13E+00			
1SIBP02----MP-FR	HPSI Pump B Fails to Run	4.80E-04	5.33E-04	1.11E+00			
1SABHP-K125RXAFT	HPSI Pump B Fails to Start Due to K125 Failure	3.27E-04	3.56E-04	1.09E+00			
1SIBP02----CB0CM	HPSI Pump B Circuit Breaker (PBB-S04E) Unavailable Due to Mntc	2.20E-04	2.32E-04	1.05E+00			
1SIBP02----CBBFT	HPSI Pump B Circuit Breaker (PBB-S04E) Fails to Close (Local Fault)	2.04E-04	2.14E-04	1.05E+00			

3 **1. Adjusted for IEF correction if used**

4

5 **Table G 4 Cooling Water Support System FV Calculation Results (one table per train/component/failure mode)**

FV _a (or FV _c)	FV _{ie}	FV _{sa} (or FV _{sc})	UA (or UR)	Calculated FV (per appendix F) (result is put in Basic Event column of table 1 or table 2 as appropriate)

6

TABLE G 5. ASME PRA Standard Supporting Requirements Requiring Self-Assessment	
Supporting Requirement	Comments
IE-A4	Focus on plant-specific initiators and special initiators, especially loss of DC bus, Loss of AC bus, or Loss of room cooling type initiators
IE-A7	Category I in general. However, precursors to losses of cooling water systems in particular, e.g., from fouling of intake structures, may indicate potential failure mechanisms to be taken into account in the system analysis (IE-C6, 7, 8, 9)
IE-A9	Category II for plants that choose fault trees to model support systems. Watch for initiating event frequencies that are substantially (e.g., more than 3 times) below generic values.
IE-C1	Focus on loss of offsite power (LOOP) frequency as a function of duration
IE-C2	Focus on LOOP and medium and small LOCA frequencies including stuck open PORVs
IE-C6	For plants that choose fault trees for support systems, attention to loss of cooling systems initiators.
IE-C9	Category II for plants that choose fault trees for support systems. Pay attention to initiating event frequencies that are substantially (i.e., more than 3 times) below generic values
AS-A3	Focus on credit for alternate sources, e.g., gas turbines, CRD, fire water, SW cross-tie, recovery of FW
AS-A4	Focus on credit for alternate sources, e.g., gas turbines, CRD, fire water, SW cross-tie, recovery of FW
AS-A5	Focus on credit for alternate sources, e.g., gas turbines, CRD, fire water, SW cross-tie, recovery of FW
AS-A9	Category II for MSPI systems and components and for systems such as CRD, fire water, SW cross-tie, recovery of FW
AS-A10	Category II in particular for alternate systems where the operator actions may be significantly different, e.g., more complex, more time limited.
AS-B3	Focus on credit for injection post-venting (NPSH issues, environmental survivability, etc.)
AS-B6	Focus on (a) time phasing in LOOP/SBO sequences, including battery depletion, and (c) adequacy of CRD as an adequate injection source.
SC-A4	Focus on modeling of shared systems and cross-ties in multi-unit sites
SC-B1	Focus on proper application of the computer codes for T/H calculations, especially for LOCA, IORV, SORV, and F&B scenarios.
SC-C1	Category II

TABLE G 5. ASME PRA Standard Supporting Requirements Requiring Self-Assessment	
1 Supporting Requirement	Comments
SY-A4	Category II for MSPI systems and components
SY-A11	Focus on (d) modeling of shared systems
SY-A20	Focus on credit for alternate injection systems, alternate seal cooling
SY-B1	Should include EDG, AFW, HPI, RHR CCFs
SY-B5	Focus on dependencies of support systems (especially cooling water systems) to the initiating events
SY-B9	Focus on credit for injection post-venting (NPSH issues, environmental survivability, etc.)
SY-B15	Focus on credit for injection post-venting (NPSH issues, environmental survivability, etc.)
HR-E1	Focus on credit for cross ties, depressurization, use of alternate sources, venting, core cooling recovery, initiation of F&B
HR-E2	Focus on credit for cross ties, depressurization, use of alternate sources, venting, core cooling recovery, initiation of F&B
HR-G1	Category II , though Category I for the critical HEPs would produce a more sensitive MSPI (i.e., fewer failures to change a color)
HR-G2	Focus on credit for cross ties, depressurization, use of alternate sources, venting, core cooling recovery, initiation of F&B
HR-G3	Category I. See note on HR-G1. Attention to credit for cross ties, depressurization, use of alternate sources, venting, core cooling recovery, initiation of F&B
HR-G5	Category II. See note on HR-G1.
HR-H2	Focus on credit for cross ties, depressurization, use of alternate sources, venting, core cooling recovery, initiation of F&B
HR-H3	The use of some systems may be treated as a recovery action in a PRA, even though the system may be addressed in the same procedure as a human action modeled in the accident sequence model (e.g., recovery of feedwater may be addressed in the same procedure as feed and bleed). Neglecting the cognitive dependency can significantly decrease the significance of the sequence.
DA-B1	Focus on service condition (clean vs. untreated water) for SW systems
DA-C1	Focus on LOOP recovery
DA-C15	Focus on recovery from LOSP and loss of SW events
DA-D1	For BWRs with isolation condenser, focus on the likelihood of a stuck open SRV
QU-B2	Truncation limits should be chosen to be appropriate for F-V calculations.

TABLE G 5. ASME PRA Standard Supporting Requirements Requiring Self-Assessment	
1 Supporting Requirement	Comments
QU-B3	This is an MSPI implementation concern and should be addressed in the guidance document. Truncation limits should be chosen to be appropriate for F-V calculations.
QU-D3	Understanding the differences between plant models, particularly as they affect the MSPI, is important for the proposed approach to the identification of outliers recommended by the task group.
QU-D5	Category II for those who have used fault tree models to address support system initiators.
QU-E4	Category II for the issues that directly affect the MSPI

[This page left intentionally blank.]

APPENDIX H

USwC Basis Document

The USwC PI will monitor the following six conditions that either have the potential to complicate the operators' scram ~~recovery-response~~ actions or involve the unavailability of or inability to recover main feedwater during the scram response.

FAQ481
(10-02)

1. Reactivity Control
2. Pressure Control (BWRs)/Turbine Trip (PWRs)
3. Power available to Emergency Busses
4. Need to actuate emergency injection sources
5. Availability of Main Feedwater
6. Utilization of scram recovery Emergency Operating Procedures (EOPs)

Since the complicating conditions are not the same for Pressurized Water Reactors (PWRs) versus Boiling Water Reactors (BWRs), a separate flow chart for each type has been developed. If any one of the conditions in the appropriate flow chart is met the condition must be counted as a USwC event.

H 1 PWR Flowchart Basis Discussion

H 1.1 Did two or more control rods fail to fully insert?

This question is designed to verify that the Reactor did actually trip. As long as a plant uses the EOP questions to verify that the reactor tripped without entering a "response not obtained" or "contingency actions" requirement this question should be answered as "No". Some specific examples from plant EOPs are provided below.

Some CE plant EOPs use the following checks:

- Check that reactor power is dropping.
- Check that start-up rate is negative.
- Check that no more than one full strength CEA is **NOT** inserted.

If the operations staff determines that one of these questions is not satisfied then they must perform a contingency action. The requirement to perform that contingency action would be considered as a complication for the Unplanned Scrams with Complications metric.

Some Westinghouse plant EOPs verify the following items:

- Verify Reactor Trip
 - Rod bottom lights – LIT
 - Reactor trip and bypass breakers – OPEN
 - Neutron flux - LOWERING

1
2 If the operations staff determines that one of these questions is not satisfied then they must
3 perform a response not obtained action. The requirement to perform that contingency
4 action would be considered as a complication for the Unplanned Scrams with
5 Complications metric. There is an exception in this question for Westinghouse plants using
6 the question structure given in this example. A single rod bottom light not lit would be
7 acceptable in the Unplanned Scrams with Complications metric even though it would
8 require a response not obtained action. This exception is allowed to make the metric
9 consistent between vendor procedures, also the reactor analysis allows for the single most
10 reactive control rod to be stuck in the full out position.

11
12 **Some B&W plants EOPs verify the following:**

- 13
14
 - Verify Alternate Rod Insertion and reactor power dropping

15
16 If the operations staff determines that this question is not satisfied then they must perform a
17 contingency action. The requirement to perform that contingency action would be
18 considered as a complication for the Unplanned Scrams with Complications metric. There
19 is an exception in this question for B & W plants using the question structure given in this
20 example. A single rod not fully inserted would be acceptable in the Unplanned Scrams
21 with Complications metric even though it would require a contingency action. This
22 exception is allowed to make the metric consistent between vendor procedures, also the
23 reactor analysis allows for the single most reactive control rod to be stack in the full out
24 position

25
26 **H 1.2 Did the turbine fail to trip?**

27
28 This question is designed to verify that the Turbine did actually trip. As long as a plant
29 uses the EOP questions to verify that the turbine tripped without entering a “response not
30 obtained” or “contingency actions” requirement this question should be answered as “No”.
31 There is one exemption to this step that allows an Operator to use the manual turbine trip
32 handswitch/pushbutton as an acceptable alternative. The simplicity of the action and the
33 fact that Operators are specifically trained on this action provide the basis for this
34 exception. It is NOT an acceptable alternative for the Operators to close individual
35 governor or throttle valves, main steam isolation valves, or secure hydraulic control pumps.
36 The failure of a generator output breaker to trip with the turbine is considered as a
37 complication. Any actions beyond the use of one handswitch/pushbutton would need to be
38 considered as a complication for this question. For reactor trips that occur prior to the
39 turbine being placed in service or “latched” this specific question should be answered as
40 “No” since the turbine is already tripped. Some specific examples from plant EOPs are
41 provided below:

42
43 **Some CE plant EOPs use the following checks:**

- 44
45
 - **Check that the main turbine is tripped**
 - **Check that the main generator output breakers are open**

1
2 The use of the contingency action to manually trip the turbine is an acceptable alternative.
3 Performance of any other contingency actions would require answering this question as
4 “Yes”.

5
6 **Some Westinghouse plant EOPs verify the following items:**

- 7
- 8 • **Verify all turbine throttle valves – CLOSED**
- 9 • **Main generator output breaker - OPEN**

10
11 The use of the contingency action to manually trip the turbine is an acceptable alternative.
12 Performance of any other response not obtained actions would require answering this
13 question as “Yes”.

14
15 **Some B&W plant EOPs verify the following:**

- 16
- 17 • **Verify turbine throttle and governor valve closed**
- 18

19 The use of the contingency action to manually trip the turbine is an acceptable alternative.
20 Performance of any other contingency actions would require answering this question as
21 “Yes”.

22
23 **H 1.3 Was power lost to any ESF bus?**

24
25 Most EOP versions check that power is available in response to the reactor trip. This
26 question is designed to verify that electric power was available after the reactor trip. As
27 long as a plant uses the EOP questions to verify that power was available without entering
28 a “response not obtained” or “contingency actions” requirement this question should be
29 answered as “No”. There is an exemption to this step that allows an Operator to manually
30 restore power within 10 minutes as an acceptable alternative. The exception is limited to
31 those actions necessary to close a breaker from the main control board. Actions requiring
32 access to the back of the control boards or any other remote location would require
33 answering this question as “Yes”. It is acceptable to manipulate more than one switch,
34 such as a sync switch, in the process of restoring power to the bus. It is acceptable to close
35 more than one breaker. It is acceptable to restore power from the emergency AC source,
36 such as diesel generators, or from off-site power. This exception is allowed since most
37 EOPs are configured to check that power is available to at least one of the safety busses
38 which will satisfy plant safety concerns. If power is not available to at least one safety bus
39 most EOPs will direct transition to another EOP to mitigate this condition. The additional
40 operator action to restore power to additional busses has been discussed and considered
41 acceptable as long as it can be completed within the time limitations of 10 minutes (chosen
42 to limit the complexity) and the constraints of switch operation from the main control
43 board. Any actions beyond these would need to be considered as a complication for this
44 question. Because of the wide variation in power distribution designs, voltage, and
45 nomenclature across the PWR fleet, no specific EOP examples are given here.
46

1
2 **H 1.4 Was a Safety Injection signal received?**
3

4 This question is designed to verify that the plant conditions are stable and do not require
5 the actuation of the emergency injection system (safety injection for Westinghouse plants,
6 SIAS for CE). Plant conditions that result from a loss of inventory or loss of pressure
7 control in the RCS or Steam Generator (SG) would likely require actuation of the
8 emergency injection systems and would be considered a complication. Conversely, plant
9 conditions following the reactor trip that do not result in a safety injection actuation would
10 not be considered as complications. An exception to this is the existence of a severe steam
11 generator tube leak. In those limited circumstances where a steam generator tube leak
12 exists that is severe enough to require a reactor trip but can be controlled by starting
13 additional inventory control pumps that are not normally running during normal power
14 operations without initiating a safety injection signal should result in a “Yes” answer and
15 considered as a complication. A small steam generator tube leak where inventory can be
16 maintained using the already running inventory control pumps would NOT be considered
17 as complicated even if the reactor was tripped. Those instances where a safety injection
18 was not required by actual plants conditions but occurred due to operator error, spurious
19 actuations, or set-point error should be considered as complications and this question
20 answered as “Yes”.
21

22 **H 1.5 Was Main Feedwater unavailable or not recoverable using approved plant**
23 **procedures following during the scram response?**
24

FAQ481
(10-02)

25 This section of the indicator is a holdover from the Scrams with Loss of Normal Heat
26 Removal indicator which the USwC indicator ~~is replaie~~replaced. Since all PWR
27 designs have an emergency Feedwater system that operates if necessary, the availability
28 of the normal or main Feedwater systems ~~is-as~~ a backup in emergency situations ~~can be~~
29 ~~important for managing risk following a reactor scram~~. This portion of the indicator is
30 designed to ~~measure-assess~~ that backup availability ~~or ability to recover main feedwater as~~
31 directed by ~~approved plant procedures (e.g., the EOPs)~~ on a loss of all emergency
32 Feedwater.
33

FAQ481
(10-02)

34 It is not necessary for the main Feedwater system to continue operating following a
35 reactor trip. ~~Some plants, by design, have certain features to prevent main feedwater~~
36 ~~from continued operation or from allowing it to be restarted unless certain criteria are met.~~
37 ~~The system must be free from damage or failure that would prohibit restart of the system if~~
38 ~~necessary.~~—Since some plant designs do not include ~~electric-electric~~-driven main Feedwater
39 pumps (~~steam-steam~~-driven pumps only), it may not be possible to restart main Feedwater
40 pumps without a critical reactor. ~~Those plants should answer this question as “No” and~~
41 ~~move on.~~—Additionally, ~~some~~Some other plant designs have interlocks in place ~~and signals~~
42 ~~to-that~~ prevent feeding the steam generators with main Feedwater unless reactor coolant
43 temperature is greater than the no-load average temperature. ~~In both cases, These-these~~
44 plants ~~should also answer~~may be justified in answering this question as “No” if Main
45 Feedwater is free from damage or failure that can prevent it from performing its intended
46 function and is available for use. ~~and move on.~~

FAQ481
(10-02)

1
2 Licensees should rely on the material condition availability of the equipment to reach the
3 decision for this question. Condenser vacuum, cooling water, and steam pressure values
4 should be evaluated based on the requirements to operate the pumps and may be lower than
5 normal if procedures allow pump operation at that lower value. As long as these support
6 systems are able to be restarted (if not running) to support main feedwater restart within
7 the ~~estimated 30~~-30-minute timeframe they can be considered as available. These
8 requirements apply until the completion or exit of the scram response ~~procedure~~.
9

FAQ481
(10-02)

10 The availability of steam dumps to the condenser does NOT enter into this indicator at all.
11 Use of atmospheric steam dumps following the reactor trip is acceptable for any duration.
12

13 Loss of one feed pump does not cause a loss of main feedwater. Only one is needed to
14 remove residual heat after a trip. As long as at least one pump can still operate and provide
15 Feedwater to the minimum number of steam generators required by the EOPs to satisfy the
16 heat sink criteria, main feedwater should be considered available.
17

18 The failure in a closed position of a feedwater isolation valve to a steam generator is a loss
19 of feed to that one steam generator. As long as the main feedwater system is able to feed
20 the minimum number of steam generators required by the EOPs to satisfy the heat sink
21 criteria, the loss of ability to feed other steam generators should not be considered a loss of
22 feedwater. Isolation of the feedwater regulating or isolation valves does not constitute a
23 loss of feedwater if nothing prevents them from being reopened in accordance with
24 procedures.
25

26 A Steam Generator Isolation Signal or Feedwater Isolation Signal does not constitute a loss
27 of main feedwater as long as it can be cleared and feedwater restarted. If the isolation
28 signal was caused by a high steam generator level, the 30 minute estimate for restart
29 timeframe should start once the high level isolation signal has cleared.
30

31 The ~~estimated 30~~-30-minute timeframe for restart of main Feedwater was chosen based
32 on restarting from a hot and filled condition. Since this timeframe will not be measured
33 directly it should be an estimation developed based on the material condition of the plants
34 systems following the reactor trip. If no abnormal material conditions exist the 30 minutes
35 should be met. If plant procedures and design would require more than 30 minutes even if
36 all systems were hot and the material condition of the plants systems following the reactor
37 trip were normal, that routine time should be used in the evaluation of this question,
38 provided SG dry-out cannot occur on an uncomplicated trip if the time is longer than 30
39 minutes. The ~~opinion-judgment~~ of the on-shift licensed SRO during the reactor trip
40 should be ~~accepted-used~~ in determining if this timeframe was met.
41

FAQ481
(10-02)

FAQ481
(10-02)

42 **H 1.6 Was the scram response procedure unable to be completed without entering another** 43 **EOP?** 44

45 When a scram occurs plant operators enter the EOPs to respond to the condition. In the
46 case of a routine scram the procedure entered will be exited fairly rapidly after verifying

1 that the reactor is shutdown, excessive cooling is not in progress, electric power is
2 available, and reactor coolant pressures and temperatures are at expected values and
3 controlled. Once these verifications are done and the plant conditions are considered
4 “stable” operators may exit the initial procedure to another procedure that will stabilize and
5 prepare the remainder of the plant for transition to the normal operating procedures. The
6 plant could then be maintained in Hot Standby, to perform a controlled normal cool down,
7 or to begin the restart process. The criteria in this question is used to verify there were no
8 other conditions that developed during the stabilization of the plant in the scram response
9 that required re-entry into the EOPs or transition to a follow on EOP.

10
11 There are some EOPs that are used specifically at the operator discretion and are not
12 required to be used. In the Westinghouse EOP suite these are Yellow Path functional
13 restoration procedures and the re-diagnosis procedures. These procedures typically verify
14 that the operator is taking the correct action (re-diagnosis) or the stabilization of some
15 minor plant parameters (Yellow path). Use of these procedures is an allowed exception to
16 this step. The transition out of these procedures to an EOP different from the current
17 procedure in effect, i.e. a new procedure or the base procedure, would count as a
18 complication.

20 **H 2 PWR Case Studies**

22 **H 2.1 PWR Case Study 1**

23
24 At approximately 100% steady state reactor power, Control Room operators initiated a manual
25 reactor trip as a result of indications that multiple Control Rods (CRs) had dropped into the
26 reactor core. All Reactor Trip (RT) breakers opened but all rod bottom lights did not illuminate.
27 Rod Cluster Control Assemblies (RCCA) L7, J13, F6, F10, K10, C5, and C13 were not
28 considered fully inserted because the rod bottom lights for these RCCAs did not illuminate. The
29 Plant Information Computer System indicated all RCCAs were fully inserted. In accordance
30 with plant procedures, operators re-initiated a manual RT. Operations verified the reactor was
31 tripped and all RCCAs were fully inserted.

32
33 Prior to the event all CRs were withdrawn from the reactor core and in Automatic, both Main
34 Boiler Feedwater Pumps (MBFPs) were in service, the Auxiliary Feedwater Pumps (AFWPs)
35 were in standby, the EDGs were in standby, and off-site power was in service. At 1435 hours,
36 indicated reactor power decreased from approximately 99.87% to 50% (based on the Nuclear
37 Instrumentation System power range neutron flux monitors) as a result of 12 CRs dropping into
38 the core. Of the twelve CRs that dropped into the core, four (4) CRs (M-12, M-4, D-12, and D-4)
39 went from 223 steps to 150 steps out and eight (8) control rods (N-13, L-13, N-5, N-3, E-3, C-3,
40 C13, and C-11) went from 223 steps out to 0 steps. Reactivity control is achieved by a
41 combination of 53 CRs [29 RCCAs are in control banks (CB) and 24 in shutdown banks (SDBs)]
42 and chemical shim (boric acid). The CRs are divided into 1) a shutdown (SD) group comprised
43 of two SDBs of eight rod clusters each and two SDBs of four rod clusters each, and 2) a control
44 group comprised of four CBs containing eight, four, eight, and nine rod clusters.

1 After the manual RT, seven (7) rod bottom lights for CR SDB A, Rod L7, SDB 3, Rod J12, SDB
2 D, Rods F6, F10, K10, CB A, Rod C5, and CB C, Rod C13 did not illuminate. All other
3 reactivity indications were normal. As a result of the manual RT, the Main Turbine-Generator
4 tripped, and the AFWPs automatically started. The EDGs did not start as off-site power
5 remained in service. An alarm for low pressurizer pressure annunciated as a result of a reduction
6 of the RCS pressure to the normal trip setpoint (1985 psig). The decrease in pressure was due to
7 the negative reactivity from the initial rod insertion. All primary safety systems functioned
8 properly. Unexpected responses included: both MBFP suction relief valves lifted (reset at
9 approximately 1458 hours), a "Not in Sync" alarm was received for the 24 Static Inverter
10 (adjusted and cleared), and a low oil level alarm on upper reservoir was received for the 23
11 Reactor Coolant Pump (RCP). Power for the rod control system is distributed to five power
12 cabinets from two motor-generator sets connected in parallel through two series of Reactor Trip
13 Breakers (RTBs). The ac power distribution lines downstream of the RTBs are routed above the
14 power cabinets through a fully enclosed three-phase, four wire plug-in, bus duct assembly.

15
16 The ac power to each cabinet is carried by the bus duct assembly through three plug-in fused
17 disconnect switches for the stationary, movable and lift coil circuits of the mechanisms
18 associated with that cabinet. During the investigation of the event the disconnect switch (JSI on
19 top of rod control power cabinet (CAB) IAC was discovered to be open. Opening the disconnect
20 switch caused loss of power to the stationary coils for twelve (12) CRs. The switch that was
21 placed in the open position was for power cabinet IAC which controls the rods for CB A, Group
22 1, CB C, Group 1, and SDB A, Group 1. Loss of power to these CRs caused the rods to drop into
23 the reactor core per design. Four (4) CRs partially inserted (223 steps in to 150 steps). CR power
24 cabinet (IAC) disconnect switch was inadvertently bumped open by a contractor erecting
25 scaffolding around the CR power cabinets in the cable spreading room of the Control Building
26 (NA). The disconnect switch to rod control power cabinet IAC was re-closed. An assessment of
27 the condition by reactor engineering concluded that power was removed from the CR stationary
28 gripper coils when the disconnect switch was opened. When no motion is demanded and rods are
29 stationary, current is sent to the coils, which keeps the grippers engaged on the CR. The CR
30 system sensed the power loss condition and transmitted a high current order to the movable
31 gripper coils which had not lost their power. The movable gripper coils were able to catch four of
32 the CRs as they were falling but did not catch the remaining CRs in the other CR groups. The
33 cause of the failure of seven (7) rod bottom lights to illuminate after the dropped rod event was
34 due to failed light bistables.

35
36 In answering the questions for this indicator, some additional information beyond that gathered
37 for the LER will be required. In this case the usage history of the EOPs will be required. For
38 this example consider that there were no additional EOPs used beyond the normal procedures.

39
40 **1. Did two or more control rods fail to fully insert?**

41
42 Did control rods that are required to move on a reactor trip fully insert into the core as
43 evidenced by the Emergency Operating Procedure (EOP) evaluation criteria? As an
44 example for some PWRs using rod bottom light indications, if more than one-rod bottom
45 light is not illuminated, this question must be answered "Yes." The basis of this step is to
46 determine if additional actions are required by the operators as a result of the failure of all

1 rods to insert. Additional actions, such as emergency boration, pose a complication beyond
2 the normal scram response that this metric is attempting the measure. It is allowable to
3 have one control rod not fully inserted since core protection design accounts for one control
4 rod remaining fully withdrawn from the core on a reactor trip. This question must be
5 evaluated using the criteria contained in the plant EOP used to verify that control rods
6 inserted. During performance of this step of the EOP the licensee staff would not need to
7 apply the "Response Not Obtained" actions. Other means not specified in the EOPs are not
8 allowed for this metric.

9
10 Answer:

11 YES. This question should be answered as "YES" and the trip counted as a Scram with
12 Complications since the rod bottom lights did not indicate fully inserted control rods. If
13 the EOP allows the use of the plant computer indications instead of rod bottom lights this
14 question should be answered as "NO." To qualify the plant computer indication must not
15 be considered as a "Response Not Obtained" step but rather as a listed normal indication.
16

17 **2. Did the turbine fail to trip?**

18
19 Did the turbine fail to trip automatically/manually as required on the reactor trip signal? To
20 be a successful trip, steam flow to the main turbine must have been isolated by the turbine
21 trip logic actuated by the reactor trip signal, or by operator action from a single switch or
22 pushbutton. The allowance of operator action to trip the turbine is based on the operation
23 of the turbine trip logic from the operator action if directed by the EOP. Operator action to
24 close valves or secure pumps to trip the turbine beyond use of a single turbine trip switch
25 would count in this indicator as a failure to trip and a complication beyond the normal
26 reactor trip response. Trips that occur prior to the turbine being placed in service or
27 "latched" should have this question answered as "No".

28 c

29 Answer:

30 NO. The turbine tripped per design,
31

32 **3. Was power lost to any ESF bus?**

33
34 During a reactor trip or during the period operators are responding to a reactor trip using
35 reactor trip response procedures, was power lost to any ESF bus that was not restored
36 automatically by the Emergency Alternating Current (EAC) power system and remained
37 de-energized for greater than 10 minutes? Operator action to re-energize the ESF bus from
38 the main control board is allowed as an acceptable action to satisfy this metric. This
39 question is looking for a loss of power at any time for any duration where the bus was not
40 energized/re-energized within 10 minutes. The bus must have:

- 41
42
- remained energized until the scram response procedure was exited, or
 - been re-energized automatically by the plant EAC power system (i.e., EDG), or
 - been re-energized from normal or emergency sources by an operator closing a
45 breaker from the main control board.
- 46

1 The question applies to all ESF busses (switchgear, load centers, motor control centers and
2 DC busses). This does NOT apply to 120-volt power panels. It is expected that operator
3 action to re-energize an ESF bus would not take longer than 10 minutes.
4

5 Answer:

6 NO. Emergency diesels were not required to start. Offsite power remained available
7 throughout the trip response. All ESF busses remained energized throughout the trip
8 response.
9

10 **4. Was a Safety Injection signal received?**

11
12 Was a Safety Injection signal generated either manually or automatically during the reactor
13 trip response? The questions purpose is to determine if the operator had to respond to an
14 abnormal condition that required a safety injection or respond to the actuation of additional
15 equipment that would not normally actuate on an uncomplicated scram. This question
16 would include any condition that challenged Reactor Coolant System (RCS) inventory,
17 pressure, or temperature severely enough to require a safety injection. A severe steam
18 generator tube leak that would require a manual reactor trip because it was beyond the
19 capacity of the normal at power running charging system should be counted even if a safety
20 injection was not used since additional charging pumps would be required to be started.
21

22 Answer:

23 NO. No SI signal was required or received.
24

25 **5. Was Main Feedwater unavailable or not recoverable using approved plant**
26 **procedures following during the scram response?**

27
28 If operating prior to the scram, did Main Feedwater cease to operate and was it unable to be
29 restarted during the reactor scram response? The consideration for this question is whether
30 Main Feedwater could be used to feed the steam generators if necessary. The qualifier of
31 “not recoverable using approved plant procedures” will allow a licensee to answer “No” to
32 this question if there is no physical equipment restraint to prevent the operations staff from
33 starting the necessary equipment, aligning the required systems, or satisfying required logic
34 using plant procedures approved for use and in place prior to the reactor scram occurring.
35

36 The operations staff must be able to start and operate the required equipment using
37 normal alignments and approved **emergency**, normal and off-normal operating
38 procedures to feed the minimum number of steam generators required by the EOPs to
39 satisfy the heat sink criteria. Manual operation of controllers/equipment, even if normally
40 automatic, is allowed if addressed by procedure. Situations that require maintenance **or**
41 **repair** activities or non-proceduralized operating alignments require an answer of “Yes.”
42 Additionally, the restoration of Feedwater must be capable of feeding the Steam Generators
43 in a reasonable period of time. Operations should be able to start a Main Feedwater pump
44 and start feeding Steam Generators with the Main Feedwater System within **about 30**
45 **minutes from the time it was recognized that Main Feedwater was needed.** During
46 startup conditions where Main Feedwater was not placed in service prior to the scram this

FAQ481
(10-02)

FAQ481
(10-02)

1 question would not be considered and should be skipped. If design features or procedural
2 prohibitions prevent restarting Main Feedwater this question should be answered as “No”.

3
4 Answer:

5 NO. Main feedwater pumps were available and the feedwater system could have been
6 operated to supply feedwater to all steam generators.

7
8 **6. Was the scram response procedure unable to be completed without entering another**
9 **EOP?**

10
11 The response to the scram must be completed without transitioning to an additional EOP
12 after entering the scram response procedure (e.g., ES01 for Westinghouse). This step is
13 used to determine if the scram was uncomplicated by counting if additional procedures
14 beyond the normal scram response required entry after the scram. A plant exiting the
15 normal scram response procedure without using another EOP would answer this step as
16 “No”. The discretionary use of the lowest level Function Restoration Guideline (Yellow
17 Path) by the operations staff is an approved exception to this requirement. Use of the Re-
18 diagnosis Procedure by Operations is acceptable unless a transition to another EOP is
19 required.

20
21 Answer:

22 NO. The reactor trip response procedures were completed without re-entering another
23 EOP.

24
25 **H 2.2 PWR Case Study 2**

26
27 At 100% steady state reactor power, Operators manually tripped the reactor as a result of
28 oscillating Feedwater (FW) flow and SG level with flow perturbations and FW pipe movement
29 in the Auxiliary FW (AFW) Pump Building. Prior to the transient, while operating at 100%
30 reactor power, with SG level control in AUTO, 22 SG Narrow Range (NR) level records show
31 two cycles of level changes of approximately 2% and correction in automatic with no operator
32 action. Subsequently, operators observed 22 SG NR level starting to decrease from a normal
33 value of 49% to 30% with a deviation alarm annunciating at 44%. CR operators observed
34 oscillating FW flow and erratic behavior of the 22 Main FW regulating valve FCV-427.
35 Operators entered Abnormal Operating Procedure 2AOP-FW-1 and placed the FW regulating
36 valve (FCV-427) in manual and attempted to increase FW flow in 22 SG without success.
37 Excessive FW flow oscillations continued. Operators then opened low flow bypass valve FCV-
38 427L to increase SG level which started 22 SG level increasing at a level of 30%. At
39 approximately 35% SG level valve FCV- 427L was returned to closed. A Nuclear Plant Operator
40 (NPO) in the AFW Pump Building reported to the control room loud noises due to flow
41 perturbations and pipe movement. Based on plant conditions, the Control Room Supervisor
42 (CRS) directed a manual reactor trip. All control rods fully inserted and all primary systems
43 functioned properly. The 22 FW regulating valve FCV-427 failed to fully close. Operators
44 initiated FW isolation by closing FW motor operated isolation valves (MOV) BFD-5-1 and
45 BFD-90-1. A 22 SG high level trip was actuated at 73% SG level, initiating automatic closure of
46 the Main FW Pump motor operated discharge valves (BFD-2-21 and BFD-2-22), Main FW and

1 Low Flow FW regulating and isolation valves, and trip of the turbine driven Main FW Pumps.
2 The plant was stabilized in hot standby with decay heat being removed by the main condenser.
3 Offsite power remained available and therefore the EDGs did not start. The AFW System
4 automatically started as a result of a SG low level normally experienced on trips from full power.
5 FW regulating valve FCV-427 is a Copes-Vulcan globe valve with Copes-Vulcan actuator
6 Model D-1000-160. The valve has a positioner to perform its modulating function and 3
7 solenoids attached to the actuator for fast closure. CR operators observed the rod bottom lights,
8 RT First Out Annunciator (Manual Trip). The plant was stabilized in hot standby with decay heat
9 being released to the main condenser through the steam dump valves. A post transient
10 evaluation was performed. A non-intrusive inspection was performed of the remaining FW
11 regulating valves (FCV-417, FCV-437, FCV-447) to verify that their valve cages had not
12 unthreaded from the valve body webs. The verification was done by obtaining the maximum
13 stroke capability of the FCVs and relating that to a point at which the valve stem is connected
14 into the actuator yoke (Measurements of the FCVs exposed stem threads and actuator posts were
15 compared to the available actuator travel). These measurements provided reasonable assurance
16 that the remaining FCV cages were properly threaded into their body webs. Following plant
17 shutdown a walk down was performed of the four (4) FW lines inside containment and FW and
18 AFW piping outside containment for any impacts of the FW flow perturbations. There were no
19 indications of excessive movement or damage to the insulation, supports or piping above the 95
20 foot elevation of containment nor was there any observed signs of excessive movements, support
21 damage, support impacts/scarring, or insulation damage on FW lines to SG-21, SG-22, SG-23,
22 SG-24 on any containment elevations. For FW and AFW piping outside containment, no piping
23 or support damage was evident due to pipe movements from the flow perturbations. FW piping
24 inside and outside containment showed some light powder insulation dust on the floor indicative
25 of pipe vibration.

26
27 In answering the questions for this indicator, some additional information beyond that gathered
28 for the LER will be required. In this case the usage history of the EOPs will be required. For
29 this example consider that there were no additional EOPs used beyond the normal procedures.

30
31 **1. Did two or more control rods fail to fully insert?**

32
33 Did control rods that are required to move on a reactor trip fully insert into the core as
34 evidenced by the Emergency Operating Procedure (EOP) evaluation criteria? As an
35 example for some PWRs using rod bottom light indications, if more than one-rod bottom
36 light is not illuminated, this question must be answered "Yes." The basis of this step is to
37 determine if additional actions are required by the operators as a result of the failure of all
38 rods to insert. Additional actions, such as emergency boration, pose a complication beyond
39 the normal scram response that this metric is attempting the measure. It is allowable to
40 have one control rod not fully inserted since core protection design accounts for one control
41 rod remaining fully withdrawn from the core on a reactor trip. This question must be
42 evaluated using the criteria contained in the plant EOP used to verify that control rods
43 inserted. During performance of this step of the EOP the licensee staff would not need to
44 apply the "Response Not Obtained" actions. Other means not specified in the EOPs are not
45 allowed for this metric.

1 Answer:

2 NO. All control rods fully inserted as indicated by the rod bottom lights.

3
4 **2. Did the turbine fail to trip?**

5
6 Did the turbine fail to trip automatically/manually as required on the reactor trip signal? To
7 be a successful trip, steam flow to the main turbine must have been isolated by the turbine
8 trip logic actuated by the reactor trip signal, or by operator action from a single switch or
9 pushbutton. The allowance of operator action to trip the turbine is based on the operation
10 of the turbine trip logic from the operator action if directed by the EOP. Operator action to
11 close valves or secure pumps to trip the turbine beyond use of a single turbine trip switch
12 would count in this indicator as a failure to trip and a complication beyond the normal
13 reactor trip response. Trips that occur prior to the turbine being placed in service or
14 “latched” should have this question answered as “No”.

15
16 Answer:

17 NO. The turbine tripped per design,

18
19 **3. Was power lost to any ESF bus?**

20
21 During a reactor trip or during the period operators are responding to a reactor trip using
22 reactor trip response procedures, was power lost to any ESF bus that was not restored
23 automatically by the Emergency Alternating Current (EAC) power system and remained
24 de-energized for greater than 10 minutes? Operator action to re-energize the ESF bus from
25 the main control board is allowed as an acceptable action to satisfy this metric. This
26 question is looking for a loss of power at any time for any duration where the bus was not
27 energized/re-energized within 10 minutes. The bus must have:

- 28
29
- remained energized until the scram response procedure was exited, or
 - been re-energized automatically by the plant EAC power system (i.e., EDG), or
 - been re-energized from normal or emergency sources by an operator closing a
32 breaker from the main control board.
- 33

34 The question applies to all ESF busses (switchgear, load centers, motor control centers and
35 DC busses). This does NOT apply to 120-volt power panels. It is expected that operator
36 action to re-energize an ESF bus would not take longer than 10 minutes.

37
38 Answer:

39 NO. Emergency diesels were not required to start. Offsite power remained available
40 throughout the trip response. All ESF busses remained energized throughout the trip
41 response.

42
43 **4. Was a Safety Injection signal received?**

44
45 Was a Safety Injection signal generated either manually or automatically during the reactor
46 trip response? The questions purpose is to determine if the operator had to respond to an

1 abnormal condition that required a safety injection or respond to the actuation of additional
2 equipment that would not normally actuate on an uncomplicated scram. This question
3 would include any condition that challenged Reactor Coolant System (RCS) inventory,
4 pressure, or temperature severely enough to require a safety injection. A severe steam
5 generator tube leak that would require a manual reactor trip because it was beyond the
6 capacity of the normal at power running charging system should be counted even if a safety
7 injection was not used since additional charging pumps would be required to be started.
8

9 Answer:

10 NO. No SI signal was required or received.

11
12 **5. Was Main Feedwater unavailable or not recoverable using approved plant**
13 **procedures following during the scram response?**

FAQ481
(10-02)

14
15 If operating prior to the scram, did Main Feedwater cease to operate and was it unable to be
16 restarted during the reactor scram response? The consideration for this question is whether
17 Main Feedwater could be used to feed the steam generators if necessary. The qualifier of
18 “not recoverable using approved plant procedures” will allow a licensee to answer “No” to
19 this question if there is no physical equipment restraint to prevent the operations staff from
20 starting the necessary equipment, aligning the required systems, or satisfying required logic
21 using plant procedures approved for use and in place prior to the reactor scram occurring.
22

23 The operations staff must be able to start and operate the required equipment using normal
24 alignments and approved **emergency**, normal and off-normal operating procedures to feed
25 the minimum number of steam generators required by the EOPs to satisfy the heat sink
26 criteria. Manual operation of controllers/equipment, even if normally automatic, is
27 allowed if addressed by procedure. Situations that require maintenance **or repair** activities
28 or non-proceduralized operating alignments require an answer of “Yes.” Additionally, the
29 restoration of Feedwater must be capable of feeding the Steam Generators in a reasonable
30 period of time. Operations should be able to start a Main Feedwater pump and start feeding
31 Steam Generators with the Main Feedwater System within **about 30 minutes from the time**
32 **it was recognized that Main Feedwater was needed**. During startup conditions where Main
33 Feedwater was not placed in service prior to the scram this question would not be
34 considered and should be skipped. If design features or procedural prohibitions prevent
35 restarting Main Feedwater this question should be answered as “No”.
36

FAQ481
(10-02)

37 Answer:

38 NO. Main FW was the cause of the manual reactor trip: one of four feed regulating
39 valves (FRV-447) was unavailable for FW addition to SGs. FW pumps were available to
40 be restarted and three FW loops could have been operated to supply FW to 3 of 4 SGs.
41

42 **6. Was the scram response procedure unable to be completed without entering another**
43 **EOP?**

44
45 The response to the scram must be completed without transitioning to an additional EOP
46 after entering the scram response procedure (e.g., ES01 for Westinghouse). This step is

1 used to determine if the scram was uncomplicated by counting if additional procedures
2 beyond the normal scram response required entry after the scram. A plant exiting the
3 normal scram response procedure without using another EOP would answer this step as
4 "No". The discretionary use of the lowest level Function Restoration Guideline (Yellow
5 Path) by the operations staff is an approved exception to this requirement. Use of the Re-
6 diagnosis Procedure by Operations is acceptable unless a transition to another EOP is
7 required.

8
9 Answer:

10 NO. The reactor trip response procedures were completed without re-entering another
11 EOP.

12 13 **H 2.3 PWR Case Study 3**

14
15 The An automatic reactor trip was initiated due to a low reactor coolant flow condition following
16 a trip of the 'B' Reactor Coolant Pump (RCP) motor. The RCP trip was initiated by a current
17 imbalance sensed by the motor's protective relay. The current imbalance was a result of a
18 transmission system disturbance. At the time of the event, the plant was operating in Mode 1
19 (Hot Full Power) at 100 percent power. The system disturbance was initiated by a transmission
20 line fault within a neighboring electric cooperative's transmission system. Due to a defective
21 electrical connection within the electric cooperative's protective relaying scheme, the
22 transmission line breakers protecting the affected line did not receive a trip signal to clear the
23 fault. Since the breaker failure relaying scheme utilized the same circuitry containing the
24 defective electrical connection, breaker failure logic was not initiated to trip the next breakers
25 upstream of the transmission line fault. In addition, there was no redundant line relaying or local
26 backup relaying on the substation transformer. As a result, the fault was not properly cleared
27 from the electric cooperative's transmission system. For approximately the next eight minutes,
28 multiple subsequent faults were introduced onto the system as the transmission line incurred
29 damage and fell to the ground over an approximate distance of six miles. Ultimately, the fault
30 condition was cleared following the failure of the distribution system transformer supplying the
31 faulted transmission line. Approximately one minute into the event, the "B" RCP tripped due to
32 a motor current imbalance, which resulted from the transmission system disturbance. The
33 automatic reactor trip was initiated for a low reactor coolant flow condition due to the RCP trip.
34 Shortly after the reactor trip, the three remaining RCPs and all main condenser circulating water
35 pumps also tripped because of motor current imbalance. Due to the tripping of all RCPs, the
36 pressurizer spray system was unavailable. Additionally, the tripping of all main condenser
37 circulating water pumps affected the ability to use the main condenser as a heat sink. This
38 resulted in reliance on the atmospheric steam dumps causing reactor coolant system average
39 temperature (RCS Tavg) to increase from 557 to 562 degrees F. The combination of establishing
40 natural circulation due to the loss of all RCPs and increasing RCS Tavg, caused a pressurizer in-
41 surge raising RCS pressure to the pressurizer power-operated relief valve (PORV) set point.
42 Prior to re-establishing the pressurizer spray system, both PORVs momentarily lifted once,
43 relieving RCS pressure to the pressurizer relief tank. RCPs were restored approximately 32
44 minutes after initiation of the event. During this entire event, all safety-related and non safety-
45 related systems and components functioned in accordance with design.

1 In answering the questions for this indicator, some additional information beyond that gathered
2 for the LER will be required. In this case the usage history of the EOPs will be required. For
3 this example consider that there were no additional EOPs used beyond the normal procedures.
4

5 **1. Did two or more control rods fail to fully insert?**
6

7 Did control rods that are required to move on a reactor trip fully insert into the core as
8 evidenced by the Emergency Operating Procedure (EOP) evaluation criteria? As an
9 example for some PWRs using rod bottom light indications, if more than one-rod bottom
10 light is not illuminated, this question must be answered "Yes." The basis of this step is to
11 determine if additional actions are required by the operators as a result of the failure of all
12 rods to insert. Additional actions, such as emergency boration, pose a complication beyond
13 the normal scram response that this metric is attempting the measure. It is allowable to
14 have one control rod not fully inserted since core protection design accounts for one control
15 rod remaining fully withdrawn from the core on a reactor trip. This question must be
16 evaluated using the criteria contained in the plant EOP used to verify that control rods
17 inserted. During performance of this step of the EOP the licensee staff would not need to
18 apply the "Response Not Obtained" actions. Other means not specified in the EOPs are not
19 allowed for this metric.
20

21 Answer:

22 NO. All control rods fully inserted as indicated by rod bottom lights.
23

24 **2. Did the turbine fail to trip?**
25

26 Did the turbine fail to trip automatically/manually as required on the reactor trip signal? To
27 be a successful trip, steam flow to the main turbine must have been isolated by the turbine
28 trip logic actuated by the reactor trip signal, or by operator action from a single switch or
29 pushbutton. The allowance of operator action to trip the turbine is based on the operation
30 of the turbine trip logic from the operator action if directed by the EOP. Operator action to
31 close valves or secure pumps to trip the turbine beyond use of a single turbine trip switch
32 would count in this indicator as a failure to trip and a complication beyond the normal
33 reactor trip response. Trips that occur prior to the turbine being placed in service or
34 "latched" should have this question answered as "No".
35

36 Answer:

37 NO. The turbine tripped per design.
38

39 **3. Was power lost to any ESF bus?**
40

41 During a reactor trip or during the period operators are responding to a reactor trip using
42 reactor trip response procedures, was power lost to any ESF bus that was not restored
43 automatically by the Emergency Alternating Current (EAC) power system and remained
44 de-energized for greater than 10 minutes? Operator action to re-energize the ESF bus from
45 the main control board is allowed as an acceptable action to satisfy this metric. This

1 question is looking for a loss of power at any time for any duration where the bus was not
2 energized/re-energized within 10 minutes. The bus must have:

- 3
- 4 • remained energized until the scram response procedure was exited, or
- 5 • been re-energized automatically by the plant EAC power system (i.e., EDG), or
- 6 • been re-energized from normal or emergency sources by an operator closing a
7 breaker from the main control board.
- 8

9 The question applies to all ESF busses (switchgear, load centers, motor control centers and
10 DC busses). This does NOT apply to 120-volt power panels. It is expected that operator
11 action to re-energize an ESF bus would not take longer than 10 minutes.

12
13 Answer:

14 NO. All ESF busses remained energized throughout the trip response.

15
16 **4. Was a Safety Injection signal received?**

17
18 Was a Safety Injection signal generated either manually or automatically during the reactor
19 trip response? The questions purpose is to determine if the operator had to respond to an
20 abnormal condition that required a safety injection or respond to the actuation of additional
21 equipment that would not normally actuate on an uncomplicated scram. This question
22 would include any condition that challenged Reactor Coolant System (RCS) inventory,
23 pressure, or temperature severely enough to require a safety injection. A severe steam
24 generator tube leak that would require a manual reactor trip because it was beyond the
25 capacity of the normal at power running charging system should be counted even if a safety
26 injection was not used since additional charging pumps would be required to be started.

27
28 Answer:

29 NO. No SI signal was required or received.

30
31 **5. Was Main Feedwater unavailable or not recoverable using approved plant**
32 **procedures following during the scram response?**

FAQ481
(10-02)

33
34 If operating prior to the scram, did Main Feedwater cease to operate and was it unable to be
35 restarted during the reactor scram response? The consideration for this question is whether
36 Main Feedwater could be used to feed the steam generators if necessary. The qualifier of
37 “not recoverable using approved plant procedures” will allow a licensee to answer “No” to
38 this question if there is no physical equipment restraint to prevent the operations staff from
39 starting the necessary equipment, aligning the required systems, or satisfying required logic
40 using plant procedures approved for use and in place prior to the reactor scram occurring.

41
42 The operations staff must be able to start and operate the required equipment using normal
43 alignments and approved **emergency**, normal and off-normal operating procedures to
44 feed the minimum number of steam generators required by the EOPs to satisfy the heat
45 sink criteria. Manual operation of controllers/equipment, even if normally automatic, is
46 allowed if addressed by procedure. Situations that require maintenance **or repair** activities

FAQ481
(10-02)

1 or non-proceduralized operating alignments require an answer of “Yes.” Additionally, the
2 restoration of Feedwater must be capable of feeding the Steam Generators in a reasonable
3 period of time. Operations should be able to start a Main Feedwater pump and start
4 feeding Steam Generators with the Main Feedwater System within **about** 30 minutes.
5 During startup conditions where Main Feedwater was not placed in service prior to the
6 scram this question would not be considered and should be skipped. If design features or
7 procedural prohibitions prevent restarting Main Feedwater this question should be
8 answered as “No”.

9
10 Answer:

11 YES. The loss of power resulted in a complete loss of circulating water and the ability of
12 main feedwater pump turbines to exhaust to the condenser. This question could be
13 answered as “NO” if circulating water, condenser vacuum, and main feedwater could be
14 restored within the 30 minute timeframe, or if an electric driven main feedwater pump
15 was available that did not required condenser vacuum to feed steam generators.

16
17 **6. Was the scram response procedure unable to be completed without entering another**
18 **EOP?**

19
20 The response to the scram must be completed without transitioning to an additional EOP
21 after entering the scram response procedure (e.g., ES01 for Westinghouse). This step is
22 used to determine if the scram was uncomplicated by counting if additional procedures
23 beyond the normal scram response required entry after the scram. A plant exiting the
24 normal scram response procedure without using another EOP would answer this step as
25 “No”. The discretionary use of the lowest level Function Restoration Guideline (Yellow
26 Path) by the operations staff is an approved exception to this requirement. Use of the Re-
27 diagnosis Procedure by Operations is acceptable unless a transition to another EOP is
28 required.

29
30 Answer:

31 NO. The reactor trip response procedures were completed without re-entering another
32 EOP.

33
34 **H 3 BWR Flowchart Basis Discussion**

35
36 **H 3.1 Did an RPS actuation fail to indicate / establish a shutdown rod pattern for a cold**
37 **clean core?**

38
39 The purpose of this question is to verify that the reactor actually tripped and had sufficient
40 indication for operations to verify the trip. As long as a plant uses the EOP questions to
41 verify that the reactor tripped without entering the level/pressure control leg of the EOPs, the
42 response to this question should be “No”.

43
44 The generic BWROG EPG/SAG Revision 2 Appendix B statement is offered as an example:
45

1 Any control rod that cannot be determined to be inserted to or beyond position [02
2 (Maximum Subcritical Banked Withdrawal Position)] and it has not been determined that the
3 reactor will remain shutdown under all conditions without boron, enter Level/Power Control.
4

5 For example:

6 Are all control rods inserted to or beyond position 02 (if no then this is a yes for this PI)?
7 Will the reactor remain subcritical under all conditions without boron (if no then this is a
8 “Yes” for this PI)?
9

10 For example:

11 All rods not fully inserted; and, the reactor will not remain shutdown under all conditions
12 without boron then enter level/pressure control (if yes then this is a “Yes” for this PI).
13

14 **H 3.2 Was pressure control unable to be established following the initial transient?**

15

16 This question is designed to verify the ability to transfer reactor energy to the environment
17 using the normal pressure control system. The initial cycling of SRVs is typical for some
18 transients in which there was no failure of the normal pressure control system. Initial
19 operation of the SRVs is not indicative of pressure control problems with the normal pressure
20 control system. Therefore, cycling may occur post-trip until the pressure is controlled. Any
21 subsequent cycling after pressure has been controlled would result in a “YES” answer. Some
22 plant designs also may have a setpoint setdown of SRVs which would open additional SRVs
23 and reduce reactor pressure below the normal SRV closing setpoint. Any additional opening
24 of SRVs to control reactor pressure either automatically or manually indicates the inability of
25 the normal pressure control system to operate properly. Stuck open SRV(s) bypass the
26 normal pressure control system and would result in a “YES” for this PI.
27

28 For example:

29 A turbine trip occurs and SRVs open to control reactor pressure. The setpoint setdown
30 actuates and reduces reactor pressure from a normal 1025 psig to 930 psig. Following
31 closure of SRVs reactor pressure increases due to decay heat and bypass valves open. This
32 question would be answered “NO”.
33

34 For example:

35 A pressure controller failure occurs with scram on high reactor pressure. The SRVs open to
36 control reactor pressure. The setpoint setdown actuates and reduces reactor pressure from a
37 normal 1025 psig to 930 psig. Following closure of SRVs reactor pressure increases due to
38 decay heat and SRVs open again to control reactor pressure. The operator takes manual
39 control of bypass valves and opens the bypass valves to maintain reactor pressure. This
40 question would be answered “YES”. The yes answer is a result of SRVs opening after
41 pressure control was established from the initial transient.
42

43 For example:

44 The pressure controller failure occurs with scram on high reactor pressure. The SRVs open to
45 control reactor pressure. Setpoint setdown actuates and reduces reactor pressure from a
46 normal 1025 psig to 930 psig. Following closure of SRVs reactor pressure does not increase

1 because the scram occurred with low decay heat load and Main Steam Line drains were open.
2 This question would be answered “NO”.

3
4 **H 3.3 Was power lost to any Class 1E Emergency / ESF bus?**

5
6 Plants with a dedicated High Pressure Core Spray (HPCS) bus do not count the HPCS ESF
7 bus in this PI.

8
9 The purpose of this question is to verify that electric power was available after the reactor
10 trip. Loss of electrical power may result in other criteria being met in this PI. This question
11 deals only with electrical power. Should electrical power be maintained or restored within
12 the allowed 10 minutes, the response to this question should be ”No”. There is an exemption
13 to this step that permits an Operator to manually restore power within 10 minutes as an
14 acceptable alternative. The exception is limited to those actions necessary to close a
15 breaker(s) or switch(es) from the main control board. Actions requiring access to the back of
16 the control boards or any other remote location would require answering this question as
17 “Yes”. It is acceptable to manipulate more than one switch, such as a sync switch, in the
18 process of restoring power to the bus. It is acceptable to close more than one breaker. It is
19 acceptable to restore power from the emergency AC source, such as the diesel generators, or
20 from off-site power. The additional operator action to restore power to additional buses has
21 been discussed and considered acceptable as long as it can be completed within the time
22 limitations of 10 minutes (chosen to limit the complexity) and the constraints of breaker or
23 switch operation from the main control board. Any actions beyond these would need to be
24 considered as a complication for this question. Because of the wide variation in power
25 distribution designs, voltage, and nomenclature in various plant designs no specific examples
26 are given here. There is an exception for a plant designed with a dedicated High Pressure
27 Core Spray Pump (HPCS) ESF bus. If a plant has a dedicated (only provides power to
28 HPCS equipment) then the HPCS ESF bus does not have to be considered in this question.
29 This would be similar to a scram with a loss of HPCI which in of itself would not count in
30 this PI.

31
32 **H 3.4 Was a Level 1 Injection signal received?**

33
34 The consideration of this question is whether or not the operator had to respond to abnormal
35 conditions that required a low pressure safety injection or if the operator had to respond to
36 the actuation of additional equipment that would not normally actuate on an uncomplicated
37 scram. For some plant designs some events result in a high pressure injection signal on
38 vessel level. Automatic or manual initiation of low pressure ECCS indicates the inability of
39 high pressure systems to operate properly or that a significant leak has occurred. Alternately,
40 the question would be plants that do not have a separate high pressure ECCS level signal
41 from their Low level ECCS signal an allowance is made to deviate from this question and
42 answer “Yes” if the system injected.
43

1 **H 3.5 Was Main Feedwater not available or not recoverable using approved plant**
2 **procedures during the scram response?**

FAQ481
(10-02)

3
4 If operating prior to the scram, did Main Feedwater cease to operate and was it unable to be
5 restarted during the reactor scram response? The consideration for this question is whether
6 Main Feedwater could be used to feed the reactor vessel if necessary. The qualifier of “not
7 recoverable using approved plant procedures” will allow a licensee to answer “NO” to this
8 question if there is no physical equipment restraint to prevent the operations staff from
9 starting the necessary equipment, aligning the required systems, or satisfying required logic
10 circuitry using plant procedures approved for use that were in place prior to the scram
11 occurring.

12
13 The operations staff must be able to start and operate the required equipment using normal
14 alignments and approved **emergency**, normal and off-normal operating procedures.
15 Manual operation of controllers/equipment, even if normally automatic, is allowed if
16 addressed by procedure. Situations that require maintenance **or repair** activities or non-
17 proceduralized operating alignments will not satisfy this question. Additionally, the
18 restoration of Main Feedwater must be capable of being restored to provide feedwater to the
19 reactor vessel in a reasonable period of time. Operations should be able to start a Main
20 Feedwater pump and start feeding the reactor vessel with the Main Feedwater System within
21 **about 30 minutes from the time it was recognized that Main Feedwater was needed**. During
22 startup conditions where Main Feedwater was not placed in service prior to the scram, this
23 question would not be considered, and should be skipped.
24

FAQ481
(10-02)

25 **H 3.6 Following initial transient, did stabilization of reactor pressure/level and drywell**
26 **pressure meet the entry conditions for EOPs?**

27
28 Since BWR designs have an emergency high pressure system that operates automatically
29 between a vessel-high and vessel-low level, it is not necessary for the Main Feedwater
30 System to continue operating following a reactor trip. However, failure of the Main
31 Feedwater System to be available is considered to be risk significant enough to require a
32 “Yes” response for this PI. To be considered available, the system must be free from damage
33 or failure that would prohibit restart of the system. Therefore, there is some reliance on the
34 material condition or availability of the equipment to reach the decision for this question.
35 Condenser vacuum, cooling water, and steam pressure values should be evaluated based on
36 the requirements to operate the pumps, and may be lower than normal if procedures allow
37 pump operation at that lower value.
38

39 The **estimated** 30-minute timeframe for restart of Main Feedwater was chosen based on
40 restarting from a hot condition with adequate reactor water level. Since this timeframe
41 will not be measured directly, it should be an estimation developed based on the material
42 condition of the plants systems following the reactor trip. If no abnormal material conditions
43 exist, the 30 minutes should be capable of being met. If plant procedures and design would
44 require more than 30 minutes, even if all systems were hot and the material condition of the
45 systems following the reactor trip were normal, a routine time should be used in the

FAQ481
(10-02)

1 | evaluation of this question. The ~~considered opinion~~ judgment of an on-shift licensed SRO
2 | ~~should be used in determining if in-meeting~~ this timeframe is ~~acceptable~~ met.
3 |

FAQ481
(10-02)

4 | When a scram occurs plant operators will enter the EOPs to respond to the condition. In the
5 | case of a routine scram the procedure entered will be exited fairly rapidly after verifying that
6 | the reactor is shutdown, excessive cooling is not in progress, electric power is available, and
7 | reactor coolant pressures and temperatures are at expected values and controlled. Once these
8 | verifications are done and the plant conditions considered “stable” (see guidance in the
9 | **Definition of Terms section under *scram response***) operators will exit the initial procedure
10 | to another procedure that will stabilize and prepare the remainder of the plant for transition
11 | for the use of normal operating procedures. The plant would then be ready be maintained in
12 | Hot Standby, to perform a controlled normal cool down, or to begin the restart process. The
13 | criteria in this question is used to verify that there were no other conditions that developed
14 | during the stabilization of the plant in the scram response related vessel parameters that
15 | required continued operation in the EOPs or re-entry into the EOPs or transition to a follow-
16 | on EOP. Maintaining operation in EOPs that are not related to vessel and drywell parameters
17 | do not count in this PI.

FAQ481
(10-02)

18 |
19 | For example:

20 | Suppression Pool level high or low require entry into an EOP on Containment Control.
21 | Meeting EOP entry conditions for this EOP do not count in this PI.
22 |

23 | **H 4 BWR Case Studies**

24 | **H 4.1 BWR Case Study 1**

25 |
26 |
27 | A plant experienced an automatic reactor scram as a result of a breaker tripping due to a
28 | ground fault on the 34.5kv bus work downstream of the Service Transformer. Loss of
29 | service transformer resulted in the loss of power to 2 of 4 balance of plant main busses and
30 | one of 3 ESF busses. Emergency Diesel Generator Division 1 started on a loss of power and
31 | connected to the ESF bus.
32 |

33 | The Main Generator tripped on reverse power and the turbine bypass valves opened to
34 | control pressure. No SRVs opened during this event.
35 |

36 | Both RPS actuation systems actuated, although for different reasons. The “A” RPS system
37 | actuated on loss of power to the Balance of Plant (BOP) (power to RPS “A” MG set) bus
38 | since it was powered from a service transformer. With the accompanying loss of power to
39 | the condensate/feedwater system components, the “B” RPS system actuated on low reactor
40 | water level of 11.4 inches. All control rods inserted to 00 position.
41 |

42 | Reactor water level dropped to approximately -75 inches on wide range level instrumentation
43 | before the High Pressure Core Spray (HPCS) and Reactor Core Isolation Cooling (RCIC)
44 | systems initiated at -41.6 and restored level to the EOP specified band. Level control was
45 | transferred to the startup level controller and both HPCS and RCIC were secured.
46 |

1 Primary, secondary, and drywell isolations occurred as designed at -41.6 inches along with
2 the start of the Division III (HPCS) diesel.

3
4 A walk down of the switchyard following the reactor scram discovered that a raccoon had
5 entered the service transformer area and caused the ground fault.

6
7 Prior to the scram power was 100% with both main feedwater pumps in service.

8
9 Feedwater was unavailable to control level.

10
11 Vessel level was restored to the EOP level band (+11.4 inches [low level scram setpoint]
12 to +53.5 inches [high level feedpump trip setpoint]) without any additional scram signals.
13 Drywell pressure was not affected noticeably by this event.
14

15 **1. Did RPS actuation fail to indicate/establish a shutdown rod pattern for a cold clean**
16 **core.**

17 **Answer:** “No”. As indicated Alternate Rod Insertion was not indicated or required.

18 Alternate yes / no answers as examples:

19 Answer: “No”. While all rods did not fully insert, reactor engineering, using an approved
20 procedure, ran a computer calculation that determined the reactor would remain shutdown
21 under cold clean conditions.

22 Answer: “Yes”. All rods did not insert, reactor engineering could not be contacted so
23 operations entered the ATWS leg of EOPs. Subsequent calculation by reactor engineering
24 determined the reactor would remain shutdown under cold clean conditions.

25 Answer: “Yes”. All rods failed to fully insert.

26 **2. Was pressure control unable to be established following initial transient?**

27 **Answer:** “No”. The Main Turbine did not trip as a result of the switchyard transient.
28 The turbine did eventually trip on reverse power at which time the turbine bypass valves
29 operated to control reactor pressure.

30 Alternate yes / no answers as examples.

31 Answer: “No”. The main turbine tripped resulting in opening of one or more SRVs.
32 Following the initial opening of the SRVs, the main turbine bypass valves opened to
33 control pressure.

34 Answer: “Yes”. The main turbine tripped resulting in opening of all 20 SRVs. As a result
35 of pressure controller problems operations subsequently manually opened an additional
36 SRV to control reactor pressure.

1 Answer: "Yes". The main turbine tripped and as a result of loss of condenser vacuum,
2 one or more SRVs were used to control reactor pressure.

3 **3. Was power lost to any class 1E Emergency/ESF bus?**

4 **Answer:** "No". While an ESF bus (Division I) did lose power, the EDG started and
5 restored power to the ESF bus.

6 Alternate yes / no answers as examples.

7 Answer: "No". Power was lost to an ESF bus. The EDG was out of service and power
8 was restored by closing an alternate feed breaker from the control room.

9 Answer: "Yes". Power was lost to an ESF bus. The EDG was out of service. Power was
10 restored to the ESF bus by resetting a lockout in the back panels and closing the breaker
11 from the control room.

12 **4. Was a level 1 Injection signal received?**

13 **Answer:** "No". Vessel level did decrease to approximately -75 inches resulting in the
14 automatic start of RCIC and HPCS. However, for this plant Level 1 is -150.3 inches.

15 Alternate yes / no answers as examples,

16 Answer: "No". HPCS and RCIC failed to start/run. Level dropped to -110 inches but was
17 stabilized by use of Control Rod Drive (CRD) pumps.

18 Answer: "Yes". HPCS and RCIC failed to start/run. Vessel level decreased to
19 near -150.3 inches and operators manually initiated low pressure.

20 **5. Was main feedwater unavailable or not recoverable using approved plant**
21 **procedures following during the scram response?**

FAQ481
(10-02)

22 **Answer:** "No". While some of the condensate system pumps lost power resulting in
23 both feedwater pumps tripping, the feedwater system was restored by use of normal
24 procedures. Feedwater was restored, and RCIC/HPCS was secured.

25 Alternate yes / no answers as examples

26 Answer: "No". Level was restored by RCIC. A condensate and condensate booster
27 pump remained operating. While both feedwater pumps tripped there were no known
28 issues with either pump that would prevent restarting if needed.

29 Answer: "Yes". Level was restored by RCIC. A condensate and condensate booster
30 pump remained operating. Both feedwater pumps tripped and problems with condenser
31 vacuum prevented restart of the feedpumps if they had been needed.

1 **6. Following initial transient did stabilization of reactor pressure/level and drywell**
2 **pressure meet the entry conditions for EOPs?**

3 **Answer:** “No”. Following the initial event, reactor pressure was controlled by the
4 turbine pressure control system to less than the high reactor pressure entry condition of
5 1064.7 psig [reactor high pressure scram setpoint]. Vessel level was restored to the EOP
6 level band (+11.4 inches[low level scram setpoint] to +53.5 inches [high level feedpump
7 trip setpoint]) without any additional scram signals. Drywell pressure was not affected
8 noticeably by this event.

9 Alternate yes / no answers as examples.

10 **Answer:** “No”. Following the initial event, reactor pressure was controlled by the turbine
11 pressure control system to less than the high reactor pressure entry condition of 1064.7
12 psig [reactor high pressure scram setpoint]. Vessel level was restored to the EOP level
13 band (+11.4 inches [low level scram setpoint] to +53.5 inches [high level feedpump trip
14 setpoint]) without any additional scram signals. The vessel was overfed twice, resulting
15 in a high level trip of the feedpump. However, when level decreased to less than the high
16 level trip setpoint, the feed pump was restored to operation by procedure. Drywell
17 pressure was not affected noticeably by this event.

18 **Answer:** “Yes”. Following the initial event, reactor pressure was controlled by the
19 turbine pressure control system to less than the high reactor pressure entry condition of
20 1064.7 psig [reactor high pressure scram setpoint]. Vessel level was restored to the EOP
21 level band (+11.4 inches[low level scram setpoint] to +53.5 inches [high level feedpump
22 trip setpoint]) but startup level control valve problems resulted in an additional low level
23 scram signal.

24 **H 4.2 BWR Case Study 2**

25
26 A plant received an automatic scram on a Turbine Control Valve Fast Closure as a result of a
27 load reject. The initiating event for the automatic scram was closure of a 500 kV disconnect
28 which was open for maintenance. High winds contributed to the disconnect closing and
29 contacting the energized bus. The pressure exerted by the wind on the disconnect blades
30 overcame the spring counterbalance of the disconnect switch. Additionally, the “Open”
31 position lock bracket on the motor operator was broken. A low impedance ground fault was
32 created through the installed maintenance grounds.

33 The fault resulted in actuation of the Service Transformer differential lockout and the West
34 500 kV buss differential lockout. Breakers opened as designed due to the Service
35 transformer lockouts and the West Bus lockouts. This resulted in the loss of one of the 2
36 service transformers and all plant busses normally powered from this transformer, including
37 safety related busses Division 2 and 3 which were powered from the service transformer.
38 The Division 2 & 3 EDGs subsequently started and appropriately re-energized the ESF
39 buses.

40 Within 3-5 cycles of the ground fault, breakers opened at a nearby substation de-energizing
41 the remaining 500 kV incoming power to the switchyard. This left the main generator

1 supplying power to some of the in-house loads including Balance of Plant and Division I
2 Safety Related Bus (ESF Division I)

3 The load reject relays then actuated producing a Turbine Control Valve Fast Closure
4 (TCV/FC) signal and a subsequent reactor scram. Approximately 4 seconds later the turbine
5 speed increased to 1900 rpm and generator output frequency increased to 63.5 Hz.
6 Subsequently, the turbine tripped as the generator remained excited and the turbine-generator
7 began coasting down into an under-frequency condition. Generator output voltage remained
8 constant.

9 As the turbine coasted down an under frequency condition occurred resulting in the turbine
10 output breaker opening. This resulted in loss of the Division 1 ESF bus as well as loss of the
11 2nd service transformer and all remaining balance of plant loads about 2-3 minutes following
12 the initial scram.

13 In summary the loss of power to the plant BOP, which resulted in loss of Feedwater and
14 normal pressure control, occurred in stages over several minutes, but still within the initial
15 transient. The ESF buses also lost power but were restored automatically by the D/Gs.

16
17 **1. Did RPS actuation fail to indicate/establish a shutdown rod pattern for a cold clean**
18 **core?**

19 **Answer:** “No”. Alternate Rod Insertion was not indicated or required.

20 **2. Was pressure control unable to be established following initial transient?**

21 **Answer:** “Yes”. While SRVs open once on the load reject and steam pressure decreased
22 as the turbine coasted down, the loss of all balance of plant power several minutes later
23 when the main generator tripped, resulted in loss of pressurized fluid for the hydraulic
24 bypass valves. This resulted in the use of the SRVs to control reactor pressure following
25 the initial scram. Additionally, the loss of the balance of plant power resulted in loss of
26 main condenser cooling which prevented use of the main condenser as a heat sink.

27 **3. Was power lost to any class 1E Emergency/ESF bus?**

28 **Answer:** “No”. While all ESF busses lost power the EDGs started and restored power
29 automatically to the ESF busses.

30 **4. Was a level 1 Injection signal received?**

31 **Answer:** “No”. Vessel level did drop to about -42 inches resulting in auto start of
32 RCIC. The level 1 setpoint is -150.3 inches.

33 **5. Was main feedwater unavailable or not recoverable using approved plant**
34 **procedures following-during the scram response?**

35 **Answer:** “Yes”. The loss of balance of plant power after several minutes resulted in loss
36 of all condensate and condensate booster pumps as well as loss of power to condensate

1 and feedwater valves, preventing the use of feedwater to control level. Level was
2 controlled by RCIC.

3 **6. Following initial transient did stabilization of reactor pressure/level and drywell**
4 **pressure meet the entry conditions for EOPs?**

5 **Answer:** “No”. Following the initial event, reactor pressure was controlled by the SRVs
6 to maintain the reactor pressure below the EOP entry setpoint of 1067.5 psig [reactor
7 high pressure scram setpoint]. The vessel level was restored to the EOP level band
8 (+11.4 inches[low level scram setpoint] to + 53.5 inches [high level feedpump trip
9 setpoint]) by use of RCIC with one additional scram signal on high level. Drywell
10 pressure did increase slightly as a result of loss of cooling but never exceeded the EOP
11 setpoint of 1.23 psig. The EOP for containment control was entered as a result of high
12 suppression pool level due to swell from the heat/mass addition from the operation of
13 systems (e.g.RCIC, SRVs).