

SCID-5-MICS

STRUCTURED CLINICAL INTERVIEW FOR DSM-5® DISORDERS

MODIFIED FOR THE MENTAL ILLNESS CALIBRATION STUDY

Michael B. First, M.D., Janet B. W. Williams, Ph.D., Rhonda S. Karg, Ph.D., and
Robert L. Spitzer, M.D.

Copyright © 2015 Michael B. First, M.D., Janet B. W. Williams, Ph.D., and Robert L. Spitzer, M.D.

For citation: First MB, Williams JBW, Karg RS, Spitzer RL: *User's Guide for the Structured Clinical Interview for DSM-5 Disorders, Research Version (SCID-5-RV)*. Arlington, VA, American Psychiatric Association, 2015

The Structured Clinical Interview for DSM-5®, Research Version (SCID-5-RV), includes the User's Guide and score sheets. Use of any component of the SCID-5-RV requires permission or licensing through American Psychiatric Publishing before use. Inquiries should be directed to SCID Permissions & Licensing, American Psychiatric Publishing, 1000 Wilson Boulevard, Suite 1825, Arlington, VA 22209-3901, or online at: <http://www.appi.org/CustomerService/Pages/Permissions.aspx>. For more information, please visit the SCID products page on www.appi.org.

DSM and DSM-5 are registered trademarks of the American Psychiatric Association. Use of these terms is prohibited without permission of the American Psychiatric Association.

DSM-5® diagnostic criteria are reprinted or adapted with permission from American Psychiatric Association: *Diagnostic and Statistical Manual of Mental Disorders*, Fifth Edition. Arlington VA, American Psychiatric Association, 2013. Copyright © 2013 American Psychiatric Association. Used with permission.

ALL RIGHTS RESERVED. Unless authorized in writing by the American Psychiatric Association (APA), no part of the DSM-5® criteria may be reproduced or used in a manner inconsistent with the APA's copyright. This prohibition applies to unauthorized uses or reproductions in any form, including electronic applications. Correspondence regarding copyright permission for DSM-5 criteria should be directed to DSM Permissions, American Psychiatric Publishing, 1000 Wilson Boulevard, Suite 1825, Arlington, VA 22209-3901, www.appi.org.

All versions of the SCID-5 represent the findings, conclusions, and views of the individual authors and do not necessarily represent the policies and opinions of American Psychiatric Publishing or the American Psychiatric Association.

Respondent: _____

Date of Interview: _____
Month Day Year

Clinical Interviewer: _____

Nonpatient Overview

I'm going to be asking you about problems or difficulties you may have had, and I'll be making some notes as we go along. Do you have any questions before we begin?

NOTE: Any current suicidal thoughts, plans, or actions should be thoroughly assessed by the clinician and action taken if necessary.

Demographic Data

What is your current gender?

GENDER:

ONP1

What's your date of birth?

DOB: _____ AGE: ____ ____
 month day year

ONP2

ONP3

Are you married?

MARITAL STATUS (most recent):

IF NO: Do you live with someone as if you are married?

1 Married or living with someone as if married

ONP4

IF NO: Were you ever married?

2 Widowed

3 Divorced or annulled

4 Separated

5 Never married

How long have you been (MARITAL STATUS)?

IF EVER MARRIED: How many times have you been married?

Do you have any children?

IF YES: How many? (What are their ages?)

With whom do you live? (How many children under the age of 18 live in your household?)

In what city, town, or neighborhood do you live?

In what kind of place do you live? (A house, an apartment, a shelter, a halfway house, or some other living arrangement? Are you homeless?)

I would like to now ask you about your cultural background or identity. By background or identity, I mean, for example, the communities you belong to, the languages you speak, where you or your family are from, your race or ethnic background, your gender or sexual orientation, or your faith or religion.

For you, what are the most important aspects of your background or identity?

Education and Work History

How far did you go in school?

EDUCATION:

- 1 Grade 6 or less
- 2 Grades 7 to 12 (without graduating high school)
- 3 Graduated high school or high school equivalent
- 4 Part college/trade school
- 5 Graduated 2-year college or trade school
- 6 Graduated 4-year college
- 7 Part graduate/professional school
- 8 Completed graduate/professional school

ONP5

IF FAILED TO COMPLETE A PROGRAM IN WHICH THEY WERE ENROLLED: Why did you leave?

What kind of work do you do? (Do you work outside of your home?)

Education and Work History (continued)

Have you always done that kind of work?

IF NO: What other kind of work have you done in the past?

What's the longest you've worked at one place?

Are you currently employed (getting paid)?

PRIMARY EMPLOYMENT STATUS:

- 1 Full-time job
- 2 Part-time job
- 3 Keeping house or care giving full-time
- 4 In school/training
- 5 Retired
- 6 Unemployed, looking for work
- 7 Unemployed, not looking for work
- 8 Disabled

ONP6

IF YES: Do you work part-time or full-time?

IF PART-TIME: How many hours do you typically work each week? (Why do you work part-time instead of full-time?)

IF NO: Why is that? When was the last time you worked? How are you supporting yourself now?

IF DISABLED: Are you currently receiving disability payments? What are you receiving disability for?

IF EMPLOYED: How long have you worked at your current job?

IF LESS THAN 6 MONTHS: Why did you leave your last job?

IF UNKNOWN: Has there ever been a period of time when you were unable to work or go to school?

IF YES: Why was that?

Have you ever been arrested, involved in a lawsuit, or had other legal trouble?

Current and Past Periods of Psychopathology

NOTE: FOR A COMPLICATED HX, USE THE LIFE CHART ON PAGE 7.

Have you ever seen anybody for emotional or psychiatric problems?

▶ **IF YES: What was that for? (What treatment did you get? Any medications? When was that? When was the first time you ever saw someone for emotional or psychiatric problems?)**

▶ **IF NO: Was there ever a time when you, or someone else, thought you should see someone because of the way you were feeling or acting? (Tell me more.)**

Have you ever seen anybody for problems with alcohol or drugs?

IF YES: What was that for? (What treatment[s] did you get? Any medications? When was that?)

Have you ever attended a self-help group, like Alcoholics Anonymous, Gamblers Anonymous, or Overeaters Anonymous?

IF YES: What was that for? When was that?

Hospitalization History

Have you ever been a patient in a psychiatric hospital? Number of previous hospitalizations (Do not include transfers):

IF YES: What was that for? (How many times?)

ONP7

IF AN INADEQUATE ANSWER IS GIVEN, CHALLENGE GENTLY: e.g., Wasn't there something else? People don't usually go to psychiatric hospitals just because they are tired or nervous.

Have you ever been in a hospital for treatment of a medical problem?

IF YES: What was that for?

Thinking back over your whole life, when were you the most upset? (Why? What was that like? How were you feeling?)

Suicide Attempt

CHECK FOR ATTEMPT: In the past year, have you tried to kill yourself?

IF NO: **In the past year, have you done anything to harm yourself?**

IF NO: GO TO ***OTHER CURRENT PROBLEMS,*** BELOW.

IF YES TO EITHER OF ABOVE: **What did you do? (Tell me what happened.) Were you trying to end your life?**

IF MORE THAN ONE ATTEMPT: **Which attempt had the most severe medical consequences (going to emergency department, needing hospitalization, requiring ICU)?**

Have you made any suicide attempts in the past week (including today)?

Check if:

Suicide attempt past week

ONP14

Other Current Problems

Have you had any other problems in the past year? (How are things going at work, at home, and with other people?)

What has your mood been like?

How has your physical health been? (Have you had any medical problems?)

Do you take any medication, vitamins, nutritional supplements, or natural health remedies (other than those you've already told me about?)

IF YES: **How much and how often do you take (MEDICATION)? (Has there been any change in the amount you have been taking?)**

How have you been spending your free time? Who do you spend time with?

GO TO NEXT MODULE

SCID Screening Module (including optional disorders)

Now I want to ask you some more specific questions about problems you may have had. We'll go into more detail about them later.

1. In the past year, since (1 YEAR AGO), have you had an intense rush of anxiety, or what someone might call a "panic attack," when you suddenly felt very frightened, or anxious or suddenly developed a lot of physical symptoms?

(screening for panic attacks)

NO	YES	S1
CIRCLE "NO" ON F.1	CIRCLE "YES" ON F.1	

2. In the past year, since (1 YEAR AGO), have you been very anxious about or afraid of situations like going out of the house alone, being in crowds, going to stores, standing in lines, or traveling on buses or trains?

(screening for Agoraphobia)

NO	YES	S2
CIRCLE "NO" ON F.8	CIRCLE "YES" ON F.8	

3. In the past year, since (1 YEAR AGO), have you been especially nervous or anxious in social situations like having a conversation or meeting unfamiliar people?

(screening for Social Anxiety Disorder)

NO	YES	S3
CIRCLE "NO" ON 1 st ITEM, F.14	CIRCLE "YES" ON 1 st ITEM, F.14	

4. In the past year, since (1 YEAR AGO), was there anything that you have been afraid to do or felt very uncomfortable doing in front of other people, like speaking, eating, writing, or using a public bathroom?

(screening for Social Anxiety Disorder)

NO	YES	S4
CIRCLE "NO" ON 2 nd ITEM, F.14	CIRCLE "YES" ON 2 nd ITEM, F.14	

5. Are there any other things since (1 YEAR AGO) that have made you especially anxious or afraid, like flying, seeing blood, getting a shot, heights, closed places, or certain kinds of animals or insects?

(screening for Specific Phobia)

NO	YES	S5
CIRCLE "NO" ON F.19	CIRCLE "YES" ON F.19	

6. Over the last 12 months have you been feeling anxious and worried for a lot of the time?

(screening for current Generalized Anxiety Disorder)

NO	YES	S6
CIRCLE "NO" ON F.24	CIRCLE "YES" ON F.24	

8. In the past year, since (1 YEAR AGO), have you been bothered with thoughts that kept coming back to you even when you didn't want them to, like being exposed to germs or dirt or needing everything to be lined up in a certain way?

(screening for obsessions in Obsessive-Compulsive Disorder)

NO	YES	S8
CIRCLE "NO" ON 1 st ITEM, G.1	CIRCLE "YES" ON 1 st ITEM, G.1	

9. How about having images pop into your head that you didn't want like violent or horrible scenes or something of a sexual nature?

(screening for obsessions in Obsessive-Compulsive Disorder)

NO	YES	S9
CIRCLE "NO" ON 2 nd ITEM, G.1	CIRCLE "YES" ON 2 nd ITEM, G.1	

10. How about having urges to do something that kept coming back to you even though you didn't want them to, like an urge to harm a loved one?

(screening for obsessions in Obsessive-Compulsive Disorder)

NO	YES	S10
CIRCLE "NO" ON 3 rd ITEM, G.1	CIRCLE "YES" ON 3 rd ITEM, G.1	

11. In the past year, since (1 YEAR AGO), was there anything that you had to do over and over again and was hard to resist doing, like washing your hands again and again, repeating something over and over again until it "felt right," counting up to a certain number, or checking something many times to make sure that you'd done it right?

(screening for compulsions in Obsessive-Compulsive Disorder)

NO	YES	S11
CIRCLE "NO" ON G.2	CIRCLE "YES" ON G.2	

12. In the past year, since (1 YEAR AGO), have you had a time when you weighed much less than other people thought you ought to weigh?

(screening for Anorexia Nervosa)

NO	YES	S12
CIRCLE "NO" ON I.1	CIRCLE "YES" ON I.1	

13. Have you had eating binges in the past year, that is, times when you couldn't resist eating a lot of food or stop eating once you started?

(screening for binge eating in Bulimia Nervosa and Binge Eating Disorder)

NO	YES	S13
CIRCLE "NO" ON I.4	CIRCLE "YES" ON I.4	

15a. In the past year, since (1 YEAR AGO), have you frequently lost control of your temper and ended up yelling or getting into arguments with others?

(screening for current Intermittent Explosive Disorder)

NO	YES	S15a
CIRCLE "NO" ON 1 st ITEM, Opt-K.1	CIRCLE "YES" ON 1 st ITEM, Opt-K.1	

15b. In the past year, since (1 YEAR AGO), have you lost your temper so that you shoved, hit, kicked, or threw something at a person or an animal, or damaged someone's property?

(screening for current Intermittent Explosive Disorder)

NO	YES	S15b
CIRCLE "NO" ON 2 nd ITEM, Opt-K.1	CIRCLE "YES" ON 2 nd ITEM, Opt-K.1	

A. MOOD EPISODES

CURRENT MAJOR DEPRESSIVE EPISODE

Now I am going to ask you some more questions about your mood.

Since (1 YEAR AGO), has there been a period of time when you were feeling depressed or down most of the day nearly every day? (Has anyone said that you look sad, down, or depressed?)

IF NO: What about feeling empty or hopeless most of the day nearly every day?

IF YES TO EITHER OF ABOVE: What has that been like? How long has it lasted? (As long as 2 weeks?)

→ *IF PREVIOUS ITEM CODED "3:"*
During that time, did you lose interest or pleasure in things you usually enjoyed? (What has that been like? Give me some examples.)

→ *IF PREVIOUS ITEM NOT CODED "3:"*
What about a time since (1 YEAR AGO) when you lost interest or pleasure in things you usually enjoyed? (What has that been like? Give me some examples.)

IF YES: Has it been nearly every day? How long has it lasted? (As long as 2 weeks?)

FOR THE FOLLOWING QUESTIONS, FOCUS ON THE WORST 2 WEEKS IN THE PAST YEAR (OR ELSE THE PAST 2 WEEKS IF EQUALLY DEPRESSED FOR ENTIRE YEAR).

IF UNKNOWN: Since (1 YEAR AGO), during which 2-week period would you say you have been doing the worst?

MAJOR DEPRESSIVE EPISODE CRITERIA

A. Five (or more) of the following symptoms have been present during the same 2-week period and represent a change from previous functioning; at least one of the symptoms is either (1) depressed mood, or (2) loss of interest or pleasure.

1. Depressed mood most of the day, nearly every day, as indicated either by subjective report (e.g., feels sad, empty, hopeless) or observation made by others (e.g., appears tearful). NOTE: in children or adolescents, can be irritable mood.

2. Markedly diminished interest or pleasure in all, or almost all, activities most of the day, nearly every day (as indicated either by subjective account or observation).

NOTE: When rating the following items, code "1" if the symptoms are clearly due to a general medical condition (e.g., insomnia due to severe back pain).

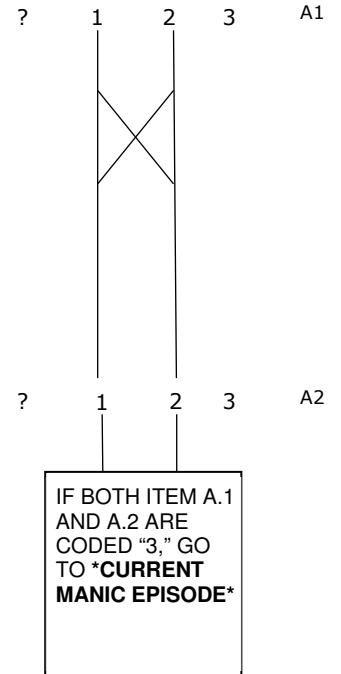

During (2-WEEK PERIOD)...

...how has your appetite been? (What about compared to your usual appetite? Have you had to force yourself to eat? Eat [less/more] than usual? Has that been nearly every day? Have you lost or gained any weight? How much?)

IF YES: Have you been trying to [lose/gain] weight?)

3. Significant weight loss when not dieting, or weight gain (e.g., a change of more than 5% of body weight in a month) or decrease or increase in appetite nearly every day. NOTE: in children, consider failure to make expected weight gains.

? 1 2 3 A3

Check if:

___ weight loss or decreased appetite
___ weight gain or increased appetite

A4
A5

...how have you been sleeping? (Trouble falling asleep, waking frequently, trouble staying asleep, waking too early, OR sleeping too much? How many hours of sleep [including naps] have you been getting? How many hours of sleep did you typically get before you got [depressed/OWN WORDS]? Has it been nearly every night?)

4. Insomnia or hypersomnia nearly every day.

? 1 2 3 A6

Check if:

___ insomnia
___ hypersomnia

A7
A8

...have you been so fidgety or restless that you were unable to sit still? What about the opposite—talking more slowly, or moving more slowly than is normal for you, as if you're moving through molasses or mud? (In either instance, has it been so bad that other people have noticed it? What have they noticed? Has that been nearly every day?)

5. Psychomotor agitation or retardation nearly every day (observable by others, not merely subjective feelings of restlessness or being slowed down)

? 1 2 3 A9

NOTE: Consider behavior during the interview.

Check if:

___ psychomotor agitation
___ psychomotor retardation

A10
A11

...what has your energy level been like? (Tired all the time? Nearly every day?)

6. Fatigue or loss of energy nearly every day.

? 1 2 3 A12

...have you been feeling worthless?

7. Feelings of worthlessness or excessive or inappropriate guilt (which may be delusional) nearly every day (not merely self-reproach or guilt about being sick)

? 1 2 3 A13

What about feeling guilty about things you have done or not done?

IF YES: What things? (Is this only because you can't take care of things since you have been sick?)

Check if:

___ worthlessness
___ inappropriate guilt

A14
A15

IF YES TO EITHER OF ABOVE: Nearly every day?

...have you had trouble thinking or concentrating? Has it been hard to make decisions about everyday things? (What kinds of things has it been interfering with? Nearly every day?)

8. Diminished ability to think or concentrate, or indecisiveness, nearly every day (either by subjective account or as observed by others).

? 1 2 3 A16

...have things been so bad that you thought a lot about death or that you would be better off dead? Have you thought about taking your own life?

IF YES: Have you done something about it? (What have you done? Have you made a specific plan? Have you taken any action to prepare for it? Have you actually made a suicide attempt?)

9. Recurrent thoughts of death (not just fear of dying), recurrent suicidal ideation without a specific plan, or a suicide attempt or a specific plan for committing suicide.

? 1 2 3 A17

NOTE: Code "1" for self-mutilation without suicidal intent.

Check if:

- thoughts of own death
- suicidal ideation
- specific plan
- suicide attempt

A18
A19
A20
A21

NOTE: Any current suicidal thoughts, plans, or actions should be thoroughly assessed by the clinician and action taken if necessary.

AT LEAST FIVE OF THE ABOVE SXS (A.1–A.9) ARE CODED "3" AND AT LEAST ONE OF THESE IS ITEM A.1 OR A.2.

1 3 A22

1
|
GO TO *CURRENT MANIC EPISODE*

IF UNKNOWN: What effect have (DEPRESSIVE SXS) had on your life?

ASK THE FOLLOWING QUESTIONS AS NEEDED TO RATE CRITERION B:

How have (DEPRESSIVE SXS) affected your relationships or your interactions with other people? (Has this caused you any problems in your relationships with your family, romantic partner or friends?)

B. The symptoms cause clinically significant distress or impairment in social, occupational, or other important areas of functioning.

? 1 2 3 A23

1
|
GO TO *CURRENT MANIC EPISODE*

How have (DEPRESSIVE SXS) affected your work/school? (How about your attendance at work or school? Did [DEPRESSIVE SXS] make it more difficult to do your work/schoolwork? How have [DEPRESSIVE SXS] affected the quality of your work/schoolwork?)

How have (DEPRESSIVE SXS) affected your ability to take care of things at home? How about doing simple everyday things like getting dressed, bathing, or brushing your teeth? What about doing other things that are important to you like religious activities, physical exercise, or hobbies? Have you avoided doing anything because you felt like you weren't up to it?

Have (DEPRESSIVE SXS) affected any other important part of your life?

IF DOES NOT INTERFERE WITH LIFE: How much have you been bothered or upset by having (DEPRESSIVE SXS)?

?=inadequate information

1=absent or false

2=subthreshold

3=threshold or true

IF UNKNOWN: When did (EPISODE OF DEPRESSION) begin?

Just before this began, were you physically ill?

IF YES: What did the doctor say?

Just before this began, were you using any medications?

IF YES: Any change in the amount you were using?

Just before this began, were you drinking or using any drugs?

C. [Primary Depressive Episode:] The episode is not attributable to the physiological effects of a substance (e.g., a drug of abuse, medication) or to another medical condition.

IF THERE IS ANY INDICATION THAT THE DEPRESSION MAY BE SECONDARY (I.E., A DIRECT PHYSIOLOGICAL CONSEQUENCE OF GMC OR SUBSTANCE/MEDICATION), GO TO *GMC/SUBSTANCE* A.45, AND RETURN HERE TO MAKE A RATING OF "1" OR "3."

Etiological medical conditions include: stroke, Huntington's disease, Parkinson's disease, traumatic brain injury, Cushing's disease, hypothyroidism, multiple sclerosis, systemic lupus erythematosus.

Etiological substances/medications include: alcohol (I/W), phencyclidine (I), hallucinogens (I), inhalants (I), opioids (I/W), sedative, hypnotics or anxiolytics (I/W), amphetamine and other stimulants (I/W), cocaine (I/W), antiviral agents (etavirenz), cardiovascular agents (clonidine, guanethidine, methyldopa, reserpine), retinoic acid derivatives (isotretinoin), antidepressants, anticonvulsants, anti-migraine agents (triptans), antipsychotics, hormonal agents (corticosteroids, oral contraceptives, gonadotropin-releasing hormone agonists, tamoxifen), smoking cessation agents (varenicline) and immunological agents (interferon).

MAJOR DEPRESSIVE EPISODE CRITERIA A, B, AND C ARE CODED "3."

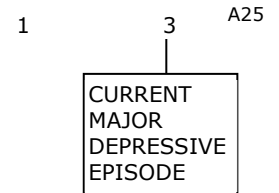
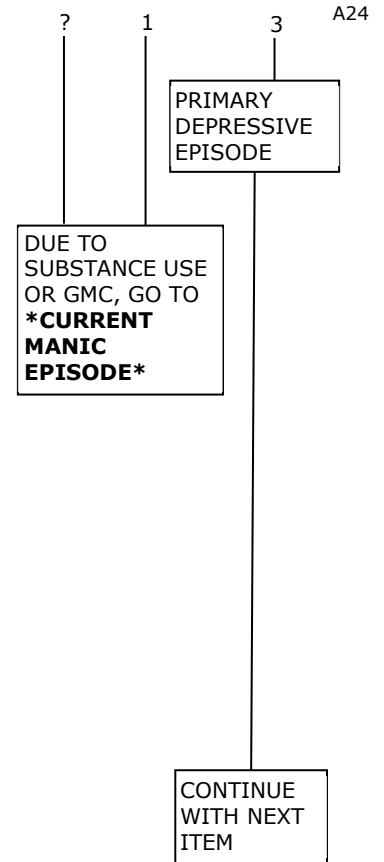

?=inadequate information

1=absent or false

2=subthreshold

3=threshold or true

CURRENT MANIC EPISODE

MANIC EPISODE CRITERIA

Since (1 YEAR AGO), has there been a period of time when you were feeling so good, "high," excited, or "on top of the world" that other people thought you were not your normal self?

→ **IF YES: What has it been like? (More than just feeling good?)**

Have you also been feeling like you were "hyper" or "wired" and had an unusual amount of energy? Have you been much more active than is typical for you? (Have other people commented on how much you have been doing?)

→ **IF NO: Since (1 YEAR AGO), have you had a period of time when you were feeling irritable, angry, or short-tempered most of the day, nearly every day, for at least several days? What has it been like? (Is that different from the way you usually are?)**

IF YES: Have you also been feeling like you were "hyper" and had an unusual amount of energy? Have you been much more active than is typical for you? (Have other people commented on how much you have been doing?)

How long has this lasted? (As long as 1 week?)

IF LESS THAN 1 WEEK: Did you need to go into the hospital to protect you from hurting yourself or someone else, or from doing something that could have caused serious financial or legal problems?

Have you been feeling (high/irritable/OWN WORDS) for most of the day, nearly every day during this time?

FOCUS ON THE MOST SEVERE WEEK IN THE PAST YEAR OF THE CURRENT EPISODE FOR THE FOLLOWING QUESTIONS.

IF UNCLEAR: During (EPISODE), when were you the most (high/irritable/OWN WORDS)?

During that time...

...how did you feel about yourself?

(More self-confident than usual? Did you feel much smarter or better than everyone else? Did you feel like you had any special powers or abilities?)

...did you need less sleep than usual? (How much sleep did you get?)

IF YES: Did you still feel rested?

A. A distinct period [lasting at least several days] of abnormally and persistently elevated, expansive, or irritable mood and abnormally and persistently increased [...] activity or energy.

Check if:

- elevated, expansive mood
- irritable mood

? 1 2 3 A54

GO TO *PAST MANIC EPISODE*

A55
A56

...lasting at least 1 week and present most of the day, nearly every day (or any duration if hospitalization is necessary).

? 1 2 3 A57

GO TO *PAST MANIC EPISODE*

NOTE: If elevated mood lasts less than 1 week, check whether irritable mood lasts at least 1 week before skipping to A.14.

B. During the period of mood disturbance and increased energy or activity, three (or more) of the following symptoms have persisted (four if the mood is only irritable) and have been present to a significant degree and represent a noticeable change from usual behavior:

1. Inflated self-esteem or grandiosity.

? 1 2 3 A58

2. Decreased need for sleep (e.g., feels rested after only 3 hours of sleep).

? 1 2 3 A59

?=inadequate information

1=absent or false

2=subthreshold

3=threshold or true

During that time...

...were you much more talkative than usual? (Did people have trouble stopping you or understanding you? Did people have trouble getting a word in edgewise?)

3. More talkative than usual or pressure to keep talking. ? 1 2 3 A60

...did you have thoughts racing through your head? (What was that like?)

4. Flight of ideas or subjective experience that thoughts are racing. ? 1 2 3 A61

...were you so easily distracted by things around you that you had trouble concentrating or staying on one track? (Give me an example of that.)

5. Distractibility (i.e., attention too easily drawn to unimportant or irrelevant external stimuli) as reported or observed. ? 1 2 3 A62

...how did you spend your time? (Work, friends, hobbies? Were you especially busy during that time?)

6. Increase in goal-directed activity (either socially, at work or school, or sexually) or psychomotor agitation (i.e., purposeless non-goal-directed activity). ? 1 2 3 A63

(Did you find yourself more enthusiastic at work or working harder at your job? What about being more engaged in school activities or studying harder?)

Check if:

increase in activity

psychomotor agitation

A64

A65

(Were you more sociable during that time, such as calling on friends or going out with them more than you usually do or making a lot of new friends?)

(Were you spending more time thinking about sex or involved in doing something sexual, by yourself or with others? Was that a big change for you?)

Were you physically restless during this time, doing things like pacing a lot, or being unable to sit still? (How bad was it?)

...were you doing anything that could have caused trouble for you or your family?

7. Excessive involvement in activities that have a high potential for painful consequences (e.g., engaging in unrestrained buying sprees, sexual indiscretions, or foolish business investments). ? 1 2 3 A66

(Spending money on things you didn't need or couldn't afford? How about giving away money or valuable things? Gambling with money you couldn't afford to lose?)

(Anything sexual that was likely to get you in trouble? Driving recklessly?)

(Did you make any risky or impulsive business investments or get involved in a business scheme that you wouldn't normally have done?)

AT LEAST THREE "B" SXS ARE CODED "3" (FOUR IF MOOD ONLY IRRITABLE).

	1		3	A67
	↓			
	GO TO *PAST MANIC EPISODE*			

IF UNKNOWN: What effect have these (MANIC SXS) had on your life?

C. The mood disturbance is sufficiently severe to cause marked impairment in social or occupational functioning or to necessitate hospitalization to prevent harm to self or others, or there are psychotic features.

?	1	2	3	A68
	↓			
	GO TO *PAST MANIC EPISODE*			

IF UNKNOWN: Have you needed to go into the hospital to protect you from hurting yourself or someone else, or from doing something that could have caused serious financial or legal problems?

NOTE: Code "3" if psychotic symptoms have been present. You may need to return here to recode after screening for psychotic symptoms in Module B.

ASK THE FOLLOWING QUESTIONS AS NEEDED TO RATE CRITERION C.

DESCRIBE:

How have (MANIC SXS) affected your relationships or your interactions with other people? (Have (MANIC SXS) caused you any problems in your relationships with your family, romantic partner or friends?)

How have (MANIC SXS) affected your work/school? (How about your attendance at work or school? Did [MANIC SXS] make it more difficult to do your work/schoolwork? How have [MANIC SXS] affected the quality of your work/schoolwork?)

How have (MANIC SXS) affected your ability to take care of things at home?

IF UNKNOWN: When did this period of being (high/irritable/OWN WORDS) begin?

Just before this began, were you physically ill?

IF YES: What did the doctor say?

Just before this began, were you taking any medications?

IF YES: Any change in the amount you were taking?

Just before this began, were you drinking or using any drugs?

D. [Primary Manic Episode:] The episode is not attributable to the physiological effects of a substance (i.e., a drug of abuse, medication) or to another medical condition.

IF THERE IS ANY INDICATION THAT MANIA MAY BE SECONDARY (I.E., A DIRECT PHYSIOLOGICAL CONSEQUENCE OF A GMC OR SUBSTANCE), GO TO ***GMC/SUBSTANCE*** A.41 AND RETURN HERE TO MAKE A RATING OF "1" OR "3."

NOTE: A full Manic Episode that emerges during antidepressant treatment (e.g., medication, electroconvulsive therapy) but persists at a fully syndromal level beyond the physiological effect of that treatment is sufficient evidence for a Manic Episode and, therefore, a Bipolar I diagnosis.

Etiological medical conditions include: Alzheimer's disease, vascular dementia, HIV-induced dementia, Huntington's disease, Lewy body disease, Wernicke-Korsakoff, Cushing's disease, multiple sclerosis, ALS, Parkinson's disease, Pick's disease, Creutzfeldt-Jakob disease, stroke, traumatic brain injuries, hyperthyroidism

Etiological substances/medications include: alcohol (I/W), phencyclidine (I), hallucinogens (I), sedatives, hypnotics, anxiolytics (I/W), amphetamines (I/W), cocaine (I/W), corticosteroids, androgens, isoniazid, levodopa, interferon alpha, varenicline, procarbazine, clarithromycin, ciprofloxacin

MANIC EPISODE CRITERIA A, B, C, AND D ARE CODED "3."

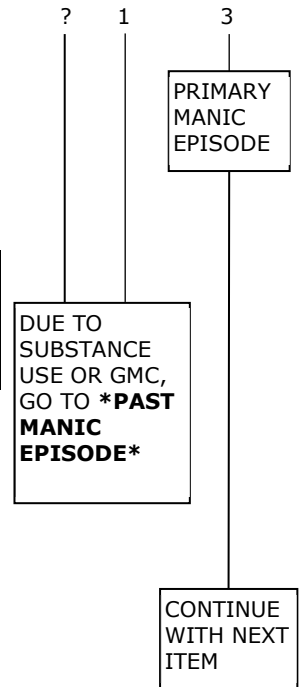

A69

1

3

A70



?=inadequate information

1=absent or false

2=subthreshold

3=threshold or true

PAST MANIC EPISODE

NOTE: IF CURRENTLY ELEVATED OR IRRITABLE MOOD BUT FULL CRITERIA ARE NOT MET FOR A MANIC EPISODE, SUBSTITUTE THE PHRASE "Has there ever been another time ..." IN EACH OF THE SCREENING QUESTIONS BELOW.

MANIC EPISODE CRITERIA

IF CURRENT MAJOR DEPRESSIVE EPISODE HAS BEEN CONFIRMED, GO TO ***CURRENT PERSISTENT DEPRESSIVE DISORDER***

Have you ever had a period of time when you were feeling so good, "high," excited, or "on top of the world" that other people thought you were not your normal self?

→ IF YES: What was it like? (Was that more than just feeling good?) Did you also feel like you were "hyper" or "wired" and had an unusual amount of energy? Were you much more active than is typical for you? (Did other people comment on how much you were doing?)

→ IF NO: Have you ever had a period of time when you were feeling irritable, angry, or short-tempered for most of the day, every day, for at least several days? What was that like? (Was that different from the way you usually are?)

IF YES: Did you also feel like you were "hyper" or "wired" and had an unusual amount of energy? Were you much more active than is typical for you? (Did other people comment on how much you were doing?)

A. A distinct period [lasting at least several days] of abnormally and persistently elevated, expansive or irritable mood and abnormally and persistently increased [...] activity or energy.

Check if:

- elevated, expansive mood
- irritable mood

? 1 2 3 A92

GO TO ***CURRENT PERSISTENT DEPRESSIVE DISORDER***

A93
A94

When was that?

How long did that last? (As long as 1 week?)

IF LESS THAN 1 WEEK: Did you need to go into the hospital to protect you from hurting yourself or someone else, or from doing something that could have caused serious financial or legal problems?)

...lasting at least 1 week and present most of the day, nearly every day (or any duration if hospitalization is necessary).

NOTE: If elevated mood lasts less than 1 week, check whether irritable mood lasts at least 1 week before skipping to A.23.

? 1 2 3 A95

GO TO ***CURRENT PERSISTENT DEPRESSIVE DISORDER***

Did you feel (high/irritable/OWN WORDS) for most of the day, nearly every day during this time?

NOTE: If there is evidence for more than one past episode, select the worst episode that occurred in the prior year; if none of the past episodes occurred in the prior year, select the worst episode that occurred regardless of the time it occurred.

Have you had more than one time like that? (Which time was the most extreme?)

IF UNCLEAR: Have you had any times like that in the past year, since (1 YEAR AGO)?

FOCUS ON THE WORST PERIOD OF THE EPISODE THAT YOU ARE INQUIRING ABOUT.

IF UNCLEAR: During (EPISODE), when were you the most (high/irritable/OWN WORDS)?

During that time...

...how did you feel about yourself? (More self-confident than usual? Did you feel much smarter or better than everyone else? Did you feel like you had any special powers or abilities?)

B. During the period of mood disturbance and increased energy or activity, three (or more) of the following symptoms have persisted (four if the mood is only irritable) and have been present to a significant degree and represent a noticeable change from usual behavior:

1. Inflated self-esteem or grandiosity. ? 1 2 3 A96

...did you need less sleep than usual? (How much sleep did you get?)

2. Decreased need for sleep (e.g., feels rested after only 3 hours of sleep). ? 1 2 3 A97

IF YES: Did you still feel rested?

...were you much more talkative than usual? (Did people have trouble stopping you or understanding you? Did people have trouble getting a word in edgewise?)

3. More talkative than usual or pressure to keep talking. ? 1 2 3 A98

...did you have thoughts racing through your head? (What was that like?)

4. Flight of ideas or subjective experience that thoughts are racing. ? 1 2 3 A99

...were you so easily distracted by things around you that you had trouble concentrating or staying on one track? (Give me an example of that.)

5. Distractibility (i.e., attention too easily drawn to unimportant or irrelevant external stimuli) as reported or observed. ? 1 2 3 A100

...how did you spend your time? (Work, friends, hobbies? Were you especially busy during that time?)

6. Increase in goal-directed activity (either socially, at work or school, or sexually) or psychomotor agitation (i.e., purposeless non-goal-directed activity). ? 1 2 3 A101

(Did you find yourself more enthusiastic at work or working harder at your job? Did you find yourself more engaged in school activities or studying harder?)

Check if:

increase in activity

A102

psychomotor agitation

A103

(Were you more sociable during that time, such as calling on friends or going out with them more than you usually do or making a lot of new friends?)

(Were you spending more time thinking about sex or involved in doing something sexual, by yourself or with others? Was that a big change for you?)

Were you physically restless during this time, doing things like pacing a lot, or being unable to sit still?

(How bad was it?)

?=inadequate information

1=absent or false

2=subthreshold

3=threshold or true

During that time...

...did you do anything that could have caused trouble for you or your family?

7. Excessive involvement in activities which have a high potential for painful consequences (e.g., engaging in unrestrained buying sprees, sexual indiscretions, or foolish business investments) ? 1 2 3 A104

(Spending money on things you didn't need or couldn't afford? How about giving away money or valuable things? Gambling with money you couldn't afford to lose?)

(Anything sexual that was likely to get you in trouble? Driving recklessly?)

(Did you make any risky or impulsive business investments or get involved in a business scheme that you wouldn't normally have done?)

AT LEAST THREE "B" SXS ARE CODED "3" (FOUR IF MOOD ONLY IRRITABLE).

1

3

A105

GO TO *CURRENT PERSISTENT DEPRESSIVE DISORDER*

CONTINUE ON NEXT PAGE

IF UNKNOWN: What effect did these (MANIC SXS) have on your life?

IF UNKNOWN: Did you need to go into the hospital to protect you from hurting yourself or someone else, or from doing something that could have caused serious financial or legal problems?

ASK THE FOLLOWING QUESTIONS AS NEEDED TO RATE CRITERION C.

How did (MANIC SXS) affect your relationships or your interactions with other people? (Did (MANIC SXS) cause you any problems in your relationships with your family, romantic partner or friends?)

How did (MANIC SXS) affect your work/school? (How about your attendance at work or school? Did [MANIC SXS] make it more difficult to do your work/schoolwork? How did [MANIC SXS] affect the quality of your work/schoolwork?)

How did (MANIC SXS) affect your ability to take care of things at home?

C. The mood disturbance is sufficiently severe to cause marked impairment in social or occupational functioning or to necessitate hospitalization to prevent harm to self or others or there are psychotic features.

?

1 2

3

A106

CONTINUE ON NEXT PAGE

GO TO *CURRENT PERSISTENT DEPRESSIVE DISORDER*

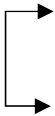

IF UNKNOWN: When did this period of being (high/irritable/OWN WORDS) begin?

Just before this began, were you physically ill?

IF YES: What did the doctor say?

Just before this began, were you taking any medications?

IF YES: Any change in the amount you were taking?

Just before this began, were you drinking or using any drugs?

D. [Primary Manic Episode:] The episode is not attributable to the physiological effects of a substance (e.g., a drug of abuse, medication) or to another medical condition.

IF THERE IS ANY INDICATION THAT THE MANIA MAY BE SECONDARY (I.E., A DIRECT PHYSIOLOGICAL CONSEQUENCE OF GMC OR SUBSTANCE), GO TO *GMC/SUBSTANCE* A.41, AND RETURN HERE TO MAKE A RATING OF "1" OR "3."

NOTE: A full Manic Episode that emerges during antidepressant treatment (e.g., medication, electroconvulsive therapy) but persists at a fully syndromal level beyond the physiological effect of that treatment is sufficient evidence for a Manic Episode and, therefore a Bipolar I diagnosis.

NOTE: Refer to lists of etiological medical conditions and substances/medications on page A.13.

? 1 3 A107



GO TO *CURRENT PERSISTENT DEPRESSIVE DISORDER*

CONTINUE WITH NEXT ITEM

MANIC EPISODE CRITERIA A, B, C, AND D ARE CODED "3."

1 3 A108

PAST MANIC EPISODE

GO TO *CURRENT PERSISTENT DEPRESSIVE DISORDER*

SCID-RV (for DSM-5®) (Version 1.0.0)Current Persistent Depressive Disorder Mood Episodes A

?=inadequate information

1=absent or false

2=subthreshold

3=threshold or true

CURRENT PERSISTENT DEPRESSIVE DISORDER

CURRENT PERSISTENT DEPRESSIVE DISORDER CRITERIA

IF THERE HAS EVER BEEN A MANIC OR HYPOMANIC EPISODE, CHECK HERE ____ AND GO TO THE NEXT MODULE A139

Since (1 YEAR AGO), have you been bothered by depressed mood most of the day, more days than not? (More than half of the time?)

IF YES: **What has that been like?**

A. Depressed mood for most of the day, for more days than not, as indicated either by subjective account or observation by others, for at least 2 years. NOTE: in adolescents, mood can be irritable and duration must be at least 1 year.

? 1 2 3 A140

GO TO THE NEXT MODULE

During these periods of (OWN WORDS FOR CHRONIC DEPRESSION) did you often...

B. Presence, while depressed, of two (or more) of the following:

...lose your appetite? (What about overeating?)

1. Poor appetite or overeating.

? 1 2 3 A141

...have trouble sleeping or sleep too much?

2. Insomnia or hypersomnia.

? 1 2 3 A142

...have little energy to do things or feel tired a lot?

3. Low energy or fatigue.

? 1 2 3 A143

...feel down on yourself? (Feel worthless, or a failure?)

4. Low self-esteem.

? 1 2 3 A144

...have trouble concentrating or making decisions?

5. Poor concentration or difficulty making decisions.

? 1 2 3 A145

...feel hopeless?

6. Feelings of hopelessness.

? 1 2 3 A146

AT LEAST TWO "B" SYMPTOMS ARE CODED "3."

? 1 2 3 A147

GO TO THE NEXT MODULE

Since (1 YEAR AGO), what was the longest period of time that you felt OK (NO DYSTHYMIC SYMPTOMS)?

C. During the 1-year period of the disturbance, the individual has never been without the symptoms in Criteria A and B for more than 2 months at a time.

1 3 A148

GO TO THE NEXT MODULE

NOTE: Code "1" if normal mood for more than 2 months at a time.

E. There has never been a Manic Episode or a Hypomanic Episode, and criteria have never been met for Cyclothymic disorder.

1 3 A149

GO TO THE NEXT MODULE

?=inadequate information

1=absent or false

2=subthreshold

3=threshold or true

IF NOT ALREADY CLEAR, RETURN TO THIS ITEM AFTER COMPLETING THE PSYCHOTIC DISORDERS SECTION.

F. The disturbance is not better explained by a persistent Schizoaffective Disorder, Schizophrenia, Delusional Disorder, or Other Specified or Unspecified Schizophrenia Spectrum or Other Psychotic Disorder.

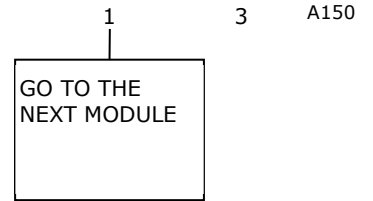

NOTE: Code "3" if *NO* chronic psychotic disorder has been present or if *NOT* better explained by a chronic psychotic disorder.

IF UNKNOWN: When did this begin?

Just before this began, were you physically ill?

IF YES: What did the doctor say?

Just before this began, were you using any medications?

IF YES: Any change in the amount you were using?

Just before this began, were you drinking or using any drugs?

G. [Primary Persistent Depressive Disorder:] The symptoms are not attributable to the physiological effects of a substance (e.g., a drug of abuse, medication) or to another medical condition (e.g., hypothyroidism).

IF THERE IS ANY INDICATION THAT THE DEPRESSION MAY BE SECONDARY (I.E., A DIRECT PHYSIOLOGICAL CONSEQUENCE OF GMC OR SUBSTANCE), GO TO *GMC/SUBSTANCE/MEDICATION* A.45, AND RETURN HERE TO MAKE A RATING OF "1" OR "3."

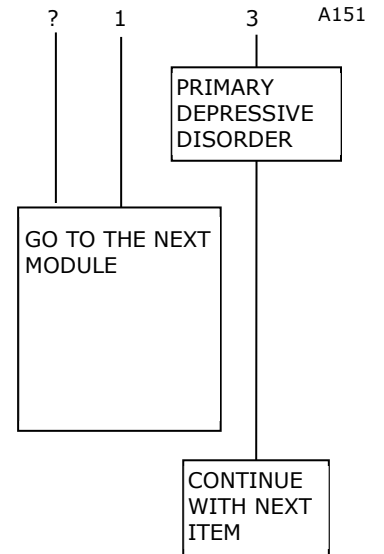

NOTE: Refer to lists of etiological medical conditions and substances/medications on page A.4.

IF UNKNOWN: What effect have these (DEPRESSIVE SXS) had on your life?

ASK THE FOLLOWING QUESTIONS AS NEEDED TO RATE CRITERION H:

How have (DEPRESSIVE SXS) affected your relationships or your interactions with other people? (Has it caused you any problems in your relationships with your family, romantic partner or friends?)

How have these (DEPRESSIVE SXS) affected your work/school? (How about your attendance at work or school? Have [DEPRESSIVE SXS] made it more difficult to do your work/schoolwork? How did [DEPRESSIVE SXS] affect the quality of your work/schoolwork?)

How have (DEPRESSIVE SXS) affected your ability to take care of things at home? How about doing simple everyday things like getting dressed, bathing, or brushing your teeth? How about doing other things that are important to you like religious activities, physical exercise, or hobbies? Did you avoid doing anything because you felt like you weren't up to it?

H. The symptoms cause clinically significant distress or impairment in social, occupational, or other important areas of functioning.

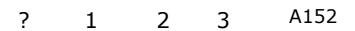

Have these (DEPRESSIVE SXS) affected any other important part of your life?

IF DOES NOT INTERFERE WITH LIFE: How much you been bothered or upset by having (DEPRESSIVE SXS)?

PERSISTENT DEPRESSIVE DISORDER CRITERIA A, B, C, D, E, F, G, AND H ARE CODED "3."

1

3

A153

CURRENT PERSISTENT DEPRESSIVE DISORDER

Indicate **onset specifier**:
 1 - **Early onset**: onset before age 21
 2 - **Late onset**: onset age 21 or older

A154

Specify if (for most recent 2 years of Persistent Depressive Disorder):

A155

NOTE: Additional information about onset and offset of Major Depressive Episodes during the past 2 years may be needed to evaluate this specifier.

___ **With pure dysthymic syndrome**: Full criteria for a Major Depressive Episode have not been met in at least the preceding 2 years.

___ **With persistent Major Depressive Episode**: Full criteria for a Major Depressive Episode have been met throughout the preceding 2-year period.

___ **With intermittent Major Depressive Episodes, with current episode**: Full criteria for a Major Depressive Episode are currently met, but there have been periods of at least 8 weeks in at least the preceding 2 years with symptoms below the threshold for a full Major Depressive Episode.

___ **With intermittent Major Depressive Episodes, without current episode**: Full criteria for a Major Depressive Episode are not currently met, but there has been one or more Major Depressive Episodes in at least the preceding 2 years.

Specify if:

A156

IF UNKNOWN: Have there been any panic attacks in the past month?

GO TO THE NEXT MODULE

?=inadequate information

1=absent or false

2=subthreshold

3=threshold or true

GMC/SUBSTANCE CAUSING BIPOLAR AND RELATED SYMPTOMS

BIPOLAR AND RELATED DISORDER DUE TO ANOTHER MEDICAL CONDITION **BIPOLAR AND RELATED DISORDER DUE TO ANOTHER MEDICAL CONDITION CRITERIA**

IF SYMPTOMS NOT TEMPORALLY ASSOCIATED WITH A GENERAL MEDICAL CONDITION, CHECK HERE ___ AND GO TO ***SUBSTANCE-INDUCED BIPOLAR AND RELATED DISORDER* A.43.** A193

CODE BASED ON INFORMATION ALREADY OBTAINED. A. A prominent and persistent period of abnormally elevated, expansive, or irritable mood and abnormally increased activity or energy that predominates in the clinical picture. ? 1 2 3 A194

B/C. There is evidence from the history, physical examination, or laboratory findings that the disturbance is the direct physiological consequence of another medical condition and the disturbance is not better accounted for by another mental disorder. ? 1 3 A195

GO TO
SUBSTANCE INDUCED
A.43

Did the (BIPOLAR SXS) change after (GMC) began? Did (BIPOLAR SXS) start or get much worse only after (GMC) began? How long after (GMC) began did (BIPOLAR SXS) start or get much worse? NOTE: The following factors should be considered and, if present, support the conclusion that a general medical condition is etiologic to the bipolar symptoms.

- IF GMC HAS RESOLVED: Did the (BIPOLAR SXS) get better once the (GMC) got better?**
- 1) There is evidence from the literature of a well-established association between the general medical condition and the bipolar symptoms. (Refer to list of etiological medical conditions on page A.13.)
 - 2) There is a close temporal relationship between the course of the bipolar symptoms and the course of the general medical condition.
 - 3) The bipolar symptoms are characterized by unusual presenting features (e.g., late age-at-onset).
 - 4) The absence of alternative explanations (e.g., bipolar symptoms as a psychological reaction to the stress of being diagnosed with a general medical condition).

IF UNKNOWN: What effect have (BIPOLAR SXS) had on your life?

ASK THE FOLLOWING QUESTIONS AS NEEDED TO RATE CRITERION E:

How have (BIPOLAR SXS) affected your relationships or your interactions with other people? (Have they caused you any problems in your relationships with your family, romantic partner or friends?)

How have they affected your work/school? (How about your attendance at work or school? Have they affected the quality of your work/schoolwork?)

How did (BIPOLAR SXS) affect your ability to take care of things at home? Did you need to go into the hospital to protect you from hurting yourself or someone else, or from doing something that could have caused serious financial or legal problems?

Have (BIPOLAR SXS) affected any other important part of your life?

IF HAVE NOT INTERFERED WITH LIFE: How much have (BIPOLAR SXS) bothered or upset you?

E. The disturbance causes clinically significant distress or impairment in social, occupational, or other important areas of functioning or necessitates hospitalization to prevent harm to self or others, or there are psychotic features.

? 1 2 3 A196

GO TO
***SUBSTANCE
INDUCED***
A.43

NOTE: The D criterion (delirium rule-out) has been omitted.

BIPOLAR DISORDER DUE TO AMC CRITERIA A, B/C, AND E ARE CODED "3."

1 3 A197

BIPOLAR
DISORDER
DUE TO AMC

Check here ___ if current
in the past month.

A198

Specify if:

- 1 - With manic features:** Full criteria are not met for a manic or hypomanic episode.
- 2 - With manic- or hypomanic-like episode:** Full criteria are met except Criterion D for a manic episode or except Criterion F for a hypomanic episode.
- 3 - With mixed features:** Symptoms of depression are also present but do not predominate in the clinical picture.

A199

CONTINUE ON NEXT PAGE

?=inadequate information

1=absent or false

2=subthreshold

3=threshold or true

SUBSTANCE-/MEDICATION-INDUCED BIPOLAR DISORDER

SUBSTANCE-/MEDICATION-INDUCED BIPOLAR DISORDER CRITERIA

IF SYMPTOMS ARE NOT TEMPORALLY ASSOCIATED WITH SUBSTANCE/MEDICATION USE, CHECK HERE ____ AND RETURN TO EPISODE BEING EVALUATED, CONTINUING WITH THE ITEM FOLLOWING "SYMPTOMS ARE NOT ATTRIBUTABLE TO THE PHYSIOLOGICAL EFFECTS OF A SUBSTANCE OR ANOTHER MEDICAL CONDITION" (SEE PAGE NUMBERS IN BOX TO THE RIGHT).

PAGE TO RETURN TO IN EPISODE BEING EVALUATED:	
Current Manic	A.13
Past Manic	A.22

A200

CODE BASED ON INFORMATION ALREADY OBTAINED.

A. A prominent and persistent disturbance in mood that predominates in the clinical picture and is characterized by elevated, expansive, or irritable mood, with or without depressed mood, or markedly diminished interest or pleasure in all, or almost all activities. ? 1 2 3 A201

IF UNKNOWN: **When did the (BIPOLAR SXS) begin? Were you already using (SUBSTANCE/MEDICATION) or had you just stopped or cut down your use?**

B. There is evidence from the history, physical examination, or laboratory findings of both (1) and (2): ? 1 2 3 A202

IF UNKNOWN: **How much (SUBSTANCE/MEDICATION) were you using when you began to have (BIPOLAR SXS)?**

1. The symptoms in criterion A developed during or soon after substance intoxication or withdrawal or exposure to a medication.
2. The involved substance/medication is capable of producing the symptoms in Criterion A. NOTE: Refer to list of etiological substances/medications on page A.13.

NOT SUBSTANCE-INDUCED. RETURN TO EPISODE BEING EVALUATED

ASK ANY OF THE FOLLOWING QUESTIONS AS NEEDED TO RULE OUT A NON-SUBSTANCE-INDUCED ETIOLOGY.

C. The disturbance is NOT better accounted for by a bipolar or related disorder that is not substance-induced. Such evidence of an independent bipolar or related disorder could include the following: ? 1 3 A203

IF UNKNOWN: **Which came first, the (SUBSTANCE/MEDICATION USE) or the (BIPOLAR SXS)?**

IF UNKNOWN: **Have you had a period of time when you stopped using (SUBSTANCE/MEDICATION)?**

IF YES: **After you stopped using (SUBSTANCE/MEDICATION) did the (BIPOLAR SXS) go away or get better?**

IF YES: **How long did it take for them to get better? Did they go away within a month of stopping?**

IF UNKNOWN: **Have you had any other episodes of (BIPOLAR SXS)?**

IF YES: **How many? Were you using (SUBSTANCE/MEDICATION) at those times?**

NOTE: The following three statements constitute evidence that the bipolar symptoms are not substance-induced. Code "1" if any are true. Code "3" only if none are true.

- 1) The symptoms precede the onset of the substance/medication use;
- 2) The symptoms persist for a substantial period of time (e.g., about 1 month) after the cessation of acute withdrawal or severe intoxication; or
- 3) There is other evidence suggesting the existence of an independent non-substance/medication-induced bipolar and related disorder (e.g., a history of recurrent non-substance/medication-related episodes).

RETURN TO EPISODE BEING EVALUATED

?=inadequate information

1=absent or false

2=subthreshold

3=threshold or true

SCID-RV (for DSM-5®) (Version 1.0.0) Substance-Induced Bipolar Mood Episodes A

IF UNKNOWN: **What effect have (BIPOLAR SXS) had on your life?**

E. The symptoms cause clinically significant distress or impairment in social, occupational, or other important areas of functioning.

? 1 2 3

A204

ASK THE FOLLOWING QUESTIONS AS NEEDED TO RATE CRITERION E:

NOTE: The D criterion (delirium rule-out) has been omitted.

RETURN TO EPISODE BEING EVALUATED

How have (BIPOLAR SXS) affected your relationships or your interactions with other people? (Have they caused you any problems in your relationships with your family, romantic partner, or friends?)

How have (BIPOLAR SXS) affected your work/school? (How about your attendance at work or school? Have they affected the quality of your work/schoolwork?)

How did (BIPOLAR SXS) affect your ability to take care of things at home? Have you needed to go into the hospital to protect you from hurting yourself or someone else, or from doing something that could have caused serious financial or legal problems?

Have (BIPOLAR SXS) affected any other important part of your life?

IF HAVE NOT INTERFERED WITH LIFE: How much have (BIPOLAR SX) bothered or upset you?

SUBSTANCE-INDUCED BIPOLAR DISORDER CRITERIA A, B, C, AND E ARE CODED "3."

1 3

A205

SUBSTANCE-/ MEDICATION- INDUCED BIPOLAR DISORDER

Check here ___ if current in the past month.

A206

Indicate **context of development** of mood symptoms:
 1 - **With onset during intoxication**
 2 - **With onset during withdrawal**

A207

RETURN TO EPISODE BEING EVALUATED

?=inadequate information

1=absent or false

2=subthreshold

3=threshold or true

GMC/SUBSTANCE CAUSING DEPRESSIVE SYMPTOMS

DEPRESSIVE DISORDER DUE TO ANOTHER MEDICAL CONDITION

DEPRESSIVE DISORDER DUE TO ANOTHER MEDICAL CONDITION CRITERIA

IF SYMPTOMS NOT TEMPORALLY ASSOCIATED WITH A GENERAL MEDICAL CONDITION, CHECK HERE ____ AND GO TO ***SUBSTANCE-INDUCED DEPRESSIVE DISORDER* A.48**

A208

CODE BASED ON INFORMATION ALREADY OBTAINED.

A. A prominent and persistent period of depressed mood or markedly diminished interest or pleasure in all, or almost all, activities that predominates in the clinical picture.

? 1 2 3

A209

B./C. There is evidence from the history, physical examination, or laboratory findings that the disturbance is the direct physiological consequence of another medical condition and the disturbance is not better accounted for by another mental disorder.

? 1 3

A210

GO TO
SUBSTANCE INDUCED
A.48

Did the (DEPRESSIVE SXS) change after (GMC) began? Did (DEPRESSIVE SXS) start or get much worse only after (GMC) began? How long after (GMC) began did (DEPRESSIVE SXS) start or get much worse?

NOTE: The following factors should be considered and, if present, support the conclusion that a general medical condition is etiologic to the depressive symptoms.

IF GMC HAS RESOLVED: **Did the (DEPRESSIVE SXS) get better once the (GMC) got better?**

- 1) There is evidence from the literature of a well-established association between the general medical condition and the depressive symptoms. (Refer to list of etiological general medical conditions on page A.4.)
- 2) There is a close temporal relationship between the course of the depressive symptoms and the course of the general medical condition.
- 3) The depressive symptoms are characterized by unusual presenting features (e.g., late age-at-onset).
- 4) The absence of alternative explanations (e.g., depressive symptoms as a psychological reaction to the stress of being diagnosed with a general medical condition).

IF UNKNOWN: What effect have (DEPRESSIVE SX) had on your life?

- E. The disturbance causes clinically significant distress or impairment in social, occupational, or other important areas of functioning.

? 1 2 3 A211

GO TO *SUBSTANCE INDUCED* A.48

ASK THE FOLLOWING QUESTIONS AS NEEDED TO RATE CRITERION E:

How have (DEPRESSIVE SXS) affected your relationships or your interactions with other people? (Have they caused you any problems in your relationships with your family, romantic partner, or friends?)

How have (DEPRESSIVE SXS) affected your work/school? (How about your attendance at work or school? Have they affected the quality of your work/schoolwork?)

How have (DEPRESSIVE SXS) affected your ability to take care of things at home? How about doing simple everyday things like getting dressed, bathing, or brushing your teeth? How about doing other things that are important to you like religious activities, physical exercise, or hobbies? Did you avoid doing anything because you felt like you weren't up to it?

Have (DEPRESSIVE SXS) affected any other important part of your life?

IF HAVE NOT INTERFERED WITH LIFE: How much have (DEPRESSIVE SXS) bothered or upset you?

NOTE: The D criterion (delirium rule-out) has been omitted.

DEPRESSIVE DISORDER DUE TO AMC CRITERIA A, B/C, AND E ARE CODED "3."

A212

1 3
DEPRESSIVE DISORDER DUE TO AMC

Check here ___ if current in the past month.

A213

Specify if:
1 - **With depressive features:** Full criteria are not met for a major depressive episode.
2 - **With major depressive-like episode:** Full criteria are met (except Criterion C) for a major depressive episode.
3 - **With mixed features:** Symptoms of mania or hypomania are also present but do not predominate in the clinical picture.

A214

CONTINUE ON NEXT PAGE

SUBSTANCE-/MEDICATION-INDUCED DEPRESSIVE DISORDER

SUBSTANCE-/MEDICATION-INDUCED DEPRESSIVE DISORDER CRITERIA

IF SYMPTOMS NOT TEMPORALLY ASSOCIATED WITH SUBSTANCE/MEDICATION USE, CHECK HERE ____ AND RETURN TO EPISODE BEING EVALUATED, CONTINUING WITH THE ITEM FOLLOWING "SYMPTOMS ARE NOT ATTRIBUTABLE TO THE PHYSIOLOGICAL EFFECTS OF A SUBSTANCE OR ANOTHER MEDICAL CONDITION" (SEE PAGE NUMBERS IN BOX TO THE RIGHT).

PAGE TO RETURN TO IN EPISODE BEING EVALUATED:		A215
Current MDE	A.4	
Current Persistent Depressive Disorder	A.31	

CODE BASED ON INFORMATION ALREADY OBTAINED.

A. A prominent and persistent disturbance in mood that predominates in the clinical picture and is characterized by depressed mood or markedly diminished interest or pleasure in all, or almost all, activities

? 1 2 3 A216

IF UNKNOWN: **When did the (DEPRESSIVE SXS) begin? Were you already using (SUBSTANCE/MEDICATION) or had you just stopped or cut down your use?**

B. There is evidence from the history, physical examination, or laboratory findings of both (1) and (2):

? 1 2 3 A217

1. The symptoms in criterion A developed during or soon after substance intoxication or withdrawal or exposure to a medication
2. The involved substance/medication is capable of producing the symptoms in Criterion A. NOTE: refer to list of etiological substances/medications on page A.4.

NOT SUBSTANCE-INDUCED.RETURN TO EPISODE BEING EVALUATED

IF UNKNOWN: **How much (SUBSTANCE/MEDICATION) were you using when you began to have (DEPRESSIVE SXS)?**

ASK ANY OF THE FOLLOWING QUESTIONS AS NEEDED TO RULE OUT A NON-SUBSTANCE-INDUCED ETIOLOGY.

C. The disturbance is NOT better accounted for by a depressive disorder that is not substance-induced. Such evidence of an independent depressive disorder could include the following:

? 1 3 A218

IF UNKNOWN: **Which came first, the (SUBSTANCE/MEDICATION USE) or the (DEPRESSIVE SXS)?**

IF UNKNOWN: **Have you had a period of time when you stopped using (SUBSTANCE/MEDICATION)?**

IF YES: **After you stopped using (SUBSTANCE/MEDICATION) did the (DEPRESSIVE SXS) go away or get better?**

IF YES: **How long did it take for them to get better? Did they go away within a month of stopping?**

IF UNKNOWN: **Have you had any other episodes of (DEPRESSIVE SXS)?**

IF YES: **How many? Were you using (SUBSTANCE/MEDICATION) at those times?**

NOTE: The following three statements constitute evidence that the depressive symptoms are not substance-induced. Code "1" if any are true. Code "3" only if none are true.

- 1) The symptoms precede the onset of the substance/medication use;
- 2) The symptoms persist for a substantial period of time (e.g., about 1 month) after the cessation of acute withdrawal or severe intoxication; or
- 3) There is other evidence suggesting the existence of an independent non-substance/medication-induced depressive disorder (e.g., a history of recurrent non-substance/medication-related episodes).

RETURN TO EPISODE BEING EVALUATED

IF UNKNOWN: What effect have (DEPRESSIVE SXS) had on your life?

E. The symptoms cause clinically significant distress or impairment in social, occupational, or other important areas of functioning.

? 1 2 3 A219

ASK THE FOLLOWING QUESTIONS AS NEEDED TO RATE CRITERION E:

NOTE: the D criterion (delirium rule-out) has been omitted.

RETURN TO EPISODE BEING EVALUATED

How have (DEPRESSIVE SXS) affected your relationships or your interactions with other people? (Have they caused you any problems in your relationships with your family, romantic partner or friends?)

How have (DEPRESSIVE SXS) affected your work/school? (How about your attendance at work or school? Have they affected the quality of your work/schoolwork?)

How have (DEPRESSIVE SXS) affected your ability to take care of things at home? How about doing simple everyday things like getting dressed, bathing, or brushing your teeth? How about doing other things that are important to you like religious activities, physical exercise, or hobbies? Did you avoid doing anything because you felt like you weren't up to it?

Have (DEPRESSIVE SXS) affected any other important part of your life?

IF HAVE NOT INTERFERED WITH LIFE: How much have (DEPRESSIVE SXS) bothered or upset you?

SUBSTANCE-INDUCED DEPRESSIVE DISORDER CRITERIA A, B, C, AND E ARE CODED "3."

1 3 A220

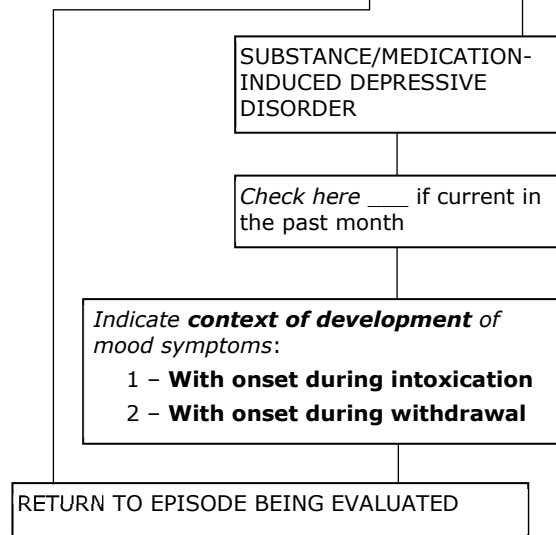

B/C. PSYCHOTIC SCREENING MODULE

NOTE: This module is for coding psychotic and associated symptoms that have been present in the past year. It can be used for settings in which cases with primary psychotic symptoms are to be excluded i.e., psychotic symptoms that are not due to substance/medication use or to a general medical condition) and/or psychotic symptoms that occur outside the context of a Major Depressive or Manic Episode.

For each psychotic symptom coded "3," describe the actual content and indicate the period of time during which the symptom was present. Moreover, for any psychotic symptom coded "3," determine whether the symptom is definitely "primary" or whether there is a possible or definite etiological substance (including medication) or general medical condition. Refer to page B/C.6 for a list of possible etiological general medical conditions and substances/medications.

The following questions may be useful if the Overview has not already provided the information.

Just before (PSYCHOTIC SXS) began, were you using drugs? ...were you taking any medications? ...did you drink much more than usual or stop drinking after you had been drinking a lot for a while? ...were you physically ill?

IF YES TO ANY: Has there been a time in the past year when you had (PSYCHOTIC SXS) and were not (USING DRUGS/TAKING MEDICATION/CHANGING YOUR DRINKING HABITS/ILL)?

DELUSIONS

Now I'd like to ask you about unusual experiences that people sometimes have.

A false belief based on incorrect inference about external reality that is firmly held despite what almost everyone else believes and despite what constitutes incontrovertible and obvious proof or evidence to the contrary. The belief is not one ordinarily accepted by other members of the person's culture or subculture. When a false belief involves a value judgment, it is regarded as a delusion only when the judgment is so extreme as to defy credibility. Code overvalued ideas (unreasonable and sustained beliefs that are maintained with less than delusional intensity) as "2."

In the past year, since (1 YEAR AGO), has it seemed like people were talking about you or taking special notice of you? (What do you think they were saying about you?)

Delusion of reference, i.e., events, objects, or other persons in the individual's immediate environment are seen as having a particular and unusual significance.

? 1 2 3 BC1

1	3	BC1a
POSS/DEF SUBST/GMC	PRIMARY	

IF YES: Were you convinced they were talking about you or did you think it might have been your imagination? DESCRIBE:

Did you ever have the feeling that something on the radio, TV, or in a movie was meant especially for you? (...not just that it was particularly relevant to you, but that it was specifically meant for you.)

Did you have the feeling that the words in a popular song were meant to send you a special message? (...not just that they were particularly relevant to you, but that they were specifically meant for you.)

Did you have the feeling that what people were wearing was intended to send you a special message?

Did you have the feeling that street signs or billboards had a special meaning for you?

What about anyone going out of their way to give you a hard time, or trying to hurt you? (Tell me about that.)

Persecutory delusion, i.e., the central theme is that one (or someone to whom one is close to) is being attacked, harassed, cheated, persecuted, or conspired against.

?	1	2	3	BC2
1		3		BC2a
POSS/DEF SUBST/GMC		PRIMARY		

Have you had the feeling in the past year that you were being followed, spied on, manipulated, or plotted against?

DESCRIBE:

Did you have the feeling that you were being poisoned or that your food had been tampered with?

In the past year, since (1 YEAR AGO), Have you thought that you were especially important in some way, or that you had special powers or knowledge? (Tell me about that.)

Grandiose delusion, i.e., content involves inflated worth, power, knowledge identity, or a special relationship to a deity or famous person.

?	1	2	3	BC3
1		3		BC3a
POSS/DEF SUBST/GMC		PRIMARY		

DESCRIBE:

In the past year, since (1 YEAR AGO), did you believe that you had a special or close relationship with a celebrity or someone else famous?

In the past year, since (1 YEAR AGO), have you been convinced that something was very wrong with your physical health even though your doctor said nothing was wrong...like you had cancer or some other disease? (Tell me about that.)

Somatic delusion, i.e., main content pertains to the appearance or functioning of one's body.

?	1	2	3	BC4
1		3		BC4a
POSS/DEF SUBST/GMC		PRIMARY		

DESCRIBE:

Did you feel that something strange was happening to parts of your body?

In the past year, since (1 YEAR AGO), have you felt that you had committed a crime or done something terrible for which you should be punished? (Tell me about that.)

Delusion of guilt, i.e., a belief that a minor error in the past will lead to disaster, or that he or she has committed a horrible crime and should be punished severely, or that he or she is responsible for a disaster (e.g., an earthquake or fire) with which there can be no possible connection

?	1	2	3	BC5
1		3		BC5a
POSS/DEF SUBST/GMC		PRIMARY		

DESCRIBE:

Have you felt that something you did, or should have done but did not do, caused serious harm to your parents, children, other family members, or friends?

What about feeling responsible for a disaster such as a fire, flood, or earthquake?

In the past year, since (1 YEAR AGO), have you been convinced that your spouse or partner was being unfaithful to you?

Jealous delusion, i.e., that one's sexual partner is unfaithful

?	1	2	3	BC6
1		3		BC6a
POSS/DEF SUBST/GMC		PRIMARY		

DESCRIBE:

IF YES: **How did you know they were being unfaithful? (What clued you into this?)**

In the past year, since (1 YEAR AGO), did you have a "secret admirer" who, when you tried to contact them, denied that they were in love with you? (Tell me about that.)

Erotomantic delusion, i.e., that another person, usually of higher status, is in love with the individual.

	?	1	2	3	BC7
		1		3	BC7a
		POSS/DEF		PRIMARY	
		SUBST/GMC			

DESCRIBE:

Were you romantically involved with someone famous? (Tell me about that.)

Are you a religious or spiritual person?

Religious delusion, i.e., a delusion with a religious or spiritual content.

	?	1	2	3	BC8
		1		3	BC8a
		POSS/DEF		PRIMARY	
		SUBST/GMC			

DESCRIBE:

→ **IF YES: In the past year, since (1 YEAR AGO), have you had any religious or spiritual experiences that the other people in your religious or spiritual community have not experienced?**

→ **IF YES: Tell me about your experiences. (What did they think about these experiences of yours?)**

→ **IF NO: Have you felt that God, the devil, or some other spiritual being or higher power has communicated directly with you? (Tell me about that. Do others in your religious or spiritual community also have such experiences?)**

→ **IF NO: In the past year, since (1 YEAR AGO), have you felt that God, or the devil or some other spiritual being or higher power has communicated directly with you? (Tell me about that. Do others in your religious or spiritual community also have such experiences?)**

In the past year, since (1 YEAR AGO), did you feel that someone or something outside yourself was controlling your thoughts or actions against your will? (Tell me about that.)

Delusion of being controlled, i.e., feelings, impulses, thoughts, or actions are experienced as being under the control of some external force rather than under one's own control.

	?	1	2	3	BC9
		1		3	BC9A
		POSS/DEF		PRIMARY	
		SUBST/GMC			

DESCRIBE:

In the past year, since (1 YEAR AGO), did you feel that certain thoughts that were not your own were put into your head? (Tell me about that.)

Thought insertion, i.e., that certain thoughts are not one's own, but rather are inserted into one's mind.

	?	1	2	3	BC10
		1		3	BC10a
		POSS/DEF		PRIMARY	
		SUBST/GMC			

DESCRIBE:

What about thoughts being taken out of your head? (Tell me about that.)

Thought withdrawal, i.e., that one's thoughts have been "removed" by some outside force.

	?	1	2	3	BC11
		1		3	BC11a
		POSS/DEF		PRIMARY	
		SUBST/GMC			

DESCRIBE:

?=inadequate information

1=absent or false

2=subthreshold

3=threshold or true

In the past year, since (1 YEAR AGO), did you feel as if your thoughts were being broadcast out loud so that other people could actually hear what you were thinking? (Tell me about that.)

Thought broadcasting, i.e., the delusion that one's thoughts are being broadcast out loud so that others can perceive them.

DESCRIBE:

?	1	2	3	BC12				
<table border="1" style="width: 100%; height: 80px;"> <tr> <td style="text-align: center;">1</td> <td style="text-align: center;">3</td> </tr> <tr> <td style="text-align: center;">POSS/DEF SUBST/GMC</td> <td style="text-align: center;">PRIMARY</td> </tr> </table>				1	3	POSS/DEF SUBST/GMC	PRIMARY	BC12a
1	3							
POSS/DEF SUBST/GMC	PRIMARY							

In the past year, since (1 YEAR AGO), did you believe that someone could read your mind? (Tell me about that.)

Other delusions (e.g., that others can read the person's mind, a delusion that one has died several years ago).

DESCRIBE:

?	1	2	3	BC13				
<table border="1" style="width: 100%; height: 80px;"> <tr> <td style="text-align: center;">1</td> <td style="text-align: center;">3</td> </tr> <tr> <td style="text-align: center;">POSS/DEF SUBST/GMC</td> <td style="text-align: center;">PRIMARY</td> </tr> </table>				1	3	POSS/DEF SUBST/GMC	PRIMARY	BC13a
1	3							
POSS/DEF SUBST/GMC	PRIMARY							

HALLUCINATIONS

A perception-like experience with the clarity and impact of a true perception, but without the external stimulation of the relevant sensory organ. The person may or may not have insight into the nonveridical nature of the hallucination (i.e., one hallucinating person may recognize the false sensory experience, whereas another may be convinced that the experience is grounded in reality).

NOTE: Code "2" for hallucinations that are so transient as to be without diagnostic significance. Code "1" for hypnagogic or hypnopompic hallucinations.

In the past year, since (1 YEAR AGO), did you hear things that other people couldn't, such as noises, or the voices of people whispering or talking? (Were you awake at the time?)

Auditory hallucinations, i.e., involving the perception of sound, most commonly of voice) when fully awake, heard either inside or outside of one's head.

DESCRIBE:

?	1	2	3	BC14				
<table border="1" style="width: 100%; height: 80px;"> <tr> <td style="text-align: center;">1</td> <td style="text-align: center;">3</td> </tr> <tr> <td style="text-align: center;">POSS/DEF SUBST/GMC</td> <td style="text-align: center;">PRIMARY</td> </tr> </table>				1	3	POSS/DEF SUBST/GMC	PRIMARY	BC14a
1	3							
POSS/DEF SUBST/GMC	PRIMARY							

IF YES: What did you hear? How often did you hear it?

In the past year, since (1 YEAR AGO), did you have visions or see things that other people couldn't see? (Tell me about that. Were you awake at the time?)

Visual hallucinations, i.e., a hallucination involving sight, which may consist of formed images, such as of people or of unformed images, such as flashes of light.

DESCRIBE:

?	1	2	3	BC15				
<table border="1" style="width: 100%; height: 80px;"> <tr> <td style="text-align: center;">1</td> <td style="text-align: center;">3</td> </tr> <tr> <td style="text-align: center;">POSS/DEF SUBST/GMC</td> <td style="text-align: center;">PRIMARY</td> </tr> </table>				1	3	POSS/DEF SUBST/GMC	PRIMARY	BC15a
1	3							
POSS/DEF SUBST/GMC	PRIMARY							

NOTE: DISTINGUISH FROM AN ILLUSION, I.E., A MISPERCEPTION OF A REAL EXTERNAL STIMULUS.

What about strange sensations on your skin, like feeling like something is creeping or crawling on or under your skin? How about the feeling of being touched or stroked? (Tell me about that.)

Tactile hallucinations, i.e., a hallucination involving the perception of being touched or of something being under one's skin.

DESCRIBE

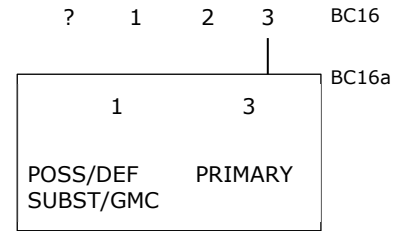

What about having unusual sensations inside a part of your body, like a feeling of electricity? (Tell me about that.)

Somatic hallucination, i.e., a hallucination involving the perception of physical experience localized within the body (e.g., a feeling of electricity).

DESCRIBE:

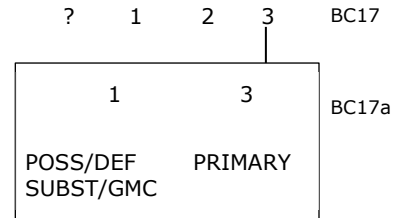

How about eating or drinking something in the past year that you thought tasted bad or strange even though everyone else who tasted it thought it was fine? (Tell me about that.)

Gustatory hallucinations, i.e., a hallucination involving the perception of taste (usually unpleasant)

DESCRIBE:

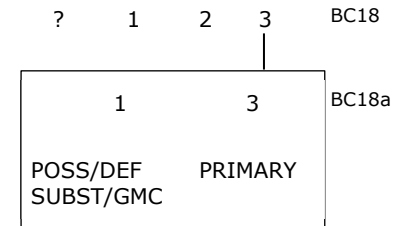

What about smelling unpleasant things that other people couldn't smell, like decaying food or dead bodies? (Tell me about that.)

Olfactory hallucinations, i.e., a hallucination involving the perception of odor

DESCRIBE:

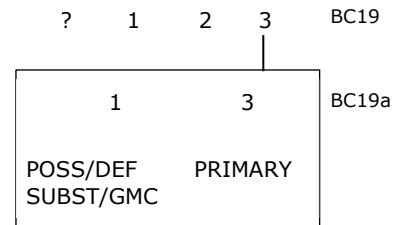

ANY ITEM CODED "3" IN "PRIMARY" SECTION

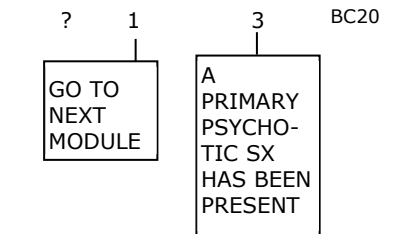

*IF A MAJOR DEPRESSIVE OR MANIC EPISODE HAS EVER BEEN PRESENT: **Has there ever been a time in the past year when you had (PSYCHOTIC SXS) and you were not (depressed/high/irritable/OWN WORDS)?***

Psychotic symptoms occur at times other than during mood episodes.

NOTE: Code "3" if psychotic symptoms have been present and either: 1) there have never been any Major Depressive or Manic Episodes, or 2) psychotic symptoms occurred outside of Major Depressive or Manic Episodes. Code "1" if psychotic symptoms have occurred only during Major Depressive or Manic Episodes.

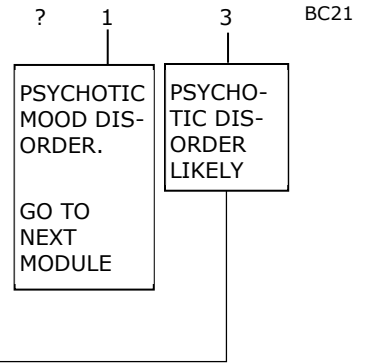

EXPLORE DETAILS AND DESCRIBE DIAGNOSTIC SIGNIFICANCE:

BC22

Etiological general medical conditions include:

Neurological conditions (e.g., neoplasms, cerebrovascular disease, Huntington's disease, multiple sclerosis, epilepsy, auditory or visual nerve injury or impairment, deafness, migraine, central nervous system infections), endocrine conditions (e.g., hyper- and hypothyroidism, hyper- and hypoparathyroidism, hyper- and hypoadrenocorticism), metabolic conditions (e.g., hypoxia, hypercarbia, hypoglycemia), fluid or electrolyte imbalances, hepatic or renal diseases, and autoimmune disorders with central nervous system involvement (e.g., systemic lupus erythematosus).

Etiological substances/medications include:

Alcohol (during intoxication or withdrawal); cannabis (during intoxication); hallucinogens (during intoxication), phencyclidine (and related substances (during intoxication); inhalants (during intoxication); sedatives, hypnotics, and anxiolytics (during intoxication or withdrawal); and stimulants (including cocaine) (during intoxication);

Other substances and medications that can cause psychotic symptoms include anesthetics and analgesics, anticholinergic agents, anticonvulsants, antihistamines, antihypertensive and cardiovascular medications, antimicrobial medications, antiparkinsonian medications, chemotherapeutic agents (e.g., cyclosporine, procarbazine), corticosteroids, gastrointestinal medications, muscle relaxants, nonsteroidal anti-inflammatory medications, other over-the-counter medications (e.g., phenylephrine, pseudoephedrine), antidepressant medication, and disulfiram. Toxins include anticholinesterase, organophosphate insecticides, sarin and other nerve gases, carbon monoxide, carbon dioxide, and volatile substances such as fuel or paint.

L. TRAUMA- AND STRESSOR-RELATED DISORDERS

TRAUMA HISTORY

I'd now like to ask about some things that may have happened to you that may have been extremely upsetting. People often find that talking about these experiences can be helpful. I'll start by asking if these experiences apply to you, and if so, I'll ask you to briefly describe what happened and how you felt at the time.

SCREEN FOR EACH TYPE OF TRAUMA USING QUESTIONS BELOW; THEN, ON PAGES L.2-L.5 REVIEW AND INQUIRE IN DETAIL FIRST FOR ANY EVENTS OCCURRING IN THE PAST MONTH AND THEN FOR UP TO THREE PAST EVENTS (E.G., THREE WORST EVENTS, THREE MOST RECENT EVENTS, ETC.)

Have you ever been in a life-threatening situation like a major disaster or fire, combat, or a serious car or work-related accident? L1

What about being physically or sexually assaulted or abused, or threatened with physical or sexual assault? L2

How about seeing another person being physically or sexually assaulted or abused, or threatened with physical or sexual assault? L3

Have you ever seen another person killed or dead, or badly hurt? L4

How about learning that one of these things happened to someone you are close to? L5

IF UNKNOWN: **Have you ever been the victim of a serious crime?** L6

IF NO EVENTS ENDORSED: **What would you say has been the most stressful or traumatic experience you have had over your life?** L7

*IF NO EVENTS ACKNOWLEDGED, CHECK HERE ____ AND GO TO *ADJUSTMENT DISORDER* L.20. OTHERWISE CONTINUE ON NEXT PAGE.* L8

Did any of these happen in the past month, since (1 MONTH AGO)?

→ IF YES: ASSESS THE TRAUMATIC EVENT IN PAST MONTH USING THE QUESTIONS BELOW.

→ IF NO: CONTINUE ON TOP OF PAGE L.3.

DETAILS FOR EVENT IN PAST MONTH

Description of traumatic event:

L9

→ IF DIRECT EXPOSURE TO TRAUMA:

What happened? Were you afraid of dying or being seriously hurt? Were you seriously hurt?

→ IF WITNESSED TRAUMATIC EVENT HAPPENING TO OTHERS:

What happened? What did you see? How close were you to (TRAUMATIC EVENT)? Were you concerned about your own safety?

Indicate **type of traumatic event**: (check all that apply)

___ Death, actual

L10

___ Death, threatened

L11

___ Serious Injury, actual

L12

___ Serious injury, threatened

L13

___ Sexual violence, actual

L14

___ Sexual violence, threatened

L15

→ IF LEARNED ABOUT TRAUMATIC EVENT:

What happened? Who did it involve? (How close [emotionally] were you to them? Did it involve violence, suicide or a bad accident?)

Indicate **mode of exposure** to traumatic event: (check all that apply)

___ Directly experienced

L16

___ Witnessed happening to others in person

L17

___ Learning about actual or threatened violence or accidental death of a close family member or friend

L18

___ Repeated or extreme exposure to aversive details of traumatic events (e.g., police officers repeatedly exposed to details of child abuse)

L19

IF UNKNOWN: **How old were you at the time?**

Age at time of event: ____

L20

IF UNKNOWN: **Did this happen more than once?**

Indicate **type of exposure**: (circle the appropriate number)

1 – Single event

L21

2 – Prolonged or repeated exposure to same trauma (e.g., witnessing repeated episodes of parental domestic violence over years)

- IF NO EVENTS PRIOR TO PAST MONTH, GO TO ***ADJUSTMENT DISORDER***.
- IF EVENTS PRIOR TO PAST MONTH, REVIEW THE TYPES OF TRAUMA INDICATED ON SCREENING AND CHOOSE THE THREE MOST SEVERE EVENTS TO ASSESS, USING THE FOLLOWING QUESTIONS:

DETAILS FOR PAST EVENT #1

	Description of traumatic event:	L22
→ IF DIRECT EXPOSURE TO TRAUMA: What happened? Were you afraid of dying or being seriously hurt? Were you seriously hurt?	_____	

→ IF WITNESSED TRAUMATIC EVENT HAPPENING TO OTHERS: What happened? What did you see? How close were you to (TRAUMATIC EVENT)? Were you concerned about your own safety?	<i>Indicate type of traumatic event:</i> (check all that apply)	
	<input type="checkbox"/> Death, actual	L23
	<input type="checkbox"/> Death, threatened	L24
	<input type="checkbox"/> Serious Injury, actual	L25
→ IF LEARNED ABOUT TRAUMATIC EVENT: What happened? Who did it involve? (How close [emotionally] were you to them? Did it involve violence, suicide or a bad accident?)	<input type="checkbox"/> Serious injury, threatened	L26
	<input type="checkbox"/> Sexual violence, actual	L27
	<input type="checkbox"/> Sexual violence, threatened	L28
	<i>Indicate mode of exposure to traumatic event:</i> (check all that apply)	
	<input type="checkbox"/> Directly experienced	L29
	<input type="checkbox"/> Witnessed happening to others in person	L30
	<input type="checkbox"/> Learning about actual or threatened violence or accidental death of a close family member or friend	L31
	<input type="checkbox"/> Repeated or extreme exposure to aversive details of traumatic events (e.g., police officers repeatedly exposed to details of child abuse)	L32
IF UNKNOWN: How old were you at the time?	Age at time of event: _____	L33
IF UNKNOWN: Did this happen more than once?	<i>Indicate type of exposure:</i> (circle the appropriate number)	L34
	1 – Single event	
	2 – Prolonged or repeated exposure to same trauma (e.g., witnessing repeated episodes of parental domestic violence over years)	

DETAILS FOR PAST EVENT #2

<p>→ IF DIRECT EXPOSURE TO TRAUMA: What happened? Were you afraid of dying or being seriously hurt? Were you seriously hurt?</p>	<p>Description of traumatic event:</p> <p>_____</p> <p>_____</p>	<p>L35</p>
<p>→ IF WITNESSED TRAUMATIC EVENT HAPPENING TO OTHERS: What happened? What did you see? How close were you to (TRAUMATIC EVENT)? Were you concerned about your own safety?</p>	<p><i>Indicate type of traumatic event: (check all that apply):</i></p> <p><input type="checkbox"/> Death, actual</p> <p><input type="checkbox"/> Death, threatened</p> <p><input type="checkbox"/> Serious Injury, actual</p> <p><input type="checkbox"/> Serious injury, threatened</p> <p><input type="checkbox"/> Sexual violence, actual</p> <p><input type="checkbox"/> Sexual violence, threatened</p>	<p>L36</p> <p>L37</p> <p>L38</p> <p>L39</p> <p>L40</p> <p>L41</p>
<p>→ IF LEARNED ABOUT TRAUMATIC EVENT: What happened? Who did it involve? (How close [emotionally] were you to them? Did it involve violence, suicide or a bad accident?)</p>	<p><i>Indicate mode of exposure to traumatic event: (check all that apply)</i></p> <p><input type="checkbox"/> Directly experienced</p> <p><input type="checkbox"/> Witnessed happening to others in person</p> <p><input type="checkbox"/> Learning about actual or threatened violence or accidental death of a close family member or friend</p> <p><input type="checkbox"/> Repeated or extreme exposure to aversive details of traumatic events (e.g., police officers repeatedly exposed to details of child abuse)</p>	<p>L42</p> <p>L43</p> <p>L44</p> <p>L45</p>
<p><i>IF UNKNOWN:</i> How old were you at the time?</p>	<p>Age at time of event: _____</p>	<p>L46</p>
<p><i>IF UNKNOWN:</i> Did this happen more than once?</p>	<p><i>Indicate type of exposure: (circle the appropriate number)</i></p> <p>1 – Single event</p> <p>2 – Prolonged or repeated exposure to same trauma (e.g., witnessing repeated episodes of parental domestic violence over years)</p>	<p>L47</p>

DETAILS FOR PAST EVENT #3

	Description of traumatic event:	L48
<p>→ IF DIRECT EXPOSURE TO TRAUMA: What happened? Were you afraid of dying or being seriously hurt? Were you seriously hurt?</p>	<p>_____</p> <p>_____</p>	
<p>→ IF WITNESSED TRAUMATIC EVENT HAPPENING TO OTHERS: What happened? What did you see? How close were you to (TRAUMATIC EVENT)? Were you concerned about your own safety?</p>	<p><i>Indicate type of traumatic event: (check all that apply)</i></p> <p><input type="checkbox"/> Death, actual</p> <p><input type="checkbox"/> Death, threatened</p> <p><input type="checkbox"/> Serious Injury, actual</p>	<p>L49</p> <p>L50</p> <p>L51</p>
<p>→ IF LEARNED ABOUT TRAUMATIC EVENT: What happened? Who did it involve? (How close [emotionally] were you to them? Did it involve violence, suicide or a bad accident?)</p>	<p><input type="checkbox"/> Serious injury, threatened</p> <p><input type="checkbox"/> Sexual violence, actual</p> <p><input type="checkbox"/> Sexual violence, threatened</p>	<p>L52</p> <p>L53</p> <p>L54</p>
	<p><i>Indicate mode of exposure to traumatic event: (check all that apply)</i></p> <p><input type="checkbox"/> Directly experienced</p> <p><input type="checkbox"/> Witnessed happening to others in person</p> <p><input type="checkbox"/> Learning about actual or threatened violence or accidental death of a close family member or friend</p> <p><input type="checkbox"/> Repeated or extreme exposure to aversive details of traumatic events (e.g., police officers repeatedly exposed to details of child abuse)</p>	<p>L55</p> <p>L56</p> <p>L57</p> <p>L58</p>
<p><i>IF UNKNOWN: How old were you at the time?</i></p>	<p>Age at time of event: _____</p>	<p>L59</p>
<p><i>IF UNKNOWN: Did this happen more than once?</i></p>	<p><i>Indicate type of exposure: (circle the appropriate number)</i></p> <p>1 – Single event</p> <p>2 – Prolonged or repeated exposure to same trauma (e.g., witnessing repeated episodes of parental domestic violence over years)</p>	<p>L60</p>

***POSTTRAUMATIC STRESS DISORDER* POSTTRAUMATIC STRESS DISORDER CRITERIA**

FOR FOLLOWING QUESTIONS, FOCUS ON THE THREE MOST SEVERE TRAUMATIC EVENT(S) DESCRIBED ON PAGES L.3-L.5.

IF ALL TRAUMAS ARE CONFINED TO THE PAST MONTH, CHECK HERE ___ AND SKIP TO ***ADJUSTMENT DISORDER***.

L87

IF MORE THAN ONE TRAUMATIC EVENT IS REPORTED: **Which of these do you think affected you the most?**

IF SELECTED EVENT IS ULTIMATELY NOT ASSOCIATED WITH THE FULL PTSD SYNDROME, CONSIDER RE-ASSESSING THE ENTIRE PTSD CRITERIA SET (PAGES L.11-L.17) FOR OTHER REPORTED TRAUMAS.

A. Exposure to actual or threatened death, serious injury, or sexual violence in one (or more) of the following ways:

- 1. Directly experiencing the traumatic event(s). ? 1 2 3 L88
- 2. Witnessing, in person, the event(s) as it occurred to others. ? 1 2 3 L89
- 3. Learning that the traumatic event(s) occurred to a close family member or close friend. In cases of actual or threatened death of a family member or friend, the event(s) must have been violent or accidental. ? 1 2 3 L90
- 4. Experiencing repeated or extreme exposure to aversive details of the traumatic event(s) (e.g., first responders collecting human remains; police officers repeatedly exposed to details of child abuse). ? 1 2 3 L91

Note: Criterion A4 does not apply to exposure through electronic media, television, movies, or pictures, unless the exposure is work-related.

AT LEAST ONE A ITEM CODED "3"

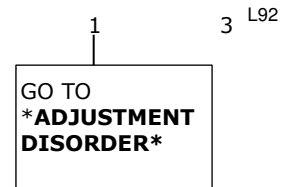

Now I'd like to ask a few questions about specific ways that (TRAUMATIC EVENT) may have affected you in the past year, since (1 YEAR AGO).

For example, in the past year...

...have you had memories of (TRAUMATIC EVENT), including feelings, physical sensations, sounds, smells, or images, when you didn't expect to or want to? (How often has this happened?)

IF PAST YEAR RATING OF "3": Has this also happened in the past month, since (1 MONTH AGO)? How many times?

(IN THE PAST YEAR...) what about having upsetting dreams that reminded you of (TRAUMATIC EVENT)? Tell me about that.

IF PAST YEAR RATING OF "3": Has this also happened in the past month? How many times?

B. Presence of one (or more) of the following intrusion symptoms associated with the traumatic events), beginning after the traumatic event(s) occurred:

- 1. Recurrent, involuntary, and intrusive distressing memories of the traumatic event(s). ? 1 2 3 L93
- 2. Recurrent distressing dreams in which the content and/or affect of the dream are related to the traumatic event. ? 1 2 3 L95

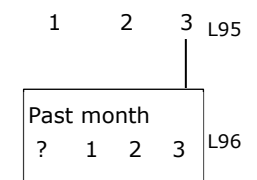
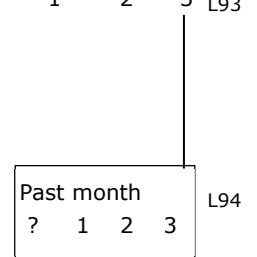

(IN THE PAST YEAR...)

...what about having found yourself acting or feeling as if you were back in the situation? (Have you had "flashbacks" of [TRAUMATIC EVENT]?)

IF PAST YEAR RATING OF "3": Has this also happened in the past month? How many times?

(IN THE PAST YEAR...) **have you had a strong emotional or physical reaction when something reminded you of (TRAUMATIC EVENT)? Give me some examples of the kinds of things that would have triggered this reaction. (Things like...seeing a person who resembles the person who attacked you, hearing the screech of brakes if you were in a car accident, hearing the sound of helicopters if you were in combat, any kind of physically intimacy in someone who was raped?)**

NOTE: IF DENIES EMOTIONAL OR PHYSICAL REACTION TO REMINDERS, CODE "1" FOR BOTH B.4 (EMOTIONAL REACTION) AND B.5 (PHYSICAL REACTION).

IF YES: What kind of reaction did you have? Did you get very upset or stay upset for a while, even after the reminder had gone away?

IF PAST YEAR RATING OF "3": Has this also happened in the past month, since (1 MONTH AGO)? How many times?

IF ACKNOWLEDGES STRONG EMOTIONAL OR PHYSICAL REACTION: **What about having physical symptoms—like breaking out in a sweat, breathing heavily or irregularly, or feeling your heart pound or race when something reminded you of (TRAUMATIC EVENT)? How about feeling tense or shaky?**

IF PAST YEAR RATING OF "3": Has this also happened in the past month? How many times?

3. Dissociative reactions (e.g., flashbacks) in which the individual feels or acts as if the traumatic event(s) were recurring. (Such reactions may occur on a continuum, with the most extreme expression being a complete loss of awareness of present surroundings.)

?	1	2	3	L97
Past month				
?	1	2	3	L98

4. Intense or prolonged psychological distress at exposure to internal or external cues that symbolize or resemble an aspect of the traumatic event(s).

?	1	2	3	L99
Past month				
?	1	2	3	L100

5. Marked physiological reactions to internal or external cues that symbolize or resemble an aspect of the traumatic event(s).

?	1	2	3	L101
Past month				
?	1	2	3	L102

AT LEAST ONE "B" SX IS CODED "3."

1	3	L103
GO TO *ADJUSTMENT DISORDER*		
CRITERION B MET PAST MONTH:		
1	3	L104

In the past year...

C. Persistent avoidance of stimuli associated with the traumatic event(s), beginning after the traumatic event(s) occurred, as evidenced by one or both of the following:

...have you done things to avoid remembering or thinking about (TRAUMATIC EVENT) like keeping yourself busy, distracting yourself like by playing computer or video games or watching TV, or using drugs or alcohol to "numb" yourself or try to forget what happened? (Since [TRAUMATIC EVENT], how long has this gone on?)

IF NO: How about doing things to avoid having feelings similar to those you had during (TRAUMATIC EVENT)? (Since [TRAUMATIC EVENT], how long has this gone on?)

IF PAST YEAR RATING OF "3": Has this also happened in the past month, since (1 MONTH AGO)? How many times?

(IN THE PAST YEAR) ...have there been things, places, or people that you have tried to avoid because it brought up upsetting memories, thoughts, or feelings about (TRAUMATIC EVENT)? (Since [TRAUMATIC EVENT], how long has this gone on?)

IF NO: How about avoiding certain activities, situations, or topics of conversation? (Since [TRAUMATIC EVENT], how long has this gone on?)

IF PAST YEAR RATING OF "3": Has this also happened in the past month? How many times?

1. Avoidance of, or efforts to avoid distressing memories, thoughts, or feelings about or closely associated with the traumatic event(s). ? 1 2 3 L105

Past month				
?	1	2	3	L106

2. Avoidance of or efforts to avoid external reminders (people, places, conversations, activities, objects, situations), that arouse distressing memories, thoughts, or feelings about or closely associated with the traumatic event(s). ? 1 2 3 L107

Past month				
?	1	2	3	L108

AT LEAST ONE "C" SX IS CODED "3."

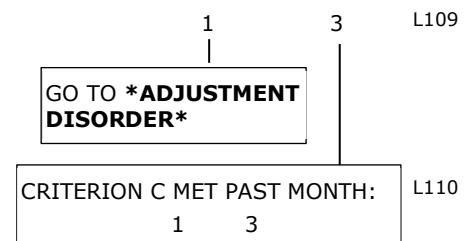

In the past year...

D. Negative alterations in cognitions and mood associated with the traumatic event(s), beginning or worsening after the traumatic event(s) occurred, as evidenced by two (or more) of the following:

...have you been unable to remember some important part of what happened? (Tell me about that.)

IF YES: Did you get a head injury during (TRAUMATIC EVENT)? Were you drinking a lot or were taking any drugs at the time of (TRAUMATIC EVENT)?

IF PAST YEAR RATING OF "3": Has this also happened in the past month, since (1 MONTH AGO)? How many times?

1. Inability to remember an important aspect of the traumatic event(s) (typically due to dissociative amnesia and not to other factors such as head injury, alcohol, or drugs).

? 1 2 3 L111

Past month				L112
?	1	2	3	

(IN THE PAST YEAR) ...has there been a change in how you think about yourself? (Like feeling you are "bad," or permanently damaged or "broken?" Tell me about that. Since this started, have you felt this way most of the time?)

IF NO: Has there been a change in how you see other people or the way the world works? (Like you can't trust anyone anymore? Like the world is a completely dangerous place? Tell me about that. Since this started, have you felt this way most of the time?)

IF PAST YEAR RATING OF "3": Has this also happened in the past month? How much of the time?

2. Persistent and exaggerated negative beliefs or expectations about oneself, others, or the world (e.g., "I am bad," "No one can be trusted," "The world is completely dangerous," "My whole nervous system is permanently ruined").

? 1 2 3 L113

Past month				L114
?	1	2	3	

(IN THE PAST YEAR) ...have you blamed yourself for the (TRAUMATIC EVENT) or how it affected your life? (Like feeling that (TRAUMATIC EVENT) was your fault or that you should have done something to prevent it? Like feeling that you should have gotten over it by now?)

IF YES: Tell me about that. (Since this started, have you felt this way most of the time?)

IF NO: Have you blamed someone else for (TRAUMATIC EVENT)? Tell me about that. (What did they have to do with [TRAUMATIC EVENT]?)

IF PAST YEAR RATING OF "3": Has this also happened in the past month? How much of the time?

3. Persistent, distorted cognitions about the cause or consequences of the traumatic event(s) that lead the individual to blame himself/herself or others.

? 1 2 3 L115

Past month				L116
?	1	2	3	

(IN THE PAST YEAR) ...have you had bad feelings much of the time, like feeling sad, angry, afraid, guilty, ashamed, "in shock"? (Tell me about that.)

IF YES: Is this different from the way you were before (TRAUMATIC EVENT)?

IF PAST YEAR RATING OF "3": Has this also happened in the past month? How many times?

4. Persistent negative emotional state (e.g., fear, horror, anger, guilt, or shame).

? 1 2 3 L117

Past month				L118
?	1	2	3	

(IN THE PAST YEAR...)

...have you been less interested in things that you were interested in before (TRAUMATIC EVENT), like spending time with family or friends, reading books, watching TV, cooking, or sports? (Tell me about that.)

IF NO LOSS OF INTEREST: Are you still doing as many activities as you used to?

IF PAST YEAR RATING OF "3": Has this also happened in the past month? How many times?

(IN THE PAST YEAR) **...have you felt distant or disconnected from others or have you closed yourself off from other people? (Tell me about that.)**

IF PAST YEAR RATING OF "3": Has this also happened in the past month, since (1 MONTH AGO)? How often?

(IN THE PAST YEAR) **...have you been unable to experience good feelings, like feeling happy, joyful, satisfied, loving, or tender towards other people? (Tell me about that.)**

IF YES: Is this different from the way you were before (TRAUMATIC EVENT)?

IF PAST YEAR RATING OF "3": Has this also happened in the past month? How often?

AT LEAST THREE "D" SXS ARE CODED "3."

In the past year...

...have you lost control of your anger, so that you threatened or hurt someone or damaged something? Tell me what happened. (Was it over something little or even nothing at all?)

IF NO: Since (TRAUMATIC EVENT), have you been more quick-tempered or had a shorter "fuse" than before?

IF YES TO EITHER: How different is this from the way you were before (TRAUMATIC EVENT)?

IF PAST YEAR RATING OF "3": Has this also happened in the past month, since (1 MONTH AGO)? How often?

5. Markedly diminished interest or participation in significant activities.

? 1 2 3

L119

Past month
? 1 2 3

L120

6. Feelings of detachment or estrangement from others.

? 1 2 3

L121

Past month
? 1 2 3

L122

7. Persistent inability to experience positive emotions (e.g., inability to experience happiness, satisfaction, or loving feelings).

? 1 2 3

L123

Past month
? 1 2 3

L124

1
GO TO *ADJUSTMENT DISORDER*

L125

CRITERION D MET PAST MONTH:
1 3

L126

E. Marked alterations in arousal and reactivity associated with the traumatic event(s), beginning or worsening after the traumatic event(s) occurred, as evidenced by two (or more) of the following:

1. Irritable behavior and angry outbursts (with little or no provocation) typically expressed as verbal or physical aggression toward people or objects.

? 1 2 3

L127

Past month
? 1 2 3

L128

(IN THE PAST YEAR...)

...have you done reckless things, like driving dangerously, or drinking or using drugs without caring about the consequences?

IF NO: How about hurting yourself on purpose or trying to kill yourself? (What did you do?)

IF YES TO EITHER: How different is this from the way you were before (TRAUMATIC EVENT)?

IF PAST YEAR RATING OF "3": Has this also happened in the past month? How often?

(IN THE PAST YEAR) **...have you noticed that you have been more watchful or on guard? (What are some examples?)**

IF NO: Have you been extra aware of your surroundings and your environment?

IF PAST YEAR RATING OF "3": Has this also happened in the past month, since (1 MONTH AGO)? How often?

(IN THE PAST YEAR) **...have you been jumpy or easily startled, like by sudden noises? (Is this a change from before [TRAUMATIC EVENT]?)**

IF PAST YEAR RATING OF "3": Has this also happened in the past month? How often?

(IN THE PAST YEAR) **...have you had trouble concentrating? (What are some examples? (Is this a change from before [TRAUMATIC EVENT]?)**

IF PAST YEAR RATING OF "3": Has this also happened in the past month? How often?

(IN THE PAST YEAR) **...how have you been sleeping since (TRAUMATIC EVENT)? (Is this a change from before [TRAUMATIC EVENT]?)**

IF PAST YEAR RATING OF "3": Has this also happened in the past month? How often?

2. Reckless or self-destructive behavior.

NOTE: Any current suicidal thoughts, plans, or actions should be thoroughly assessed by the clinician and action taken if necessary.

3. Hypervigilance.

4. Exaggerated startle response.

5. Problems with concentration.

6. Sleep disturbances (e.g., difficulty falling or staying asleep or restless sleep).

AT LEAST TWO "E" SXS ARE CODED "3."

? 1 2 3 L129

Past month
? 1 2 3

L130

? 1 2 3 L131

Past month
? 1 2 3

L132

? 1 2 3 L133

Past month
? 1 2 3

L134

? 1 2 3 L135

Past month
? 1 2 3

L136

? 1 2 3 L137

Past month
? 1 2 3

L138

1 3 L139
GO TO *ADJUSTMENT DISORDER*
CRITERION E MET PAST MONTH
1 3 L140

SCID-RV (for DSM-5®) (Version 1.0.0)

PTSD Trauma and Stressor-Related Disorders L.62

About how long did these (PTSD SYMPTOMS CODED "3") last altogether?

F. Duration of the disturbance (symptoms in criteria B, C, D, and E) is more than 1 month.

? 1 2 3 L141

GO TO
***ADJUSTMENT
DISORDER***

IF UNKNOWN: **What effect did (PTSD SXS) have on your life in the past year?**

G. The disturbance causes clinically significant distress or impairment in social, occupational, or other important areas of functioning.

? 1 2 3 L142

GO TO
***ADJUSTMENT
DISORDER***

ASK THE FOLLOWING QUESTIONS AS NEEDED TO RATE CRITERION G:

CRITERION H HAS BEEN OMITTED.

How have (PTSD SXS) affected your relationships or your interactions with other people? (Have they caused you any problems in your relationships with your family, romantic partner or friends?)

How have (PTSD SXS) affected your work/school? (How about your attendance at work or school? Have they affected the quality of your work/schoolwork?)

How have they affected your ability to take care of things at home? What about being involved in things that are important to you like religious activities, physical exercise, or hobbies?

Have (PTSD SXS) affected any other important part of your life?

IF HAVE NOT INTERFERED WITH LIFE IN PAST YEAR: **How much have you been bothered or upset by (PTSD SXS)?**

IF PAST YEAR RATING OF "3": **How have (PTSD SXS) affected your life in the past month, since (1 MONTH AGO)?**

CRITERION G MET
PAST MONTH
? 1 2 3

L143

? =inadequate information

1=absent or false

2=subthreshold

3=threshold or true

ADJUSTMENT DISORDER

CONSIDER THIS SECTION ONLY IF THERE ARE SYMPTOMS OCCURRING IN THE PAST YEAR THAT DO NOT MEET THE CRITERIA FOR ANOTHER DSM-5 DISORDER. OTHERWISE, CHECK HERE ___ AND GO TO **THE NEXT MODULE**. INFORMATION OBTAINED FROM OVERVIEW OF PRESENT ILLNESS WILL USUALLY BE SUFFICIENT TO RATE THE CRITERIA FOR ADJUSTMENT DISORDER. L151

ADJUSTMENT DISORDER CRITERIA

IF UNKNOWN: Did anything happen to you before (SYMPTOMS) began?

IF YES: Tell me about what happened. Do you think that (STRESSOR) had anything to do with your developing (SXS)?

→ **IF SINGLE EVENT: How long after (STRESSOR) did you first develop (SXS)? (Was it within 3 months?)**

→ **IF CHRONIC STRESSOR: How long after (STRESSOR) began did you first develop (SXS)? (Was it within 3 months?)**

A. The development of emotional or behavioral symptoms in response to an identifiable stressor(s) occurring within 3 months of the onset of the stressor(s).

DESCRIBE SYMPTOMS:

DESCRIBE STRESSOR:

? 1 2 3 L152

|
GO TO THE
NEXT MODULE

IF UNKNOWN: What effect did (SXS) have on your life in the past year?

ASK THE FOLLOWING QUESTIONS AS NEEDED TO RATE CRITERION B:

How have (SXS) affected your relationships or your interactions with other people? (Have they caused you any problems in your relationships with your family, romantic partner or friends?)

How have (SXS) affected your work/school? (How about your attendance at work or school? Did [SXS] make it more difficult to do your work/schoolwork? How did [SXS] affect the quality of your work/schoolwork?)

How have they affected your ability to take care of things at home? What about being involved in things that are important to you like religious activities, physical exercise, or hobbies?

Have (SXS) affected any other important part of your life?

IF HAVE NOT INTERFERED WITH LIFE: How much have you been bothered or upset by having (SXS)? How upset are you about (STRESSOR)? (Are you more upset than most other people would be? Have others said that you're more upset than you should be? Have [SXS] lasted longer than you or other people think they should have?)

B. These symptoms or behaviors are clinically significant as evidenced by one or both of the following:

1. Marked distress that is out of proportion to the severity and intensity of the stressor, taking into account the external context and the cultural factors that might influence symptom severity and presentation.
2. Significant impairment in social, occupational, or other important areas of functioning.

? 1 2 3 L153

|
GO TO THE
NEXT MODULE

Have you had this kind of reaction many times before?

IF UNKNOWN: Were you having these (SXS) even before (STRESSOR) happened?

C. The stress-related disturbance does not meet the criteria for another mental disorder and is not merely an exacerbation of a preexisting mental [including personality] disorder.

? 1 3 L154

GO TO THE NEXT MODULE

IF UNKNOWN: Did someone close to you die just before (SXS)?

D. The symptoms do not represent normal bereavement.

? 1 3 L155

GO TO THE NEXT MODULE

IF UNKNOWN: How long has it been since (STRESSOR AND ITS CONSEQUENCES) was over?

E. Once the stressor (or its consequences) has terminated, the symptoms do not persist for more than an additional 6 months.

? 1 2 3 L156

GO TO THE NEXT MODULE

ADJUSTMENT DISORDER CRITERIA A, B, C, D, AND E ARE CODED "3" DURING THE PAST 6 MONTHS.

1 3 L157

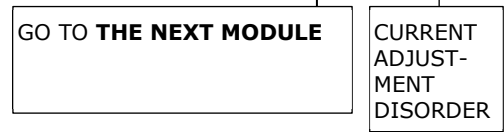

Indicate **type** based on predominant symptoms: (circle the appropriate number) L158

- 1 – **With depressed mood:** Low mood, tearfulness, or feelings of hopelessness are predominant.
- 2 – **With anxiety:** Nervousness, worry, jitteriness, or separation anxiety is predominant.
- 3 – **With mixed anxiety and depressed mood:** A combination of depression and anxiety is predominant.
- 4 – **With disturbance of conduct:** Disturbance in conduct is predominant.
- 5 – **With mixed disturbance of emotions and conduct:** Both emotional symptoms (e.g., depression, anxiety) and a disturbance of conduct are predominant.
- 6 – **Unspecified:** For maladaptive reactions that are not classifiable as one of the specific subtypes of adjustment disorder (e.g., physical complaints, social withdrawal, or work or academic inhibition).

GO TO THE NEXT MODULE

F. ANXIETY DISORDERS

PANIC DISORDER

PANIC DISORDER CRITERIA

→ IF SCREENING QUESTION #1 ANSWERED "NO," SKIP TO *AGORAPHOBIA* F.8.

→ IF QUESTION #1 ANSWERED "YES":
You've said that you have had an intense rush of anxiety, or what someone might call a "panic attack," in the past year when you suddenly felt very frightened, or anxious or suddenly developed a lot of physical symptoms.

→ IF SCREENER NOT USED: **In the past year, since (1 YEAR AGO), have you had an intense rush of anxiety, or what someone might call a "panic attack," when you suddenly felt very frightened, or anxious or suddenly developed a lot of physical symptoms?**

Tell me about that.
When was the last bad one?
What was it like? How did it begin?

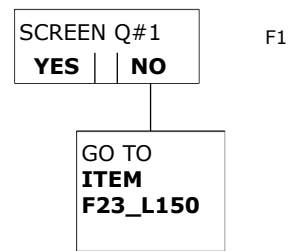

IF UNKNOWN: Did the symptoms come on suddenly?

A panic attack is an abrupt surge of intense fear or intense discomfort that reaches a peak within minutes.

? 1 2 3 F2

IF YES: How long did it take from when it began to when it got really bad? (Did it happen within a few minutes?)

Note: The abrupt surge can occur from a calm state or an anxious state.

During that attack...

...did your heart race, pound or skip?

1. Palpitations, pounding heart, or accelerated heart rate.

? 1 2 3 F3

...did you sweat?

2. Sweating.

? 1 2 3 F4

...did you tremble or shake?

3. Trembling or shaking.

? 1 2 3 F5

...were you short of breath? (Have trouble catching your breath? Feel like you were being smothered?)

4. Sensations of shortness of breath or smothering.

? 1 2 3 F6

...did you feel as if you were choking?

5. Feelings of choking.

? 1 2 3 F7

...did you have chest pain or pressure?

6. Chest pain or discomfort.

? 1 2 3 F8

...did you have nausea or upset stomach or the feeling that you were going to have diarrhea?

7. Nausea or abdominal distress.

? 1 2 3 F9

...did you feel dizzy, unsteady, or like you might faint?

8. Feeling dizzy, unsteady, lightheaded or faint.

? 1 2 3 F10

?=Inadequate information

1=Absent or false

2=Subthreshold

3=Threshold or true

...did you have flushes, hot flashes, or chills? 9. Chills or heat sensations. ? 1 2 3 F11

During that attack...

...did you have tingling or numbness in parts of your body? 10. Paresthesias (numbness or tingling sensations) ? 1 2 3 F12

...did you have the feeling that you were detached from your body or mind, that time was moving slowly, or that you were an outside observer of your own thoughts or movements? 11. Derealization (feelings of unreality) or depersonalization (being detached from oneself). ? 1 2 3 F13

IF NO: How about feeling that everything around you was unreal or that you were in a dream?

...were you afraid you were going crazy or might lose control? 12. Fear of losing control or "going crazy." ? 1 2 3 F14

...were you afraid that you were dying? 13. Fear of dying. ? 1 2 3 F15

AT LEAST FOUR ITEMS CODED "3" AND REACHED THEIR PEAK WITHIN MINUTES 1 3 F16

PANIC ATTACK;
CONTINUE WITH NEXT ITEM

Besides the one you just described, have you had any other attacks in the past year which had even more of the symptoms that I just asked you about?

IF YES, GO BACK TO PAGE 1 AND ASSESS THE SYMPTOMS OF THAT ATTACK.

IF NO: GO TO **ITEM F23_150**

In the past year, since (1 YEAR AGO), have any of these attacks come on out of the blue—in situations where you didn't expect to be nervous or uncomfortable?

A. Recurrent unexpected panic attacks.

? 1 2 3 F17

→ **IF YES: What was going on when the attack(s) happened? (What were you doing at the time? Were you already nervous or anxious at the time or rather were you relatively calm or relaxed?)**

→ **IF NO: How about the very first one you had in the past year. What were you doing at the time? (Were you already nervous or anxious at the time or rather were you relatively calm or relaxed?)**

GO TO ITEM
F23_L150

CONTINUE
ON NEXT
PAGE

IF ATTACK IS UNEXPECTED: How many of these kinds of attacks have you had? (At least two?)

After any of these attacks...

B. At least one of the attacks has been followed by 1 month (or more) of one or both of the following:

...were you concerned or worried that you might have another attack or worried that you would feel like you were having a heart attack again, or worried that you would lose control or go crazy?

1. Persistent concern or worry about additional attacks or their consequences (e.g., losing control, having a heart attack, "going crazy").

? 1 2 3 F18

IF YES: How long did that concern or worry last? (Did it last at least a month? Nearly every day?)

...did you do anything differently because of the attacks (like avoiding certain places or not going out alone)? (What about avoiding certain activities like exercise? What about things like always making sure you're near a bathroom or exit?)

2. A significant maladaptive change in behavior related to the attacks (e.g., behaviors designed to avoid having panic attacks, such as avoidance of exercise or unfamiliar situations).

? 1 2 3 F19

IF YES: How long did that last? (As long as a month?)

CRITERION B.1 OR B.2 CODED "3"

1 3 F20
GO TO ITEM
F23_L150

IF UNKNOWN: When did your panic attacks start?

Just before you began having panic attacks, were you taking any drugs, caffeine, diet pills, or other medicines?

(How much coffee, tea, or caffeinated beverages do you drink a day?)

Just before the attacks, were you physically ill?

IF YES: What did the doctor say?

C. [Primary Anxiety Disorder:] The disturbance is not attributable to the physiological effects of a substance (e.g., a drug of abuse, a medication) or another medical condition (e.g. hyperthyroidism, cardiopulmonary disorders).

IF THERE IS ANY INDICATION THAT PANIC ATTACKS MAY BE SECONDARY (I.E., A DIRECT PHYSIOLOGICAL CONSEQUENCE OF A GMC OR SUBSTANCE/MEDICATION), GO TO *GMC/SUBSTANCE* F.33, AND RETURN HERE TO MAKE A RATING OF "1" OR "3."

Etiological medical conditions include: endocrine disease (e.g., hyperthyroidism, pheochromocytoma, hypoglycemia, hyperadrenocortisolism), cardiovascular disorders (e.g., congestive heart failure, pulmonary embolism, arrhythmia such as atrial fibrillation), respiratory illness (e.g., chronic obstructive pulmonary disease, asthma, pneumonia), metabolic disturbances (e.g., vitamin B₁₂ deficiency, porphyria), and neurological illness (e.g., neoplasms, vestibular dysfunction, encephalitis, seizure disorders).

Etiological substances/medications include: alcohol (I/W), caffeine (I), cannabis (I), opioids (W), phencyclidine (I), other hallucinogens (I), inhalants, and stimulants (including cocaine) (I/W), sedatives, hypnotics, and anxiolytics (W); anesthetics and analgesics, sympathomimetics or other bronchodilators, anticholinergics, insulin, thyroid preparations, oral contraceptives, antihistamines, antiparkinsonian medications, corticosteroids, antihypertensive and cardiovascular medications, anticonvulsants, lithium carbonate, antipsychotic medications, antidepressant medications, and exposure to heavy metals and toxins such as organophosphate insecticide, nerve gases, carbon monoxide, carbon dioxide, volatile substances such as gasoline and paint.

IF NECESSARY, RETURN TO THIS ITEM AFTER COMPLETING MODULES FOR OC AND RELATED DISORDERS AND TRAUMA- AND STRESS-RELATED DISORDERS.

D. The disturbance is not better explained by another mental disorder (e.g., the panic attacks do not occur only in response to feared social situations, as in Social Anxiety Disorder; in response to circumscribed phobic objects or situations, as in Specific Phobia; in response to obsessions, as in Obsessive-Compulsive Disorder; in response to reminders of traumatic events, as in Posttraumatic Stress Disorder; or in response to separation from attachment figures, as in Separation Anxiety Disorder).

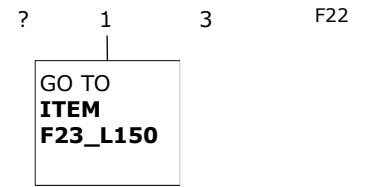
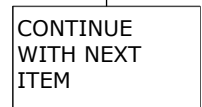
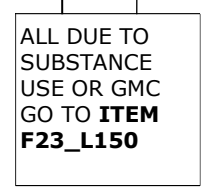
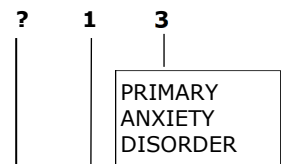

A, B, C, AND D ARE CODED "3."

GO TO ***AGORAPHOBIA***

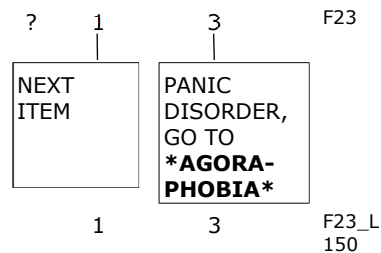

AGORAPHOBIA

AGORAPHOBIA CRITERIA

- IF SCREENING QUESTION #2 ANSWERED "NO," SKIP TO ***SOCIAL ANXIETY DISORDER*** F.14
- IF QUESTION #2 ANSWERED "YES": **You've said that in the past year you have been very anxious or afraid of situations like going out of the house alone, being in crowds, going to stores, standing in lines, or traveling on buses or trains.**
- IF SCREENER NOT USED: **In the past year, since (1 YEAR AGO), have you been very anxious about or afraid of situations like going out of the house alone, being in crowds, going to stores, standing in lines, or traveling on buses or trains?**

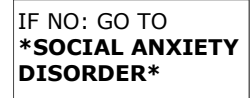
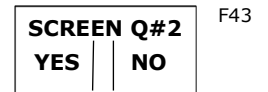

Tell me about the situations that you've been afraid of.

A. Marked fear or anxiety about two (or more) of the following five situations:

IF UNKNOWN: **Have you been afraid of, or anxious about, travelling in taxi cabs, buses, trains, ships or planes?**

1. Using public transportation (e.g., [taxi cabs], buses, trains, ships, planes).	?	1	2	3	F44
-----------------------------------------------------------------------------------	---	---	---	---	-----

IF UNKNOWN: **How about being in open spaces, like parking lots, outdoor marketplaces, or bridges?**

2. Being in open spaces (e.g., parking lots, marketplaces, bridges).	?	1	2	3	F45
----------------------------------------------------------------------	---	---	---	---	-----

IF UNKNOWN: **How about being in enclosed places like stores, movie theaters, or shopping malls?**

3. Being in enclosed places (e.g., shops, theaters, cinemas).	?	1	2	3	F46
---------------------------------------------------------------	---	---	---	---	-----

IF UNKNOWN: **How about standing in a line or being in a crowd?**

4. Standing in line or being in a crowd.	?	1	2	3	F47
------------------------------------------	---	---	---	---	-----

IF UNKNOWN: **How about being outside of the house alone?**

5. Being outside of the home alone.	?	1	2	3	F48
-------------------------------------	---	---	---	---	-----

AT LEAST TWO ITEMS ARE CODED "3"

	1	3	F49
--	---	---	-----

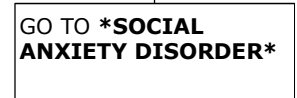

In the past year, since (1 YEAR AGO), why did you avoid (SITUATIONS CODED "3") (What were you afraid would happen?)

(Were you afraid that it might be hard for you to get out of the situation if you absolutely needed to...like if you suddenly developed a panic attack?)

(Or developing something else that would be embarrassing like losing control of your bladder or bowels or vomiting?)

(Or becoming impaired in some way like by falling or passing out?)

(How about being worried that there would be nobody there to help you in case these kinds of things happened?)

In the past year, since (1 YEAR AGO), did you almost always feel frightened or anxious when you were in (SITUATIONS CODED "3" ABOVE)?

Have you gone out of your way to avoid these situations in the past year?

IF NO: **Have you been only able to go into one of these situations if you were with someone you knew?**

IF NO: **When you have had to be in one of these situations, have you felt intensely afraid or anxious?**

IF UNKNOWN: **Have you felt any danger or threat to your safety when you were in (SITUATIONS CODED "3" ABOVE)? (Tell me about that.)**

B. The individual fears or avoids these situations because of thoughts that escape might be difficult or help might not be available in the event of developing panic-like symptoms or other incapacitating or embarrassing symptoms (e.g., fear of falling in the elderly, fear of incontinence).

? 1 2 3 F50

GO TO
SOCIAL ANXIETY DISORDER

C. The agoraphobic situations almost always provoke fear or anxiety.

? 1 2 3 F51

GO TO
SOCIAL ANXIETY DISORDER

D. The agoraphobic situations are actively avoided, require the presence of a companion, or are endured with intense fear or anxiety.

? 1 2 3 F52

GO TO
SOCIAL ANXIETY DISORDER

E. The fear or anxiety is out of proportion to the actual danger posed by the agoraphobic situations and the sociocultural context.

? 1 2 3 F53

GO TO
SOCIAL ANXIETY DISORDER

NOTE: Code "3" if situations do not pose danger or if fear or anxiety is out of proportion to actual danger or sociocultural context.

How long have you been afraid of or avoided (SITUATIONS CODED "3")? (At least 6 months?)

F. The fear, anxiety, or avoidance is persistent, typically lasting for 6 months or more.

? 1 2 3 F54

GO TO
SOCIAL ANXIETY DISORDER

IF UNKNOWN: **What effect have (AGORAPHOBIC SXS) had on your life in the past year?**

G. The fear, anxiety, or avoidance causes clinically significant distress or impairment in social, occupational, or other important areas of functioning.

? 1 2 3 F55

GO TO
SOCIAL ANXIETY DISORDER

ASK THE FOLLOWING QUESTIONS AS NEEDED TO RATE CRITERION G:

How have (AGORAPHOBIC SXS) affected your relationships or your interactions with other people? (Have they caused any problems in your relationships with your family, romantic partner or friends?)

How have (AGORAPHOBIC SXS) affected your ability to work, take care of your family or household needs, or be involved in things that are important to you like religious activities, physical exercise, or hobbies?

Have (AGORAPHOBIC SXS) affected any other important part of your life?

IF HAVE NOT INTERFERED WITH FUNCTIONING:
How much have you been bothered or upset by having (AGORAPHOBIC SXS)?

IF A GENERAL MEDICAL CONDITION CHARACTERIZED BY INCAPACITATING SYMPTOMS IS PRESENT: **Is your avoidance of (SITUATION) related to your (MEDICAL CONDITION)? (Tell me about it. How often has [INCAPACITATING SYMPTOM] actually happened in [AVOIDED SITUATION]?)**

H. If another medical condition (e.g., inflammatory bowel disease, Parkinson's disease) is present, the fear, anxiety, or avoidance is clearly excessive.

? 1 2 3 F56

GO TO
SOCIAL ANXIETY DISORDER

IF NECESSARY, RETURN TO THIS ITEM AFTER COMPLETING MODULES FOR OC AND RELATED DISORDERS.

- I. The fear, anxiety, or avoidance is not better explained by the symptoms of another mental disorder—for example, the symptoms are not confined to Specific Phobia, situational type; do not involve only social situations (as in Social Anxiety Disorder); and are not related exclusively to obsessions (as in Obsessive-Compulsive Disorder), perceived defects or flaws in physical appearance (as in Body Dysmorphic Disorder), reminders of traumatic events (as in Posttraumatic Stress Disorder), or fear of separation (as in Separation Anxiety Disorder).

? 1 3 F57

GO TO ***SOCIAL ANXIETY DISORDER***

NOTE: Consider a diagnosis of Specific Phobia if fear is limited to one or only a few specific situations, or a diagnosis of Social Anxiety Disorder if fear is limited to social situations.

AGORAPHOBIA CRITERIA A, B, C, D, E, F, G, H, AND I ARE CODED "3."

1 3 F58

GO TO ***SOCIAL ANXIETY DISORDER***

AGORA-PHOBIA

SOCIAL ANXIETY DISORDER

SOCIAL ANXIETY DISORDER CRITERIA

- IF SCREENING QUESTIONS #3 AND #4 ARE BOTH ANSWERED "NO," SKIP TO ***SPECIFIC PHOBIA*** F.19.
- IF QUESTION #3 ANSWERED "YES":
You've said that you have been especially anxious or afraid in social situations in the past year, like having a conversation or meeting unfamiliar people.
- IF QUESTION #4 ANSWERED "YES":
You've [also] said that there are things that you have been afraid or felt very uncomfortable doing in front of other people in the past year, like speaking, eating, writing, or using a public bathroom.

IF SCREENER NOT USED: In the past year, since (1 YEAR AGO), have you been especially nervous or anxious in social situations like having a conversation or meeting unfamiliar people?

IF NO: Is there anything that you have been afraid to do or felt very uncomfortable doing in front of other people, like speaking, eating, writing, or using a public bathroom?

IF YES TO ANY OF ABOVE: Tell me about that. Give me some examples of when this has happened. (Situations like having a conversation, meeting people you don't know, being observed eating, drinking or going to the bathroom or performing in front of others?)

In the past year, what were you afraid would happen when you were in (SOCIAL OR PERFORMANCE SITUATION)? (Were you afraid of being embarrassed because of what you might say or how you might act? Were you afraid that this would lead to your being rejected by other people? How about making others uncomfortable or offending them because of what you said or how you acted?)

- A. Marked fear or anxiety about one or more social situations in which the person is exposed to possible scrutiny by others. Examples include social interactions (e.g., having a conversation, meeting unfamiliar people), being observed (e.g., eating or drinking), and performing in front of others (e.g., giving a speech).

NOTE: Code "1" if fear or anxiety is limited to public speaking and is within normal limits.

- B. The individual fears that he or she will act in a way or show anxiety symptoms that will be negatively evaluated (i.e., will be humiliating or embarrassing; will lead to rejection or offend others).

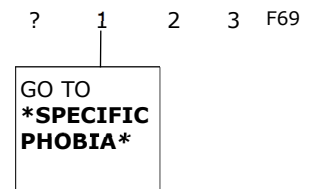
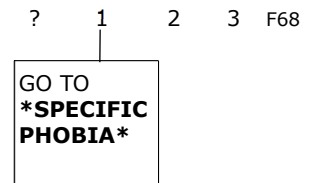
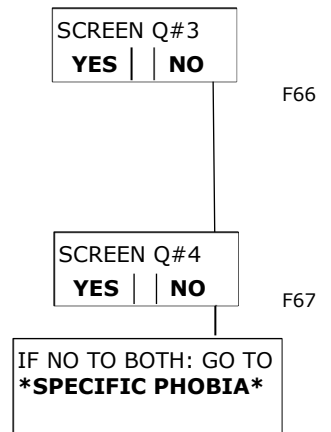

In the past year, did you almost always feel frightened when you would be in (FEARED SOCIAL OR PERFORMANCE SITUATIONS)?

C. The social situations almost always provoke fear or anxiety.

? 1 2 3 F70

GO TO
***SPECIFIC
PHOBIA***

IF UNKNOWN: **Did you go out of your way to avoid (FEARED SOCIAL OR PERFORMANCE SITUATIONS) in the past year?**

D. The social situations are avoided or endured with intense fear or anxiety.

? 1 2 3 F71

GO TO
***SPECIFIC
PHOBIA***

IF NO: **How hard was it for you to be in (FEARED SOCIAL SITUATION)?**

IF UNKNOWN: **What would you say would be the likely outcome of (PERFORMING POORLY IN SOCIAL SITUATIONS)? (Were these situations actually dangerous in some way, like avoiding being bullied or tormented by someone?)**

E. The fear or anxiety is out of proportion to the actual threat posed by the social situation and to the sociocultural context.

? 1 2 3 F72

GO TO
***SPECIFIC
PHOBIA***

NOTE: Code "3" if no threat posed by social situation or if out of proportion to actual threat or sociocultural context.

IF UNCLEAR: **How long have (SXS OF SOCIAL ANXIETY DISORDER) lasted? (Have they lasted for at least 6 months or more?)**

F. The fear, anxiety, or avoidance is persistent, typically lasting for 6 months or more.

? 1 2 3 F73

GO TO
***SPECIFIC
PHOBIA***

IF UNKNOWN: **What effect have (SOCIAL ANXIETY SXS) had on your life in the past year?**

ASK THE FOLLOWING QUESTIONS AS NEEDED TO RATE CRITERION G:

How have (SOCIAL ANXIETY SXS) affected your ability to have friends or meet new people? (How about dating?) How have (SOCIAL ANXIETY SXS) affected your interactions with other people, especially unfamiliar people?

How have (SOCIAL ANXIETY SXS) affected your ability to do things at school or at work that require interacting with other people? (How about making presentations or giving talks?)

Have you avoided going to school or to work if you think you will be put in a situation which makes your uncomfortable?

How have (SOCIAL ANXIETY SXS) affected your ability to work, take care of your family or household needs, or be involved in things that are important to you like religious activities, physical exercise, or hobbies?

Have (SOCIAL ANXIETY SXS) affected any other important part of your life?

IF HAVE NOT INTERFERED WITH FUNCTIONING: **How much you been bothered or upset by having (SOCIAL ANXIETY SXS)?**

IF UNKNOWN: **When did you begin having (SOCIAL ANXIETY SXS)?**

Just before you began having (SOCIAL ANXIETY SXS), were you taking any drugs, caffeine, diet pills, or other medicines?

(How much coffee, tea, or caffeinated beverages did you drink a day?)

Just before (SOCIAL ANXIETY SXS) began, were you physically ill?

IF YES: **What did the doctor say?**

G. The fear, anxiety, or avoidance causes clinically significant distress or impairment in social, occupational, or other important areas of functioning.

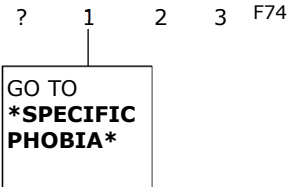

H. [Primary Anxiety Disorder:] The fear, anxiety, or avoidance is not attributable to the physiological effects of a substance (e.g., a drug of abuse, a medication) or another medical condition.

IF THERE IS ANY INDICATION THAT THE ANXIETY MAY BE SECONDARY (I.E., A DIRECT PHYSIOLOGICAL CONSEQUENCE OF GMC OR SUBSTANCE), GO TO ***GMC/SUBSTANCE*** F.33, AND RETURN HERE TO MAKE A RATING OF "1" OR "3."

NOTE: Refer to list of etiological medical conditions or substances/medications on page F.4.

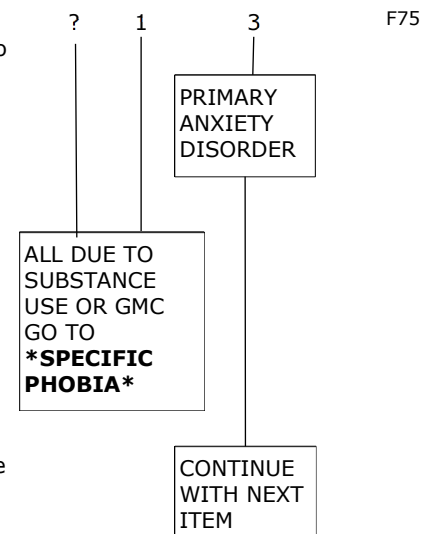

IF NECESSARY, RETURN TO THIS ITEM AFTER COMPLETING MODULES FOR OC AND RELATED DISORDERS.

I. The fear, anxiety, or avoidance is not better explained by the symptoms of another mental disorder such as Panic Disorder, Separation Anxiety Disorder, Body Dysmorphic Disorder, or Autism Spectrum Disorder.

?	1	2	3	F76
GO TO *SPECIFIC PHOBIA*				

IF A GENERAL MEDICAL CONDITION OR MENTAL DISORDER CHARACTERIZED BY POTENTIALLY EMBARRASSING SYMPTOMS IS PRESENT: **Has your avoidance of (SOCIAL SITUATIONS) been related to your (MEDICAL CONDITION OR MENTAL DISORDER)?**

J. If another medical condition (e.g., Parkinson's disease, obesity, disfigurement from burns or injury) [or potentially embarrassing mental disorder] is present, the fear, anxiety, or avoidance is clearly unrelated or is excessive.

?	1	2	3	F77
GO TO *SPECIFIC PHOBIA*				

IF YES: **How have you dealt with your condition?**

SOCIAL ANXIETY DISORDER CRITERIA A, B, C, D, E, F, G, H, I AND J ARE CODED "3."

1	3	F78
GO TO *SPECIFIC PHOBIA*	SOCIAL ANXIETY DISORDER	

GO TO ***SPECIFIC PHOBIA***

SPECIFIC PHOBIA

SPECIFIC PHOBIA CRITERIA

→ **IF SCREENING QUESTION #5 ANSWERED "NO," SKIP TO *CURRENT GENERALIZED ANXIETY DISORDER* F.24.**

→ **IF QUESTION #5 ANSWERED "YES":**
You've said that there are other things that have made you especially anxious or afraid in the past year, like flying, seeing blood, getting a shot, heights, closed places, or certain kinds of animals or insects...

→ **IF SCREENER NOT USED: Are there any other things that have made you especially anxious or afraid in the past year, like flying, seeing blood, getting a shot, heights, closed places, or certain kinds of animals or insects?**

Tell me about that.

In the past year, since (1 YEAR AGO), did you almost always immediately feel frightened or anxious when you were (CONFRONTED WITH PHOBIC STIMULUS)?

In the past year, did you go out of your way to avoid (PHOBIC STIMULUS)? (Are there things you didn't do because of this fear that you would otherwise have done?)

IF NO: How hard was it for you when (CONFRONTED WITH PHOBIC STIMULUS)?

IF PHOBIC STIMULUS IS POSSIBLY DANGEROUS: How dangerous would you say it actually is to (BE EXPOSED TO PHOBIC STIMULUS)?

Do you think that you have been more afraid of (PHOBIC STIMULUS) than you should have been given the actual danger?

A. Marked fear or anxiety about a specific object or situation (e.g., flying, heights, animals, receiving an injection, seeing blood).

B. The phobic object or situation almost always provokes immediate fear or anxiety.

C. The phobic situation(s) is actively avoided, or endured with intense fear or anxiety.

D. The fear or anxiety is out of proportion to the actual danger posed by the specific object or situation and to the sociocultural context.

NOTE: Code "3" if objects or situations do not pose danger or if fear or anxiety is out of proportion to actual danger or sociocultural context.

SCREEN Q#5
YES | NO F88

IF NO: GO TO *CURRENT GENERALIZED ANXIETY DISORDER*

? 1 2 3 F89
GO TO *CURRENT GENERALIZED ANXIETY DISORDER*

? 1 2 3 F90
GO TO *CURRENT GENERALIZED ANXIETY DISORDER*

? 1 2 3 F91
GO TO *CURRENT GENERALIZED ANXIETY DISORDER*

? 1 2 3 F92
GO TO *CURRENT GENERALIZED ANXIETY DISORDER*

?=Inadequate information

1=Absent or false

2=Subthreshold

3=Threshold or true

IF UNKNOWN: **How long have you had these fears? (For 6 months or more?)**

E. The fear, anxiety, or avoidance is persistent, typically lasting for 6 months or more.

? 1 2 3

F93

GO TO
***CURRENT
GENERALIZED
ANXIETY
DISORDER***

IF UNKNOWN: **What effect have (PHOBIC SXS) had on your life in the past year?**

F. The fear, anxiety, or avoidance causes clinically significant distress or impairment in social, occupational, or other important areas of functioning.

? 1 2 3

F94

GO TO
***CURRENT
GENERALIZED
ANXIETY
DISORDER***

ASK THE FOLLOWING QUESTIONS AS NEEDED TO RATE CRITERION F:

How have (PHOBIC SXS) affected your relationships with your family, romantic partner or friends?

How have (PHOBIC SXS) affected your work/school? (How about your attendance at work or school?)

How about doing other things that are important to you like religious activities, physical exercise, or hobbies?

IF BLOOD-INJECTION-INJURY TYPE: **Have you avoided going to the dentist or doctor because of (PHOBIC SXS)? (How has this affected your health?)**

Have (PHOBIC SXS) affected any other important part of your life?

IF HAVE NOT INTERFERED WITH LIFE: **How much have you been bothered or upset by having (PHOBIC SXS)?**

IF NECESSARY, RETURN TO THIS ITEM AFTER COMPLETING MODULES FOR OC AND RELATED DISORDERS.

G. The disturbance is not better explained by the symptoms of another mental disorder, including fear, anxiety, and avoidance of situations associated with panic like symptoms or other incapacitating symptoms (as in Agoraphobia), objects or situations related to obsessions (as in Obsessive-Compulsive Disorder) reminders of traumatic events (as in Posttraumatic Stress Disorder), separation from home or attachment figures (as in Separation Anxiety Disorder) or social situations (as in Social Anxiety Disorder).

? 1 3

F95

GO TO
***CURRENT
GENERALIZED
ANXIETY
DISORDER***

SPECIFIC PHOBIA CRITERIA A, B, C, D, E, F, AND G ARE CODED "3."

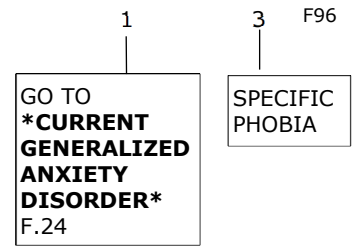

GO TO *CURRENT GENERALIZED ANXIETY DISORDER*

CURRENT GENERALIZED ANXIETY DISORDER **GENERALIZED ANXIETY DISORDER CRITERIA**

→ IF SCREENING QUESTION #6 ANSWERED "NO," SKIP TO
***PAST GENERALIZED ANXIETY DISORDER* F.27**

→ IF QUESTION #6 ANSWERED "YES": **You've said that over the past year you've been feeling anxious and worried for a lot of the time. (Tell me about that.)**

→ IF SCREENER NOT USED: **Over the past year, have you been feeling anxious and worried for a lot of the time? (Tell me about that.)**

SCREEN Q#6	
YES	NO

F111

GO TO THE NEXT MODULE

What kinds of things have you worried about? (What about your job, your health, your family members, your finances, or other smaller things like being late for appointments?) How much did you worry about (EVENTS OR ACTIVITIES)? What else have you worried about?

A. Excessive anxiety and worry (apprehensive expectation), occurring more days than not for at least 6 of the past 12 months, about a number of events or activities (such as work or school performance).

? 1 2 3

F112

GO TO THE NEXT MODULE

Have you worried about (EVENTS OR ACTIVITIES) even when there was no reason? (Have you worried more than most people would in your circumstances? Has anyone else thought you worried too much? Have you worried more than you should have given your actual circumstances?)

During the past year, since (1 YEAR AGO), would you say that you have been worrying more days than not?

When you're worrying this way, have you found that it's hard to stop yourself or to think about anything else?

B. The person finds it difficult to control the worry.

? 1 2 3

F113

GO TO THE NEXT MODULE

Now I am going to ask you some questions about symptoms that often go along with being nervous or worried.

C. The anxiety and worry are associated with three (or more) of the following six symptoms (with at least some symptoms present for more days than not for at least 6 of the past 12 months):

Thinking about those periods since (1 YEAR AGO) when you have been feeling nervous, anxious, or worried...

...have you often felt physically restless, like you couldn't sit still?

1. Restlessness or feeling keyed up or on edge.

? 1 2 3

F114

...have you often felt keyed up or on edge?

2. Being easily fatigued.

F115

?=Inadequate information

1=Absent or false

2=Subthreshold

3=Threshold or true

...have you often tired easily?

? 1 2 3

...have you often had trouble concentrating or has your mind often gone blank?

3. Difficulty concentrating or mind going blank.

? 1 2 3

F116

...have you often been irritable?

4. Irritability.

? 1 2 3

F117

...have your muscles often been tense?

5. Muscle tension.

? 1 2 3

F118

...have you often had trouble falling or staying asleep? How about often feeling tired when you woke up because you didn't get a good night's sleep?

6. Sleep disturbance (difficulty falling or staying asleep, or restless unsatisfying sleep).

? 1 2 3

F119

IF UNCLEAR: **Did at least some of these symptoms like (SXS CODED "3") happen for more days than not over a six-month period in the past year?**

AT LEAST THREE "C" SXS ARE CODED "3" AND AT LEAST SOME OCCURRED MORE DAYS THAN NOT FOR AT LEAST 6 OF THE PAST 12 MONTHS

? 1 2 3

F120

GO TO THE NEXT MODULE

IF UNKNOWN: **What effect have (GAD SXS) had on your life in the past year?**

D. The anxiety, worry, or physical symptoms cause clinically significant distress or impairment in social, occupational, or other important areas of functioning.

? 1 2 3

F121

GO TO THE NEXT MODULE

ASK THE FOLLOWING QUESTIONS AS NEEDED TO RATE CRITERION D:

How have (GAD SXS) affected your relationships or your interactions with other people? (Have [GAD SXS] caused you any problems in your relationships with your family, romantic partner or friends?)

How have (GAD SXS) affected your work/schoolwork? (How about your attendance at work or school? Have [GAD SXS] made it more difficult to do your work/schoolwork? How have [GAD SXS] affected the quality of your work/schoolwork?)

How have (GAD SXS) affected your ability to take care of things at home? How about doing other things that are important to you like religious activities, physical exercise, or hobbies? Have you avoided doing anything because you felt like you weren't up to it?

Has your anxiety or worry affected any other important part of your life?

IF HAS NOT INTERFERED WITH LIFE: **How much have you been bothered or upset by having (GAD SXS)?**

IF UNKNOWN: When did (GAD SXS) begin?

Just before you began having (GAD SXS), were you taking any drugs, caffeine, diet pills, or other medicines?

(How much coffee, tea, or caffeinated soda do you drink a day?)

Just before (GAD SXS) began, were you physically ill?

IF YES: What did the doctor say?

E. [Primary Anxiety Disorder:] The disturbance is not attributable to the physiological effects of a substance (e.g., a drug of abuse, a medication) or to another medical condition.

IF THERE IS ANY INDICATION THAT THE ANXIETY MAY BE SECONDARY (I.E., A DIRECT PHYSIOLOGICAL CONSEQUENCE OF GMC OR SUBSTANCE/MEDICATION), GO TO *GMC/SUBSTANCE* F.33 AND RETURN HERE TO MAKE A RATING OF "1" OR "3."

NOTE: Refer to list of etiological medical conditions and substances/medications on page F.4.

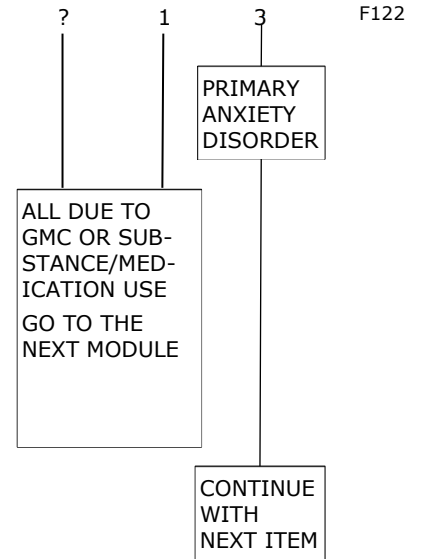

IF NECESSARY, RETURN TO THIS ITEM AFTER COMPLETING MODULE FOR OC AND RELATED DISORDERS AND EATING DISORDERS.

F. The disturbance is not better explained by another mental disorder (e.g., anxiety or worry about having a panic attacks in Panic Disorder, negative evaluation in Social Anxiety Disorder, contamination or other obsessions in Obsessive Compulsive Disorder, separation from attachment figures in Separation Anxiety Disorder, gaining weight in Anorexia Nervosa, physical complaints in Somatic Symptom disorder, perceived appearance flaws in Body Dysmorphic Disorder or having a serious illness in Illness Anxiety Disorder, or the content of delusional beliefs in Schizophrenia or Delusional Disorder).

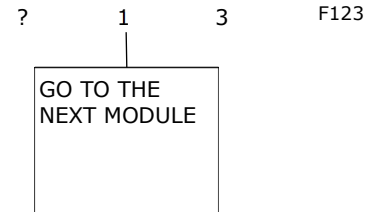

GENERALIZED ANXIETY CRITERIA A, B, C, D, E, AND F ARE CODED "3."

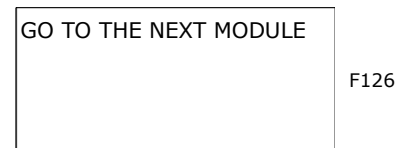
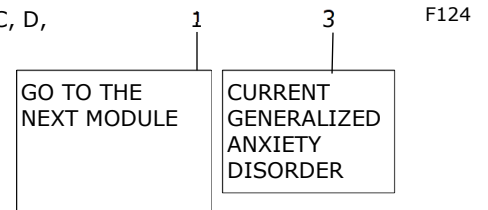

GMC/SUBSTANCE AS ETIOLOGY FOR ANXIETY SYMPTOMS

ANXIETY DISORDER DUE TO ANOTHER MEDICAL CONDITION

ANXIETY DISORDER DUE TO ANOTHER MEDICAL CONDITION CRITERIA

IF SYMPTOMS NOT TEMPORALLY ASSOCIATED WITH A GENERAL CONDITION CHECK HERE ____ AND GO TO ***SUBSTANCE/MEDICATION-INDUCED ANXIETY DISORDER*** F.35

F147

CODE BASED ON INFORMATION ALREADY OBTAINED

A. Panic attacks or anxiety is predominant in the clinical picture.

? 1 3

F148

B/C. There is evidence from this history, physical examination, or laboratory findings that the disturbance is the direct physiological consequence of another medical condition AND the disturbance is not better accounted for by another mental disorder.

? 12 3

F149

GO TO ***SUBSTANCE INDUCED*** F.35

Did the (ANXIETY SXS) start or get much worse only after (GMC) began? How long after (GMC) began did (ANXIETY SXS) start or get much worse?

NOTE: The following factors should be considered and, if present, support the conclusion that a general medical condition is etiologic to the anxiety symptoms.

IF GMC HAS RESOLVED: **Did the (ANXIETY SXS) get better once the (GMC) got better?**

- 1) There is evidence from the literature of a well-established association between the general medical condition and the anxiety symptoms. (Refer to list of etiological general medical conditions on page F.4.)
- 2) There is a close temporal relationship between the course of the anxiety symptoms and the course of the general medical condition.
- 3) The anxiety symptoms are characterized by unusual presenting features (e.g., late age-at-onset).
- 4) The absence of alternative explanations (e.g., anxiety symptoms as a psychological reaction to the stress of being diagnosed with a general medical condition).

IF UNKNOWN: What effect did (ANXIETY SXS) have on your life?

ASK THE FOLLOWING QUESTIONS AS NEEDED TO RATE CRITERION E:

How did (ANXIETY SXS) affect your relationships or your interactions with other people? (Did [ANXIETY SXS] cause you any problems in your relationships with your family, romantic partner or friends?)

How did (ANXIETY SXS) affect your school/work? (How about your attendance at work or school? Did [ANXIETY SXS] make it more difficult to do your work/schoolwork? How did [ANXIETY SXS] affect the quality of your work/schoolwork?)

How did (ANXIETY SXS) affect your ability to take care of things at home? How about doing other things that are important to you like religious activities, physical exercise, or hobbies? Did you avoid doing anything because you felt like you weren't up to it?

Did your anxiety or worry affect any other important part of your life?

IF HAS NOT INTERFERED WITH LIFE: How much were you bothered or upset by having (ANXIETY SXS)?

E. The disturbance causes clinically significant distress or impairment in social, occupational, or other important areas of functioning.

NOTE: The D criterion (delirium rule-out) has been omitted.

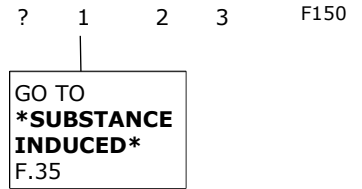

ANXIETY DISORDER DUE TO AMC CRITERIA A, B/C, AND E CODED "3."

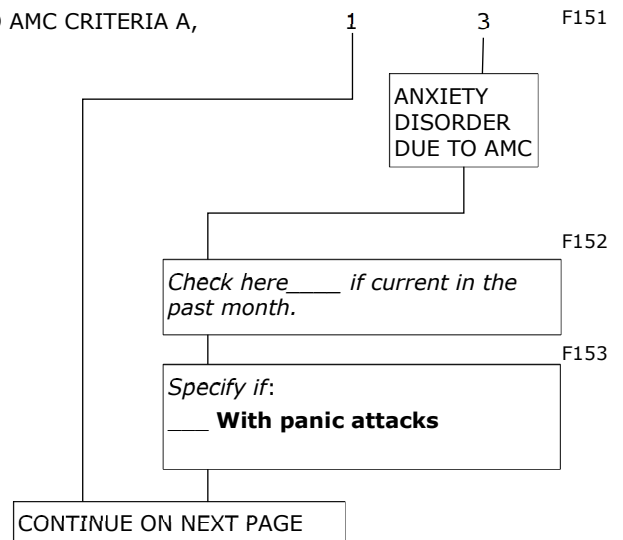

SUBSTANCE/MEDICATION-INDUCED ANXIETY DISORDER

SUBSTANCE/MEDICATION-INDUCED ANXIETY DISORDER CRITERIA

F154

IF SYMPTOMS NOT TEMPORALLY ASSOCIATED WITH SUBSTANCE/MEDICATION USE, CHECK HERE ___ AND RETURN TO DISORDER BEING EVALUATED, CONTINUING WITH THE ITEM FOLLOWING "SYMPTOMS ARE NOT ATTRIBUTABLE TO THE PHYSIOLOGICAL EFFECTS OF A SUBSTANCE OR ANOTHER MEDICAL CONDITION" (SEE PAGE NUMBERS IN BOX TO THE RIGHT).

CODE BASED ON INFORMATION ALREADY OBTAINED

A. Panic attacks or anxiety is predominant in the clinical picture.

? 1 2 3

F155

IF NOT KNOWN: **When did the (ANXIETY SXS) begin? Were you already using (SUBSTANCE/MEDICATION) or had you just stopped or cut down your use?**

B. There is evidence from the history, physical examination, or laboratory findings of both (1) and (2):

? 1 2 3

F156

IF UNKNOWN: **How much (SUBSTANCE/MEDICATION) were you using when you began to have (ANXIETY SXS)?**

1. The symptoms in criterion A developed during or soon after substance intoxication or withdrawal or exposure to a medication.
2. The involved substance/ medication is capable of producing the symptoms in Criterion A.

NOT
SUBSTANCE
INDUCED
RETURN TO
DISORDER
BEING
EVALUATED

NOTE: Refer to list of substances/medications on page F.4.

ASK ANY OF THE FOLLOWING QUESTIONS AS NEEDED TO RULE OUT A NON-SUBSTANCE-INDUCED ETIOLOGY:

C. The disturbance is NOT better accounted for by an anxiety disorder that is not substance-induced. Such evidence of an independent anxiety disorder could include the following:

? 1 3

F157

IF UNKNOWN: **Which came first, the (SUBSTANCE/MEDICATION USE) or the (ANXIETY SXS)?**

NOTE: The following three statements constitute evidence that the anxiety symptoms are not substance-induced. Code "1" if any are true. Code "3" only if none are true.

NOT
SUBSTANCE
INDUCED
RETURN TO
DISORDER
BEING
EVALUATED

IF UNKNOWN: **Have you had a period of time when you stopped using (SUBSTANCE/MEDICATION)?**

IF YES: **After you stopped using (SUBSTANCE/MEDICATION) did the (ANXIETY SXS) go away or get better?**

IF YES: **How long did it take for them to get better? Did they go away within a month of stopping?**

- 1) The symptoms precede the onset of the substance/medication use;
- 2) The symptoms persist for a substantial period of time (e.g., about 1 month) after the cessation of acute withdrawal or severe intoxication; or

IF UNKNOWN: **Have you had any other episodes of (ANXIETY SXS)?**

IF YES: **How many? Were you using (SUBSTANCE/MEDICATION) at those times?**

- 3) There is other evidence suggesting the existence of an independent non-substance/ medication-induced anxiety disorder (e.g., a history of recurrent non-substance/ medication-related episodes).

?=Inadequate information

1=Absent or false

2=Subthreshold

3=Threshold or true

IF UNKNOWN: What effect did (ANXIETY SXS) have on your life?

E. The symptoms cause clinically significant distress or impairment in social, occupational, or other important areas of functioning.

? 1 2 3 F158

ASK THE FOLLOWING QUESTIONS AS NEEDED TO RATE CRITERION E:

How did (ANXIETY SXS) affect your relationships or your interactions with other people? (Did [ANXIETY SXS] cause you any problems in your relationships with your family, romantic partner or friends?)

How did (ANXIETY SXS) affect your work/schoolwork? (How about your attendance at work or school? Did [ANXIETY SXS] make it more difficult to do your work/schoolwork? How did [ANXIETY SXS] affect the quality of your work/schoolwork?)

How did (ANXIETY SXS) affect your ability to take care of things at home? How about doing other things that are important to you like religious activities, physical exercise, or hobbies? Did you avoid doing anything because you felt like you weren't up to it?

Did your anxiety or worry affect any other important part of your life?

IF HAS NOT INTERFERED WITH LIFE: How much were you bothered or upset by having (ANXIETY SXS)?

NOTE: The D criterion (delirium rule-out) has been omitted.

RETURN TO DISORDER BEING EVALUATED

SUBSTANCE-INDUCED ANXIETY DISORDER CRITERIA A, B, C, AND E ARE CODED "3."

1 3 F159

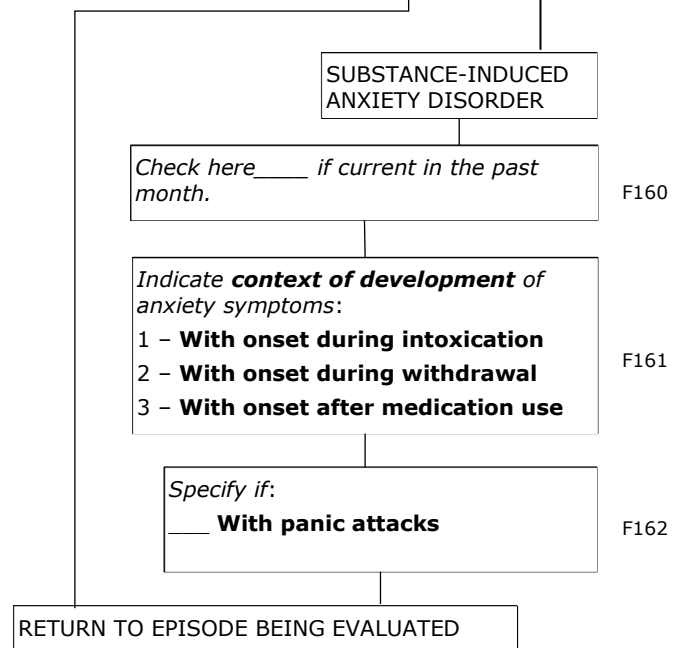

?=Inadequate information

1=Absent or false

2=Subthreshold

3=Threshold or true

0G. OBSESSIVE-COMPULSIVE AND RELATED DISORDERS

OBSESSIVE-COMPULSIVE DISORDER

OBSESSIVE-COMPULSIVE DISORDER CRITERIA

IF SCREENING QUESTIONS #8, #9, AND #10 ARE ALL ANSWERED "NO" SKIP TO *COMPULSIONS* G.2, (NOTE: BECAUSE SOME SUBJECTS WITH OCD MAY BE RELUCTANT TO CONFIDE THEIR OBSESSIONS DURING THE SCREENING, CONSIDER RE-ASKING SCREENING QUESTIONS BELOW AT THIS POINT IN THE SCID.)

IF QUESTION #8 ANSWERED "YES": In the past year, you've said that you've been bothered by thoughts that kept coming back to you even when you didn't want them to, like being exposed to germs or dirt or needing everything to be lined up in a certain way. What were they?

IF QUESTION #9 ANSWERED "YES": In the past year, you've [also] said that you've had images pop into your head that you didn't want like violent or horrible scenes or something of a sexual nature. What were they?

IF QUESTION #10 ANSWERED "YES": In the past year, you've [also] said that you've had urges to do something that kept coming back to you even though you didn't want them to, like an urge to harm a loved one. What were they?

IF SCREENER NOT USED: In the past year, since (1 YEAR AGO), have you been bothered by thoughts that kept coming back to you even when you didn't want them to, like being exposed to germs or dirt or needing everything to be lined up in a certain way? (What were they?)

How about having images pop into your head that you didn't want like violent or horrible scenes or something of a sexual nature? (What were they?)

How about having urges to do something that kept coming back to you even though you didn't want them to, like an urge to harm a loved one? (What were they?)

IF YES TO ANY OF ABOVE: Have these (THOUGHTS/IMAGES/URGES) made you very anxious or upset in the past year?

In the past year, since (1 YEAR AGO), when you had these (THOUGHTS/IMAGES/URGES) did you try hard to get them out of your head? (What would you try to do?)

A. Presence of obsessions, compulsions, or both:

Obsessions are defined by (1) and (2):

1. Recurrent and persistent thoughts, urges, or images that are experienced, at some time during the disturbance, as intrusive and unwanted, and that in most individuals cause marked anxiety or distress.

2. The individual attempts to ignore or suppress such thoughts, urges, or images, or to neutralize them with some other thought or action (i.e., by performing a compulsion).

SCREEN Q#8 YES NO G1

SCREEN Q#9 YES NO G2

SCREEN Q#10 YES NO G3

IF ALL ARE ANSWERED "NO" SKIP TO *COMPULSIONS* G.2

? 1 2 3 G4
NO OBSESSIONS GO TO *COMPULSIONS* G.2

? 1 2 3 G5
NO OBSESSIONS CONTINUE ON NEXT PAGE OBSESSIONS

DESCRIBE CONTENT OF OBSESSION(S):

?=Inadequate information

1=Absent or false

2=Subthreshold

3=Threshold or true

COMPULSIONS

IF SCREENING QUESTION #11 ANSWERED "NO," GO TO ***SKIP OUT IF NEITHER OBSESSIONS NOR COMPULSIONS*** G.3 (NOTE: BECAUSE SOME SUBJECTS WITH OCD MAY BE RELUCTANT TO CONFIDE THEIR COMPULSIONS DURING THE SCREENING, CONSIDER RE-ASKING SCREENING QUESTION BELOW AT THIS POINT IN THE SCID.)

IF QUESTION #11 ANSWERED "YES": **In the past year, since (1 YEAR AGO), you've said that there were things you had to do over and over again and were hard to resist doing, like washing your hands again and again, repeating something over and over again until it "felt right," counting up to a certain number, or checking something many times to make sure that you'd done it right. Tell me about that.**

SCREEN Q#11 G6
 YES | NO

IF NO: GO TO ***SKIP OUT IF NEITHER OBSESSIONS NOR COMPULSIONS*** G.3

IF SCREENER NOT USED: **In the past year, since (1 YEAR AGO), was there anything that you had to do over and over again and was hard to resist doing, like washing your hands again and again, repeating something over and over again until it "felt right," counting up to a certain number, or checking something many times to make sure that you'd done it right?**

Compulsions are defined by (1) and (2):

1. Repetitive behaviors (e. g., hand washing, ordering, checking) or mental acts (e.g., praying, counting, repeating words silently) that the individual feels driven to perform in response to an obsession, or according to rules that must be applied rigidly.

? 1 2 3 G7

Tell me about that. (What did you have to do?)

IF UNCLEAR: **Why did you have to do (COMPULSIVE ACT)? What would happen if you didn't do it?**

2. The behaviors or mental acts are aimed at preventing or reducing anxiety or distress, or preventing some dreaded event or situation; however these behaviors or mental acts either are not connected in a realistic way with what they are designed to neutralize or prevent, or are clearly excessive.

? 1 2 3 G8

IF UNCLEAR: **How many times would you do (COMPULSIVE ACT)? Have you been doing (COMPULSIVE ACT) more than really made sense?**

COMPULSIONS

GO TO ***SKIP OUT IF NEITHER OBSESSIONS NOR COMPULSIONS*** G.3 (TOP OF NEXT PAGE)

DESCRIBE CONTENT OF COMPULSION(S):

SKIP OUT IF NEITHER OBSESSIONS NOR COMPULSIONS

→ IF EITHER OBSESSIONS OR COMPULSIONS, OR BOTH, CONTINUE BELOW.

→ IF NEITHER OBSESSIONS NOR COMPULSIONS, CHECK HERE ____ AND GO TO **THE NEXT MODULE**.

G9

IF UNKNOWN: **How much time do you spend on (OBSESSION OR COMPULSION) in the past year?**

IF UNKNOWN: **What effect did these (OBSESSIONS OR COMPULSIONS) have on your life in the past year?**

B. The obsessions or compulsions are time consuming (e.g., take more than 1 hour per day) or cause clinically significant distress or impairment in social, occupational, or other important areas of functioning.

? 1 2 3

G10

GO TO **THE NEXT MODULE**.

ASK THE FOLLOWING QUESTIONS AS NEEDED TO RATE CRITERION B:

How have (OBSESSIONS OR COMPULSIONS) affected your relationships or your interactions with other people in the past year? (Have they caused you any problems in your relationships with your family, romantic partner, roommates or friends?)

How have (OBSESSIONS OR COMPULSIONS) affected your work/school in the past year? (How about your attendance at work or school? Have [OBSESSIONS OR COMPULSIONS] made it more difficult to do your work/ schoolwork)? How have (OBSESSIONS OR COMPULSIONS) affected the quality of your work/schoolwork?)

How have (OBSESSIONS OR COMPULSIONS) affected your ability to take care of things at home in the past year? How about doing other things that are important to you like religious activities, physical exercise, or hobbies?

Have (OBSESSIONS OR COMPULSIONS) affected any other important part of your life in the past year?

IF HAVE NOT INTERFERED WITH LIFE: **How much have you been bothered in the past year by having (OBSESSIONS OR COMPULSIONS)?**

?=Inadequate information

1=Absent or false

2=Subthreshold

3=Threshold or true

IF UNKNOWN: **When did** (OBSESSIONS OR COMPULSIONS) **begin?**

Just before this began, were you physically ill?

IF YES: **What did the doctor say?**

Just before this began, were you using any medications?

IF YES: **Any change in the amount you were using?**

Just before this began, were you drinking or using any drugs?

C. [Primary Obsessive-Compulsive Disorder.] The obsessive-compulsive symptoms are not attributable to the physiological effects of a substance/medication or to another medical condition.

IF THERE IS ANY INDICATION THAT THE OBSESSIONS OR COMPULSIONS MAY BE SECONDARY (I.E., A DIRECT PHYSIOLOGICAL CONSEQUENCE OF GMC OR SUBSTANCE), GO TO *GMC/SUBSTANCE* G.11 AND RETURN HERE TO MAKE A RATING OF "1" OR "3."

Etiological medical conditions include:

Sydenham's chorea, medical conditions leading to striatal damage, such as cerebral infarction.

Etiological substances/medications include:

intoxication with cocaine, amphetamines or other stimulants and exposure to heavy metals.

D. The disturbance is not better explained by the symptoms of another mental disorder (e.g., excessive worries, as in Generalized Anxiety Disorder; preoccupation with appearance, as in Body Dysmorphic Disorder; difficulty discarding or parting with possessions, as in Hoarding Disorder; hair pulling, as in Trichotillomania; skin picking, as in Excoriation Disorder; stereotypies, as in Stereotypic Movement Disorder; ritualized eating behavior, as in Eating Disorders; preoccupation with substances or gambling, as in Substance-Related and Addictive Disorders; preoccupation with having an illness, as in Illness Anxiety Disorder; sexual urges or fantasies, as in Paraphilic Disorders; impulses, as in Disruptive, Impulse-Control, and Conduct Disorders; guilty ruminations, as in Major Depressive Disorder; thought insertion or delusional preoccupations, as in Schizophrenia Spectrum and Other Psychotic Disorders; or repetitive patterns of behavior, as in Autism Spectrum Disorder).

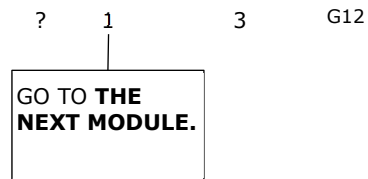
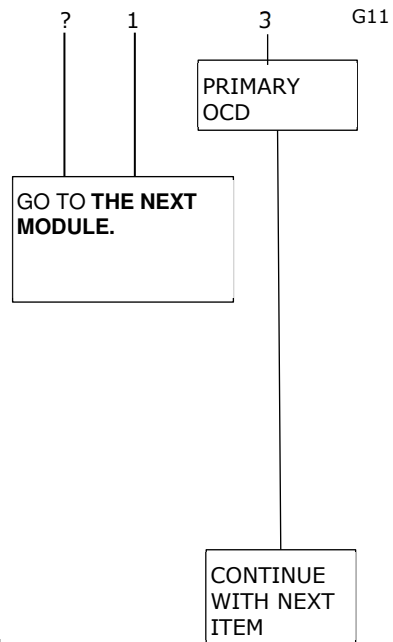

?=Inadequate information

1=Absent or false

2=Subthreshold

3=Threshold or true

OBSESSIVE COMPULSIVE DISORDER
CRITERIA A, B, C, D, AND E ARE CODED "3."

1

3

G13

GO TO **THE
NEXT
MODULE.**

OBSESSIVE-
COMPULSIVE
DISORDER;
CONTINUE
BELOW.

GO TO **THE NEXT MODULE.**

?=Inadequate information

1=Absent or false

2=Subthreshold

3=Threshold or true

I. FEEDING AND EATING DISORDERS

ANOREXIA NERVOSA

ANOREXIA NERVOSA CRITERIA

→ IF SCREENING QUESTION #12 ANSWERED "NO," CHECK HERE ___ AND SKIP TO *BULIMIA NERVOSA* I.4

→ IF QUESTION #12 ANSWERED "YES":
You've said that there was a time in the past year when you weighed much less than other people thought you ought to weigh...

→ IF SCREENER NOT USED: **Now I would like to ask you some questions about your eating habits and your weight in the past year. Have you had a time when you weighed much less than other people thought you ought to weigh?**

IF YES: Why was that? How much did you weigh? How old were you then? How tall were you?

IF PAST YEAR RATING OF "3": During the past 3 months, since (3 MONTHS AGO), what is the lowest your weight has been?

In the past year, since (1 YEAR AGO), were you very afraid that you could become fat?

IF NO: Tell me about your eating habits. (Have you avoided high calorie foods or high fat foods? How strict are you about it? Have you ever thrown up after you eaten? How often? Do you exercise a lot after you eat?)

IF PAST YEAR RATING OF "3": Has this also been the case during the past 3 months, since (3 MONTHS AGO)?

At your lowest weight in the past year, did you still feel too fat or that part of your body was too fat?

IF NO: Did you need to be very thin in order to feel better about yourself?

IF NO AND LOW WEIGHT IS MEDICALLY SERIOUS: When you were that thin, did anybody tell you it could be dangerous to your health to be that thin? (What did you think?)

IF PAST YEAR RATING OF "3": Has this also been the case in the past 3 months, since (3 MONTHS AGO)?

A. Restriction of energy intake relative to requirements, leading to a significantly low body weight in the context of age, sex, developmental trajectory, and physical health. Significantly low weight is defined as a weight that is less than minimally normal or, for children and adolescents, less than minimally expected.

B. Intense fear of gaining weight or of becoming fat, or persistent behavior that interferes with weight gain, even though underweight.

C. Disturbance in the way in which one's body weight or shape is experienced; undue influence of body weight or shape on self-evaluation, or persistent lack of recognition of the seriousness of the current low body weight.

ANOREXIA NERVOSA CRITERIA A, B, AND C ARE CODED "3"

SCREEN Q#12
 YES | NO I1

IF NO: GO TO *BULIMIA NERVOSA*

? 1 2 3 I2
 GO TO *BULIMIA NERVOSA*

Past 3 months
 ? 1 2 3 I3

? 1 2 3 I4
 GO TO *BULIMIA NERVOSA*

Past 3 months
 ? 1 2 3 I5

? 1 2 3 I6
 GO TO *BULIMIA NERVOSA*

Past 3 months
 ? 1 2 3 I7

1 3 I8
 IF NO: GO TO *BULIMIA NERVOSA* ANOREXIA NERVOSA

?=inadequate information

1=absent or false

2=subthreshold

3=threshold or true

When did you last have (ANY SXS OF ANOREXIA NERVOSA)? Number of months prior to interview when last had a symptom of Anorexia Nervosa _____

Do you have eating binges in which you eat a lot of food in a short period of time and feel that your eating is out of control? (How often?)

*Specify **subtype** for current episode: (circle the appropriate number)*

IF NO: What kinds of things have you done to keep weight off? (Do you ever make yourself vomit or take laxatives, enemas, or water pills? How often?)

1 – Restricting type:

During the last 3 months, the individual has NOT engaged in recurrent episodes of binge eating or purging behavior (i.e., self-induced vomiting or the misuse of laxatives, diuretics, or enemas). This subtype describes presentations in which weight loss is accomplished primarily through dieting, fasting and/or excessive exercise.

2 – Binge-eating/purging type:

During last 3 months, the individual has engaged in recurrent episodes or binge-eating or purging behavior (i.e., self-induced vomiting or misuse of laxatives, diuretics, or enemas).

BULIMIA NERVOSA

BULIMIA NERVOSA CRITERIA

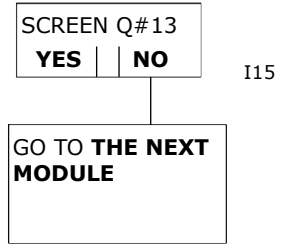

→ IF SCREENING QUESTION #13 IS ANSWERED "NO," GO TO **THE NEXT MODULE**.

→ *IF QUESTION #13 ANSWERED "YES":* In the past year, since (1 YEAR AGO), you've said that you've had eating binges, that is, times when you couldn't resist eating a lot of food or stop eating once you've started. Tell me about those times.

→ *IF SCREENER NOT USED:* In the past year, since (1 YEAR AGO), have you had eating binges, that is, times when you couldn't resist eating a lot of food or stop eating once you started? Tell me about those times.

A. Recurrent episodes of binge eating. An episode of binge eating is characterized by BOTH of the following:

During these times, were you unable to control what or how much you were eating?

- 2. A sense of lack of control over eating during the episode (e.g., a feeling that one cannot stop eating or control what or how much one is eating)

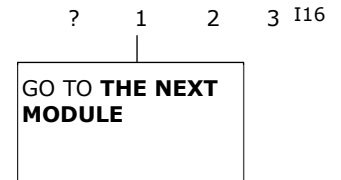

NOTE: Criterion A.2 (lack of control) precedes criterion A.1 to tie in with screening question.

During those times in the past year, how much did you eat? Over what period of time? What's the most you might eat at such times? (Does this only happen during celebrations or holidays?)

- 1. Eating, in a discrete period of time (e.g., within any 2-hour period), an amount of food that is definitely larger than most people would eat during a similar period of time and under similar circumstances

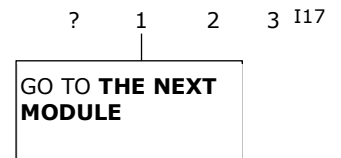

CRITERIA A.2 AND A.1 ARE CODED "3"

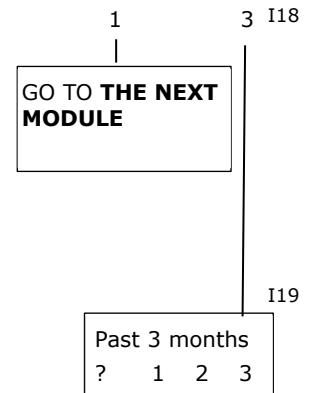

IF PAST YEAR RATING OF "3" FOR BOTH CRITERIA A.2 AND A.1: **During the past 3 months, since (3 MONTHS AGO), have you had such episodes?**

In the past year, have you done anything to keep yourself from gaining weight because of the binge eating (like making yourself vomit, taking laxatives, enemas, water pills, or thyroid hormone, strict dieting or fasting, or exercising a lot)? Tell me about that. How often did this occur?

- B. Recurrent inappropriate compensatory behavior in order to prevent weight gain, such as: self-induced vomiting; misuse of laxatives, diuretics, enemas, or other medications; fasting; or excessive exercise.

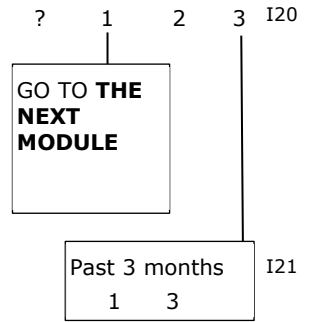

IF PAST YEAR RATING OF "3": **Have you done (COMPENSATORY BEHAVIOR[S]) during the past 3 months, since (3 MONTHS AGO)?**

In the past year, how often were you binge eating and (COMPENSATORY BEHAVIOR[S])? (At least once a week for at least 3 months?)

- C. The binge eating and inappropriate compensatory behaviors both occur, on average, at least once a week for 3 months.

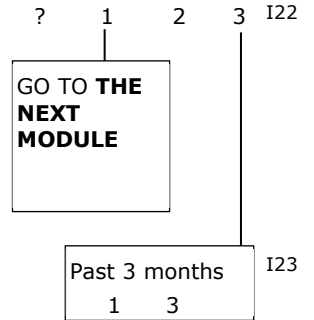

IF PAST YEAR RATING OF "3": **Since (3 MONTHS AGO), how often were you binge eating and (COMPENSATORY BEHAVIOR[S])? At least once a week?**

In the past year, has your body shape and weight ever been an important factor in how you felt about yourself?

- D. Self-evaluation is unduly influenced by body shape and weight.

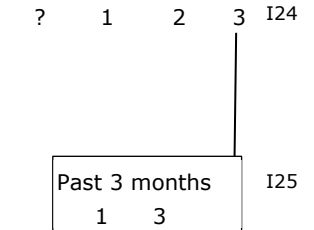

IF YES: How important?

IF PAST YEAR RATING OF "3": **Has this also been the case during the past 3 months?**

IF UNKNOWN: **In the past year, did you binge eat and then (ENGAGE IN COMPENSATORY BEHAVIOR) only when your weight was very low?**

- E. The disturbance does not occur exclusively during episodes of Anorexia Nervosa.

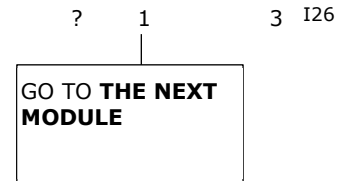

BULIMIA NERVOSA CRITERIA
A, B, C, D, AND E ARE CODED "3."

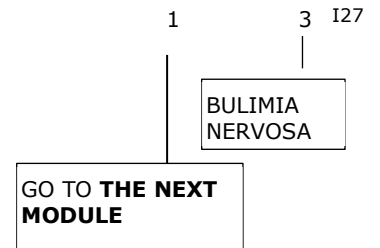

?=inadequate information

1=absent or false

2=subthreshold

3=threshold or true

TABLE FOR DETERMINING SEVERITY OF ANOREXIA NERVOSA BASED ON BODY MASS INDEX

Anorexia Nervosa Severity	Mild (BMI≥17)	Moderate (BMI=16-16.99)	Severe (BMI=15-15.99)	Extreme (BMI=<15)
Height cms (inches/feet)	Body Weight kg (pounds)	Body Weight kg (pounds)	Body Weight kg (pounds)	Body Weight kg (pounds)
148 (58" / 4'10")	≥38 (≥84)	35-37 (77-82)	33-34 (72-76)	<33 (<72)
150 (59" / 4'11")	≥39 (≥86)	37-38 (79-81)	35-36 (74-78)	<35 (<74)
153 (60" / 5')	≥40 (≥90)	38-39 (84-87)	36-37 (77-81)	<36 (<77)
155 (61" / 5'1")	≥41 (≥95)	39-40 (86-90)	37-38 (80-85)	<37 (<80)
158 (62" / 5'2")	≥43 (≥95)	41-42 (89-93)	38-39 (82-88)	<38 (<82)
160 (63" / 5'3")	≥44 (≥97)	42-43 (92-96)	39-40 (85-91)	<39 (<85)
163 (64" / 5'4")	≥46 (≥101)	44-45 (97-99)	40-41 (88-92)	<40 (<88)
165 (65" / 5'5")	≥47 (≥104)	45-46 (100-102)	41-43 (91-95)	<41 (<91)
168 (66" / 5'6")	≥48 (≥106)	46-47 (100-105)	43-44 (93-99)	<43 (<93)
170 (67" / 5'7")	≥49 (≥108)	47-48 (103-107)	44-46 (95-102)	<44 (<95)
173 (68" / 5'8")	≥51 (≥112)	49-50 (104-109)	46-47 (97-103)	<46 (<97)
175 (69" / 5'9")	≥52 (≥115)	50-51 (106-113)	47-48 (99-105)	<47 (<99)
178 (70" / 5'10")	≥54 (≥119)	52-53 (109-116)	48-50 (102-108)	<48 (<102)
180 (71" / 5'11")	≥55 (≥121)	53-54 (115-123)	51-52 (108-114)	<51 (<108)
183 (72" / 6'0")	≥57 (≥126)	54-55 (119-125)	52-53 (111-118)	<52 (<111)
185 (73" / 6'1")	≥58 (≥128)	55-57 (124-129)	53-54 (114-121)	<53 (<114)
188 (74" / 6'2")	≥60 (≥132)	57-59 (125-132)	54-55 (117-124)	<54 (<117)
191 (75" / 6'3")	≥61 (≥134)	59-60(128-136)	55-58 (122-127)	<55 (<122)
193 (76" / 6'4")	≥63 (≥140)	60-62 (132-140)	58-59 (123-131)	<58 (<123)
Severity	Mild	Moderate	Severe	Extreme

Source: Adapted from *Clinical Guidelines on the Identification, Evaluation, and Treatment of Overweight and Obesity in Adults: The Evidence Report*.

?=inadequate information

1=absent or false

2=subthreshold

3=threshold or true

?=inadequate information

1=absent or false

2=subthreshold

3=threshold or true

GMC/SUBSTANCE CAUSING OBSESSIVE-COMPULSIVE AND RELATED SYMPTOMS

***OBSESSIVE-COMPULSIVE AND RELATED DISORDER DUE TO ANOTHER MEDICAL CONDITION* OBSESSIVE-COMPULSIVE AND RELATED DISORDER DUE TO ANOTHER MEDICAL CONDITION CRITERIA**

IF SYMPTOMS NOT TEMPORALLY ASSOCIATED WITH A GENERAL MEDICAL CONDITION, CHECK HERE ___ AND GO TO ***SUBSTANCE-INDUCED OC AND RELATED DISORDER* G.14.**

G28

CODE BASED ON INFORMATION ALREADY OBTAINED

A. Obsessions, compulsions, preoccupations with appearance, hoarding, skin picking, hair pulling, other body-focused repetitive behaviors, or other symptoms characteristic of obsessive-compulsive and related disorder predominate in the clinical picture.

? 1 2 3

G29

GO TO
***SUB-
STANCE
INDUCED***
G.14

B/C. There is evidence from the history, physical examination, or laboratory findings that the disturbance is the direct physiological consequence of another medical condition AND the disturbance is not better accounted for by another mental disorder.

? 1 3

G30

GO TO
***SUB-
STANCE
INDUCED***
G.14

Did (OC AND RELATED SXS) start or get much worse only after (GMC) began? How long after (GMC) began did (OC AND RELATED SXS) start or get much worse?

NOTE: The following factors should be considered and, if present, support the conclusion that a general medical condition is etiologic to the obsessive-compulsive and related symptoms.

IF GMC HAS RESOLVED: Did the (OC AND RELATED SYMPTOMS) get better once the (GMC) got better?

- 1) There is evidence from the literature of a well-established association between the general medical condition and the obsessive-compulsive and related symptoms. (Refer to list of etiological general medical conditions on page G.4.)
- 2) There is a close temporal relationship between the course of the obsessive-compulsive and related symptoms and the course of the general medical condition.
- 3) The obsessive-compulsive and related symptoms are characterized by unusual presenting features (e.g., late age-at-onset).
- 4) The absence of alternative explanations (e.g., obsessive-compulsive and related symptoms as a psychological reaction to the stress of being diagnosed with a general medical condition).

?=inadequate information

1=absent or false

2=subthreshold

3=threshold or true

IF UNKNOWN: **What effect have (OC-RELATED SXS) had on your life?**

E. The disturbance causes clinically significant distress or impairment in social, occupational, or other important areas of functioning

? 1 2 3

G31

ASK THE FOLLOWING QUESTIONS AS NEEDED TO RATE CRITERION E.:

How have (OC-RELATED SXS) affected your relationships or your interactions with other people? (Have they caused you any problems in your relationships with your family, romantic partner or friends?)

How have (OC-RELATED SXS) affected your work/school? (How about your attendance at work or school? Have [OC-RELATED SXS] made it more difficult to do your work/schoolwork)? How have [OC-RELATED SXS] affected the quality of your work/schoolwork?)

How have (OC-RELATED SXS) affected your ability to take care of things at home? What about being involved in things that are important to you, like religious activities, physical exercise, or hobbies? Have you avoided situations or people because you didn't want other people to see you doing (OC-RELATED BEHAVIORS)?

Have (OC-RELATED SXS) affected any other important part of your life?

IF HAVE NOT INTERFERED WITH LIFE: **How much have your (OC-RELATED SXS) bothered or upset you?**

NOTE: The D criterion (delirium rule-out) has been omitted.

GO TO
***SUB-
STANCE
INDUCED***
G.14

OC AND RELATED DISORDER DUE TO AMC
CRITERIA A, B/C, AND E CODED "3."

1

3

G32

OC AND
RELATED
DISORDER
DUE TO AN
AMC

Check here ___ if current in the past
month. G33

Specify if:

G34

- 1 - **With obsessive-compulsive disorder-like symptoms:** If obsessive-compulsive disorder-like symptoms predominate in the clinical presentation.
- 2 - **With appearance preoccupations:** If preoccupation with perceived appearance defects or flaws predominates in the clinical presentation.
- 3 - **With hoarding symptoms:** If hoarding predominates in the clinical presentation.
- 4 - **With hair-pulling symptoms:** If hair pulling predominates in the clinical presentation.
- 5 - **With skin-picking symptoms:** If skin picking predominates in the clinical presentation.

CONTINUE ON NEXT PAGE

SUBSTANCE-/MEDICATION-INDUCED OC AND RELATED DISORDER **SUBSTANCE-/MEDICATION-INDUCED OC AND RELATED DISORDER CRITERIA**

EPISODE BEING EVALUATED:	
OCD	G.4
	G35

IF SYMPTOMS NOT TEMPORALLY ASSOCIATED WITH SUBSTANCE/MEDICATION USE (OR IF SYMPTOMS CONFINED TO HOARDING), CHECK HERE ____ AND RETURN TO EPISODE BEING EVALUATED, CONTINUING WITH THE ITEM FOLLOWING "SYMPTOMS ARE NOT ATTRIBUTABLE TO THE PHYSIOLOGICAL EFFECTS OF A SUBSTANCE OR ANOTHER MEDICAL CONDITION" (SEE PAGE NUMBERS IN BOX TO THE RIGHT).

CODE BASED ON INFORMATION ALREADY OBTAINED.

A. Obsessions, compulsions, skin picking, hair pulling, other body-focused repetitive behaviors, or other symptoms characteristic of the obsessive-compulsive and related disorders predominate in the clinical picture.	?	1	2	3	G36
--------------------------------------------------------------------------------------------------------------------------------------------------------------------------------------------------------------------------	---	---	---	---	-----

IF NOT KNOWN: **When did the (OC AND RELATED SXS) begin? Were you already using (SUBSTANCE/MEDICATION) or had you just stopped or cut down your use?**

B. There is evidence from the history, physical examination, or laboratory findings of both (1) and (2):	?	1	2	3	G37
----------------------------------------------------------------------------------------------------------	---	---	---	---	-----

IF UNKNOWN: **How much (SUBSTANCE/MEDICATION) were you using when you began to have (OC AND RELATED SXS)?**

1. The symptoms in criterion A developed during or soon after substance intoxication or withdrawal or exposure to a medication
2. The involved substance/ medication is capable of producing the symptoms in Criterion A

NOT SUBSTANCE INDUCED RETURN TO EPISODE BEING EVALUATED

NOTE: Refer to list of etiological substances/medications on page G.4.

ASK ANY OF THE FOLLOWING QUESTIONS AS NEEDED TO RULE OUT A NON-SUBSTANCE-INDUCED ETIOLOGY.

C. The disturbance is NOT better accounted for by an obsessive-compulsive and related disorder that is not substance-induced. Such evidence of an independent obsessive-compulsive disorder and related disorder could include the following:	?	1	3	G38
-----------------------------------------------------------------------------------------------------------------------------------------------------------------------------------------------------------------------------------------------	---	---	---	-----

IF UNKNOWN: **Which came first, the (SUBSTANCE/MEDICATION USE) or the (OC AND RELATED SXS)?**

IF UNKNOWN: **Have you had a period of time when you stopped using (SUBSTANCE/MEDICATION)?**

IF YES: **After you stopped using (SUBSTANCE/MEDICATION) did the (OC AND RELATED SXS) go away or get better?**

IF YES: **How long did it take for them to get better? Did they go away within a month of stopping?**

NOTE: The following three statements constitute evidence that the anxiety symptoms are not substance-induced. Code "1" if any are true. Code "3" only if none are true.

The symptoms precede the onset of the substance/medication use;

The symptoms persist for a substantial period of time (e.g., about 1 month) after the cessation of acute withdrawal or severe intoxication;

IF UNKNOWN: **Have you had any other episodes of (OC AND RELATED SXS)?**

IF YES: **How many? Were you using (SUBSTANCE/ MEDICATION) at those times?**

There is other evidence suggesting the existence of an independent non-substance/medication-induced obsessive-compulsive and related disorder (e.g., a history of recurrent non-substance/ medication-related episodes).

RETURN TO EPISODE BEING EVALUATED

?=inadequate information

1=absent or false

2=subthreshold

3=threshold or true

SCID-RV (for DSM-5®) (Version 1.0.0) Substance-Induced OCD OC and Related Disorders G.109

IF UNKNOWN: What effect have (OC-RELATED SXS) had on your life?

E. The symptoms cause clinically significant distress or impairment in social, occupational, or other important areas of functioning.

? 1 2 3 G39

ASK THE FOLLOWING QUESTIONS AS NEEDED TO RATE CRITERION E:

How have (OC-RELATED SXS) affected your relationships or your interactions with other people? (Have they caused you any problems in your relationships with your family, romantic partner or friends?)

How have (OC-RELATED SXS) affected your work/school? (How about your attendance at work or school? Have [OC-RELATED SXS] made it more difficult to do your work/schoolwork)? How have [OC-RELATED SXS] affected the quality of your work/schoolwork?)

How have (OC-RELATED SXS) affected your ability to take care of things at home? What about being involved in things that are important to you like religious activities, physical exercise, or hobbies? Have you avoided situations or people because you didn't want other people to see you doing (OC-RELATED BEHAVIOR)?

Have (OC-RELATED SXS) affected any other important part of your life?

IF HAVE NOT INTERFERED WITH LIFE: How much have your (OC-RELATED SXS) bothered or upset you?

RETURN TO EPISODE BEING EVALUATED

?=inadequate information

1=absent or false

2=subthreshold

3=threshold or true

SUBSTANCE/MEDICATION-INDUCED
 OBSESSIVE-COMPULSIVE AND RELATED
 DISORDER CRITERIA A, B, C, AND E ARE
 CODED "3."

1

3

G40

SUBSTANCE-/MEDICATION-
 INDUCED OC AND RELATED
 DISORDER

G41

Check here ___ if current in past
 month.

G42

Specify if:

- 1 - **With onset during intoxication:**
 If the criteria are met for
 intoxication with the substance and
 the symptoms develop during
 intoxication.
- 2 - **With onset during withdrawal:**
 If criteria are met for withdrawal
 from the substance and the
 symptoms develop during, or shortly
 after, withdrawal.
- 3 - **With onset after medication use:**
 Symptoms may appear either at
 initiation of medication or after a
 modification or change in use.

RETURN TO EPISODE BEING EVALUATED

INTERMITTENT EXPLOSIVE DISORDER

INTERMITTENT EXPLOSIVE DISORDER CRITERIA

- IF SCREENING QUESTIONS #15a AND #15b ARE BOTH ANSWERED "NO," GO TO **next section**.
- IF SCREENING QUESTION #15a IS ANSWERED "YES": **You've said that in the past year have frequently lost control of your temper and ended up yelling or getting into arguments with others. Tell me about that.**
- IF SCREENING QUESTION #15b IS ANSWERED "YES": **You've (also) said that in the past year, you have lost your temper so that you shoved, hit, kicked or threw something at a person or an animal or damaged someone's property. Tell me about that.**
- IF SCREENER NOT USED: **In the past year, since (1 YEAR AGO), have you frequently lost control of your temper and ended up yelling or getting into arguments with others? (Tell me about that.)**

IF NO: In the past year, have you lost your temper so that you shoved, hit, kicked or threw something at a person or an animal or damaged someone's property? (Tell me about that.)

IF THERE IS NO EVIDENCE THAT THE SUBJECT HAS HAD VERBAL OR PHYSICAL AGGRESSION, CHECK HERE ___ AND GO TO next section.

IF UNKNOWN: In the past year, have your angry outbursts resulted in someone getting physically hurt? (Tell me about that.)

IF UNKNOWN: In the past year, have you physically injured an animal in anger?

IF UNKNOWN: In the past year, have your outbursts resulted in damaging things, breaking things, smashing windows, punching a hole in a wall, or other damage to property?

IF YES TO ANY OF THESE: During the past year have you had at least 3 such outbursts?

A. Recurrent behavioral outbursts representing a failure to control aggressive impulses as manifested by either of the following:

2. Three behavioral outbursts involving damage or destruction of property and/or physical assault involving physical injury against animals or other individuals occurring within a 12-month period.

NOTE: Physical injury includes, at a minimum, a scratch or bruise, whether or not medical attention is sought.

DESCRIBE:

SCREEN Q#15a
YES || NO

OK1

SCREEN Q#15b
YES || NO

OK2

IF BOTH HAVE BEEN ANSWERED "NO," GO TO **THE NEXT MODULE.**

OK3

? 1 2 3

OK4

IF UNKNOWN: In the past year, have you had angry outbursts in which you shoved, kicked, hit, or threw something without anything or anyone being damaged or injured?

1. Verbal aggression (e.g., temper tantrums, tirades, verbal arguments or fights) or physical aggression toward property, animals, or other individuals, occurring twice weekly, on average, for a period of 3 months. The physical aggression *does not result* in damage or destruction of property and *does not result* in physical injury to animals or other individuals.

? 1 2 3 OK5

IF UNKNOWN: In the past year have you also had angry outbursts that involved heated arguments, yelling at people, having temper tantrums, or going on "rants," but without physically hurting anyone or damaging anything?

Check if:

- Verbal aggression (e.g., tantrums, tirades, verbal arguments or fights) twice weekly for 3 months
- Physical aggression without damage or destruction of property (e.g., throwing clothes or books around that do not get damaged) twice weekly for 3 months

OK6

OK7

IF YES TO EITHER: If you were to include all the kinds of angry outbursts that we just talked about in the past year (both verbal and physical), did they altogether ever happen as often as twice a week, on average, for at least 3 months?

EITHER CRITERION A.2 OR A.1 IS CODED "3"

1 3 OK8

GO TO THE NEXT MODULE

What kinds of things have set you off? (Do you think your reactions have been much stronger than they should have been given the circumstances? Has anyone told you that your reactions were way off-base given the situation in question?)

- B. The magnitude of aggressiveness expressed during the recurrent outbursts is grossly out of proportion to the provocation or to any precipitating psychosocial stressors.

? 1 2 3 OK9

GO TO THE NEXT MODULE

IF UNCLEAR: Have all of these outbursts been "on purpose," that is, in order to intimidate someone or force someone to give you what you want?

- C. The recurrent aggressive outbursts are not premeditated (i.e., they are impulsive and/or anger-based) and are not committed to achieve some tangible objective (e.g., money, power, intimidation).

? 1 2 3 OK10

GO TO THE NEXT MODULE

NOTE: Code "1" if all outbursts are premeditated or intended to achieve a tangible objective.

IF UNKNOWN: What effect have your outbursts had on your life in the past year?

ASK THE FOLLOWING QUESTIONS AS NEEDED TO RATE CRITERION D:

Have you gotten into trouble because of them? (For example, has anyone called the police or a supervisor because of these outbursts? Have you ever been arrested as a result of your outbursts? Have you ever had to pay a lot of money to compensate someone for the damage you caused?)

How have your outbursts affected your relationships or your interactions with other people? (Have they caused you any problems in your relationships with your family, romantic partner or friends?)

How have they affected your work/school? (How about getting fired from a job or expelled from school or getting "written up" for disciplinary action because of your outbursts?)

Have your outbursts affected any other important part of your life?

IF DOES NOT INTERFERE WITH LIFE: How much have you been bothered or upset by your outbursts?

IF HX OF MANIA, DEPRESSION, OR PSYCHOSIS: Did these outbursts happen only when you were feeling excited, irritable, or depressed, or only when you were having (PSYCHOTIC SXS)?

IF HX OF PTSD: Did you have any outbursts like this prior to exposure to (TRAUMATIC EVENT)?

IF HX OF ADHD: Have you gotten any treatment specifically for the aggressive outbursts?

D. The recurrent aggressive outbursts cause either marked distress in the individual or impairment in occupational or interpersonal functioning, or are associated with financial or legal consequences.

? 1 2 3

GO TO THE NEXT MODULE

OK11

NOTE: Criterion E regarding minimum chronological age has been omitted.

F. The recurrent aggressive outbursts are not better explained by another mental disorder (e.g., Major Depressive Disorder, Bipolar Disorder, [Posttraumatic Stress Disorder], Disruptive Mood Dysregulation Disorder, a Psychotic Disorder, Antisocial Personality Disorder, Borderline Personality Disorder)...

? 1 2 3

GO TO THE NEXT MODULE

OK12

Note: This diagnosis can be made in addition to the diagnosis of Attention-Deficit/ Hyperactivity Disorder when recurrent impulsive aggressive outbursts are in excess of those usually seen in this disorder and warrant independent clinical attention.

Do you have these outbursts only when you've been drinking, using drugs, or taking medications?

...and are not attributable to another medical condition (e.g., head trauma, Alzheimer's disease) or to the physiological effects of a substance (e.g., alcohol, phencyclidine, cocaine and other stimulants, barbiturates, inhalants, or a medication).

IF UNKNOWN: **Have you ever had a head injury, seizure, stroke, or some other kind of neurological illness?**

IF YES: **Have these outbursts occurred only during** (ILLNESS MENTIONED ABOVE)?

CRITERIA A, B, C, D, AND F ARE CODED "3"

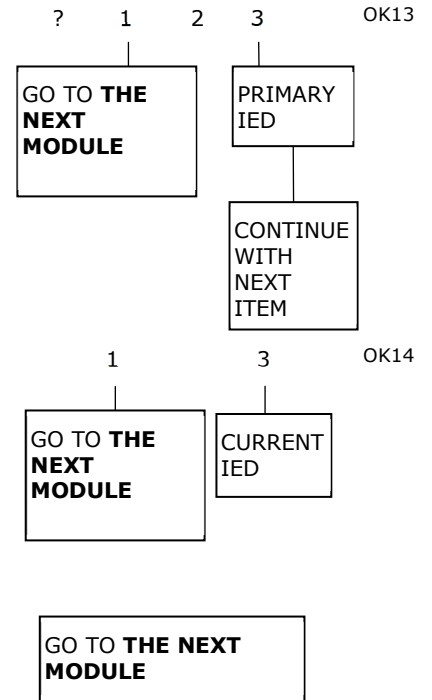

THIS ITEM HAS ALREADY BEEN ASKED AS PART OF THE OVERVIEW AND HAS BEEN PREPOPULATED BASED ON INFORMATION PREVIOUSLY OBTAINED:

IF UNKNOWN: How were you affected by the coronavirus pandemic? (Did you or someone close to you need to be hospitalized for treatment? Did you lose someone whom you were close to? How about the financial implications for people close to you related to the crisis?)

QUESTIONS TO DETERMINE POSSIBLE ASSOCIATION OF **EACH PAST 12 MONTH DIAGNOSIS** WITH CORONAVIRUS AND ASSOCIATED STRESSORS:

(FILL OUT THIS PAGE SEPARATELY FOR EACH PAST 12 MONTH DIAGNOSIS)

FOR EACH DISORDER DIAGNOSED IN PAST 12 MONTHS:

IF UNKNOWN: When did [SXS OF DIAGNOSED DISORDER] start?

▶ IF ONSET SINCE START OF CORONAVIRUS PANDEMIC IN JANUARY 2020:

IF UNKNOWN: What was going on in your life when (SXS) started?

Do you think (SXS) were due to the effects of the coronavirus pandemic on your life?

▶ IF ONSET PRIOR TO START OF CORONAVIRUS PANDEMIC IN JANUARY 2020: **Did (SXS) become worse since the start of the pandemic?**

IF YES: When did they get worse? How much worse? Do you think they got worse because of the effects of the coronavirus pandemic on your life?

BASED ON ALL AVAILABLE INFORMATION, INDICATE FOR EACH 12-MONTH DIAGNOSIS THE LIKELIHOOD THAT DISORDER OCCURRING IN PAST 12 MONTHS WAS DUE TO THE EFFECTS OF CORONAVIRUS PANDEMIC: (INCLUDING ECONOMIC EFFECTS)

1 2 3 4 5 6 7 8 9 10

Not at all likely

Somewhat likely

Very likely

?=inadequate information

1=absent or false

2=subthreshold

3=threshold or true

?=inadequate information

1=absent or false

2=subthreshold

3=threshold or true